

AD-A032 403

NORTHROP CORP HAWTHORNE CALIF AIRCRAFT DIV
NORTHROP/UNITED STATES AIR FORCE F-5E AIRCRAFT FATIGUE STRUCTUR--ETC(U)
MAY 75 S R MURNANE

F/G 1/3

UNCLASSIFIED

NL

1 OF 1
AD-A
032 403



END
DATE
FILMED
1-26-77
NTIS

U.S. DEPARTMENT OF COMMERCE
National Technical Information Service

AD-A032 403

NORTHROP/UNITED STATES AIR FORCE F-5E AIRCRAFT
FATIGUE STRUCTURAL INTEGRITY PROGRAM

NORTHROP CORPORATION,
HAWTHORNE, CALIFORNIA

MAY 1975

334102.

AD A032403

*ICAF Doc. 774

*INTERNATIONAL COMMITTEE ON AERONAUTICAL FATIGUE



**NORTHROP/UNITED STATES AIR FORCE
F-5E AIRCRAFT
FATIGUE STRUCTURAL INTEGRITY PROGRAM**

MAY 1975



REPRODUCED BY
**NATIONAL TECHNICAL
INFORMATION SERVICE**
U. S. DEPARTMENT OF COMMERCE
SPRINGFIELD, VA. 22161

NORTHROP
Northrop Corporation
Aircraft Division
3901 West Broadway
Hawthorne, California 90250

DISTRIBUTION STATEMENT A
Approved for public release;
Distribution Unlimited

NORTHROP/UNITED STATES AIR FORCE
F-5E AIRCRAFT FATIGUE STRUCTURAL INTEGRITY PROGRAM

MAY 1975

PREPARED BY:

Stanley R. Murnane

STANLEY R. MURNANE, MANAGER
STRUCTURAL ANALYSIS DEPARTMENT
NORTHROP CORPORATION, AIRCRAFT DIVISION
3901 WEST BROADWAY, HAWTHORNE, CALIFORNIA 90250

This paper has been accepted for presentation
at the American Institute of Aeronautics and
Astronautics Aircraft Systems and Technology
Conference August 4-7, 1975, at the International
Hotel, Los Angeles, California.

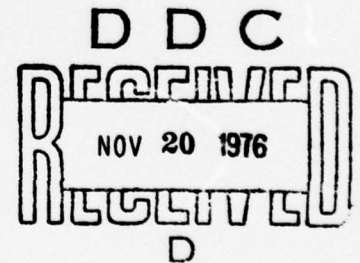

DISTRIBUTION STATEMENT A

Approved for public release;
Distribution Unlimited

ACKNOWLEDGMENT

The author wishes to acknowledge the assistance given by
Mr. O. B. Davenport, who serves as Fatigue Project Engineer,
Airframe Division, International Fighter System Program
Office, Aeronautical Systems Division, United States Air
Force, Wright-Patterson Air Force Base, Dayton, Ohio.

NORTHROP/UNITED STATES AIR FORCE
F-5E AIRCRAFT FATIGUE STRUCTURAL INTEGRITY PROGRAM

ABSTRACT

The Northrop Corporation, Aircraft Division's F-5E air superiority fighter has successfully completed a comprehensive Aircraft Structural Integrity Program (ASIP), including a flight flutter and flight loads survey program, and a static test and fatigue test program. The primary objective of the ASIP Master Plan was to insure that the aircraft's structural design would operate satisfactorily when subjected to the conditions associated with air-to-air combat and air-to-ground weapon delivery in peactime and in hostile environments. The F-5E fatigue program was formulated during a transition phase of fundamental change in USAF Aircraft Structural Integrity Program Philosophy. Therefore, this program was primarily structured to meet existing requirements while utilizing state-of-the-art techniques in fatigue analysis and fracture mechanics. The fatigue program consisted of three phases: Load spectra and loading sequence development; a complete airframe flight-by-flight fatigue test; and a counting accelerometer/service loads recording program for aircraft operated by the United States Air Force. The service life design objective of 4,000 flight hours was demonstrated by the successful completion of the fatigue test in February 1975, when four lifetimes (16,000 hours) were achieved. This paper is primarily concerned with a description of the fatigue program with only brief discussions devoted to the other aspects of the overall Aircraft Structural Integrity Program.

INTRODUCTION

The Northrop F-5E Air Superiority Fighter Aircraft Structural Integrity Program (ASIP) was established in order to verify the structural integrity of the aircraft in the air combat arena. Significant features of the program were the Flight Flutter, Flight Loads Survey, Static Test, and the Full Scale Fatigue Test Programs, which are reviewed in this paper.

The primary objectives of the fatigue test program were to locate critical areas and to permit early improvement at relatively low cost, as well as to develop scheduled inspection and modification procedures that would minimize unscheduled structural maintenance. The fatigue loads spectra was developed for a completely balanced aircraft simulating a phase-by-phase, flight-by-flight loading history with 85% of the missions in air-to-air combat and the remaining 15% in air-to-ground combat. Anticipated mission profiles were combined with N_2 occurrence data from MIL-A-008866A to derive the load spectra.

The complete airframe fatigue test program began in March 1973 with the objectives of locating the fatigue critical areas, making early production fatigue improvements, and demonstrating a satisfactory service life. Loads were applied on a phase-by-phase, flight-by-flight basis with 3244 unique flights occurring in one lifetime (4,000 hours). The original test target of four lifetimes was completed in February 1975. Additional testing is currently underway to simulate operations in more severe environments, such as Dissimilar Air Combat Training. At the conclusion of the test program the major airframe elements will be disassembled for a thorough inspection to locate fatigue cracks not found by normal inspection procedures.

Test results have located critical areas in the vertical stabilizer and its support structure; leading edge flaps and flap hinges; trailing edge flap hinges; the upper cockpit longeron; the speed brake package structure; and the 15%, 44% and 66% wing spars. These results have confirmed the slow crack growth characteristics anticipated with the extensive use of overaged 7000 series aluminum alloys and reduced nominal stress levels. Production changes and service inspections have also been incorporated for these critical areas to protect flight safety and reduce maintenance costs.

Actual recorded usage data from the instrumented aircraft will be used to modify the loads spectra and analysis to refine estimated service lives.

DESIGN PHILOSOPHY

The objective of the development of a new Military Assistance Program aircraft was to reverse the trend of increasing cost and complexity of maintenance. The utilization of small high thrust engines resulted in significant reductions in aircraft size and weight. Smaller size and weight are fundamental to reduction in procurement and operating costs, and are major contributors to easier maintenance and improved operational readiness. Studies of these newer engines for applications in manned aircraft led to the development of the T-38 supersonic jet trainer. The application of advanced technology provided a maximum force effectiveness at minimum cost and became the Northrop philosophy in the development of the T-38 lightweight trainer and the F-5 fighter aircraft.

The new development technology included second generation supersonic aerodynamics, the newest high thrust-to-weight ratio engines available, and the most advanced structural and fatigue technology were integrated into the design of an aircraft with low maintenance and operating costs.

The reduction of transonic wave drag and transonic wing airfoil development provided effective cruise performance, and horizontal and vertical tail configurations added superior flying qualities. The development of the J-85 engine with its major increase in thrust-to-weight ratio was paramount in the design.

The advanced structures technology resulted in a minimum weight airframe structure. Using the "one component layer" concept with easily removable components, as well as ground level accessibility without use of ladders or stands resulted in a reduction of the size of the aircraft.

DESIGN CRITERIA

The F-5E structural design criteria are based on the requirements of MIL-A-8860, MIL-A-8871 and AFSCM 80-1. The F-5E is an air superiority fighter with 7.33 g flight capability in the air-to-air configuration throughout the combat area of the flight envelope. The load factor capability for 50 percent fuel is presented in Figure 1. In the air-to-ground role, the aircraft has a 6.5 g capability with underwing stores. The symmetrical load factors used for structural design are shown in Table I. The limit speed for airframe design is a speed equivalent to a dynamic pressure of 1700 psf or Mach 2.0, whichever is less.

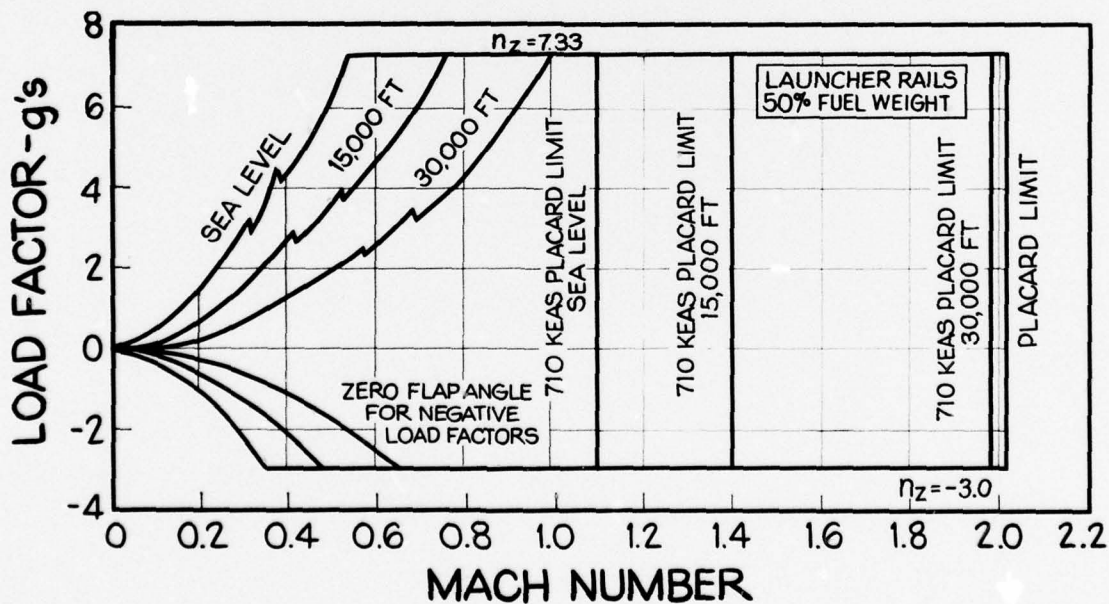

FIGURE 1 -- F-5E STRUCTURAL LOAD FACTOR DIAGRAM

The flutter characteristics of the F-5E in the air-to-air role are unrestricted throughout the flight envelope. Flutter clearances for heavy weight wing stores is 520 KEAS or Mach 0.85 and V_{max} for light weight wing stores.





CONFIGURATIONS (ALL WITH FULL AMMO)		WEIGHT LB	DESIGN LOAD FACTOR	
			+n _z	-n _z
 BASIC MISSION	100% INT FUEL	15,745	7.33(1)	-3.00
	50% INT FUEL	13,565	7.33	-3.00
 ALTERNATE I	100% INT FUEL	17,860	5.00	-2.00
	75% INT FUEL	16,770	5.00	-2.00
	LESS C STORE	14,800	SEE BASIC MISSION	
 ALTERNATE II	100% INT/EXT FUEL	21,682	4.00(4)	-2.00
	LESS C TANK	19,696	6.50(2)	-2.00
	75% INT FUEL	18,606	6.50(2)	-2.00
	LESS INBD STORES	16,946	6.50(2)	-2.00
	LESS OUTBD STORES	15,286	SEE BASIC MISSION	
 ALTERNATE III	100% INT FUEL	21,818	5.00	-2.00
	75% INT FUEL	20,728	5.00	-2.00
	LESS C STORE	18,758	6.50(2)	-2.00
	LESS INBD STORES	16,072	6.50(3)	-2.00
	LESS OUTBD STORES	15,286	SEE BASIC MISSION	
EXTERNAL STORE LEGEND:	(1) LINEAR REDUCTION ABOVE 0.95M TO 6.5g AT 2.0M (2) LINEAR REDUCTION ABOVE 0.85M TO 5.0g AT 1.0M(V _L) (3) LINEAR REDUCTION ABOVE 0.85M TO 5.0g AT 1.4M(V _L) (4) 275 GAL FUEL TANK LIMITATION			
X AIM-9 MISSILE ● 275-GAL FUEL TANK ■ MK-84 BOMB ⊗ M117 BOMB □ BLU-27(FINNED) BOMB				

TABLE I -- F-5E STRUCTURAL DESIGN CRITERIA

STRUCTURAL ARRANGEMENT

The fuselage is an all-metal stressed skin semimonocoque structure consisting primarily of longerons, skins, decks, bulkheads and formers. The metals used are conventional aluminum, stainless steel and titanium. Chemically milled skins are used extensively. A field break separates a section of the aft fuselage structure for ease of engine installation. The fuselage structural arrangement has continuous load paths and a minimum of splices. The number of structural elements was determined by detailed analysis of a minimum weight structural arrangement, the required service life of the aircraft, and ease of manufacturing and maintenance.

The wing is a multi-spar, all aluminum structure except for steel ribs supporting the landing gear and wingtip stores. It is attached to the fuselage at four primary attach points, located at the 15 percent and 44 percent spars. Two secondary shear ties are located at the 66 percent spar. The upper and lower wing skins are both one-piece machined aluminum plate, 7075-T651 and 7075-T7351, respectively. The spars are primarily over-aged 7000 series aluminum forgings and extrusions. The ribs, except for the landing gear and wing tip ribs, are also 7000 series aluminum forgings.

The wing was designed to be assembled in one piece from tip to tip to provide structural continuity and eliminate splices in heavily loaded members. The continuous skins from tip to tip require special mill runs and forming techniques. They are also extensively machined in order to provide maximum strength to weight ratios.

The vertical stabilizer is a single spar, multi-rib all aluminum structure with homogeneous integrally stiffened machined skins. The main spar is swept back twelve degrees. The basic structural box extends from the 12 percent to 72 per-

cent chord where spars are used as closing members. The main spar extends into the fuselage and transfers its load through two primary attach points. Torsional loads are reacted through attach angles around the periphery of the fin at the fuselage deck.

The horizontal stabilizer is an all movable surface, driven by dual hydraulic actuators housed inside the fuselage. The surfaces are basically two cell bonded assemblies composed of 7075-T6 chem-milled skins supported by full depth aluminum honeycomb core and a central spar. At the panel root, the spar transfers all surface loads to the fuselage. A steel hinge fitting, which forms the main spar in the inboard region of the surface, serves also as a carry through member across the fuselage. The right and left surfaces are connected at the airplane centerline by a splice of the hinge fittings.

STATIC TEST PROGRAM

The F-5E Full Scale Structural Static Test Program was conducted during a 14-month period between April 1972 and June 1973. The fuselage, wing, horizontal stabilizer, two-position nose gear, and main gear were subjected to their critical design conditions to demonstrate the static structural integrity of the airframe structure. Each individual condition was first tested to limit load, to verify that there was no yielding or permanent set; and secondly to ultimate load, to verify structural strength capability to 1.5 times limit load.

Internal loadings from air pressurization and hydraulic actuators were added as required for each condition. Testing was conducted in three separate phases: Phase I - Wing structure jig mounted; Phase II - Fuselage structure jig mounted; Phase III - Wing and fuselage mated.

In Phase I, the full span wing was mounted on a rigid support pedestal at the wing-to-fuselage attach points. Ten major conditions and three minor conditions were tested. Three hundred twenty-seven strain gages and seventy deflection gage locations were utilized to provide desired test data.

The fuselage, in Phase II, was mounted on a similar rigid support pedestal and also attached at the main wing-to-fuselage trunnions. The fuselage was structurally complete, and included the canopy and windshield, vertical tail, and boattail/horizontal stabilizer. Twelve major conditions and ten minor conditions were tested. Four hundred seventy-six strain gages and ninety-three deflection gage locations provided test data.

Phase III consisted of conditions that were critical for the wing-to-fuselage interaction structure. The mated wing and fuselage were tested as a floating specimen. The trailing edge flap was included to complete the structural configuration. Four major conditions and two minor conditions were tested.

One structural failure occurred during the entire static test program, which consisted of a total of forty-one test conditions. This failure occurred in the level landing spin-up condition and resulted in permanent buckles in the trailing edge spar structure at limit load. This required a production redesign and rework of the static test article prior to a subsequent successful retest to ultimate load.

F-5E FLIGHT LOADS SURVEY PROGRAM

Flight loads testing on all Northrop aircraft has been extremely thorough and in keeping with the latest USAF specifications. Each successive test program benefits to a great extent from the previous program. Thus, follow-on programs focus attention on the new systems, components, and higher weights. The T-38 and F-5 series flight loads program was based on MIL-A-5711 requirements, and the F-5E program is based on MIL-A-8871 requirements. Table II summarized the extent of the T-38/F-5 Flight Loads Programs.

	T-38	F-5 Series	F-5E
Types of Programs	Flight Loads Landing Loads	Landing & Flight Loads Barrier Engagements Drag Chute Store Ejection Air-to-Air Combat Assisted Take-Off	Landing & Flight Loads Barrier Engagements Store Ejection Air-to-Air Combat
Number of Aircraft and Test Programs	2	4	1
Maneuver Survey Data Points	806	625	341

TABLE II -- T-38/F-5 FLIGHT LOADS PROGRAM

Strain gage loads instrumentation at locations shown in Figure 2 was utilized on all flight loads programs. By this means, total net loads, shears, bending moments and torsional data have been obtained at all key structural locations for all critical flight and landing conditions.

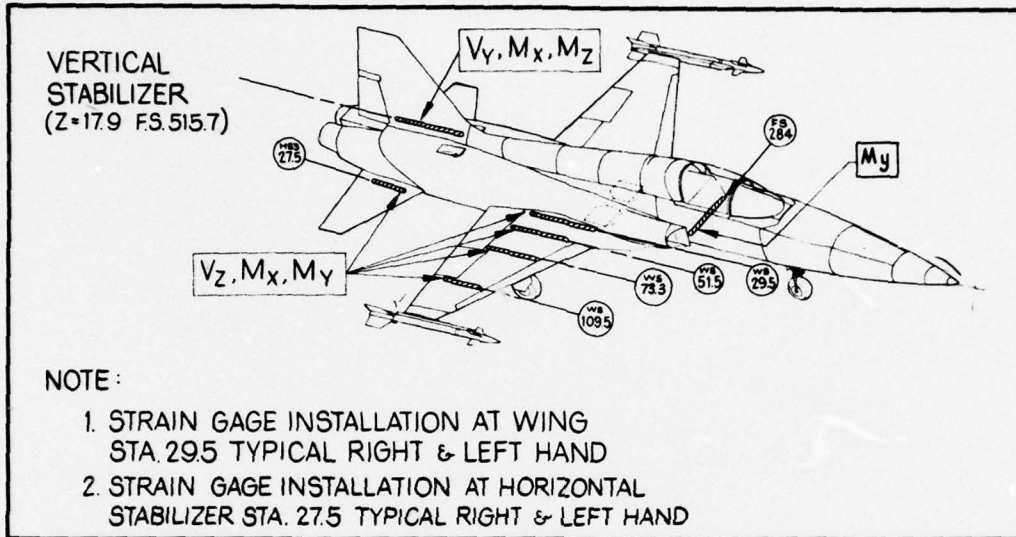

FIGURE 2 -- T-38/F-5 LOCATION OF LOADS INSTRUMENTATION

DESIGN FATIGUE ANALYSIS

Detailed working stresses were established analytically using finite element analysis programs in addition to standard computerized techniques. Measured strain data from the full scale static test and fatigue test articles were used to substantiate the analytical stresses. The distortion energy theory was employed to calculate equivalent stresses where bi-axial or shear stresses were significant. The cumulative damage method devised by Miner was used in conjunction with quality indices derived mathematically or from component tests. This approach considers the load transfer in addition to the geometric K_t , and when the quality index is test derived, accounts for other variables such as fastener fit, hole condition, and fretting at stress levels below the endurance limit.

In addition to the use of classical fatigue mechanics, significant analyses were conducted using residual stress techniques.

F-5E FATIGUE TEST PROGRAM

The F-5E fatigue program was formulated during a transition period of fundamental change in USAF Aircraft Structural Integrity Program philosophy. Therefore, this program was primarily structured to meet these new requirements while utilizing the latest technology in the areas of fatigue analysis and fracture mechanics. The program consisted of three phases: Spectra and load sequence development; complete airframe fatigue test; and a service loads monitoring program for those aircraft owned and operated by the United States Air Force.

Northrop started the structural fatigue test program on a complete F-5E airplane in March 1973. The primary objective was to locate fatigue critical areas, to implement early production improvements, and to demonstrate a satisfactory service life. The test aircraft was subjected to a spectra of cyclic loads simulating predicted usage during a 4,000 hour lifetime. Loads were applied on a flight-by-flight basis with 3,244 unique flights occurring in one lifetime. The simulation of a realistic flight-by-flight loading sequence has resulted in one of the most representative fatigue tests ever conducted by a contractor on a fighter aircraft for the United States Air Force. The original target test life was four lifetimes, i.e., a total of 16,000 flight hours to account for the scatter in structural fatigue. The fourth lifetime of the 16,000 hour test was completed in February 1975. The program has been highly

successful, and production structural improvements and in-service inspections have been implemented to insure the structural integrity of the F-5E aircraft. Inspection threshold periods and techniques were established utilizing the latest methods of fracture mechanics analysis.

Two additional lifetimes of fatigue testing are currently underway. The fifth lifetime represents 4,000 hours of aircraft usage for pilot training in air-to-air and air-to-ground combat. The sixth lifetime simulates 4,000 hours of Dissimilar Air Combat Training usage. Both of these training spectra are more severe than the design spectra.

A comprehensive Analytical Condition Inspection (ACI) will be conducted at the completion of the 24,000 hours of fatigue testing. This will consist of a thorough disassembly of the airframe structure to inspect for initial flaws and fatigue crack propagation.

Fatigue Aircraft Structural Integrity Program Flow Chart

Fatigue loads spectra are based on service life requirements and planned aircraft usage. They are the basic data necessary to conduct fatigue analysis and testing to arrive at the estimated service life of the structure. The USAF Aircraft Structural Integrity Program Plan requires that all aircraft have on-board counting accelerometers, and that 25 percent of the aircraft be equipped with more sophisticated instrumentation capable of recording such parameters as velocity, altitude, load factor, and roll, pitch and yaw rates. This recording system has been implemented for all F-5E aircraft currently in the United States Air Force inventory. This actual usage data is then used to modify the

loads spectra and fatigue analysis in order to arrive at a more accurate estimated service life. Figure 3 shows the Fatigue ASIP Flow Chart:

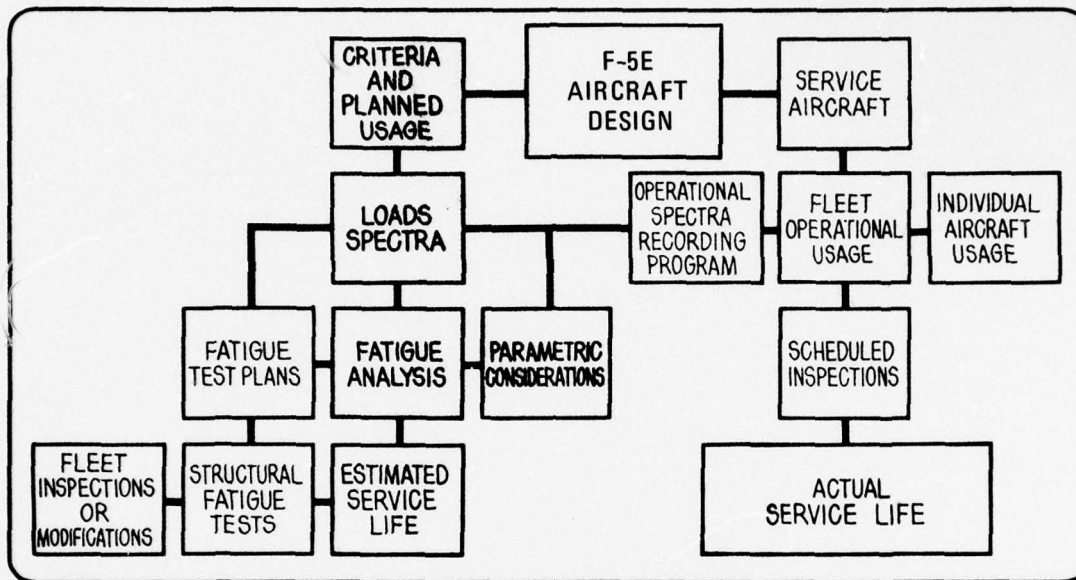

FIGURE 3 -- FATIGUE AIRCRAFT STRUCTURAL INTEGRITY PROGRAM FLOW CHART

Fatigue Test Program Objectives

The four main fatigue test program objectives are to: Locate fatigue critical areas; permit early improvement of the fleet aircraft at relatively low cost; develop scheduled inspection procedures to minimize unscheduled structural maintenance; and provide test data to establish the predicted structural service life.

Airframe Test Article Description

The fatigue test article is the fifth production aircraft and is completely representative of the production aircraft from a structural standpoint. The cockpit is pressurized during each flight, and the maneuvering leading and

trailing edge flaps are operational. Strain gage locations were based on the results of analytical fatigue analyses and strain gage surveys conducted on the full scale static test airplane. There are 360 strain gages and 300 crack-wire circuits installed in closed-out areas for early crack detection on the fatigue test article.

Fatigue Loads Spectra Development

The F-5E airplane was designed for 85 percent air-to-air and 15 percent air-to-ground usage to fulfill its primary mission as a defensive air superiority fighter. In 4,000 hours there are 3,244 flights, of which over 2,700 flights are air-to-air missions with air combat maneuver engagements occurring during each flight. The mission profiles provide specific duration, altitude, speeds, weights, and configurations experienced during each phase of the mission. Structural load producing activity within a flight is segregated into basic unique phases, as shown in Figure 4.

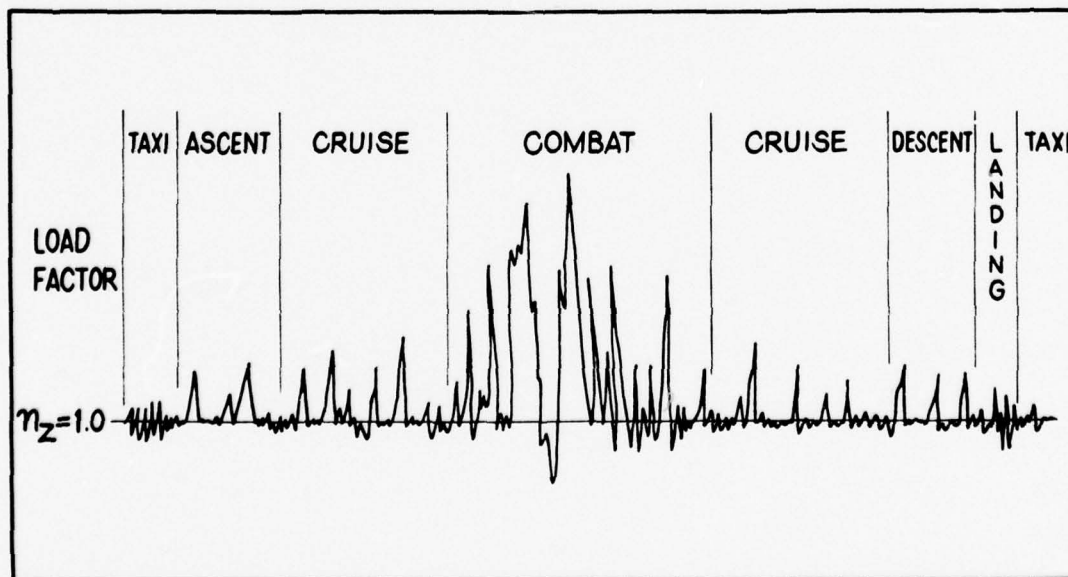

FIGURE 4 -- MANEUVER ACTIVITY WITHIN A FLIGHT

The time in each phase for all of the flights composing the service life requirement is combined with the appropriate load factor occurrence data to obtain the total load factor occurrences in each of the mission phases for the life of the airplane, as shown in Figure 5.

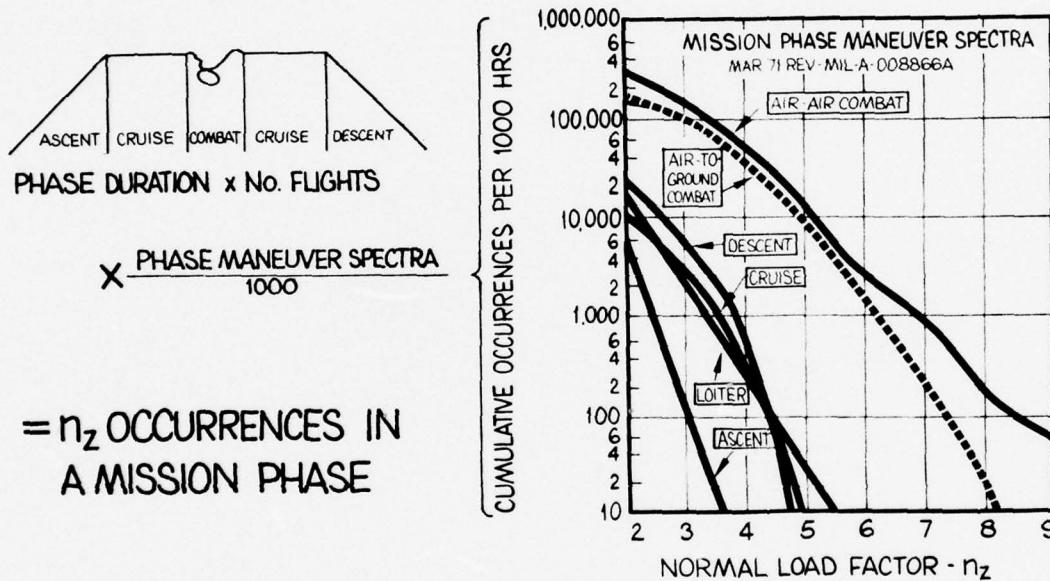

FIGURE 5 -- MISSION PHASE MANEUVER SPECTRA

The resulting composite maneuver spectra is the summation of the load factor occurrence data from the total individual mission phase load factor occurrence data. The F-5E Composite Maneuver Spectra are shown in Figure 6.

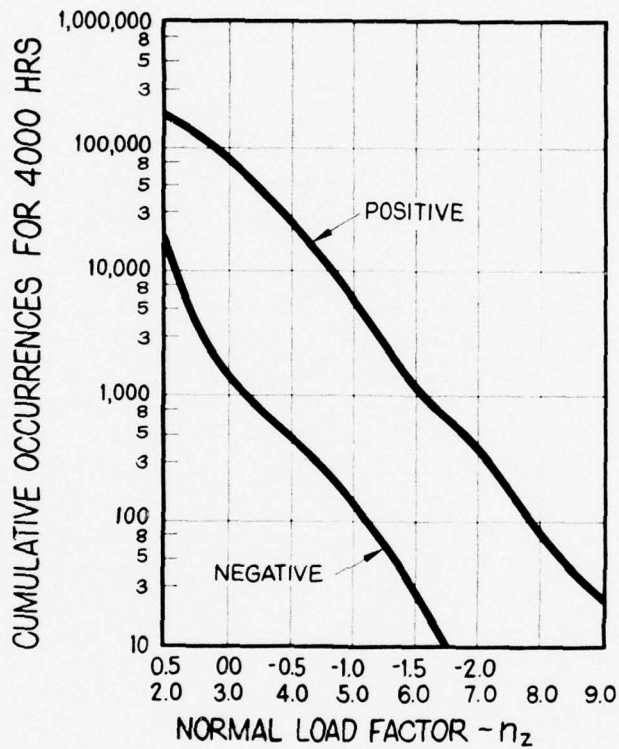

FIGURE 6 -- F-5E COMPOSITE MANEUVER SPECTRA

The load conditions applied to the full scale fatigue test article include variations in gross weight, configuration, Mach number, and altitude as defined by the mission profiles. All of these conditions are typical of those experienced in actual flight. The type of load conditions applied to the test article include ground handling and taxiing, landing, positive and negative symmetrical maneuvers, roll, yaw and pitch maneuvers, and gust and store ejection conditions. There are thirty types of load events and seventeen hundred discrete load conditions. The total test load events applied to the fatigue test article during 16,000 hours is in excess of 1,000,000.

Airframe Load Application

Balanced aircraft loads are applied through the 44 load control channels as shown in Figure 7. The wing, fuselage, and empennage are all under load, as well as the landing gears and speed brakes. External store loads are introduced at the six wing store locations and at the fuselage centerline pylon.

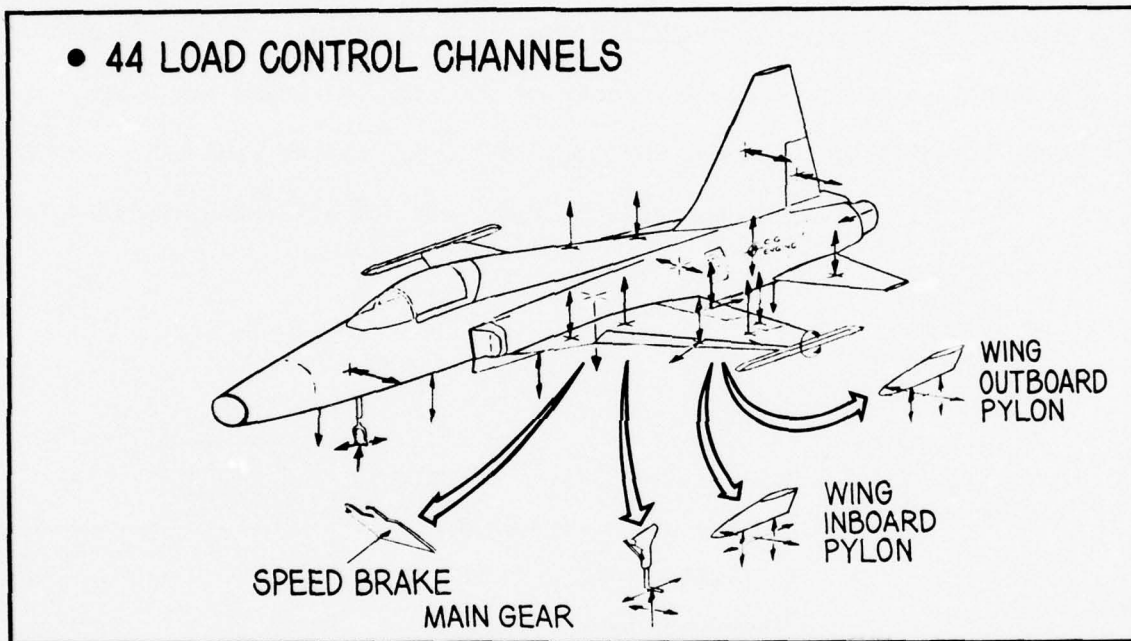

FIGURE 7 -- AIRFRAME LOAD APPLICATION SYSTEM

Airframe Load Control System

A "Loads Matrix Tape" contains the complete airplane balanced loads for seven-hundred conditions. The tape also includes the load conditions identification numbers, flaps and speed brake positions, and the balanced aircraft loads for 44 load control channels, which in this case are connected to hydraulic cylinders.

A "Loads Event Sequence Tape" contains the flight number and the sequence of loading conditions within each mission phase. All loads events were randomly distributed within each mission phase and then entered on the loads event sequence tape.

The Test Control Computer, as shown in Figure 8, reads the information from the Loads Event Sequence Tape and the Loads Matrix Tape. This allows instantaneous selection of any load condition. As each condition is selected, as determined by the Load Event Sequence Tape, the 44 channel loads for that condition are supplied by the Load Matrix Tape. The computer controls the flap and speed brake positions and calls for the proper cockpit pressure.

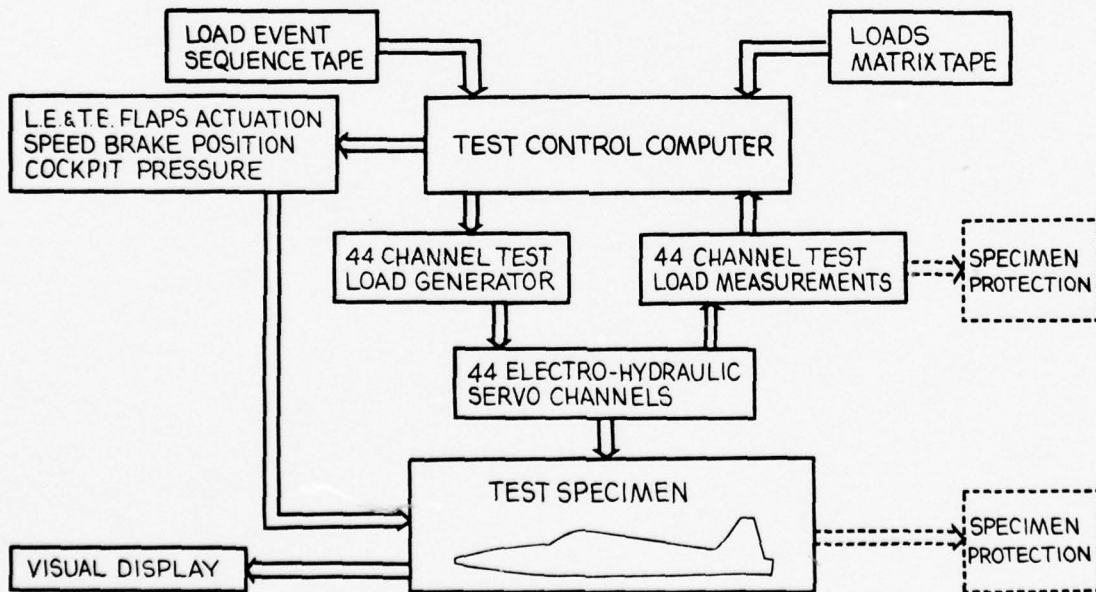

FIGURE 8 -- LOAD CONTROL SYSTEM

Airframe Specimen Protection

All loads are monitored by the Test Control Computer, as shown in Figure 9. If any of the loads are in error by more than ± 15 percent, the Test Control Computer automatically shuts down the test. The 300 crackwire detection circuits are monitored visually by the test operator. Limit switches are set to trip if the maximum expected wing or fuselage deflections in the up or down direction are exceeded. If this happens, then the hydraulic pressure is automatically dumped. If any of the loads are in error by more than ± 5 percent an exception report is printed out.

The fuselage is supported by instrumented gimball fittings at the forward jack point and at the aft hoist points. Since balanced loads are applied to the airplane, these reaction points should experience zero load. The actual loads experienced by each reaction point are monitored and displayed on optical meter relays, and if predetermined limits on the reaction points are exceeded, then hydraulic pressure is automatically dumped. All cylinders are sized so that they cannot exceed the maximum programmed loads by more than 15 percent.

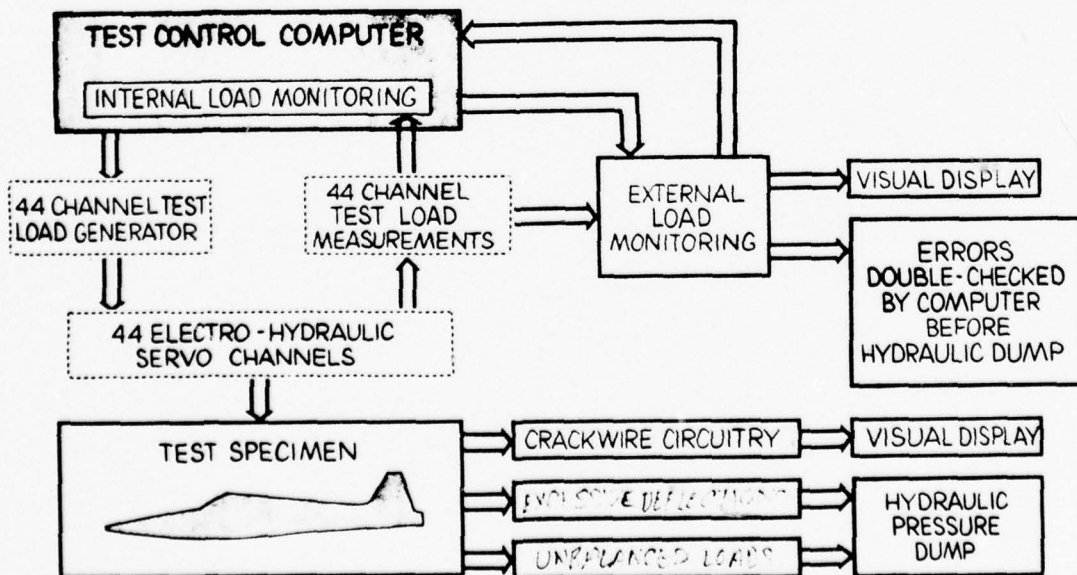

FIGURE 9 -- F-5E AIRFRAME SPECIMEN PROTECTION

Fatigue Test Results

The F-5E fatigue test failures following the application of sixteen thousand hours of simulated service usage are indicated in Figure 10. In all cases, the required production changes and in-service inspections and/or modification programs have been initiated to insure structural integrity.

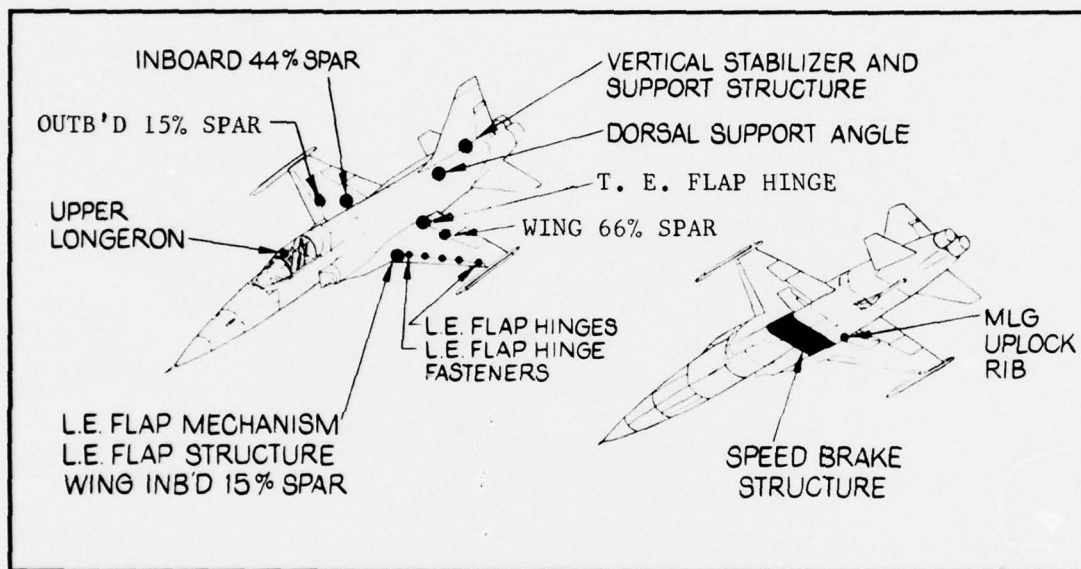

FIGURE 10 -- F-5E FATIGUE TEST INCIDENTS

Fleet Tracking Program

There are twenty F-5E aircraft at Williams Air Force Base for the purpose of pilot training. All twenty aircraft will be equipped with counting accelerometers in order to record the cumulative occurrences of vertical load factor. Six aircraft will have multi-channel recorders in order to record the time histories for twelve flight parameters which include roll, pitch and yaw rates as well as translational accelerations in each axis. This actual recorded usage data will be used to modify the loads spectra and fatigue analysis in

order to arrive at a more accurate estimated service life. Fatigue damage computer programs have been written to analyze these data.

CONCLUSIONS

The airframe structure of the Northrop F-5E Air Superiority Fighter has been subjected to a comprehensive test program. This testing has verified that the primary airframe components meet all strength requirements. The flight safety of the aircraft has been verified by the Flight Flutter Test, Flight Loads Survey, Static Test and Fatigue Test Programs. In summary, the F-5E aircraft has demonstrated its ability to meet and surpass the original design objectives of the Aircraft Structural Integrity Program.

**NORTHROP/UNITED STATES AIR FORCE
F-5E AIRCRAFT
FATIGUE STRUCTURAL INTEGRITY
PROGRAM**

75-0073B
II

MAY 75

STRUCTURAL DESIGN CRITERIA BASIC F-5E

DESIGN WEIGHTS

- MAX (STORED AIRCRAFT) = 21,818 LB
- MAX (TIP MISSILES ONLY) = 15,745 LB
- EMPTY STRUCTURE = 9588 LB
- STRUCTURE = 5210 LB

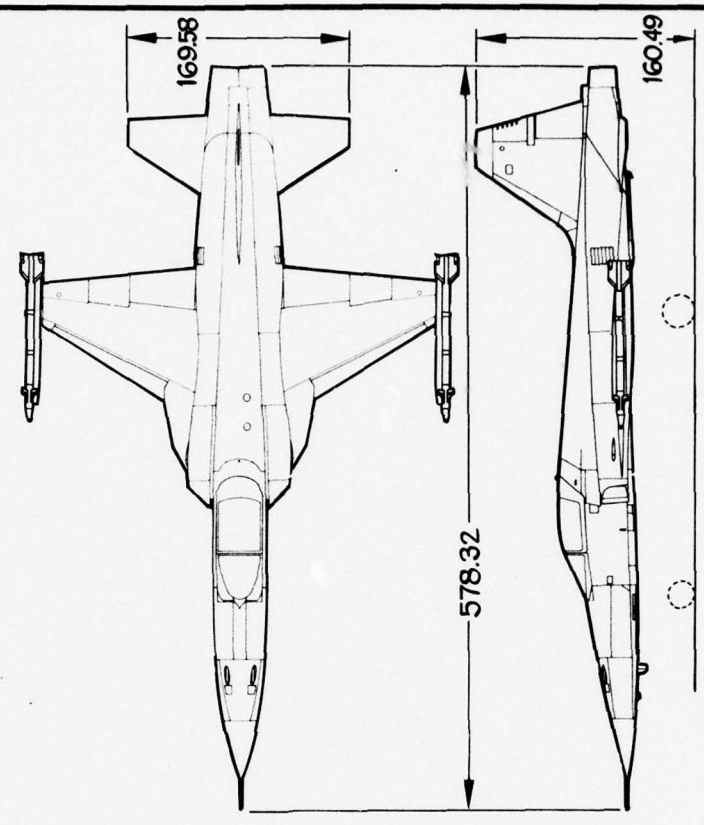
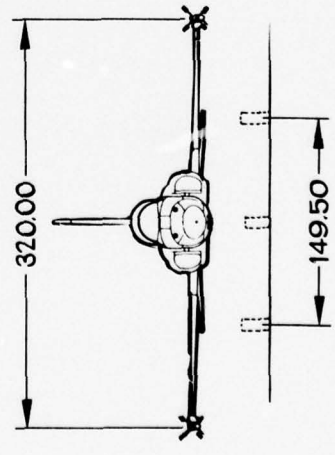

24



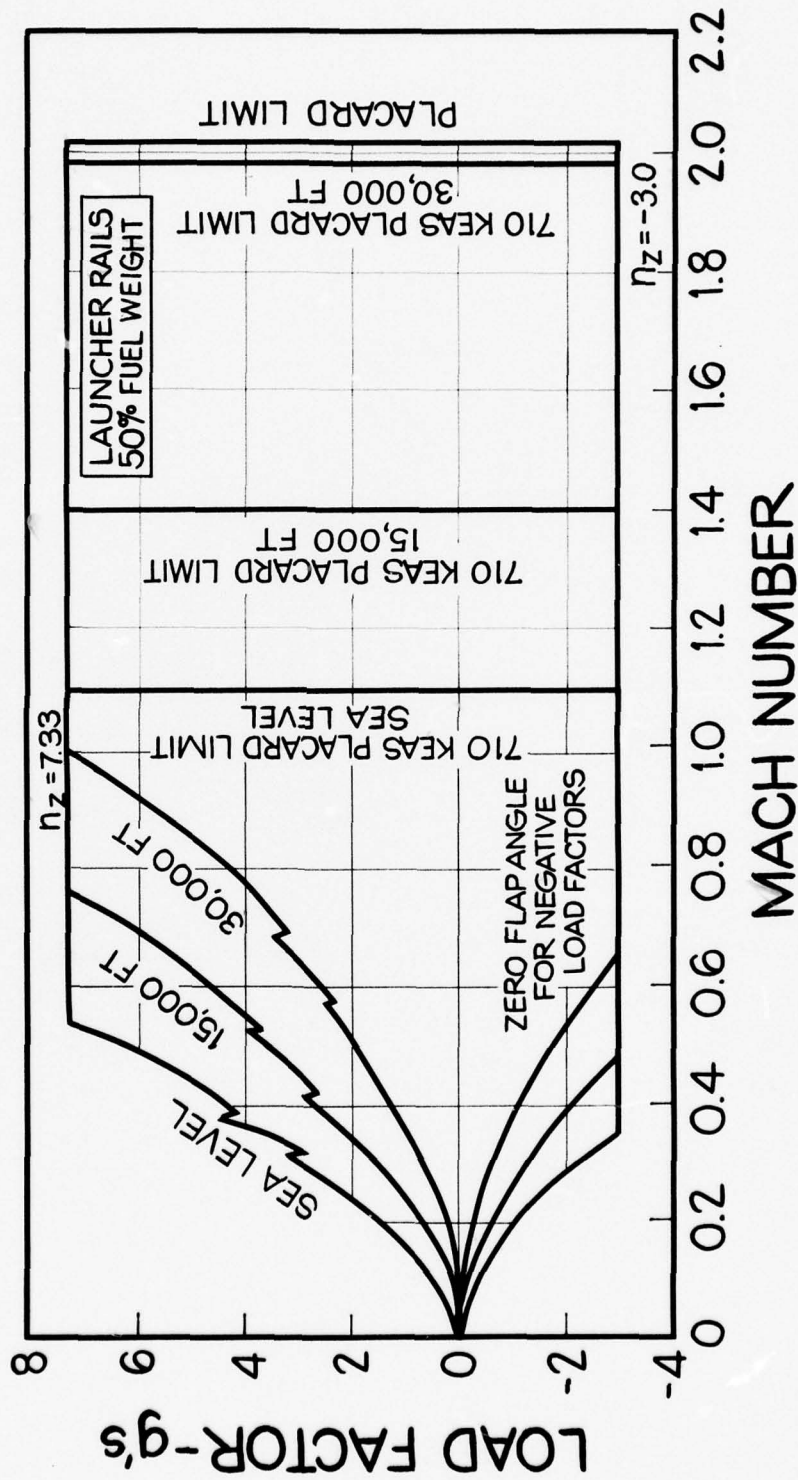

F-5E STRUCTURAL DESIGN CRITERIA



75-0075A
3P

45

F-5E DESIGN CONFIGURATIONS

CONFIGURATIONS (ALL WITH FULL AMMO)	WEIGHT LB	DESIGN LOAD FACTOR	
		+nz	-nz
BASIC MISSION 	15,745	7.33 ⁽¹⁾	-3.00
ALTERNATE I 	13,565	7.33	-3.00
ALTERNATE II 	17,860 16,770 14,800	5.00 5.00 SEE BASIC MISSION	-2.00 -2.00 SEE BASIC MISSION
ALTERNATE III 	21,682 19,696 18,606 16,946 15,286	4.00 ⁽⁴⁾ 6.50 ⁽²⁾ 6.50 ⁽²⁾ 6.50 ⁽²⁾ SEE BASIC MISSION	-2.00 -2.00 -2.00 -2.00 SEE BASIC MISSION
EXTERNAL STORE LEGEND: X AIM-9 MISSILE ● 275-GAL FUEL TANK ● MK-84 BOMB ⊗ M117 BOMB ⊙ BLU-27 (FINNED) BOMB	21,818 20,728 18,758 16,022 15,286	5.00 5.00 6.50 ⁽²⁾ 6.50 ⁽³⁾ SEE BASIC MISSION	-2.00 -2.00 -2.00 -2.00 SEE BASIC MISSION
NOTES: (1) LINEAR REDUCTION ABOVE .95M TO 6.5 g AT 2.0M (2) LINEAR REDUCTION ABOVE 0.85M TO 5.0 g AT 1.0M (V _L) (3) LINEAR REDUCTION ABOVE 0.85M TO 5.0 g AT 1.4M (V _L) (4) 275-GAL FUEL TANK LIMITATION			

F-5E STRUCTURAL MATERIAL IMPROVEMENTS

ELIMINATE STRESS CORROSION CRACKING

- PROHIBIT USE OF:
 - 7079-T6 IN ANY FORM
 - 7075-T6 IN FORGINGS, PLATE AND EXTRUSIONS WITH EXPOSED END GRAIN
- REPLACE WITH 7075-T73, 7175-T736 OR 7049-T73

IMPROVE FRACTURE TOUGHNESS

- PROHIBIT USE OF 17-4PH-H900 STEEL
- REPLACE WITH PH13-8M0-H1000
- USE VACUUM MELT STEEL ABOVE 180 KSI HEAT TREAT

F-5E FATIGUE IMPROVEMENTS - LOWER WING SKIN

- 7075-T7351 AL PLATE WAS 7075-T651
- REDUCED STRESS LEVEL
- PLANFORM RADII CHANGES
- POCKET RADII INCREASED
- SKIN TO ROOT RIB ATTACHMENT FIT AND COLD WORKED HOLES
- 100% SHOT PEENING
- CONTROL FOR HANDLING & SURFACE FINISH

STRUCTURAL ARRANGEMENT - AIRFRAME

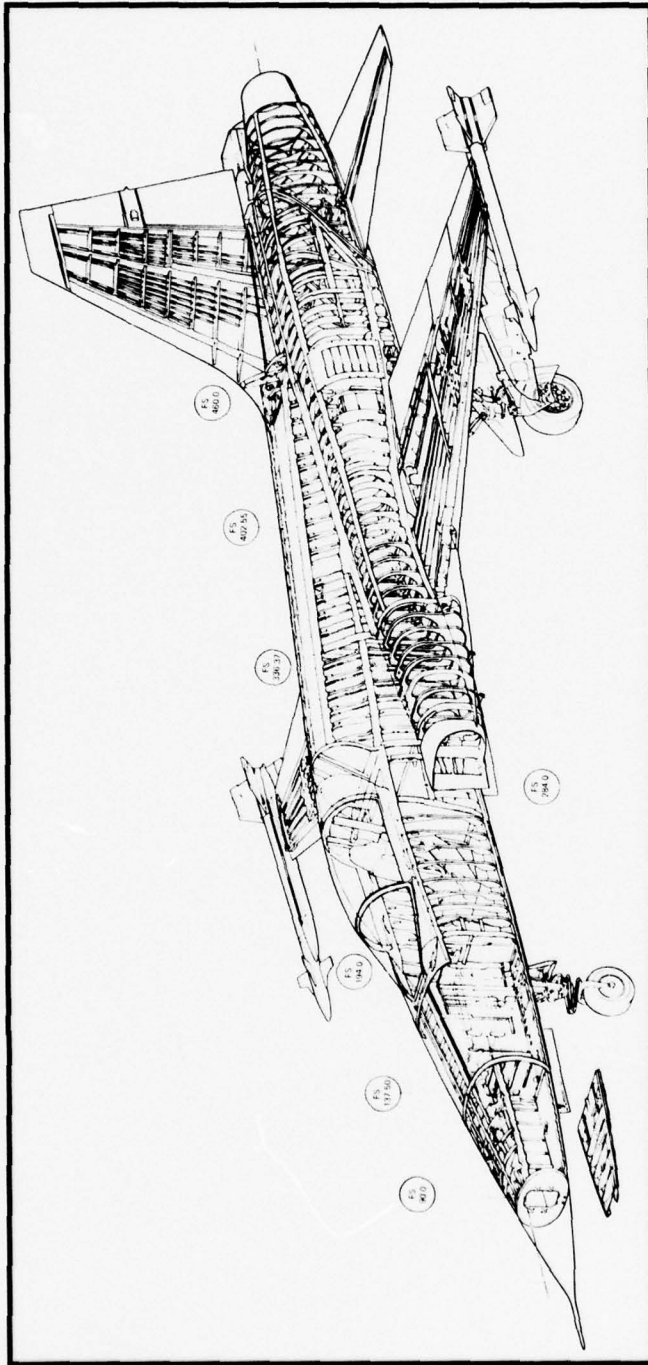

- THIN SKIN / FRAME CONSTRUCTION
- MULTI LONGERON
- TWO MANUFACTURING BREAKS, ONE FIELD BREAK
- 7000 SERIES ALUMINUM
- TITANIUM ENGINE BAY

STRUCTURAL ARRANGEMENT - VERTICAL STABILIZER

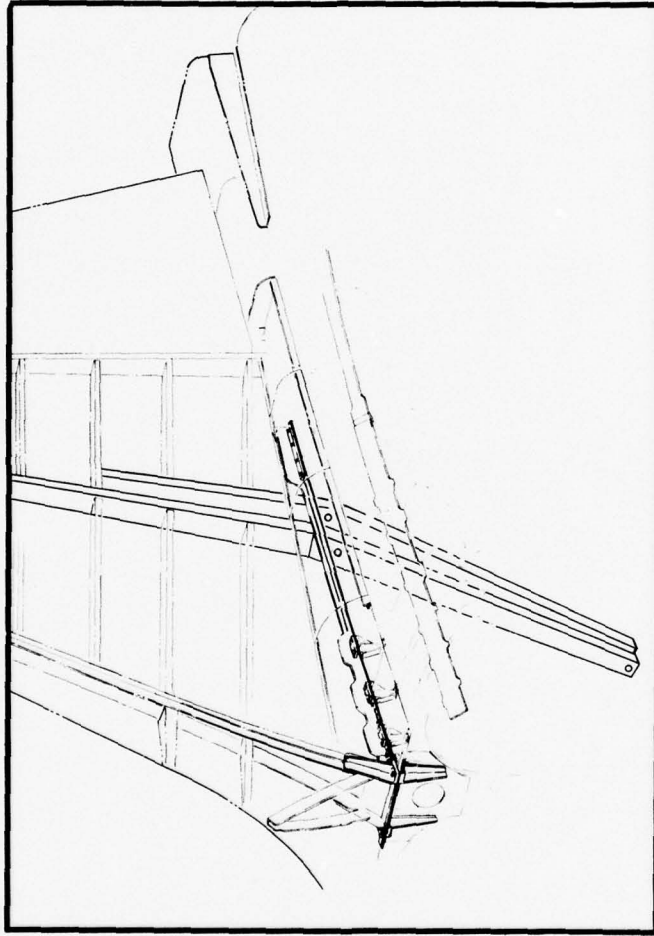

- ONE PIECE THICK SKIN
- TWO POINT MAIN SPAR ATTACH
- TWO CELL MULTI RIB BOX
- 7000 SERIES ALUMINUM

.74-2065A
3K

21

STRUCTURAL ARRANGEMENT - HORIZONTAL STABILIZER

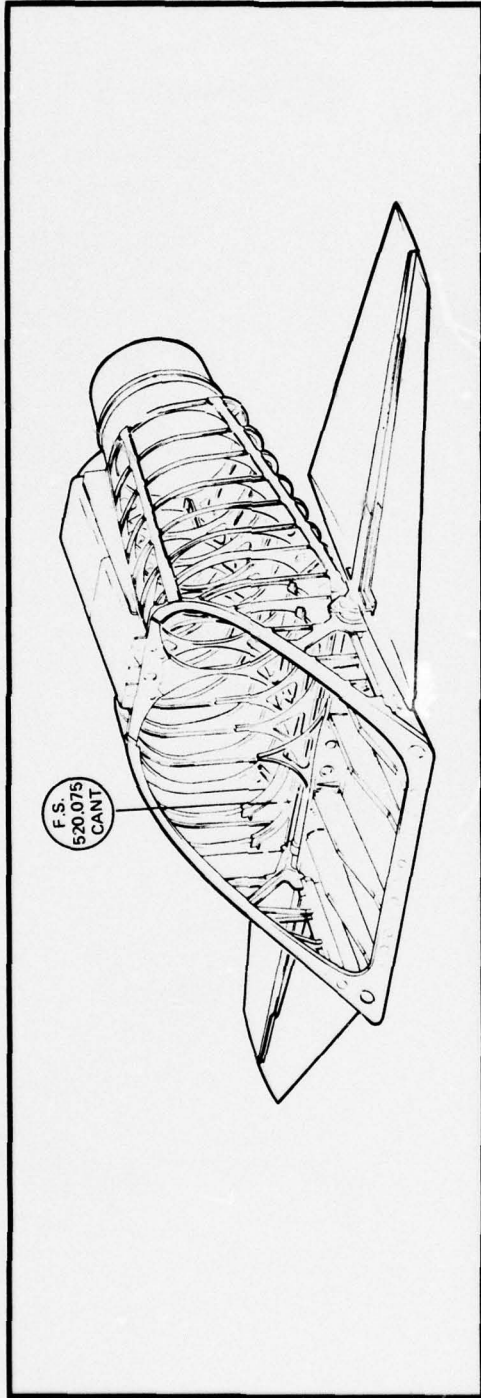

- ALL - MOVABLE SURFACE
- FULL DEPTH ALUMINUM HONEYCOMB
- TWO POINT SUPPORT
- 43M30 STEEL CARRY- THROUGH TORQUE TUBE

74-2066A
3K

32

F-5E STATIC TEST PROGRAM

- COMPLETE AIRFRAME AND LANDING GEAR
- TEST COMPLETED JUNE 1973
- COMMON STRUCTURE QUALIFIED BY PRIOR F-5/T-38 TESTS
 - VERTICAL TAIL
 - HORIZONTAL TAIL
 - AILERON
 - WING PYLONS

F-5E STATIC TEST PROGRAM

- THREE PHASE TEST
 - WING JIG MOUNTED
 - FUSELAGE JIG MOUNTED
 - FUSELAGE MATED WITH WING
- 19 MAJOR CONDITIONS
- 783 STRAIN GAGES
- 193 DEFLECTION GAGES
- PERMANENT DEFORMATION IN 66% WING SPAR AT LIMIT LOAD
- LOWER SURFACE SKIN REINFORCED AND TESTED TO 100% ULTIMATE LOAD

T-38/F-5 FLIGHT LOAD SURVEY

AIRCRAFT	DATA POINTS
T-38	806
F-5	625
F-5E	<div style="display: flex; flex-direction: column; align-items: center;"> <div style="display: flex; justify-content: space-around; width: 100%;"> 96 PULL UP & PUSH DOWN 106 ABRUPT ROLLS 58 ABRUPT PITCH 81 RUDDER MANEUVER </div> <div style="margin-top: 10px;"> 341 </div> </div>

F-5E FLIGHT LOADS SURVEY INSTRUMENTATION

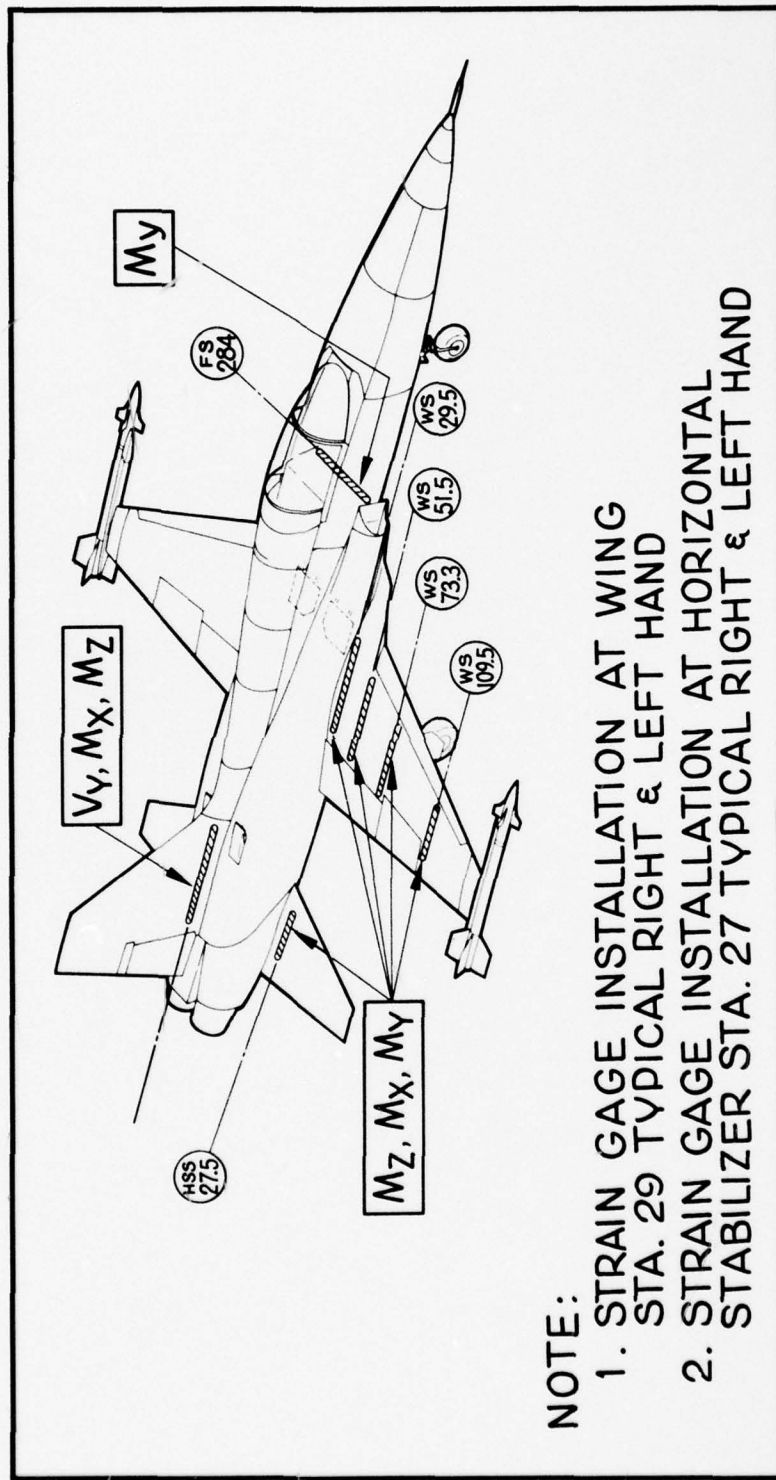

*NORTHROP F-5E
STRUCTURAL FATIGUE
TEST PROGRAM*

37

74-0339
12C,11

FATIGUE ASIP FLOW CHART

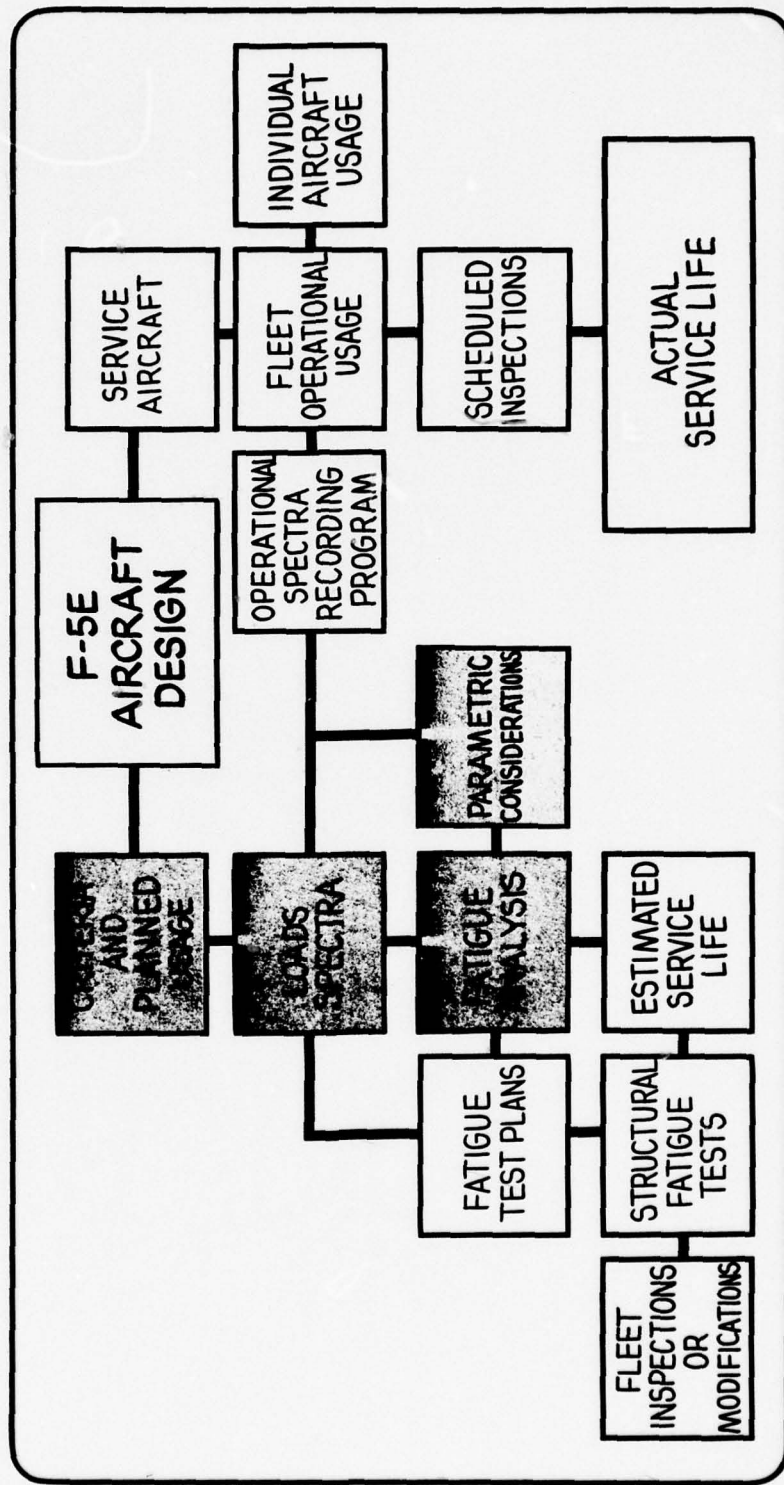

T-38/F-5 FLEET RECORDS

	TOTAL A/C DELIVERED	TOTAL FLIGHT HOURS	HIGH-TIME A/C (FLT HOURS)
T-38A	1187	5,000,000	7500
F-5A/RF-5A	710	850,000	3000
F-5B	158	200,000	4000
CF-5	115	60,000	2000
NF-5	101	55,000	800
F-5E	275	35,000	600
TOTAL	2546	6,200,000	~

74-0424E
12C

39

1 JUNE 75

F-38/F-5 MAJOR FATIGUE TESTS

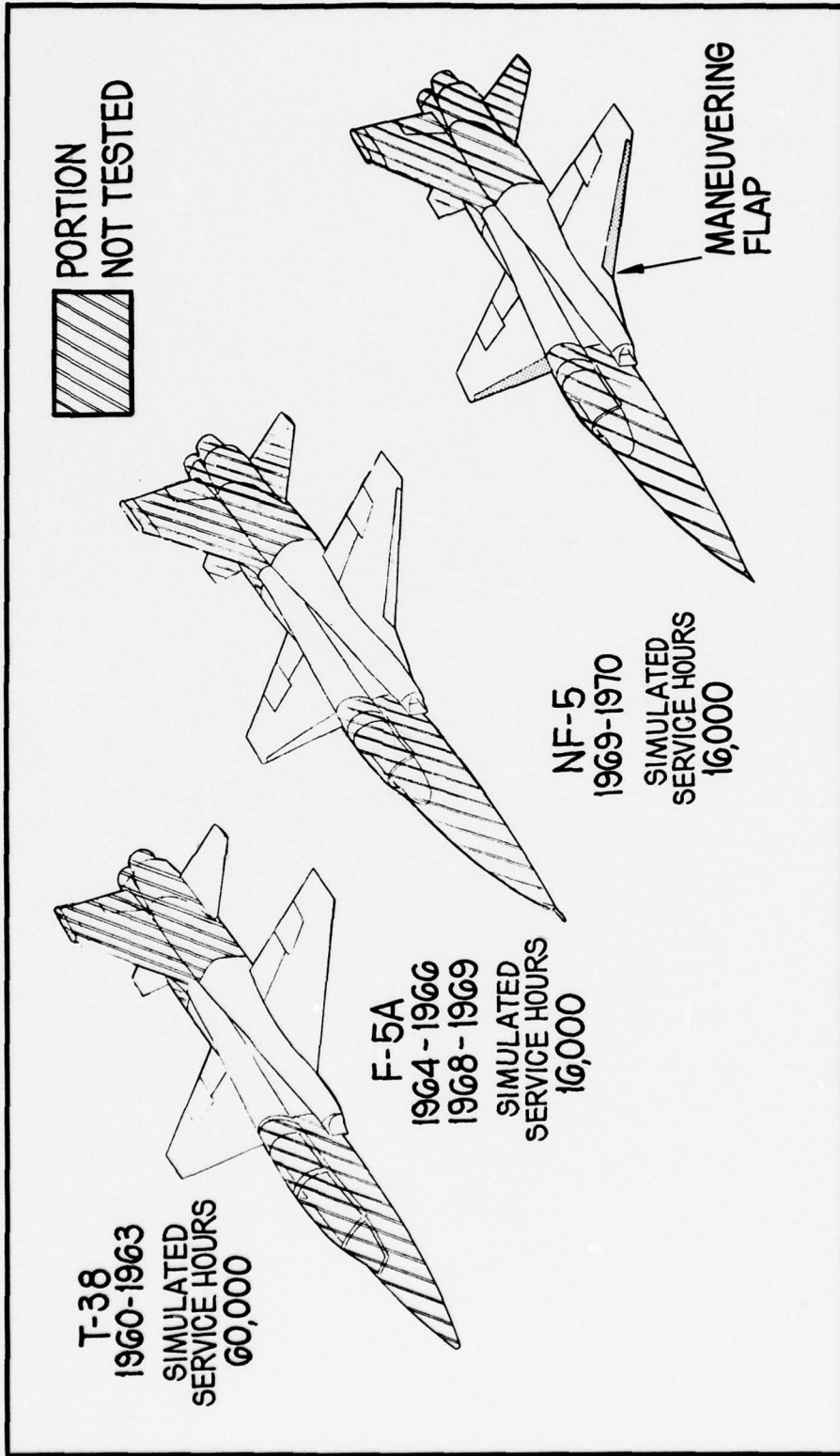

F-5E FATIGUE TEST PROGRAM OBJECTIVES

● LOCATE FATIGUE CRITICAL AREAS

● PERMIT EARLY IMPROVEMENT AT RELATIVELY
LOW COST

● DEVELOP SCHEDULED INSPECTION PROCEDURES TO
MINIMIZE UNSCHEDULED STRUCTURAL MAINTENANCE

● PROVIDE TEST DATA TO ESTABLISH THE
PREDICTED STRUCTURAL SERVICE LIFE

F-5E FATIGUE CRITERIA

<ul style="list-style-type: none">● SERVICE LIFE DESIGN OBJECTIVE<ul style="list-style-type: none">- 4000 FLIGHT HRS- 4000 LANDINGS	<ul style="list-style-type: none">● TARGET TEST LIFE<ul style="list-style-type: none">- 16,000 FLIGHT HRS- 16,000 LANDINGS
--	---

74-0113A
12C

1 JAN 75

42

F-5E FATIGUE TEST PROGRAM

- COMPLETE AIRPLANE TEST

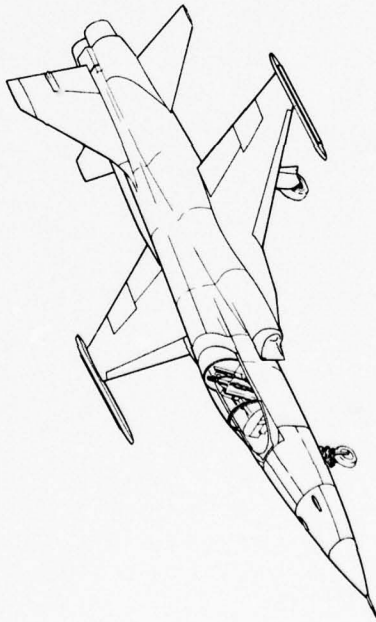

- COMPONENT TESTS

- LEADING EDGE FLAP MECHANISMS
- NOSE LANDING GEAR
- MAIN LANDING GEAR

FATIGUE TEST ARTICLE

F-5B PRODUCTION AIRCRAFT

**PRESSURIZED
COCKPIT**

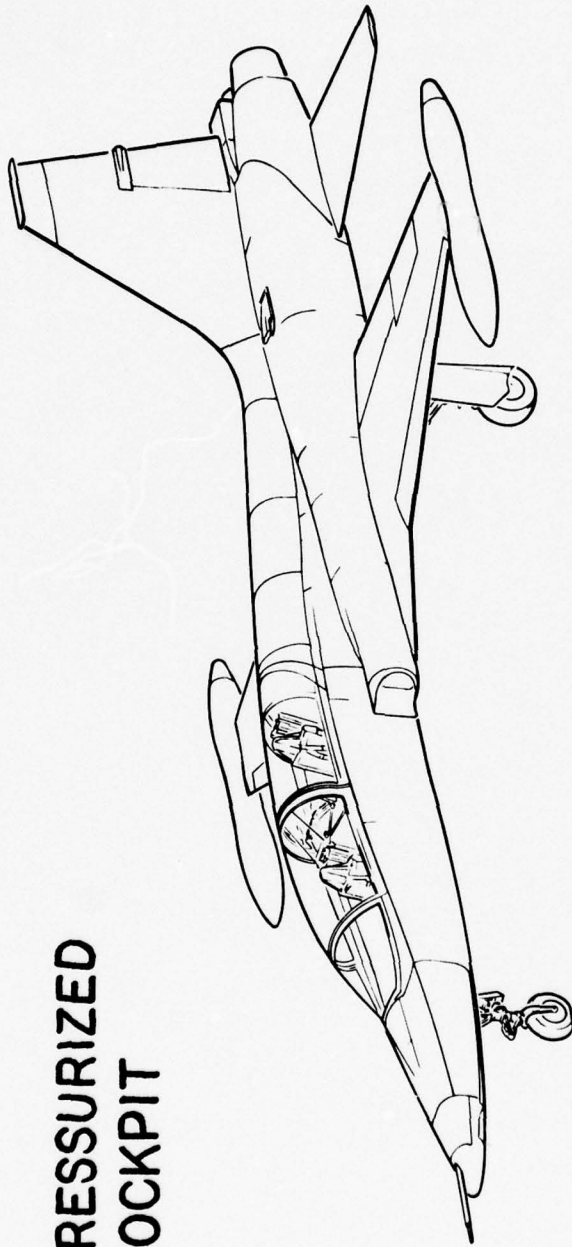

**OPERATIONAL SPEED BRAKES
AND FLAPS**

74-0348A
12C

F-5E COMPLETE AIRFRAME

FATIGUE TEST SET-UP

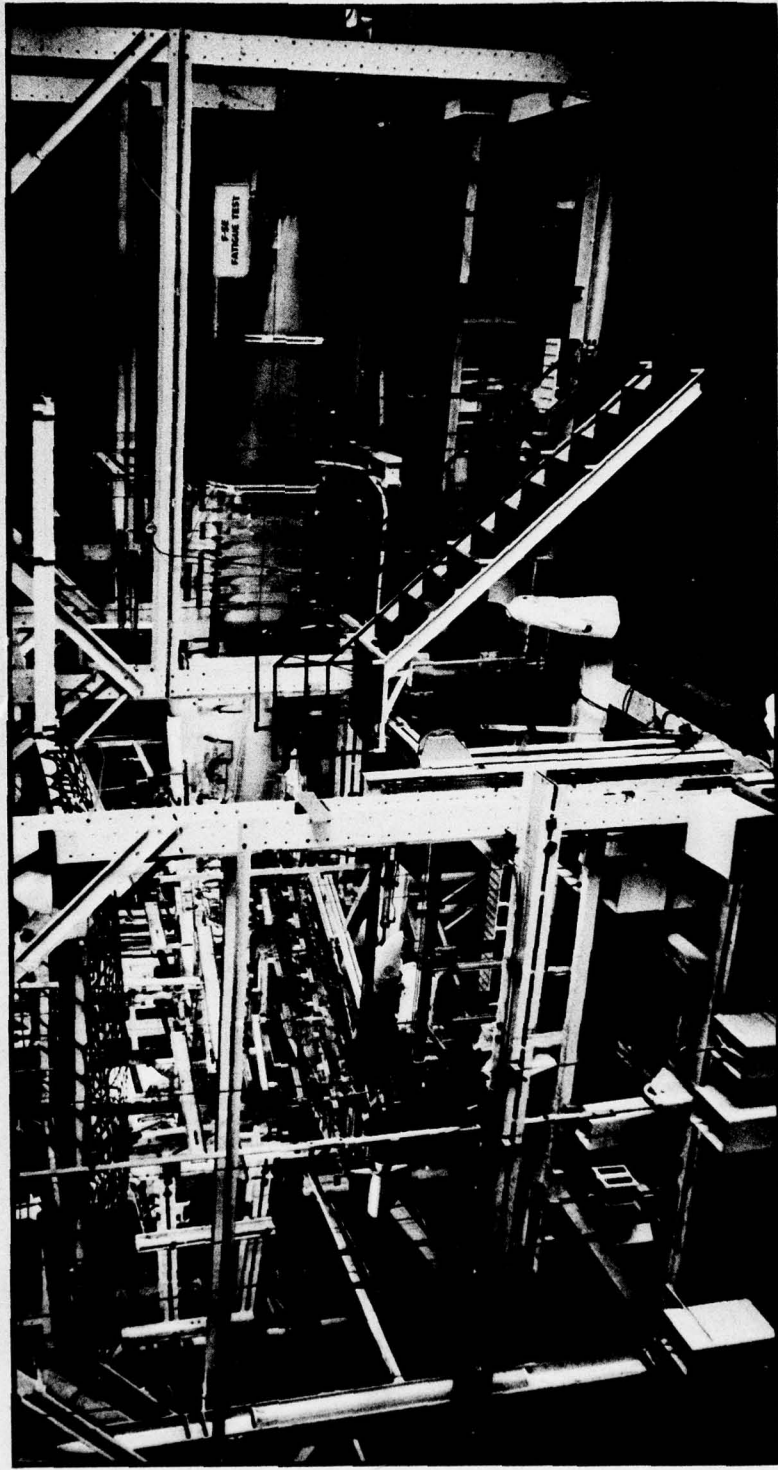

74-0114
12C

F-5E DESIGN CRITERIA

MISSION UTILIZATION

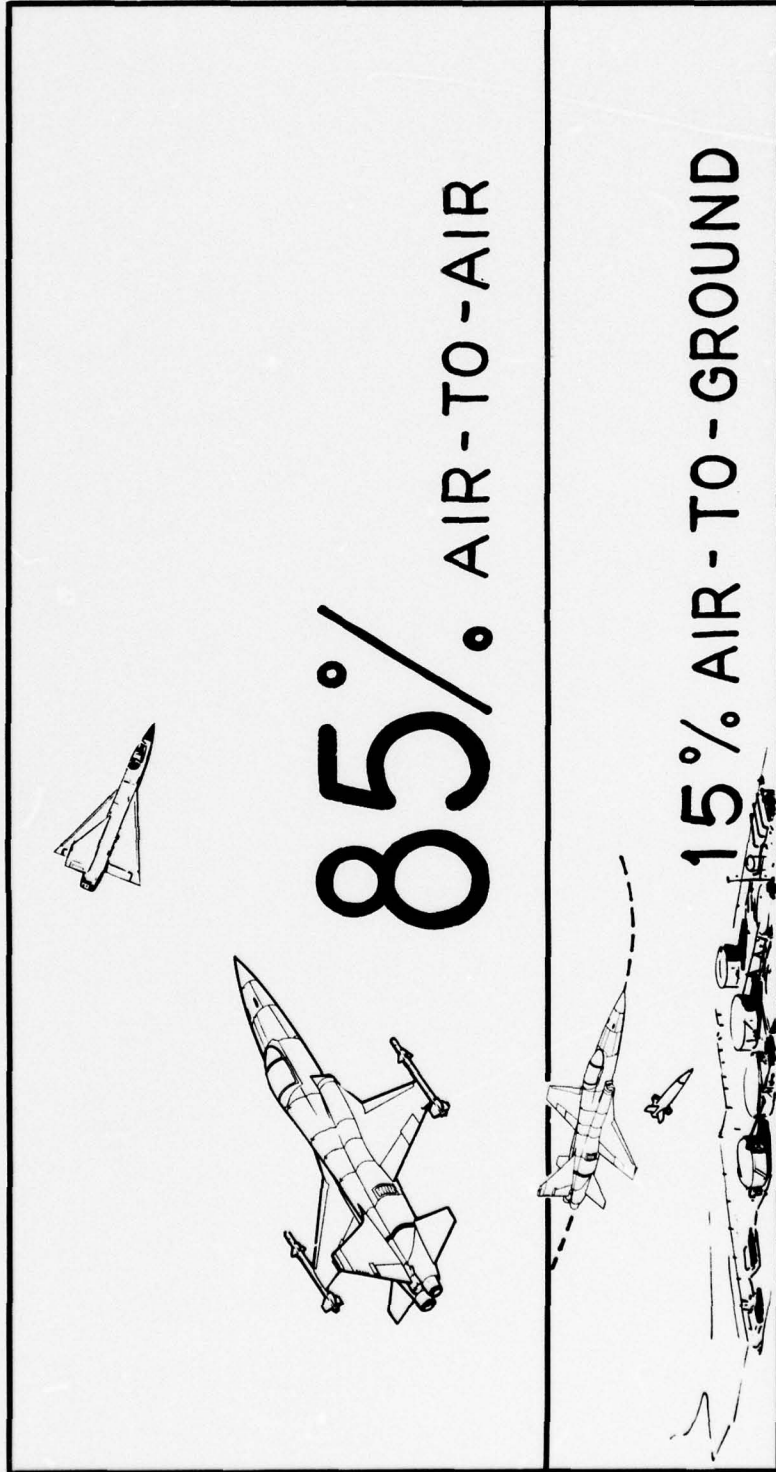

74-0112A
12C

10 JAN 74

46

DEVELOPMENT OF FATIGUE LOADS SPECTRUM

- MISSION PROFILES
- MISSION PHASE MANEUVER SPECTRA
- COMPOSITE MANEUVER SPECTRA
- LOAD CONDITIONS
- AIRFRAME TEST SPECTRUM

MISSION PROFILES DEFINE BASIC ORDER OF EVENTS



5 MISSIONS { **3 AIR-AIR COMBAT**
2 AIR-GROUND COMBAT

MANEUVER ACTIVITY WITHIN A FLIGHT

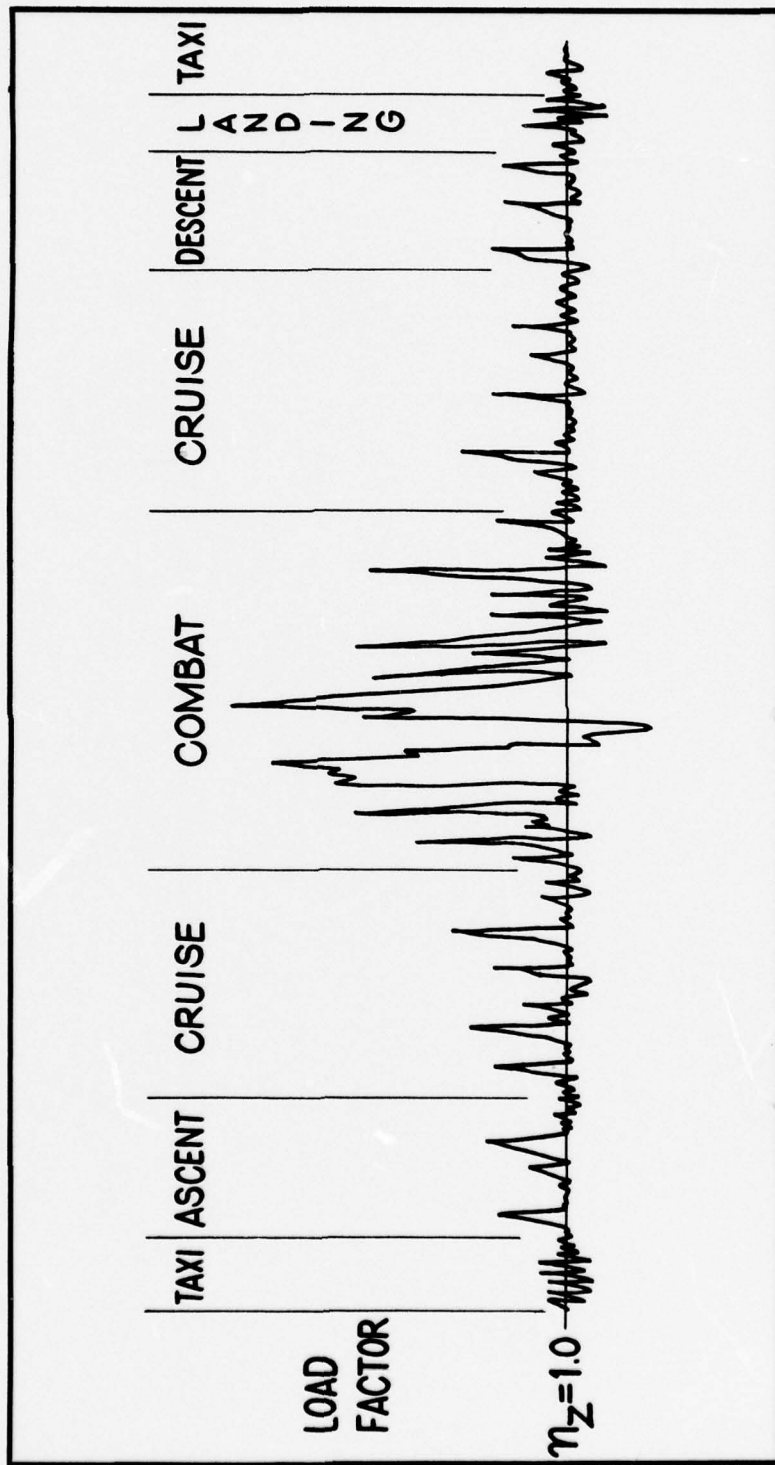

74-0337-1A
12C

DEVELOPMENT OF COMPOSITE MANEUVER SPECTRA

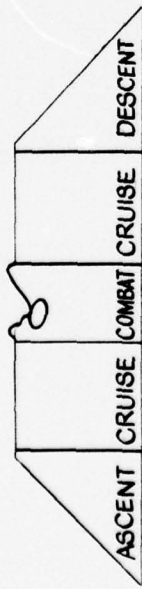

PHASE DURATION X NO. FLIGHTS

x $\frac{\text{PHASE MANEUVER SPECTRA}}{1000}$

n_z OCCURRENCES IN
A MISSION PHASE

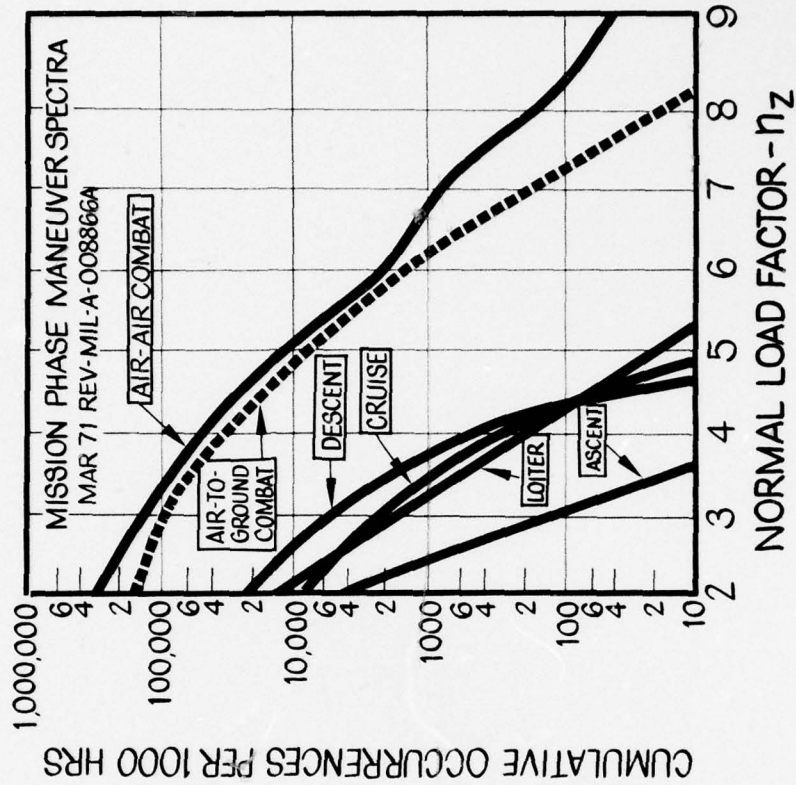

F-5E COMPOSITE MANEUVER SPECTRA

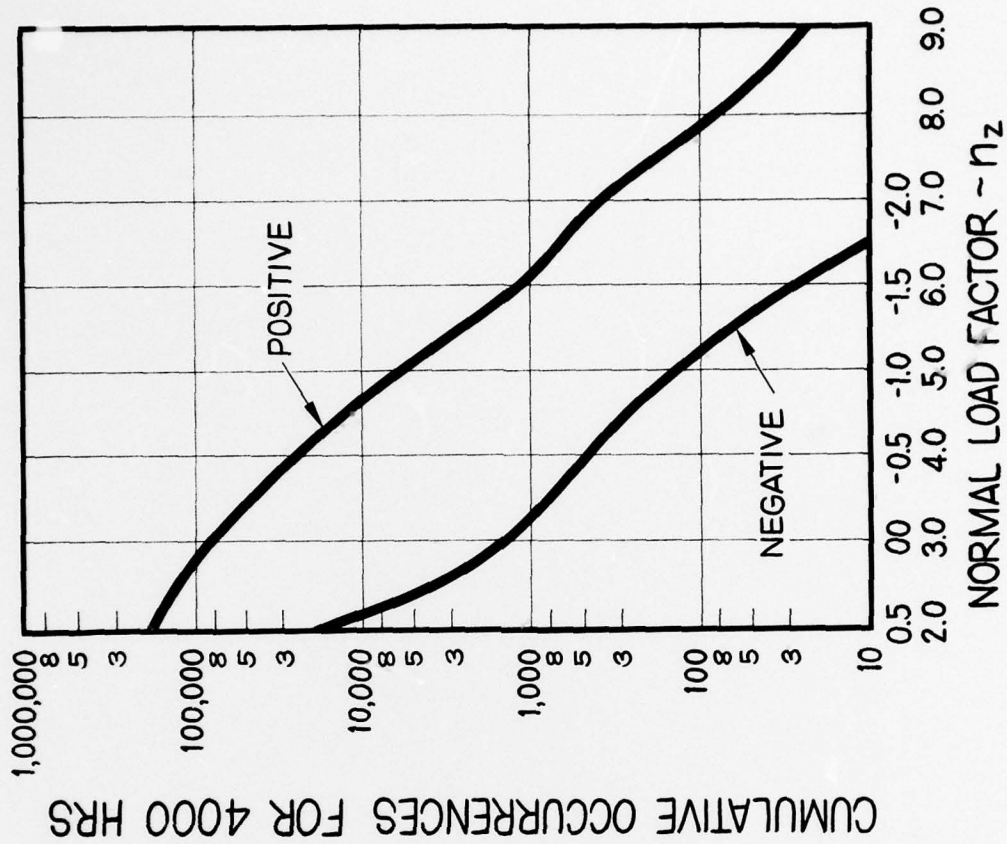

74-0335A
12C

1 FEB 74

51

LOAD CONDITIONS

MISSION PROFILES

- GROSS WEIGHT
- CONFIGURATION
- MACH & ALTITUDE

TYPE OF LOAD CONDITIONS

- GROUND HANDLING & TAXI
- LANDING
- POSITIVE & NEGATIVE SYMMETRIC MANEUVER
- ROLL MANEUVER
- YAW MANEUVER
- ABRUPT PITCH MANEUVER
- GUST
- STORE EJECTION

FLIGHT BY FLIGHT FATIGUE TEST

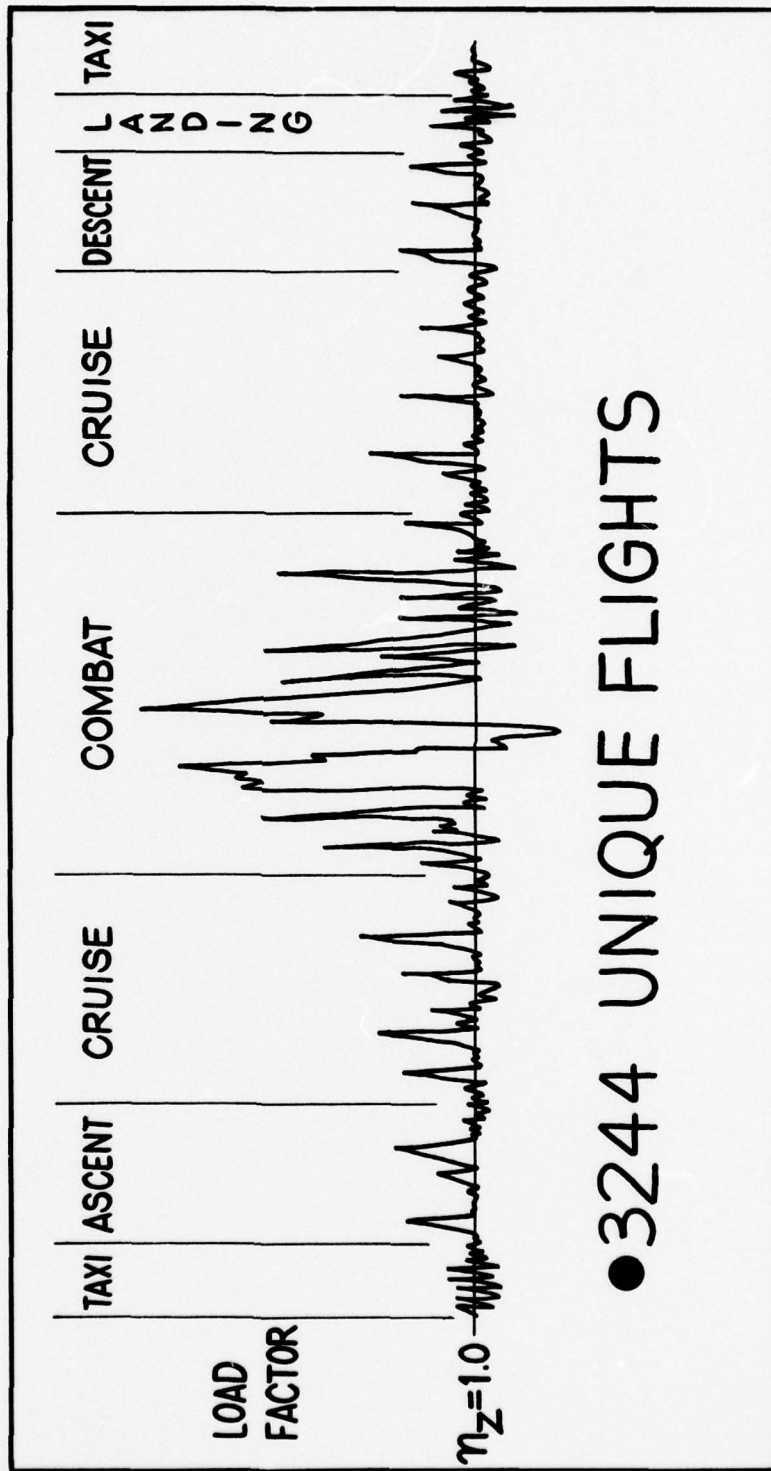

● 3244 UNIQUE FLIGHTS

LOAD EVENT DESCRIPTION

30 TYPES OF LOAD EVENTS

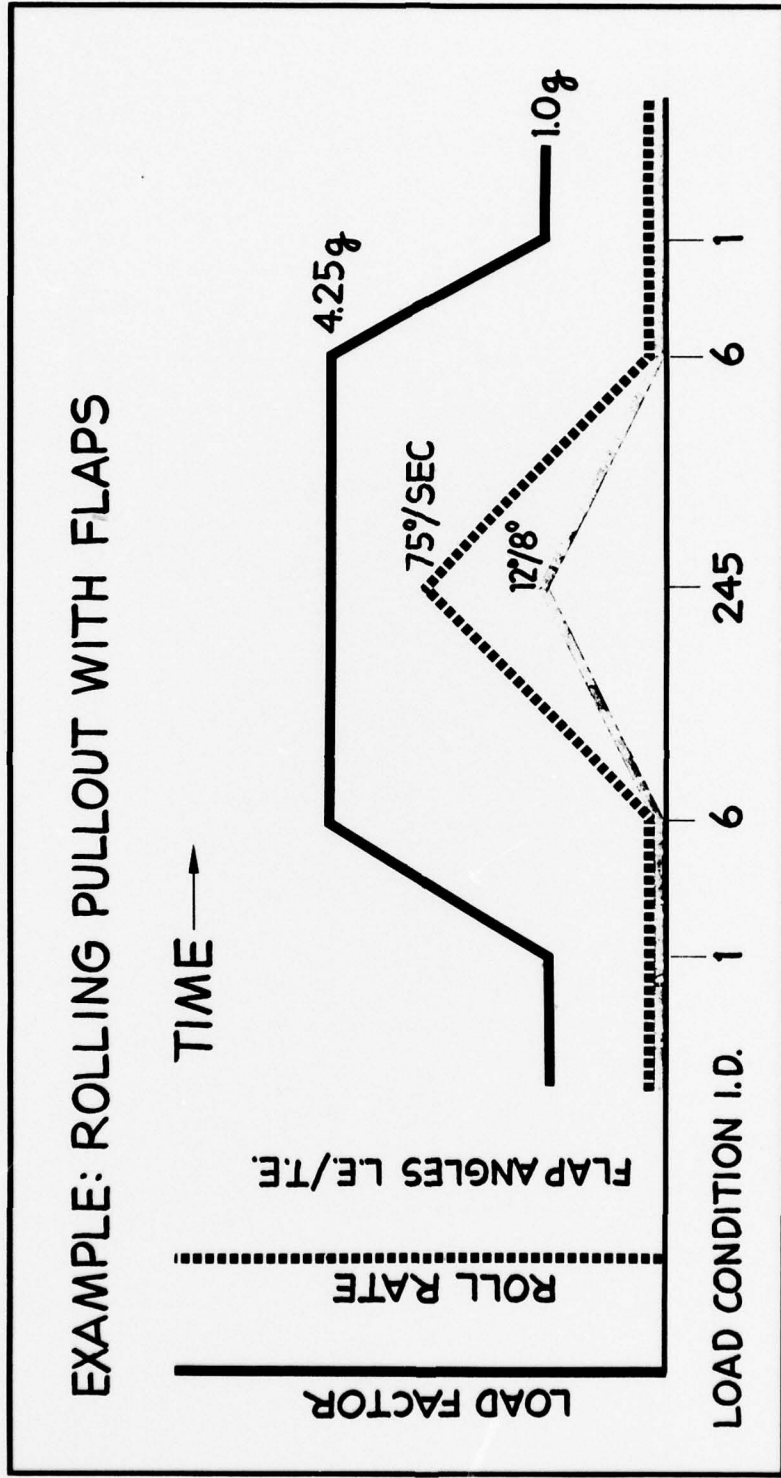

TOTAL TEST LOAD EVENTS > 1,000,000

AIRFRAME LOAD APPLICATION

- 44 LOAD CONTROL CHANNELS

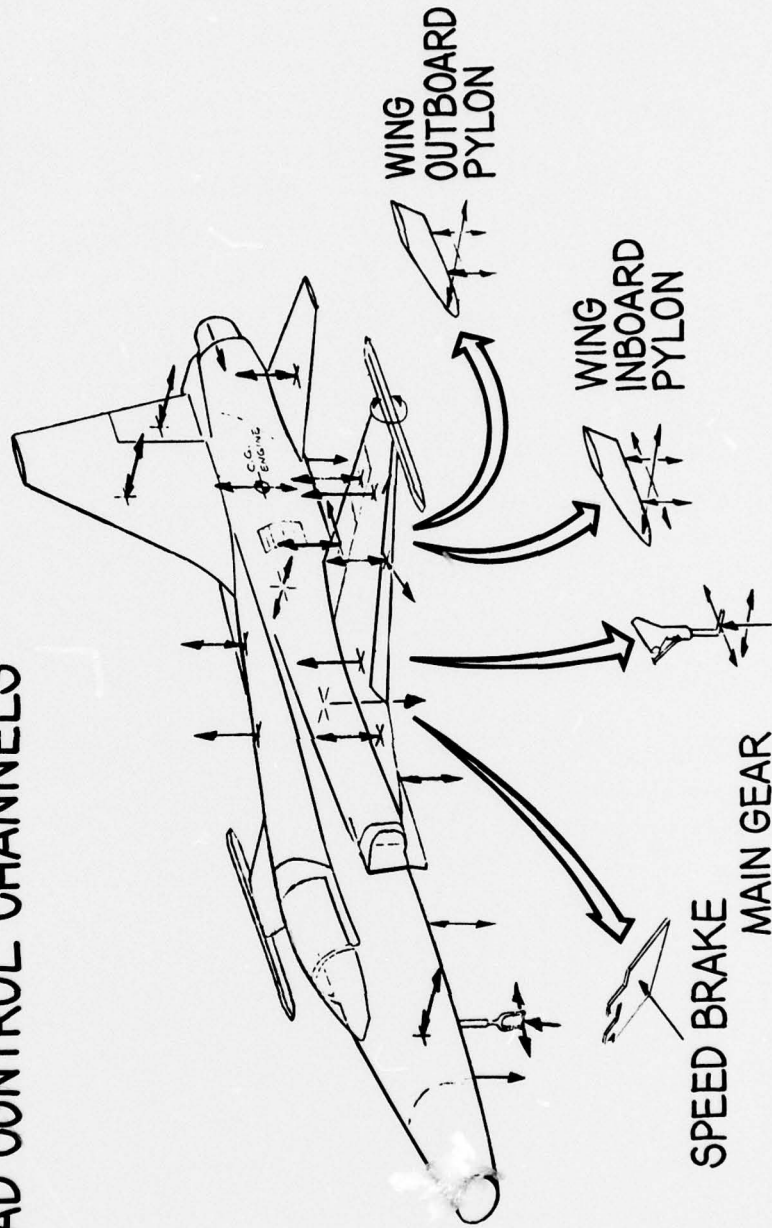

LOAD EVENT SEQUENCE TAPE

- FLIGHT BY FLIGHT SEQUENCE
- 3244 UNIQUE FLIGHTS

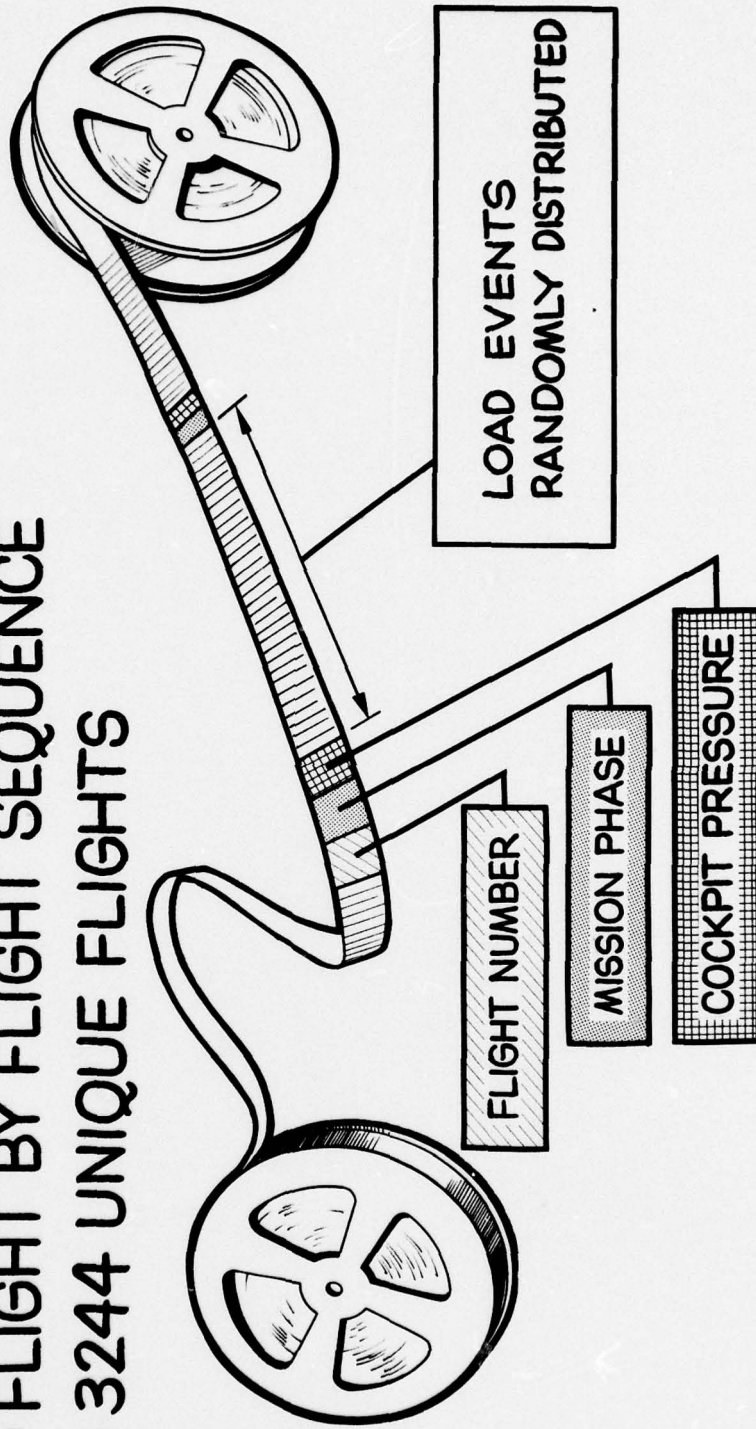

LOADS MATRIX TAPE

- TOTAL AIRCRAFT LOADS
- 1700 CONDITIONS

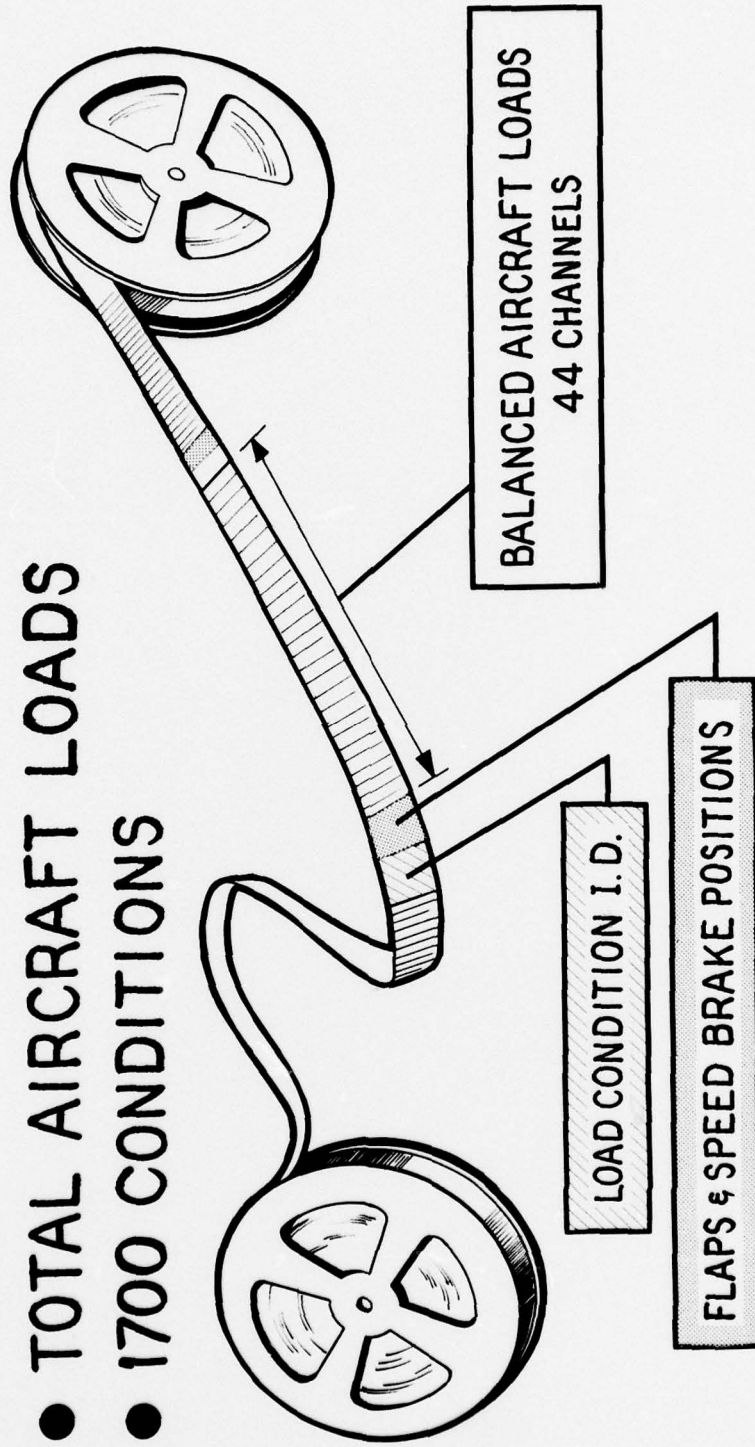

F-5 COMPLETE AIRFRAME LOAD CONTROL SYSTEM

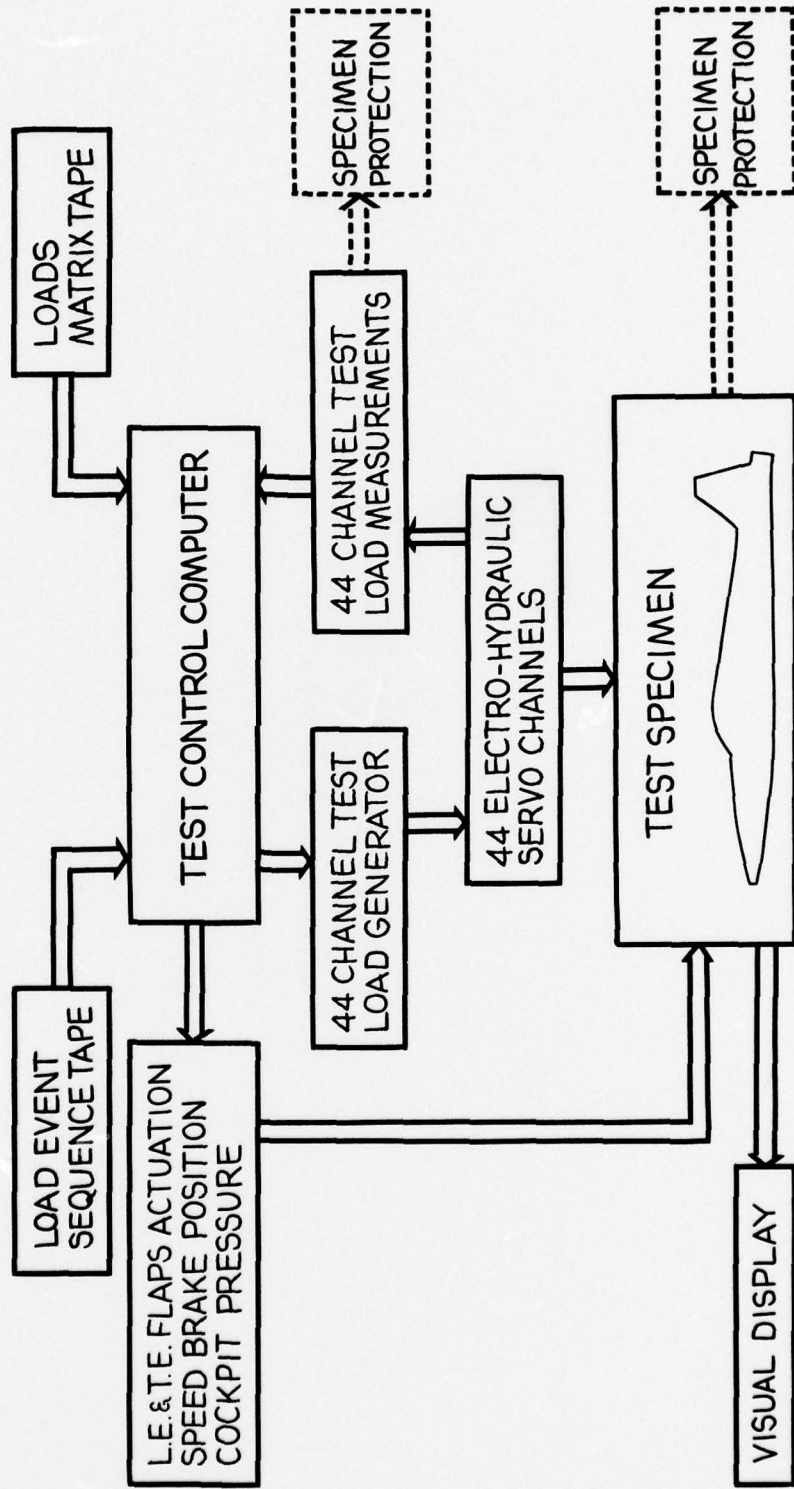

74-0425A

F-5E COMPLETE AIRFRAME SPECIMEN PROTECTION

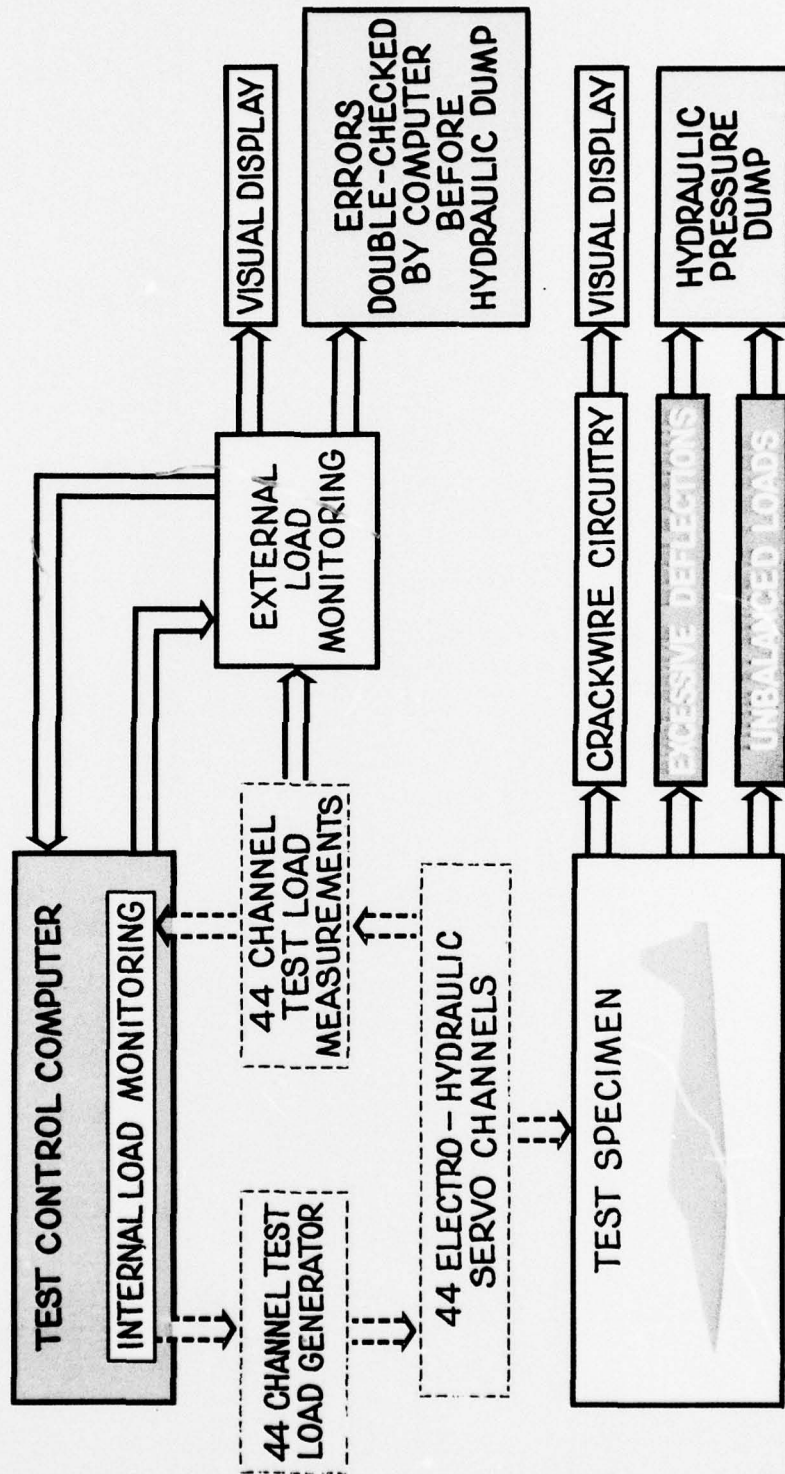

74-0426
12C

F-5E FATIGUE TEST PROGRESS

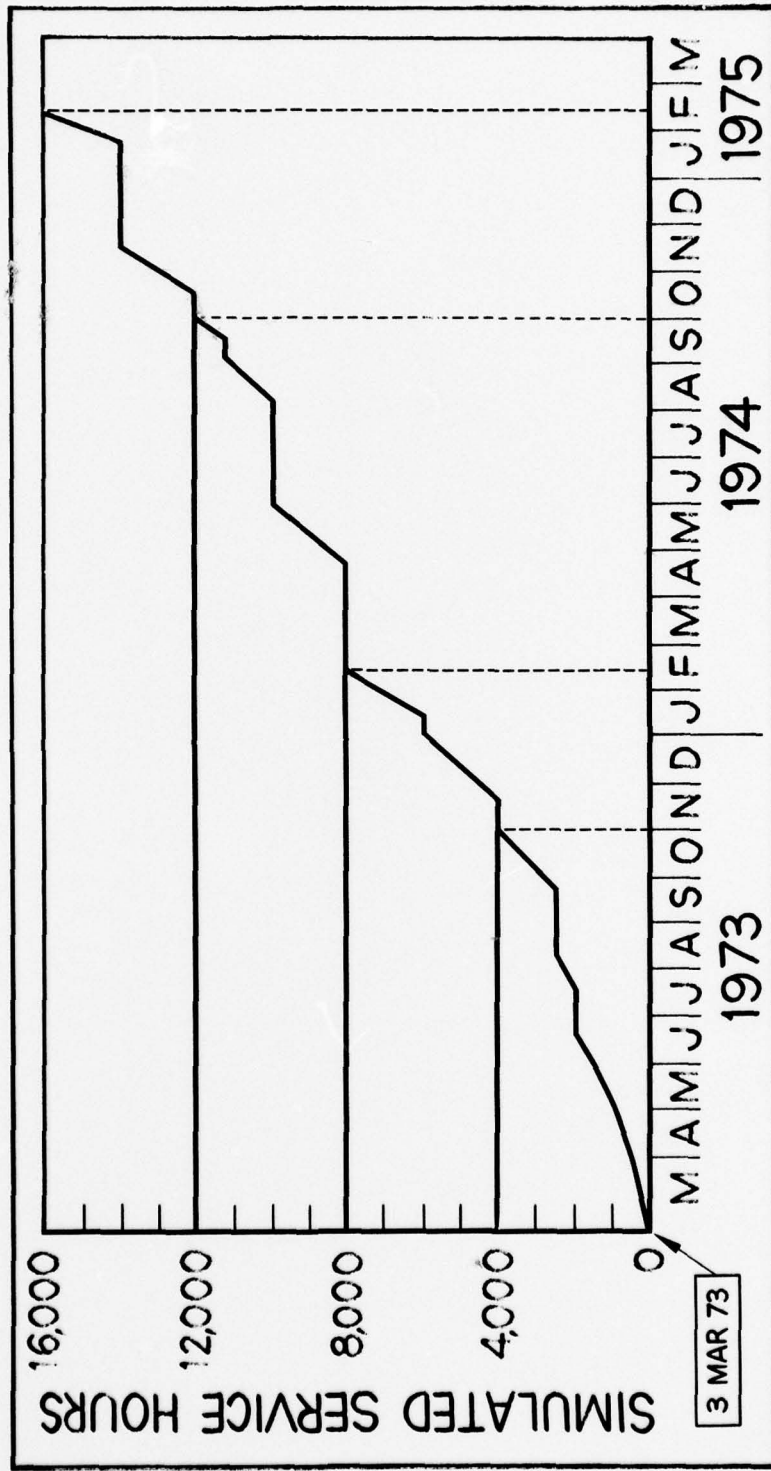

74-0072D
12C

F-5E FATIGUE TEST - ESTABLISHED CRITICAL AREAS

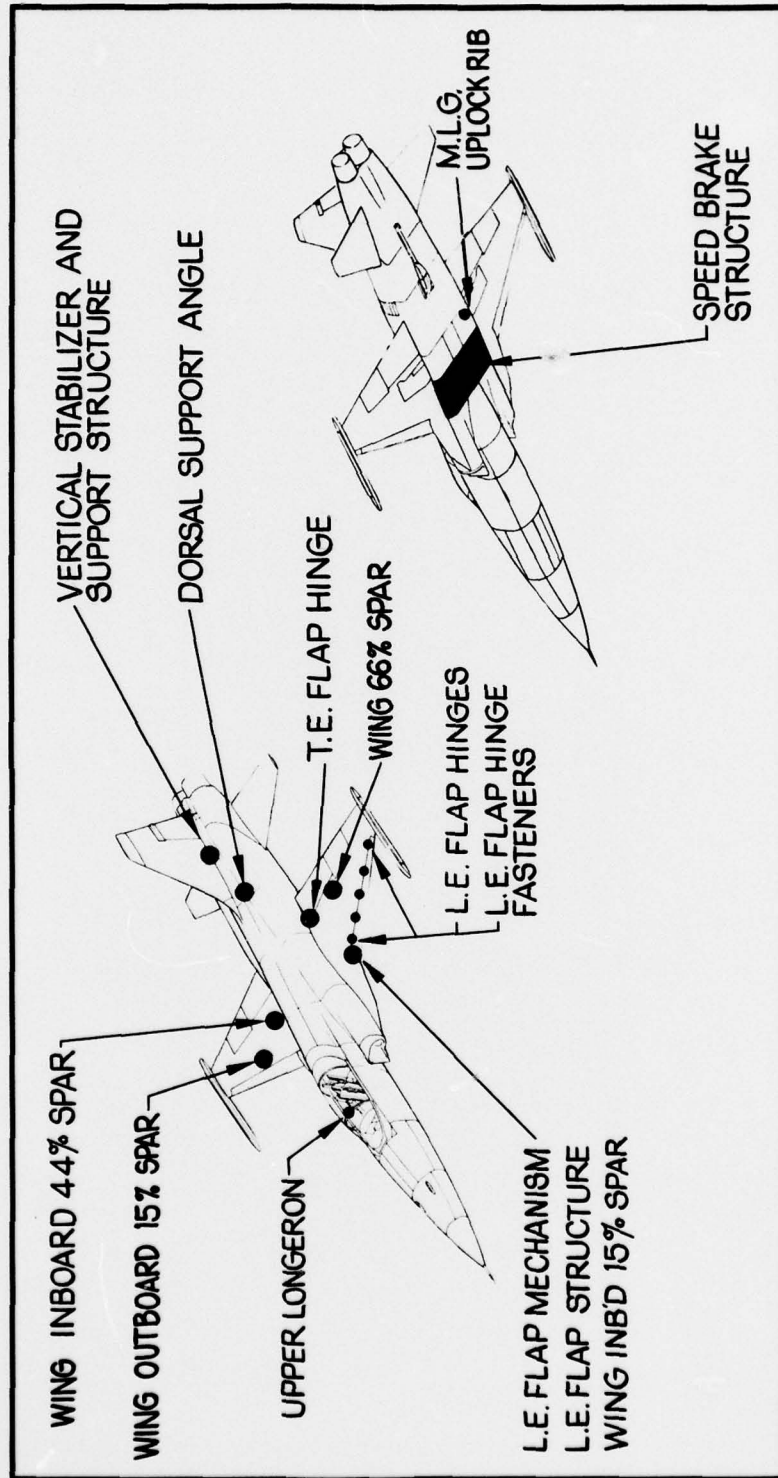

74-0073B
12C

JAN 75

61

F-5 FATIGUE TESTING SCHEDULES

	1973	1974	1975	1976	1977	1978
<p>F-5E FATIGUE TESTING (16,000 HRS)</p> <ul style="list-style-type: none"> • CURRENT AIRFRAME TEST 85% AIR TO AIR 15% AIR TO GROUND • CP-118 FOLLOW-ON TEST FMS TRAINING DAC TRAINING • ACI INSPECTION 						
<p>F-5A/B COMPLETE AIRFRAME FATIGUE TEST (24,000 HRS)</p> <ul style="list-style-type: none"> • ECP 801 MAP USAGE 						

F-5E OPERATIONAL SPECTRA RECORDING PROGRAM
DATA ACQUISITION

WILLIAMS AFB, ~ 20 AIRCRAFT

- MXU-553 MULTI-CHANNEL RECORDERS (6 A/C)
 - BASIC DATA — MISSION, WEIGHTS, CONFIG. ETC.
 - TIME HISTORIES — 12 FLIGHT PARAMETERS
- COUNTING ACCELEROMETERS (20 A/C)
 - BASIC DATA
 - LOAD FACTOR (7Z) CUMULATIVE OCCURRENCES

F-5E OPERATIONAL SPECTRA RECORDING PROGRAM
COMPUTER PROGRAMS

MXU - 553

- LOAD SPECTRA DEFINITION
- FATIGUE DAMAGE RATES - 5 LOCATIONS
- PARAMETRIC FATIGUE ANALYSIS
 - MISSION PHASE
 - MISSION MIX

COUNTING ACCELEROMETER

- INTEGRATION WITH MXU RESULTS
- ESTIMATED SERVICE LIFE - INDIVIDUAL A/C