

AD-A026697

ADA026697

RDF-A



WVT-TR-76020

AD

FEASIBILITY STUDY OF FILAMENT WOUND
COMPOSITE ROAD WHEEL

TECHNICAL
LIBRARY

JUNE 1976

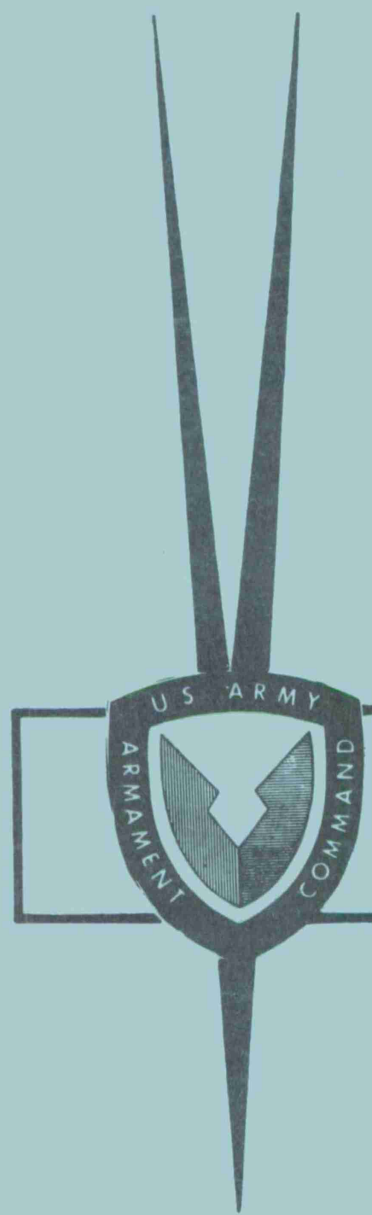

BENET WEAPONS LABORATORY
WATERVLIET ARSENAL
WATERVLIET, N.Y. 12189

TECHNICAL REPORT

AMCMS No. 662601.11.H9100

DA Project No. 1G662601AH91

Pron No. EH-6-2E346-01-EH-M7

APPROVED FOR PUBLIC RELEASE: DISTRIBUTION UNLIMITED

DISCLAIMER

The findings in this report are not to be construed as an official Department of the Army position unless so designated by other authorized documents.

The use of trade name(s) and/or manufacturer(s) in this report does not constitute an official indorsement or approval.

DISPOSITION

Destroy this report when it is no longer needed. Do not return it to the originator.

UNCLASSIFIED

SECURITY CLASSIFICATION OF THIS PAGE (When Data Entered)

REPORT DOCUMENTATION PAGE		READ INSTRUCTIONS BEFORE COMPLETING FORM
1. REPORT NUMBER WVT-TR-76020	2. GOVT ACCESSION NO.	3. RECIPIENT'S CATALOG NUMBER
4. TITLE (and Subtitle) Feasibility Study of Filament Wound Composite Road Wheel		5. TYPE OF REPORT & PERIOD COVERED
		6. PERFORMING ORG. REPORT NUMBER
7. AUTHOR(s) Giuliano D'Andrea Peter G. O'Hara Paul G. Croteau		8. CONTRACT OR GRANT NUMBER(s)
9. PERFORMING ORGANIZATION NAME AND ADDRESS Benet Weapons Laboratory Watervliet Arsenal, Watervliet, N.Y. 12189 SARW-RT-TP		10. PROGRAM ELEMENT, PROJECT, TASK AREA & WORK UNIT NUMBERS AMCMS No. 662601.11.H9100 DA Proj. No. 1G662601AH91 Pron No. EH-6-2E346-01-EH-M7
11. CONTROLLING OFFICE NAME AND ADDRESS U.S. Army Armament Command Rock Island, Illinois 61201		12. REPORT DATE June 1976
		13. NUMBER OF PAGES 54
14. MONITORING AGENCY NAME & ADDRESS (if different from Controlling Office)		15. SECURITY CLASS. (of this report) UNCLASSIFIED
		15a. DECLASSIFICATION/DOWNGRADING SCHEDULE
16. DISTRIBUTION STATEMENT (of this Report) Approved for public release; distribution unlimited.		
17. DISTRIBUTION STATEMENT (of the abstract entered in Block 20, if different from Report)		
18. SUPPLEMENTARY NOTES		
19. KEY WORDS (Continue on reverse side if necessary and identify by block number) Composite Tank Road Wheels Composite Manufacturing Methods Composite Tank's Components		
20. ABSTRACT (Continue on reverse side if necessary and identify by block number) The feasibility of fabricating a M113 composite road wheel by the filament winding process has been demonstrated. Theoretical results, showing road wheel deformation where subjected to a radial compression load, have been obtained for both the conventional and composite M113 road wheel. Experimental results, for radial compression tests, show correlation between theory and experiment. Concepts for reducing road wheel vulnerability to mine blasts are also presented.		

SECURITY CLASSIFICATION OF THIS PAGE(When Data Entered)

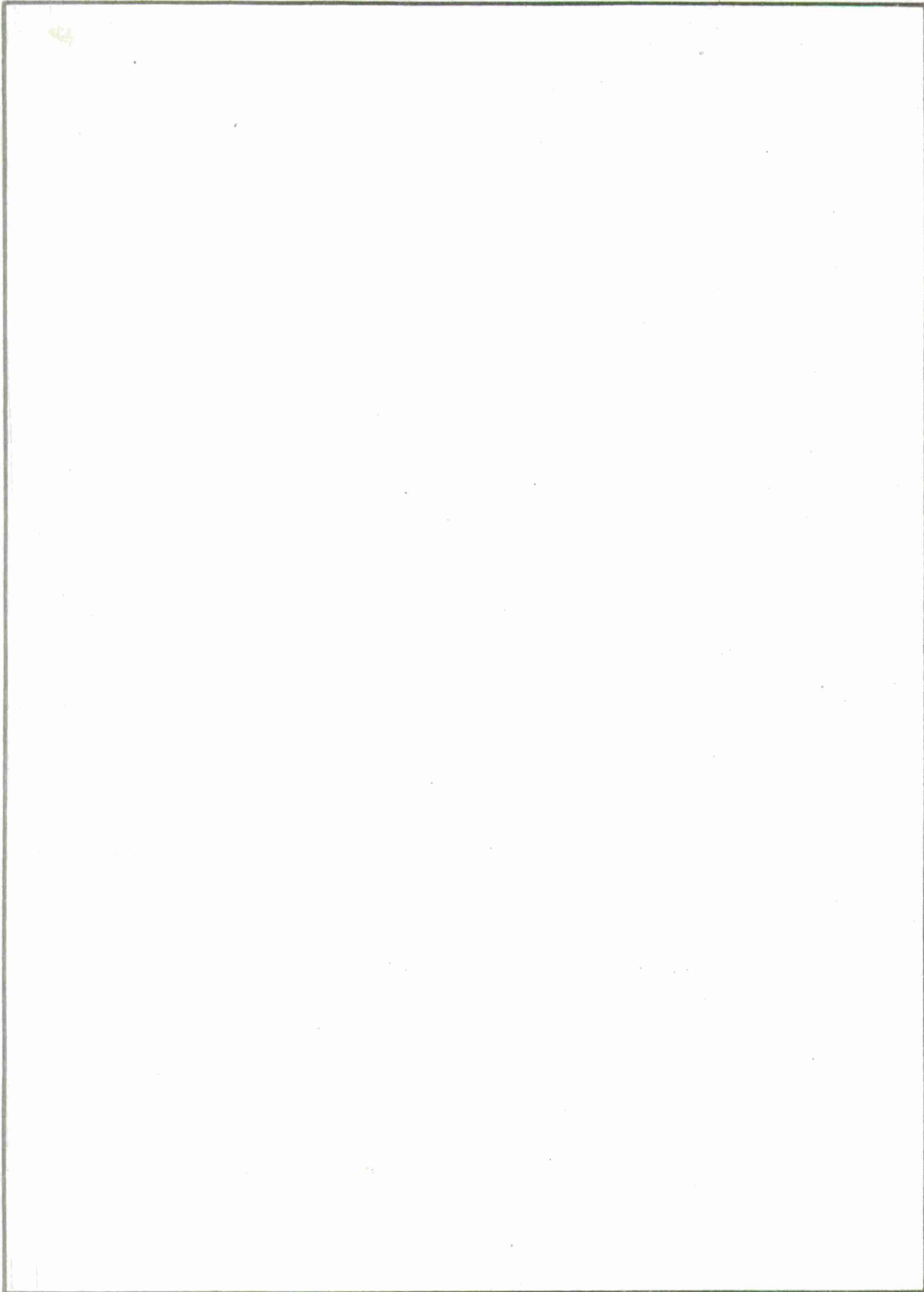

SECURITY CLASSIFICATION OF THIS PAGE(When Data Entered)

WVT-TR-76020

AD

FEASIBILITY STUDY OF FILAMENT WOUND
COMPOSITE ROAD WHEEL

Giuliano D'Andrea
Peter G. O'Hara
Paul J. Croteau

JUNE 1976



BENET WEAPONS LABORATORY
WATERVLIET ARSENAL
WATERVLIET, N.Y. 12189

TECHNICAL REPORT

AMCMS No. 662601.11.H9100

DA Project No. 1G662601AH91

Pron No. EH-6-2E346-01-EH-M7

APPROVED FOR PUBLIC RELEASE; DISTRIBUTION UNLIMITED

ACKNOWLEDGMENT

1. The authors gratefully acknowledge the excellent assistance, cooperation and contributions of the following individuals:

Mr. R. Soanes, Mr. R. L. Cullinan, Mr. H. S. Scheck
and Lt Arnold M. Manaker

2. Special thanks to Mr. R. Siorek of TACOM for his valuable suggestions and guidance, and Mrs. Patricia Clinton for the preparation of the manuscript.

3. Particular appreciation is extended to Colonel Richard H. Sawyer, and Colonel R. E. Philipp without whose recommendations this work would not have been possible.

TABLE OF CONTENTS

	Page
REPORT DOCUMENTATION PAGE, DD FORM 1473	
ACKNOWLEDGMENT	i
INTRODUCTION	1
I. THEORY	5
M113 Road Wheel	7
Composite Road Wheel	7
II. FABRICATION	15
III. TESTING	30
IV. CONCLUSIONS AND RECOMMENDATIONS	36
DISTRIBUTION LIST	

LIST OF ILLUSTRATIONS

Figure		
1	Front view of prototype composite road wheel.	3
2	Side view of prototype composite road wheel.	4
3	Schematic of M113 aluminum road wheel.	8
4	Undeformed shape of the M113 aluminum road wheel.	9
5	Deformed shape of the M113 aluminum road wheel.	10
6	Schematic of the composite road wheel.	12
7	Undeformed shape of the composite road wheel.	13
8	Deformed shape of the composite road wheel.	14
9	Overall view of the photo controlled, servo driven, filament winding machine.	16
10	Close-up of control panel of winder.	17
11	Side view of traversing mechanism.	18
12	Rear view of traversing mechanism with four tension devices (with spools).	19
13	Close-up of a compensating type tensioning device used for the pre-preg glass roving.	20
14	Close-up of winder's photo control mechanism.	21
15	Photo control mechanism with program on drum.	22
16	Composite road wheel mandrel and M113 disk.	23
17	Pulley arrangement to wind mandrel shown in Figure 14.	24

LIST OF ILLUSTRATIONS (Cont)

	Page
18 Composite road wheel disks after separation from mandrel and placed back to back for further winding.	26
19 Side view of road wheel.	27
20 Composite disks wound to provide clearance for track indexing lug.	28
21 Typical filament winding program showing also mandrel geometry and angle of wrap vs distance.	29
22 Load deflection curve for the M113 aluminum disk (without rubber pad).	31
23 Load deflection curve of one composite disk.	32
24 Load deflection curve of the prototype composite road wheel.	33
25 Composite road wheel #1.	40
26 Composite road wheel #2.	41

LIST OF TABLES

Table	
1 Road wheel modeling accomplished by the use of NASTRAN finite element system.	6
2 Stress state in M113 and composite road wheels when subjected to a 12,000 pound radial load.	11
3 Compliance data for the test and theory.	34

INTRODUCTION

The road wheel study provides a convincing demonstration of the broad utility of filamentary composites. Although the original objective of this work was to minimize or reduce conventional road wheel weight, it seems that the use of composites might also reduce road wheel vulnerability to mine blast effects. The Watervliet Arsenal's proposal to TACOM was made October 1974, followed by a visit from Mr. R. Siorek (TACOM) on April 7, 1975, and actually funded 7 August 1975.

The April 7, 1975 meeting with Mr. R. Siorek produced the following recommendations:

1. It was felt that every effort should be made to start an organized R&E effort in developing a lightweight composite road wheel choosing as a model the M113 wheel.
2. A two year plan was tentatively sketched.
 - a. 1st Year:
 - Phase I: Preparation of a design
 - II: Fabrication of three prototypes
 - III: Limited in-house testing
 - IV: In-house testing at TACOM which would include:
 - a. Static and Rolling Loads
 - b. Impact Tests
 - c. Drum Endurance Tests
 - d. Side-Load Tests

b. 2nd Year: (Upon successful completion of first year phases)

Phase I: Fabrication of a full set of road wheels plus spares (a total of 26 wheels)

Phase II: Field test which would include

- a. Endurance
- b. Performance
- c. Noise
- d. Vibration
- e. Cold Tests

This report presents the first attempt in the design, fabrication, and testing of the Fiberglass/Epoxy composite road wheel depicted in Figures 1 and 2. The work accomplished is reported as follows:

I. Theory

- a. Analysis of the conventional M113 road wheel
- b. Analysis of the proposed composite wheel

II. Fabrication

III. Testing

Static test results for

- a. M113 road wheel
- b. Glass/Epoxy wheel

IV. Conclusions and Recommendations

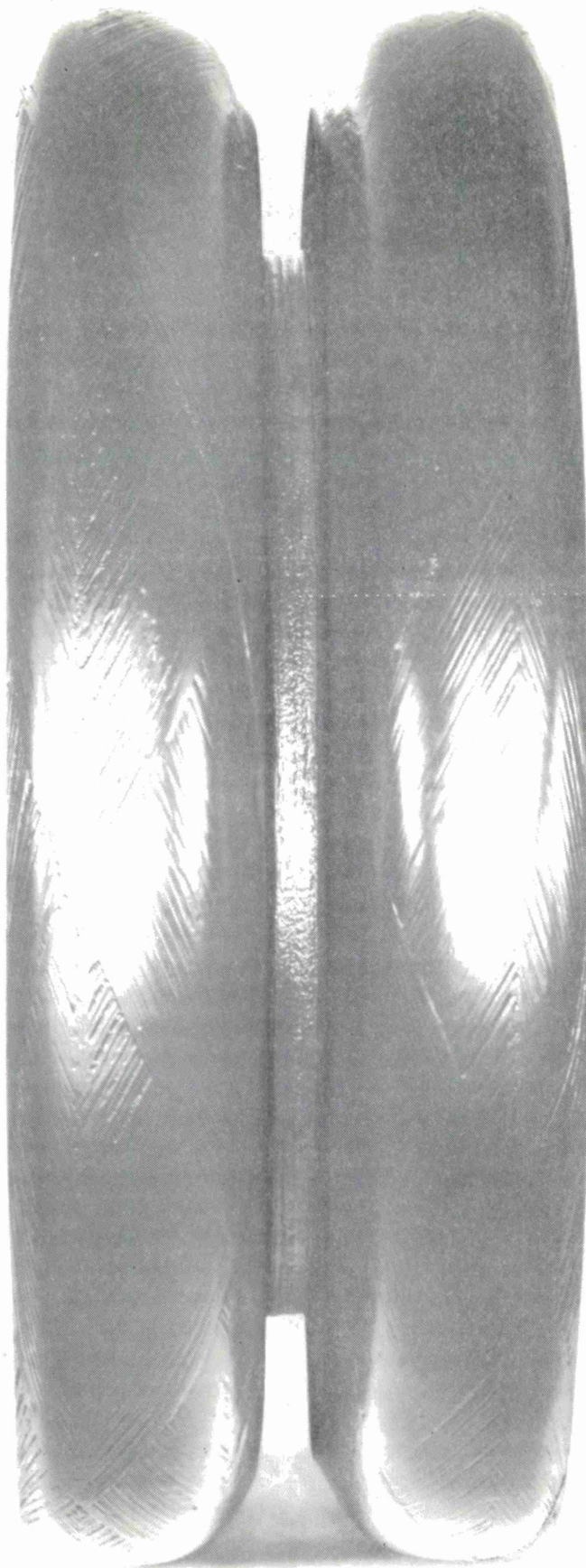

Figure 1. Front view of prototype composite road wheel.

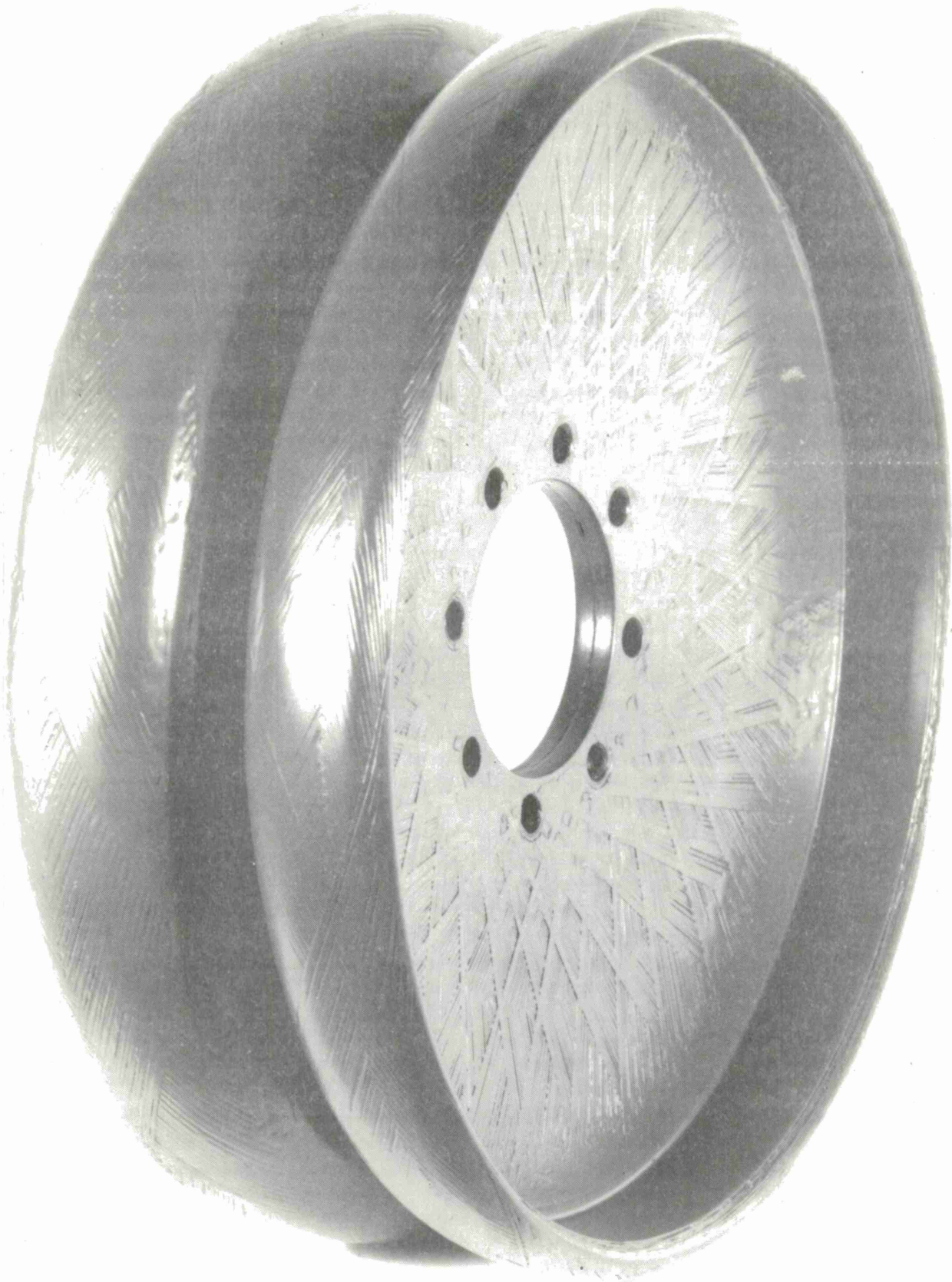

Figure 2. Side view of prototype composite road wheel.

I. THEORY

The theoretical modeling of the composite road wheel has been accomplished by the use of NASTRAN finite element system. The structure, characterized as an axisymmetric, anisotropic shell with non-symmetric loads, is analyzed by using the triangular membrane and bending plate element (CTRIA1) with transverse shear included. To test the theoretical procedure, and to provide a basis for comparison, the standard aluminum M113 road wheel was analyzed, and a simple experiment was performed on both configurations.

The rather limited project comprises primarily a comparative study, with some simplifying assumptions:

- a. The rubber tire and wear ring were not included in the analysis.
- b. Only one disk was considered.
- c. Only a simple diametrical compression load was used.

The two finite element grids needed for the analysis were generated for one fourth (1/4) of each wheel using the program SGEN. These two grids both contain 113 grid points, 186 elements, and have similar element number systems. Rigid body movement is eliminated by grid point constraint (accomplished by the required symmetry constraints) whereas translation normal to the disk is eliminated by constraints at the lug bolt hole positions.

A total of ten (10) computer runs were made on the two configurations. This was done to account for the different thicknesses, the concentration of the load at one point in the test, and an altered constraint to account for the bonded composite wheel.

A summary of the conditions used in the runs is shown in Table 1. This work resulted in several hundred pages of computer printout which is much too

TABLE 1. ROAD WHEEL MODELING ACCOMPLISHED BY THE USE OF NASTRAN FINITE ELEMENT SYSTEM.

<u>RUN</u>	<u>MODEL</u>	<u>THICKNESS</u>	<u>WEIGHT</u>	<u>MATERIAL</u>	<u>LOAD</u>	<u>CONSTRAINT</u>
1	S	0.375	20.4	al.	press.	half
3	S	0.375	20.4	al.	point	half
4	S	0.310	16.9	al.	point	half
5	C	0.500	18.9	S-Glass	press.	half
7	C	0.500	25.2	al.	press.	half
8	C	0.500	18.9	S-Glass	point	half
9	C	0.500	18.9	S-Glass	point	full
10	C	0.375	14.2	S-Glass	press.	half

extensive for detailed description. In this report the results will be discussed in terms of three (3) runs and stresses in seven (7) elements of each run.

M113 Road Wheel

Figure 3 shows the cross-section or shape of the standard aluminum M113 road wheel. This wheel has a maximum thickness of 0.375 inches (Run #1). The narrow band pressure load is shown by two vectors because only two (2) grid points fall on the outer flat portion of this configuration as it can be seen in the undeformed plot (Figure 4). A deformed grid plot is shown in Figure 5 and stress values are given in Table 2.

Composite Road Wheel

Figure 6 shows the cross section or shape of the composite wheel made of S-Glass filaments (68% by volume) embedded into an epoxy matrix. Because of the different filament angles (Figure 21), twenty (20) different material property sets were generated using computer program PLAPROP. This process was carried out for thicknesses of 0.5 inches and 0.375 inches. The load was applied at three (3) points as shown in the undeformed plot in Figure 6. Figures 7 and 8 show a undeformed and deformed plot of the grid, whereas the stress values are given in Table 2 for both thicknesses.

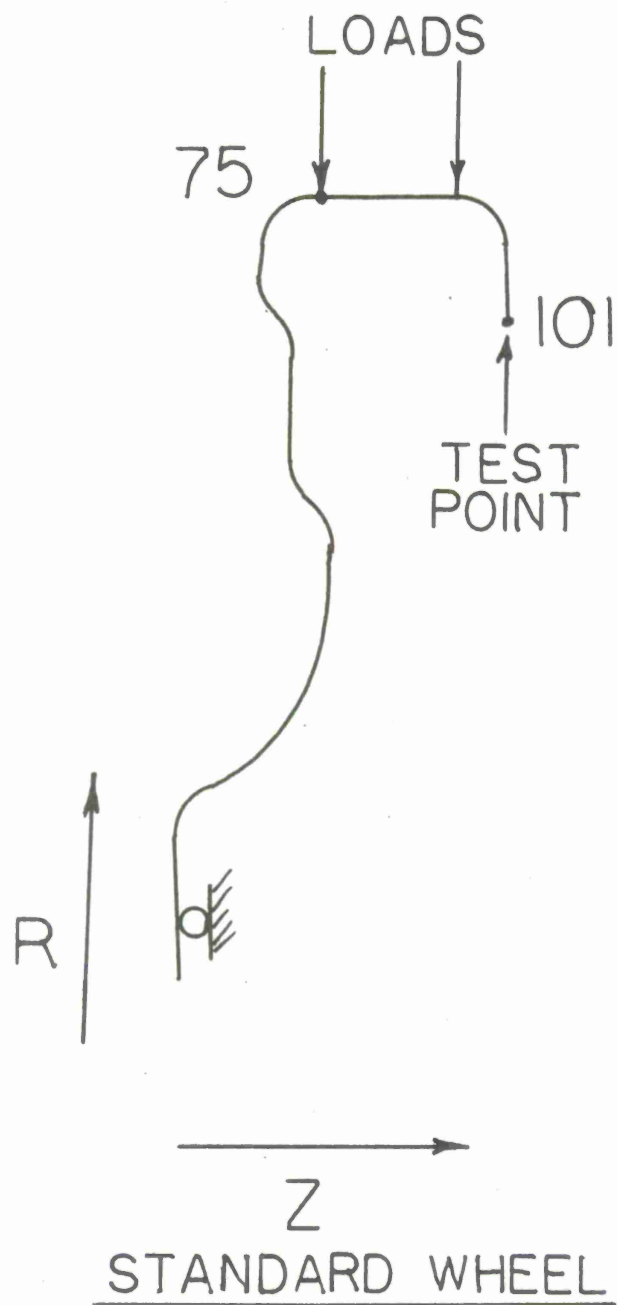

Figure 3. Schematic of M113 aluminum road wheel.

ALUMINUM WHEEL
T=0.375
1/4 WHEEL
UNDEFORMED SHAPE

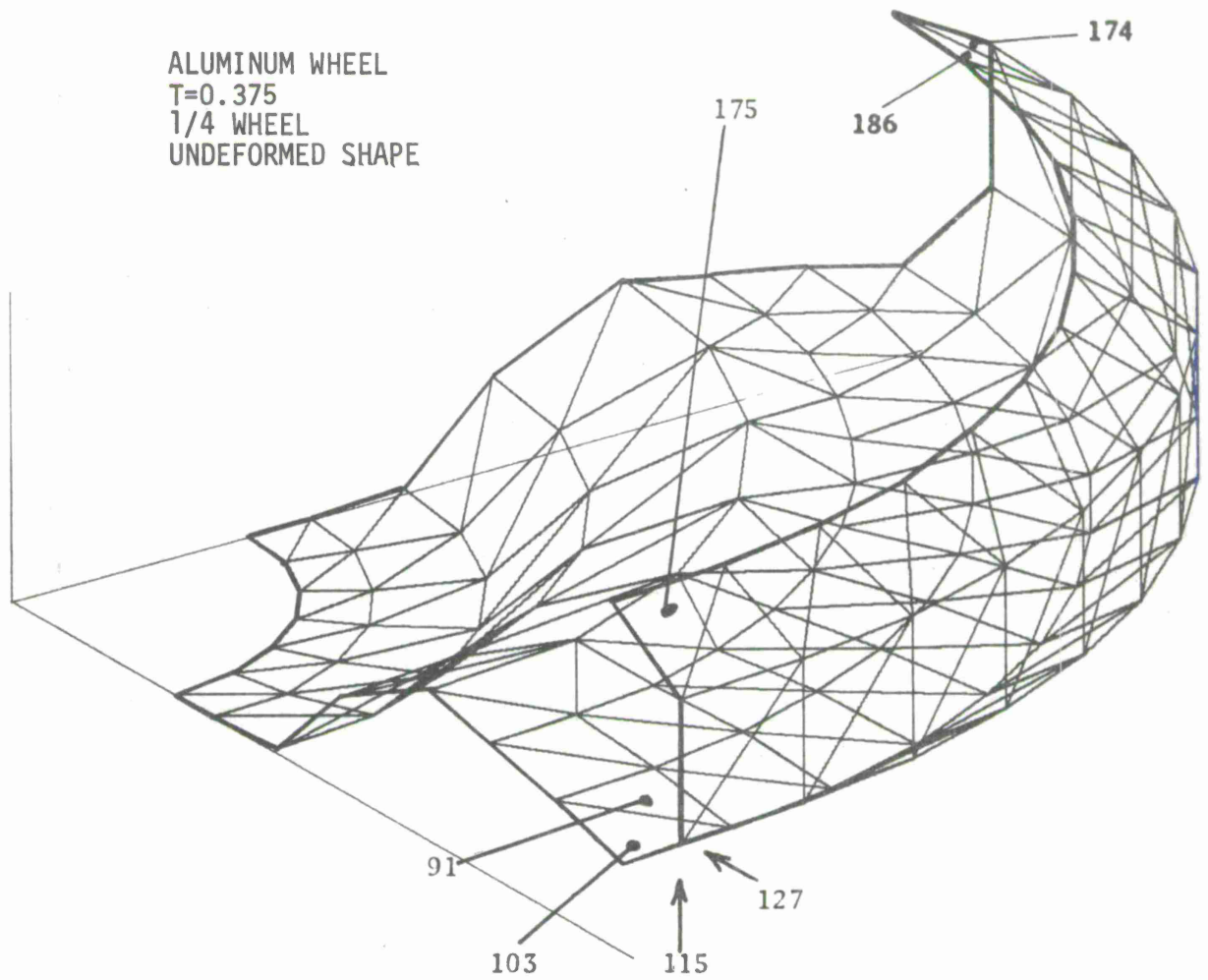

Figure 4. Undeformed shape of the M113 aluminum road wheel.

ALUMINUM WHEEL
T=0.375
RADIAL CONSTRAINT OF 0.100 INCHES
STATIC DEFORMATION - SUBCASE 12 LOAD SET 0

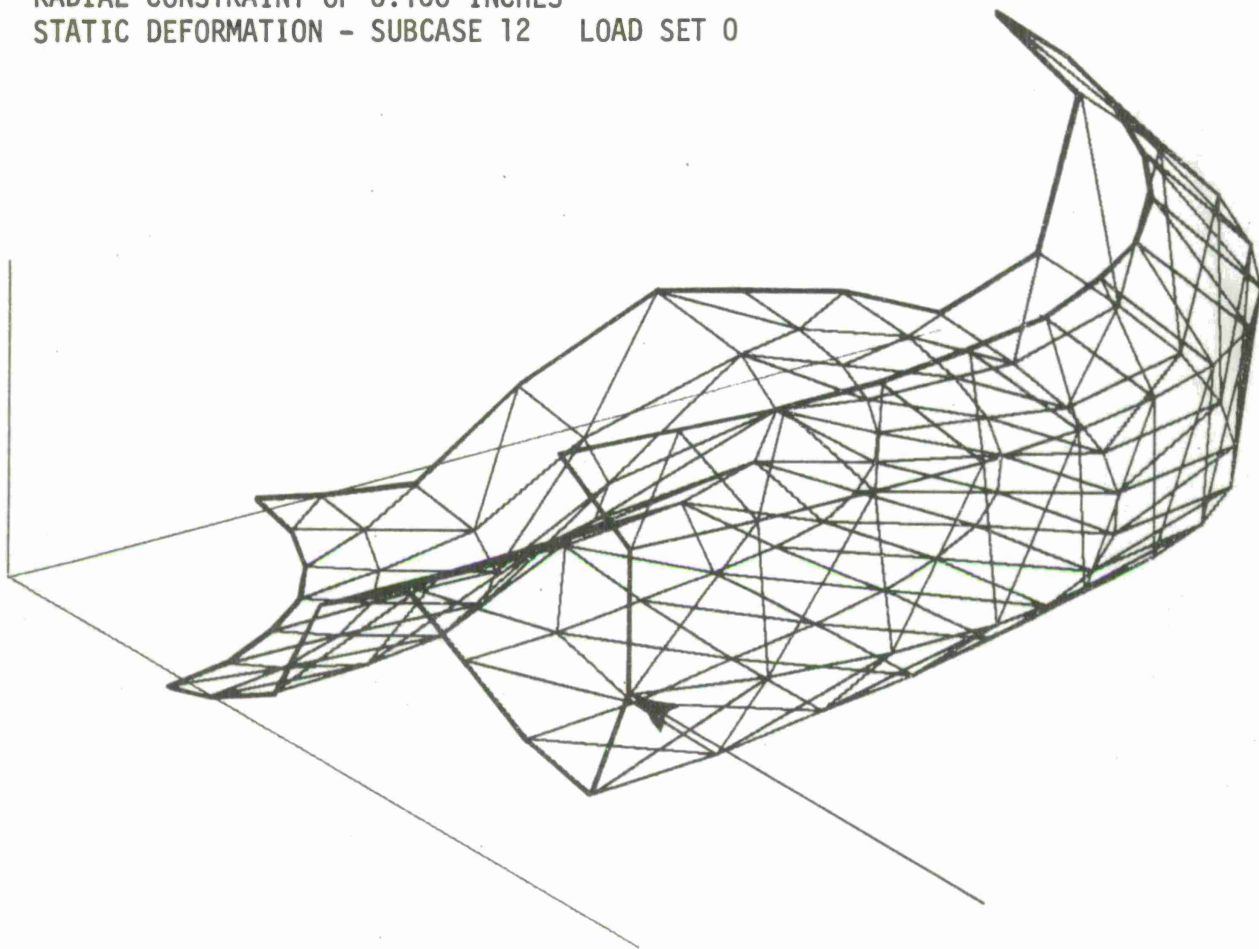

Figure 5. Deformed shape of the M113 aluminum road wheel.

TABLE 2. STRESS STATE IN M113 AND COMPOSITE ROAD WHEELS WHEN SUBJECTED TO A 12,000 POUND RADIAL LOAD.

Load	M113 (Run 1)		COMPOSITE WHEEL			
	1.0 Pound	12,000 Pounds	T=0.5, 1.0 Pound	(Run 5) 12,000 Pounds	T=0.375 1.0 Pound	(Run 10) 12,000 Pounds
Max. stress						
91	-4.76	-51,100	-0.57	-6,800	-0.59	7,080
103	-6.12	-73,400	-1.59	-19,100	-2.14	25,700
115	-4.32	-51,800	-0.89	-10,700	-1.32	15,800
127	-5.36	-64,300	-1.96	-23,500	-3.10	37,200
174	-1.04	-12,500	-0.72	-8,600	-0.99	11,900
175	7.03	84,400	0.85	10,200	1.18	14,200
186	-2.83	-34,000	-1.23	-1,480	-1.66	19,900
Max. shear stress						
91	1.17	14,000	0.11	1,300	0.10	1,200
103	1.86	22,300	0.53	6,400	0.76	9,100
115	1.72	20,600	0.23	2,800	0.37	4,400
127	1.85	22,200	0.59	7,100	1.12	13,400
174	0.74	8,900	0.34	4,100	0.47	5,600
175	4.28	51,400	0.67	8,000	0.98	11,800
186	1.31	15,700	0.58	7,000	0.79	9,500

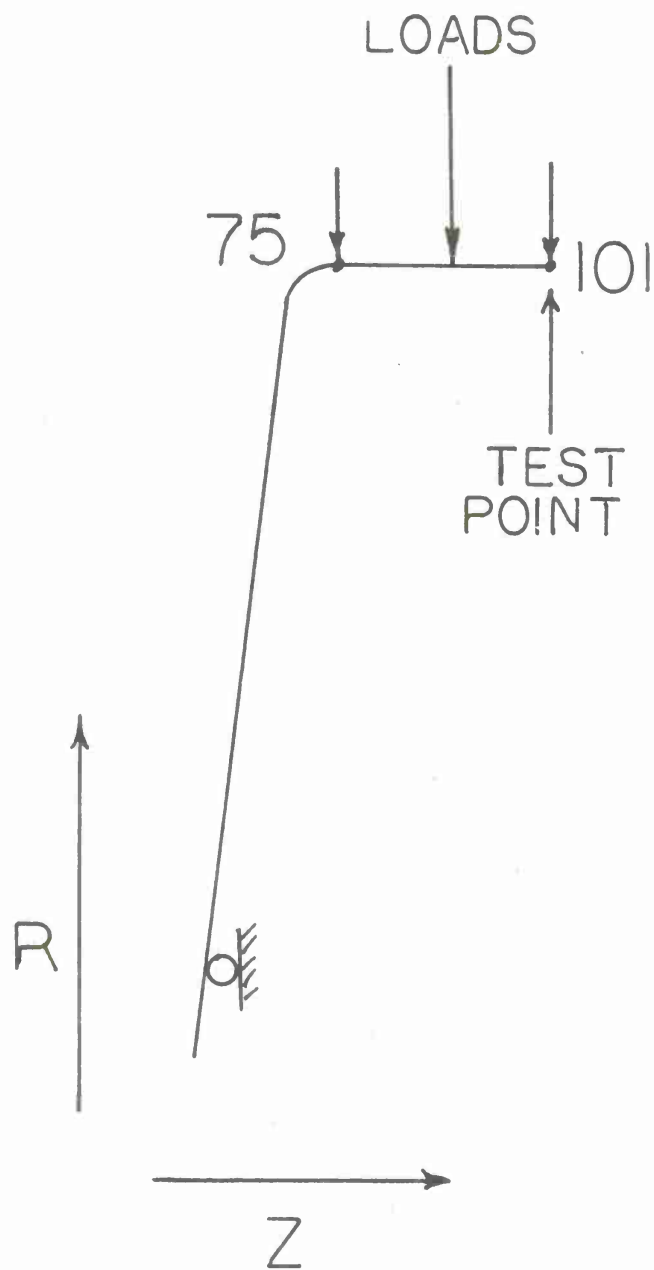

Figure 6. Schematic of the composite road wheel.

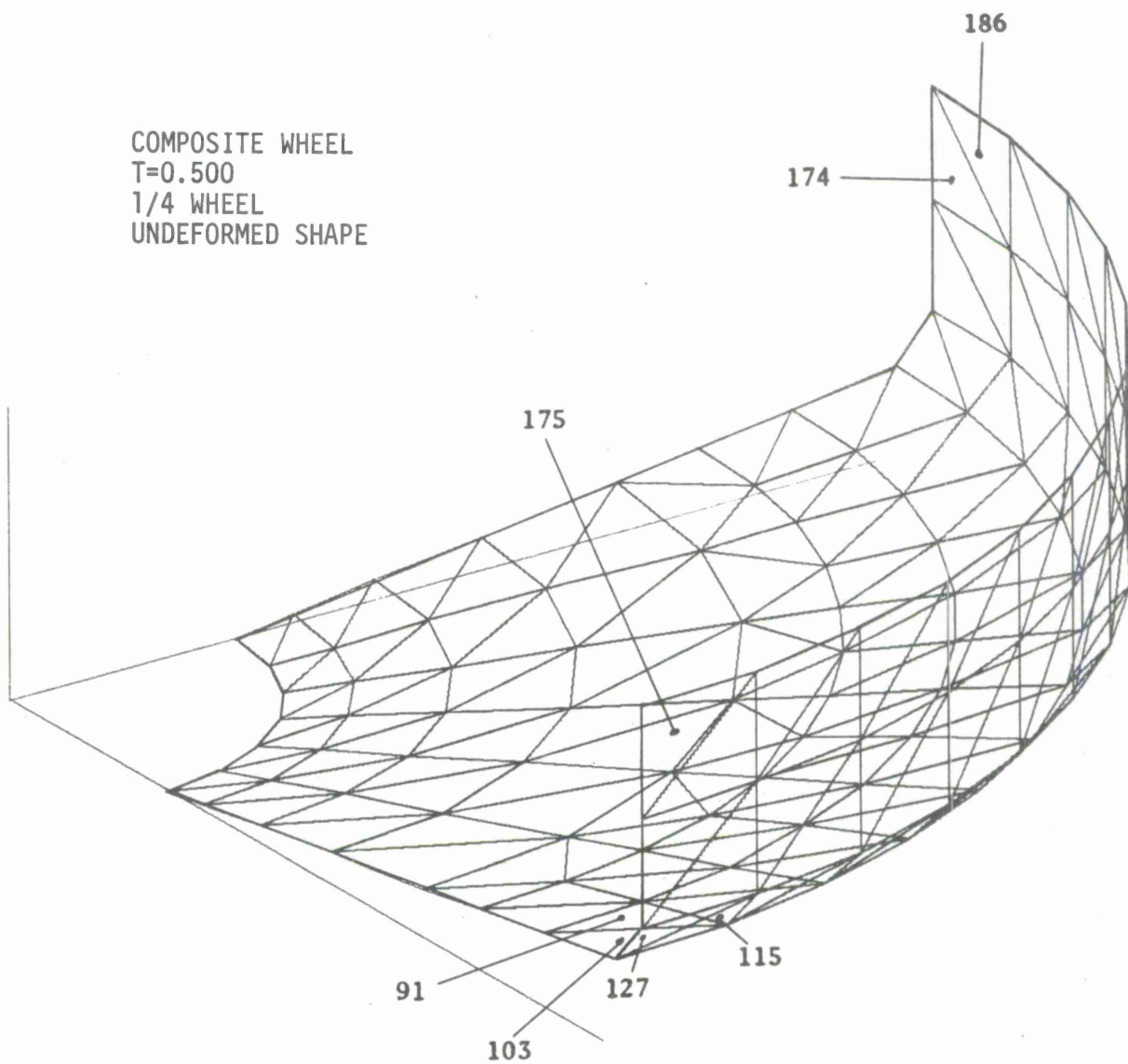

Figure 7. Undeformed shape of the composite road wheel.

COMPOSITE WHEEL
T=0.500
RADIAL LOAD = 1.0 POUND
STATIC DEFORMATION - SUBCASE 10 LOAD SET 10

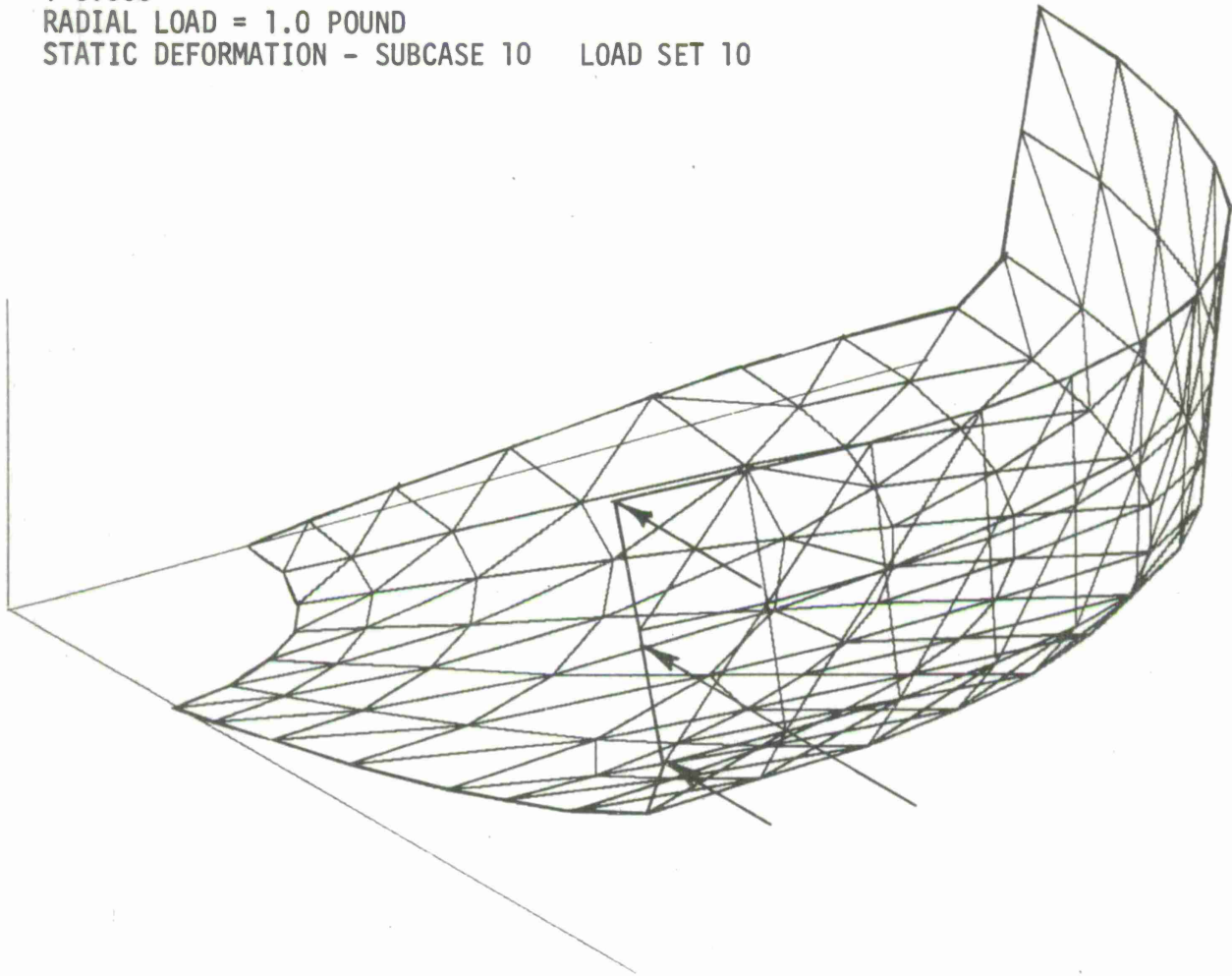

Figure 8. Deformed shape of the composite road wheel.

II. FABRICATION

The composite road wheel was fabricated by using a sophisticated filament winding machine (Figs 9 and 10). This versatile machine is an electronically-controlled, programmable, servo-driven unit with a high degree of winding flexibility. This machine will helically wind all stable shapes from 1 to 90°, polar, and hoop. Cones and objects with unequal pole diameters and varying winding angles are all within the capabilities of this machine. Once the interface drawing is made available, a mandrel and a machine program (obtained by the computer program GEOD) are then used to wind the composite structure. Figures 11 and 12 depict the traversing mechanism loaded with spools of glass, and Figure 13, a close-up view of a constant tension device (the tension of the glass roving, throughout the manufacturing process, was maintained at 6 lbs/roving). Figures 14 and 15 depict the photo control system without and with the drum supporting the plotted winding pattern obtained from Computer Program "GEOD". Details on the machine can be found in the Watervliet Arsenal Instruction and Maintenance Manual on the Filament Winding Machine Model 830-140, serial number 1088. Figure 16 depicts a M113 conventional disk and the mandrel designed for the composite wheel. The present filament delivery mechanism had to be redesigned to accommodate the low angle of wrap needed to wind mandrel of Figure 16; see pulleys arrangement shown in Figure 17. After mandrel is wrapped, the whole structure is cured under controlled conditions, later the composite component is released from the mandrel and the two disks obtained are located back to back on a second mandrel and re-set in the filament winding machine

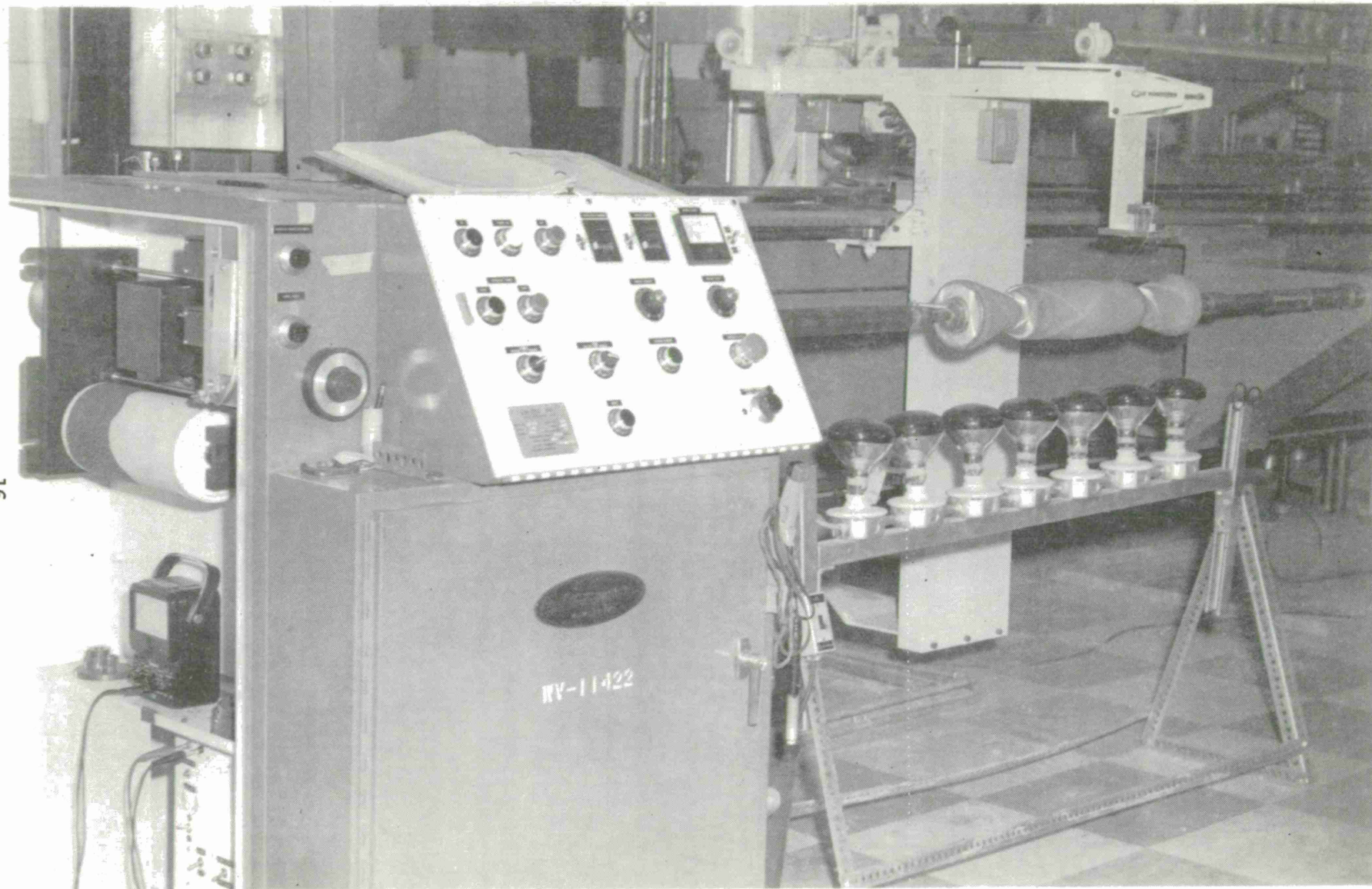

Figure 9. Overall view of the photo controlled, servo driven, filament winding machine.

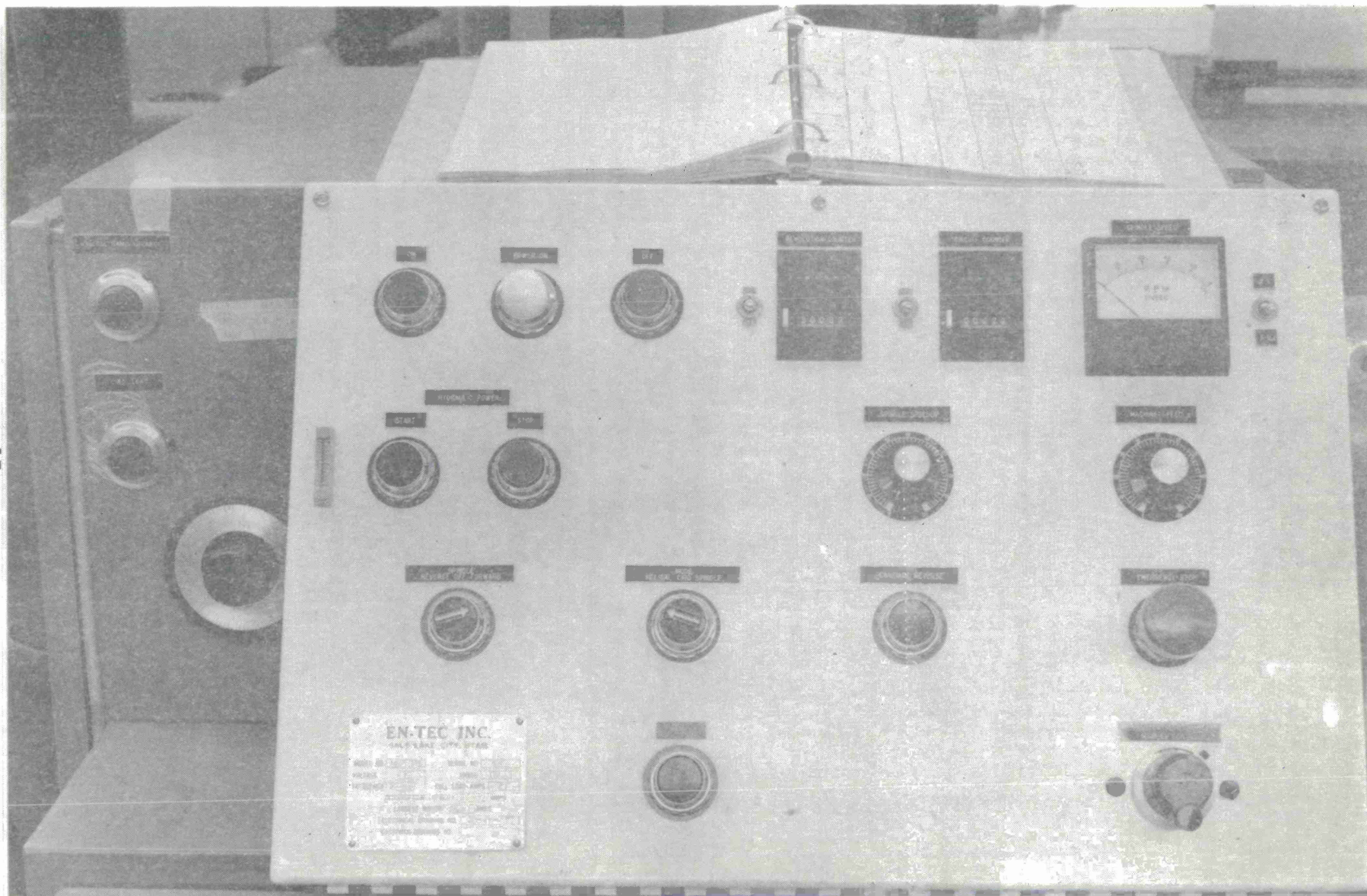

Figure 10. Close-up of control panel of winder.



Figure 11. Side view of traversing mechanism.

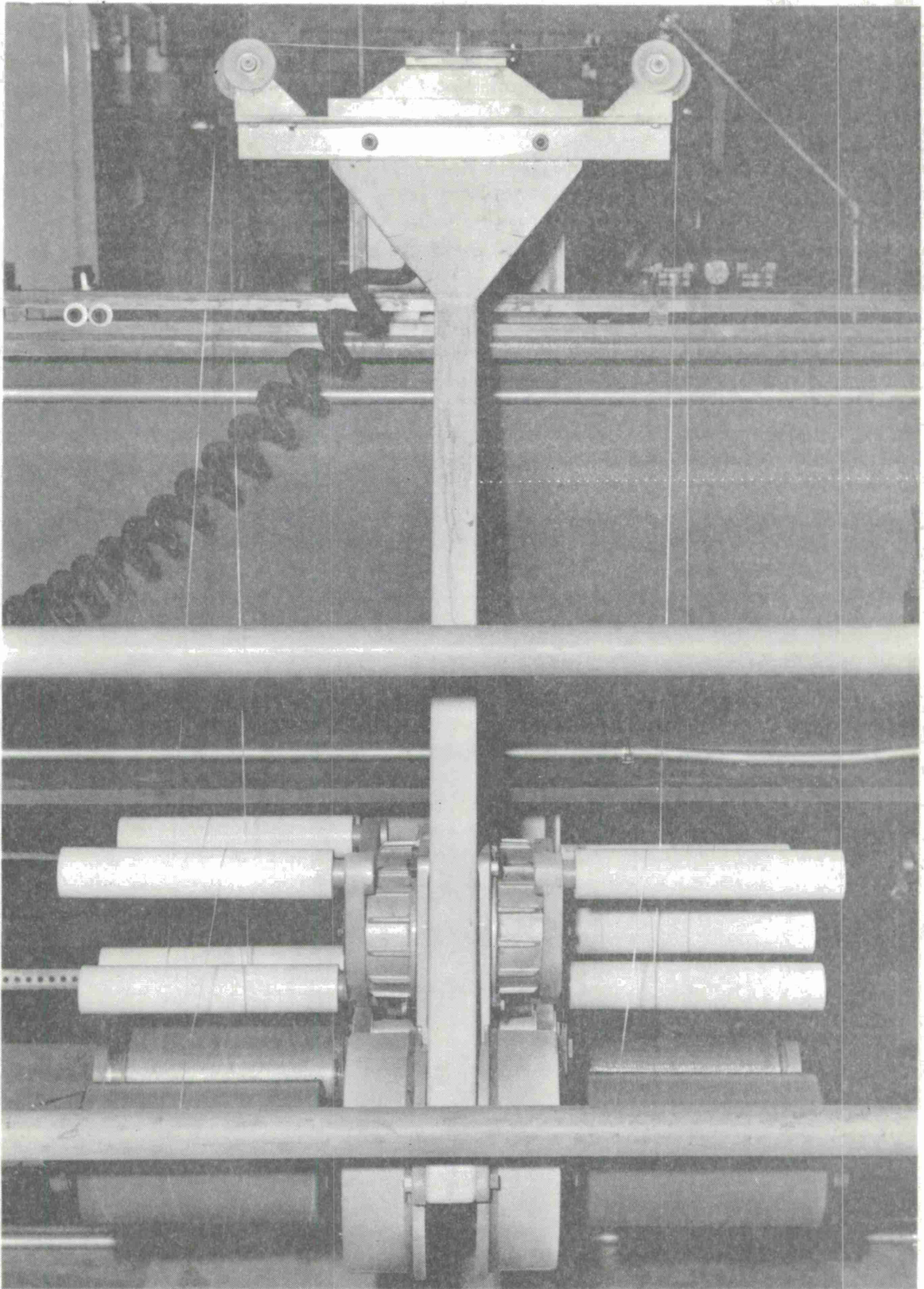

Figure 12. Rear view of traversing mechanism with four tension devices (with spools).

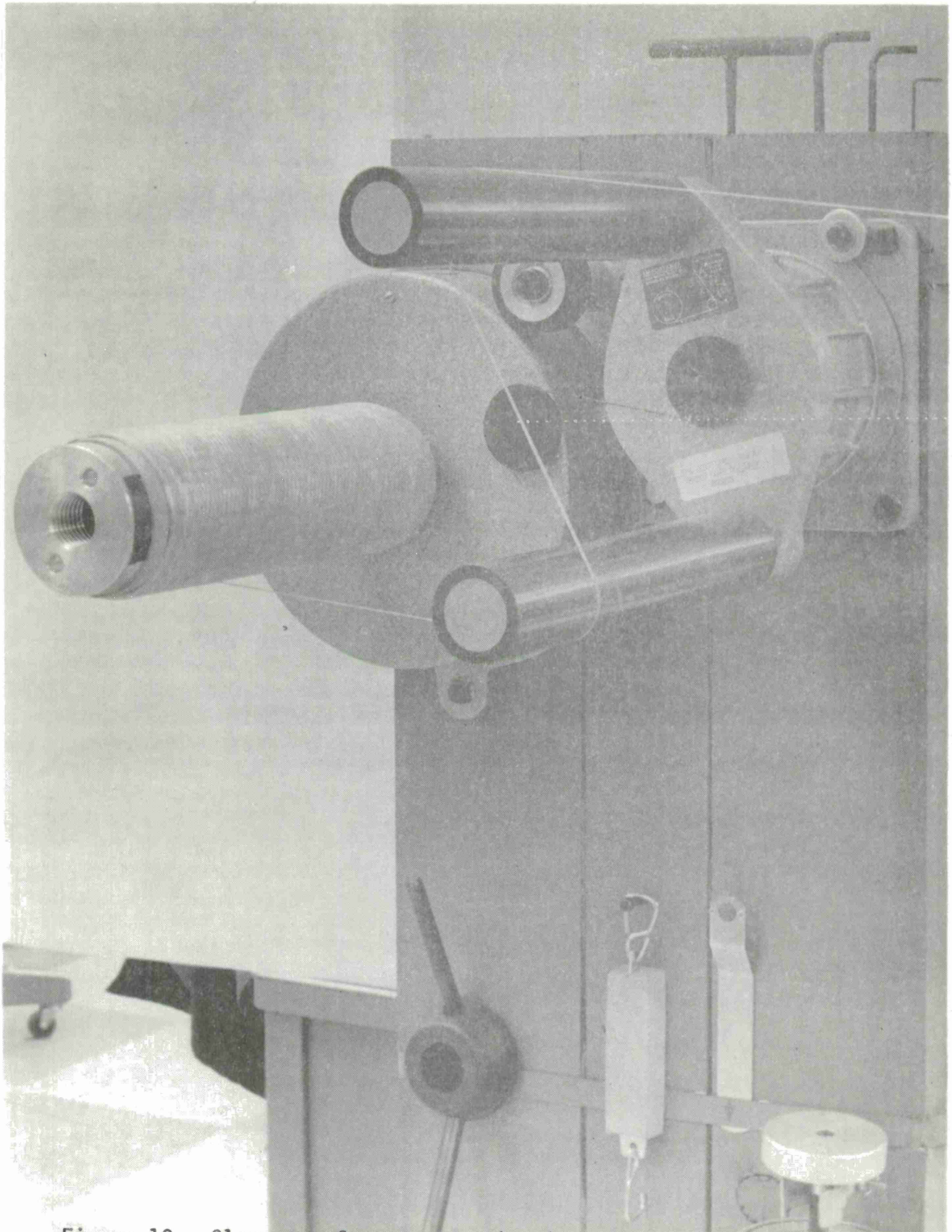

Figure 13. Close-up of a compensating type tensioning device used for the pre-preg glass roving.

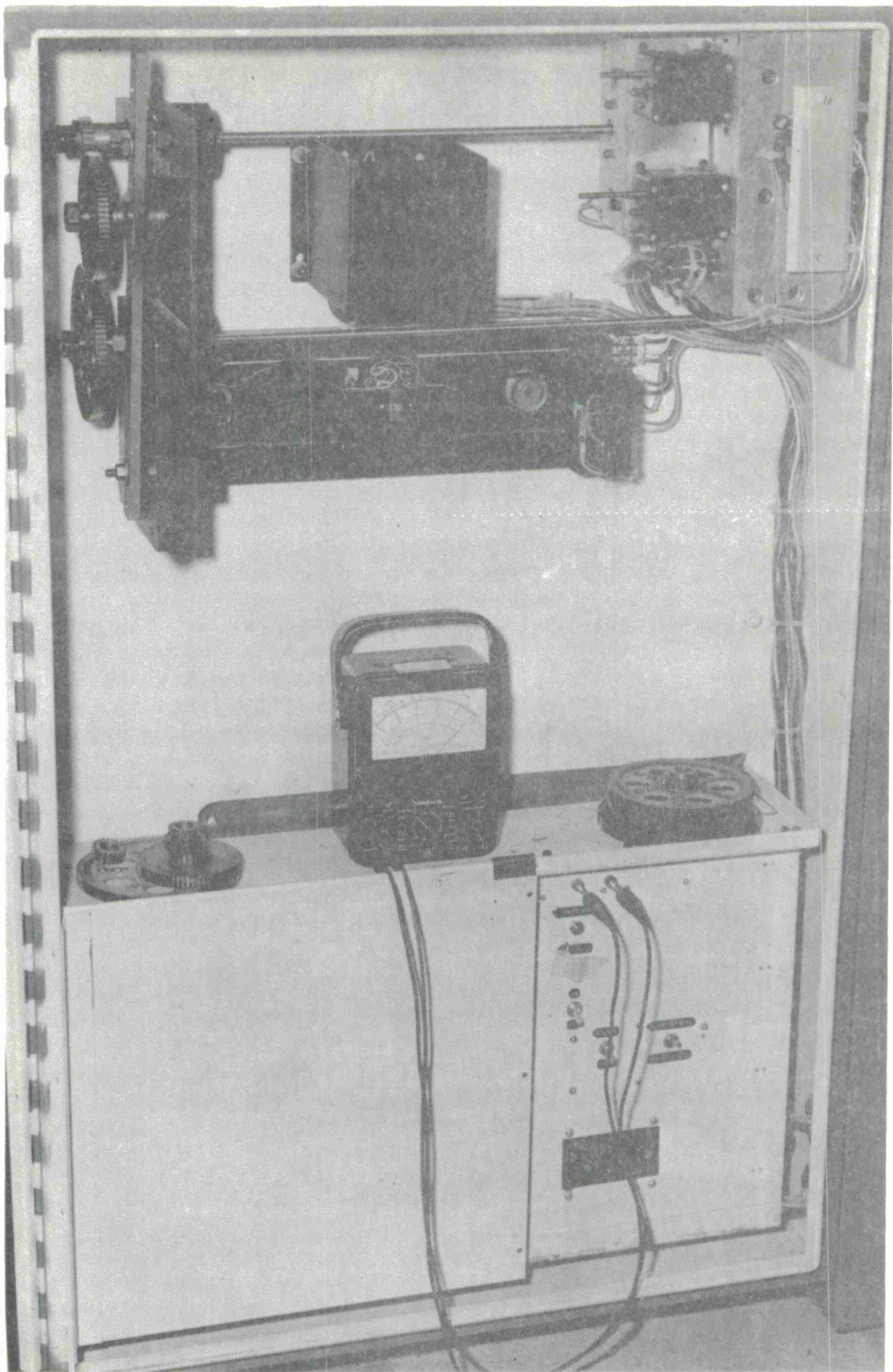

Figure 14. Close-up of winder's photo control mechanism.

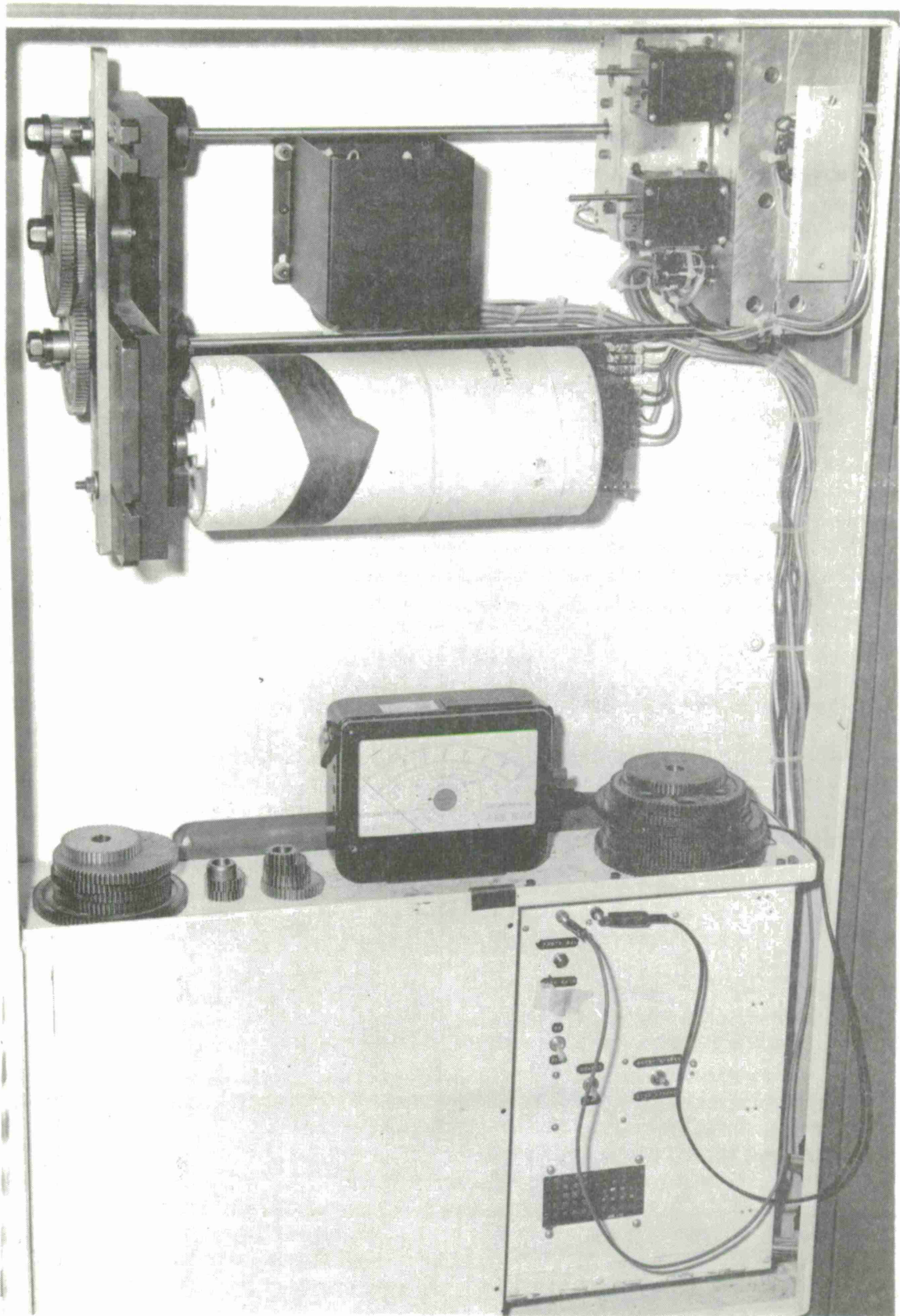

Figure 15. Photo control mechanism with program on drum.

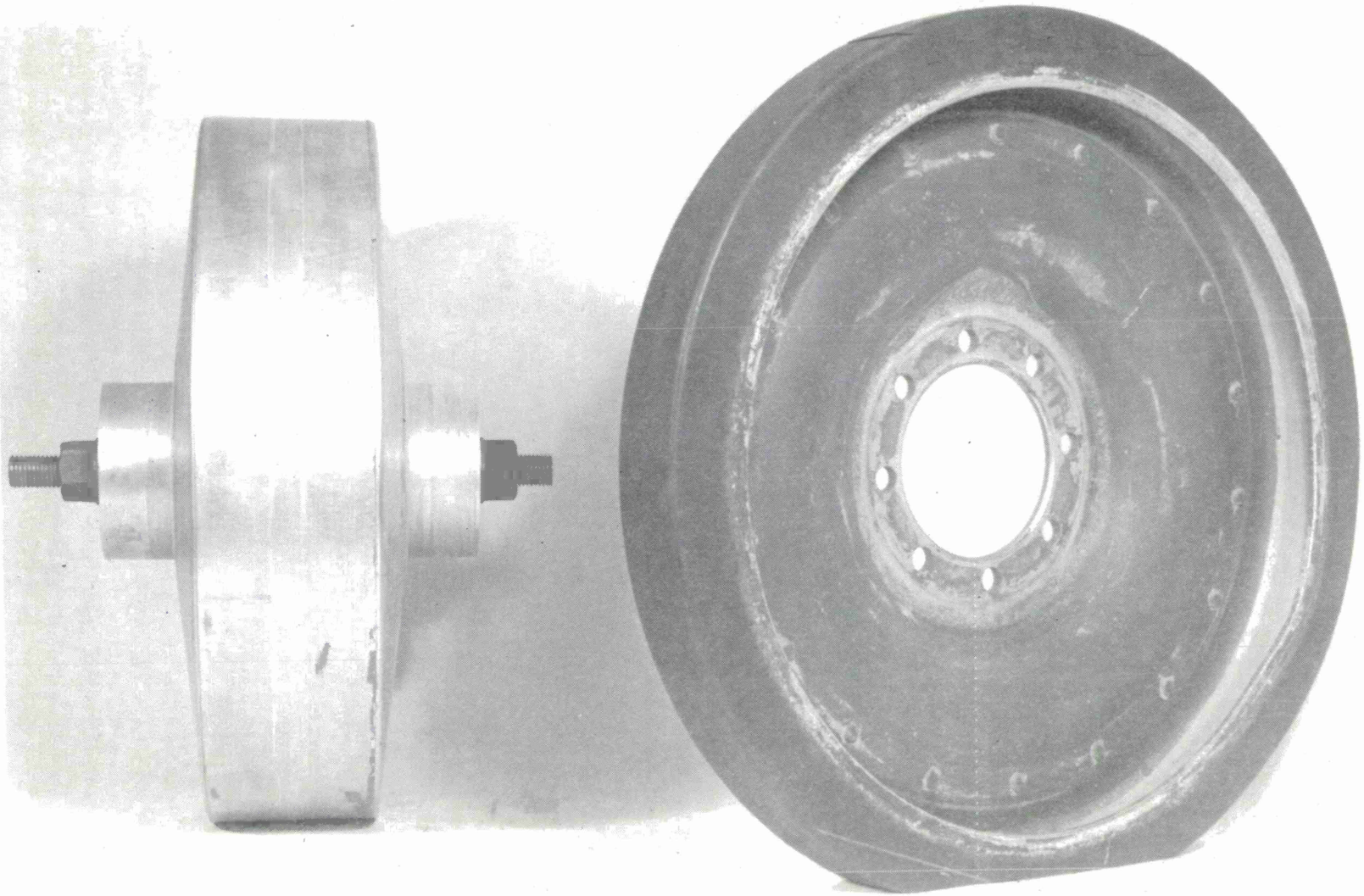

Figure 16. Composite road wheel mandrel and M113 disk.

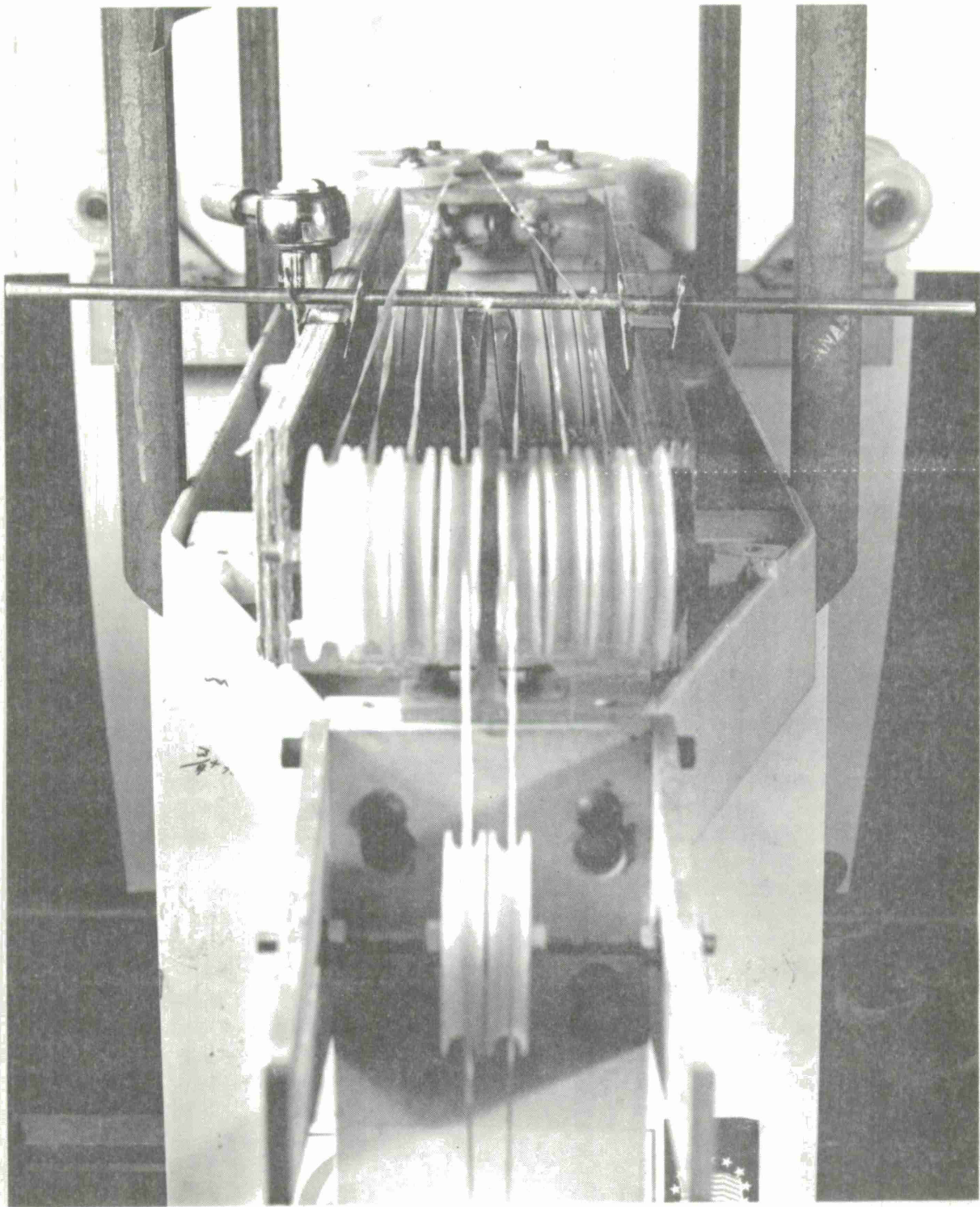

Figure 17. Pulley arrangement to wind mandrel shown in Figure 14.

as shown in Figures 18 and 19. Figure 20 shows the last wrapping or filament winding operation which provides the proper gap or clearance for the track indexing lug. Eight filament winding programs were used to complete the composite road wheel. A typical filament winding program as obtained from the computer is displayed in Figure 21; this program was used to wrap the mandrel shown in Figure 16.

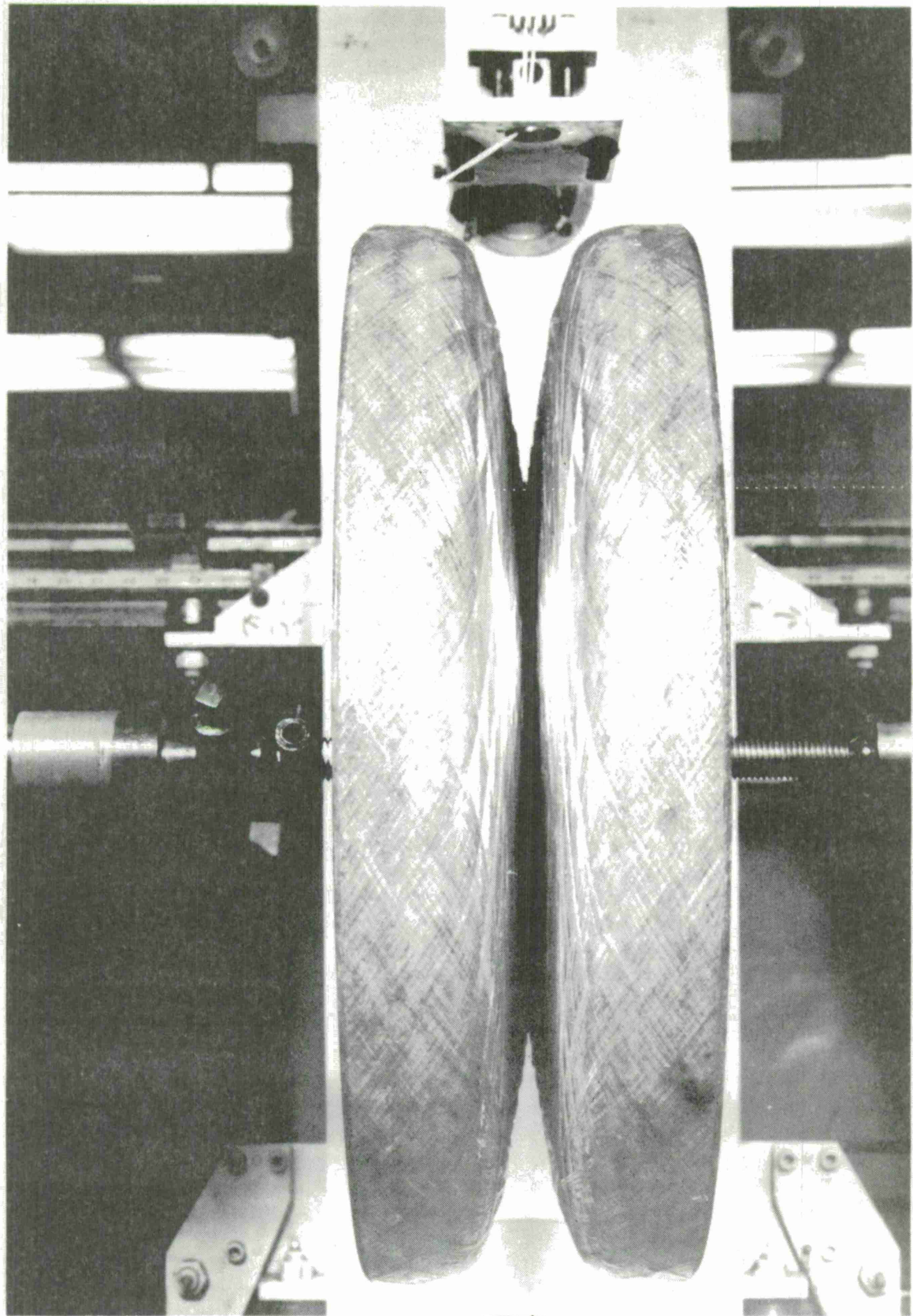

Figure 18. Composite road wheel disks after separation from mandrel and placed back to back for further winding.

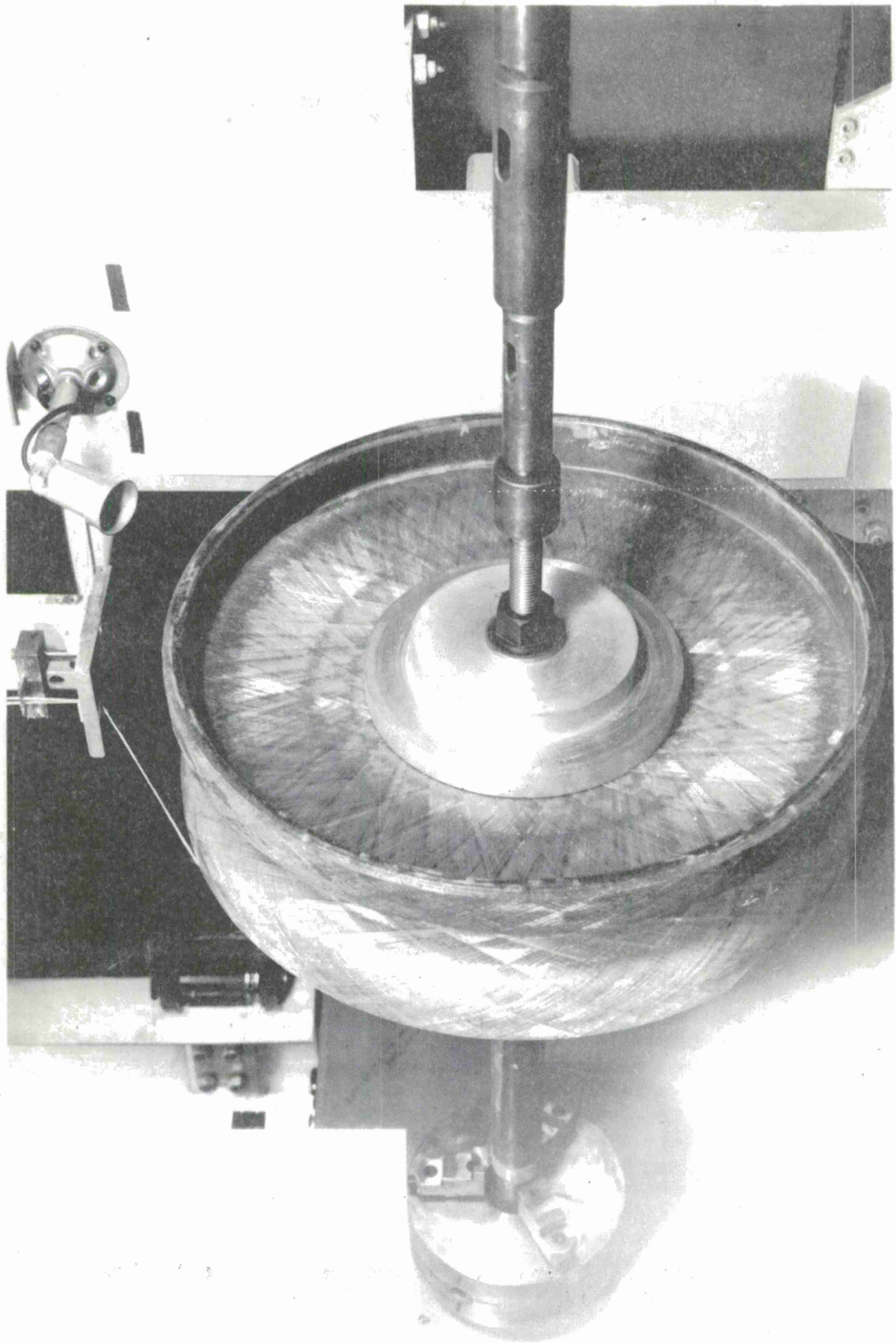

Figure 19. Side view of road wheel.

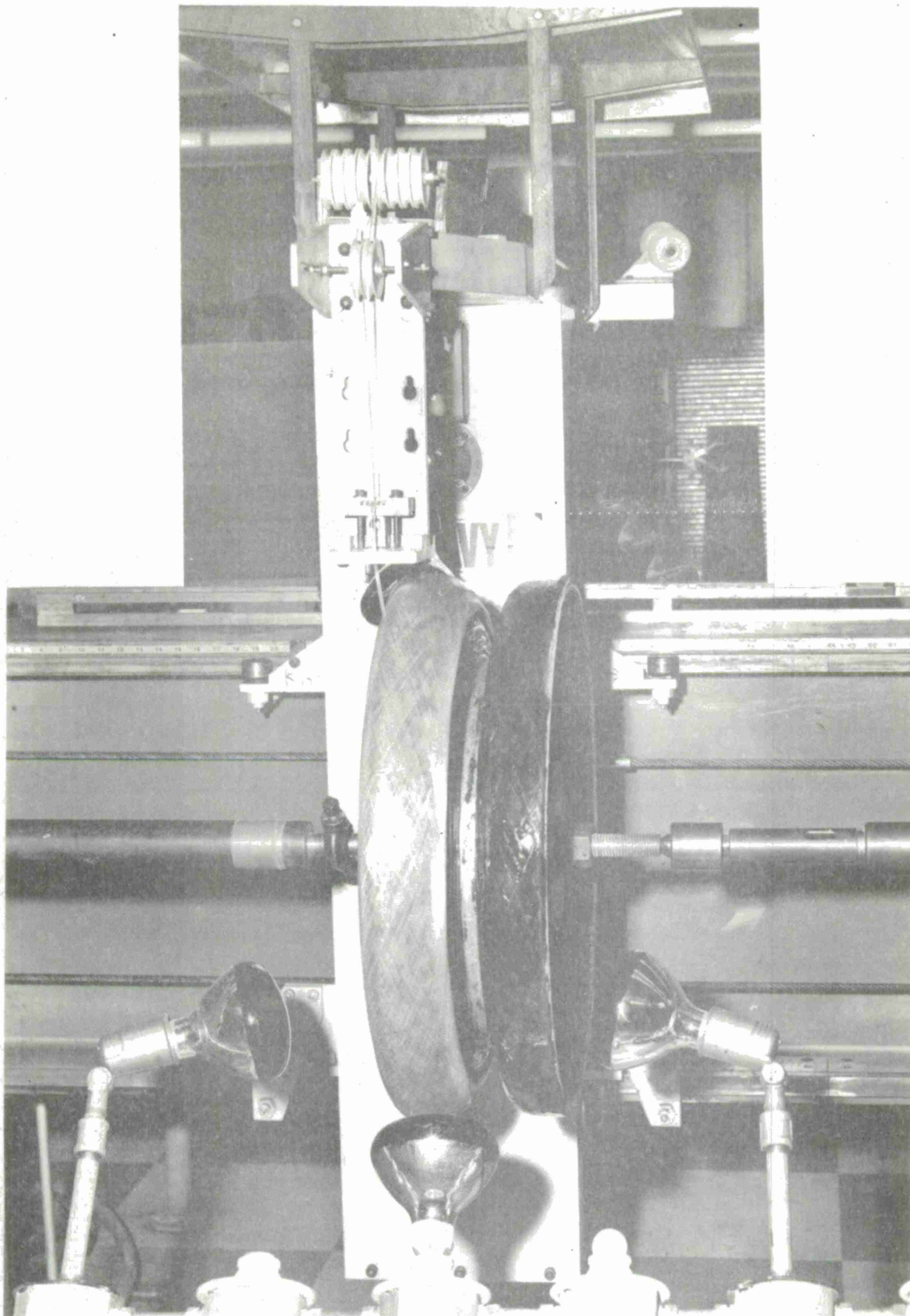

Figure 20. Composite disks wound to provide clearance for track indexing lug.

TANK WHEEL #2
CENTER BOSS DIA=6.109

EYE HT. ABOVE AXIS=12.500
EYE DIAMETER=0.625
MIN TRAVEL=.30.84

SCALE FACTOR=15.940/1
DRUM CIRCUMFERENCE=17.300

NO. OF CIRCUITS=29
NO. OF REVOLUTIONS=25

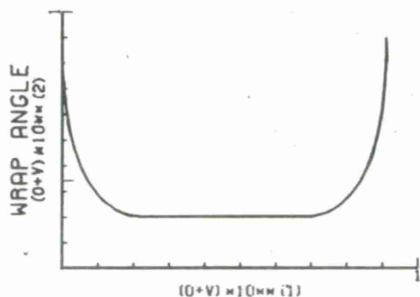
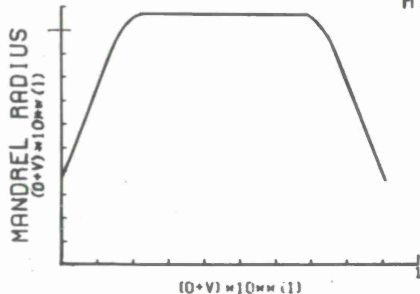

29

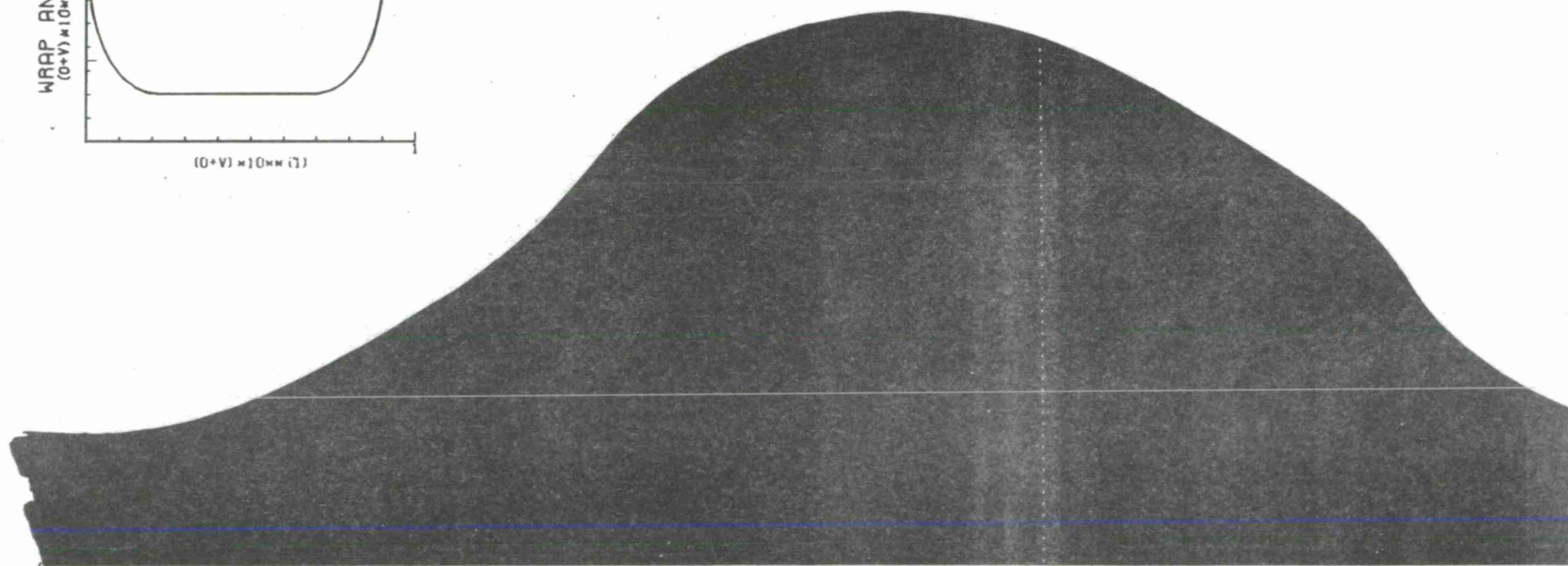

Figure 21. Typical filament winding program showing also mandrel geometry and angle of wrap vs distance.

III. TESTING

Three tests were performed in a Baldwin-Tate-Emery 120,000 pound Universal Testing Machine. In each dial indicators were used to measure compliance across the diameter of the test point shown in Figures 3 and 6. In each case the maximum load used was set primarily to give a substantial reading on the dial indicators.

The three tests were:

- a. Large disk of the M113 road wheel.
- b. Large disk of the composite road wheel.
- c. The finished composite road wheel.

The plots of the data are shown in Figures 22, 23 and 24; a summary of the compliances are given in Table 3.

This program has presented great difficulties in the comparison of the test and theoretical results, hence several computer programs were required to find a suitable loading condition to simulate the test. Runs 3 and 4 were the results of uncertainty about the thickness of the 113 wheel: thus the theoretical data is given in terms of an upper and lower bound on thickness.

In the case of the single disk of the composite wheel there is a rather large difference between the material properties used in the analysis and the finished disk; this produces a rather large error.

The test on the finished wheel presented another problem since one disk was about 0.05 inches smaller than the other and steel shims were used to improve the contact condition between the wheel and the table of

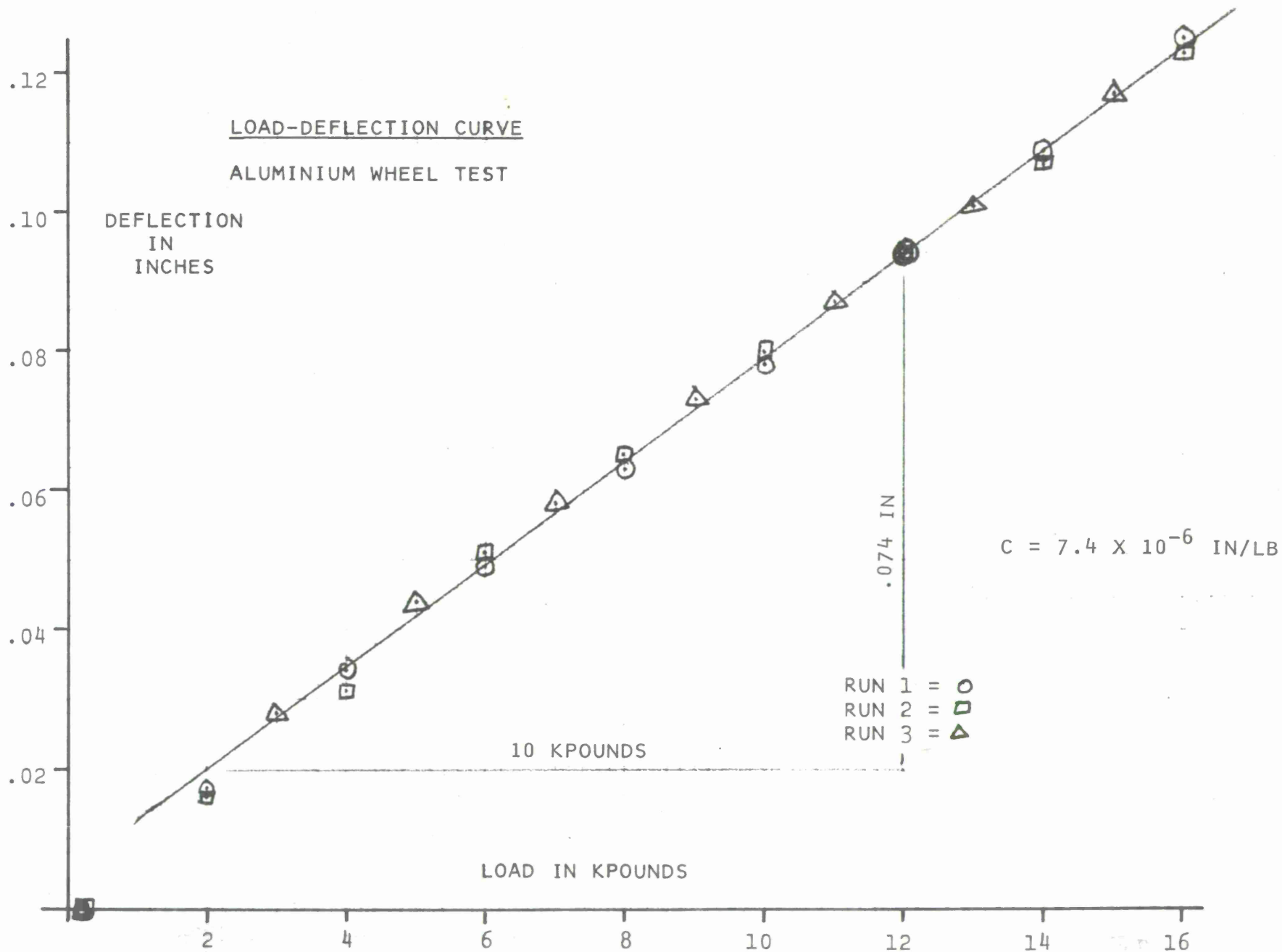

Figure 22. Load deflection curve for the M113 aluminum disk (without rubber pad).

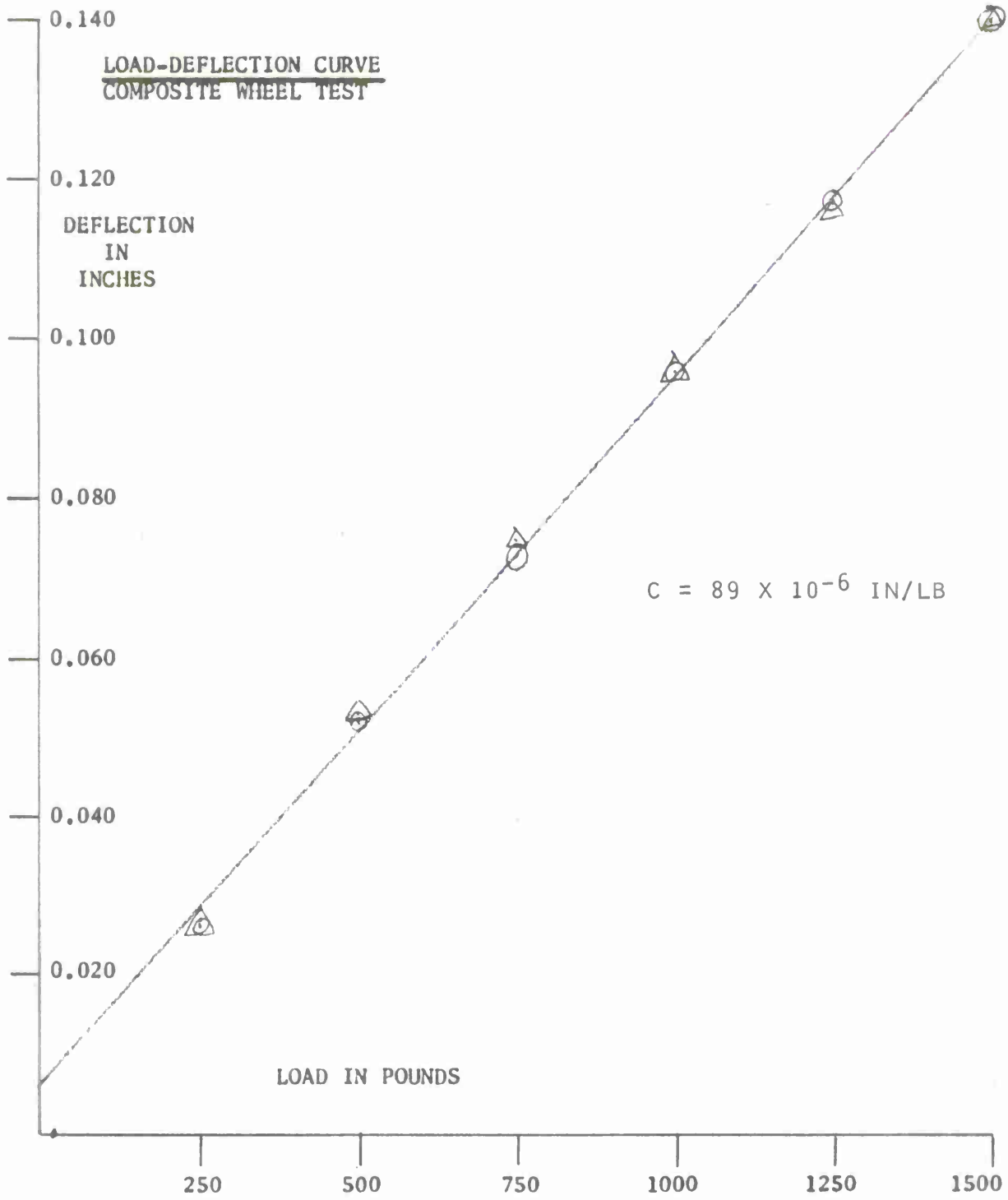

Figure 23. Load deflection curve of one composite disk.

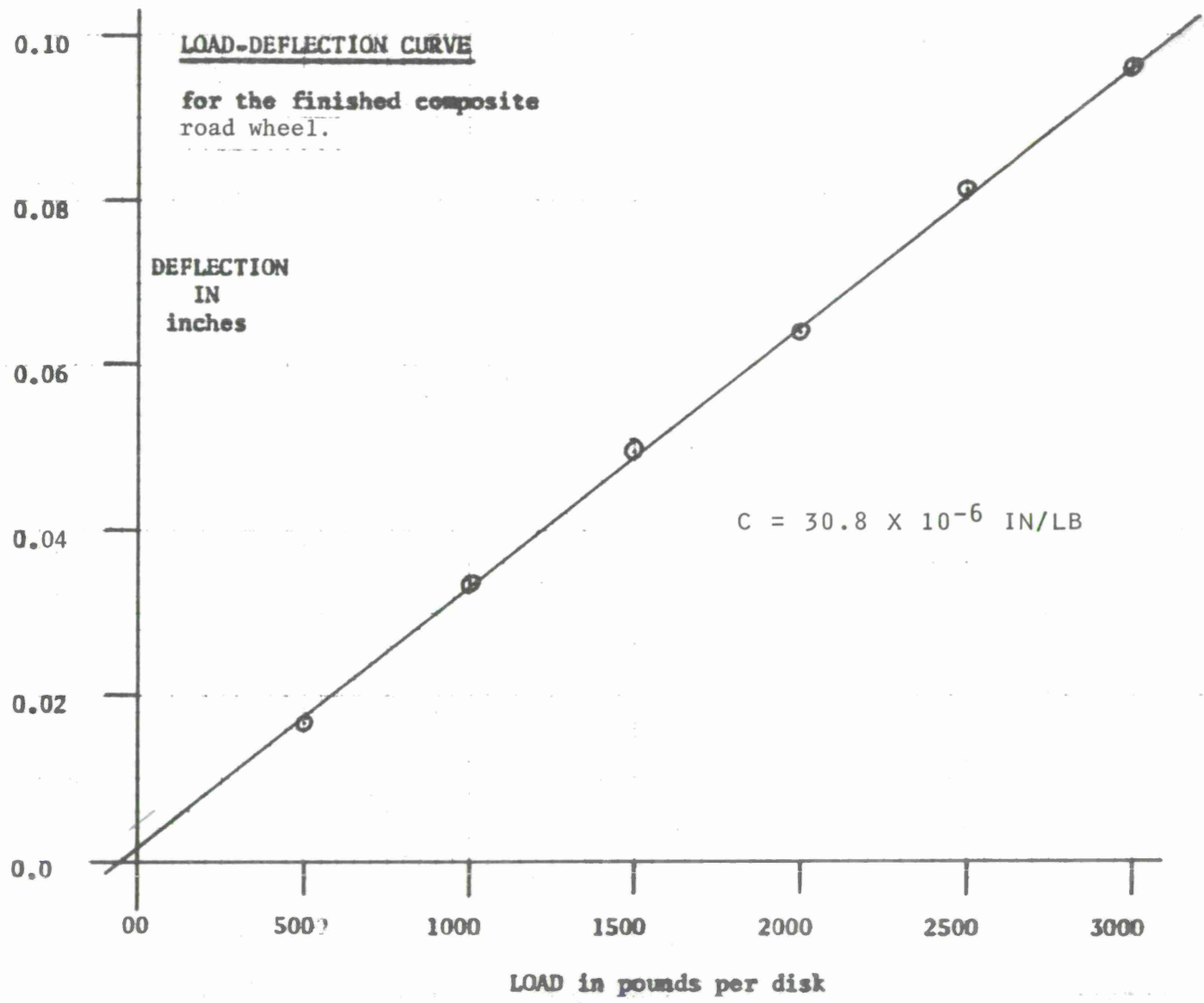

Figure 24. Load deflection curve of the prototype composite road wheel.

33

TABLE 3. COMPLIANCE* DATA FOR THE TEST AND THEORY

TEST		THEORY	
M113 Single Disk	7.4	UPPER BOUND	5.54 (Run 3)
		LOWER BOUND	8.27 (Run 4)
Composite Single Disk	89.0		19.9 (Run 8)
Composite Finished Wheel	30.8		22.8 (Run 9)

* Compliance in micro inches per pound load

the machine. In both of the composite wheel tests thin pads of rubber were used between the steel of the machine and wheel. In this case the rubber prevents lateral expansion of the wheel which in turn decreases the apparent compliance.

IV. CONCLUSIONS AND RECOMMENDATIONS

The feasibility of fabricating a M113 road wheel by the filament winding process has been demonstrated.

It can be seen in Table 2 that the stresses in either composite wheel configuration are generally lower than the M113 wheel, however, these values must be compared with a failure criterion for the material.

If the Tresca yielding criteria were applied to the M113 wheel and the tensile strength of the aluminum is 70,000 psi, yield would start at a maximum shearing stress of 35,000 psi. This stress is exceeded only in one element (#175) in Table 2, and a small plastic region at the 12,000 pounds load does not seem to be a serious problem.

The maximum shear failure is a controlling factor in composites. Shearing strength of composites are function of methods of fabrication. For example in the filament winding operation, because of filaments "cross-over" shearing strengths up to 35 Ksi have been reported for Glass/Epoxy systems; whereas in compression molding operations maximum shearing strength reported has been around 13 Ksi.

If 13,000 psi shearing strength is used for the composite wheel, this stress is exceeded only in one element (#127) of the thinner (.375") wheel.

The thinner wheel (the 0.375" thick) was introduced when the 0.5" thick wheel produced very low stresses. This configuration produces a 30% reduction in weight if weights in Table 1 are used (Note: Aluminum wheel weight of Table 1 excludes steel wear ring).

It is unfortunate that neither of these cases is a good model for the wheel which was fabricated. The theoretical model used material property definition parameters based on Figure 6, whereas the first and only composite road wheel shown in Figures 1 and 2 was fabricated mainly to show the feasibility of the filament winding process.

The rims are thicker than had been anticipated since the filament winding operation included a series of hoop windings which are now found to be unnecessary. The elimination of these windings will reduce the prototype wheel weight by approximately 5 lb. The prototype composite road wheel as shown in Figures 1 and 2 weighs 46.5 lb, while the M113 aluminum road wheel (which includes rubber) weighs 68 lb.

It is felt that the constraints that were imposed by trying to adapt filamentary composite materials to an already existing structure could detract from fully demonstrating the value of composites. Although low weight saving was achieved with the first prototype, there is a significant potential for further improvement of design, and fabrication is uninhibited by the present instilled metals technology.

An example is found in the DARCOM 6.1 Assessment Meeting of 6 Feb 76. In Assessment Report A#51 - Combat Support - MERDC page 27 there is a mention of using composites for tracked vehicle wheels. When MERDC was contacted, it was learned that

- a. MERDC's main interest is in improved blast survivability of vehicle components designed in combination of metals and glass-epoxy composites.

- b. An experimental tank road wheel made from high strength composite material, retained an acceptable degree of serviceability when subjected to a blast of 25 lb of high explosives.
- c. The aforementioned road wheel made by a private contractor did not have constraints as far as wheel geometry, weight, and cost, since the wheel is a component of an experimental concept. This last finding was very important since it shows an awareness that the structural and fabrication concepts which must exploit the unique characteristics of composites (weight reduction; high strength) have to be implemented in the initial stages of the total system configuration development. On the other hand, if composite materials are used to exploit and/or optimize an existing metal component (such as it has been in this project) then the buyer has to be aware of limitations encountered on weight, production, and cost.

It is recommended:

- a. To continue work on present concept per plan outlined in "Introduction".
- b. From a fabrication point of view, it is felt that a more economical way to build the present composite road wheel would be to mate a compression molded process with the filament winding process. The molding process will be used to make a wheel mandrel, while the filament winding process will be used to reinforce this mandrel for the desired load capacity.

c. If vulnerability is of interest it is felt that filament winding is the process to use in obtaining an economical structure. Figure 25 depicts a composite road wheel made of axisymmetric structures, weighing approximately 120 lb, while Figure 26 depicts a second concept weighing approximately 100 lb. To prove blast survivability, tests have to be performed for either concept.

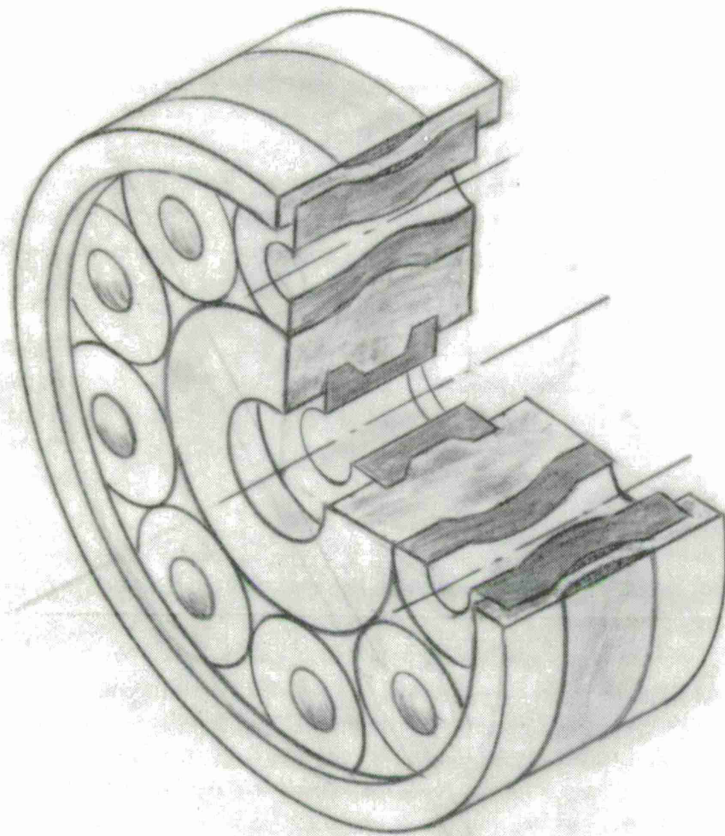

Figure 25. Composite road wheel #1.

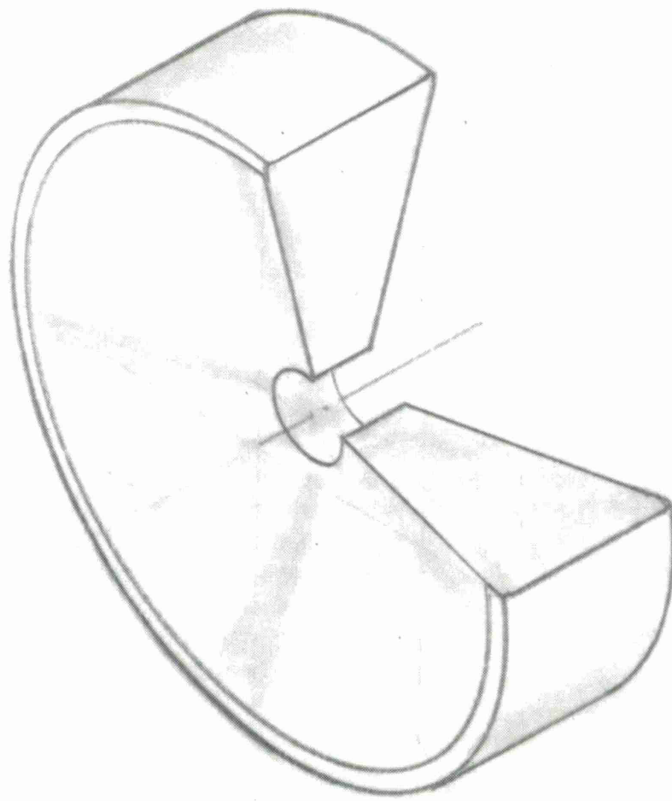

Figure 26. Composite road wheel #2.

WATERVLIET ARSENAL INTERNAL DISTRIBUTION LIST

May 1976

	<u>No. of Copies</u>
COMMANDER	1
DIRECTOR, BENET WEAPONS LABORATORY	1
DIRECTOR, DEVELOPMENT ENGINEERING DIRECTORATE	1
ATTN: RD-AT	1
RD-MR	1
RD-PE	1
RD-RM	1
RD-SE	1
RD-SP	1
DIRECTOR, ENGINEERING SUPPORT DIRECTORATE	1
DIRECTOR, RESEARCH DIRECTORATE	2
ATTN: RR-AM	1
RR-C	1
RR-ME	1
RR-PS	1
TECHNICAL LIBRARY	5
TECHNICAL PUBLICATIONS & EDITING BRANCH	2
DIRECTOR, OPERATIONS DIRECTORATE	1
DIRECTOR, PROCUREMENT DIRECTORATE	1
DIRECTOR, PRODUCT ASSURANCE DIRECTORATE	1
PATENT ADVISORS	1

EXTERNAL DISTRIBUTION LIST

May 1976

1 copy to each

CDR
US ARMY MAT & DEV READ. COMD
ATTN: DRCRD
DRCRD-TC
DRCRD-W
5001 EISENHOWER AVE
ALEXANDRIA, VA 22304

OFC OF THE DIR. OF DEFENSE R&E
ATTN: ASST DIRECTOR MATERIALS
THE PENTAGON
WASHINGTON, D.C. 20315

CDR
US ARMY TANK-AUTMV COMD
ATTN: AMDTA-UL
AMSTA-RKM MAT LAB
WARREN, MICHIGAN 48090

CDR
PICATINNY ARSENAL
ATTN: SARPA-TS-S
SARPA-VP3 (PLASTICS
TECH EVAL CEN)
DOVER, NJ 07801

CDR
FRANKFORD ARSENAL
ATTN: SARFA
PHILADELPHIA, PA 19137

DIRECTOR
US ARMY BALLISTIC RSCH LABS
ATTN: AMXBR-LB
ABERDEEN PROVING GROUND
MARYLAND 21005

CDR
US ARMY RSCH OFC (DURHAM)
BOX CM, DUKE STATION
ATTN: RDRD-IPL
DURHAM, NC 27706

CDR
WEST POINT MIL ACADEMY
ATTN: CHMN, MECH ENGR DEPT
WEST POINT, NY 10996

CDR
US ARMY ARMT COMD
ATTN: AMSAR-PPW-IR
AMSAR-RD
AMSAR-RDG
ROCK ISLAND, IL 61201

CDR
US ARMY ARMT COMD
FLD SVC DIV
ARMCOM ARMT SYS OFC
ATTN: AMSAR-ASF
ROCK ISLAND, IL 61201

CDR
US ARMY ELCT COMD
FT MONMOUTH, NJ 07703

CDR
REDSTONE ARSENAL
ATTN: AMSMI-RRS
AMSMI-RSM
ALABAMA 35809

CDR
ROCK ISLAND ARSENAL
ATTN: SARRI-RDD
ROCK ISLAND, IL 61202

CDR
US ARMY FGN SCIENCE & TECH CEN
ATTN: AMXST-SD
220 7TH STREET N.E.
CHARLOTTESVILLE, VA 22901

DIRECTOR
US ARMY PDN EQ. AGENCY
ATTN: AMXPE-MT
ROCK ISLAND, IL 61201

CDR
HQ, US ARMY AVN SCH
ATTN: OFC OF THE LIBRARIAN
FT RUCKER, ALABAMA 36362

EXTERNAL DISTRIBUTION LIST (Cont)

1 copy to each

CDR
US NAVAL WPNS LAB
CHIEF, MAT SCIENCE DIV
ATTN: MR. D. MALYEVAC
DAHLGREN, VA 22448

DIRECTOR
NAVAL RSCH LAB
ATTN: DIR. MECH DIV
WASHINGTON, D.C. 20375

DIRECTOR
NAVAL RSCH LAB
CODE 26-27 (DOCU LIB.)
WASHINGTON, D.C. 20375

NASA SCIENTIFIC & TECH INFO FAC
PO BOX 8757, ATTN: ACQ BR
BALTIMORE/WASHINGTON INTL AIRPORT
MARYLAND 21240

DEFENSE METALS INFO CEN
BATTELLE INSTITUTE
505 KING AVE
COLUMBUS, OHIO 43201

MANUEL E. PRADO / G. STISSER
LAWRENCE LIVERMORE LAB
PO BOX 808
LIVERMORE, CA 94550

DR. ROBERT QUATTRONE
CHIEF, MAT BR
US ARMY R&S GROUP, EUR
BOX 65, FPO N.Y. 09510

2 copies to each

CDR
US ARMY MOB EQUIP RSCH & DEV COMD
ATTN: TECH DOCU CEN
FT BELVOIR, VA 22060

CDR
US ARMY MAT RSCH AGCY
ATTN: AMXMR - TECH INFO CEN
WATERTOWN, MASS 02172

CDR
WRIGHT-PATTERSON AFB
ATTN: AFML/MXA
OHIO 45433

CDR
REDSTONE ARSENAL
ATTN: DOCU & TECH INFO BR
ALABAMA 35809

12 copies

CDR
DEFENSE DOCU CEN
ATTN: DDC-TCA
CAMERON STATION
ALEXANDRIA, VA 22314

NOTE: PLEASE NOTIFY CDR, WATERVLIET ARSENAL, ATTN: SARWV-RT-TP,
WATERVLIET, N.Y. 12189, IF ANY CHANGE IS REQUIRED TO THE ABOVE.

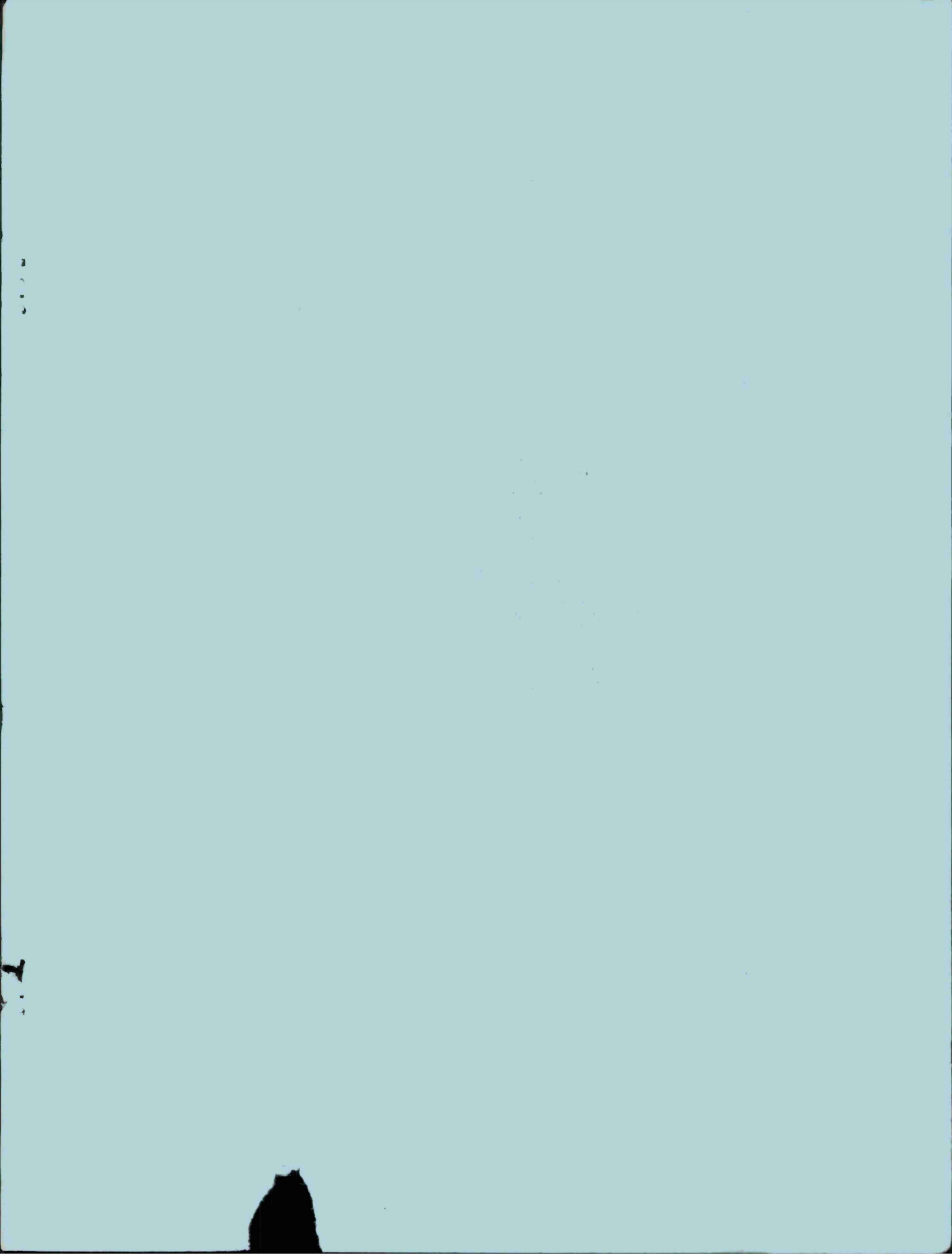

DEPARTMENT OF THE ARMY
WATERVLIET ARSENAL
WATERVLIET, N. Y. 12189

OFFICIAL BUSINESS
PENALTY FOR PRIVATE USE, \$300

SARWV-RDT-TP

POSTAGE AND FEES PAID
DEPARTMENT OF THE ARMY

DOD-314

THIRD CLASS

COMMANDER
U.S. ARMY ARMAMENT COMMAND
ATTN. AMSAR-RDG
ROCK ISLAND, ILLINOIS 61201