

ADA 025947

Technical Report RL-CR-76-2

Final Report:

on

COMPUTER-AIDED PRELIMINARY DESIGN OF
LIGHT ANTITANK WEAPONS

by

Thomas L. Cost

July 1975

Approved for public release; distribution unlimited.

Prepared for

Ground Equipment and Materials Directorate
US Army Missile Research,
Development and Engineering Laboratory

US ARMY MISSILE COMMAND

REDSTONE ARSENAL, ALABAMA 35809

Under Contract

DAAH01-73-C-0654

390 814

LB
D.D.C.
JUN 21 1976
C

AEC

UNCLASSIFIED

SECURITY CLASSIFICATION OF THIS PAGE (When Data Entered)

(Single Copy)

REPORT DOCUMENTATION PAGE		READ INSTRUCTIONS BEFORE COMPLETING FORM
1. REPORT NUMBER Technical Report RL CR-76-2	2. GOVT ACCESSION NO.	3. RECIPIENT'S CATALOG NUMBER
4. TITLE (and Subtitle) COMPUTER-AIDED PRELIMINARY DESIGN OF LIGHT ANTI-TANK WEAPONS	5. NUMBER OF REPORT & PERIOD COVERED Final Report	
7. AUTHOR(s) Thomas L. Cost	8. CONTRACT OR GRANT NUMBER(s) DAAH01-73-C-0654/1000	6. PERFORMING ORG. REPORT NUMBER
9. PERFORMING ORGANIZATION NAME AND ADDRESS Athena Engineering Company P.O. Box 235 Northport, AL 35476	10. PROGRAM ELEMENT, PROJECT, TASK AREA & WORK UNIT NUMBERS	
11. CONTROLLING OFFICE NAME AND ADDRESS Commander, US Army Missile Command Attn: AMSMI-RPR Redstone Arsenal, AL 35809	12. REPORT DATE July 1975	13. NUMBER OF PAGES 92 pages
14. MONITORING AGENCY NAME & ADDRESS (if different from Controlling Office) 12 95p.	15. SECURITY CLASS. (of this report) UNCLASSIFIED	
16. DISTRIBUTION STATEMENT (of this Report) Approved for public release; distribution unlimited		
17. DISTRIBUTION STATEMENT (of the abstract entered in Block 20, if different from Report)		
18. SUPPLEMENTARY NOTES		
19. KEY WORDS (Continue on reverse side if necessary and identify by block number) computer-aided design in-tube rocket design automated design closed-system rocket design interactive design recoilless design optimum design antitank weapon		
20. ABSTRACT (Continue on reverse side if necessary and identify by block number) A design system has been developed to perform preliminary optimized design studies of both conventional in-tube burning and closed-system recoilless light antitank weapons. The system is referred to as CADLAW (an acronym for Computer Aided Design of Light Antitank Weapons). The computer-aided system operates in an interactive demand mode with the designer situated at a computer terminal with an interactive graphics capability. A pattern search optimization method has been added to the		

D B C
RECEIVED
JUN 21 1975

390 814

UNCLASSIFIED

SECURITY CLASSIFICATION OF THIS PAGE(When Data Entered)

20. ABSTRACT (Continued)

FR 81473A
→ conventional design process to allow an optimum design to be selected in an automated manner. After the optimum design has been selected, the designer is afforded the opportunity to ^{may then} conduct a performance evaluation with the results presented in either tabular or graphical form. For convenience of use, a data base containing all design parameters is contained within the system and may be used by request. All input is through an interactive terminal keyboard and output is displayed at the graphics terminal. Mathematical models of the conventional in-tube burning rocket and the closed-system recoilless system contain propulsion, weight and structures, aerodynamics, guidance and control, and trajectory simulation components.

A

ACCESSION FOR	
DTIC	WFO Section <input checked="" type="checkbox"/>
DIC	DDP Section <input type="checkbox"/>
UNCLASSIFIED	<input type="checkbox"/>
JUSTIFICATION	
BY	
DISTRIBUTION/AVAILABILITY TYPES	
Dist.	Availability of Tables
A	

UNCLASSIFIED

FOREWORD

The computer-aided preliminary design system for light antitank weapons described in this report was developed by Athena Engineering Company under contract DAAH01-73-C-0654 with the U.S. Army Missile Command, Redstone Arsenal, Alabama. The development was sponsored and technically monitored by the Ground Equipment and Materials Directorate, US Army Missile Research, Development, and Engineering Laboratory. The computer-aided design system, referred to as CADLAW, is operational on the MICOM CDC 6600 computer and operates interactively through a Tektronix 4015 communication terminal. The system is also operational on a UNIVAC 1108 system used by Athena Engineering Company.

The author wishes to acknowledge the valuable technical contributions of Athena Engineering Company personnel Mr. James Dagen, Dr. James L. Hill, and Dr. Howard B. Wilson and Mr. Richard Eppes, Ground Equipment and Materials Directorate. Mr. Dagen provided comprehensive general programming support including developing the interactive graphics capability, Dr. Hill developed the CADLAW component which calculates the missile trajectory, Dr. Wilson developed the CADLAW recoilless launcher component and provided the basic optimization program, and Mr.

Eppes provided overall technical guidance and assisted in making the CADLAW program operational on the CDC system.

Since the CADLAW program is interactive it is largely system dependent due to the overlay structure. For this reason no listing of the program is included in this report. The program can be made operational on other systems with minor modifications.

TABLE OF CONTENTS

1.	INTRODUCTION	3
2.	GENERAL DESIGN SYSTEM DESCRIPTION.	8
2.1	System Components	9
2.2	Optimization Strategy	11
2.3	Design Variables and Parameters	13
3.	CONVENTIONAL ROCKET SYSTEM	14
3.1	Ballistic Performance Equations	16
3.2	Structural Design and Weight Equations.	22
4.	RECOILLESS LAUNCHER SYSTEM	27
4.1	Equations of Motion	29
4.2	Continuity Equation	32
4.3	Propellant Burning Rate and Gas Constitutive Equations.	33
4.4	Combined Field Equations.	34
4.5	Conditions After Propellant Burnout	36
4.6	Solution Method	38
4.7	System Weight	40
5.	TRAJECTORY ANALYSIS.	43
5.1	Equations of Motion	43
5.2	Aerodynamic Forces.	47
5.3	Solution Technique.	50
5.4	Control Law	51
5.5	Target Motion	51
5.6	Wind Model.	53
6.	OPTIMIZATION ALGORITHM	54
6.1	Flexible Polyhedron Search.	57
6.2	The Tolerance Criterion	61
6.3	Criterion for Constraint Violation.	64
6.4	Concept of Near-Feasibility	65
6.5	Strategy of the Flexible Tolerance Algorithm.	66

7. CADLAW DESCRIPTION AND USER INSTRUCTIONS	72
7.1 Design Program Organization	72
7.2 User Instructions	73
7.3 Sample CADLAW Execution	75
REFERENCES	89

1. INTRODUCTION

Conventional preliminary design of missile systems requires the interaction of people representing various technical and managerial disciplines in a process which is sometimes vaguely defined and which is almost always iterative in nature. The advantages of incorporating the computer into this design process appear numerous: the process could be conducted more rapidly with less human effort, the interaction of various disciplines could be examined more easily and precisely, a greater number of iterations could be performed in a given period of time, a more efficient "optimum design" could be selected, etc. The developments reported here are directed toward the goal of utilizing the computer as an aid in the preliminary design of light antitank weapons.

The conventional preliminary design process typically begins by having the designer select, on the basis of previous experience, a design which appears to meet the design specifications. After the initial design has been selected it is passed to various people representing a broad spectrum of technical and managerial disciplines where the performance and financial costs are evaluated. Detailed evaluation of

the initial design generally reveals the need for several design modifications whose impact must be evaluated through trade-off studies. Since the goals of high strength and performance conflict with the concurrent goals of low weight and cost, inevitably compromises must be made.

The performance evaluations and trade-off studies conducted in the course of the design development are usually conducted separately and involve a significant amount of human effort. Also, the final selection of a particular design configuration is generally not obvious and involves the judgment of the designer to a large extent. Use of the computer to aid in this design process appears an attractive goal.

Although computers are employed to a large extent in the performance evaluation and trade-off studies in the conventional design process, they are not typically used in the decision-making process nor in the interactive demand mode. The CAD-E program sponsored by NASA [1] and the CAMS program sponsored by the Air Force [2] represent attempts to utilize the computer to a greater extent in the decision-making process of design.

To explore the feasibility of automating the preliminary design process for a realistic missile system, a light, shoulder-fired, antitank weapon system was selected for application. The objective of the developmental effort

was to demonstrate the feasibility of the computer-aided preliminary design process on a realistic weapon system. No attempt was made to be unduly precise in system modeling. Instead, reasonable mathematical models of all systems were developed with the awareness that more sophisticated models could be substituted for developmental models, if desired. The basic operation of the system would still be valid.

Two versions of the light antitank weapon were selected for application, a conventional in-tube burning rocket system and a closed combustion chamber recoilless system. Two versions were studied as a result of contemporary interest by the U. S. Army Missile Command. The in-tube burning rocket system has been the subject of several recent developmental studies [3-6]. The closed recoilless system has also attracted attention due to its apparent lack of signature and blast effects [7-11]. The object of the present effort was not to develop optimum designs for these type weapons but rather to develop a computer-aided design system which would allow such optimum design studies to be performed.

A significant feature of the CADLAW system is the ability to select an "optimum design" automatically. It is not clear that conventional preliminary design processes result in such an optimum design. Thus, the ability to determine such an optimum design automatically is significant.

The feature which allows a determination of the optimum design is based upon an optimization method known as the "flexible tolerance" algorithm [12]. This method constitutes a particularly versatile optimization method which is a member of a wide class of such methods [13]. The method involves an iterative pattern search of a multi-dimensional hypersurface specified by the designer in the form of an objective function. The flexible tolerance algorithm searches the hypersurface defined by the objective function until an optimum, maximum or minimum, design point is reached. Thus, an optimum design depends on the character of the objective function and constraints on the design variables.

The in-tube burning rocket system and recoilless system have propulsion, structures and weights, aerodynamics, guidance and control, and trajectory simulation components. From an optimization standpoint the propulsion and the structure and weight components are separate from the aerodynamics, the guidance and control, and the trajectory simulation components. The design variables associated with the propulsion and the structures and weights systems are selected in an optimum manner independent of the aerodynamics, the guidance and control, and the trajectory system variables. This separation is permitted in this application since all propulsion is accomplished within the launch tube before the aerodynamic and

guidance characteristics affect performance. Hence, one objective function is needed for the propulsion phase of the system performance and another for the flight phase.

In summary, computer-aided design techniques offer advantages impossible to obtain with conventional preliminary design and analysis techniques. Computer modeling of all system components and their interactions permit design iterations to be evaluated very rapidly. The speed of evaluation permits optimum designs to be selected in an automated fashion. Perhaps the greatest advantage of the automated design cycle is the freedom from computational drudgery afforded the designer who is then able to devote more of his effort to creative thinking. Details of the CADLAW system are contained in the following sections of this report.

2. GENERAL DESIGN SYSTEM DESCRIPTION

As indicated previously, the CADLAW system operates in a "demand mode" and requires interaction of the designer with the computer. For operation on the MICOM CDC-6600 computer the computer program was designed to operate in separate segments so that the OVERLAY feature of CDC computers could be employed. Table 2.1 contains a list of the various overlays in the CADLAW system and gives an indication of the basic program structure.

TABLE 2.1

CADLAW SYSTEM COMPONENTS

OVERLAY (0,0) -	Main Program
OVERLAY (1,0) -	Conventional Rocket System
OVERLAY (1,1) -	Optimization Algorithm
OVERLAY (1,2) -	Performance Evaluation
OVERLAY (2,0) -	Recoilless Rocket System
OVERLAY (2,1) -	Optimization Algorithm
OVERLAY (2,2) -	Performance Evaluation
OVERLAY (3,)) -	Trajectory Simulation
OVERLAY (3,1) -	Optimization Algorithm
OVERLAY (3,-2) -	Performance Evaluation

2.1 System Components

The Main Program, OVERLAY (0,0) serves mainly as an instructional element to explain the basic purpose and use of the design system. The user is provided, interactively, with information about the system and is allowed to select which system component he desires to work with.

It is assumed that all propulsion, in both the conventional and recoilless systems, is accomplished within the launch tube. This assumption allows the trajectory simulation and guidance and control phases of the missile performance to be separated from the propulsion phase. Since the strength and weight requirements are largely associated with the forces exerted during the propulsion phase, these components are also separated from the trajectory simulation and guidance and control phases of the system performance.

The optimized design and performance evaluation of the conventional in-tube burning light antitank propulsion and launch systems is accomplished in OVERLAY (1,0) of CADLAW. The influence of such parameters as motor diameter, launcher length, and propellant burning rate are dealt with. To perform an optimized design study OVERLAY (1,1) is called while OVERLAY (1,2) is called if a certain design is to be evaluated with a parameter study. OVERLAY (1,2) contains an advanced graphics package for plotting all results if desired.

The recoilless rocket system model is contained in OVERLAY (2,0). Such parameters as recoil-mass weight, launcher length, and propellant burning rate are typical parameters dealt with in OVERLAY (2,0). To conduct an optimized design study OVERLAY (2,1) must be called while OVERLAY (2,2) must be called to evaluate a particular design, conduct parameter studies or plot all results. OVERLAY (2,2) also contains the advanced graphics routines mentioned above.

The flight characteristics of both the conventional and recoilless systems are assumed to be the same after the missile leaves the launch tube. This allows the flight characteristics of the missile to be evaluated in OVERLAY (3,0). The aerodynamic force and moment coefficients, guidance system gain setting and miss-distance are typical parameters dealt with in OVERLAY (3,0). As in the other overlays, OVERLAY (3,1) is called to conduct an optimized design study while OVERLAY (3,2) is called if one wishes to conduct a parameter study with a graphics capability.

The designer, of course, does not need to understand the overlay system nor how to call them since these operations are conducted automatically as a result of the answers provided to certain simple questions. These characteristics are illustrated by example in Section 7 of this report.

The brief descriptions contained in this section are intended to mainly provide an overview of the CADLAW system. Details of the various mathematical models used to describe the different systems are contained in Sections 3, 4, and 5.

2.2 Optimization Strategy

The criterion used to determine what constitutes an "optimum design" must be decided upon by the designer. The existing CADLAW system has certain built-in criteria in the form of specified objective functions. However, these criteria may be changed at the discretion of the designer should the desire arise.

There are two types of objective functions employed in CADLAW: one to govern the optimization of the propulsion phase of the rocket performance and one to regulate the optimization study of the flight phase. The optimum design of the propulsion phase parameters for both the conventional and recoilless systems are based upon an objective function of the form

$$F_1(V_m, W_s) = C_1 [V_m]^\alpha + C_2 [W_s]^\beta \quad (2.1)$$

where the notation $F_1(V_e, W_s)$ indicates the objective function F_1 is a function of the muzzle velocity V_m and system weight W_s . The muzzle velocity V_m and system weight W_s . The quantities C_1 , C_2 , α , and β are constant parameters to be

specified by the designer. The objective function in Eq. (2.1) was selected on the basis of convenience and what appears to be a rational design philosophy. The importance of muzzle velocity relative to system weight can be changed by merely changing the quantities C_1 , C_2 , α , and β . An optimum design is defined as the set of design variables which produce a minimum value for the objective function F_1 . This results in a system with low weight and high muzzle velocity.

The design variables associated with the flight phase of the rocket system performance are selected on the basis of minimizing the miss distance d_m and the time of flight t_f . The objective function selected to accomplish this is of the form

$$F_2(t_f, d_m) = C_3 [t_f]^\lambda + C_4 [d_m]^\mu \quad (2.2)$$

where, as before, C_3 , C_4 , λ , and μ are parameters with which to change the relative importance of the time of flight and miss distance.

CADLAW contains default values for the parameters C_1 , C_2 , C_3 , C_4 , α , β , λ , and μ if the designer does not wish to specify these parameters himself. The optimization strategy is to search combinations of design variables which result in a maximum or minimum value for the objective function.

2.3 Design Variables and Parameters

One concept which is basic to the optimization capability of CADLAW concerns design variables and design parameters. Obviously, there are literally hundreds of quantities to be specified in calculating the propulsion and flight characteristics of a light antitank missile system. State-of-the-art optimization methods do not permit the evaluation of a large number of parameters in an optimized design process. Consequently, the design quantities are divided into two groups, design variables which are selected in the optimization process, and design parameters which must be arbitrarily selected by the designer. Although the design parameters are not optimized automatically, they may be changed in such a way that their influence can be examined and appropriate values selected for the design.

3. CONVENTIONAL ROCKET SYSTEM

The computer-aided preliminary design system applicable to conventional rocket launcher systems assumes the system to consist of a small rocket propelled missile launched from a tube. Figure 3.1 contains a schematic diagram of the system. As can be seen, the rocket motor consists of a combustion chamber where solid propellant is burned and a nozzle. The burned gases are exhausted from the rear of the launch tube. For protection of the person holding the launcher, combustion is completed and the chamber is allowed to exhaust to a low pressure before the missile leaves the launch tube.

Typical parameters of interest in the preliminary design of this conventional-in-tube-burning rocket system are the system diameter, launcher length, propellant burning rate, propellant mass, chamber pressure and nozzle expansion ratio. CADLAW allows these design variables to be selected such that the system performance is optimized.

As discussed in Section 2.3, the performance of the conventional rocket system is measured by the value of an arbitrarily defined objective function which depends on the muzzle velocity and system weight. An optimum design is defined as a set of design variable values which minimizes

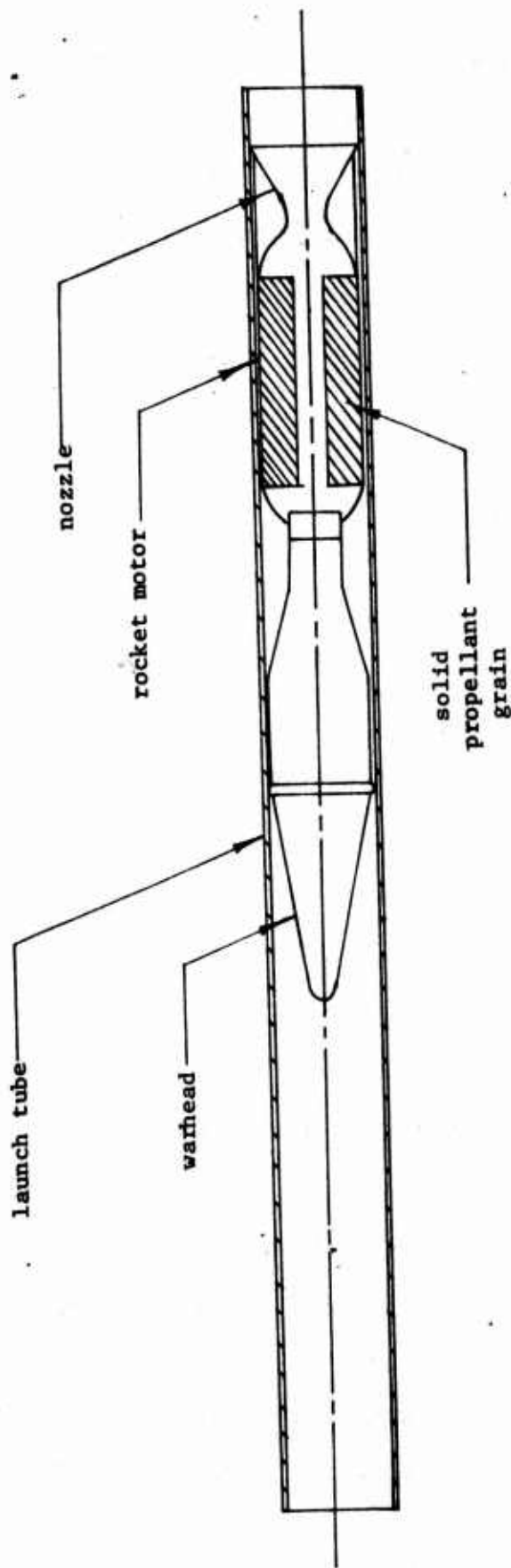

Figure 3.1 Schematic Diagram of Conventional In-Tube Burning Rocket and Antitank Weapon

the objective function and thereby maximizes the muzzle velocity while keeping the system weight low. To calculate the muzzle velocity and system weight when all design parameters are specified, resort must be made to a system of mathematical relations obtained by application of the principles of mechanics.

3.1 Ballistic Performance Equations

The mathematical equations which describe the ballistic performance of small solid rockets are described in detail in the literature [14]. For the sake of completeness, the equations are repeated here in the form and order in which they are evaluated in CADLAW.

The following parameters are assumed to be specified numerically at the time the performance equations are evaluated to obtain the muzzle velocity and system weight:

1. P_{ca} = chamber pressure at ambient temperature (psi)
2. A_e/A_t = nozzle expansion ratio (dimensionless)
3. D_m = outer diameter of motor case (in.)
4. kA_b = propellant volumetric burning rate coefficient (in^3/sec)
5. W_p = weight of solid propellant (lbs)
6. L_m = length of motor combustion chamber (in.)
7. α = specific heat of gas (BTU/lb $^\circ$ F)
8. ρ_p = propellant density (lbs/in. 3)

- 9. FS = system factor of safety
- 10. T_c = cold temperature extreme ($^{\circ}F$)
- 11. T_a = ambient temperature ($^{\circ}F$)
- 12. T_h = hot temperature extreme ($^{\circ}F$)
- 13. π_k = pressure sensitivity parameter ($\%/^{\circ}F$)
- 14. P_f = final chamber blowdown pressure (psi)
- 15. T_l = thickness of launcher (in.)
- 16. ρ_m = density of motor-launcher material
($lbs/in.^3$)
- 17. σ_a = allowable stress for motor material (psi)
- 18. α = nozzle expansion angle (degrees)
- 19. W_w = warhead weight (lbs)
- 20. W_x = weight of fins, pole piece, fixtures,
etc. (lbs)

With numerical values specified for the above parameters, the following geometrical quantities can be evaluated:

$$A_e = \frac{\pi D_m^2}{4} \quad (3.1)$$

$$A_t = \left(\frac{A_t}{A_e}\right) (A_e) \quad (3.2)$$

and

$$V_c = \frac{\pi D_m^2 L_m}{4} \quad (3.3)$$

where A_e is the area of the nozzle exit plane, A_t is the area of the nozzle throat and V_c is the volume of the motor combustion chamber.

The Mach number at the nozzle exit plane M_e can be evaluated by solving the nonlinear equation

$$M_e^2 = \frac{2}{(\gamma-1)} \left[\frac{\gamma+1}{2} \left(M_e \frac{A_e}{A_t} \right)^{\frac{2(\gamma-1)}{(\gamma+1)}} - 1 \right] \quad (3.4)$$

for M_e . This is accomplished in CADLAW by using a rapid step-by-step evaluation routine. Based upon a knowledge of the motor chamber pressure P_{ca} at ambient temperature T_a and the temperature extremes T_c and T_h , the chamber pressures at the temperature extremes, P_{cc} and P_{ch} , can be evaluated as

$$P_{cc} = P_{ca} \left[\frac{200 + \pi_k (T_c - T_a)}{200 - \pi_k (T_c - T_a)} \right] \quad (3.5)$$

and

$$P_{ch} = P_{ca} \left[\frac{200 + \pi_k (T_h - T_a)}{200 - \pi_k (T_h - T_a)} \right] \quad (3.6)$$

The conventional system performance varies with temperature. For a given set of parameters the system muzzle velocity and chamber pressure will be lower when operated at the cold temperature extreme than when operated at the hot temperature extreme. The system weight depends strongly on the motor

chamber pressure. For conservative purposes the system muzzle velocity and launcher weight are based upon operation at the cold temperature extreme T_c while the motor weight is based upon the chamber pressure when the system is operated at the hot temperature extreme T_h .

The pressure at the nozzle exit plane P_{ec} for temperature T_c is

$$P_{ec} = P_{cc} \left[1 + \frac{\gamma-1}{2} M_e^2 \right]^{\frac{\gamma}{1-\gamma}} \quad (3.7)$$

The thrust F_c at T_c is given by the equation

$$F_c = \left\{ \left(\frac{2}{\gamma-1} \right)^{\frac{\gamma+1}{\gamma-1}} \frac{2\gamma^2}{\gamma-1} \left[1 - \frac{P_{ec}}{P_{cc}} \right]^{\frac{\gamma-1}{\gamma}} \right\}^{1/2} x$$

$$[1/2 (1 + \cos\alpha)] A_t P_{cc} \quad (3.8)$$

and the propellant mass discharge rate \dot{W}_c at temperature T_c by the relation

$$\dot{W}_c = \rho_p k A_b (P_{cc})^\beta = \rho_p K_b (P_{cc})^\beta \quad (3.9)$$

where the parameter K_b is one of the optimum design variables in CADLAW. Knowing the thrust and mass discharge rate permits the calculation of an effective exhaust velocity V_{ec} by use of the equation

$$v_{ec} = \frac{F_c}{\dot{W}_c/g} \quad (3.10)$$

The burning time of the propellant t_b can be determined by the equation

$$t_{bc} = \frac{W_p}{\dot{W}_c} \quad (3.11)$$

where W_p is the weight of the propellant. Using the equation

$$c_d = \frac{\dot{W}_c}{A_t P_{cc}} \quad (3.12)$$

to calculate the mass discharge coefficient permits the elapsed time from the time when burning is completed until the motor exhausts to a pressure P_f , i.e., the "blowdown" time t_{bd} , to be calculated by using the equation

$$t_{bd} = \frac{v_c c_d}{6g\gamma(\gamma-1)A_t} \left(\frac{\gamma+1}{\gamma} \right)^{\frac{\gamma+1}{\gamma-1}} \left[\left(\frac{P_{cc}}{P_f} \right)^{\frac{\gamma-1}{2\gamma}} - 1 \right] \quad (3.13)$$

The chamber pressure, thrust, propellant burning time, and motor blowdown time have been calculated using Eqs. (3.1--3.13). Before the missile exit velocity can be determined, the total missile weight, both with propellant W_{wl} and without propellant W_{wu} , must be known. This includes the structural weights of the motor and nozzle. A description of the structural and system weight calculations are contained

in Section 3.2. It is sufficient to recognize that, from a performance viewpoint, the structural weight depends directly on the highest operational pressures P_{ch} . The other weight components are specified by the designer.

Assuming the weights W_{wl} and W_{wu} are known, the missile velocity at the time of burnout v_m is

$$v_m = v_e \ln (W_{wl}/W_{wu}) \quad (3.14)$$

where $\ln(x)$ denotes the natural logarithm of x . The specific impulse can be expressed as

$$I_{sc} = F_c / \dot{W}_c \quad (3.15)$$

and the distance traveled during burning S_b as

$$S_b = g I_{sc} t_b \left[1 - \left(\frac{W_{wu}}{W_p} \right) \ln(W_{wl}/W_{wu}) \right] \quad (3.16)$$

The distance traveled during blowdown can be expressed as

$$S_{bd} = v_m \cdot t_{bd} \quad (3.17)$$

since the missile velocity is assumed to remain constant from the time of burnout until the missile exits the launch tube. Therefore, v_m is the muzzle velocity.

3.2 Structural Design and Weight Equations

As indicated in Section 3.1, the structural design and resulting weight depends directly on the maximum operating pressures. The effects of high acceleration are small, relative to the pressure induced stresses and strains, due to the small size of the weapon system. The design pressure P_d is obtained by multiplying the maximum chamber pressure P_{ch} by the factor of safety FS, i.e.,

$$P_d = (FS) P_{ch} \quad (3.18)$$

Thin-walled pressure vessel theory is utilized in the structural design of the rocket motor case and nozzle. The rocket motor structure is idealized as illustrated schematically in Figure 3.2. The nozzle consists of two truncated cones of thickness t_n , the chamber is a thin-walled circular cylinder and the dome consists of a 2:1 ellipse of thickness t_d .

Based upon a maximum normal stress failure criterion, the weight of the nozzle can be shown to be

$$W_n = \frac{\pi \rho_m P_d (D_t)^3}{24 \sigma_a} \times \left[4 \left(\frac{D_m}{D_t} \right)^3 + \frac{25}{4} \left(\frac{D_m}{D_t} \right)^2 - 7.5833 \right] \quad (3.19)$$

where σ_a is the maximum allowable stress in the nozzle. The cylindrical chamber weight can likewise be expressed as

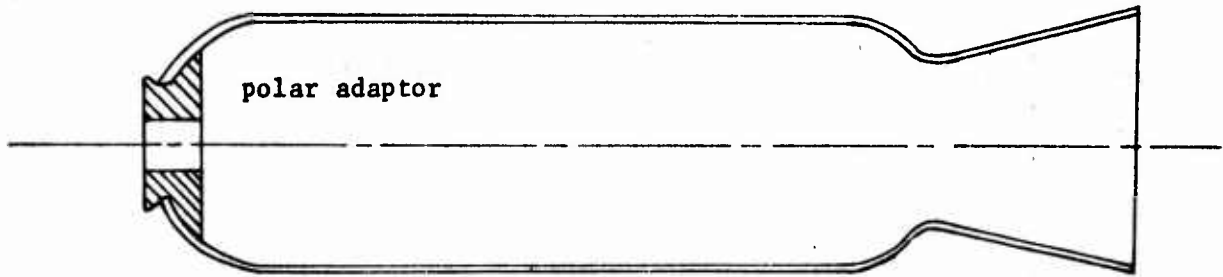

a) Actual Configuration

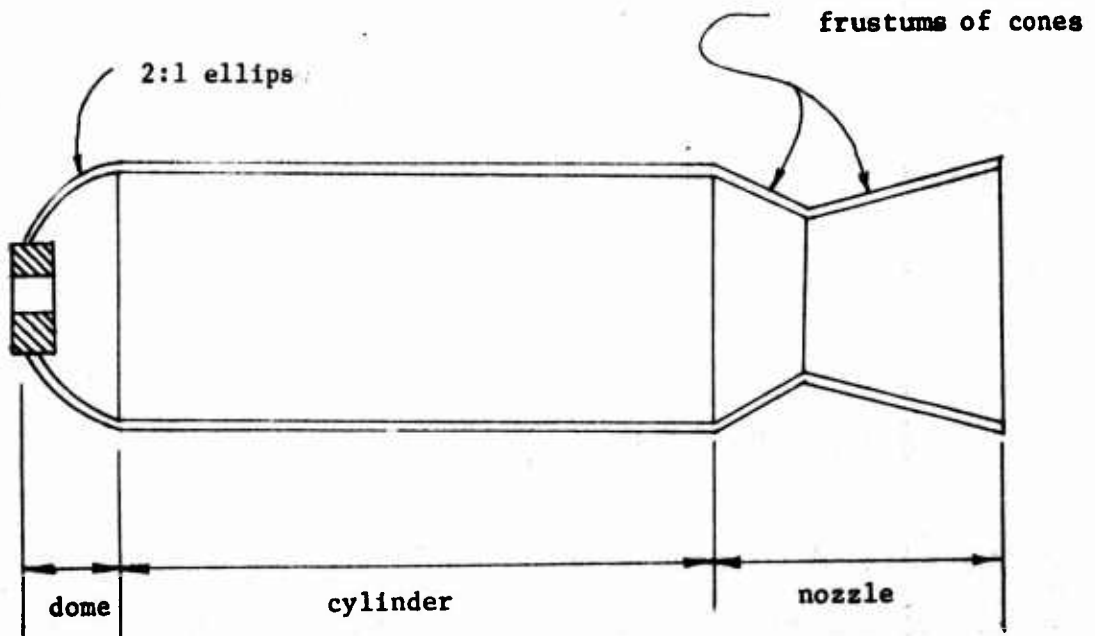

b) Idealized Configuration

Figure 3.2 Structural Model Idealization

$$W_c = \frac{\pi \rho_m L_m D_m^2}{2} \left[\frac{P_d}{\sigma_a - P_d} \right] \quad (3.20)$$

and the end-closure dome weight expressed as

$$W_d = \frac{11}{128} \pi \rho_m D_m^3 \left(\frac{P_d}{\sigma_a - P_d} \right) \left[1 + \frac{P_d}{\sigma_a - P_d} \right] \quad (3.21)$$

the unloaded motor structural weight can be expressed as

$$W_m = W_n + W_c + W_d + W_x \quad (3.22)$$

where W_x is the weight of the non-structural components such as the polar adaptor and guidance fins.

The unloaded weapon weight is calculated by adding the weight of the warhead W_w to the unloaded motor weight, i.e.,

$$W_{wu} = W_m + W_w \quad (3.23)$$

The initial, loaded weapon weight W_{wl} is obtained by adding the weight of the propellant W_p to the unloaded weapon weight W_{wu} ,

$$W_{wl} = W_{wu} + W_p \quad (3.24)$$

In addition to the motor structural weight and the warhead weight, the system weight must include the weight of

the launcher. The launcher length depends upon the burning time of the motor and the distance traveled during burning and subsequent blowdown. These distances have been calculated in Eqs. 3.14 and 3.15. With numerical values for S_b and S_{bd} , the launcher length L_1 can be expressed as

$$L_1 = S_b + S_{bd} \quad (3.25)$$

and the launcher weight as

$$W_1 = \pi D_m t_1 L_1 \quad (3.26)$$

where t_1 is the thickness of the launch tube as specified by the designer. Finally, the total system weight W_s is the sum of the loaded weapon weight W_{w1} and launcher weight W_1 ,

$$W_s = W_{w1} + W_1 \quad (3.27)$$

As discussed earlier, the purpose of the mathematical modeling of the conventional rocket performance is to permit the muzzle velocity v_m and system W_s to be calculated as a function of the design variables, k_b , d_m , L_m , L_1 , and the design parameters. The muzzle velocity and system weight have been calculated in Eqs. 2.14 and 2.27, respectively. Their dependence on the design variables can be seen to be quite complicated. This complication precludes the use of

any analytical optimization technique and instead requires the use of a pattern search routine such as that described in Section 6.

4. RECOILLESS LAUNCHER SYSTEM

A schematic diagram of the recoilless launcher system, upon which the mathematical model is based, is illustrated in Figure 4.1. The parameters utilized in the analysis of the recoilless launcher system, some of which are contained in Figure 4.1, are defined as follows:

- W_1 = weight of warhead, (lbs)
- W_2 = weight of recoil mass, (lbs)
- L = total length of launch tube, (in.)
- L_1 = portion of launch tube traversed by warhead, (in.)
- L_2 = portion of launch tube traversed by recoil mass, (in.)
- W_p = weight of solid propellant charge, (lbs)
- d = inside diameter of launch tube, (in.)
- t_w = wall-thickness of launch tube, (in.)
- t_r = thickness of reinforcing ring, (in.)
- L_r = length of reinforcing ring, (in.)
- K = propellant burning rate coefficient, (in.³/lb-sec/sec)
- n = burning rate exponent (dimensionless)
- Δ_1 = initial position of warhead, (in.)

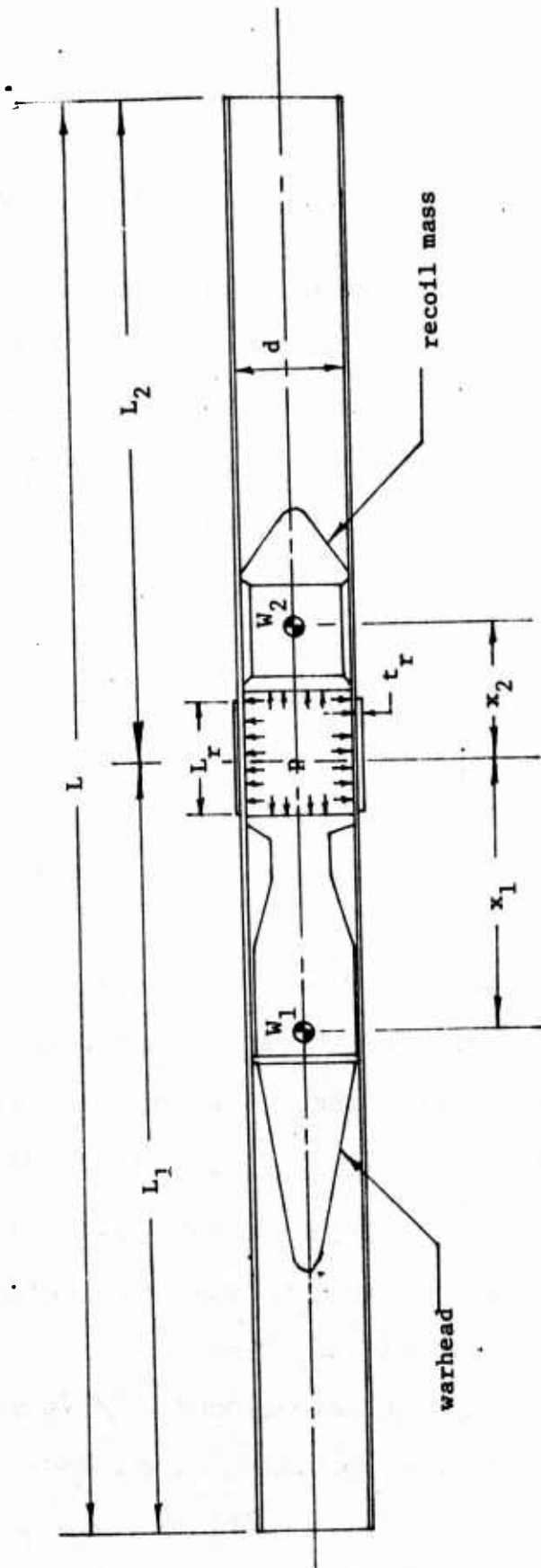

Figure 4.1 Schematic Diagram of Recoilless Antitank Weapon

$\Delta_2 =$ initial position of recoil mass, (in.)

The objective of the analysis is to develop a means for calculating the exit velocity of the warhead and the total system weight when all parameters of the system are defined. The performance of the system can then be evaluated in terms of the warhead exit velocity and system weight values. An optimum design is defined as one which simultaneously maximizes the muzzle velocity and minimizes the system weight, according to some predetermined relation.

To calculate the muzzle velocity and system weight, resort must be made to various principles of mechanics. Specifically, the principles of balance of momentum, mass, and energy must be employed along with concepts of structural mechanics and fluid dynamics to arrive at mathematical equations which describe the system behavior.

4.1 Equations of Motion

Application of Newton's Second Law yields the equations of motion for the warhead and recoil mass:

$$\frac{W_1}{g} \ddot{x}_1 = \left(\frac{\pi d^2}{4}\right) P_g \quad (4.1a)$$

and

$$\frac{W_2}{g} \ddot{x}_2 = \left(\frac{\pi d^2}{4}\right) P_g \quad (4.1b)$$

where

W_1 = weight of warhead, (lbs)

W_2 = weight of recoil mass, (lbs)

x_1 = position of warhead at time t , (in.)

x_2 = position of recoil mass at time t , (in.)

P_g = pressure of gas in chamber, (psi)

d = inside diameter of launch tube, (in.), and

g = gravitational constant, (in./sec²).

A dot over a variable is used to denote the derivative of that variable with respect to time. The initial conditions are

$$1) \quad @ t = 0, x_1 = \Delta, x_2 = 0 \text{ and} \quad (4.2a)$$

$$2) \quad @ t = 0, \dot{x}_1 = \dot{x}_2 = 0 \quad (4.2b)$$

where Δ is the initial position of the warhead. From Eqs. (4.1a) and (4.1b), it is observed that the acceleration of the warhead and recoil mass are related as

$$\frac{W_1}{g} \ddot{x}_1 = \frac{W_2}{g} \ddot{x}_2 \quad (4.3)$$

Integration of Eq. (4.3) and employment of the initial conditions listed in Eqs. (4.2a) and (4.2b) allows the establishment of a linear relationship between the respective positions of the two masses and between the forward and rearward lengths of the launch tube. These relationships are

$$x_2 = \frac{W_1}{W_2} (x_1 - \Delta) \quad (4.4)$$

and

$$L_2 = \frac{W_1}{W_2} (L_1 - \Delta) \quad (4.5)$$

where Δ is the initial position of the warhead with respect to the origin of the coordinate system illustrated in Figure 4.1.

The relationship expressed in Eq. (4.4) eliminates the necessity of solving Eq. (4.1b). By solving only the equation of motion for the warhead, Eq. (4.1a), the motion of the recoil mass can be determined through the use of Eq. (4.4). As will be shown in subsequent developments, the equation of motion for the warhead is highly nonlinear and must be solved using numerical integration procedures. To this end, Eq. (4.1a) can be replaced by the following two first order differential equations:

$$\frac{dx_1}{dt} = v_1 \quad (4.6)$$

and

$$\frac{dv_1}{dt} = \frac{\pi d^2 g}{4W_1} P_g \quad (4.7)$$

where v_1 is the speed of the warhead in units of in./sec.

4.2 Continuity Equation

The principle of conservation of mass can be expressed here by equating the mass rate of propellant combustion to the mass rate of gas generation within the pressure chamber, i.e.,

$$rA_b\rho_p = \frac{d}{dt}(W_g) = \frac{d}{dt}(\rho_g V_g) \quad (4.8)$$

where

W_g = gas weight, (lbs)

r = propellant burning rate, (in./sec.)

A_b = propellant burning surface area, (in.²)

ρ_p = propellant density, (lbs/in.³)

ρ_g = gas density, (lbs/in.³)

and

V_g = volume of gas in chamber, (in.³)

The volume occupied by the gas at any time can be expressed in terms of the distance between the warhead and the recoil mass and the launch tube diameter or, using Eq. (4.4),

$$V_g = \frac{\pi d^2}{4}(x_1 + x_2) \quad (4.9)$$

or, using Eq. (4.4),

$$V_g = \frac{\pi d^2}{4} \left[\left(\frac{W_1 + W_2}{W_2} \right) x_1 - \frac{W_1}{W_2} \Delta \right] \quad (4.10)$$

Thus, the weight of the gas at any time is

$$W_g = \rho_g V_g = \frac{\pi d^2}{4} \rho_g \left[\left(\frac{W_1 + W_2}{W_2} \right) x_1 - \frac{W_1}{W_2} \Delta \right] \quad (4.11)$$

These equations must be further developed through the use of the propellant burning rate and gas constitutive equations.

4.3 Propellant Burning Rate and Gas Constitutive Equations

The propellant burning rate is assumed to depend on the chamber pressure through the relation

$$r = k P_g^n \quad (4.12)$$

where k and n are constants and the gas is assumed to obey the perfect gas law, i.e.,

$$P_g = \rho_g R T_g \quad (4.13)$$

In Eq. (4.11), R is a gas constant (37.69908 in./°R) and T_g is the local gas temperature in degrees Rankine. Furthermore, the temperature-pressure relationship assumed for this gas is

$$T_g = \frac{2T_0}{\pi} \tan^{-1} (P_g/P_0) \quad (4.14)$$

Where T_0 and P_0 are reference temperature and pressure, respectively. T_0 is assumed to have the value of 5500°R and the reference pressure P_0 is 100 psi.

4.4 Combined Field Equations

Through the use of Eqs. (4.13) and (4.14), the gas weight can be expressed in terms of the pressure P_g and position x_1 as

$$W_g = \left[\frac{\pi^2 d^2 (W_1 + W_2)}{8RT_0 W_2} \right] \frac{P_g}{\tan^{-1}(P_g/P_0)} x \left(x_1 - \frac{W_1}{W_1 + W_2} \Delta \right) \quad (4.15)$$

For simplicity of notation, if we define two constants α and β as

$$\alpha = \frac{W_2 \Delta}{W_1 + W_2}$$

and

$$\beta = \frac{8RT_0 W_2 \rho_p A_b k}{\pi^2 d^2 (W_1 + W_2)} \quad (4.16)$$

then the conservation of mass equation, Eq. (3.6) can be expressed

$$\beta P_g^n = \frac{d}{dt} \left[(x_1 - \alpha) \frac{P_g}{\tan^{-1}(P_g/P_0)} \right] \quad (4.17)$$

Expanding the derivative in this equation gives

$$\beta P_g^n = \frac{v_1 P_g}{\tan^{-1}(P_g/P_o)} + (x_1^{-\alpha}) \dot{P}_g \times$$

$$\left[\frac{1}{\tan^{-1}(P_g/P_o)} - \frac{P_g/P_o}{[1+(P_g/P_o)^2][\tan^{-1}(P_g/P_o)]^2} \right] \quad (4.18)$$

where, as in Eqs. (4.6) and (4.7), v_1 is the speed of the warhead. Eq. (4.18) represents a nonlinear first order differential equation in terms of the pressure P_g .

Solving Eq. (4.18) for P_g and restating Eqs. (4.6) and (4.7) allows the final governing equations to be summarized as three simultaneous, first order, nonlinear differential equations of the form

$$\dot{x}_1 = v_1 \quad (4.6)$$

$$\dot{v}_1 = \frac{\pi d^2 g}{4W_1} P_g \quad (4.7)$$

and

$$\dot{P}_g = \frac{\left[\beta P_g^n - \frac{v_1 P_g}{\tan^{-1}(P_g/P_o)} \right]}{(x_1^{-\alpha}) \left[\frac{1}{\tan^{-1}(P_g/P_o)} - \frac{(P_g/P_o)}{[1+(P_g/P_o)^2][\tan^{-1}(P_g/P_o)]^2} \right]} \quad (4.19)$$

In addition, the rate of propellant combustion is determined

by the differential equation

$$\dot{W}_p = -kA_b p_g^n \quad (4.20)$$

This equation must be solved to determine the time at which propellant burning ceases. The initial conditions which apply for the above equations are:

$$\begin{aligned} 1) \quad x_1 &= \Delta \\ 2) \quad v_1 &= 0 \\ 3) \quad P_g &= P_0 \end{aligned} \quad (4.21)$$

and

$$4) \quad W_p = W_0$$

4.5 Conditions After Propellant Burnout

The governing Eqs. (4.6), (4.7) and (4.19) apply only until the propellant is totally consumed. After this time of burnout, the gas in the pressure chamber is assumed to expand isentropically until the warhead and recoil masses leave the launch tube. The equations of motion of the warhead and recoil masses are the same as before burnout, Eqs. (4.1a) and (4.1b), and the positions of the two masses can be related as in Eq. 4.4. For isentropic expansion the pressure depends on the temperature as

$$P_g = k_1 T_g^{\frac{\gamma}{\gamma-1}} \quad (4.22)$$

where k_1 is a constant to be determined from the conditions at burnout and γ is the ratio of specific heats. After burnout the weight of the gas is constant

$$W_g^* = \frac{\pi d^2 (W_1 + W_2)}{4R_0 W_2} (k_1)^{\frac{\gamma-1}{\gamma}} P_g^{\frac{1}{\gamma}} (x_1 - \alpha) \quad (4.23)$$

where all of these parameters have been defined earlier. By inspection of Eq. (4.23) the product $P_g^{1/\gamma} (x_1 - \alpha)$ is assumed to be a constant

$$P_g^{1/\gamma} (x_1 - \alpha) = P_g^*{}^{1/\gamma} (x_1^* - \alpha) \quad (4.24)$$

where P_g^* and x_1^* are the gas pressure and position of the warhead at the time of burnout. Thus, P_g can be expressed as

$$P_g = P_g^* (x_1 - \alpha)^\gamma (x_1^* - \alpha)^{-\gamma} \quad (4.25)$$

and the equation of motion becomes

$$\left(\frac{\pi d^2}{4}\right) P_g = \left(\frac{\pi d^2}{4}\right) P_g^* (x_1^* - \alpha)^\gamma (x_1 - \alpha)^{-\gamma} = \frac{W_1}{g} \ddot{x}_1 \quad (4.26)$$

This equation can be integrated in closed form if it is first expressed in terms of the velocity as

$$v_1 \frac{dv_1}{dx} = \frac{\pi d^2 g P^*}{4W_1} (x_1^* - \alpha)^\gamma (x_1 - \alpha)^{-\gamma} \quad (4.27)$$

Integrating each side of this equation and denoting the warhead velocity as v_e when $x=L_1$, allows the exit velocity to be expressed as

$$v_e^2 = v_1^2 + \frac{g \pi d^2 P^*}{2W_1 (\gamma-1)} (x_1^* - \alpha)^\gamma \left\{ 1 - \left[\frac{(x_1^* - \alpha)}{(L_1 - \alpha)} \right]^{\gamma-1} \right\} \quad (4.28)$$

where it is understood that $x_1^* > \alpha$ and $L_1 > \alpha$.

4.6 Solution Method

As mentioned earlier, the object of this development is to permit calculation of the warhead and recoil masses exit velocities and the system weight. The exit velocities of the two masses can be calculated from Eqs. (4.28) and (4.4) and the system weight can be calculated from a knowledge of the peak pressure. To evaluate Eq. (4.28) and the peak pressure, the governing field equations, Eqs. (4.6), (4.7), and (4.19) must be integrated with respect to time.

A fourth order Runge-Kutta integration procedure has been utilized to solve this system of equations. To allow for a description of this solution method, let the governing equation be expressed in vector form as

$$\frac{d}{dt} \underline{x} = \underline{F}(t, \underline{x}) \quad (4.29)$$

where $\tilde{x}^T = [x_1, v_1, P_g]$ and \tilde{F} is the right hand of the governing equations and may depend on $x_1, v_1,$ or P_g . By discretizing the field variables to correspond to discrete time values t_i , separated by a time increment Δt , the Runge-Kutta method provides an accurate method for calculating the vector \tilde{x}^{i+1} which contains the field variables at time t_{i+1} if the values of \tilde{x}^i at time t_i are known. The algorithm can be expressed as

$$\tilde{x}^{i+1} = \tilde{x}^i + \frac{\Delta t}{6} [K_1 + 2K_2 + 2K_3 + K_4] \quad (4.30)$$

where

$$K_1 = \tilde{F}(t_i, \tilde{x}^i) \quad (4.31)$$

$$K_2 = \tilde{F}(t_i + \frac{\Delta t}{2}, \tilde{x}^i + \frac{\Delta t}{2} K_1) \quad (4.32)$$

$$K_3 = \tilde{F}(t_i + \frac{\Delta t}{2}, \tilde{x}^i + \frac{\Delta t}{2} K_2) \quad (4.33)$$

and

$$K_4 = \tilde{F}(t_{i+1}, \tilde{x}^i + \Delta t K_3). \quad (4.34)$$

This procedure may be employed to determine the values of x_1^* , v_1^* , and P_g^* at the time of burnout as well as the maximum pressure in the chamber. With these values known the velocities of the two masses can be determined from Eqs. (4.28) and (4.4) and the system weight determined from the peak pressure calculation.

4.7 System Weight

The system weight W_s may be expressed in terms of system component weights as

$$W_s = W_1 + W_2 + W_{lt} + W_p + W_x \quad (4.35)$$

where W_1 and W_2 are the weights of the warhead and recoil masses, W_{lt} is the weight of the launch tube, W_p is the propellant weight, and W_x is the weight of such extras as handles, straps, sights, etc. The weight of the launch tube can be calculated assuming a maximum normal stress failure criterion and using thin-walled tube theory to calculate the maximum stress in the tube as a function of the maximum internal pressure P_{max} . P_{max} must be determined by integrating the nonlinear differential equation, Eq. (3.19), as discussed earlier. The maximum pressure is selected from the entire pressure history during burning. A design pressure for the launch tube is computed as

$$P_d = (FS) P_{max} \quad (4.36)$$

Design of the launch tube requires a special feature near the initial position of the warhead and recoil mass. Very early after the propellant is ignited and before the warhead and recoil mass have had a chance to move significantly, the burning gas pressure within the launch tube increases to an extremely high pressure. After the two masses begin to move, the pressure within the launch tube drops considerably.

If the weight of the launch tube were designed based upon these early high pressures, the system weight would be unacceptably high. To avoid this problem and thus reduce the system weight, the launch tube is assumed to have a high-strength reinforcing ring which surrounds the launch tube in the vicinity of the initial position of the masses. This feature is illustrated in Figure 4.1. The reinforcing ring weight can be expressed as

$$W_r = \frac{\pi d_L^2 P_d (L_r) \rho_r}{\sigma_a^*} \quad (4.37)$$

where L_r is the length of the ring, normally assumed to be approximately 3 inches, and σ_a^* is the ultimate strength of the reinforcing ring.

Finally, the weight of the launch tube can be expressed as

$$W_L = W_r + \frac{\pi d_L^2 P_d (L_1 + L_2) \rho_L}{\sigma_a} \quad (4.38)$$

where σ_a is the maximum stress allowable in the non-reinforced portion of the launch tube. Eq. (4.38) now permits the entire system weight to be calculated as in Eq. (4.35).

The muzzle velocity v_e and system weight W_s can be calculated as indicated in Eqs. (4.28) and (4.38), respectively. Obviously it is not possible to express the dependence

of these quantities on the design variables in any sort of functional form. This precludes the use of an analytical optimization routine and instead requires that a pattern search method such as that described in Section 6 be utilized to select an optimum design.

5. TRAJECTORY ANALYSIS

To determine the effectiveness of light antitank weapons, the capability for hitting the target must be evaluated by computing the trajectories of the missile and target. This calculation involves modeling the aerodynamic and ballistic forces on the missile as well as any guidance and control systems which exist and integrating these systems into a mathematical model. Due to the exploratory nature of this project, a trajectory analysis was developed which embodies all the pertinent features of the system but allows for guidance and control characteristics only within a horizontal plane. Motion normal to this plane was assumed to follow a ballistic trajectory. This assumed motion corresponds closely to the motion of light antitank weapons due to the high muzzle velocities and to the character of the evasive actions of the target. The trajectory analysis includes target motion and random crosswind effects.

5.1 Equations of Motion

The coordinate system and system parameters used to define motion of the missile are illustrated in Figure 5.1. Control of the missile is maintained with a rudder. The equations of motion of the missile can be expressed as

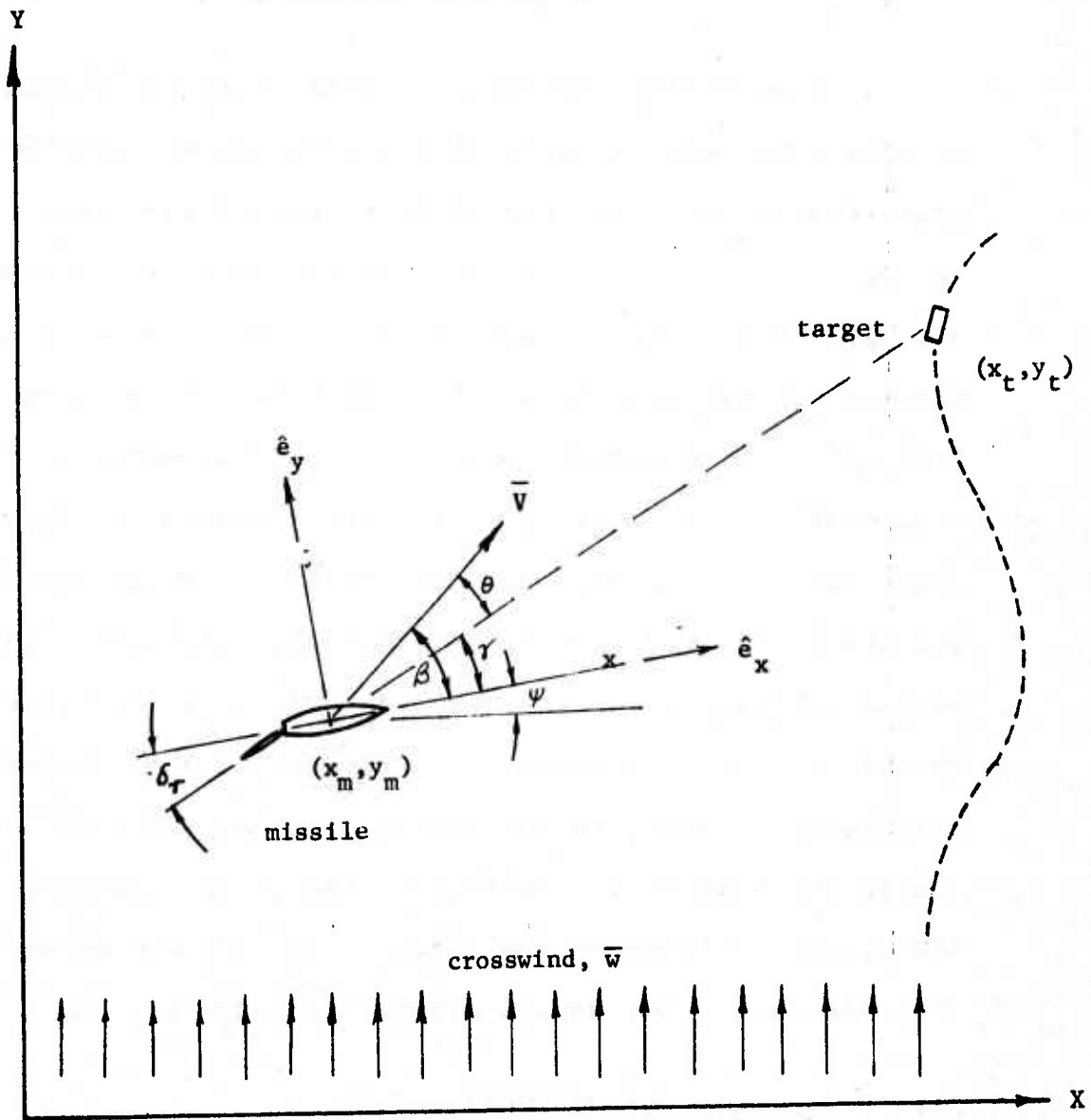

Figure 5.1 Trajectory Coordinates for Guided Missile and Target

$$\Sigma \vec{F} = m \dot{\vec{v}} \quad (5.1)$$

and

$$\Sigma \vec{M} = I_{zz} \ddot{\psi} \quad (5.2)$$

where

\vec{F} = force vector, (lbs)

\vec{M} = moment, (in.-lbs)

\vec{v} = velocity vector, (in./sec.)

ψ = angle of rotation, (radians)

m = mass of missile, (lbs-sec²/in.)

I_{zz} = mass moment of inertia, (in.-lbs-sec²).

The velocity vector can be expressed in terms of the unit vectors \hat{e}_x and \hat{e}_y through the following equations

$$\dot{\vec{v}} = (\dot{\vec{v}})_T + \vec{W} \times \vec{v}, \quad (5.3)$$

$$\vec{W} = \dot{\psi} \hat{e}_z, \quad (5.4)$$

and

$$\dot{\vec{v}} = (\dot{v}_x - \dot{\psi} v_y) \hat{e}_x + (\dot{v}_y + \dot{\psi} v_x) \hat{e}_y \quad (5.5)$$

The equations of motion can then be expressed in component form as

$$\Sigma F_x = \dot{m}(\dot{v}_x - \dot{\psi}v_y) \quad (5.6)$$

$$\Sigma F_y = m(\dot{v}_y + \dot{\psi}v_x) \quad (5.7)$$

and

$$\Sigma M_z = I_{zz} \dot{\psi} \quad (5.8)$$

To make solution of these equations possible, linearize the velocity components about an equilibrium position as

$$v_x = U_0 + \Delta u \quad (5.9)$$

$$v_y = \Delta v \quad (5.10)$$

and

$$\psi = \psi_0 + \Delta\psi \quad (5.11)$$

where Δu , Δv and $\Delta\psi$ are perturbations about the equilibrium state. The equations of motion, Eqs. (5.6)--(5.8), reduce to

$$\Sigma F_x = m\Delta\dot{u}, \quad (5.12)$$

$$\Sigma F_y = m(\Delta\dot{v} + U_0\Delta\dot{\psi}), \quad (5.13)$$

and

$$\Sigma M_z = I_{zz}\Delta\ddot{\psi}. \quad (5.14)$$

5.2 Aerodynamic Forces

Aerodynamic forces are exerted on the missile due to drag and pitching moment effects. As illustrated in Figure 5.1, the relative wind acts at an angle β with respect to the missile axis. The relative wind can be expressed in vector form as

$$\vec{v}_{m/w} = \vec{v} - \vec{w} \quad (5.15)$$

or, in terms of the previously defined quantities

$$\vec{v}_{m/w} = (U_0 + \Delta u) \hat{e}_x + \Delta v \hat{e}_y - w_x \hat{e}_x - w_y \hat{e}_y \quad (5.16)$$

$$\begin{aligned} \vec{v}_{m/w} = & (U_0 + \Delta u - w_x \cos \psi - w_y \sin \psi) \hat{e}_x \\ & + (\Delta v + w_x \sin \psi - w_y \cos \psi) \hat{e}_y \end{aligned} \quad (5.17)$$

Then, β can be expressed as

$$\beta = \tan^{-1} \left[\frac{\Delta v + w_x \sin \psi - w_y \cos \psi}{U_0 + \Delta u - w_x \cos \psi - w_y \sin \psi} \right] \quad (5.18)$$

If β and ψ are assumed small

$$\beta \approx \frac{\Delta v - w_y}{U_0} \quad (5.19)$$

The aerodynamic forces F_x , F_y and M_z are functions of the

dynamic pressure q , a characteristic area S , the missile length b , as well as the variables Δu , β , δ_r and $\dot{\Psi}$. For convenience, introduce the dimensionless velocity components $\Delta \bar{u}$ and $\Delta \bar{v}$ defined as

$$\Delta u = U_0 \Delta \bar{u} \text{ and } \Delta v = U_0 \Delta \bar{v} \quad (5.20)$$

and express the aerodynamic forces as

$$F_x = qS (C_x + C_{xu} \Delta \bar{u} + C_{x\beta} \beta + C_{x\delta_r} \delta_r), \quad (5.21)$$

$$F_y = qS (C_{y\beta} \beta + \frac{b}{2U_0} C_{y\dot{\Psi}} \Delta \dot{\Psi} + C_{y\delta_r} \delta_r), \quad (5.22)$$

and

$$M_z = qSb (C_{z\beta} \beta + \frac{b}{2U_0} C_{z\dot{\Psi}} \Delta \dot{\Psi} + C_{z\delta_r} \delta_r), \quad (5.23)$$

where

$$q = \frac{1}{2} \rho v_{m/w}^2 \quad (5.24)$$

$$q \approx \frac{1}{2} \rho [(U_0 - w_x)^2 + w_y^2], \quad (5.25)$$

and where the coefficients are force and moment coefficients determined by experiment or estimated from tests on similar vehicles.

The equations of motion can then be expressed as

$$\frac{mU_0}{qS} \Delta \ddot{\bar{u}} = C_x + C_{xu} \Delta \bar{u} + C_{x\beta} \beta + C_{x\delta_r} \delta_r, \quad (5.26)$$

$$\frac{mU_0}{qS} (\Delta \dot{\bar{v}} + \Delta \dot{\Psi}) = C_{y\beta} \beta + \frac{6}{2U_0} C_{y\dot{\Psi}} \Delta \dot{\Psi} + C_{y\delta_r} \delta_r, \quad (5.27)$$

and

$$\frac{I_z}{qSb} \Delta \ddot{\Psi} = C_{z\beta} \beta + \frac{b}{2U_0} C_{z\dot{\Psi}} \Delta \dot{\Psi} + C_{z\delta_r} \delta_r. \quad (5.28)$$

The velocity components of the missile relative to the (X,Y) reference coordinate system can be expressed as

$$\ddot{X}_m = U_0 [(1+\Delta \bar{u}) \cos \Psi - \Delta \bar{v} \sin \Psi], \quad (5.29)$$

and

$$\ddot{Y}_m = U_0 [(1+\Delta \bar{u}) \sin \Psi + \Delta \bar{v} \cos \Psi] \quad (5.30)$$

These governing equations must be integrated in time subject to the initial conditions

$$X_m(0) = 0, \quad Y_m(0) = 0, \quad \Delta \bar{u}(0) = \Delta \bar{u}_0, \quad (5.31)$$

$$\Delta \bar{v}(0) = \Delta \bar{v}_0, \quad \Delta \Psi(0) = \Psi_0, \quad \dot{\Psi}(0) = W_0.$$

5.3 Solution Technique

The differential equations of motion, Eqs. (4.26)--(4.28), represent a set of coupled second order linear differential equations which can be reduced to a set of first order differential equations of the form

$$\frac{d}{dt}(\Delta\bar{u}) = g_1 \quad (5.32)$$

$$\frac{d}{dt}(\Gamma) = g_2 \quad (5.33)$$

$$\frac{d}{dt}(\Omega) = g_3 \quad (5.34)$$

$$\frac{d}{dt}(\Delta\Psi) = \Omega \quad (5.35)$$

where $\Gamma = \Delta\dot{\bar{v}} + \Delta\dot{\Psi}$ and the other quantities in Eqs. (5.32)--(5.35) can be inferred by comparison with Eqs. (5.26)--(5.28). These equations, Eqs. (5.32)--(5.35), can be cast into vector form as

$$\frac{d}{dt} \tilde{x} = F(t, \tilde{x})$$

where

$$\tilde{x}^T = [\Delta\bar{u}, \Gamma, \Omega, \Delta\Psi] \quad (5.36)$$

and

$$F^T = [g_1, g_2, g_3, \Omega].$$

This vector differential equation is now in the same form as Eq. (4.29) and the step-by-step Runge-Kutta integration method described in Section 4 can be used to solve Eq. (5.36).

With the solution of Eqs. (5.32)--(5.35) known at each instant of time, Eqs. (5.29) and (5.30) can be solved to obtain the X and Y coordinates of the missile in a step-by-step process.

5.4 Control Law

The control law used in CADLAW to insure intercept of the missile with the moving target is a simple rate dependent relation of the form

$$\delta_r = G_1 \xi + G_2 \dot{\xi} \quad (5.37)$$

where

$$\xi = y_t - Y_m \quad (5.38)$$

and

$$\dot{\xi} = \dot{y}_t - \dot{Y}_m \quad (5.39)$$

and where y_t and Y_m are coordinates of the target and missile, respectively. The parameters G_1 and G_2 are gain settings and can be determined in an optimization process.

5.5 Target Motion

To evaluate the performance of the aerodynamic and guidance and control systems, the antitank missile is assumed

to be attempting to intercept a target which moves in the horizontal plane. To provide a variety of evasion tactics, the target is assumed to follow a curve defined as

$$ax_t^2 + bx_t y_t + cy_t^2 + dx_t + ey_t + f = 0 \quad (5.40)$$

where (x_t, y_t) denote the target location and where a, b, c, \dots, f are arbitrary constants used to describe the target motion. The target speed v_t is assumed constant and may also be changed by the designer to study the effects of different evasive tactics. With the target speed constant the target location can be determined at any time by integrating the differential equations

$$\dot{x}_t = v_t \cos \theta_t \quad (5.41)$$

and

$$\dot{y}_t = v_t \sin \theta_t \quad (5.42)$$

where

θ_t is defined by

$$\tan \theta_t = \frac{dy_t}{dx_t} = - \frac{2a x_t + by_t + d}{bx_t + 2cy_t + e} \quad (5.43)$$

The distance from the missile to the target can be expressed in terms of the missile position coordinates X_m and Y_m , obtained by solving Eqs. (5.29) and (5.30), respectively, and the target coordinates x_t and y_t as

$$d_t = [(x_t - X_m)^2 + (y_t - Y_m)^2]^{1/2} \quad (5.44)$$

The minimum value that d_t obtains during a particular flight is defined as the "miss distance" ϕ_m , i.e.,

$$\phi_m = \min_{t \rightarrow \infty} (d_t) \quad (5.45)$$

The performance of the missile in flight depends strongly on the parameter ϕ_m .

5.6 Wind Model

To simulate the effects of cross-winds on the missile trajectory, a stochastic wind model is incorporated into CADLAW. The wind is assumed to blow in the y-direction (see Figure 5.1) only and to have a magnitude given by

$$w_y = w_{ym} [1 + 2\sigma(R - 0.5)] \quad (5.46)$$

where w_{ym} is the mean velocity of the wind, σ is the standard deviation of the distribution about the mean, and R is a random number between zero and one. The value of w_{ym} may be varied by the designer.

6. OPTIMIZATION ALGORITHM

Perhaps the key element of the CADLAW system is the optimization process used to determine the "optimum design." As described in Section 2, the optimization process involves a pattern search of a hypersurface, defined by an objective function, to obtain a design point which gives a maximum or minimum value for the function. The objective functions employed in CADLAW have previously been defined in Section 2. The objective of this section is to describe the particular optimization method utilized in CADLAW.

The particular algorithm adapted to the computer program CADLAW is the flexible tolerance method originally described by Paviani and Himmelblau [12]. The remaining discussion in this section represent mainly excerpts from Reference 13. The flexible tolerance method can be classed as a "search" method as opposed to the derivative-type methods of optimization. In the purest of the search methods, the directions of minimization are determined solely from successive evaluation of the objective functions $f(x)$.

As a general rule, in solving unconstrained nonlinear programming problems, gradient and second-derivative methods converge faster than direct search methods. However, in practice, the derivative-type methods have two main barriers

to their implementation. First, in problems with a modestly large number of variables, it is laborious or impossible to provide analytical functions for the derivatives needed in a gradient or second-derivative algorithm. Although evaluation of the derivatives by difference schemes can be substituted for evaluation of the analytical derivatives the numerical error introduced, particularly in the vicinity of the extremum can impair the use of such substitutions. In principle, symbolic manipulation to evolve analytical derivatives is possible, but this technique still requires considerable development before it becomes a feasible tool in practice. In any case, search methods do not require regularity and continuity of the objective function and the existence of derivatives. Second, and a related point, optimization techniques based on the evaluation of first and possibly second derivatives require a relatively large amount of problem preparation by the user before he introduces the problem into the algorithm, as compared with search techniques.

Because of the difficulties described above, direct search optimization algorithms have been devised that, although slower to execute for simple problems, in practice may prove more satisfactory from the user's viewpoint than gradient or second-derivative methods, and may cost less to use if the cost of problem preparation time is high relative to the computation time.

The general nonlinear programming problem can be stated as follows:

$$\begin{aligned} \text{Minimize: } & f(\underline{x}) \quad \underline{x} \in E^n \\ \text{Subject to: } & h_i(\underline{x}) = 0 \quad i = 1, \dots, M \\ & g_i(\underline{x}) \geq 0 \quad i = m + 1, \dots, p \end{aligned} \quad (6-1)$$

where $f(\underline{x})$, $h_i(\underline{x})$, and $g_i(\underline{x})$ may be linear and/or nonlinear functions. In many nonlinear programming methods a considerable portion of the computation time is spent on satisfying rather rigorous feasibility requirements. The flexible tolerance algorithm [12], on the other hand, improves the value of the objective function by using information provided by feasible points, as well as certain nonfeasible points termed near-feasible points. The near-feasibility limits are gradually made more restrictive as the search proceeds toward the solution of the programming problem, until in the limit only feasible x vectors in Eqs. (6-1) are accepted. As a result of this basic strategy problem, Eq. (6-1) can be replaced by a simpler problem, having the same solution:

$$\begin{aligned} \text{Minimize: } & f(\underline{x}) \quad \underline{x} \in E^n \\ \text{Subject to: } & \phi^{(k)} - T(\underline{x}) \geq 0 \end{aligned} \quad (6-2)$$

where $\phi^{(k)}$ is the value of the flexible tolerance criterion for feasibility on the k th stage of the search as defined by

Eq. (6-3) below, and $T(\underline{x})$ is a positive functional of all the equality and/or inequality constraints of Problem (6-1) used as a measure of the extent of constraint violation.

In the particular application here, $f(\underline{x})$ is the squared difference between the total strain energy density and the element strain energy density summed over all the elements of the shell. Hence, $f(\underline{x})$ is a nonlinear function of \underline{x} . The $h_i(\underline{x})$ and $g_i(\underline{x})$ are linear constraint relations for the composite shell optimization problem.

6.1 Flexible Polyhedron Search

Nelder and Mead [15] proposed a method of search which has proved to be an effective strategy and one which is easily implemented on a digital computer. The method of Nelder and Mead minimizes a function of n independent variables using $(n + 1)$ vertices of a flexible polyhedron in E^n . Each vertex can be defined by a vector \underline{x} . The vertex (point) in E^n which yields the highest value of $f(\underline{x})$ is projected through the center of gravity (centroid) of the remaining vertices. Improved (lower) values of the objective function are found by successively replacing the point with the highest value of $f(\underline{x})$ by better points until the minimum of $f(\underline{x})$ is found.

The details of the algorithm are as follows.

Let $\underline{x}_i^{(k)} = [x_{i1}^{(k)}, \dots, x_{ij}^{(k)}, \dots, x_{in}^{(k)}]^T, i = 1, \dots, n + 1,$

be the i th vertex (point) in E^n on the k th stage of the search, $k = 0, 1, \dots$, and let the value of the objective function at $\underline{x}_i^{(k)}$ be $f(\underline{x}_i^{(k)})$. In addition, we need to label \underline{x} vectors in the polyhedron that give the maximum and minimum values of $f(\underline{x})$.

Define

$$f(\underline{x}_h^{(k)}) = \max \{f(\underline{x}_1^{(k)}), \dots, f(\underline{x}_{n+1}^{(k)})\}$$

with the corresponding $\underline{x}_i^{(k)} = \underline{x}_h^{(k)}$, and

$$f(\underline{x}_1^{(k)}) = \min \{f(\underline{x}_1^{(k)}), \dots, f(\underline{x}_{n+1}^{(k)})\}$$

with the corresponding $\underline{x}_i^{(k)} = \underline{x}_1^{(k)}$. Since the polyhedron in E^n is made up of $(n+1)$ vertices, $\underline{x}_1, \dots, \underline{x}_{n+1}$, let \underline{x}_{n+2} be the centroid of all the vertices excluding \underline{x}_h . The coordinates of the centroid are given by

$$x_{n+2,j}^{(k)} = \frac{1}{n} \left[\left(\sum_{i=1}^{n+1} a_{ij}^{(k)} \right) - x_{hj}^{(k)} \right] \quad j = 1, \dots, n \quad (6-3)$$

where the index j designates each coordinate direction.

The initial polyhedron usually is selected to be a regular simplex (it does not have to be), with point 1 as the origin, or perhaps the centroid as the origin, as in the computer code. The procedure of finding a vertex in E^n at which $f(\underline{x})$ has a better value involves four operations:

1. Reflection. Reflect $\underline{x}_h^{(k)}$ through the centroid by computing

$$\underline{x}_{n+3}^{(k)} = \underline{x}_{n+2}^{(k)} + \alpha(\underline{x}_{n+2}^{(k)} - \underline{x}_h^{(k)}) \quad (6-4)$$

where $\alpha > 0$ is the reflection coefficient,

$\underline{x}_{n+2}^{(k)}$ = centroid computed by Eq. (6-3)

$\underline{x}_h^{(k)}$ = vertex at which $f(\underline{x})$ is the largest of

$(n + 1)$ values of $f(\underline{x})$ on k th stage

2. Expansion. If $f(\underline{x}_{n+3}^{(k)}) \leq f(\underline{x}_1^{(k)})$, expand the vector

$(\underline{x}_{n+3}^{(k)} - \underline{x}_{n+2}^{(k)})$ by computing

$$\underline{x}_{n+4}^{(k)} = \underline{x}_{n+2}^{(k)} + \gamma(\underline{x}_{n+3}^{(k)} - \underline{x}_{n+2}^{(k)}) \quad (6-5)$$

where $\gamma > 1$ is the expansion coefficient. If

$f(\underline{x}_{n+4}^{(k)}) < f(\underline{x}_1^{(k)})$, replace $\underline{x}_h^{(k)}$ by $\underline{x}_{n+4}^{(k)}$ and continue from step 1 with $k = k + 1$. Otherwise, replace $\underline{x}_h^{(k)}$ by $\underline{x}_{n+3}^{(k)}$ and continue from step 1 with $k = k + 1$.

3. Contractions. If $f(x_{n+3}) > f(x_i^{(k)})$ for all $i \neq h$, contract the vector $(x_h^{(k)} - x_{n+2}^{(k)})$ by computing

$$x_{n+5}^{(k)} = x_{n+2}^{(k)} + \beta(x_h^{(k)} - x_{n+2}^{(k)}) \quad (6-6)$$

where $0 < \beta < 1$ is the contraction coefficient. Replace

$x_h^{(k)}$ by $x_{n+5}^{(k)}$ and return to step 1 to continue the

search on the $(k + 1)$ st stage.

4. Reduction. If $f(x_{n+3}) > f(x^{(k)})$, reduce all the vectors $(x_{n+3}^{(k)} - x_h^{(k)})$, $i = 1, \dots, n + 1$, by one-half from $x_1^{(k)}$ by computing

$$x_i^{(k)} = x_1^{(k)} + 0.5(x_i^{(k)} - x_1^{(k)})$$

$$i = 1, \dots, n + 1 \quad (6-7)$$

and return to step 1 to continue the search on the $(k + 1)$ st stage.

The criterion used by Nelder and Mead to terminate the search was to test to determine if

$$\left\{ \frac{1}{n+1} \sum_{i=1}^{n+1} [f(\underline{x}_i^{(k)}) - f(\underline{x}_{n+2}^{(k)})]^2 \right\}^{\frac{1}{2}} \leq \epsilon \quad (6-8)$$

where ϵ is an arbitrarily small number, and $f(\underline{x}_{n+2}^{(k)})$ is the value of the objective function at the centroid $\underline{x}_{n+2}^{(k)}$.

6.2 The Tolerance Criterion

The tolerance criterion ϕ in Eq. 6-2 is selected to be a positive decreasing function of the vertices of the flexible polyhedron in E^n ; $\phi^{(k)} = \phi^{(k)}(\underline{x}_1^{(k)}, \underline{x}_2^{(k)}, \dots, \underline{x}_{r+1}^{(k)}, \underline{x}_{r+2}^{(k)})$. The function ϕ acts as a tolerance criterion for constraint violation throughout the entire search, and also serves as a criterion for termination of the search. Many alternative definitions of ϕ are possible, but the one incorporated into the algorithm to be described is

$$\begin{aligned} \phi^{(k)} &= \min\{\phi^{(k-1)}, \frac{m+1}{r+1} \sum_{i=1}^{r+1} \left\| \underline{x}_i^{(k)} - \underline{x}_{r+2}^{(k)} \right\|\} \phi^{(0)} \\ &= 2(m+1)t \end{aligned} \quad (6-9)$$

where t = size of initial polyhedron
 m = number of equality constraints
 $\underline{x}_i^{(k)}$ = i th vertex of polyhedron in E^n
 \underline{r} = $(n - m)$ = number of degrees of freedom
of $f(\underline{x})$ in Problem (4-1)
 $\underline{x}_{n+2}^{(k)}$ = vertex corresponding to centroid as defined
by Eq. (4-3), with $n = r$
 $k = 0, 1, \dots$ is an index referring to number of
completed stages of search
 $\phi^{(k-1)}$ = value of tolerance criterion on $(k - 1)$ st
stage of search

Let the second term in the braces of Eq. (6-9) be
denoted by $\theta^{(k)}$.

$$\theta^{(k)} = \frac{m+1}{r+1} \left\| \sum_{i=1}^{r+1} \underline{x}_i^{(k)} - \underline{x}_{r+2}^{(k)} \right\|$$

$$= \frac{m+1}{r+1} \left\{ \sum_{i=1}^{r+1} \sum_{j=1}^n (x_{ij}^{(k)} - x_{r+2,j}^{(k)})^2 \right\}^{\frac{1}{2}} \quad (6-10)$$

where $x_{ij}^{(k)}$, $j = 1, \dots, n$, are the coordinates of the i th
vertex of the flexible polyhedron in E^n . Observe that $\theta^{(k)}$
represents the average distance from each $\underline{x}_i^{(k)}$, $i = 1, \dots,$
 $r + 1$, to the centroid $\underline{x}_{r+2}^{(k)}$ of the polyhedron in E^n . To

understand the behavior of $\phi^{(k)}$ it is necessary first to understand the behavior of θ . It is obvious that the value of θ will depend on the size of the polyhedron in E^n , which may remain unchanged, expand, or contract, depending on which one of the four operations described in Sec. 4.1 is used to carry out the transition from $\underline{x}_i^{(k)}$ to $\underline{x}_i^{(k+1)}$. Thus $\phi^{(k)}$ behaves as a positive decreasing function of \underline{x} , although $\theta^{(k)}$ may increase or decrease during the progress of the search, and as the solution of the problem is approached, both $\theta^{(k)}$ and $\phi^{(k)}$ approach zero

$$\phi^{(0)} \geq \phi^{(1)} \geq \dots \geq \phi^{(k)} \geq 0 \quad (6-11)$$

In the method of Nelder and Mead, when it is not possible to find better values of $f(\underline{x})$ by Eq. (6-4), the vertices of the flexible polyhedron are drawn nearer and nearer to that vertex corresponding to the best value of the objective function. In the limit complete collapse of all the vertices of the flexible polyhedron takes place onto the stationary solution of $f(\underline{x})$. Thus, as the search approaches the stationary solution of $f(\underline{x})$, the value of $\theta^{(k)}$ given by Eq. (6-10) becomes progressively smaller because the average distance between the vertices and the centroid of the polyhedron shrinks to zero. Since on each k th stage of the search $\phi^{(k)}$ is set equal to the smaller value of either $\phi^{(k-1)}$ or $\theta^{(k)}$, the tolerance criterion $\phi^{(k)}$

also collapses and in the limit,

$$\lim_{x \rightarrow x^*} \phi^{(k)} = 0 \quad (6-12)$$

6.3 Criterion for Constraint Violation

Consider now a functional of the equality and inequality constraints of Problem (4-1).

$$T(\underline{x}) = + \left[\sum_{i=1}^m h_i(\underline{x}) + \sum_{i=m+1}^p U_i g_i^2(\underline{x}) \right]^{\frac{1}{2}} \quad (6-13)$$

where U_i is the Heaviside operator such that $U_i = 0$ for $g_i(\underline{x}) \geq 0$ and $U_i = 1$ for $g_i(\underline{x}) < 0$. Therefore $T(\underline{x})$ is defined as the positive square root of the sum of the squared values of all the violated equality and/or inequality constraints of Problem (6-1). Note that $T(\underline{x}) \geq 0$ for all $\underline{x} \in E^n$. In particular, if $\sum_{i=1}^m h_i(\underline{x})$ is convex and the $g_i(\underline{x})$, $i = m + 1, \dots, p$, are concave functions, then $T(\underline{x})$ is a convex function with a global minimum $T(\underline{x}) = 0$ for all feasible \underline{x} vectors; i.e., for any $\{\underline{x} | h_i(\underline{x}) = 0, g_i(\underline{x}) \geq 0 \text{ for } i = 1, \dots, p\}$. Also, $T(\underline{x}) > 0$ for all \underline{x} vectors that are nonfeasible. For a given $\underline{x}^{(k)} \in E^n$, the value of $T(\underline{x})$ evaluated at $\underline{x}^{(k)}$ using Eq. (4-13) can be used to distinguish between feasible and nonfeasible points. If $T(\underline{x}^{(k)}) = 0$, $\underline{x}^{(k)}$ is feasible; if $T(\underline{x}^{(k)}) > 0$, $\underline{x}^{(k)}$ is nonfeasible. On the other hand, a small value of $T(\underline{x}^{(k)})$ implies that $\underline{x}^{(k)}$ is relatively near

to the feasible region, and a large value for $T(\underline{x}^{(k)})$ implies that $\underline{x}^{(k)}$ is relatively far from the feasible region.

6.4 Concept of Near-Feasibility

Near-feasible \underline{x} vectors are those points in E^n that are not feasible, but nevertheless almost feasible, in the sense given below. To establish a clear-cut distinction between feasible, near-feasible, and nonfeasible points, let $\phi^{(k)}$ be the value of ϕ on the k th stage of the optimization search and let $\underline{x}^{(k)}$ be any vector in E^n . The $\underline{x}^{(k)}$ vector is said to be

1. Feasible, if $T(\underline{x}^{(k)}) = 0$
2. Near-feasible, if $0 \leq T(\underline{x}^{(k)}) \leq \phi^{(k)}$
3. Nonfeasible, if $T(\underline{x}^{(k)}) > \phi^{(k)}$

Thus the region of near-feasibility is defined as

$$\phi^{(k)} - T(\underline{x}) \geq 0 \quad (6-14)$$

On any transition from $\underline{x}^{(k)}$ to $\underline{x}^{(k+1)}$, the move is said to be feasible if $T(\underline{x}^{(k+1)}) = 0$, near-feasible if

$$0 \leq T(\underline{x}^{(k+1)}) \leq \phi^{(k)}, \text{ and nonfeasible if } T(\underline{x}^{(k+1)}) > \phi^{(k)}.$$

Note that the value of ϕ on the $(k+1)$ th stage of the search is determined only after $\underline{x}^{(k+1)}$ has been located as either a feasible or near-feasible point.

6.5 Strategy of the Flexible Tolerance Algorithm

In this section it is demonstrated that the general nonlinear programming Problem (4-1) can be replaced by the easier problem of minimizing $f(x)$ subject to one gross inequality constraint as follows:

$$\begin{aligned} \text{Minimize:} \quad & f(\underline{x}) \quad \underline{x} \in E^n \\ \text{Subject to:} \quad & \phi^{(k)} - T(\underline{x}) \geq 0 \end{aligned} \quad (6-15)$$

The flexible polyhedron search of Nelder and Mead is a convenient and effective but not essential method of minimizing $f(\underline{x})$ as an unconstrained function when the constraint in (6-15) is not active, and is also used to minimize $T(\underline{x})$ to satisfy the single constraint in (6-15) when the constraint is active. The general strategy is to reduce $\phi^{(k)}$ as the search progresses, thus tightening the region of near-feasibility, and to segregate the minimization of $f(\underline{x})$ from the steps taken to satisfy the constraint in (6-15). For a given value of $\phi^{(k)}$, the value for $T(\underline{x})$ at $\underline{x}^{(k+1)}$ will be either (1) $T(\underline{x}^{(k+1)}) \leq \phi^{(k)}$, in which case $\underline{x}^{(k+1)}$ is either a feasible or a near-feasible point and will be accepted as a permitted move, or (2) $T(\underline{x}^{(k+1)}) > \phi^{(k)}$, in which case $\underline{x}^{(k+1)}$ is classed as nonfeasible, and an \underline{x} vector closer to or in the feasible region must be found in lieu of $\underline{x}^{(k+1)}$. One way of getting an $\underline{x}^{(k+1)}$ closer to the feasible region is to minimize the value of $T(\underline{x}^{(k+1)})$ as defined by Eq. (6-13)

until $T(\underline{x}^{(k+1)}) \leq \phi^{(k)}$.

To demonstrate that the solution of Problem (6-15) is equivalent to the solution of Problem (6-1), it is sufficient to consider the behavior of $\phi^{(k)}$. Because $\phi^{(k)}$ is a positive nonincreasing function such that $\phi^{(k)} = 0$ only when it is no longer possible to improve the value of $f(\underline{x})$ in Problem (6-15) the region of near-feasibility, given by Eq. (6-14) is gradually restricted as the search proceeds toward the solution of Problem (6-15). In the limit, that is, when all the vertices, $\underline{x}_i^{(k)}$, $i = 1, \dots, r + 1$, of the flexible polyhedron in E^n have collapsed into one single point at \underline{x}^* , then $\phi^* = 0$ and only \underline{x} vectors that are feasible, that is, $\{\underline{x} \mid h_i(\underline{x}) = 0, g_i(\underline{x}) \geq 0 \text{ for } i\}$, can satisfy the requirements of the inequality in Eq. (4-14). In other words, if $\phi^{(k)} = 0$, since $T(\underline{x})$ cannot be negative, the only possible value for $T(\underline{x})$ is $T(\underline{x}) = 0$, which requires that all the constraints of Problem (6-1) be satisfied.

Because the tolerance criterion ϕ is a positive nonincreasing function of the sequence of points $\underline{x}^{(0)}$, $\underline{x}^{(1)}$, \dots , \underline{x}^* generated during the progression of the search, because ϕ does not depend on the value of the objective function nor on the values of the constraints, and because in the limit $\phi^* = 0$, convergence of the algorithm is assured for the following reasons:

1. The manner in which ϕ is computed by Eq. (6-9) prevents the tolerance criterion from increasing. If ϕ were allowed to increase without bound, the possibility would arise of being able to improve the value of $f(\underline{x})$ at the expense of getting further and further away from the feasible region.
2. When the optimal solution of Problem (6-1) is an interior point (no equality constraints), convergence of the algorithm is assured because of the property of the flexible polyhedron of collapsing only when approaching the optimum of $f(\underline{x})$ in Problem (6-1). In these circumstances $T(\underline{x})$ has no effect on the convergence of the algorithm because, in the final stages of the search, x_i^k , $i = 1, \dots, r + 1$, are interior points yielding a $T(\underline{x}^{(k)}) = 0$, which implies that inequality (6-14) is satisfied for all $\underline{x}_i^{(k)}$ and that Problem (6-1) has not active constraints.
3. When the optimum of Problem (6-1) is not an interior point [either because \underline{x}^* is a boundary point or because Problem (6-1) includes only equality constraints], convergence is assured because of the condition imposed by inequality (6-14), that is $\phi^{(k)} - T(\underline{x}) \geq 0$. The flexible

polyhedron will not collapse as long as it is possible to find a better $f(x_i^{(k)})$ such that $\phi^{(k)} - T(x_i^{(k)}) \geq 0$.

Let $x_l^{(k)}$ be the vertex of the flexible polyhedron such that $\phi^{(k)} - T(x_l^{(k)}) \geq 0$; $f(x_l^{(k)})$ is the best value of $f(x)$ obtained on the k th stage of the search. Let $x_i^{(k+1)}$ be the vertices obtained during any reflection of $x_h^{(k)}$ through the centroid of the polyhedron such that $\phi^{(k)} - T(x_i^{(k+1)}) \geq 0$. If $f(x_i^{(k+1)}) > f(x_l^{(k)})$ for every reflection of $x_h^{(k)}$ through the centroid, the values of $\phi^{(k)}$ will decrease because of contractions in the flexible polyhedron. In such a case, the values of $\phi^{(k)}$ are reduced, and $x_l^{(k)}$ must satisfy the constraints of Problem (4-1) more and more closely until the search is terminated because $\phi^{(k)} \leq \epsilon$.

On the other hand, if $f(x_i^{(k+1)}) \leq f(x_l^{(k)})$, the value of $\phi^{(k)}$ will not decrease because no contraction of the polyhedron takes place and $x_l^{(k)}$ is replaced by a better vertex. As long as it is possible to determine either a feasible or near-feasible point such that $f(x_i^{(k+1)}) \leq f(x_l^{(k)})$, there will be reflections and expansions of the flexible polyhedron. Thus premature termination of the search at a nonlocal optimum is avoided because the polyhedron will not collapse if there exists an $x_i^{(k+1)}$ such that $\phi^{(k)} - T(x_l^{(k+1)}) \geq 0$ and $f(x_i^{(k+1)}) \leq f(x_l^* \pm \epsilon)$. (6-15)

One advantage of the flexible tolerance strategy typified by Problem (6-15) is that the extent of the violation of the constraints included in Problem (6-1) is progressively decreased as the search moves toward the solution of Problem (4-1). Because the equality and/or the inequality constraints are loosely satisfied in the early stages of the search, and more tightly satisfied only as the search approaches the solution of Problem (6-15), the overall computation effort required in the optimization is considerably reduced.

Another advantage of the flexible tolerance strategy is that $\phi^{(k)}$ can be conveniently used as a criterion for termination of the search. For all practical purposes it is sufficient to continue the search until $\phi^{(k)}$ becomes smaller than some arbitrarily selected positive number ϵ . In the final stages of the search, $\phi^{(k)}$ is also a measure of the average distance from each vertex $\underline{x}_i^{(k)}$, $i = 1, \dots, r + 1$, to the centroid $\underline{x}_{r+2}^{(k)}$ of the polyhedron in E^n . If $\phi^{(k)} \leq \epsilon$, a substantial number of the vertices $\underline{x}_i^{(k)}$ are contained in a hypersphere of radius ϵ . (If the last polyhedron of the search were regular, all the vertices $\underline{x}_i^{(k)}$ would be contained by the hypersphere of radius ϵ , but because the polyhedron is distorted, some vertices may be outside the sphere.) Therefore, if $\phi^{(k)} \leq \epsilon$, the chances are that the value of $f(\underline{x})$ cannot be improved without having to further reduce the

size of the polyhedron. This implies that a change of 2ϵ in the $x_i^{(k)}$ corresponding to the best value of $f(x)$, that is, $x_\ell^{(k)}$, will not improve the value of the objective function. Hence, upon termination of the search, the following condition is satisfied:

$$f(x_\ell^{(k)}) \leq f(x^* \pm \epsilon) \quad (6-16)$$

Since Eq. (4-14) is satisfied for every move, if $\phi^{(k)} \leq \epsilon$, it is obvious that the condition $\epsilon - T(x_\ell^{(k)}) \geq 0$ is also satisfied, or

$$T(x_\ell^{(k)}) = \left[\sum_{i=1}^m h_i^2(x) + \sum_{i=m+1}^p U_i(x) g_i(x) \right]^{1/2} \leq \epsilon \quad (6-17)$$

Equation (6-17) implies that, upon termination of the search, the combined value of all the violated constraints does not exceed ϵ . Certainly, no individual constraint can be violated by more than ϵ either.

Thus, by conducting the search in the manner described one arrives at an "optimum design" point. This procedure is employed in CADLAW.

7. CADLAW DESCRIPTION AND USER INSTRUCTIONS

The design program CADLAW operates interactively from a demand terminal. The program has the capability to perform optimized design studies or classical parameter studies and to present the results in either a tabular or graphical form. To operate the program a basic awareness of the organization of the program is helpful.

7.1 Design Program Organization

As described earlier in Section 2, CADLAW is designed to permit study of three different, independent subjects related to light antitank weapon systems. The first subject concerns the propulsion system, including structural features, of a conventional in-tube burning rocket system. The second subject concerns the propulsion system, including structural features, of a recoilless, closed rocket system. The third subject with which CADLAW deals is the flight or trajectory phase of operation of a light antitank weapon system. The different type propulsion systems can obviously be studied independently since most antitank systems will have only one propulsion system. The trajectory phase of antitank weapon operation can be studied independent of the propulsion phase

since all propulsion is accomplished within the launch tube before flight characteristics become of interest. The CADLAW user must decide which of the three subject areas is to be studied and direct the computer to implement the subject matter of interest. Each of these three subjects are contained in three separate overlays and are loaded and unloaded from the computer core as the user directs. The basic overlay design of CADLAW is described schematically in Table 7.1.

Within each of the basic overlays dealing with one of the three subjects described above, there exists a capability to either perform an optimized design study or classical parameter study as the user desires. Only one type of study may be performed at a time. However, both type studies may be performed by operating in a sequential mode. These components of the program are also illustrated in Table 7.1.

7.2 User Instructions

The CADLAW system is basically semi-tutorial in nature, i.e., if desired, the system explains the basic organization of itself and informs the user of the responses to be made to implement the system. To save time the system will skip over all instructions if the user is familiar with it.

Since the CADLAW system is interactive, the system communicates with the user by printing messages on the CRT screen of the interactive terminal. These messages are either

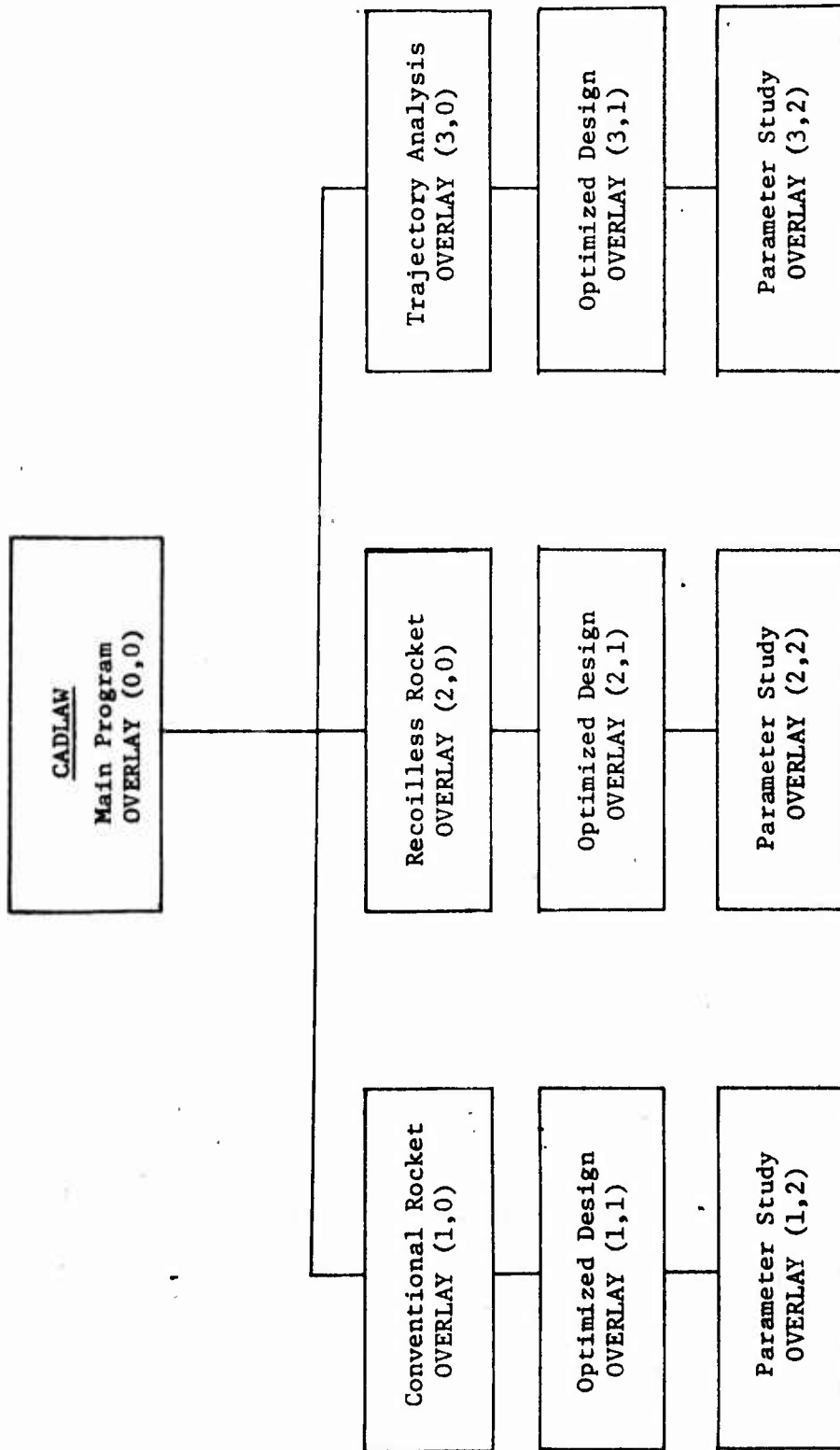

Table 7.1 Description of CADLAW Overlay Structure

instructions on program usage, questions for the user, or statements of results or data. The user responds to the computer by typing information on the terminal keyboard. Since the program is self explanatory, no specific instructions need be supplied the user. Only those data which differ from a basic data set defined within the system required input. All others assume default values.

7.3 Sample CADLAW Execution

It appears that familiarity with the program can best be gained by following through a typical execution cycle. The following pages represent copies of the CRT screen displays as seen by the user. When a right bracket appears in column one, the computer is asking for a response from the user. All data input to the program is in a free-format style. Hence the user may simply type in the desired pieces of information, each separated by a comma. A read sequence is terminated by typing in a series of zeros for the information asked for.

THE TITLE YOU HAVE SELECTED IS

***** SAMPLE EXECUTION *****

IS THIS TITLE SATISFACTORY? Y/N

>Y

WHICH OF THE FOLLOWING SEGMENTS OF THE PROGRAM WOULD YOU LIKE TO EXECUTE? (INPUT INDEX NO)

- 1 CONVENTIONAL ROCKET DESIGN
- 2 RECOILLESS ROCKET DESIGN
- 3 AERODYNAMIC DESIGN

>1

SECTION 1 0 **** CONVENTIONAL ROCKET DESIGN ****

DO YOU NEED INSTRUCTIONS? Y/N

>Y

THIS SECTION OF CADLAW ALLOWS THE OPTIMIZED DESIGN AND EVALUATION OF A CONVENTIONAL ROCKET SYSTEM

THE PARAMETERS WHICH COMPLETELY DEFINE A LIGHT ANTI-TANK WEAPON SYSTEM HAVE BEEN DIVIDED INTO TWO GROUPS ONE GROUP CONSISTS OF THE DESIGN VARIABLES WHOSE NUMERICAL VALUES ARE TO BE DETERMINED BY CADLAW A SECOND GROUP CONSISTS OF FIXED PARAMETERS WHOSE NUMERICAL VALUES ARE SPECIFIED BY THE DESIGNER

CADLAW IS CONSTRUCTED IN SUCH A WAY THAT MANY OF THE REQUIRED PARAMETERS ARE PRESET TO TYPICAL VALUES YOU MAY CHANGE THE DEFAULT VALUES BY RESPONDING TO CERTAIN QUESTIONS APPROPRIATELY ALL INPUT IS IN A FREE FORMAT FORM. THUS, THE DESIGNER NEED NOT BE CONCERNED WITH FORMAT SPECIFICATIONS WHEN SEVERAL DATA VALUES ARE CALLED FOR AT ONE TIME. THEY SHOULD BE TYPED IN SEQUENTIALLY WITH A CORNER SEPARATING THE DIFFERENT VALUES.

WOULD YOU LIKE TO SEE A TABLE OF DEFAULT VALUES FOR BOTH THE DESIGN VARIABLES AND FIXED PARAMETERS? Y/N

>Y

***** ANTI-TANK WEAPON DESIGN *****

DO YOU NEED INSTRUCTIONS TO RUN THE PROGRAM? Y/N

>Y

***** CADLAW *****

COMPUTER AIDED DESIGN OF LIGHT ANTI-TANK WEAPONS

THIS COMPUTER PROGRAM AIDS THE ENGINEERING DESIGNER IN SIMULTANEOUSLY SELECTING PARTICULAR VALUES OF THE DESIGN VARIABLES WHICH RESULT IN AN 'OPTIMUM DESIGN' OF A LIGHT ANTI-TANK WEAPON

THE PROGRAM IS DIVIDED INTO THE FOLLOWING SECTIONS

0 0 MAIN PROGRAM

1 0 CONVENTIONAL ROCKET DESIGN

- 1 1 OPTIMIZED DESIGN
- 1 2 PERFORMANCE EVALUATION

2 0 RECOILLESS ROCKET DESIGN

- 2 1 OPTIMIZED DESIGN
- 2 2 PERFORMANCE EVALUATION

3 0 AERODYNAMIC DESIGN

- 3 1 OPTIMIZED DESIGN
- 3 2 PARAMETER STUDY

YOU ARE NOW OPERATING IN SECTION (0.0)

TO BEGIN THE DESIGN PROCEDURE, PLEASE TYPE IN A TITLE FOR THIS PARTICULAR PROBLEM THIS TITLE WILL SUBSEQUENTLY BE DISPLAYED ON ALL GRAPHS AND TABLES WHICH RELATE TO THIS PROBLEM.

***** CENTER THE TITLE BETWEEN THE ASTERISKS *****

***** SAMPLE EXECUTION *****

THE TITLE YOU HAVE SELECTED IS

IS THIS TITLE SATISFACTORY? Y/N

>N

INPUT DESIRED TITLE.

***** SAMPLE EXECUTION *****

***** SAMPLE EXECUTION *****

>

```

*****DEFAULT PARAMETER TABLE*****
17 AMBIENT CHAMBER PRESSURE (DU) 12500 02002
18 NOZZLE EXPANSION RATIO (DU) 3 50000
19 MOTOR DIAMETER (DU) 3 10000
20 BURNING RATE CONSTANT (DU) 8 80000
21 PROPELLANT WEIGHT (DU) 7 50000
22 MOTOR LENGTH (DU) 7 00000
23 PRINT SWITCH 3
1 FOR DESIGN SUMMARY
2 FOR COMPREHENSIVE DESIGN SUMMARY
3 FOR PARAMETER STUDY
24 NO. OF PARAMETER STUDY PTS 70

```

DO YOU WANT TO CHANGE THE DEFAULT PARAMETERS? Y/N

>N

YOU ARE NOW OPERATING IN SECTION 1.0 AT THIS POINT YOU HAVE THE OPTION OF EITHER PERFORMING AN OPTIMIZED DESIGN STUDY OR CONDUCTING A PARAMETER STUDY WITH THE DESIGN PARAMETERS DO YOU WANT TO CALL THE CONVENTIONAL ROCKET OPTIMIZATION PROGRAM? Y/N

>Y

SECTION 1 1 *** CONVENTIONAL ROCKET OPTIMIZATION PROGRAM ***

DO YOU WANT INSTRUCTIONS? Y/N

>Y

THIS SECTION OF CADLAW ALLOWS FOR THE OPTIMIZED DESIGN OF A CONVENTIONAL ROCKET SYSTEM WOULD YOU LIKE TO SEE A TABLE CONTAINING THE DEFAULT VALUES FOR THE DESIGN VARIABLES? Y/N

>Y

***** DEFAULT DESIGN VARIABLE TABLE *****

INIT	PRESSURE CHAMBER GUESS	MIN	GUESS	MAX
1	INIT	2500	3000	11000
2	INIT	NOZZLE EXP. RATIO GUESS	2.50	3.50
3	INIT	MOTOR DIAMETER GUESS	2.50	3.10
4	INIT	BURNING RATE CONST. GUESS	7.00	8.00
5	INIT	PROPELLANT WT GUESS	600	800
6	INIT	MOTOR LENGTH GUESS	6.50	7.50
7	PRINT SWITCH			0
8	FOR OPTIMIZATION SUMMARY			
1	FOR INTERMEDIATE OPTIMIZATION RESULTS			
8	CONVERGENCE INDEX			0.10
9	POLYHEDRON SIZE			40

*****DEFAULT PARAMETER TABLE*****

```

1 SPECIFIC HEAT RATIO 1 40000
2 NOZZLE EXPANSION ANGLE 15 00000
3 PROPELLANT DENSITY 8 05000
4 FACTOR OF SAFETY 2 00000
5 TEMPERATURE EXTREME(HOT) 140 00000
6 TEMPERATURE AMBIENT 77 00000
7 TEMPERATURE EXTREME(COLD) -40 00000
8 PRESSURE SENSITIVITY 10000
9 WEIGHT OF MSHHEAD 2 11500
10 WEIGHT OF EXTRINS 50000
11 BURNING RATE EXPONENT 62000
12 FINAL BLOWDOWN PRESSURE 600 00000
13 DENSITY OF MOTOR MATERIAL 07000
14 DENSITY OF LAUNCHER MATERIAL 07000
15 ALLOWABLE MOTOR STRESS 130000 00000
16 THICKNESS OF LAUNCHER 18500 00000
17 AMBIENT CHAMBER PRESSURE (DU) 12500 00000
18 NOZZLE EXPANSION RATIO (DU) 3 50000
19 MOTOR DIAMETER (DU) 3 10000
20 BURNING RATE CONSTANT (DU) 8 80000
21 PROPELLANT WEIGHT (DU) 7 50000
22 MOTOR LENGTH (DU) 7 00000
23 PRINT SWITCH 3
1 FOR DESIGN SUMMARY
2 FOR COMPREHENSIVE DESIGN SUMMARY
3 FOR PARAMETER STUDY
24 NO. OF PARAMETER STUDY PTS 30

```

DO YOU WANT TO CHANGE THE DEFAULT PARAMETERS? Y/N

>Y

INPUT TABLE NO AND NEW VARIABLE. (INTEGER.REAL)

>23.3
>24.70
>0.0

WOULD YOU LIKE TO SEE A TABLE OF DEFAULT VALUES FOR BOTH THE DESIGN VARIABLES AND FIXED PARAMETERS? Y/N

>Y

*****DEFAULT PARAMETER TABLE*****

1	SPECIFIC HEAT RATIO	1	40000
2	NOZZLE EXPANSION ANGLE	15	00000
3	PROPELLANT DENSITY	8	05000
4	FACTOR OF SAFETY	2	00000
5	TEMPERATURE EXTREME(HOT)	140	00000
6	TEMPERATURE AMBIENT	77	00000
7	TEMPERATURE EXTREME(COLD)	-40	00000
8	PRESSURE SENSITIVITY	10000	
9	WEIGHT OF MSHHEAD	2	11500
10	WEIGHT OF EXTRINS	50000	
11	BURNING RATE EXPONENT	62000	
12	FINAL BLOWDOWN PRESSURE	600	00000
13	DENSITY OF MOTOR MATERIAL	07000	
14	DENSITY OF LAUNCHER MATERIAL	07000	
15	ALLOWABLE MOTOR STRESS	130000	00000
16	THICKNESS OF LAUNCHER	18500	00000

POINT YOU HAVE THE OPTION OF EITHER PERFORMING AN OPTIMIZED DESIGN STUDY OR CONDUCTING A PARAMETER STUDY WITH THE DESIGN PARAMETERS DC VOL WANT TO CALL THE CONVENTIONAL ROCKET OPTIMIZATION PROGRAM? Y/N

>N

SECTION 1.8 XXX PROPULSION AND STRUCTURAL COMPONENT EVALUATION AND REDESIGN CONVENTIONAL ROCKET VERSION

DO YOU WANT INSTRUCTIONS? Y/N

>Y

THIS SECTION OF CADLAW ALLOWS THE DESIGN OF PROPULSION AND STRUCTURAL COMPONENTS OF THE CONVENTIONAL LIGHT ANTI-TANK WEAPON SYSTEM TO BE EVALUATED AND REDESIGNED IF DESIRED

AN EVALUATION OF THE DESIGN CAN BE MADE BY TRYING EITHER GRAPHICAL PLOTS OR TABLES OR BOTH WHICH ILLUSTRATE THE DEPENDENCE OF THE SYSTEM WEIGHT, MUZZLE VELOCITY AND OBJECTIVE FUNCTION ON ANY OF THE DESIGN PARAMETERS OF INTEREST

DO YOU WANT A LISTING OF THE MAX/MIN TABLE? Y/N

>Y

PARAMETER	MAX VALUE	MIN VALUE
1 CHAMBER PRESSURE (DU)	11000	8000
2 EXPANSION RATIO (DU)	4.0000	2.5000
3 MOTOR DIAMETER (DU)	3.0000	7.0000
4 BURNING RATE COEFFICIENT (DU)	9000	6.0000
5 PROPELLANT WEIGHT (DU)	7.5000	1.0000
6 MOTOR LENGTH (DU)	1.0000	10.0000
7 SPECIFIC HEAT RATIO	20.0000	0.4000
8 NOZZLE EXPANSION ANGLE	3.0000	1.0000
9 PROPELLANT DENSITY	100.0000	50.0000
10 FACTOR OF SAFETY	1.0000	1.0000
11 TEMPERATURE EXTREME (HOT)	100.0000	100.0000
12 TEMPERATURE AMBIENT	50.0000	50.0000
13 TEMPERATURE EXTREME (COLD)	0.0000	-50.0000
14 PRESSURE SENSITIVITY	15000	5000
15 WEIGHT OF WARHEAD	4.0000	10000
16 WEIGHT OF EXTRAS	1.0000	50000
17 BURNING RATE EXPONENT	1.0000	200.0000
18 FINAL BLODOWN PRESSURE	0.0000	0.0000
19 DENSITY OF MOTOR MATERIAL	0.0000	0.0000
20 DENSITY OF LAUNCHER MATERIAL	0.0000	0.0000
21 ALLOWABLE MOTOR STRESS	200000	100000
22 THICKNESS OF LAUNCHER	10000	0.1000

DO YOU WANT TO CHANGE THE DEFAULT PARAMETER AND RANGE FOR THE PARAMETER STUDY? Y/N

>Y

DO YOU WANT TO CHANGE ANY DEFAULT PARAMETERS? Y/N

>Y

INPUT DEFAULT TABLE INDEX AND A NEW VALUE
EX (COL NUM., TABLE NUM., NEW VALUE)

>8.2.005
>0.0.0

THIS SECTION OF CADLAW ALLOWS FOR THE OPTIMIZED DESIGN OF A CONVENTIONAL ROCKET SYSTEM. YOU LIKE TO SEE A TABLE CONTAINING THE DEFAULT VALUES FOR THE DESIGN VARIABLES? Y/N

>N

INPUT THE NUMBER OF VARIABLES TO BE OPTIMIZED FROM THE LIST BELOW

- 1 CHAMBER PRESSURE
- 2 EXPANSION RATIO
- 3 MOTOR DIAMETER
- 4 BURNING RATE CON.
- 5 PROPELLANT WEIGHT
- 6 MOTOR LENGTH

>6

DO YOU WANT AN OBJECTIVE FUNCTION DISCUSSION? Y/N

>N

THE PROGRAM IS NOW COMPUTING VALUES FOR THE DESIGN VARIABLES WHICH RESULT IN AN OPTIMUM DESIGN. THE RESULTS ARE AS FOLLOWS

TOTAL NUMBER OF STAGE CALCULATIONS = 88
THE TOLERANCE CRITERION = 345174-02

THE OPTIMAL CONFIGURATION HAS ATTAINED FOR THE FOLLOWING VALUES OF THE STATE VECTOR

VARIABLE	VALUE	FIXED	OPTIMIZED
CHAMBER PRESSURE	82067+00		X
NOZZLE EXPANSION RATIO	84949+01		X
MOTOR DIAMETER	25558+01		X
BURNING RATE CONSTANT	70327+01		X
PROPELLANT WEIGHT	74069+01		X
MOTOR LENGTH	65005+01		X
OPT WEIGHT	5.824	OPT EXIT VELOCITY = 20075.5	
OBJECTIVE FUNCTION	-57408-08		

THE EXECUTION TIME IN SECONDS = 3.76
OBJECTIVE FUNCTION EVALUATIONS = 189
INEQUALITY CONSTRAINT EVALUATIONS = 3000

XXX THESE ARE FINAL ANSWERS XXX

YOU ARE NOW OPERATING IN SECTION 1.0 AT THIS

INPUT THE INDEX FROM THE MAX/MIN TABLE TO
INDICATE WHICH PARAMETER WILL BE STUDIED

>6

PARAMETER CHOSEN IS 6 DO YOU WANT TO
MAKE ANOTHER CHOICE? Y/N (INPUT IF Y)

>N

DO YOU WANT TO CHANGE THE DEFAULT RANGE? Y/N

>Y

PLEASE TYPE Y OR N

>Y

INPUT AN UPPER AND LOWER LIMIT FOR THE NEW RANGE

>7 6.6 4

NEW MAXIMUM IS 7 60000. MINIMUM IS 6 40000
ARE THESE SATISFACTORY? Y/N (IF NO. INPUT NEW RANGE)

>Y

DO YOU WANT A TABULAR OR GRAPHICAL
PARAMETER STUDY? T/C

>G

PARAMETER STUDY OF A CONVENTIONAL ROCKET

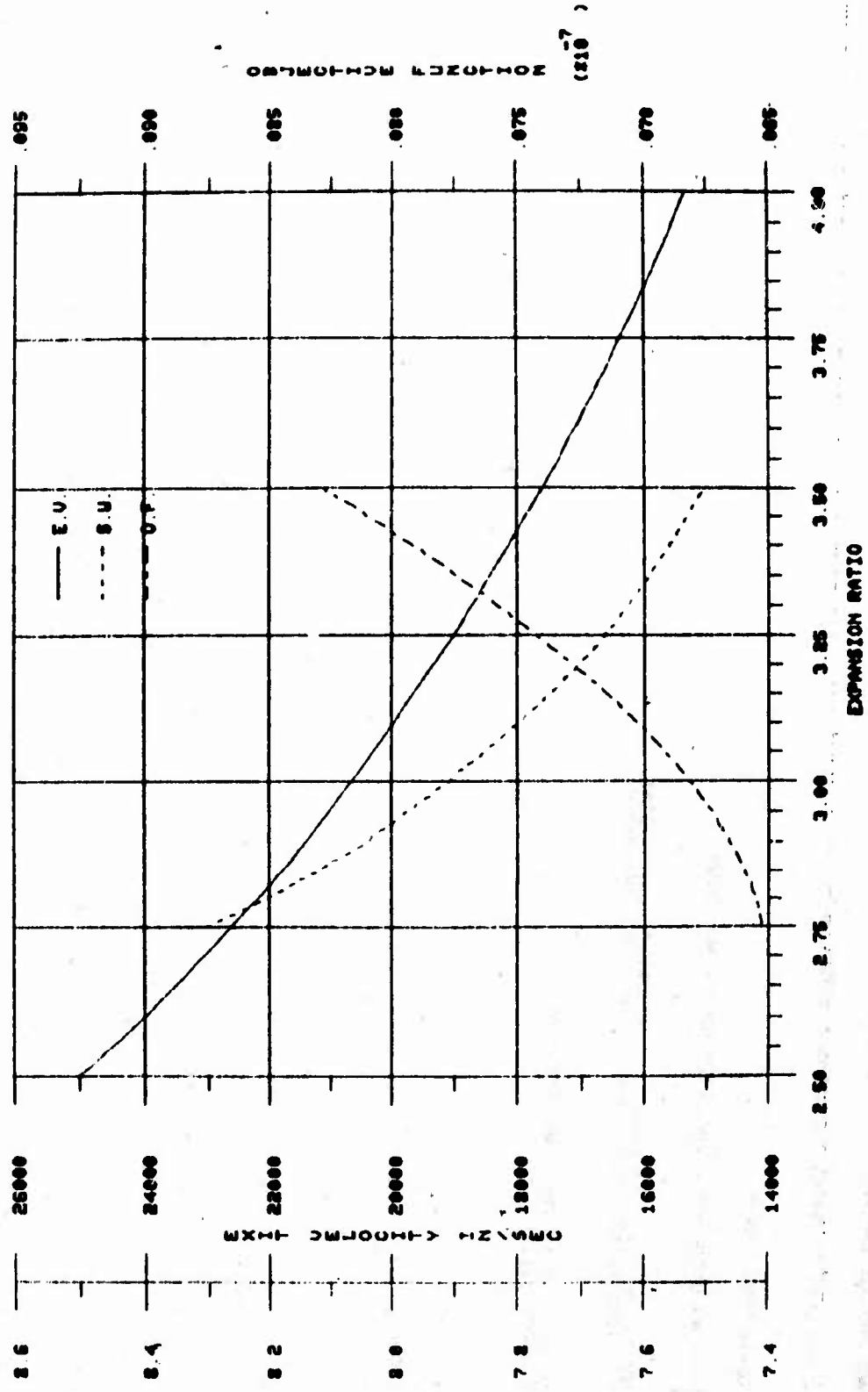

EXAMPLE EXECUTION

PARAMETER STUDY OF A CONVENTIONAL ROCKET

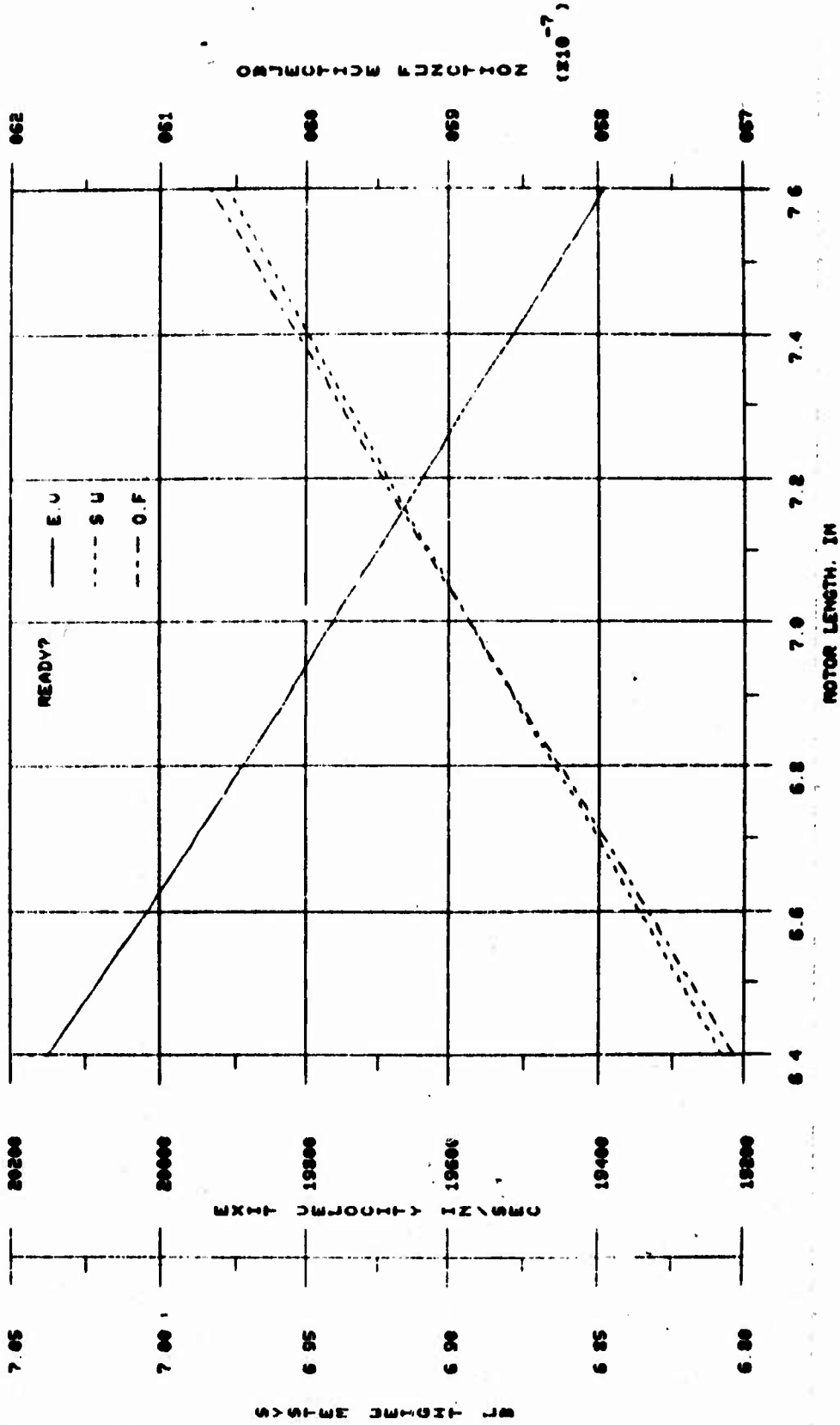

XX

PARAMETER STUDY OF A CONVENTIONAL ROCKET

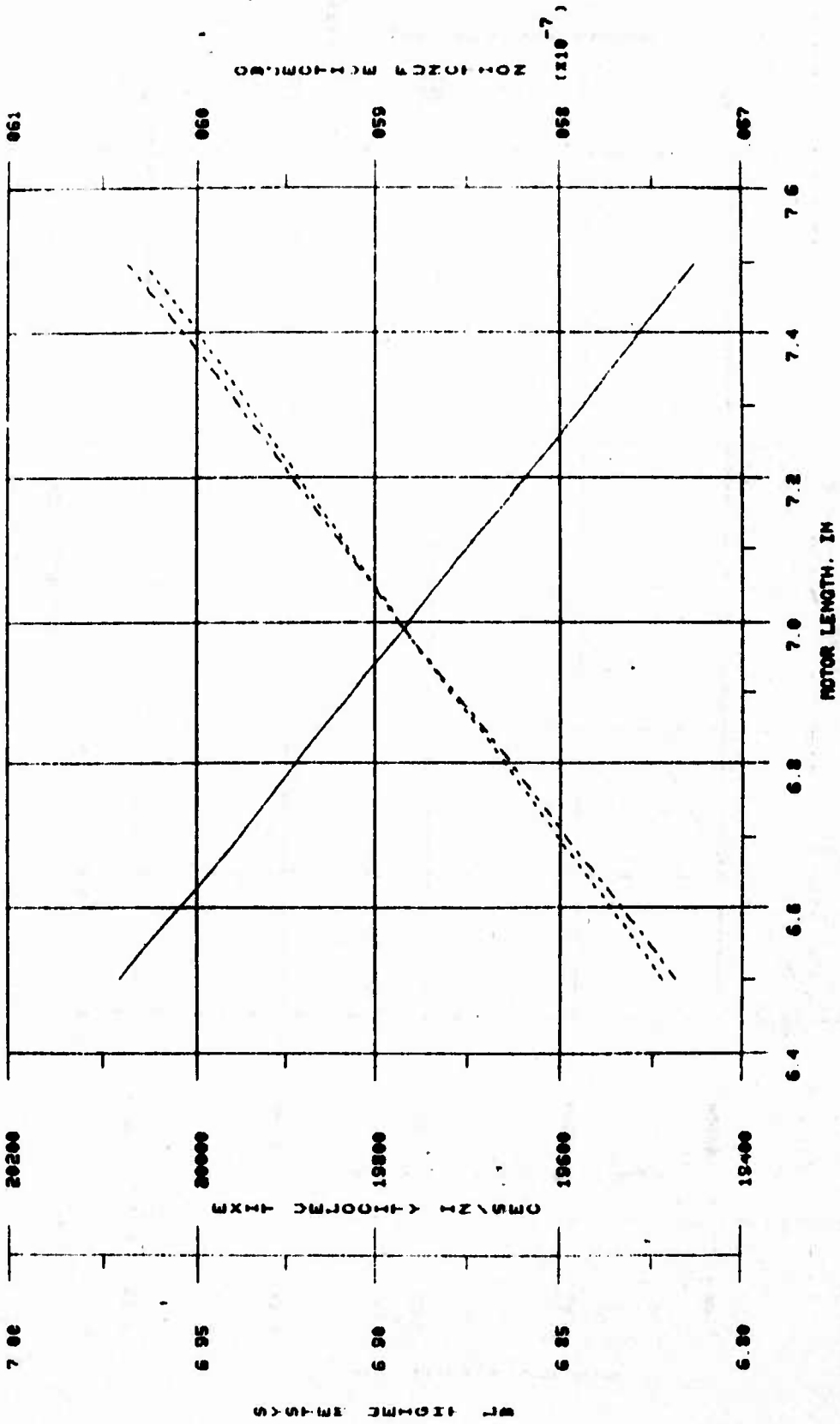

XXXXXXXXXX SAMPLE EXECUTION XXXXXXXXXXXXX

FREE FORMAT FORM. THUS THE DESIGNER NEED NOT BE CONCERNED WITH FORMAT SPECIFICATIONS WHEN SEVERAL DATA VALUES ARE CALLED FOR AT ONE TIME. THEY SHOULD BE TYPED IN SEQUENTIALLY WITH A COMMA SEPARATING THE DIFFERENT VALUES

WOULD YOU LIKE TO SEE A TABLE OF DEFAULT VALUES FOR BOTH THE DESIGN VARIABLES AND FIXED PARAMETERS? Y/N

#####DEFAULT PARAMATER TABLE#####

1 KAB. BURNING RATE CONSTANT (DU)	9 00
2 UTRCOL.WEIGHT OF THE RECOIL MASS (DU)	3 50
3 TUDDIA. TUBE DIAMETER (DU)	2 750 .
4 TUDLEN. TUBE LENGTH (DU)	4 200
5 NZRO. PRESSURE EXPONENT	6000
6 RHOPRP. PROPELLENT DENSITY	.05733
7 RNOTUB. DENSITY OF THE TUBE	8662
8 UTRPROJ. WEIGHT OF THE PROJECTILE	2 4145
9 PINITL. INITIAL CHAMBER PRESSURE	100 0
10 PREF. REFERENCE PRESSURE	100 0
11 SALOM. ALLOWABLE TUBE STRESS	30000
12 GAMA. HEAT RATIO OF EXHAUST GAS	1 2500
13 TDEL. INTEGRATION TIME STEP	00010
14 ILMNCH. PRINT SWITCH	1
1 FOR SHORT DESIGN SUMMARY	
2 FOR SHORT INTERMEDIATE RESULTS	
3 FOR EXTENSIVE INTERMEDIATE RESULTS	
4 FOR A PARAMETER STUDY	
15 MODIU. NO. OF PARAMETER STUDY PTS	30

DO YOU WANT TO CHANGE THE DEFAULT VARIABLES? Y/N

INPUT THE INTEGER AND THE NEW VARIABLE IN FREE FORMAT (INT,REAL)

>14.4
>15
>16.70
>20.0

DO YOU WANT TO PRINT A NEW PARAMETER TABLE? Y/N

DO YOU WANT ANOTHER CONVENTIONAL ROCKET PARAMETER STUDY? Y/N

DO YOU WANT ANOTHER CONVENTIONAL ROCKET DESIGN EXECUTION? Y/N

DO YOU WANT TO CONTINUE MAIN PROGRAM EXECUTION? Y/N

#####ANTI-TANK WEAPON DESIGN #####

DO YOU NEED INSTRUCTIONS TO RUN THE PROGRAM? Y/N

THE TITLE YOU HAVE SELECTED IS

#####SAMPLE EXECUTION #####

IS THIS TITLE SATISFACTORY? Y/N

WHICH OF THE FOLLOWING SEGMENTS OF THE PROGRAM WOULD YOU LIKE TO EXECUTE? (INPUT INDEX NO.)

- 1 CONVENTIONAL ROCKET DESIGN
- 2 RECOILLESS ROCKET DESIGN
- 3 AERODYNAMIC DESIGN

SECTION 2 0 #####RECOILLESS ROCKET DESIGN #####

DO YOU NEED INSTRUCTIONS? Y/N

THIS SECTION OF CADLAW ALLOWS THE OPTIMIZED DESIGN AND EVALUATION OF A RECOILLESS ROCKET SYSTEM.

THE PARAMETERS WHICH COMPLETELY DEFINE A LIGHT ANTI-TANK WEAPON SYSTEM HAVE BEEN DIVIDED INTO TWO GROUPS. ONE GROUP CONSISTS OF THE DESIGN VARIABLES WHOSE NUMERICAL VALUES ARE TO BE DETERMINED BY CADLAW. A SECOND GROUP CONSISTS OF FIXED PARAMETERS WHOSE NUMERICAL VALUES ARE SPECIFIED BY THE DESIGNER.

CADLAW IS CONSTRUCTED IN SUCH A WAY THAT MANY OF THE REQUIRED PARAMETERS ARE PRESET TO TYPICAL VALUES. YOU MAY CHANGE THE DEFAULT VALUES BY RESPONDING TO CERTAIN QUESTIONS APPROPRIATELY. ALL INPUT IS IN A

*****DEFAULT PARAMETER TABLE*****

1	KAB. BURNING RATE CONSTANT (DU)	9 00
2	UTRCOL. WEIGHT OF THE RECOIL MASS (DU)	3 50
3	TUBDIA. TUBE DIAMETER (DU)	2 750
4	TUBLEN. TUBE LENGTH (DU)	4 200
5	NZRO. PRESSURE EXPONENT	.6000
6	RHOIMP. PROPELLENT DENSITY	.05733
7	RHOTUB. DENSITY OF THE TUBE	.2562
8	UTPROJ. WEIGHT OF THE PROJECTILE	2 4145
9	PINITL. INITIAL CHAMBER PRESSURE	100.0
10	PREF. REFERENCE PRESSURE	100 0
11	SALOU. ALLOWABLE TUBE STRESS	30000
12	GAMA. HEAT RATIO OF EXHAUST GAS	1 2500
13	TDEL. INTEGRATION TIME STEP	.00010
14	ILANCH. PRINT SWITCH	4
15	MODIV. NO OF PARAMETER STUDY PTS	70

DO YOU WANT TO CHANGE THE DEFAULT VARIABLES? Y/N

>N

YOU ARE NOW OPERATING IN SECTION 2.0 AT THIS POINT YOU HAVE THE OPTION OF EITHER PERFORMING AN OPTIMIZED DESIGN STUDY OR CONDUCTING A PARAMETER STUDY WITH THE DESIGN PARAMETERS DO YOU WANT TO CALL THE OPTIMIZATION PROGRAM? Y/N

>Y

SECTION 2.1 RECOILLESS ROCKET OPTIMIZATION PROGRAM

DO YOU WANT INSTRUCTIONS? Y/N

>Y

THIS SECTION OF CADLAW ALLOWS FOR THE OPTIMIZED DESIGN OF A RECOILLESS ROCKET SYSTEM WOULD YOU LIKE TO SEE A TABLE CONTAINING THE DEFAULT VALUES FOR THE DESIGN VARIABLES? Y/N

>Y

*****DEFAULT PARAMETER TABLE*****

1	INIT BURNING RATE COEFF GUESS	5 002
2	INIT UT OF RECOIL MASS GUESS	3 500
3	INIT TUBE DIAMETER GUESS	2 750
4	INIT TUBE LENGTH GUESS	42 000
5	PRINT SWITCH	0
6	FOR OPTIMIZATION SUMMARY	0
7	FOR SHORT INTERMEDIATE RESULTS	1
8	FOR EXTENSIVE INTERMEDIATE RESULTS	2
9	FOR INTERMEDIATE OPTIMIZATION RESULTS	3
10	CONVERGENCE INDEX	020
11	POLYHEDRON SIZE	500

DO YOU WANT TO CHANGE ANY DEFAULT PARAMETERS? Y/N

>Y

INPUT DEFAULT TABLE INDEX AND A NEW VALUE

>4.44
>0.0

THIS SECTION OF CADLAW ALLOWS FOR THE OPTIMIZED DESIGN OF A RECOILLESS ROCKET SYSTEM WOULD YOU LIKE TO SEE A TABLE CONTAINING THE DEFAULT VALUES FOR THE DESIGN VARIABLES? Y/N

>Y

*****DEFAULT PARAMETER TABLE*****

1	INIT BURNING RATE COEFF GUESS	44 000
2	INIT UT OF RECOIL MASS GUESS	3 500
3	INIT TUBE DIAMETER GUESS	2 750
4	INIT TUBE LENGTH GUESS	42 000
5	PRINT SWITCH	0
6	FOR OPTIMIZATION SUMMARY	0
7	FOR SHORT INTERMEDIATE RESULTS	1
8	FOR EXTENSIVE INTERMEDIATE RESULTS	2
9	FOR INTERMEDIATE OPTIMIZATION RESULTS	3
10	CONVERGENCE INDEX	020
11	POLYHEDRON SIZE	500

DO YOU WANT TO CHANGE ANY DEFAULT PARAMETERS? Y/N

>Y

INPUT DEFAULT TABLE INDEX AND A NEW VALUE

>1.9

ILLEGAL PRINT SWITCH. TRY AGAIN. (0<N<3)

>4.2
>0.0

THIS SECTION OF CADLAW ALLOWS FOR THE OPTIMIZED DESIGN OF A RECOILLESS ROCKET SYSTEM WOULD YOU LIKE TO SEE A TABLE CONTAINING THE DEFAULT VALUES FOR THE DESIGN VARIABLES? Y/N

>Y

```

1 UTCON  722-10      2 UTEXP  1.00
3 VELCON  1.10       4 VELEXP --2.00
  
```

```

DO YOU WANT TO CHANGE THE O F ? Y/N
  
```

```

THE PROGRAM IS NOW COMPUTING VALUES FOR THE DESIGN
VARIABLES WHICH RESULT IN AN OPTIMUM DESIGN THE
RESULTS ARE AS FOLLOWS
  
```

```

TOTAL NUMBER OF STAGE CALCULATIONS  46
THE TOLERANCE CRITERION  123674-01
  
```

```

THE OPTIMAL CONFIGURATION WAS ATTAINED FOR
THE FOLLOWING VALUES OF THE STATE VECTOR
  
```

VARIABLE	VALUE	FIXED	OPTIMIZED
BURNING RATE CONSTANT	30169.01	X	X
WEIGHT OF THE RECOIL MASS	42928.01	X	X
TUBE DIAMETER	27500.01	X	X
TUBE LENGTH	42000.01	X	X
KK-KKSSSSSSSSSSSSSSSSSSSS	70302.01	X	X
JLJBJBJ'JBSSS(SSE)E	74877.01	X	X
SSSSSSSSSSSSSSSSSSSSSSSSSS	65124.01	X	X
IGS(OUNTC MCOLLC I.4GAL	XXXXXXXXXX	X	X
TEO.SLOWEA E.OLO MA(XED	10378.07	X	X
TRYS/O MEFS./3IU LSSF.BN	70151.00	X	X
UA .77HIBGE0.0 H17HFTTU.	54597.00	X	X

```

INPUT THE NUMBER OF VARIABLES TO BE
OPTIMIZED FROM THE LIST BELOW
  
```

```

1 BURNING RATE CONSTANT  3 TUBE DIAMETER
2 WEIGHT OF RECOIL MASS  4 TUBE LENGTH
  
```

```

INPUT THE INDICES OF THE PARAMETERS TO BE OPTIMIZED
  
```

```

DO YOU WANT AN OBJECTIVE FUNCTION DISCUSSION? Y/N
  
```

```

THE DESIGNER MUST DECIDE FOR HIMSELF WHAT CONSTI-
TUTES AN 'OPTIMUM DESIGN', THE CURRENT VERSION
OF CADLON DEFINES AN OPTIMUM DESIGN AS ONE WHICH
SATISFIES CERTAIN CONSTRAINTS RELATIVE TO SIZE AND
SHAPE AND ONE WHICH RESULTS IN A MINIMUM VALUE FOR
THE FOLLOWING OBJECTIVE FUNCTION.
  
```

```

F = UTCON * (SYSUT) + UTEXP * VELEXP
WHERE
  
```

```

SYSUT = SYSTEM WEIGHT
VELEXP = MISSILE MUZZLE VELOCITY
  
```

```

AND UTCON, VELCON, UTEXP, AND VELEXP ARE ARB-
ITRARY CONSTANTS. OTHER OBJECTIVE FUNCTIONS
CAN BE USED IF DESIRED
  
```

```

DO YOU WANT TO PRINT THE O F CONSTANTS? Y/N
  
```

```

XXXXX DEFAULT OBJECTIVE FUNCTION CONSTANTS XXXXX
  
```

```

1 UTCON  700-10      2 UTEXP  1.00
3 VELCON  1.00       4 VELEXP --2.00
  
```

```

DO YOU WANT TO CHANGE THE O F ? Y/N
  
```

```

INPUT THE TABLE INDEX AND THE NEW CONSTANT
  
```

```

23.1.1
20.0
  
```

```

DO YOU WANT TO PRINT THE O F CONSTANTS? Y/N
  
```

```

XXXXX DEFAULT OBJECTIVE FUNCTION CONSTANTS XXXXX
  
```

INITIAL PARAMETER STUDY OF A RECOILLESS ROCKET

ERROR RECOVERY

-7

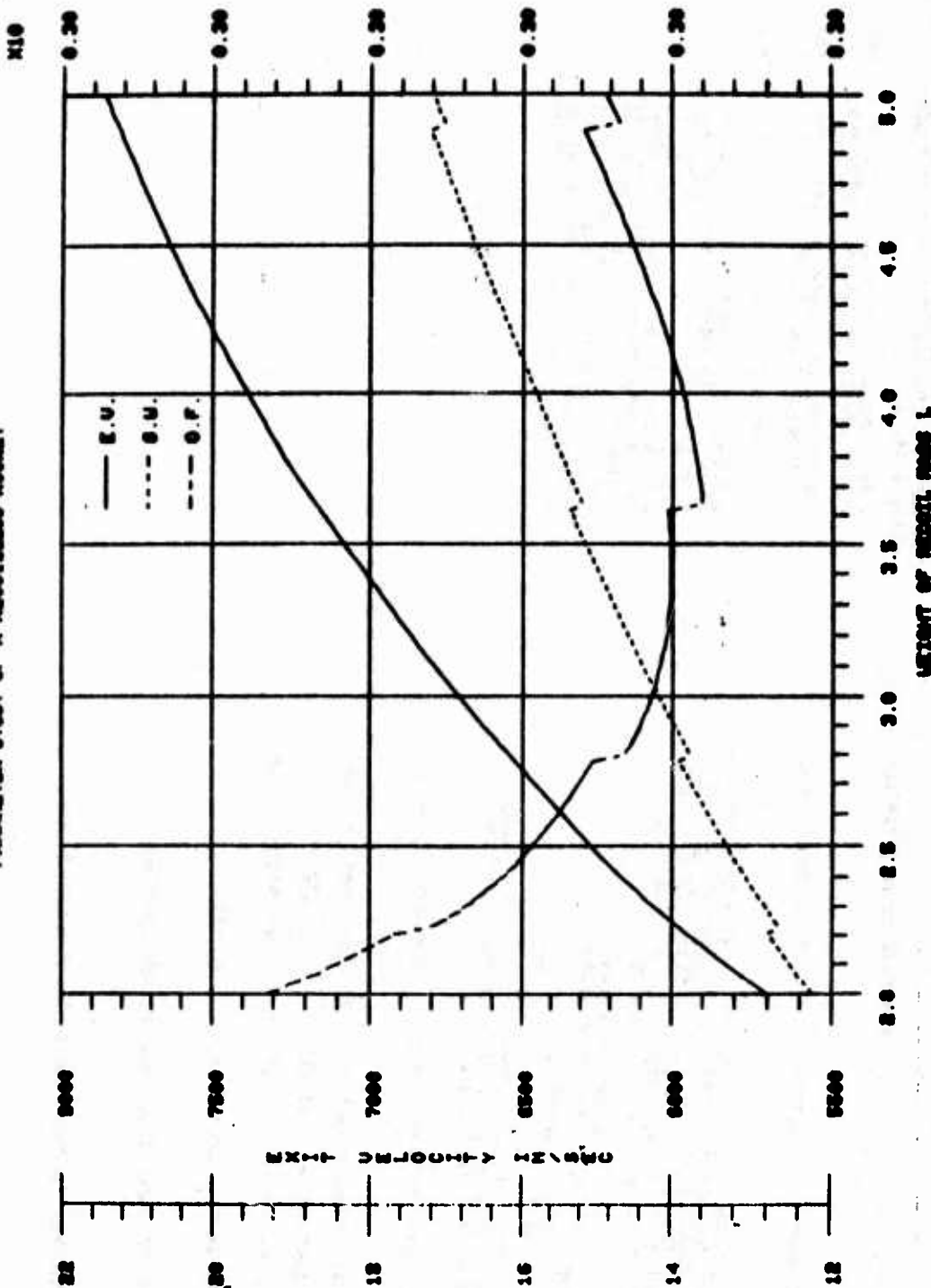

A CHECK FOR OPTIMIZED RESULTS

ERROR RECOVERY.

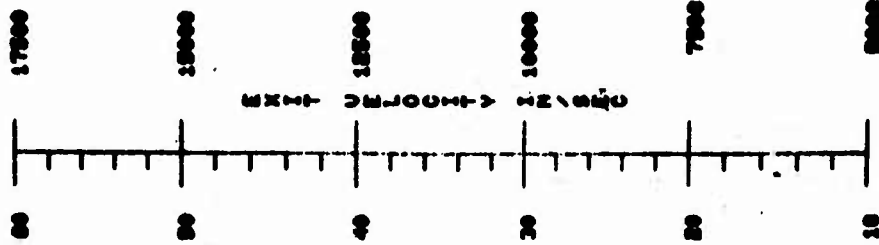

WT. INCREASE PER 1000

PERCENTAGE INCREASE

INITIAL PARAMETER STUDY OF A RECOILLESS ROCKET

X10 -6

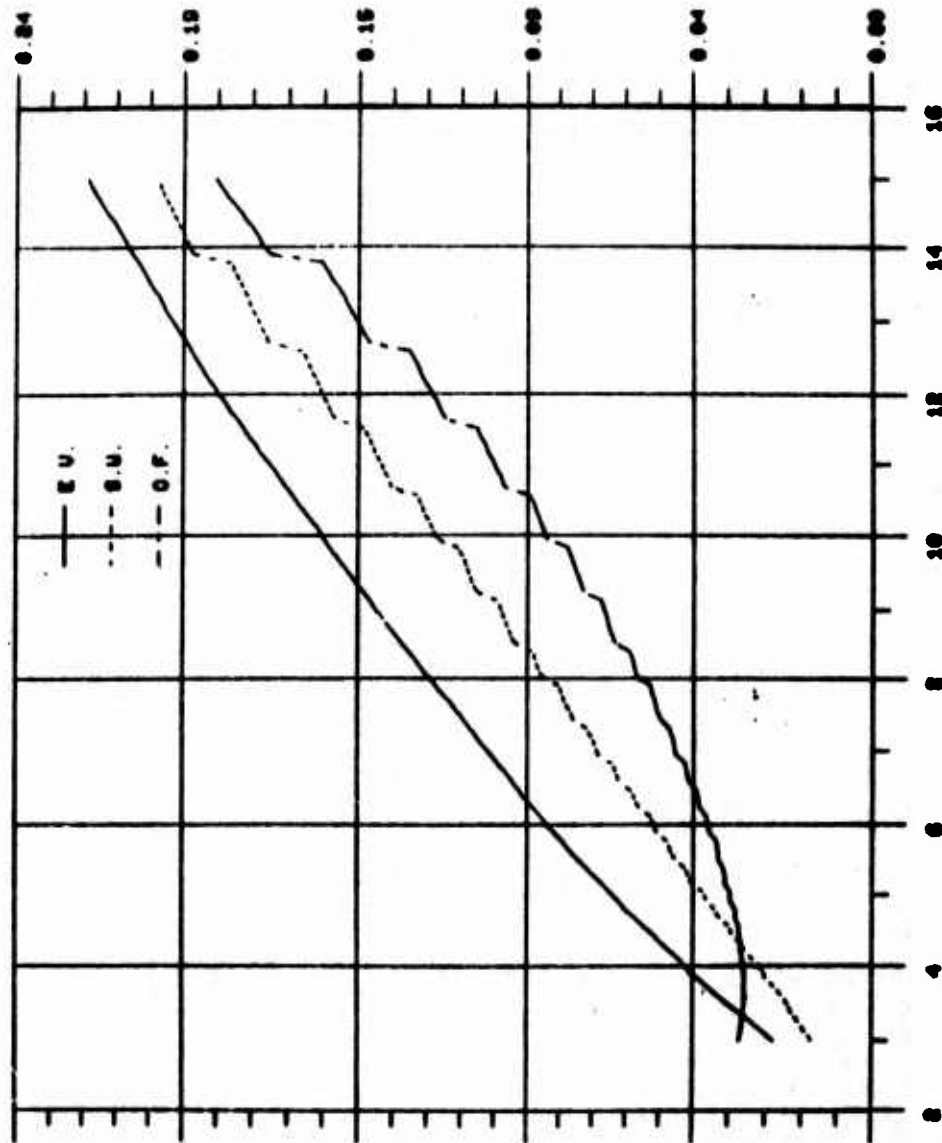

BURNING RATE COEFFICIENT

A CHECK FOR OPTIMIZED RESULTS

ERROR RECOVERY.

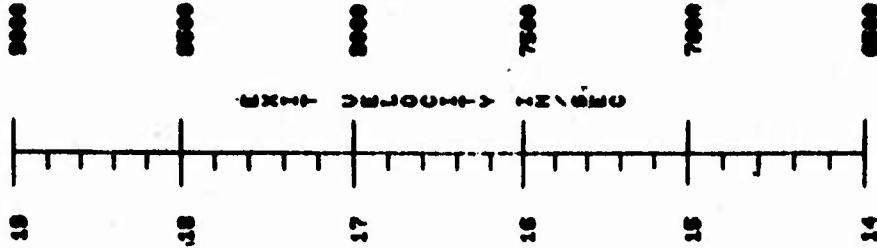

OF TIONING RECOVERY

INITIAL CALIBER PARAMETER STUDY OF A RECOILLESS ROCKET

X10 -7

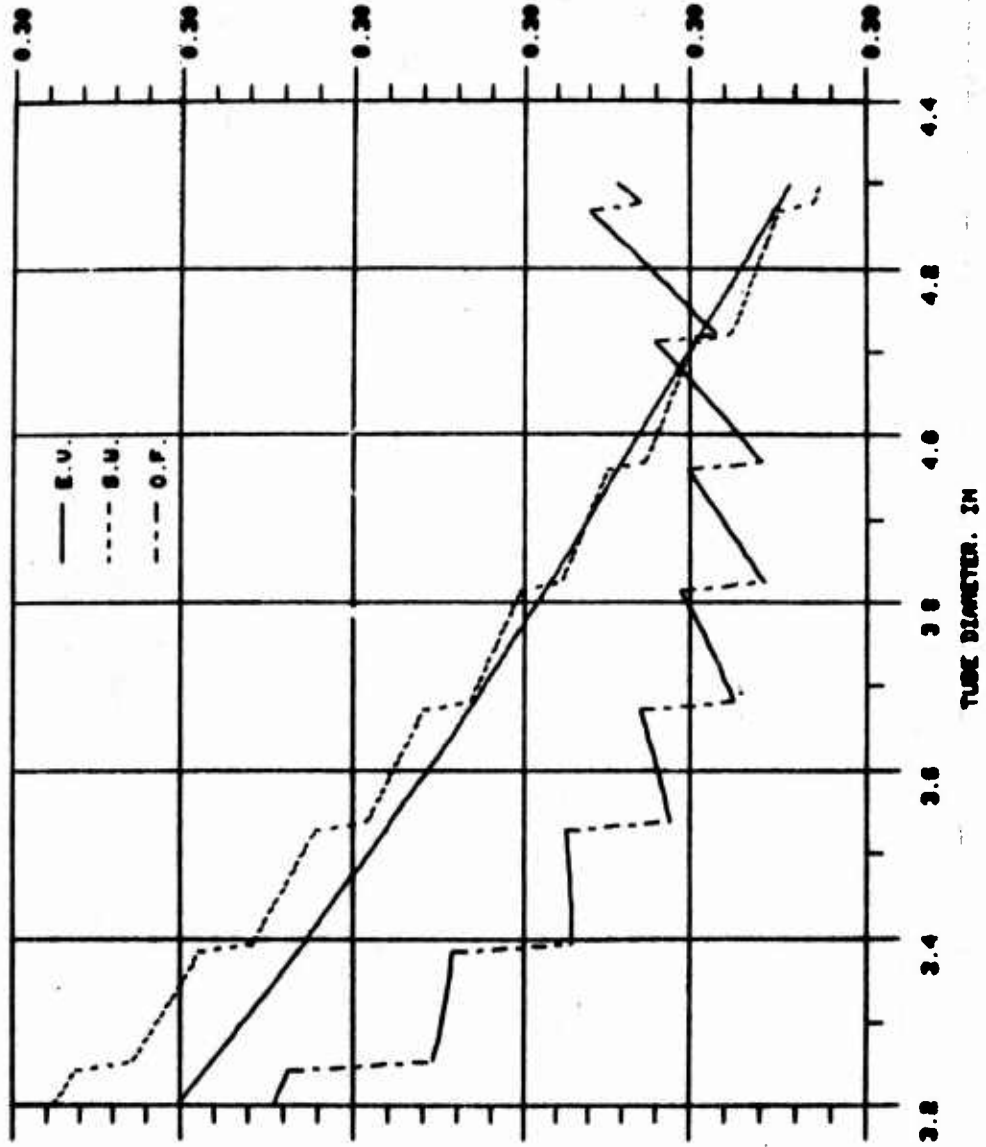

RECOILLESS ROCKET

REFERENCES

1. Martin Marietta Corp., "Missile Synthesis and Performance Computer Program," Report No. OR 10,717 P, May 1970.
2. McDonnell Douglas Astronautics Company, "Air-to-Air and Air-to-Ground Missile Synthesis and Performance Program," Report No. MDC E0160, May 1970.
3. Allen, E. L., "Computer Programs for Design Optimization of In-Tube-Burning Rockets," Rohm and Haas Company, Huntsville, Alabama, Technical Report No. S-253, May 1970.
4. Aerojet General Corporation, "Improved Lightweight Anti-tank/Assault Weapon (LAW), Final Report," Report No. 5101, AD 507 108, January 1970.
5. McDonnell-Douglas Astronautics Company, "Antitank/Assault/Air Defense (ATAAD) Weapon Systems Concept Study, Final Report, Volume I, Main Study," Report No. G790, January 1970.
6. Johnson, J. L., "Antitank/Assault/Air Defense Weapon (ATAAD) System Concepts," Philco-Ford Corp., Aeronautics Division, January 1970.
7. Air Force Weapons Laboratory, "ZORRO, A New Concept for Low Altitude Percision Ordnance Delivery, Final Report," Air Force Systems Command, Technical Report AFWL-TR-70-31, Kirtland AFB, New Mexico, July 1970.
8. Katsanis, D. J., "Graphical Presentation of Ballistics for Recoilless Rifles," Frankford Arsenal, Philadelphia, Pa., Report No. R-1410, October 1957.
9. Goldstein, S. and Marisi, S., "Analog Computer Study of Reactionless Launchers," Frankford Arsenal, Philadelphia, Pa., Technical Report No. R-1589, June 1961.
10. Lehner, R. and Jezek, B., "Low Recoil Weapon System," AAI Corporation, Baltimore, Md., AD 514 165, March 1971.

11. Goldstein, Sidney, "Performance Analysis of Davis Gun Launchers for Vehicles," Frankford Arsenal, Philadelphia, Pa., Report No. M66-3-1, August 1965.
12. Paviani, D. and Himmelblau, D. M., Operations Research, Vol. 17, 1969.
13. Himmelblau, David M., Applied Nonlinear Programming McGraw Hill Book Company, New York, 1972.
14. Lee, Robert F., Supersonic Aerodynamics and Rocket Propulsion, General Printing and Lithograph Co., Los Angeles, 1963.
15. Nelder, J. A. and Mead, R., Computer Journal, Vol. 7, p. 308, 1964.