

AD-A025 804

ADA 025804

USADAC TECHNICAL LIBRARY



5 0712 01016783 0

WVT-TR-76013

AD

TECHNICAL LIBRARY

THERMAL EFFECTS OF A HOT WEAPON
ON RAMMED PROJECTILES

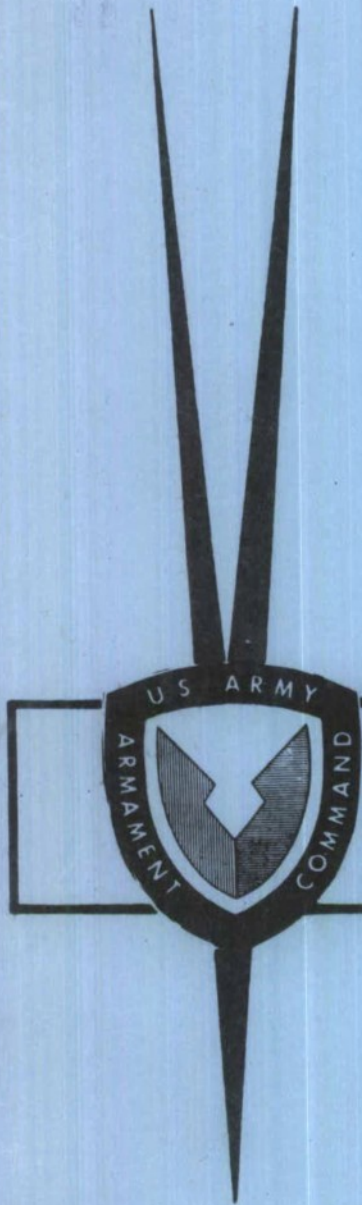

**BENET WEAPONS LABORATORY
WATERVLIET ARSENAL
WATERVLIET, N.Y. 12189**

April 1976

TECHNICAL REPORT

AMCMS No. 553G. 12. 42621

Pron No. 71-X-00609

APPROVED FOR PUBLIC RELEASE; DISTRIBUTION UNLIMITED

DISPOSITION

Destroy this report when it is no longer needed. Do not return it to the originator.

DISCLAIMER

The findings in this report are not to be construed as an official Department of the Army position unless so designated by other authorized documents.

UNCLASSIFIED

SECURITY CLASSIFICATION OF THIS PAGE (When Data Entered)

REPORT DOCUMENTATION PAGE		READ INSTRUCTIONS BEFORE COMPLETING FORM
1. REPORT NUMBER WVT-TR-76013	2. GOVT ACCESSION NO.	3. RECIPIENT'S CATALOG NUMBER
4. TITLE (and Subtitle) Thermal Effects of Hot Weapon on Rammed Projectiles	5. TYPE OF REPORT & PERIOD COVERED	
	6. PERFORMING ORG. REPORT NUMBER	
7. AUTHOR(s) R. G. Hasenbein	8. CONTRACT OR GRANT NUMBER(s)	
9. PERFORMING ORGANIZATION NAME AND ADDRESS Benet Weapons Laboratory Watervliet Arsenal, Watervliet, N.Y. 12189 SARWV-RT	10. PROGRAM ELEMENT, PROJECT, TASK AREA & WORK UNIT NUMBERS AMCMS No. 553G.12.42621 Pron No. 71-X-00609	
11. CONTROLLING OFFICE NAME AND ADDRESS	12. REPORT DATE April 1976	
	13. NUMBER OF PAGES 35	
14. MONITORING AGENCY NAME & ADDRESS (if different from Controlling Office)	15. SECURITY CLASS. (of this report) UNCLASSIFIED	
	15a. DECLASSIFICATION/DOWNGRADING SCHEDULE	
16. DISTRIBUTION STATEMENT (of this Report) Approved for public release; distribution unlimited.		
17. DISTRIBUTION STATEMENT (of the abstract entered in Block 20, if different from Report)		
18. SUPPLEMENTARY NOTES		
19. KEY WORDS (Continue on reverse side if necessary and identify by block number) 155mm M107 HE Projectile 155mm XM549 RAP HE Projectile Thermal Effects Projectile Cannon Tube In-bore Detonation		
20. ABSTRACT (Continue on reverse side if necessary and identify by block number) The Thermal Effects Test V provides data concerning thermal effects on M107 and XM549 Projectiles which have been rammed into a hot XM199 Cannon. This was accomplished by preheating an XM181 Cannon stub tube (which is very similar in configuration to the XM199) as uniformly as possible to selected temperatures in the nominal range 400 - 600°F. M107 and XM549 Projectiles, having been emptied and conditioned to 145°F were then rammed into the stub tube. In all, four M107 and four XM549 Projectiles were rammed a total of twenty-one times. (SEE REVERSE SIDE)		

DD FORM 1 JAN 73 1473

EDITION OF 1 NOV 65 IS OBSOLETE

UNCLASSIFIED

SECURITY CLASSIFICATION OF THIS PAGE (When Data Entered)

20. Tube temperatures at various points near the bore were monitored by thermocouples; likewise, five thermocouples located on the inside wall of the shell simultaneously indicated shell temperatures. This data is intended to be used in determining safe times/temperatures for which the subject shell may be allowed to remain in a hot XM199 Cannon without danger of an in-bore premature.

WVT-TR-76013

AD

THERMAL EFFECTS OF A HOT WEAPON
ON RAMMED PROJECTILES

R.G. HASENBEIN



BENET WEAPONS LABORATORY
WATERVLIET ARSENAL
WATERVLIET, N.Y. 12189

April 1976

TECHNICAL REPORT

AMCMS No. 553G. 12. 42621

Pron No. 71-X-00609

APPROVED FOR PUBLIC RELEASE; DISTRIBUTION UNLIMITED

TABLE OF CONTENTS

	<u>Page</u>
Abstract	i
Background	1
Purpose	1
Method	2
Data	3
Conclusions	3
Recommendation	3
References	12

LIST OF FIGURES AND TABLES

Fig. 1	M107 Projectile Thermocouple Numbers and Locations (Sketch)	4
Fig. 2	XM549 Projectile Thermocouple Numbers and Locations (Sketch)	4
Fig. 3	XM181 Tube, Finish Machined	5
Fig. 4	XM181 Tube, Chamber Details	6
Fig. 5	Tube Thermocouple Numbers and Locations	7
Fig. 6	XM181 Breech Mechanism Assembly	8
Table 1	Test Log	9
Fig. 7	Unramming Device (Schematic)	11

APPENDIX

Raw Data	13-32
----------	-------

Background

A "projectile premature" (or simply "premature") may be defined as the explosion of a projectile before desired detonation by the fuse. If this occurs while the projectile is at any point in a gun tube, the event may be termed an "in-bore premature". In-bores have been known to occur in the field both before and after firing, and due to their normally catastrophic nature, have been the object of at least two extensive studies.

The Kintish study¹, which specifically investigated prematures in Composition B-loaded 105mm M1 Shell, determined that prematures may be obtained when shell "that have been allowed to remain in a hot weapon for twelve minutes or longer are fired." Further, the explosive within shell "that have been allowed to remain in a hot weapon longer than 12 minutes or less than 130 minutes is molten." During the test, in-bore prematures were produced after shell had been allowed to remain in the hot tube for certain periods of time. In all but one case, the shell that exploded in-bore did so after intentional firing of the gun; one shell was allowed to remain in the tube until it exploded spontaneously. Kintish concludes that the rammed shell heats up and melts the explosive wax contained inside. The molten explosive expands and exudes from the shell, and Kintish presumes that this exudate lying in the bore during firing is a primary cause of in-bore prematures. Thus, shell heating effects are of primary importance in the study of prematures, especially at the interior surface of the shell where explosive is in contact with hot metal.

The Adams-Vassallo study², which specifically investigated prematures in the M126 155mm Howitzer, concluded that "the temperature of the projectile before insertion into the weapon has a strong influence on the time required" for the shell to reach a given temperature. Further, the "heat path with the lowest thermal resistance is through the rotating band which is therefore the region of highest temperature rise" in the projectile tested. The Adams-Vassallo report implicitly cites the need for gathering data to aid in determining safe times and temperatures for which shell may be allowed to remain in a hot tube for various systems. This test, therefore, is a primary step in that direction for the XM198 155mm Howitzer system.

Purpose

The purpose of this test is to determine temperatures attained at various locations on the inside walls of emptied M107 and XM549 Projectiles which have been rammed into a hot 155mm XM199 Cannon tube. Further, tube temperatures are to be monitored near the bore at various axial locations for comparison with changing shell temperatures. Due to similarities between the XM181 and XM199 Cannon tubes, results will be identical if we monitor M107 and XM549 Projectiles in an XM181 Cannon tube.

Method

Due to the extreme safety hazards and expense which would be involved in testing Composition B-loaded shell, the 155mm shell used (four M107 and four XM549 Projectiles) were emptied of all explosive, propellant, and other interior components and steam cleaned; thus, the "filler" in all cases was air, which has exceptionally well known thermal properties. After being emptied, the shell bodies were instrumented with thermocouples at five points on their interior surfaces as shown in Figures 1 and 2.

An XM181 Cannon tube (viz. Fig. 3 and 4) was machined to stub tube length, and radial holes were drilled to a distance of .062 inches from the bore at seven axial locations; see Fig. 5 for details. Due to similarities between the XM199 and XM181 Cannon tubes, the results derived using this stub tube will be equally applicable to the XM199 Cannon. The tube was assembled to an XM181 Breech Mechanism (viz. Fig. 6), and the assembly was mounted onto the Universal Test Stand, WTV-F11989. Wooden yokes were employed to support the tube on the test stand in order to prevent the creation of significant localized heat sinks. Thermocouples were inserted into the machined holes in the tube in order to monitor tube temperatures near the bore.

Calrod strip heaters were then placed around the tube's circumference, followed by a layer of fiberglass insulation. The tube was then heated as uniformly as possible to predetermined temperatures in the nominal range 400 - 600°F. The projectiles themselves were conditioned for 24 hours to a temperature of 145°F. Once the nominal tube temperatures had been attained, the conditioned shell was rammed and the breechblock immediately closed. Rising shell temperatures and decreasing tube temperatures were monitored and recorded once every ten seconds for a ten minute total duration. It should be noted that the four XM549 and four M107 Projectiles were rammed and monitored from two to three times each during the overall test (viz. Log, Table I) in order to eliminate the cost of instrumenting additional projectiles.

Great difficulties were encountered during attempts to unram the hot projectiles. Evidently the heat loss of the tube (which thereby shrinks in accordance with thermal expansion principles) to the relatively cool shell (which expands) produces an effective press fit, thus making the shell extremely difficult to unram. Several methods of extraction were attempted without success including jacking with a 100 ton jack between two concrete abutments, ramming with a fork lift, and repeated pendulum impact with steel bar stock. Analysis of the situation led to the unramming devices schematically illustrated in Fig. 7. The bracket proved to be an efficient utilization of the 100 ton jacking force, and the water cooling system, which was required only once, effectively reversed the press fit process. No further unramming problems were encountered.

Data

Test results are displayed in the Appendix in graphic form. Thermocouples numbered 1-7 are located in the tube as per the numbering system in Fig. 5. Thermocouples numbered 8-12 are located in the respective shell as per the numbering system in Fig. 1 and 2.

Shot number P3 has been eliminated from consideration since the projectile was not rammed adequately. Further, shot number P16 has produced extraneous data far outside the normal data band and has thus been discarded.

Conclusions

1. The data in the Appendix fulfills the short-range purpose of this test, that is: to determine temperatures attained at various locations on the inside walls of emptied M107 and XM549 Projectiles which have been rammed into a hot XM198 Cannon tube.
2. The data, in its raw form, agrees with the Adams-Vassallo study's conclusion that the "heat path with the lowest thermal resistance is through the rotating band which is therefore the region of highest temperature rise." Thermocouple number 11, located over the copper rotating band, invariably indicates the greatest temperature rise.
3. The region of greatest tube heat loss is at the origin of rifling. Based on conclusion 2, this is expected since the shell's copper rotating band facilitates heat transfer in this region.

Recommendation

It is recommended that the data presented in the Appendix be used to determine safe times/temperatures for which the subject shells may be allowed to remain in a hot XM198 Cannon without danger of an in-bore premature. Further, due to the sensitivity of such a determination, it is recommended that this task be reserved for personnel specializing in fillers for the subject projectiles.

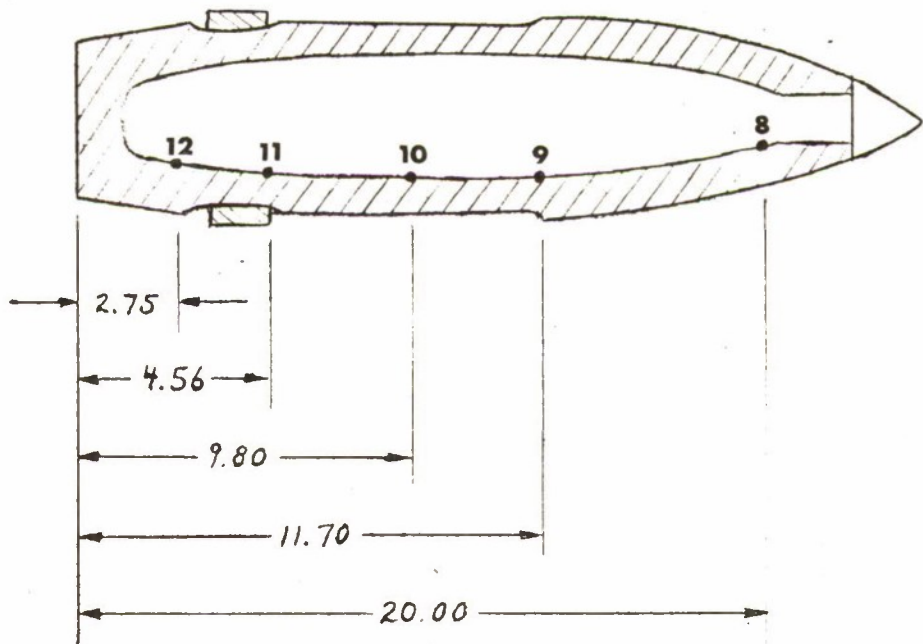

Fig. 1 M107 Projectile Thermocouple Numbers and Locations (Sketch)

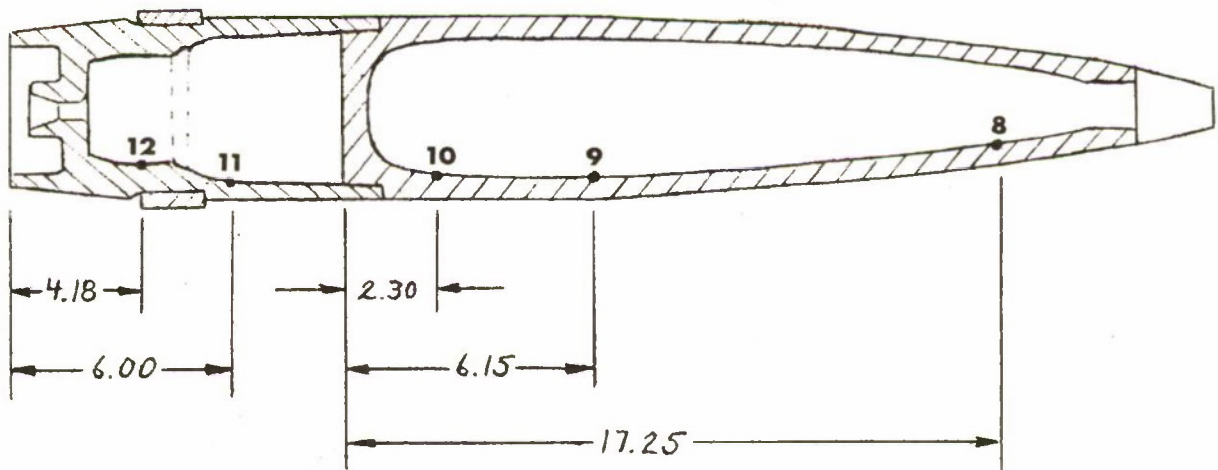

Fig. 2 XM549 Projectile Thermocouple Numbers and Locations (Sketch)

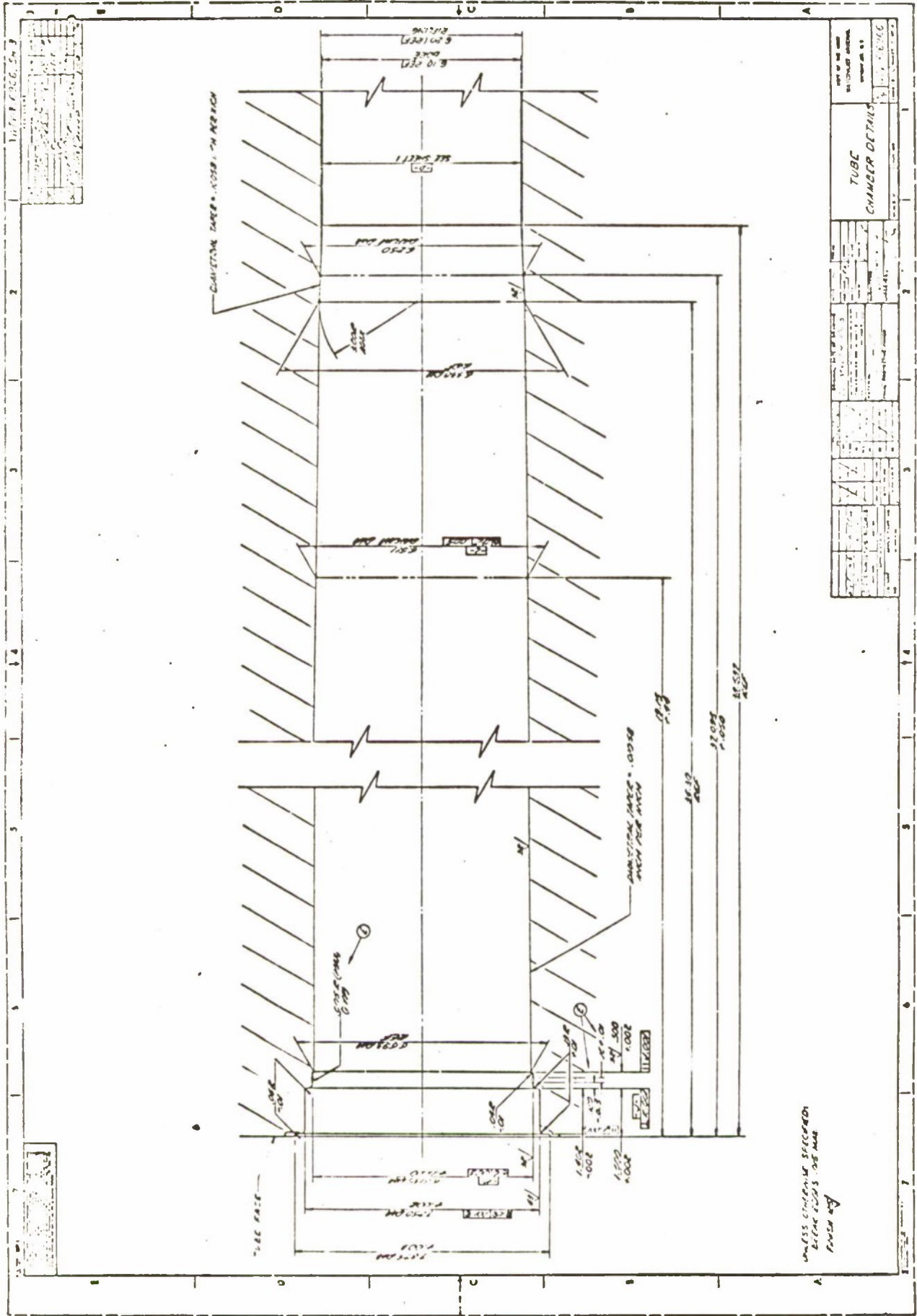

Fig. 4 XM181 Tube, Chamber Details

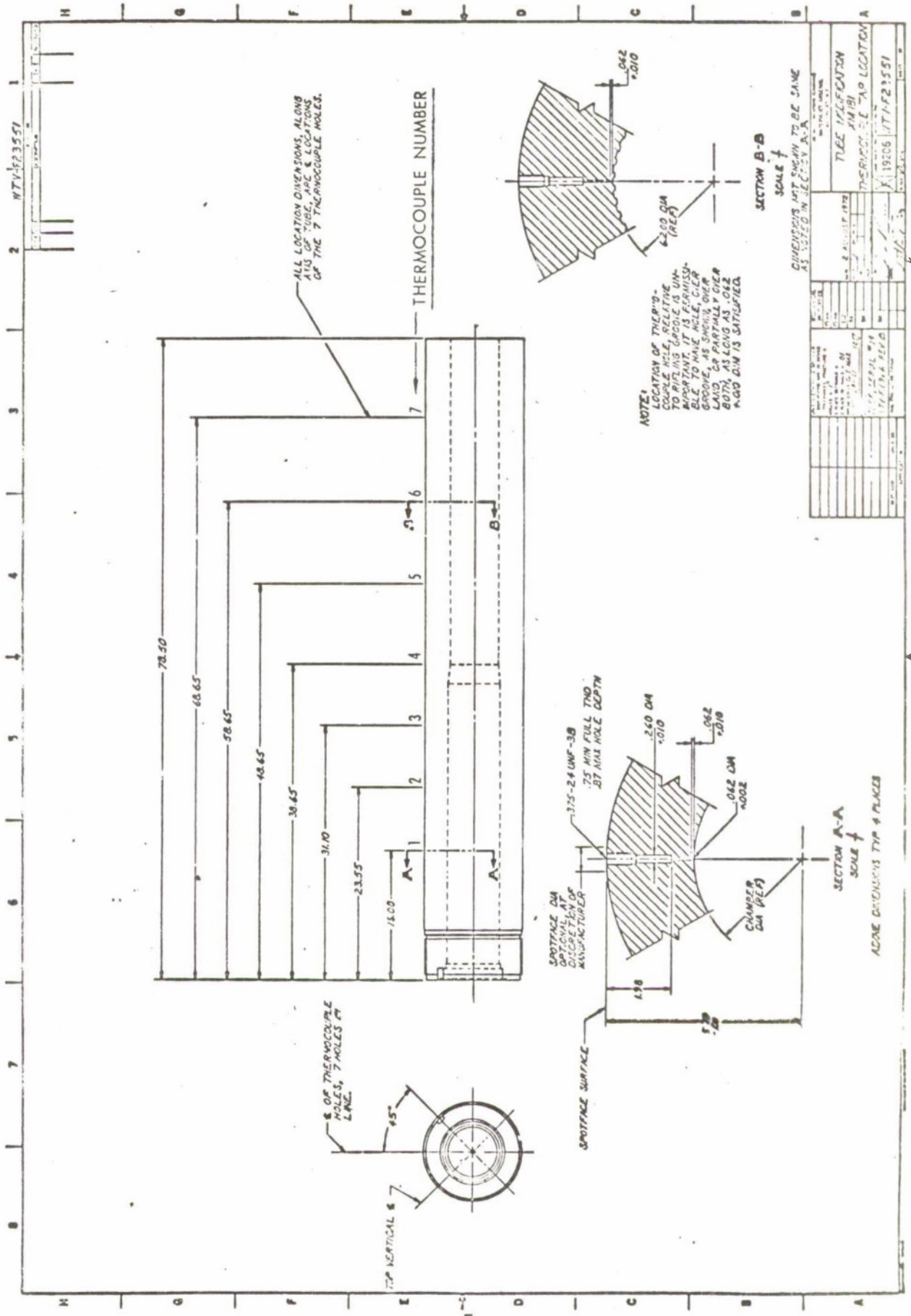

Figure 5 Tube Thermocouple Numbers and Locations

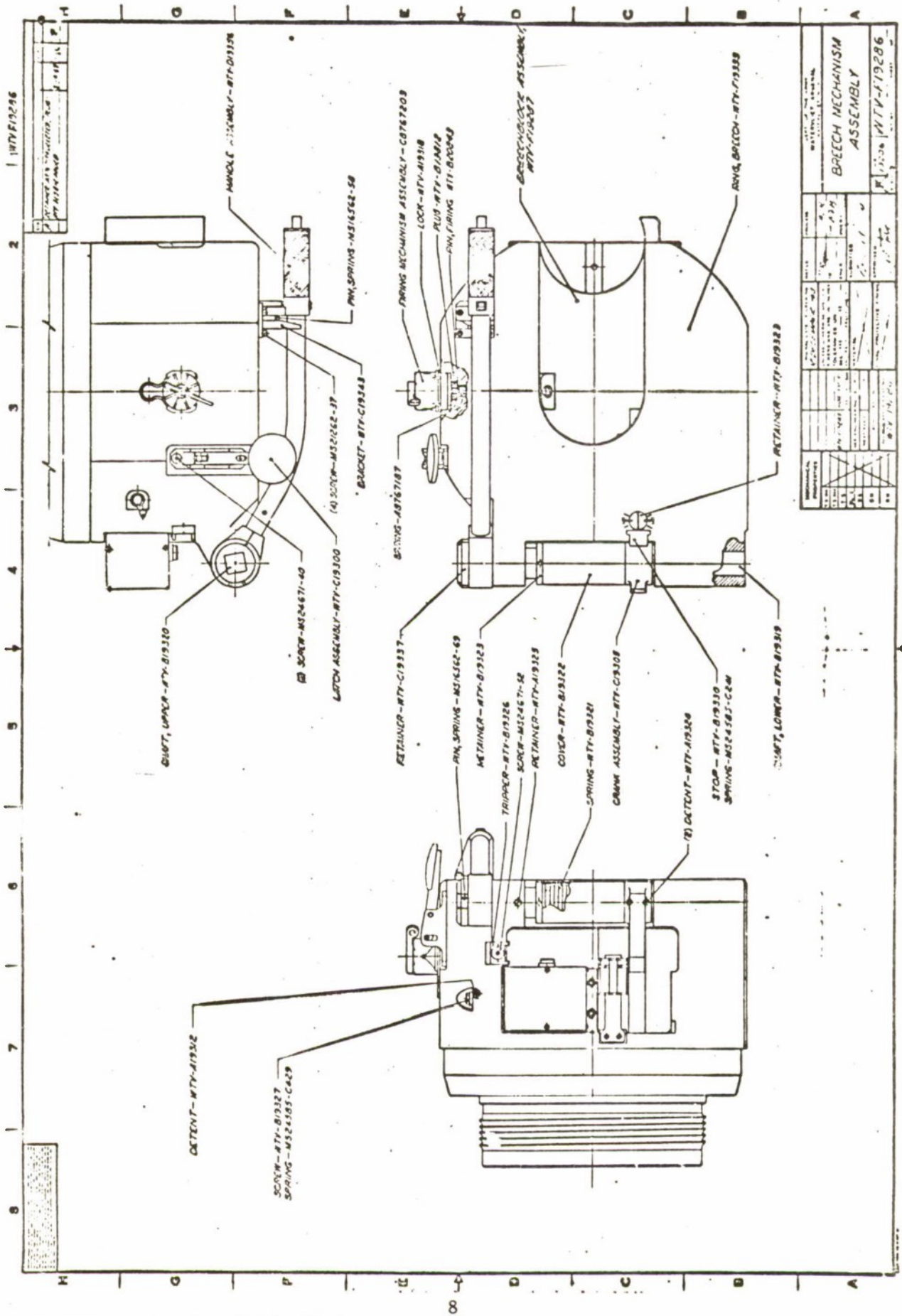

Fig. 6 XM181 Breech Mechanism Assembly

WTV
THERMAL TEST
CONTRACT #DAAF07-73-C-0045
Table 1 Test Log

DATE: 9-22-72

Shot No.	Proj. No.	S/N	Amb. Temp. of	R.H. %	Wind Direction & Velocity	Sky Conditions	Proj. Temp. of	Ins. Temp.	Time Proj. Ins.	DATE
1P	M107-0		66	45	SW @ 7 MPH	Sunny 10% Cloud	145 F	400 F	11:20AM	9-29-72
2P	XM549-0		58	70	NNW @ 10 MPH	Cloudy	145 F	400 F	11:45AM	10-3-72
3P	M107-0		67	47	Calm	Sunny	145 F	450 F	12:50PM	Not rammmed adequately.
4P	M107-0		64	55	Calm	Sunny	145 F	450 F	10:57AM	DATE: 10-4-72
5P	XM549-0		52	80	Calm	Cloudy & rain	145 F	450 F	3:40PM	DATE: 10-12-72 Projectile hung up on seal obturator on first try-(Seal upside down)
6P	M107-1	-	41	57	W @ 12 MPH	Cloudy Partly	145 F	450 F	10:55AM	DATE: 11-27-72
7P	XM549-2	1840	42	55	W @ 8 MPH	Cloudy	145 F	450 F	2:24PM	DATE: 11-28-72
8P	M107-2	-	38	74	Calm	Cloudy	145 F	500 F	9:57AM	
9P	XM549-3	2721	39	80	Calm	Raining Snow &	145 F	500 F	12:32PM	
10P	M107-3	-	35	78	Calm	Rain	145 F	500 F	15:06PM	

MTV
THERMAL TEST
CONTRACT #DAAF07-73-C-0045
Table 1 Test Log (Cont.)

DATE: 11-29-72

Shot No.	Proj. No.	S/N	Amb. Temp. OF	R.H. %	Wind Direction & Velocity	Sky Conditions	Proj. Temp. of	Ins. Therm.	Time Proj. Ins.		
11-P	XM549-1	1922	34	62	NW @ 2 MPH	Clear & Sunny	145 F	500 F	10:00AM		Projectile to misnumbered-see attached sketch for as is.
12-P	M107-2	-	36	57	NW @ 7 MPH	Cloudy	145 F	400 F	12:21PM		
13-P	XM549-2	1840	34	56	NW @ 5 MPH	Partly Cloudy	145 F	400 F	15:10PM		
											DATE: 11-30-72
14-P	M107-1	-	34	60	Calm	90% Cloudy	145 F	550 F	10:25AM		
15-P	XM549-3	2721	35	51	Calm	100% Cloudy	145 F	550 F	12:54PM		
16-P	M107-3	-	32	69	Calm	Snowing	145 F	550 F	15:28PM		
											DATE: 12-1-72
17-P	XM549-2	1840	35	70	W @ 8 MPH	90% Cloudy	145 F	550 F	10:33AM		
18-P	M107-2	-	38	68	W @ 5 MPH	90% Cloudy	145 F	600 F	12:55PM		
19-P	XM549-1	1922	36	65	NW @ 15 MPH	30% Clouds	145 F	600 F	15:16PM		#2 Projectile Ic (-Channel 8) reading questionable
20-P	M107-1	-	22	68	NE @ 8 MPH	Snowing	145 F	600 F	11:15AM		
21-P	XM549-3	2721	20	73	NE @ 10 MPH	Snowing	145 F	600 F	16:16PM		
											DATE: 12-4-72

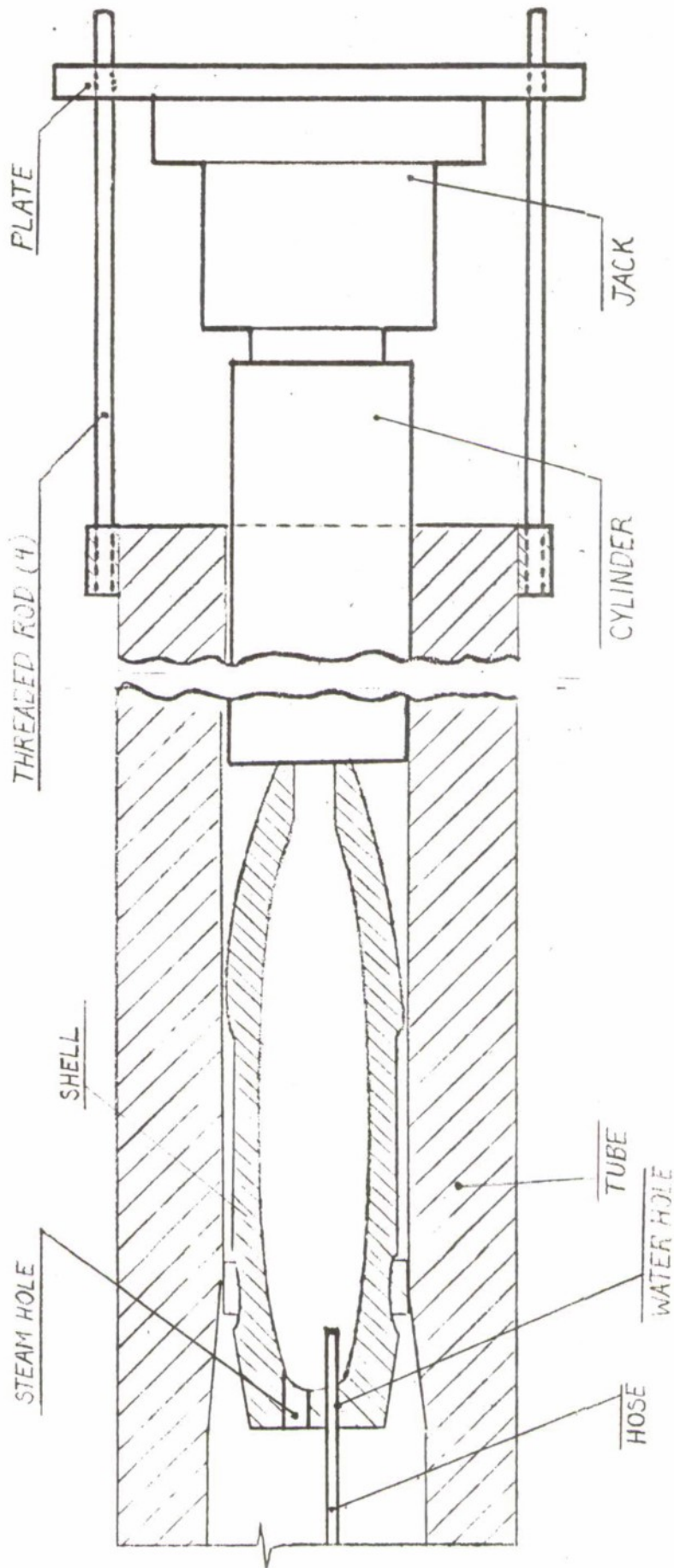

Fig. 7 Unramming Device (Schematic)

Normal Operation:

1. Steam and water hole plugs removed.
2. Fuze removed.
3. Steel cylinder inserted into tube.
4. Jack employed and operated.
5. Water pumped into shell through hose while jack continues to exert unramming force on cylinder and shell.
6. Step 5 required only if step 4 proves insufficient.

REFERENCES

Kintish, I.L.:

"Effect of a Hot Weapon on Composition B-Loaded 105mm
M1 HE Shell," Picatinny Arsenal Technical Report 2131,
January 1955.

Adams, D.E. and F.A. Vassallo:

"Thermal Study of Explosive Projectiles in Hot Weapons,"
Cornell Aeronautical Laboratory, Inc. Report
No. GM-2278-W-3, November 1968.

APPENDIX

The following is a graphic presentation of shell interior wall temperatures (as monitored by thermocouples 8-12; see page 4) and corresponding stub tube temperatures (as monitored by thermocouples 1-7; see page 7).

For details of test conditions and the type of projectile used for each round, see also pages 9-10.

TEMP. DEG. F

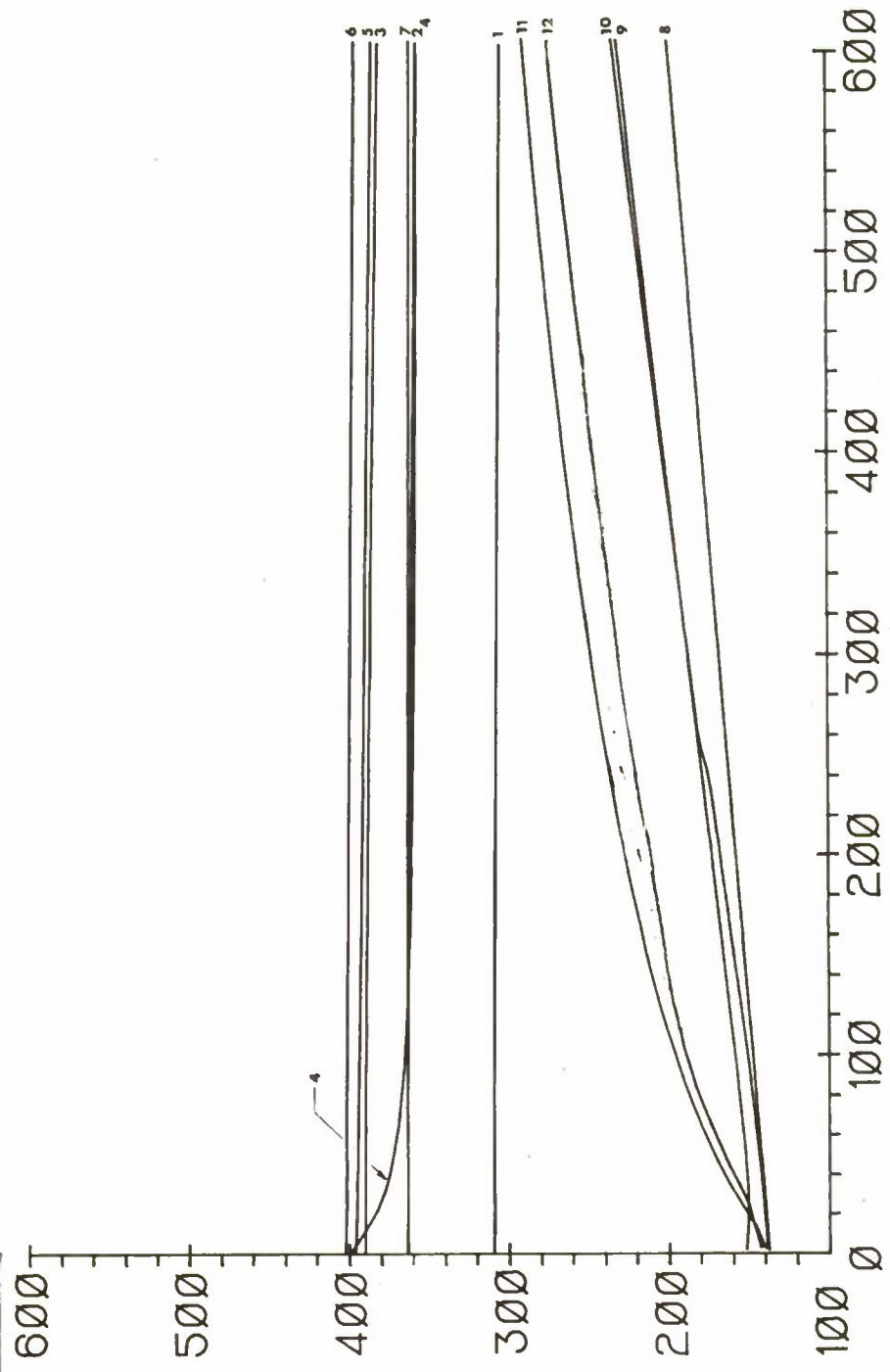

TIME IN SEC.

ROUND NO. P1

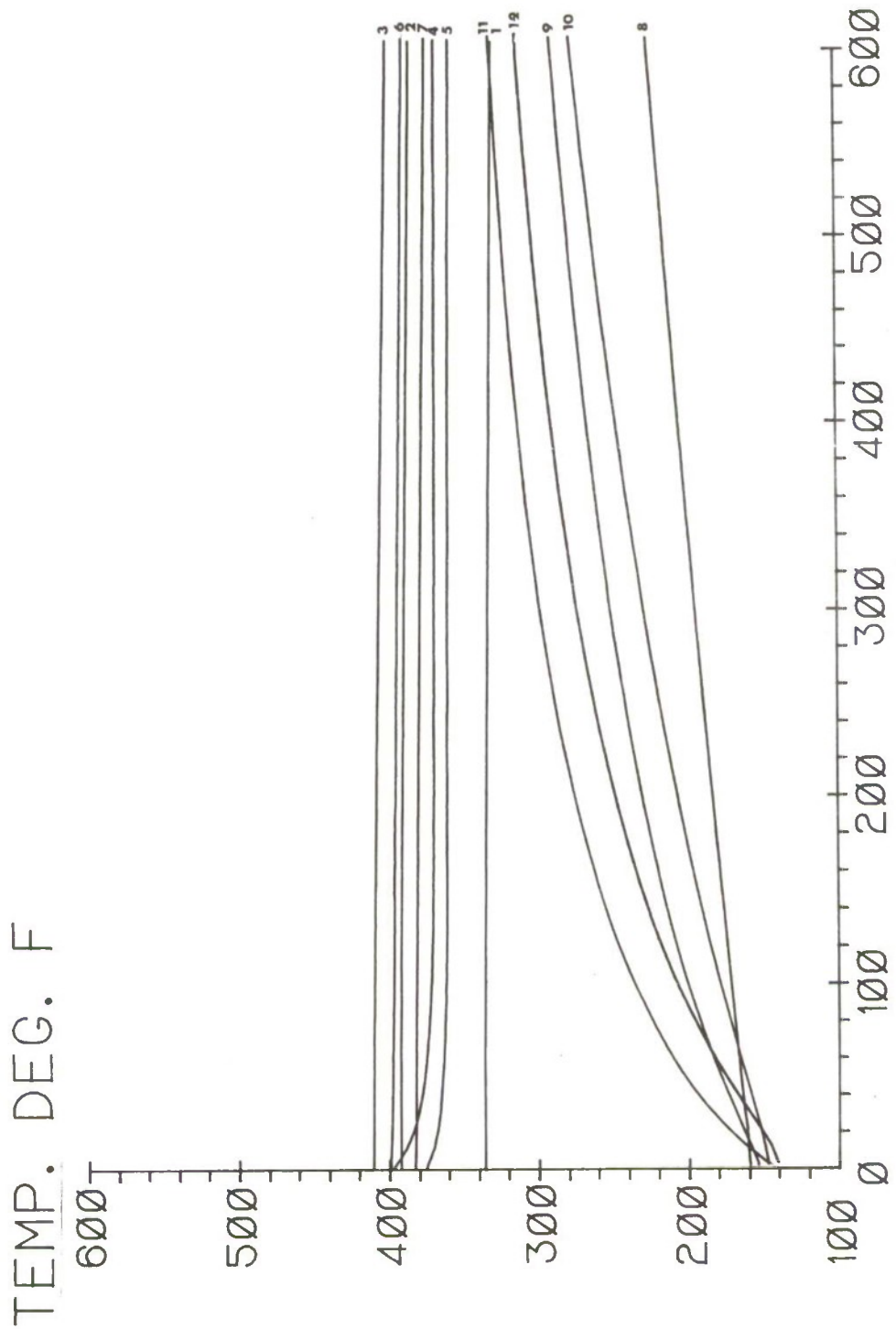

TIME IN SEC.

ROUND NO. P2

TEMP. DEG. F

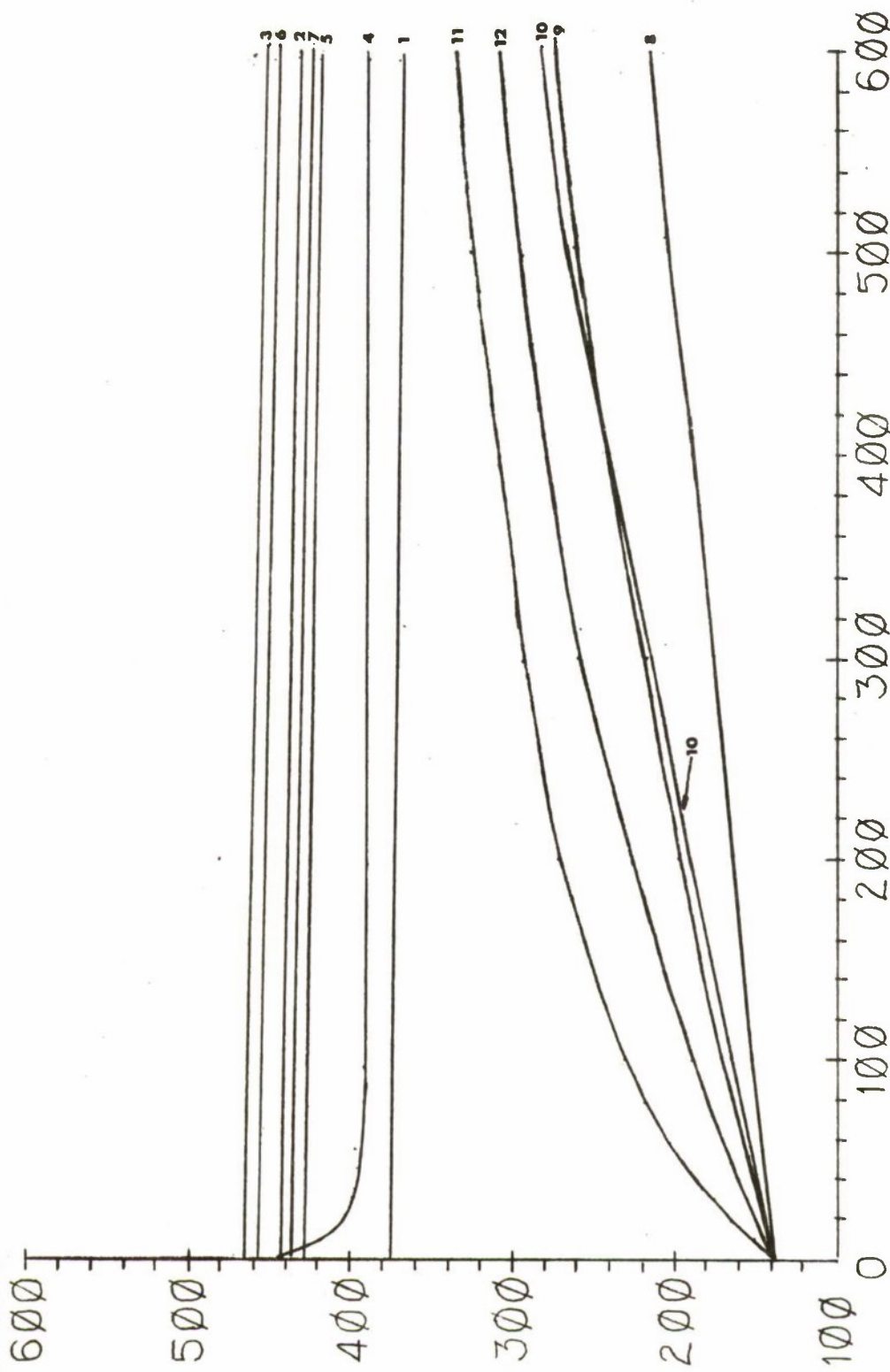

TIME IN SEC.

ROUND NO. P4

TEMP. DEG. F

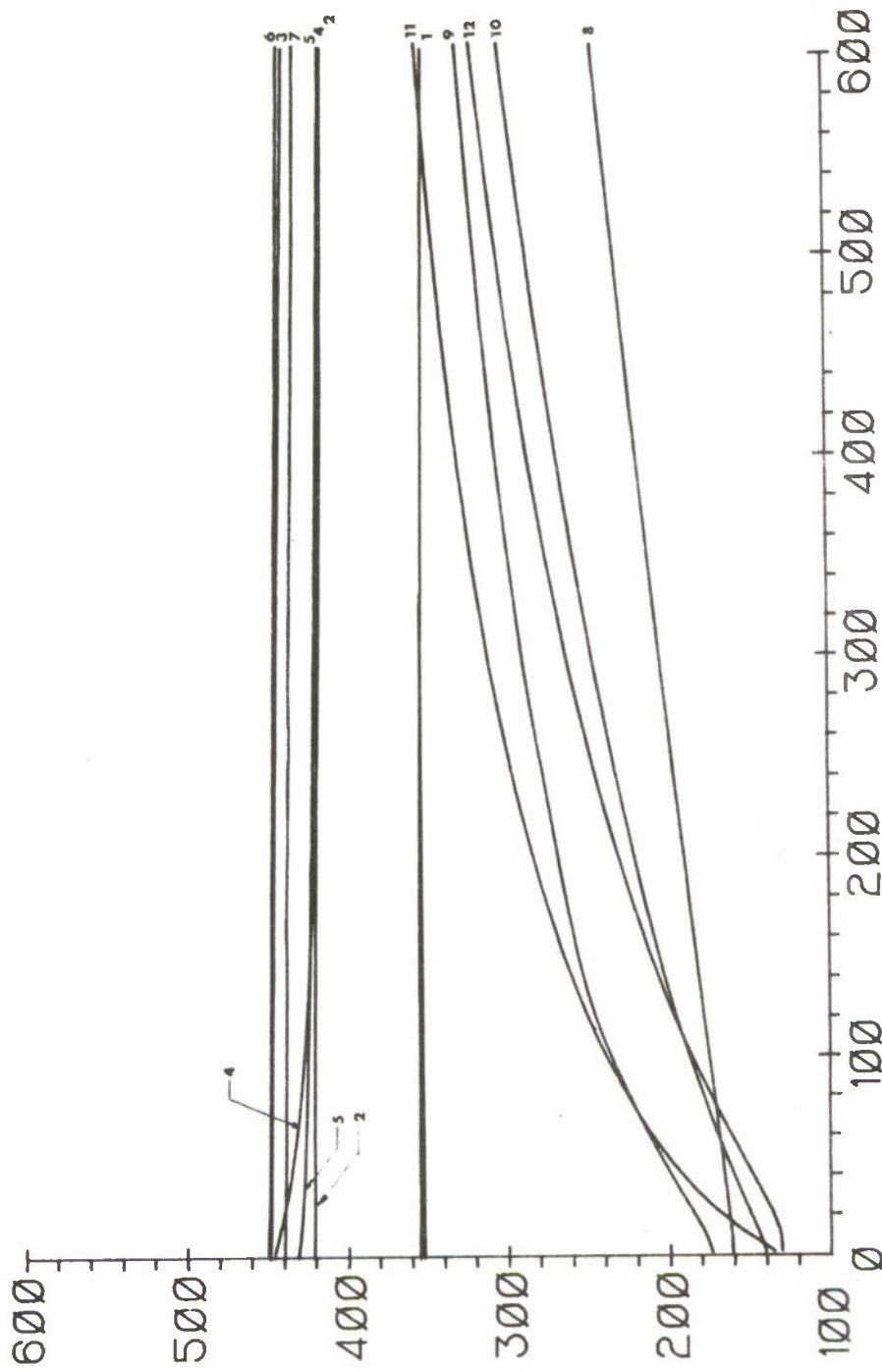

ROUND NO. P5

TEMP. DEG. F

600
500
400
300
200
100
0

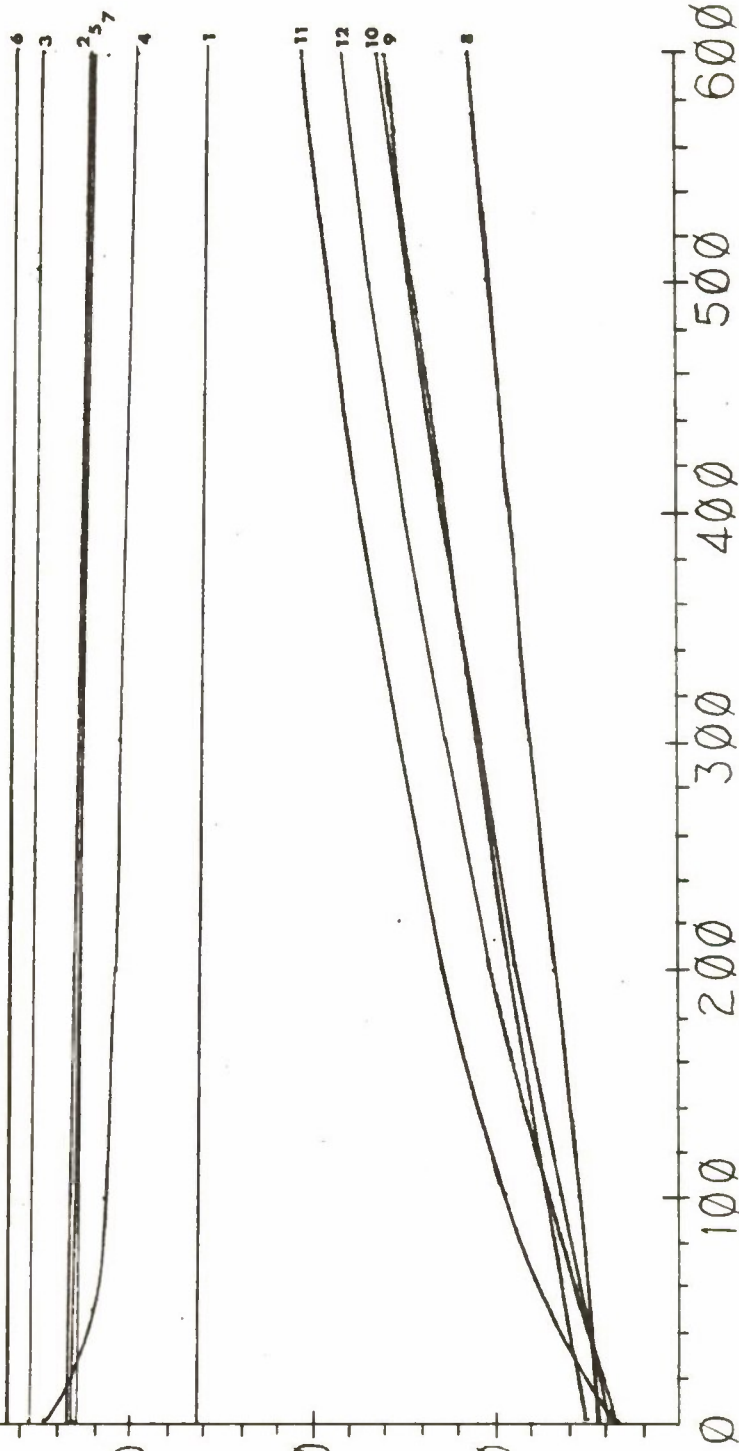

TIME IN SEC.

ROUND NO. P6

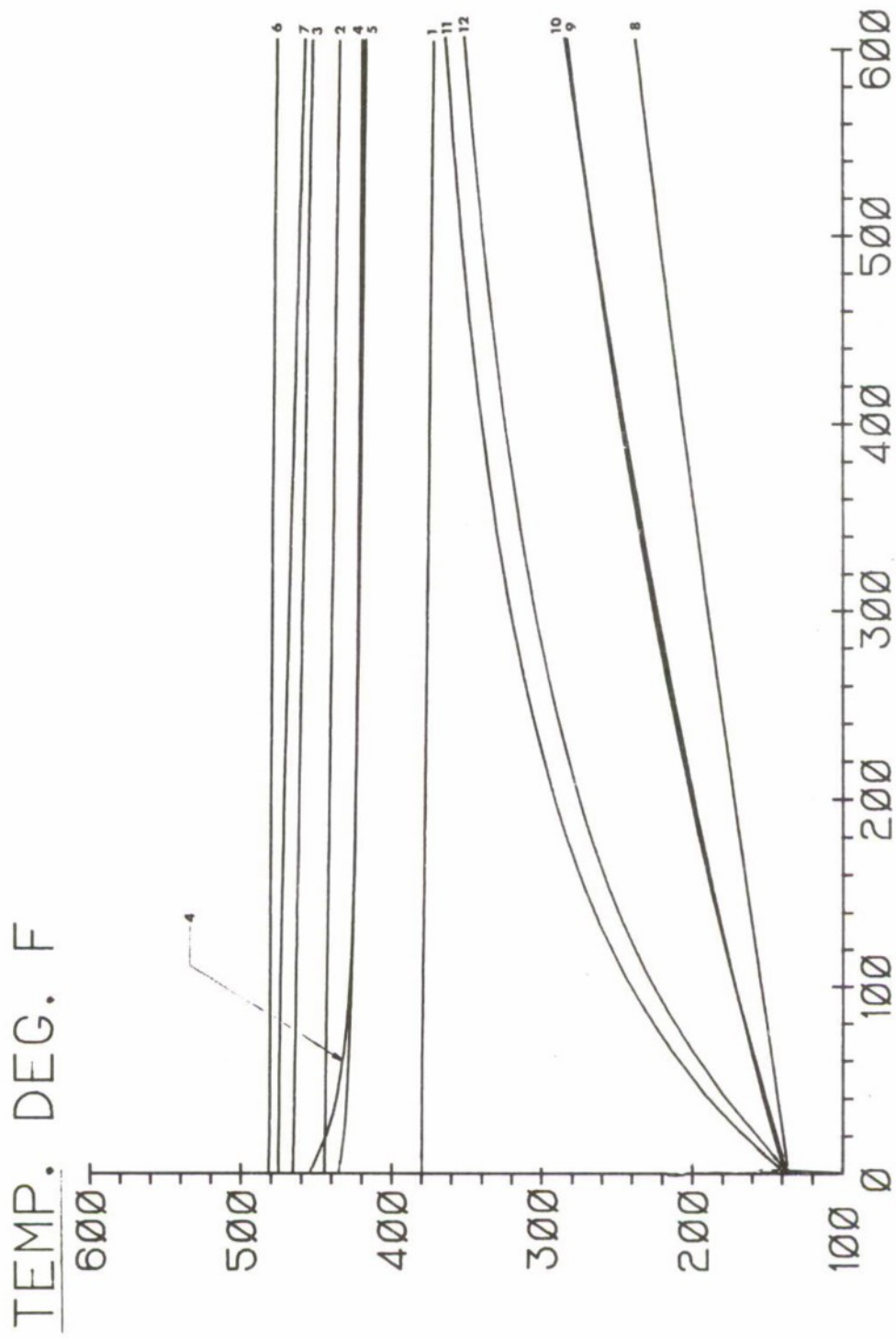

TIME IN SEC.

ROUND NO. P7

TEMP. DEG. F

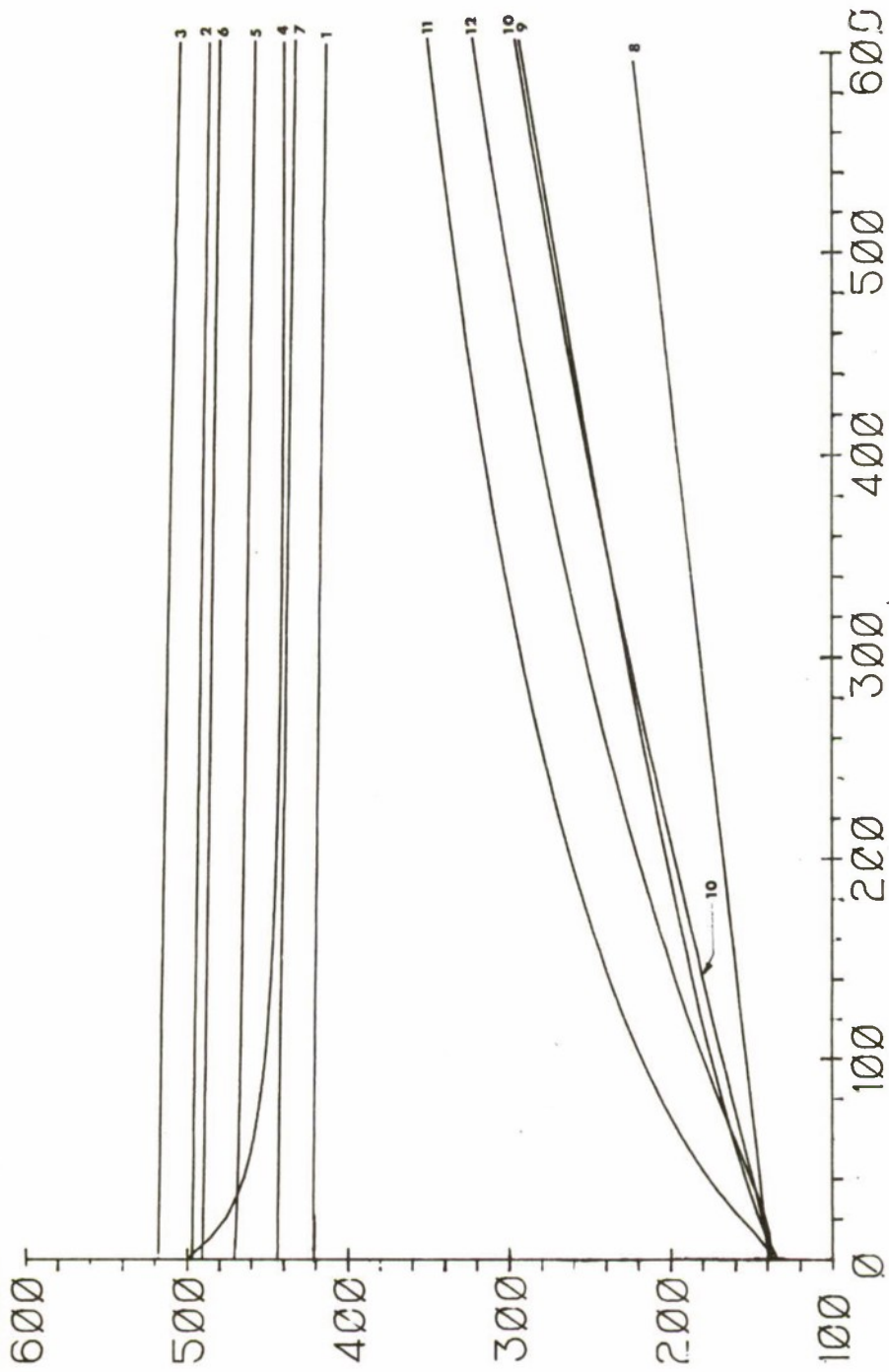

TIME IN SEC.

ROUND NO. P8

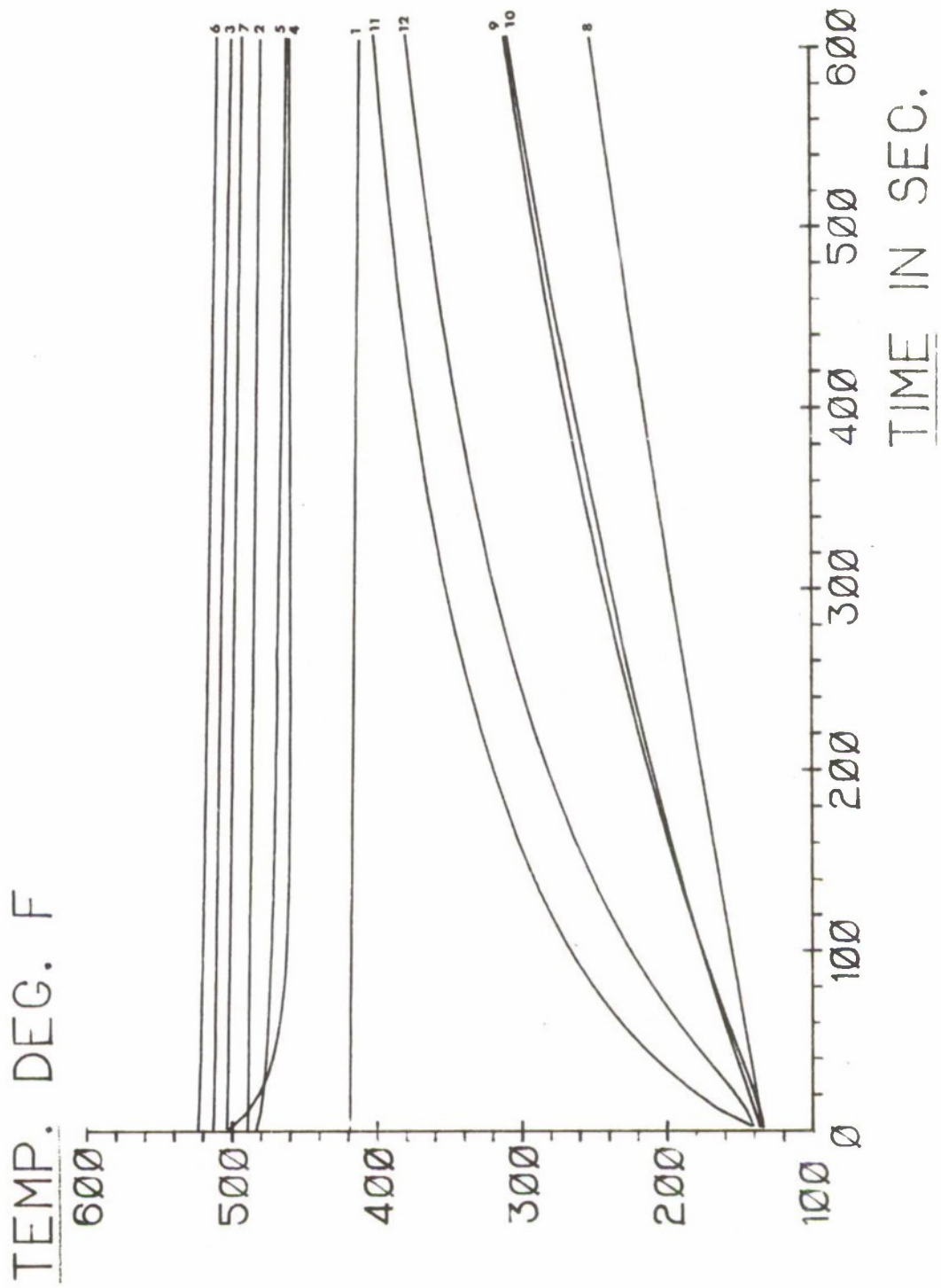

TEMP. DEG. F

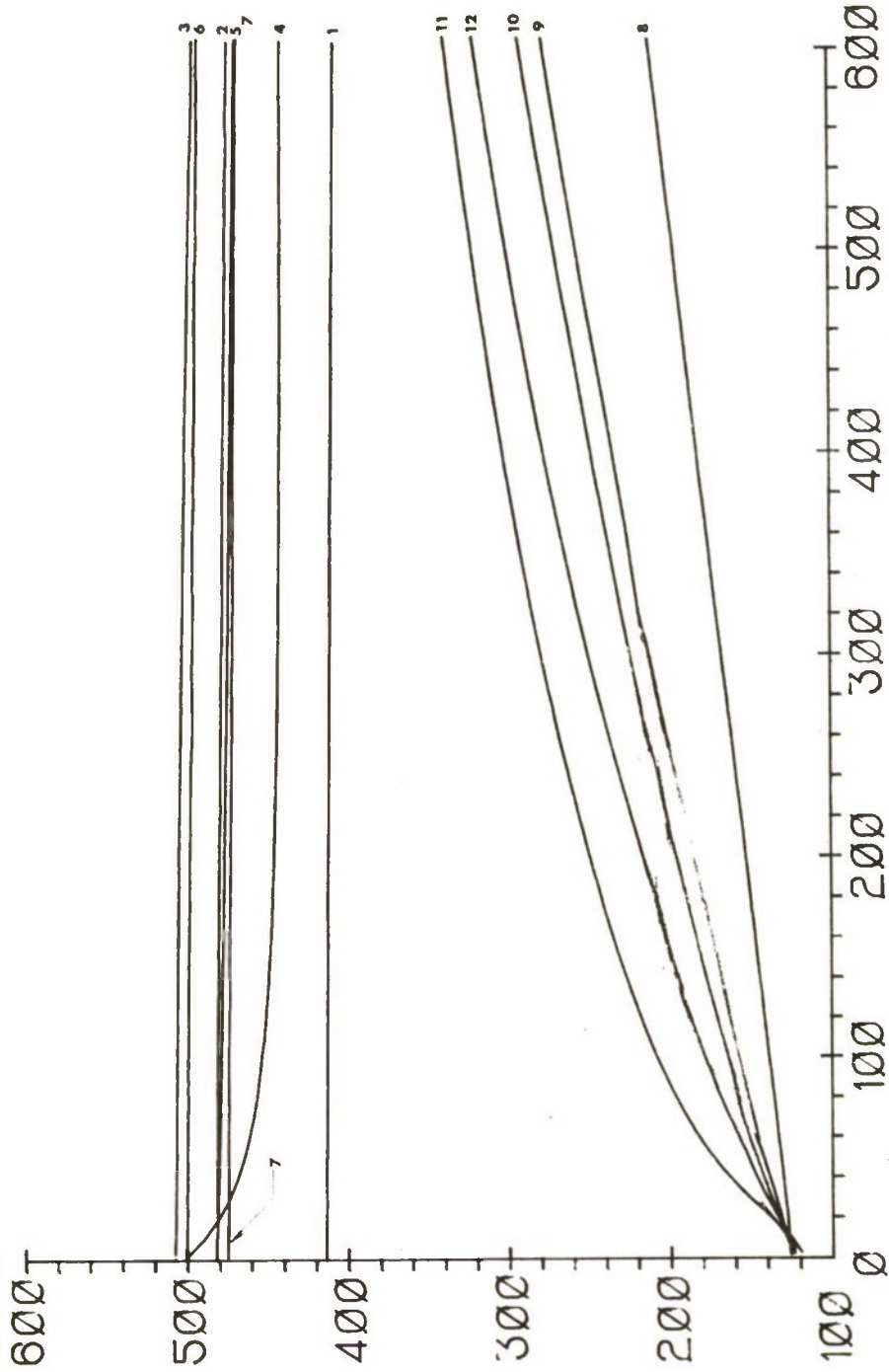

TIME IN SEC.

ROUND NO. P10

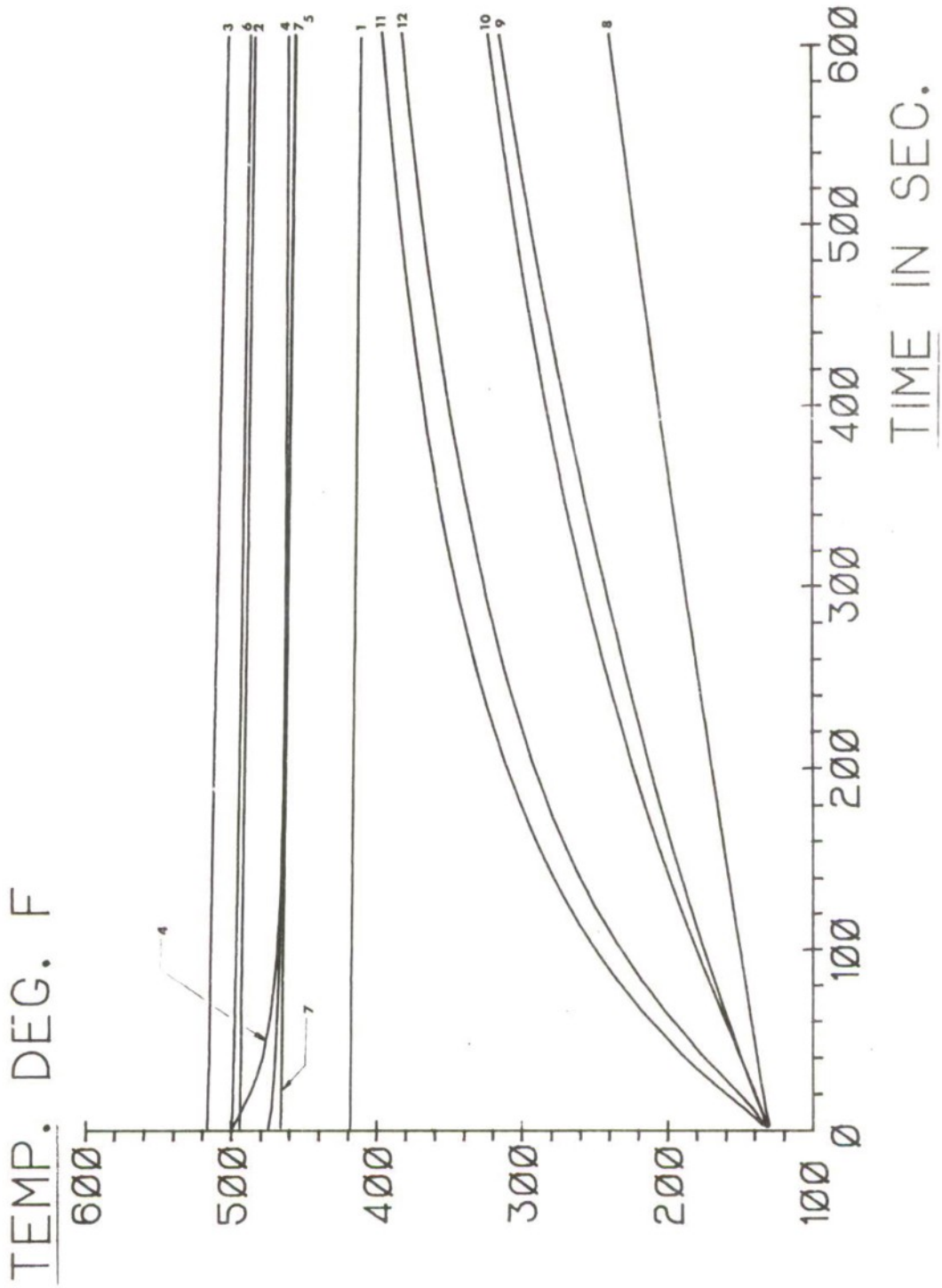

ROUND NO. P11

TEMP. DEG. F



TIME IN SEC.

ROUND NO. P12

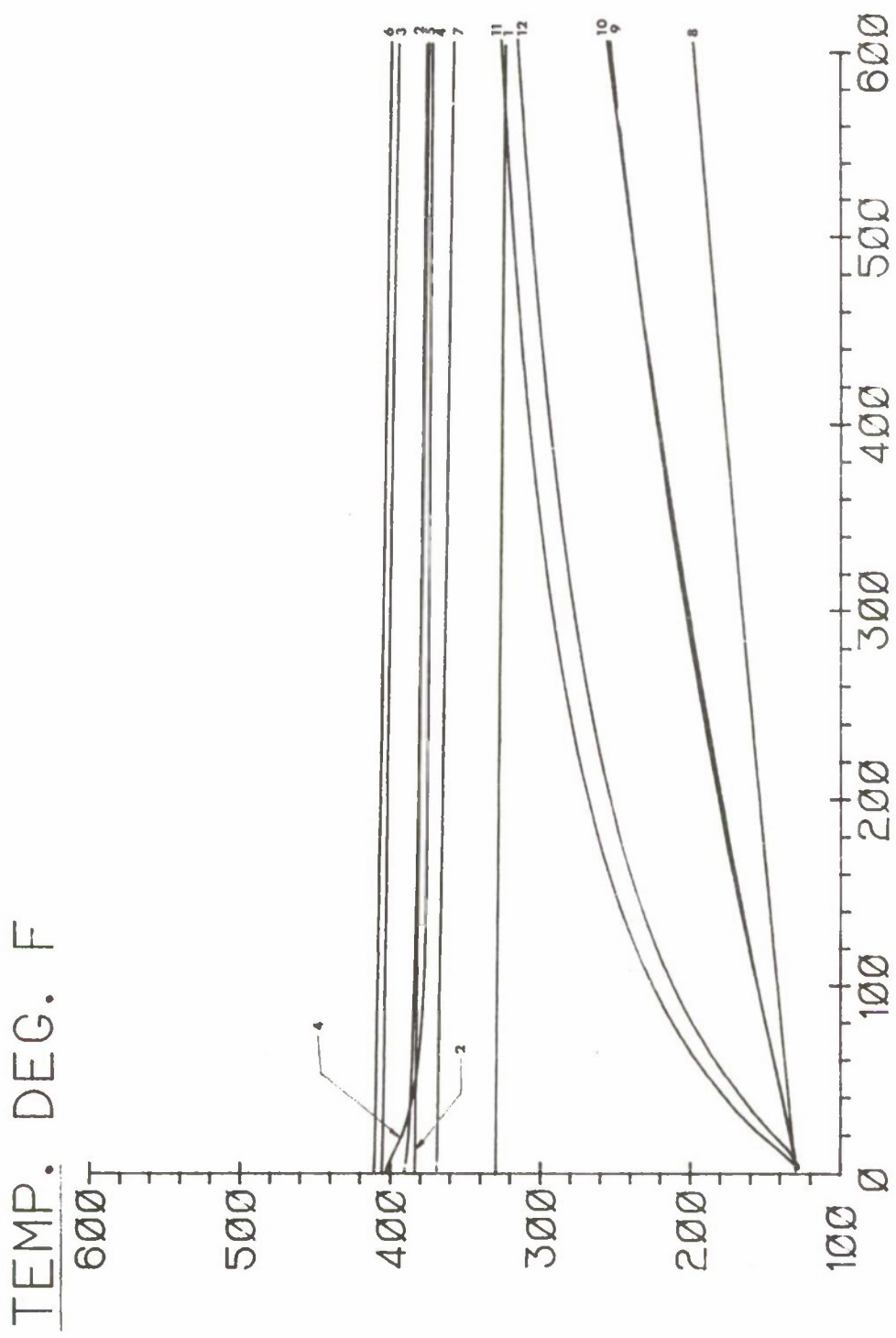

TIME IN SEC.

ROUND NO. P13

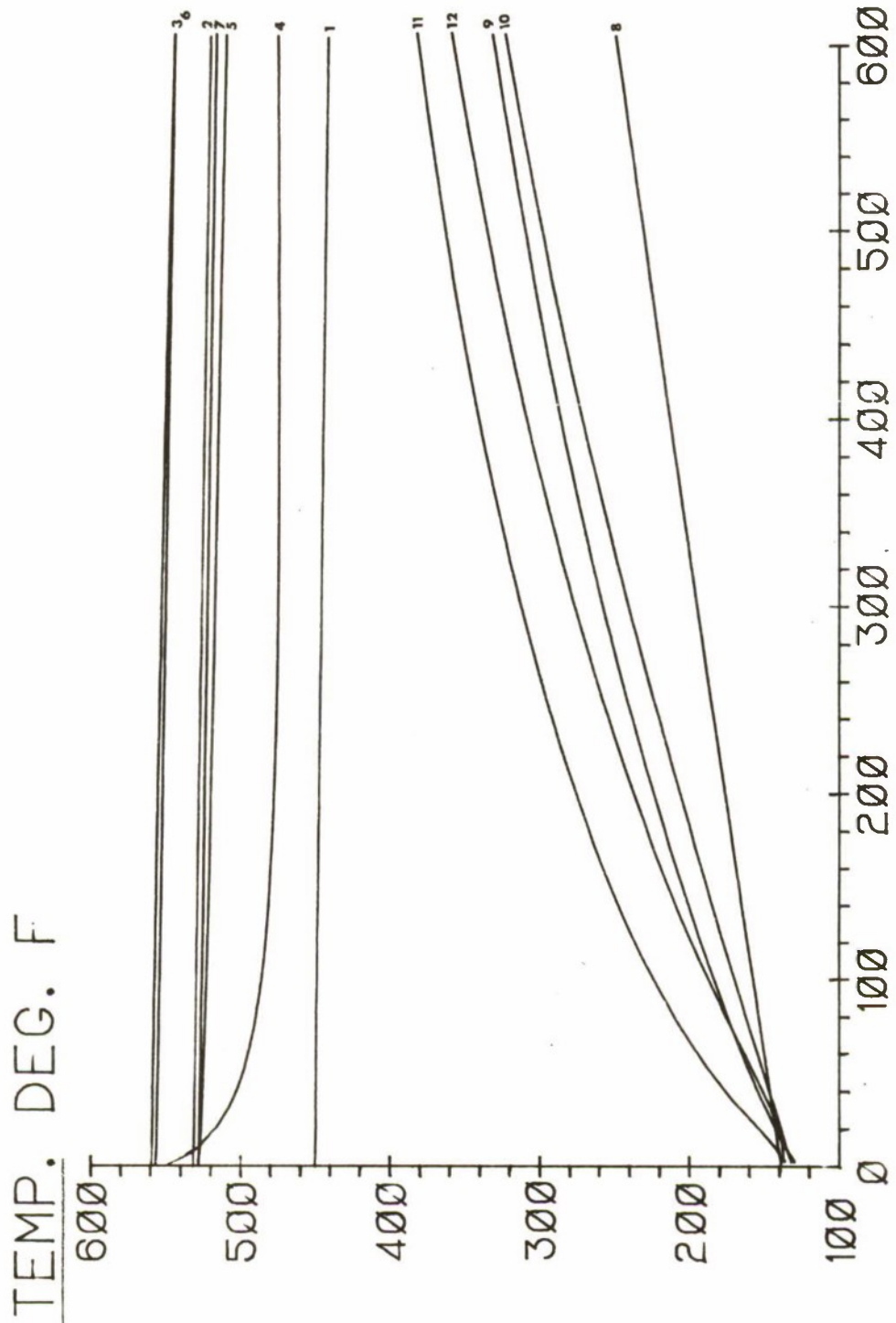

TIME IN SEC.

ROUND NO. P14

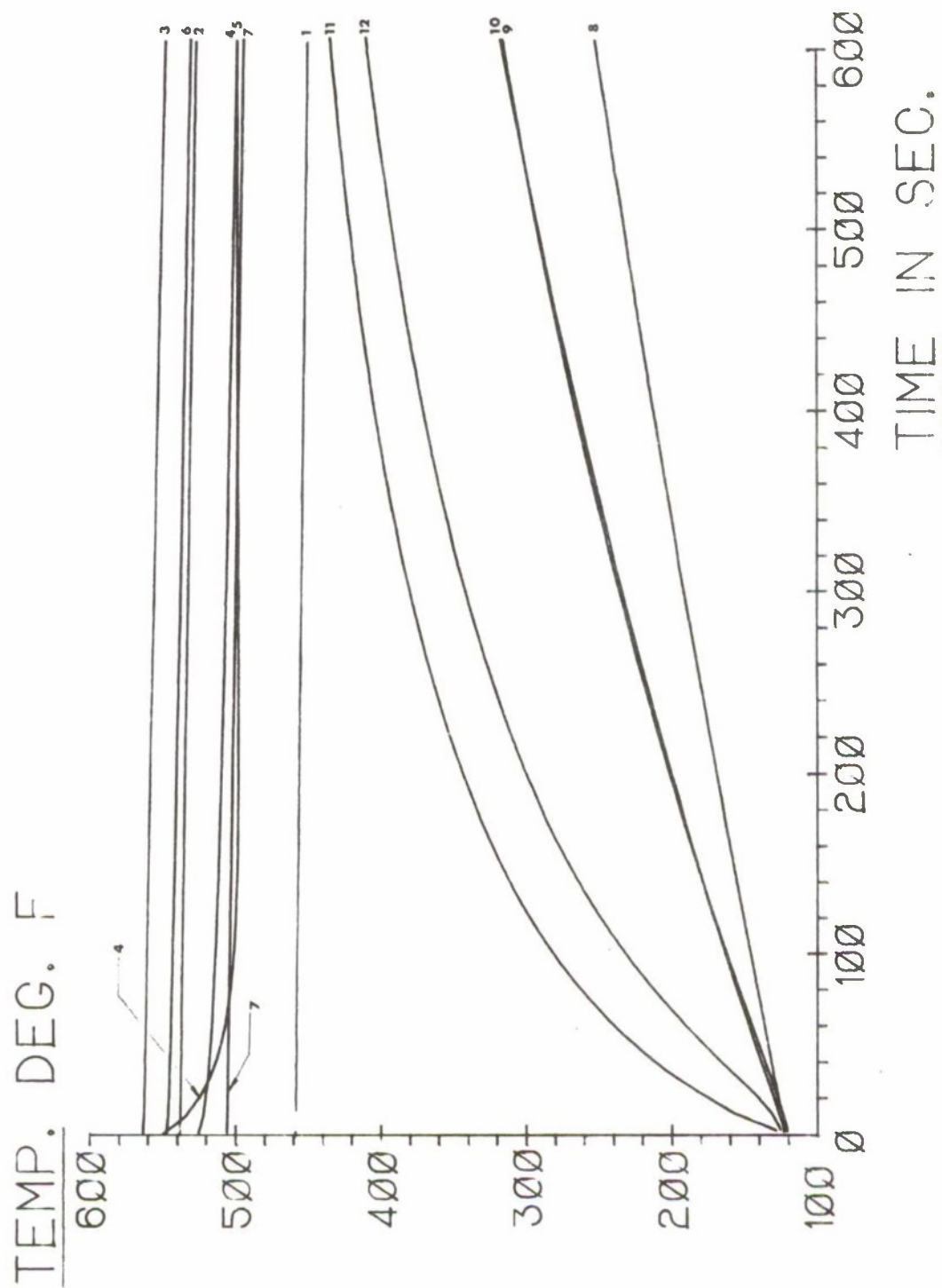

ROUND NO. P15

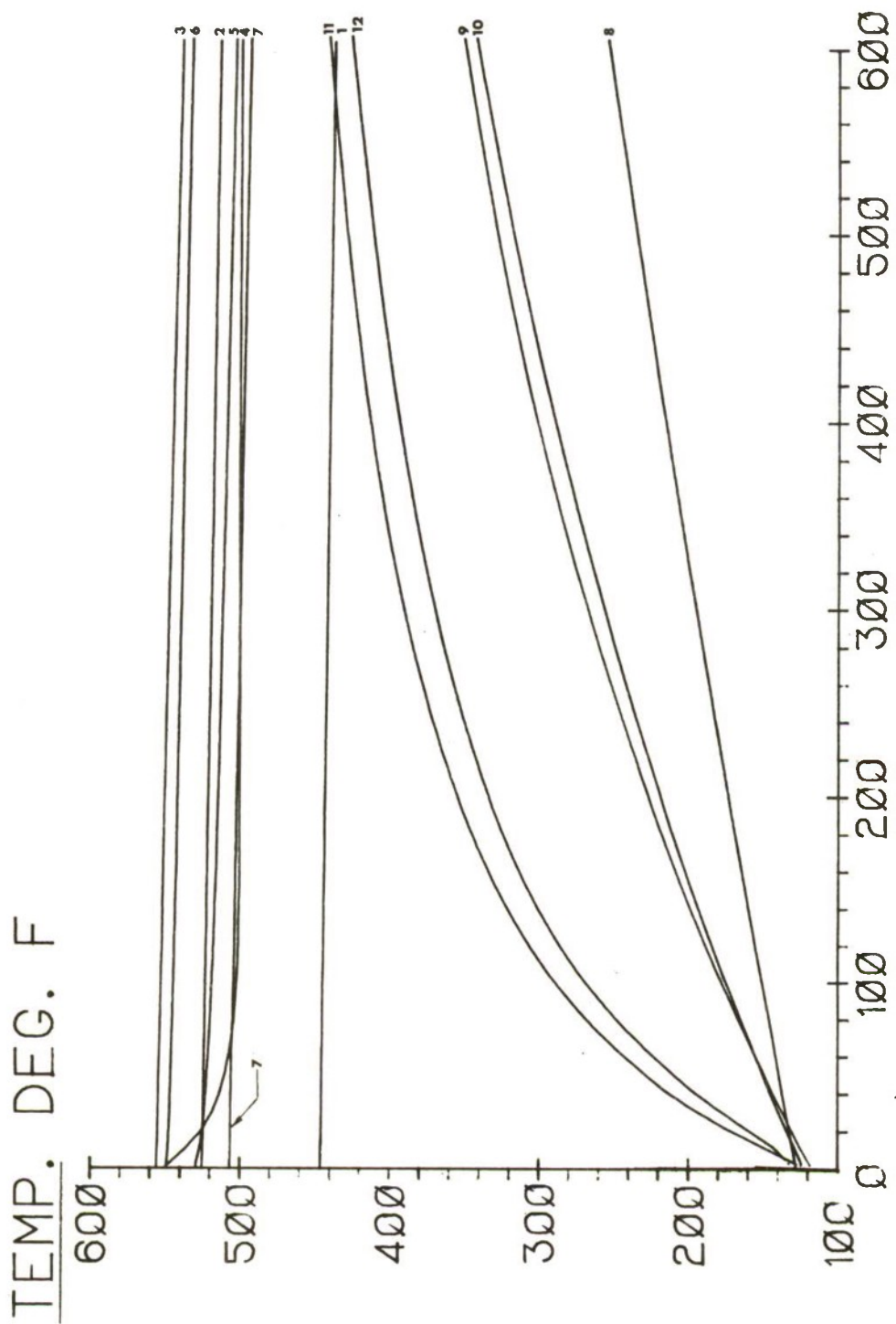

TIME IN SEC.
 ROUND NO. P17

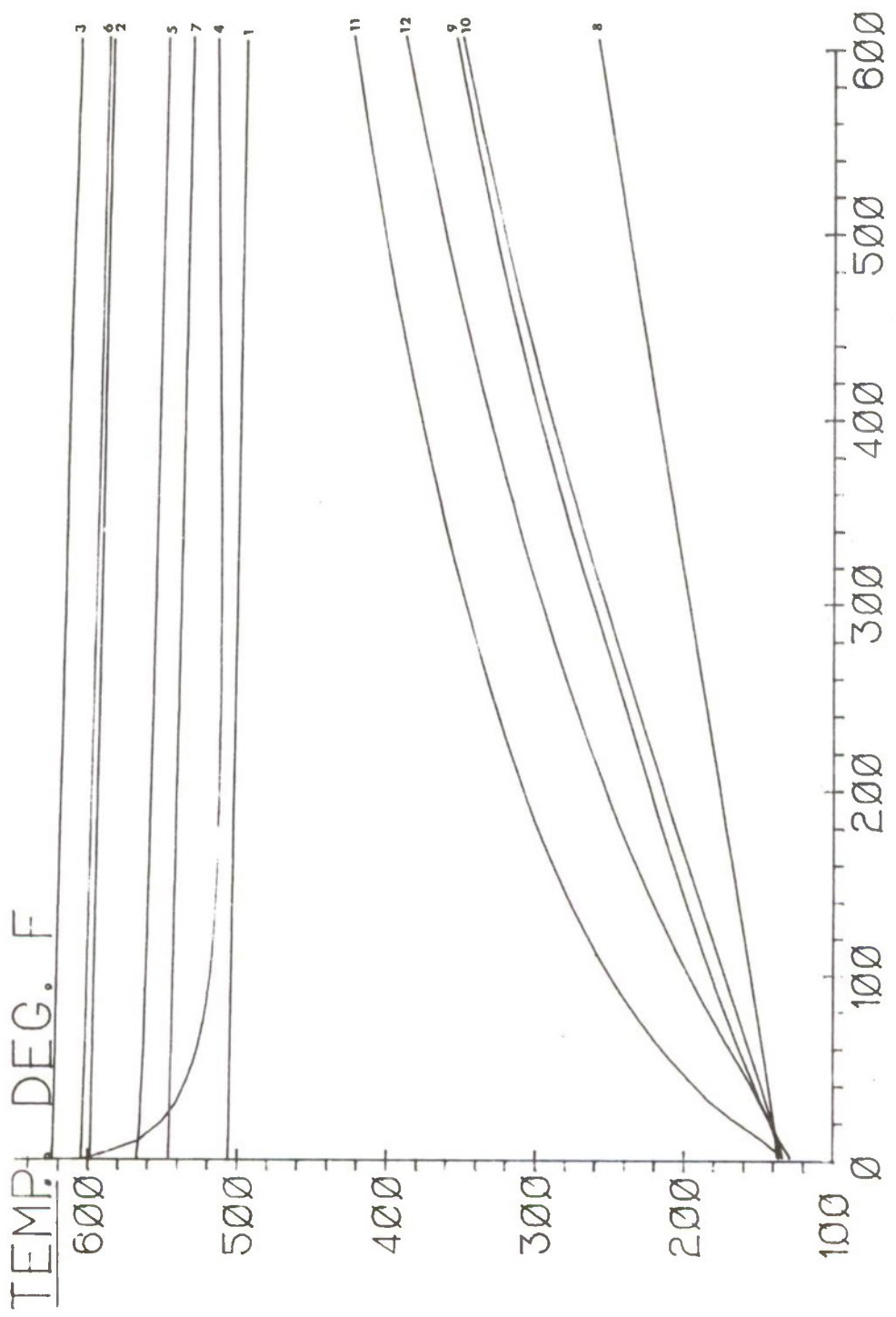

TIME IN SEC.

ROUND NO. P18

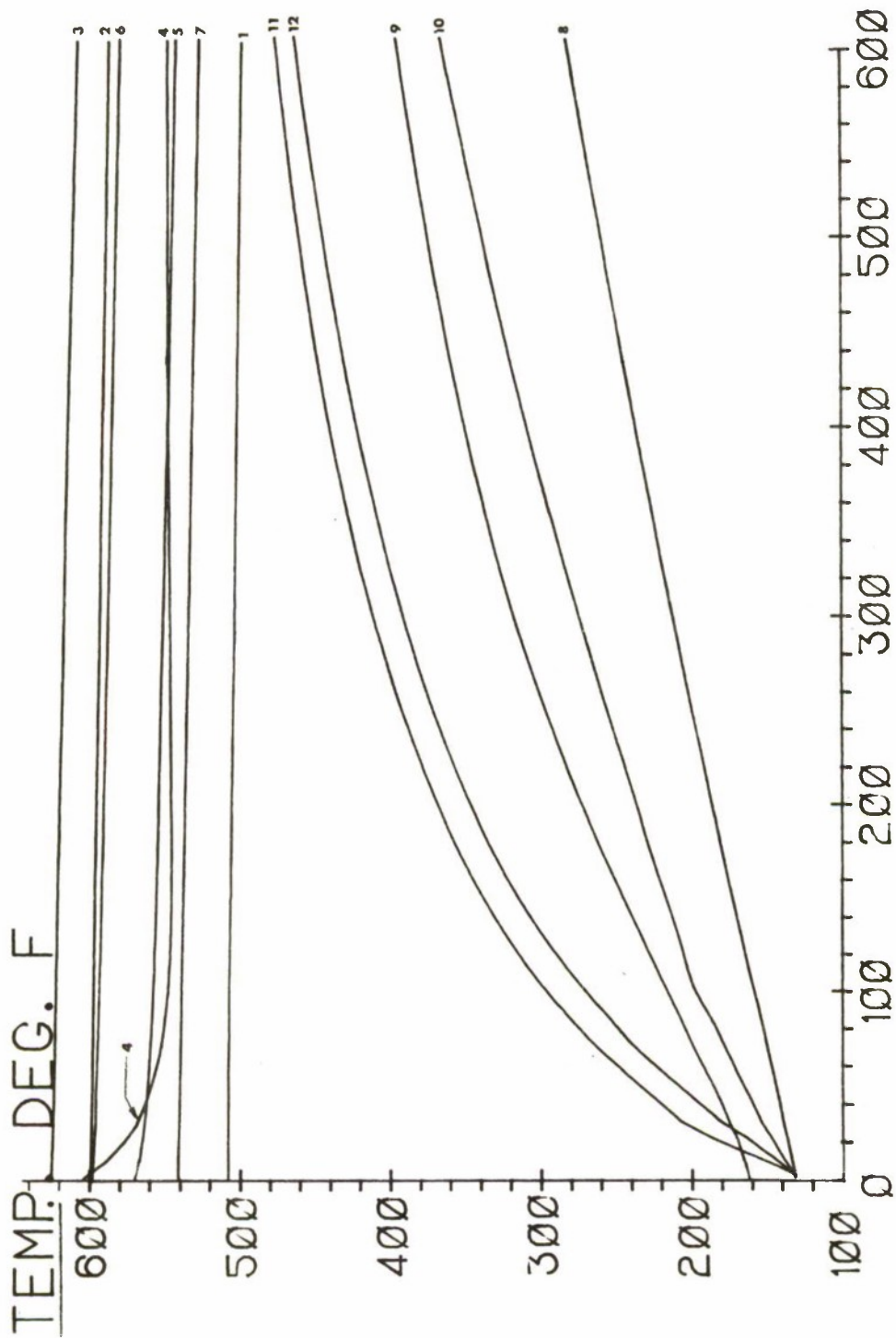

TIME IN SEC.

ROUND NO. P19

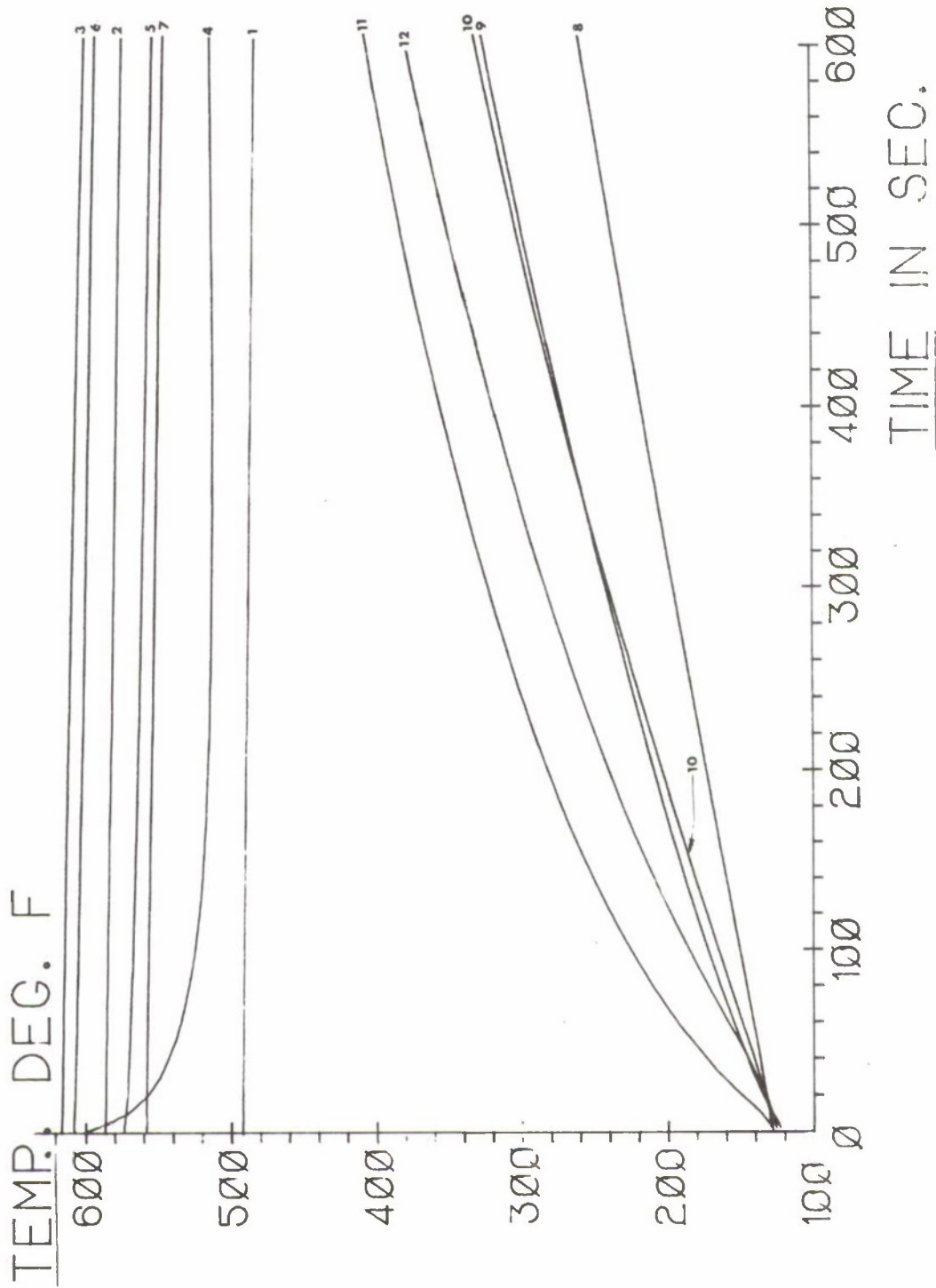

ROUND NO. P20

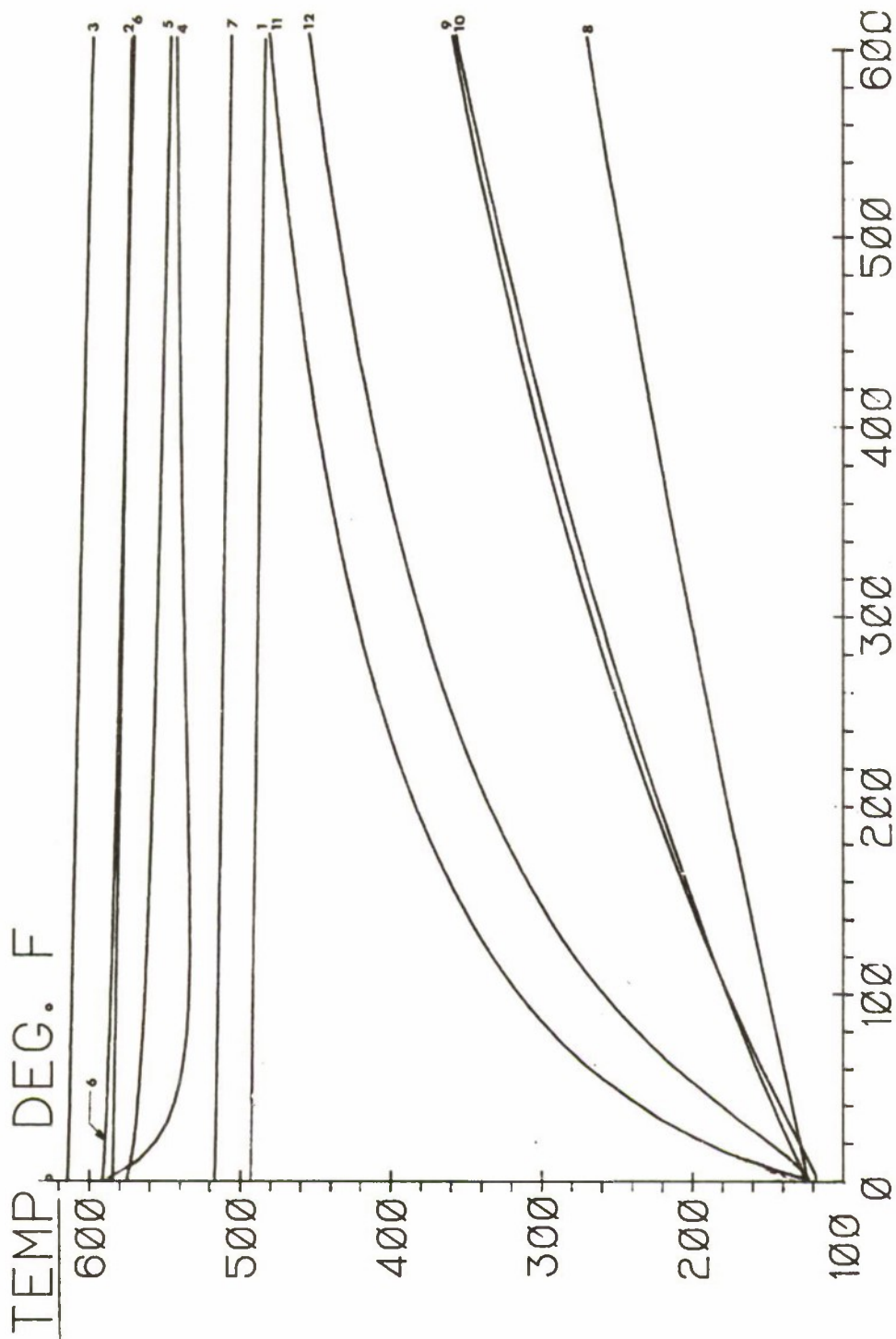

TIME IN SEC.

ROUND NO. P21