

AD-A018 517

FABRICATION AND INVESTIGATION OF NICKEL-ALKALINE CELLS.
PART 1. FABRICATION OF NICKEL-HYDROXIDE ELECTRODES
USING ELECTROCHEMICAL IMPREGNATION TECHNIQUES

David F. Pickett

Air Force Aero Propulsion Laboratory
Wright-Patterson Air Force Base, Ohio

October 1975

DISTRIBUTED BY:

NTIS

National Technical Information Service
U. S. DEPARTMENT OF COMMERCE

357084

AFAPL-TR-75-34

Part I

ADA018512

**FABRICATION AND INVESTIGATION OF
NICKEL-ALKALINE CELLS**

Part I

**Fabrication of Nickel Hydroxide
Electrodes Using Electrochemical
Impregnation Techniques**

*ENERGY CONVERSION BRANCH
AEROSPACE POWER DIVISION*

OCTOBER 1975

TECHNICAL REPORT AFAPL-TR-75-34 Part I
INTERIM REPORT FOR PERIOD 1 JANUARY 1971 - 1 JANUARY 1974

Approved for public release; distribution unlimited

ADDC
RECEIVED
DEC 18 1975
RECEIVED

AIR FORCE AERO PROPULSION LABORATORY
AIR FORCE WRIGHT AERONAUTICAL LABORATORIES
Air Force Systems Command
Wright-Patterson Air Force Base, Ohio 45433

Reproduced by
NATIONAL TECHNICAL
INFORMATION SERVICE
U S Department of Commerce
Springfield VA 22151

NOTICE

When Government drawings, specifications, or other data are used for any purpose other than in connection with a definitely related Government procurement operation, the United States Government thereby incurs no responsibility nor any obligation whatsoever; and the fact that the government may have formulated, furnished, or in any way supplied the said drawings, specifications, or other data, is not to be regarded by implication or otherwise as in any manner licensing the holder or any other person or corporation, or conveying any rights or permission to manufacture, use, or sell any patented invention that may in any way be related thereto.

This report contains the results of an effort to develop a nickel-hydroxide electrode having improved capacity, charge acceptance, overcharge capability and cycle life. The work was performed in the Aerospace Power Division (POE-1) of the Air Force Aero Propulsion Laboratory, Air Force Systems Command, Wright-Patterson AFB, Ohio, under Project 3145, Task 314522, and Work Unit 31452240. The effort was conducted by Dr. David F. Pickett during the period January 1971 to January 1974. Mr. Unie D. Martin and Mr. James W. Logsdon collected most of the data presented. Mr. Martin constructed the pilot plant unit and performed most of the design work with technical assistance from the project scientist. Mr. Logsdon designed the circuit for information cycling of beaker production level cells. Mr. Martin assembled pilot production cells. Cycling of pilot production cells was performed by Mr. Paul W. Schliesser, Mr. Michael J. Davis and Mr. Logsdon. Dr. J. J. Lander provided technical advice throughout the work.

This report has been reviewed by the Information Office, (ASD/OIP) and is releasable to the National Technical Information Service (NTIS). At NTIS, it will be available to the general public, including foreign nations.

This technical report has been reviewed and is approved for publication.

David F. Pickett
David F. Pickett
Project Scientist

Donald P. Mortel
Donald P. Mortel
Technical Area Manager
Batteries/Fuel Cells

NTIS	Year Set	<input checked="" type="checkbox"/>
DEC	Est. 4000	<input type="checkbox"/>
UNANNOUNCED		<input type="checkbox"/>
JUSTIFICATION		
71		
DISTRIBUTION		
Dist.	APPROVAL	SPECIAL
A		

Copies of this report should not be returned unless return is required by security considerations, contractual obligations, or notice on a specific document.

11a

UNCLASSIFIED

SECURITY CLASSIFICATION OF THIS PAGE (When Data Entered)

REPORT DOCUMENTATION PAGE		READ INSTRUCTIONS BEFORE COMPLETING FORM
1. REPORT NUMBER AFAPL-TR-75-34, Part I	2. GOVT ACCESSION NO.	3. RECIPIENT'S CATALOG NUMBER
4. TITLE (and Subtitle) Fabrication and Investigation of Nickel-Alkaline Cells Part I. Fabrication of Nickel-Hydroxide Electrodes Using Electrochemical Impregnation Techniques		5. TYPE OF REPORT & PERIOD COVERED Technical Report (Interim) 1 Jan 1971 - 1 Jan 1974
		E. PERFORMING ORG. REPORT NUMBER
7. AUTHOR(s) David F. Pickett	8. CONTRACT OR GRANT NUMBER(s) In-House	
9. PERFORMING ORGANIZATION NAME AND ADDRESS Air Force Aero-Propulsion Laboratory (POE-1) Wright-Patterson Air Force Base, OH 45433		10. PROGRAM ELEMENT, PROJECT, TASK AREA & WORK UNIT NUMBERS Project 3145, Task 314522 W.U. 31452240
11. CONTROLLING OFFICE NAME AND ADDRESS Air Force Aero-Propulsion Laboratory (POE-1) Wright-Patterson Air Force Base, OH 45433		12. REPORT DATE October 1975
		13. NUMBER OF PAGES 77
14. MONITORING AGENCY NAME & ADDRESS (if different from Controlling Office)		15. SECURITY CLASS. (of this report) Unclassified
		15a. DECLASSIFICATION/DOWNGRADING SCHEDULE
16. DISTRIBUTION STATEMENT (of this Report) Approved for public release; distribution unlimited		
17. DISTRIBUTION STATEMENT (of the abstract entered in Block 20, if different from Report)		
18. SUPPLEMENTARY NOTES		
19. KEY WORDS (Continue on reverse side if necessary and identify by block number) Nickel electrodes Electrochemical impregnation Nickel oxide electrodes Batteries Nickel sinter Nickel-cadmium batteries Nickel plaque		
20. ABSTRACT (Continue on reverse side if necessary and identify by block number) Several electrochemical impregnation techniques for deposition of active Nickel-Hydroxide inside nickel sinters have been investigated. The most favorable means of impregnation appears to be deposition from alcoholic nitrate solutions. Formation cycling of electrodes made from the various techniques has been performed using 20-50% overcharge for 10-30 cycles. Some electrodes show capacities as high as 9.5 ampere-hours per cubic inch after these cycles. The alcohol process has been scaled to pilot production,		

UNCLASSIFIED

SECURITY CLASSIFICATION OF THIS PAGE(When Data Entered)

and several 20-25 A-H vented Nickel-Cadmium cells were constructed using cadmium electrodes fabricated from another electrochemical technique. These cells show vastly improved charge acceptance, at a wide temperature range, over state-of-the-art vented aircraft cells and improved cycle life at high temperatures and deep depths of discharge.

11

SECURITY CLASSIFICATION OF THIS PAGE(When Data Entered)

TABLE OF CONTENTS

	PAGE
INTRODUCTION	1
THEORY OF ELECTROCHEMICAL IMPREGNATION	4
EXPERIMENTAL	8
I. Preparation of Impregnating Solutions	8
Aqueous Solutions	8
Alcohol Solutions	8
II. Plaque	8
III. Impregnation Cells	10
Beaker Level Operations	10
Intermediate Scale-up	10
IV. Formation - Characterization of Beaker Level Production Plates	10
Cell Construction	10
Charge-Discharge Circuit Design	12
Cycling Procedure	12
V. Pilot Plant Construction	12
VI. Pilot Plant Operation	19
Impregnation	19
Formation	20
Cell Assembly	20
VII. Analysis Methods	21
Bath Analysis	21
a. Metal Ion Analysis	21
b. Volatile Component Analysis	21
Plate Analysis	21

	PAGE
DATA AND RESULTS	24
I. Loading Data from Beaker Level Operations	24
Aqueous Solutions	24
Ethanol Solutions	28
Other Solutions	28
II. Performance of Beaker Production Plates	31
Aqueous Solutions	31
Ethanol Solutions	43
a. Cobalt Additive	43
b. Various Additives Present	49
III. Pilot Production of Electrodes for 20 A-H Vented Cells	49
Loading Data	50
Cell Fabrication Data	56
Charge Efficiency with Respect to Temperature	58
DISCUSSION OF RESULTS	60
REFERENCES	64

LIST OF ILLUSTRATIONS

FIGURE		PAGE
1.	Scanning Electron Micrograph of Typical Plaque Used Material in Electrode Fabrication	7
2.	Electrode Assembly for Impregnation Cell	9
3.	Anode Assembly for Multiple Plaque Impregnations	11
4.	Circuit Used for Formation Cycling	13
5.	Voltage-Time Curves for Typical Charge-Discharge Cycle	14
6.	Impregnation Tank for Pilot Production of Nickel Hydroxide Electrodes Using Ethanol Solutions (Top View)	15
7.	Impregnation Tank for Pilot Production of Nickel Hydroxide Electrodes Using Ethanol Solutions (Side View)	16
8.	Master Plaque Design for 20 A-H Cell Electrodes	17
9.	Assembly of Electrolysis Cell for Electrochemical Impregnation of Nickel Plaques	18
10.	Cell Case Used for Experimental Cell Studies.	23
11-15.	Formation Cycles for Nickel Hydroxide Electrodes Impregnated from Aqueous Solutions Electrochemically (c charge, c discharge, 20% over charge, Ni Anodes)	34 - 39
16.	Charging Efficiency versus State of Charge for Nickel Hydroxide Electrodes Impregnated from Aqueous Solutions on a Beaker Production Level	40
17.	Formation Cycles for Nickel Hydroxide Electrodes Impregnated from Aqueous Solutions Electrochemically (c charge, c discharge, 20% overcharge, Inert Anodes)	42
18,19.	Formation Cycles for Nickel Hydroxide Electrodes Impregnated from Ethanol Solutions Electrochemically (c charge, c discharge, 20% overcharge, Ni Anodes)	45,46
20.	Formation Cycles for Nickel Hydroxide Electrodes Impregnated from Ethanol Solutions Electrochemically (c charge, c discharge, 20% overcharge, Various Additives Present)	48

FIGURE		PAGE
21.	Charge Efficiency versus State of Charge at Selected Ambient Temperatures (AFAPL Cells)	54
22.	Charge Efficiency Versus State of Charge- (Aircraft Cells)	55
23.	Comparison of Experimental Cells and Aircraft Cells	56
24.	Scanning Electron Micrograph of Aircraft Positive Plate	58
25.	Scanning Electron Micrograph of AFAPL Positive Plates	59

LIST OF TABLES

TABLE		PAGE
1.	Loading Characteristics of Nickel Hydroxide Electrodes Impregnated from Aqueous Solutions	25
2.	Loading Characteristics of Nickel Hydroxide Electrodes Impregnated from Aqueous Solutions With Cobalt Present	26
3.	Loading Characteristics of Nickel Hydroxide Electrodes Impregnated from Aqueous Solutions Using Inert Counter Electrodes	27
4.	Loading Characteristics of Nickel Hydroxide Electrodes Impregnated from Ethanol Solution With Cobalt Present	29
5.	Loading Characteristics of Nickel Hydroxide Electrodes Impregnated from Ethanol Solutions With Various Additives Present	30
6.	Listing of Positive Plates Present in Formation-Characterization Cells	32
7.	Performance of Nickel Hydroxide Electrodes Impregnated from Aqueous Solutions	33
8.	Performance of Nickel Hydroxide Electrodes Impregnated from Aqueous Solutions with Cobalt Present	35
9.	Performance of Nickel Hydroxide Electrodes Impregnated from Aqueous Media (Cobalt Present, Inert Anodes)	41
10.	Performance of Nickel Hydroxide Electrodes Impregnated from Ethanol Solutions Using Only Cobalt Additive	44
11.	Performance of Nickel Hydroxide Electrodes Impregnated from Ethanol Solutions with Various Additives Present	47
12.	Loading Data for Plaques from Pilot Production (Aqueous Solutions)	50

TABLE		PAGE
13.	Loading Data for Plaques from Pilot Production (Ethanol Solutions)	52
14.	Cell Fabrication Data	56

INTRODUCTION

The nickel hydroxide electrode, the positive plate in a nickel-cadmium, nickel-zinc, or nickel hydrogen cell, occurs in a number of forms, but the only one used extensively for Air Force applications is the sintered electrode.* The electrode receives its name from the method used to form the substrate carrying active material and collecting current. This substrate is made by sintering a high surface area nickel powder, along with a supporting metal grid, into a highly porous matrix called a plaque.

Sintered plates have a large active surface area, can be made unusually thin, and may be placed very close together. These features give rise to good high rate performance. This characteristic, along with their excellent low temperature performance, make sintered plate nickel-cadmium cells excellent power sources for military applications.

There are a number of methods used to load active material into sintered structures. In conventional plate manufacturing the plaque is usually loaded with active material by dipping in a nitrate solution under vacuum then converting the imbibed nitrate salts to their hydroxides by a second immersion in caustic solution. The dip in caustic is usually accompanied by a cathodic treatment to expel residual nitrogen as ammonia. This procedure must be repeated several

* Presently only nickel-cadmium cells are used in Air Force missions; Nickel-hydrogen and nickel-zinc cells are under development.

times in order to obtain a fully loaded plaque⁽¹⁾. Another method uses immersion in molten hydrates of nickel and cadmium nitrates followed by a heat treatment to decompose the imbibed nitrates to hydroxides^(2,3). The final process in all Ni-Cd plate manufacturing is conversion of the hydroxides to elemental Cadmium and Nickel (III) hydroxide. This step is called formation.

Electrochemical precipitation of hydroxides in the pores of nickel sinters has received considerable attention in the last few years. The first appearance in the patent literature was due to Kandler⁽⁴⁾. As described in the patent, five hours of deposition yielded a nickel hydroxide electrode having a capacity of 2.5 to 4.0 ampere-hours per cubic inch. The impregnation was performed by making the plaque cathodic in a nickel nitrate solution using nickel foil as an anode. Cadmium electrodes were also impregnated using a similar technique.

Since this time there have been reports of other cathodic methods^(5,7,8,9,10,11,12), and studies have been reported for purposes of evaluating the Kandler process⁽¹³⁾ and elucidating the reaction mechanism of cathodic precipitation⁽¹⁴⁾.

An anodic method for preparing nickel hydroxide electrodes has been reported by Kober⁽⁶⁾. In this method nickel formate is dissolved in ammoniacal solution forming the nickel amine formate complex. Oxidation of the Amine Complex inside the anodic plaque leaves a deposit of nickel hydroxide.

Probably the most rapid process for electrochemical loading of nickel sinters with hydroxides, yet reported, has been developed at Bell Telephone Laboratories by Beauchamp and co-workers^(9,10). In this process,

boiling aqueous solutions of nitrates, containing small amounts of sodium nitrite, are used to impregnate nickel plaques to as high as 2.3 grams of active material per cubic centimeter of void within 30 to 75 minutes. The resulting capacity of these electrodes is about 8 ampere-hours per cubic inch. Their performance in experimental cells with respect to percent utilization of active material and retention of capacity with cycle life is far superior to electrodes in conventional sintered plate nickel-cadmium cells. The process is certainly more convenient than most commercial methods which require several hours to fully load a nickel plaque.

Prior to reports of the Bell process, various electrochemical methods of plaque impregnation were under investigation at the Air Force Aero-Propulsion Laboratory (AFAPL); on emergence of the Bell method it was also included for study. As a result of these investigations, another technique for electrochemical fabrication of nickel hydroxide electrodes has resulted and is the main process, treated in this report. The method is similar to the Bell process to the extent that both use boiling or near boiling solutions approximately 2.0 molar in nickel nitrate. It has the advantage of being a lower temperature process than the Bell method and may be carried out using plastic tanks, lines, and pumps. Nickel hydroxide electrodes made by this process have capacities of about 8 ampere-hours per cubic inch when measured at the one hour rate in 32% in a flooded cell (15,16).

THEORY OF ELECTROCHEMICAL IMPREGNATION

In order to obtain a qualitative idea of principles involved in deposition of hydroxides in porous conducting matrices, let us consider what probably happens to an aqueous nitrate solution when D.C. current is passed through it. At the cathode nitrate and water are reduced, depending upon the applied potential, and hydrogen ions are removed (or OH^- ions are produced). Equations representing the possible half-reactions are shown below.

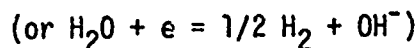
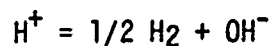
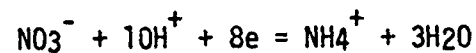
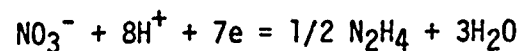
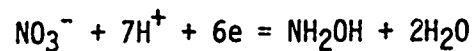
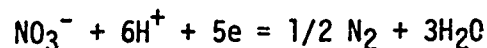
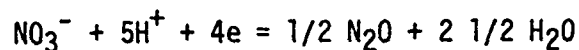
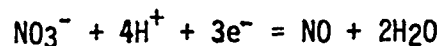
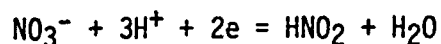
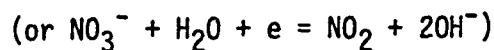
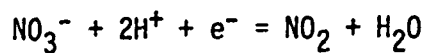

If metal ions, such as Ni^{++} or Cd^{++} , are present that form insoluble hydroxides, they are deposited on the cathode or precipitated in solution as soon as pH of solution becomes sufficiently high.

In other words, the reaction

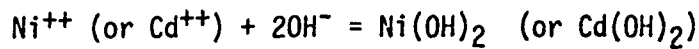

occurs.

At the anode, reactions occurring depend on the composition of the electrode as well as the applied potential. If an inert anode is present, such as platinum, water is oxidized to oxygen and hydrogen ions are generated in solution.* If nickel, cadmium, or other oxidizable metal anodes are used, the anodes are eventually consumed into solution. In summary,

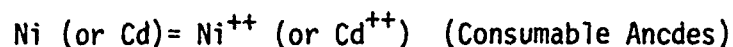
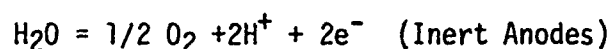

As indicated, the above reactions are reversible. Thus, it is possible to plate nickel or cadmium as metals on the cathode, but this will not occur if the potential is controlled at sufficiently low values.

The above account is a very simplified outline of electrochemical precipitation of metal ions having insoluble hydroxides. If precipitation inside a porous structure with metal ions being replenished from a large reservoir is now considered, even a restrained elucidation can become suddenly complicated. The fact that precipitation must not occur in the bulk or reservoir further complicates the issue. The transport of hydrogen ions and metal ions in and out of the plaque must be considered. Equilibrium of soluble complexes, resulting from presence of cathodically produced ligands, with the metal hydroxide must also be taken into account. In short, a number of variables are present making

* If the potential is sufficiently high, platinum can be oxidized (17).

quantitative description of the process extremely difficult. The complexity becomes even greater if a mixed solvent such as ethanol and water is introduced. Experimentally the process is relatively simple as may be seen in the following account.

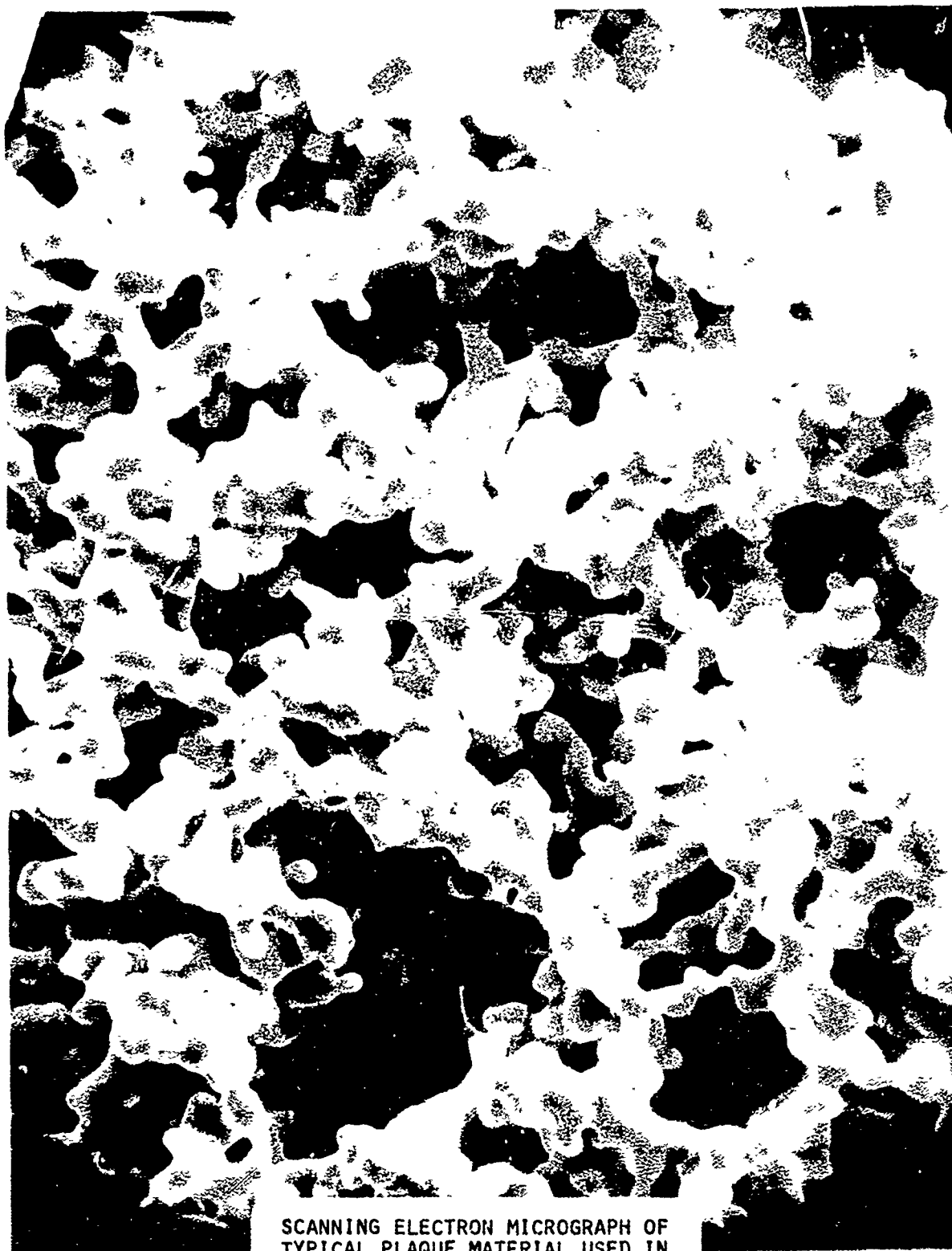

SCANNING ELECTRON MICROGRAPH OF
TYPICAL PLAQUE MATERIAL USED IN
ELECTRODE FABRICATION.

FIGURE 1

EXPERIMENTAL

I. Preparation of Impregnating Solutions

Aqueous Solutions. As specified in the literature an aqueous solution 2.0 molar in nickel nitrate is preferred with a 0.5 - 1.0 molar concentration of sodium nitrite (9). Cobalt nitrate is sometimes present at 0.1 molar (10). In all work reported here, 1.8 molar nickel nitrate and 0.2 molar cobalt nitrate with 0.5 molar sodium nitrite was used.

Alcohol Solutions. In most cases the solvent was 50% by volume denatured alcohol and water. The final solution was again 1.8 molar in nickel nitrate and 0.2 molar in cobalt nitrate. The alcohol content sometimes varied from 20% to 70% by volume. In one instance a 50% water, 30% acetone and 50% methanol solvent was used. In another experiment, 0.5 molar nickel acetate in ethanol solution was investigated.

II. Plaque

Sintered nickel plaque was furnished mainly by Eagle-Picher Industries, Colorado Springs, Colorado, but other manufacturer's plaques were sometimes used. In some cases plaque made in AFAPL's sintering furnace was used. This plaque is made by a dry sinter process using a graphite mold. Type 287 carbonyl nickel powder was used carrying a 200 nickel expanded metal grid. All plaque porosity varied from 78 to 87% as measured by water imbibition. For most of the impregnations on a beaker scale, the plaque was cut to 3" x 3" dimensions coined 0.100 inches on all edges. Thickness was between 0.015 to 0.042 inches. A typical Scanning Electron Micrograph (SEM) of the Eagle-Picher plaque is shown in Figure 1 at 2000x magnification.

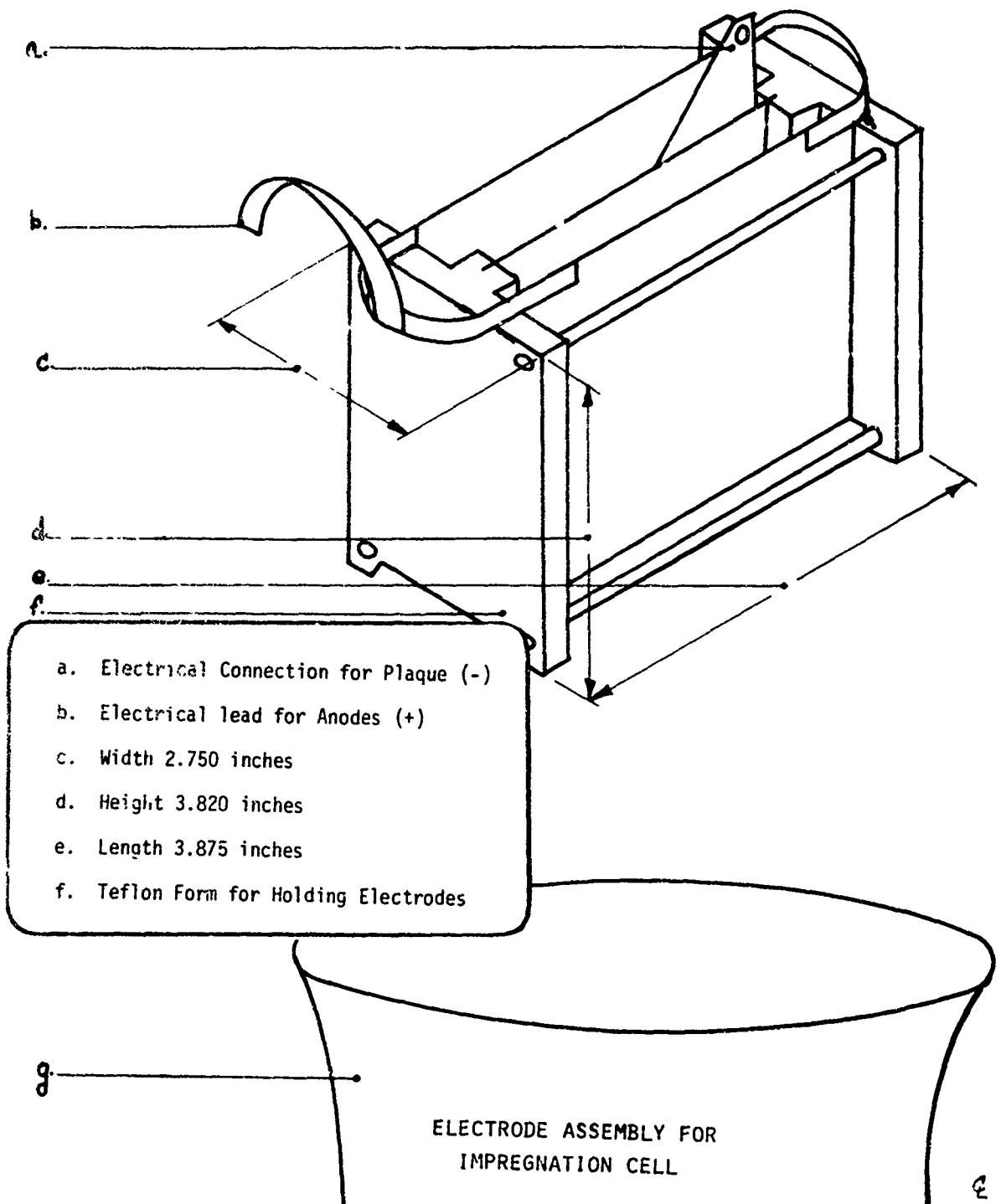

ELECTRODE ASSEMBLY FOR
IMPREGNATION CELL

FIGURE 2

III. Impregnation Cells.

Beaker Level Operations. The cell used in impregnating plaque having 3" x 3" dimensions is shown in Figure 2. The plaque simply serves as cathode with either nickel or platinum plated titanium (inert) anodes on each side. Electrode separation is from 0.50 to 0.75 inches. The form was fabricated from Teflon and could easily fit inside a 1500 ml. beaker. Current was supplied to the cell by a 30 ampere, 50 volt power supply at 2.7 to 9.0 amperes for 1.0 to 2.5 hours. In aqueous solutions temperature varied from 100 to 105°C; ethanol solutions ranged from 70° to 85°C. Solution level was always maintained above edges of the plaque.

Intermediate Scale-up. Multiple 3" x 3" plaque impregnations could be made with the holder shown in Figure 3. A 5 gallon Pyrex bottle with the top cut away was used to contain impregnating solutions. Anodes are connected by Heliarc Welded Strips of Nickel. Inert anodes were not used in this configuration.

IV. Formation-Characterization of Beaker Level Production Plates.

Cell Construction. Generally, three or nine plate cells, positive limited, were fabricated for purposes of forming plates impregnated using electrochemical deposition. Either cadmium electrodes taken from vented aircraft cells out of Air Force stock, or in-house fabricated negatives were used. Fabrication of in-house electrodes will be described in detail in a subsequent report. The process has been described, in general, in two earlier publications (18,19).

In addition to the usual one to three formation cycles given freshly impregnated plates, these positive electrodes (or positive limited cells) were given a number of cycles with considerable overcharge for purposes of roughly evaluating their performance under this condition. The philosophy

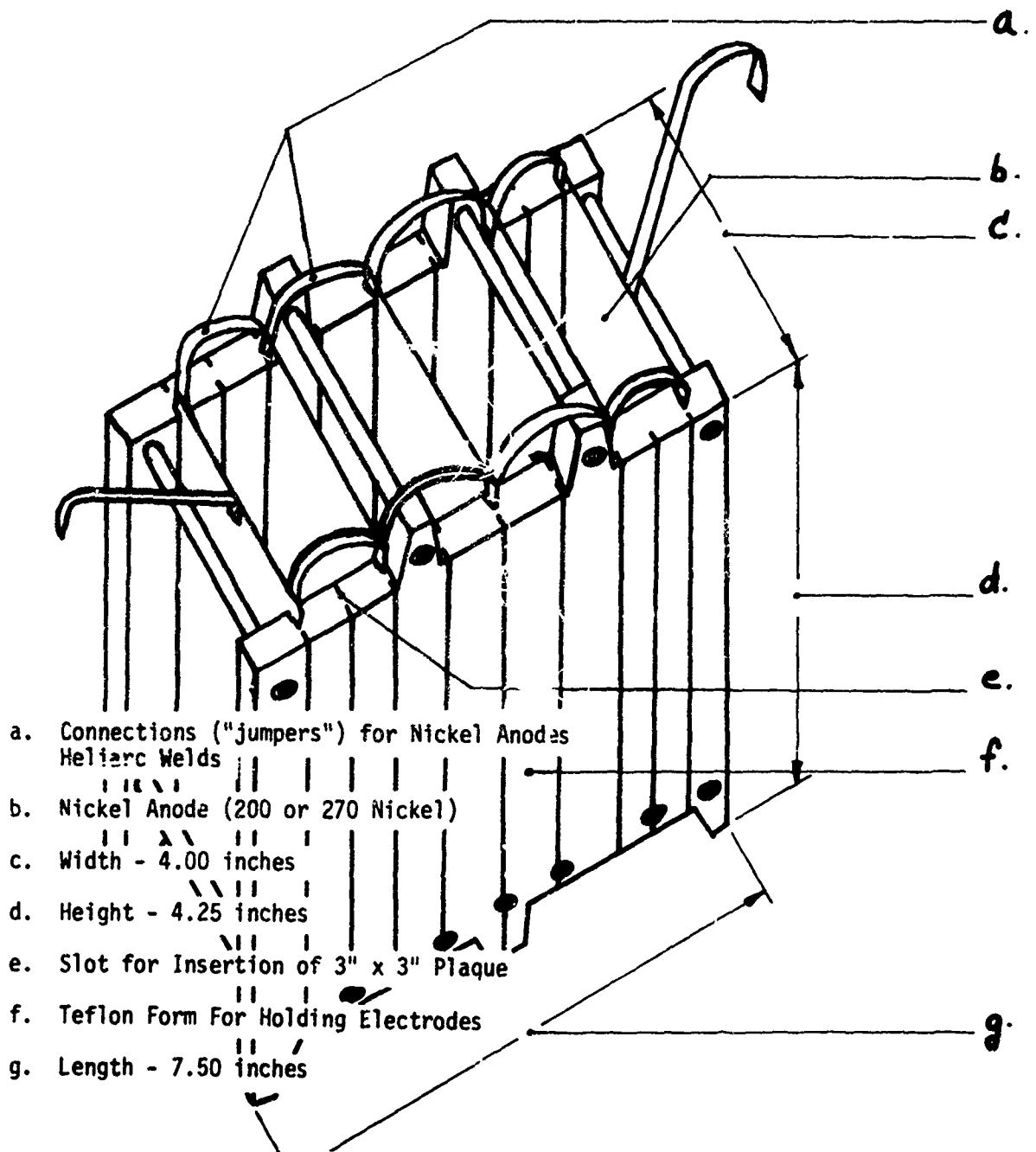

ANNODE ASSEMBLY FOR MULTIPLY
PLAQUE IMPREGNATIONS

FIGURE 3

for this test, along with data, are given in the next section of this report.

The cell was assembled in the simplest manner possible, commensurate with data to be obtained. One wrap of Pellon 2505 non-woven nylon was used for separation. The cell pack was held together with two Plexiglass plates with approximate 4" x 4" x 0.2" dimensions and drawn tight with two 3" x 3/16" stainless steel bolts. The entire assembly was placed in a 1500 ml. beaker containing 30 - 38% aqueous potassium hydroxide.

Charger-Discharge Circuit Design. The circuit used for electrical characterization of freshly impregnated electrodes is diagrammed in Figure 4. The apparatus is simply the positive limited cell that is discharged through a diode load band. Voltage is monitored between the positive plate and a cadmium bar electrode. Charging is carried out with a 30 ampere, 50 volt power supply. Voltages and currents are monitored with freshly calibrated meters.

Cycling Procedure. Charge-discharge cycling using the above apparatus was performed by first charging the cell at its theoretical C rate to 100% overcharge. Discharge was made at the same rate until voltage between the positive plate and cadmium bar electrode reached 0.9. Subsequent charges were made at the measured C rate to 20 - 50% overcharge. Discharge was made at the C rate based on capacity from previous discharge. The above procedure was repeated until a definite decline in capacity was observed. This usually occurred somewhere between 20-30 cycles. Typical voltage-time curves for a cycle are shown in Figure 5.

V. Pilot Plant Construction

An impregnation cell capable of loading twenty-four 2.75"x 4.75" electrodes in a single impregnation is diagrammed in Figures 6 and 7.

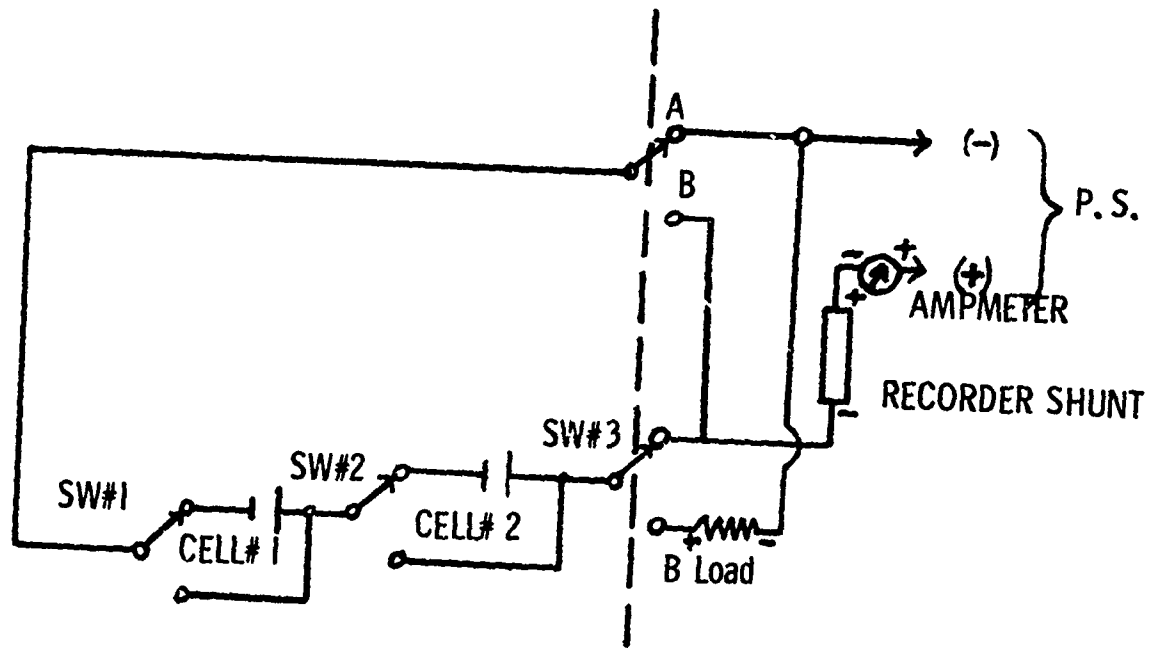

CIRCUIT USED FOR FORMATION CYCLING

FIGURE 4

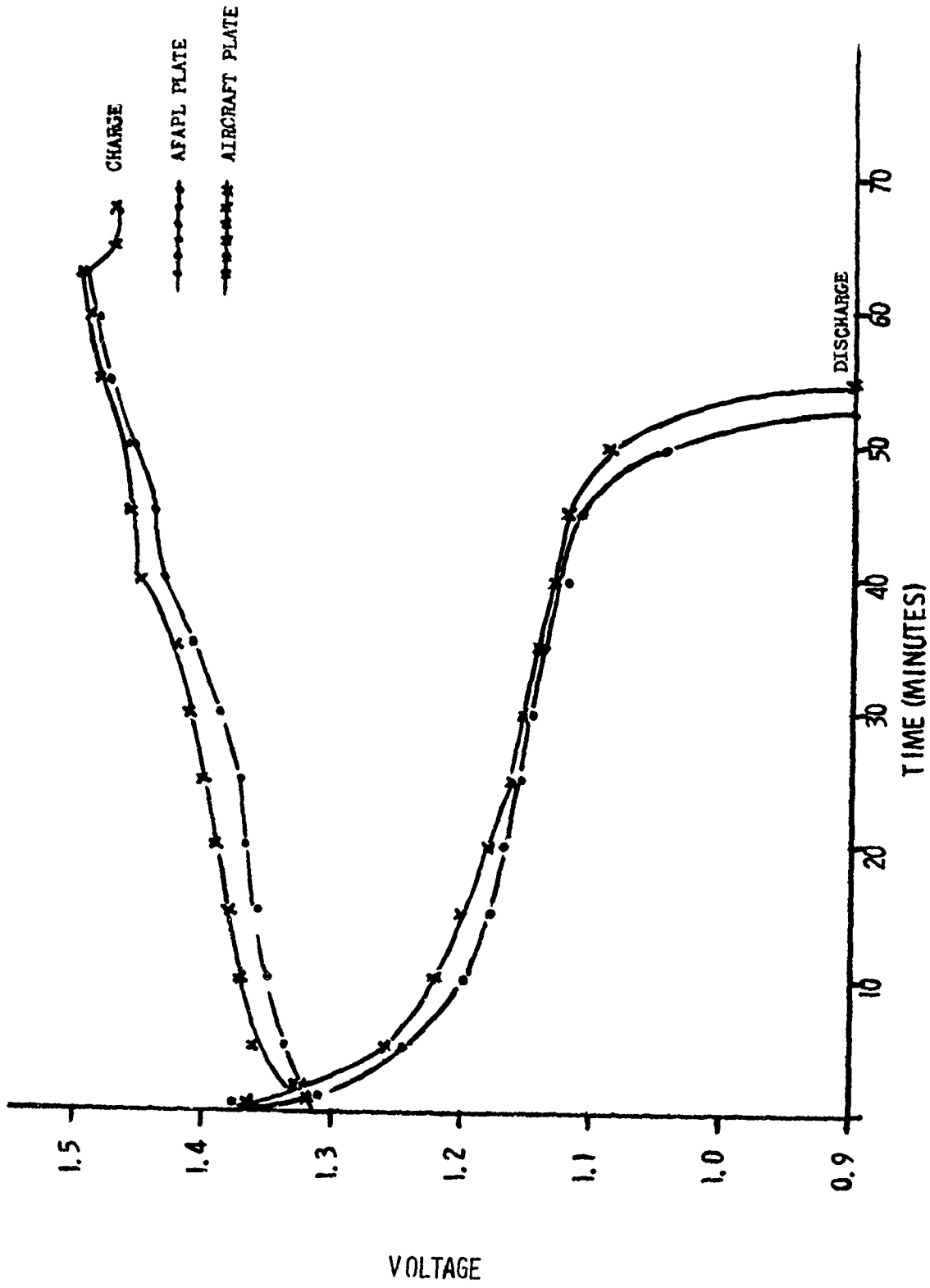

VOLTAGE-TIME CURVES FOR TYPICAL
CHARGE-DISCHARGE CYCLE

FIGURE 5

VOLTAGE

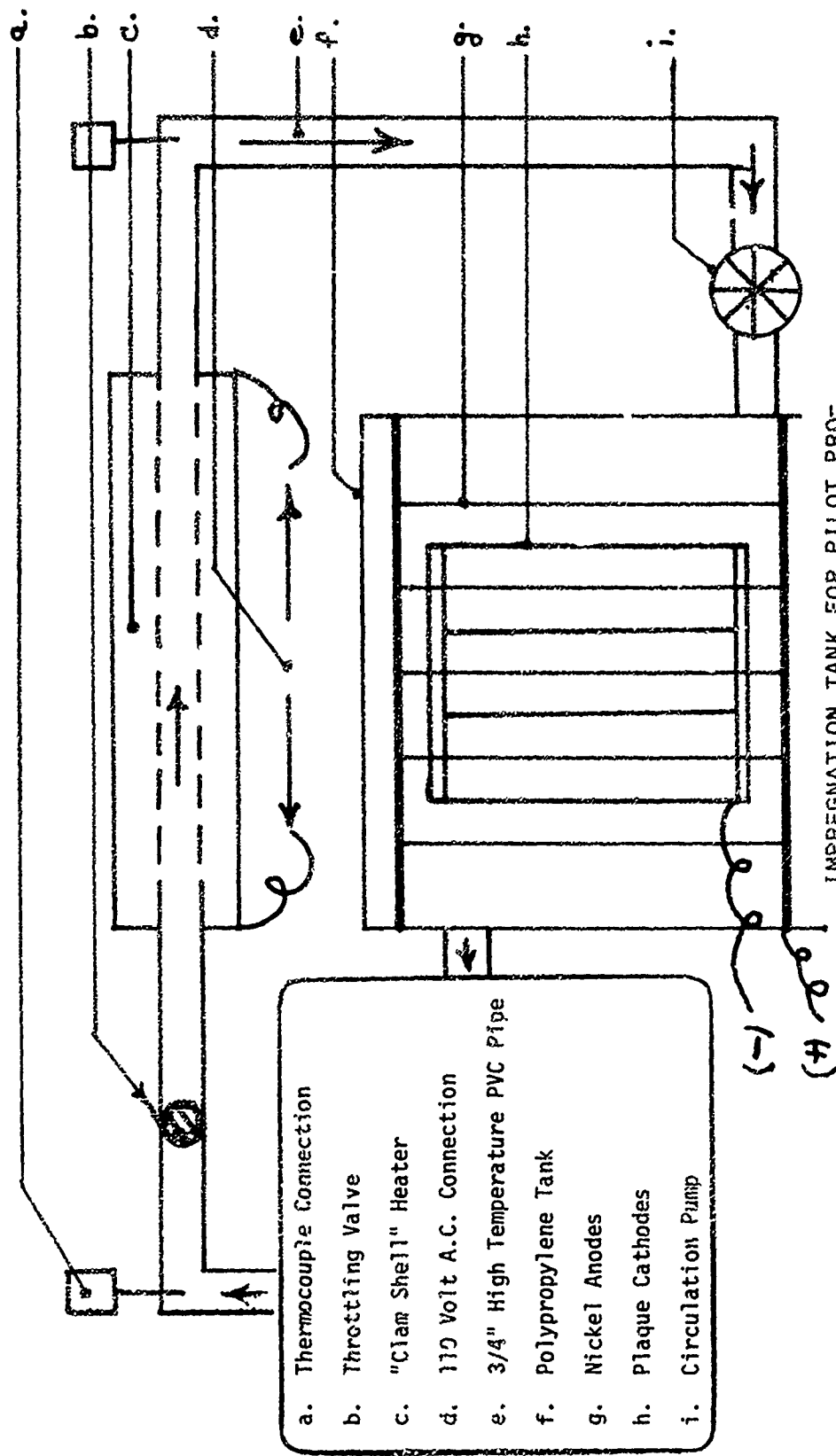

IMPREGNATION TANK FOR PILOT PRODUCTION OF NICKEL-HYDROXIDE ELECTRODES USING ETHANOL SOL. (TOP VIEW)

FIGURE 6

- a. Dimensions 2.0" x 2.0" Across Top
- b. Polypropylene Cover - Condenser
- c. Dimensions - 12" x 12"
- d. 3/4" High Temperature PVC Pipe
- e. Solution Outlet to Heater through PVC Pipe
- f. Solution Level (Maintained at 2.0 inches above Plaque)
- g. Polypropylene Tank. 12.0" x 12.0" x 12.0" Dimensions
- h. Nickel 270 Anodes
- i. Plaque Holders
- j. Solution Inlet to Tank
- k. PVC Pipe Connecting Tank to Circulation Pump.
- l. Dimensions - 1.5" each

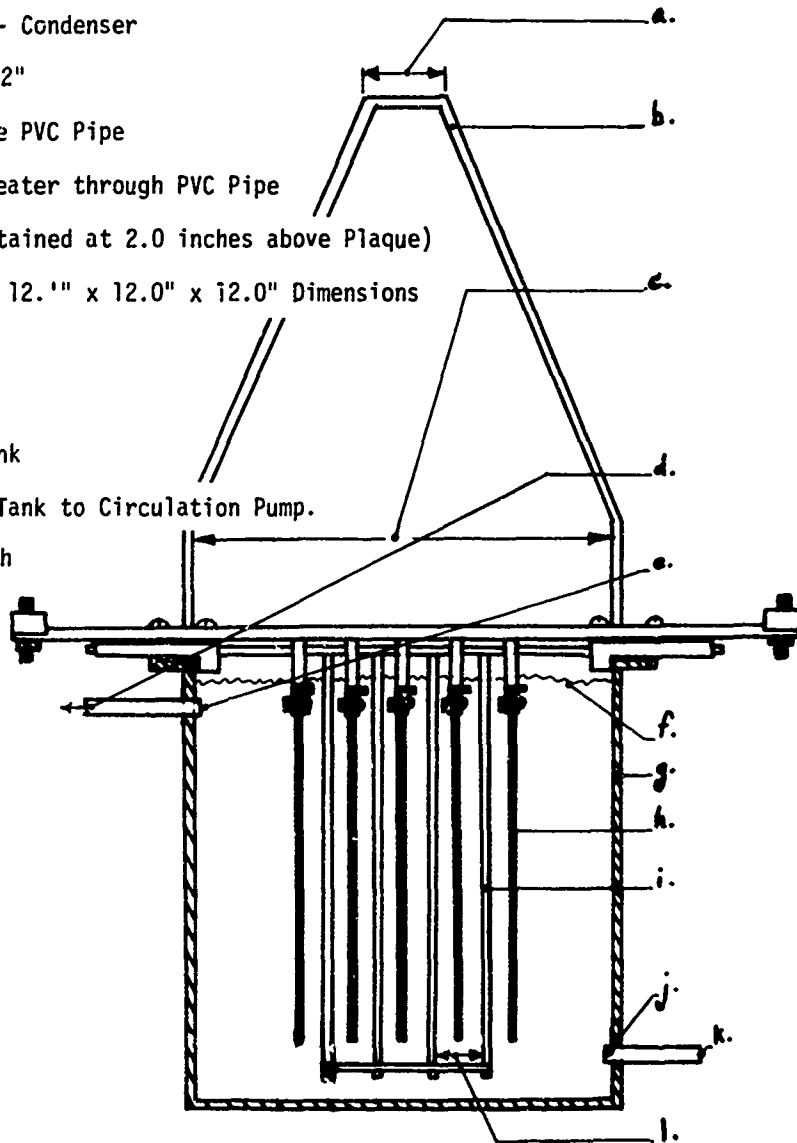

IMPREGNATION TANK FOR PILOT PRO-
DUCTION OF NICKEL-HYDROXIDE
ELECTRODES USING ETHANOL SOLUTION (Side View)
FIGURE 7

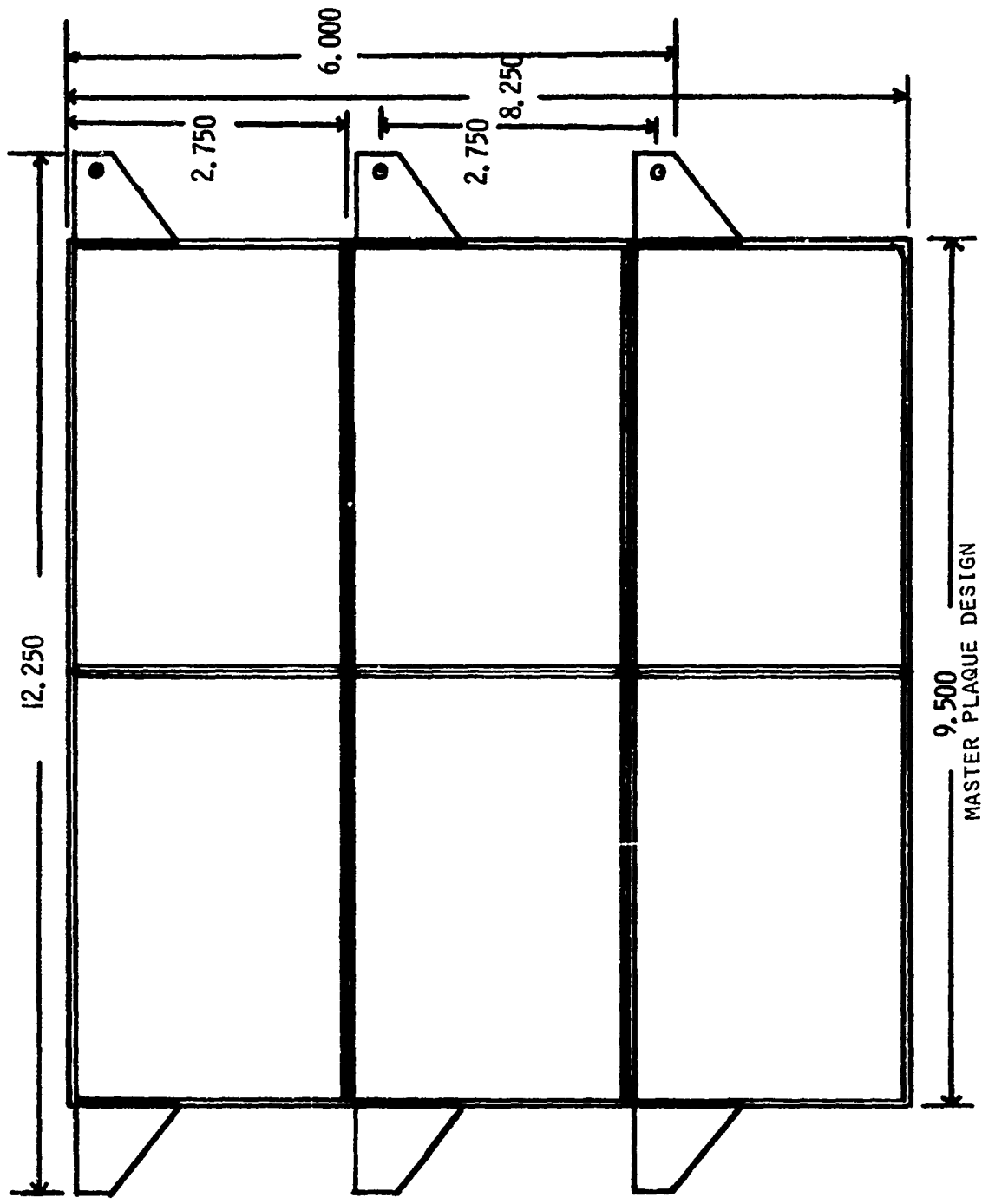

9.500
MASTER PLAQUE DESIGN

FIGURE 8



ASSEMBLY OF ELECTROLYSIS CELL FOR
ELECTROCHEMICAL IMPREGNATION OF
NICKEL PLAQUES

FIGURE 9

The master plaque design is shown in Figure 8. The polypropylene tank has 12" x 12" x 12" dimensions. High temperature PVC pipe and fittings are used to connect the tank to the circulation pump and external heater. Tank and fittings were obtained from the United States Plastic Corporation, Lima, Ohio. Two types of circulation pumps were used. One was a model #94100-2MD supplied by U.S. Plastic Corporation. This pump being plastic was not as sturdy as the other pump used, a model #678E Crane Dynapump, which was stainless steel construction.

The solution heater is made from 304 stainless steel pipe wrapped with asbestos tape then wrapped with 16 A.W.G. nichrome wire for the heating element. A final wrapping with asbestos tape followed by coating with Sauereisen cement is used for covering.

The condenser-cover is made from strips of polypropylene welded together with polypropylene rod.

A photograph of electrode assembly in the cell shown in Figure 9. Details of entire pilot plant assembly are given elsewhere (20).

VI. Pilot Plant Operation

Impregnation. The four master plaques shown in Figure 8 are impregnated using a procedure similar to the one outlined for beaker operations. Heating is performed in this case by means of the Circulatory Heater System (CHS) and immersion heaters. The CHS heats the solution, in a period of a couple of hours, to approximately 75°C (176°F). After removal of immersion heaters, plaques and anodes are added, and the current applied (usually 0.35 amperes per square inch of plaque). The heater is turned off on the CHS at this

point with circulation continuing. The solution maintains its temperature, as heating due to applied current continues. A one inch polystyrene sheet insulates exterior walls of the tank. After one and one-half to two and one-half hours, impregnation is complete. Loadings as a function of impregnation time are about the same as previous reports for similar apparatus based on this design (16). Voltage versus time during impregnation is similar to that reported for impregnation units modeled after this one (16).

Formation. Immediately after impregnation the master plaques and anodes are transferred to 30-40% aqueous potassium hydroxide solution. Usually cathodization of the plaques is repeated in this medium at a current of 0.55 amperes per square inch of plaque for about 20 minutes. Polarity is then reversed using a double pole-double throw knife switch (100 ampere capacity), and plaques are anodized using same current-time conditions. The cathodization-anodization process is repeated one to five times then the plaques are washed in room temperature deionized water, overnight, with good circulation.

Drying is performed in a vacuum oven at 25°C.

Formation of plates in newly assembled cells is repeated under different current-time conditions. Usually first charge is at the C/2 rate with 100% overcharge with discharge at the C rate. A second charge at the C/2 rate using 20% overcharge follows.

Cell Assembly. A "knock down" case used for experimental cell studies with plates from the pilot unit is shown in Figure 10. Usually experimental cells consisted of 14 to 16 positive plates and 15 to 17 negative plates. One layer of 2505 Pellon non-woven

Nylon separation five inches wide with an accordion wrap was used.

VIII. Analysis Methods

Bath Analysis. The impregnating solution used in pilot plant operations was analyzed after each deposition for both metal ion content (Cobalt and Nickel) and volatile component content. Details of exact analysis procedures will be given in a subsequent report.

A general description of procedures used is given below:

a. Metal Ion Analysis. Total metal ion concentration was determined using an E.D.T.A titration (21). Cobalt content was then analyzed using atomic absorption spectrophotometry (AA). Assuming all metal ions to be either cobalt or nickel, nickel concentration was deduced from the difference in the E.D.T.A. titration and AA results.

b. Volatile Component Analysis. Water, Ethanol, and oxidation products of ethanol, such as acetaldehyde, acetic acid, and ethyl acetate, were analyzed using gas chromatography. Prior to analysis, a room temperature distillation of volatile components from metal nitrates is performed.

Plate Analysis Electrodes were analyzed for cobalt content and total active material content on a random basis. AA was used for cobalt analysis after dissolving sections of the plate in 7.5 molar nitric acid. Total weight gain of the plaque after impregnation was assumed to be due to Ni(OH)_2 and Co(OH)_2 . From AA analysis total Co(OH)_2 content was calculated. Ni(OH)_2 content was determined by difference.

Scanning electron microscopy was used to estimate pore size distribution. SEMs of commercial and in-house fabricated electrodes

are shown in the following section of this report.

Surface areas of electrodes were measured using the gas adsorption technique of Brunauer, Emmett, and Teller (22). Values ranged from 2 to 50 square meters per gram.

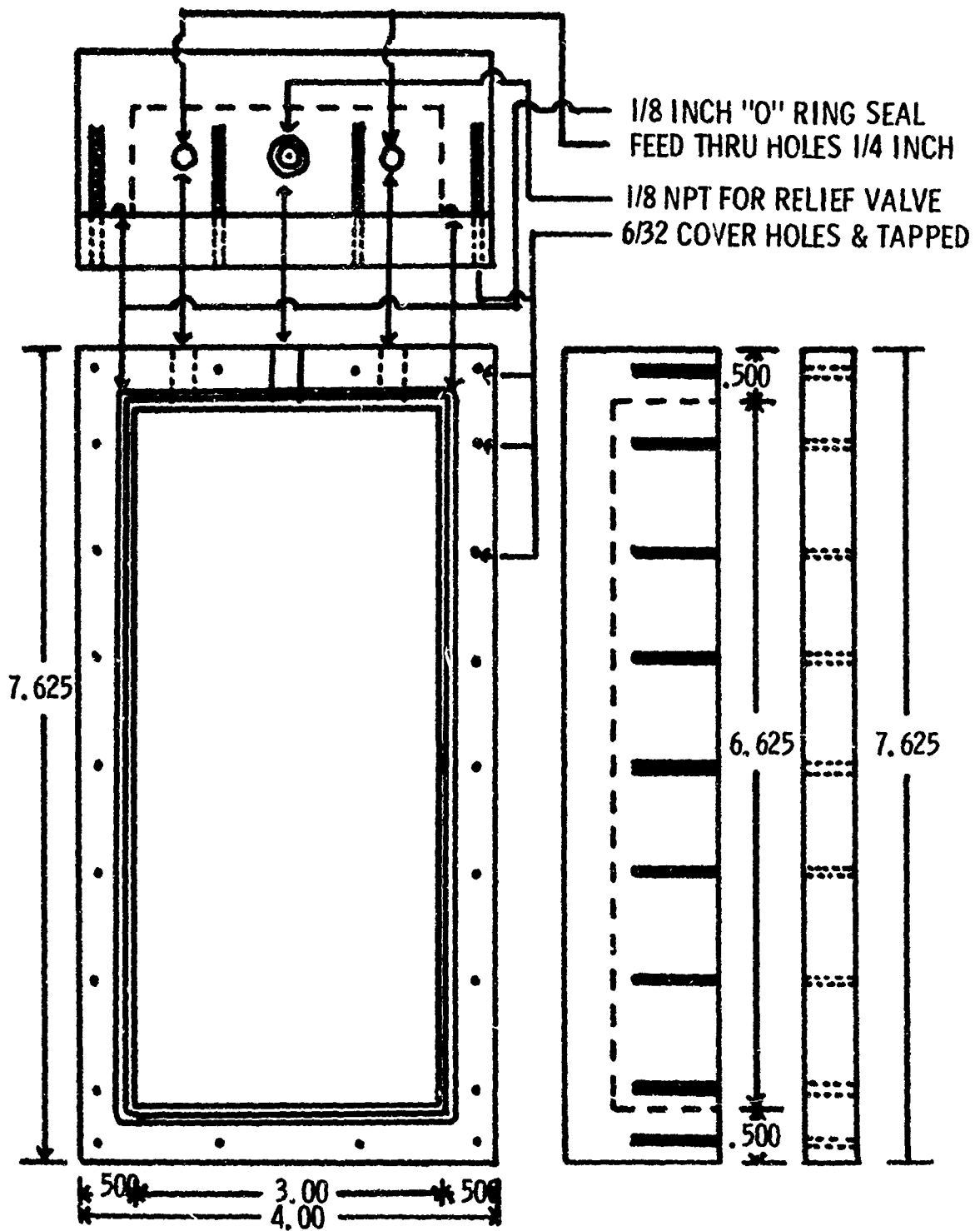

CELL CASE USED FOR EXPERIMENTAL CELL STUDIES

FIGURE 10

DATA AND RESULTS

I. LOADING DATA FROM BEAKER LEVEL OPERATIONS

Aqueous Solutions Loading of plaques from aqueous solutions was performed under three conditions. Results of these depositions are shown in Tables 1, 2 and 3. Two variations were attempted using consumable nickel anodes: (a) with cobalt present as nitrate and (b) without cobalt present. Since cobalt appeared to have an enhancing effect on capacity with increasing cycle life, at moderate amounts of overcharge, all further investigations were attempted only with this additive present. In all solutions pH was initially adjusted to 4.0.

In Table 1, loading data on plaques first impregnated without cobalt are presented. Performance of electrodes during formation cycling is summarized in Table 7 and illustrated in Figure 11. Manufacturer A's plaque was fabricated from 255 carbonyl nickel powder and appeared to load better than manufacturer B's, but as shown in Table 7, utilization of active material was poor.

In Table 2 loading data for various plaque sizes are shown. Cobalt's presence in the impregnating solutions did not appear to affect the loading levels. In thicker plaques loading, on a basis of grams per cubic centimeter of void, appears to be lower than loading in thinner plaques. In fact, in plaques more than 40 mils in thickness, loading above 2.0 grams per cc of void is extremely difficult. Current efficiency is greatly reduced as well as one can see from data in Table 8.

In results obtained in our laboratory, loading of plaques using inert anodes was generally lower than obtained when nickel counter electrodes were used. Table 3 summarizes this data. This by no means should be taken as proof that high loadings cannot be obtained from use of inert

TABLE 1

LOADING CHARACTERISTICS OF NICKEL HYDROXIDE ELECTRODES
IMPREGNATED FROM AQUEOUS SOLUTIONS

(3"x3" plaques coined 0.010" (depth) x 0.100" (width) on all edges. Impregnating solution 2.0 molar in nickel nitrate and 0.5 molar in sodium nitrite. Nickel 200 counter electrodes used.)

Plaque Number	Wt. After Impreg. (grams)	Wt. of Deposit (grams)	Thickness Before (inches)	Plaque* Porosity (percent)	Grams of Deposit per CC of Void	Current Density (Amp/in ²)	Loading Time (Hrs:Min)
1W-30	18.639	8.839	0.0310	80+3	2.59	0.65	1:15
2W-30	17.549	8.346	0.0315	80+3	2.40	0.65	1:15
3W-30	17.504	8.824	0.0300	80+3	2.67	0.65	1:15
4W-30	18.230	8.459	0.0300	80+3	2.58	0.65	1:15
5W-30	18.800	8.872	0.0331	80+3	2.43	0.30	2:30
6W-30	19.315	9.214	0.0332	80+3	2.52	0.30	2:30
7W-30	17.554	9.001	0.0334	80+3	2.44	0.30	2:30
8W-30	18.745	8.859	0.0333	80+3	2.41	0.30	2:30
(30 mil plaque, Manufacturer B)							
9W-30	17.335	7.9849	0.0310	83+1	2.25	0.30	2:30
10W-30	17.194	7.8736	0.0315	83+1	2.22	0.30	2:30
11W-30	17.110	7.8405	0.0310	83+1	2.21	0.30	2:30
12W-30	17.186	7.9115	0.0310	83+1	2.31	0.30	2:30
13W-30	16.398	7.250	0.0300	80+1	2.19	0.30	2:30
14W-30	16.425	7.205	0.0299	80+1	2.19	0.30	2:30
15W-30	16.271	7.173	0.0298	80+1	2.18	0.30	2:30
16W-30	16.200	7.174	0.0305	80+1	2.13	0.30	2:30

* Porosity for Manufacturer A was supplied by vendor.
Porosity for Manufacturer B was measured using water imbibition.

TABLE 2
LOADING CHARACTERISTICS OF NICKEL HYDROXIDE ELECTRODES
IMPREGNATED FROM AQUEOUS SOLUTIONS
WITH COBALT PRESENT

(3"x3" plaques coined 0.010" (depth) x 0.100" (width) on all edges. Impregnating solution 1.8 molar nickel nitrate, 0.2 molar cobalt nitrate, and 0.5 molar sodium nitrite. Nickel 200 counter electrodes used.)

Plaque Number	Wt. After Impreg. (grams)	Wt. of Deposit (grams)	Thickness Before (inches)	Plaque* Porosity (percent)	Grams of Deposit per CC of Void	Current Density (Amp/in ²)	Loading Time (Hrs:Min)
(15 mil plaque, Manufacturer B)							
1W-15	8.202	1.947	0.0160	66+2	1.31	0.50	0:25
2W-15	9.153	3.037	0.0170	66+2	1.96	0.50	0:50
3W-15	9.828	3.766	0.0180	66+2	2.30	0.50	1:15
4W-15	10.693	4.594	0.0170	66+2	2.97	0.50	1:40
(20 mil plaque, Manufacturer B)							
1W-20	13.354	5.466	0.0215	78+2	2.36	0.35	1:45
2W-20	13.202	5.413	0.0218	78+2	2.31	0.35	2:00
(30 mil plaque, Manufacturer A)							
17W-30	17.711	8.337	0.0340	80+3	2.22	0.30	2:30
18W-30	17.754	8.269	0.0340	80+3	2.21	0.30	2:30
19W-30	17.057	8.165	0.0340	80+3	2.18	0.30	2:30
20W-30	17.015	8.206	0.0340	80+3	2.19	0.30	2:30
(40 mil plaque, Manufacturer B)							
1W-40	20.523	9.224	0.0397	85+2	1.98	0.35	1:30
2W-40	21.149	9.901	0.0401	85+2	2.10	0.30	2:00

* Porosity for manufacturer A was supplied by vendor.
Porosity for manufacturer B was measured using water imbibition.

TABLE 3

LOADING CHARACTERISTICS OF NICKEL HYDROXIDE
ELECTRODES IMPREGNATED FROM AQUEOUS SOLUTIONS
USING INERT COUNTER ELECTRODES

(3" X 3" plaques coined 0.010" (depth) X 0.100 (width) on all edges. Impregnating solution 1.8 molar in nickel nitrate, and 0.5 molar in Sodium Nitrite. Platinum plated titanium anodes. Plaque Mfg. B)

Plaque Number	Wt. After Impreg. (gms)	Wt. of Deposit (gms)	Thickness Before (in)	Gms. of Deposit per cc of void	Current Density (A/in ²)	Loading Time (Hrs:min)
(20 mil plaque, porosity 78 ± 2%)						
3W-20	12.3807	5.6395	.0219	2.39	0.50	1:30
4W-20	12.3877	5.5221	.0215	2.39	0.50	1:30
5W-20	12.2465	4.4434	.0220	1.84	0.50	1:30
6W-20	12.2619	4.3061	.0225	1.79	0.50	1:30
7W-20	11.8115	4.0900	.0218	1.74	0.50	1:30
8W-20	12.2440	4.2121	.0225	1.74	0.50	1:30
(30 mil plaque, porosity 85 ± 2%)						
21W-30	14.3260	5.2282	.0300	1.49	0.50	1:30
22W-30	14.6690	5.3672	.0306	1.50	0.50	1:30
23W-30	13.9380	4.5236	.0283	1.36	0.50	1:30
24W-30	14.4686	5.0673	.298	1.45	0.50	1:30
25W-30	15.1516	6.0914	.301	1.73	0.50	1:30
26W-30	15.0542	6.1074	.305	1.71	0.50	1:30
(40 mil plaque, porosity 82 ± 1%)						
3W-40	16.5870	5.3570	.0388	1.22	0.35	2:15
4W-40	17.3900	6.3406	.0367	1.53	0.35	2:15
5W-40	16.0153	4.8691	.0361	1.19	0.35	2:15
6W-40	16.7173	5.5888	.0381	1.30	0.35	2:15
7W-40	16.5791	5.5653	.0376	1.31	0.50	2:00
8W-40	15.2935	3.9973	.0394	0.90	0.50	2:00

anodes. Workers at Bell Telephone Laboratories (9) and Eagle Picher Industries (23) have reported much higher loadings than reported here.

Ethanol Solutions Results of plaque loading from ethanol solutions are displayed in Tables 4 and 5. In this data thickness increases after loading are displayed, but increases are not exceedingly different from those found in aqueous solutions. The reason for displaying them here is to show that higher currents tend to cause a build-up on the outside of the plaque quite readily. Loadings in terms of grams per cc of void are calculated using initial plaque thickness. By using low current densities and long times, one can load a plaque to a reasonably high value without creating a buildup on the outside of the plaque. However, any build-up is easily removed after a few formation cycles. Consistent results with respect to thickening may be obtained if current density, concentration and loading time are closely controlled. For depositions displayed in Table 5 current densities of 0.35 amperes per square inch were used. Additions of other ions to impregnating solutions does not greatly affect the loading as long as they are 0.2 molar or lower.

Other Solutions Impregnation of nickel plaques was attempted using two other impregnating solutions. Both were unsuccessful.

In one instance a 50% acetone - 50% methanol solution made 1.8 molar in nickel-nitrate and 0.2 molar in cobalt nitrate was heated to boiling (Ca., 60°C) and deposition carried out using two different current densities, 0.35 amperes per square inch and 0.50 amperes per square inch. Impregnation time was two and one-half hours. Loadings of 1.0 and 1.7 grams of deposit per cc of void were obtained with a substantial buildup on the surface of the plaque.

Substitution of nickel acetate for nickel nitrate in the ethanol

TABLE 4

LOADING CHARACTERISTICS OF NICKEL HYDROXIDE ELECTRODE
 IMPREGNATED FROM ETHANOL SOLUTIONS
 WITH COBALT PRESENT

(3"x3" plaques coined 0.010" (depth) x 0.100" (width) on all edges. Impregnating solution 1.8 molar nickel nitrate, 0.2 molar cobalt nitrate in 50% ethanol-water by volume. Nickel 200 counter electrodes).

Plaque Number	Wt. After Impreg. (grams)	Wt. of Deposit (grams)	Thickness Before (inches)	Thickness* After (inches)	Grams of Deposit per CC of Void	Current Density (Amp/in ²)	Loading Time (Hrs:Min)
(20 mil plaques) Mfg. B porosity = 78 ± 2% *							
1A-20	12.034	4.188	0.0217	0.0268	5.1 1.80	0.30	1:00
2A-20	13.981	6.120	0.0221	0.0364	14.3 2.58	0.50	1:30
3A-20	12.412	4.408	0.0216	0.0238	4.2 1.93	0.35	1:10
6A-20	13.396	5.380	0.0220	0.0249	2.9 2.27	0.45	1:20
5A-20	13.138	5.256	0.0224	0.0249	2.5 2.18	0.45	1:20
7A-20	11.586	3.751	0.0220	0.0252	3.2 1.59	0.30	1:00
4A-20	12.535	4.701	0.0219	0.0239	2.0 2.00	0.35	1:10
(30 mil plaques) Mfg. B Porosity = 85 ± 2% *							
1A-30	16.052	6.8080	0.0306	0.0372	6.6 1.64	0.35	2:30
2A-30	16.312	7.184	0.0309	0.0319	1.0 1.92	0.35	2:00
3A-30	16.115	7.031	0.0308	0.0319	1.1 1.89	0.35	2:00
4A-30	16.158	6.828	0.0296	0.0307	1.1 1.91	0.35	2:00
5A-30	16.116	6.827	0.0305	0.0320	1.5 1.85	0.35	2:00
6A-30	16.458	7.325	0.0315	0.0315	0.0 1.98	0.35	2:00
(30 mil plaque) Mfg C Porosity = 83.7 % *							
74-30	18.555	8.238	0.0325	0.0339	1.4 2.18	0.35	2:30
82-30	18.427	8.127	0.0327	0.0333	0.6 2.15	0.2	4:33

* Porosities - measured using water imbibition.

TABLE 5
LOADING CHARACTERISTICS OF NICKEL HYDROXIDE ELECTRODES
IMPREGNATED FROM ETHANOL SOLUTIONS WITH
VARIOUS ADDITIVES PRESENT

Plaque Number	Wt. After Impreg. (grams)	Wt. of Deposit (grams)	Thickness Before (inches)	Thickness Increase (mils)	Grams of Deposit per CC of Void	Molarity of Metal Ions in Impreg. Soln.
9A-30	16.733	7.448	0.0306	1.8	2.11	1.8 Ni ⁺⁺ , 0.2 Mn ⁺⁺
10A-30	16.221	7.019	0.0301	1.5	2.03	1.8 Ni ⁺⁺ , 0.1 Mn ⁺⁺ , 0.1 Co ⁺⁺
11A-30	16.294	7.104	0.0313	1.9	1.97	1.8 Ni ⁺⁺ , 0.05 Mn ⁺⁺ , 0.15 Co ⁺⁺
12A-30	16.218	7.124	0.0317	1.3	1.95	1.8 Ni ⁺⁺ , 0.05 Cd ⁺⁺ , 0.15 Co ⁺⁺
13A-30	17.211	8.217	0.0305	4.1	2.15	3.5 Ni ⁺⁺ , 0.2 Co ⁺⁺

impregnation process was not successful at all. In addition to the insolubility (Ca., 0.5 molar at 80°C), electrolysis yielded a metallic deposit on the surface of the plaque, regardless of the current density used.

II. PERFORMANCE OF BEAKER PRODUCTION PLATES

Aqueous Solutions. Performance of electrodes without cobalt additive is summarized in Table 7 and illustrated in Figure 11 with cells 1-4. Table 6 lists electrodes present in each of the cells. Cell 5 has a positive electrode taken from an aircraft cell out of Air Force stock. The aircraft cell which originally contained the electrode had not been cycled. The positive plate in Cell 5 was estimated to have about 5% cobalt hydroxide as part of the active material. Capacities of cells without cobalt additive began to fade after about eight cycles under conditions given. One should also notice from Table 7 that percent utilization of active material was rather poor. The contrast in performance of these plates with those listed in Table 8 is quite remarkable. The type of plaque used for the electrode does affect the performance to some extent, but not near as greatly as presence of cobalt in the active material.

To show effect of loading level on performance various loadings of 15 mil plaques are given in Table 8. As can be seen there is a slight decrease in percent utilization of active material at higher loading levels. There is also a slight thickening of the plaque after 30 or more cycles at higher loadings, but thickening is by no means comparable to that experienced by chemically, vacuum impregnated plates. 15 mil plaque formation cycles are shown in Figure 12.

The 15 mil plaque loading data as a function deposition current efficiency has been presented elsewhere (24).

TABLE 6

LISTING OF POSITIVE PLATES PRESENT IN FORMATION-
CHARACTERIZATION CELLS

CELL NR	PLAQUE NUMBER OF POSITIVE PLATES PRESENT IN CELL
1	1W-30, 2W-30, 3W-30, 4W-30
2	5W-30, 6W-30, 7W-30, 8W-30
3	9W-30, 10W-30, 11W-30, 12W-30
4	13W-30, 14W-30, 15W-30, 16W-30
5	34 A-H Aircraft Cell Electrode
6	1W-15
7	2W-15
8	3W-15
9	4W-15
10	1W-20
11	2W-20
12	18W-30, 19W-30, 20W-30, 21W-30
13	Same as Cell Nr 5
14	1W-40
15	2W-40
16	3W-20, 4W-20, 5W-20, 6W-20, 7W-20, 8W-20
17	22W-30, 23W-30, 24W-30, 25W-30, 26W-30, 27W-30
18	3W-40, 4W-40, 5W-40, 6W-40, 7W-40, 8W-40
19	Same As Cell Nr 5
20	4A-20
21	1A-30
22	2A-30, 3A-30, 4A-30, 5A-30
23	6A-30
24	Same As Cell Nr 5
25	7A-30
26	8A-30
27	Same As Cell Nr 5
28	9A-30
29	10A-30
30	11A-30
31	12A-30
32	13A-30

TABLE 7
 PERFORMANCE OF NICKEL HYDROXIDE ELECTRODES
 IMPREGNATED FROM AQUEOUS SOLUTIONS

Plaque Nr	Theo ¹ Capacity (Amp-Hrs)	Measured ² Capacity (Amp-Hrs)	% Util. ³ of Active Material	A-H ⁴ Per In ³	A-H ⁵ Per Lb.	Thickness ⁶ Gain (in x 10 ³)	Nr of Cycles
(30 mil plaque, Manufacturer A)							
1W-30	2.554	1.175	46.0	3.78	28.6	6.0	9
2W-30	2.412	1.175	48.7	3.99	30.4	4.5	9
3W-30	2.550	1.175	46.1	4.23	30.5	4.0	9
4W-30	2.445	1.175	48.1	4.23	29.3	3.0	9
5W-30	2.564	1.602	62.5	4.37	38.7	10.5	17
6W-30	2.663	1.602	60.2	4.79	37.7	6.6	17
7W-30	2.601	1.602	61.6	4.95	41.4	5.1	17
8W-30	2.560	1.602	62.6	4.70	38.8	7.2	17
(30 mil plaque, Manufacturer B)							
9W-30	2.308	1.625	70.4	5.22	42.6	6.0	11
10W-30	2.275	1.625	71.4	5.68	42.9	2.5	11
11W-30	2.266	1.625	71.7	5.37	43.1	5.0	11
12W-30	2.286	1.625	71.1	5.08	42.9	8.0	11
13W-30	2.096	1.610	76.8	5.33	44.6	6.0	12
14W-30	2.082	1.610	77.3	5.65	44.5	4.1	12
15W-30	2.073	1.610	77.6	5.68	44.9	3.2	12
16W-30	2.073	1.610	77.6	5.32	45.1	5.5	12

- 1 - Value given assumes weight gain of plaque is due to Ni(OH)₂. 0.289 ampere-hours per gram of deposit is assumed.
- 2 - Capacity measured to 0.9 volt cut off against a cd bar electrode. Value given is 1/4th capacity of a flooded 9 plate NiCd cell.
- 3 - Value calculated as ratio of measured to theoretical capacity x 100.
- 4 - Coined area of plaque neglected in calculation.
- 5 - A-H per lb of electrode weight prior to charge-discharge cycling is used.
- 6 - Increase is difference between original plaque thickness and plate thickness after indicated Number of Cycles.

FORMATION CYCLES FOR NICKEL HYDROXIDE ELECTRODES
IMPREGNATED FROM AQUEOUS SOLUTIONS ELECTRO-
CHEMICALLY (C CHARGE, C DISCHARGE, 20% OVER-
CHARGE, CONSUMABLE ANODES, NO COBALT)

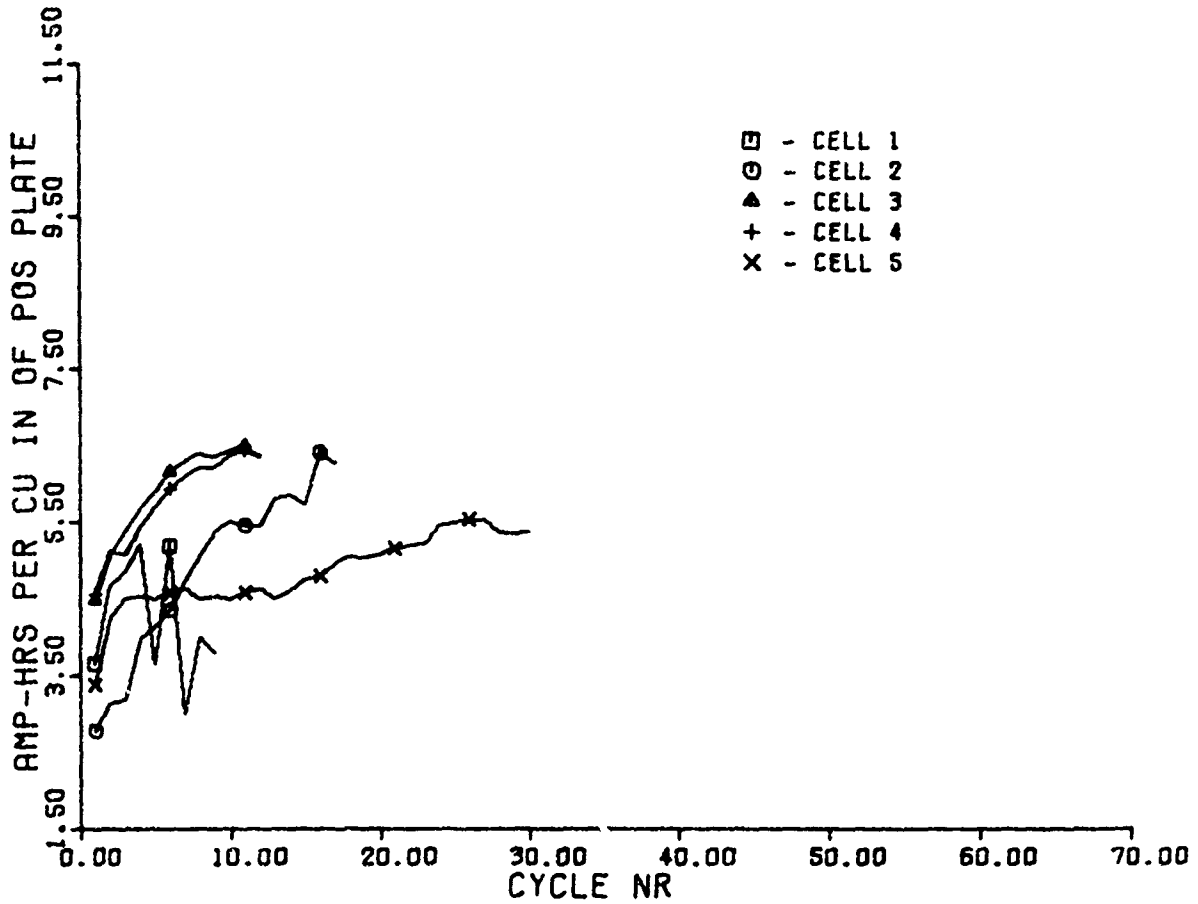

FIGURE 11

TABLE 8
 PERFORMANCE OF NICKEL HYDROXIDE ELECTRODES
 IMPREGNATED FROM AQUEOUS SOLUTIONS
 WITH COBALT PRESENT

Plaque Nr	Theo. ¹ Capacity (A-H)	Measured ² Capacity (A-H)	% Utilization ³ of Active Material	A-H ⁴ Per In. ³	A-H ⁵ Per Lb.	Thickness Gain (Mils)	Nr of Cycles
(15 mil plaque, Manufacturer B)							
1W-15	0.563	0.681	121.0	4.71	37.7	1.2	35
2W-15	0.878	1.088	123.9	6.99	54.0	1.5	35
3W-15	1.088	1.346	123.7	8.08	62.2	1.8	33
4W-15	1.328	1.525	114.8	9.55	64.7	2.0	38
(20 mil plaque, Manufacturer B)							
1W-20	1.580	1.829	115.8	8.98	62.2	2.7	32
2W-20	1.564	1.879	120.1	9.19	64.6	2.5	32
(30 mil plaque, Manufacturer A)							
18W-30	2.409	2.545	105.6	6.74	65.2	10.9	19
19W-30	2.390	2.545	106.5	7.23	65.1	7.8	19
20W-30	2.360	2.545	107.8	7.58	67.7	5.9	19
21W-30	2.371	2.545	107.3	6.91	67.9	19.8	19
(40 mil plaque, Manufacturer B)							
1W-40	2.666	2.834	106.3	7.69	62.5	4.1	33
2W-40	2.861	3.046	106.5	8.17	65.4	4.2	33

1 - Value given assumes weight gain of plaque is due to Ni(OH)₂ and Co(OH)₂ and Co(OH)₂ is active material.

2 - Capacity taken to 0.9 volt cut off.

3 - Value assuming both Ni(OH)₂ and Co(OH)₂ are active material, and a one electron change occurs during discharge.

4 - Value measured neglects coined area. Thickness values used in volume calculation were measured after cycles given in last column.

5 - Electrode weight prior to charge-discharge cycling is used.

FORMATION CYCLES FOR NICKEL HYDROXIDE ELECTRODES
 IMPREGNATED FROM AQUEOUS SOLUTIONS ELECTRO-
 CHEMICALLY (C CHARGE. C DISCHARGE. 20% OVER-
 CHARGE. 10% OF ACTIVE MATL. COBALT HYDROXIDE)
 ELECTRODE THICKNESS = 0.015'-0.020'

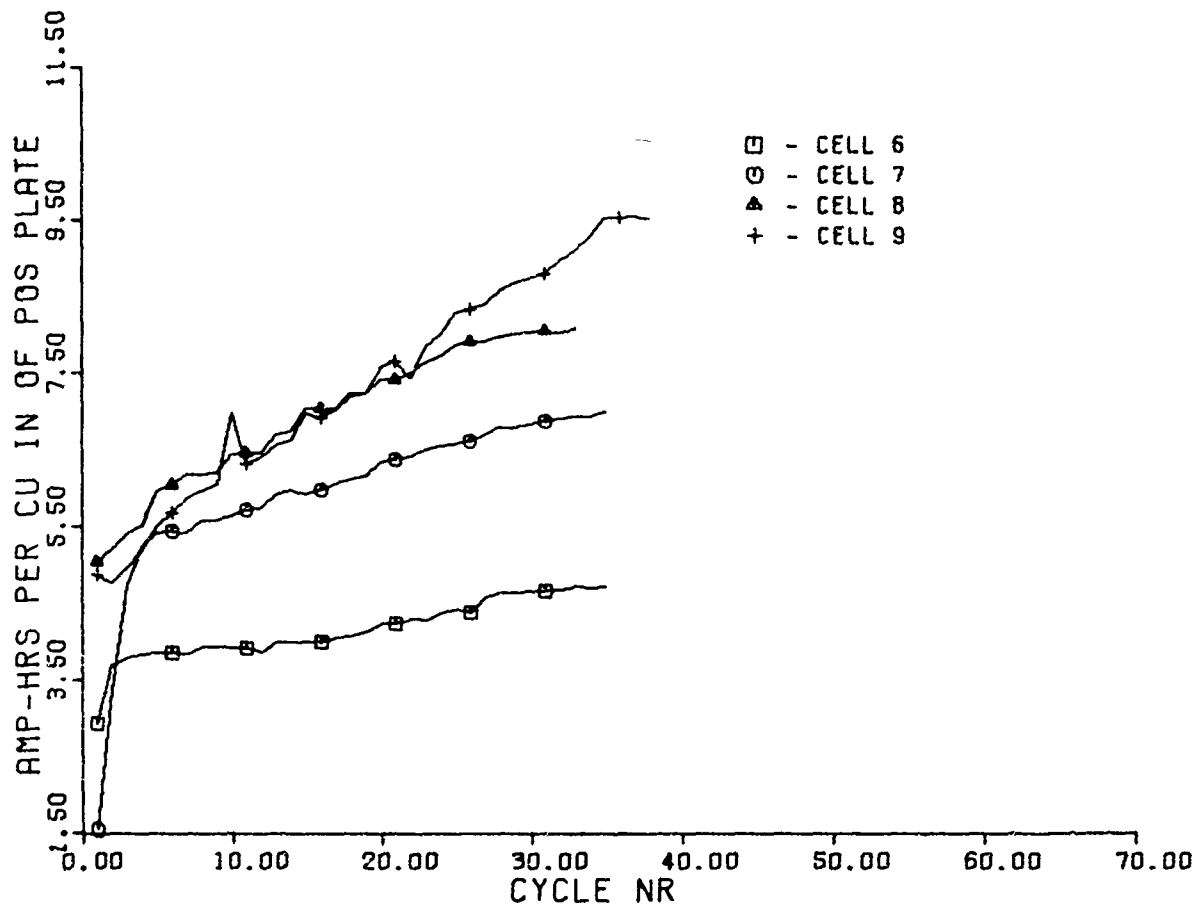

FIGURE 12

FORMATION CYCLES FOR NICKEL HYDROXIDE ELECTRODES
IMPREGNATED FROM AQUEOUS SOLUTIONS ELECTRO-
CHEMICALLY (C CHARGE. C DISCHARGE. 20% OVER-
CHARGE. 10% OF ACTIVE MATL. COBALT HYDROXIDE)
ELECTRODE THICKNESS = 0.020'-0.030'

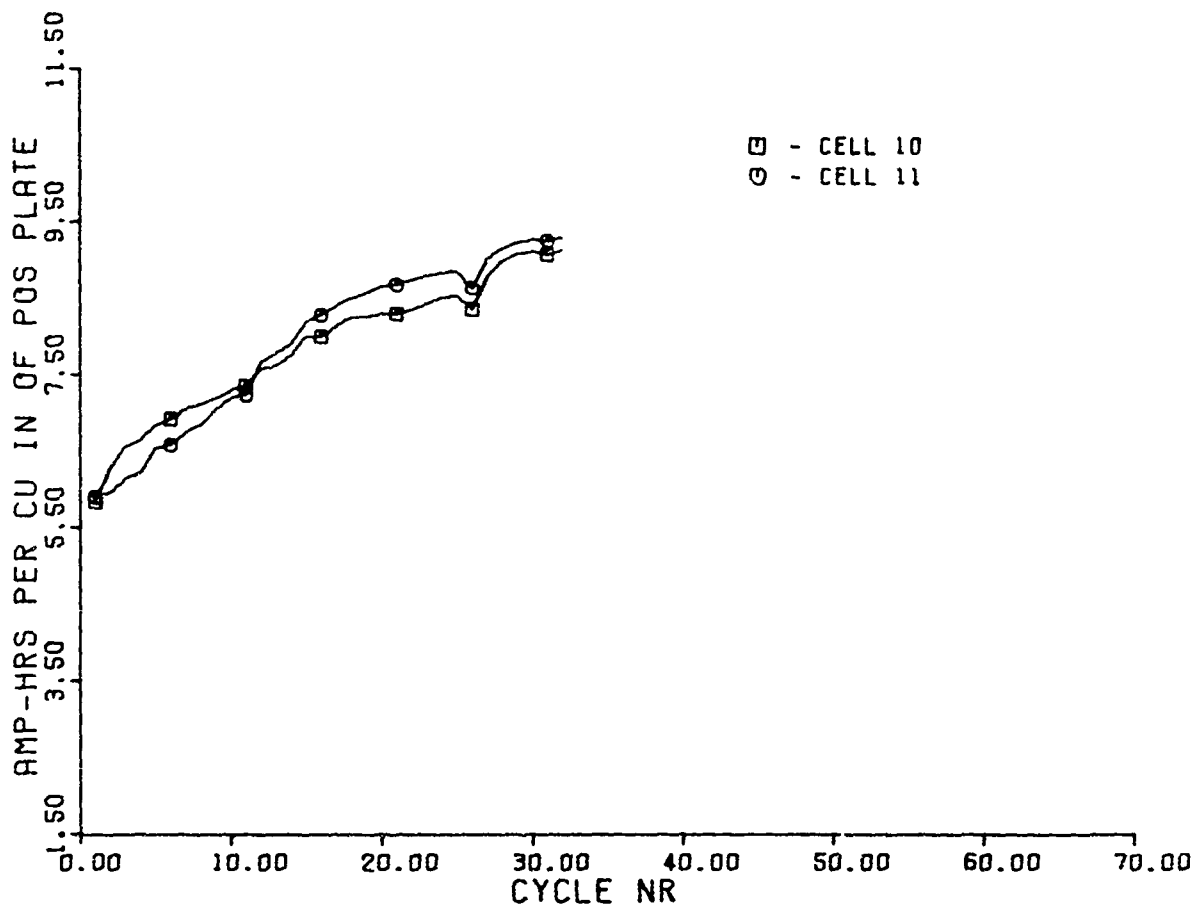

FIGURE 13

FORMATION CYCLES FOR NICKEL HYDROXIDE ELECTRODES
IMPREGNATED FROM AQUEOUS SOLUTIONS ELECTRO-
CHEMICALLY (C CHARGE, C DISCHARGE, 20% OVER-
CHARGE, 10% OF ACTIVE MATL. COBALT HYDROXIDE)
ELECTRODE THICKNESS = 0.030-0.040''

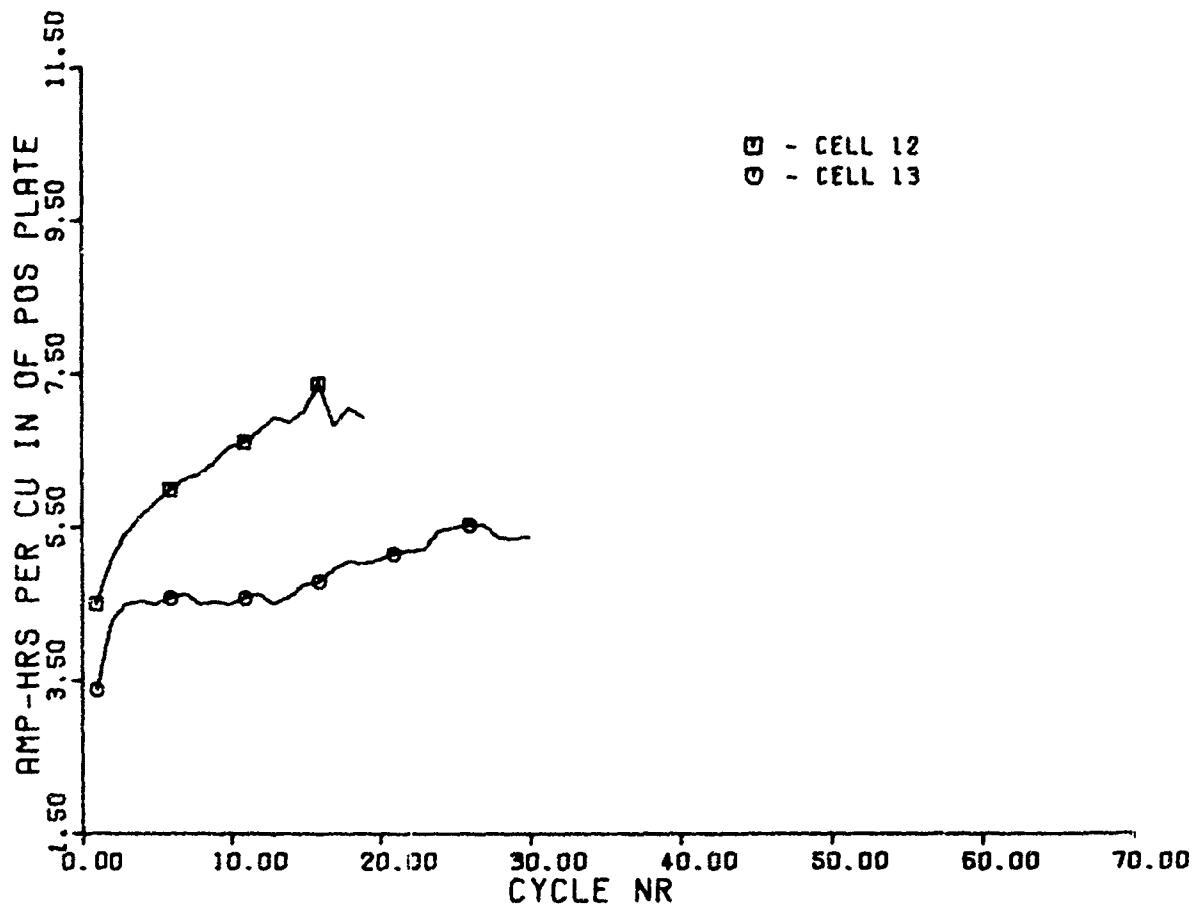

FIGURE 14

FORMATION CYCLES FOR NICKEL HYDROXIDE ELECTRODES
IMPREGNATED FROM AQUEOUS SOLUTIONS ELECTRO-
CHEMICALLY (C CHARGE. C DISCHARGE. 20% OVER-
CHARGE. 10% OF ACTIVE MATL. COBALT HYDROXIDE)
ELECTRODE THICKNESS = 0.040-0.050''

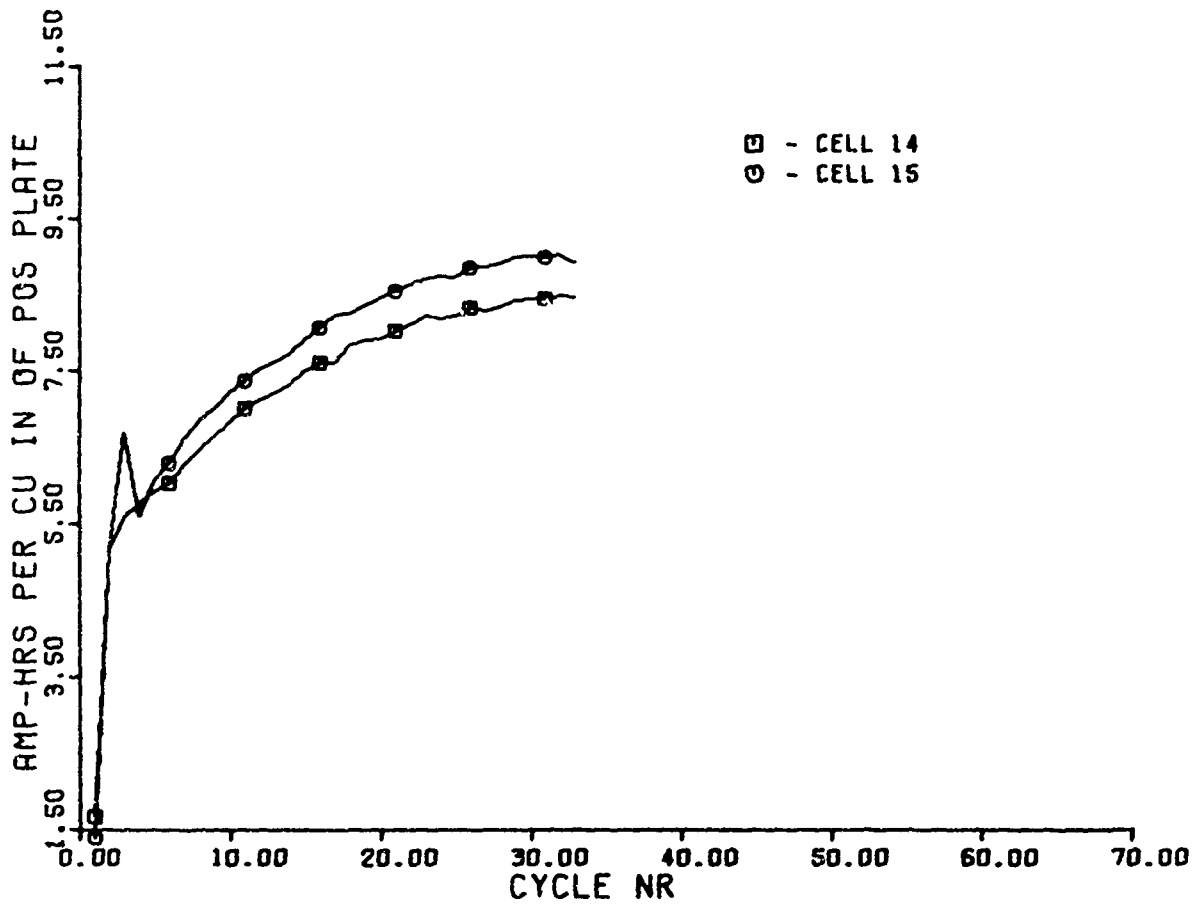

FIGURE 15

CHARGING EFFICIENCY VERSUS STATE
OF CHARGE FOR NICKEL HYDROXIDE ELECTRODES
IMPREGNATED FROM AQUEOUS SOLUTIONS
ON A BEAKER PRODUCTION LEVEL

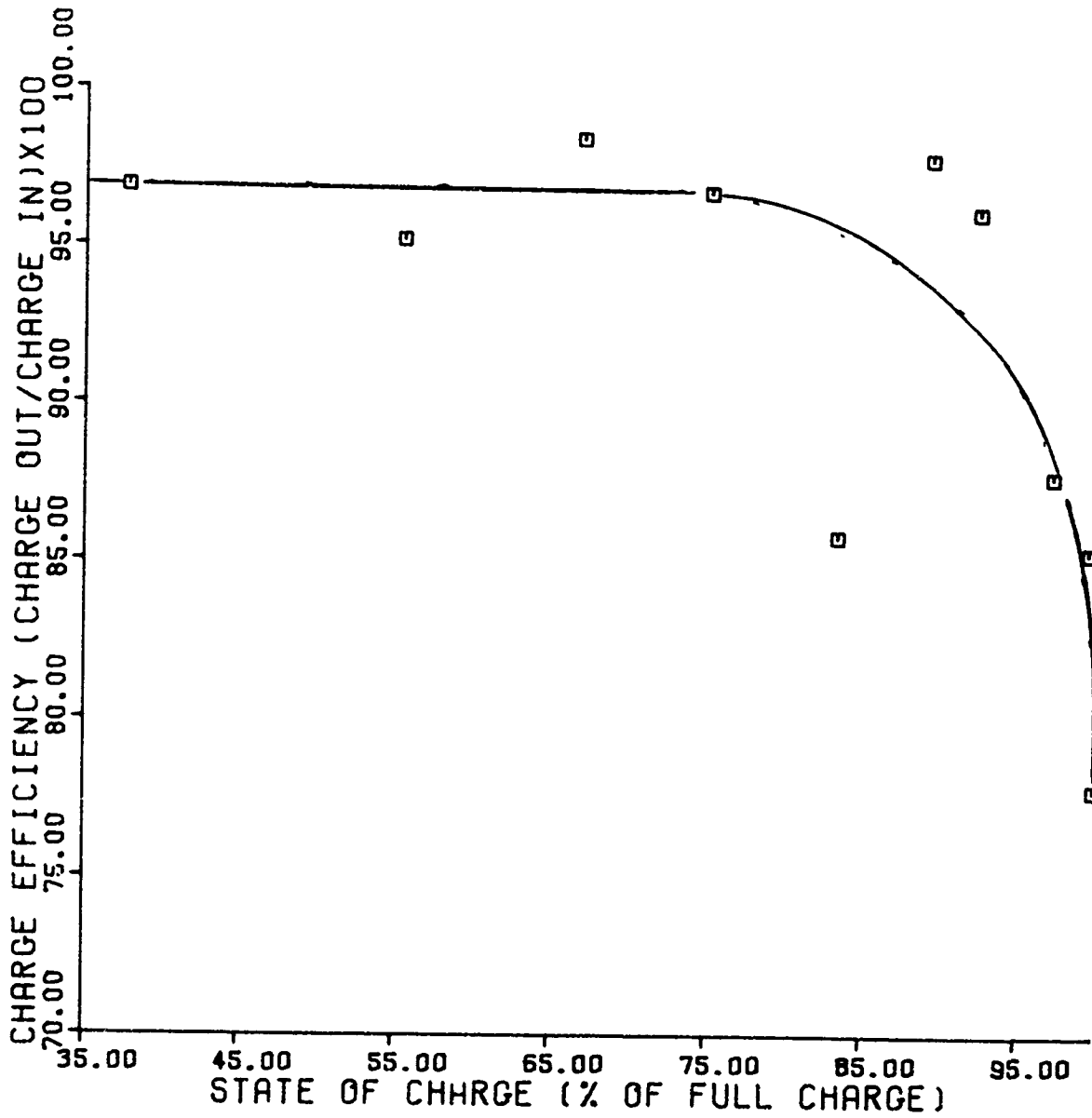

FIGURE 16

TABLE 9
 PERFORMANCE OF NICKEL HYDROXIDE ELECTRODES
 IMPREGNATED FROM AQUEOUS MEDIA
 (COBALT PRESENT, INERT COUNTER ELECTRODES)

Plaque Number	Theo ¹ Capacity (Amp-Hrs)	Measured ² Capacity (Amp-Hrs)	% Util. ³ of Active Material	A-H ⁴ Per In ³	A-H ⁵ Per Lb	Thickness ⁶ Gain (Mils)	# Cycles
(20 mil plaque)							
3W-20	1.630	1.512	92.8	5.27	55.4	12.2	36
4W-20	1.596	1.512	94.7	5.89	55.4	9.0	36
5W-20	1.284	1.512	117.8	5.88	56.1	8.6	36
6W-20	1.244	1.512	121.5	6.26	56.0	6.2	36
7W-20	1.182	1.512	127.9	6.23	58.1	6.6	36
8W-20	1.217	1.512	124.2	6.42	56.1	5.5	36
(30 mil plaque)							
22W-30	1.511	1.170	77.4	4.49	37.1	1.0	36
23W-30	1.511	1.170	77.4	4.49	37.1	1.0	36
24W-30	1.307	1.170	89.5	4.64	38.1	1.8	36
25W-30	1.464	1.170	61.1	4.65	36.7	0.1	36
26W-30	1.760	1.170	66.5	4.12	35.1	3.7	36
27W-30	1.765	1.170	66.2	4.25	35.3	2.2	36
(40 mil plaque)							
3W-40	1.553	1.355	87.3	3.66	37.1	1.2	36
4W-40	1.832	1.355	74.0	3.38	35.4	10.9	36
5W-40	1.407	1.355	96.3	3.81	38.4	6.2	36
6W-40	1.615	1.355	82.9	3.32	36.8	10.4	36
7W-40	1.634	1.355	82.9	3.58	37.1	7.4	36
8W-40	1.155	1.355	117.3	4.01	40.2	7.0	36

1, 2, 3, 4, 5, 6 - See Footnotes on Table 7

FORMATION CYCLES FOR NICKEL HYDROXIDE ELECTRODES
 IMPREGNATED FROM AQUEOUS SOLUTIONS ELECTRO-
 CHEMICALLY (C CHARGE, C DISCHARGE, 20% OVER-
 CHARGE, INERT ANODES, 10% COBALT HYDROXIDE)
 ELECTRODE THICKNESS = 0.020-0.050''

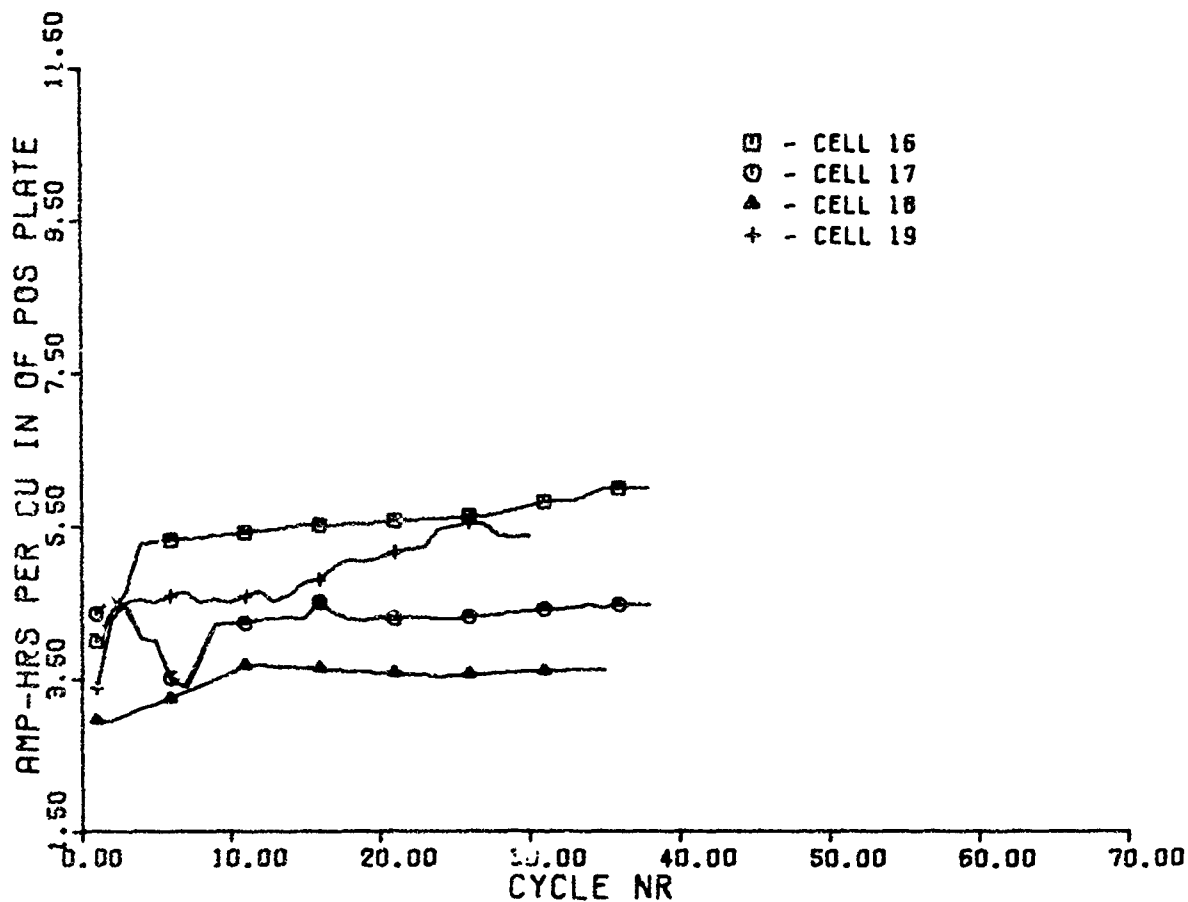

FIGURE 17

Formation cycles for 20 mil plaque in Table 8 are shown in Figure 13. Capacity data for electrodes made from this material is similar to electrodes made from 15 mil plaque. Formation data is plotted in Figure 14 along with vacuum impregnated plate data for comparison. Percent utilization values are about the same as those for electrodes made from manufacturer B's plaque.

Performance of electrodes impregnated under conditions where inert anodes were used is summarized in Table 9. Results are shown somewhat erratic. For this reason further investigation of this process was not attempted. Better electrodes are reported to result from impregnating solutions having lower pH and from plaque having a more closely controlled porosity (25,26). Formation cycles for these electrodes are shown in Figure 17 along with a vacuum impregnated electrode.

Charge acceptance versus state of charge for 30 mil electrodes, whose performance is summarized in Table 8, is plotted in Figure 16. Other electrodes considered here behave similarly.

Ethanol Solutions Performance of electrodes resulting from impregnation in an alcoholic medium is summarized in Table 10. Results here are not drastically different than those obtained from electrodes impregnated from aqueous media where nickel counter electrodes were used. Results are much better than obtained where inert counter electrodes were used in the impregnation. There is quite a difference in performance of electrodes made from ethanol media and aqueous media upon scale up to pilot production. Substantially better performance was obtained from ethanol impregnated electrodes in this case. The apparent reason for the improvement was due to addition of slight amounts of nitric acid in regeneration of solution for subsequent impregnations. No "pH" or acidity control was exercised in loading the electrodes, whose performance results are given in Table 10.

TABLE 10
 PERFORMANCE OF NICKEL HYDROXIDE ELECTRODES
 IMPREGNATED FROM ETHANOL SOLUTIONS
 USING ONLY COBALT ADDITIVE

Plaque Nr	Theo. ¹ Capacity (A-H)	Measured ² Capacity (A-H)	% Util. ³ of Active Material	A-H ⁴ Per In ³	A-H ⁵ Per Lb.	Thickness ⁶ Gain (Mils)	Nr of Cycles	% Co(OH) ₂ in Active Material
(20 mil plaques, Mfg. B, Porosity = 72 ± 2%)								
4A-20	1.359	1.520	112	7.28	55.1	2.0	37	
(30 mil plaques, Mfg. B, Porosity = 85 ± 2%)								
1A-30	1.968	2.208	112	8.19	62.4	1.7	32	11.28
2A-30	2.076	2.113	102	7.76	58.8	2.6	30	13.17
3A-30	2.031	2.113	104	7.78	59.5	2.5	30	-
4A-30	1.973	2.113	107	8.11	59.4	2.1	30	13.40
5A-30	1.973	2.113	107	8.17	59.5	1.1	30	13.56
6A-30	2.117	2.387	113	8.70	65.8	1.0	37	-
(30 mil plaques, Mfg. C, Porosity = 83.7%)								
7A-30	2.381	2.090	87.8	7.10	51.1	1.4	27	-
8A-30	2.341	2.479	106	8.57	61.1	0.6	26	-

1 - Value given assumes weight gain of plaque is due to Ni(OH)₂ and Co(OH)₂ and Co(OH)₂ is active material.

2 - Capacity taken to 0.9 volt cut off against a Cd bar electrode.

3 - Value assuming both Ni(OH)₂ and Co(OH)₂ are active materials and a one electron change occurs during discharge.

4 - Value measured neglects coined area. Thickness used in volume calculation was measured after cycles given in last column.

5 - Electrode weight prior to charge-discharge cycling is used.

6 - Increase is difference between original plaque thickness and thickness after number of cycles indicated.

FORMATION CYCLES FOR NICKEL HYDROXIDE ELECTRODES
 IMPREGNATED FROM ETHANOL SOLUTIONS ELECTRO-
 CHEMICALLY (C CHARGE, C DISCHARGE, 20% OVER-
 CHARGE, 10% OF ACTIVE MATL. COBALT HYDROXIDE)
 ELECTRODE THICKNESS = 0.020'-0.040'

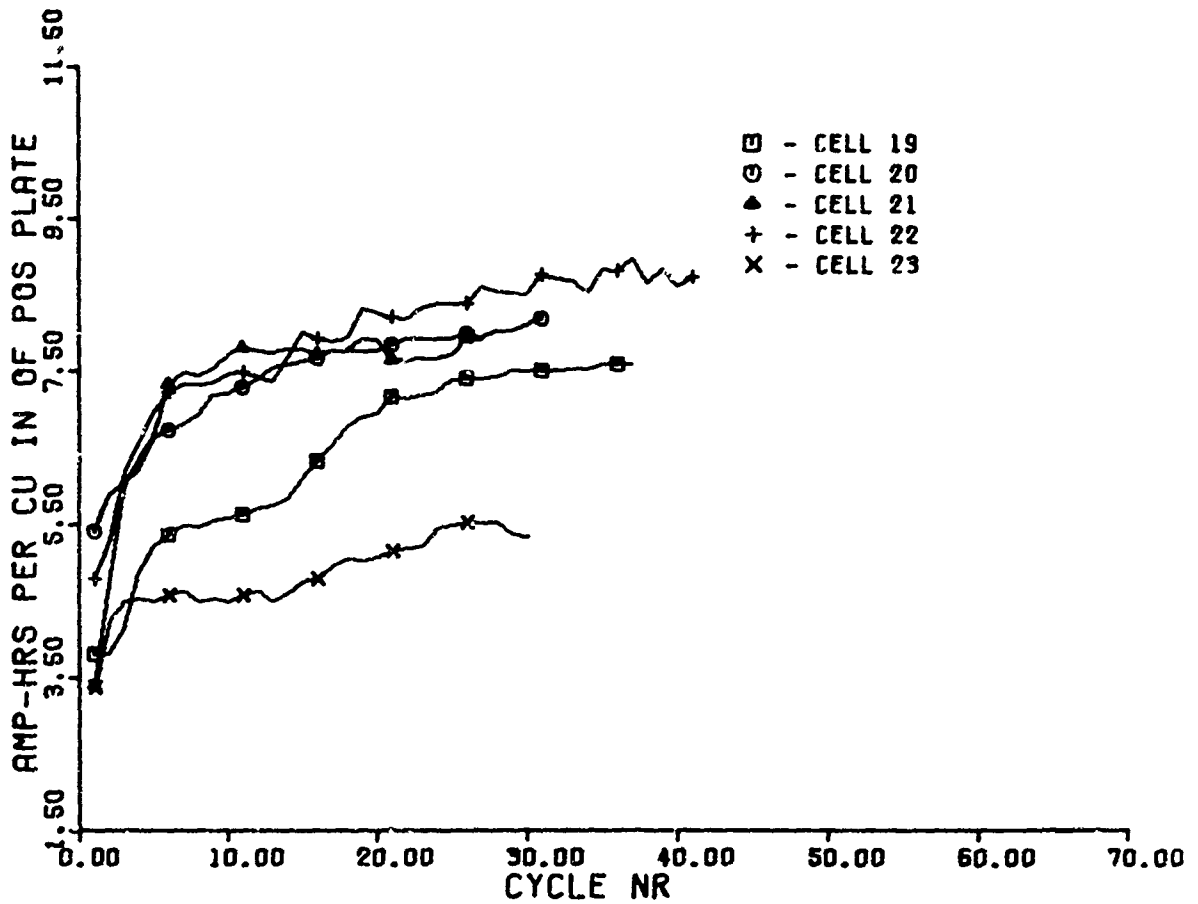

FIGURE 18

FORMATION CYCLES FOR NICKEL HYDROXIDE ELECTRODES
IMPREGNATED FROM ETHANOL SOLUTIONS ELECTRO-
CHEMICALLY (C CHARGE, C DISCHARGE, 20% OVER-
CHARGE, 10% OF ACTIVE MATL. COBALT HYDROXIDE)
ELECTRODE THICKNESS = 0.030'-0.040'

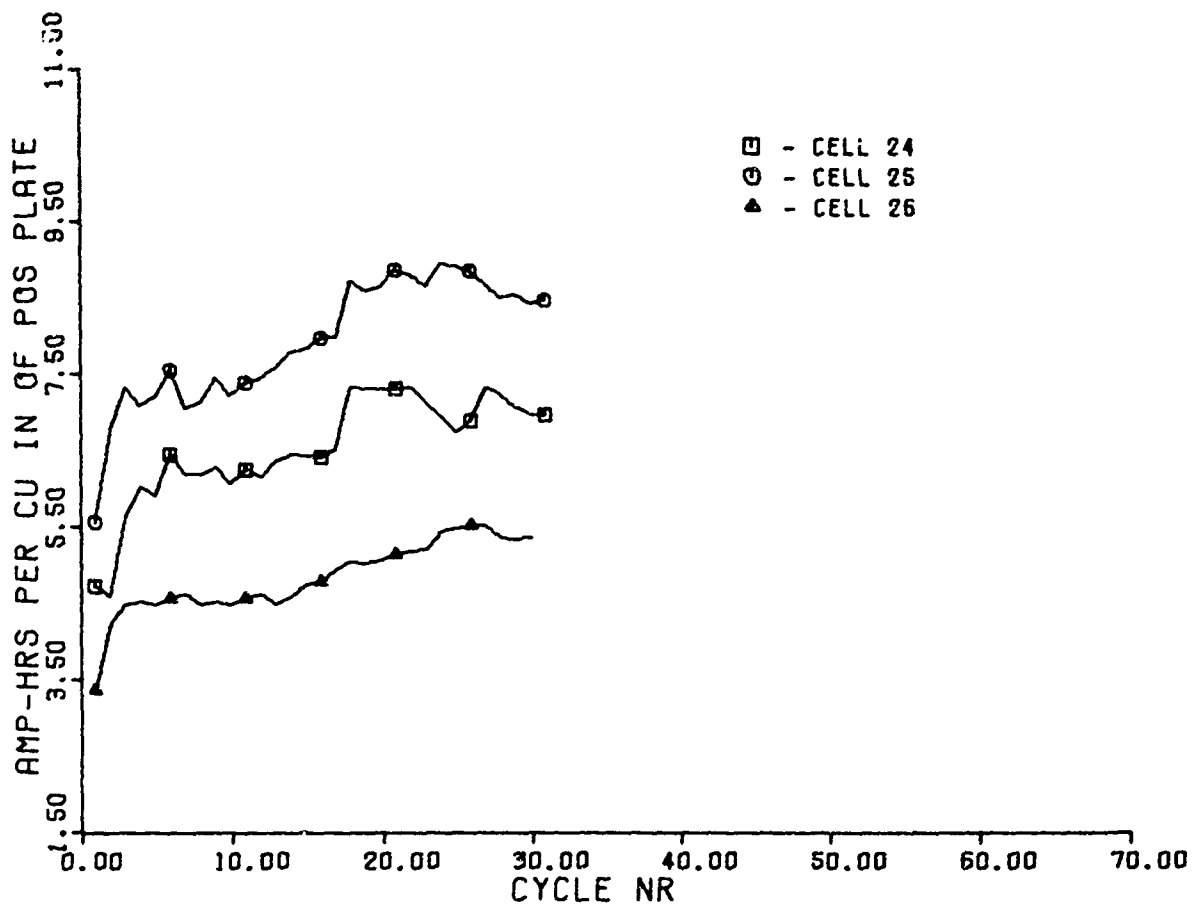

FIGURE 19

TABLE 11

PERFORMANCE OF NICKEL HYDROXIDE ELECTRODES
 IMPREGNATED FROM ETHANOL SOLUTIONS
 WITH VARIOUS ADDITIVES PRESENT

Plaque Nr	Theo. ¹ Capacity (A-H)	Measured ² Capacity (A-H)	% Util. ³ of Active Material	A-H ⁴ Per In ³	A-H ⁵ Per Lb.	Thickness ⁶ Gain (Mils)	Nr of Cycles
(30 mil plaque, Mfg. B)							
9A-30	1.937	1.700	87.8	6.20	41.6	1.7	34
10A-30	1.826	1.860	102	6.85	52.0	2.2	35
11A-30	1.848	1.870	101	6.66	52.1	4.5	38
12A-30	1.853	2.180	118	8.18	61.0	4.1	37
13A-30	2.137	2.233	104	7.42	58.9	5.3	35

1 - Value given assumes weight gain of plaque is due to 90% Ni(OH)₂ and 10% additive hydroxide. Additive is not considered active material.

2 - Capacity taken to 0.9 volt cut off versus a Cd bar electrode.

3 - Value assuming only a one electron change occurs.

4 - Value given neglects coined area.

5 - Based on electrode weight prior to charge-discharge cycling.

6 - Increase is difference between original plaque thickness and thickness after number of cycles shown.

FORMATION CYCLES FOR NICKEL HYDROXIDE ELECTRODES
 IMPREGNATED FROM ETHANOL SOLUTIONS ELECTRO-
 CHEMICALLY (C CHARGE, C DISCHARGE, 20% OVER-
 CHARGE, VARIOUS ADDITIVES PRESENT)
 ELECTRODE THICKNESS = 0.030'-0.040'

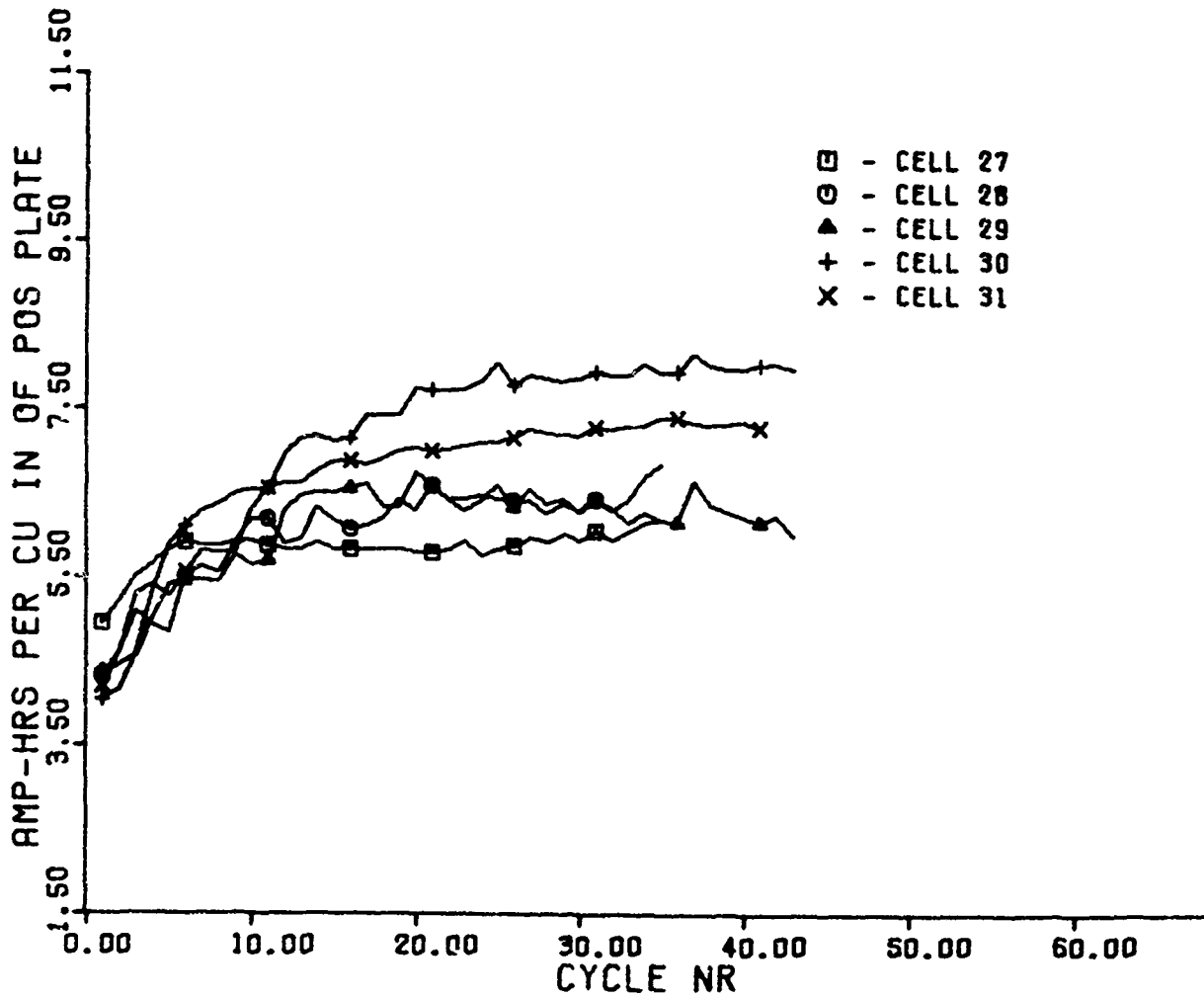

FIGURE 20

Acidity level is important in loading. This topic will be discussed later in more detail. Formation cycles are illustrated in Figures 17, 18 and 19.

Table 11 summarizes results obtained from electrodes having additive ions present in active material. Capacities during formation are shown in Figure 20. No improvement over cobalt additive is indicated. Cadmium appears to improve capacity at close to that obtained with cobalt. Cadmium has earlier been reported to decrease capacity of Ni(OH)_2 electrodes (27, 28).

III. PILOT PRODUCTION OF ELECTRODES FOR 20 A-H VENTED CELLS

Loading Data: Examples of plaque loadings obtained from pilot plant operation are shown in Table 12 and Table 13. Data in Table 12 are taken from aqueous media, and data from Table 13 are from ethanol solutions. Both sets of data are for 20 mil plaques obtained from the same vendors.

Aqueous Solutions: Results summarized in Table 12 are from two separate impregnations. Values for plaque weights include tabs. Coined areas were only considered in theoretical ampere-hours per pound and final weight values. Loadings observed here are about the same as observed for commercial electrodes.

Ethanol Solutions: Loadings from ethanol solutions are considerably higher, but a thickness gain due to impregnation is also observed. Loading levels shown here are close to limiting values which can be used without decreasing the ampere-hours per cubic inch of electrode for this plaque thickness. Higher values may be obtained using 30 mil plaque. This data has been presented in a earlier report (29).

TABLE 12

LOADING DATA FOR PLAQUES FROM PILOT PRODUCTION - AQUEOUS SOLUTION

(9.50" x 8.25 x 0.020" Plaques including six 2.75" x 4.75" electrode areas with 0.020" coining between areas and 0.010" coining around edges.

PLAQUE NR	FINAL WT. (gms)	GRAMS MATL. ¹ PFR CC VOID	THICKNESS ² GAIN (in)	THEO. ³ A-H/in	THEO. ⁴ A-H/lb.
P-20-1	104.45	1.76	.0020	6.33	50.0
P-20-2	105.80	1.72	.0019	6.36	49.1
P-20-3	105.30	1.73	.0020	6.40	49.4
P-20-4	104.00	1.70	.0017	6.26	50.0
P-20-5	99.60	1.61	.0004	5.96	46.2
P-20-6	105.95	1.62	.0034	5.97	49.4
P-20-7	101.95	1.62	.0023	5.96	47.4
P-20-8	96.35	1.28	.0024	4.71	40.8

Above plaques were loaded using a current density of 0.35 Amps per square inch of plaque for 135 minutes at 100°C.

1 - Calculated neglecting coined area, using porosity of 78% and using corrected thickness after impregnation.

2 - Measured after scrubbing and one formation cycle.

3 - Calculated neglecting coined area and assuming all active materials to be Ni(OH)₂.

4 - Value includes coined area and tab.

TABLE 13

LOADING DATA FOR PLAQUES FROM PILOT PRODUCTION - ETHANOL SOLUTION

(9.50" x 8.25" x 0.020" Plaques including six 2.75" x 4.75" electrode areas with 0.020" coining between areas and 0.010" coining around edges)

PLAQUE NR	FINAL WT.(gms)	GRAMS MATL. ¹ PER CC VOID	THICKNESS ² GAIN (in)	THEO ³ A-H/in	THEO ⁴ A-H/lb.
P-20-9	123.70	2.22	.0053	8.22	62.1
P-20-10	125.90	2.32	.0054	8.58	63.5
P-20-11	131.20	2.34	.0044	8.63	64.8
P-20-12	126.80	2.01	.0081	7.43	62.7
P-20-13	116.40	2.03	.0026	7.50	57.1
P-20-14	124.80	2.19	.0027	8.07	58.2
P-20-15	116.10	2.04	.0022	7.54	56.3
P-20-16	123.20	2.14	.0026	7.91	58.7

Above plaques were loaded using a current density of 0.35 Amps per square inch of plaque for 135 minutes at 80°C.

1 - Calculated neglecting coined area, using porosity of 78% and using corrected thickness after impregnation

2 - Measured after scrubbing and one formation cycle.

3 - Calculated neglecting coined area and assuming all active material to be Ni(OH)₂.

4 - Value includes coined area and tab.

Charge Efficiency Versus State of Charge At Selected Ambient Temperatures

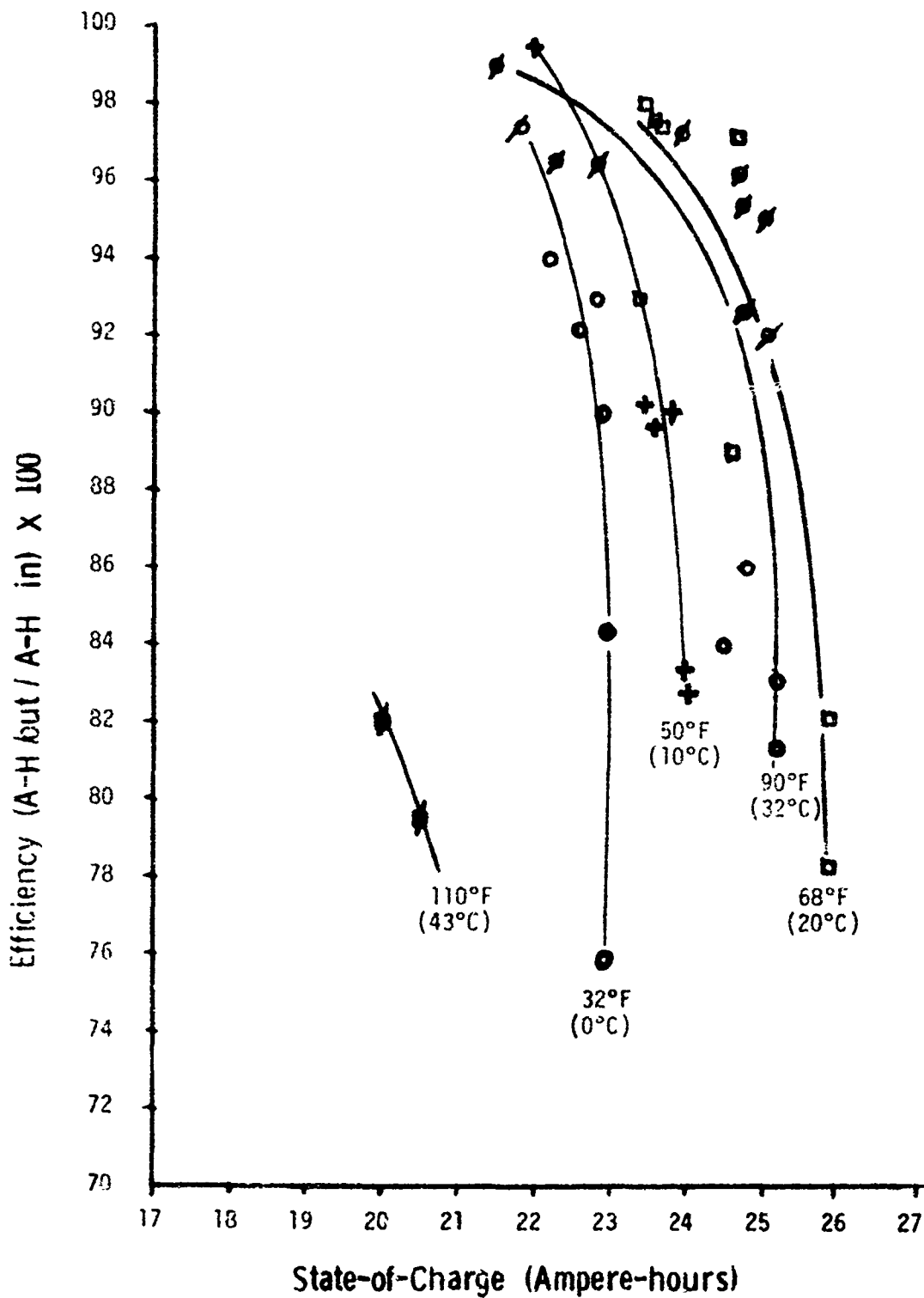
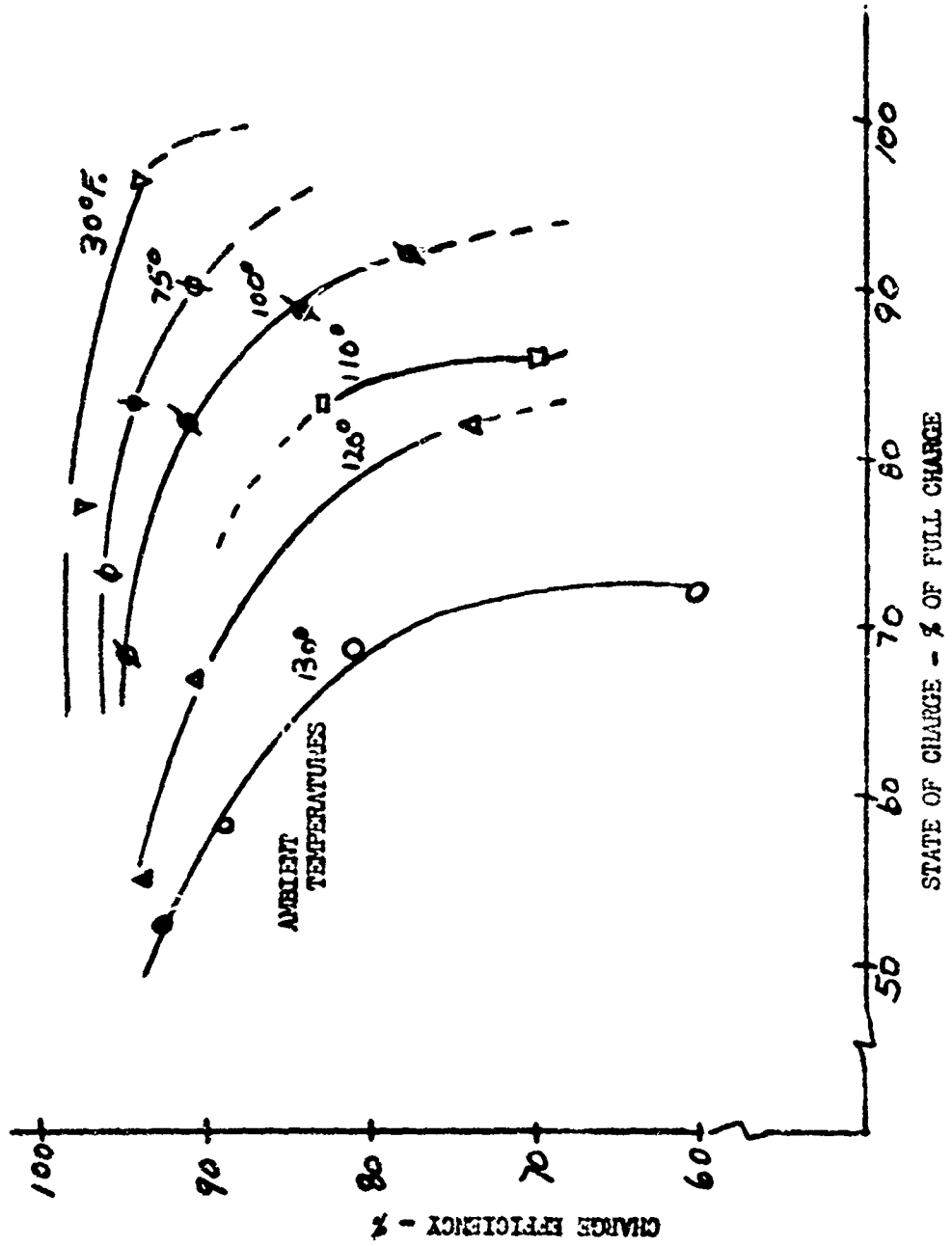

FIGURE 21

CHARGE EFFICIENCY VS STATE OF CHARGE

AIRCRAFT CELLS



CHARGE EFFICIENCY VS STATE OF CHARGE

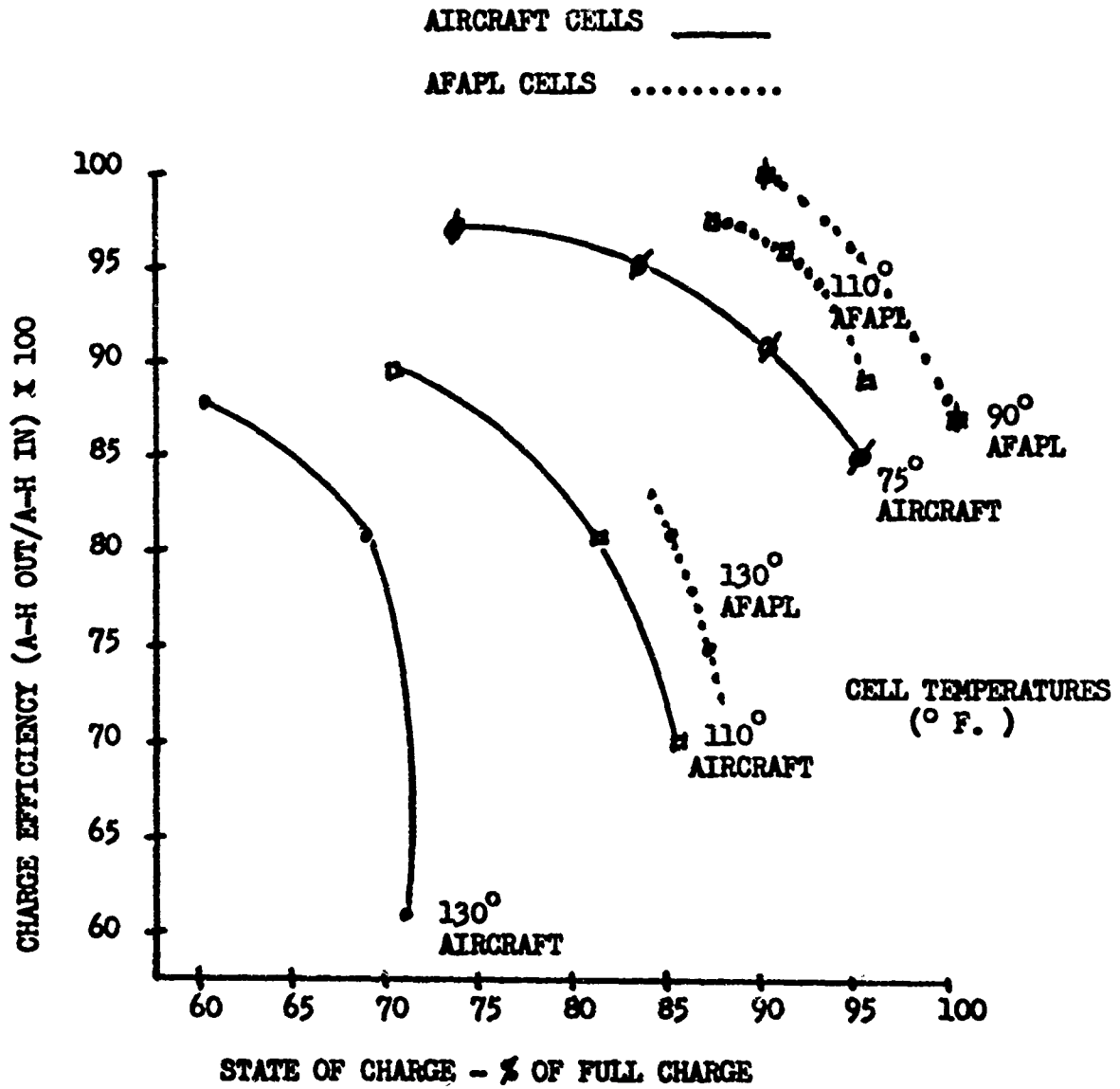

FIGURE 23

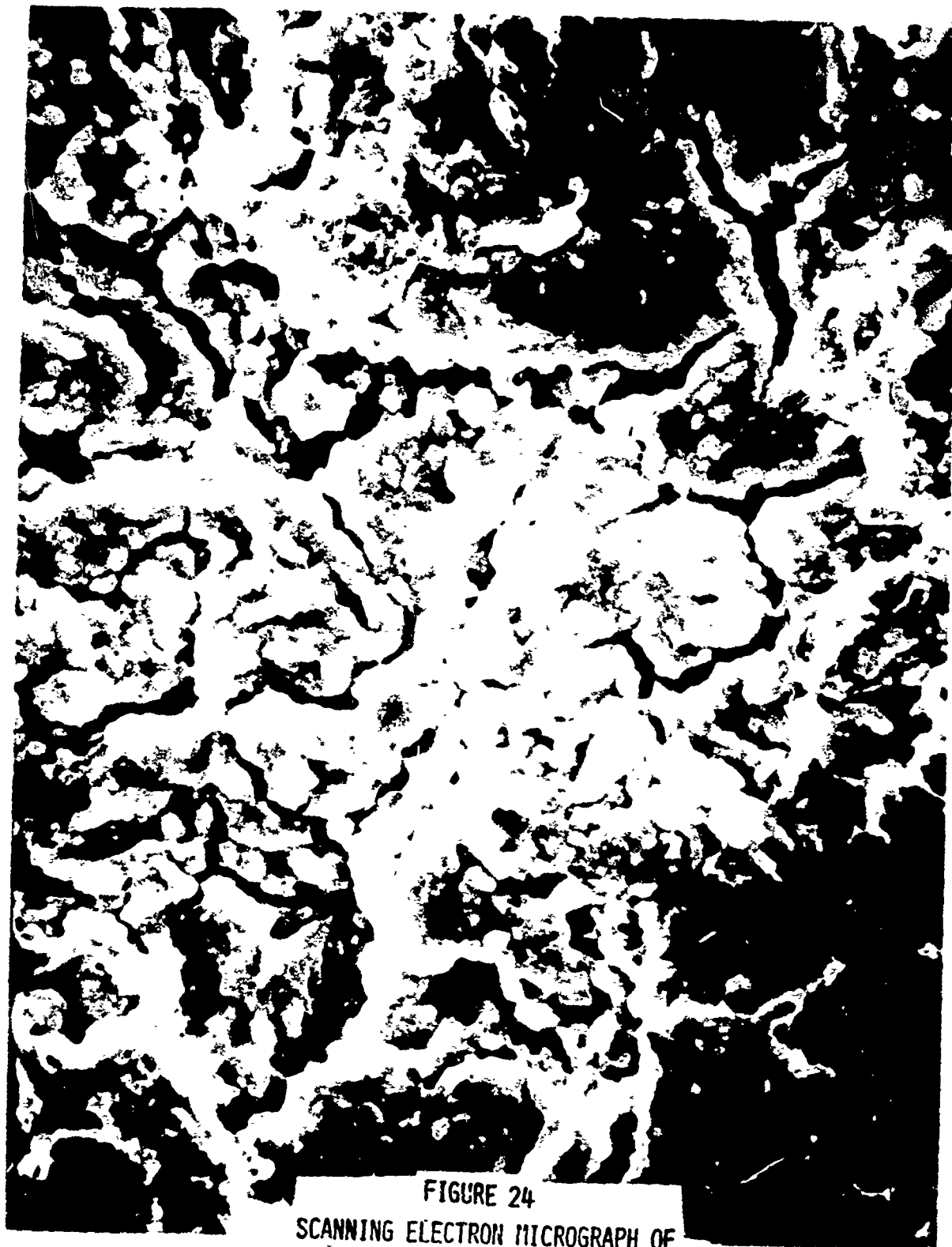

FIGURE 24
SCANNING ELECTRON MICROGRAPH OF
A/C POSITIVE PLATE (1000X MAGNIFI-
CATION, ENLARGED APPROX 2X)

TABLE 14

CELL FABRICATION DATA

	C e l l N r 1		C e l l N r 2	
	Positive Electrodes	Negative Electrodes	Positive Electrodes	Negative Electrodes
Number	13	14	13	14
Individual Thickness	.0330 ± .0010"	.0220 ± .0010"	.0360 ± .0010"	.0218 ± .0015"
Individual Loading	9.81 ± .05 gms	6.58 ± .10 gms*	9.62 ± .07 gms	6.24 ± .09 gms*
Total Loading	127.5 gms	92.1 gms*	125.0 gms	87.3 gms*
Dimensions	4.25" x 2.75"	4.25" x 2.75"	4.25" x 2.75"	4.25" x 2.75"
Coining	0.010"	0.010"	0.010"	0.010"
Total Theo. Capacity	36.8 A-H	35.8 A-H	36.1 A-H	35.8 A-H

Both cells have 0.005" pellon 2505 separation. Electrolyte is 30% KOH. Cells were vacuum filled with electrolyte then drained and refilled to 50% of case volume.

* - 80% Cd(OH)₂, 20% Cd

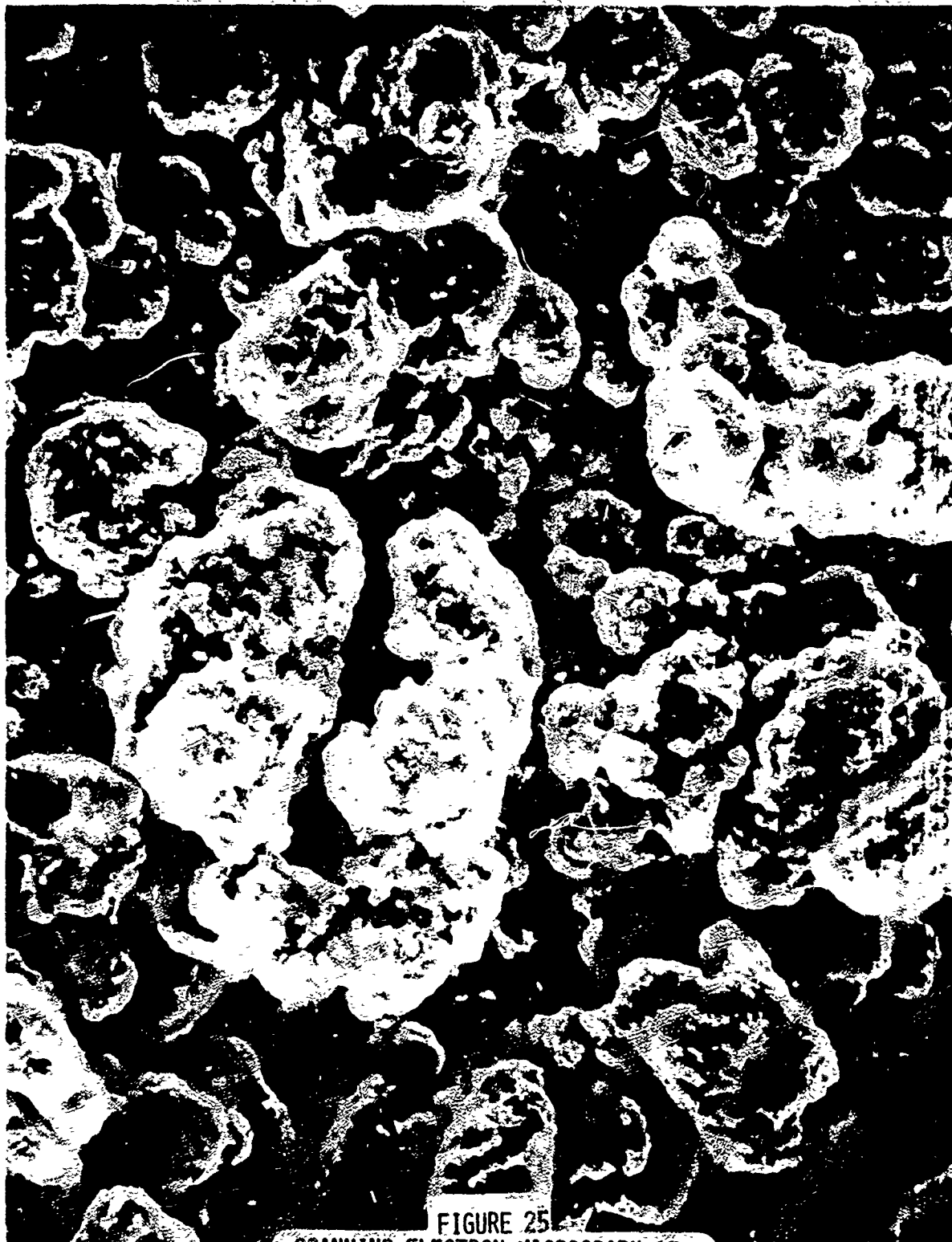

FIGURE 25

SCANNING ELECTRON MICROGRAPH OF
AFAPL POSITIVE PLATE (1000X MAGNI-
FICATION, ENLARGED APPROX 2X)

Cell Fabrication Data: Dimensions, loading levels, number of plates, etc., for vented cells fabricated from electrochemically impregnated electrodes are shown in Table 14. All electrodes were impregnated using ethanol solutions.

Charge Efficiency with Respect to Temperature: Charging efficiencies at various depths of discharge for cells having electrochemically impregnated electrodes are plotted in Figure 21. As Table 14 indicates, these are negative limited cells. The charge regime used here was a constant potential charge with potential initially adjusted that the cells were fully charged within an hour. Discharge was at the one hour rate to a cut-off of 0.9 volts per cell. The curves shown in Figure 21 represent an average of the two cells.

Similar curves for two 22 ampere-hour vented aircraft cells are shown in Figure 22. These cells are of about 1970 vintage. The cells are positive limited standard military specification #MS24497-1 design. The cells were cycled under the same regime as the experimental variety.

Comparison of performance between the two types of cells is given in Figure 23. The comparison may be questioned because of difference in separator material and positive to negative ratio. However, charging efficiency is mainly governed by the nature of the positive plate. Further support of the superior performance with respect to charging efficiency will be given in a later report (30). The difference in physical appearance of the plates from both types of cells may be seen in Figures 24 and 25.

Both sets of data were recorded first at lower temperatures. After 50 to 100 cycles, the temperature was raised to ambient. Limited data was taken at the higher temperatures ($\geq 110^{\circ}\text{F}$) as performance of both cell types appeared to deteriorate more rapidly than desired. Cycling at 90°F (32°C) was continued until failure. Aircraft cells failed at 550 cycles. AFAPL cells failed at 720 cycles.

DISCUSSION

In the preceding section result of over three years' work on nickel plaque impregnation techniques with nickel hydroxide have been summarized. Work on impregnation of plaques with cadmium has been mentioned, and a complete report on cadmium impregnation techniques is in progress. Other interim reports on cadmium electrode preparation have been published (18, 19). At the time of this writing, a patent was issued to the Air Force on the cadmium electrode process (31).

Although extensive results with respect to loading and formation cycling have been presented on nickel electrodes, there are other parameters that could have been measured and included. However, if one thoroughly investigated each one that comes to mind, completion of the project in a timely manner would be questionable. What was attempted with the time apportioned to this effort was evaluation of most promising plaque impregnation techniques and development of improved techniques. The new techniques were included for evaluation.

There are probably other tests that could be tried other than the one used here, full cycle charge and discharge with overcharge, to evaluate performance of the electrodes, but there is no good accelerated life test for nickel cadmium cells. The Air Force and NASA are attempting to develop one (32). The test used here is similar to one used at Bell Telephone Laboratories (10).

Other questions might arise regarding the technique used to measure acidity of ethanol solutions used in plaque impregnation. In this case a pH meter having standard glass and calomel electrodes was used, and

readings were taken on the aqueous pH scale. No attempts were made to interpret these readings they were only used for relative purposes. A "pH" scale for ethanol solutions has been suggested by Grunwald and Gutbezahl (33). Other work has been performed in the area by Bates (34), who has written a review on the subject (35).

The technique used to obtain the loading data is straightforward. No questions should arise here.

The loadings obtained for various plaques depend upon plaque type, thickness, and technique but in general, lightly loaded plaques did not swell very much as a result of impregnation. One manufacturer's plaque appeared to swell extensively as a result of impregnation.

Performance of resulting electrodes likewise was dependent, to some extent, on the above parameters. Especially swelling as a result of cycle life testing. However, the most important factor appeared to be the type of additive present with active material. Cobalt definitely appeared necessary for long cycle life under conditions tested.

Pilot plant studies are still in progress. Preliminary results have been shown here, but more extensive testing has been performed. Results will be reported later (30). It should be noted that heavier loaded plaques were obtained using ethanol solutions in this case. Probably equivalent loadings could be obtained with aqueous solutions at slightly higher impregnating temperatures (Ca., 105°C). Cycle life data and efficiency data for pilot plant electrodes impregnated from aqueous solutions will be presented later (30). It is interesting to point out that electrodes from pilot plant cells have no more than two to three

mils swelling after 750 cycles under conditions given. Approximately ten (10) mils or more of swelling was incurred with conventional aircraft battery electrodes under the same conditions.

In addition to tests performed in our laboratory, evaluations of the electrochemically impregnated electrodes have been performed at various aerospace companies (36, 37, 38, 39, 40). Results of these tests show:

- (1) "Positive plates impregnated using the electrochemical deposition process are significantly stronger and resistant to degradation than are plates impregnated by the more conventional acid-immersion/caustic precipitation process" (36).
- (2) Electrochemically impregnated positive plates are the only electrodes which have shown stable hydrogen pressure characteristics in nickel-hydrogen battery cells (37, 38).
- (3) When placed in sealed nickel-cadmium cells, cells show significantly superior performance after five years' equivalent testing in a synchronous orbit cycling regime at 70 percent depth-of-discharge (39).
- (4) Because of reduced thickening in the positive electrode, it appears that a 20 WH/Lb sealed nickel-cadmium cell (versus 15-16 for state-of-the-art) is obtainable without sacrifice of quality (40).

At present 50 ampere-hour nickel-cadmium cells, which have these electrodes, developed under Contract F33615-73-C-2012, are undergoing

cycle life testing at N.A.D. Crane. Completion of this test will yield more data for evaluating these electrodes.

At present it appears that this type of positive electrode should offer improvement to any nickel-alkaline cell for any extended cycle life application.

REFERENCES

1. Fleischer, Arthur; J. Electrochem. Soc. 94(6) 289-299 (1948).
2. Bourgault, P. L.; Lake, P. E.; Casey, E. J.; and Bubojs, A. R.; Canadian Journal of Technology, 34(8), 295-502 (1957).
3. Iwaki, Tsutomu and Fukuda, Masataro; Kagaku, Denki; 33(10), 737-743 (1965).
4. Kandler, Ludwig; British Patent 917,291 (1933); U.S. Patent 3,214,355 (1965).
5. McHenry, Edward J.; Electrochemical Society Fall Meeting, Battery Division, Philadelphia, PA, October 1966; Electrochemical Technology, 5(5-6), 275-279 (1967).
6. Kober, Fredrick P.; Electrochemical Technology 4(7-8), 423-426 (1966).
7. Matsui, Masayo; U.S. Patent, 3,343,987 (1967).
8. MacArthur, Donald M.; U.S. Patent 3,466,231 (1969).
9. Beauchamp, R. L.; Electrochemical Society Fall Meeting, Atlantic City, New Jersey, October 1970, Extended Abstracts Publication, Abstract 65, page 161. U.S. Patent 3,653,967 (1972).
10. Beauchamp, R. L.; and Mauer, D.W.; Electrochemical Society Fall Meeting, Cleveland, OH, October 1971, Extended Abstracts Publication, Abstract 7, page 23.
11. Pell, Melvyn B.; and Blossom, Raymond W.; U.S. Patent 3,507,699 (1970).
12. Kroger, Hans H.; AFAPL-TR-72-35, July 1972.
13. Hausler, E.; Power Sources 1966, D. H. Collins, Ed., Pergamon Press, NY, 1967, pages 287-296.
14. MacArthur, D. M.; Power Sources 3, D. H. Collins, Ed., Pergamon Press, NY, 1971, pages 91-116.
15. Pickett, David F.; Electrochemical Society Fall Meeting Boston, MA, October 1973, Extended Abstracts Publication, Abstract 49, page 119; U.S. Patent 3,827,911 (1974).
16. Puglisi, Vincent J.; Seiger, H. N.; and Pickett, D. F.; Proceedings of the 9th IECEC Conference, San Francisco, CA, August 1974, page 873; AFAPL-TR-74-56, Part II.

17. Latimer, W. M.; Oxidation States of the Elements and Their Potentials in Aqueous Solution, Prentice-Hall, Englewood Cliffs, NJ, 2nd Edition, 1952.
18. Pickett, D. F.; Transcripts of Proceedings, NASA/GSFC Battery Workshop, pages 93-102, ACE-Federal Reporters, Inc., Washington, D.C., 1973.
19. Pickett, D. F.; and Puglisi, V. J.; Electrochemical Society Fall Meeting, New York, NY, Extended Abstracts Publication, Abstract 46, pages 114-115; AFAPL-TR-74-119.
20. Pickett, D. F.; and Martin, U.D.; AFAPL-TR-75-XX, In Publication, 1975.
21. Welcher, Frank J.; The Analytical Uses of Ethylenediaminetetracetic Acid, D. Van Nostrand, Princeton, NJ, 1965.
22. Brunauer, S.; Emmett, P./ and Teller, E.; J. Am. Chemical Society, 60, 309 (1939).
23. Carr, Earl; Eagle-Picher Industries, Personal Communication.
24. Pickett, David F.; NASA/GSFC Report Nr. X-711-74-348, November 1974, page 145a.
25. Mauer, D. W.; Bell Telephone Laboratories, Personal Communication.
26. Beauchamp, R. L.; Bell Telephone Laboratories, Personal Communication.
27. May, L.; NASA/GSFC Report Nr X-711-74-287, September 1974.
28. May, L.; NASA/GSFC Report Nr X-711-74-548.
29. Pickett, David F.; Transcript of Proceedings, NASA/GSFC Battery Workshop, page 107, ACE - Federal Reporters, Inc., Washington, D.C. 1972.
30. Lander, J. J.; and Pickett, D. F.; AFAPL-TR-75-XX, In Preparation.
31. Pickett, David F.; U.S. Patent 3,873,368 (7:5)
32. Hennigan, Thomas J.; NASA/GSFC Report Nr X-761-73-183, October 1973.
33. Gutbezahl, Boris and Grunwald, Ernest; J. Am. Chem. Soc., 75 559 (1953)
34. Bates, R. G.; Anal. Chem., 40(6), 35A (1968)
35. Bates, R. G.; The Chemistry of Non-Aqueous Solvents, J. J. Lagowski, Ed., Academic Press, New York, Vol. I, page 97, 1966.

36. Scott, Willard R.; TRW Report No. 24118-6002-RU-00, Prepared Under JPL Contract Nr 953649, 1974.
37. Patterson, Robert E.; Sparks, R. H.; and Luft, W.; TRW Report Nr. 74-8215.6-058, 1974, IR&D Final Report on Nickel-Hydrogen Battery System Development, 31 Dec 1974 (proprietary-referenced by permission)
38. Ritterman, Paul; and Sparks, R. H.; TRW Report Nr. 74.8215.6-057, 1974 IR&D Final Report on Nickel-Cadmium Battery Development, 31 Dec 1974 (proprietary-referenced by permission)
39. Sparks, R. H.; Briefing to AFAPL, February 1975.
40. Seiger, H. N., et al., AFAPL-TR-74-56, Part I, August 1974.