

AD-A017 610

**ASSESSMENT OF FLUID MECHANICS DATA FOR FIRE
PROTECTION STUDY**

Charles G. Richards

New Mexico University

Prepared for:

Air Force Weapons Laboratory

October 1975

DISTRIBUTED BY:

NTIS

**National Technical Information Service
U. S. DEPARTMENT OF COMMERCE**

332067

AFWL-TR-75-102

AFWL-TR-
75-102

00
P3
ADA017610



ASSESSMENT OF FLUID MECHANICS DATA FOR FIRE PROTECTION STUDY

Charles G. Richards

Eric H. Wang Civil Engineering Research Facility
University of New Mexico
University Hill Campus Post Office, Albuquerque, NM 87131

October 1975

Final Report for Period June 1974 to March 1975

Approved for public release; distribution unlimited.

Reproduced by
NATIONAL TECHNICAL
INFORMATION SERVICE
US Department of Commerce
Springfield, VA. 22151



AIR FORCE WEAPONS LABORATORY
Air Force Systems Command
Kirtland Air Force Base, NM 87117

This final report was prepared by the Civil Engineering Research Facility, at the University of New Mexico, Albuquerque, New Mexico under Contract F29601-74-C-0030, Job Order 21022F06 with the Air Force Weapons Laboratory, Kirtland Air Force Base, New Mexico. Capt Michael D. DeWitte was the Laboratory Project Officer-in-Charge.

When US Government drawings, specifications, or other data are used for any purpose other than a definitely related Government procurement operation, the Government thereby incurs no responsibility nor any obligation whatsoever, and the fact that the Government may have formulated, furnished, or in any way supplied the said drawings, specifications, or other data is not to be regarded by implication or otherwise as in any manner licensing the holder or any other person or corporation or conveying any rights or permission to manufacture, use, or sell any patented invention that may in any way be related thereto.

This technical report has been reviewed and is approved for publication.



MICHAEL D. DeWITTE
Captain, USAF
Project Officer



L. M. WOMACK
Chief, Aerospace Facilities Division

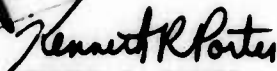

KENNETH R. PORTER
Major, USAF
Commander, AFCEC/OL-AA

This report has been reviewed by the Information Office (OI) and is releasable to the National Technical Information Service (NTIS). At NTIS, it will be available to the general public, including foreign nations.

UNCLASSIFIED

SECURITY CLASSIFICATION OF THIS PAGE (When Data Entered)

REPORT DOCUMENTATION PAGE		READ INSTRUCTIONS BEFORE COMPLETING FORM
1. REPORT NUMBER AFWL-TR-75-102	2. GOVT ACCESSION NO.	3. REPORT TYPE CATALOG NUMBER
4. TITLE (and Subtitle) ASSESSMENT OF FLUID MECHANICS DATA FOR FIRE PROTECTION STUDY		5. TYPE OF REPORT & PERIOD COVERED Final Report ; June 1974 - March 1975
7. AUTHOR(s) Charles G. Richards		6. PERFORMING ORG. REPORT NUMBER
9. PERFORMING ORGANIZATION NAME AND ADDRESS Eric H. Wang Civil Engineering Research Facility University of New Mexico, University Hill Campus Post Office, Albuquerque, NM 87131		8. CONTRACT OR GRANT NUMBER(s) F29601-74-C-0030
11. CONTROLLING OFFICE NAME AND ADDRESS Air Force Weapons Laboratory (DEZ) Kirtland Air Force Base, NM 87117		10. PROGRAM ELEMENT PROJECT, TASK AND WORK UNIT NUMBERS 63723F; 21022F06
14. MONITORING AGENCY NAME & ADDRESS (if different from Controlling Office)		12. REPORT DATE October 1975
		13. NUMBER OF PAGES 32
		15. SECURITY CLASS (of this report) Unclassified
		15a. DECLASSIFICATION DOWNGRADING SCHEDULE
16. DISTRIBUTION STATEMENT (of this Report) Approved for public release; distribution unlimited.		
17. DISTRIBUTION STATEMENT (of the abstract entered in Block 20, if different from Report)		
18. SUPPLEMENTARY NOTES		
19. KEY WORDS (Continue on reverse side if necessary and identify by block number) Civil Engineering Fire Protection Fluid Mechanics Sprinkler Systems		
20. ABSTRACT (Continue on reverse side if necessary and identify by block number) The fire protection systems in warehouses at Hill, Kelly, McClellan, Robins, and Tinker Air Force Bases were studied. Twelve different sprinkler system configurations were analyzed using a numerical technique and the performance of the systems after being retrofitted with 0.64-in orifice sprinkler heads was predicted. The numerical results for buildings 380 and 385 at Robins Air Force Base and for buildings 10, 18 and 412 at Tinker Air Force Base were used as the standard reference values in determining whether or not other systems would give adequate protection when retrofitted with the 0.64-in.		

UNCLASSIFIED

SECURITY CLASSIFICATION OF THIS PAGE(When Data Entered)

orifice heads. On the basis of these results, it appears that retrofitting the systems in building 850 at Hill Air Force Base and building 783 at McClellan Air Force Base will not give adequate protection. It also appears that the retrofitted systems in building 416 at Tinker Air Force Base, a retrofitted system in a building at Kelly Air Force Base, and one retrofitted system in buildings 350, 368, and 660 at Robins Air Force Base will give adequate protection. Retrofitting the other systems will provide marginal protection. However, these systems may give adequate protection if boost pumps are used to increase supply pressure and if a 1-in diameter pipe is replaced by 1-1/4-in-diameter pipe.

ia

UNCLASSIFIED

SECURITY CLASSIFICATION OF THIS PAGE(When Data Entered)

CONTENTS

<u>Section</u>		<u>Page</u>
1	INTRODUCTION	3
2	COMPUTATION PROCEDURE	4
3	DATA DISCUSSION	20
4	CONCLUSIONS AND RECOMMENDATIONS	21
	APPENDIX A: SAMPLE PROCEDURE FOR CALCULATING SPRINKLER SYSTEM FLOW RATES	23
	APPENDIX B: PROCEDURE FOR CALCULATING TOTAL FLOW RATE AVAILABLE TO SPRINKLER SYSTEMS	27

ILLUSTRATIONS

<u>Figure</u>		<u>Page</u>
1	Sprinkler System in Building 850 at Hill Air Force Base	5
2	Small Sprinkler System in Air Materiel's Command Warehouses at Kelly Air Force Base	5
3	Large Sprinkler System in Air Materiel's Command Warehouses at Kelly Air Force Base	6
4	Sprinkler System in Building 783 at McClellan Air Force Base	7
5	Sprinkler System in Building 786 at McClellan Air Force Base	8
6	Sprinkler System in Mezzanine of Building 786 at McClellan Air Force Base	9
7	Sprinkler System in Buildings 380 and 385 at Robins Air Force Base	10
8	Small Sprinkler Systems in Buildings 350, 368, and 660 at Robins Air Force Base	11
9	Large Sprinkler Systems in Buildings 350, 368, and 660 at Robins Air Force Base	12
10	Sprinkler System in Air Materiel's Command Warehouses at Robins Air Force Base	13
11	Sprinkler System in Buildings 10, 18, and 412 at Tinker Air Force Base	14
12	Sprinkler System in Building 416 at Tinker Air Force Base	15

TABLES

<u>Table</u>		<u>Page</u>
1	Comparison of Flow Density Data	17
2	Flow Densities in Building 850 at Hill Air Force Base	18
3	Flow Densities in Building 783 at McClellan Air Force Base	18
4	Flow Densities in Building 350, 368, and 660 at Robins Air Force Base	19
5	Comparison of Predicted Maximum Flow Rates in Retrofitted Systems	19

SECTION 1
INTRODUCTION

Because of devastating fires which periodically occur in industrial warehouses, industry has revised the engineering guidelines for the protection of high piled storage. This revision, plus an internal assessment by the Air Force Logistics Command (AFLC) of the fire hazards and protection problems in Air Force warehouses, resulted in a request that the fire protection systems in the Air Force warehouses be studied with the objective of upgrading the systems, if necessary.

After some burn tests (ref. 1) and preliminary assessment of the existing systems, it appeared that replacing all the sprinkler heads with the new 0.64-in-orifice sprinkler heads developed by Factory Mutual Research Corporation might be a way to upgrade existing systems in Air Force warehouses. However, before embarking on a burn test program or a massive retrofitting operation, it was decided to study the problem by a computer simulation.

Specifically, all existing systems, for which drawings were supplied, were simulated as if the new sprinklers had been installed. The flow rates and flow rate densities were obtained for the cases of from one sprinkler in operation to the entire system in operation on a single branch line from the valve closet. These values were then compared with the computed flow rates for the two systems previously reported* (ref. 2) to give adequate protection when retrofitted with the new 0.64-in sprinkler heads.

-
1. Miller, M. J., et al., *New Criteria For Fire Protection of Large Air Force Warehouses*, AFWL-TR-70-1, Vol. I. Air Force Weapons Laboratory, Kirtland Air Force Base, New Mexico, August 1970.
 2. Krasner, L. M., et al., *Fire Protection Study: USAF Mobility Program Structures and Large Air Force Warehouses*, AFWL-TR-72-246, Air Force Weapons Laboratory, Kirtland Air Force Base, May 1973.

* The systems in buildings 380 and 385 at Robins Air Force Base and in buildings 10, 18, and 412 at Tinker Air Force Base were simulated in burn tests conducted by Factory Mutual Research Corporation. On the basis of these tests, it was concluded that retrofitting the systems would provide adequate fire protection.

SECTION 2
COMPUTATION PROCEDURE

The schematic diagrams of the sprinkler systems analyzed are shown in figures 1 through 12. A computer program was written to solve the system of equations governing the flow. The system of equations consisted of the continuity, Hazen-Williams, and orifice equations written for each sprinkler head. For each system, the value of the pressure at the sprinkler farthest from the supply (e.g. this would be sprinkler 1 in figure 1) was estimated to start the computational procedure. The various flow rates and pressure drops were then calculated based on this estimate. Based on these calculations, the water supply pressure necessary for these flows was computed and compared with the actual water pressure. If the agreement was not within 0.1 pct, the process was repeated (iterated) until satisfactory agreement was reached.

Data was computed for the cases of one active sprinkler, two active sprinklers, etc., until all sprinklers were active. (An example of the computational sequence is outlined in appendix A.)

The computations used the continuity equation

$$\sum Q = 0 \quad (1)$$

the Hazen-Williams formula* (refs. 3 and 4)

$$\Delta p = kQ^{1.85} \quad (2)$$

-
3. Factory Mutual Research Corporation, *Handbook of Industrial Loss Prevention*, McGraw-Hill Publishing Company, New York, 1967.
 4. Giles, R. V., *Fluid Mechanics and Hydraulics*, Schaum Publishing Company, New York, 1962.

* This formula is considerably easier than the Moody diagram to use in a computer program.

City Water Supply Pressure is 69 psig

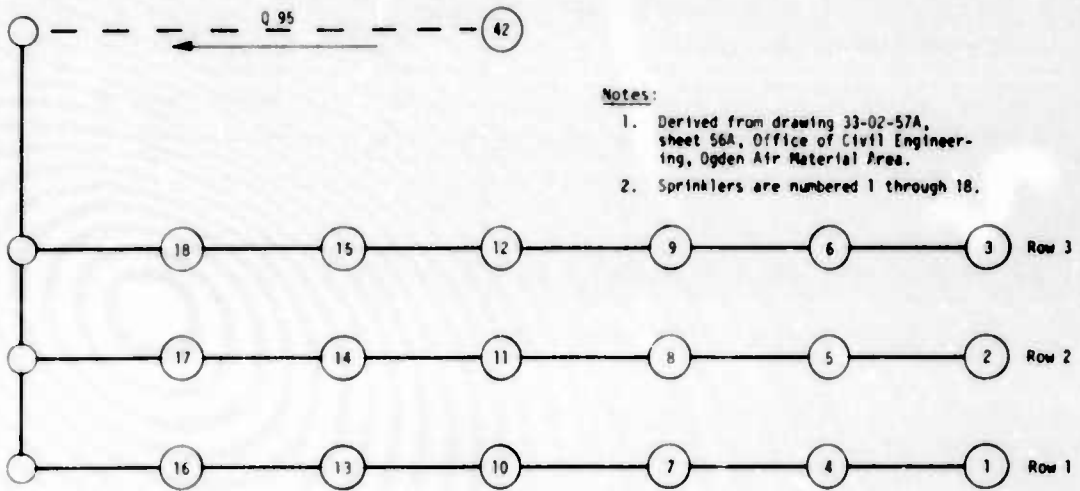

Figure 1. Sprinkler System in Building 850 at Hill Air Force Base

City Water Supply Pressure is 68 psig

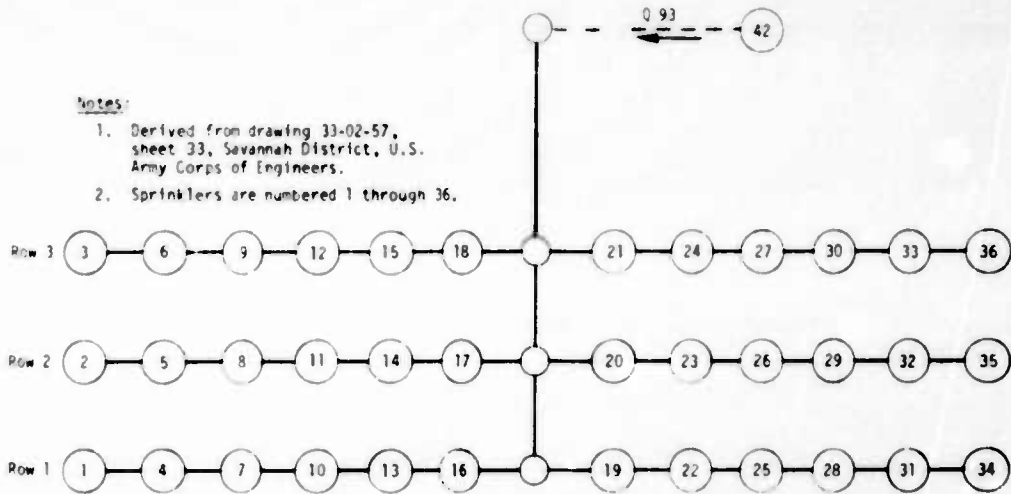

Figure 2. Small Sprinkler System in Air Materials Command Warehouses at Kelly Air Force Base

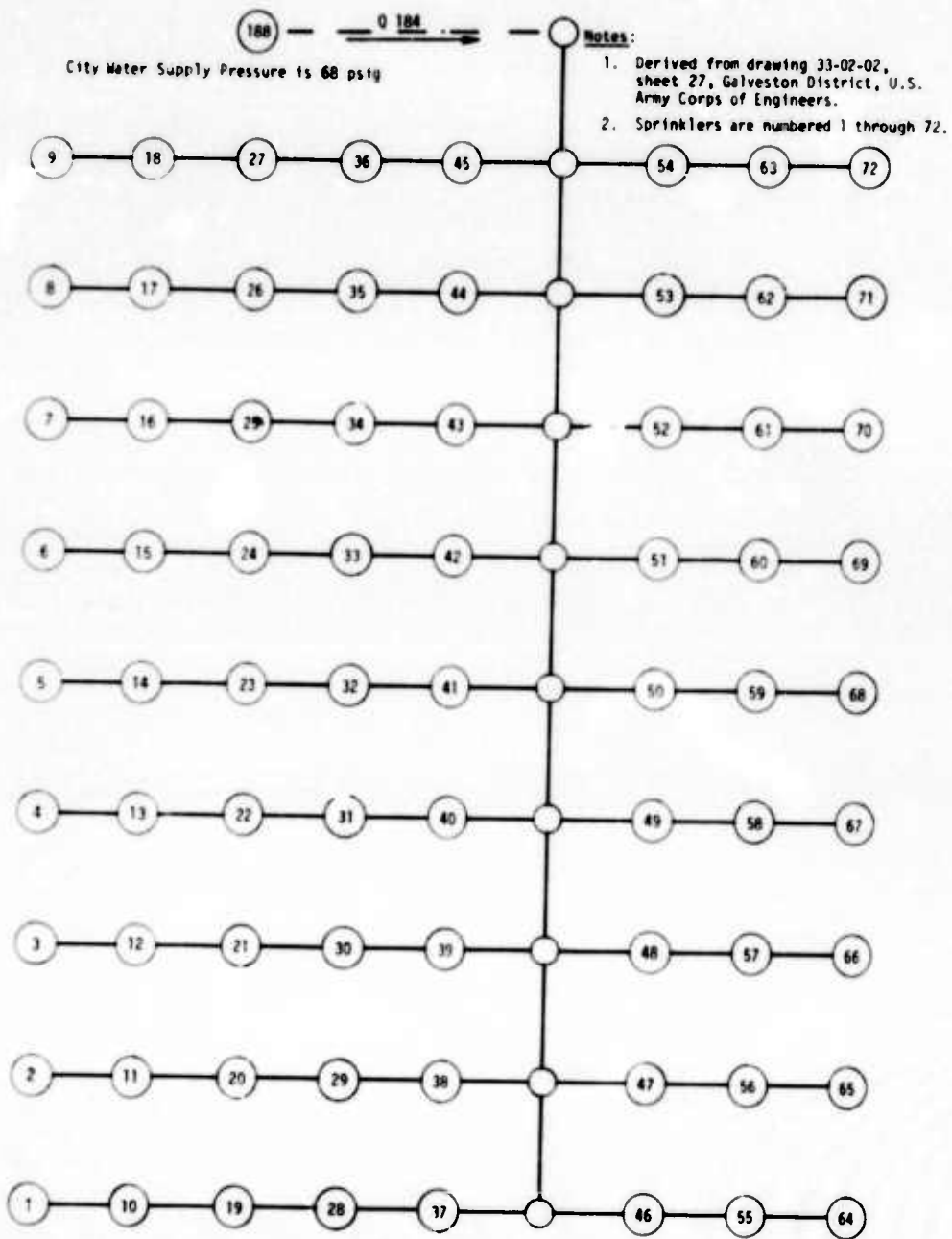

Figure 3. Large Sprinkler System in Air Materiel's Command Warehouses at Kelly Air Force Base

City Water Supply Pressure is 61 psig

Notes:

1. Derived from drawing 33-02-17, sheet 43, File No. 100-25-1123, Grinnell Co.
2. Sprinklers are numbered 19 through 72.

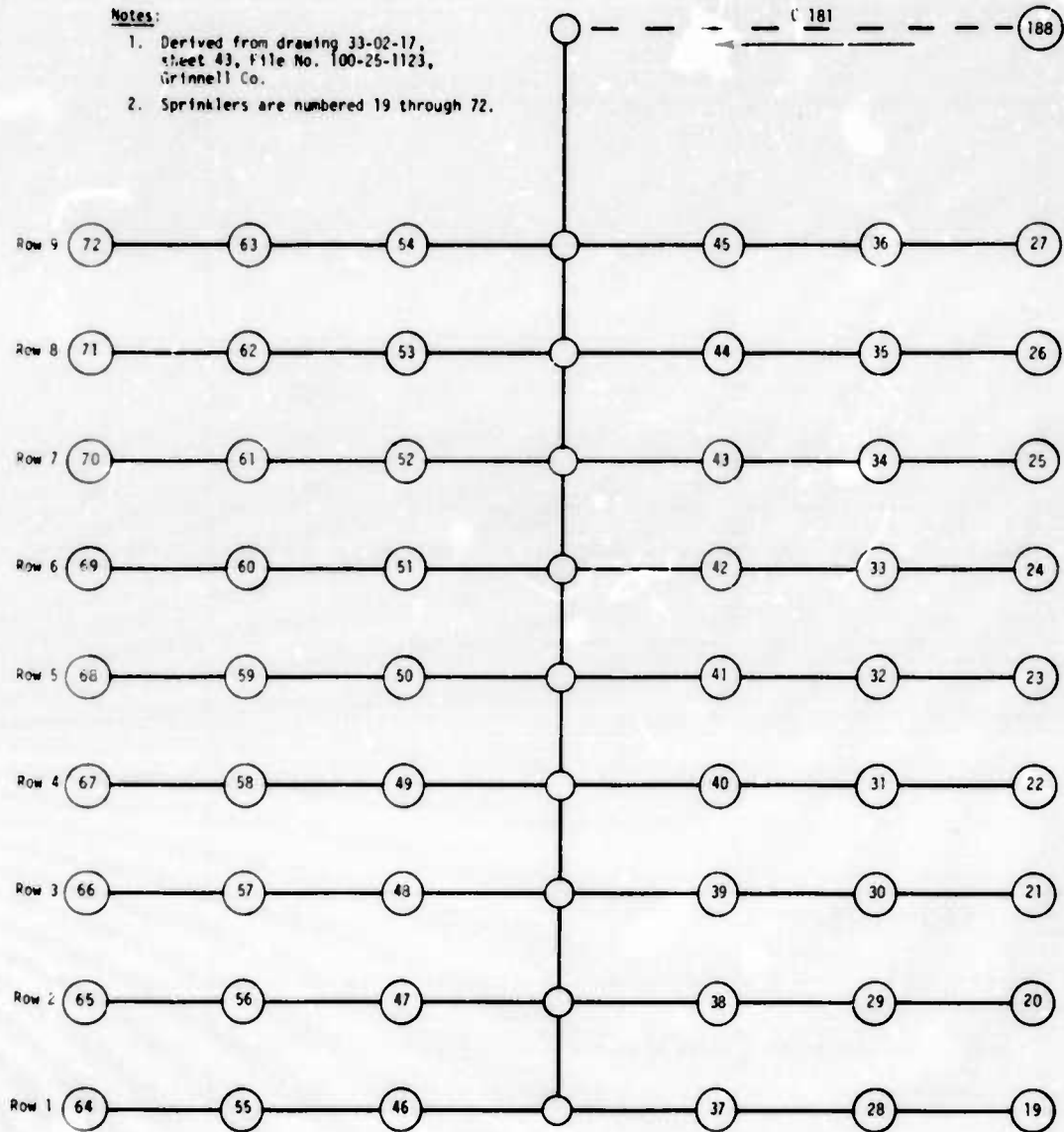
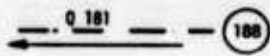

Figure 4. Sprinkler System in Building 783 at McClellan Air Force Base

Notes:

1. Derived from drawing 33-02-31, sheet 61, Region III, File No. 100-25-1148.
2. Sprinklers are numbered 1 through 72.



City Water Supply Pressure is 61 psig

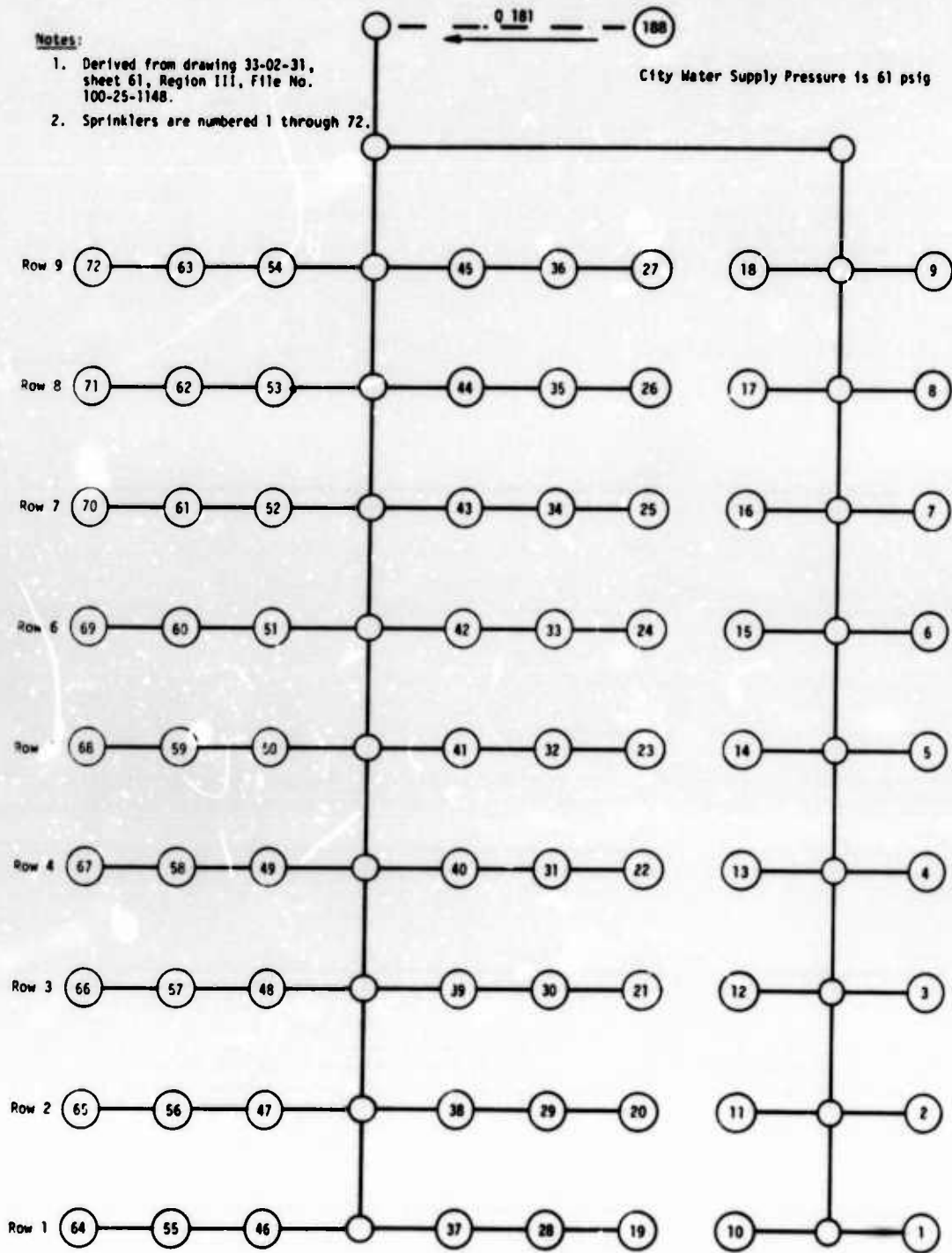

Figure 5. Sprinkler System in Building 786 at McClellan Air Force Base

City Water Supply Pressure is 61 psig

Notes:

1. Derived from drawing 33-02-31, sheet 62, File No. 100-25-1148.
2. Sprinklers are numbered 1 through 48.

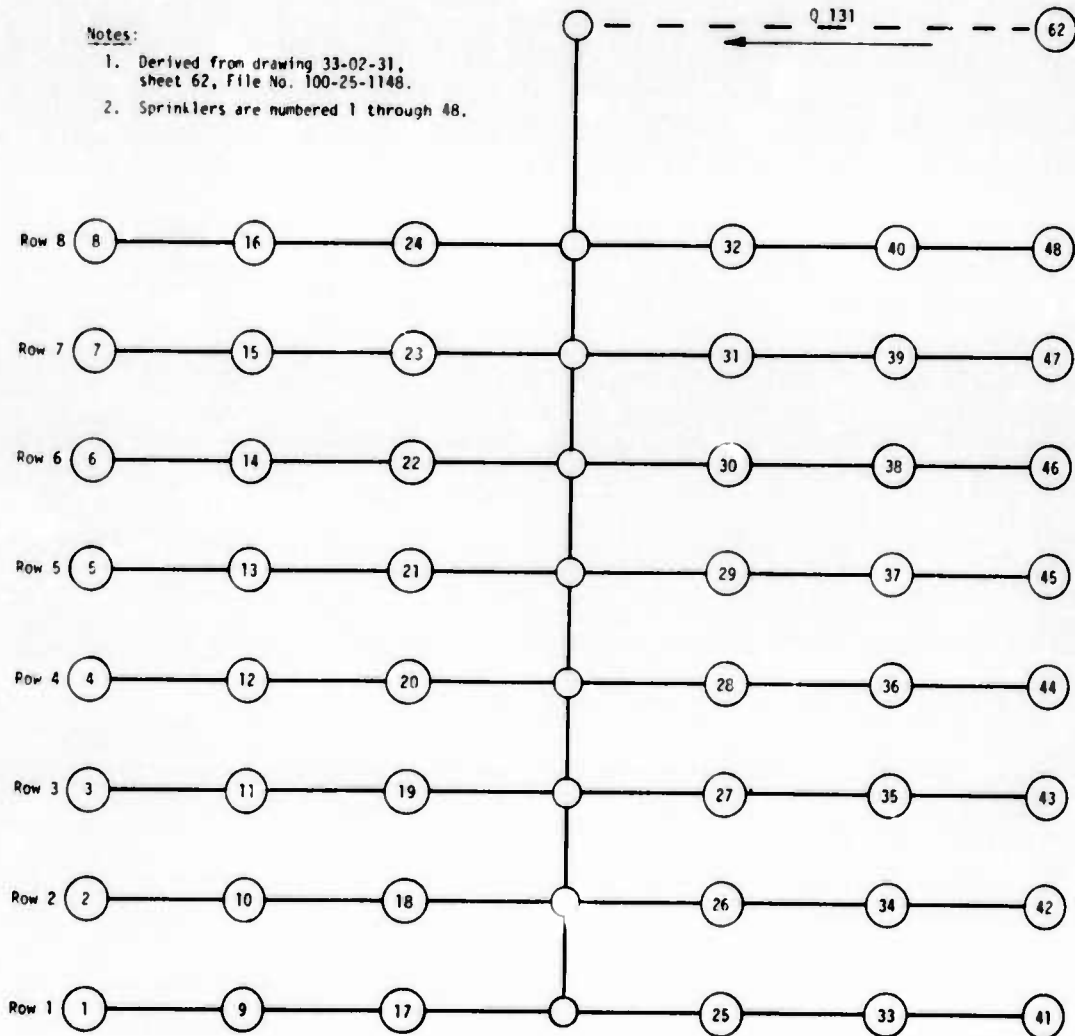

Figure 6. Sprinkler System in Mezzanine of Building 786 at McClellan Air Force Base

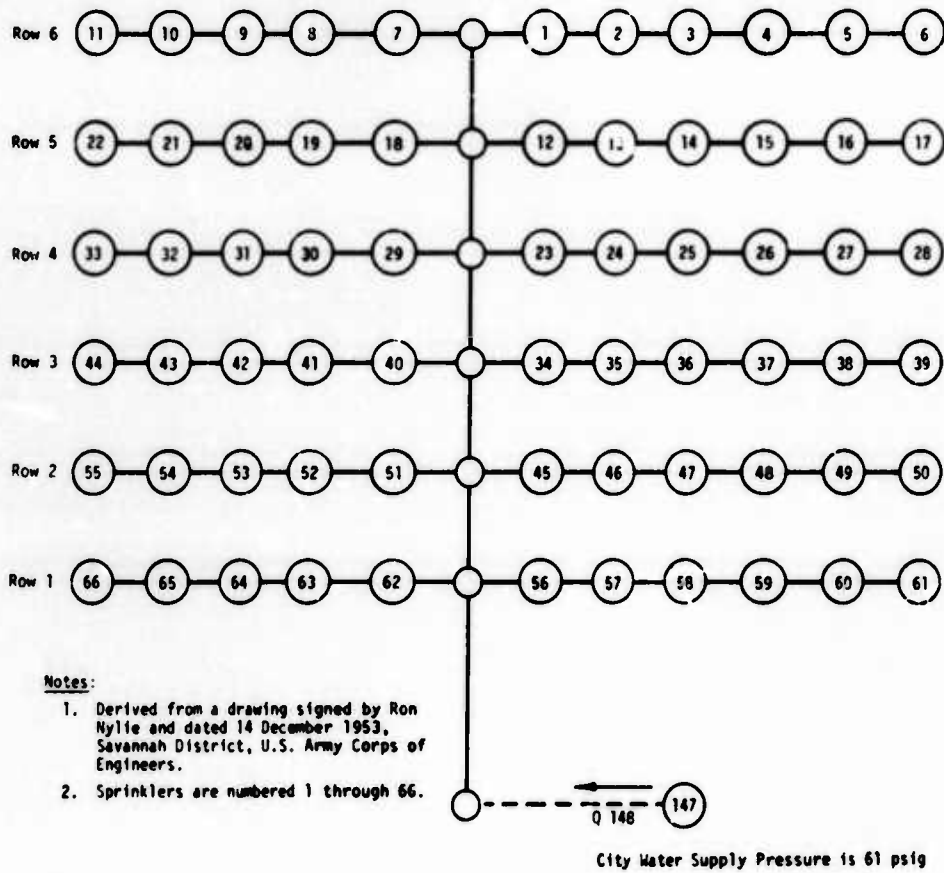

Figure 7. Sprinkler System in Buildings 380 and 385 at Robins Air Force Base

City Water Supply Pressure is 60 psig

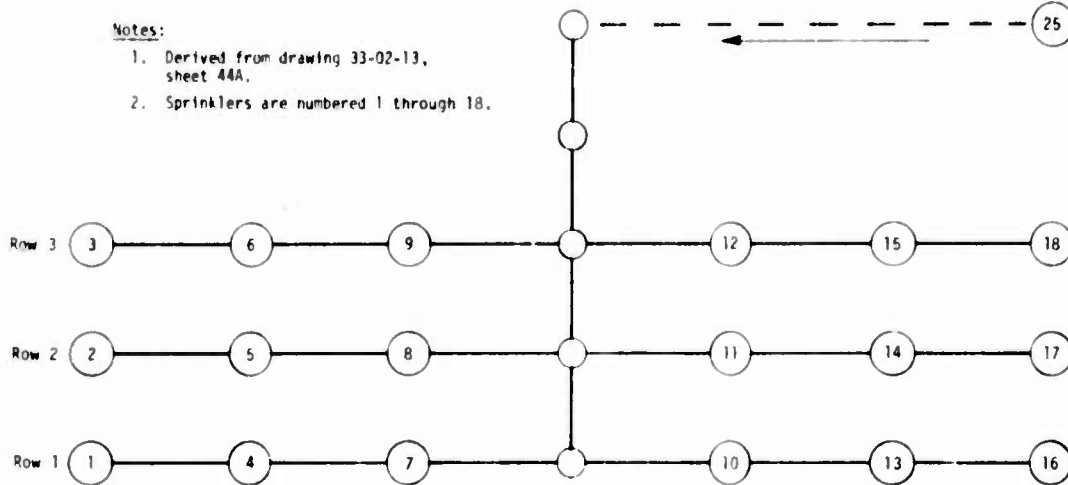

Figure 8. Small Sprinkler System in Buildings 350, 368, and 660 at Robins Air Force Base

and the orifice equation

$$Q = \sqrt{p/a} \quad (3)$$

where

- Q = flow rate in gpm
- p = pressure in psig
- Δp = pressure drop along a pipe
- k = pipe resistance factor
- a = orifice coefficient computed from experimental data for the sprinkler head (ref. 2, fig. 17)

The continuity equation (conservation of mass) was applied at each sprinkler

-
2. Krasner, L. M., et al., *Fire Protection Study: USAF Mobility Program Structures and Large Air Force Warehouses*, AFWL-TR-72-246, Air Force Weapons Laboratory, Kirtland Air Force Base, New Mexico, May 1973.

Notes:

- 1. Derived from drawing 33-02-13, sheet 44E.
- 2. Sprinklers are numbered 1 through 29.

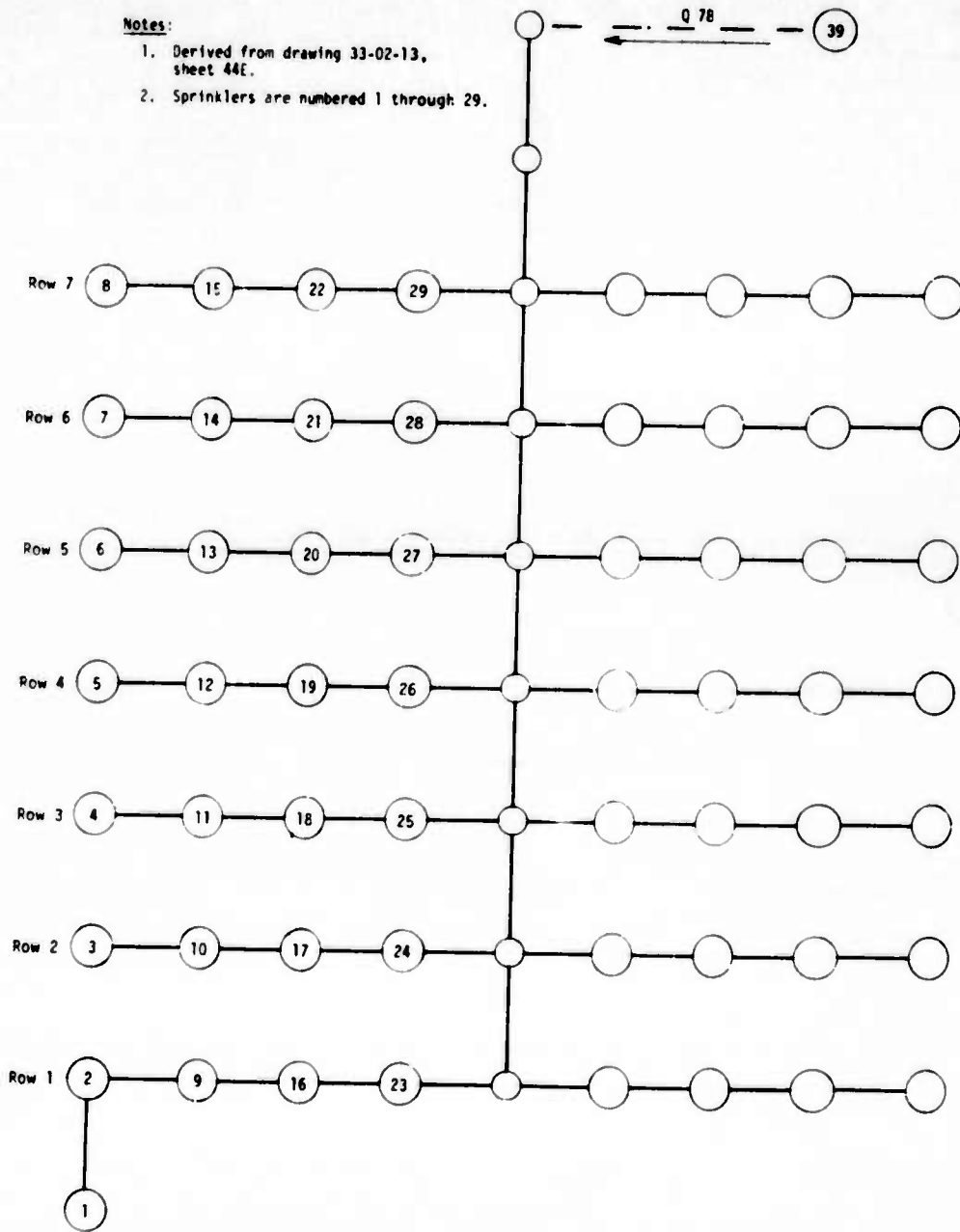

Figure 9. Large Sprinkler System in Buildings 350, 368, and 660 at Robins Air Force Base

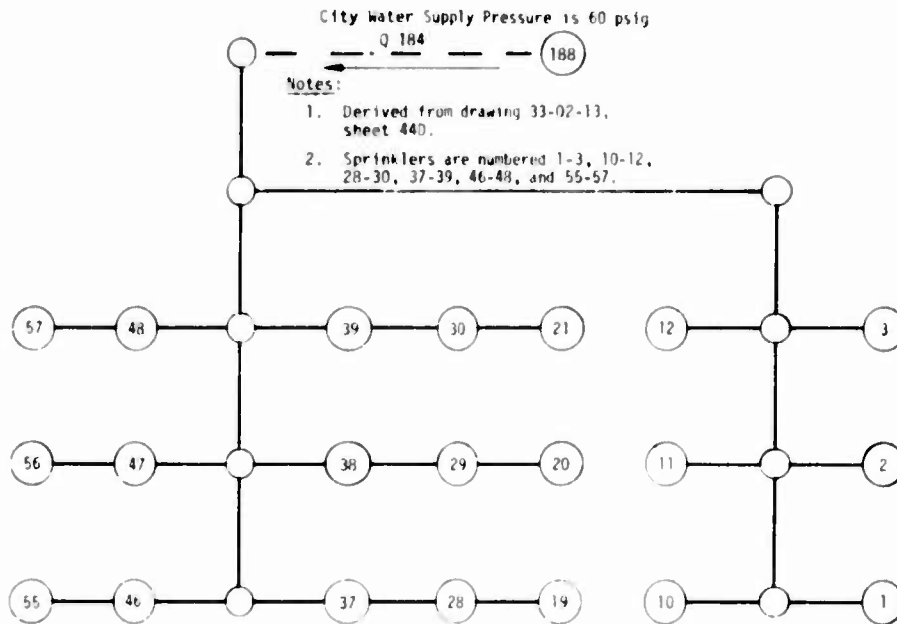

Figure 10. Sprinkler System in Air Materiels Command Warehouses at Robins Air Force Base

and pipe junction; the Hazen-Williams formula was applied along each length of pipe; and the orifice equation was applied at each sprinkler.

The pressure used in the orifice equation (3) to determine the discharge from the sprinkler was the total pressure, not the static pressure. This was done to simplify the computations but introduces small errors in the values of the sprinkler discharge flow rate densities which, at most, are about 3 pct*. These errors are highest in the lower values of the flow rate densities. In

* The static pressure is the total pressure minus the dynamic pressure, $\frac{\rho V^2}{2}$, where ρ is the density of the fluid and V its average velocity. For a 1-in-diameter pipe with a flow rate of 30.9 gpm (0.44 gpm/ft²), the total pressure at the upstream sprinkler with a discharge rate of 35.6 gpm is 11.85 psig (in buildings 350, 368, and 660 at Robins Air Force Base for the system shown on sheet 44E of drawing 33-02-13) and the dynamic pressure is 1.07 psig so the static pressure is 10.78 psig. Thus, the values of the discharge rate should be reduced by 1.0 to 1.5 gpm, which is about 3 pct. The flow rate densities would also be reduced proportionately.

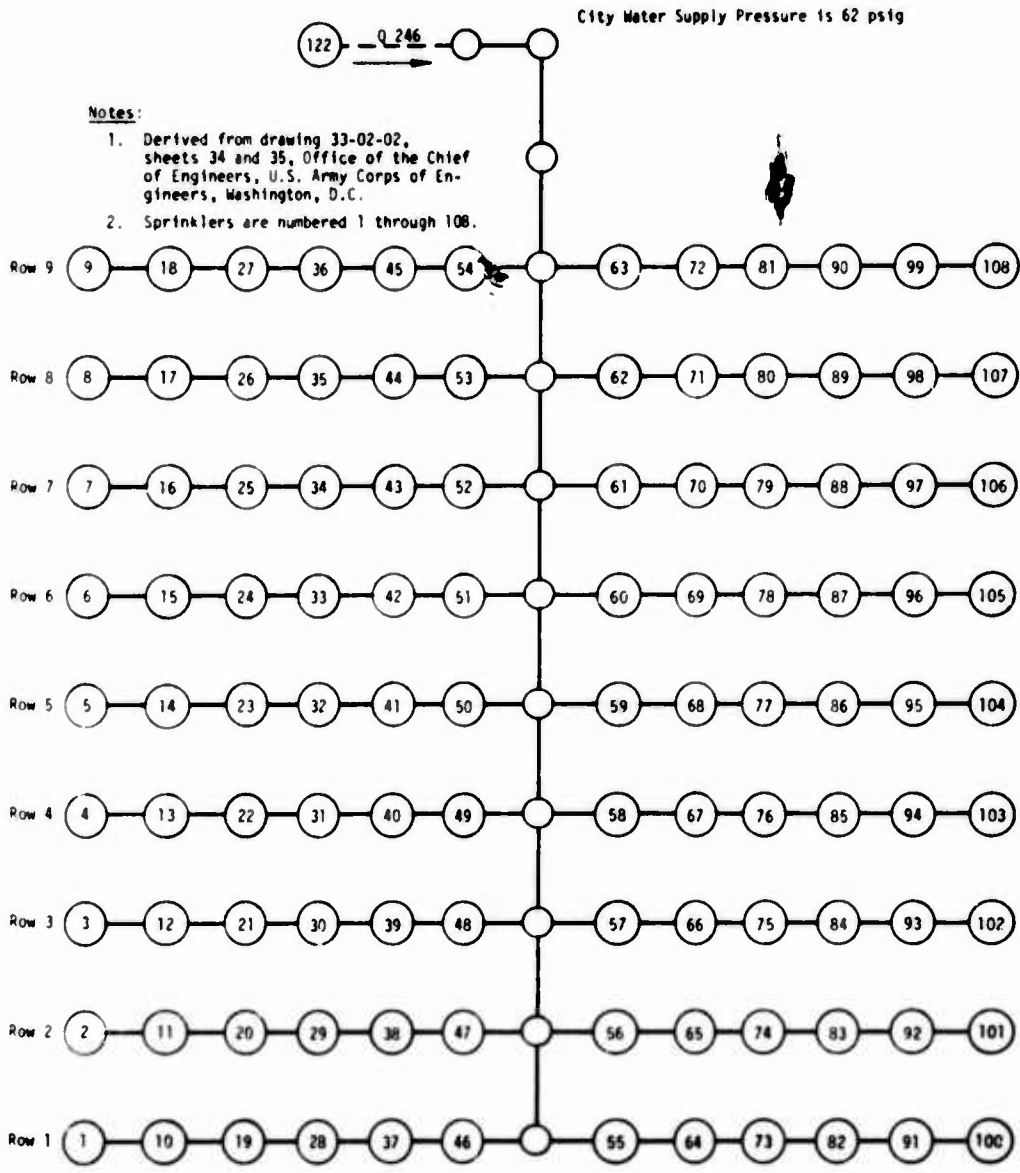

Figure 11. Sprinkler System in Buildings 10, 18, and 412 at Tinker Air Force Base

City Water Supply Pressure is 62 psig

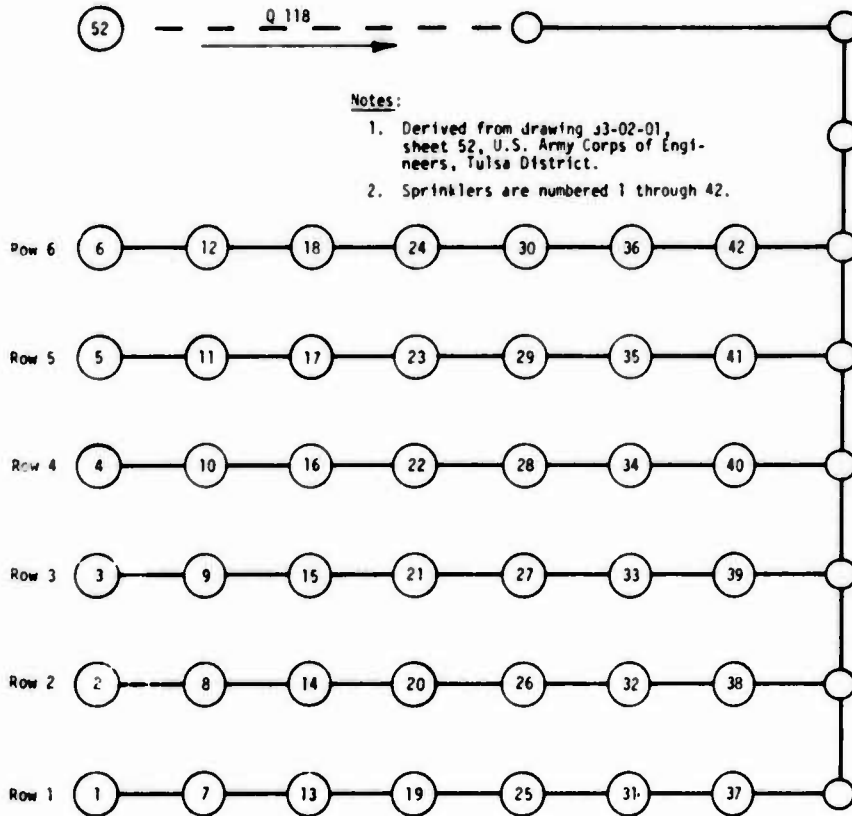

Figure 12. Sprinkler System in Building 416 at Tinker Air Force Base

other words, the values given in tables 1 through 5 for the lower end of the ranges may be as much as 3 pct too high.

No corrections have been made for bends, reducing sections, valves, or T-connections. Taking these into account would result in a further small reduction in all values shown in tables 1 through 4.

In addition to simulating the systems with the 0.64-in sprinkler heads, a few studies were made of the effects of adding an auxiliary pump to boost the system pressure, of replacing all 1-in-diameter pipe with 1-1/4-in diameter pipe, and of both of these modifications simultaneously. The results are shown in tables 2, 3, and 4.

The total flow rates which can be supplied by the existing city water supplies are shown in table 5. These values are compared with the flow rates which would be used by the systems retrofitted with the new sprinkler heads.

Table 1. Comparison of Flow Density Data

Location	Two Rows of Three Sprinklers			Three Rows of Two Sprinklers			Sprinkler Schematic
	Flow Density, gpm/ft. ²		Sprinkler Numbers	Flow Density, gpm/ft. ²		Sprinkler Numbers	
	No Ceiling Correction	Corrected for 23-ft Ceiling*		No Ceiling Correction	Corrected for 23-ft Ceiling*		
Bldg 850, Hill AFB	0.18-0.39	0.16-0.35	1,2,4,5, 7,8	0.24-0.31	0.22-0.28	1,2,3,4, 5,6	Figure 1
AMC Warehouse, Kelly AFB	0.37-0.61	0.34-0.56	1,2,4,5, 7,8	0.45-0.52	0.42-0.48	1,2,3,4, 5,6	Figure 2
AMC Warehouse, Kelly AFB	0.30-0.51	0.28-0.47	1,2,10,11, 19,20	0.38-0.44	0.35-0.40	1,2,3,10, 11,12	Figure 3
Bldg 783, McClellan AFB	0.08-0.51	0.07-0.48	19,20,28, 29,37,38	0.16-0.42	0.14-0.39	19,20,21, 28,29,30	Figure 4
Bldg 786, McClellan AFB	0.28-0.41	0.26-0.38	1,2,10, 11,19,20	0.23-0.41	0.21-0.38	1,2,3,10, 11,12	Figure 5
Mezzanine, Bldg 766, McClellan AFB**	0.26-0.59	0.24-0.54	1,2,9,10, 17,18	0.32-0.38	0.29-0.35	1,2,3,9, 10,11	Figure 6
Bldg 380 & 385, Robins AFB	0.37-0.61	0.34-0.55	4,5,6,15 16,17	0.45-0.52	0.41-0.48	5,6,16,17, 27,28	Figure 7
Bldg 350,368, & 660, Robins AFB	0.24-0.45	0.22-0.41	1,2,4,5, 7,8	0.27-0.34	0.25-0.31	1,2,3,4, 5,6	Figure 8
Bldg 350,368, & 660, Robins AFB	0.44-0.91	0.40-0.83	1,2,3,9, 10,16,17	0.49-0.88	0.45-0.80	1,2,3,4,9, 10,11	Figure 9
AMC Warehouse, Robins AFB	0.26-0.45	0.23-0.41	1,2,10,11 19,20	0.22-0.44	0.20-0.40	1,2,3,10, 11,12	Figure 10
Bldg 10,18, & 412, Tinker AFB**	0.33-0.59	0.30-0.54	1,2,10,11 19,20	0.41-0.49	0.37-0.45	1,2,3,10, 11,12	Figure 11
Bldg 416, Tinker AFB	0.31-0.58	0.28-0.53	1,2,7,8, 13,14	0.40-0.49	0.37-0.45	1,2,3,7, 8,9	Figure 12

* A 23-ft rise in piping causes a 10-psig pressure drop.

** Systems simulated in burn tests conducted by Factory Mutual Research Corporation.

† This system has a total of seven sprinklers.

Table 2. Flow Densities in Building 850 at Hill Air Force Base (fig. 1)

Flow Rate, gpm/ft ²		Modification
Two Rows of Three Sprinklers, Sprinkler Numbers 1,2,4,5,7,8	Three Rows of Two Sprinklers, Sprinkler Numbers 1,2,3,4,5,6	
0.18-0.39	0.24-0.31	None (supply pressure = 69 psig) Boost pump (supply pressure = 138 psig) All 1-1/4-in diameter pipe replaced with 1-1/4-in diameter pipe (supply pressure = 69 psig) Boost pump, all 1-in diameter pipe replaced with 1-1/4-in diameter pipe (supply pressure = 138 psig)
0.26-0.55	0.34-0.44	
0.23-0.34	0.30-0.33	
0.34-0.49	0.43-0.50	

Table 3. Flow Densities in Building 783 at McClellan Air Force Base (fig. 4)

Flow Rate, gpm/ft ²		Modification
Two Rows of Three Sprinklers, Sprinkler Numbers 19,20,26,29,37,38	Three Rows of Two Sprinklers, Sprinkler Numbers 19,20,21,28,29,30	
0.08-0.51	0.16-0.42	None (supply pressure = 61 psig) Boost pump (supply pressure = 122 psig) All 1-in diameter pipe replaced by 1-1/4-in diameter pipe (supply pressure = 61 psig) Boost pump, All 1-in diameter pipe replaced by 1-1/4-in diameter pipe (supply pressure = 122 psig)
0.15-0.72	0.26-0.60	
0.29-0.46	0.36-0.43	
0.43-0.65	0.52-0.62	

Table 4. Flow Densities in Buildings 350, 368, and 660 at Robins Air Force Base (fig. 8)

Flow Rate, gpm/ft ²		Modification
Two Rows of Three Sprinklers, Sprinkler Numbers 1,2,4,5,7,8	Three Rows of Two Sprinklers, Sprinkler Numbers 1,2,3,4,5,6	
0.24-0.45	0.27-0.34	None (supply pressure = 60 psig) Boost pump (supply pressure = 120 psig)
0.35-0.65	0.40-0.48	

Table 5. Comparison of Predicted Maximum Flow Rates in Retrofitted Systems

Air Force Base	Flow Rate Available at Valve Closet*, gpm	Maximum Totals		Flow Rate, gpm
		Flow Rate Used for Six Sprinklers, gpm	Number of Sprinklers Active	
Hill	2700	200	18	362
Kelly	6700	273	40	1034
McClellan	2130	285	48	1014
Robins	2800	360	36	1210
Tinker	4400	250	44	1097

*The method used to calculate these values is shown in appendix B.

SECTION 3
DATA DISCUSSION

Since all computational values have approximately the same small errors, the other values in the tables can be compared with those obtained for the systems which were judged "adequate" in actual burn tests using the new 0.64-in-orifice sprinkler heads. The burn tests were conducted by simulating one of the systems in buildings 380 and 385 at Robins Air Force Base and (apparently) all of the systems in buildings 10, 18, and 416 at Tinker Air Force Base as if the 0.64-in orifices were installed. Thus, the computational values obtained for these two systems (ref. 1) are used as the acceptable standard. It is interesting to note that the values given in table 1 for these two systems bracket the value of 0.5 gpm/ft² which the Factory Mutual Research Corporation feels to be "safe" or "adequate" for Air Force warehouses.

A separate computer program was written for each system studied in order to allow modifications to be easily made and their effects assessed in any future studies.

Since it was not clear from previous data (ref. 1, table 1), and the blueprints furnished, where the water supply pressures were measured, two computer studies were conducted: The first assumed these pressures were measured at ceiling level and the second at ground level. Table 1 shows the results for the study in which the pressure was assumed to have been measured at ceiling level and compares these results with the results from the studies where a 23-ft ceiling correction was made in the supply pressures (the 23-ft ceiling correction results in an overall 10-psi drop in pressure). The results of this study are unaltered by this consideration.

The new 0.64-in sprinkler heads were not available to the Civil Engineering Research Facility (CERF), so no flow tests were made.

-
1. Miller, M. J., et al., *New Criteria for Fire Protection of Large Air Force Warehouses*, AFWL-TR-70-1, Vol. 1, Air Force Weapons Laboratory, Kirtland Air Force Base, New Mexico, August 1970.

SECTION 4
CONCLUSIONS AND RECOMMENDATIONS

As shown in table 1, the systems in building 850 at Hill Air Force Base and building 783 at McClellan Air Force Base definitely will not give adequate protection when fitted with the new 0.64-in-orifice sprinklers.

This study also indicates that the system in building 416 at Tinker Air Force Base, the system (fig. 2) in a building at Kelly Air Force Base, and one system (fig. 9) in buildings 350, 365, and 660 at Robins Air Force Base will give adequate protection when retrofitted with the new sprinklers.

The remaining systems studied will give marginal protection. These could probably be made adequate by the addition of a boost pump. As shown in tables 2 and 3, the systems judged "worst" in this study (building 850 at Hill Air Force Base and building 783 at McClellan Air Force Base) would provide "adequate" protection if a boost pump and 1-1/4-in pipe were installed. Only a boost pressure equal to the available water supply was considered (i.e., a total supply pressure equal to twice the currently available supply pressure). It may be possible to achieve an adequate level of protection by using higher boost pressures. However, replacing all 1-in pipe with 1-1/4-in pipe would reduce the need for extremely high boost pressures. Also, table 5 indicates that the current water supplies are more than adequate, so utilizing a boost pump would be feasible.

Based on the results of this study as correlated with the burn tests previously mentioned, the following recommendations are made:

- (1) All Air Force warehouse sprinkler systems be fitted with the new 0.64-in-orifice sprinkler heads.
- (2) All 1-in-diameter pipe in the current systems be replaced with 1-1/4-in pipe*.

* Replacing all 1-in and 1-1/4-in pipe with 1-1/2-in pipe would be more desirable. However, this would entail about twice as much pipe.

- (3) Auxiliary boost pumps be installed for all systems.
- (4) All future warehouse sprinkler systems incorporate recommendations 1 and 3 and use pipes 1-1/2-in or larger in diameter.

Recommendation 3 can be considered and acted on immediately since it should be very easy and relatively inexpensive to implement. In fact, if the current systems can withstand very high boost pressures, a boost pump may supply adequate protection with the current systems, thus eliminating the need for installing new sprinkler heads. (This could be evaluated using the computer programs developed in this study with slight modifications. Then burn tests could be conducted to verify the results).

APPENDIX A
 SAMPLE PROCEDURE FOR CALCULATING SPRINKLER SYSTEM FLOW RATES

This appendix uses equations (1), (2), and (3) from the body of this report to calculate flow rates in a simplified sprinkler system. With a steady flow and all sprinklers operating, use the following sequence of operations to determine the flow rates:

- (1) Assume a value for p_1 (the pressure causing flow out of sprinkler 1) which is some fraction of the city water supply pressure, p_7 .
- (2) With p_1 , compute the flow rate from sprinkler 1 using eq. (3), i.e.

$$Q_1 = \sqrt{p_1/a}$$

- (3) From eq. (1), the flow rate in pipe 15 is

$$Q_{15} = Q_1$$

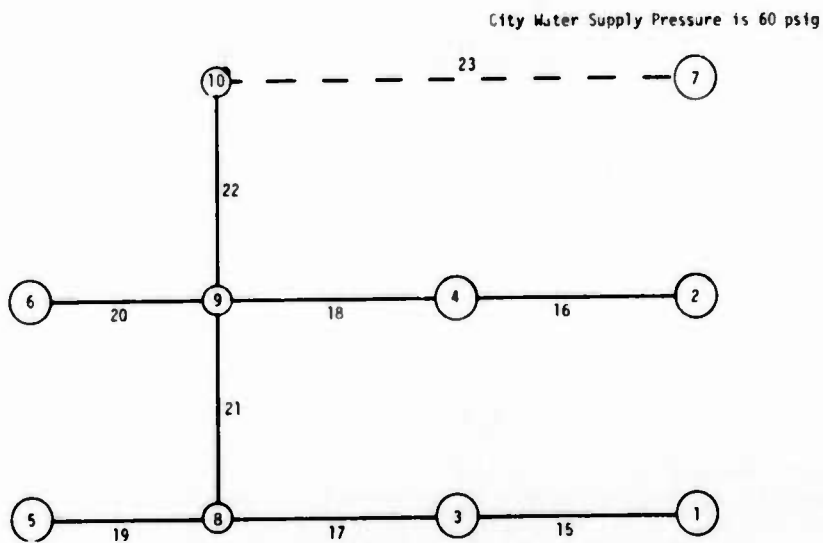

Simplified Sprinkler System. Sprinklers are numbered 1-6, pipes are numbered 1-15, pipe junctions are numbered 8-10, and water supply is numbered 7.

(4) From eq. (2)

$$p_3 = p_1 + k_{15} Q_{15}^{1.85}$$

(5) From eq. (3)

$$Q_3 = \sqrt{p_3/a}$$

(6) From eq. (1)

$$Q_{17} = Q_3 + Q_{15}$$

(7) From eq. (2)

$$p_8 = p_3 + k_{17} Q_{17}^{1.85}$$

(8) Assume a value for p_5 .

(9) From eq. (3)

$$Q_5 = \sqrt{p_5/a}$$

(10) From eq. (1)

$$Q_{19} = Q_5$$

(11) From eq. (2)

$$p'_8 = k_{19} Q_{19}^{1.85}$$

(12) If p'_8 equals p_8 (to within 0.1 pct) continue to step 13. If p'_8 does not equal p_8 , assume a new value of p_5 and repeat steps 9 through 12 until agreement is reached. Note: From the equations one sees that p'_8 greater than p_8 is caused by p_5 being too large. The correction used in this study was

$$p_5 \text{ (new)} = p_5 \text{ (old)} \left(\frac{p_8 - p_8'}{p_8} + 1 \right)$$

(13) From eq. (1)

$$Q_{21} = Q_{19} + Q_{17}$$

(14) From eq. (2)

$$p_9 = p_8 + k_{21} Q_{21}^{1.85}$$

(15) Assume a value for p_2 which is some fraction of p_9 .

(16) Compute the flows in pipes 16 and 18, the flow and pressure in sprinkler 4 and the pressure at joint 9 (call this p_9') as in steps 2 through 7. If p_9' equals p_9 , continue to step 17. If p_9' does not equal p_9 , correct p_2 as in step 12 and repeat the process similar to steps 2 through 7 until agreement is reached.

(17) Assume a value for p_6 and compute the flows and pressure p_9'' . If p_9'' equals p_9 , continue to step 18. If not, correct p_6 as outlined in step 12 and repeat the process until agreement is reached.

(18) From eq. (1)

$$Q_{22} = Q_{23} = Q_{18} + Q_{20} + Q_{21}$$

(19) From eq. (2)

$$p_7 = p_9 + (k_{22} + k_{23}) Q_{23}^{1.85}$$

(20) If p_7 equals 60 psig, the results are printed and the computation terminated. If p_7 does not equal 60 psig, p_1 is corrected as in step 12 and steps 2 through 19 repeated until agreement is reached. It can be shown that the appropriate values of the resistance, k , used in the Hazen-Williams formula are obtained using the formula

$$k = \frac{62.4}{144} L \left[\frac{1.547}{694.444 \times 1.318 C_1 \left(\frac{D}{4}\right)^{0.63} \pi \frac{D^2}{4}} \right]^{1.85}$$

where

- L = length of pipe in feet
- D = diameter of pipe in feet
- C₁ = Hazen-Williams coefficient

The units of in eq. (2) are then pounds per square inch for p and gallons per minute for Q.

APPENDIX B
PROCEDURE FOR CALCULATING TOTAL
FLOW RATE AVAILABLE TO SPRINKLER SYSTEMS

The furnished data (ref. 1, table 1) provided a static (tested water) pressure (which is the total pressure available) and a "1000 GPM Flowing" pressure (which is the pressure available when 1000 gpm are flowing through the system). Both pressures were measured at the valve closet, so the Hazen-Williams formula, [eq. (2) in the body of this report] can be used to obtain

$$Q_2 = Q_1 \left(\frac{\Delta p_2}{\Delta p_1} \right)^{0.54}$$

With Δp_2 as the "tested water" pressure, Δp_1 as the difference between the "tested water" pressure and the "1000 GPM Flowing" pressure, and Q_1 as 1000 gpm, Q_2 becomes the maximum flow rate available at the valve closet. Thus,

$$Q_{\max} = 1000 \left(\frac{P_{\text{tested}}}{P_{\text{tested}} - P_{1000}} \right)^{0.54}$$

Here the assumption has been made that the pressure at the valve closet will be atmospheric pressure, i.e., a boost pump would be required at the valve closet. The inlet pressure to the boost pump would be atmospheric. (Actually, it would be possible to reduce this pressure below atmospheric --and hence have a higher flow rate available --but the values given in table 5 are adequate for all but extremely large fires).

-
1. Miller, M. J., *New Criteria for Fire Protection of Large Air Force Warehouses*, AFWL-TR-70-1, Vol. I, Air Force Weapons Laboratory, Kirtland Air Force Base, New Mexico, August 1970.

ABBREVIATIONS, ACRONYMS, AND SYMBOLS

C_1	Hazen-Williams coefficient
D	Pipe diameter
L	Pipe length
Q	Flow rate
V	Average fluid velocity
a	Orifice discharge coefficient for sprinkler head
k	Pipe flow resistance
p	Pressure
Δp	Pressure drop
ρ	Fluid density

Subscript Convention:

All subscripts denote the particular pipe or sprinkler head as designated in the figures with which the flow rate, pressure, or flow resistance is associated.