

FINAL REPORT

Field Testing A Passive Multisampler To Measure
Dioxins/Furans And Other Contaminant Bioavailability
In Aquatic Sediments - Phase II

SERDP Project ER-2538

JULY 2020

Rainer Lohmann, Ph.D.
University of Rhode Island

Michael Weinstein
Montclair State University

Distribution Statement A

This document has been cleared for public release



This report was prepared under contract to the Department of Defense Strategic Environmental Research and Development Program (SERDP). The publication of this report does not indicate endorsement by the Department of Defense, nor should the contents be construed as reflecting the official policy or position of the Department of Defense. Reference herein to any specific commercial product, process, or service by trade name, trademark, manufacturer, or otherwise, does not necessarily constitute or imply its endorsement, recommendation, or favoring by the Department of Defense.

REPORT DOCUMENTATION PAGE

Form Approved
OMB No. 0704-0188

The public reporting burden for this collection of information is estimated to average 1 hour per response, including the time for reviewing instructions, searching existing data sources, gathering and maintaining the data needed, and completing and reviewing the collection of information. Send comments regarding this burden estimate or any other aspect of this collection of information, including suggestions for reducing the burden, to Department of Defense, Washington Headquarters Services, Directorate for Information Operations and Reports (0704-0188), 1215 Jefferson Davis Highway, Suite 1204, Arlington, VA 22202-4302. Respondents should be aware that notwithstanding any other provision of law, no person shall be subject to any penalty for failing to comply with a collection of information if it does not display a currently valid OMB control number.
PLEASE DO NOT RETURN YOUR FORM TO THE ABOVE ADDRESS.

1. REPORT DATE (DD-MM-YYYY) 07/07/2020		2. REPORT TYPE SERDP Final Report		3. DATES COVERED (From - To) 7/26/2018 - 7/25/2021	
4. TITLE AND SUBTITLE Field Testing A Passive Multisampler To Measure Dioxins/Furans And Other Contaminant Bioavailability In Aquatic Sediments (Task 1) - Phase II				5a. CONTRACT NUMBER 18-C-0050	
				5b. GRANT NUMBER	
				5c. PROGRAM ELEMENT NUMBER	
6. AUTHOR(S) Rainer Lohmann, University of Rhode Island Michael Weinstein, Montclair State University				5d. PROJECT NUMBER ER-2538	
				5e. TASK NUMBER	
				5f. WORK UNIT NUMBER	
7. PERFORMING ORGANIZATION NAME(S) AND ADDRESS(ES) University of Rhode Island South Ferry Road Narragansett, RI 02882				8. PERFORMING ORGANIZATION REPORT NUMBER ER-2538	
9. SPONSORING/MONITORING AGENCY NAME(S) AND ADDRESS(ES) Strategic Environmental Research and Development Program (SERDP) 4800 Mark Center Drive, Suite 16F16 Alexandria, VA 22350-3605				10. SPONSOR/MONITOR'S ACRONYM(S) SERDP	
				11. SPONSOR/MONITOR'S REPORT NUMBER(S) ER-2538	
12. DISTRIBUTION/AVAILABILITY STATEMENT DISTRIBUTION STATEMENT A. Approved for public release: distribution unlimited.					
13. SUPPLEMENTARY NOTES					
14. ABSTRACT The project further developed and field-tested an in situ passive multi-sampler to quantify polychlorinated dibenzo-p-dioxins and dibenzofurans (PCDD/Fs), and other hydrophobic organic contaminants (HOCs), such as polychlorinated biphenyls (PCBs) in sediment and water column. The novel sampler was validated and field-tested – without the need for divers - both in shallow and deep sediments at several sites along the Passaic River (NJ) and Newark Bay (NJ/NY). Our proposed technology development thus continued to address key SERDP objectives, to 'Develop a multi-purpose passive sampling device capable of collecting data on several contaminants of interest; [...] in sediment and the immediate overlying surface water'.					
15. SUBJECT TERMS Passive sampling, dioxins, furans, PCBs, porewater, dissolved, bioaccumulation					
16. SECURITY CLASSIFICATION OF:			17. LIMITATION OF ABSTRACT UNCLASS	18. NUMBER OF PAGES 57	19a. NAME OF RESPONSIBLE PERSON Rainer Lohmann
a. REPORT UNCLASS	b. ABSTRACT UNCLASS	c. THIS PAGE UNCLASS			19b. TELEPHONE NUMBER (Include area code) 401-874-6612

FINAL REPORT

Project: ER-2538

TABLE OF CONTENTS

	Page
ABSTRACT	vii
EXECUTIVE SUMMARY	ES-1
1 SERDP RELEVANCE	1
2 TECHNICAL OBJECTIVES	2
3 TECHNICAL APPROACH.....	4
3.1 Background	4
3.2 Materials and Methods.....	6
3.2.1 PE preparation	6
3.2.2 <i>Ex situ</i> porewater equilibrations	7
3.2.3 Sample extraction and clean-up	7
3.2.4 PE processing	7
3.2.5 Chemical analysis of PCDD/Fs, PCBs, and OCPs.....	7
3.2.6 Sediment total organic carbon (TOC) and BC	8
3.2.7 PRC corrections.....	8
3.2.8 QA/QC.....	8
3.3 Approach	8
3.4 Research Team	21
3.5 Transition Potential:	21
4 LITERATURE CITED	23
Appendix A Supporting Data.....	A-1
Appendix B List of Scientific Publications	B-1

LIST OF FIGURES

	Page
Figure 1. Previous SEED In Situ Multisampling Device for Dioxins/Furans and HOCs in Sediments.....	6
Figure 2. Basic Danforth Anchor Design.....	9
Figure 3. Technical Design of Modified Danforth PE In Situ Multisampler, Where Both Flukes Will Hold Passive Sampler PE Sheets.....	10
Figure 4. The Modified Multisampler Anchor Without PE Sheets in the Laboratory.....	11
Figure 5. The Modified Multisampler Anchor During Field Deployment.....	11
Figure 6. Calculated Porewater (A) and River Water (B) Concentrations of PCDD/Fs.....	12
Figure 7. Calculated Porewater (A) and River Water (B) Concentrations of PCBs.....	13
Figure 8. Comparison Between Using Either d-PAHs or ¹³ C-PCDDs as PRCs for Correcting Porewater Passive Samplers for Nonequilibrium Using <i>In Situ</i> (A) and <i>Ex Situ</i> (B) Approaches at the Sampling Sites. (<i>Khairy et al., 2020</i>).....	14
Figure 9. Concentration Differences Between Passive Multisamplers (Circle <i>In Situ</i> ; Anchor-style <i>In Situ</i> , and <i>Ex Situ</i> Porewater) at Each Site for Selected PCB Congeners.....	15
Figure 10. Summer 2019 Sampling Sites in Newark Bay.....	17
Figure 11. Deployment Sites of Anchor PE-multisampler During Second Deployment, January -February 2020.....	18
Figure 12. Comparison of <i>Ex Situ</i> vs <i>In Situ</i> PCB Porewater Concentrations for Newark Bay (Winter 2020).....	19
Figure 13. Derived <i>Ex Situ</i> Porewater Concentrations from Newark Bay (Winter 2020).....	20

LIST OF TABLES

	Page
Table 1. Summary of the First Field Season Deployments (Summer 2019).....	14
Table 2. Summary of the Second Field Season Deployments (January-February 2020)..	16

ACRONYMS AND ABBREVIATIONS

>	greater than
°	degree(s)
%	percent
~	approximately
µm	micrometer(s)
a_w	chemical activity
BAF	bioaccumulation factor
BC	black carbon
$C_{lip,OC}$	estimated lipid concentrations from sediment organic carbon partitioning
$C_{lip,OC+BC}$	lipid concentration based on sediment's organic carbon and black carbon
$C_{lip,PEdw}$	lipid concentrations based on deep water concentrations
$C_{lip,PEpw}$	lipid concentrations based on porewater concentrations
C_{PE}	concentration in PE membrane
C_{sed}	concentration in sediments
$C_{W, app}$	apparent dissolved HOC concentration
$C_{W, corr}$	DOC corrected apparent dissolved HOC concentration
$C_{W, diss}$	freely dissolved aqueous concentration
cm	centimeter(s)
d-PAHs	deuterated polycyclic aromatic hydrocarbons
DCM	dichloromethane
DiCDD	dichlorinated dibenzo-p-dioxin
DiCDF	dichlorinated dibenzofuran
dioxins/furans	polychlorinated dibenzo-p-dioxins and dibenzofurans
DOC	dissolved organic carbon
DoD	Department of Defense
EPA	U.S. Environmental Protection Agency
f_{oc}	organic carbon fraction
f_{Bc}	black carbon fraction
FY	fiscal year
g	gram(s)
GC	gas chromatography
GC-MS/MS	gas chromatograph coupled to tandem mass spectrometric analyzer
GSO	Graduate School of Oceanography
Hex	hexane

HOCs	hydrophobic organic contaminants
HpCDD	heptachlorinated dibenzo- <i>p</i> -dioxin
HpCDF	heptachlorinated dibenzofuran
hr	hour(s)
HxCDD	hexachlorinated dibenzo- <i>p</i> -dioxin
ID	inner diameter
K_{BC}	black carbon–water equilibrium partition constant
K_{DOCw}	DOC and water equilibrium partition constant
K_{OC}	organic carbon–water equilibrium partition constant
K_{ow}	octanol–water equilibrium partition constant
K_{Pew}	PE-water equilibrium partition constant
LDPE	low density polyethylene
m	meter(s)
mg	milligram(s)
mL	milliliter(s)
mm	millimeter(s)
ng	nanogram(s)
NIST	National Institute of Standards and Technology
NJ	New Jersey
NY	New York
OC	organic carbon
OCDD	octachlorinated dibenzo- <i>p</i> -dioxin
OCPs	organochlorine pesticides
PAHs	polycyclic aromatic hydrocarbons
PBBs	polybrominated biphenyls
PBDEs	polybrominated diphenyl ethers
PCBs	polychlorinated biphenyls
PCDD/Fs	dioxins/furans – polychlorinated dibenzo- <i>p</i> -dioxins and dibenzofurans
PE	polyethylene
PeCDD	pentachlorinated dibenzo- <i>p</i> -dioxin
PeCDF	pentachlorinated dibenzofuran
pg/g	picogram(s) per gram
pg/L	picogram(s) per liter
PI	Primary Investigator
POPs	persistent organic pollutants
PRC	performance reference compound

QA	quality assurance
QC	quality control
RI	Rhode Island
RPM	remedial project manager
SE	standard error
SERDP	Strategic Environmental Research and Development Program
SEED	SERDP Exploratory Development
sq ft	square foot/feet
S_w	water solubility
TCDD	tetrachlorinated dibenzo- <i>p</i> -dioxin
TCDF	tetrachlorinated dibenzofuran
TEQ	toxic equivalents
TL	trophic level
TOC	total organic carbon
WA	Washington

KEYWORDS

Passive sampling, dioxins, furans, PCBs, porewater, dissolved, bioaccumulation

ACKNOWLEDGMENTS

We thank Jim Lodge (HRF), Mark Reiss (EPA), and Jim Nickels (Monmoth College) for help with field deployments.

ABSTRACT

INTRODUCTION AND OBJECTIVES

The project further developed and field-tested an *in situ* passive multisampler to quantify polychlorinated dibenzo-*p*-dioxins and dibenzofurans (PCDD/Fs), and other hydrophobic organic contaminants (HOCs), such as polychlorinated biphenyls (PCBs) in sediment and water column. The novel sampler was validated and field-tested, without the need for divers, both in shallow and deep sediments at several sites along the Passaic River (NJ) and Newark Bay (NJ/NY). Our proposed technology development addresses a key Department of Defense (DoD) Strategic Environmental Research and Development Program (SERDP) objective, to ‘*Develop a multi-purpose passive sampling device capable of collecting data on several contaminants of interest; [...] in sediment and the immediate overlying surface water.*’

TECHNICAL APPROACH

The technical approach consisted of the construction, deployment, and validation of a modified sediment porewater multisampler for dioxins/furans and other HOCs. The construction of a passive multisampler in the flukes of a Danforth-style anchor was optimized in field tests. Initial field trials needed a diver to ensure deployments, while the final field deployment proceeded without divers. Performance reference compounds (PRCs) were included to be able to correct for the lack of equilibrium of target HOCs during field deployments. At each site, sediment grabs were collected to derive HOC porewater concentrations through *ex situ* equilibrations.

RESULTS

A first major deployment trial in Newark Bay included a comparison to a previously circular sampler and sediment equilibrations for PCBs and PCDD/Fs. The retrieval rate of the Danforth anchors exceeded 80% and was helped by the use of extra anchor chain. At all sites, porewater concentrations derived from *ex situ* equilibrations exceeded those from the *in situ* passive samplers. A second field trial across Newark Bay confirmed the easy deployment of these anchor-based passive samplers without the need for divers; again retrievals were mostly successful. The comparison of *ex situ* versus *in situ* porewater concentrations again showed *ex situ* concentrations of PCBs to exceed *in situ* concentrations by two to three fold. At most sites, PCDD/Fs were below detection limits. A newly published standard protocol was followed for the *ex situ* determination of HOC porewater concentrations that prevented depletion of porewater, which might have contributed to the observed discrepancy. A reanalysis of foodweb samples from the Passaic River suggested the passive sampling could be a powerful tool to predict HOC concentrations in the storage lipids of biota.

BENEFITS

The specific research objective supported the main interest of the DoD SERDP in the SERDP Exploratory Development (SEED) solicitation to simplify and speed up acquisition of information on relevant exposure to contaminants of interest *in situ*. Following this research, it will be possible to design and implement projects at current DoD sites to aid in remediation decision making.

Benefits of the sampler deployments include optimization of both pre-cleanup design and post-cleanup monitoring of contaminated sites. Potential deployments include contaminated sites such as the Lower Willamette River (WA), sites in the Great Lakes and Newark Bay (NY/NJ), where PCDD/Fs and other organic contaminants, including PCBs, are of concern. The field-tested sampler developed and validated as part of this project can be used to determine temporal and spatial contaminant concentrations in porewater and water column and be used to predict the bioaccumulation of these contaminants in benthic invertebrates at these sites.

EXECUTIVE SUMMARY

Field Testing a Passive Multisampler to Measure Dioxins/Furans and Other Contaminant Bioavailability in Aquatic Sediments (Task 1)

INTRODUCTION

The project further developed and field-tested an *in situ* passive multisampler to quantify polychlorinated dibenzo-*p*-dioxins and dibenzofurans (PCDD/Fs), and other hydrophobic organic contaminants (HOCs), such as polychlorinated biphenyls (PCBs), in sediment and water column. The novel sampler was validated and field-tested, without the need for divers, both in shallow and deep sediments at several sites along the Passaic River (NJ) and Newark Bay (NJ/NY). Our proposed technology development addresses the key Department of Defense (DoD) Strategic Environmental Research and Development Program (SERDP) objective, to ‘*Develop a multi-purpose passive sampling device capable of collecting data on several contaminants of interest; [...] in sediment and the immediate overlying surface water.*’

In this follow-up research proposal, we focused on task 1, namely to field test an *in situ* passive multisampler covering shallow and deep-water sediment sites without relying on divers for deployments or retrievals.

If task 1 has been successfully accomplished, we propose to use the new sampler to:

- *Further demonstrate the benefit of the in situ passive multisampler as a surrogate for the prediction of tissue PCDD/F, PCB, toxic equivalents (TEQs), and organochlorine pesticide (OCP) concentrations in benthic invertebrates and vertebrates (eel, mummichog) across several sites (task 2); and*
- *Assess the capability of the passive multisampler to yield representative spatial interrogation of site HOCs by contrasting various sediment sites and site-fidel biota (task 3).*

The specific research objectives support the main interest of SERDP to simplify and speed up acquisition of information on relevant exposure to contaminants of interest. Following this research it will be possible for Remedial Project Managers (RPMs) to design and implement passive sampler projects at current DoD sites affected by numerous HOCs to aid in remediation decision making. This will include both pre-cleanup design and post-cleanup monitoring of contaminated sites.

OBJECTIVES

In our previous SERDP Exploratory Development (SEED) project (ER-2538) we demonstrated the utility of polyethylene (PE)-based passive multisamplers for determining dissolved concentrations of PCDD/Fs, PCBs, and other HOCs at shallow sediment sites. Porewater measurements agreed well between *in situ* and *ex situ* measurement approaches. The use of porewater passive samplers was used to predict the bioaccumulation of HOCs in benthic invertebrates. Different benthic invertebrates displayed vastly differing body burdens of targeted HOCs. The site fidelity of porewater measurements was difficult to assess due to lack of consistent matrices to compare to. The SEED-funded work raised several important questions and objectives for follow-on work, which were targeted in task 1; in particular, the challenge of being able to deploy and retrieve the *in situ* multisampler in deeper water sediment without the use of divers.

We therefore field-tested a modification of the *in situ* passive sampling device to sample truly dissolved dioxins/furans and PCBs in sediment without the use of divers. Our SEED work demonstrated that the passive multisampler device was adequately designed to measure porewater concentrations of dioxins/furans, PCBs, polycyclic aromatic hydrocarbons (PAHs), and OCPs. The remaining challenge was to make it amenable for deployments without the use of divers. To achieve this objective, we proposed a modification of our previous sampler design and assessed its performance by comparison with the old design and porewater incubations in the laboratory. The proposed PE sampler combined working as an equilibrium passive sampler for some smaller molecular weight HOCs but relied on performance reference compounds (PRCs) for most dioxins/furans and PCBs.

We further tested whether ¹³C-labeled PRCs are needed to obtain accurate results for PCBs, or if more cost-effective PRCs can be used (i.e., deuterated PRCs or non-labeled compounds). We continued testing the passive sampling devices in the Passaic River/ Newark Bay, which has a known contamination history with several HOCs, including dioxins/furans.

TECHNICAL APPROACH

The technical approach consisted of the construction, deployment, and validation of a modified sediment porewater multisampler for dioxins/furans and other HOCs. The construction of a passive multisampler in the flukes of a Danforth-style anchor was optimized in field tests. Initial field trials needed a diver to ensure deployments, while the final field deployment proceeded without divers. PRCs were included to be able to correct for the lack of equilibrium of target HOCs during field deployments. At each site, sediment grabs were collected to derive HOC porewater concentrations through *ex situ* equilibrations.

RESULTS AND DISCUSSION

To be able to deploy and retrieve a PE-based multisampler from boats without the use of divers, we opted to modify its design, without losing its proven effectiveness to derive porewater concentrations of dioxins/furans and other HOCs. We need to deploy a somewhat large PE sheet in the sediment but switched to a design proven for its effectiveness in sediment deployments (**Figure ES-1**), a modification of the Danforth sediment anchor.

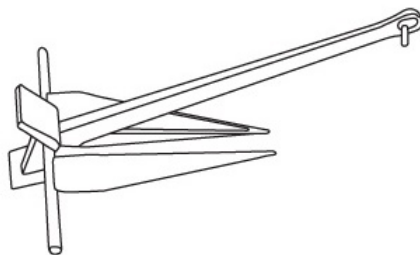

Figure ES-1. Basic Danforth Anchor Design.

This is a tried and proven, simple approach of lodging the anchor/its flukes into the sediment to secure and moor a floating object, such as a boat. Crucially, no divers are needed for its deployment (throwing overboard, and pulling it tight), nor its retrieval. The modified multisampler anchor is shown in **Figure ES-2** below.

The comparison of porewater concentrations derived from the *in situ* deployed PE multisampling device to porewater concentrations equilibrated in the laboratory showed good agreement between both approaches (**Figure ES-3** for PCDD/Fs). These results were obtained as part of the SEED funding for ER-2538.



Figure ES-2.The Modified Multisampler Anchor without PE Sheets in the Laboratory.

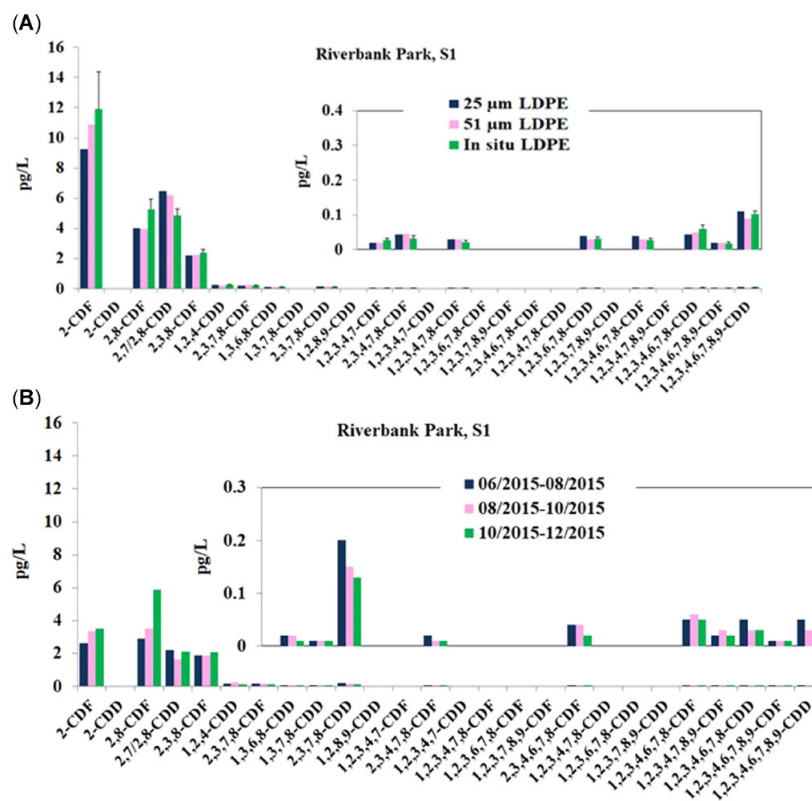

Figure ES-3. Calculated Porewater (A) and River Water (B) Concentrations of PCDD/Fs.

Error bars for the *in situ* low density polyethylene (LDPE) samplers represent the standard deviation of the four deployments. Concentrations of 1,2,3,4,7-CDF to 1,2,3,4,6,7,8,9-CDD in the porewater samples (A) and 1,3,6,8-CDD to 1,2,3,4,6,7,8,9-CDD in the river water samples (B) are shown in the figure inserts. Results are shown for sampling site S1, Riverbank Park (NJ). (Khairy and Lohmann, 2020)

The question of which PRCs to use is of course important in terms of preparation, cost, and validity of results. Results from ER-2538 suggest that there is little difference in relying on deuterated-PAHs (d-PAHs) or ^{13}C -PCDD/Fs (see **Figure ES-4**) for the non-equilibrium correction for PCDD/Fs.

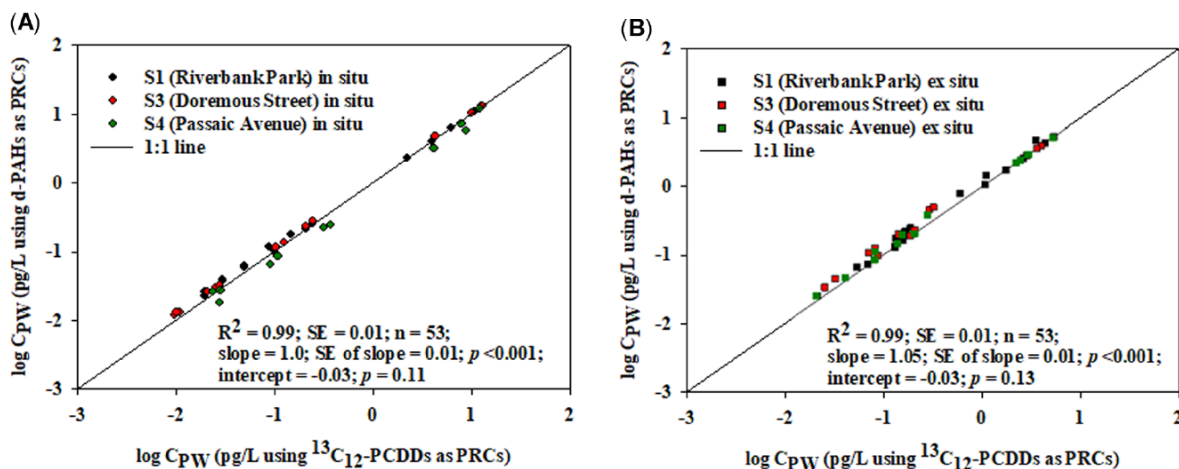

Figure ES-4. Comparison Between Using Either d-PAHs or ^{13}C -PCDDs as PRCs for Correcting Porewater Passive Samplers for Nonequilibrium Using *in situ* (A) and *ex situ* (B) Approaches at the Sampling Sites (Khairy and Lohmann, 2020).

The main technical question we propose to address is whether we can successfully deploy and retrieve a modified PE-multisampler in situ to derive porewater concentrations not significantly different from ex situ results.

In year 1, we field-tested and compared the Danforth-style multisampler mostly in the shallow bank river sediments of the Passaic River (**Table ES-1**). Samplers were secured at low tide in shallow sediment/mudflats, with a line back to shore for retrieval. Surface sediment were collected to derive porewater concentrations in the laboratory.

Table ES-1. Summary of the First Field Season Deployments (Summer 2019)

	Shallow (< 1m depth)	Deep (> 1m depth)
Number of sites deployed	5+1	3
Round samplers retrieved	5	2
Danforth sampler retrieved	5+1	3
<i>Ex situ</i> sediment sample equilibration	5	2

Major problems with the first round of field deployments was to find a diver to help us with deep water deployments of the reference round multisampler which had to be manually pushed into deep sediment. Retrieval of the samplers was very successful. All Danforth anchor samplers were recovered and only one water column PE sheet and one circular sampler were lost to a cut line and snapped messenger line respectively. Surface buoys were not used due to concerns of interference of recreational boaters disturbing the samplers or cutting the line attaching to the anchor. However, during the off season this would be a viable retrieval method. Grappling for the submerged line worked well with the hook grabbing the submerged line within a matter of seconds.

Our GO-NO GO point was a retrieval rate of 80% or greater of the Danforth anchors, and we achieved 100% recovery rate. The difficulties of securing a diver highlighted the benefits of being able to rely on a diverless deployment system for passive samplers.

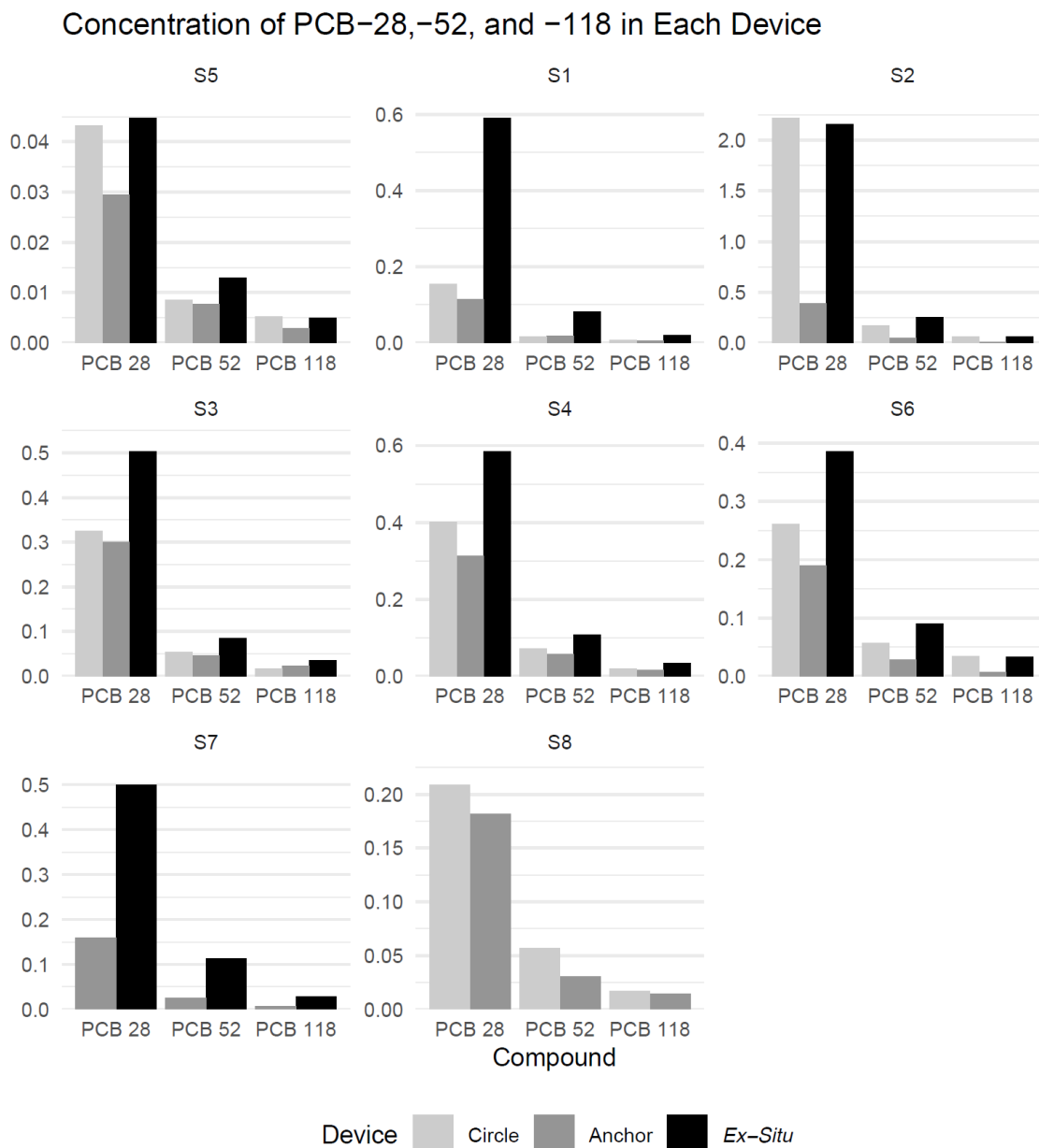

Figure ES-5. Concentration Differences between Passive Multisamplers (Circle *In Situ*; Anchor-style *In Situ*, and *Ex Situ* Porewater) at Each Site for Selected PCB Congeners.

We then compared the porewater concentrations derived from the use of the new anchor-style *in situ* passive multisampler with those obtained from the previous *in situ* circle-sampler and *ex situ* sediment equilibrations (**Figure ES-5**). Further analysis of the *in situ* and *ex situ* samplers show that lighter PCBs are the main driver behind the difference observed between the *in situ* and *ex situ* samplers (**Figure ES-5**). This is in line with results from (Apell *et al.*, 2018), who noted up to a two-fold difference in PCB porewater concentrations between *in situ* and *ex situ*.

This difference was attributed to the sediment porewater being in disequilibrium caused by bioirrigation. At sites 1, 3, 4, 6, and 7 we see a similar trend where the sediment porewater could be in disequilibrium with the sediment (**Figure ES-5**). In our previous work in the Passaic River (**Figure ES-3**), we observed no significant difference between *in situ* and *ex situ* concentrations. We postulate that the summer season might indeed have caused a depletion of the porewater in the field.

Second field season deployments (winter 2020)

Given the success of the modified PE multisamplers (in terms of % retrieval from the field), and comparable results to the round multisampler, we proceeded to field test the Danforth-style multisampler in a range of deeper sites across Newark Bay in year 2 (**Table ES-2**). Sites were located across Newark Bay and covered the three sites used in year 1, the two rivers in the north, two kills in the south, and mid-Bay sites. These deployments were performed by boat without divers, no further comparison to the round multisampler was done. At each site, two Danforth-style multisamplers were co-deployed to account for potential losses during recovery. Again, at each deployment site, surface grab sediment samples were collected to derive porewater concentrations in the laboratory for comparison.

Table ES-2. Summary of the Second Field Season Deployments (January-February 2020).

Overall deployment success was 17 out of 24 total (71% for in situ Danforth-style porewater) and 9/12 (75% for water column PE multisamplers). For the in situ porewater samplers, we retrieved samplers from 10.5/12 sites (87.5% retrieval success).

Deployment Site (see Figure ES-6)	Sediment Sampler a	Sediment Sampler b	Water Sampler
NB01	0	0	0
NB02	1	1	1
NB03	1	1	0
NB04	0.5	0	1
NB05	0.5	1	1
NB06	1	0.5	1
NB07	1	0	1
NB08	0.5	1	1
NB09	1	1	1
NB10	1	1	0
PR	1	0	1
HR	1	1	1

Note: A 1 denotes the whole sampler was recovered; 0.5 denotes one fluke, or ½ the sampler, was recovered; and a 0 denotes the sampler was lost. At each site, duplicate samplers were deployed to maximize the chance of recovering passive samplers from each site.

The protocol described the selection and preconditioning of the passive sampling polymer, critical incubation system component dimensions, equilibration and equilibrium condition confirmation, quantitative sampler extraction, quality assurance/control issues and final calculations of C_{free} . The full procedure requires several weeks (depending on the sampler used) because of prolonged equilibration times. However, hands-on time, excluding chemical analysis, is approximately 3 days for a set of about 15 replicated samples.

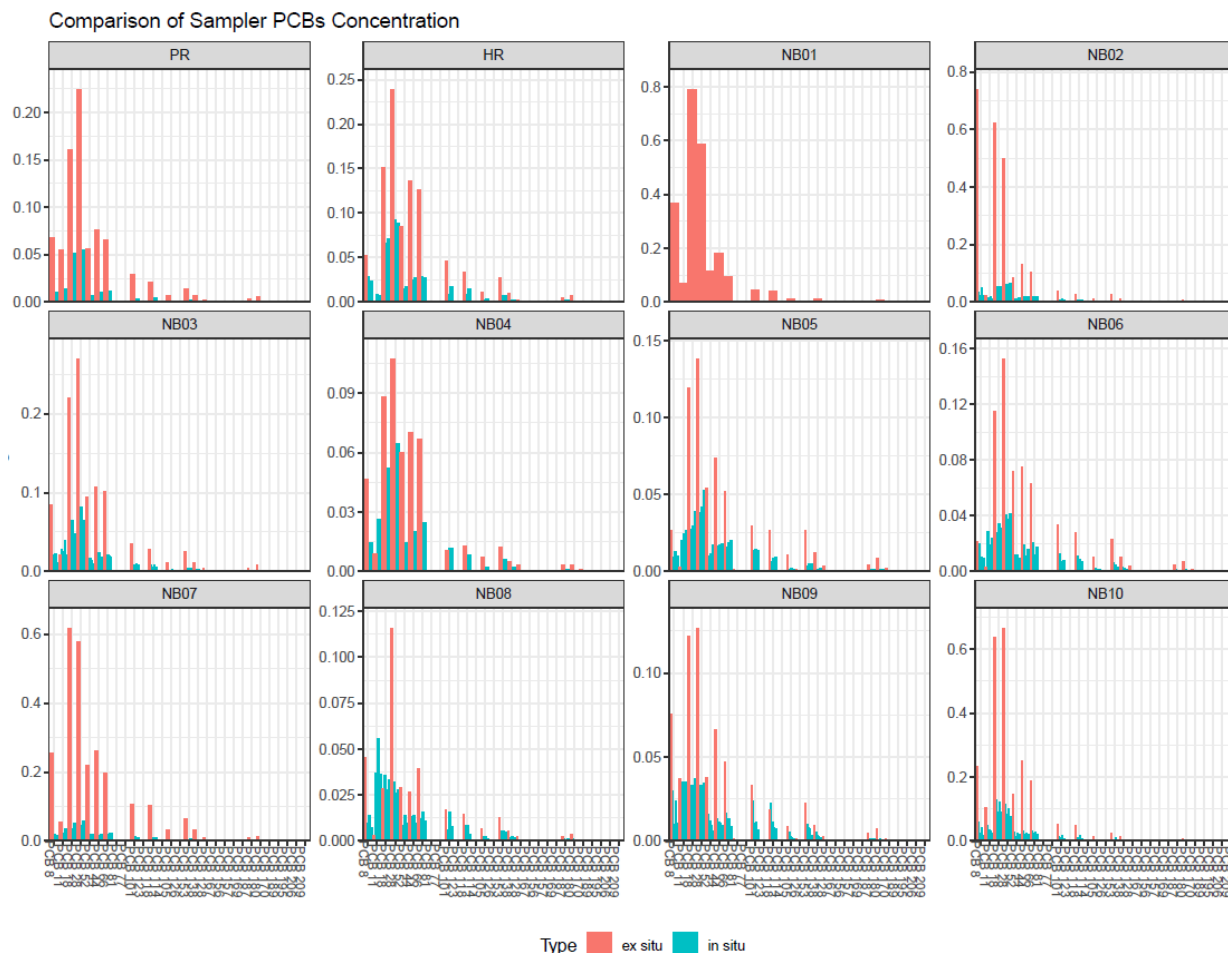

Figure ES-7. Comparison of *Ex Situ* Versus *In Situ* PCB Porewater Concentrations for Newark Bay (Winter 2020).

In situ concentrations were based on the Danforth multisampler.

We followed this new protocol for the *ex situ* equilibrations of the Passaic and Newark Bay sediment samples. The main change to our previous work was a much-reduced PE to sediment organic carbon (OC) ratio, to avoid depletion of the HOCs by more than 5%. While the new protocol is easy to follow, it resulted in two new challenges for this SERDP project: (a) for PCBs we now clearly observe a significant difference between *ex situ* and *in situ* (**Figure ES-5** and **Figure ES-7**), and (b) a fallout from the new protocol, which was optimized for PCBs and PAHs, is that we are now unable to detect most PCDD/Fs, given the much reduced size of the PE sheets used in the protocol.

The comparison of *ex situ* versus *in situ* porewater concentrations again showed *ex situ* concentrations of PCBs to exceed *in situ* concentrations by two to three-fold. At most sites, PCDD/Fs were below detection limits. A newly published standard protocol was followed for the *ex situ* determination of HOC porewater concentrations that prevented depletion of porewater, which might have contributed to the observed discrepancy.

A reanalysis of foodweb samples from the Passaic River suggested the passive sampling could be a powerful tool to predict HOC concentrations in the storage lipids of biota (Khairy *et al.*, 2019, Khairy and Lohmann, 2020).

IMPLICATIONS

The proposed research field tested a passive multisampler that can be *deployed in sediment of various depths without the need for divers*. Results of the passive multisampler can then be *used to predict the bioaccumulation of dioxins/furans and other HOCs*.

The *objectives for follow-on research* are (1) the deployment of the multisamplers at DoD sites to measure porewater concentrations and those in the overlying water for dioxins/furans and other HOCs, (2) establish representative concentrations of targeted HOCs, and (3) assess risk pre- and post-clean-up. There are opportunities for joint deployments with the U.S. Environmental Protection Agency (EPA) as they characterize the Erie Pier/ St. Louis River with an intensive field program including passive sampling of water and porewater, benthic macrobenthos, potential fish and sediment grabs (for us to verify *in situ* results with *ex situ* equilibrations). This might happen in July/August 2020 for a 6-week field deployment of passive samplers targeting PCBs and PCDD/Fs prior to remediation work. This would then also call for deployments post remediation to assess the success of contaminant reduction work.

Another potential for joint field deployments with the EPA Office of Research and Development would be along the Ottawa River, where up to 20 sites along a 9-mile stretch of the river will be characterized for PAHs/PCBs, in mid/late August, for another 6 weeks.

If this entire SERDP project is successful, including tasks 2 and 3, we propose to transition to a site demonstration project in a place such as Newark Bay, the Lower Willamette River or any other site which is affected by numerous HOCs. The passive porewater and water column samplers can then be deployed to accurately reflect on porewater and overlying water concentrations and predict bioaccumulation concentrations of targeted HOCs. RPMs can also deploy these passive samplers to assess the importance of on-going releases relative to water column and sediment porewater concentrations.

1 SERDP RELEVANCE

We proposed to further develop and field test an *in situ* passive multisampler to quantify polychlorinated dibenzo-*p*-dioxins and dibenzofurans (dioxins/furans) (PCDD/Fs) and other hydrophobic organic contaminants (HOCs), such as polychlorinated biphenyls (PCBs) and organochlorine pesticides (OCPs). The sampler was validated and field tested, without the need for divers, both in shallow and deep sediments at several sites along the Passaic River (NJ) and Newark Bay (NJ/NY). Our proposed technology development thus continues to address key Department of Defense (DoD) Strategic Environmental Research and Development Program (SERDP) objectives, as were recently expressed in SERDP's fiscal year (FY) 2015 Statement of Need in the Environmental Restoration Program Area:

- 1) *'Develop passive sampling methodologies for one of the following groups of contaminants: dioxin/furans'; and*
- 2) *'Develop a multi-purpose passive sampling device capable of collecting data on several contaminants of interest; A multi-purpose sampling device could include measurement of multiple hydrophobic organic compounds [...] in sediment and the immediate overlying surface water.'*

2 TECHNICAL OBJECTIVES

In our previous SERDP Exploratory Development (SEED) project (ER-2538) we demonstrated the utility of polyethylene (PE)-based passive multisamplers for determining dissolved concentrations of PCDD/Fs, PCBs, and other HOCs at shallow sediment sites. Porewater measurements agreed well between *in situ* and *ex situ* measurement approaches. The exact choice of performance reference compounds (PRCs) was important, with ^{13}C -PCDDs improving predictions of porewater PCDD/F concentrations, as opposed to relying on deuterated polycyclic aromatic hydrocarbons (d-PAHs) and polybrominated biphenyls (PBBs) as PRCs.

The use of porewater passive samplers was used to predict the bioaccumulation of HOCs in benthic invertebrates. Different benthic invertebrates displayed vastly differing body burdens of targeted HOCs. The site fidelity of porewater measurements was difficult to assess due to lack of consistent matrices to compare to. The SEED-funded work raised several important questions and objectives for follow-on work, which were targeted in task 1; in particular the challenge of being able to deploy and retrieve the *in situ* multisampler in deeper water sediment without the use of divers will form the focus of the follow-on research proposed here.

We therefore field tested a modification of the *in situ* passive sampling device to sample truly dissolved dioxins/furans, PCBs, and OCPs in sediment without the use of divers. Our SEED work demonstrated that the passive multisampler device was adequately designed to measure porewater concentrations of dioxins/furans, PCBs, PAHs, and OCPs. The remaining challenge was to make it amenable for deployments without the use of divers. To achieve this objective, we proposed a modification of our previous sampler design and assessed its performance by comparison with the old design and porewater incubations in the laboratory. The proposed PE sampler combined working as an equilibrium passive sampler for some smaller molecular weight HOCs, but relied on PRCs for most dioxins/furans, PCBs and OCPs.

We further tested whether ^{13}C -labeled PRCs are needed to obtain accurate results for PCBs, or if more cost-effective PRCs can be used (i.e., deuterated PRCs or non-labeled compounds). We continued testing the passive sampling devices in the Passaic River/ Newark Bay, which has a known contamination history with several HOCs, including dioxins/furans. We have experience working in the region as documented in our previous work on HOCs in sediment (*Lambert et al.*, 2011; *Khairy et al.*, 2017), water column (*Friedman et al.*, 2012) and foodweb (*Khairy et al.*, 2014b). It was thus ideally suited for the proposed SERDP follow-up research. Lastly, the U.S. Environmental Protection Agency (EPA) Newark Bay study is ongoing and expresses interest in this research.

In this follow-up research proposal, we focused on task 1, namely to: field test an *in situ* passive multisampler covering shallow and deep water sediment sites without relying on divers for deployments or retrievals. *If task 1 has been successfully accomplished, we propose to use the new sampler to:*

- *Further demonstrate the benefit of the in situ passive multisampler as a surrogate for the prediction of tissue PCDD/F, PCB, toxic equivalents (TEQs) and OCP concentrations in benthic invertebrates and vertebrates (eel, mummichog) across several sites (task 2); and*

- *Assess the capability of the passive multisampler to yield representative spatial interrogation of site HOCs by contrasting various sediment sites and site-fidel biota (task 3).*

The specific research objectives support the main interest of SERDP to simplify and speed up acquisition of information on relevant exposure to contaminants of interest. Following this research it will then be possible for Remedial Project Managers (RPMs) to design and implement passive sampler projects at current DoD sites affected by numerous HOCs to aid in remediation decision making. This will include both pre-cleanup design and post-cleanup monitoring of contaminated sites.

3 TECHNICAL APPROACH

3.1 BACKGROUND

Passive sampling methods can measure the concentration of freely dissolved contaminants ($C_{W, \text{diss}}$), which are directly related to the contaminants' chemical activity (α_w) (Mayer *et al.*, 2003):

$$\alpha_w = C_{W, \text{diss}} / S_w \quad (1)$$

where S_w is the contaminant solubility in water (at the same temperature and salinity).

The difference in chemical activity between the two compartments quantifies the potential for diffusive uptake. This also indicates the bioavailability or pressure (fugacity) of contaminants on organisms (Reichenberg and Mayer, 2006) and consequently represents the exposure level for organisms. Consequently, $C_{W, \text{diss}}$ provides a more relevant dose metric than total sediment concentration. Recent developments in passive sampling methods have significantly improved our ability to reliably measure $C_{W, \text{diss}}$, even at very low levels. Application of passive sampler methods in sediments is preferably conducted in the equilibrium regime, where freely dissolved concentrations in the sediment are well linked to the measured concentration in the sampler via analyte-specific partition ratios (Mayer *et al.*, 2014).

Passive samplers, such as PE sheets, take up organic compounds from the water column via molecular diffusion until phase equilibrium is reached (Jonker and Koelmans, 2001; Mayer *et al.*, 2003; Adams *et al.*, 2007; Lohmann, 2012). Uptake is driven by the difference in chemical activity between the HOC in the passive sampler and the surrounding environment. At equilibrium, the measured PE concentration (C_{PE}), together with the corresponding PE-water equilibrium partition coefficients (K_{PEw}), quantifies the compound's freely dissolved concentration ($C_{W, \text{diss}}$):

$$C_{W, \text{diss}} = C_{PE} / K_{PEw} \quad (2)$$

Nonpolar passive sampling devices absorb hydrophobic compounds from the aqueous phase and concentrate them to a level that can be easily analyzed with standard equipment, thereby avoiding the procedural errors that result from the processing of large water volumes needed in batch water sampling. A similar logic applies to porewater measurements, which are difficult to do with active sampling (both to squeeze enough porewater out of the sediment, and to deal with the bias caused by co-extracted dissolved organic carbon (DOC) in these squeezed porewaters).

We will continue to work with PE sheets, as their partitioning behavior is known under a range of temperatures and salinities (Adams *et al.*, 2007; Lohmann, 2012). We have successfully deployed PE sheets to measure concentrations of dissolved PCDD/Fs (Lambert *et al.*, 2011; Friedman *et al.*, 2012; Friedman and Lohmann, 2014), PAHs (Lohmann *et al.*, 2011; Reitsma *et al.*, 2013; McDonough *et al.*, 2014; Ruge *et al.*, 2015), PCBs (Morgan and Lohmann, 2008; Liu *et al.*, 2016), polybrominated diphenyl ethers (PBDEs) (Sacks and Lohmann, 2012; Khairy *et al.*, 2017; Ruge *et al.*, 2015; McDonough *et al.*, 2016), and emerging contaminants (Sacks and Lohmann, 2011; McDonough *et al.*, 2016; McDonough *et al.*, 2016).

The inclusion of PRCs enables passive samplers to be calibrated *in situ*, thereby accounting for changes in currents, temperature, or membrane properties due to biofouling, etc. PRCs are compounds included in the passive sampler prior to deployment (Booij *et al.*, 2002; Huckins *et al.*, 2002). PRCs do not occur in the natural environment, guaranteeing that there is only a one-dimensional flux out of the sampler.

In situ sediment sampling offers major benefits over laboratory equilibrations of retrieved sediment samples in terms of trueness of porewater concentrations. Yet it is also made more challenging by more complicated deployments (both deployment and retrieval are needed), potential losses (vandalism, losses due to weather, inadvertent ship strikes, fishing), and lack of equilibration in the field. Due to a local depletion of HOCs in the vicinity of the passive porewater sampler, equilibration is slowed down, and a numerical approach is needed to correct for lack of equilibration based on PRC loss (Fernandez *et al.*, 2009; Apell and Gschwend, 2014; Gschwend *et al.*, 2014). Longer deployment times increase the mass of HOCs accumulated by the passive *in situ* sampler, but also increase the possibility of sampler loss.

We included PRCs in the passive samplers to be deployed in this study in porewater and water column. PRCs enable the determination of dissolved persistent organic pollutant (POP) concentrations even for the heavier molecular weight compounds which will not have reached equilibrium during the exposure time in the field. For deriving porewater concentrations of dioxins/furans, we will rely on ¹³C-PCDD/Fs as PRCs as they resulted in more accurate results (see below). In this proposal, we will assess whether we can use PBBs and non-Aroclor PCBs as PRCs for the accurate determination of porewater concentrations of PCBs (or whether we need to include ¹³C-labeled PCBs). Knowing the depuration kinetics of the PRCs, we can calculate the HOC's truly dissolved concentrations at equilibrium in porewater [Gschwend *et al.*, 2014] or the water column (Booij and Smedes, 2010).

Previous *in situ* sampling.

In our previous SEED project, we developed a round PE sampler frame to hold a 10 × 86 centimeter (cm) PE strip of 51 micrometer (μm) thickness (approximately 3.5 to 4 grams (g) each) (**Figure 1**). The sampler was designed to hold a large PE sheet to amass sufficient amounts of dioxins/furans and other HOCs, as the concentrations of dioxins/furans in sediments are low (at the picogram per gram [pg/g] level), their sorption to carbonaceous particles is high, and their mobility in the sediment is thus reduced. The sampler was thus designed to expose a maximum surface area for a considerable length of time (approximately 6 weeks in the field). As a control, sediment samples were collected and taken back to the laboratory for porewater measurements under agitation (i.e., tumbling), as detailed in (Lohmann *et al.*, 2005). This sampler was successfully deployed at several sites along the Passaic River.

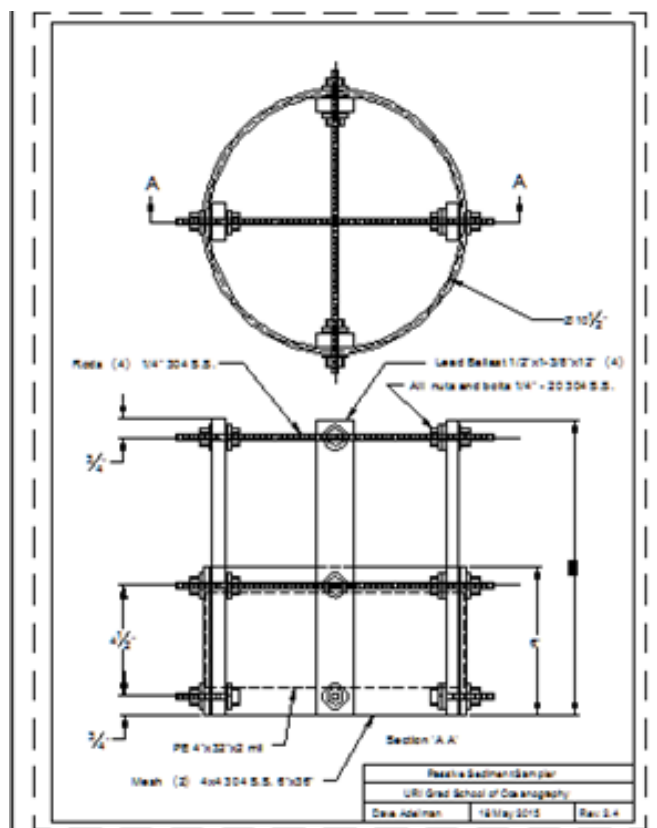

Figure 1. Previous SEED In Situ Multisampling Device for Dioxins/Furans and HOCs in Sediments.

3.2 MATERIALS AND METHODS

Analysis of PCDD/Fs, PCBs, OCPs, lipids, black carbon (BC), organic carbon (OC) and quality assurance (QA)/quality control (QC):

3.2.1 PE preparation

PEs were deployed as passive *in situ* equilibrium samplers in the field and in sediment incubations in the laboratory and field. Low-density 51 μm -thick PE sheet (Carlisle Plastics, Minneapolis, MN 55431) will be cut into small pieces and pre-cleaned by extracting for 24 hours (hr) once in dichloromethane (DCM) and once in hexane (Hex). Approximately 16 PE pieces will be impregnated in batches with PRCs in an approximately 350 milliliter (mL) 80:20 methanol:water solution for at least 4 weeks based on a method by (Booij *et al.*, 2002). For PCBs, we will test 2,5-dibromobiphenyl (PBB9), 2,2',5,5'-tetrabromobiphenyl (PBB52), 2,2',4,5',6-pentabromobiphenyl (PBB103) and octachloro-naphthalene as PRCs and combine them with non-Aroclor PCBs 2, 14, 30, 50 and 145 (Apell and Gschwend, 2014; Perron *et al.*, 2014). We will combine PBBs 9, 52, and 103 with $^{13}\text{C}_{12}$ 1,3,6,8-tetrachlorinated dibenzo-p-dioxin ($^{13}\text{C}_{12}$ 1,3,6,8-TCDD), $^{13}\text{C}_{12}$ 1,2,3,8,9-pentachlorinated dibenzo-p-dioxin ($^{13}\text{C}_{12}$ 1,2,3,8,9-PeCDD) and $^{13}\text{C}_{12}$ 1,2,3,4,6,7-hexachlorinated dibenzo-p-dioxin ($^{13}\text{C}_{12}$ 1,2,3,4,6,7-HxCDD) as PRCs for PCDD/Fs. Initial PRC concentrations will be determined from laboratory and field blanks from the same batch of PE samplers.

3.2.2 *Ex situ* porewater equilibrations

For the *ex situ* determination of porewater concentrations, the newly published protocol by Jonker *et al.* (2020) was used for the determination of porewater HOC concentrations for the first field campaign (~ 250 g sediment wet weight, one PE sheet of 30 milligrams (mg), shaking for 31 days). Given the problems with overcoming detection limits with the small PE sheet, the size of the PE sheets was increased to ~ 160 mg, and it was left shaking for ~ 3 months (due to COVID restrictions).

3.2.3 Sample extraction and clean-up

For all samples, ¹³C₁₂-internal standards (50 µL of a 100 pg/µL solution in nonane containing ¹³C-labeled 2,7-dichlorinated dibenzo-p-dioxin (¹³C-labeled 2,7-DiCDD), 2,3,7,8-TCDD, 1,2,3,6,7,8-HxCDD, and octachlorinated dibenzo-p-dioxin (OCDD); ¹³C-labeled PCBs 8, 28, 52, 118, 138, 180, and 209; and ¹³C-labeled HCB and p,p'-DDT, each at 40 nanograms (ng) (all from Cambridge Isotopes, Andover, MA, USA) will be added before extraction. Sample extraction will be performed as detailed in previous publications (Khairy *et al.*, 2014b, 2016). After extraction, samples will be concentrated to *ca.* 1 mL under a flow of nitrogen. Sediment and biological extracts were cleaned using a mixed silica gel column, carbon column, and as needed, a gel permeation chromatography (for the separation of lipids from the analytes). Extracts were reduced under nitrogen and transferred into gas chromatography (GC) vials. An injection standard was added and the sample reduced to *ca.* 100 µL final volume before analysis by gas chromatography coupled to a tandem mass spectrometric analyzer (GC-MS/MS).

3.2.4 PE processing

Following recovery from the field, PEs are kept at -4 degrees Celsius (°C) until analysis. Sampler surfaces are rinsed with Milli-Q water and dried with laboratory-grade tissue to remove particles. PEs are extracted with DCM and Hex in 60 mL vials for 24 hrs. Combined extracts are reduced to ~2 mL and exchanged to hexane under high purity N₂. Extracts are cleaned using a silica gel column. PCDD/Fs and PCBs were eluted with 40 mL Hex and DCM 9:1. The extracts were concentrated down to 1 mL under the flow of nitrogen and transferred to GC-vials. 10 µL of 100 pg/µL d₁₄-p-terphenyl in nonane are added as an injection standard.

3.2.5 Chemical analysis of PCDD/Fs, PCBs, and OCPs

Chemical analysis will be performed in the Principal Investigator's (PI's) laboratory at the Graduate School of Oceanography (GSO). At the GSO laboratory, the PI's primary laboratory space is 514 square feet (sq ft), with an additional instrument room/storage space of 230/200 sq ft, respectively. For PE, water, biota, and sediment analysis, all samples will be analyzed on a Waters MICRO GC-MS/MS, coupled to an Agilent 6890 GC. A 60-meter (m) DB DIOXIN column (0.250 millimeter [mm] inner diameter [ID], 0.25 µm film thickness) will be used for the separation and quantification of PCDD/Fs, while a 30 m DB-5 will be used for PCBs, and OCPs. Two parent/daughter mass transitions are monitored for each compound. The detection limit for the GC-MS analysis is on the order of several pg per component on column. In total, seven PCDD, ten PCDF, and 29 PCB congeners, including co-planar congeners are targeted with at least one congener from each chlorine substitution group (mono, di, etc.), as in (Khairy *et al.*, 2014b, 2016; Liu *et al.*, 2016). OCPs will be targeted as detailed in prior work in our laboratory (Khairy *et al.*, 2014a, 2014b; McDonough *et al.*, 2016).

3.2.6 Sediment total organic carbon (TOC) and BC

For TOC determinations, sediments are dried at 60°C, ground after shell material was removed, treated with H₂SO₃, and analyzed for %C on a Carlo Erba NA 1500 elemental analyzer coupled to a VG-Optima stable isotope mass spectrometer. BC is determined using previously published methods (*Gustafsson et al.*, 1997). NIST Standard Reference Material 1941b will be analyzed with this method to compare to established results from a BC intercomparison study (*Hammes et al.*, 2007). Amorphous OC (i.e., the fraction of TOC not considered BC) is determined by subtracting the fraction of BC from TOC.

3.2.7 PRC corrections

The loss of PRCs in both field and laboratory exposures will be used to correct for lack of equilibrium reached. In case of the tumbling experiment, disequilibrium correction will be performed according to (*Booij and Smedes*, 2010). For the *in situ* deployed sediment porewater samplers, we will use the software available from the Massachusetts Institute of Technology to correct for disequilibrium according (*Gschwend et al.*, 2014). The comparison of the best PRCs to use in the field relies on the laboratory equilibrations representing the ‘true’ porewater concentrations. For PCDD/Fs, we will rely on ¹³C-PCDD/Fs (see above). For the second field deployment, we added 1,2,3,8,9-PeCDD as an additional PRC. For PCBs we initially relied on our generic, cheap PRCs (3 PBBs and octachloronaphthalene) but added non-Aroclor PCBs for the second field deployment (see above).

3.2.8 QA/QC

Stringent QA/QC procedures will be followed for the analytical work. These include the processing of laboratory blanks (one in ten) and fortified solvent samples (one in ten each) and certified reference materials for trueness of analytical results. Recoveries of surrogate standards will be quantified to validate sample treatment. Calibration standards will bracket the sample concentrations of target analytes and will be used to derive response factors of the analytes relative to the appropriate isotope-labeled surrogate standards. Identification of analytes will be based on retention time and correct ratios of isotope distributions.

3.3 APPROACH

Task 1: Construction, deployment, and validation of a modified sediment porewater multisampler for dioxins/furans and other HOCs.

Technical hypothesis: *The modified passive PE multisampler device can be successfully deployed and retrieved to sample dioxins/furans and other HOCs in situ both in shallow and deep sediment without the use of divers*

Scientific hypothesis: *At each site, porewater concentrations of targets HOCs from the modified PE passive multisamplers are not significantly different from porewater HOC concentrations derived from ex situ equilibrations of the same sediment.*

Task 1 directly addresses SERDP’s objective to (1) ‘Develop passive sampling methodologies for one of the following groups of contaminants: dioxin/furans’; and to (2) ‘Develop a multi-purpose passive sampling device capable of collecting data on several contaminants of interest.’

Experimental design and methodology:

To be able to deploy and retrieve a PE-based multisampler from boats without the use of divers, we opted to modify its design, without losing its proven effectiveness to derive porewater concentrations of dioxins/furans and other HOCs. We need to deploy a somewhat large PE sheet in the sediment but suggest to switch to a design proven for its effectiveness in sediment deployments (**Figure 2**), a modification of the Danforth sediment anchor. This is a tried and proven, simple approach of lodging the anchor/its flukes into the sediment to secure and moor a floating object, such as a boat. Crucially, no divers are needed for its deployment (throwing overboard, and pulling it tight), nor its retrieval.

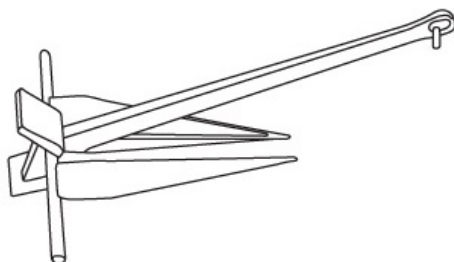

Figure 2. Basic Danforth Anchor Design

We proposed to modify this basic design by replacing the solid flukes with two similarly sized triangular frames that contain PE sheets. Each modified PE multisampler Danforth anchor will hold two PE sheets (base width 25 cm, height 40 cm) (**Figure 3**). Together the two triangles are of the same surface area and size as in our previous SEED round multisampler (**Figure 1**). Both flukes will be modified to house a PE sheet protected by two meshes (to prevent tear during deployment or retrieval), held together by two frames via screws. The maximum penetration depth of the PE sheets in the anchors is about 30 cm (considering the deployment angle of 33°).

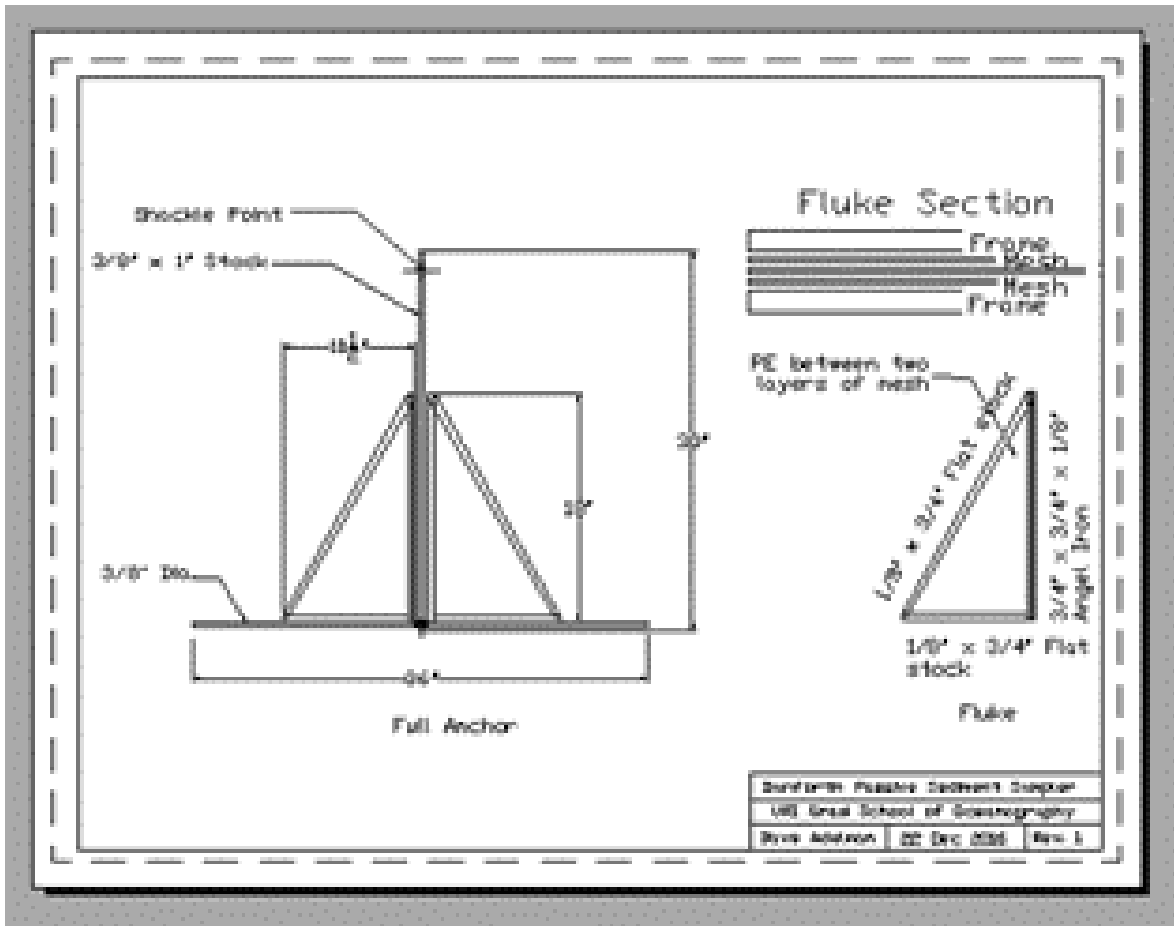

Figure 3. Technical Design of Modified Danforth PE In Situ Multisampler, Where Both Flukes Will Hold Passive Sampler PE Sheets.

Recent Progress: During our development trials, there were two problems observed: (i) that at times the multisampler anchor design wanted to twist and flip over and (ii) that the back of the anchor would tend to kick up if it snagged a harder patch of sediment. To address the twisting and the flipping over, the back bar of the anchor was extended to give it more horizontal stability. To address the second problem of the anchor kicking up in the back, the angle at which the anchor digs into the sediment was decreased, changing the angle at which the force is being applied to the anchor. The modified multisampler anchor is shown in **Figure 4**.



Figure 4. The Modified Multisampler Anchor Without PE Sheets in the Laboratory

We performed several training deployments in the Narrow River (RI). **Figure 5** shows its deployment in shallow sediment. This was the final design we used for field deployments in the lower Passaic River and Newark Bay.



Figure 5. The Modified Multisampler Anchor During Field Deployment

The comparison of porewater concentrations derived from the *in situ* deployed PE multisampling device to porewater concentration equilibrated in the laboratory showed good agreement between both approaches (**Figure 6** for PCDD/Fs reproduced here, **Figure 7** for PCBs). These results were obtained as part of the SEED funding for ER-2538.

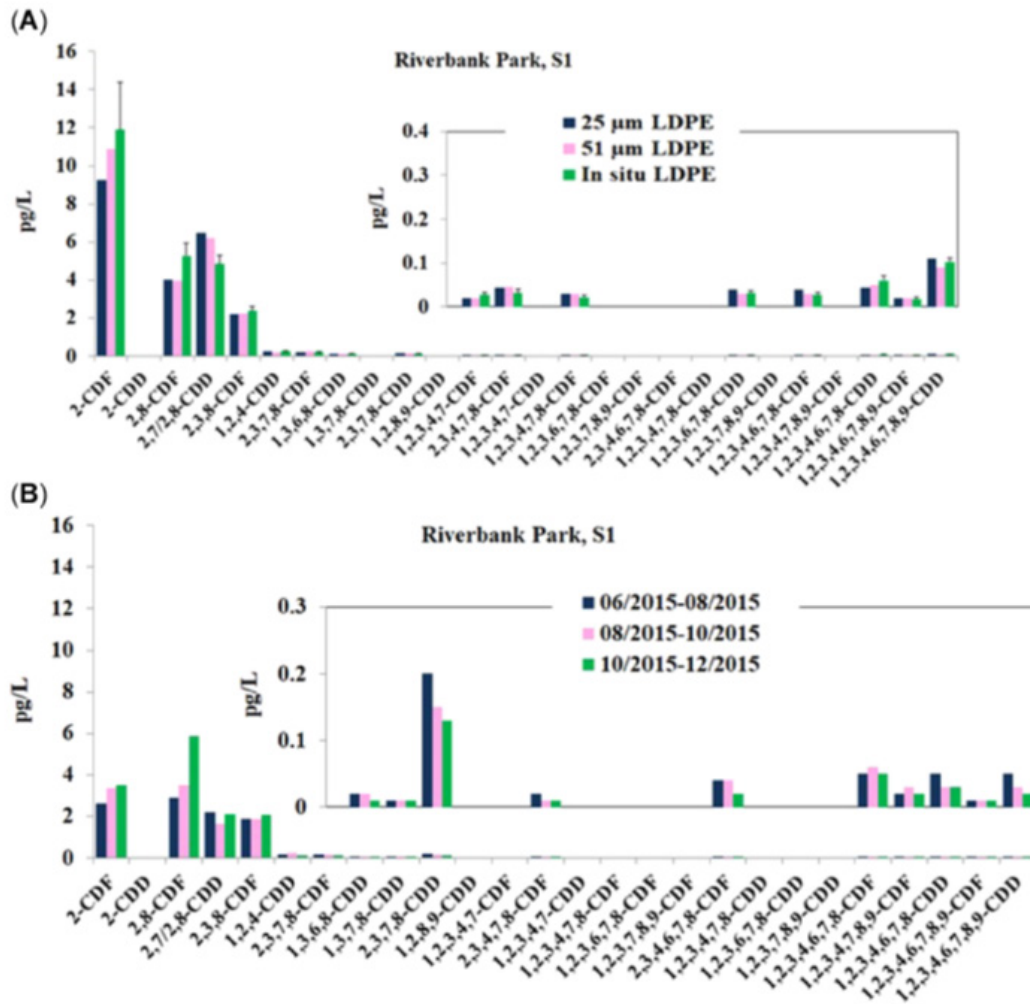

Figure 6. Calculated Porewater (A) and River Water (B) Concentrations of PCDD/Fs.

Error bars for the in situ LDPE samplers represent the standard deviation of the four deployments. Concentrations of 1,2,3,4,7-CDF to 1,2,3,4,6,7,8,9-CDD in the porewater samples (A) and 1,3,6,8-CDD to 1,2,3,4,6,7,8,9-CDD in the river water samples (B) are shown in figure inserts. Results are shown for sampling site S1, Riverbank Park (NJ). (Khairy et al., 2020)

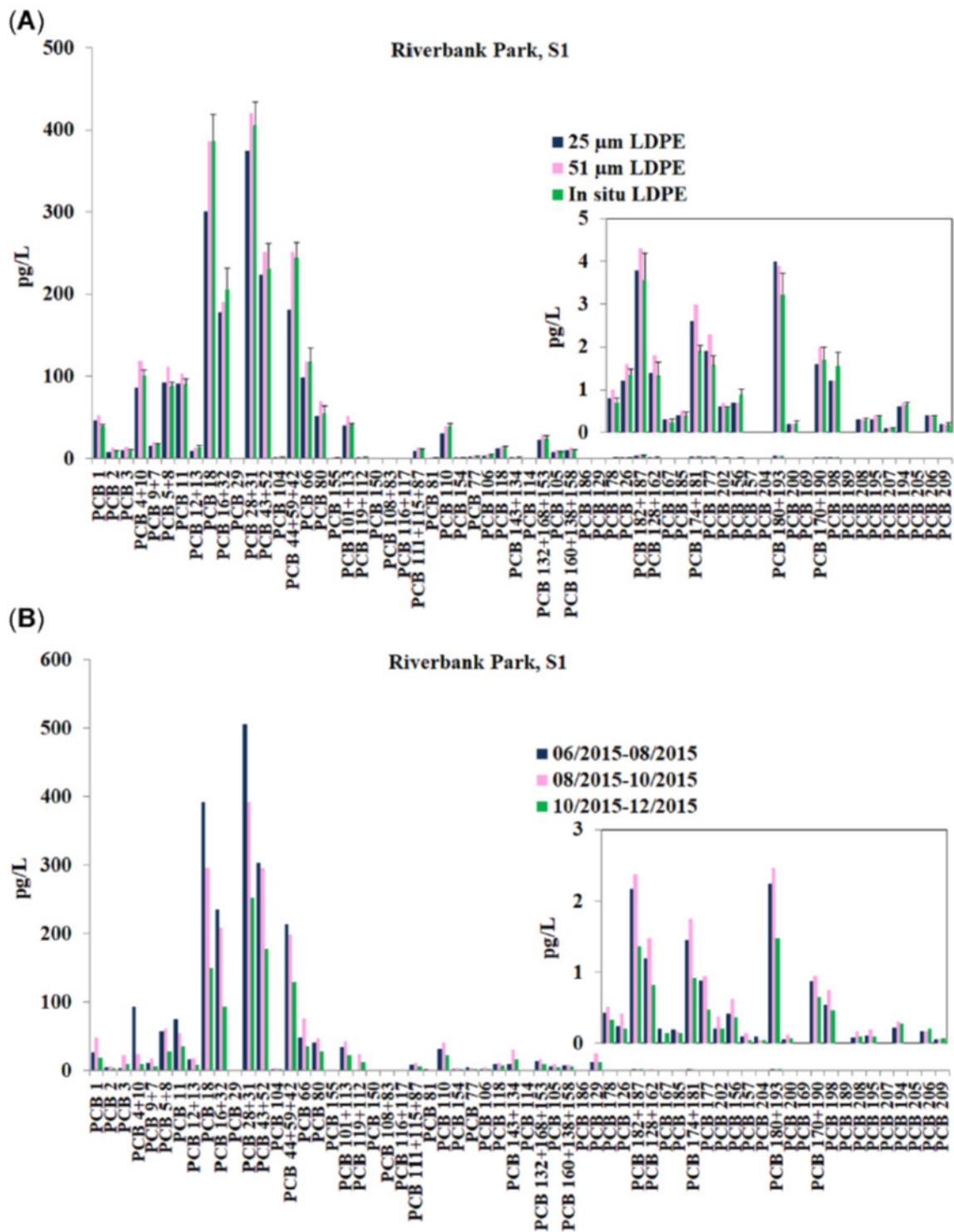

Figure 7. Calculated Porewater (A) and River Water (B) Concentrations of PCBs.

Error bars for the in situ LDPE samplers represent the standard deviation of the four deployments.

Figure inserts show the concentrations of the more highly chlorinated PCB congeners (A) in the porewater samples (B) and in the river water samples. Results are shown for sampling site S1, Riverbank Park (NJ). (Khairy et al., 2020)

The question of which PRCs to use is of course important in terms of preparation, cost, and validity of results. Results from ER-2538 suggest that there is little difference in relying on d-PAHs or ^{13}C -PCDD/Fs (see **Figure 8**) for the non-equilibrium correction for PCDD/Fs.

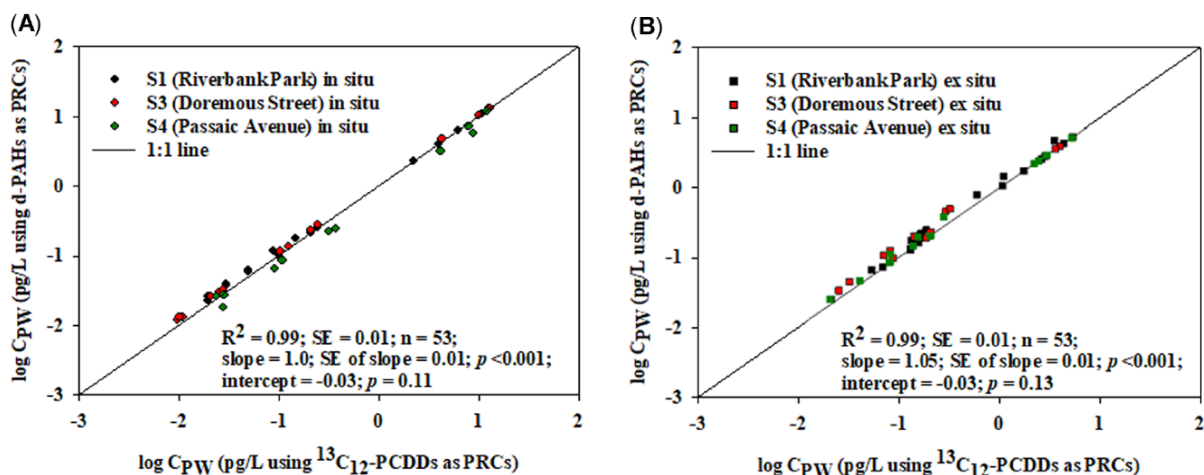

Figure 8. Comparison Between Using Either d-PAHs or ^{13}C -PCDDs as PRCs for Correcting Porewater Passive Samplers for Nonequilibrium Using *In Situ* (A) and *Ex Situ* (B) Approaches at the Sampling Sites. (Khairy et al., 2020)

The main technical question we propose to address is whether we can successfully deploy and retrieve a modified PE-multisampler in situ to derive porewater concentrations not significantly different from ex situ results.

To verify its effectiveness, we proposed a series of validation and field-testing deployments in the Passaic River and Newark Bay. The Danforth PE multisampler was deployed side-by-side with our previous round multisampler in both shallow and deeper sediments and results were compared to laboratory equilibrations of PE from field-retrieved sediment samples (**Figure 5**). In year 1, we field tested and compared the Danforth-style multisampler mostly in the shallow bank river sediments of the Passaic River (**Table 1**). Samplers were secured at low tide in shallow sediment/mudflats, with a line back to shore for retrieval. Surface sediment were collected to derive porewater concentrations in the laboratory.

Table 1. Summary of the First Field Season Deployments (Summer 2019)

	Shallow	Deep
Number of sites deployed	5+1	3
Round samplers retrieved	5	2
Danforth sampler retrieved	5+1	3
<i>Ex situ</i> sediment sample equilibration	5	2

Major problems with the first^t round of field deployments was to find a diver to help us with deep water deployments of the reference round multisampler (**Figure 1**) which had to be manually pushed into deep sediment. Retrieval of the samplers was very successful. All Danforth anchor samplers were recovered and only one water column PE sheet and one circular sampler were lost to a cut line and snapped messenger line respectively. Surface buoys were not used due to concerns

of interference of recreational boaters disturbing the samplers or cutting the line attaching to the anchor. However, during the off season this would be a viable retrieval method. Grappling for the submerged line worked well with the hook grabbing the submerged line within a matter of seconds.

Our GO-NO GO point was a retrieval rate of 80% or greater of the Danforth anchors, and we achieved 100% recovery rate. The difficulties of securing a diver highlighted the benefits of being able to rely on a diverless deployment system for passive samplers.

We then compared the porewater concentrations derived from the use of the new anchor-style *in situ* passive multisampler with those obtained from the previous *in situ* circle-sampler and *ex situ* sediment equilibrations (Figure 9). Further analysis of the *in-situ* and *ex-situ* samplers show that lighter PCBs are the main driver behind the difference observed between the *in-situ* and *ex-situ* samplers (Figure 9). This is in line with results from (Apell *et al.*, 2018), who noted an up to a two-fold difference in PCB porewater concentrations between *in-situ* and *ex-situ*. This difference was attributed to the sediment porewater being in disequilibrium caused by bioirrigation. At sites 1, 3, 4, 6, and 7 we see a similar trend where the sediment porewater could be in disequilibrium with the sediment (Figure 7). In our previous work in the Passaic River (Figure 5 and Figure 6), we observed no significant difference between *in situ* and *ex situ* concentrations. We postulate that the summer season might indeed have caused a depletion of the porewater in the field.

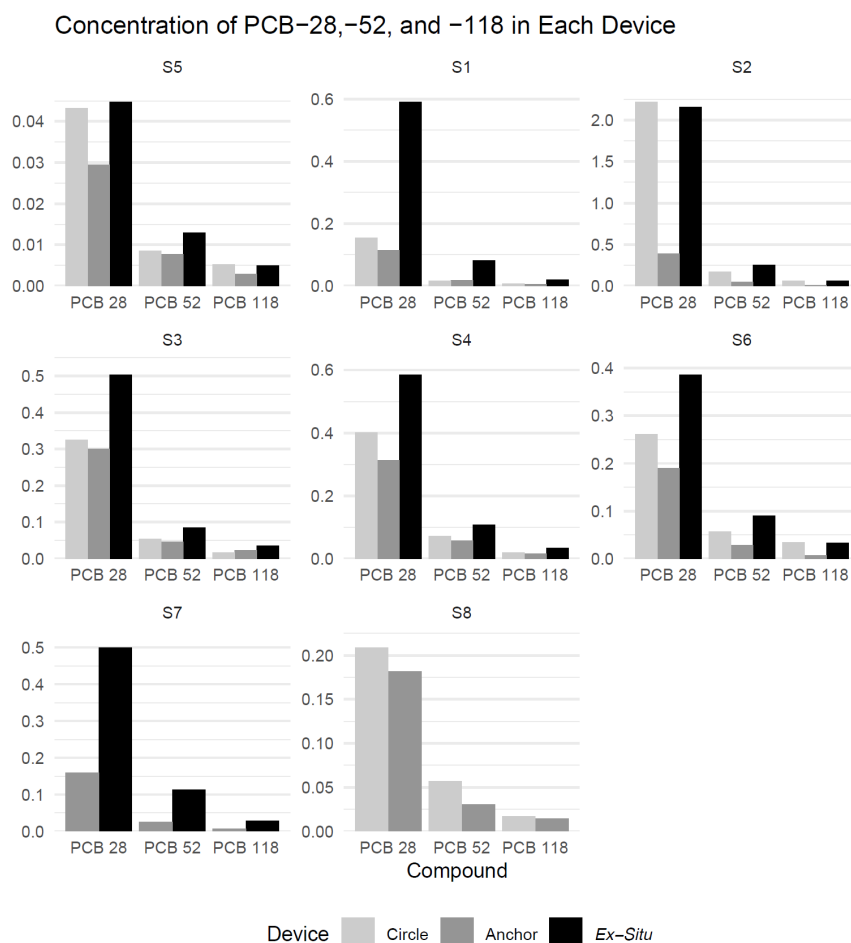

Figure 9. Concentration Differences Between Passive Multisamplers (Circle *In Situ*; Anchor-style *In Situ*, and *Ex Situ* Porewater) at Each Site for Selected PCB Congeners.

Second field season deployments (winter 2020)

Given the success of the modified PE multisamplers (% recovery from the field), and comparable results to the round multisampler, we proceeded to field-test the Danforth-style multisampler in a range of deeper sites across Newark Bay in year 2. Sites will be across Newark Bay and covered the three sites used in year 1, the two rivers in the north, two kills in the south, and mid-Bay sites. These deployments were performed by boat; no further comparison to the round multisampler was done. At each site, 2 Danforth-style multisamplers were co-deployed to account for potential losses during recovery. Again, at each deployment site, surface grab sediment samples were collected to derive porewater concentrations in the laboratory for comparison.

Table 2. Summary of the Second Field Season Deployments (January-February 2020).

Overall deployment success was 17 out of 24 total (71% for in situ Danforth-style porewater) and 9/12 (75% for water column PE multisamplers) For the in situ porewater samplers, we retrieved samplers from 10.5/12 sites (87.5% retrieval success).

Deployment Site (see Figure 10)	Sediment Sampler a	Sediment Sampler b	Water Sampler
NB01	0	0	0
NB02	1	1	1
NB03	1	1	0
NB04	0.5	0	1
NB05	0.5	1	1
NB06	1	0.5	1
NB07	1	0	1
NB08	0.5	1	1
NB09	1	1	1
NB10	1	1	0
PR	1	0	1
HR	1	1	1

Note: A 1 denotes the whole sampler was recovered; 0.5 denotes one fluke, or ½ the sampler, was recovered; and a 0 denotes the sampler was lost. At each site, duplicate samplers were deployed to maximize the chance of recovering passive samplers from each site.

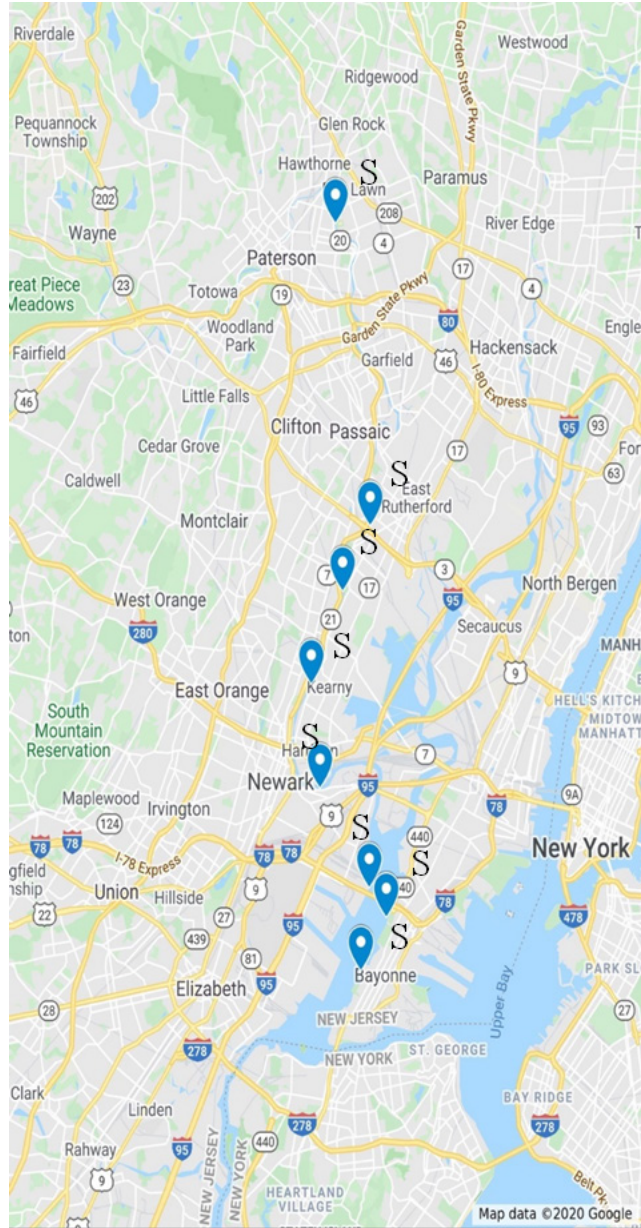

Figure 10. Summer 2019 Sampling Sites in Newark Bay

The deployment of duplicate anchor style multisamplers paid off, as we were able to retrieve *in situ* multisamplers from 11 sites (deployed at 12; one site only had one fluke retrieved). **Figure 11** shows the spatial coverage of the deployment sites during winter 2020, covering both rivers feeding into Newark Bay, the Bay itself and the two kills connecting Newark Bay to New York Harbor.

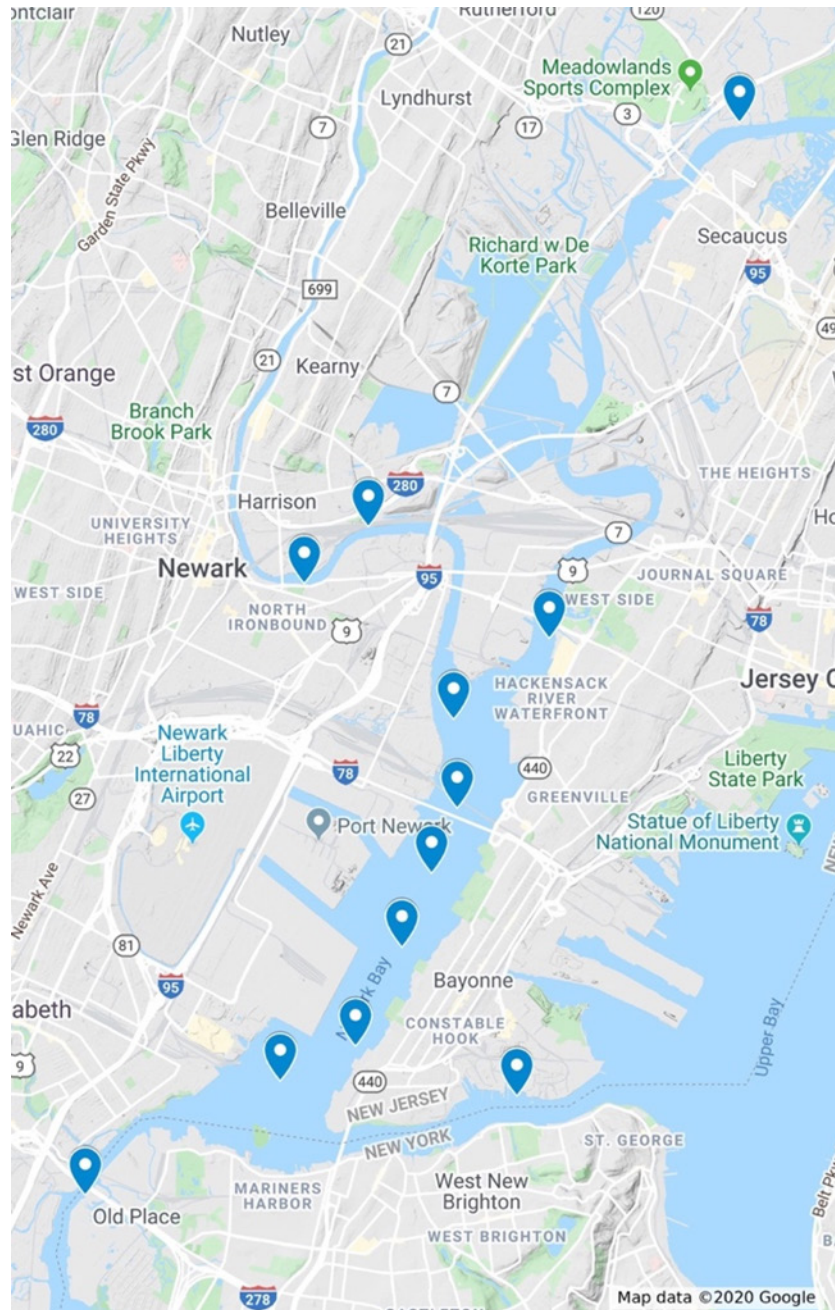

Figure 11. Deployment Sites of Anchor PE-multisampler During Second Deployment, January -February 2020

Ex situ equilibration of HOCs

I was part of a group of scientists, lead by Michiel Jonker (Utrecht University) that published a protocol for *ex situ* equilibrations of sediment to derive porewater concentrations (Jonker et al., 2020). In summary, we provided a state-of-the-art passive sampling protocol for determining C_{free} in sediment and soil samples. It represents an international consensus procedure, developed during a recent interlaboratory comparison study. The protocol describes the selection and preconditioning of the passive sampling polymer, critical incubation system component

dimensions, equilibration and equilibrium condition confirmation, quantitative sampler extraction, QA/QC issues, and final calculations of C_{free} . The full procedure requires several weeks (depending on the sampler used) because of prolonged equilibration times. However, hands-on time, excluding chemical analysis, is approximately three days for a set of about 15 replicated samples.

We followed this new protocol for the *ex situ* equilibrations of the Passaic and Newark Bay sediment samples. The main change to our previous work was a much reduced PE to sediment OC ratio, to avoid depletion of the HOCs by more than 5%. While the new protocol is easy to follow, it resulted in two new challenges: (a) for PCBs we now clearly observe a significant difference between *ex situ* and *in situ* (Figure 9 and Figure 12, and (b) a fallout from the new protocol, which was optimized for PCBs and PAHs, is that we are now unable to detect most PCDD/Fs, given the much reduced size of the PE sheets used in the protocol (Figure 13).

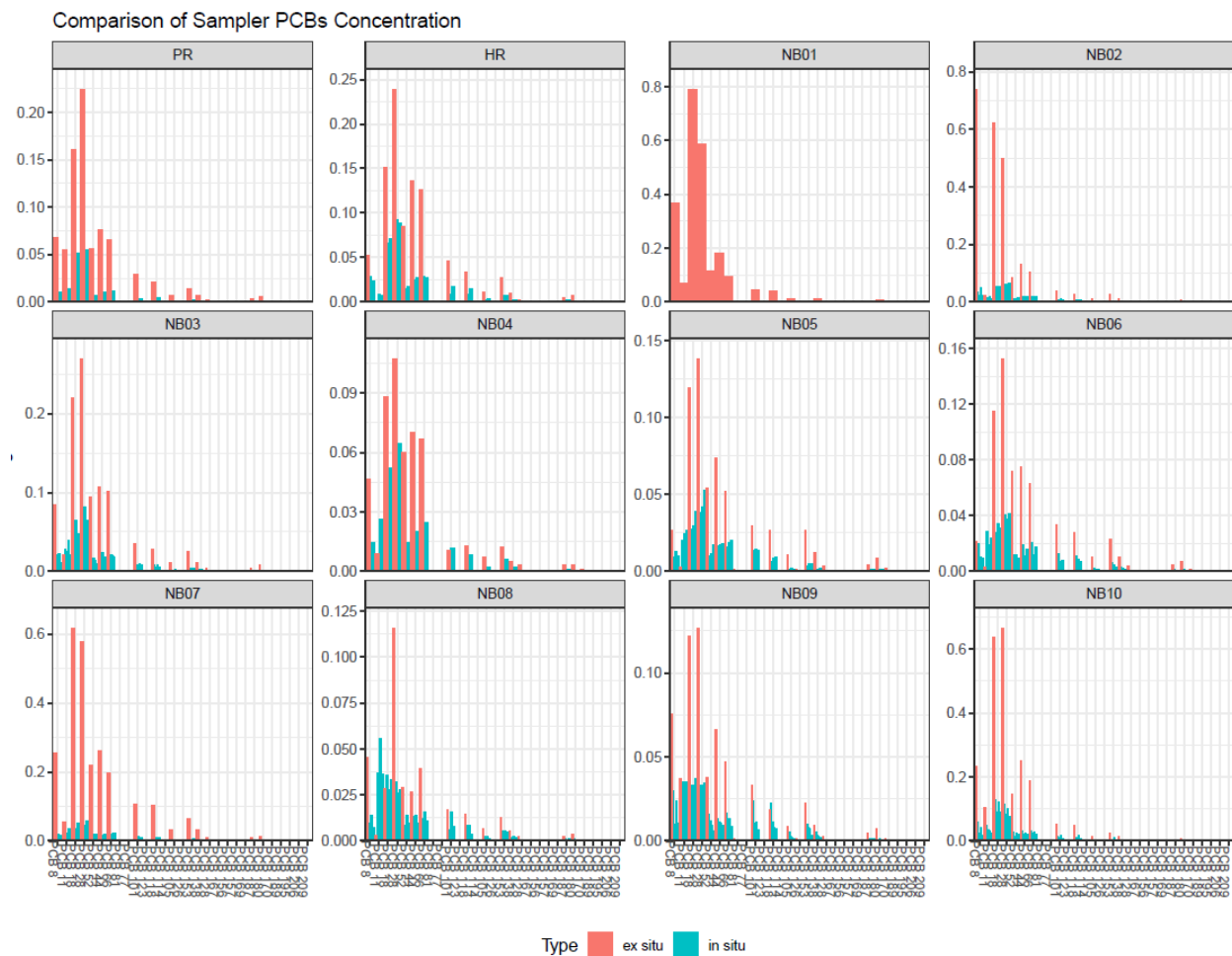

Figure 12. Comparison of *Ex Situ* vs *In Situ* PCB Porewater Concentrations for Newark Bay (Winter 2020).

In situ concentrations were based on the Danforth multisampler.

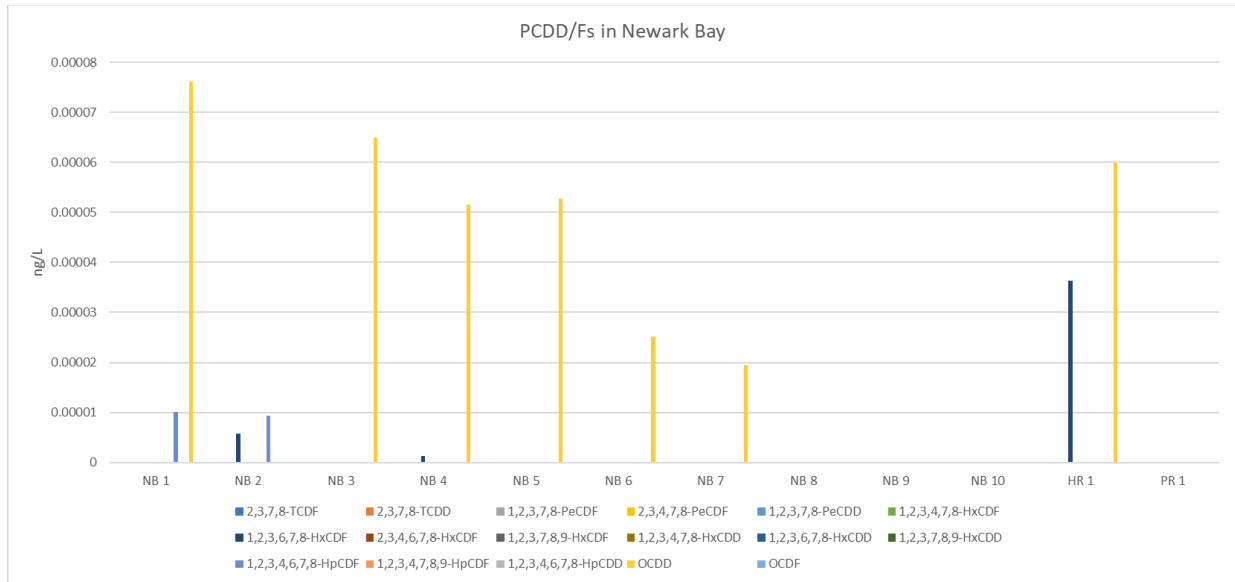

Figure 13. Derived *Ex Situ* Porewater Concentrations from Newark Bay (Winter 2020)

Summary of accomplishments

Milestones for Tasks 1:

(1) Successful construction of sediment multisamplers within the first 4 months of the project;

ACHIEVED

(2) Successful deployment and retrieval of multisamplers in the field during first field trials in Narragansett Bay during the first 6 months.

ACHIEVED

(3) Successful deployment and retrieval of sediment multisamplers and sediment in the Passaic River/Newark Bay in year 1. If problems occur with milestones (1) through (3), we have time to adjust by delaying deployments for a few weeks while rectifying the problem.

ACHIEVED

(4) Analysis of multisamplers and derivation of porewater and overlying water concentrations by early 2020.

ACHIEVED

(5) Successful deployment and retrieval of multisamplers in the Passaic River/Newark Bay deep sediment sites in year 2.

ACHIEVED

(6) Ground-truthing of porewater and overlying water concentrations by August 2020.

ACHIEVED

The following Go/No-Go Points were proposed for the project:

1. At 6 months: Has the Danforth-style sampler been constructed and successfully deployed and recovered in field trials in Narragansett Bay?

YES

2. At 12 months: Have samplers been recovered from field deployments in Passaic River/Newark Bay with at least 80% success rate?

YES

Technical hypothesis: *The modified passive PE multisampler device can be successfully deployed and retrieved to sample dioxins/furans and other HOCs in situ both in shallow and deep sediment without the use of divers*

We achieved this objective.

Scientific hypothesis: *At each site, porewater concentrations of target HOCs from the modified PE passive multisamplers are not significantly different from porewater HOC concentrations derived from ex situ equilibrations of the same sediment.*

We could not validate this hypothesis; porewater concentrations of target HOCs from the modified PE passive multisampler were significantly lower than porewater HOC concentrations derived from ex situ equilibrations of the same sediment.

Task 1 directly addresses SERDP's objective to (1) 'Develop passive sampling methodologies for one of the following groups of contaminants: dioxin/furans'; and to (2) 'Develop a multi-purpose passive sampling device capable of collecting data on several contaminants of interest.'

3.4 RESEARCH TEAM

PI: Rainer Lohmann: Project and QA/QC oversight; data interpretation and discussion; presentations and final report.

Graduate Student: Sam Katz: Field work; laboratory extractions; instrumental analysis and data interpretation.

Technician: Initially Dave Adelman, followed by Tom Garrow: Construction of samplers; field work preparation and deployments; instrument maintenance.

3.5 TRANSITION POTENTIAL:

The proposed research will provide *critical data to validate a passive multisampler for dioxins/furans, and other HOCs*, such that SERDP can monitor for a wide range of organic contaminants in sediments and the overlying water, assess exposure, predict bioaccumulation in benthic invertebrates, and guide and support remediation of contaminated sites.

The proposed research will field test a passive multisampler that can be *deployed in sediment of various depths without the need for divers*. Results of the passive multisampler can then be *used to predict the bioaccumulation of dioxins/furans and other HOCs*.

The *objectives for follow-on research* are (1) the deployment of the multisamplers at DoD sites to measure porewater concentrations and those in the overlying water for dioxins/furans and other HOCs, (2) establish representative concentrations of targeted HOCs, and (3) assess risk pre- and post-clean-up. There are opportunities for joint deployments with EPA as they characterize the Erie Pier/ St. Louis River with an intensive field program including passive sampling of water and porewater, benthic macrobenthos, and potential fish and sediment grabs (for us to verify *in situ* results with *ex situ* equilibrations). This might happen in July/August 2020 for a six-week field deployment of passive samplers targeting PCBs and PCDD/Fs prior to remediation work. This would then also call for deployments post remediation to assess the success of contaminant reduction work.

Another potential for joint field deployments with the EPA Office of Research and Development would be along the Ottawa River, where up to 20 sites along a 9-mile stretch of the river will be characterized for PAHs/PCBs, in mid/late August, for another 6 weeks.

If this entire SERDP project is successful, including tasks 2 and 3, we propose to transition to a site demonstration project in a place such as Newark Bay, the Lower Willamette River, or any other site which is affected by numerous HOCs. The passive porewater and water column samplers can then be deployed to accurately reflect on porewater and overlying water concentrations and predict bioaccumulation concentrations of targeted HOCs. RPMs can also deploy these passive samplers to assess the importance of on-going releases relative to water column and sediment porewater concentrations.

4 LITERATURE CITED

- Adams, R. G., R. Lohmann, L. A. Fernandez, J. K. MacFarlane, and P. M. Gschwend (2007), Polyethylene devices: Passive samplers for measuring dissolved hydrophobic organic compounds in aquatic environments, *Environ. Sci. Technol.*, *41*(4), 1317–1323, doi:10.1021/es0621593.
- Apell, J. N., and P. M. Gschwend (2014), Validating the Use of Performance Reference Compounds in Passive Samplers to Assess Porewater Concentrations in Sediment Beds, *Environ. Sci. Technol.*, *48*, 10301–10307.
- Apell, J. N., D. H. Shull, A. M. Hoyt, and P. M. Gschwend (2018), Investigating the Effect of Bioirrigation on In Situ Porewater Concentrations and Fluxes of Polychlorinated Biphenyls Using Passive Samplers, *Env. Sci. Technol.*, *52*, 4565–4573. <https://doi.org/10.1021/acs.est.7b05809>.
- Booij, K., and F. Smedes (2010), An improved method for estimating in situ sampling rates of nonpolar passive samplers, *Environ. Sci. Technol.*, *44*(17), 6789–94, doi:10.1021/es101321v.
- Booij, K., F. Smedes, and E. M. van Weerlee (2002), Spiking of performance reference compounds in low density polyethylene and silicone passive water samplers, *Chemosphere*, *46*(8), 1157–1161, doi:10.1016/S0045-6535(01)00200-4.
- Fernandez, L. A., J. K. Macfarlane, A. P. Tcaciuc, and P. M. Gschwend (2009), Measurement of Freely Dissolved PAH Concentrations in Sediment Beds Using Passive Sampling with Low-Density Polyethylene Strips, *Environ. Sci. Technol.*, *43*, 1430–1436, doi:10.1021/es802288w.
- Friedman, C. L., and R. Lohmann (2014), Comparing sediment equilibrium partitioning and passive sampling techniques to estimate benthic biota PCDD/F concentrations in Newark Bay, New Jersey (U.S.A.), *Environ. Pollut.*, *186*, 172–179, doi:10.1016/j.envpol.2013.12.002.
- Friedman, C. L., M. G. Cantwell, and R. Lohmann (2012), Passive sampling provides evidence for Newark Bay as a source of polychlorinated dibenzo-p-dioxins and furans to the New York/New Jersey, USA, atmosphere, *Environ. Toxicol. Chem.*, *31*(2), 253–261, doi:10.1002/etc.742.
- Gschwend, P. M., A. P. Tcaciuc, and J. Apell (2014), Passive PE Sampling in Support of In Situ Remediation of Contaminated Sediments - Passive Sampler PRC Calculation Software User's Guide.
- Gustafsson, O., F. Haghete, C. Chan, J. Macfarlane, and P. M. Gschwend (1997), Quantification of the Dilute Sedimentary Soot Phase - Implications for PAH Speciation and Bioavailability, *Environ. Sci. Technol.*, *31*(1), 203–209.
- Hammes, K. et al. (2007), Comparison of quantification methods to measure fire-derived (black-elemental) carbon in soils and sediments using reference materials from soil, water, sediment and the atmosphere, *Global Biogeochem. Cycles*, *21*, doi:10.1029/2006GB002914.

- Huckins, J. N., J. D. Petty, J. A. Lebo, F. V. Almeida, K. Booij, D. A. Alvarez, W. L. Cranor, R. C. Clark, and B. B. Mogensen (2002), Development of the Permeability/Performance Reference Compound Approach for in situ Calibration of Semipermeable Membrane Devices, *Environ. Sci. Technol.*, 36(1), 85–91, doi:10.1021/es010991w.
- Jonker, M. T. O., and A. A. Koelmans (2001), Polyoxymethylene Solid Phase Extraction as a Partitioning Method for Hydrophobic Organic Chemicals in Sediment and Soot, *Environ. Sci. Technol.*, 35(18), 3742–3748, doi:10.1021/es0100470.
- Jonker, M. T. O., R. M. Burgess, U. Ghosh, P. M. Gschwend, S. E. Hale, R. Lohmann, M. J. Lydy, K. A. Maruya, D. Reible, and F. Smedes (2020), Ex Situ Determination of Freely Dissolved Concentrations of Hydrophobic Organic Chemicals in Sediments and Soils: Basis for Interpreting Toxicity and Assessing Bioavailability, Risks and Remediation Necessity. *Nat. Protoc.*, 15:1800-1828. <https://doi.org/10.1038/s41596-020-0311-y>.
- Khairy, M., D. Muir, C. Teixeira, and R. Lohmann (2014a), Spatial Trends, Sources, and Air – Water Exchange of Organochlorine Pesticides in the Great Lakes Basin Using Low Density Polyethylene Passive Samplers, *Environ. Sci. Technol.*, 48, 9315–9324, doi.org/10.1021/es501686a.
- Khairy, M. A., M. P. Weinstein, and R. Lohmann (2014b), Trophodynamic behavior of hydrophobic organic contaminants in the aquatic food web of a tidal river, *Environ. Sci. Technol.*, 48, 12533–12542.
- Khairy, M., D. Muir, C. Teixeira, and R. Lohmann (2015), Spatial Distribution, Air-Water Fugacity Ratios and Source Apportionment of Polychlorinated Biphenyls in the Lower Great Lakes Basin. *Environ. Sci. Technol.*, 49 (23), 13787–13797. <https://doi.org/10.1021/acs.est.5b00186>.
- Khairy, M., K. Barrett, and R. Lohmann (2016), Changing sources of polychlorinated dibenzo-p-dioxins and furans in sediments and ecological risk for nekton in the lower Passaic River and Newark Bay, New Jersey, USA, *Environ. Toxicol. Chem.*, 35(3), 550–562, doi:10.1002/etc.3223.
- Khairy, M. A. and R. Lohmann (2017), Assessing Benthic Bioaccumulation of Polychlorinated Partitioning, Fluxes and Bioaccumulation of PBDEs in an Urban River. *Environ Sci Technol*, 51, 9062–9071. <http://dx.doi.org/10.1021/acs.est.7b02418>
- Khairy, M. A., G. O. Noonan, and R. Lohmann (2019), Uptake of Hydrophobic Organic Compounds, Including Organochlorine Pesticides, Polybrominated Diphenyl Ethers, and Perfluoroalkyl Acids in Fish and Blue Crabs of the Lower Passaic River, New Jersey, USA. *Environ. Toxicol. Chem.*, 38 (4), 872–882. <https://doi.org/10.1002/etc.4354>.
- Khairy, M. A. and R. Lohmann (2020), Assessing Benthic Bioaccumulation of Polychlorinated Dioxins/ Furans and Polychlorinated Biphenyls in the Lower Passaic River (NJ, USA) Based on In Situ Passive Sampling. *Environ. Toxicol. Chem.*, 39 (6), 1174–1185. <https://doi.org/10.1002/etc.4716>.

- Lambert, M. K., C. Friedman, P. Luey, and R. Lohmann (2011), Role of black carbon in the sorption of polychlorinated dibenzo-p-dioxins and dibenzofurans at the diamond alkali superfund site, Newark Bay, New Jersey, *Environ. Sci. Technol.*, *45*, 4331–4338, doi:10.1021/es103953t.
- Liu, Y., S. Wang, C. A. Mcdonough, M. Khairy, D. C. G. Muir, P. A. Helm, and R. Lohmann (2016), Gaseous and Freely-Dissolved PCBs in the Lower Great Lakes Based on Passive Sampling: Spatial Trends and Air – Water Exchange, *Environ. Sci. Technol.*, *50*, 4932–4939, doi:10.1021/acs.est.5b04586.
- Lohmann, R. (2012), Critical Review of Low-Density Polyethylene’s Partitioning and Diffusion Coefficients for Trace Organic Contaminants and Implications for Its Use As a Passive Sampler, *Environ. Sci. Technol.*, *46*, 606–618.
- Lohmann, R., J. K. Macfarlane, and P. M. Gschwend (2005), Importance of black carbon to sorption of native PAHs, PCBs, and PCDDs in Boston and New York harbor sediments., *Environ. Sci. Technol.*, *39*(1), 141–148, doi:10.1021/es049424+.
- Lohmann, R., M. Dapsis, E. J. Morgan, V. Dekany, and P. J. Luey (2011), Determining air-water exchange, spatial and temporal trends of freely dissolved PAHs in an urban estuary using passive polyethylene samplers, *Environ. Sci. Technol.*, *45*, 2655–2662, doi:10.1021/es1025883.
- Mayer, P., J. Tolls, J. L. M. Hermens, and D. Mackay (2003), Equilibrium sampling devices: An emerging strategy for monitoring exposure to hydrophobic organic chemicals, *Environ. Sci. Technol.*, *37*, 184A– 191A.
- Mayer, P. et al. (2014), Passive sampling methods for contaminated sediments: scientific rationale supporting use of freely dissolved concentrations., *Integr. Environ. Assess. Manag.*, *10*(2), 197–209, doi:10.1002/ieam.1508.
- McDonough, C. A., P. A. Helm, D. Muir, G. Puggioni, and R. Lohmann (2016), Polycyclic Musks in the Air and Water of the Lower Great Lakes: Spatial Distribution and Volatilization from Surface Waters, *Environ. Sci. Technol.*, *50*, 11575–11583, doi:10.1021/acs.est.6b03657.
- McDonough, C. A., M. A. Khairy, D. C. G. Muir, and R. Lohmann (2014), Significance of population centers as sources of gaseous and dissolved PAHs in the lower Great Lakes, *Environ. Sci. Technol.*, *48*, 7789–7797, doi:10.1021/es501074r.
- McDonough, C. A., G. Puggioni, P. A. Helm, D. Muir, and R. Lohmann (2016), Spatial Distribution and Air – Water Exchange of Organic Flame Retardants in the Lower Great Lakes, *Environ. Sci. Technol.*, *50*, 9133–9141, doi:10.1021/acs.est.6b02496.
- Morgan, E. J., and R. Lohmann (2008), Detecting air-water and surface-deep water gradients of PCBs using polyethylene passive samplers, *Environ. Sci. Technol.*, *42*, 7248–7253, doi:10.1021/es800518g.
- Perron, M. M., R. M. Burgess, M. G. Cantwell, and L. A. Fernandez (2014), Evaluating Cost when

Selecting Performance Reference Compounds for the Environmental Deployment of Polyethylene Passive Samplers, *Integr. Environ. Assess. Manag.*, 11(2), 256–265, doi:10.1002/ieam.1582.

Reichenberg, F., and P. Mayer (2006), Two complementary sides of bioavailability: Accessibility and chemical activity of organic contaminants in sediments and soil, *Environ. Toxicol. Chem.*, 25(5), 1239–1245.

Reitsma, P. J., D. Adelman, and R. Lohmann (2013), Challenges of using polyethylene passive samplers to determine dissolved concentrations of parent and alkylated PAHs under cold and saline conditions, *Environ. Sci. Technol.*, 47, 10429–10437, doi:10.1021/es402528q.

Ruge, Z., D. Muir, P. Helm, and R. Lohmann (2015), Concentrations, Trends, and Air – Water Exchange of PAHs and PBDEs Derived from Passive Samplers in Lake Superior in 2011, *Environ. Sci. Technol.*, 49, 13777–13786, doi:10.1021/acs.est.5b02611.

Sacks, V. P., and R. Lohmann (2011), Development and use of polyethylene passive samplers to detect triclosans and alkylphenols in an Urban estuary, *Environ. Sci. Technol.*, 45, 2270–2277, doi:10.1021/es1040865.

Sacks, V. P., and R. Lohmann (2012), Freely dissolved PBDEs in water and porewater of an urban estuary, *Environ. Pollut.*, 162, 287–293, doi:10.1016/j.envpol.2011.11.028.

APPENDIX A SUPPORTING DATA

Table A1. PRC Correction for PCBs, 1st Newark Bay Deployment

From PRC GUI																
Note: Red cell means the PRCs was not used in model and calculation																
If f >.9 or <.1 it was not used																
OCN and PCB 104 were removed																
	201-01	201-04	201-05	201-07	201-09	202-02	202-05	203-01/(203-03/(203-05/(203-07/(203-09/:	203-11/:	203-13/:	203-14/:	203-16/1
Kd - Kow stats																
slope	0.14	0.36	0.41	0.41	0.09	-0.48	0.52	0.32	0.28	0.35	0.45	0.40	0.32	0.57	0.53	0.36
intercept	4.35	3.26	2.95	2.83	4.86	8.24	2.31	3.13	3.55	3.23	2.80	2.64	3.54	1.92	2.36	3.08
R2	0.50	0.76	0.48	0.54	1.00	0.06	0.53	1.00	0.96	0.64	0.59	0.60	0.59	0.61	0.59	0.36
PRC used																
DiBB (2,5 dib	0.82	0.84	0.84	0.82	0.88	0.85	0.85	0.79	0.82	0.81	0.84	0.77	0.86	0.78	0.85	0.83
TeBB (2,2',5,5	0.24	0.41	0.33	0.33	0.32	0.58	0.43	0.39	0.39	0.42	0.41	0.27	0.37	0.43	0.49	0.24
PeBB (2,2',4,5	0.14	0.20	0.23	0.19	-0.01	0.45	0.27	0.05	0.15	0.29	0.27	0.13	0.20	0.37	0.39	0.19
OCN	0.02	0.11	0.21	0.17	-0.01	0.43	0.36	0.08	-0.09	0.06	0.22	0.11	0.13	0.26	0.32	0.19
Compounds																
PCB 8	0.92	0.92	0.92	0.91	0.94	0.97	0.92	0.88	0.91	0.92	0.92	0.87	0.93	0.90	0.93	0.91
PCB 11	0.87	0.88	0.88	0.86	0.91	0.94	0.89	0.83	0.86	0.88	0.89	0.82	0.90	0.86	0.90	0.87
PCB 18	0.88	0.89	0.88	0.87	0.91	0.95	0.89	0.83	0.87	0.88	0.89	0.82	0.90	0.87	0.90	0.88
PCB 28	0.71	0.76	0.76	0.72	0.78	0.82	0.78	0.66	0.71	0.74	0.77	0.65	0.78	0.74	0.80	0.74
PCB 44	0.66	0.72	0.72	0.68	0.74	0.78	0.75	0.61	0.67	0.70	0.74	0.60	0.74	0.71	0.77	0.70
PCB 52	0.61	0.68	0.68	0.64	0.69	0.72	0.71	0.56	0.62	0.66	0.70	0.56	0.70	0.67	0.74	0.66
PCB 66	0.40	0.50	0.51	0.46	0.48	0.45	0.55	0.38	0.43	0.48	0.53	0.38	0.52	0.51	0.59	0.47
PCB 77	0.32	0.41	0.43	0.39	0.39	0.34	0.48	0.30	0.35	0.40	0.46	0.31	0.43	0.44	0.51	0.39
PCB 81	0.32	0.41	0.43	0.39	0.39	0.34	0.48	0.30	0.35	0.40	0.46	0.31	0.43	0.44	0.51	0.39
PCB 101	0.30	0.39	0.41	0.37	0.37	0.31	0.46	0.28	0.33	0.38	0.44	0.29	0.41	0.42	0.49	0.37
PCB 105	0.19	0.27	0.29	0.25	0.23	0.17	0.34	0.19	0.22	0.26	0.31	0.19	0.29	0.31	0.37	0.26
PCB 114	0.19	0.27	0.29	0.25	0.23	0.17	0.34	0.19	0.22	0.26	0.31	0.19	0.29	0.31	0.37	0.26
PCB 118	0.16	0.24	0.26	0.22	0.20	0.13	0.30	0.16	0.19	0.23	0.28	0.17	0.25	0.28	0.33	0.22
PCB 123	0.16	0.24	0.26	0.22	0.20	0.13	0.30	0.16	0.19	0.23	0.28	0.17	0.25	0.28	0.33	0.22
PCB 126	0.12	0.19	0.20	0.18	0.15	0.09	0.25	0.12	0.15	0.18	0.23	0.13	0.20	0.23	0.28	0.18
PCB 128	0.16	0.23	0.25	0.22	0.19	0.13	0.30	0.16	0.18	0.22	0.27	0.16	0.24	0.27	0.32	0.22
PCB 138	0.13	0.20	0.22	0.19	0.16	0.10	0.26	0.13	0.16	0.19	0.24	0.14	0.21	0.24	0.29	0.19
PCB 153	0.11	0.17	0.19	0.16	0.13	0.08	0.23	0.11	0.13	0.16	0.21	0.12	0.18	0.21	0.25	0.16
PCB 156	0.07	0.11	0.13	0.11	0.08	0.04	0.16	0.07	0.08	0.11	0.14	0.08	0.12	0.15	0.18	0.11
PCB 157	0.07	0.11	0.13	0.11	0.08	0.04	0.16	0.07	0.08	0.11	0.14	0.08	0.12	0.15	0.18	0.11
PCB 167	0.05	0.10	0.11	0.09	0.07	0.03	0.14	0.06	0.07	0.09	0.12	0.07	0.10	0.13	0.16	0.09
PCB 169	0.04	0.07	0.08	0.07	0.05	0.02	0.11	0.05	0.05	0.07	0.10	0.05	0.08	0.10	0.13	0.07
PCB 170	0.05	0.09	0.11	0.09	0.07	0.03	0.14	0.06	0.07	0.09	0.12	0.06	0.10	0.12	0.15	0.09
PCB 180	0.04	0.08	0.09	0.08	0.05	0.02	0.12	0.05	0.06	0.07	0.10	0.06	0.08	0.11	0.13	0.07
PCB 187	0.06	0.11	0.12	0.11	0.08	0.04	0.16	0.07	0.08	0.10	0.14	0.08	0.12	0.14	0.18	0.10
PCB 189	0.02	0.04	0.05	0.04	0.03	0.01	0.07	0.03	0.03	0.04	0.06	0.03	0.04	0.06	0.08	0.04
PCB 195	0.03	0.05	0.06	0.05	0.03	0.01	0.08	0.03	0.04	0.05	0.07	0.04	0.06	0.08	0.10	0.05
PCB 206	0.01	0.02	0.02	0.02	0.01	0.00	0.04	0.01	0.01	0.02	0.03	0.01	0.02	0.03	0.04	0.02
PCB 209	0.01	0.02	0.02	0.02	0.01	0.00	0.03	0.01	0.01	0.02	0.02	0.01	0.02	0.03	0.03	0.02

Table A2. PRC Correction for PCDD/Fs, 1st Newark Bay Deployment

Note: Red cell means the PRCs was not used in model and calculation								
PRCs > .9 or < .1 are not used								
Kd - Kow stat	203-01/02	203-03/04	203-05/06	203-09/10	203-11/12	203-13/14	203-15/16	203-17/18
slope	0.37	0.30	0.41	0.37	0.32	0.61	0.57	0.35
intercept	3.24	3.76	3.20	3.20	3.80	1.53	2.14	3.37
R2	0.43	0.32	0.37	0.26	0.39	0.64	0.60	0.31
PRC used								
13C 1,3,6,8-T	0.32	0.38	0.36	0.33	0.36	0.20	0.29	0.34
13C 1,2,3,4,6	0.27	0.29	0.39	0.43	0.31	0.19	0.31	0.23
DiBB (2,5 dib	0.79	0.82	0.81	0.77	0.86	0.78	0.85	0.83
TeBB (2,2',5,5	0.39	0.39	0.42	0.27	0.37	0.43	0.49	0.24
PeBB (2,2',4,5	0.05	0.15	0.29	0.13	0.20	0.37	0.39	0.19
OCN	0.08	-0.09	0.06	0.11	0.13	0.26	0.32	0.19
Compounds								
2-CDD	0.96	0.97	0.96	0.96	0.97	0.93	0.96	0.96
2,7-DiCDD	0.71	0.74	0.75	0.70	0.77	0.64	0.74	0.73
2,8-DiCDD	0.71	0.74	0.75	0.70	0.77	0.64	0.74	0.73
2,3,7-TriCDD	0.71	0.74	0.76	0.71	0.77	0.69	0.77	0.73
1,3,6,8-TCDD	0.30	0.32	0.35	0.29	0.35	0.29	0.38	0.31
1,2,3,7,8-PeC	0.29	0.31	0.35	0.29	0.35	0.29	0.38	0.31
1,2,3,4,6,8-Hx	0.13	0.13	0.16	0.13	0.15	0.16	0.21	0.13
1,2,3,6,7,8-Hx	0.12	0.12	0.15	0.12	0.14	0.15	0.20	0.13
1,2,3,7,8,9-Hx	0.12	0.12	0.15	0.12	0.14	0.15	0.20	0.13
1,2,3,4,6,7,8-	0.10	0.10	0.13	0.10	0.12	0.15	0.19	0.10
OCDD	0.02	0.02	0.03	0.02	0.03	0.04	0.05	0.02
2,3,7,8-TCDF	0.40	0.43	0.46	0.40	0.47	0.36	0.47	0.42
1,2,3,7,8-PeC	0.22	0.24	0.27	0.22	0.27	0.22	0.29	0.24
2,3,4,7,8-PeC	0.16	0.17	0.20	0.16	0.20	0.16	0.21	0.17
1,2,3,4,7,8-Hx	0.03	0.03	0.03	0.03	0.03	0.03	0.04	0.03
1,2,3,4,6,7,8-	0.01	0.01	0.01	0.01	0.01	0.01	0.01	0.01
OCDF	0.00	0.00	0.00	0.00	0.00	0.00	0.00	0.00

Table A3. PRC Correction for PCBs, 2nd Newark Bay Deployment

From PRC GUI																
Note: Red cell means the PRCs was not used in model and calculation																
If f >.9 or <.1 it was not used																
OCN and PCB 104 were removed																
	204-04	204-05	204-06	204-07a	204-07b	204-08a	204-08b	204-09a	204-09b	204-10a	204-10b	204-11	210-05	210-06a	210-06b	210-07a
Model stats																
Slope	0.47	0.65	0.95	1.08	0.74	1.12	0.54	0.73	0.37	1.25	0.54	0.59	0.31	0.63	0.47	0.96
Intercept	2.97	0.10	-0.11	-1.28	0.89	-1.92	1.99	0.57	3.17	-2.52	2.01	2.18	3.73	1.61	2.66	-0.92
R2	0.91	0.77	0.93	0.90	0.75	0.89	0.56	0.68	0.33	0.83	0.44	0.82	0.60	0.86	0.91	0.93
f of PRCs used																
PCB 2	0.97	0.96	0.96	0.93	0.99	0.91	0.99	0.97	1.00	0.95	0.98	1.00	0.99	0.99	0.99	0.92
PCB 14	0.97	0.78	0.86	0.77	0.92	0.71	0.89	0.80	0.96	0.74	0.89	0.97	0.93	0.86	0.94	0.70
PCB 30	0.92	0.63	0.75	0.60	0.77	0.48	0.67	0.58	0.88	0.50	0.71	0.92	0.87	0.78	0.86	0.56
PCB 50	0.88	0.51	0.72	0.52	0.63	0.33	0.53	0.42	0.70	0.37	0.52	0.81	0.77	0.64	0.75	0.43
PCB 145	0.61	0.44	0.60	0.51	0.55	0.38	0.42	0.36	0.33	0.42	0.38	0.53	0.51	0.47	0.50	0.39
DIBB	0.96	0.72	0.84	0.75	0.92	0.67	0.87	0.77	0.96	0.68	0.87	0.97	0.95	0.87	0.95	0.70
TetraBB	0.59	0.36	0.51	0.55	0.55	0.37	0.43	0.45	0.38	0.43	0.37	0.58	0.52	0.45	0.38	0.35
PentaBB	0.36	0.12	-0.04	0.29	0.19	0.28	0.18	0.13	-0.04	0.08	-0.02	0.28	0.26	0.25	0.01	0.23
Days	67.00	39.00	39.00	39.00	39.00	39.00	39.00	39.00	39.00	39.00	39.00	39.00	39.00	39.00	39.00	39.00
Compounds Fractional Equilibration																
PCB 8	0.96	0.82	0.88	0.79	0.87	0.68	0.88	0.80	0.91	0.69	0.88	0.93	0.92	0.89	0.92	0.74
PCB 11	0.94	0.76	0.84	0.74	0.83	0.63	0.84	0.74	0.88	0.65	0.84	0.90	0.89	0.85	0.88	0.68
PCB 18	0.94	0.76	0.84	0.74	0.83	0.63	0.84	0.75	0.88	0.64	0.84	0.90	0.90	0.86	0.89	0.68
PCB 28	0.87	0.59	0.74	0.62	0.70	0.50	0.70	0.59	0.74	0.54	0.69	0.81	0.79	0.73	0.77	0.54
PCB 44	0.85	0.55	0.72	0.60	0.67	0.47	0.66	0.55	0.70	0.51	0.65	0.78	0.76	0.70	0.73	0.50
PCB 52	0.82	0.51	0.69	0.57	0.64	0.45	0.62	0.51	0.66	0.49	0.61	0.75	0.73	0.66	0.70	0.48
PCB 66	0.69	0.36	0.58	0.46	0.50	0.35	0.46	0.37	0.48	0.41	0.45	0.61	0.58	0.51	0.53	0.36
PCB 77	0.62	0.31	0.53	0.42	0.43	0.32	0.38	0.31	0.40	0.37	0.38	0.54	0.50	0.44	0.45	0.32
PCB 81	0.62	0.31	0.53	0.42	0.43	0.32	0.38	0.31	0.40	0.37	0.38	0.54	0.50	0.44	0.45	0.32
PCB 101	0.60	0.29	0.51	0.40	0.42	0.30	0.37	0.30	0.38	0.36	0.36	0.52	0.48	0.42	0.43	0.30
PCB 105	0.47	0.21	0.42	0.33	0.32	0.24	0.26	0.22	0.26	0.30	0.26	0.40	0.36	0.32	0.31	0.23
PCB 114	0.47	0.21	0.42	0.33	0.32	0.24	0.26	0.22	0.26	0.30	0.26	0.40	0.36	0.32	0.31	0.23
PCB 118	0.43	0.18	0.39	0.31	0.29	0.23	0.23	0.20	0.23	0.28	0.23	0.36	0.33	0.29	0.28	0.22
PCB 124	0.44	0.19	0.40	0.31	0.29	0.23	0.24	0.20	0.23	0.29	0.23	0.37	0.33	0.29	0.28	0.22
PCB 126	0.36	0.15	0.35	0.27	0.24	0.20	0.19	0.16	0.18	0.26	0.18	0.30	0.27	0.24	0.23	0.19
PCB 128	0.42	0.18	0.38	0.30	0.28	0.22	0.23	0.19	0.22	0.28	0.22	0.35	0.32	0.28	0.27	0.21
PCB 138	0.38	0.16	0.36	0.28	0.25	0.20	0.20	0.17	0.19	0.26	0.19	0.32	0.28	0.25	0.24	0.19
PCB 153	0.34	0.14	0.32	0.25	0.22	0.19	0.17	0.15	0.16	0.24	0.17	0.28	0.25	0.22	0.21	0.17
PCB 156	0.24	0.10	0.26	0.21	0.17	0.15	0.12	0.11	0.11	0.20	0.12	0.20	0.18	0.16	0.14	0.13
PCB 157	0.24	0.10	0.26	0.21	0.17	0.15	0.12	0.11	0.11	0.20	0.12	0.20	0.18	0.16	0.14	0.13
PCB 167	0.21	0.09	0.24	0.19	0.15	0.14	0.10	0.10	0.09	0.19	0.10	0.18	0.16	0.14	0.12	0.12
PCB 169	0.17	0.07	0.21	0.17	0.12	0.12	0.08	0.08	0.07	0.17	0.08	0.15	0.12	0.11	0.10	0.10
PCB 170	0.21	0.08	0.23	0.19	0.15	0.14	0.10	0.09	0.09	0.19	0.10	0.18	0.15	0.13	0.12	0.12
PCB 180	0.18	0.07	0.21	0.17	0.13	0.12	0.09	0.08	0.08	0.17	0.09	0.15	0.13	0.12	0.10	0.11
PCB 187	0.24	0.10	0.26	0.20	0.16	0.15	0.12	0.11	0.11	0.20	0.11	0.20	0.17	0.15	0.14	0.13
PCB 189	0.10	0.04	0.15	0.12	0.08	0.09	0.05	0.05	0.04	0.13	0.05	0.09	0.08	0.07	0.06	0.07
PCB 195	0.13	0.05	0.17	0.14	0.10	0.10	0.06	0.06	0.05	0.15	0.06	0.11	0.09	0.09	0.07	0.08
PCB 206	0.05	0.02	0.09	0.08	0.05	0.06	0.03	0.03	0.02	0.09	0.02	0.05	0.04	0.04	0.03	0.04
PCB 209	0.04	0.02	0.08	0.07	0.04	0.05	0.02	0.02	0.02	0.08	0.02	0.04	0.03	0.03	0.02	0.04

Table A3. PRC Correction for PCBs, 2nd Newark Bay Deployment, ctd.

From PRC GUI															
Note: Red cell means the PRCs was not used in model and calculation															
If f >.9 or <.1 it was not used															
OCN and PCB 104 were removed															
	210-07b	210-08	210-09a	210-09b	210-10	210-11a	210-11b	210-12a	210-12b	210-13a	210-13b	210-14a	210-14b	210-15a	210-15b
Model stats															
Slope	0.70	0.49	0.84	0.26	0.48	1.07	0.62	1.18	0.62	1.03	0.80	0.98	0.62	0.94	0.77
Intercept	1.10	2.51	0.38	4.07	2.18	-1.63	1.09	-2.27	1.23	-1.26	0.34	-0.77	1.62	-0.61	0.89
R2	0.77	0.92	0.91	0.52	0.45	0.84	0.60	0.94	0.69	0.90	0.78	0.95	0.75	0.89	0.79
f of PRCs used															
PCB 2	0.98	0.99	0.97	0.99	0.99	0.95	0.98	0.84	0.97	0.89	0.98	0.87	0.96	0.90	0.96
PCB 14	0.87	0.89	0.84	0.95	0.86	0.71	0.80	0.62	0.81	0.67	0.84	0.73	0.87	0.77	0.90
PCB 30	0.69	0.83	0.73	0.89	0.73	0.54	0.61	0.47	0.64	0.52	0.66	0.62	0.71	0.51	0.71
PCB 50	0.55	0.71	0.63	0.78	0.47	0.36	0.35	0.40	0.44	0.37	0.50	0.57	0.58	0.57	0.61
PCB 145	0.51	0.50	0.47	0.49	0.21	0.22	0.28	0.33	0.26	0.38	0.33	0.48	0.51	0.47	0.55
DiBB	0.86	0.91	0.86	0.97	0.88	0.73	0.82	0.62	0.83	0.70	0.85	0.76	0.87	0.73	0.88
TetraBB	0.39	0.40	0.48	0.46	0.34	0.27	0.19	0.33	0.26	0.39	0.36	0.46	0.40	0.32	0.46
PentaBB	0.26	0.21	0.34	0.17	0.18	0.38	0.20	0.40	0.20	0.30	0.32	0.26	0.22	0.27	0.35
Days	39.00	39.00	39.00	39.00	39.00	39.00	39.00	39.00	39.00	39.00	39.00	39.00	39.00	39.00	39.00
Compounds Fractional Equilibration															
PCB 8	0.87	0.91	0.87	0.94	0.87	0.69	0.80	0.68	0.82	0.74	0.83	0.79	0.88	0.78	0.89
PCB 11	0.83	0.88	0.83	0.92	0.81	0.64	0.73	0.63	0.76	0.68	0.79	0.75	0.84	0.73	0.85
PCB 18	0.83	0.88	0.83	0.92	0.82	0.63	0.74	0.62	0.76	0.68	0.79	0.74	0.84	0.72	0.85
PCB 28	0.70	0.76	0.71	0.81	0.65	0.50	0.56	0.51	0.59	0.55	0.65	0.62	0.71	0.59	0.74
PCB 44	0.66	0.72	0.68	0.78	0.61	0.47	0.52	0.48	0.55	0.52	0.61	0.59	0.67	0.55	0.71
PCB 52	0.63	0.68	0.65	0.74	0.57	0.45	0.48	0.46	0.51	0.49	0.58	0.56	0.64	0.52	0.68
PCB 66	0.48	0.52	0.52	0.56	0.39	0.35	0.33	0.37	0.36	0.38	0.44	0.44	0.48	0.40	0.55
PCB 77	0.42	0.44	0.46	0.48	0.32	0.31	0.27	0.33	0.30	0.34	0.39	0.39	0.41	0.35	0.48
PCB 81	0.42	0.44	0.46	0.48	0.32	0.31	0.27	0.33	0.30	0.34	0.39	0.39	0.41	0.35	0.48
PCB 101	0.40	0.42	0.44	0.45	0.31	0.29	0.26	0.32	0.28	0.32	0.37	0.38	0.39	0.34	0.46
PCB 105	0.30	0.31	0.35	0.32	0.21	0.23	0.18	0.26	0.20	0.26	0.28	0.30	0.29	0.26	0.36
PCB 114	0.30	0.31	0.35	0.32	0.21	0.23	0.18	0.26	0.20	0.26	0.28	0.30	0.29	0.26	0.36
PCB 118	0.27	0.27	0.32	0.28	0.19	0.22	0.16	0.25	0.18	0.24	0.26	0.28	0.26	0.24	0.33
PCB 124	0.28	0.28	0.33	0.28	0.19	0.22	0.16	0.25	0.18	0.24	0.26	0.28	0.26	0.24	0.34
PCB 126	0.23	0.22	0.28	0.22	0.15	0.19	0.13	0.22	0.15	0.21	0.22	0.24	0.22	0.21	0.28
PCB 128	0.27	0.26	0.31	0.27	0.18	0.21	0.16	0.24	0.17	0.23	0.25	0.27	0.25	0.24	0.32
PCB 138	0.24	0.23	0.29	0.23	0.16	0.19	0.14	0.22	0.15	0.21	0.23	0.25	0.23	0.22	0.30
PCB 153	0.21	0.20	0.26	0.20	0.13	0.17	0.12	0.20	0.13	0.19	0.20	0.22	0.20	0.19	0.26
PCB 156	0.15	0.14	0.20	0.13	0.09	0.14	0.08	0.17	0.09	0.15	0.15	0.18	0.14	0.15	0.20
PCB 157	0.15	0.14	0.20	0.13	0.09	0.14	0.08	0.17	0.09	0.15	0.15	0.18	0.14	0.15	0.20
PCB 167	0.14	0.12	0.18	0.11	0.08	0.13	0.07	0.16	0.08	0.14	0.13	0.16	0.12	0.14	0.18
PCB 169	0.11	0.10	0.15	0.08	0.06	0.11	0.06	0.14	0.06	0.12	0.11	0.14	0.10	0.11	0.15
PCB 170	0.13	0.12	0.17	0.11	0.08	0.12	0.07	0.15	0.08	0.14	0.13	0.16	0.12	0.13	0.17
PCB 180	0.12	0.10	0.16	0.09	0.07	0.11	0.06	0.14	0.07	0.12	0.12	0.14	0.11	0.12	0.16
PCB 187	0.15	0.14	0.19	0.13	0.09	0.14	0.08	0.17	0.09	0.15	0.15	0.17	0.14	0.15	0.20
PCB 189	0.07	0.06	0.10	0.05	0.04	0.08	0.04	0.11	0.04	0.09	0.07	0.10	0.06	0.08	0.10
PCB 195	0.09	0.07	0.12	0.06	0.05	0.09	0.04	0.12	0.05	0.10	0.09	0.11	0.08	0.09	0.12
PCB 206	0.04	0.03	0.06	0.02	0.02	0.05	0.02	0.07	0.02	0.06	0.04	0.06	0.03	0.05	0.06
PCB 209	0.03	0.02	0.05	0.02	0.02	0.05	0.02	0.06	0.02	0.05	0.04	0.05	0.03	0.04	0.05

Table A4. PRC Correction for PCDD/Fs, 2nd Newark Bay Deployment

Note: Red cell means the PRCs was not used in model and calculation																			
PRCs > .9 or < .1 are not used																			
	204-04	204-05	204-06	204-07	204-08	204-09	204-10	204-11	210-05	210-06	210-07	210-08	210-09	210-10	210-11	210-12	210-13	210-14	210-15
Model stats																			
Slope	0.30	0.54	0.57	0.51	0.58	0.80	0.55	0.72	0.47	2.27	0.34	0.38	0.63	0.19	0.16	0.32	0.57	0.41	0.33
Intercept	4.39	1.83	1.74	2.22	1.62	-0.09	1.79	0.96	2.40	-10.12	3.35	2.80	0.85	4.15	4.24	3.28	1.86	2.80	3.76
R2	0.16	0.59	0.76	0.78	0.62	0.53	0.55	0.60	0.62	0.92	0.58	0.55	0.67	0.43	0.17	0.38	0.56	0.45	0.44
f of PRCs used																			
DiBB (2,5 dib)	0.96	0.72	0.84	0.87	0.83	0.92	0.84	0.97	0.95	0.94	0.82	0.91	0.94	0.88	0.80	0.77	0.81	0.84	0.84
TeBB (2,25,5)	0.59	0.36	0.51	0.55	0.41	0.39	0.38	0.58	0.52	0.39	0.38	0.40	0.47	0.34	0.21	0.28	0.37	0.42	0.42
PeBB (2,2,4,5)	0.36	0.12	-0.04	0.22	0.20	0.00	0.00	0.28	0.26	0.07	0.25	0.21	0.21	0.18	0.24	0.26	0.32	0.23	0.33
OCN	0.26	0.23	0.22	0.17	0.27	0.35	0.27	0.35	0.05	0.06	-0.08	0.05	-0.03	0.01	0.10	0.06	0.28	0.09	0.03
13C 1,3,6,8-T	0.36	0.34	0.22	0.17	0.13	0.25	NA	0.26	0.16	0.16	0.19	0.14	0.07	0.16	0.21	0.15	0.00	0.11	0.00
13C 1,2,3,8,9	0.63	0.06	0.18	0.25	-0.05	0.12	0.13	0.04	0.29	0.10	0.29	0.22	0.10	0.19	0.18	0.25	0.18	0.25	0.39
13C 1,2,3,4,6	0.59	-0.11	0.01	0.02	-0.22	0.03	0.11	0.03	0.05	0.05	0.14	0.07	0.03	-0.01	0.09	0.13	0.14	0.21	0.23
Days	67.00	39.00	39.00	39.00	39.00	39.00	39.00	39.00	39.00	39.00	39.00	39.00	39.00	39.00	39.00	39.00	39.00	39.00	39.00
Compounds Fractional Equilibration																			
2-CDD	0.99	0.92	0.92	0.94	0.92	0.83	0.92	0.92	0.93	0.12	0.95	0.93	0.85	0.96	0.96	0.95	0.93	0.94	0.97
2,7-DiCDD	0.90	0.57	0.60	0.64	0.58	0.42	0.58	0.61	0.62	0.08	0.68	0.59	0.41	0.67	0.66	0.64	0.63	0.64	0.77
2,8-DiCDD	0.90	0.57	0.60	0.64	0.58	0.42	0.58	0.61	0.62	0.08	0.68	0.59	0.41	0.67	0.66	0.64	0.63	0.64	0.77
2,3,7-TriCDD	0.89	0.62	0.65	0.68	0.63	0.52	0.63	0.68	0.64	0.29	0.68	0.60	0.48	0.64	0.62	0.63	0.67	0.65	0.77
1,3,6,8-TCDD	0.58	0.23	0.25	0.28	0.24	0.18	0.24	0.29	0.24	0.12	0.27	0.21	0.15	0.23	0.21	0.23	0.27	0.25	0.36
2,3,7,8-TCDD	0.59	0.24	0.27	0.29	0.25	0.20	0.25	0.31	0.25	0.15	0.27	0.22	0.16	0.23	0.21	0.23	0.29	0.26	0.37
1,2,3,7,8-PeC	0.57	0.23	0.26	0.28	0.24	0.19	0.24	0.30	0.24	0.15	0.26	0.21	0.15	0.22	0.20	0.22	0.27	0.25	0.35
1,2,3,4,6,8-Hx	0.28	0.11	0.12	0.13	0.12	0.11	0.11	0.17	0.11	0.30	0.10	0.08	0.07	0.07	0.06	0.08	0.13	0.10	0.14
1,2,3,6,7,8-Hx	0.28	0.11	0.12	0.13	0.12	0.11	0.11	0.17	0.11	0.30	0.10	0.08	0.07	0.07	0.06	0.08	0.13	0.10	0.14
1,2,3,7,8,9-Hx	0.28	0.11	0.12	0.13	0.12	0.11	0.11	0.17	0.11	0.30	0.10	0.08	0.07	0.07	0.06	0.08	0.13	0.10	0.14
1,2,3,4,6,7,8-OCDD	0.23	0.10	0.12	0.12	0.11	0.12	0.10	0.18	0.09	0.60	0.08	0.07	0.07	0.05	0.05	0.07	0.13	0.09	0.12
OCDD	0.06	0.02	0.03	0.03	0.03	0.03	0.03	0.05	0.02	0.45	0.02	0.01	0.02	0.01	0.01	0.01	0.03	0.02	0.03
2,3,7,8-TCDF	0.70	0.30	0.32	0.36	0.31	0.22	0.31	0.35	0.33	0.08	0.37	0.29	0.20	0.34	0.32	0.32	0.35	0.34	0.47
1,2,3,7,8-PeC	0.37	0.12	0.13	0.15	0.13	0.09	0.12	0.16	0.13	0.06	0.14	0.11	0.08	0.12	0.11	0.12	0.15	0.13	0.20
2,3,4,7,8-PeC	0.37	0.12	0.13	0.15	0.13	0.09	0.12	0.16	0.13	0.06	0.14	0.11	0.08	0.12	0.11	0.12	0.15	0.13	0.20
1,2,3,4,7,8-Hx	0.07	0.02	0.02	0.02	0.02	0.02	0.02	0.03	0.02	0.02	0.02	0.02	0.01	0.02	0.02	0.02	0.02	0.02	0.03
1,2,3,4,6,7,8-OCDF	0.02	0.01	0.01	0.01	0.01	0.01	0.01	0.01	0.01	0.01	0.01	0.01	0.00	0.00	0.00	0.00	0.01	0.01	0.01
OCDF	0.00	0.00	0.00	0.00	0.00	0.00	0.00	0.00	0.00	0.01	0.00	0.00	0.00	0.00	0.00	0.00	0.00	0.00	0.00

Table A5. PCB Porewater Concentrations, Ex Situ, 1st Newark Bay Deployment

ID	S-01	S-01	S-03	S-04	S-05	S-07	S-08	S-09
User ID	Ex Situ	Ex Situ	Ex Situ	Ex Situ	Ex Situ	Ex Situ	Ex Situ	Ex Situ
Locality	40° 49' 25.37	40° 49' 25.37	40° 48' 4.074	40° 43' 58.70	40° 55' 41.38	40° 55' 41.38	40° 41' 54.6"	40° 41' 17.52'
Environ	Sediment	Sediment	Sediment	Sediment	Sediment	Sediment	Sediment	Sediment
PCB-8	0.08766805	0.06575743	0.21344523	0.00198301	0.09199066	0	0.07929696	0.22699388
PCB-11								
PCB-18	2.83E-01	1.90E-01	1.12E+00	1.36E-01	2.28E-01	3.38E-03	1.20E-01	1.21E-01
PCB-28	2.25E-01	1.74E-01	8.17E-01	1.31E-01	1.96E-01	1.29E-02	1.08E-01	1.08E-01
PCB-52								
PCB-44								
PCB-66								
PCB-81	5.48E-04	0.00E+00	5.89E-03	0.00E+00	0.00E+00	0.00E+00	3.10E-04	1.65E-03
PCB-77								
PCB-101								
PCB-123								
PCB-118								
PCB-114								
PCB-105								
PCB-126								
PCB-153								
PCB-138								
PCB-128	0.00E+00	0.00E+00	0.00E+00	0.00E+00				
PCB-167								
PCB-156								
PCB-157								
PCB-169	0.00E+00	0.00E+00	0.00E+00	0.00E+00	0.00E+00	0.00E+00	0.00E+00	0.00E+00
PCB-187	2.95E-04	1.28E-04	6.01E-04	4.66E-04	4.50E-04	8.82E-05	5.78E-04	7.84E-04
PCB-180	5.75E-04	2.53E-04	1.09E-03	7.65E-04	9.97E-04	1.14E-04	4.57E-04	2.88E-04
PCB-170	9.66E-06	3.51E-05	2.64E-04	1.45E-04	3.80E-04	0.00E+00	6.89E-05	1.21E-04
PCB-189	0.00E+00	0.00E+00	0.00E+00	0.00E+00	0.00E+00	0.00E+00	0.00E+00	0.00E+00
PCB-195	4.09E-07	1.45E-06	2.74E-05	0.00E+00	2.22E-05	0.00E+00	2.17E-05	6.44E-05
PCB-206								
PCB-209								

Table A6. PCB Porewater Concentrations, In Situ, 1st Newark Bay Deployment

ID	201-01	201-02	203-01/(203-03/(201-03	201-04	203-05/(201-05	201-06	203-07/(201-07	201-08	203-09/(201-09	202-01	203-11/(202-02	202-03	202-05	202-06
site	S1	S1	S1	S1	S2	S2	S2	S3	S3	S3	S4	S4	S4	S5	S5	S5	S6	S7	S8	S8
type	PE-sed	PE-wate	PE-sed	PE-sed	PE-wate	PE-sed	PE-sed	PE-wate	PE-sed	PE-wate	PE-sed	PE-wate	PE-sed	PE-sed	PE-wate	PE-sed	PE-sed	PE-wate	PE-sed	PE-wate
PCB8	7.4E-02	1.5E-02	7.4E-02	4.5E-02	4.1E-02	2.4E+00	4.2E-01	1.1E-01	3.6E-02	1.1E-01	1.2E-01	4.7E-02	1.1E-01	3.6E-03		3.5E-04		3.6E-02		3.6E-02
PCB11	3.0E-02	2.0E-02	2.8E-02	2.6E-02	3.2E-02	3.8E-01	9.6E-02	3.6E-02	3.3E-02	4.3E-02	2.8E-02	4.2E-02	3.4E-02	8.4E-03	4.0E-03	7.9E-03		3.3E-02		3.6E-02
PCB18	1.8E-01	6.2E-02	1.4E-01	9.5E-02	1.5E-01	3.3E+00	6.1E-01	3.6E-01	1.6E-01	3.2E-01	4.6E-01	2.3E-01	3.6E-01	2.9E-02	6.5E-03	2.8E-02		2.7E-01		2.6E-01
PCB28	1.5E-01	6.9E-02	1.1E-01	8.2E-02	1.5E-01	2.2E+00	3.9E-01	3.2E-01	1.7E-01	3.0E-01	4.0E-01	2.3E-01	3.1E-01	4.3E-02	1.3E-02	2.9E-02		2.7E-01		2.7E-01
PCB52	1.7E-02	1.6E-02	1.8E-02	1.2E-02	2.9E-02	1.7E-01	5.1E-02	5.4E-02	3.3E-02	4.6E-02	7.1E-02	3.9E-02	5.7E-02	8.4E-03	3.0E-03	7.6E-03		5.2E-02		6.4E-02
PCB44	4.5E-02	2.8E-02	3.1E-02	2.3E-02	5.2E-02	3.8E-01	8.1E-02	9.0E-02	6.3E-02	7.6E-02	1.2E-01	7.0E-02	9.1E-02	1.4E-02	6.4E-03	1.1E-02		7.6E-02		8.8E-02
PCB66	2.4E-02	1.3E-02	1.2E-02	1.3E-02	2.4E-02	1.8E-01	4.4E-02	5.0E-02	3.6E-02	4.0E-02	5.5E-02	3.5E-02	4.5E-02	6.9E-03	3.7E-03	6.3E-03		5.0E-02		6.7E-02
PCB81																				
PCB77																				
PCB101	9.9E-03	7.4E-03	4.5E-03	4.2E-03	1.3E-02	5.1E-02	1.2E-02	2.2E-02	1.7E-02	2.2E-02	2.2E-02	1.8E-02	2.0E-02	4.3E-03	3.6E-03	3.7E-03				
PCB123								8.5E-03												
PCB118	7.6E-03	4.5E-03	4.5E-03	5.4E-03	8.6E-03	6.3E-02	9.7E-03	1.6E-02	1.1E-02	2.2E-02	1.9E-02	1.1E-02	1.5E-02	5.1E-03	2.7E-03	2.9E-03		1.3E-02		1.9E-02
PCB114																				
PCB105	2.3E-03	1.4E-03	1.2E-03	1.4E-03	2.7E-03	2.4E-02	3.1E-03	5.4E-03	2.7E-03	6.7E-03	7.1E-03	2.6E-03	5.5E-03	1.4E-03	1.1E-03	1.0E-03				
PCB126																				
PCB153	9.2E-03	5.3E-03	3.7E-03	4.6E-03	9.7E-03	3.0E-02	8.6E-03	1.8E-02	1.3E-02	1.3E-02	1.9E-02	1.2E-02	1.4E-02	5.3E-03	4.2E-03	2.9E-03		1.4E-02		2.9E-02
PCB138	3.9E-03	3.9E-03	1.9E-03	2.1E-03	6.6E-03	1.4E-02	3.8E-03	7.8E-03	9.5E-03	5.9E-03	8.5E-03	8.1E-03	6.0E-03	2.5E-03	3.3E-03	1.3E-03		1.1E-02		2.2E-02
PCB128	1.4E-03	7.0E-04	6.8E-04	9.5E-04	1.5E-03	5.3E-03	1.6E-03	3.2E-03	1.9E-03	2.2E-03	2.8E-03	1.6E-03	1.9E-03	9.5E-04	6.4E-04	5.5E-04		1.8E-03		4.6E-03
PCB167	1.2E-04	4.9E-05	1.4E-05	7.5E-05	1.7E-04	3.6E-04	1.0E-04	1.4E-04	2.6E-04	1.9E-04	2.2E-04	1.8E-04	1.5E-04	8.3E-05	7.6E-05	1.8E-05				
PCB156	3.0E-04	2.3E-04	1.4E-04	2.7E-04	4.8E-04	1.3E-03	2.8E-04	5.0E-04	6.9E-04	3.9E-04	5.5E-04	4.5E-04	4.8E-04	2.3E-04	1.9E-04	1.2E-04				
PCB157	7.6E-06	1.5E-05	1.0E-05		1.9E-05	3.5E-04	2.0E-05	2.1E-04	3.2E-05	4.3E-05	8.8E-05	2.0E-05	9.9E-05			1.3E-05				
PCB169																				
PCB187	1.2E-03	9.6E-04	5.6E-04	6.9E-04	1.3E-03	3.3E-03	9.9E-04	2.1E-03	2.6E-03	1.6E-03	2.5E-03	1.6E-03	1.7E-03	9.4E-04	7.0E-04	4.4E-04		2.5E-03		7.9E-03
PCB180	2.9E-03	1.9E-03	1.1E-03	1.9E-03	2.9E-03	1.2E-02	2.4E-03	6.2E-03	4.9E-03	4.0E-03	6.1E-03	3.2E-03	4.6E-03	2.3E-03	1.3E-03	5.7E-04		4.1E-03		8.1E-03
PCB170	5.2E-04	7.6E-04	3.4E-04	3.1E-04	9.4E-04	2.6E-03	6.4E-04	1.4E-03	1.9E-03	8.7E-04	1.3E-03	1.1E-03	1.0E-03	4.7E-04	4.9E-04	2.5E-04		1.6E-03		3.2E-03
PCB189																				
PCB195							3.3E-05		1.7E-04	2.8E-05	1.1E-04	1.2E-04								
PCB206		2.6E-04			3.4E-04	3.8E-04	8.5E-05	1.9E-04	4.0E-04	1.1E-04	1.3E-04	2.3E-04			1.2E-04			3.1E-04		6.0E-04
PCB209		2.5E-05			6.3E-05	2.3E-04		9.5E-05	1.7E-04	4.4E-05	2.0E-05	4.7E-05	6.7E-05					2.6E-04		5.6E-04

Table A7. PCDD/F Porewater Concentrations, Ex Situ, 1st Newark Bay Deployment

ID	S-01A	S-01B	S-03	S-04	S-05	S-07	S-08	S-09
User ID	Ex Situ	Ex Situ	Ex Situ	Ex Situ	Ex Situ	Ex Situ	Ex Situ	Ex Situ
Locality	40° 49' 25.37	40° 49' 25.37	40° 48' 4.074	40° 43' 58.70	40° 55' 41.38	40° 55' 41.388	40° 41' 54.6"	40° 41' 17.52
Environ	Sediment	Sediment	Sediment	Sediment	Sediment	Sediment	Sediment	Sediment
2,3,7,8-TCDF		0	0	0	0	0	0	0
2,3,7,8-TCDD		0	0	0	0	0	0	0
1,2,3,7,8-PeC		0	0	0	0	0	0	0
2,3,4,7,8-PeC		0	0	0	0	0	0	0
1,2,3,7,8-PeC		0	0	0	0	0	0	0
1,2,3,4,7,8-Hx		0	0	0	0	0	0	0
1,2,3,6,7,8-Hx		0	0	0	0	0	0	0
2,3,4,6,7,8-Hx		0	0	0	0	0	0	0
1,2,3,7,8,9-Hx		0	0	0	0	0	0	0
1,2,3,4,7,8-Hx		0	0	0	0	0	0	0
1,2,3,6,7,8-Hx		0	0	0	0	0	0	0
1,2,3,7,8,9-Hx		0	0	0	0	0	0	0
1,2,3,4,6,7,8-		0	0	0	0	0	1.73199E-05	0
1,2,3,4,7,8,9-		0	0	0	0	0	0	0
1,2,3,4,6,7,8-		0	0	0	0	0	0	0
OCDD		0	0	0	0	0	0	0
OCDF		0	0	0	0	0	0	0

Table A8. PCDD/F Porewater Concentrations, In Situ, 1st Newark Bay Deployment

ID	203-01/02	203-03/04	203-05/06	203-07/08	203-09/10	203-11/12	203-13/14	203-15/16	203-17/18
site	S1	S1	S2	S3	S4	S5	S6	S7	S8
Locality	40° 49' 25.374	40° 49' 25.37	40° 48' 4.074"	40° 46' 8.502	40° 43' 58.704	40° 55' 41.388	40° 41' 17.52"	40° 41' 17.52"	40° 40' 11.03"
Type	PE-sed	PE-sed	PE-sed	PE-sed	PE-sed	PE-sed	PE-sed	PE-sed	PE-sed
2,3,7,8-TCDF	0	0	0	0	0	0	0	0	0
2,3,7,8-TCDD	0	0	1.00373E-05	0	3.59368E-06	0	6.31579E-06	0	0
1,2,3,7,8-PeC	0	0	0	0	0	0	0	0	0
2,3,4,7,8-PeC	0	0	0	0	0	0	0	0	0
1,2,3,7,8-PeC	0	0	0	0	0	0	0	0	0
1,2,3,4,7,8-Hb	0	0	0	0	0	0	1.23664E-07	1.79645E-07	1.15312E-07
1,2,3,6,7,8-Hb	0	0	0	0	0	0	0	0	0
2,3,4,6,7,8-Hb	0	0	0	0	0	0	0	0	0
1,2,3,7,8,9-Hb	0	0	0	0	0	0	0	0	0
1,2,3,4,7,8-Hb	0	0	0	0	0	0	0	0	0
1,2,3,6,7,8-Hb	0	0	0	0	0	0	0	0	0
1,2,3,7,8,9-Hb	0	0	0	0	0	0	0	0	0
1,2,3,4,6,7,8-	0	0	0	0	0	0	9.47733E-10	2.00475E-09	1.03635E-09
1,2,3,4,7,8,9-	0	0	0	0	0	0	0	0	0
1,2,3,4,6,7,8-	0	0	0	0	0	0	0	0	0
OCDD	1.55689E-08	0	2.59368E-08	0	1.74406E-08	2.72528E-08	1.59698E-08	2.72656E-08	6.1628E-09
OCDF	0	0	0	0	0	0	0	0	0

Table A9. PCB Porewater Concentrations, Ex Situ, 2nd Newark Bay Deployment

ID	NB01	NB02	NB03	NB04	NB05	NB06	NB07	NB08	NB09	NB10	HR01	PR01
Lat	40.74216	40.72405	40.71092	40.69644	40.68588	40.67384	40.65782	40.65211	40.6497	40.63358	40.807778	40.732973
Long	-74.13677	-74.098	-74.11845	-74.11768	-74.12319	-74.12953	-74.13956	-74.15568	-74.10489	-74.19747	-74.057222	-74.150501
PCB-8	3.7E-01	7.4E-01	8.4E-02	4.7E-02	2.7E-02	2.1E-02	2.6E-01	4.5E-02	7.5E-02	2.3E-01	5.2E-02	6.8E-02
PCB-11	6.9E-02	2.2E-02	2.2E-02	9.0E-03	3.0E-03	3.2E-03	5.4E-02	3.1E-03	3.7E-02	1.0E-01	0.0E+00	5.5E-02
PCB-18	7.9E-01	6.2E-01	2.2E-01	8.8E-02	1.2E-01	1.2E-01	6.2E-01	2.8E-02	1.2E-01	6.4E-01	1.5E-01	1.6E-01
PCB-28	5.9E-01	5.0E-01	2.7E-01	1.1E-01	1.4E-01	1.5E-01	5.8E-01	1.2E-01	1.3E-01	6.6E-01	2.4E-01	2.2E-01
PCB-52	1.2E-01	8.4E-02	9.4E-02	6.0E-02	5.4E-02	7.2E-02	2.2E-01	2.9E-02	3.8E-02	1.4E-01	8.4E-02	5.7E-02
PCB-44	1.8E-01	1.3E-01	1.1E-01	7.0E-02	7.3E-02	7.5E-02	2.6E-01	2.6E-02	6.6E-02	2.5E-01	1.4E-01	7.7E-02
PCB-66	9.4E-02	1.0E-01	1.0E-01	6.7E-02	5.2E-02	6.3E-02	2.0E-01	4.0E-02	4.7E-02	1.9E-01	1.3E-01	6.5E-02
PCB-81	0.0E+00	0.0E+00	0.0E+00	0.0E+00	1.3E-03	1.1E-03	2.7E-03	8.0E-04	1.1E-03	2.3E-03	1.5E-03	9.5E-04
PCB-77	0.0E+00	0.0E+00	0.0E+00	0.0E+00	0.0E+00	0.0E+00	0.0E+00	0.0E+00	0.0E+00	0.0E+00	0.0E+00	0.0E+00
PCB-101	4.4E-02	3.6E-02	3.4E-02	1.1E-02	3.0E-02	3.4E-02	1.1E-01	1.7E-02	3.3E-02	5.3E-02	4.6E-02	2.9E-02
PCB-123	0.0E+00	0.0E+00	0.0E+00	0.0E+00	0.0E+00	0.0E+00	0.0E+00	0.0E+00	0.0E+00	0.0E+00	0.0E+00	0.0E+00
PCB-118	4.0E-02	2.5E-02	2.9E-02	1.3E-02	2.7E-02	2.8E-02	1.0E-01	1.4E-02	1.9E-02	4.7E-02	3.3E-02	2.1E-02
PCB-114	0.0E+00	0.0E+00	0.0E+00	0.0E+00	0.0E+00	0.0E+00	0.0E+00	0.0E+00	0.0E+00	0.0E+00	0.0E+00	0.0E+00
PCB-105	1.3E-02	9.8E-03	1.2E-02	7.4E-03	1.1E-02	1.0E-02	3.1E-02	6.6E-03	8.8E-03	1.5E-02	1.2E-02	7.0E-03
PCB-126	7.7E-04	1.3E-03	9.6E-04	2.1E-04	1.2E-03	7.5E-04	1.5E-03	4.3E-04	1.1E-03	1.0E-03	9.3E-04	6.4E-04
PCB-153	0.0E+00	2.5E-02	2.5E-02	1.2E-02	2.7E-02	2.3E-02	6.5E-02	1.3E-02	2.2E-02	2.5E-02	2.7E-02	1.4E-02
PCB-138	1.2E-02	1.1E-02	1.1E-02	5.2E-03	1.2E-02	1.1E-02	3.1E-02	5.2E-03	9.6E-03	1.3E-02	1.0E-02	7.1E-03
PCB-128	2.8E-03	3.2E-03	3.8E-03	3.5E-03	3.6E-03	3.7E-03	9.2E-03	2.5E-03	2.7E-03	4.6E-03	2.8E-03	1.8E-03
PCB-167	2.2E-04	2.5E-04	0.0E+00	0.0E+00	2.5E-04	2.0E-04	5.0E-04	1.5E-04	9.4E-05	3.2E-04	2.6E-04	9.9E-05
PCB-156	5.5E-04	6.0E-04	6.4E-04	7.2E-04	6.7E-04	5.5E-04	1.9E-03	3.4E-04	5.9E-04	7.5E-04	6.9E-04	5.4E-04
PCB-157	0.0E+00	0.0E+00	0.0E+00	0.0E+00	0.0E+00	0.0E+00	0.0E+00	0.0E+00	0.0E+00	0.0E+00	0.0E+00	0.0E+00
PCB-169	0.0E+00	0.0E+00	0.0E+00	0.0E+00	0.0E+00	0.0E+00	0.0E+00	0.0E+00	0.0E+00	0.0E+00	0.0E+00	0.0E+00
PCB-187	4.5E-03	4.6E-03	4.8E-03	3.0E-03	4.5E-03	4.4E-03	8.2E-03	2.7E-03	4.9E-03	4.3E-03	4.2E-03	3.6E-03
PCB-180	8.5E-03	6.7E-03	7.9E-03	3.4E-03	8.3E-03	7.3E-03	1.4E-02	3.8E-03	7.2E-03	8.5E-03	7.0E-03	6.0E-03
PCB-170	1.7E-03	1.4E-03	1.5E-03	1.3E-03	2.0E-03	1.8E-03	2.9E-03	8.6E-04	1.3E-03	2.1E-03	1.6E-03	1.5E-03
PCB-189	0.0E+00	0.0E+00	0.0E+00	0.0E+00	0.0E+00	0.0E+00	0.0E+00	0.0E+00	0.0E+00	0.0E+00	0.0E+00	0.0E+00
PCB-195	1.9E-04	2.9E-04	4.7E-04	3.7E-04	4.9E-04	3.0E-04	6.3E-04	1.6E-04	3.6E-04	3.4E-04	2.9E-04	1.5E-04
PCB-206	1.6E-04	1.7E-04	2.4E-04	1.7E-04	2.3E-04	1.8E-04	3.8E-04	1.4E-04	3.2E-04	1.0E-04	1.6E-04	1.1E-04
PCB-209	6.7E-05	1.0E-04	2.5E-04	7.3E-05	1.5E-04	7.4E-05	1.5E-04	6.1E-05	8.0E-05	6.1E-05	6.7E-05	3.2E-05

Table A10 PCB porewater Concentrations, In Situ, 2nd Newark Bay Deployment

ID	204-04	204-05	204-06	204-07a	204-07b	204-08a	204-08b	204-09a	204-09b	204-10a	204-10b	204-11	210-05	210-06a	210-06b	210-07a	210-07b
Site	PR	HR	HR	NB02	NB02	NB02	NB02	NB03	NB03	NB03	NB03	NB04	NB05	NB05	NB05	NB06	NB06
Batch	204	204	204	204	204	204	204	204	204	204	204	204	210	210	210	210	210
lat	40.733	40.808	40.808	40.724	40.724	40.724	40.724	40.711	40.711	40.711	40.711	40.696	40.686	40.686	40.686	40.674	40.674
long	-74.15	-74.06	-74.06	-74.1	-74.1	-74.1	-74.1	-74.12	-74.12	-74.12	-74.12	-74.12	-74.12	-74.12	-74.12	-74.13	-74.13
Type	PE_sed	PE_sed	PE_sed	PE_sed	PE_sed	PE_sed	PE_sed	PE_sed	PE_sed	PE_sed	PE_sed	PE_sed	PE_sed	PE_sed	PE_sed	PE_sed	PE_sed
PCB 8	9.8E-03	2.8E-02	2.4E-02	3.5E-02	2.4E-02	4.8E-02	2.1E-02	1.7E-02	2.1E-02	2.2E-02	1.1E-02	1.5E-02	9.5E-03	1.3E-02	9.8E-03	2.0E-02	1.0E-02
PCB 11	1.4E-02	7.9E-03	7.3E-03	1.5E-02	1.3E-02	2.0E-02	1.3E-02	2.8E-02	2.5E-02	3.9E-02	2.0E-02	2.6E-02	2.0E-02	2.5E-02	2.7E-02	2.8E-02	1.9E-02
PCB 18	5.1E-02	6.6E-02	7.1E-02	3.8E-02	5.2E-02	5.4E-02	5.5E-02	4.5E-02	6.5E-02	4.4E-02	4.8E-02	5.2E-02	2.7E-02	2.9E-02	3.9E-02	2.8E-02	3.4E-02
PCB 28	5.4E-02	9.2E-02	8.8E-02	3.9E-02	6.0E-02	6.0E-02	6.4E-02	6.1E-02	8.1E-02	5.4E-02	6.4E-02	6.5E-02	3.9E-02	4.2E-02	5.3E-02	4.1E-02	3.7E-02
PCB 52	6.4E-03	1.5E-02	1.7E-02	7.7E-03	1.1E-02	1.1E-02	1.6E-02	1.1E-02	1.7E-02	1.4E-02	9.7E-03	1.4E-02	9.9E-03	1.2E-02	1.7E-02	1.2E-02	1.2E-02
PCB 44	1.0E-02	2.4E-02	2.7E-02	1.3E-02	1.9E-02	1.7E-02	1.8E-02	1.8E-02	2.3E-02	1.8E-02	1.9E-02	2.0E-02	1.7E-02	1.7E-02	1.8E-02	1.9E-02	1.1E-02
PCB 66	1.2E-02	2.8E-02	2.8E-02	1.3E-02	2.0E-02	1.8E-02	2.0E-02	1.8E-02	2.1E-02	1.9E-02	1.8E-02	2.5E-02	1.6E-02	1.9E-02	2.0E-02	2.0E-02	1.2E-02
PCB 81																	
PCB 77		2.9E-04	2.0E-04	1.2E-04	2.1E-04	2.9E-04	1.8E-04	3.2E-04			1.9E-04	2.6E-04					
PCB 101	3.4E-03	8.5E-03	1.7E-02	5.2E-03	8.6E-03	9.6E-03	6.5E-03	8.5E-03	8.0E-03	9.6E-03	8.4E-03	1.2E-02	1.4E-02	1.4E-02	1.4E-02	1.2E-02	7.1E-03
PCB 123																	
PCB 118	4.4E-03	9.1E-03	1.5E-02	5.3E-03	7.1E-03	7.4E-03	5.9E-03	8.4E-03	5.9E-03	8.2E-03	6.2E-03	8.6E-03	6.7E-03	8.3E-03	9.4E-03	1.1E-02	8.5E-03
PCB 114																	
PCB 105	1.1E-03	2.3E-03	2.9E-03	1.7E-03	1.3E-03	1.7E-03	1.4E-03	1.5E-03	1.3E-03	2.6E-03	1.7E-03	2.1E-03	1.3E-03	2.0E-03	1.6E-03	2.3E-03	1.6E-03
PCB 126																	
PCB 153	2.1E-03	7.2E-03	7.8E-03	2.6E-03	3.7E-03	3.1E-03	3.9E-03	3.4E-03	4.7E-03	4.3E-03	4.5E-03	6.3E-03	3.9E-03	4.9E-03	5.3E-03	6.3E-03	4.7E-03
PCB 138	1.3E-03	2.7E-03	2.7E-03	7.6E-04	1.1E-03	1.5E-03	1.5E-03	2.1E-03	2.2E-03	2.7E-03	1.9E-03	2.1E-03	1.4E-03	1.7E-03	1.9E-03	2.8E-03	2.0E-03
PCB 128																	
PCB 167																	
PCB 156																	
PCB 157																	
PCB 169																	
PCB 187	7.4E-04	1.9E-03	2.0E-03	3.6E-04	1.1E-03	5.6E-04	1.0E-03	1.2E-03	1.3E-03	1.1E-03	1.3E-03	1.1E-03	6.6E-04	1.1E-03	1.2E-03	1.9E-03	8.7E-04
PCB 180	1.0E-03	1.4E-03	8.7E-04	4.5E-04	7.9E-04	6.7E-04	7.0E-04		1.4E-03	1.0E-03	9.7E-04	7.0E-04	6.7E-04	1.1E-03	1.2E-03	1.1E-03	6.3E-04
PCB 170	8.4E-05	4.0E-04	6.7E-05		4.1E-05		2.1E-04		1.4E-04		1.3E-04				1.5E-04		1.0E-04
PCB 189																	
PCB 195																	
PCB 206		2.9E-04															
PCB 209																	

Table A10. PCB Porewater Concentrations, In Situ, 2nd Newark Bay Deployment ctd.

ID	210-08	210-09a	210-09b	210-10	210-11a	210-11b	210-12a	210-12b	210-13a	210-13b	210-14a	210-14b	210-15a	210-15b
Site	NB06	NB07	NB07	NB08	NB08	NB08	NB09	NB09	NB09	NB09	NB10	NB10	NB10	NB10
Batch	210	210	210	210	210	210	210	210	210	210	210	210	210	210
lat	40.674	40.658	40.658	40.652	40.652	40.652	40.65	40.65	40.65	40.65	40.634	40.634	40.634	40.634
long	-74.13	-74.14	-74.14	-74.16	-74.16	-74.16	-74.1	-74.1	-74.1	-74.1	-74.2	-74.2	-74.2	-74.2
Type	PE sed	PE sed	PE sed	PE sed	PE sed	PE sed	PE sed	PE sed	PE sed	PE sed	PE sed	PE sed	PE sed	PE sed
PCB 8	9.3E-03	1.8E-02	1.7E-02	9.4E-03	1.4E-02	7.4E-03	3.0E-02	9.8E-03	2.4E-02	1.1E-02	6.0E-02	2.4E-02	4.2E-02	1.7E-02
PCB 11	2.4E-02	2.4E-02	3.5E-02	3.7E-02	5.6E-02	3.6E-02	3.5E-02	3.5E-02	3.0E-02	3.5E-02	4.8E-02	3.3E-02	3.3E-02	2.4E-02
PCB 18	3.1E-02	3.5E-02	5.2E-02	3.6E-02	2.8E-02	3.3E-02	2.6E-02	3.3E-02	2.7E-02	3.7E-02	1.3E-01	9.0E-02	1.2E-01	8.9E-02
PCB 28	4.1E-02	4.4E-02	5.8E-02	3.2E-02	2.6E-02	2.8E-02	3.1E-02	3.3E-02	2.6E-02	3.5E-02	1.2E-01	8.3E-02	1.0E-01	7.8E-02
PCB 52	9.7E-03	1.8E-02	1.8E-02	8.4E-03	1.4E-02	9.9E-03	1.6E-02	1.2E-02	9.4E-03	6.0E-03	2.6E-02	1.5E-02	2.5E-02	2.0E-02
PCB 44	1.6E-02	1.7E-02	2.0E-02	1.3E-02	1.4E-02	9.9E-03	1.3E-02	1.1E-02	1.1E-02	9.1E-03	3.1E-02	2.1E-02	2.5E-02	2.2E-02
PCB 66	1.8E-02	2.0E-02	2.3E-02	1.2E-02	1.6E-02	1.1E-02	1.6E-02	1.3E-02	1.3E-02	8.4E-03	3.2E-02	2.3E-02	2.8E-02	2.1E-02
PCB 81														
PCB 77														
PCB 101	7.8E-03	1.4E-02	9.2E-03	6.2E-03	1.6E-02	7.9E-03	2.4E-02	1.1E-02	1.2E-02	6.4E-03	1.4E-02	1.2E-02	1.7E-02	7.5E-03
PCB 123														
PCB 118	7.4E-03	8.7E-03	8.8E-03	8.2E-03	8.5E-03	3.9E-03	2.2E-02	1.1E-02	7.9E-03	7.3E-03	1.0E-02	1.1E-02	1.7E-02	7.1E-03
PCB 114														
PCB 105	1.9E-03	2.2E-03	2.1E-03	2.1E-03	2.7E-03	1.3E-03	5.0E-03	2.6E-03	2.3E-03	1.6E-03	2.7E-03	2.5E-03	4.0E-03	1.7E-03
PCB 126														
PCB 153	2.8E-03	4.3E-03	5.3E-03	5.2E-03	5.2E-03	4.6E-03	9.8E-03	7.7E-03	7.1E-03	3.5E-03	5.0E-03	4.4E-03	8.9E-03	2.7E-03
PCB 138	1.4E-03	1.8E-03	2.1E-03	2.0E-03	2.4E-03	1.6E-03	5.2E-03	3.0E-03	2.4E-03	1.9E-03	2.5E-03	2.2E-03	3.8E-03	1.4E-03
PCB 128														
PCB 167														
PCB 156														
PCB 157														
PCB 169														
PCB 187	1.0E-03	6.1E-04	1.4E-03	1.2E-03		9.8E-04	9.9E-04	1.6E-03	1.3E-03	1.1E-03	1.6E-03	8.8E-04	7.7E-04	5.7E-04
PCB 180	7.8E-04	6.7E-04	9.5E-04	1.1E-03	4.6E-04	6.4E-04	5.8E-04	9.8E-04	8.0E-04	6.8E-04	7.5E-04	1.0E-03	1.3E-03	8.3E-04
PCB 170			1.2E-04			2.2E-04						1.5E-04		9.5E-05
PCB 189														
PCB 195														
PCB 206														
PCB 209														

Table A11. PCDD/F porewater concentrations, Ex Situ, 2nd Newark Bay Deployment

ID	NB 1	NB 2	NB 3	NB 4	NB 5	NB 6	NB 7	NB 8	NB 9	NB 10	HR 1	PR 1
Lat	40.74216	40.72405	40.71092	40.69644	40.68588	40.67384	40.65782	40.65211	40.6497	40.63358	40.807778	40.732973
Long	-74.13677	-74.098	-74.11845	-74.11768	-74.12319	-74.12953	-74.13956	-74.15568	-74.10489	-74.19747	-74.057222	-74.150501
Type	ex-situ	ex-situ	ex-situ	ex-situ	ex-situ	ex-situ	ex-situ	ex-situ	ex-situ	ex-situ	ex-situ	ex-situ
2,3,7,8-TCDF	0.00E+00	0.00E+00	0.00E+00	0.00E+00	0.00E+00	0.00E+00	0.00E+00	0.00E+00	0.00E+00	0.00E+00	0.00E+00	0.00E+00
2,3,7,8-TCDD	0.00E+00	0.00E+00	0.00E+00	0.00E+00	0.00E+00	0.00E+00	0.00E+00	0.00E+00	0.00E+00	0.00E+00	0.00E+00	0.00E+00
1,2,3,7,8-PeC	0.00E+00	0.00E+00	0.00E+00	0.00E+00	0.00E+00	0.00E+00	0.00E+00	0.00E+00	0.00E+00	0.00E+00	0.00E+00	0.00E+00
2,3,4,7,8-PeC	0.00E+00	0.00E+00	0.00E+00	0.00E+00	0.00E+00	0.00E+00	0.00E+00	0.00E+00	0.00E+00	0.00E+00	0.00E+00	0.00E+00
1,2,3,7,8-PeC	0.00E+00	0.00E+00	0.00E+00	0.00E+00	0.00E+00	0.00E+00	0.00E+00	0.00E+00	0.00E+00	0.00E+00	0.00E+00	0.00E+00
1,2,3,4,7,8-Hx	0.00E+00	0.00E+00	0.00E+00	0.00E+00	0.00E+00	0.00E+00	0.00E+00	0.00E+00	0.00E+00	0.00E+00	0.00E+00	0.00E+00
1,2,3,6,7,8-Hx	0.00E+00	5.71E-06	0.00E+00	1.26E-06	0.00E+00	0.00E+00	0.00E+00	0.00E+00	0.00E+00	0.00E+00	3.63E-05	0.00E+00
2,3,4,6,7,8-Hx	0.00E+00	0.00E+00	0.00E+00	0.00E+00	0.00E+00	0.00E+00	0.00E+00	0.00E+00	0.00E+00	0.00E+00	0.00E+00	0.00E+00
1,2,3,7,8,9-Hx	0.00E+00	0.00E+00	0.00E+00	0.00E+00	0.00E+00	0.00E+00	0.00E+00	0.00E+00	0.00E+00	0.00E+00	0.00E+00	0.00E+00
1,2,3,4,7,8-Hx	0.00E+00	0.00E+00	0.00E+00	0.00E+00	0.00E+00	0.00E+00	0.00E+00	0.00E+00	0.00E+00	0.00E+00	0.00E+00	0.00E+00
1,2,3,6,7,8-Hx	0.00E+00	0.00E+00	0.00E+00	0.00E+00	0.00E+00	0.00E+00	0.00E+00	0.00E+00	0.00E+00	0.00E+00	0.00E+00	0.00E+00
1,2,3,7,8,9-Hx	0.00E+00	0.00E+00	0.00E+00	0.00E+00	0.00E+00	0.00E+00	0.00E+00	0.00E+00	0.00E+00	0.00E+00	0.00E+00	0.00E+00
1,2,3,4,6,7,8-	1.01E-05	9.34E-06	0.00E+00	0.00E+00	0.00E+00	0.00E+00	0.00E+00	0.00E+00	0.00E+00	0.00E+00	0.00E+00	0.00E+00
1,2,3,4,7,8,9-	0.00E+00	0.00E+00	0.00E+00	0.00E+00	0.00E+00	0.00E+00	0.00E+00	0.00E+00	0.00E+00	0.00E+00	0.00E+00	0.00E+00
1,2,3,4,6,7,8-	0.00E+00	0.00E+00	0.00E+00	0.00E+00	0.00E+00	0.00E+00	0.00E+00	0.00E+00	0.00E+00	0.00E+00	0.00E+00	0.00E+00
OCDD	7.61E-05	0.00E+00	6.51E-05	5.15E-05	5.28E-05	2.52E-05	1.96E-05	0.00E+00	0.00E+00	0.00E+00	5.98E-05	0.00E+00
OCDF	0.00E+00	0.00E+00	0.00E+00	0.00E+00	0.00E+00	0.00E+00	0.00E+00	0.00E+00	0.00E+00	0.00E+00	0.00E+00	0.00E+00

Table A12. PCDD/F Porewater Concentrations, In Situ, 2nd Newark Bay Deployment

ID	204-04	204-05	204-06	204-07	204-08	204-09	204-10	204-11	210-05	210-06	210-07	210-08	210-09	210-10	210-11	210-12	210-13	210-14	210-15
Batch	204	204	204	204	204	204	204	204	210	210	210	210	210	210	210	210	210	210	210
Site	PRa	HRa	HRb	NB2	NB2	NB3	NB3	NB4	NB5	NB5	NB6	NB6	NB7	NB8	NB8	NB9	NB9	NB10	NB10
Lat	40.733	40.808	40.808	40.724	40.724	40.711	40.711	40.696	40.686	40.686	40.674	40.674	40.658	40.652	40.652	40.65	40.65	40.634	40.634
Long	-74.15	-74.06	-74.06	-74.1	-74.1	-74.12	-74.12	-74.12	-74.12	-74.12	-74.13	-74.13	-74.14	-74.16	-74.16	-74.1	-74.1	-74.2	-74.2
Type	PE_sed	PE_sed	PE_sed	PE_sed	PE_sed	PE_sed	PE_sed	PE_sed	PE_sed	PE_sed	PE_sed	PE_sed	PE_sed	PE_sed	PE_sed	PE_sed	PE_sed	PE_sed	PE_sed
2,3,7,8-																			
2,3,7,8-																			
1,2,3,7,8-																			
2,3,4,7,8-																			
1,2,3,7,8-																			
1,2,3,4,7-																			
1,2,3,6,7-													5E-06						4E-06
2,3,4,6,7-																			
1,2,3,7,8-																			
1,2,3,4,7-																			
1,2,3,6,7-																			
1,2,3,7,8-																			
1,2,3,4,6-																			
1,2,3,4,7-																			
1,2,3,4,6-																			
OCDD																			
OCDF																			

APPENDIX B LIST OF SCIENTIFIC PUBLICATIONS

i) Peer-reviewed publications

1. M.T.O. Jonker, S.A. van der Heijden, D. Adelman, J.N. Apell, R.M. Burgess, Y. Choi, L.A. Fernandez, G.M. Flavetta, U. Ghosh, P.M. Gschwend, S.E. Hale, M. Jalalizadeh, M. Khairy, M.A. Lampi, W. Lao, R. Lohmann, M.J. Lydy, K.A. Maruya, S.A. Nutile, A.M.P. Oen, M.I. Rakowska, D.Reible, T.P. Rusina, F. Smedes, and Y. Wu. Advancing the use of passive sampling in risk assessment and management of contaminated sediments: Results of an international passive sampling inter-laboratory comparison. *Environ Sci Technol* 2018, 52, 3574–3582.
2. M.A. Khairy, G.O. Noonan, and R. Lohmann. Contrasting Uptake and Bioaccumulation of legacy and emerging contaminants in the Aquatic Food Web of the Lower Passaic River: OCPs, PBDEs and PFAAs. *Environ Tox Chem* 2019, 38, 872–882.
3. M.T.O. Jonker, R.M. Burgess, U. Ghosh, P.M. Gschwend, S.E. Hale, R. Lohmann, M.J. Lydy, K.A. Maruya, D. Reible, and F. Smedes. Passive sampling protocol for the ex situ determination of freely dissolved concentrations of organic contaminants in sediments and soils: Basis for interpreting toxicity and assessing bioavailability, actual risks, and remediation necessity and -efficiency. *Nature Sci Protocols*, 2020, 15, 2020-2038.
4. M. Khairy, M., and R. Lohmann. *In Situ* measurement of freely dissolved concentrations of polychlorinated dioxins/furans (PCDD/Fs) and polychlorinated biphenyls (PCBs) in the lower Passaic River and assessing their bioavailability. *Environ Tox Chem* 2020, 39, 1174-1185.

ii) Conference or symposium abstracts

1. Lohmann, R.; Katz, S.; Adelman, D. Field Testing A Passive Multisampler To Measure Dioxins/Furans And Other Contaminant Bioavailability In Aquatic Sediments. SERDP 2018 Symposium, Washington (DC), November 2018.
2. Khairy, M.; Lohmann, R Passive-sampler based Partitioning, Fluxes and Bioaccumulation of PBDEs in an Urban River. SERDP 2018 Symposium, Washington (DC), November 2018.
3. S. Katz, D. Adelman, R. Lohmann. Field Testing A Passive Multisampler To Measure Dioxins/Furans And Other Contaminant Bioavailability In Aquatic Sediments. SERDP Symposium, Washington (DC), December 2019.
4. Lohmann, R.; Katz, S.; Adelman, D. Field Testing A Passive Multisampler To Measure Dioxins/Furans And Other Contaminant Bioavailability In Aquatic Sediments Battelle Contaminated Sediments, New Orleans (LA), Feb. '19.
5. M. Khairy, R. Lohmann Passive-sampler based Partitioning, Fluxes and Bioaccumulation of PBDEs in an Urban River. Battelle Contaminated Sediments, New Orleans (LA), Feb. '19.
6. M. Khairy, R. Lohmann. Assessing bioaccumulation of dioxins, furans and PCBs in the lower Passaic River (NJ, USA) based on in situ passive sampling. SETAC EU SciCom May 2020.
7. S. Katz, D. Adelman, R. Lohmann. Development of a Diverless Sediment Porewater Sampler for Hydrophobic Organic Contaminants. International Passive Sampling Workshop, Boston (MA) Sept 2019.