



**NAVAL
POSTGRADUATE
SCHOOL**

MONTEREY, CALIFORNIA

THESIS

**UTILIZING A MODEL-BASED SYSTEMS
ENGINEERING APPROACH TO DEVELOP A COMBAT
SYSTEM PRODUCT LINE**

by

Robert Hall

June 2018

Thesis Advisor:

John M. Green

Co-Advisor:

Raymond J. Madachy

Second Reader:

Douglas Van Bossuyt

Approved for public release. Distribution is unlimited.

THIS PAGE INTENTIONALLY LEFT BLANK

REPORT DOCUMENTATION PAGE			Form Approved OMB No. 0704-0188	
Public reporting burden for this collection of information is estimated to average 1 hour per response, including the time for reviewing instruction, searching existing data sources, gathering and maintaining the data needed, and completing and reviewing the collection of information. Send comments regarding this burden estimate or any other aspect of this collection of information, including suggestions for reducing this burden, to Washington headquarters Services, Directorate for Information Operations and Reports, 1215 Jefferson Davis Highway, Suite 1204, Arlington, VA 22202-4302, and to the Office of Management and Budget, Paperwork Reduction Project (0704-0188) Washington, DC 20503.				
1. AGENCY USE ONLY (Leave blank)		2. REPORT DATE June 2018	3. REPORT TYPE AND DATES COVERED Master's thesis	
4. TITLE AND SUBTITLE UTILIZING A MODEL-BASED SYSTEMS ENGINEERING APPROACH TO DEVELOP A COMBAT SYSTEM PRODUCT LINE			5. FUNDING NUMBERS	
6. AUTHOR(S) Robert Hall				
7. PERFORMING ORGANIZATION NAME(S) AND ADDRESS(ES) Naval Postgraduate School Monterey, CA 93943-5000			8. PERFORMING ORGANIZATION REPORT NUMBER	
9. SPONSORING / MONITORING AGENCY NAME(S) AND ADDRESS(ES) N/A			10. SPONSORING / MONITORING AGENCY REPORT NUMBER	
11. SUPPLEMENTARY NOTES The views expressed in this thesis are those of the author and do not reflect the official policy or position of the Department of Defense or the U.S. Government.				
12a. DISTRIBUTION / AVAILABILITY STATEMENT Approved for public release. Distribution is unlimited.			12b. DISTRIBUTION CODE A	
13. ABSTRACT (maximum 200 words) Current U.S. Navy combat system suites are ship class dependent. There are a variety of configurations that include sensors, weapons, and system interfaces to accomplish similar goals. The Navy Surface Warfare Center recommends developing combat system architectures utilizing reusable product line components. This recommendation is accomplished by applying model-based systems engineering and product line engineering to develop a combat system architecture with planned reuse of system components. Current U.S. Navy and European combat systems are reviewed as an introduction to the architecture and components of operational systems. Conducting functional decomposition and identifying commonalities of the reviewed combat systems allow for development of a system architecture following the Hatley-Pirbhai modeling framework. The system architecture helps identify system variability, which, in turn, is used to generate orthogonal variability models that are used to design the combat system product line. A product line orthogonal variability model features packaged variants for three proposed combat system tiers representing scalable capabilities. The benefits of a product line engineering approach are validated by a system-level Constructive Product Line Investment Model. This research provides a methodology and cost modeling tool for future combat system design as well as background for further research in combat system product line engineering.				
14. SUBJECT TERMS systems engineering, SE, model-based systems engineering, MBSE, product line engineering, PLE, product line, Combat Systems, Constructive Product Line Investment Model, COPLIMO, Hatley-Pirbhai modeling, orthogonal variability modeling, future combat systems, surface combatant, Aegis			15. NUMBER OF PAGES 97	
			16. PRICE CODE	
17. SECURITY CLASSIFICATION OF REPORT Unclassified	18. SECURITY CLASSIFICATION OF THIS PAGE Unclassified	19. SECURITY CLASSIFICATION OF ABSTRACT Unclassified	20. LIMITATION OF ABSTRACT UU	

THIS PAGE INTENTIONALLY LEFT BLANK

Approved for public release. Distribution is unlimited.

**UTILIZING A MODEL-BASED SYSTEMS ENGINEERING APPROACH TO
DEVELOP A COMBAT SYSTEM PRODUCT LINE**

Robert Hall
Lieutenant, United States Navy
BS, Virginia Tech, 2010

Submitted in partial fulfillment of the
requirements for the degree of

MASTER OF SCIENCE IN SYSTEMS ENGINEERING

from the

**NAVAL POSTGRADUATE SCHOOL
June 2018**

Approved by: John M. Green
Advisor

Raymond J. Madachy
Co-Advisor

Douglas Van Bossuyt
Second Reader

Ronald E. Giachetti
Chair, Department of Systems Engineering

THIS PAGE INTENTIONALLY LEFT BLANK

ABSTRACT

Current U.S. Navy combat system suites are ship class dependent. There are a variety of configurations that include sensors, weapons, and system interfaces to accomplish similar goals. The Navy Surface Warfare Center recommends developing combat system architectures utilizing reusable product line components. This recommendation is accomplished by applying model-based systems engineering and product line engineering to develop a combat system architecture with planned reuse of system components. Current U.S. Navy and European combat systems are reviewed as an introduction to the architecture and components of operational systems. Conducting functional decomposition and identifying commonalities of the reviewed combat systems allow for development of a system architecture following the Hatley-Pirbhai modeling framework. The system architecture helps identify system variability, which, in turn, is used to generate orthogonal variability models that are used to design the combat system product line. A product line orthogonal variability model features packaged variants for three proposed combat system tiers representing scalable capabilities. The benefits of a product line engineering approach are validated by a system-level Constructive Product Line Investment Model. This research provides a methodology and cost modeling tool for future combat system design as well as background for further research in combat system product line engineering.

THIS PAGE INTENTIONALLY LEFT BLANK

TABLE OF CONTENTS

I.	INTRODUCTION.....	1
A.	BACKGROUND	1
B.	RESEARCH QUESTIONS.....	1
C.	SPECIFIC CONTRIBUTIONS.....	3
D.	ORGANIZATION	3
E.	SUMMARY	5
II.	LITERATURE REVIEW	7
A.	PRODUCT LINE ENGINEERING	7
B.	SYSTEM ARCHITECTURE AND OPEN ARCHITECTURE.....	8
C.	COMBAT SYSTEM DEVELOPMENT.....	9
1.	Aegis Combat System	9
2.	Ship Self-Defense System	13
3.	Component Based Total Ship System (COMBATSS-21).....	17
4.	European Combat Systems	20
D.	SUMMARY	28
III.	METHODOLOGY AND APPROACH	31
A.	SYSTEM ARCHITECTURE	32
B.	SYSTEM VARIABILITY	34
C.	SYSTEM MODELING TECHNIQUE.....	36
1.	Combat System Enhanced Data Flow Diagram.....	36
2.	Combat System Architectural Flow Diagram.....	38
3.	Variation Points and Textual Requirements.....	40
4.	Allocated Architectural Flow Diagram.....	42
5.	Orthogonal Variability Models.....	44
D.	ANALYSIS	52
1.	System Constructive Product Line Investment Model.....	52
E.	SUMMARY	62
IV.	CONCLUSION	63
A.	RECOMMENDATIONS.....	65
B.	FUTURE WORK.....	66
	LIST OF REFERENCES.....	67
	INITIAL DISTRIBUTION LIST	73

THIS PAGE INTENTIONALLY LEFT BLANK

LIST OF FIGURES

Figure 1.	Thesis Organization Flow Diagram.	5
Figure 2.	The Aegis Weapon System. Source: Threston (2009).	10
Figure 3.	LSD 41/49 SSDS Mk1 Configuration. Source: Norcutt (2001).	14
Figure 4.	SSDS Double Star Topology Network Configuration. Source: Norcutt (2001).	15
Figure 5.	SSDS Mk 2 System Interface Configuration. Source: Thomas et al. (2001).	16
Figure 6.	COMBATSS Combat Management System. Source: Ukrainsky, Orest and Nix (1998).	19
Figure 7.	C-Series - Maritime and Naval System Suite. Source: Terma (2012d).	22
Figure 8.	COMPACT All Weather Gun Control System. Source: Terma (2012f).	23
Figure 9.	COMPACT Link T Data Link System. Source: Terma (2012h).	24
Figure 10.	SAAB 9LV CMS Integration. Source: SAAB (2015).	26
Figure 11.	Combat System Product Line Three Tier Nested Relationship	31
Figure 12.	The Architecture Template. Adapted from Hatley, Hruschka, and Pirbhai (2000).	33
Figure 13.	System Physical Hierarchy Numbering Convention	34
Figure 14.	Orthogonal Variability Model Graphical Notation. Source: Pohl, Böckle, and van der Linden (2005, 82).	36
Figure 15.	Combat System Enhanced Data Flow Diagram.	38
Figure 16.	Combat System Architectural Flow Diagram.	40
Figure 17.	Component Allocation to Architectural Flow Diagram.	42
Figure 18.	Sensors Variation Point Orthogonal Variability Model.	45
Figure 19.	Weapons Variation Point Orthogonal Variability Model	46

Figure 20.	Weapons Variation Point Orthogonal Variability Model	46
Figure 21.	Data Links Variation Point Orthogonal Variability Model	47
Figure 22.	Combat System Product Line Orthogonal Variability Model	51
Figure 23.	System COPLIMO for SUW / ISR (1st Tier) Packaged Variant. Source: Madachy (2018).....	59
Figure 24.	System COPLIMO for Cruise Missile Defense (2nd Tier) Packaged Variant. Source: Madachy (2018).....	60
Figure 25.	System COPLIMO for TBMD + Cruise Missile Defense (3rd Tier) Packaged Variant. Source: Madachy (2018).	61
Figure 26.	Combat System Product Line Engineering Methodology	65

LIST OF TABLES

Table 1.	Sensors Variation Point Textual Requirements	41
Table 2.	HSI / Console Variation Point Textual Requirements	41
Table 3.	Weapons Variation Point Textual Requirements.....	41
Table 4.	Data Links Variation Point Textual Requirements	42
Table 5.	Product Line Variant Classification.....	53
Table 6.	1st Tier Packaged Variant Product Line Percentages	55
Table 7.	2nd Tier Packaged Variant Product Line Percentages.....	55
Table 8.	3rd Tier Packaged Variant Product Line Percentages	55
Table 9.	1st Tier System COPLIMO Input Summary	56
Table 10.	2nd Tier System COPLIMO Input Summary	56
Table 11.	3rd Tier System COPLIMO Input Summary	57

THIS PAGE INTENTIONALLY LEFT BLANK

LIST OF ACRONYMS AND ABBREVIATIONS

AAW	anti-air warfare
ASW	anti-submarine warfare
ADS	Aegis display system
AFD	architecture flow diagram
AMDR	Advanced Missile Defense Radar
AMR	associated measurement report
ASCM	anti-ship cruise missile
ASMS	Advanced Surface Missile System
BFIT	integrated battle force trainer
BMD	ballistic missile defense
C&D	command and decision
CEC	cooperative engagement capability
CG	guided missile cruiser
CIWS	close-in weapon system
CMS	combat management system
CNO	Chief of Naval Operations
COMBATSS	Component Based Total Ship System
COPLIMO	Constructive Product Line Investment Model
COTS	commercial off-the-shelf
CPL	common product line
DDG	guided missile destroyer
DDS	data distribution service
DoD	Department of Defense
ECM	electronic countermeasures
ECCM	electronic counter-countermeasures
ECDIS	electronic chart display and information system
EDFD	enhanced data flow diagram
EO	electro-optical
EO-IR	electro-optical-infrared
ESM	electronic support measures

ESSM	Evolved Sea Sparrow Missile
EW	electronic warfare
FCS	fire control system
FDDI	fiber distributed data interface
GFCS	gun fire control system
GPS	Global Positioning System
HPD	high-powered discriminator
HSI	human system interface
IAMD	integrated air and missile defense
IFF	identification, friend or foe
IR	infrared
ISR	intelligence, surveillance, and reconnaissance
KW	kinetic warhead
LAN	local area network
LCS	Littoral Combat Ship
LEAP	Lightweight Exo-atmospheric Projectile
LIDAR	light detection and ranging
LOS	line of sight
MBSE	model-based systems engineering
MMI	multi-media interface
NATO	North Atlantic Treaty Organization
NSSMS	NATO Seasparrow Surface Missile System
NSWC	Naval Surface Warfare Center
NTS	Naval Tactical Simulator
OA	open architecture
ORTS	operational readiness and test system
OVM	orthogonal variability model
PL	product line
PLE	product line engineering
qCOPLIMO	quality-based constructive product line investment model
QOS	quality of service
RAM	rolling airframe missile

REO	remote engagement order
ROI	return on investment
SDACS	Solid-propellant Divert and Attitude Control System
SERC	System Engineering Research Center
SM	standard missile
SOS	system of systems
SSDS	Ship Self-Defense System
SUW	surface warfare
TBMD	theater ballistic missile defense
TDL	tactical data link
TPM	technical performance measure
TSCE	Total Ship Computing Environment
VLS	vertical launching system
VME	virtual machine environment
WCS	weapons control system

THIS PAGE INTENTIONALLY LEFT BLANK

EXECUTIVE SUMMARY

In 2017, the Chief of Naval Operations (CNO), ADM John Richardson, released “The Future Navy, A CNO White Paper.” Within this document, the CNO discussed the need for a 355-ship Navy using advanced technology, new types of ships, and new methods of employing these ships and technology. The CNO described the need for the future Navy to have the ability to operate in blue water, as well as the littorals, with adequate numbers of ships and capability to defeat enemy attacks. Additionally, ADM Richardson described unmanned systems as “an integral part of the future fleet” that are networked and “affordable to buy in large numbers” (Richardson 2017). The need for a large, technologically advanced future Navy, with unmanned systems, further emphasizes the utility of a combat-systems product line due to the capabilities overlap that occurs when designing combat systems for blue water and littoral missions. These capability overlaps lend themselves well to the product-line engineering concept of designing a system with the planned intent of reusing and modifying various components to allow for mass customization of products. Additionally, planned reuse of system components results in a greater return on investment for the combat system customer.

Current U.S. Navy combat system suites are ship-class dependent. There are a variety of configurations that include sensors, weapons, and hardware/software integrations to accomplish similar goals. Aegis combat system is the integrated combat system of Ticonderoga-class guided missile cruisers and Arleigh Burke-class guided missile destroyers. Aegis’s development in the 1970s was not conducted with the concepts of product line engineering (PLE) or open architecture (OA) in mind. Ship Self-Defense System (SSDS) combat system development for aircraft carriers and amphibious warfare ships incorporated OA and systems thinking; however, the application and integration of the combat system was unique to the ship-class (DOT&E 2011, 171). The Zumwalt-class guided missile destroyer utilizes the Total Ship Computing Environment (TSCE), which integrates engineering and damage control automation systems along with the combat system (Henry, Iacovelli, and Thatcher 2009, 21–22). Zumwalt’s TSCE was also developed utilizing OA and systems engineering processes, but it is also ship-class specific

and is not designed for integration on other platforms. The LCS-class and future frigate variant (FFX) use an Aegis derived system called COMBATSS-21 (Lockheed Martin 2017). Ship-class dependent combat system suites do not follow the Navy Surface Warfare Center's (NSWC) vision for the "development of reusable product line components into a single combat system architecture" (Murphy, Richardson, and Sheehan 2013, 11–12).

The disaggregated nature of current U.S. Navy combat systems is not optimal from a technical design nor from a cost perspective throughout the system's life cycle. Employing a product line engineering approach to future combat system design is beneficial for both the combat system developer and the customer. Product line engineering concepts such as building once and the planned reuse of system components, helps the Navy achieve the overarching strategic guidance of the CNO as well as technical guidance from NSWC.

This research explores the possibility of applying product line engineering and open architecture to develop a common system design for future Navy combat systems. Product line engineering and open architecture, including their application to combat system design are discussed in detail. A functional decomposition of current Navy combat system suites provides the framework for a product line incorporating the commonalities needed for effective combat capabilities regardless of platform or ship- class. The system architecture is used to integrate the commonalities into a functional system. Currently, no combat systems product line in the U.S. Navy exists. The benefits of PLE including cost savings and program continuity have not been realized by the Navy due to the current stovepipe arrangement of combat systems across multiple platforms.

A robust engineering product line, focusing on the functional components of Navy combat system commonalities across multiple platforms is developed. Additionally, a product line strategy economic analysis is conducted utilizing the System Constructive Product Line Investment Model (COPLIMO). This includes parametric cost analysis of hardware and software architectural options for the combat systems. The representative results utilizing analogous, current Aegis combat system cost data suggest a strong return on investment (ROI) of a product line approach.

References

- Henry, Mark, Michael Iacovelli, and Jeffrey Thatcher. 2009. "DDG 1000 Engineering Control System (ECS)." In ASNE Intelligent Ship VIII Symposium. 20–21.
- Lockheed Martin. 2017. "Integrating the Aegis Derived COMBATSS-21." Accessed August 7, 2017. <http://www.lockheedmartin.com/us/news/features/2016/160112-mst-integrating-the-aegis-derived-combatss-21-with-the-littoral-combat-ship.html>
- Murphy, Alvin, David S. Richardson, and Terence Sheehan. 2013. "The Importance of System-of-Systems Integration" Leading Edge, February. Accessed August 9, 2017. http://www.navsea.navy.mil/Portals/103/Documents/NSWC_Dahlgren/LeadingEdge/CSEI/CombSys.pdf.
- The Office of the Director, Operational Test and Evaluation. 2011. DOT&E FY2011 Annual Report, Ship Self-Defense. 171.
- Richardson, John, ADM USN. Chief of Naval Operations. 2017. "The Future Navy." Accessed January 9, 2018. <http://www.navy.mil/navydata/people/cno/Richardson/Resource/TheFutureNavy.pdf>.

THIS PAGE INTENTIONALLY LEFT BLANK

ACKNOWLEDGMENTS

I thank my advisor, John Green, for his subject matter expertise and valued mentorship throughout the thesis process. I thank my co-advisor, Dr. Ray Madachy, for his time and investment model contributions. I also thank my second reader, Dr. Douglas Van Bossuyt, for his time and effort reviewing my thesis. Lastly, I thank my wife for her support throughout this process.

THIS PAGE INTENTIONALLY LEFT BLANK

I. INTRODUCTION

A. BACKGROUND

Current U.S. Navy combat system suites are ship-class dependent. There are a variety of configurations that include sensors, weapons, and hardware/software integrations to accomplish similar goals. Aegis combat system is the integrated combat system of Ticonderoga-class guided missile cruisers and Arleigh Burke-class guided missile destroyers. Aegis's development in the 1970s was not conducted with the concepts of product line engineering (PLE) or open architecture (OA) in mind. Ship Self-Defense System (SSDS) is the installed combat system on aircraft carriers and amphibious warfare ships (DOT&E 2011, 171). Ship Self-Defense System development incorporated OA and systems thinking, however, the application and integration of the combat system was unique to the ship-class. The Zumwalt-class guided missile destroyer utilizes the TSCE, which integrates engineering and damage control automation systems along with the combat system (Henry, Iacovelli, and Thatcher 2009, 21–22). Zumwalt's TSCE was also developed utilizing OA and systems engineering processes, but it is also ship-class specific and is not designed for integration on other platforms. The LCS-class and future frigate variant (FFX) use an Aegis derived system called COMBATSS-21 (Lockheed Martin 2017). Ship-class dependent combat system suites do not follow the Navy Surface Warfare Center's (NSWC) vision for the "development of reusable product line components into a single combat system architecture" (Murphy, Richardson, and Sheehan 2013, 11–12).

B. RESEARCH QUESTIONS

The NSWC vision for the engineering product line methodology applied to combat system architecture results in the following research questions:

1. Can PLE be used to develop a common system architecture design for future Navy combat systems instead of using unique, platform specific combat system suites?

2. What common functional and physical features as part of the architecture are important aspects of developing a combat systems product line?
3. How can a product line strategy economic analysis be conducted utilizing a system level parametric model for cost and return on investment analysis of product options for the combat system?

The first question is addressed by reviewing the components of current and past combat systems to provide the foundation for a common system architecture. Software product line engineering concepts are applied at the system level to conduct physical and functional analysis. The warfare capabilities are bounded to three tiers of combat systems. The first tier is designed for surface warfare (SUW) or intelligence, surveillance, and reconnaissance (ISR) missions. The second tier combat system provides cruise missile defense capability. Finally, the third tier is capable of theater ballistic missile defense (TBMD) and cruise missile defense. These tiered concepts are applicable to the broader problem of specific warfare areas addressed by combat systems.

The second question is explained by conducting a functional analysis and allocation of current ship-class specific combat system suites to decompose the combat system into top level and lower level functions. Upon developing the system functional breakdown, common functions of the combat system are identified. These functions are used to develop a system architecture utilizing Hatley-Pirbhai modeling, including an enhanced data flow diagram (EDFD) and an architecture flow diagram (AFD). The system architecture is a tool to help identify system variability, which is related to variability subjects that correspond to variation points. Components defined as variation points provide the structure for orthogonal variability models (OVMs) which in turn be used to design the product line. An OVM with packaged variants representing the three warfare capability tiers describe the product line as a whole.

The third question is answered by applying a system level adaptation of the Constructive Product Line Investment Model (COPLIMO) to conduct a cost analysis on the proposed combat systems architecture product line. The model called System

COPLIMO is used to conduct an analysis of alternatives when comparing the combat systems product line to current one-off combat system suites.

C. SPECIFIC CONTRIBUTIONS

The author offers the following application of system architecture and modeling techniques as new contributions to the field of combat system design and engineering. The Hatley-Pirbhai architecture framework is used as a template for the detect, control, engage paradigm of combat system functionality. This is proposed as a standardized high level architectural form for combat system design. Applying software PLE techniques at the system level, to system components, is proposed as a best practice for identifying variability within the combat system. Using the Hatley-Pirbhai architectural models to develop orthogonal variability models (OVMs) is recommended to identify product line variants and associated variation points within the combat system architecture. The author offers that OVMs are a valid method of quantifying mission unique, adapted, and reused components as percentages for System COPLIMO.

The architecture and modeling methods used in this thesis are accepted systems engineering techniques. However, the integrated model-based systems engineering (MBSE) methodology of Hatley-Pirbhai modeling, software PLE processes, and System COPLIMO is a distinct contribution to this subject matter.

D. ORGANIZATION

The thesis is organized into three main segments that address a literature review, methodology and approach, and conclusions including future work. Figure 1 is a flow diagram that depicts the segments, associated chapters, and thought process throughout the thesis. Chapters I and II give the background and need for a combat system product line. A review of current surface combatant combat systems, including U.S. Navy and European systems, introduces the reader to the architecture and components of operational systems.

This review sets the stage for the modeling processes that the author proposes for developing a combat system product line. The process is illustrated in the Chapter III flow diagram section of Figure 1. As discussed earlier, the modeling method begins with Hatley-

Pirbhai modeling, using the functional and physical components of current combat systems to propose a common combat system architecture. The enhanced data flow diagram is developed first, showing the functional components of the combat system. The functions in the EDFD are synthesized into physical components to produce the AFD, utilizing a common architecture template.

The combat system AFD provides the model necessary for variation point identification and analysis. Variation point identification in the AFD is the first step in the orthogonal variability modeling process. Each variation point is decomposed into different variants that comprise the OVMs, these variation points and associated variants are described as requirements in the textual requirements step of orthogonal variability modeling. The textual requirements are then used to revise the Hatley-Pirbhai AFD model in more detail by allocating components (variants) to each variation point. Next, the individual variation point OVMs are developed from the allocated AFD and related textual requirements. Packaged variants used to represent three tiers of combat system and constraint dependencies on the individual variation point OVMs create the product line OVM. This model displays the feasible combinations of packaged variants, variation points, and variants for the product line.

The product line OVM is necessary for developing the inputs for System COPLIMO that completes the work presented in Chapter III. The System COMPLIMO requires identification of system components (variants) that are mission-unique, adapted, reused across products. These unique, modified, and common components are quantified in the System COPLIMO and are used to create an investment model that describes return on investment by using a product line engineering approach to combat system design.

Chapter IV concludes the material presented by conducting a summary of analysis and presenting future work. The current surface combatant combat systems are revisited and the outcomes of the modeling techniques are recapped. The thesis is organized in such a manner that the reader can flow logically between topics and use Figure 1 to reference as necessary.

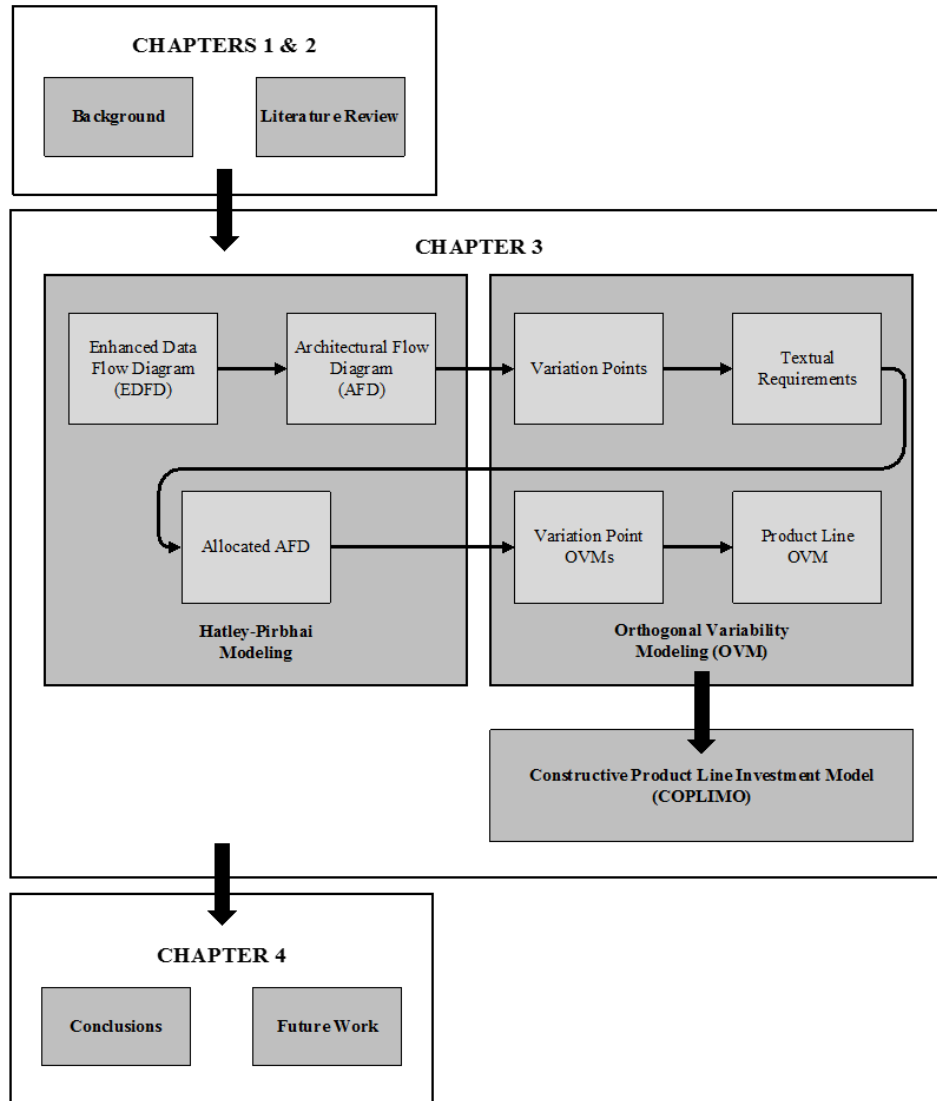

Figure 1. Thesis Organization Flow Diagram.

E. SUMMARY

This research explores the possibility of applying product line engineering and open architecture to develop a common system design for future Navy combat systems. Product line engineering and open architecture, including their application to combat system design is discussed in detail. A functional decomposition of current Navy combat system suites provides the framework for a product line incorporating the commonalities needed for effective combat capabilities regardless of platform or ship-class. The system architecture is used to integrate the commonalities into a functional system. Currently, no combat

systems product line in the U.S. Navy exists. The benefits of PLE including cost savings and program continuity have not been realized by the Navy due to the current stovepipe arrangement of combat systems across multiple platforms.

A robust engineering product line, focusing on the functional components of Navy combat system commonalities across multiple platforms is developed. Additionally, a product line strategy cost analysis is conducted utilizing System COPLIMO. This includes parametric cost analysis of hardware and software architectural options for the combat system. The representative results utilizing analogous current Aegis combat system cost data suggest a strong ROI of a product line approach.

In the following chapter, a comprehensive literature review is conducted describing the concepts of PLE, OA, and COPLIMO. The literature review provides a brief history of current combat system suites including Aegis and SSDS. Additionally, a U.S. Navy air defense background is provided to focus the engineering product line to this specific warfare area. The literature review provides the evidence that demonstrates the need for a combat systems product line.

II. LITERATURE REVIEW

Developing an engineering product line for a future U.S. Navy combat system requires an understanding of the components and functions of current combat systems, operational at sea. Comparing different combat systems offerings allow for further analysis and development of a proposed combat system product line. A brief description of product line engineering, system architecture, and open architecture is necessary to understand the underlying framework of combat systems. The U.S. Navy combat systems reviewed include Aegis, SSDS Mk 1 and Mk 2, and COMBATSS. Additionally, European combat systems including Terma C-Series, SAAB 9LV, and Thales TACTICOS are analyzed to determine the necessary architectural functions, behaviors, and components for a product line.

A. PRODUCT LINE ENGINEERING

The term product line is derived from the production line, which was conceived by Ford as the most effective method of mass-producing automobiles. Prior to production lines, products were built specifically for individual customers. In this case, product customization is relatively easy since each product is built individually. Production lines allow manufactures to produce hardware or software, repetitively, for mass consumption by as many customers as the consumer market allows. Due to the larger number of products being produced in a production line, customization is more difficult, so the customer has fewer choices of hardware or software. Product lines introduce the concept of mass customization, which combines the mass output of a production line with the ability to customize hardware and software to the individual user's needs (Pohl, Böckle, and van der Linden 2005, 4).

A more formal definition of a product line is, “a set of systems that share a common, managed set of features that satisfy the specific needs of a particular market segment or mission and that are developed from a common set of core assets in a prescribed way” (Guertin, Nicholas, and Clements 2010, 78). The technical work conducted to develop product lines is referred to as Product Line Engineering, “a well-established engineering

discipline that provides an efficient way to build and maintain portfolios of systems that share common features and capabilities” (Clements et al. 2014, 12).

Department of Defense (DoD) systems developed with PLE have “demonstrated improvements in development time, cost, quality, and engineering productivity that consistently attain integer-multiple improvements over comparable non-PLE engineering efforts” (Clements et al. 2014, 12). In the Aegis combat system, “Lockheed Martin’s Maritime Systems and Sensors Division maintains the Common Product Line (CPL) requirements” which allows the product line to “develop once, and build and deploy many times from one set of common assets—principally requirements, source code, and tests.” (Clements et al., 2014, 15). An additional characteristic of the product line approach is “repeatable per-product cost savings of 50% to 67% to 90%” (Guertin, Nicholas, and Clements 2010, 87). Product line engineering is used in concert with open architecture in developing robust systems engineering solutions.

B. SYSTEM ARCHITECTURE AND OPEN ARCHITECTURE

A basic system architecture is the aggregate of system operational requirements, support and maintenance model, defined technical performance measures (TPMs), and properly prioritizing the TPMs. The architecture includes top-level system configurations including operational interfaces, the environment in which the system is going to operate, and projected mission scenarios (Blanchard and Fabrycky 2001, 93). A functional architecture can be developed from the system architecture by conducting functional analysis to describe the system in terms of functionality. The system’s physical architecture is a further evolution of the functional architecture, developed by assigning physical components to the functions of the system that facilitate mission accomplishment (Blanchard and Fabrycky 2001, 93).

System architecture is described as an open architecture if “the hardware and software interfaces are sufficiently well defined so that additional resources can be added to the system with little or no adjustment” (Buede 2009, 274). Successful system architectures are both proprietary and open, with the developer controlling system specific standards and protocols (Maier and Rechtin 2009). The open systems and open architecture

construct is what makes product line engineering achievable. The common core attributes of an engineering product line require open architecture in order to build, deploy, and evolve the system effectively over time.

C. COMBAT SYSTEM DEVELOPMENT

1. Aegis Combat System

Aegis is the U.S. Navy's air defense weapon system installed on Ticonderoga-class cruisers (CG) and Arleigh Burke-class destroyers (DDG), first operational at sea on the USS Ticonderoga (CG-47) in 1981 (Emch 1992, 50). The development of Aegis, which spanned over 20 years, began with the Advanced Surface Missile System (ASMS) and resulted in "the integration of the entire ship's combat system and the design and construction of a completely system engineered and integrated ship" (Threston 2009, 85). Over the 30 plus year production of Aegis, its expandable and scalable system architecture has provided the flexibility to evolve and remain relevant (Threston 2009, 85).

The primary function of Aegis is to integrate SPY-1 radar to control standard missiles (SM) to provide air defense from various threats including anti-ship cruise missiles (ASCM), ballistic missiles, aircraft, and other airborne threats. Aegis was designed and developed to "deal with long-range saturation attacks...and was the first weapon system to use missiles with commandable autopilots, which could be launched then guided into 'baskets' near their targets without continuous radar illumination" (Friedman 2006, 104). Since the illuminators are only turned on when the fired missile is in close proximity to its target, the commandable autopilot allows each illuminator to share multiple missiles (Friedman 2006, 104). Additionally, Aegis was the first U.S. combat system with the ability to make doctrinal decisions, based on rules that can be changed onboard the ship, via software running on the command and decision (C&D) processor (Friedman 2006, 104).

The eight major elements of Aegis represented in Figure 2 are as follows (Threston 2009, 89–91):

1. AN/SPY-1A Phased Array Radar

2. Mk-1 C&D System
3. Mk-1 Aegis Display System (ADS)
4. Mk-1 Weapons Control System (WCS)
5. Mk-99 Fire Control System (FCS)
6. Vertical Launching System (VLS) Mk-41
7. Standard Missile Family
8. Mk-1 Operational Readiness and Test System (ORTS)

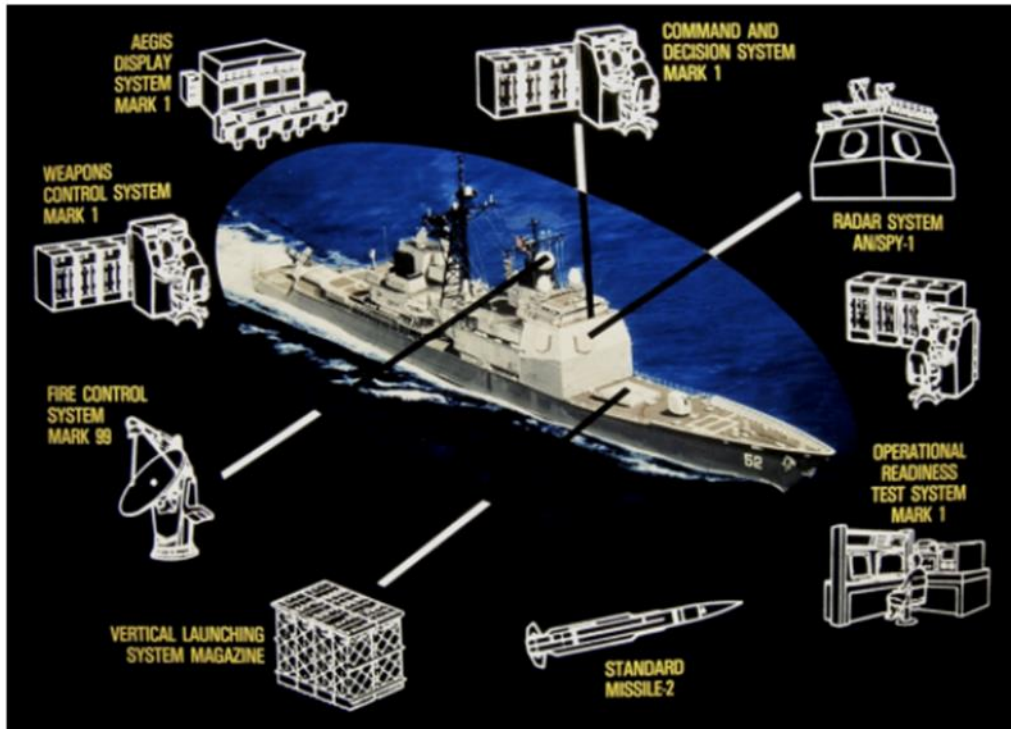

Figure 2. The Aegis Weapon System. Source: Threston (2009).

On the Ticonderoga-class cruiser platform, the Aegis weapon system Mk 7 is designed “around the command and decision, system Mk 1, Aegis display system, and weapons control system Mk 1” (Friedman 2006, 104). The Arleigh Burke-class destroyer

platform is designed around “C&D Mk 2, Aegis display system Mk 2 (with two screens rather than four), and WCS Mk 8” (Friedman 2006, 104). Both CG and DDG platforms employ SPY-1 radar, which integrates both fire control and air search radar, allowing for very quick reaction times to air threats (Friedman 2006, 104).

It is essential that Aegis have the ability to evolve in order to address continuously advancing threats and mission sets. The most significant upgrades to Aegis over its 30 year production run include integrating Mk-41 VLS, AN/SPY-1 B/D radar, AN/SPY-1 D (V) radar, computer and display upgrades, and various advances in missile technology (Threston 2009, 103–105).

Installing Mk-41 VLS in place of the Mk-26 Dual Arm Launching System had the greatest impact of the other major upgrades. VLS enabled Aegis to “perform new missions, decreased system reaction time still further, increased the number of missiles that could be carried in the ship, and vastly improved mission reliability” (Threston 2009, 103). Additionally, VLS’s large number of launch cells allowed Aegis to carry Tomahawk, Standard Missile 2 Block IV, Standard Missile 3, Evolved Sea Sparrow Missiles (ESSM), and Standard Missile 6.

The AN/SPY-1 B/D radar was developed as a redesign of the AN/SPY-1 phased array antenna, giving it greater resistance to electronic countermeasures (ECM) (Threston 2009, 104). Along with the phased array antenna redesign, “the signal processor was redesigned to reduce processing losses, improve electronic counter-countermeasures (ECCM) performance, and greatly improve maintainability by introducing a number of automatic alignment features” (Threston 2009, 104). The AN/SPY-1 D (V) radar evolved from the B/D radar as stealth technology became more prevalent. The D(V) upgrades included “wave forms designed to reduce background clutter thereby increasing the potential for detecting the stealth target,” additional ECCM capabilities, and improved capabilities in the littorals (Threston 2009, 104).

Computer and display upgrades have been necessary to fully utilize the capabilities of the upgraded radar and missile technologies. Aegis was introduced with Navy standard AN/UYK-7 computers and UYA-4 displays. The computing power and technological

limits of the AN/UKY-7 computers bounded what was achievable with the Aegis functional architecture. Aegis had to allocate functionality to three different AN/UKY-7 computers, allocated to AN/SPY-1, C&D, and WCS. In this configuration, the AN/UKY-7 allocated to process the AN/SPY-1 data was overloaded, which required (repartitioned to) resources from the AN/UKY-7 allocated to C&D. Adjunct processors were added to the AN/UKY-7 computers to allow for upgrades in displays and radar doctrine, in anticipation of developing OA for Aegis.¹ Adjunct processors took on additional processes identified for Aegis baseline upgrades, such as baselines 5.3 and 6.1.

The computers were upgraded to the next generation of Navy standard AN/UYK-43/44, AN/UYQ-21 displays, and later, AN/UYQ-70 displays (Threston 2009, 104). A Navy policy change in the 1990s resulted in the use of commercial-off-the-shelf (COTS) computer equipment, to “reflect the best in current day computing technology” (Threston 2009, 104). With the addition of COTS computers, Aegis evolved by “redesigning the computer programs to take advantage of the increased memory and computer computational power” (Threston 2009, 104). Open Architecture was also introduced to Aegis for the first time.

The most recent development of the Aegis combat system is its integration and use as a TBDM platform, which is a block improvement program announced in 2003 (Friedman 2006, 107). The ballistic missile defense (BMD) system for Aegis incorporates a high-powered discriminator (HPD) radar that “is a phased array with a relatively narrow field of view, trained toward the incoming missile warheads using SPY-1 data” (Friedman 2006, 107). Aegis utilizes different SM missile variants as launch vehicles, with a Lightweight Exo-atmospheric Projectile (LEAP) to intercept ballistic targets. The LEAP includes a kinetic warhead (KW) with “a longwave infrared (IR) seeker and Solid-propellant Divert and Attitude Control System (SDACS)” which guides the KW to hit and kill the ballistic target (Landis 2001, 436). This ballistic missile defense capability was derived from Aegis’s original design for the anti-air warfare (AAW) mission.

¹ John M. Green, interview by author, November 13, 2017.

Aegis's ability to adapt and incorporate additional functionality has allowed it to remain the Navy's most widely deployed and versatile air-defense weapon system over the past three decades. Aegis continues to evolve with emerging threats, new missions, and technological advancements.

2. Ship Self-Defense System

Ship Self-Defense System is the air defense combat system for non-Aegis ships that “integrates existing sensors and weapons using commercial-off-the-shelf components” to provide defense against ASCMs for ships operating within range of these missiles (Whitley 2001, 516). SSDS Mk 1 was designed “for the LHD 1, LSD 41, LSD 49, and LPD 17 classes” of amphibious assault ships (Friedman 2006, 123). Mk 1 later evolved into SSDS Mk 2, which was designed for CVN class aircraft carriers and was installed on LPD 17, LHD 8, and LHA 6 class amphibious ships (DOT&E 2012, 203).

The fundamental performance requirement for both SSDS Mk 1 and Mk 2 is raid annihilation, described by the “probability of raid annihilation P_{RA} against a range of potential threats” (Whitley 2001, 520). This probability of raid annihilation requirement drove the argument “that integrated ship defense systems must have open, distributed architecture designs” (Prengaman, Wetzlar, and Bailey 2001, 523). The SSDS architecture permits weapon and sensor integration that support meeting the P_{RA} requirement against ASCMs (Prengaman, Wetzlar, and Bailey 2001, 523). The “system was developed to support sensor fusion using dissimilar sensors” (Friedman 2006, 124).

SSDS Mk 1 employs the detect, control, and engage principle for self-defense. The sensors utilized for target detection include Phalanx close-in weapon system (CWIS), AN/SPS-67 surface search radar, AN/SLQ-32 ECM system, and AN/SPS-49 air search radar. The tactical control data system requires three operators, working between five operator consoles, and two large screen displays. Engagement capabilities are performed by rolling airframe missiles (RAM), Phalanx CWIS, and electronic countermeasures. SSDS Mk 1 utilizes an Aegis style doctrine that allows for automatic engagement of targets via weapons and sensor interactions (Friedman 2006, 124). A fiber-optic local area network (LAN) connects the ship's sensors, control system, and weapons giving SSDS the

capability to integrate system data to form target tracks (Friedman 2006, 122). The LSD 41/49 SSDS configuration is shown in Figure 3.

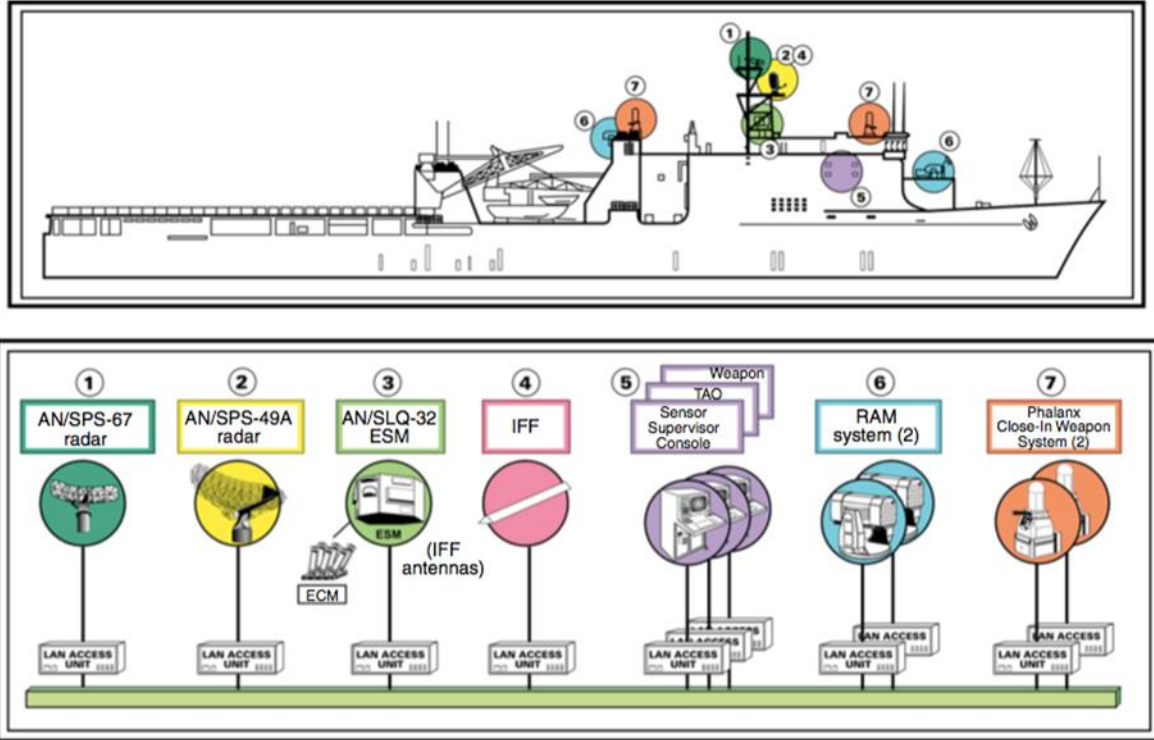

Figure 3. LSD 41/49 SSDS Mk1 Configuration.
Source: Norcutt (2001).

The SSDS network, shown in Figure 4, is configured as “a dual home star topology incorporating network hubs that are positioned in different regions of the ship” (Norcutt 2001, 543). This network configuration allows for efficient troubleshooting, effective COTS upgradability, simplified network reconfigurability, as well as decentralization for improved survivability (Norcutt 2001, 543). The system “software runs under a UNIX operating system, and it uses virtual machine environment (VME)-card computers linked by a FDDI bus” (Friedman 2006, 123). UNIX is a standardized COTS computer operating system with an open source framework (The Open Group 2018). The UNIX system operates on VME-card computers, which provide data processing and control computational power. The standard for data transfer between systems over the LAN is the

fiber-distributed data interface (FDDI). Instead of using Ethernet cables, “glass fiber for data transfer was selected for its performance, low weight, and low electromagnetic susceptibility” (Norcutt 2001, 543).

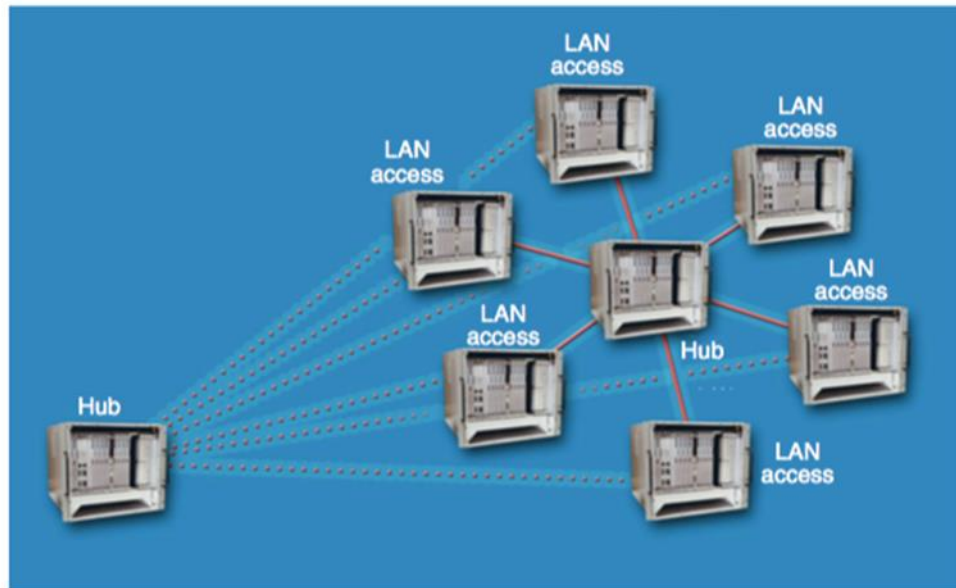

Figure 4. SSDS Double Star Topology Network Configuration.
Source: Norcutt (2001).

During the implementation of SSDS Mk 1, technological advancements in computing power and sensors development created potential for a more capable self-defense combat system utilizing the basic SSDS architecture. The evolution of SSDS Mk 1 was driven by the need to integrate RAM, the NATO Seasparrow Surface Missile System (NSSMS), as well as the cooperative engagement capability (CEC) into a combat system designed for CVN ship-classes (Thomas et al. 2001, 547). The weapons and command and control integration resulted in the development of SSDS Mk 2 which “includes new functions such as remote sensor cueing (CEC) and ESSM control (in addition to RAM and CIWS)” (Friedman 2006, 124). The number of system interfaces increased from seven for SSDS Mk 1 to a total of 16 interfaces for SSDS Mk 2, as shown in Figure 5. These interfaces include, “radars (SPS-48 and -49, SPQ-9, SPS-67), the ship’s ASW system (CV-TSC), IFF, CEC, GCCS-M, data links (Links 4A, 11, 16), SGS/AC (gridlock/auto-

et al. 2001, 547). In order to conduct engagements with SSDS Mk 2's own weapons via CEC, the following integration between SSDS and CEC was developed. CEC provides tracks, "sensors measurements associated with each track (Associated Measurement Reports or AMRs) of interest, and statistics for false tracks / engagement control" (Thomas et al. 2001, 547). The AMRs provided by CEC are then processed and filtered by SSDS in order to determine if the engagement is valid or false based on the CEC provided statistics. This "interface between SSDS and CEC is a high-fidelity interface that transfers composite track, identification (ID), engagement, sensor measurement, and control data between CEC and SSDS" (Thomas et al. 2001, 547). The SSDS Mk 2 engagement then takes place utilizing the CEC track and SSDS's organic weapons, NSSMS and RAM. The integration of NSSMS with RAM and SSDS "supports multiple engagements, improved CEC track continuity, and improved resistance to degradation" (Thomas et al. 2001, 547). SSDS Mk 2 continues Mk 1's use of Aegis style doctrinal decision making for automatic engagement of targets. There is a supplementary weapon assignment function that "refers to the ship's aircraft and to weapons in the accompanying ships of the battle group" (Friedman 2006, 124). The expansion of SSDS to include additional engagement, weapons, and sensors capabilities is a result of its design as a collection of these systems, rather than designed as a complete combat system.

3. Component Based Total Ship System (COMBATSS-21)

COMBATSS is a shipboard combat system using COTS technology, that was "developed and tested at-sea an open architecture, 'plug-and-play,' component-based combat system" (Ukrainsky, Orest, and Nix 1998, 3). The system was designed as a scalable combat system based on the Aegis functional structure, that could be adapted to different ship platforms and mission sets based on using component based software. It "maximizes the use of commercially available hardware and software to produce a combat system suitable for installation in vessels both as small as patrol boats and as large as or larger than destroyers" (Ukrainsky, Orest, and Nix 1998, 4). Currently, COMBATSS is operational on the Littoral Combat Ship (LCS) Freedom-class as well as on ships of multiple international navies. It is fully network enabled to operate in battle groups and joint operations (Lockheed Martin Corporation 2010, 4).

Similar to SSDS, COMBATSS uses a modular approach to combat systems design with subsystems providing various sub functions within the overall COMBATSS Combat Management System (CMS). Figure 6 depicts the various subsystems that make up COMBATSS, including:

1. Electro-optics
2. Gun
3. Tracking radar
4. Surface missiles
5. Bridge system
6. Training simulation system
7. Chaff launcher
8. Electronic support measures (ESM)
9. Optical sight
10. Data links
11. Search radar
12. Identify friend or foe (IFF) antenna
13. Message system

An example of the modular design is shown by the Gun Fire Control System (GFCS), which is a subsystem of COMBATSS. The electro-optics, gun, and tracking radar that make up the GFCS can operate either as peripheral systems integrated into COMBATSS or as individual, self-sufficient subsystems (Ukrainsky, Orest, and Nix 1998, 4). The other subsystems follow this same approach to systems integration, which “enables quick and cost effective integration of various sensors and weapon systems into one coherent CMS” (Ukrainsky, Orest, and Nix 1998, 4). Where SSDS and COMBATSS differ

in the design approach, is COMBATSS planned reuse of software within a scalable component framework (Lockheed Martin Corporation 2010, 4).

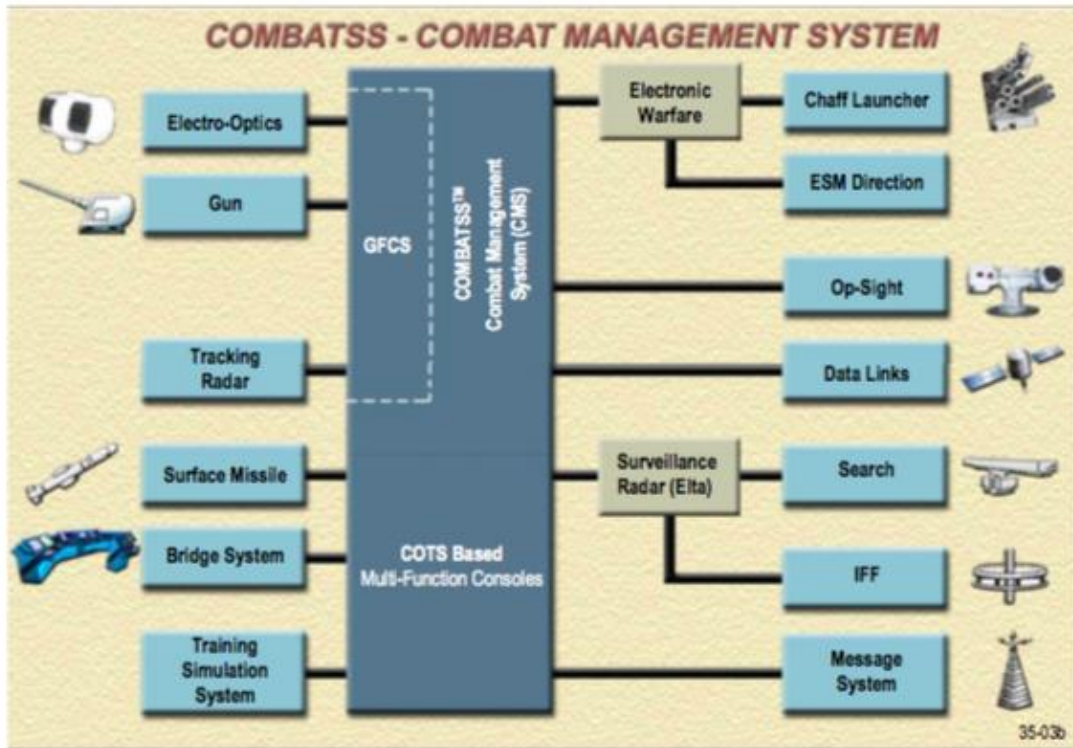

Figure 6. COMBATSS Combat Management System. Source: Ukrainsky, Orest and Nix (1998).

Within the CMS framework of COMBATSS, the software components are divided into four major groups; track management, weapons control, missions, and navigation (Ukrainsky, Orest, and Nix 1998, 6). Depending on the platform application, the CMS can use any combination of these major software groups (Ukrainsky, Orest, and Nix 1998, 7). Each software group includes a collection of components that are defined within the CMS framework and receive data inputs from the COMBATSS subsystems. Various sensors and weapons can be introduced into the combat system since all the software components look the same once they are entered into COMBATSS CMS. This allows for rapid upgrades as more sophisticated weapons and sensors are developed (Ukrainsky, Orest, and Nix 1998, 6).

The track management group components define “system tracks, local tracks, a track repository, a correlator, and an identifier” (Ukrainsky, Orest, and Nix, 6). Data inputs are received from radars, datalinks, and the electronic warfare subsystem (Ukrainsky, Orest, and Nix, 6). The mission group components define the logic that allows the accomplishment of specific mission sets with operator interaction. “An example mission coordinator is an anti-air warfare defense mission coordinator capable of coordinating multiple engagements, with different weapons, against a single or multiple targets” (Ukrainsky, Orest, and Nix, 6).

The navigation group of components define “ownship location, compass, log, heading control, drive control, and navigator components” (Ukrainsky, Orest, and Nix, 6). Data from ownship location includes “current position and kinematics of ownship as reported by a shipboard device, usually a GPS” (Ukrainsky, Orest, and Nix, 6). The compass, log, heading control, and drive control data are standardized outputs from shipboard sensors. The navigator component uses these data outputs to predict ownship location on a given voyage plan (Ukrainsky and Nix, 6).

Similarly, the weapons control group components define “engagement coordinator, weapon model, and weapon selector” (Ukrainsky and Nix, 6). The engagement coordinator component can provide planning, scheduling, and engagement execution orders within the CMS to order a specific weapons system, such as GFCS or missiles, to engage a target. The weapon model component creates a model for the weapons integrated into a specific COMBATSS platform. This model could be for gun systems or missile systems and it “provides the engagability calculations of the specific weapon” (Ukrainsky and Nix, 6). The weapon selector component provides operator support for selecting the most suitable weapon for the planned engagement. COMBATSS evolved from the Aegis combat system architecture to include planned use of COTS components with an open architecture concept.

4. European Combat Systems

When discussing product line engineering and combat systems, it is important to examine European naval combat systems. Terma, SAAB, and Thales all have combat

system offerings that follow the product line methodology. Terma's combat system offerings feature the C-series product suite, based on a command and control (C2) system that can be combined with a range of modules that support various missions (Terma 2012j). SAAB'S 9LV combat system suite is a product line designed for various types of vessels, that support multiple missions through three different combat system packages, the 9LV Combat System (CS), 9LV Combat Management System, and the 9LV Fire Control System (SAAB 2015, 2). Thales's TACTICOS is a combat management system based on open, scalable, modular architecture that can perform multiple missions on various types of vessels (Thales 2017).

a. Terma C-Series

Terma's C-Series combat system suite is a product line that includes different mission modules that "are proven both as stand-alone and as an integrated system" (Terma 2012j). The product line provides Electro-Optical Fire Control, 2D Air and Surface Surveillance radar, and data link, designed for amphibious ships, frigates, command ships, as well as smaller offshore patrol and patrol vessels. The C-series product line includes the following modules depicted in Figure 7 (Terma 2012d):

1. C-Flex Naval C2 System
2. C-Fire EO
3. C-Search Naval Radar and IFF System
4. C-Link Naval Link System
5. C-Guard Naval Decoy System
6. C-Sim Naval Simulation

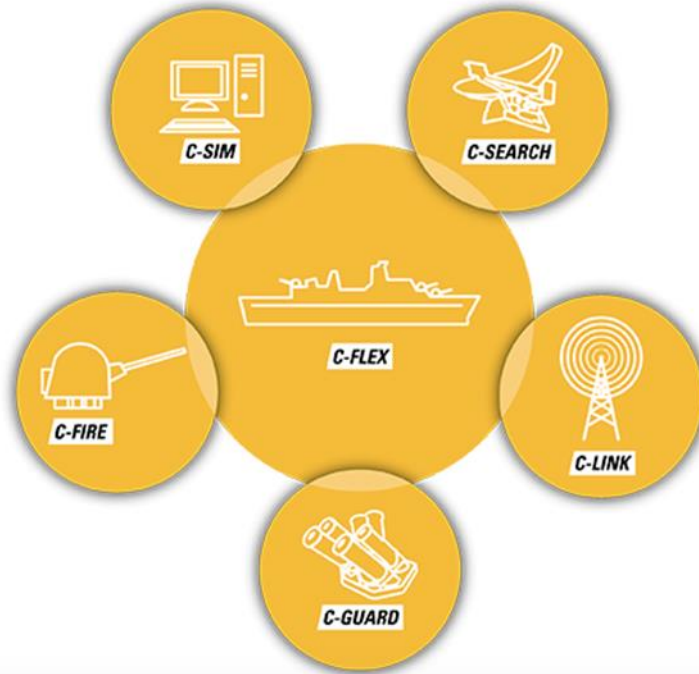

Figure 7. C-Series - Maritime and Naval System Suite.
Source: Terma (2012d).

The C-Flex Naval C2 System is a modular, scalable command and control system that provides the integration and user interfaces for the C-series products listed above (Terma 2016a). The C-Flex system integrates data from ownship sensors, radars, weapons, external communications, and electronic support measure systems. This data plotted as tracks “on top of an Electronic Chart Display and Information System (ECDIS) / sea chart together with radar video” (Terma 2012b). The system is scalable to allow for between one and 24 operators and Operator Consoles, based on the application. C-Flex uses COTS hardware and software such as Microsoft Windows and Linux operating systems. The core C-series software is separate from the operating system, which allows for adding and removing sensors and weapon systems as required (Terma 2012b). Terma also provides the C-Search Naval Radar and IFF System that integrates into the C-Flex System. The naval radars include the SCANTER 6000 series, 4000 series, and 2600 series radars for various applications (Terma 2012i).

The C-Fire EO system includes the COMPACT All Weather Gun Control System and the COMPACT Electro-Optical Gun Control System. The COMPACT All Weather Gun Control System “provides a standalone Fire-Control System with a combined Radar & Electro-Optical (EO) Director, Ballistic Predictor & Interface of one Naval Gun and an Operator Console for controlling any in-service naval gun,” from 30–127mm (Terma 2012f, 1). The COMPACT Electro-Optical Gun Control System “provides a standalone Fire-Control System with an EO Director, Ballistics Prediction and Interface of one Naval Gun and an Operator Console for controlling any in-service naval gun,” from 30–76mm (Terma 2012g, 1). The C-Fire EO system can provide gun fire control for as many as three gun mounts and provide firing solutions for AAW, SUW, and naval gunfire support missions (Terma 2012a). The C-Fire system is designed to be fully integrated with the F-Flex command and control (C2) system and can be operated from any of the C-Flex Operator Consoles (Terma 2012a). Additionally, the C-Fire EO system offers add on options to the existing product. These options include software modules such as a surveillance software for the C-Flex system (Terma 2012f, 2). Figure 8 depicts the integrated system architecture of the COMPACT All Weather Gun Control System, the COMPACT EO Gun Control System follows the same configuration.



Figure 8. COMPACT All Weather Gun Control System.
Source: Terma (2012f).

The C-Link Naval Link System provides tactical data link capabilities that is supported by and integrated as an application within the C-Flex command and control system. C-Link can be used on different platforms, including ships, fixed and rotary wing aircraft, and land based applications to support various missions. C-Link supports the NATO tactical data links (TDLs) including, Link-11, Link-16, Link-22, and JREAP C. For non-NATO nations, Terma offers its own TDL as part of the C-Link system, called Link T (Terma 2012c). Link T is “based on the NATO Link 16 data model and protected by advanced commercial SW [software] encryption” (Terma 2012h, 1). Figure 9 depicts the system architecture of the COMPACT Link T Data Link System integrated into the C-series product line.

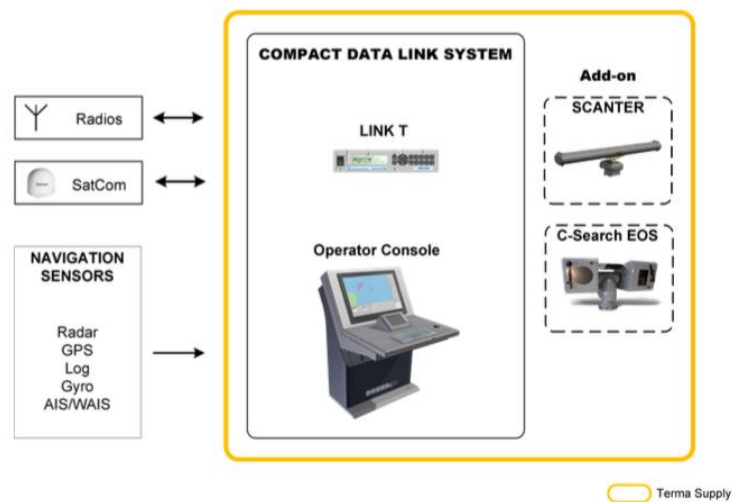

Figure 9. COMPACT Link T Data Link System.
Source: Terma (2012h).

The C-Sim Naval Simulation is a Naval Tactical Simulator (NTS) based on COTS products that fully integrates with the C-Flex command and control system. C-Sim creates a virtual battle space with “simulated entities and live tracks, radar emissions, IFF, AIS, TDL, communication, and environmental conditions” (Terma 2012e). This allows for realistic operator training on ownship and shore based facilities utilizing the C-series

combat system products. The training can be scaled from a single ship, single console configuration, up to multi ship, 20+ console configurations (Terma 2012e).

The C-Guard Naval Decoy System is a decoy launching system that is designed to counter various missiles and torpedoes. C-Guard's expandable architecture allows it to control from 6 to 24, standard NATO 130mm firing tubes. The system can be controlled locally by touch screen, from the C-Flex command and control system, or other combat management systems that the user chooses to integrate with C-Guard (Terma 2016b).

b. SAAB 9LV

SAAB 9LV is a modular combat systems product line that includes the combat system, combat management system, and fire control system for both surface and subsurface applications (SAAB 2015, 15). The 9LV Mk 3E (enhanced) series was SAAB's first offering of the 9LV combat system utilizing COTS products. The Mk 3E uses COTS flat screen displays, a standard fiber distributed data interface to transmit data on the local area network, and Windows based multi-media interface (MMI) at the operator consoles (Friedman 2006, 91). Software for 9LV "is written in ADA, an object-oriented [programming] language specifically adapted to such modular applications" (Friedman 2006, 92).

1. 9LV100 Mk 3, for small ship or fire control systems with optical sensors
2. 9LV200 Mk 3, for fast attack craft with radar
3. 9LV300 Mk 3, for fast attack craft with optical sensors
4. 9LV400 Mk 3, for larger warships

9LV is currently in the Mk 4 series that has the ability to be scaled for coast guard, military combat boats, patrol vessels, large surface combatants, and submarines. 9LV Mk 4 CMS is fully integrated with the 9LV FCS and can automate threat evaluation, engagement planning, and weapons control. 9LV CMS and FCS provide the ability to conduct multiple missions utilizing various gun configurations and surface to air missiles (SAMs) (SAAB 2015, 8).

Figure 10 depicts the 9LV Mk 4 CMS on a surface combatant with various hardware modules (weapons, sensors, antennas) that can be provided by third parties and integrated into 9LV's open architecture.

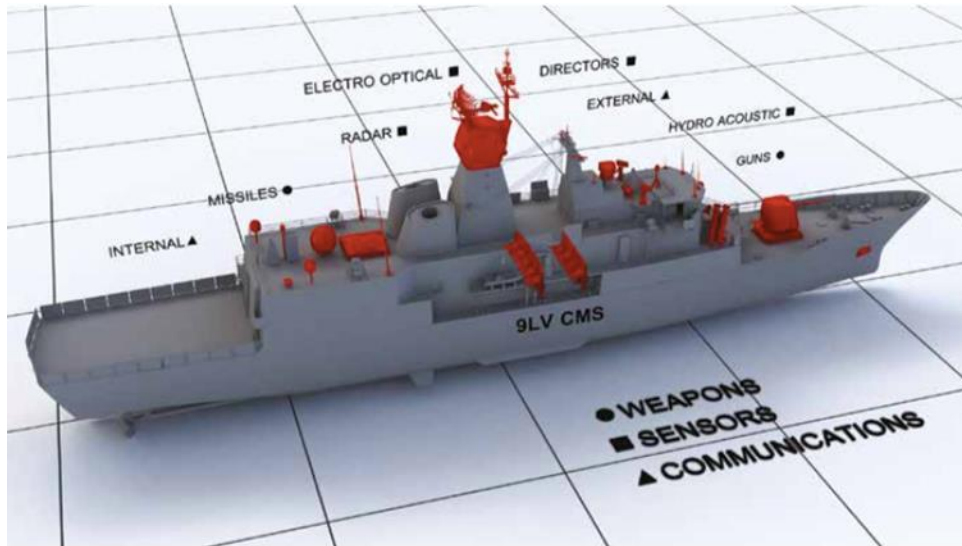

Figure 10. SAAB 9LV CMS Integration. Source: SAAB (2015).

c. Thales TACTICOS

Thales TACTICOS is an integrated, automated, CMS designed for surface combatants that can be implemented across multiple warfare areas. It is a scalable, modular system that includes open architecture and a data distribution service (DDS) system called OpenSplice, which allows the CMS to share real time data to the various applications of the combat system (Thales 2014, 2). TACTICOS runs a single architecture with a common hardware platform to integrate sensor and weapons for various mission requirements. Thales calls these mission requirements “Mission Solutions,” and the missions TACTICOS can perform range from littoral security operations to theater ballistic missile defense. Similar to SAAB, Thales designates products for different mission solutions as follows (Thales 2014, 6):

1. MS-100, for littoral security operations
2. MS-150, for ocean security operations

3. MS-300, for low intensity naval operations
4. MS-400, for medium intensity naval operations
5. MS-500, for high intensity naval operations
6. MS-1000, for high intensity naval operations with theater ballistic missile defense capability

The capabilities for mission solutions MS-300 through MS-1000 are as follows (Thales 2014, 6):

1. MS-300, provides point defense with guns and littoral security
2. MS-400, provides point defense with guns and missiles, point defense with guns, ocean security, and littoral security
3. MS-500, provides wide area defense added to the capabilities of MS-400
4. MS-1000, provides ballistic missile defense added to the capabilities of MS-500

The data distribution service within the networked CMS is a “standards-based [quality of service] QOS-enabled data-centric middleware platform that enables applications to communicate by publishing information they have and subscribing to information they need in a timely manner” (Schmidt, Corsaro, and Hag 2008, 24). DDS allows the information model for the CMS to be properly implemented at the beginning of the system design and it provides the information framework with fault tolerance for each application (Schmidt, Corsaro, and Hag 2008, 28). It is important to note that “DDS has been mandated by the U.S. Navy’s Open Architecture Computing Environment as the standard publish/subscribe technology to use in next-generation combat management systems” (Schmidt, Corsaro, and Hag 2008, 28).

European combat systems from Terma, SAAB, and Thales utilize a different paradigm than U.S. Navy combat systems. The six components of Terma’s C-series combat system suite are modular, designed for interoperability with third party sensors, weapons,

as well as other hardware and software components. The SAAB 9LV combat system is explicitly a product line, with scalable offerings of the same core architecture for various applications. Thales TACTICOS follows a similar design framework to 9LV and includes scalable combat system platforms for different applications based on the amount of functionality and features needed for a specific platform.

D. SUMMARY

Navy combat systems are systems of subsystems, or system of systems (SOS), that perform various functions to facilitate mission tasks and accomplishment. The architecture of a combat system must allow for interoperability between all subsystems. An understanding of system architecture and open architecture is required to decompose the means of subsystem interoperability to perform the combat system mission tasks. Describing the components and functions of the various combat system offerings from both the U.S. and Europe provides insight into combat system design.

Aegis was designed as a complete combat system. Its functional architecture allows for upgrades as technology advances. This upgradability has been proven with the introduction of Mk-41 VLS, SPY radar upgrades, modern COTS computer integration, BMD capabilities, and increased functionality via baseline improvements. SSDS Mk 1 was designed as a collection of existing weapons and sensor systems including RAM, CWIS, AN/SPS-67 and AN/SPS-49 radars, and AN/SLQ-32 ECM. These existing hardware platforms were integrated as subsystems into the SSDS Mk 1 via software package, with capabilities limited by the existing weapons and sensor systems. SSDS Mk 2 further evolved the Mk 1 system by integrating existing weapons and sensors with increased capability. NSSMS and SPS-48 radar allowed for greater detect and engagement ranges. CEC provided Mk 2 the ability to detect and engage targets from other platforms such as DDGs with greater combat systems capability. Also, Mk 2's introduction of C and C++ open source software signaled a trend towards open architecture concepts within combat systems design. COMBATTS's scalable, modular, open architecture utilizes all of these concepts yet is not a true engineering product line. The European combat systems offerings including the C-series, 9LV, and TACTICOS are true engineering product lines. These

products offer scalable, modular, open architecture explicitly designed for various missions and platforms.

Future U.S. Navy combat systems would improve several ways with a focus on product line engineering. The product line's common, core set of features that are managed to meet the needs of a mission make the product line concept an excellent fit for the system of systems that is a combat system. Developing the products and core software once, with the plan to reuse it multiple times, on different applications, needs to be a design philosophy that occurs from the earliest stage of future combat system design. The future result of implementing product line engineering in combat system design is greater engineering productivity, faster development time, better quality products, and reduced cost.

THIS PAGE INTENTIONALLY LEFT BLANK

III. METHODOLOGY AND APPROACH

Development of the combat system product line architecture utilized Hatley–Pirbhai and orthogonal variability model modeling techniques to capture variability points within the combat system that define the product line. The scope of the proposed product line includes products for surface ship-based combat system scaled to three tiers as shown in Figure 11. The first tier includes a SUW capability designed for a small surface combatant, on the order of magnitude of a patrol type vessel, with the potential for fully unmanned capabilities focused on ISR. The second tier is designed around a cruise missile defense capability that could be employed on a future frigate (FFGX), amphibious assault ship, and aircraft carrier (CVN) platforms. The third includes theater ballistic missile defense and cruise missile defense capabilities, designed to facilitate the needs of a future guided missile destroyer (DDGX) and guided missile cruiser (CGX). Each tier of the product line captures the detect, control, engage paradigm.

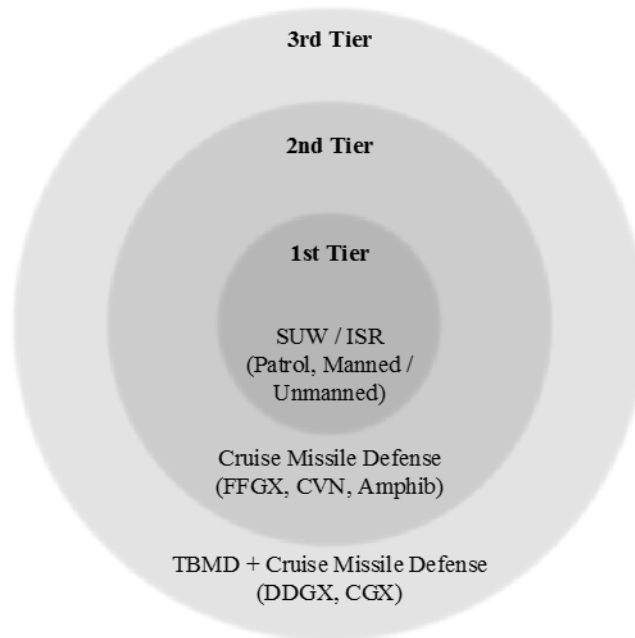

Figure 11. Combat System Product Line Three Tier Nested Relationship

The System COPLIMO is applied as a method of conducting product line life-cycle cost estimations. It includes “a product line development cost model and an annualized post-development life cycle extended at the system level (Boehm, Barry, et al., 2004, 1)” with defined input parameters, algorithms, and outputs. This model helps validate the benefits of creating a combat system product line. Although this analysis is conducted on the proposed combat system product line’s focused mission areas, the same concepts could be applied to incorporate anti-submarine warfare (ASW), electronic warfare (EW), cyber warfare, and other mission areas.

A. SYSTEM ARCHITECTURE

The combat system functional architecture is an adaptation of Horner’s architectural functional model, emphasizing detect, control, and engage paradigm as the primary combat system functions (Horner 1999, 192). The functional architecture was refined using the Aegis top-level functional flow model (Navy 1989). The system functions were further developed with concepts from the FORCENet Open Architecture Warfare System Domain Functional Architecture developed by the CNO Strategic Studies Group and outlined in the “FORCENet Implementation Strategy” (National Academies Press 2005, 128). Each function utilizes open architecture constructs in order to provide the foundation for a combat system product line. The proposed combat system functions are as follows:

1. Sense
2. Coordinate Mission
3. Engage Target
4. Provide Data / Information Services
5. Assess Engagement

In order to develop a combat system product line from the proposed combat system functions, the Hatley-Pirbhai methodology was used to develop a system architecture that can be translated to identify variation points and variability within the architectural model.

The Hatley-Pirbhai methodology utilizes graphical notation to separate the system’s functional and physical attributes into requirements and architectural models. The architecture template, as shown in Figure 12, is utilized to develop data flow diagrams and architecture flow diagrams. This template includes input processing, output processing, main functions or core processing, user interface processing, and support functions. An EDFD shows the functional boundaries and interfaces of the system. System functions or “processes” are represented as labeled circles and the arrows connecting the functions show data flow. Parallel lines divide the model into stores that represent the functional boundaries between the different functions. Each function converts data inputs into outputs (Haggerty and Haggerty 2015).

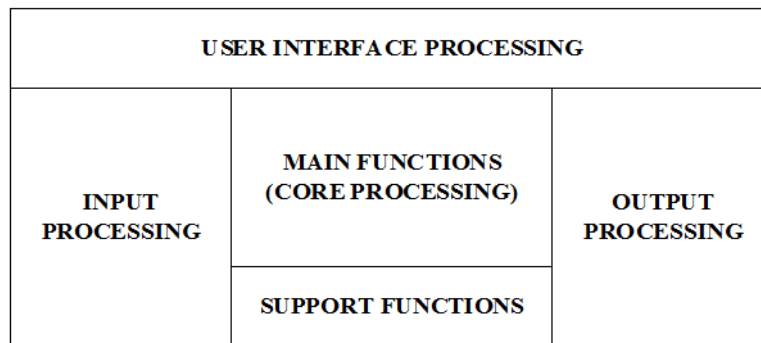

Figure 12. The Architecture Template. Adapted from Hatley, Hruschka, and Pirbhai (2000).

The EDFD provides the functionality to partition the system into physical entities represented in the AFD. The physical entities, also known as architecture modules can be systems, subsystems, or components of the physical system. Arrows indicate information transfer between physical entities and the functional boundaries are represented in the same manner as the EDFD. Further decomposition of the AFD results in component allocation to the architecture modules (Haggerty and Haggerty 2015). For the purpose of this thesis, component allocation includes two levels of the physical hierarchy. The top-level physical components are derived from the top-level system functions and the second level system physical components are decompositions of the top-level components. Top-level

components are numbered from 1.0 to N.0, second level components are numbered from N.1 to N.n, third-level components are numbered N.n.1 to N.n.n, and so on. The hierarchy numbering convention continues in the same manner for lower levels. The top-level component 1.0, decomposed into the second level is shown in Figure 13, adapted from Blanchard and Fabrycky (Blanchard and Fabrycky 2011, 87).

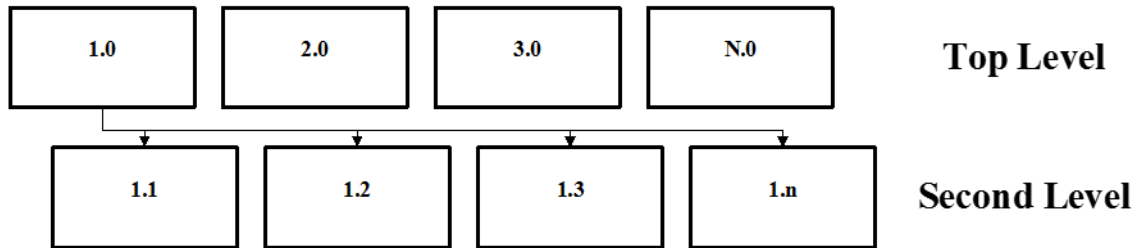

Figure 13. System Physical Hierarchy Numbering Convention

B. SYSTEM VARIABILITY

The combat system functional and physical architectures provide the construct for identifying variability subjects within the combat system. Variability subjects are variable items within the system architecture. These variability subjects correspond with the variation points within the product line. The variation points each have different variants that are a representation of a variability subject. There are three steps necessary to create valid variation points and variants for the product line. The first step is to identify the variability subjects as discussed above. The second step is to define the variation point based on the real world variability helped determined by the system architecture. This variation point definition indicates that the product line has to support different types of variants, without explicitly stating each one. The third step is to identify variants of the variation point that supplement the information of the variation point.

Variants of any given variation point may change over time based on advances in technology or fiscal environments, however, variation points usually remain constant throughout the life cycle of the system. Variability is modeled into the product line to allow

for customization by reuse of predefined objects, either functional or physical (Pohl, Böckle, and van der Linden 2005, 63–64).

An OVM uses graphic notation to display the variability within a product line. The two classes within the OVM are the variation point and variant. Variability dependencies show the association between the variation point and variant classes. Variation points offers certain variants that must follow the following associative conditions:

1. Each variation point must be associated with at least one variant.
2. Each variant must be associated with at least one variation point.
3. A variation point can offer more than one variant.
4. A variant can be associated with different variation points (Pohl, Böckle, and van der Linden 2005, 76).

The conditions above are explicitly stated in Pohl, Böckle, and van der Linden's *Software Product Line Engineering, Foundations, Principles, and Techniques*. Once variation points are defined as textual requirements, variants are assigned to them as textual requirements. Variability constraints are added to the OVM, which describe the relationships between different variants and variation points. These relationships, known as constraint dependencies, allow for the modeling of variants and variation points either requiring or excluding each other in the OVM. Each variant for a given variation point is shown as an alternative choice which takes a minimum and maximum value based on the number of variants for its associated variation point (Pohl, Böckle, and van der Linden 2005, 82).

Graphic notation for displaying variability within the proposed combat system architecture employ the Halmans and Pohl notation as shown in Figure 14. Developing OVMs for the system combine various aspects of this notation to show variability, relationships, dependencies, and constraints. Complex variability models can use grouping or packaging in the form of packaged variants to show relationships between variation points and variants. A packaged variant serves as a variation point that has associated constraint dependencies. This helps reduce OVM complexity in systems such as combat

systems, with numerous variation points and associated variants. When developed properly, OVMs provide a clear and concise method of communicating product lines to the customer (Pohl, Böckle, and van der Linden 2005, 87–88).

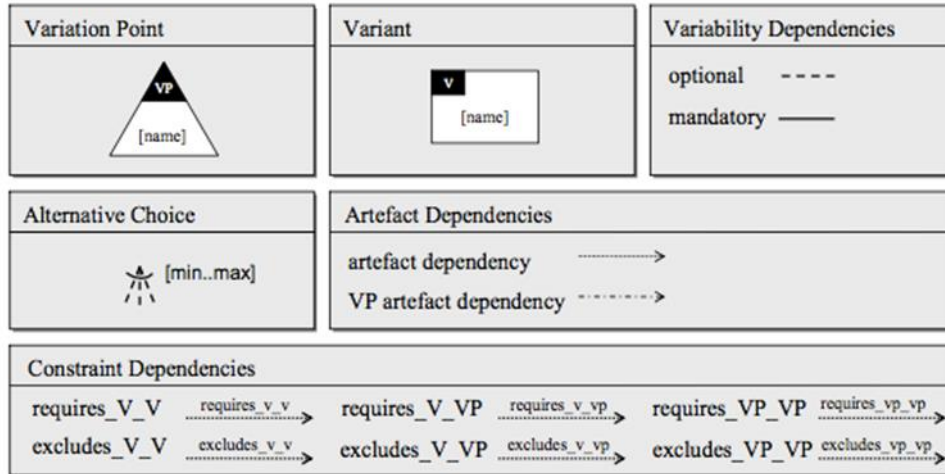

Figure 14. Orthogonal Variability Model Graphical Notation. Source: Pohl, Böckle, and van der Linden (2005, 82).

C. SYSTEM MODELING TECHNIQUE

1. Combat System Enhanced Data Flow Diagram

The EDFD in Figure 15 was developed from the proposed combat system functions discussed earlier in this chapter. Hatley-Pirbhai modeling techniques and the architecture template provide a framework for the detect, control, engage paradigm that describes the overarching behavior of the combat system. The ovals labeled 1.0 Sense, 2.0 Coordinate Mission, 3.0 Engage Target, 4.0 Provide Data / Information Services, and 5.0 Assess Engagement are the five combat system functions. The arrows show the flow of data between functions as well as between the combat system and the external environment.

Each individual contact (C_1 through C_n) external to the combat system, enters the system via the Sense function. The Sense function transmits signals to the external environment and receives a signal internal to the combat system if a contact is detected. This occurs in the input processing partition of the architecture template. Contact data from

the Sense function flows to the Coordinate Mission and Provide Data / Information Services functions.

The Coordinate Mission function is within the core processing area of the architecture template as it also receives tactical data from the Provide Data / Information Services function, a target engaged verification from the Engage Target function, as well as a kill assessment from the Assess Engagement function. Additionally, the Coordinate Mission function provides target classification and weapons scheduling data to the Engage Target function.

The output processing partition of the architecture template houses the Engage Target function and the Assess Engagement function. Weapons link data is provided by the Engage Target function to the individual kills (K_1 through K_n), external to the combat system. Similar to the Sense function, the Assess Engagement function transmits and receives signals to the individual kills to provide a kill assessment or determine if the target needs to be re-engaged.

The Provide Data / Information Services function resides within the support functions area of the architecture template. In addition to receiving contact data from the Sense function, it transmits and receives track data to external entities and provides tactical data to the Coordinate Mission Function. The human system interface (HSI) encompasses all areas of the detect, control, engage paradigm and is part of the user interface processing in the architecture template.

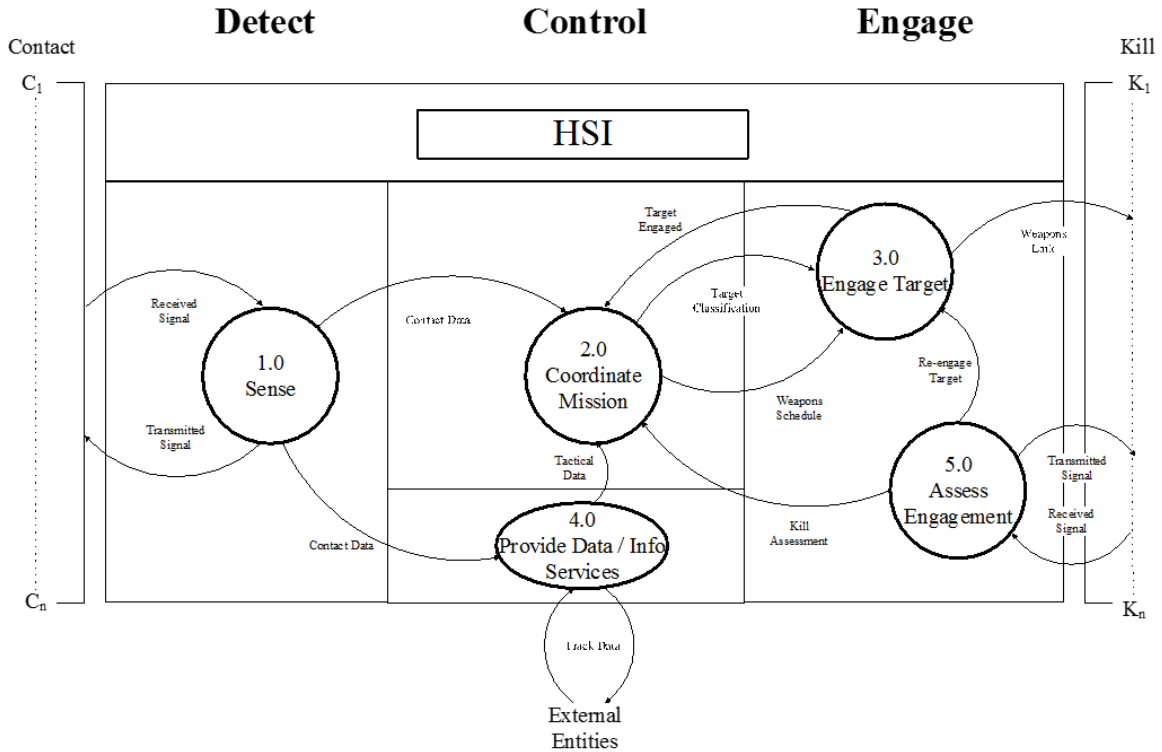

Figure 15. Combat System Enhanced Data Flow Diagram

Each function is a black box that converts data inputs into outputs. The EDFD shows the data flows between functional boundaries and system interfaces. Developing the EDFD allows for assigning physical entities to the model to create the architectural flow diagram which is used to determine variability within the combat system.

2. Combat System Architectural Flow Diagram

The Hatley-Pirbhai AFD in Figure 16 is an evolution of the EDFD with physical entities, or architecture modules, describing the combat system as opposed to system functions. Functional boundaries on the AFD are maintained utilizing the same architecture template used for the EDFD. Arrows between architecture modules in the AFD indicate data transfer.

The AFD follows the detect, control, engage paradigm that is the central theme of the proposed combat system. Contacts (C_1 through C_n) are detected via transmitted and received signals from the sensors module, this occurs in the input processing area of the

architecture template. These received signals are transformed into contact data, which is sent to the system bus / network. The combat system receives remote track data and remote engagement orders (REOs) from non-organic sensors and force-planning assets through the data links module. This data is in turn transferred to the system bus / network. Both data links and the network bus reside in the support functions section of the architecture template.

The output from the bus / network is track data, which inputs to the command and control system. The command and control system sends target data to consoles and displays as part of the user interface processing area of the architecture template. Additionally, the command and control system provides sensor and weapons control for the sensors and fire control modules. Since the command and control system handles the core processing for the combat system, it occupies the main functions space of the architecture template.

In order to engage a target, the fire control module also receives weapons scheduling data from the consoles and display module. Weapons data is then transferred to the weapons (W_1 through W_n) based on the target engagement. This occurs in the output processing section of the architecture template. Each of the physical entities, functional boundaries, and data transfers, describes the functional combat system developed in the EDFD as a physical combat system in the AFD.

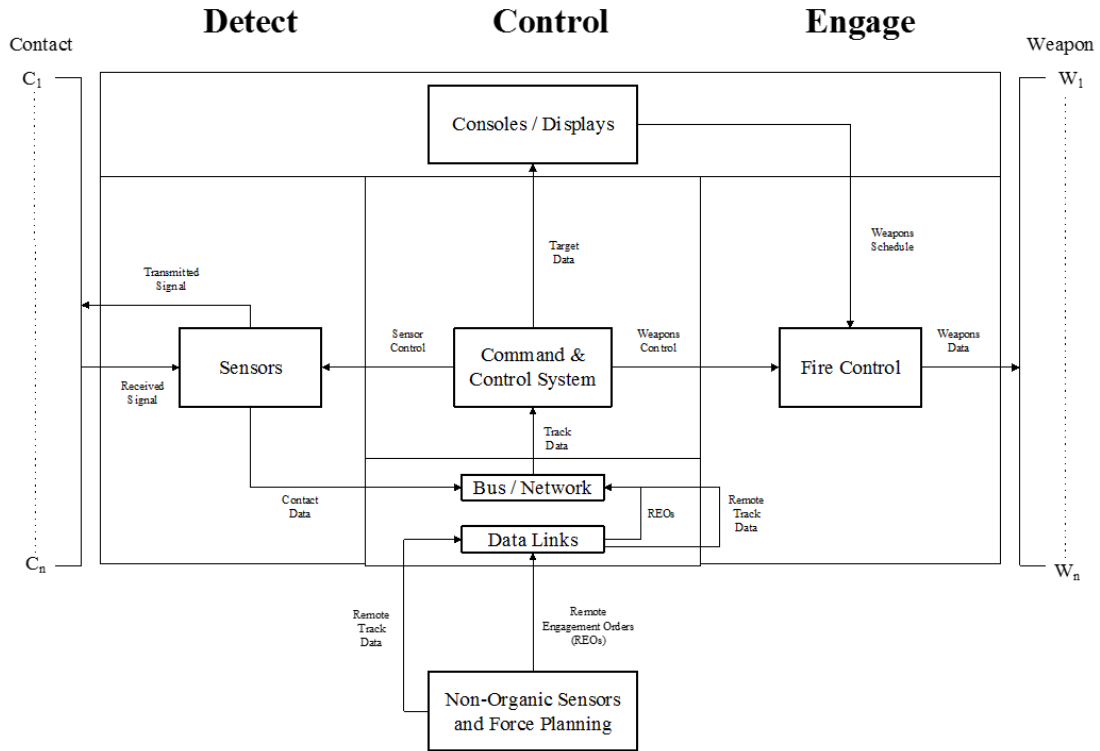

Figure 16. Combat System Architectural Flow Diagram

3. Variation Points and Textual Requirements

Through analyzing the functional and physical constructs of the EDFD and AFD, four variation points were identified for further decomposition and component allocation. The next step towards developing orthogonal variability models for the combat system is to derive variability textual requirements for the following variation points:

1. Sensors (VP)
2. HSI / Console (VP)
3. Weapons (VP)
4. Data Links (VP)

Components, and subsequently variants, are allocated to the variation points with explicit textual requirements that allow for greater accuracy in developing orthogonal variability models. The variation points provide the top-level components and the variants

provide the second level components in the physical hierarchy. The textual requirements for the four variation points are listed in Tables 1 through 4.

Table 1. Sensors Variation Point Textual Requirements

Variation Point	The sensors shall have the ability to...
Variant	...conduct volume air search and tracking...
Variant	...and conduct surface search and tracking...
Variant	...and search / track in the electro-optical / infrared spectrum...
Variant	...and provide high-resolution imagery for identification and targeting...
Variant	...and query manned / unmanned aerial systems...
Variant	...and provide passive electromagnetic (EM) wave detection.

Table 2. HSI / Console Variation Point Textual Requirements

Variation Point	The console / HSI shall be equipped with...
Variant	...either single...
Variant	...or multiple consoles...
Variant	...and single...
Variant	...or multiple displays...
Variant	...and allow for various display sizes.

Table 3. Weapons Variation Point Textual Requirements

Variation Point	The weapons shall have the ability to...
Variant	...target and engage air targets at long range...
Variant	...and target and engage surface targets at long range...
Variant	...and target and engage air / surface targets a short range...
Variant	...and provide long-range naval surface fire support...
Variant	...and provide supportability for future weapons technology...
Variant	...and provide offensive capability in the EM spectrum.

Table 4. Data Links Variation Point Textual Requirements

Variation Point	The data links shall have the ability to...
Variant	...transfer data with assets within line of sight (LOS)...
Variant	...and transfer data with assets beyond LOS...
Variant	...and transfer data via satellite...

4. Allocated Architectural Flow Diagram

Incorporating the variability textual requirements for variation point allocation results in an AFD with allocated components to each variation point. This revised, allocated AFD uses SysML notation for the variation points and associated variants listed below them. The allocated AFD follows the same architecture template and includes the same information transfers between physical entities as the AFD in Figure 17.

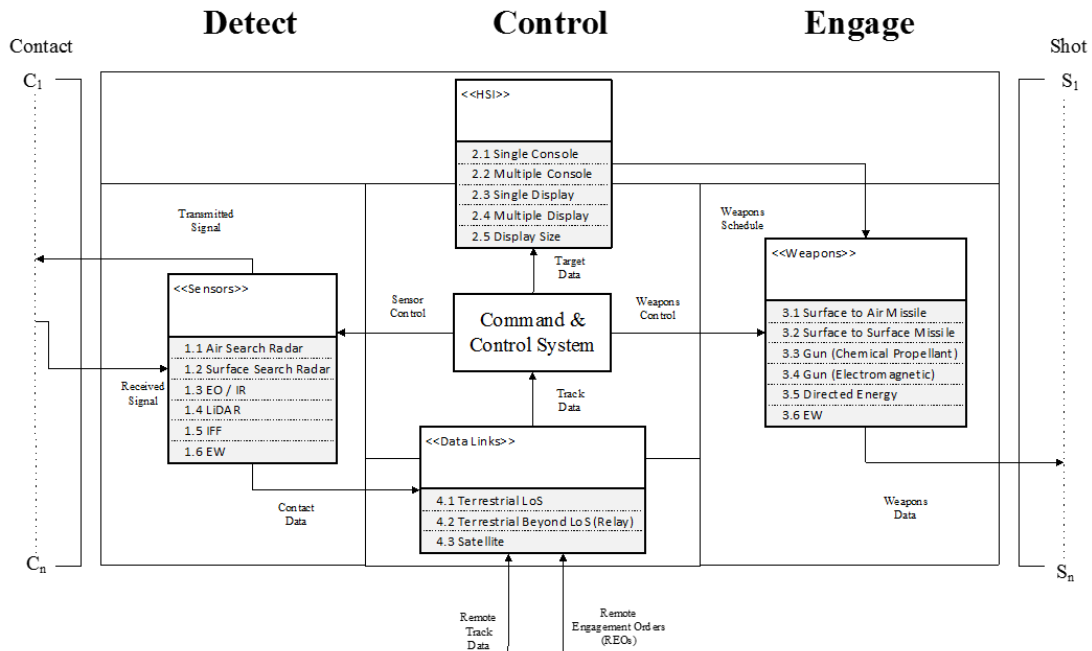

Figure 17. Component Allocation to Architectural Flow Diagram

The variants for the sensors variation point are traced back to the 1.0 Sense function and 5.0 Assess Engagement function in the EDFD. Each variant for the sensors variation point is numbered using the second level components of the physical hierarchy numbering convention discussed earlier in the chapter. The variants include air and surface search radars, which fulfill the textual requirements of having the ability to conduct search / track in the air and surface battle spaces. The electro-optical and infrared integrated sensor provides the search and track capability in the electro-optical-infrared (EO-IR) spectrum. High-resolution imagery is provided organically by a light detection and ranging (LIDAR) sensor and air contact querying services are provided by an IFF antenna. Finally, an electronic warfare subsystem allows the combat system to passively detect EM waves.

The 2.0 Coordinate Mission function is associated with the consoles / HSI variation point. There are five variants for this variation point, which are all concerned with the human system interface to coordinate the mission within the combat system. The variants follow the second level component numbering convention and are unchanged from the variant textual requirements. For example, the variant textual requirement of “or multiple displays” is represented in the allocated AFD as “2.4 Multiple Display” for the consoles / HSI variation point.

The weapons variation point has different weapon variants that relate to the 3.0 Engage Target function. Weapon variants include missiles, both surface to air and surface to surface, which fulfil the textual requirements of engaging air and surface targets at long or short ranges. Engaging air and surface targets at short ranges is satisfied by chemical (conventional) propellant and electromagnetic guns. Additionally, electromagnetic railguns provide the capability to provide long-range naval surface fire support, meeting that textual requirement. Directed energy weapons allow the combat system to coincide with the textual requirement of providing supportability for future weapons technology. Electronic warfare systems that can engage targets actively or passively provide an offensive capability in the EM spectrum.

The 4.0 Provide Data and Information Services function is accomplished via the data links variation point. The variant textual requirements and subsequent variants of “terrestrial, line of sight,” “terrestrial, beyond LOS (Relay),” and “satellite,” were derived

from the Key Navy Communication Systems outlined in Figure 6.1 in the National Academy Press's "C4ISR for Future Naval Strike Groups" (National Academy Press 2006, 152). The data transfer textual requirements and numbering convention correspond with the three variants for the data links variation point.

5. Orthogonal Variability Models

Developing the enhanced data flow diagram and architectural flow diagram provides the process to identify variation points within the combat system. Allocating components in the architectural flow diagram via variation point textual requirements ensures the associated variants can be traced back to the AFD and EDFD architectures. OVMs are necessary for modeling the variation points, their associated variants, packaged variants, alternative choices, and dependencies. This forms the construct of the combat system engineering product line. All OVMs utilize Halmans and Pohl notation for each of following variation points identified in the variability textual requirements and associated allocated AFD.

OVMs for each of the four variation points show the alternative choices of variants as well as variability dependencies. The variants utilized in the product line are determined by the packaged combat system variant (SUW / IRS, cruise missile defense, or TBMD + cruise missile defense) chosen by the customer. Each of the four variation points and the packaged combat system variants are combined to produce the product line OVM. This product line OVM details constraint dependencies for variants and variation points. It provides a common model for determining which variation points and variants are required for each packaged variant constituting the combat system product line.

The OVM for the sensors variation point is shown in Figure 18. This variation point has six alternative choices that are all optional variants. As described previously in Figure 14, the dashed lines between the sensors variation point and each variant represent the "optional" variability dependency. The solid arch denotes each of the variants as an alternative choice for this variation point. These variants were identified from the variation point textual requirements and allocated to the sensors variation point in the allocated AFD. Air search radar, surface search radar, EO-IR, LIDAR, IFF, and EW are all optional

variants for the sensors variation point. These variants supply the capability for the 1.0 Sense and 5.0 Assess Engagement functions of the combat system. The variants also allow for a common interface for the sensors variation point in the product line.

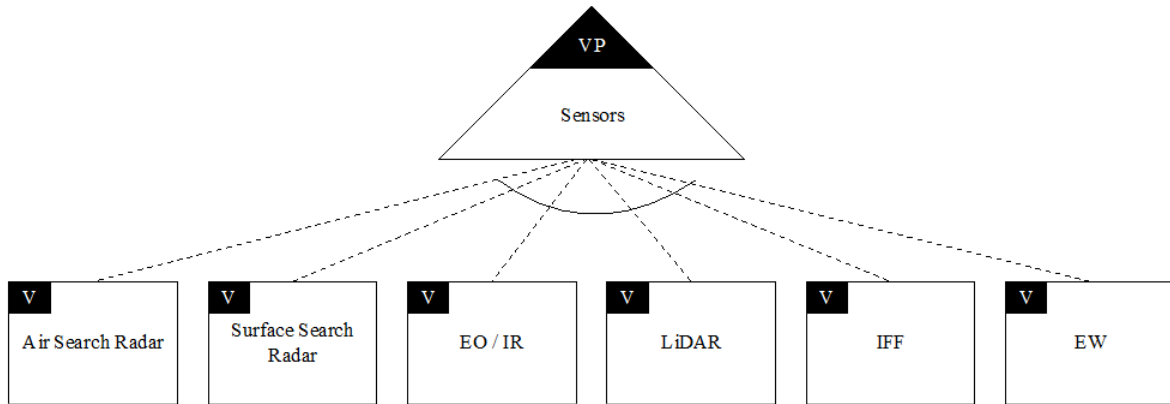

Figure 18. Sensors Variation Point Orthogonal Variability Model

The HSI / consoles variation point offers five optional variants as alternative choices that are focused on the consoles and displays for the combat system. The number of consoles and displays depend on the tier of combat system represented as a packaged variant. These dependencies are described later in the combat system product line OVM. Figure 19 shows the optional variability dependencies amongst alternative choices for the HSI / consoles variation point and its variants. This variation point is mapped to the 2.0 Coordinate Mission NS the variants were generated from the variation point textual requirements. The variants allow for numerous configurations based on the combat system tier chosen.

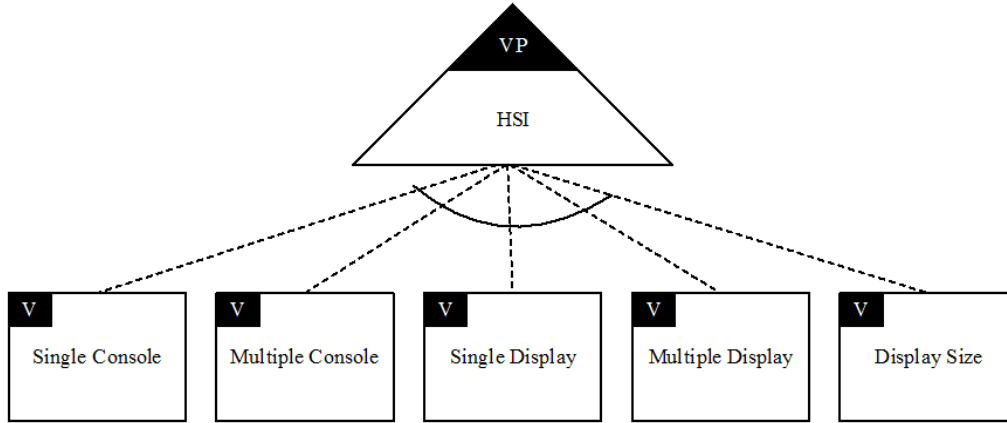

Figure 19. Weapons Variation Point Orthogonal Variability Model

The variants for the weapons variation point in Figure 20 are directly related to the combat system's ability to perform the 3.0 Engage function. All of the alternative choices are optional variants; however, constraint dependencies in the product line variant determine which variants to use based on the required warfare area capabilities for each of the three combat system tiers. These warfare area capabilities are associated with the variation point textual requirements. Surface warfare engagement capabilities differ from theater ballistic missile defense and cruise missile defense capabilities. Furthermore, additional variants provide the flexibility to incorporate future weapons such as electromagnetic guns and directed energy weapons. Constraint dependencies for the combat system tiers in relation to the weapons variation point are discussed in greater detail in the product line OVM description.

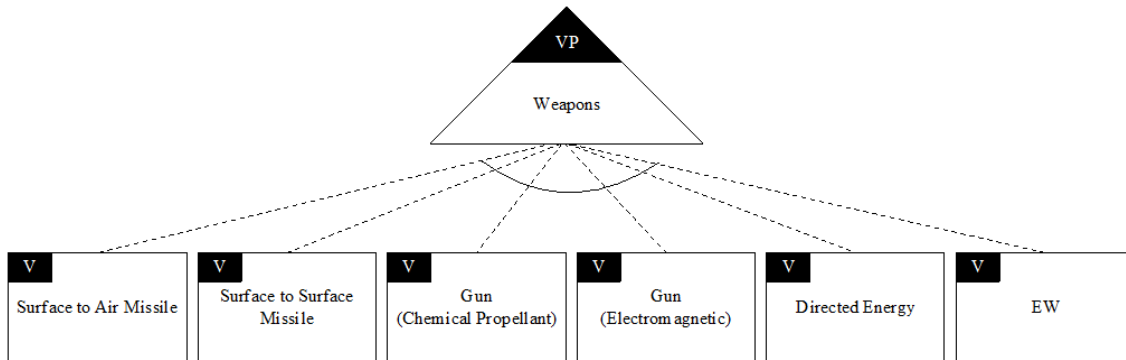

Figure 20. Weapons Variation Point Orthogonal Variability Model

The data links variation point and its three associated variants relate to function 4.0 Provide Data / Information Services. Transmitting and receiving data, external of the combat system, requires wireless data transfer. These data link variants are optional variants, as shown in Figure 21; however, they are required through constraint dependencies for each of the three combat system tiers. The capability line of sight, beyond line of sight, and satellite data links provide what is required for the “control” action of the detect, control, engage paradigm represented in this combat system model.

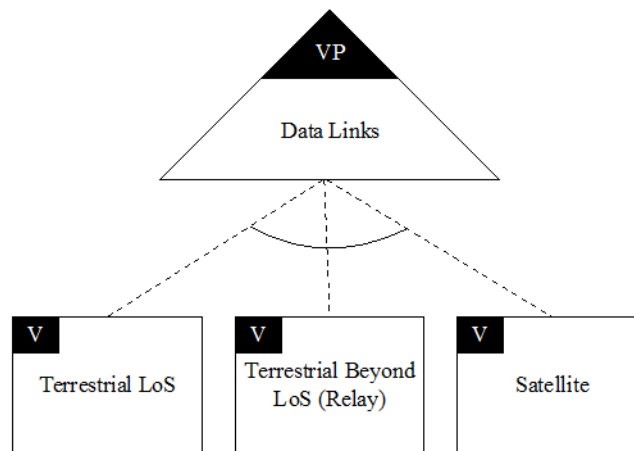

Figure 21. Data Links Variation Point Orthogonal Variability Model

The product line orthogonal variability model, Figure 22, describes the three tiers of combat systems that are being proposed for the product line. This OVM introduces the concept of packaged variants to reduce complexity of the model when representing each of the tiers. The variation point of “Combat System Package” includes three variants, SUW / ISR (1st tier), cruise missile defense (2nd tier), and TBMD + cruise missile defense (3rd tier). These variants are all optional, packaged variants that can be chosen based on the customer’s needs.

Variation points and associated variants for sensors, HSI, weapons, and data links are also included in the product line OVM. These variation points and variants remain unchanged from the individual variation point OVMs detailed previously. In addition to the combat system package variation point and packaged variants, the product line OVM

shows constraint dependencies between variation points and variants. The constraint dependencies follow the same Halmans and Pohl notation presented earlier in Figure 14. The combat system package variation point requires the sensors, HSI, weapons, and data links variation points. The packaged variants require or exclude different variants depending on the capabilities of the combat system tier. These variant requirements and exclusions parallel the detect, control, engage paradigm of the combat system and are discussed below for each of the three tiers.

a. SUW / ISR (1st Tier) Packaged Variant

The proposed SUW / ISR combat system package is intended for small surface combatants that could be manned or unmanned. This packaged variant includes constraint dependencies that require the surface search radar and EO-IR sensor from the sensors variation point. These sensors are necessary to fulfil the SUW and ISR missions that may include engagement of surface targets as well as surveillance of surface targets. Since this packaged variant does not include the ability to engage air targets, constraint dependencies excluding air search radar and IFF are integrated into the OVM. The EW sensor is also excluded from the SUW / ISR packaged variant. LIDAR is an available optional variant, although, it does not have any constraint dependencies.

If the surface ship is to be manned, the SUW / ISR packaged variant requires at least a single console and single display variant, to have the human system interface necessary to control the combat system. Multiple console and multiple display variants are options but not requirements. Display sizes can be selected based on to the customer's needs. Additionally, all data link variants are required for this packaged variant as previously discussed.

The only required variant for the weapons variation point is a chemical propellant gun, which is necessary to engage targets. This packaged variant excludes the surface to air missile variant due to the first tier's intended surface warfare capability. Similarly, the electromagnetic gun, directed energy, and EW system variants are excluded from the SUW / ISR packaged variant. The surface-to-surface missile variant is an optional variant since it has the capability to engage surface targets.

b. Cruise Missile Defense (2nd Tier) Packaged Variant

The 2nd tier of the combat system product line is designed as a system focused on cruise missile defense capability. It is defined by the cruise missile defense packaged variant and its constraint dependencies. The cruise missile defense packaged variant is envisioned for use on future guided missile frigate (FFGX), aircraft carrier (CVN), and amphibious assault ships. Each of the required variants is focused on the cruise missile defense mission. The 2nd tier packaged variant has constraint dependencies that require both air search and surface search radars, necessary to detect and engage targets. There is also an EW variant required, part of the sensors and weapons variation point, for detecting electromagnetic waves, as well as providing offensive capability in the EM spectrum. The required IFF variant is needed to assist with hostile, friendly, or unknown determination of a target. EO-IR and LIDAR variants are optional sensors but are not required for the cruise missile defense packaged variant.

Due to the complexity and scale of cruise missile defense scenarios, the human system interface for this packaged variant requires multiple consoles and multiple displays. Single consoles and single displays are options for the HSI variation point, allowing for greater customization. As with the 1st tier packaged variant, display size is selected based on the customer's needs and all three data links are required variants.

The cruise missile defense packaged variant requires surface to air missiles in order to engage targets. Surface to surface missiles, chemical propellant and electromagnetic guns, and directed energy weapons are all optional variants that can be added to this packaged variant; however, they are not required. Focused constraint dependencies allow each packaged variant to have the necessary components required for the proposed mission capability. The additional optional variants without constraint dependencies allow for mass customization for specific combat system applications.

c. Theater Ballistic Missile Defense + Cruise Missile Defense (3rd Tier) Packaged Variant

The addition of theater ballistic missile defense capability to the cruise missile defense packaged variant results in the 3rd tier packaged variant. This packaged variant is

intended for future guided missile destroyer and guide missile cruiser platforms tasked with ballistic missile defense in addition to cruise missile defense missions. Constraint dependencies remain the same, as shown in Figure 22, since the physical components of the product line are similar. For example, the power requirements for the necessary ranges and target resolution for the air search radar may be greater for the TBMD packaged variant (3rd Tier) than the cruise missile defense (2nd Tier) packaged variant. However, this hardware upgrade does not affect the orthogonal variability model because the TBMD packaged variant requires an air search radar, the OVM does not specify the air search radar.

Similarly, the TBMD packaged variant also requires surface to air missiles to engage ballistic targets. The 3rd tier packaged variant surface to air missiles may require different capabilities than the 2nd tier packaged variant missiles, such as greater ranges, kill mechanisms, and probability of kill (P_k) requirements. Again, the hardware capabilities do not affect the constraint dependencies in the product line OVM. The OVM and constraint dependencies show the required variants for the 3rd tier packaged variant which happen to be the same constraint dependencies as the 2nd tier packaged variant.

The product line approach to combat system design is facilitated with the product line orthogonal variability model. The OVM construct with packaged variants, variation point, and variant constraint dependencies provides a method of developing different products with different capabilities. It allows for variant options within the packaged variants themselves. This results in the ability to create a combat system product line from variation points and variants while ensuring integrity of the design due to the underlying system architecture.

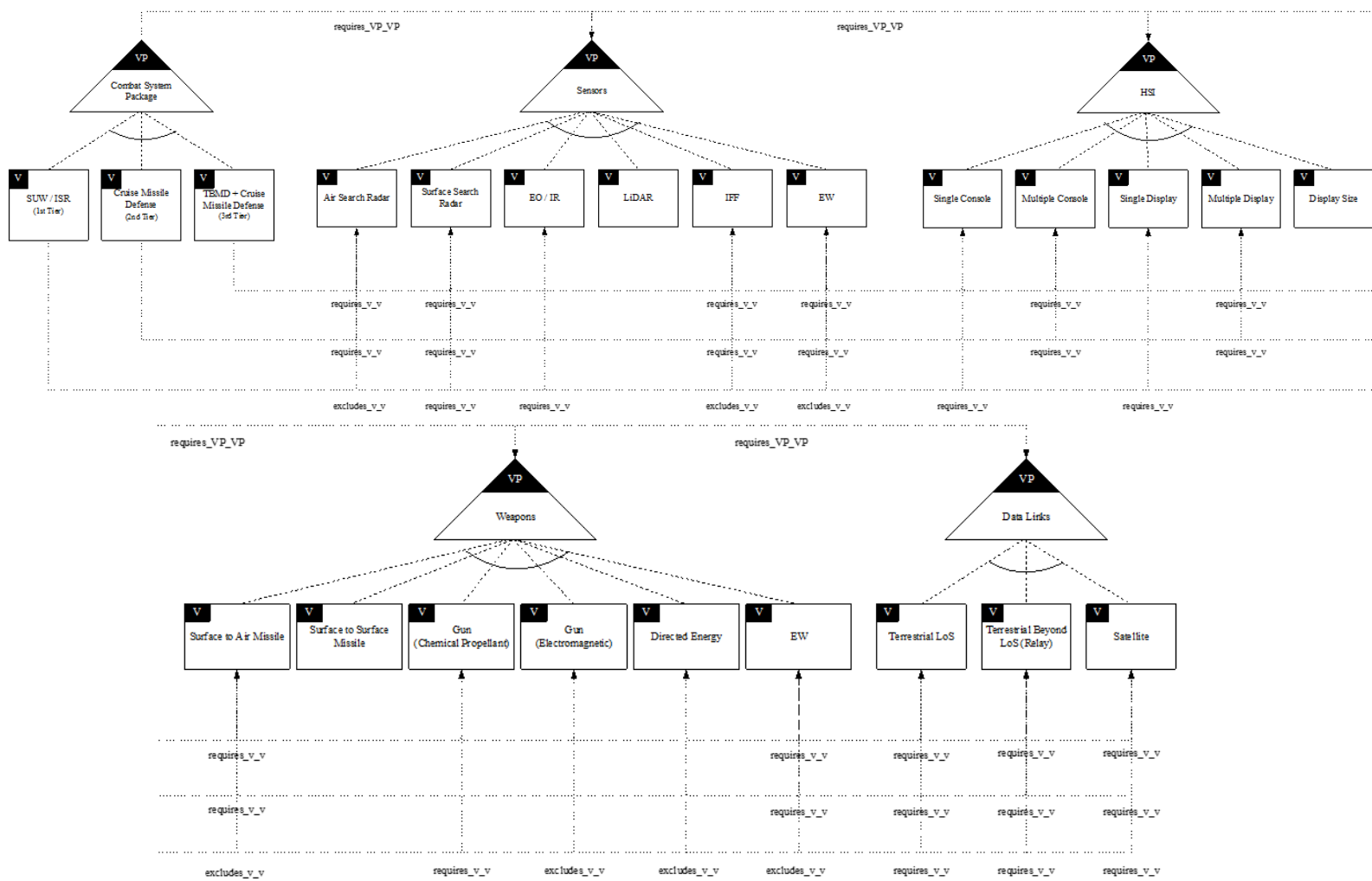

Figure 22. Combat System Product Line Orthogonal Variability Model

D. ANALYSIS

1. System Constructive Product Line Investment Model

The system level Constructive Product Line Investment Model utilizes parametric model inputs related to engineering product lines for various system types. The outputs of the model describe the life cycle savings of product reuse and return on investment. Originally, standard COPLIMO was a detailed model for software product lines to quantify the benefit of reusing source computer code (Boehm, Barry, et al., 2004, 8). It was also extended for software quality as a quality-base constructive product line investment model (qCOPLIMO) (Hoh, Peter, et al. 2006, 86). The software model was later modified for systems-level product lines on the System Engineering Research Center (SERC) Valuing Flexibility research (SERC RT18, 2012). Detailed inputs for software were replaced by aggregate factors for both hardware and software subsystems (SERC RT18, 2012). COPLIMO was demonstrated for representative DoD system types using empirical system maintenance data (Boehm, Lane, and Madachy 2011, 4). That demonstration model was further generalized as System COPLIMO and applied in this research.

Inputs for the System COPLIMO include:

1. System Costs
2. Product Line Percentages
3. Relative Cost of Reuse Percentages
4. Investment Cost

These inputs will be applied to each of the three, combat system product line packaged variants (proposed combat system tiers). System costs are defined by four parametric inputs, average product development cost, ownership time, annual change cost (percentage of development cost), and annual interest rate. The SUW / ISR (1st Tier), cruise missile defense (2nd Tier), and TBMD + cruise missile defense (3rd Tier) packaged variants each have estimated average product development costs. These estimated costs are based on current combat system average unit costs with similar capabilities to the three

tiers proposed by the author. The 1st Tier cost is \$10 million per system, the 2nd Tier is \$147 million per system based on FY17 Aegis Weapon System cost data, and the 3rd tier is \$322 million per system based on FY17 Aegis Weapon System and FY17 Advanced Missile Defense Radar (AMDR) cost data (Department of Defense Fiscal Year (FY) 2017 President’s Budget Submission 2016, 127–138).

For the purposes of this demonstrated cost model, the average unit costs do not include missile or ammunition load outs. Ownership time is defined as 40 years, which is an estimated average service life of a surface combatant, not dependent on system type. Annual change cost is set at 10 percent, which is an estimate required by COPLIMO. Annual interest rate is 2.625 percent (Bureau of the Fiscal Service, U.S. Department of the Treasury 2018) in accordance with the Department of Defense Financial Management Regulation (Department of Defense Financial Management Regulation 2018, 119).

Product line percentages for the three packaged variants were determined using countable system components (variants), identified from Figure 22, that are mission unique, adapted, or reused across products. For the purpose of System COPLIMO, the packaged variants are parametric inputs. The 20 total variants are organized by variation point listed in Table 5 with rationale for their classification of mission unique, adapted, or reused across products.

Table 5. Product Line Variant Classification

Variation Point: Sensors		
Product Line Classification	Variant	Rationale
Adapted	Air Search Radar	Power, beam forming, and search / track functions different for 2nd and 3rd tier packaged variants.
Adapted	EW	Power and physical size requirements may be different for 2nd and 3rd tier packaged variants.
Reused	Surface Search Radar	Physical size and capabilities of sensor can be used for 1st, 2nd, and 3rd tier packaged variants.
Reused	EO-IR Sensor	See Surface Search Radar justification.
Reused	LIDAR	See Surface Search Radar justification.
Reused	IFF	Hardware and interfaces are the same for 2nd and 3rd tier packaged variants.

Variation Point: Sensors		
Variation Point: HSI		
Product Line Classification	Variant	Rationale
Reused	Single Console	Consoles common across 1st, 2nd, and 3rd tier packaged variants.
Reused	Multiple Console	See Single Console justification.
Reused	Single Display	Displays common across 1st, 2nd, and 3rd tier packaged variants.
Reused	Multiple Display	See Single Display justification.
Adapted	Display Size	Displays are common but size can be specified by customer.
Variation Point: Data Links		
Product Line Classification	Variant	Rationale
Reused	Terrestrial LOS	Data links standardized across U.S. and NATO platforms, therefore they are also common across 1st, 2nd, and 3rd tier packaged variants.
Reused	Terrestrial Beyond LOS	See Terrestrial LOS justification.
Reused	Satellite	See Terrestrial LOS justification.
Variation Point: Weapons		
Product Line Classification	Variant	Rationale
Mission Unique	Surface to Air Missile	Ranges and kill mechanisms are different for 2nd and 3rd tiers.
Mission Unique	Surface to Surface Missile	Ranges and size of missile different for 1st, 2nd and 3rd tiers based on mission and ship size.
Mission Unique	Gun Electro-Magnetic	Power and size constraints dependent on ship size and cost for 2nd and 3rd tiers.
Mission Unique	Directed Energy Weapon	See Gun, Electro-Magnetic justification.
Adapted	Gun Chemical Propellant	Size and range of gun dependent on ship size and cost for 1st, 2nd, and 3rd tiers.
Adapted	EW	Power and physical size requirements may be different for 2nd and 3rd tier packaged variants.

Tables 6 through 8 provide a summary of the variants mission unique, adapted, and reused in each of the three packaged variants of product line, represented as product line percentage inputs for the System COPLIMO.

Table 6. 1st Tier Packaged Variant Product Line Percentages

1st Tier Packaged Variant (13 Total Possible Components)		
System Component Type	Count	Product Line Percentage
Reused	10	77 %
Adapted	2	15 %
Mission Unique	1	8 %

Table 7. 2nd Tier Packaged Variant Product Line Percentages

2nd Tier Packaged Variant (20 Total Possible Components)		
System Component Type	Count	Product Line Percentage
Reused	11	55 %
Adapted	5	25 %
Mission Unique	4	20 %

Table 8. 3rd Tier Packaged Variant Product Line Percentages

3rd Tier Packaged Variant (20 Total Possible Components)		
System Component Type	Count	Product Line Percentage
Reused	11	55 %
Adapted	5	25 %
Mission Unique	4	20 %

The relative cost of reuse percentages input field includes percentage costs for both adapted and reused variants. These percentages are 40% for adapted variants and 5% for reused variants, which is consistent with System COPLIMO inputs. The investment cost is the relative cost of developing for product line flexibility via reuse. This value is 1.7, which represents an additional 70% investment effort to develop a product line, as opposed to a

non-product line system (Boehm, Lane, and Madachy 2011, 14). The COPLIMO parametric inputs for the three product line tiers are summarized in Tables 9 through 11.

Table 9. 1st Tier System COPLIMO Input Summary

System COPLIMO Input Summary (1st Tier Packaged Variant)		
Input	Value	Rationale
System Costs		
Average Product Development Cost	\$10M	Estimate
Annual Change Cost (% of Development Cost)	10 %	Estimate
Ownership Time	40 years	DoD Selected Acquisition Report 2015, 48
Interest Rate	2.625 %	Bureau of the Fiscal Service, U.S. Department of the Treasury 2018
Product Line Percentages		
Mission Unique	8 %	From Table 6
Adapted	15 %	From Table 6
Reused	77 %	From Table 6
Relative Cost of Reuse (%)		
Relative Cost of Reuse for Adapted	40 %	COPLIMO default
Relative Cost of Reuse for Reused	5 %	COPLIMO default
Investment Cost		
Relative Cost of Developing for PL Flexibility via Reuse	1.7	COPLIMO default

Table 10. 2nd Tier System COPLIMO Input Summary

System COPLIMO Input Summary (2nd Tier Packaged Variant)		
Input	Value	Rationale
System Costs		
Average Product Development Cost	\$147M	Department of Defense Fiscal Year (FY) 2017 President's Budget Submission 2016, 127-138
Annual Change Cost	10 %	Estimate
Ownership Time	40 years	DoD Selected Acquisition Report 2015, 48
Interest Rate	2.625 %	Bureau of the Fiscal Service, U.S. Department of the Treasury 2018

System COPLIMO Input Summary (2nd Tier Packaged Variant)		
Product Line Percentages		
Mission Unique	20 %	From Table 7
Adapted	25 %	From Table 7
Reused	55 %	From Table 7
Relative Cost of Reuse		
Relative Cost of Reuse for Adapted	40 %	COPLIMO default
Relative Cost of Reuse for Reused	5 %	COPLIMO default
Investment Cost		
Relative Cost of Developing for PL Flexibility via Reuse	1.7	COPLIMO default

Table 11. 3rd Tier System COPLIMO Input Summary

System COPLIMO Input Summary (3rd Tier Packaged Variant)		
Input	Value	Rationale
System Costs		
Average Product Development Cost	\$322M	Department of Defense Fiscal Year (FY) 2017 President's Budget Submission 2016, 127–138
Annual Change Cost	10 %	Estimate
Ownership Time	40 years	DoD Selected Acquisition Report 2015, 48
Interest Rate	2.625 %	Bureau of the Fiscal Service, U.S. Department of the Treasury 2018
Product Line Percentages		
Mission Unique	20 %	From Table 8
Adapted	25 %	From Table 8
Reused	55 %	From Table 8
Relative Cost of Reuse		
Relative Cost of Reuse for Adapted	40 %	COPLIMO default
Relative Cost of Reuse for Reused	5 %	COPLIMO default
Investment Cost		
Relative Cost of Developing for PL Flexibility via Reuse	1.7	COPLIMO default

Outputs for the System COPLIMO include:

1. Development Cost
2. Ownership Cost
3. Cumulative Product Line Cost
4. Product Line Flexibility Investment
5. Product Line Effort Savings
6. Return on Investment

The System COPLIMO tool used in this research was developed by Madachy (Madachy 2018) as an adaption of the system-level product line flexibility tool demonstrated for select DoD domains (SERC RT18, 2012). The parametric input and output values are displayed in Figures 23 through 25 for System COMPLIMO applied to each of the combat system product line packaged variants (three tiers). The return on investment output provides a metric for determining the cost benefit of a product line engineering approach. ROI is defined as the net effort savings (PL Effort Savings), divided by the product line (PL) investment, shown in Equation 1. Initial results using the empirical cost data and COPLIMO defaults for relative cost of reuse and PL development, suggest a strong ROI as the number of products produced increases. All three cases demonstrate the same ROI due to constancy of the relative cost inputs.

$$\text{ROI} = \text{PL Effort Savings} / \text{PL Investment} \quad (1)$$

System COPLIMO

System Costs

Average Product Development Cost (Burdened \$M) Ownership Time (Years)
 Annual Change Cost (% of Development Cost) Interest Rate (Annual %)

Product Line Percentages Relative Costs of Reuse (%)

Unique % Relative Cost of Reuse for Adapted
 Adapted % Relative Cost of Reuse for Reused
 Reused %

Investment Cost

Relative Cost of Developing for PL Flexibility via Reuse

Calculate

Results

# of Products	1	2	3	4	5	6	7
Development Cost (\$M)	\$14.2	\$5.4	\$5.4	\$5.4	\$5.4	\$5.4	\$5.4
Ownership Cost (\$M)	\$56.8	\$21.4	\$21.4	\$21.4	\$21.4	\$21.4	\$21.4
Cum. PL Cost (\$M)	\$71.0	\$97.8	\$124.5	\$151.2	\$178.0	\$204.8	\$231.5
PL Flexibility Investment (\$M)	\$4.2	\$0	\$0	\$0	\$0	\$0	\$0
PL Effort Savings	(\$21.0)	\$2.2	\$25.5	\$48.8	\$72.0	\$95.2	\$118.5
Return on Investment	-5.00	0.54	6.07	11.61	17.14	22.68	28.21

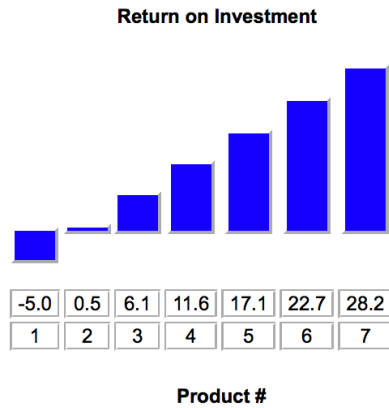

Figure 23. System COPLIMO for SUW / ISR (1st Tier) Packaged Variant. Source: Madachy (2018).

System COPLIMO

System Costs

Average Product Development Cost (Burdened \$M) Ownership Time (Years)
 Annual Change Cost (% of Development Cost) Interest Rate (Annual %)

Product Line Percentages Relative Costs of Reuse (%)

Unique % Relative Cost of Reuse for Adapted
 Adapted % Relative Cost of Reuse for Reused
 Reused %

Investment Cost

Relative Cost of Developing for PL Flexibility via Reuse

Results

# of Products	1	2	3	4	5	6	7
Development Cost (\$M)	\$208.7	\$78.6	\$78.6	\$78.6	\$78.6	\$78.6	\$78.6
Ownership Cost (\$M)	\$835.0	\$314.6	\$314.6	\$314.6	\$314.6	\$314.6	\$314.6
Cum. PL Cost (\$M)	\$1,043.7	\$1,436.9	\$1,830.1	\$2,223.4	\$2,616.6	\$3,009.8	\$3,403.0
PL Flexibility Investment (\$M)	\$61.7	\$0	\$0	\$0	\$0	\$0	\$0
PL Effort Savings	(\$308.7)	\$33.1	\$374.9	\$716.6	\$1,058.4	\$1,400.2	\$1,742.0
Return on Investment	-5.00	0.54	6.07	11.61	17.14	22.68	28.21

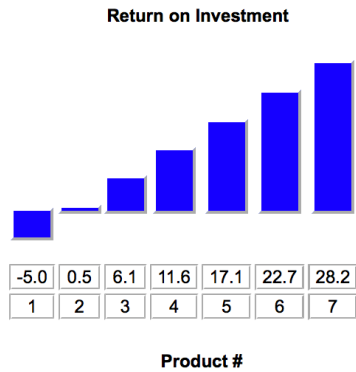

Figure 24. System COPLIMO for Cruise Missile Defense (2nd Tier) Packaged Variant. Source: Madachy (2018).

System COPLIMO

System Costs

Average Product Development Cost (Burdened \$M) Ownership Time (Years)
 Annual Change Cost (% of Development Cost) Interest Rate (Annual %)

Product Line Percentages Relative Costs of Reuse (%)

Unique % Relative Cost of Reuse for Adapted
 Adapted % Relative Cost of Reuse for Reused
 Reused %

Investment Cost

Relative Cost of Developing for PL Flexibility via Reuse

Results

# of Products	1	2	3	4	5	6	7
Development Cost (\$M)	\$457.2	\$172.3	\$172.3	\$172.3	\$172.3	\$172.3	\$172.3
Ownership Cost (\$M)	\$1,829.0	\$689.1	\$689.1	\$689.1	\$689.1	\$689.1	\$689.1
Cum. PL Cost (\$M)	\$2,286.2	\$3,147.5	\$4,008.9	\$4,870.2	\$5,731.6	\$6,593.0	\$7,454.3
PL Flexibility Investment (\$M)	\$135.2	\$0	\$0	\$0	\$0	\$0	\$0
PL Effort Savings	(\$676.2)	\$72.5	\$821.1	\$1,569.8	\$2,318.4	\$3,067.0	\$3,815.7
Return on Investment	-5.00	0.54	6.07	11.61	17.14	22.68	28.21

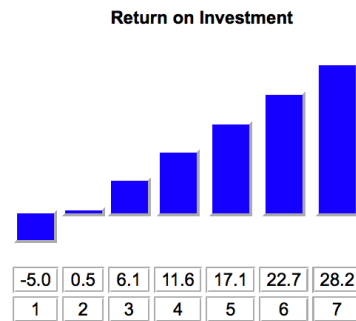

Figure 25. System COPLIMO for TBMD + Cruise Missile Defense (3rd Tier) Packaged Variant. Source: Madachy (2018).

E. SUMMARY

The methodology presented in this chapter provides a high-level structure and arrangement in which future combat system product line design can be modeled after. System design starts with a functional architecture that captures the detect, control, engage paradigm of target engagement in a combat system. This functional architecture is presented as an EDFD. The functional architecture is translated into a physical architecture based on system functions and the physical entities that perform those functions. This physical architecture is presented as an AFD. Hatley–Pirbhai modeling and the associated architecture template offer the necessary entities to display input processing, output processing, main functions or core processing, user interface processing, and support functions within the combat system. Analysis of the EDFD and AFD provides the means for identifying variation points within the combat system.

Once variation points are identified, variation point textual requirements are applied to each variation point. These textual requirements are translated into variants that can be chosen by the customer to mass customize that product line, subject to variant options and constraint dependencies. Additional variation point textual requirements can be added in the future, which allows for new technology insertion into existing combat systems. As technology advances, the product line can adapt to the future combat system needs.

Orthogonal variability modeling provides the means of displaying alternative variant choices as well as constraint dependencies. Generating package variants allows for an efficient method of describing complex variant, variation point, and constraint dependency combinations. Finally, the product line OVM furnishes the variants in a manner that facilitates enumeration of mission unique, adapted, and reused variants necessary for the System COMPLIMO. The cost model provides a trade space for determining initial investment and future return on investment with respect to product line systems versus non-product line systems with associated reuse processes.

IV. CONCLUSION

The disaggregated nature of current U.S. Navy combat systems is not optimal from a technical design nor cost perspective throughout the system's life cycle. Employing a product line engineering approach to future combat system design is beneficial for both the combat system developer as well as the customer. Product line engineering concepts such as building once and the planned reuse of system components, helps the Navy achieve the overarching strategic guidance of the CNO as well as technical guidance from NSWC. The research questions presented in Chapter I are answered:

1. Can Product Line Engineering approaches be used to develop a common system architecture design for future Navy combat systems instead of using unique, platform specific combat system suites?

The literature review in Chapter II discusses the concepts of product line engineering, system architecture, open systems and open architecture. A review of current surface combatant combat systems, both U.S. and European, provides the foundation for functional and physical analysis of combat systems. This review also reinforces the notion that current U.S. Navy combat system suites are ship-class dependent. The Aegis Combat System, Ship Self Defense System, and Component Based Total Ship System were all developed for specific missions and platforms without considering the need for commonality between systems. European combat system from Terma, SAAB, and Thales are reviewed to provide the reader with examples and context of different combat system product lines. These product lines are Terma's C-Series, SAAB's 9LV, and TACTICOS from Thales. Functional analysis of all of the combat systems results in the proposed combat system function of sense, coordinate mission, engage target, provide data / information services, and assess engagement. These functions are used to develop the system architecture in Chapter III utilizing concepts of Open Architecture and Product Line Engineering.

2. What common functional and physical features as part of the architecture would be important aspects of developing a combat systems product line?

Chapter III introduces the methodology, approach, and example for the proposed combat system product line. In order to scope the capabilities of the combat system, three combat system tiers are utilized, SUW / ISR capable (1st Tier), cruise missile defense capable (2nd Tier), and theater ballistic missile defense and cruise missile defense capable (3rd Tier). The system architecture starts with Hatley-Pirbhai modeling and the associated architecture template. An enhanced data flow diagram and related architectural flow diagram describe the functional and physical behavior of the combat system. Each system architecture diagram maintains the detect, control, engage paradigm as the central premise of the combat system architecture, both functional and physical.

The AFD provides the structure for variation point identification necessary for orthogonal variability modeling in the product line construct. Component allocation to the AFD via textual requirements, revise the AFD to represent physical components that provide the variants for each variation point in the product line. Four variations points are identified, sensors, HSI / consoles, weapons, and data links. The variation points and associated variants are presented as OVMs, showing alternative choices for each variation point. The variation point OVMs are consolidated into a product line OVM with the addition of packaged variants for each of the three combat system tiers as well as constraint dependencies. These constraint dependencies demonstrate the feasible combinations of packaged variants, variation points, and variants for the combat system product line.

3. How can a product line strategy economic analysis be conducted utilizing a system level parametric model for cost and return on investment analysis of product options for the combat system?

The System COPLIMO model analysis uses inputs based on actual cost data from current U.S. Navy combat systems with similar capabilities to the three product line tiers to provide a calibrated estimate of ROI, by product , for a product line versus non-product line approach. The orthogonal variability models are used to identify mission-unique, adapted, and reused system components (variants) across products. The System COMPLIMO uses these components' percentages as inputs for the cost model. The cost model results are valid for the case study percentages of unique, adapted, and reused system

components, however different architectures and thus variability models, result in different ROIs and cost savings over time.

A. RECOMMENDATIONS

The isomorphic mapping of software product line engineering concepts to combat system product line engineering results in a systematic methodology that should be followed during the earliest stages of combat system design. By applying the methodology demonstrated in this thesis as shown in Figure 26, future combat system design can identify common architectural components, develop a tailored engineering product line, and conduct product line economic analysis utilizing System COPLIMO.

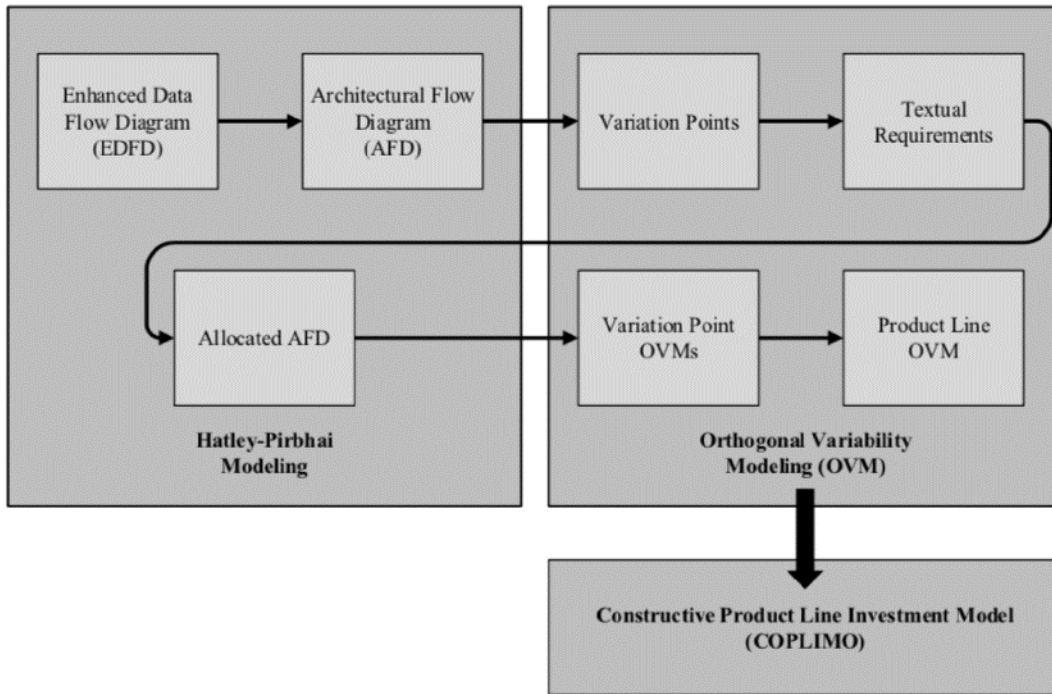

Figure 26. Combat System Product Line Engineering Methodology

Applying the engineering product line methodology to combat system architecture design and development should optimally happen at the earliest stage of design. High-level system architecture design for future U.S. Navy combat systems should focus on the product line, instead of platform specific combat systems. The three combat system tiers

that were proposed were not all-inclusive and should only be used as a means of demonstrating the product line engineering methodology.

B. FUTURE WORK

The scope of combat system design in this thesis was limited to SUW, cruise missile defense, and cruise missile + TBMD. Future work can be conducted to develop engineering product lines for additional warfare areas such as anti-submarine warfare, electronic warfare, cyber warfare, and others. Similar methodology can be applied to combat system design for applications not specific to the Surface Navy, such as integrated air and missile defense (IAMD) systems, ground vehicles, undersea vehicles, and aircraft.

Two levels of decomposition were introduced for the functional and physical architectures of the proposed combat system. This hierarchy can be further decomposed into third and fourth levels to provide greater level of detail at the subsystem level. Subsystem decomposition would provide additional variation points and associated variants that could be included in the orthogonal variability models to deliver more product line options while also exploring new constraint dependencies. These levels of detail also provide greater insight into setting input values for System COPLIMO, with expected greater precision in the results.

Furthermore, the enhanced data flow diagram and architectural flow diagrams can be tested in simulation software, following the detect, control, engage paradigm for different scenarios. Data can be generated from the simulations to validate the proposed system architecture. This can be used for iterative design on the system architecture, which may influence the variation points and variants for the combat system product line. The System COPLIMO analyses would also need to be revised for variation points and variants that were changed due to simulation testing on the system architecture.

LIST OF REFERENCES

- Blanchard, Benjamin S, and Wolter J. Fabrycky. 2011. *Systems Engineering and Analysis: 5th Edition*. Upper Saddle River, NJ: Prentice Hall.
- Boehm, Barry, A. Windsor Brown, Ray Madachy, and Ye Yang. 2004. "A Software Product Line Life Cycle Cost Estimation Model." *Proceedings of the 2004 International Symposium on Empirical Software Engineering*.
- Boehm, Barry, JoAnn Lane, and Ray Madachy. "Total Ownership Cost Models for Valuing System Flexibility." 2011 Conference on Systems Engineering Research, Los Angeles, CA, April 2011.
- Buede, Dennis M. 2009. *The Engineering Design of Systems, Models and Methods: Second Edition*. Hoboken, NJ: John Wiley & Sons, Inc.
- Bureau of the Fiscal Service, U.S. Department of the Treasury. "Prompt Pay Interest Rate History." Accessed April 16, 2018. <https://www.fiscal.treasury.gov/fsservices/gov/pmt/promptPayment/rates.htm>
- Clements, Paul, Susan P. Gregg, Charles Krueger, Jeremy Lanman, Jorge Rivera, Rick Scharadin, James T. Shepherd, and Andrew J. Winkler. 2014. "Second Generation Product Line Engineering Takes Hold in the DoD." *CrossTalk*. January/February: 12–18.
- Department of Defense Financial Management Regulation. "Contractor Debt Collection." Volume 10, Chapter 18. Accessed April 16, 2018. http://comptroller.defense.gov/Portals/45/documents/fmr/archive/10arch/10_18d.pdf
- Department of Defense Fiscal Year (FY) 2017 President's Budget Submission. 2016. "Navy Justification Book Volume 1 of 1 Shipbuilding and Conversion, Navy." Accessed April 17, 2018. http://www.secnave.navy.mil/fmc/fmb/Documents/17pres/SCN_Book.pdf
- DoD Selected Acquisition Report. 2015. "DDG 51 Arleigh Burke Class Guided Missile Destroyer (DDG 51) As of FY 2016 President's Budget Defense Acquisition Management Information Retrieval (DAMIR)." Accessed May 04, 2018. http://www.esd.whs.mil/Portals/54/Documents/FOID/Reading%20Room/Selected_Acquisition_Reports/15-F-0540_DDG_51_SAR_Dec_2014.PDF
- Emch, George F. 1992. "Air Defense for the Fleet." *Johns Hopkins APL Technical Digest* 13 (1): 40–56.
- Friedman, Norman. 2006. *The Naval Institute Guide to World Naval Weapon Systems: Fifth Edition*. Annapolis, MD: Naval Institute Press.

- Guertin, Nicholas, and Paul Clements. "Comparing Acquisition Strategies: Open Architecture versus Product Lines." Program Executive Office Integrated Warfare Systems, Washington, DC, 2010.
- Haggerty, Kip and Leslie Haggerty. 2015. "Introduction to Structured Methods." *H&A Systems Engineering*. Accessed February 12, 2018. http://www.hasys.com/tutorials/se_structured_methods.pdf
- Hatley, Derek, Peter Hruschka, and Imtiaz Pirbhai. 2000. *Process for System Architecture and Requirements Engineering*. New York, NY: Dorset House Publishing.
- Henry, Mark, Michael Iacovelli, and Jeffrey Thatcher. 2009. "DDG 1000 Engineering Control System (ECS)." In ASNE Intelligent Ship VIII Symposium, 20–21.
- Hoh, Peter In, Jongmoon Baik, Sangsoo Kim, Ye Yang, and Barry Boehm. 2006. "A Quality-based Cost Estimation Model for the Product Line Life Cycle." *Communications of the ACM*. 49 (12): 85–88.
- Horner, James D. 1999. "Combat System Architecture." *Naval Surface Warfare Center, Dahlgren Division Technical Digest*.
- Landis, Mark A. 2001. "Overview of the Fire Control Loop Process for Aegis LEAP Intercept." *Johns Hopkins APL Technical Digest*. 22 (4): 436–446.
- Lockheed Martin Corporation. 2010. "COMBATSS-21 Scalable Combat Management System for the World's Navies." Washington, DC: Lockheed Martin Mission Systems & Sensors (MS2).
- . 2017. "Integrating the Aegis Derived COMBATSS-21." Accessed August 7, 2017. <http://www.lockheedmartin.com/us/news/features/2016/160112-mst-integrating-the-aegis-derived-combatss-21-with-the-littoral-combat-ship.html>
- Madachy, Ray. 2018. "System COPLIMO." http://csse.usc.edu/tools/System_COPLIMO
- Maier, Mark W, and Eberhardt Rechtin. 2009. *The Art of Systems Architecting: Third Edition*. Boca Raton, FL: CRC Press.
- Murphy, Alvin, David S. Richardson, and Terence Sheehan. 2013. "The Importance of System-of-Systems Integration." *Leading Edge*, February. Accessed August 9, 2017. http://www.navsea.navy.mil/Portals/103/Documents/NSWC_Dahlgren/LeadingEdge/CSEI/CombSys.pdf.
- National Academies Press. 2006. "C4ISR for Future Naval Strike Groups." Accessed October 16, 2017. <https://www.nap.edu/download/11605>
- . 2005. "FORCEnet Implementation Strategy." Accessed January 15, 2018. <https://www.nap.edu/download/11456>

- Norcutt, Larry S. 2001. "Ship Self Defense System Architecture." *Johns Hopkins APL Technical Digest*. 22 (4): 536–546.
- The Office of the Director, Operational Test and Evaluation. 2011. DOT&E FY2011 Annual Report, Ship Self-Defense.
- . 2012. DOT&E FY2012 Annual Report, Ship Self-Defense.
- The Open Group. 2018. "UNIX Program Overview." Accessed April 10, 2018. <http://www.opengroup.org/subjectareas/platform/unix>
- Pohl, Klaus, Günter Böckle, and Frank van der Linden. 2005. *Software Product Line Engineering, Foundations, Principles, and Techniques*. Berlin Heidelberg, Germany: Springer-Verlag.
- Prengaman, Richard J, Edward C. Wetzlar, and Robert J. Bailey. 2001. "Integrated Ship Defense." *Johns Hopkins APL Technical Digest*. 22 (4): 523–35.
- Richardson, John, ADM USN. Chief of Naval Operations. 2017. "The Future Navy." Accessed January 9, 2018. <http://www.navy.mil/navydata/people/cno/Richardson/Resource/TheFutureNavy.pdf>
- SAAB. 2015. "9LV Combat Management System." SAAB Brochure ver.1: 2–15.
- SERC RT18. 2012. "Valuing Flexibility Phase II." A013 Final Technical Report SERC-2012-TR-10-2.
- Schmidt, Douglas C, Angelo Corsaro, and Hans van't Hag. 2008. "Addressing the Challenges of Tactical Information Management in Net-Centric Systems with DDS." PrismTech Corporation. *CrossTalk, The Journal of Defense Software Engineering*. 24–29.
- Terma. 2012a. "C-Fire EO." Accessed December 4, 2017. <https://www.terma.com/surveillance-mission-systems/naval-solutions/c-fire-eo/>
- . 2012b. "C-Flex Naval C2 System." Accessed December 4, 2017. <https://www.terma.com/surveillance-mission-systems/naval-solutions/c-flex-naval-c2-system/>
- . 2012c. "C-Link Naval Link System." Accessed December 4, 2017. <https://www.terma.com/surveillance-mission-systems/naval-solutions/c-link-naval-link-system/>
- . 2012d. "C-Series – Maritime and Naval Systems Suite." Accessed December 4, 2017. <https://www.terma.com/surveillance-mission-systems/naval-solutions/c-series/>

- . 2012e. “C-Sim Naval Simulation.” Accessed December 5, 2017. <https://www.terma.com/surveillance-mission-systems/naval-solutions/c-sim-naval-simulation/>
- . 2012f. “COMPACT - All-Weather Gun Control.” Two-Pager Defense Naval. Accessed December 4, 2017. https://www.terma.com/media/299439/two-pager_defense_naval_compact_-_all-weather_gun_control_system.pdf
- . 2012g. “COMPACT - Electro-Optical Gun Control.” Two-Pager Defense Naval. Accessed December 4, 2017. https://www.terma.com/media/299442/two-pager_defense_naval_compact_-_electro-optical_gun_control_system.pdf
- . 2012h. “COMPACT - Link T - Data Link System.” Two-Pager Defense Naval. Accessed December 4, 2017. https://www.terma.com/media/299445/two-pager_defense_naval_compact_-_link_t_-_data_link_system.pdf
- . 2012i. “Naval Radar Surveillance.” Accessed December 4, 2017. <https://www.terma.com/surveillance-mission-systems/radar-systems/naval-radar-surveillance/>
- . 2012j. “Naval Solutions.” Accessed December 15, 2017. <https://www.terma.com/surveillance-mission-systems/naval-solutions/>
- . 2016a. “C-Flex Unparalleled situational awareness.” Accessed December 4, 2017. 2–3. https://www.terma.com/media/328417/c-flex_-_a4_-_screen.pdf
- . 2016b. “C-Guard Protecting naval platforms.” Accessed December 5, 2017. 2–3. https://www.terma.com/media/328420/c-guard_-_a4_-_screen.pdf
- Thales. 2014. “TACTICOS - World’s Favourite Combat Management System, The Best Got Better.” Accessed December 15, 2017. 2–6. https://www.thalesgroup.com/sites/default/files/asset/document/thales_tacticos.pdf
- . 2017. “TACTICOS - Combat Management System.” Accessed December 15, 2017. <https://www.thalesgroup.com/en/tacticos-combat-management-system>
- Thomas, Jeffery W, Robert J. Bailey, Wayne D. Stuckey, Jay F. Roulette, Geoffrey L. Silberman, David L. Marable, M. Catherine Kuhns, Jan M. Rizzuto, Jon S. Lindberg, Mark D. Switlick, and Edward B. Allen Jr. 2001. “SSDS Mk 2 Combat System Integration.” *Johns Hopkins APL Technical Digest*. 22 (4): 547–563.
- Threston, Joseph T. 2009. “The Story of AEGIS: The AEGIS Weapon System.” *American Society of Naval Engineers*. 85–108.

Ukrainsky, Orest, and Travis Nix. 1998. "White Paper for: COMBATSS Combat Management System (CMS)." Lockheed Martin, International Business Development. Naval Electronics & Surveillance Systems-Surface Systems. 1–11.

U.S .Navy. 1989. "Navy Specified DDG 51 Superset Combat System Top Level Functional Flow Diagram." Figure 1–2.

Whitely, John E. Jr. 2001. "An Introduction to SSDS Concepts and Development." *Johns Hopkins APL Technical Digest*. 22 (4): 516–522.

THIS PAGE INTENTIONALLY LEFT BLANK

INITIAL DISTRIBUTION LIST

1. Defense Technical Information Center
Ft. Belvoir, Virginia
2. Dudley Knox Library
Naval Postgraduate School
Monterey, California