

ERDC/CERL CR-17-5

Construction Engineering
Research Laboratory



**US Army Corps
of Engineers®**
Engineer Research and
Development Center

ERDC
INNOVATIVE SOLUTIONS
for a safer, better world

DoD Corrosion Prevention and Control (CPC) Program

Modeling the Effect of a Hydrophobic Concrete Admixture on Chloride Ingress

Contractor's Supplemental Report for CPC Project F09-AR05A

Eric Samson and Tiewei Zhang

December 2017

The U.S. Army Engineer Research and Development Center (ERDC) solves the nation's toughest engineering and environmental challenges. ERDC develops innovative solutions in civil and military engineering, geospatial sciences, water resources, and environmental sciences for the Army, the Department of Defense, civilian agencies, and our nation's public good. Find out more at www.erdcl.usace.army.mil.

To search for other technical reports published by ERDC, visit the ERDC online library at <http://acwc.sdp.sirsi.net/client/default>.

Modeling the Effect of a Hydrophobic Concrete Admixture on Chloride Ingress

Contractor's Supplemental Report for CPC Project F09-AR05A

Eric Samson and Tiewei Zhang

SIMCO Technologies, Incorporated
203-1400 Boul. du Parc-Technologique
Québec City, QC G1P 4R7

Final report

Approved for public release; distribution is unlimited.

Prepared for Office of the Secretary of Defense (OUSD(AT&L))
3090 Defense Pentagon
Washington, DC 20301-3090

Under Military Interdepartmental Purchase Request (MIPR) DSAM00261; Purchase
Order W9132T-SIM-001, "Modeling the Effect of Damp-Proofing Admixtures on
Chloride Ingress"

Monitored by Construction Engineering Research Laboratory
U.S. Army Engineer Research and Development Center
Champaign, IL 61822

Abstract

This study investigated the effects on concrete transport properties provided by a commercial hydrophobic admixture called Hycrete, and used the results in a proprietary reactive transport model called STADIUM®. This model, incorporated into Unified Facilities Guide Specification 03 31 29 (Marine Concrete), supports a performance-based approach for estimating the service life of a concrete-based system in a marine environment. The researchers developed specific laboratory modules to characterize the moisture and chloride transport properties of mixtures with and without Hycrete to serve as input parameters for estimating the service life of structures.

Tests were performed on three different concrete mixtures, each prepared with 0 (reference case), 1, and 2 gal/yd³ of admixture. One test series indicated that Hycrete has no effect on compressive strength and total pore volume or, in most cases, diffusion coefficients. Moisture-transport tests showed that the admixture mildly reduced drying rates and clearly reduced water-absorption rates.

With the data implemented in STADIUM it was possible to reproduce the measured chloride profiles in samples exposed to wetting/drying cycles in sodium chloride solutions. The modeling results showed that a mixture prepared with Hycrete and exposed to exposure cycles exhibits a lower chloride-ingress rate, reasonably replicating the experimental observations.

DISCLAIMER: The contents of this report are not to be used for advertising, publication, or promotional purposes. Citation of trade names does not constitute an official endorsement or approval of the use of such commercial products. All product names and trademarks cited are the property of their respective owners. The findings of this report are not to be construed as an official Department of the Army position unless so designated by other authorized documents.

DESTROY THIS REPORT WHEN NO LONGER NEEDED. DO NOT RETURN IT TO THE ORIGINATOR.

Foreword

From FY09 to FY10, ERDC-CERL performed or supervised several studies on a hydrophobic concrete admixture to explore its characteristics, its effects on concrete to which it was added, and its ability to reduce moisture penetration as a way to mitigate the corrosion of reinforcement bars. SIMCO Technologies, Inc., was subcontracted by Mandaree Enterprise Corporation (MEC) of Warner Robins, GA, to investigate the effect of the damproofing agent Hycrete^{®*} on the moisture-transport properties of concrete and to incorporate the findings into a reactive-transport model called STADIUM^{®†}.

The first part of the study was an experimental program to gather information on the effect the admixture has on concrete properties. Compressive strength and total pore volume were not affected but the tests associated with moisture transport showed beneficial effects. Using the experimental results, a moisture-transport model developed by SIMCO was modified to account for the admixture. This was achieved by proposing a new relationship to model the relative permeability parameter. This relationship was implemented in the complete STADIUM model.

It was possible to reproduce measured chloride profiles in samples exposed to wetting/drying cycles in sodium chloride solutions. The experimental results showed that a mixture prepared with Hycrete and exposed to exposure cycles exhibits a lower chloride ingress rate. The model results were in line with those experimental observations.

The model was used to simulate the long-term effect of Hycrete in the tidal zone of a marine structure. After 50 years, the model shows that chloride profiles would penetrate much less deeply than in a comparable non-Hycrete[®] mix. The direct consequence is to significantly delay the onset of rebar corrosion, thus positively contributing to the durability of the concrete structure.

* Hycrete is a registered trademark of Hycrete, Inc., Little Falls, New Jersey.

† STADIUM (Software for Transport and Degradation in Unsaturated Materials), a registered trademark of SIMCO Technologies, Inc., Quebec City, Quebec, is a concrete service-life prediction tool.

Other ERDC-CERL research reports have been published about this admixture material:

Michael K. McInerney, Steven C. Sweeney, Orange S. Marshall Jr., and Lawrence Clark. 2017. *Investigation of Hydrophobic Concrete Additive for Seawall Replacement at Pihilaau Army Recreation Center, Hawaii: Final Report on Project F09-AR05A*. ERDC/CERL TR-17-10. Champaign, IL: ERDC-CERL.
<http://dx.doi.org/10.21079/11681/22550>

Steven C. Sweeney. 2017. *Exposure Testing of Hycrete Concrete Additive in a Wastewater Treatment Environment: Final Report on Project F09-AR05B*. ERDC/CERL TR-17-11. Champaign, IL: ERDC-CERL.
<http://dx.doi.org/10.21079/11681/22583>

Lawrence R. Wachowski, Paul G. Tourney, Mathew A. Miltenberger, and Neal S. Berke. 2018. *Hydrophobic Concrete Admixture Product Testing and Validation: Contractor's Supplemental Report for CPC Project F09-AR05A*. ERDC/CERL CR-17-4. Champaign, IL: ERDC-CERL.

Michael K. McInerney, P.E.

Program Coordinator, Corrosion Prevention and Control
ERDC-CERL
Champaign, IL

Preface

This study was conducted for the U.S. Army Engineer Research and Development Center, Construction Engineering Research Laboratory (ERDC-CERL) by SIMCO Technologies, Inc., under Military Interdepartmental Purchase Request (MIPR) DSAM00261; Purchase Order W9132T-SIM-001, “Modeling the Effect of Damproofing Admixtures on Chloride Ingress.” The contractor’s final report has been accepted for publication by the Office of the Secretary of Defense (OSD). The project monitor and CPC Program Coordinator for OSD was Michael K. McInerney, CEERD-CFM.

The work was monitored by the Materials and Structures Branch of the Facilities Division (CEERD-CFM), U.S. Army Engineer Research and Development Center, Construction Engineering Research Laboratory (ERDC-CERL), Champaign, IL. At the time of publication, Vicki L. Van Blaricum was Chief, CEERD-CFM; Donald K. Hicks was Chief, CEERD-CF; and Kurt Kinnevan, CEERD-CZT, was the Technical Director for Adaptive and Resilient Installations. The Interim Deputy Director of ERDC-CERL was Michelle J. Hanson, and the Interim Director was Dr. Kirankumar Topudurti.

The Commander of ERDC was COL Bryan S. Green, and the Director was Dr. David W. Pittman.

[This page intentionally blank.]

Content

1	Executive summary.....	3
2	Introduction	5
3	Materials and mixture design	8
4	Laboratory concrete production and curing	10
5	Experimental procedures.....	12
6	Test results	20
7	Moisture Model Development	39
8	Implementation in a reactive transport model	52
9	Conclusion.....	59
10	References.....	61

APPENDICES

A	Migration test procedure	64
B	Drying Test Procedure	73
C	Complete ASTM C642 Experimental Data.....	83
D	Simulation reports – Migration tests	86
E	Results of drying-absorption cycles and drying at variable R.H.....	114
F	Results of chloride ponding tests	140
G	Statistical analysis results for isotherm tests	151

List of acronyms

- ASTM: American Society for Testing and Materials
- CSA: Canadian Standard Association
- FA: fly ash
- GU: general use (cement)
- ICP-OES: inductively coupled plasma optical emission spectrometry
- OPC: Ordinary Portland cement
- RH: relative humidity
- UFGS: Unified Facilities Guide Specifications
- w/b: water-to-binder ratio
- w/c: water-to-cement ratio

1 Executive summary

SIMCO Technologies inc. (SIMCO) was mandated to investigate the effect of the damproofing agent Hycrete® on the transport properties of concrete material and to incorporate the findings in its proprietary reactive transport model called STADIUM®. STADIUM® is part of the Unified Facilities Guide Specification (UFGS), a performance-based approach for new concrete construction issued by the U.S. Army Corps of Engineers, the Air Force Civil Engineer Support Agency, the National Aeronautics and Space Administration, and the Naval Facilities Engineering Command. In order to test concrete mixture within the UFGS methodology, specific lab modules were developed by SIMCO. The lab modules allow the characterization of the mixtures' transport properties, which are used as input parameters in the model to estimate the service-life of a structure. These tests were part of the present study.

The first part of the study was dedicated to an experimental program aimed at gathering information on the effect this admixture has on different material properties. The tests were performed on three different concrete mixtures, and each mix was prepared with 0 (reference case), 1 and 2 gal/yd³ of admixture.

The results showed that Hycrete® has no effect on some properties. According to the results, compressive strength and total pore volume were not affected by the presence of the product in the mix. In most cases, the same could be said for diffusion coefficients. However, one mixture (0.4 w/c OPC) showed a positive effect of Hycrete®; increasing the amount of admixture contributed to lower the diffusion coefficients for this particular mix. This was confirmed by chloride ponding tests in immersed conditions.

The tests associated with moisture transport showed beneficial effect when Hycrete® was considered. For this test series, the presence of the damproofing agent was shown to mildly affect drying rates but clearly lowered water absorption rates. However, using 2 gal/yd³ of Hycrete® instead of 1 gal/yd³ did not prove more effective. The absorption rates, although clearly much lower than those measured on a comparable reference mixture, were mostly the same for the two dosages. Also, the tests showed slightly reduced drying rates when more Hycrete® was used, thus contributing to keep more humidity in the material. Overall, the beneficial effect of the 2 gal/yd³ over 1 gal/yd³ could not be shown decisively from this experimental program. But the most important conclusion from those tests is that Hycrete®, compared to a material without the admixture, clearly improved the ability of a mixture to repel water and stay dry.

An unusual effect of the admixture was to yield similar drying rates when test specimens were exposed to 50% and 75% relative humidity conditions. In comparison, the reference mixes all behaved as expected: the drying rates were higher for samples exposed to lower RH.

Based on this information, a moisture transport model developed by SIMCO was modified to account for Hycrete®. This was achieved by proposing a new relationship to model the relative permeability parameter:

$$k_r^l = \frac{1}{1 - a + aS^b}$$

with the following set of parameters, depending on the type of mixture:

Type of mixture	a	b
w/o Hycrete®	70	-5
With Hycrete®	1x10 ⁻⁴	-30

Using this new relationship in combination with a lower permeability allowed reproducing the results of drying/wetting experiments.

Being able to reproduce the behavior of a Hycrete® mixture by simply selecting the proper set of parameters in the moisture transport model means that the test procedures in the UFGS methodology could be used to test concrete batched with the admixture. The possibility of specifying the presence of Hycrete® would simply need to be added to the lab modules of STADIUM®.

This relationship was then implemented in the complete STADIUM® model. It was possible to reproduce measured chloride profiles in samples exposed to wetting/drying cycles in sodium chloride solutions. The experimental results showed that a mixture prepared with Hycrete® and exposed to exposure cycles exhibits a lower chloride ingress rate. The model results were in line with those experimental observations.

Finally, the model was used to simulate the long-term effect of Hycrete® in the tidal zone of a marine structure. After 50 years, it was shown that chloride profiles in a mixture incorporating Hycrete® would extend much less deeper than in a comparable reference mix. The direct consequence would be to significantly increase the time needed before rebar corrosion is initiated, thus positively contributing to the durability of the concrete structure.

2 Introduction

2.1 Context

SIMCO Technologies (SIMCO) has been involved over the past decade in the development of STADIUM®, a service-life prediction tool that models the penetration of contaminants such as chlorides and sulfates in concrete structures. STADIUM® is based on a multiionic reactive transport model that takes into account diffusion, moisture transport, temperature variation and chemical reactions occurring inside cementitious materials to assist civil engineers predicting the long-term service-life of structures exposed to various aggressive environments.

Since February 2010, STADIUM® is an integral part of the Unified Facilities Guide Specification (UFGS), a performance-based approach for new concrete construction issued by the U.S. Army Corps of Engineers, the Air Force Civil Engineer Support Agency, the National Aeronautics and Space Administration, and the Naval Facilities Engineering Command. The model is identified as the numerical tool of choice to estimate the service-life of newly-built concrete structures.

In order to test concrete mixture within the UFGS methodology, specific lab modules were developed by SIMCO. The lab modules allow the characterization of the mixtures' transport properties, which are used as input parameters in the model to estimate the service-life of a structure. These tests were part of the present study.

The UFGS emphasize the recent focus on concrete durability and the prediction of structures' service-life. In this context, repair materials and admixtures such as damproofing agents that have the potential to extend concrete's service-life can potentially be integrated in such performance-based approach. However, there is little information available on the impact these products have on service-life and how they can be integrated in a modeling framework.

2.2 Objective

The objective of the project was to investigate the effect of a damproofing agent on the transport properties of concrete material and to incorporate the findings in a moisture transport model coupled with STADIUM®.

The damproofing admixture selected for the project was the Hycrete® X1002, from Hycrete, Inc. The study was divided in three main tasks:

- Collect experimental information on the behavior of concrete prepared with the damproofing agent. The experimental program was designed to allow identifying which and how transport parameters are impacted by the admixture.
- Based on the collected data, develop a moisture transport model that could predict the effect of the admixture on moisture movement in cementitious materials.
- Finally, implement the new moisture model in STADIUM®, to assess the impact of Hycrete® on chloride ingress in structural concrete elements. In this section, long term simulation results are presented.

2.3 Approach

In order to collect data meaningful for model development, an experimental program was first devised to identify the material parameters that most react to the presence of Hycrete®. The tests were performed on three different concrete mixtures, and each mix was prepared with 0 (reference case), 1 and 2 gal/yd³ of admixture. The testing program included the following tests:

- Compressive strength (ASTM C39),
- Porosity (Volume of permeable voids, ASTM C642),
- Migration test,
- Pore solution extraction,
- Drying/Absorption test at 50% and 75% RH,
- Moisture Isotherm at 23°C,
- Chloride ponding, for constant and cyclic exposure conditions.

After identifying which parameters are affected by Hycrete®, they were properly integrated and represented in a moisture transport model. The model is based on the relative humidity state variable and considers the contribution of vapor and liquid water to overall moisture transport.

The moisture transport model was then integrated into STADIUM® so that the effect of Hycrete® on contaminant ingress such as chloride could be taken into account by coupling moisture and ionic transport.

This document is the final report of the study and summarizes all the experimental results and modeling developments.

Part 1 – Experimental Results

3 Materials and mixture design

The cementitious materials used in the experimental program were a CSA Type GU Portland cement and a Class F fly ash (FA). The chemical compositions and physical properties of the materials are shown in Table 1. All concrete mixtures were prepared with 0.8-5 mm fine aggregates and 5-20 mm coarse aggregates (crushed granite). A damproofing agent – Hycrete® X1002 – was incorporated in selected concrete mixtures. An air entraining admixture (Micro Air®) was used for some mixtures to adjust the air content to the target value (5-8%). Superplasticizer (Glenium® 3030NS) was also used in mixtures with w/b ratios lower than 0.5 in order to obtain the desired workability (125-200 mm slump) of fresh concrete.

Table 1 - Chemical compositions and physical properties of binders

Mass Fraction (%)	GU Cement	Fly Ash Class F
CaO	62.8	2.70
SiO ₂	19.9	52.7
Al ₂ O ₃	4.70	26.4
Fe ₂ O ₃	2.80	11.0
SO ₃	2.12	0.65
MgO	2.58	0.94
K ₂ O	0.89	2.23
Na ₂ O	0.28	0.68
TiO ₂	0.19	1.36
P ₂ O ₅	0.23	0.45
Loss on ignition	2.88	2.57
Density (g/cm ³)	3.14	2.50

Three reference concrete mixtures were designed in order to cover a wide range of transport properties and microstructures (Table 2).

Two different dosages of damproofing agent – Hycrete® X1002: 1 gal/yd³ (5 L/m³) and 2 gal/yd³ (10 L/m³) were incorporated in each of the reference mixtures. A total of nine batches were thus prepared including the reference ones. Table 3 summarizes the characteristics of all the nine concrete mixtures produced in the laboratory by SIMCO.

Table 2 - Reference concrete mixture proportions (mass ratio)

Reference Mixes	Coarse Aggregate	Fine Aggregate	Portland Cement	Fly Ash (Class F)	Water/binder ratio
No.1	3	2	1	0	0.40
No.4	3	2	1	0	0.55
No.7	3	2	0.8	0.2	0.45

Table 3 - Proportions of the concrete mixtures and fresh concrete properties

Component	Mixture proportions (kg/m ³)								
	Mix 1	Mix 2	Mix 3	Mix 4	Mix 5	Mix 6	Mix 7	Mix 8	Mix 9
Water/Binder	0.40	0.40	0.40	0.55	0.55	0.55	0.45	0.45	0.45
Cement Type GU	370	370	370	350	350	350	350	350	350
Fly ash Class F	0	0	0	0	0	0	85	85	85
Water*	148	144	140	193	189	185	153	149	145
Fine Aggregate (0.8-5mm)	780	780	780	740	740	740	750	750	750
Coarse Aggregate (5-20mm)	1040	1040	1040	975	975	975	990	990	990
Hycrete (ml/m ³)	0	5000	10000	0	5000	10000	0	5000	10000
Superplasticizer (ml/m ³)	2500	2500	2500	0	0	0	1500	1300	1300
Fresh concrete properties									
Temperature (°C)	22	21	21	21	22	22	22	22	22
Air entrainer (ml/m ³)	25	25	25	175	175	175	50	50	50
Air content (%)	8.0	5.6	5.4	6.6	6.5	7.0	6.4	7.5	5.4
Slump (mm)	170	150	130	140	135	140	190	165	150
Unit weight (kg/m ³)	2328	2340	2325	2273	2272	2271	2286	2285	2284

* The amount of mixing water was adjusted according to the water content of Hycrete® (80%).

4 Laboratory concrete production and curing

The concrete mixtures were prepared by SIMCO in its concrete laboratory (Figure 1). Using an 80-liter pan mixer (Figure 1), the constituents of the mixtures were mixed following the same sequence. The Hycrete® admixture was pre-measured and added into the mixing water. The dry constituents were first mixed for approximately 1 minute for homogenization. Then, the air-entraining admixture was added, followed by the bulk of the mixing water. Finally, the superplasticizer diluted in the remainder of the mixing water was poured in, and the mixing process lasted for 4 more minutes.



Figure 1 - SIMCO Technologies concrete laboratory

Following the mixing sequence, the fresh properties of fresh concrete (temperature, slump, air content and unit weight) were measured, and the results are shown in Table 3.

For each mixture, a full batch (80 liters) of concrete was prepared. Approximately 40 4-in cylindrical specimens ($\text{Ø}100 \text{ mm} \times 200 \text{ mm}$) were cast. After casting, the samples were placed under wet burlaps in the laboratory. Demolding was performed after 24 hours. All concrete specimens were then immersed in saturated limewater for curing until testing (Figure 2).



Figure 2 - Limewater curing tank

5 Experimental procedures

In order to evaluate the transport properties and hydric behavior of the hardened mixtures with and without Hycrete® admixture, various laboratory tests were performed at different curing ages as summarized in Table 4. The procedure of each laboratory tests is described in this section.

Table 4 – Experimental program

Test	Curing duration (days)		
	28	91	365
Compressive strength (ASTM C39)	×	×	×
Porosity (ASTM C642)*	×	×	×
Migration test	×	×	×
Pore solution extraction	×		
Drying/Absorption test at 50% RH	×	×	
Drying/Absorption test at 75% RH	×	×	
Moisture Isotherm at 23°C	×		
Chloride ponding (ASTM C1543)	×		
Chloride ponding – Cyclic	×		

* - Reversed procedure is applied to the Hycrete® mixtures

5.1 Compressive strength

After moist curing in limewater for 28, 91 and 365 days, compressive strength tests were performed on the 4-in. diameter × 8-in. cylinders in accordance with ASTM C39 – *Standard Test Method for Compressive Strength of Cylindrical Concrete Specimens*.

5.2 Porosity measurement (volume of permeable voids)

The total pore volume of the mixtures was measured on the basis of the ASTM C642 procedure - *Standard Test Method for Density, Absorption, and Voids in Hardened Concrete*. The procedure was directly applied to the reference mixtures M1, M4 and M7.

In a previous research work, it had been shown that damproofing admixtures significantly affects the moisture absorption characteristics of concrete. Hycrete® containing concrete in contact with water exhibits weak absorption ability that makes it much more difficult for water to be re-absorbed after drying, compared to a mixture prepared without the agent.

Consequently, the standard test procedure, which requires to oven dry the samples before re-saturation in water, may result in C642 results that give the wrong impression that the admixture has a very low porosity. Therefore, for the Hycrete® containing concrete mixtures (i.e. mixes 2, 3, 5, 6, 8, 9), the reversed procedure was applied. It started with initial saturation and ended with oven drying. Similar to the original procedure, the total pore volume was estimated from the mass difference between the saturated and dried states.

5.3 Pore solution extraction

The extraction procedure consists in applying sufficient pressure on a concrete sample to extract the pore solution from the material. The solution is then analyzed to measure the concentration of the main species: OH⁻, Na⁺, K⁺, and Cl⁻. The composition of the solution can provide information on the mixture chemistry and highlight differences between mixtures. It is also used in this study as an input parameter to migration test analyses and chloride ingress simulations.

For each mixture, one disk, approximately 30 mm thick, was cut from a cylinder cured in limewater. The disc was broken into pieces with a hammer and most of the coarse aggregates were removed before placing the remaining pieces in an extraction cell, as illustrated in Figure 3. A steel cylinder was inserted on top of the cell and the whole setup was placed in a testing machine. Compressive load was then applied.

About 2 ml of solution was extracted from each sample when the applied compressive loading reached about 500,000 lbs. The solution was collected from a drain at the bottom of the setup and flowed into a syringe connected to the collecting hole. Ion concentrations of the pore solution were analyzed shortly after the extraction by different techniques including potentiometric titration (for OH⁻ and Cl⁻ ions), and ICP-OES (for Na⁺ and K⁺ ions). Since a very small volume was extracted, the solution had to be diluted to allow carrying out all the chemical analyses.

5.4 Migration Tests

The objective of the migration test is to determine the tortuosity and diffusion coefficients of concrete. The test is a modified version of the ASTM C1202 procedure: *Standard test method for electrical indication of concrete's ability to resist chloride ion penetration*. The method developed by SIMCO consists in accelerating the ions under an external potential and measuring the electrical current passing through the test specimen over a 10 to 15-day period. The setup is illustrated in Figure 4.

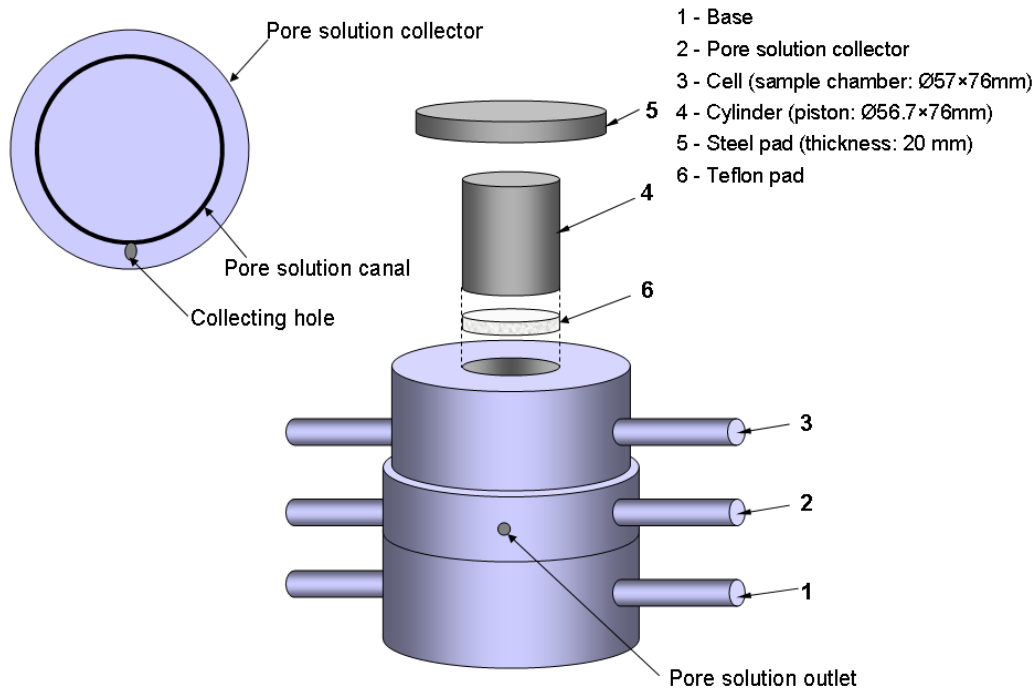

Figure 3- Experimental setup for pore solution extraction

Just before testing, 50-mm specimens were cut from the middle part of 4-in. concrete cylinders. The normal procedure for migration test requires the specimens to be vacuum saturated with 0.3M NaOH solution prior to testing. However, because saturating concrete prepared with damproofing agent is very slow, no vacuum saturation was applied for this project. Tests performed by SIMCO in previous projects have shown that if the material has been cured in moist conditions (e.g. in limewater) prior to testing, such vacuum saturation step is not needed. The specimens used for migration test in this program were cut directly from the concrete cylinders cured in limewater.

Each test series was performed on two samples. The specimens were mounted between two cells filled with 2.7 L of 0.3M NaOH solution. The upstream cell solution also contained 0.5M NaCl salt. A constant DC potential of 20 Volts was applied on each pair of cells by a DC power supply.

During testing, the electrical current passing through each specimen and the voltage across the specimen were measured on a regular basis. Solution in the downstream cell was also sampled to monitor chloride ion moving across the specimen. However, this data was not used in the ionic diffusivity analysis. It may have indicated abnormal behavior such as cracked concrete, in which case tests would have been restarted. This was never the case in this study.

After testing, the measured currents were analyzed with the STADIUM®-IDC laboratory module to evaluate the diffusion coefficients of the ionic species in the migration system. STADIUM®-IDC iteratively tries to find the set of diffusion coefficients that allow reproducing the measured current curves. The analysis uses the porosity, pore solution chemistry and mixture composition parameters as input data. Details on the experimental procedure and analysis are provided in Appendix A (Samson 2008). Migration tests were scheduled at three curing ages: 28, 91 and 365 days as shown in Table 4.

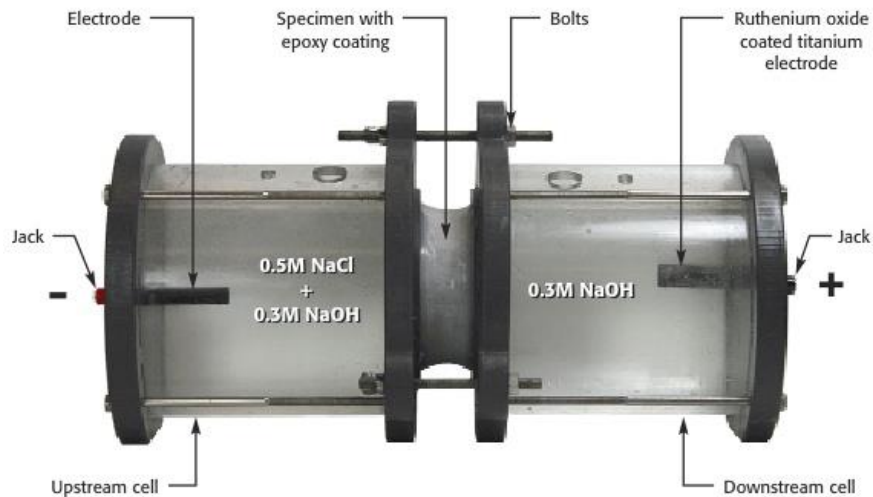

Figure 4 - Migration test setup

5.5 Drying/Absorption Tests

The drying/absorption test consists in exposing concrete samples to constant relative humidity (RH) and temperature conditions and to measure the mass variation over an extended period of time. This provides information on the drying and absorption rate behavior of mixtures. When analyzed in combination with a moisture transport model, the mass variation data can be used to estimate the moisture diffusivity (Samson 2008b).

SIMCO Technologies developed a drying test procedure that is specified in the Unified Facilities Guide Specifications (UFGS) of the US Navy and USACE for the construction of new concrete structures. The procedure is given in Appendix B and is used to determine the permeability of mixtures. The drying/absorption tests performed in this study were based on this procedure, the main difference being that an absorption stage was added after drying, to highlight the impact of Hycrete® on moisture transport.

In the present study, drying tests were carried out on 50 mm disks cut from cylinders. Tests were started after 28 days and 91 days of curing. Each test series used three disk replicates. After cutting, the round surface of each 50 mm specimen was sealed with epoxy in order to

have one dimensional mass transport. After the sealer was applied, the samples were placed back in limewater for one week prior to testing, to ensure that they were initially saturated.

After this, the samples were placed in a drying chamber, as illustrated on Figure 5. The mass of the samples was monitored on a regular basis during testing. The drying tests were performed in two environmental chambers, where constant relative humidities (50% & 75%) and constant temperature (23°C) were maintained. The tests lasted for a minimum of 50 days. Drying on 10-mm samples for moisture isotherm tests (see next section) were performed at the same time in the chambers. The drying portion of the tests was terminated after the mass of the 10-mm series samples reached equilibrium.



Figure 5 – Constant relative humidity chamber (50% RH)

At the end of drying process, the specimens were immersed in water and their mass was monitored regularly over 20+ days. This provided information of the influence of Hycrete® dosage on the absorption rate.

It should be noted that due to laboratory constraints, the absorption part of tests on mixes containing lower Hycrete dosage (i.e. Mixes 2, 5, 8) at 91 days were not all performed. (see Figures 14, 16-18)

5.6 Moisture Isotherm Tests

The objective of the moisture isotherm test is to determine the equilibrium water content (saturation) vs. relative humidity relationship at room temperature (23°C). The test provides the moisture storage capacity of a mixture as a function of RH. This is achieved by placing thin samples in different constant relative humidity environments and waiting until their mass is stable. Knowing the initial mass, final mass, pore volume and volume of samples allow calculating the water content at equilibrium for a given RH.

The isotherm tests were separated in two different series. In the first series, thin 10-mm samples were cut from cylinders cured 28 days and 91 days in limewater and placed in the same drying chambers used for drying tests (Figure 5).

In the second series, climate boxes were used to maintain a constant relative humidity environment. The boxes, illustrated on Figure 6, contained different saturated salt solutions to achieve preset RH. Boxes were maintained at 33%, 85% and 92% RH, using salts recommended by ASTM E104 – *Standard Practice for Maintaining Constant Relative Humidity by Means of Aqueous Solutions*: MgCl₂·6H₂O for 33% RH, KCl for 85% RH and KNO₃ for 92% RH. Electronic hygrometers were placed in the boxes to verify the stability of the environment. When the boxes were ready, 10-mm samples cut from cylinders cured 28 days in limewater were placed inside.

In all cases, three samples replicate were used for each testing conditions¹. The mass of each specimen was monitored by periodically weighing it until constant mass was observed. Then, the saturation level (water content divided by porosity) at each tested RH was determined according to the initial water content (porosity), the volume of the specimen and the cumulative mass loss during testing:

$$S = 1 - \frac{\Delta M}{\rho_w V \phi}$$

where S is the saturation level [-]² at a given RH, ΔM is the mass loss measured for this RH [g], V is the sample volume [cm³], ϕ is the porosity [cm³/cm³] and ρ_w is the water density, taken as a constant value of [1.0 g/cm³]. The volume of each individual thin disk was measured prior to testing by weighting in water and in air.

¹ For the tests performed in the 50% and 75% RH chambers, a total of six samples were dried since two series were carried out: 28 and 91 days of curing.

² [-] indicates dimensionless units.



Figure 6 - Typical climate boxes for moisture isotherm determination

For the three reference mixtures (M1, M4, M7) and the three high-dosage Hycrete® mixtures (2 gal/yd³) (M3, M6, M9), additional equilibrium sequences were tested. For each of these mixtures, two additional series of 10 mm-thick specimens were first dried at two different RH (Condition A): 50% and 75% RH. When equilibrium was reached, they were transferred to different humidity environments (Condition B):

- Drying tests at 50% RH:
 - One series was transferred to a 33% RH climate box,
 - The other series was transferred to the 75 % RH chamber,
- Drying tests at 75% RH:
 - One series transferred to a 85% RH climate box,
 - The other series was transferred to the 50 % RH chamber.

The masses of these specimens were monitored until new equilibrium was established at the new relative humidity. This test series was performed to further investigate the influence of Hycrete® on moisture transport behavior when environment condition (RH) changes. However, the results did not prove conclusive and were not used in the analysis.

5.7 Chloride ponding test

Chloride ponding tests were started on concrete samples after 28 days of curing in limewater following a modified version of ASTM C1543 standard procedure – *Determining the Penetration of Chloride Ion into Concrete by Ponding*.

The test specimens consisted in concrete cylinders cut in half (Figure 7). Both halves were tested. Prior to exposure, the specimens were sealed on all faces except the cut face, which was exposed to the contact solution.

A 3% sodium chloride (NaCl) aqueous solution was used as the ponding solution. Two exposure durations were scheduled: 3 months and 6 months. In order to maintain constant exposure conditions, the ponding solution was renewed on a regular basis.

After each of the scheduled ponding periods, powder samples were extracted by dry milling over small depth increments from the exposed surface of each specimen down to approximately 40 mm in order to obtain chloride penetration profiles. The dry milling and chloride analysis procedures were carried out in accordance with the ASTM C1152/C1152M standard – *Test Method for Acid-Soluble Chloride in Mortar and Concrete*. The chloride concentration was determined by potentiometric titration method using an automatic titrator (T50 model by Mettler-Toledo inc.) with a silver ring IS electrode (DMI-141-SC).

The test program also included a cyclic chloride ponding test. The test procedure was similar to the ponding test mentioned above except that the specimens were exposed to wetting/drying cycles. The same contact solution (i.e. 3% sodium chloride) was used. The exposure cycle consisted in 4 days in the sodium chloride solution followed by 3 days drying in laboratory condition (Note: in the laboratory where cyclic ponding test was performed, constant temperature of $23\pm 2^{\circ}\text{C}$ was maintained, but the relative humidity varied between 30% and 70% during the year). Similar to the first series, sampling and chloride profile analyses were performed after 3 months and 6 months of exposure.

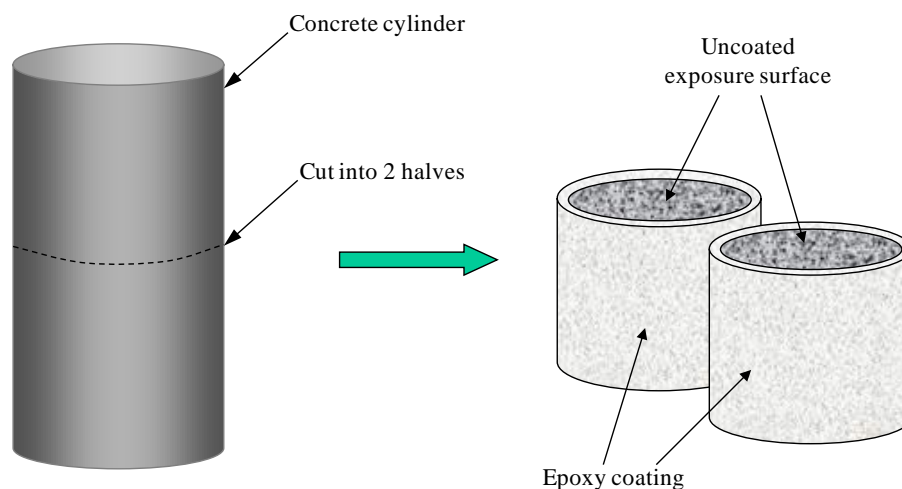

Figure 7 - Preparation of specimens for ponding test

6 Test results

This section presents the test results obtained during the project for the nine concrete mixtures with and without Hycrete® admixture (mixes M1 to M9, Table 3).

6.1 Compressive strength

The results of compressive strength testing are presented in Table 5. Each result is the average of three separate measurements.

Table 5 - Compressive strength testing result

Curing age (days)	Compressive strength (MPa)								
	M1	M2	M3	M4	M5	M6	M7	M8	M9
28	47.5	45.4	45.8	30.7	30.6	30.5	36.6	35.0	32.6
91	47.8	51.3	49.4	31.9	33.9	33.4	39.9	42.5	41.9
365	54.7	56.9	55.8	35.7	37.9	36.7	51.9	49.2	48.0

The results for the reference mixtures (without Hycrete®, M1, M4 and M7) exhibited a normal tendency to improve with curing. As expected, the improvement is more significant for the fly ash mix (0.45 w/b, M7), which started at approximately the same level as the 0.55 w/c OPC mix (M4) but almost got to the same level as the 0.40 w/c OPC concrete (M1) after one year of curing.

To better assess the influence of the Hycrete® admixture, the results are expressed as a ratio to the corresponding reference mixture result in Table 6. Overall, no significant influence on compressive strength can be reported. The only result that stands out is for the fly ash mixture prepared with 2 gal/yd³ of Hycrete® (M9) at 28 days, which is 11% lower than the reference mix. However, the compressive strength measurements on more mature samples did not show any correlation between compressive strength and the presence of Hycrete®.

Table 6 - Compressive strength as a function of the reference mix results

Curing age (days)	$f'_c / f'_{c^{ref}}$								
	M1	M2	M3	M4	M5	M6	M7	M8	M9
28	1.00	0.96	0.96	1.00	1.00	0.99	1.00	0.96	0.89
91	1.00	1.07	1.03	1.00	1.06	1.05	1.00	1.07	1.05
365	1.00	1.04	1.02	1.00	1.06	1.03	1.00	0.96	0.92

6.2 Porosity measurement (volume of permeable voids)

The results of total pore volume measurement are presented in Table 7. Each value in the table is the average of two individual measurements. As mentioned in the previous section, reversed procedure was applied to the Hycrete® containing mixtures (i.e. M2, M3, M5, M6, M8, M9) during porosity measurements. The detailed data from the tests are presented in Table 18, Table 19 and Table 20 (Appendix C).

Table 7 - Porosity measurement results

Curing age (days)	Porosity (%)								
	M1	M2	M3	M4	M5	M6	M7	M8	M9
28	11.9	11.9	12.3	14.3	14.7	14.7	13.6	14.0	13.8
91	11.9	11.9	11.8	13.3	14.4	14.5	13.1	13.9	13.7
365	12.3	12.6	11.3	14.3	14.9	15.1	13.1	14.7	14.3

The results indicated that adding Hycrete® to a mixture does not significantly affect the total pore volume. The only data that stands out was obtained on the 0.55 w/c OPC mix (M4) after 91 days of curing. A statistical analysis of this value compared to the results from the same mix series (M4, M5 and M6) show that it can be considered as an outlier, based on a 95% confidence interval. Consequently, it was not considered in the migration, moisture isotherm and drying test analyses. The previous tests used the average values presented in Table 8 when needed.

Table 8 - Average porosity values

Mix series	Average porosity (%)	COV* (%)
0.40 w/c OPC (M1, M2, M3)	12.0	3.2
0.55 w/c OPC (M4, M5, M6)	14.6	2.1
0.45 w/b + 20% FA (M7, M8, M9)	13.8	3.8

*: Coefficient of Variation (σ/μ)

6.3 Pore solution extraction

Pore solution extraction was performed on each concrete mixture after 28 days of curing in limewater. The results for the pore solution extractions, expressed as ionic concentrations, are shown in Table 9.

Table 9 - Pore solution analysis results

Ionic species	Result series	Concentration (mmol/L)								
		M1	M2	M3	M4	M5	M6	M7	M8	M9
OH-	No charge balance	301.2	349.8	310.1	283.4	243.9	244.6	236.0	241.6	290.6
Na+		91.3	121.8	126.1	87.0	91.3	95.7	82.6	87.0	117.4
K+		204.6	232.8	207.2	184.2	168.8	161.1	150.9	143.2	179.0
Cl-		4.9	4.9	3.2	5.1	4.6	5.0	4.9	4.6	6.2
OH-	Charge balance	296.1	349.8	319.7	274.6	249.5	248.1	232.3	233.5	290.4
Na+		92.8	121.8	122.2	89.7	89.2	94.3	83.9	89.9	117.5
K+		208.1	232.8	200.8	189.9	165.0	158.8	153.3	148.0	179.1
Cl-		4.8	4.9	3.3	4.9	4.7	5.1	4.8	4.4	6.2

Due to experimental errors, the measured concentrations usually are not electrically balanced (positive charges \neq negative charges). To have a neutral solution, the charges were balanced by applying a correction factor proportional to the fraction of the total charge carried by each species. The corrected values are presented in the bottom part of Table 9.

Similar to the porosity measurements, it was not possible to establish a correlation between pore solution composition and Hycrete® dosage.

6.4 Migration Test

Migration tests were scheduled after 28, 91 and 365 days of hydration for each mixture. In all cases, current was measured to be used as the main input parameter of the diffusion coefficient analysis (see Appendix A). The following figures illustrate measured current values for selected migrations tests.

In most cases, the measured currents indicated that there is a very limited, if any, influence of Hycrete® on diffusion. This is illustrated on Figure 8, which shows the current values measured after 28 days and one year of curing on fly ash mixes. The drop in current between the two series is the direct consequence of hydration on diffusivity. This is enhanced by fly ash, which is known to have a significant long-term impact on diffusion. However, for a given curing period, no discernible trend between the reference and Hycrete® mixes can be observed.

The same conclusion applies to the current measurements from the 0.55 w/c OPC mix series (M4, M5 and M6).

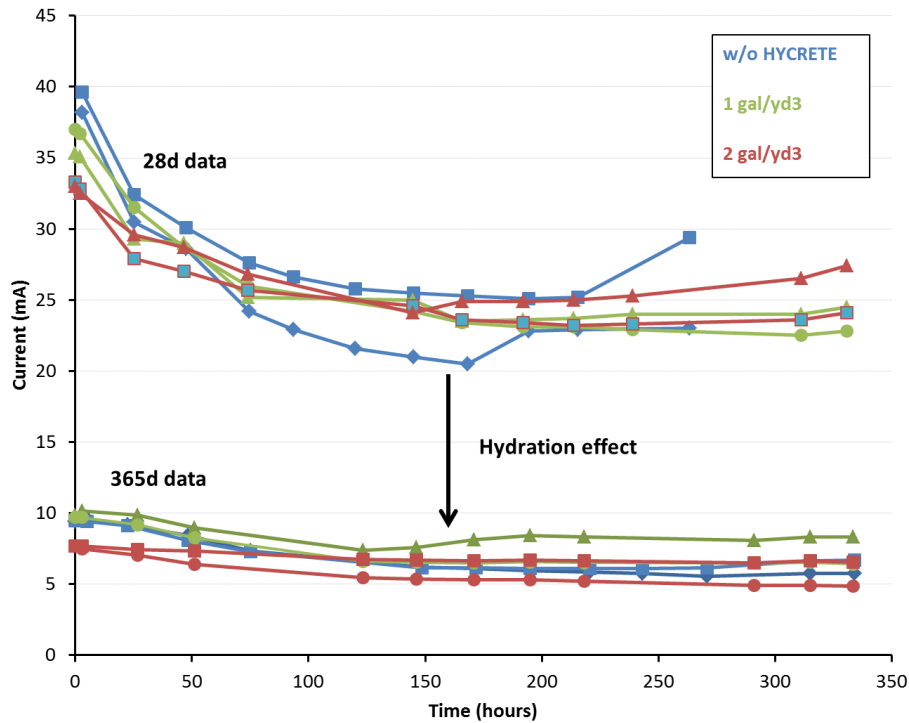

Figure 8 - Current measurements for the 0.45 w/b fly ash mix

However, contrary to the other mixtures, the 0.4 w/c OPC material (M1, M2 and M3) clearly showed that Hycrete® can have a positive effect on diffusion. As illustrated on Figure 9, the currents measured for this mix indicate the positive effect Hycrete® can have on diffusion, as the values decreased with increasing admixture dosage. Although this was observed for only one mixture out of three, there is no denying that Hycrete® played a positive role for diffusion in this case.

Current measurements were analyzed with the STADIUM®-IDC lab module in order to determine the diffusion coefficients. Table 10 summarizes the results of numerical analysis for ionic diffusivity based on the migration test results. Each value is the average of two individual results¹. Details on the analysis methodology are provided in Appendix A. The diffusion coefficient obtained from the IDC module corresponds to the product of the intrinsic tortuosity τ_s times the self-diffusion coefficient D_i^o of species i :

$$D_i = \tau_s D_i^o$$

where the diffusion coefficients are expressed in [m²/s] and the tortuosity is a factor that bears no units.

¹ A statistical analysis similar to the one presented in section 6.2 for porosity is not possible for diffusion coefficients since the values are influenced by numerous factors (e.g. age, presence of fly ash) and change with time.

It is important to note that contrary to the apparent diffusion coefficient commonly measured from chloride profiles fitted with Fick's second law, this diffusion coefficient does not incorporate the hidden effect of chemical reactions or boundary conditions (Marchand 2009). Also, only diffusion coefficients of the hydroxide are presented in the table, as the values for the other species can readily be calculated once the tortuosity and self-diffusion coefficient of a species are known (e.g. reference Li 1974 for self-diffusion coefficients). Full analysis reports from the STADIUM®-IDC module are provided in Appendix D.

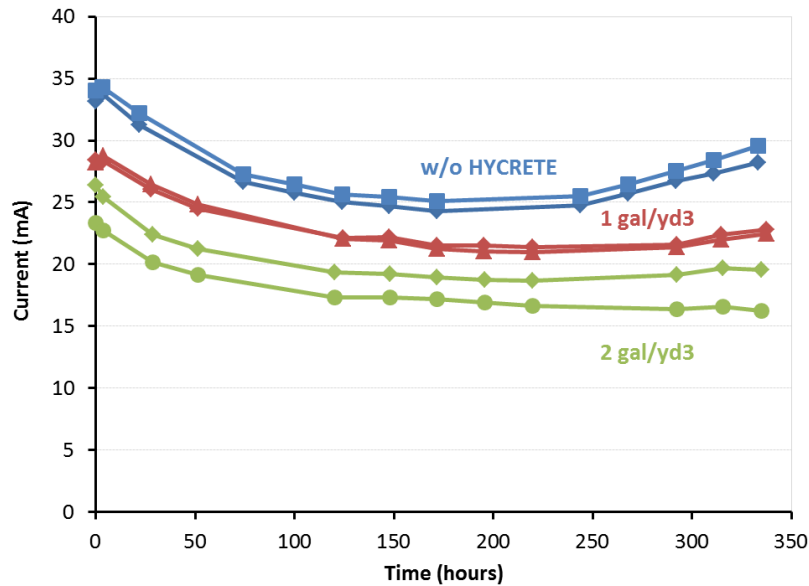

Figure 9 - Current measurements for the 0.40 w/c OPC mix after one year of curing

The reference mixture results are in line with results obtained by SIMCO on similar mixtures in the past. The diffusion values for the 0.55 w/c OPC mix (M4) are higher than those measured on the 0.40 w/c OPC (M1) mix as a consequence of the higher water to cement ratio. For the fly ash mix (M7), the diffusion coefficients are close to the mix M1 values at 28 days but significantly improve over time due to the slow hydration of fly ash. No significant time evolution of diffusion coefficients was observed on M1 and M4 results.

Table 10 - Diffusion coefficient of hydroxide

Curing age (days)	D_{OH} ($E-11 \text{ m}^2/\text{s}$)								
	M1	M2	M3	M4	M5	M6	M7	M8	M9
28	12.06	12.22	9.44	17.56	18.05	15.00	10.40	9.41	10.37
91	11.23	8.37	9.39	20.61	15.30	18.57	5.44	5.92	4.28
365	12.27	9.63	8.62	16.57	17.37	15.62	1.64	2.21	1.77

To better highlight the impact of Hycrete® on diffusion coefficients, the results are expressed in Table 11 as the ratio of the diffusion coefficient over the corresponding reference mix result. The results emphasize what was already observed on the measured currents. For the 0.55 w/c OPC and 0.45 w/b fly ash mixtures, there is no significant correlation between diffusion coefficients and Hycrete®. For those mixtures, it can be concluded that Hycrete® has no effect on diffusion properties.

Table 11 - Diffusion coefficient as a function of the reference mix results

Curing age (days)	D/D _{ref}								
	M1	M2	M3	M4	M5	M6	M7	M8	M9
28	1.00	1.01	0.81	1.00	1.11	0.91	1.00	0.91	1.01
91	1.00	0.75	0.83	1.00	0.76	0.96	1.00	1.15	0.78
365	1.00	0.80	0.65	1.00	1.13	1.00	1.00	1.05	1.08

In the case of the 0.40 w/c OPC mix (M1, M2 and M3) the diffusion coefficients reflect what the current values indicated, i.e. an improvement of diffusion coefficients as the amount of Hycrete® incorporated in the mixture increases. As will be shown later from the ponding tests results, this effect was also observed on chloride profiles.

6.5 Drying/Absorption Tests

The drying/absorption test was designed to highlight the impact of Hycrete® on moisture transport, and the test results did not disappoint. Indeed, this is the test series that most emphasized the beneficial impact that this admixture can have on long-term durability.

The next three figures show the mass variation as a function of time measured on tests started after 28 days of curing and dried at 50% RH. The first portion of the curve corresponds to drying, i.e. a positive mass loss. The sharp variation in the curve after 60+ days of drying indicates the start of water absorption¹.

The most important results concern the effect Hycrete® has when absorption occurs after materials were dried for some time. The drying phase of the test did not reveal much on the effect of Hycrete®, as the drying rate is roughly the same whether the admixture is present or not in the material. However, in all cases, mixtures with Hycrete® exhibited a much slower water absorption rate than the corresponding reference mixture.

Also interesting is the fact that for the 0.4 w/c OPC mix (Figure 10) and 0.45 w/b fly ash mixture (Figure 12), the absorption rate is the same whether 1 gal/yd³ or 2 gal/yd³ are

¹ Some mass variation curves show negative data after some time in absorption. This indicates that samples were not fully saturated initially and had a higher mass than at the start of the test. This was considered in the analysis presented in section 7.3.

admixed. For the 0.55 w/c OPC mix (Figure 11), a difference in absorption rate is observed between the two dosages, the 2 gal/yd³ mix being initially slower to absorb water back in the material. After some time, the absorption rates reach the same value. As indicated in section 5.5 of the report, the absorption tests on the 0.55 w/c OPC mix cured 91 days could not be performed. For the other mixes, the tests started after 91 days of curing replicated this observation, but it was not possible to validate it on the 0.55 mix.

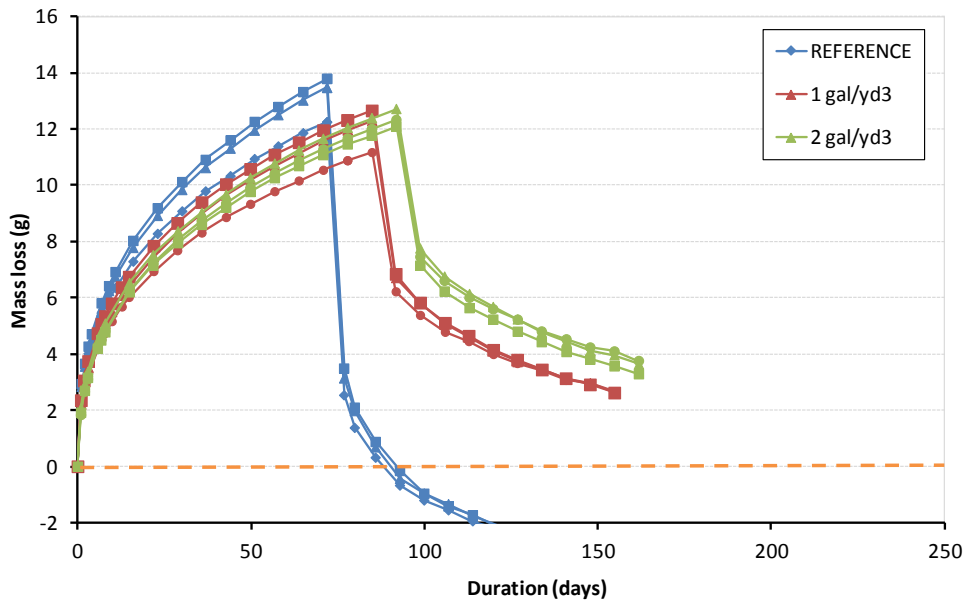

Figure 10 - Drying/absorption of the 0.4 w/c OPC mix cured 28 days and dried at 50% RH

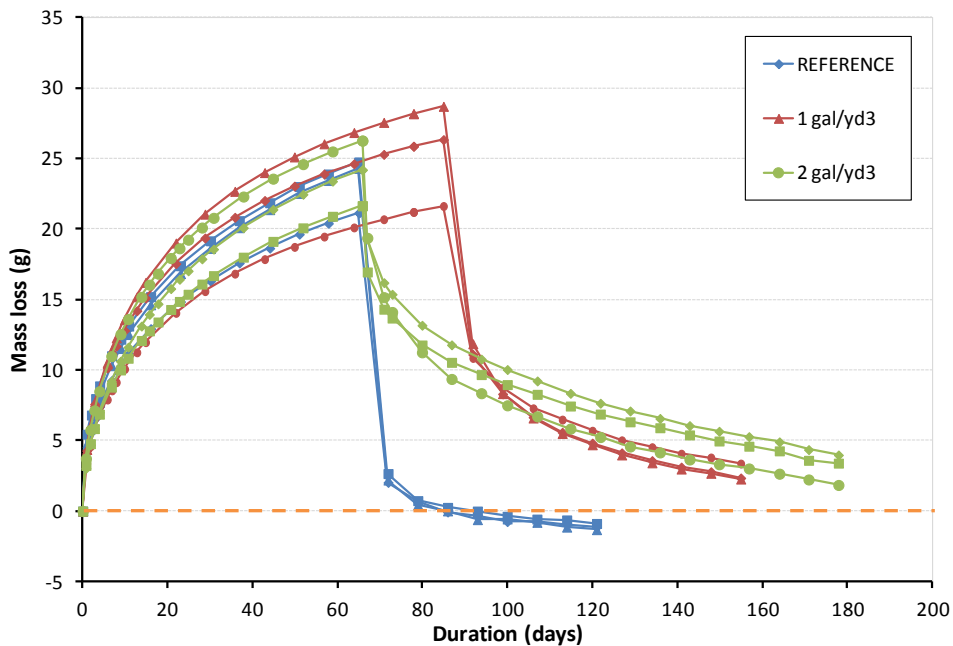

Figure 11 - Drying/absorption of the 0.55 w/c OPC mix cured 28 days and dried at 50% RH

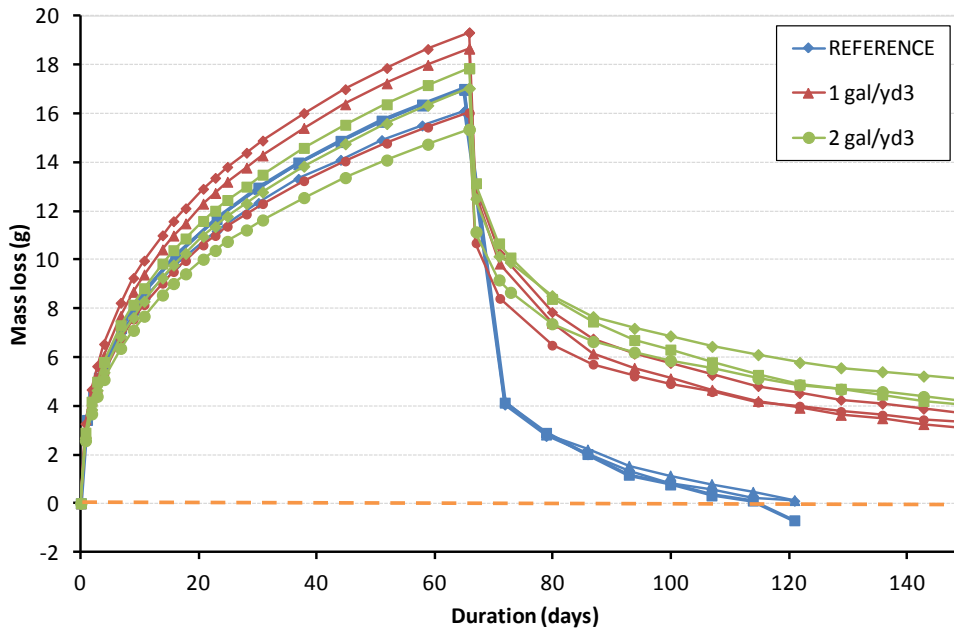

Figure 12 - Drying/absorption of the 0.45 w/b FA mix cured 28 days and dried at 50% RH

The results from samples cured 91 days are shown on the next figures. The results again highlight the effect of Hycrete® on absorption rate, and similar to the 28 days results, the absorption rate for both good quality mixtures (0.40 w/c OPC and 0.45 w/b fly ash) is nearly identical.

What is new however is the drying rate for the 2 gal/yd³ dosage. Similar to what can be observed from the 28 days results, the drying rate for reference and 1 gal/yd³ mixtures is close to being the same and shows no discernible difference. But in all tests, the samples cured 91 days show a lower drying rate for experiments carried out on 2 gal/yd³ samples, as illustrated on Figure 13 to Figure 15. The difference is not important for the average quality mix (0.55 w/c OPC), but for the other mixtures, there is clearly a drop in drying rate when more admixture is present. Although more experimental data would be needed to conclude that adding more Hycrete® to a mix can somewhat limit the drying rate, and consequently the overall efficiency of the admixture, this is a feature worth investigating in the future.

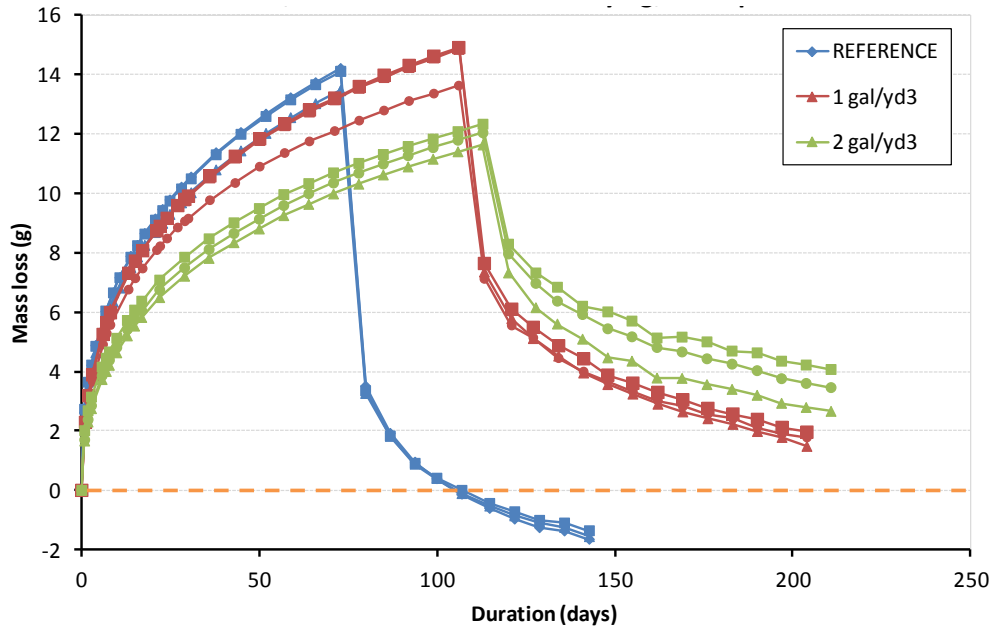

Figure 13 - Drying/absorption of the 0.4 w/c OPC mix cured 91 days and dried at 50% RH

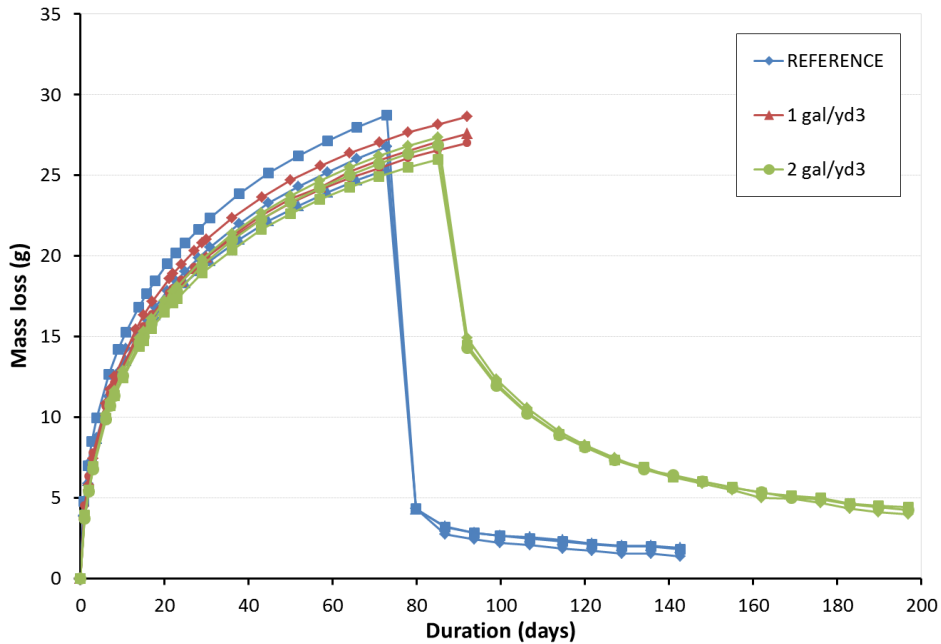

Figure 14 - Drying/absorption of the 0.55 w/c OPC mix cured 91 days and dried at 50% RH

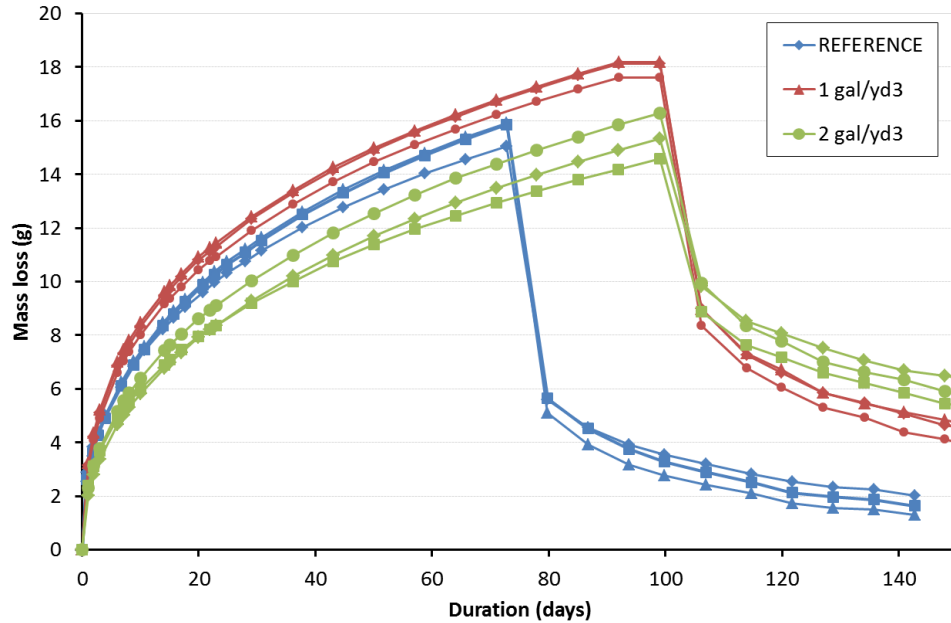

Figure 15 - Drying/absorption of the 0.45 w/b FA mix cured 91 days and dried at 50% RH

Another important influence Hycrete® has on moisture in concrete mixes was highlighted when the drying results at 75% RH were compared to their 50% counterpart. Figure 16 shows side-by-side the drying/absorption results for the 0.4 w/c OPC mix cured 91 days. The left subfigure shows the results for 1 gal/yd³ compared to the reference mixture. On the right side, the same reference mixture results are plotted, but this time compared to the 2 gal/yd³ results. As expected, the data from the reference mix show different drying rates depending on the chamber RH. Being exposed to a larger RH variation, the samples placed in the 50% RH chamber dried more rapidly than samples in the 75% RH environment. However, what is surprising is that this logical outcome is not observed in the Hycrete® mixture drying data. Whatever the dosage, mixtures prepared with Hycrete® showed similar drying rates for the 50% and 75% RH series.

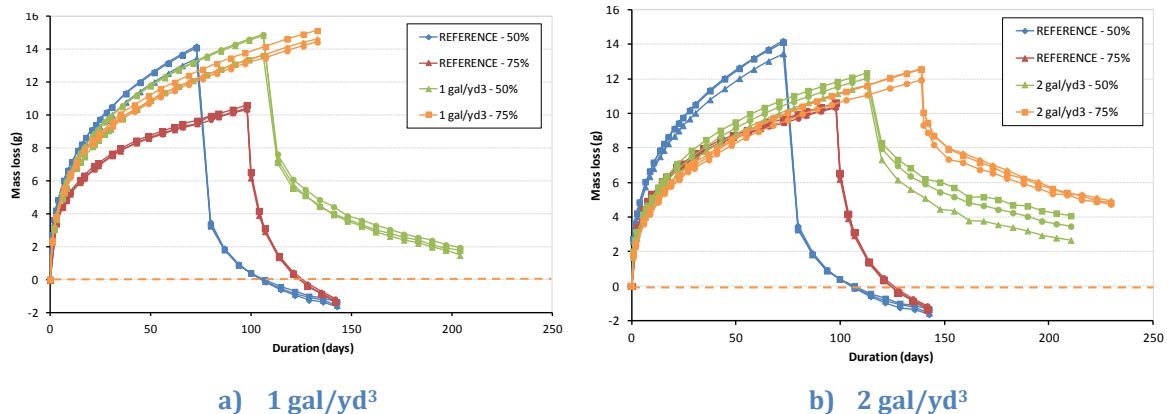

Figure 16 - Drying/absorption at 50% and 75% RH for the 0.4 w/c OPC mix cured 91 days

This unusual behavior is not unique to this mixture but was also observed in the drying data from the 0.55 w/c OPC and 0.45 w/b FA mixtures, as illustrated in Figure 17 and Figure 18. This turned out to be one of the most challenging aspects of the model development presented later in this report, as models based on linear gradients constitutive laws (Fourier law's in heat conduction, Fick's law in diffusion, Darcy's law for pressure-driven moisture flow, etc.) have a natural tendency to exhibit different flow rates when external conditions are different.

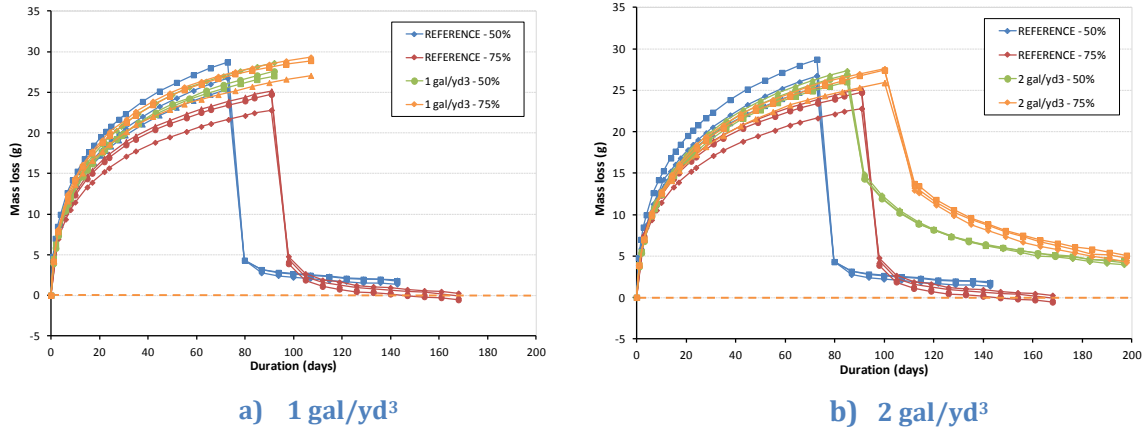

Figure 17 - Drying/absorption at 50% and 75% RH for the 0.55 w/c OPC mix cured 91 days

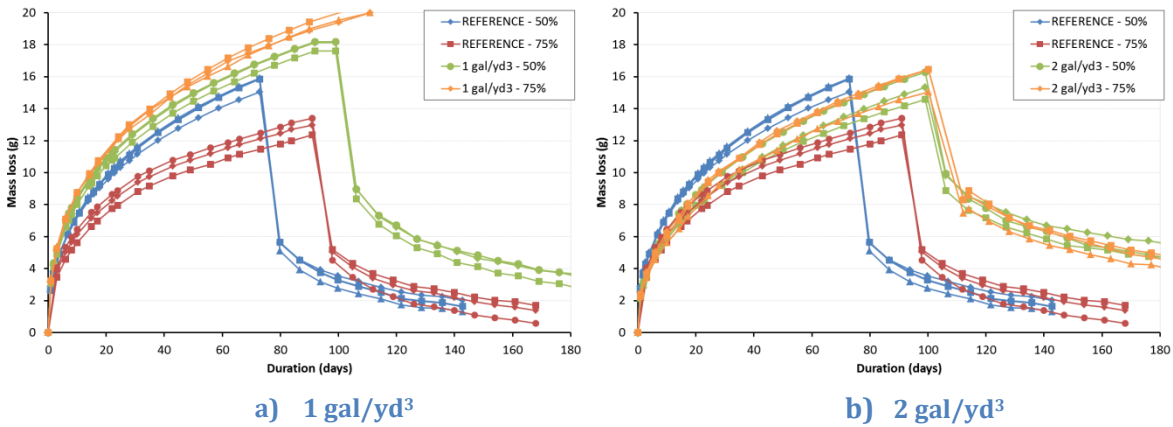

Figure 18 - Drying/absorption at 50% and 75% RH for the 0.45 w/b FA mix cured 91 days

The results presented in this section clearly emphasized the major impact Hycrete® has on concrete mixtures, which is to slow down water absorption when a dried material is exposed to a high RH environment. These results served as the basis of the model development to be presented later.

Additional results are provided in Appendix F.

6.6 Moisture Isotherm Tests

Isotherm tests were started for each mixture after 28 days of curing in limewater. When equilibrium was reached for each RH environment, the saturation level in the samples was calculated based on the cumulative mass loss, porosity and volume of the specimen, as discussed in section 5.6. The calculations were based on the average porosity as presented in Table 8.

Table 12 shows the saturation at each RH for all the mixtures. Each data is the average of 3 individual measurements, except for 50% and 75% RH. In those cases, six values were available because of tests started after 28 days and 91 days of curing. Individual measurements are listed in Appendix G. The 100% RH line in the table corresponds to the saturated state, for which water fills the whole pore volume. In this case, the water content corresponds to the porosity and the saturation is equal to 1. The isotherm results are plotted in Figure 19, Figure 20 and Figure 21.

Table 12 – Saturation level for different RH environments

RH (%)	Saturation (ratio)								
	M1	M2	M3	M4	M5	M6	M7	M8	M9
33	0.248	0.274	0.329	0.163	0.220	0.194	0.244	0.237	0.256
50	0.441	0.478	0.515	0.337	0.391	0.383	0.409	0.440	0.442
75	0.557	0.573	0.572	0.427	0.449	0.409	0.546	0.463	0.455
85	0.671	0.718	0.789	0.585	0.558	0.612	0.637	0.783	0.778
92	0.859	0.896	0.914	0.798	0.784	0.734	0.839	0.862	0.891
100	1.000	1.000	1.000	1.000	1.000	1.000	1.000	1.000	1.000

Before the project started, the moisture isotherms were viewed as one potential parameter where Hycrete® would show a significant effect. The actual results show that the impact of batching concrete with this admixture is not meaningful, results for Hycrete® mixtures being close to reference values.

A closer analysis reveals that Hycrete® does have a limited impact on the moisture storage capacity of mixtures. An analysis of moisture isotherm tests carried out over the years by SIMCO on different mixtures, including the reference mixes of the present project, show that there is a correlation between the saturation at 50% RH and the saturation at 75% RH. This is illustrated by the blue curve on Figure 22. As shown on this graph, the reference mixtures are in line with other results from SIMCO. Similar data points from mixtures with Hycrete® were also plotted on the same graph. This clearly illustrates that in this case, the relationship between both saturations is not the same. The results for Hycrete® mixes show

that the saturation at 75% is almost the same that the one at 50% RH, which tends to flatten the shape of isotherms in this humidity range. However, the modeling work showed that this has a meaningless impact on moisture transport rate and does not explain the effect Hycrete® has on absorption rate.

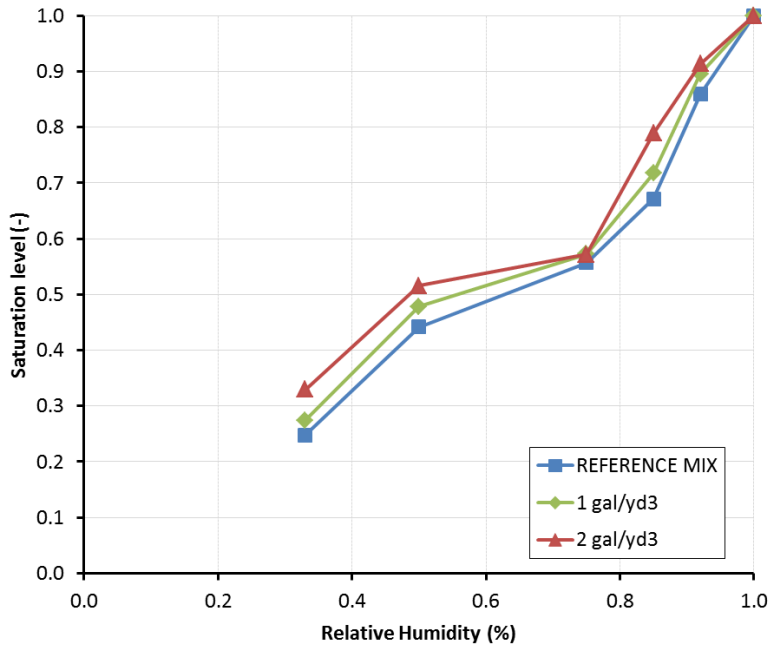

Figure 19 - Moisture isotherm - 0.40 w/c OPC mixture

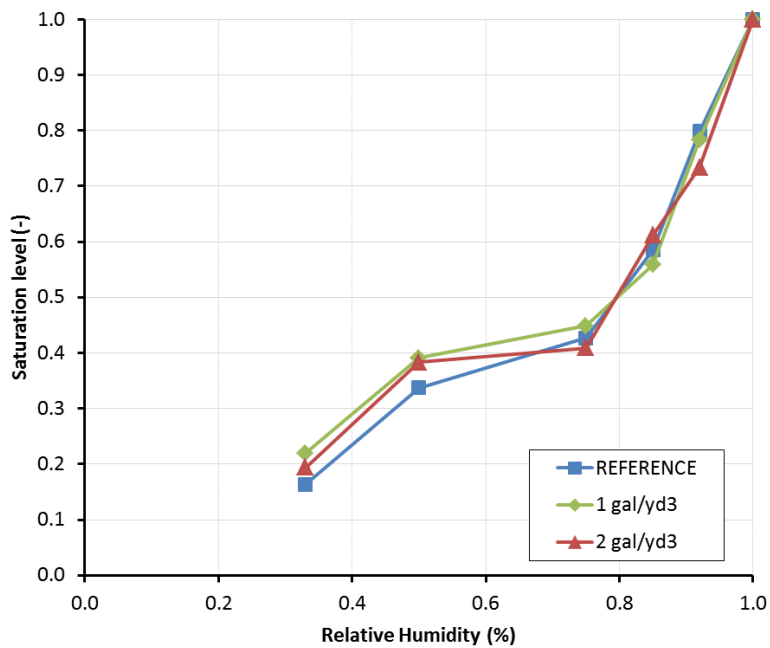

Figure 20 - Moisture isotherm - 0.55 w/c OPC mixture

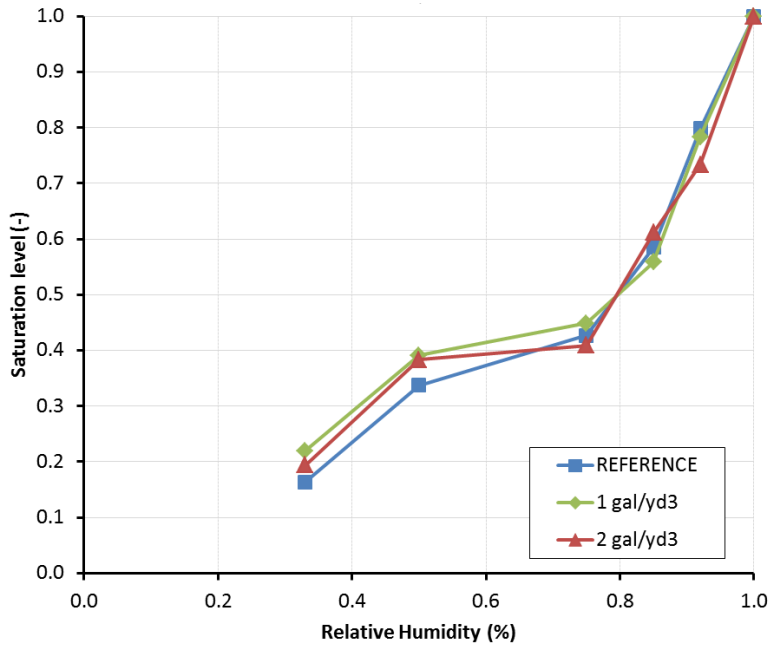

Figure 21 - Moisture isotherm – 0.45 w/b FA mixture

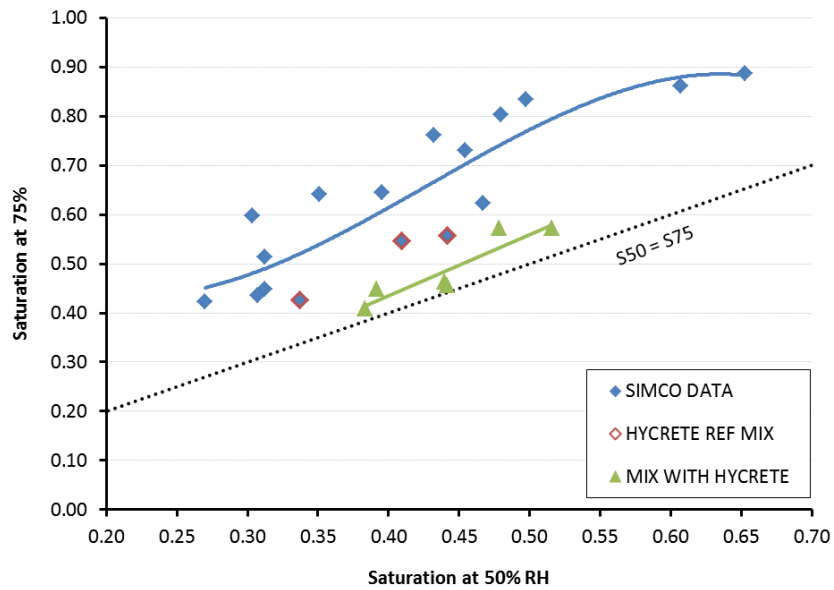

Figure 22 - Analysis of isotherm results

6.7 Chloride ponding

The complete chloride profiles are provided in Appendix F. In this section, selected profiles are presented to highlight the effect of Hycrete® on chloride ingress.

The first chloride profiles presented in the next three figures are from the ponding tests carried out after 6 months in completely submerged (i.e. no wetting/drying cycles) conditions. The profiles confirm the migration and drying test results: when the materials are saturated, Hycrete® has no effect on chloride ingress. However, it is worth mentioning that the chloride profiles for the 0.4 w/c OPC mix confirm what the migration tests revealed. For this particular mixture, the presence of Hycrete® lowered the diffusion coefficient of species (see section 6.4). As shown on Figure 23, the chloride profiles also show that even though the material was constantly immersed, the chloride ingress is slowed down compared to the reference mix profiles. This is not observed on Figure 24 and Figure 25 for the other two mixes.

Another aspect worth mentioning is that Hycrete® does not seem to have a significant impact on chloride binding. On all three figures, the total amount of chloride near the surface ($x=0$) is roughly the same, without any discernible correlation between dosage values. This suggests that Hycrete® does not affect the hydration process significantly; the same amount of C-S-H and AFm phases are formed in the paste, regardless of the presence of the admixture.

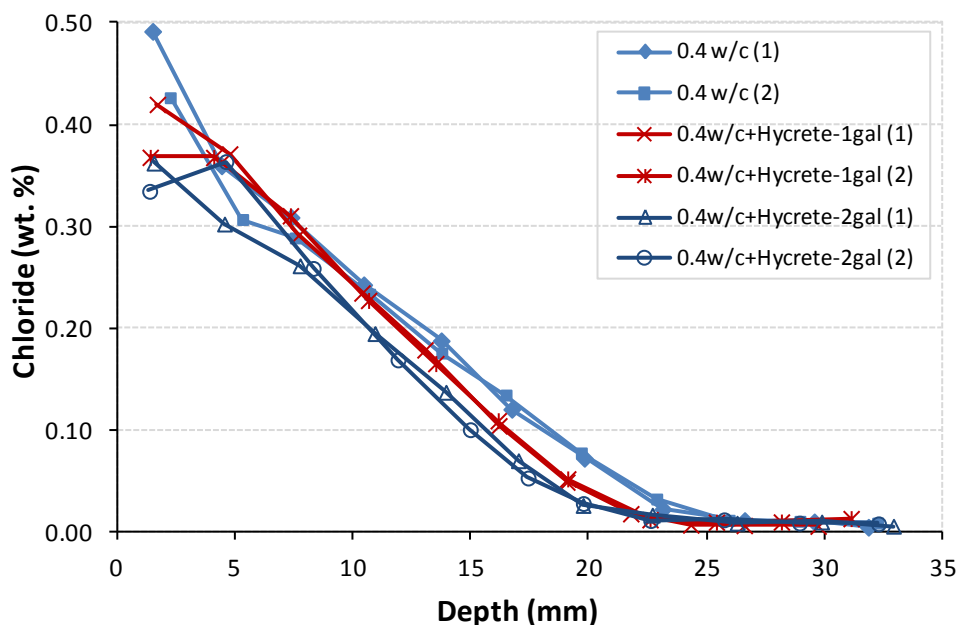

Figure 23 – Chloride profiles in 0.4 w/c mixes after 180 days of constant ponding

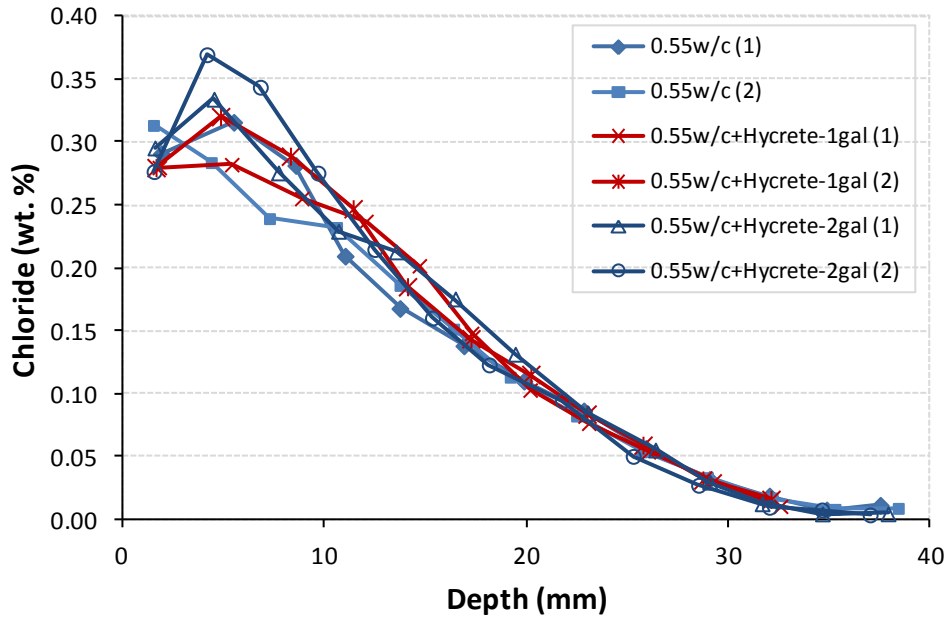

Figure 24 - Chloride profiles in 0.55 w/c mixes after 180 days of constant ponding

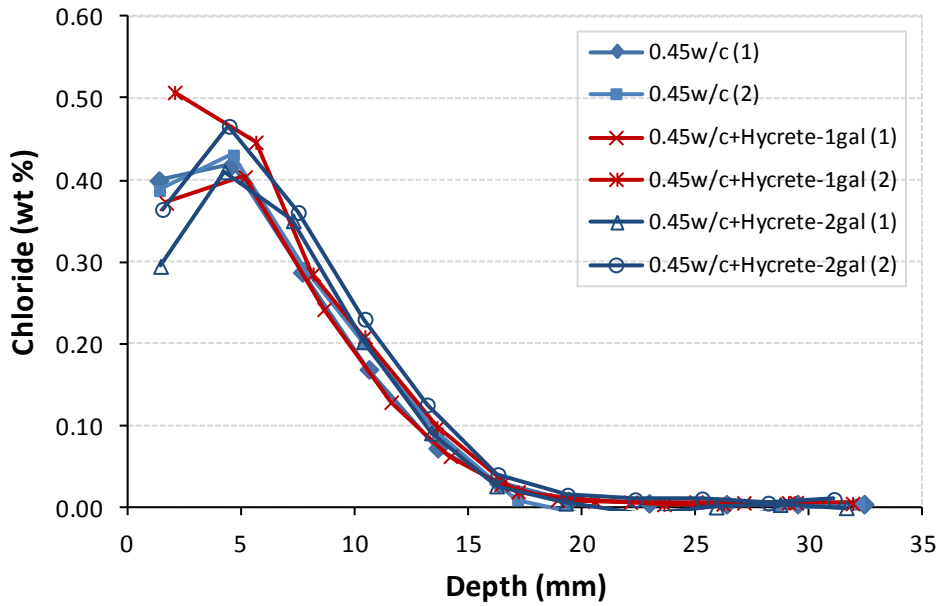

Figure 25 - Chloride profiles in 0.45 w/b mixes after 180 days of constant ponding

The Hycrete® admixture really showed its effect in the drying/adsorption test series, and not surprisingly, this translated into a positive impact for the test specimens exposed to wetting/drying chloride exposure conditions, as shown in the next three figures. On each figure, chloride profiles for the reference material exposed to cycling conditions are compared to the chloride profiles from Hycrete® mixtures. And in each case, chloride ingress rate is slower for the Hycrete® mixtures. Interestingly, the profiles for the 0.4 w/c OPC mix (Figure 26) show a difference in ingress rate for the two admixture dosage, even though the drying and absorption rates were identical (see section 6.5). This difference can be attributed entirely to the difference in diffusion coefficients measured for the different Hycrete® dosages, which was specific to this concrete mixture.

For the other two mixtures, the diffusion coefficients is not depending on the Hycrete® level and the drying/absorption tests show very similar kinetics whether 1gal/yd³ or 2 gal/yd³ was used. Accordingly, the chloride profiles for the 0.55 w/c OPC mix (Figure 27) show that profiles enters concrete less rapidly when the material is exposed to wetting/drying cycles and Hycrete® is present. However, the ingress rates are the same for the two admixture dosages.

Finally, for the case of the fly ash mixture, the ingress rate is so low that it was still not possible to clearly see the effect of Hycrete® even after six months of cycling (Figure 28). The figure hints at a smaller ingress rate with the admixture, but it is not significant.

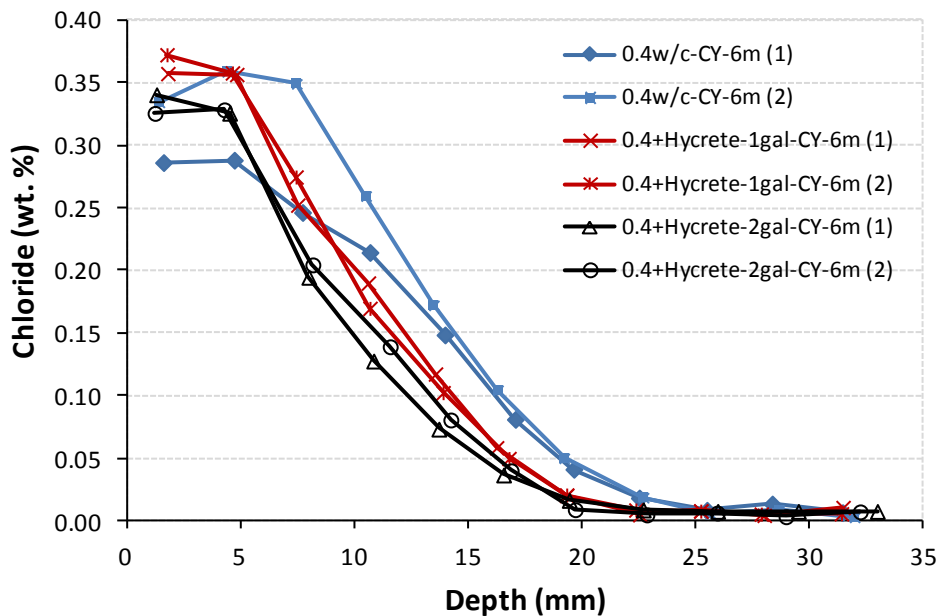

Figure 26 - Chloride profiles in 0.4 w/c OPC mixes after 180 days of cyclic ponding

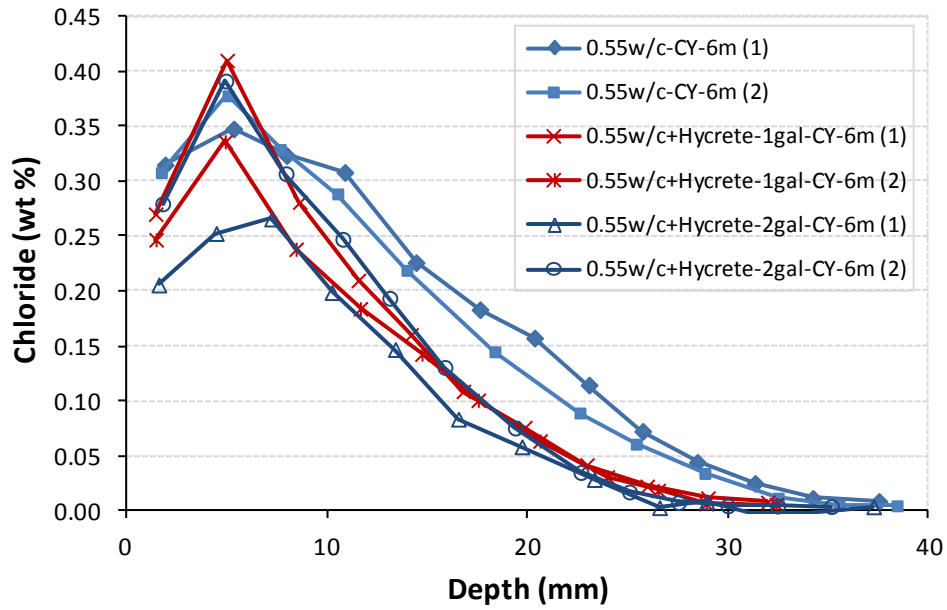

Figure 27 - Chloride profiles in 0.55 w/c OPC mixes after 180 days of cyclic ponding

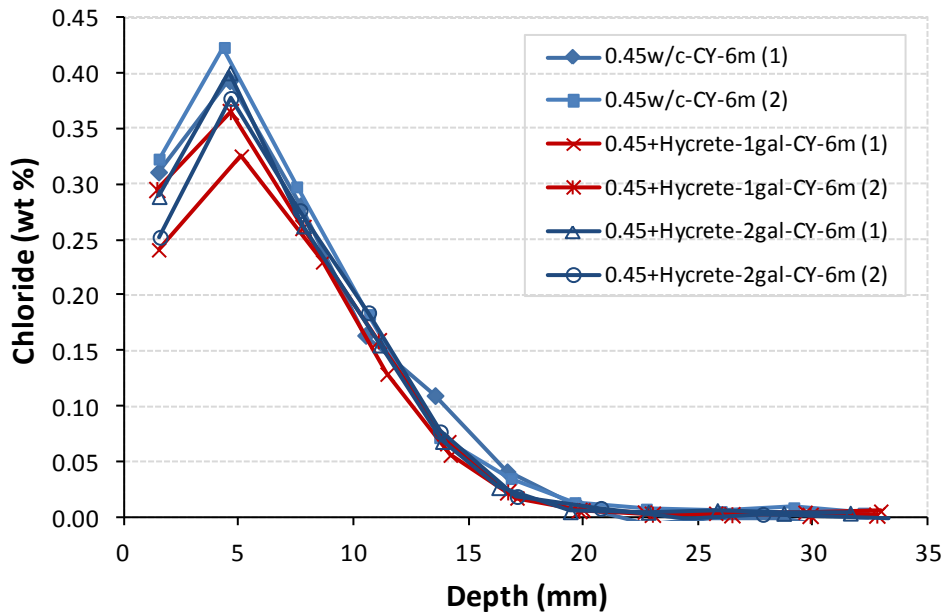

Figure 28 - Chloride profiles in 0.45 w/b FA mixes after 180 days of cyclic ponding

Part 2 – Modeling

7 Moisture Model Development

This section details the moisture transport model development. The first section is devoted to a description of the general transport equations. They are the same equations used for the moisture transport model implemented in STADIUM®. The effect of Hycrete® will be highlighted in the next section, where the transport parameters are discussed. Finally, the validation of the model on the basis of the drying/absorption test results is presented.

7.1 General modeling framework

The equation of moisture transport in unsaturated cementitious materials is developed by considering the mass conservation equations for the liquid and vapor phases. Based on the previous discussion, it is assumed that the relative humidity can be used as a state variable and that there is a unique relationship with water content. It is also assumed that the dry air contained in the gaseous phase does not exhibit significant pressure gradient. This phase is thus considered immobile. Accordingly, the only transport mechanism of vapor transport that is considered in the model is diffusion, without any contribution from an advection term. This assumption is commonly used in many moisture transport models (Chijimatsu 2000, Obeid 2001, Bary 2008). As will be shown in the following paragraphs, this hypothesis allow combining the conservation equation of liquid and vapor to yield a single equation to handle the moisture transport process. Finally, it is assumed that the gravity has a negligible effect on moisture transport, given the low permeability of cementitious materials (Hall 2002).

7.1.1 Liquid phase transport

The mass conservation equation for the liquid phase, following the averaging process over a representative elementary volume, can be written as (Whitaker 1988):

$$\frac{\partial(\rho_l w)}{\partial t} + \text{div}(\rho_l \mathbf{v}_l) + \dot{m} = 0 \quad (1)$$

where ρ_l [kg/m³] is the liquid phase density, w is the volumetric liquid phase content [m³/m³], \mathbf{v}_l [m/s] is the average liquid phase flow and \dot{m} [kg/m³/s] is the average rate of evaporation of the liquid. The term ρ_l can be approximated as the water density but a more precise approach would consider the effect of ionic species in the pore solution on the density. The constitutive law describing the average liquid phase flow is given by Darcy's law (Bear 1988, Whitaker86):

$$\mathbf{v}_l = -\frac{k_l}{\mu} \text{grad}(p_l) \quad (2)$$

where k_l [m²] is the liquid permeability of the material, μ [Pa.s] is the dynamic viscosity of the liquid phase and p_l [Pa] is the liquid pressure intrinsic average. In the previous equation, the effect of gravity was neglected. Several reports emphasize the negligible role

of gravity in cementitious materials (e.g. Hall 1994, Pel 1998). The authors in reference (Kolhapure 1997) also consider a correction due to the liquid phase activity in equation (2), which could be used to model the effect of ionic species in dissolved in the pore solution. This term is neglected in the present model.

Knowing that the capillary pressure in an unsaturated porous material can be written as (Bear 1988):

$$p_c = p_g - p_l \quad (3)$$

where p_g [Pa] is the pressure of the gas phase, and assuming that the liquid pressure dominates over a mostly constant gas pressure, one can write:

$$\mathbf{v}_l = \frac{k_l}{\mu} \text{grad}(p_c) \quad (4)$$

In the previous equations, the capillary and gas pressure correspond to intrinsic phase averages (Whitaker 1988). To take into account the fact that the saturation level of the material affects permeability, Constantz (1982) proposed to partition the permeability according to:

$$k_l = k_s k_r^l \quad (5)$$

where k_s [m²] is the intrinsic permeability of the saturated material and k_r^l [m²/m²] is the relative permeability of the liquid phase. It is a dimensionless parameter that varies between 0 for completely dry porous media and 1 for a fully saturated state.

The capillary pressure can be expressed as a function of vapor pressure or relative humidity using Kelvin's relationship (Kaviany 1995):

$$p_c = -\frac{\rho_l RT}{M_w} \ln\left(\frac{p_v}{p_v^s}\right) = -\frac{\rho_l RT}{M_w} \ln(H) \quad (6)$$

where H is the relative humidity [Pa/Pa], p_v [Pa] is the vapor pressure, p_v^s [Pa] is the saturation vapor pressure, M_w [0.018 kg/mol] is the molar mass of water, R [8.3143 J/mol/°K] is the ideal gas constant and T [°K] is the temperature. This relationship is known to be incorrect at very low relative humidity. Miyata et al. (2003) showed discrepancies between this equation and experimental results for humidities lower than 30% in nitrogen adsorption tests. In the context of this report, the objective is to develop a model that will be applicable to simulate moisture transport in concrete structures exposed to realistic field conditions, where relative humidity is most of the time above 35%. It will thus be assumed that equation 6) is valid. Since $p_c = f(p_v, T)$, one can write:

$$\text{grad}(p_c) = \frac{\partial p_c}{\partial p_v} \text{grad}(p_v) + \frac{\partial p_c}{\partial T} \text{grad}(T) \quad (7)$$

Replacing (5) and (7) with the derivatives of Kelvin's relationship in equation (4), under the assumption that ρ_l varies weakly with temperature (see data for water in CRC 1985), gives:

$$\mathbf{v}_l = -\frac{k_s k_r^l \rho_l R}{\mu M_w} \left(\frac{T}{H} \text{grad}(H) + \left[\ln(H) - \frac{T}{p_v^s} \frac{dp_v^s}{dT} \right] \text{grad}(T) \right) \quad (8)$$

The liquid phase velocity expression (8) is then replaced in the mass conservation equation (1), which gives:

$$\frac{\partial(\rho_l w)}{\partial t} - \text{div} \left(\frac{k_s k_r^l \rho_l^2 R T}{\mu M_w H} \text{grad}(H) + \frac{k_s k_r^l \rho_l^2 R}{\mu M_w} \left[\ln(H) - \frac{T}{p_v^s} \frac{dp_v^s}{dT} \right] \text{grad}(T) + \dot{m} \right) = 0 \quad (9)$$

7.1.2 Vapor phase transport

In the case of the vapor phase, it is assumed that the air inside the unsaturated pores is not moving. The main transport mechanism of vapor is diffusion and follows the generalized Fick's law. The mass conservation equation of vapor averaged over a representative elementary volume is given by (Whitaker 1988):

$$\frac{\partial(\theta_g \rho_v)}{\partial t} + \text{div}(\mathbf{j}_v) - \dot{m} = 0 \quad (10)$$

where ρ_v [kg/m³] is the vapor density intrinsic average, θ_g [m³/m³] is the volumetric gas phase content and \mathbf{j}_v [kg/m²/s] is the average vapor flux. As mentioned previously, it is assumed that the vapor flux follows Fick's law of diffusion. Based on the averaging procedure of the gradient operator detailed in (Bear 1991), the average vapor flux can be written as (Bear 1988):

$$\mathbf{j}_v = -\theta_g \tau_g D_v^o \text{grad}(\rho_v) \quad (11)$$

where τ_g [-] is the tortuosity of the gas phase and D_v^o [m²/s] is the vapor self-diffusion coefficient. This expression is valid when the mass fraction of vapor over air is small, which hold for temperature lower than 45°C (Whitaker 1988). The dimensionless tortuosity parameter varies between 0 for totally impervious materials to 1 for free diffusion and characterizes the geometry of the porous network. The value of D_v^o can be found in the literature, along with its relationship with temperature. An expression is provided in the next section.

Substituting equation (11) in (10) gives

$$\frac{\partial(\theta_g \rho_v)}{\partial t} - \text{div} \left(\theta_g \tau_g D_v^o \text{grad}(\rho_v) \right) - \dot{m} = 0 \quad (12)$$

Using the ideal gas law, it is possible to relate the vapor density to the vapor pressure:

$$\frac{\rho_v}{M_w} = \frac{n_v}{V_g} = \frac{p_v}{RT} \quad (13)$$

where n_v [mol] is the number of vapor molecule in the gas phase volume V_g [m³]. Combining equations (13) with the definition of relative humidity $H = p_v/p_v^s$ gives:

$$\rho_v = \frac{M_w}{RT} p_v^s H \quad (14)$$

Based on equation (14), one can write $\rho_v = f(H, T)$. Accordingly, it is possible to express the gradient in equation (12) as:

$$\text{grad}(\rho_v) = \frac{\partial \rho_v}{\partial H} \text{grad}(H) + \frac{\partial \rho_v}{\partial T} \text{grad}(T) \quad (15)$$

Substituting equation (14) in equation (15) yields:

$$\text{grad}(\rho_v) = \frac{M_w p_v^s}{R} \frac{1}{T} \text{grad}(H) - \frac{M_w H}{RT^2} p_v^s \text{grad}(T) \quad (16)$$

which considers the effect of temperature on the saturation vapor pressure. Substituting this expression back into the mass conservation equation (12) gives:

$$\frac{\partial(\theta_g \rho_v)}{\partial t} - \text{div} \left(\theta_g \tau_g D_v^o \frac{M_w p_v^s}{R} \frac{1}{T} \text{grad}(H) - \theta_g \tau_g D_v^o \frac{M_w H}{RT^2} p_v^s \text{grad}(T) \right) - \dot{m} = 0 \quad (17)$$

Similar to the permeability, the tortuosity is partitioned according to:

$$\tau_g = \tau_s \tau_r^g \quad (18)$$

where τ_s is the intrinsic tortuosity of the material and τ_r^g represents the variation of tortuosity for various levels of gas saturation. Incorporating relationship (18) in (17) provides the final form of the mass conservation equation for vapor:

$$\frac{\partial(\theta_g \rho_v)}{\partial t} - \text{div} \left(\theta_g \tau_g D_v^o \frac{M_w p_v^s}{R} \frac{1}{T} \text{grad}(H) - \theta_g \tau_s \tau_r^g D_v^o \frac{M_w H}{RT^2} p_v^s \text{grad}(T) \right) - \dot{m} = 0 \quad (19)$$

7.1.3 Total moisture transport

Equations (9) and (19) can be added to obtain an expression that gives the combined transport of liquid water and vapor. Doing so eliminates the \dot{m} term, which yields:

$$\begin{aligned} \frac{\partial(\rho_l w + \theta_g \rho_v)}{\partial t} - \operatorname{div} \left(\left[\frac{k_s k_r^l \rho_l^2 R T}{\mu M_w} \frac{T}{H} + \frac{\theta_g \tau_s \tau_r^g D_v^o M_w p_v^s}{R} \frac{p_v^s}{T} \right] \operatorname{grad}(H) \right. \\ \left. + \left[\frac{k_s k_r^l \rho_l^2 R}{\mu M_w} \left(\ln(H) - \frac{T}{p_v^s} \frac{dp_v^s}{dT} \right) - \frac{\theta_g \tau_s \tau_r^g D_v^o M_w H}{R} \frac{H}{T^2} p_v^s \right] \operatorname{grad}(T) \right) = 0 \quad (20) \end{aligned}$$

Since $\rho_l w$ is much larger than $\rho_v \theta_g$, the latter term can be eliminated from equation (20). Assuming that ρ_l does not depend on temperature (as in equation (8)) and $w = f(H, T)$, the time derivative term can be written as:

$$\frac{\partial(\rho_l w)}{\partial t} = \rho_l \frac{\partial w}{\partial H} \frac{\partial H}{\partial t} + \rho_l \frac{\partial w}{\partial T} \frac{\partial T}{\partial t} \quad (21)$$

Substituting equation (21) in (20) yields:

$$\begin{aligned} \rho_l \frac{\partial w}{\partial H} \frac{\partial H}{\partial t} + \rho_l \frac{\partial w}{\partial T} \frac{\partial T}{\partial t} - \operatorname{div} \left(\left[\frac{k_s k_r^l \rho_l^2 R T}{\mu M_w} \frac{T}{H} + \frac{\theta_g \tau_s \tau_r^g D_v^o M_w p_v^s}{R} \frac{p_v^s}{T} \right] \operatorname{grad}(H) \right. \\ \left. + \left[\frac{k_s k_r^l \rho_l^2 R}{\mu M_w} \left(\ln(H) - \frac{T}{p_v^s} \frac{dp_v^s}{dT} \right) - \frac{\theta_g \tau_s \tau_r^g D_v^o M_w H}{R} \frac{H}{T^2} p_v^s \right] \operatorname{grad}(T) \right) = 0 \quad (22) \end{aligned}$$

Finally, the expressions in square brackets are associated with the nonlinear moisture conductivity (or diffusivity) parameter D_{mH} [m²/s] and the D_{mT} [m²/s/°K] coupling term:

$$D_{mH} = \frac{k_s k_r^l \rho_l R T}{\mu M_w} \frac{T}{H} + \frac{\theta_g \tau_s \tau_r^g D_v^o M_w p_v^s}{\rho_l R} \frac{p_v^s}{T} \quad (23)$$

$$D_{mT} = \frac{k_s k_r^l \rho_l R}{\mu M_w} \left(\ln(H) - \frac{T}{p_v^s} \frac{dp_v^s}{dT} \right) - \frac{\theta_g \tau_s \tau_r^g D_v^o M_w H}{\rho_l R} \frac{H}{T^2} p_v^s \quad (24)$$

which leaves:

$$\rho_l \frac{\partial w}{\partial H} \frac{\partial H}{\partial t} + \rho_l \frac{\partial w}{\partial T} \frac{\partial T}{\partial t} - \operatorname{div}(D_{mH} \operatorname{grad}(H) + D_{mT} \operatorname{grad}(T)) = 0 \quad (25)$$

Equation (25) is similar in form to the well-known model proposed by Philip and de Vries in 1957. The main difference is in the choice of the state variable, where Philip and de Vries opted for water content.

This equation was discretized on the basis of the finite element method (FEM). Newton's method is used to solve the nonlinear problem. All the parameters mentioned in the previous paragraphs are defined in the next section.

7.2 Model parameters

This section details the methods used to estimate the parameters found in expressions (23) and (24). Since the variable in equation (25) is the relative humidity, the numerical resolution will involve the relative humidity at previous time steps or iterations. This means that all the parameters must be estimated on the basis of H , T , material properties such as porosity, and physical parameters such as water density. Expressions and methods to estimate all the parameters are provided in the following subsections.

7.2.1 Physical parameters and constants

Many parameters forming the moisture conductivity expression (equations 23 and 24) are either known constants or can be found in textbooks. They are listed here:

- M_w and R are constants which values are 0.018 kg/mol and 8.3143 J/mol/°K respectively.
- Liquid phase density ρ_l . In most references, the density of water is taken as a constant value equal to 1000 kg/m³. Data on the density of water between 0°C and 100°C found in reference (Robinson 2002) may be fitted to a 4th order polynomial such that:

$$\rho_l = a + bT + cT^2 + dT^3 + eT^4 \quad [\text{kg/m}^3], \text{ with } T \text{ in } ^\circ\text{C} \quad (26)$$

with $a=999.021$, $b=0.050720098$, $c=-0.0074926756$, $d=4.1397363e-5$, and $e=-1.3090956e-7$. This function gives a maximum water density of 999.99 kg/m³ at 3.484°C. Since the pore solution of cementitious materials is highly concentrated, a more precise analysis can be performed by considering the presence of dissolved ionic species in the liquid phase. Data on numerous electrolytes as well as a density model can be found in (Laliberté 2004).

- Liquid phase dynamic viscosity μ . Data on the viscosity of water between 0°C and 100°C found in reference (Robinson 2002) were fitted according to:

$$\mu = (a + bT)^{-1/c} \quad [\text{cP}], \text{ with } T \text{ in } ^\circ\text{C} \quad (27)$$

where $a=0.69472263$, $b=0.015229617$, $c=0.62614422$. Similar to the density, the viscosity of the liquid phase is influenced by the dissolved electrolytes. This is not considered here.

- Self-diffusion coefficient of water vapor D_v^o . Many expressions are listed in reference (Galbraith 1997). All expressions are dependent on temperature and the ambient atmospheric pressure. The expression selected in this paper was proposed by Schirmer (as cited in Galbraith 1997) and was also used in (Krus 1996) to model moisture transport in building materials:

$$D_v^o = 2.305 \times 10^{-5} \left(\frac{T}{273.15} \right)^{1.81} \frac{p_o}{p_b} \text{ [m}^2\text{/s]}, \text{ with } T \text{ in } ^\circ\text{K} \quad (28)$$

where p_o is the standard pressure [101.323 kPa] and p_b is the ambient atmospheric pressure. In the implementation of the present model, it was assumed that $p_o = p_b$.

- Saturation vapor pressure p_v^s . The expression proposed by (Bolton 1980) was implemented in the model:

$$p_v^s = 611.2 \exp\left(\frac{17.67T}{T+243.5}\right) \text{ [Pa]}, \text{ with } T \text{ in } ^\circ\text{C} \quad (29)$$

The derivative of this expression with regard to temperature is given by:

$$\frac{dp_v^s}{dT} = \frac{6.630 \times 10^6}{(T+243.5)^2} \exp\left(\frac{17.67T}{T+243.5}\right) \quad (30)$$

- Gas phase relative tortuosity τ_r^g . The gas phase relative tortuosity in equations (23) and (24) has not been the topic of many studies for cementitious materials. Most models rely on a Millington-type relationship (Millington 1961). A recent study by Sercombe et al. (2007) on gas diffusion in cement pastes showed that the relative tortuosity in cementitious materials fits the relationship:

$$\tau_r^g = \frac{1}{1+aS^b} \quad (31)$$

where $a=47929.444$, $b=22.342714$.

- Tortuosity τ_s . The tortuosity is directly evaluated from migration test results (see sections 5.4 and 6.4). Appendix D gives the tortuosity of every mix tested in this study.

7.2.2 Moisture isotherm

Solving the moisture transport equation (25) requires knowing the moisture isotherm of the modeled material. It is present in the time derivative $\partial w / \partial H$, and in the expression for D_{mH} through the term θ_g , since knowing water content and porosity allows calculating the gas phase volumetric content:

$$\theta_g = \phi - w \quad (32)$$

It should be noted that terms associated with the temperature dependence of the isotherm are also part of equation (25). They will not be discussed in this report since all tests have been performed at constant temperature.

The moisture isotherm is expressed in the model on the basis of the following expression:

$$S = \frac{1}{\beta(H^\delta - 1) + 1} \quad (33)$$

where β and δ are fitting parameters. Knowing that saturation is related to water content according to $S = w/\phi$, the time derivative $\partial w/\partial H$ in equation (25) can be expressed as:

$$\frac{\partial w}{\partial H} = \phi \frac{\partial S}{\partial H} \quad (34)$$

An example of measured isotherm data fitted with equation (33) is shown on the next figure. Since all simulations presented in the next sections were performed for RH conditions above 50%, only data points for $RH \geq 50\%$ were fitted to have a more accurate reproduction of the storage function. The moisture isotherm parameters for all mixes are given in Table 13.

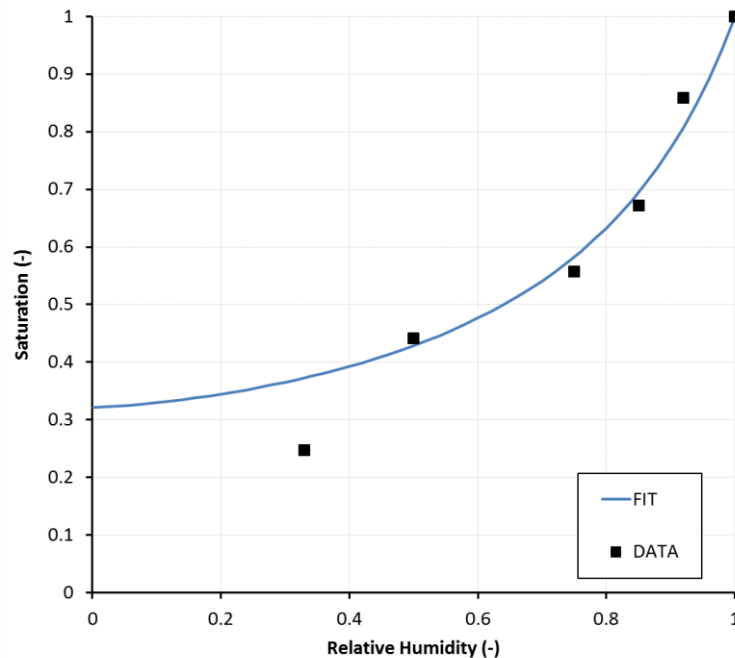

Figure 29 - Isotherm data fitted with eq. (33) for $RH \geq 50\%$ for 0.4 w/c reference mix

Table 13 - Moisture isotherm parameters (for RH ≥ 50% data)

Mixture		Isotherm parameters	
		β	δ
0.4 w/c OPC	Reference	-2.1095	1.4404
	1 gal/yd ³	-2.0056	1.2664
	2 gal/yd ³	-1.9544	1.0895
0.55 w/c OPC	Reference	-4.2966	1.0276
	1 gal/yd ³	-2.0938	2.4439
	2 gal/yd ³	-2.1976	2.4229
0.4 w/c OPC	Reference	-2.4228	1.3867
	1 gal/yd ³	-3.7475	0.7200
	2 gal/yd ³	-4.4692	0.5851

7.2.3 Permeability and relative permeability

All test results given in section 6 showed that in most cases, Hycrete® has little influence on one mixture properties, except when wetting and drying cycles are involved. Moisture isotherms were initially viewed as a potentially critical parameter for modeling the effect of Hycrete®, but they also proved relatively unaffected by the admixture, at least not enough to explain the low absorption rate highlighted by drying/absorption test results.

This leaves two parameters that can be used to reproduce the experimental results: permeability k_s and relative permeability k_r^l (see equation 23). Based on the experimental results, the main features to reproduce are:

- Low absorption rate, compared to a similar mixture without Hycrete®,
- Similar drying rates at 50% and 75% RH when Hycrete® is present in a mixture.

On top of this, the model must also work correctly for non-Hycrete® mixes, as it did before in its STADIUM® implementation. Finally, based on experimental results, when Hycrete® is present in a mixture, its dosage is not considered a significant factor affecting moisture transport. Similar results were obtained with 1 gal/yd³ and 2 gal/yd³ (see section 6.5).

To achieve all this, SIMCO proposes the use of the following relative permeability function:

$$k_r^l = \frac{1}{1-a+aS^b} \quad (35)$$

where a and b are material parameters. Using this function, it is possible to find a set of values for a and b that allows reproducing the moisture transport in a mixture, depending on the presence of Hycrete®. The parameters are provided in Table 14. The corresponding functions are plotted on Figure 30. The plot emphasizes the different behavior between mixtures with and without Hycrete®. Since lab data such as compressive strength, porosity,

and diffusion coefficients, did not show a significant difference when the admixture is used, it is safe to assume that Hycrete® does not have a major impact on the microstructure. This means that the admixture affects water by other mechanisms, such as molecule polarization. The mechanisms were not investigated in this study.

Using the correct set of relative permeability parameters, the only properties that is missing is the permeability, which can be estimated by using the model to find the value that reproduces the correct drying rate. This analysis shows that in order to reproduce the effect of Hycrete® on moisture transport, the relative permeability function needs to be coupled with a very low permeability value. This is illustrated in the next section.

Table 14 - Relative permeability parameters

Type of mixture	a	b
w/o Hycrete®	70	-5
With Hycrete®	1×10^{-4}	-30

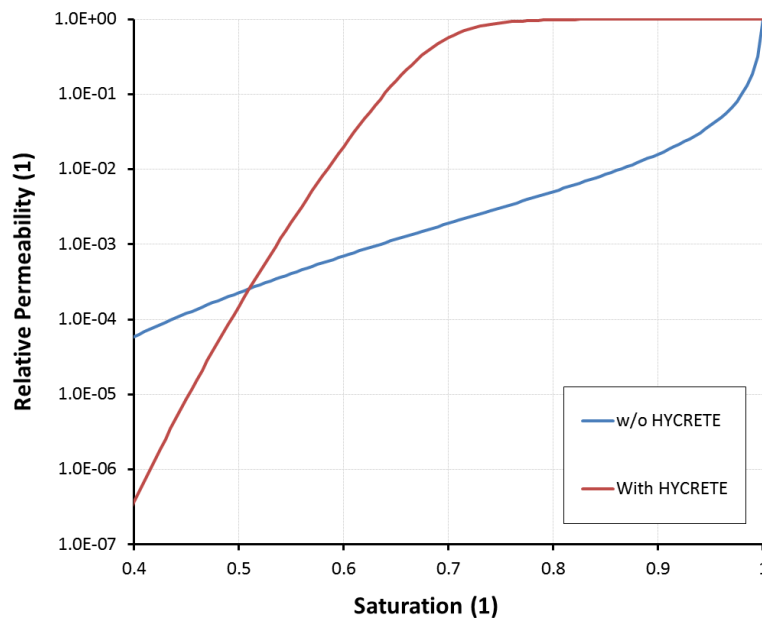

Figure 30 - Plot of the relative permeability function

7.3 Comparison with experimental data

Using the model described in section 7.1 with parameters listed in section 7.2, it is possible to replicate drying/absorption test results of both reference and Hycrete® mixtures by selecting the correct relative permeability parameters (see Table 14) and finding the permeability that fits the experimental mass variation curves.

The results of the simulations of the drying/absorption tests started after 91 days of curing on the reference and 2 gal/yd³ mixtures are summarized in Table 15. Some simulation results are also illustrated on the following figures. Overall, the model shows that it correctly captures the main feature of Hycrete® mixes, which is a slow absorption rate compared to the reference mixtures prepared without the admixture. It also correctly reproduces the similar drying rates observed at 50% and 75% RH.

Table 15 shows that the permeability values needed to replicate the drying/absorption rates of Hycrete® mixtures are much lower than the corresponding value for reference materials. Several relative permeability models were tried before the version presented in this section was finally selected. Many were inspired by similar approaches in soil transport. But in all cases, it proved impossible to model a low absorption rate without having a lower permeability for the Hycrete® mixtures.

Table 15 - Analysis of the 91d drying/absorption tests

Mixture	Permeability (e-22 m ²)	
	Reference	2 gal/yd ³
0.40 w/c OPC	61.6	0.8
0.55 w/c OPC	361.0	5.3
0.45 w/b FA	73.0	1.6

The analysis presented in the section illustrates how Hycrete® mixes could be tested within the context of the UFGS. The drying test procedure of the UFGS methodology could be used, and the results analyzed using the corresponding relative permeability parameters (Table 14). The resulting permeability would then be used in STADIUM® to perform long-term chloride ingress simulations. The implementation in STADIUM® is discussed in the next section.

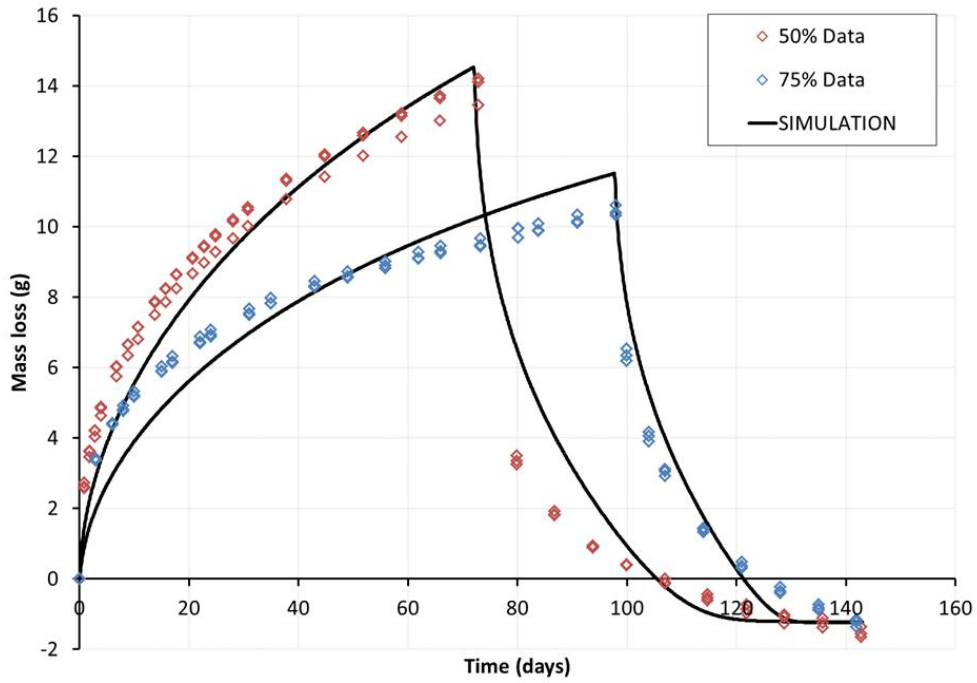

Figure 31 - Simulation of drying/absorption - 0.4 w/c OPC mix w/o Hycrete®

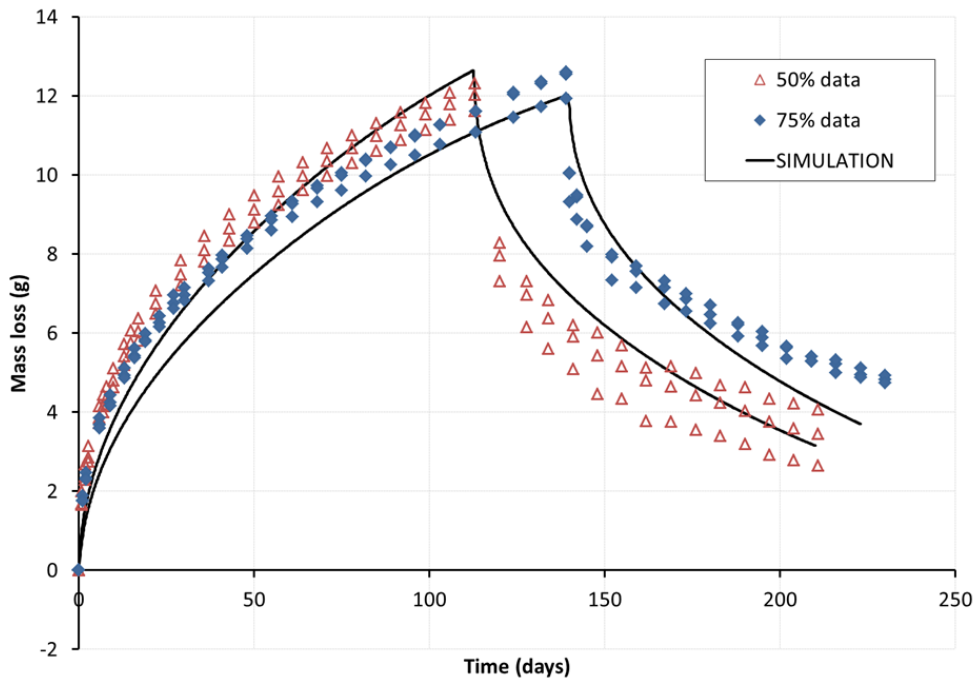

Figure 32- Simulation of drying/absorption - 0.4 w/c OPC mix + 2 gal/yd³

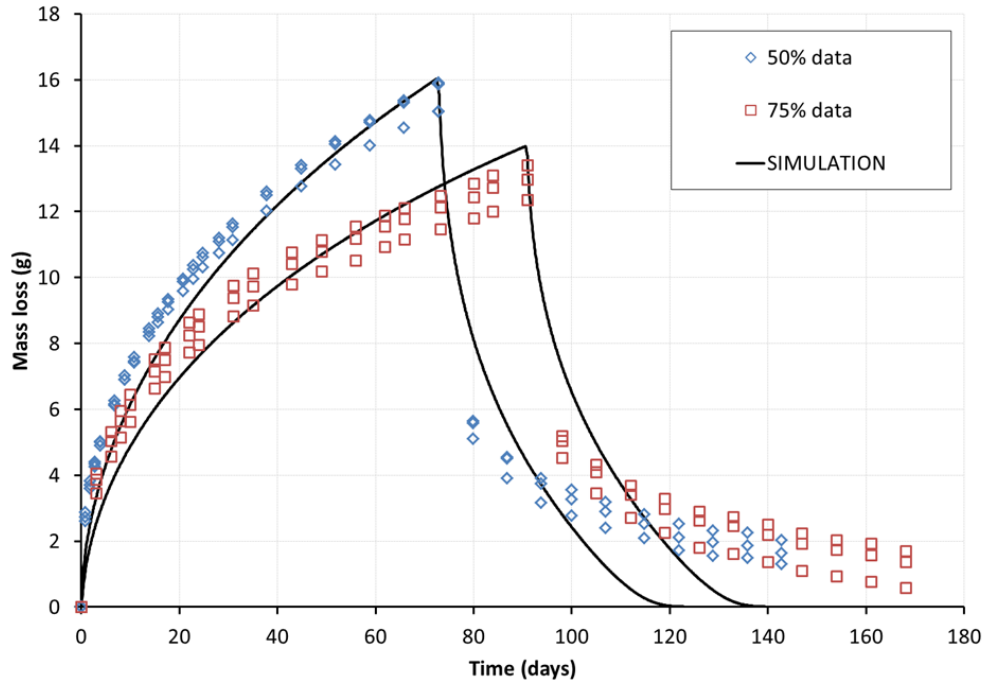

Figure 33 - Simulation of drying/absorption - 0.45 w/b FA mix w/o Hycrete®

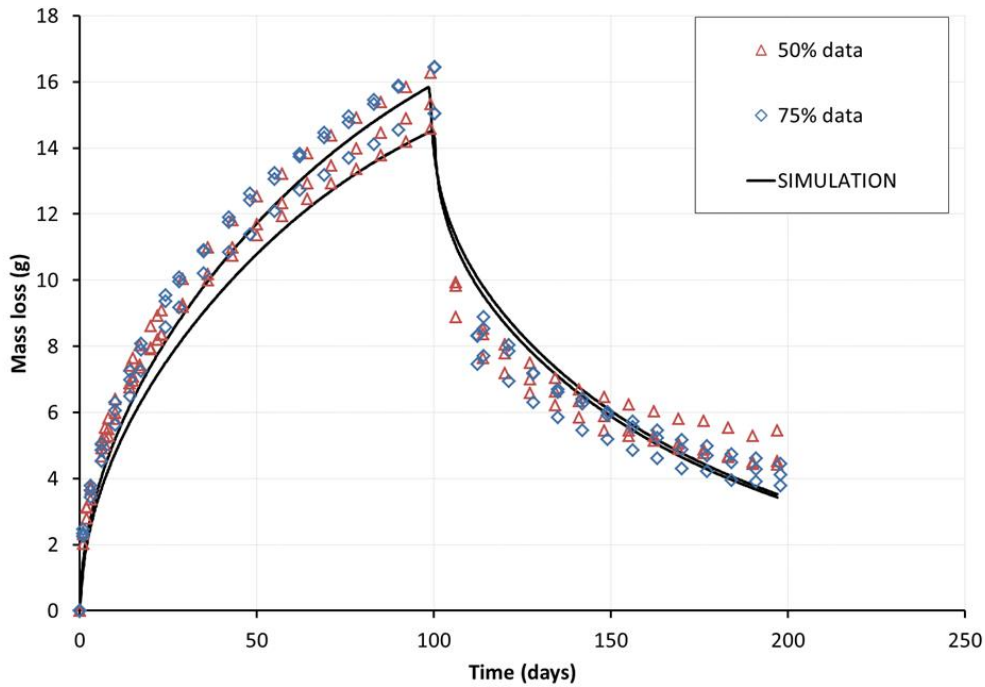

Figure 34 - Simulation of drying/absorption - 0.45 w/b FA mix + 2 gal/yd³

8 Implementation in a reactive transport model

Following the moisture model development, the next step consisted in implementing the new approach in STADIUM®. This section summarizes this last portion of the project. Simulations of long-term chloride ingress in concrete structures are also presented.

8.1 Coupling with STADIUM®

STADIUM® is a model that simulates ionic transport in saturated/unsaturated, isothermal/non-isothermal cementitious materials. STADIUM® simulates the ingress of the contaminants and leaching of the ionic species in the pore solution, and the modifications to the microstructure of the cementitious material, e.g. formation of Friedel's salt, portlandite dissolution, C-S-H decalcification, ettringite and gypsum formation.

The model is based on a Sequential Non Iterative Algorithm (SNIA) that separately solves the transport equations and the chemical equilibrium relationships (Figure 35). The transport equations (i.e., mass conservation equations for the species, moisture flow, thermal conduction, and electrodiffusion coupling) are discretized using the finite element method and solved simultaneously using a coupled algorithm.

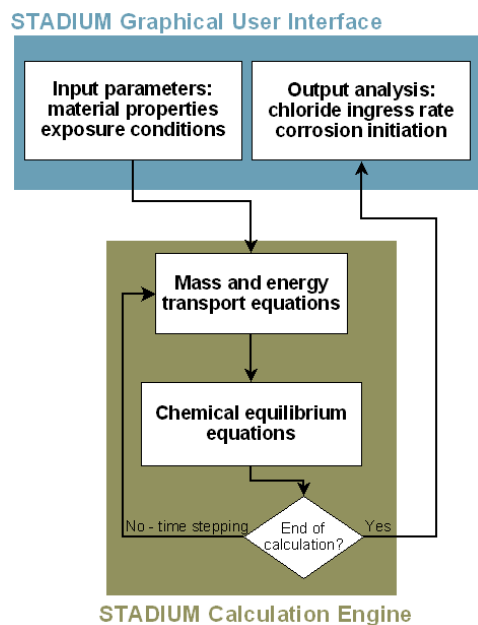

Figure 35 - General overview of STADIUM®

Although the model can address many different ionic transport cases, it focuses mainly on the ingress of chloride in concrete structures and the initiation of corrosion when it reaches

the steel reinforcement, as this corresponds to the core business of SIMCO. However, the model can be used without the interface to solve other types of problems.

The model was designed specifically for cementitious materials. Since the pores of hydrated cement pastes are filled with a high pH, high alkaline solution and that typical exposure cases involve highly concentrated solutions (e.g., seawater, deicing salts), the model takes into account the electrical coupling between the ions and chemical activity gradients. Also, the model focuses on the dissolution/precipitation chemical reactions due to the high reactivity of the paste. The formation of secondary species through complexation is not considered in the current version of the model.

Details relative to the multiionic reactive transport equations forming STADIUM® can be found in references (Samson 2007a, Samson 2007b) and will not be repeated here. The model already incorporates the moisture transport model presented in section 7.2. What needed to be modified within the context of the present study is the use of the new relative permeability parameters presented in equation (35).

8.2 Comparison with experimental data

The model was tested against the chloride profiles measured on samples constantly immersed in sodium chloride solutions and exposed to wetting and drying cycles. In order to perform calculations, STADIUM® needs the following inputs:

- Material properties: tortuosity, permeability, cement/admixtures composition, initial hydrated cement paste composition, initial pore solution, and hydration rate.
- Boundary conditions: temperature, relative humidity, and ionic concentrations of the environment. The model offers functions to provide time-dependent exposure conditions. An average of 60% RH was used to simulate lab conditions.

The transport properties were presented in section 6, except the moisture parameters, which were detailed in section 7.2. Those same data were used here to perform the simulations. The first simulations results are presented on Figure 36, and show the model output for chloride ingress in the 0.4 w/c OPC mix for fully immersed conditions after 6 months of exposure to a 3% sodium chloride solution. The migration test results and measured profiled from this specific mixture showed a benefit of using Hycrete® as it translated in lower diffusion coefficients (see section 6.4). This is captured correctly by the model as the profiles from both data sets are reproduced accurately.

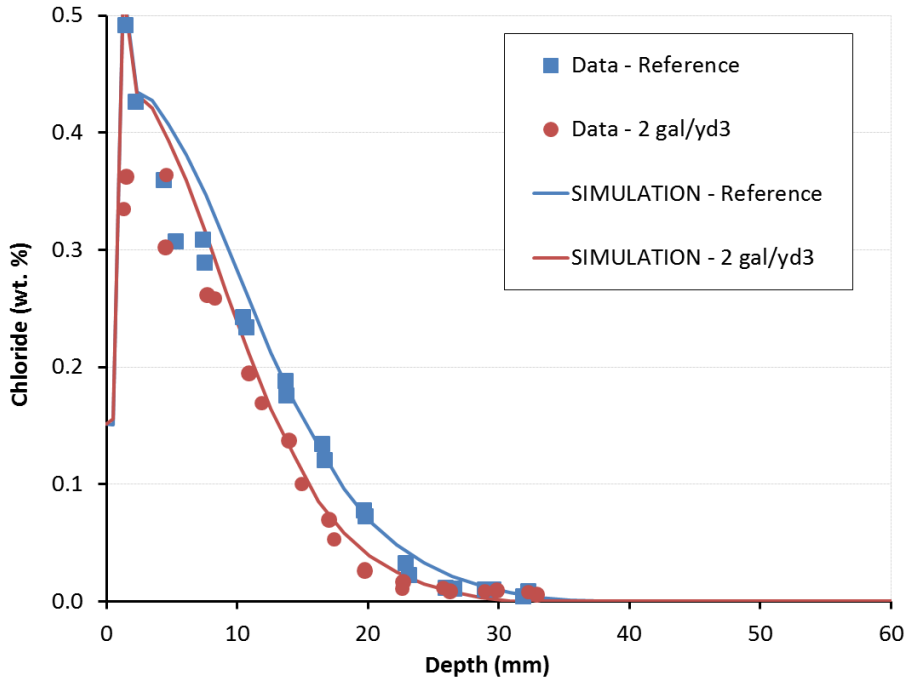

Figure 36 - Simulation of chloride ingress in the 0.4 w/c OPC mix after 6 months - Immersed conditions

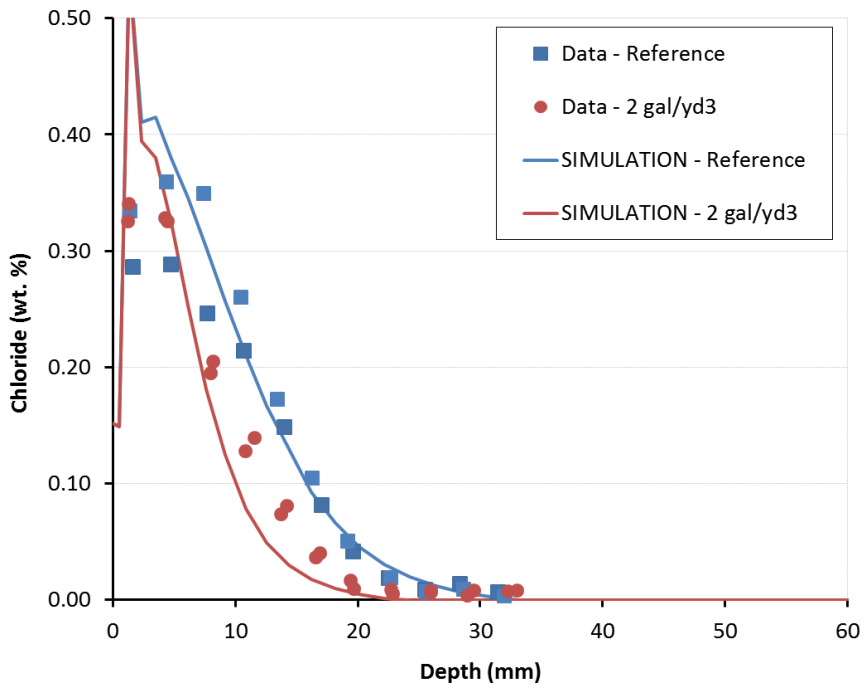

Figure 37 - Simulation of chloride ingress in the 0.4 w/c OPC mix after 6 months - Wetting/drying conditions

The next figure (Figure 37) show profiles from the same mixture exposed this time to wetting and drying cycles. This is where Hycrete® was shown to have a truly beneficial effect, as it dramatically slows down water absorption rate after a drying sequence. This leads to a drop in measured chloride ingress, and the model also captures this effect as the numerical results from the Hycrete® mix exhibit a lower chloride penetration depth, compared to the reference mixture. The results on Figure 37 show that the model tends to overestimate the impact of Hycrete®. One possible reason for this is the relationship that handles the effect of saturation on diffusion coefficients. In STADIUM®, this relationship is represented by a power function:

$$D(S) = D_{\text{sat}}[S^n] \quad (36)$$

where D_{sat} represent the diffusion coefficients measured in saturated conditions, on the basis of the migration test. Using data found in the literature (Larsen 2006), the exponent n of the power function was set at 7.0. The same function was used on reference and Hycrete® mixes. But given the impact Hycrete® has on moisture transport, there is a strong possibility that this function is affected by the admixture. This topic was not addressed in the present study.

8.3 Long-term simulations

Using the material parameters of the 0.4 w/c OPC mixes presented in the previous section (reference and 2 gal/yd³), theoretical simulations of chloride ingress in a marine structure were performed. The case study is illustrated on Figure 38. It consists in a 1-m thick vertical cope wall exposed to seawater, in the tidal zone. The wetting and drying cycles are modeled by 6 hours of drying at 70% RH, followed by 6 hours in direct contact with seawater. The chemical composition of seawater is given in Table 16.

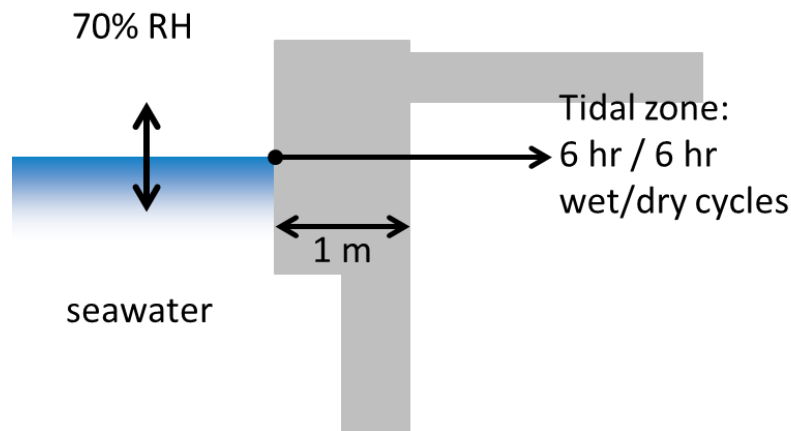

Figure 38 - Test case for the long-term simulations

Table 16 - Seawater composition for the case study

Species	Concentration (mmol/L)
Cl ⁻	546.2
Na ⁺	466.0
K ⁺	9.8
SO ₄ ²⁻	28.0
Mg ²⁺	53.1
Ca ²⁺	10.1

The simulation results clearly highlight the beneficial impact Hycrete® can have over the long term in a structure exposed to wetting and drying cycles. The chloride profiles predicted after 50 years are shown on Figure 39 and highlight a much lower penetration rate for the Hycrete® mixture. This is also emphasized on Figure 40, which shows the chloride content over time for a cover depth of 60 mm (~2.5 in.). Based on a chloride threshold of 1.24% per weight of cement (Henocq 2012), or approximately 0.2% per weight of dry concrete for the mixtures considered in this study, rebars under this concrete cover would start corroding after 12 years for the reference mixture, compared to 37 years for the Hycrete® material.

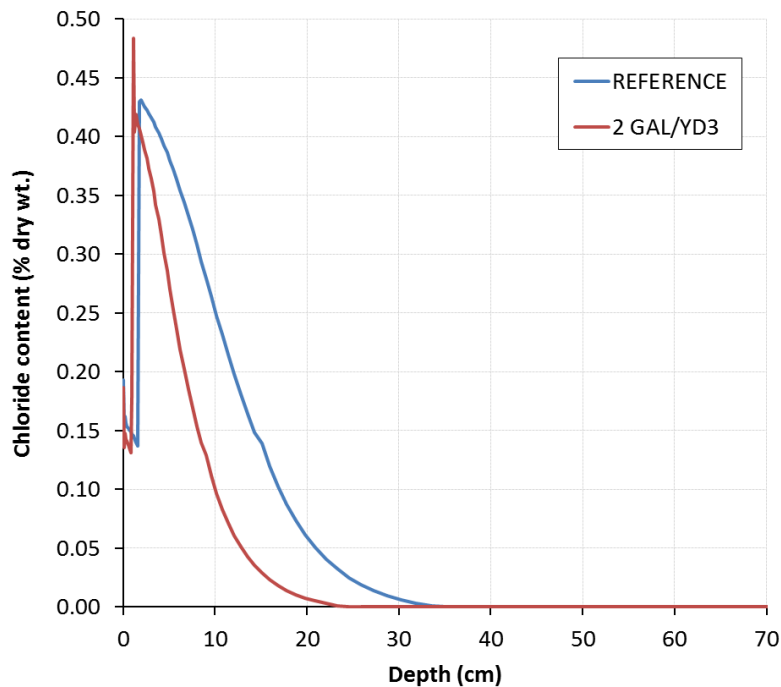

Figure 39 – Chloride profiles in the cope wall after 50 years in the tidal zone

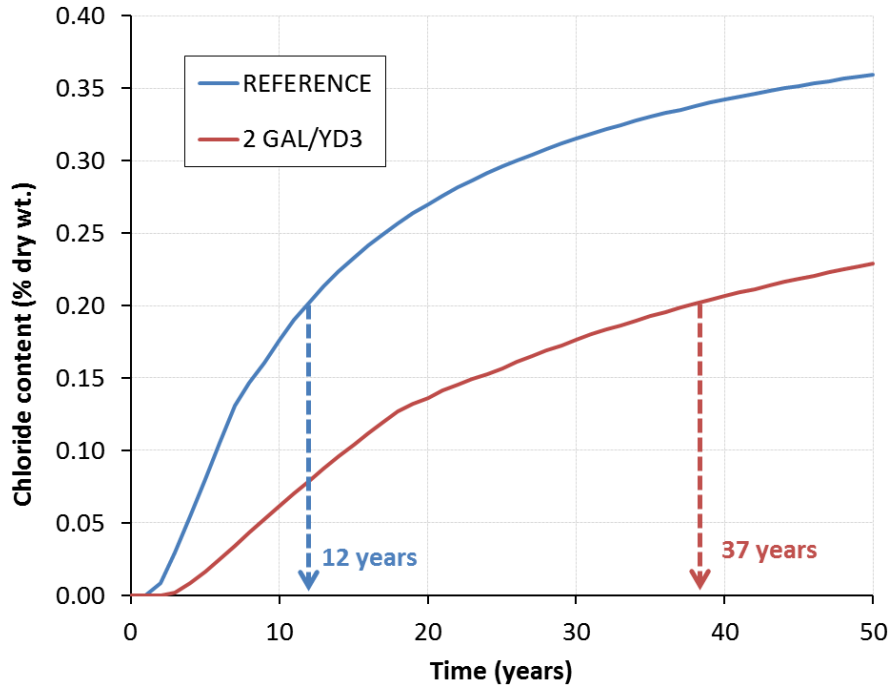

Figure 40 - Chloride content vs. time for a cover depth of 60 mm

The simulations also provide information on the saturation level inside the materials after 50 years, as shown on the next plot. Having a lower water absorption rate, the repeated wetting and drying cycles tend to dry the Hycrete® mixture. In comparison, the reference material, with its high absorption rate, can reabsorb the water it lost after 6 hours of drying during low tide. Overall, this material remains almost saturated, according to the numerical simulations.

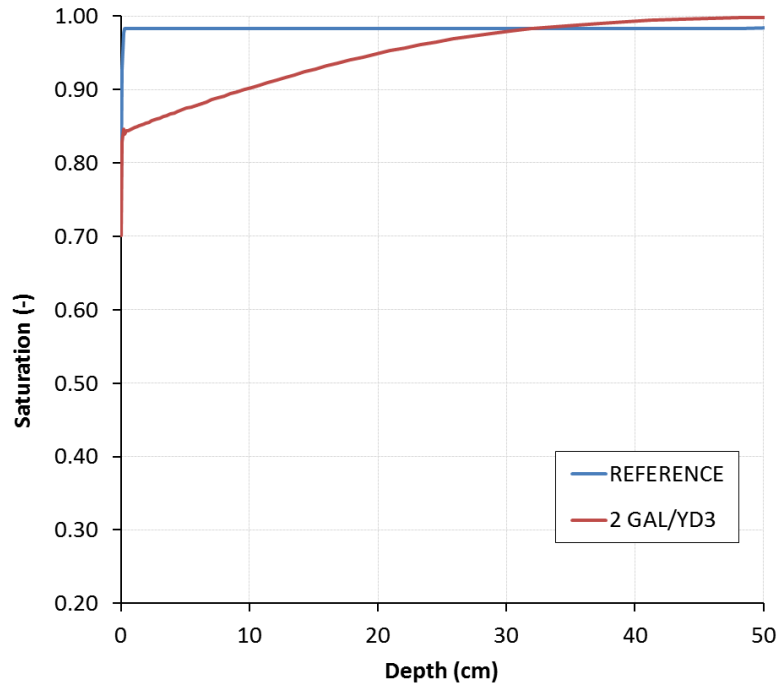

Figure 41 - Saturation levels in the cope wall after 50 years in the tidal zone

9 Conclusion

This report presented the main results of a study dedicated to the impact of the Hycrete® damproofing admixture on chloride ingress.

The first part of the study was dedicated to an experimental program aimed at gathering information on the effect this admixture has on different material properties. The tests were performed on three different concrete mixtures, and each mix was prepared with 0 (reference case), 1 and 2 gal/yd³ of admixture.

The results showed that Hycrete® has no effect on some properties. According to the results, compressive strength and total pore volume were not affected by the presence of the product in the mix. In most cases, the same could be said for diffusion coefficients. However, one mixture (0.4 w/c OPC) showed a positive effect of Hycrete®; increasing the amount of admixture contributed to lower the diffusion coefficients for this particular mix. This was confirmed by ponding tests in immersed conditions.

The tests associated with moisture transport showed beneficial effect when Hycrete® was considered. In this case, the presence of the damproofing agent was shown to mildly affect drying rates but clearly lowered water absorption rates. However, using 2 gal/yd³ of Hycrete® instead of 1 gal/yd³ did not prove effective. The absorption rates, although clearly much lower than those measured on a comparable reference mixture, were mostly the same for the two dosages. Also, the tests showed slightly reduced drying rates when more Hycrete® was used, thus contributing to keep more humidity in the material.

An unusual effect of the admixture was to yield similar drying rates when test specimens were exposed to 50% and 75% relative humidity conditions. The reference mixes all behaved as expected: the drying rates were higher for samples exposed to lower RH.

Based on this information, a moisture transport model developed by SIMCO was modified to account for Hycrete®. This was achieved by proposing a new relationship to model the relative permeability parameter. Using this new relationship in combination with a lower permeability allowed reproducing the results of drying/wetting experiments.

This relationship was then implemented in the complete STADIUM® model. It was possible to reproduce measured chloride profiles in samples exposed to wetting/drying cycles in sodium chloride solutions. The experimental results showed that a mixture prepared with Hycrete® and exposed to exposure cycles exhibits a lower chloride ingress rate. The model results were in line with those experimental observations.

Finally, the model was used to simulate the long-term effect of Hycrete® in the tidal zone of a marine structure. After 50 years, it was shown that chloride profiles in a mixture incorporating Hycrete® would extend much less deeper than in a comparable reference mix.



The direct consequence would be to significantly increase the time before rebar corrosion is initiated, thus positively contributing to the durability of the concrete structure.

10 References

ASTM C39/C39M-09a Standard Test Method for Compressive Strength of Cylindrical Concrete Specimens

ASTM C642-06 Standard Test Method for Density, Absorption, and Voids in Hardened Concrete

ASTM C1543-10 Standard Test Method for Determining the Penetration of Chloride Ion into Concrete by Ponding

Bary B., Ranc G., Durand S., Carpentier O. (2008) A coupled thermo-hydro-mechanical-damage model for concrete subjected to moderate temperatures, *Int. J. Heat Mass Transfer* 51, 2847-2862.

Bear J. (1988) *Dynamics of fluids in porous media*, Dover Publications (New-York, USA).

Bear J., Bachmat Y. (1991) *Introduction to Modeling of Transport Phenomena in Porous Media*, Kluwer Academic Publishers (The Netherlands).

Bolton D. (1980) The computation of equivalent potential temperature, *Monthly Weather Review* 108, 1046-1053.

Brouwers H.J.H., van Eijk R.J. (2003) Alkali concentrations of pore solution in hydrating OPC, *Cement and Concrete Research* 33, 191-196.

Chijimatsu M., Fujita T., Kobayashi A., Nakano M. (2000) Experiment and validation of numerical simulation of coupled thermal, hydraulic and mechanical behavior in the engineered buffer materials, *Int. J. Num. An. Meth. Geomechanics* 24, 403-424.

Constantz J. (1982) Temperature dependence of unsaturated hydraulic conductivity of two soils, *Soil Sci. Soc. Am. J.* 46, 466-470.

Galbraith G.H., McLean R.C., Kelly D. (1997) Moisture permeability measurements under varying barometric pressure, *Building Research and Information* 25, 348-353.

Glasser F.P., Marchand J., Samson E. (2008) Durability of concrete – Degradation phenomena involving detrimental chemical reactions, *Cement and Concrete Research* 38,

Hall C. (1994) Barrier performance of concrete: A review of fluid transport theory, *Materials and Structures* 27, 291-306.

Hall C., Hoff W.D. (2002) *Water transport in brick, stone and concrete*, Spon Press (New-York, USA).

Handbook of Chemistry and Physics (1985-86) CRC Press, (Boca Raton, USA), 66th ed.

Henocq P., Samson E., Marchand J. (2012) Characterizing the initiation and propagation of steel corrosion in the presence of chloride ions, in Proc. of the Int. Congress on Durability of Concrete, Justness et al. eds. (Trondheim, Norway).

Kaviany M. (1995) Principles of heat transfer in porous media, Springer (New-York, USA), 2nd ed.

Kolhapure N.H., Venkatesh K.V. (1997) An unsaturated flow of moisture in porous hygroscopic media at low moisture contents, Chemical Engineering Science 52, 3383-3392.

Krus M. (1996) Moisture transport and storage coefficients of porous mineral building materials - Theoretical principles and new test methods, Fraunhofer IRB Verlag (Stuttgart, Germany).

Laliberté M., Cooper W.E. (2004) Model for calculating the density of aqueous electrolyte solutions, J. Chem. Eng. Data 49, 1141-1151.

Larsen C.K., Sellevold E.J., Askeland F., Ostvik J.M., Vennesland O. (2006) Electrical resistivity of concrete, Part II: Influence of moisture content and temperature, in Proc. Int. Symp. Advances in Concrete through Science and Engineering, Marchand et al. eds. (Quebec City, Canada).

Li Y.H. (1974) Diffusion of ions in sea water and in deep-sea sediments, Geochimica and Cosmochimica Acta 38, 703-714.

Marchand J., Samson E. (2009) Predicting the service-life of concrete structures – Limitations of simplified models, Cement and Concrete Composites 31, 515-521.

Millington R.J., Quirk J.P. (1961) Permeability of porous solids, *Transactions of the Faraday Society* 57, 1200-1207.

Miyata T., Endo A., Ohmori T., Akiya T., Nakaiwa M. (2003) Evaluation of pore size distribution in boundary region of micropore and mesopore using gas adsorption method, Journal of Colloid and Interface Science 262, 116-125.

Obeid W., Alliche A., Mounajed G. (2001) Identification of the physical parameters used in the thermo-hygro-mechanical model (application to the case of cement mortar), Transport in Porous Media 45, 215-239.

Pel L., Hazrati K., Kopinga K., Marchand J. (1998) Water absorption in mortar determined by NMR, Magnetic Resonance Imaging 16, 525-528.

Philip J.R., de Vries D.A. (1957) Moisture movement in porous materials under temperature gradients, Transactions of the American Geophysical Union 38, 222-232.

Robinson R.A., Stokes RH (2002) *Electrolyte solutions*, 2nd ed., Dover Publications (New-York, USA).

Samson E., Marchand J. (2007a) Modeling the transport of ions in unsaturated cement-based materials, *Computers and Structures* 85, 1740-1756.

Samson E., Marchand J. (2007b) Modeling the effect of temperature on ionic transport in cementitious materials, *Cement and Concrete Research* 37, 455-468.

Samson E., Henocq P., Marchand J., Beauséjour P. (2008) "Recent advances in the determination of ionic diffusion coefficients using migration test results", *RILEM Proceedings 58-CONMOD 2008*, E. Schlangen and G. de Schutter eds. (Delft, The Netherlands) pp. 65-78.

Samson E., Maleki K., Marchand J. and Zhang T (2008b) "Determination of the Water Diffusivity of Concrete using Drying/Absorption Test Results", *Journal of ASTM International*, Vol. 5, No. 7 (Available online at www.astm.org)

Sercombe J., Vidal R., Gallé C., Adenot F. (2007) Experimental study of gas diffusion in cement paste, *Cement and Concrete Research* 37, 579-588.

Whitaker S. (1986) Flow in porous media I: A theoretical derivation of Darcy's law, *Transport in Porous Media* 1, 3-25.

Whitaker S. (1988) Coupled transport in multiphase systems: a theory of drying, in *Advances in Heat Transfer* 31, J.P. Hartnett et al. eds. (Academic Press, USA) 119-203.

A. Migration Test Procedure

Theoretical background

The STADIUM® IDC laboratory module is used to analyze migration test results and estimate the diffusion coefficients of cementitious materials. It is based on the same mass transport model that powers the full version of STADIUM®.

The mathematical model has been described in several publications (see for instance Samson 2007a, Samson 2007b). Development specific to the migration test analysis has been presented in (Samson 2008). This chapter summarizes the model and its application to migration test analysis.

The model is based on a Sequential Non Iterative Algorithm (SNIA) that separately solves the transport equations and the chemical equilibrium relationships. The transport equations are discretized using the finite element (FE) method and solved simultaneously using a coupled algorithm. The calculation core begins a time step by solving the transport conservation equations without considering chemical reactions. When this step has converged, the chemical function analyzes each node of the FE mesh and makes sure that the pore solution concentrations and the mineral phases are in equilibrium. When this is completed, another time step starts.

There are four main components to the transport conservation equations: ionic transport, electrodiffusion potential, moisture transport and temperature (energy) conservation. Since migration tests are performed in constant temperature and saturated conditions, terms associated moisture transport and temperature gradients are neglected from the test analysis. The species mass conservation equation is written as:

$$\rho \frac{\partial c_i^b}{\partial t} + \frac{\partial(\phi c_i)}{\partial t} - \text{div} \left(D_i \phi \text{grad}(c_i) + \frac{D_i z_i F \phi}{RT} c_i \text{grad}(\psi) + D_i \phi c_i \text{grad}(\ln \gamma_i) \right) = 0 \quad (\text{A1})$$

where c_i is the concentration of species i [mmol/L], c_i^b is the amount bound as a result of physical interaction [mol/kg], ϕ is the porosity [m^3/m^3], ρ is the density of the material [kg/m^3], D_i is the diffusion coefficient [m^2/s], z_i is the valence number of the ionic species i , F is the Faraday constant [96488.46 C/mol], ψ is the electrodiffusion potential [V], R is the ideal gas constant [8.3145 J/mol/°K], T is the temperature [°K], and γ_i is the activity coefficient. One such equation must be solved for each ionic species considered. The activity coefficients in the model are evaluated on the basis of the Harvie, Moller and Weare (HMW) implementation of Pitzer's ion interaction model.

As mentioned previously, chemical reaction terms are absent from the transport equations because they are solved separately by the chemical module. However, terms are included in

the previous equation to take into account the physical interaction between the paste and chloride due to double layer effects. The physical binding term was estimated from binding experiments performed on hydrated C_3S pastes exposed to different chloride concentrations. This term is zero for all ionic species except chloride, for which c_{Cl}^b is given by:

$$c_{Cl}^b = \xi p c_{Cl}^u \quad (A2)$$

where ξ is a conversion factor involving the amount of C-S-H in the material that converts the isotherm estimated in units of $[\text{mol}_{Cl}/\text{kg}_{dry C_3S}]$ into $[\text{mol}/\text{kg}_{material}]$, and p and u are fitting parameters. The binding experiments were performed at two different pH conditions: $[\text{OH}^-] = 40 \text{ mmol/L}$ and 435 mmol/L . A linear interpolation between these two hydroxide concentrations allows estimating the physical binding at any pH. To balance the charges, a similar term but opposite in sign is applied to OH^- .

The electrodiffusion term in the species conservation equation is primarily responsible for maintaining the electroneutrality in the pore solution. Its role is to balance individual ionic mobility so that there is no net accumulation of charge at any location in the pore solution. This term also accounts for the driving force induced by the external potential applied during the migration test. To solve the diffusion potential, the ionic transport equations are coupled to Poisson's equation, which relates the potential in the material to the ionic profile distributions:

$$\text{div}(\tau_s \text{grad}(\psi)) + \frac{F}{\varepsilon} \left(\sum_{i=1}^N z_i c_i \right) = 0 \quad (A3)$$

where ε [$6.9 \times 10^{-10} \text{ C/V/m}$] is the permittivity of water, τ_s is the intrinsic tortuosity of the material [m/m] and N is the number of ionic species in the pore solution.

Chemical equilibrium calculations follow transport calculations to enforce the equilibrium between the pore solution and the solid matrix at each node of the FE mesh. This is achieved mainly by precipitating and/or dissolving minerals. It is assumed that the chemical reaction rates are faster than the transport rate, even under an externally applied potential. The validity of this assumption was emphasized in (Samson 2008)). The equilibrium of each phase is modeled according to:

$$K_m = \prod_{i=1}^N c_i^{v_{mi}} \gamma_i^{v_{mi}} \quad \text{with} \quad m = 1, \dots, M \quad (A4)$$

where M is the number of solid phases, N is the number of ions, K_m is the equilibrium constant (or solubility constant) of the solid m , c_i is the concentration of the ionic species i

[mmol/L], γ_i is its chemical activity coefficient, and ν_{mi} is the stoichiometric coefficient of the i th ionic species in the m th mineral. Similar to the transport equations, the chemical activity coefficients are calculated using Pitzer's interaction model. If the solution is not in equilibrium with the paste, solid phases are either dissolved or precipitated to restore equilibrium. The pore solution is thus adjusted to enforce the equilibrium relationships of the mineral phases. After the pore solution concentrations are modified, the solid phases are also corrected according to:

$$S_m^t = S_m^{t-1} - \frac{\phi X_m \Gamma_m}{\rho} \quad (\text{A5})$$

where S_m is the amount of a given solid phase [g/kg of material], t indicates the time step, Γ_m is the molar mass of the solid m [g/mol], and X_m represent the amount of a given solid phase that has to dissolve to reach equilibrium [mol/m³].

The penetration of chlorides in concrete structures leads to the formation of a chloride-AFm solid compound called the Friedel's salt (Glasser 2008), $3\text{CaO} \cdot \text{Al}_2\text{O}_3 \cdot \text{CaCl}_2 \cdot 10\text{H}_2\text{O}$. During migration tests, chloride interacts with the paste even though the externally applied potential significantly increases the ionic velocity in the pore solution. In STADIUM®, Friedel's salt is not considered a pure phase but rather forms solid solutions with AFm phases: monosulfate and iron-based C_4FH_{13} . The equilibrium relationship for the solid solution is given by:

$$K_{ss} = \frac{(\text{Cl})^2}{(C_{ss})^{2/|z|}} \frac{\chi_{ss}}{\chi_{\text{Friedel}}} f_{ss} \quad (\text{A6})$$

where K_{ss} is the equilibrium constant of the solid solution, (Cl) is the activity of chloride in the pore solution [mmol/L], (C_{ss}) is the activity of the exchanging species in the AFm end-member [mmol/L], z is the valence number of this species, χ represents the mole fraction of the solids [mol/kg of material], and f_{ss} is a correction factor that accounts for the nonideality of the solid solution.

The diffusion coefficients in the mass conservation equation are expressed as:

$$D_i = \tau_s D_i^o \quad (\text{A7})$$

where τ_s is the intrinsic tortuosity of the material and D_i^o is the self-diffusion coefficient of species i [m²/s]. The self-diffusion coefficients are found in many textbooks and are constant. STADIUM® IDC performs iterations until it finds the tortuosity that allows reproducing the measured currents. The current I [A] are calculated in the model as the sum of the ionic fluxes:

$$I = SF \sum_{i=1}^N z_i j_i \quad (A8)$$

where j_i [mol/m²/s] is the ionic flux of species i , and S [m²] is the surface of the sample. The expression for the flux is:

$$j_i = -D_i \phi \text{grad}(c_i) - \frac{D_i z_i F \phi}{RT} c_i \text{grad}(\psi) - D_i \phi c_i \text{grad}(\ln \gamma_i) \quad (A9)$$

The next figures show examples of IDC simulations:

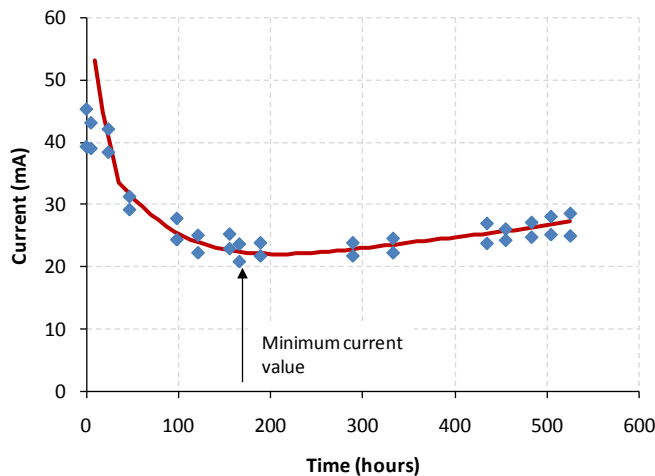

Figure 42 - Simulation of migration test measurements 0.45 w/c OPC mixture, ASTM Type I/II cement

Detailed experimental procedure

1.1 Scope

This test evaluates the diffusion coefficient of ion species in cementitious materials. It is a modified version of the AASHTO T259 and ASTM C1202 Standard Test procedures.

1.2 Summary of Test Method

The test method consists in monitoring the intensity of electrical current passed through a cylindrical test specimen over a 10 to 15-day testing period. An appropriate DC potential is maintained constant across the specimen by an electrical power supply. The upstream cell is filled with a chloride-containing electrolytic solution and connected to the negative electrode, while the downstream cell is filled with a base solution and connected to the positive electrode. If desired, chloride ion penetration through the specimen can be monitored by periodically analyzing the chloride content in the downstream cell.

1.3 Significance and use

- The ion diffusion coefficients are the main transport parameters. These coefficients must be evaluated and input into STADIUM® in order to perform a numerical simulation to estimate the service life of a concrete structure.
- The output data are the recorded current intensities during testing. This information is required to evaluate the ion diffusion coefficients.

1.4 Apparatus and test cells

- Migration cell assembly [See Section 1.10]
- Constant voltage power supply – output: 0-30V DC; capacity: 0–2 A
- Digital voltmeter: measures DC potential in the 12–24 V range and current intensity to 0.1 mA accuracy in the 0–200 mA range and to 0.01 a accuracy in the 0.2–1 A range.
- Electrically conductive wires to connect the power supply output to the electrodes through jacks attached to the test cells. The electrical resistance of each wire should be less than 0.01 ohm.
- Measuring probes inserted through small holes in the cells to measure potential difference across the specimen. One end of the probe connects to the jack on the voltmeter.
- Vacuum saturation apparatus (vacuum pump, container, pressure gauge, etc.)
- Specimen sizing apparatus (rulers)
- Balance (repeatability: 0.01g)
- Funnel and containers (made of chemical-resistant material).

1.5 Reagents and materials

- Aqueous solution of 0.5M sodium chloride (NaCl) mixed with 0.3M sodium hydroxide (NaOH) [See Section 1.10]
- Aqueous solution of 0.3 M sodium hydroxide (NaOH) [See Section 1.10]
- Sealant: waterproof silicon sealant is recommended.
- Distilled or deionized water for solution preparation.

1.6 Test specimens

Cylindrical specimens are required for the test. It is recommended to test at least two samples per concrete mixture. Specimens should be 96–102 mm (i.e., approximately 4 in.) in diameter. Concrete specimens should be 50 ± 2 mm (2 in.) thick. Mortar specimens should be 35–50 mm thick. Sample preparation and selection depend on the purpose of the test. Test specimens may be obtained from laboratory-cast cylinders or cores extracted from existing structures. All specimens should be properly identified prior to testing. A companion sample is needed for porosity measurement according to ASTM C642 Standard Test Method. This supplementary test provides data for migration test analysis. For relevant results, these additional samples should have identical histories (curing, exposure conditions, and storage conditions) to the testing samples.

1.7 Specimen Conditioning

Test specimens should be vacuum saturated with 0.3M NaOH for approximately 18 hours following the procedure described in ASTM C1202. The saturation procedure is summarized as follows: immerse the specimens in the 0.3M NaOH solution contained in the vacuum container. Turn on the vacuum pump. When the pressure gauge shows maximum vacuum pressure (less than 1 mm Hg, or 133 Pa), keep the pump running for about 2 hours. With all valves closed, turn off the pump and maintain vacuum conditions for 18 hours. Open the air valve to release the pressure.

1.8 Test Procedure

- Dry the surfaces of the vacuum-saturated specimens with a clean cotton cloth or soft tissue.
- Measure the dimensions of each specimen. Diameter and thickness should be measured to a precision of at least 0.1 mm or better. Each parameter is determined by the average of 2 measurements (minimum) at different positions. Weigh the surface-dried specimen to a precision of 0.1g.
- Seal and mount each specimen onto the two connecting rings (See Section 1.10) using silicon, and completely coat all side surfaces with silicon (about 2–3 mm thick, Figure 43).
- Place the specimens in a well-ventilated area and cover the exposed surfaces with wet paper for about 2 hours until the silicon is almost dry and strong enough for handling.
- Remove any surplus silicon from the inner surface of the specimen along the ring edges to obtain maximum exposure surface. Make sure to minimize contamination of the exposed surfaces by silicon (Figure 43).
- Measure the diameter of the specimen's actual exposure area using two measurements at different positions across the radial section. This diameter should be approximately equal to the ring mouth diameter.
- Mount the specimen and the two rings onto the two cells (Figure 44). To avoid leakage, apply vacuum grease where the ring assembly comes into contact with the cells. Securely tighten the bolts holding the two cells together. Cells should be filled with water alternatively to verify that there is no leakage. After this control step, empty the water from the cells and remove surplus water with a soft tissue.
- Fill the downstream cell with 0.3M NaOH solution.
- Fill the upstream cell with 0.5M NaCl + 0.3M NaOH solution.
- Place the setups in their testing sites and connect all the electrodes on the upstream cells to the negative output of the electricity power supply. Connect all the electrodes on the downstream cells to the positive output of the power supply (Figure 44).
- Turn on the power supply. Adjust the potential output to obtain a potential difference of 16–20 V across all specimens. Potential difference across the specimen is measured with two bent probes. Connect the two probes into the voltmeter (plug in the jacks), set the proper range for the voltmeter (e.g., 0–20 V), insert the probes into the cells through the holes in the cells, and place each probe in contact with the surface of the immersed specimen. Wait for the reading to stabilize, then record the voltmeter reading (**Note:** the potential difference across the specimen is 2–3 volts lower than the output as shown on the power supply or measured from the two electrodes of the cells).
- Measure the current passing through each specimen.

- If the current is in 5–100 mA range, the potential level has been properly set. Record the initial readings of the current intensity (to 0.1 mA accuracy) and the potential across the specimen (to 0.1 V accuracy). Record the date and time, the name of the technician performing the measurement and the digital voltmeter used.
- If the current passing through the specimen is below 5 mA, increase the output potential up to a maximum of 30 V to obtain a current in the proper range.
- If the current is above 100 mA, decrease the potential output to bring the current down to the proper level (i.e., lower than 70 mA).
- If the initial current under a low potential (e.g., 6 V) is higher than 100 mA, the test should be performed for 7-day period only.
- A single power supply can run a set of tests if they share the same potential output. The maximum number of tests depends on the supply output power and total current intensity. When tests share the same power supply, set the supply current control to maximum range to ensure a sufficient power output under the desired constant potential. During testing, both current intensity passing through the specimen and the potential difference across the specimen might vary within a certain range, even though the electrical output remains stable and constant.
- During the first day of testing, take measurements of the current intensity passing through each specimen and the potential difference across each specimen at 0, and 4 hours of duration respectively. Record the time of each measurement.
- After the first day, take measurements of the current passing through each specimen and the potential difference across each specimen at 24-hour time intervals for 14 days. Record the time of each of these measurements.

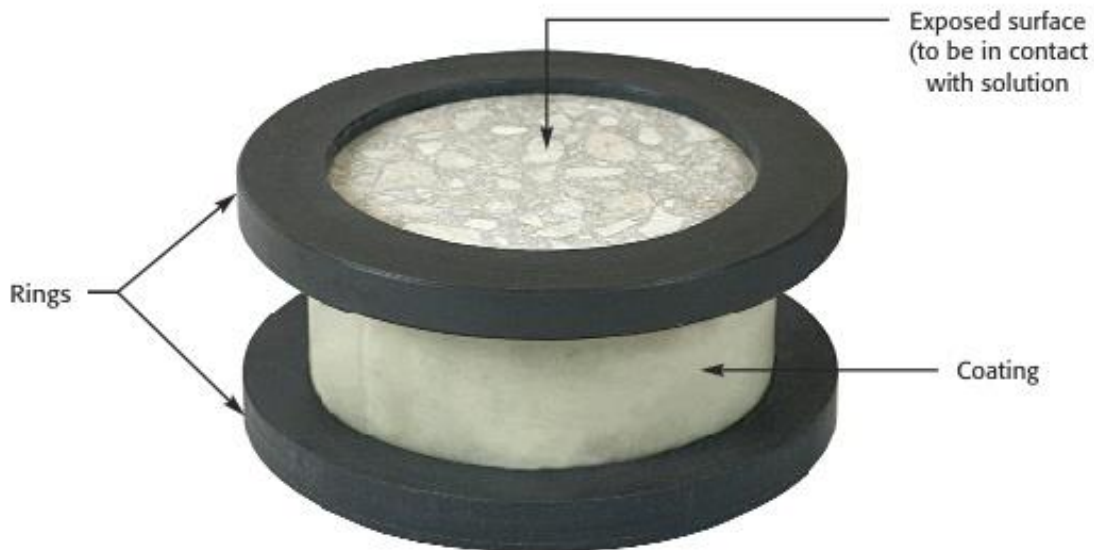

Figure 43 - Test specimen sealed and mounted onto the two rings and coated with silicon

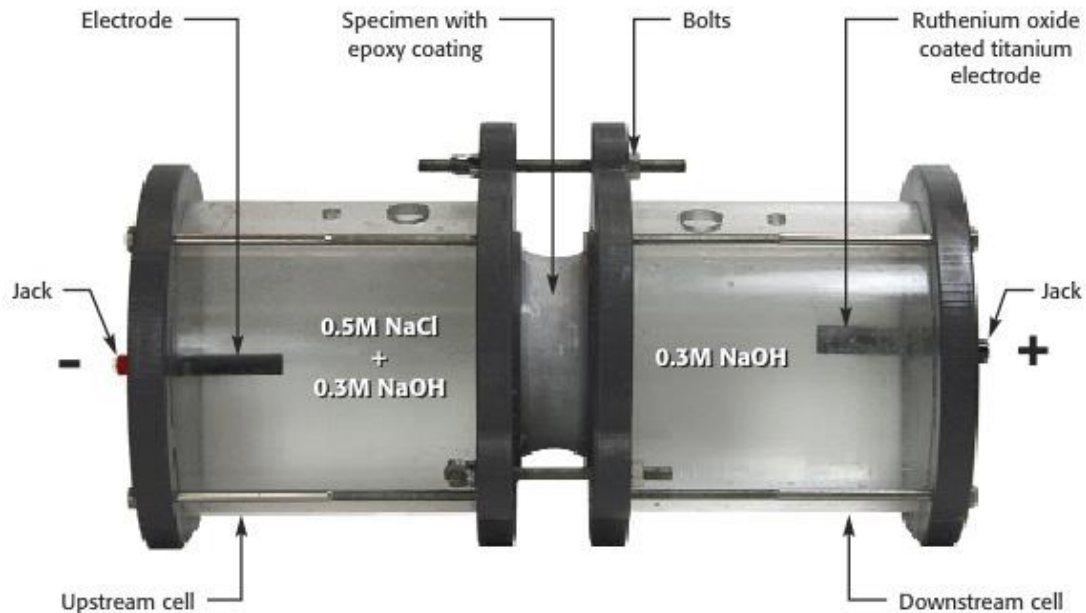

Figure 44 - Migration test setup

1.9 Report

Report the following, if known:

- Information on the specimens: origin (e.g., mixture ID and curing age of the concrete), dimensions, mass before and after vacuum saturation, and effective test exposure area (diameter) for both upstream and downstream sides.
- Porosity test results for companion samples.
- Experimental record sheet, including test specimen IDs, test conditions, date and time of each measurement, all potential readings across specimens, and currents passed through specimens for the entire testing period.
- Any abnormal phenomena observed during testing, such as changes in solution color, solution precipitation, excessive gas evolution from the electrodes, unusual odors, accidents or problems concerning the electricity supply, etc.

1.10 Additional information

Migration Cell Assembly

Cells

The migration test cells consist of two symmetrical chambers made of polymer materials (e.g., methyl methacrylate). Each cell is equipped with an electrode (see below) and an external connector (jack). The volume of each cell should be approximately 3 liters. The mouth of the cell should fit the connecting ring (Figure 45).

Connecting Rings

Two connecting rings are required for the test setup. The ring should be made of polymer materials and designed to hold the specimen from one side and connected to the cell from the other side. The exposure area should be as large as possible. A typical design for a 4-in. cylindrical specimen is shown in Figure 45.

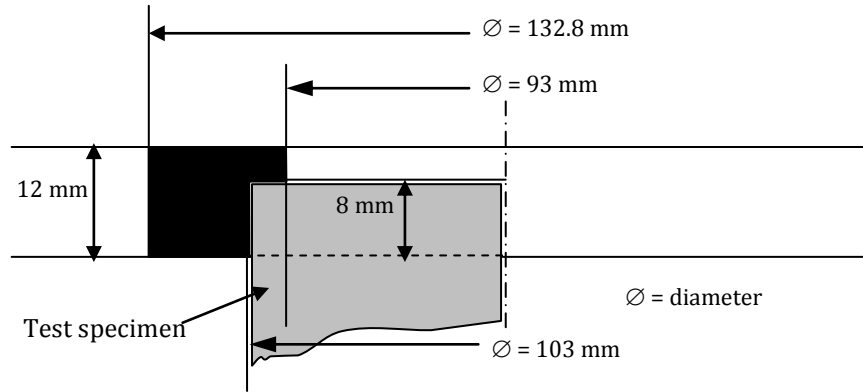

Figure 45 - Connecting ring for 4-in. specimen (96-103 mm)

Electrodes

A rod electrode is installed on each cell. Carbon electrodes should be avoided because they tend to decompose in the electrolytic solution under the application of a DC potential. Electrodes made of titanium or ruthenium oxide with titanium coating are recommended. Each electrode should be securely connected to the external connector by the jack (Figure 44).

Solution preparation

The following procedure describes the preparation of the aqueous solutions:

- Accurately weigh the salt or base (e.g., NaCl or NaOH) of high purity (>99%) to at least 0.001 g accuracy (refer to Table 17).
- Completely dissolve the salt or base into a certain amount of distilled or deionized water.
- Dilute with more distilled or deionized water to a final volume of desired range.
- Thoroughly stir the solutions to obtain homogeneity.

Table 17 - Chemical composition of 1-liter (1000 ml) solutions

Salt /Base (purity: 99%)	Upstream solution (salt): 0.5M NaCl + 0.3M NaOH	Downstream solution (base): 0.3M NaOH
NaOH (g/liter)	12.121	12.121
NaCl (g/liter)	29.515	0

B. Drying Test Procedure

Theoretical background

The STADIUM® MTC laboratory module uses the moisture transport model in STADIUM® to analyze drying test results and evaluate the intrinsic permeability of the material as well as the moisture retention (desorption isotherm) function.

The moisture transport equation combines the mass conservation of liquid and vapor phases in a single expression based on the relative humidity state variable. Since the drying test is performed in isothermal conditions, terms associated with temperature variations are not considered. The mass conservation equation is given by:

$$\frac{\partial w}{\partial H} \frac{\partial H}{\partial t} - \text{div}(D_{mH} \text{grad}(H)) = 0 \quad (\text{B1})$$

where H is the relative humidity [Pa/Pa], w is the water content [m^3/m^3] and the parameter D_{mH} [m^2/s] is the nonlinear transport coefficients. The nonlinear transport parameter D_{mH} considers the contribution of liquid and vapor phases:

$$D_{mH} = \frac{k_s k_r^l \rho_l R T}{\mu M_w H} + \frac{D_v^o \tau_s \tau_r^g M_w p_v^s (\phi - w)}{\rho_l R T} \quad (\text{B2})$$

where ϕ is the porosity [m^3/m^3], k_s is the intrinsic permeability [m^2], k_r^l is the relative liquid permeability [m^2/m^2], ρ_l is the liquid water density [kg/m^3], R is the ideal gas constant [$\text{J}/\text{mol}/^\circ\text{K}$], μ is the dynamic viscosity of the liquid phase [Pa.s], M_w is the molar mass of water [kg/mol], D_v^o is the self-diffusion coefficient of water vapor [m^2/s], θ_g is the gas phase content [m^3/m^3], τ_s is the intrinsic tortuosity [m/m], τ_r^g is the relative tortuosity of the gas phase [-], and p_v^s is the saturation vapor pressure [Pa].

Most of the parameters in the previous expression can be found in the literature:

- T : corresponds to the testing temperature. The drying tests are usually performed at 23 °C.
- R : the ideal gas constant has a value of 8.3145 J/mol/°K.
- ρ_l : data on density of water between 0 °C and 100 °C found in reference (Robinson 2002) were fitted to a fourth-order polynomial and implemented in STADIUM®.
- μ : similar to density, data on viscosity of water between 0 °C and 100 °C (Robinson 2002) were fitted to a nonlinear function and implemented in STADIUM®.

- M_w : the molar mass of water is 0.018 kg/mol.
- D_v^0 : the self-diffusion coefficient is given by an empirical function depending on temperature and ambient atmospheric pressure (Galbraith 1997).
- p_v^S : the calculation of saturation vapor pressure is based on a relationship found in Bolton (1980).

The calculation of D_{mH} also involves expressions for relative liquid permeability and relative gas tortuosity. The relationship for relative liquid permeability implemented in STADIUM® is based on a power function similar to the Millington and Quirk relationship (1961) used for ionic diffusivity. The relative gas tortuosity expression was derived on the basis of data found in the literature (Sercombe 2007).

Some parameters are obtained from other testing procedures. This is true of porosity and tortuosity. Porosity is measured from the ASTM C642 test procedure. Tortuosity is measured on the basis of a migration test. This testing procedure is part of the STADIUM® Lab package.

The final parameter needed for the analysis is the moisture isotherm function $w=f(H)$, which characterizes the moisture equilibrium of the material. In STADIUM®, this relationship is expressed as:

$$w = \frac{\phi}{\beta\phi(H^\delta - 1) + 1} \quad (B3)$$

where β [-] and δ [-] are parameters that can be determined experimentally. Typical isotherm curves are shown in the next figure. In STADIUM® MTC, the parameter δ is estimated from the concrete mixture composition. The parameter β is calculated directly from the mass loss data measured from the 10-mm series during the drying test.

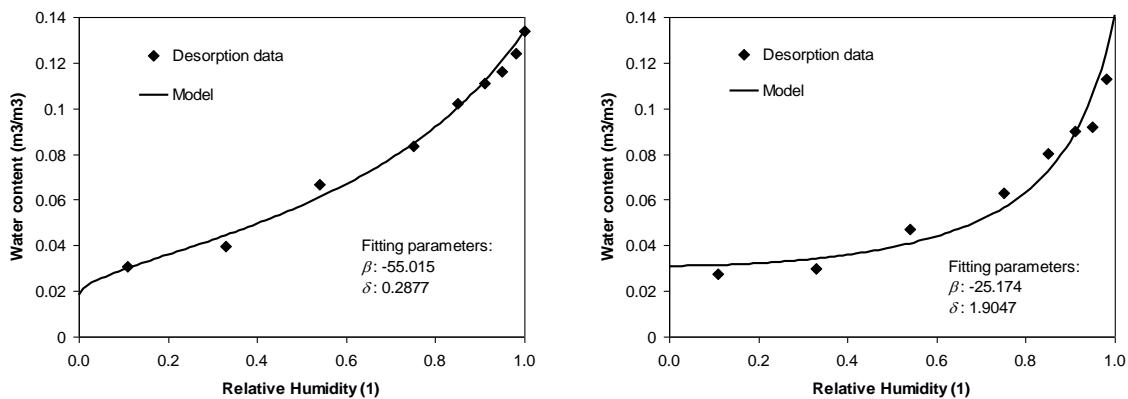

a) Ordinary concrete, 0.5 w/c

b) Ordinary concrete, 0.75 w/c

Figure 46 - Typical moisture isotherms

The only unknown parameter in the moisture transport model is the permeability. STADIUM® MTC finds the permeability iteratively by solving the moisture transport equation until the model reproduces the measured mass loss of the 5-cm drying test series. The equation is discretized using the finite element method and an Euler implicit scheme for the transient term. The nonlinear system of equation resulting from the discretization is solved using Newton's method. The calculations begin assuming initial saturation of the material ($H=1.0$). The boundary conditions are expressed as an exchange term:

$$q = h_w(H - H_\infty) \quad (\text{B4})$$

where h_w is the exchange coefficient [m/s] and H_∞ is the relative humidity of the environment. The default value of h_w is $5.0\text{e-}9$ m/s and the relative humidity is 0.5 (50%), according to the drying test laboratory procedure. The value of h_w corresponds to the exchange coefficient in a properly ventilated chamber.

The mass loss curves are calculated from the relative humidity profiles. At selected time steps, the model first calculates the water content from the relative humidity using the water desorption isotherm. The water content profile is then integrated to obtain the mass loss:

$$\Delta M|_t = \left[\int_0^L (\phi - w) dx \right] S \quad (\text{B5})$$

where $\Delta M|_t$ is the mass loss evaluated at time t [grams], L is the average thickness of the samples [cm], and S is the average exposed surface [cm²]. The next figures show examples of STADIUM® MTC simulations.

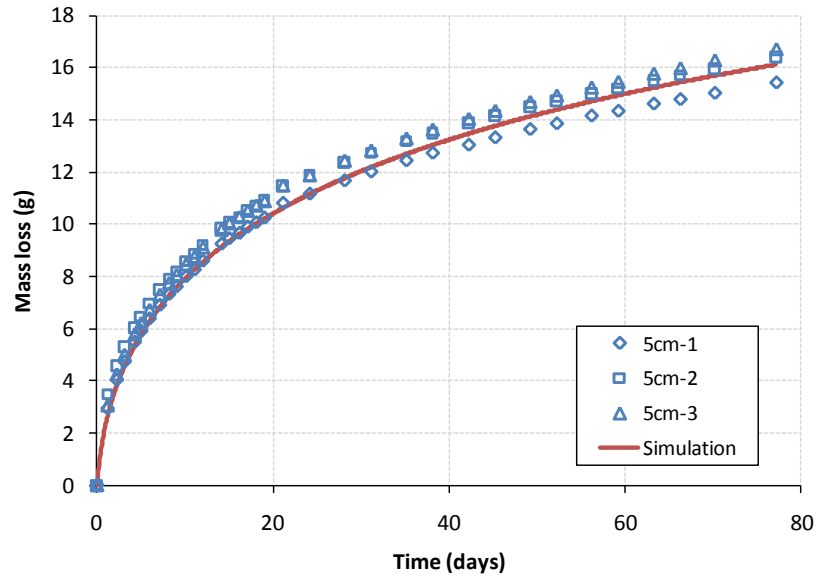

Figure 47 - STADIUM® MTC simulation of OPC mixture (Type V cement, 0.45 w/c)

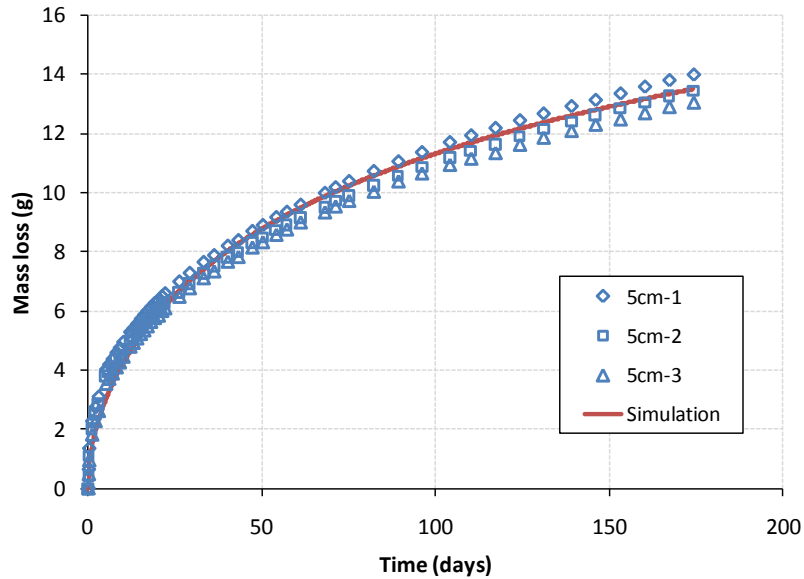

Figure 48 - STADIUM® MTC simulation of mixture with silica fume

Detailed experimental procedure

1.1 Scope

This test determines the drying rate of Portland cement concrete by measuring the mass loss due to evaporation and moisture transport in specimens exposed to constant temperature and relative humidity.

1.2 Significance and Use

Drying behavior reflects the mass transport properties of concrete (e.g., permeability) to a certain extent, and depends on a number of factors such as concrete mixture proportions, presence of chemical admixtures and supplementary cementitious materials, composition and physical characteristics of the aggregates and cementitious materials, curing conditions, degree of hydration, presence of microcracking, and surface treatments such as sealers and membranes. Drying behavior is also strongly affected by the moisture condition of the concrete as well as environmental conditions such as temperature, relative humidity, and air flow rate.

1.3 Apparatus

- Drying chamber: The test must be performed in a temperature and humidity controlled chamber with temperature maintained constant at $23\pm 2^{\circ}\text{C}$ and relative humidity at $50\pm 4\%$. The chamber should have proper support (e.g., a shelf) inside to allow airflow around each specimen. The chamber should be sufficiently spacious to hold all the test specimens. The chamber should be well ventilated, with airflow rate according to ASTM C157: 5.4 (Standard specifications for drying chamber).¹
- Hygrometer: During testing, 2–3 hygrometers should be placed near the specimens to monitor local relative humidity. Digital hygrometers are recommended.
- Absorbent tissues: at least two. Tissues should be at least $35\text{cm} \times 35\text{cm}$ in size.
- Balance: The balance for weighing the specimens should have a capacity of $\geq 1500\text{g}$ and a repeatability of $\leq 0.01\text{g}$. It should be mounted on a proper support (Figure 49) in the laboratory.
- Device for weighing specimens in water: The device should allow the operator to conveniently weigh the specimens in water using the same balance (Figure 49).

1.4 Sealing and Coating Materials

- Epoxy: Various brands of commercial epoxy may be used provided it has excellent coherence with concrete and is completely impermeable.
- In some cases, wax may also be used as sealing material.

¹ A walk-in chamber is always preferable, so that the balance can be installed inside and maintained in uniform conditions.

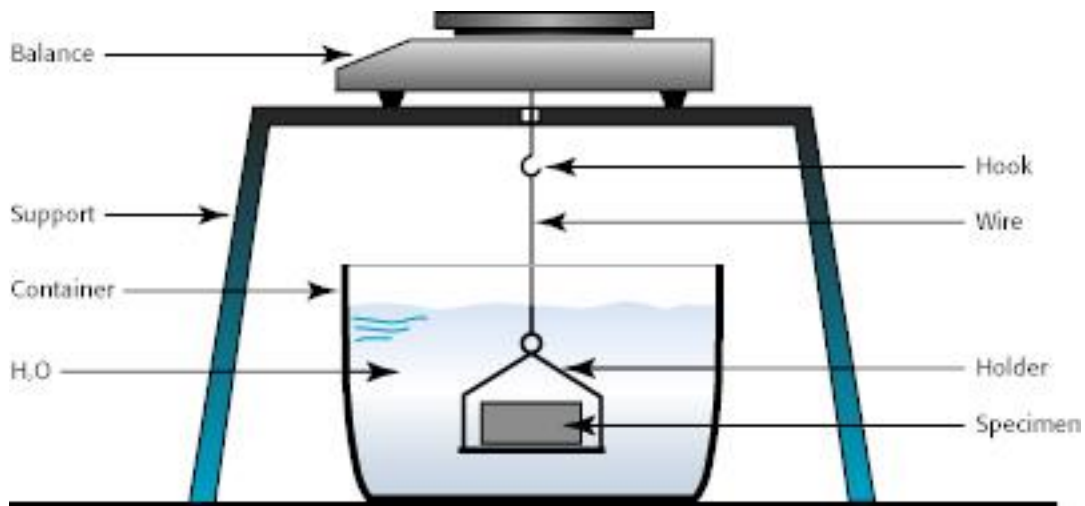

Figure 49 - Balance and device for weighing specimen in air and water

1.5 Test Specimens

- Three cylindrical specimens 10 ± 1 mm in length and three specimens 50 ± 2 mm in length should be prepared for each tested material. Test specimens may be cut from either laboratory-made cylinders or cores extracted from field structures.
- When testing laboratory-made concrete, the concrete should be cured in saturated conditions (e.g., in limewater or a 100% RH moist chamber) for at least 28 days, and the diameter of the cast cylindrical specimens should be at least 100 mm (4 inches). Prepare test specimens according to the following procedure:
 - One week prior to testing, cut test specimens as described in 1.5 from the middle portion of the cylinders (Figure 50).
 - Take the dimension of each test specimen to the nearest 0.1 mm (three length measurements and three diameter measurements).
 - Weigh each specimen in air (Note: when weighing a wet specimen, dry the surface with cloth or tissue before putting it on the balance) and in water, respectively using the balance and the device, as described in 1.4 and 1.5 and shown in Figure 49.
 - Coat and seal the side (round) surface of each specimen with impermeable material, as described in Section 1.4, leaving the two end-surfaces uncoated to act as exposed surfaces (Figure 51) (Note: before applying coating material, thoroughly dry the surface of the specimen by rapid blowing with compressed air).
 - Once the coating and sealing layer has dried and hardened, place the specimens in limewater until testing.
- When testing field concrete, cores with a diameter of at least 100 mm (4 inches) should be extracted from the structure. Once the cores are received at the laboratory, do the following:
 - Photograph the cores.

- Cut test specimens from the cores, as described in 1.5 (Note: the test specimen may or may not contain the exposed surface of the structure, depending on the requirement).
 - Take the dimensions of each test specimen to the nearest 0.1 mm (two measurements of thickness and two measurements of diameter).
 - Immerse the specimens in limewater for one week, then weigh each specimen in air (see Note for 1.5) and in water
 - Coat and seal the side (round) surface of each specimen with impermeable material, as described in Section 4 (see Figure 51).
 - Once the coating and sealing layer has dried and hardened, weigh the specimens, then immerse them in limewater for 7 days and weigh them again. If the weight determined after immersion for the same specimen shows >0.5% variation from the previous mass of the specimen, re-immerse it in limewater for another 7 days and weigh it again. Once the weight determined after the additional 7 days' immersion shows <0.5% variation from the previous mass of the specimen, the specimen is ready for testing. For the drying test, it is very important that the test be started when the samples are fully saturated. All mass should be taken in a SSD state.
- In both cases, the test specimens should be kept in limewater before beginning the drying test.
 - Porosity and ion diffusion coefficient must be determined in order to analyze the drying test results.

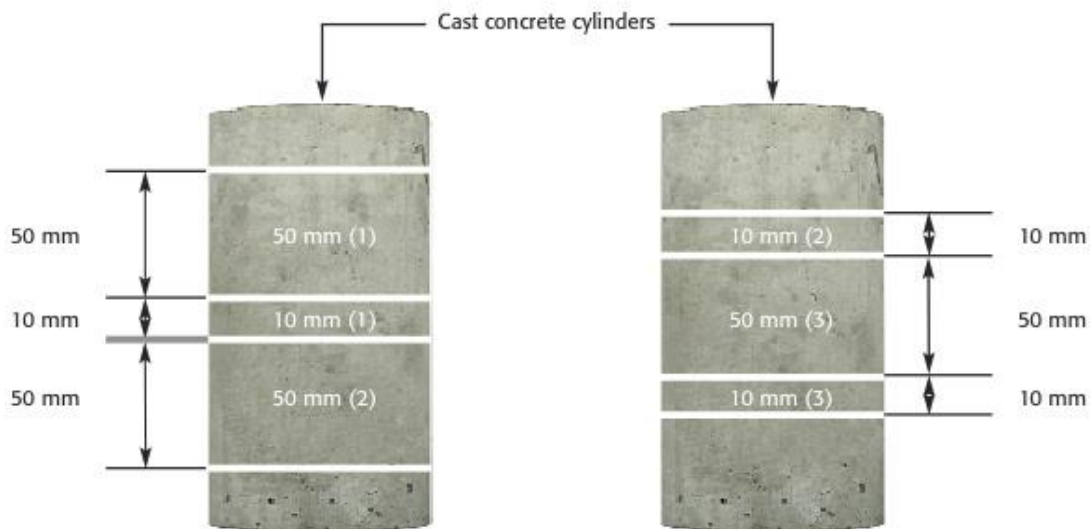

Figure 50 - Preparation of test specimens from the middle portion of laboratory cast concrete cylinders of 4 in (100mm) in diameter

3.6 Procedure

- Remove the surface water from the saturated test specimens (with sealed side surfaces) using moist tissue. Place the specimens near the balance. Protect the surfaces of specimens with moist tissue to prevent them from drying.

- Take the initial masses by weighing them on the balance one at a time (Figure 49). Each weighing should last no longer than 30 seconds. After each weighing, protect the specimen with the moist tissue to prevent it from drying.
- When the initial masses of all the specimens have been taken, transfer all the specimens at the same time to the drying chamber. Place them on the appropriate supports (Figure 51 or Figure 52). Record the time and date on the work sheet, and the drying test begins.

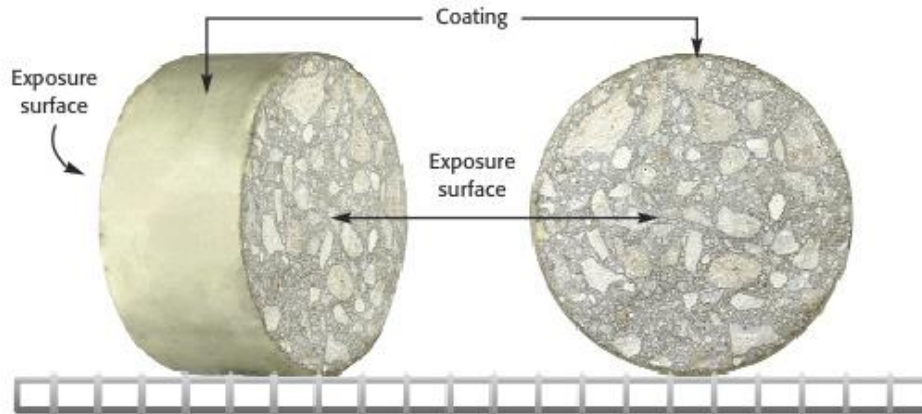

Figure 51 - Case 1: the specimen is placed on a shelf in the drying chamber

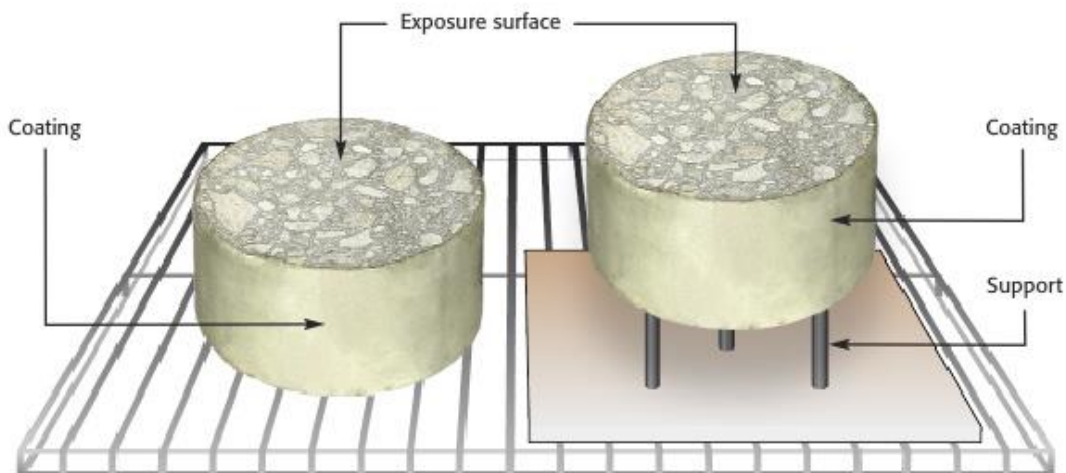

Figure 52 - Case 2: the specimen is placed on a support in the drying chamber

- Monitor the weight change of the specimens by periodically weighing them in the same place in the laboratory and using the same balance, according to the following

schedule (Note: each weighing of all six specimens should be completed within five (5) minutes):

- Week 1: one (1) measurement (including initial weighing) per day, with a time interval of 24±2 hours
- Week 2: three (3) measurements per week, with a time interval of 48±2 hours.
- After week 2: one (1) measurement per week, with a time interval of 7±1 days.
- Stop the drying test when constant mass is observed for the 10-mm thick specimens. The constant mass is defined as four successive mass measurements that show less than ±0.5% variation from the previous measurement:

$$\left| \frac{100 \times (m_i - m_{i-1})}{m_i} \right| < 0.5$$

where m_i is the current measurement and m_{i-1} is the previous one.

3.7 Report

- Data on the specimens: (1) age of hydration; (2) date when the specimens were extracted; (3) dimensions of each specimen; (4) weights of each specimen before coating, taken in air and water
- Concrete mixture or material reference number and all other relevant information (cement type, cure duration, w/c ratio, etc.).
- Porosity tested according to ASTM C642 whenever possible.
- Ion Migration Coefficient (modified ASTM C1202).
- Completed experimental records: mass determinations over the entire test period.
- Cumulative mass losses plotted against testing time (Figure 53).

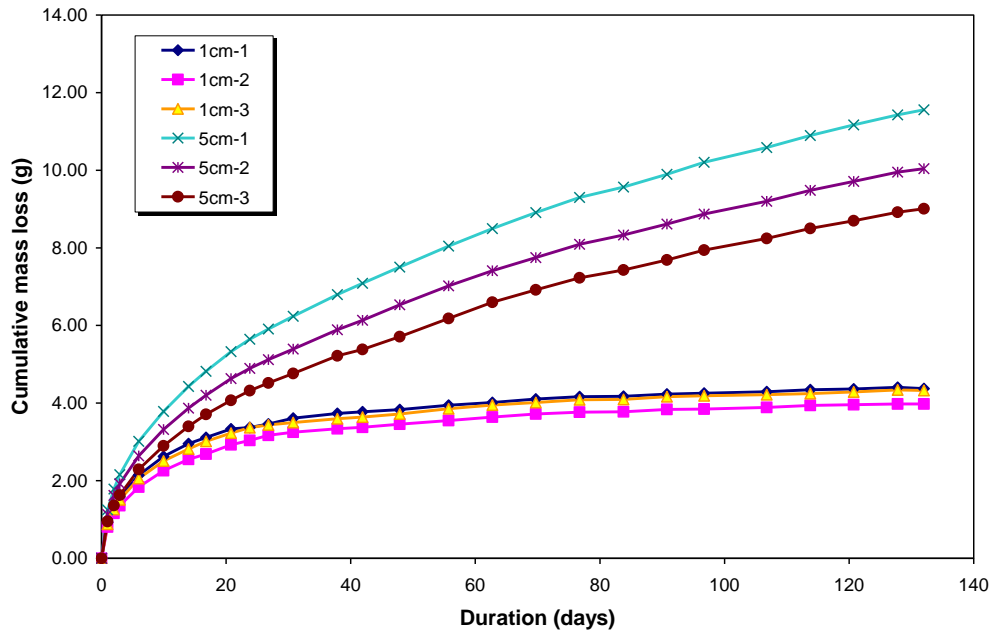

Figure 53 - Mass loss in specimens during drying test

C. Complete ASTM C642 Experimental Data

The information shown in the following tables refers to Table 7 results.

Table 18 – Completed ASTM C642 test results for concrete mixtures M1, M2, M3

Parameters	Values								
	M1 28d	M1 91d	M1 365d	M2 28d	M2 91d	M2 365d	M3 28d	M3 91d	M3 365d
A Mass of oven dried sample (g)	916.4	931.5	897.9	923.9	908.8	908.1	925.5	943.0	957.7
	865.2	923.0	875.0	942.0	934.1	895.2	947.2	928.5	950.2
B Mass of sample in air after immersion (g)	963.6	980.1	946.8	975.6	947.4	960.0	978.1	991.1	1006.5
	910.0	971.4	923.5	990.4	975.3	946.5	998.2	978.4	996.5
C Mass of sample in air after immersion and boiling (g)	965.6	980.9	947.2	974.1	956.0	958.6	977.3	990.5	1006.2
	911.7	973.0	923.9	989.0	983.2	945.2	997.1	977.7	995.4
D Apparent mass of sample in water after immersion and boiling (g)	553.3	562.2	541.8	566.8	555.6	557.9	567.8	580.1	586.5
	522.9	556.5	531.0	579.0	570.9	548.9	581.8	570.2	584.4
g1 Bulk density, dry (g/cm ³)	2.22	2.22	2.21	2.26	2.27	2.26	2.26	2.29	2.28
	2.22	2.21	2.22	2.29	2.26	2.25	2.28	2.27	2.31
g2 Apparent density (g/cm ³)	2.52	2.52	2.52	2.58	2.57	2.59	2.58	2.59	2.57
	2.52	2.51	2.54	2.59	2.57	2.58	2.59	2.59	2.59
Bulk density after immersion (g/cm ³)	2.33	2.34	2.33	2.39	2.36	2.39	2.38	2.41	2.39
	2.34	2.33	2.35	2.41	2.36	2.38	2.40	2.40	2.42
Bulk density after immersion and boiling	2.34	2.34	2.33	2.39	2.38	2.39	2.38	2.41	2.39
	2.34	2.33	2.35	2.41	2.38	2.38	2.40	2.39	2.42
Absorption after immersion (%)	5.2	5.2	5.44	5.6	4.2	5.72	5.7	5.1	5.1
	5.2	5.2	5.54	5.1	4.4	5.73	5.4	5.4	4.9
Absorption after immersion and boiling (%)	5.4	5.3	5.49	5.4	5.2	5.57	5.6	5.0	5.1
	5.4	5.4	5.59	5.0	5.3	5.59	5.3	5.3	4.8
Volume of permeable voids (%)	11.9	11.8	12.2	12.3	11.8	12.6	12.7	11.6	11.6
	12.0	12.0	12.4	11.5	11.9	12.6	12.0	12.1	11.0
(C-A)/(C-D)×100									
Average volume of permeable voids (porosity, %)	11.9	11.9	12.3	11.9	11.9	12.6	12.3	11.8	11.3
Average absorption after immersion and boiling (%)	5.4	5.4	5.5	5.2	5.2	5.6	5.4	5.2	4.9

Table 19 – Completed ASTM C642 test results for concrete mixtures M4, M5, M6

Parameters	Values								
	M4 28d	M4 91d	M4 365d	M5 28d	M5 91d	M5 365d	M6 28d	M6 91d	M6 365d
A Mass of oven dried sample (g)	865.2	901.9	885.1	925.2	878.5	865.3	897.9	905.3	903.3
	890.2	929.0	889.3	888.7	884.9	896.0	900.8	929.8	887.7
B Mass of sample in air after immersion (g)	923.9	958.9	944.5	988.9	927.0	927.8	960.2	970.1	967.7
	945.8	980.7	946.2	950.4	931.8	959.4	960.9	992.8	950.7
C Mass of sample in air after immersion and boiling (g)	925.3	960.3	945.4	987.4	937.5	926.0	960.1	967.2	966.1
	947.2	982.3	947.0	948.7	942.7	957.8	960.7	989.6	949.2
D Apparent mass of sample in water after immersion and boiling (g)	517.4	542.4	531.9	563.4	532.4	522.0	545.2	550.6	551.3
	535.2	560.2	533.5	541.0	537.6	541.4	547.5	564.0	541.3
g1 Bulk density, dry (g/cm ³)	2.12	2.15	2.14	2.18	2.16	2.14	2.16	2.17	2.17
	2.16	2.20	2.15	2.18	2.18	2.15	2.18	2.18	2.17
g2 Apparent density (g/cm ³)	2.48	2.50	2.50	2.55	2.53	2.52	2.54	2.55	2.56
	2.50	2.51	2.49	2.55	2.54	2.52	2.54	2.54	2.56
Bulk density after immersion (g/cm ³)	2.26	2.29	2.28	2.33	2.28	2.29	2.31	2.32	2.33
	2.29	2.32	2.29	2.33	2.30	2.30	2.32	2.33	2.33
Bulk density after immersion and boiling	2.26	2.29	2.28	2.32	2.31	2.29	2.31	2.32	2.32
	2.29	2.32	2.29	2.32	2.32	2.30	2.32	2.32	2.32
Absorption after immersion (%)	6.8	6.3	6.71	6.9	5.5	7.2	6.9	7.2	7.1
	6.3	5.6	6.40	6.9	5.3	7.1	6.7	6.8	7.1
Absorption after immersion and boiling (%)	6.9	6.5	6.81	6.7	6.7	7.0	6.9	6.8	6.9
	6.4	5.7	6.49	6.7	6.5	6.9	6.7	6.4	6.9
Volume of permeable voids (%) (C-A)/(C-D)×100	14.7	14.0	14.6	14.7	14.6	15.0	15.0	14.9	15.1
	13.8	12.6	14.0	14.7	14.3	14.8	14.5	14.0	15.1
Average volume of permeable voids (porosity, %)	14.3	13.3	14.3	14.7	14.4	14.9	14.7	14.4	15.1
Average absorption after immersion and boiling (%)	6.7	6.1	6.7	6.7	6.6	7.0	6.8	6.6	6.9



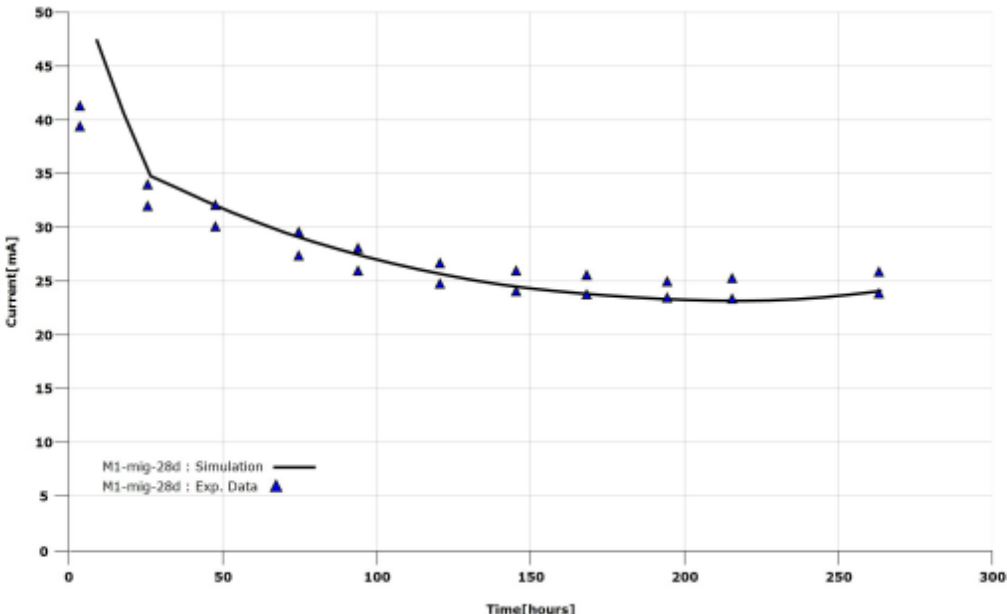

Table 20 – Completed ASTM C642 test results for concrete mixtures M7, M8, M9





Parameters	Values								
	M7 28d	M7 91d	M7 365d	M8 28d	M8 91d	M8 365d	M9 28d	M9 91d	M9 365d
A Mass of oven dried sample (g)	865.9	889.4	907.0	902.4	890.5	856.9	917.3	883.8	874.2
	897.0	904.9	895.3	889.1	901.2	860.5	924.7	919.0	898.1
B Mass of sample in air after immersion (g)	916.9	943.3	958.9	961.3	939.5	915.5	975.5	940.1	931.5
	952.8	955.2	948.6	945.3	951.4	920.1	981.4	975.9	956.0
C Mass of sample in air after immersion and boiling (g)	918.4	944.6	960.4	961.7	947.4	915.6	975.7	939.0	931.6
	954.5	956.6	949.9	645.8	959.0	920.0	981.5	975.0	956.5
D Apparent mass of sample in water after immersion and boiling (g)	520.7	535.8	547.3	544.0	536.6	515.6	558.9	539.3	530.5
	542.5	547.5	541.9	536.9	543.7	518.8	563.9	561.8	549.0
g1 Bulk density, dry (g/cm ³)	2.17	2.17	2.19	2.16	2.16	2.14	2.20	2.21	2.18
	2.17	2.21	2.19	2.17	2.17	2.14	2.21	2.22	2.20
g2 Apparent density (g/cm ³)	2.50	2.51	2.52	2.51	2.51	2.51	2.55	2.56	2.54
	2.53	2.53	2.53	2.52	2.52	2.51	2.56	2.57	2.57
Bulk density after immersion (g/cm ³)	2.30	2.30	2.32	2.30	2.28	2.28	2.34	2.35	2.32
	2.31	2.33	2.32	2.31	2.29	2.29	2.35	2.36	2.34
Bulk density after immersion and boiling	2.30	2.31	2.32	2.30	2.30	2.28	2.34	2.34	2.32
	2.31	2.33	2.32	2.31	2.30	2.29	2.35	2.36	2.34
Absorption after immersion (%)	5.9	6.1	5.72	6.5	5.5	6.8	6.3	6.4	6.6
	6.2	5.6	5.95	6.3	5.6	6.9	6.1	6.2	6.5
Absorption after immersion and boiling (%)	6.1	6.2	5.88	6.6	6.4	6.8	6.4	6.2	6.6
	6.4	5.7	6.09	6.4	6.4	6.9	6.1	6.1	6.5
Volume of permeable voids (%) (C-A)/(C-D)×100	13.2	13.5	12.9	14.2	13.9	14.7	14.0	13.8	14.3
	14.0	12.6	13.4	13.9	13.9	14.8	13.6	13.5	14.3
Average volume of permeable voids (porosity, %)	13.6	13.1	13.1	14.0	13.9	14.7	13.8	13.7	14.3
Average absorption after immersion and boiling (%)	6.2	6.0	5.99	6.5	6.4	6.9	6.3	6.2	6.5

D. Simulation reports – Migration tests

The following pages provide the simulation reports generated by the STADIUM®-IDC module, which is used to analyze migration test laboratory data.

***NOTE:** In some cases, it can be seen on the graphs that the model has trouble reproducing the initial 50 hours of migration tests. At the beginning of testing, the current is mostly controlled by the composition of the pore solution. After that, it is the diffusion characteristics (tortuosity) that control current. The difficulty with the first 50 or so hours of testing is that it is not possible to precisely know what is the exact composition and spatial distribution of the pore solution because it is influenced by the material itself but also by the conditioning (in this case, limewater curing) and vacuum conditioning procedure. However, the objective of the test is to determine diffusion coefficients, which are not much influenced by this parameter. Accordingly, the model focuses mostly on fitting the current values measured at the end of the test to determine diffusion coefficients.*

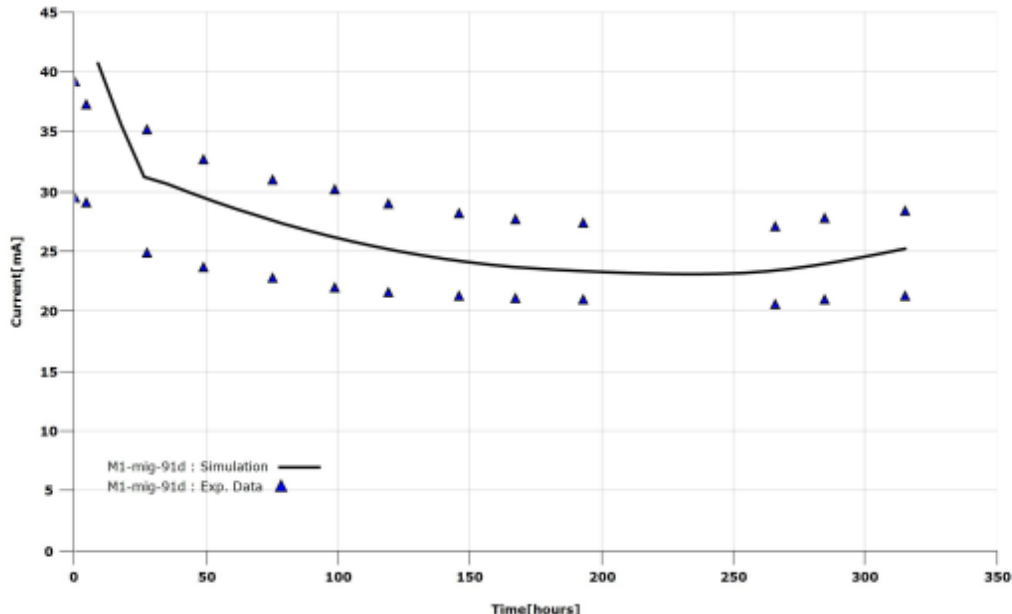
 <p>SIMCO Technologies inc.</p>	<p>This Product is Licensed to : tzhang Date : 05/08/11 Contact : Client : Project : RD09024-Hycrete Project Ref. : Test : M1-mig-28d</p>							
<table border="1"> <thead> <tr> <th>Material</th> <th>Experimental Data</th> <th>Results</th> </tr> </thead> <tbody> <tr> <td data-bbox="284 478 618 829"> W/B : 0.40 Cement Type : Type I Cement : 390 kg/m³ SCM #1 : 0 kg/m³ SCM #2 : 0 kg/m³ SCM #3 : 0 kg/m³ Coarse Agg. : 1000 kg/m³ Fine Agg. : 790 kg/m³ Water Content : 156 kg/m³ Air Content : 6.0 % Porosity : 11.9 % </td> <td data-bbox="646 478 980 829"> Temperature : 23 °C Avg. Thickness : 51.6 mm Eff. Diameter : 100.2 mm Upstream Cell : 300 mmol/L NaOH 500 mmol/L NaCl Downstream Cell : 300 mmol/L NaOH </td> <td data-bbox="1008 478 1343 829"> OH Diff. Coef. : 12.06 e-11 m²/s Tortuosity : 0.0229 </td> </tr> </tbody> </table>			Material	Experimental Data	Results	W/B : 0.40 Cement Type : Type I Cement : 390 kg/m ³ SCM #1 : 0 kg/m ³ SCM #2 : 0 kg/m ³ SCM #3 : 0 kg/m ³ Coarse Agg. : 1000 kg/m ³ Fine Agg. : 790 kg/m ³ Water Content : 156 kg/m ³ Air Content : 6.0 % Porosity : 11.9 %	Temperature : 23 °C Avg. Thickness : 51.6 mm Eff. Diameter : 100.2 mm Upstream Cell : 300 mmol/L NaOH 500 mmol/L NaCl Downstream Cell : 300 mmol/L NaOH	OH Diff. Coef. : 12.06 e-11 m ² /s Tortuosity : 0.0229
Material	Experimental Data	Results						
W/B : 0.40 Cement Type : Type I Cement : 390 kg/m ³ SCM #1 : 0 kg/m ³ SCM #2 : 0 kg/m ³ SCM #3 : 0 kg/m ³ Coarse Agg. : 1000 kg/m ³ Fine Agg. : 790 kg/m ³ Water Content : 156 kg/m ³ Air Content : 6.0 % Porosity : 11.9 %	Temperature : 23 °C Avg. Thickness : 51.6 mm Eff. Diameter : 100.2 mm Upstream Cell : 300 mmol/L NaOH 500 mmol/L NaCl Downstream Cell : 300 mmol/L NaOH	OH Diff. Coef. : 12.06 e-11 m ² /s Tortuosity : 0.0229						
 <p>Current [mA]</p> <p>Time [hours]</p> <p>M1-mig-28d : Simulation — M1-mig-28d : Exp. Data ▲</p>								
<p>Design Calculation</p> <p>Approved by:</p>		 <p>Simco Technologies Inc 2010 All right reserved STADIUM® IDC v3.0</p>						





 <p>SIMCO Technologies inc.</p>	<p>This Product is Licensed to : tzhang Date : 05/08/11 Contact : Client : Project : RD09024-Hycrete Project Ref. : Test : M1-mig-91d</p>							
<table border="1"> <thead> <tr> <th>Material</th> <th>Experimental Data</th> <th>Results</th> </tr> </thead> <tbody> <tr> <td data-bbox="284 478 620 829"> W/B : 0.40 Cement Type : Type I Cement : 390 kg/m³ SCM #1 : 0 kg/m³ SCM #2 : 0 kg/m³ SCM #3 : 0 kg/m³ Coarse Agg. : 1000 kg/m³ Fine Agg. : 790 kg/m³ Water Content : 156 kg/m³ Air Content : 6.0 % Porosity : 11.9 % </td> <td data-bbox="641 478 977 829"> Temperature : 23 °C Avg. Thickness : 51.0 mm Eff. Diameter : 101.2 mm Upstream Cell : 300 mmol/L NaOH 500 mmol/L NaCl Downstream Cell : 300 mmol/L NaOH </td> <td data-bbox="998 478 1334 829"> OH Diff. Coef. : 11.23 e-11 m²/s Tortuosity : 0.0213 </td> </tr> </tbody> </table>			Material	Experimental Data	Results	W/B : 0.40 Cement Type : Type I Cement : 390 kg/m ³ SCM #1 : 0 kg/m ³ SCM #2 : 0 kg/m ³ SCM #3 : 0 kg/m ³ Coarse Agg. : 1000 kg/m ³ Fine Agg. : 790 kg/m ³ Water Content : 156 kg/m ³ Air Content : 6.0 % Porosity : 11.9 %	Temperature : 23 °C Avg. Thickness : 51.0 mm Eff. Diameter : 101.2 mm Upstream Cell : 300 mmol/L NaOH 500 mmol/L NaCl Downstream Cell : 300 mmol/L NaOH	OH Diff. Coef. : 11.23 e-11 m ² /s Tortuosity : 0.0213
Material	Experimental Data	Results						
W/B : 0.40 Cement Type : Type I Cement : 390 kg/m ³ SCM #1 : 0 kg/m ³ SCM #2 : 0 kg/m ³ SCM #3 : 0 kg/m ³ Coarse Agg. : 1000 kg/m ³ Fine Agg. : 790 kg/m ³ Water Content : 156 kg/m ³ Air Content : 6.0 % Porosity : 11.9 %	Temperature : 23 °C Avg. Thickness : 51.0 mm Eff. Diameter : 101.2 mm Upstream Cell : 300 mmol/L NaOH 500 mmol/L NaCl Downstream Cell : 300 mmol/L NaOH	OH Diff. Coef. : 11.23 e-11 m ² /s Tortuosity : 0.0213						
 <p>Current [mA]</p> <p>Time [hours]</p> <p>M1-mig-91d : Simulation — M1-mig-91d : Exp. Data ▲</p>								
<p>Design Calculation</p> <p>Approved by:</p>		 <p>Simco Technologies Inc 2010 All right reserved STADIUM® IDC v3.0</p>						

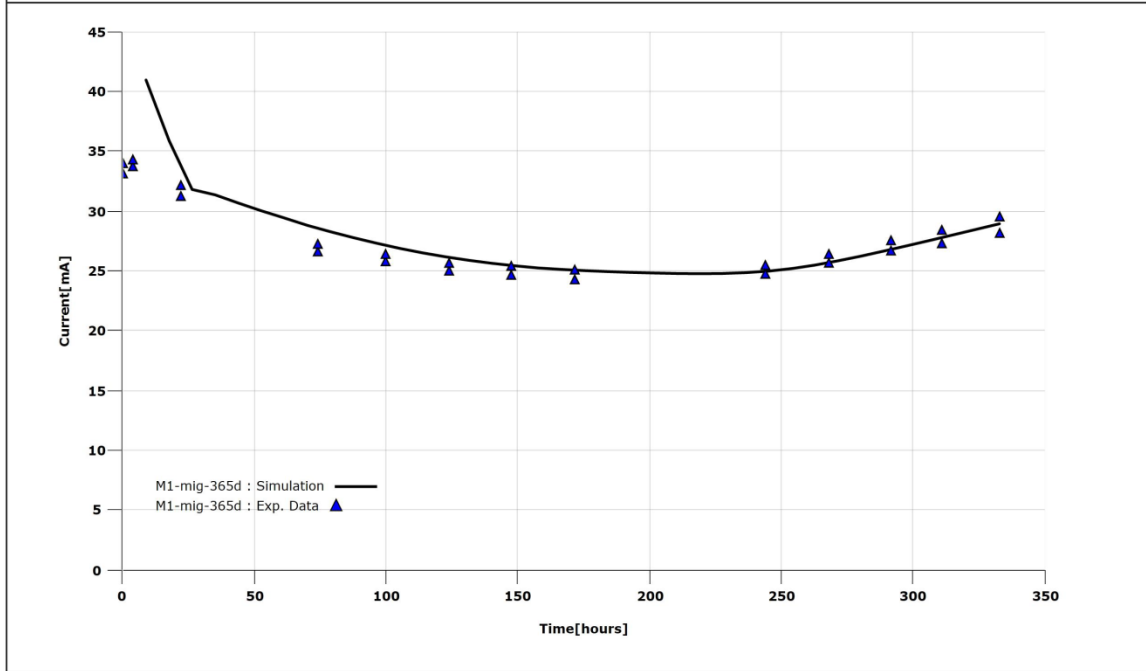

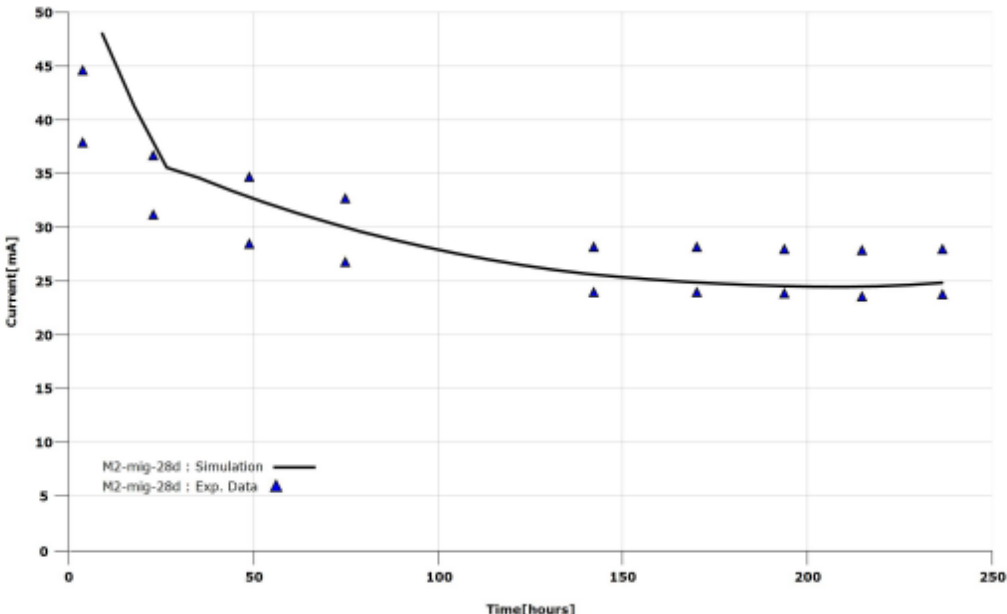

 <p>SIMCO Technologies inc.</p>	<p>This Product is Licensed to : tzhang Date : 05/01/2012 Contact : Client : Project : RD09024-Hycrete Project Ref. : Test : M1-mig-365d</p>	 <p>KNOW YOUR CONCRETE</p>
---	---	--

Material	Experimental Data	Results
<p>Mix : M1-Ref W/B : 0.40 Cement Type : Type I Cement : 390 kg/m³ Coarse Agg. : 1000 kg/m³ Fine Agg. : 790 kg/m³ Water Content : 156 kg/m³ Air Content : 6.0 % CNI : 0 l/m³ Porosity : 12.3 %</p>	<p>Temperature : 23 °C Avg. Thickness : 50.8 mm Eff. Diameter : 101.5 mm Upstream Cell : 300 mmol/L NaOH 500 mmol/L NaCl Downstream Cell : 300 mmol/L NaOH</p>	<p>OH Diff. Coef. : 12.27 e-11 m²/s Tortuosity : 0.0233</p>

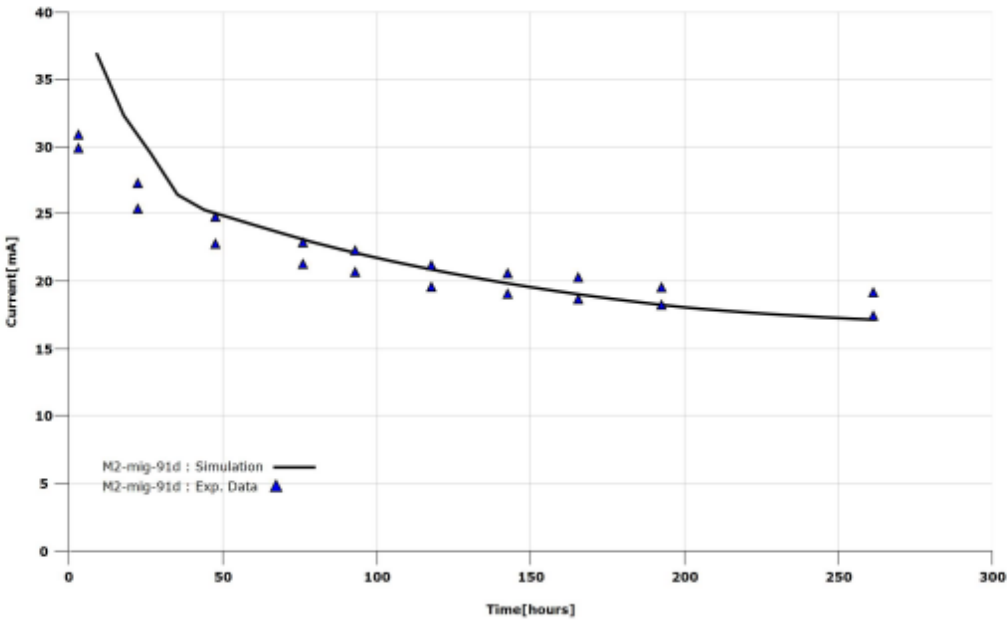

<p>Design Calculation</p> <p>Approved by:</p>		 <p>SIMCO Technologies Inc. 2012 All right reserved STADIUM® IDC v3.0 3.0.0.1067</p>
--	--	---

 <p>SIMCO Technologies inc.</p>	<p>This Product is Licensed to : tzhang Date : 05/08/11 Contact : Client : Project : RD09024-Hycrete Project Ref. : Test : M2-mig-28d</p>	 <p>KNOW YOUR CONCRETE</p>																																										
<table style="width: 100%; border-collapse: collapse;"> <thead> <tr> <th style="text-align: left; border-bottom: 1px solid black;">Material</th> <th style="text-align: left; border-bottom: 1px solid black;">Experimental Data</th> <th style="text-align: left; border-bottom: 1px solid black;">Results</th> </tr> </thead> <tbody> <tr> <td style="border: 1px solid black; padding: 5px;"> W/B : 0.40 Cement Type : Type I Cement : 390 kg/m³ SCM #1 : 0 kg/m³ SCM #2 : 0 kg/m³ SCM #3 : 0 kg/m³ Coarse Agg. : 1000 kg/m³ Fine Agg. : 790 kg/m³ Water Content : 156 kg/m³ Air Content : 6.0 % Porosity : 11.9 % </td> <td style="border: 1px solid black; padding: 5px;"> Temperature : 23 °C Avg. Thickness : 51.6 mm Eff. Diameter : 100.3 mm Upstream Cell : 300 mmol/L NaOH 500 mmol/L NaCl Downstream Cell : 300 mmol/L NaOH </td> <td style="border: 1px solid black; padding: 5px;"> OH Diff. Coef. : 12.22 e-11 m²/s Tortuosity : 0.0232 </td> </tr> </tbody> </table>	Material	Experimental Data	Results	W/B : 0.40 Cement Type : Type I Cement : 390 kg/m ³ SCM #1 : 0 kg/m ³ SCM #2 : 0 kg/m ³ SCM #3 : 0 kg/m ³ Coarse Agg. : 1000 kg/m ³ Fine Agg. : 790 kg/m ³ Water Content : 156 kg/m ³ Air Content : 6.0 % Porosity : 11.9 %	Temperature : 23 °C Avg. Thickness : 51.6 mm Eff. Diameter : 100.3 mm Upstream Cell : 300 mmol/L NaOH 500 mmol/L NaCl Downstream Cell : 300 mmol/L NaOH	OH Diff. Coef. : 12.22 e-11 m ² /s Tortuosity : 0.0232	<div style="border: 1px solid black; padding: 10px;">  <table border="1" style="width: 100%; border-collapse: collapse; margin-top: 10px;"> <caption>Approximate data points from the graph</caption> <thead> <tr> <th>Time [hours]</th> <th>Current [mA]</th> <th>Type</th> </tr> </thead> <tbody> <tr><td>0</td><td>48</td><td>Simulation</td></tr> <tr><td>5</td><td>45</td><td>Exp. Data</td></tr> <tr><td>10</td><td>38</td><td>Exp. Data</td></tr> <tr><td>20</td><td>36</td><td>Exp. Data</td></tr> <tr><td>30</td><td>31</td><td>Exp. Data</td></tr> <tr><td>50</td><td>28</td><td>Exp. Data</td></tr> <tr><td>70</td><td>26</td><td>Exp. Data</td></tr> <tr><td>100</td><td>28</td><td>Simulation</td></tr> <tr><td>150</td><td>25</td><td>Simulation</td></tr> <tr><td>200</td><td>24</td><td>Simulation</td></tr> <tr><td>250</td><td>25</td><td>Simulation</td></tr> </tbody> </table> </div>		Time [hours]	Current [mA]	Type	0	48	Simulation	5	45	Exp. Data	10	38	Exp. Data	20	36	Exp. Data	30	31	Exp. Data	50	28	Exp. Data	70	26	Exp. Data	100	28	Simulation	150	25	Simulation	200	24	Simulation	250	25	Simulation
Material	Experimental Data	Results																																										
W/B : 0.40 Cement Type : Type I Cement : 390 kg/m ³ SCM #1 : 0 kg/m ³ SCM #2 : 0 kg/m ³ SCM #3 : 0 kg/m ³ Coarse Agg. : 1000 kg/m ³ Fine Agg. : 790 kg/m ³ Water Content : 156 kg/m ³ Air Content : 6.0 % Porosity : 11.9 %	Temperature : 23 °C Avg. Thickness : 51.6 mm Eff. Diameter : 100.3 mm Upstream Cell : 300 mmol/L NaOH 500 mmol/L NaCl Downstream Cell : 300 mmol/L NaOH	OH Diff. Coef. : 12.22 e-11 m ² /s Tortuosity : 0.0232																																										
Time [hours]	Current [mA]	Type																																										
0	48	Simulation																																										
5	45	Exp. Data																																										
10	38	Exp. Data																																										
20	36	Exp. Data																																										
30	31	Exp. Data																																										
50	28	Exp. Data																																										
70	26	Exp. Data																																										
100	28	Simulation																																										
150	25	Simulation																																										
200	24	Simulation																																										
250	25	Simulation																																										
Design Calculation Approved by:	 <p>Simco Technologies Inc 2010 All right reserved STADIUM® IDC v3.0</p>																																											





 <p>SIMCO Technologies inc.</p>	<p>This Product is Licensed to : tzhang Date : 05/08/11 Contact : Client : Project : RD09024-Hycrete Project Ref. : Test : M2-mig-91d</p>	 <p>STADIUM A SIMCO SOLUTION KNOW YOUR CONCRETE</p>
<p style="text-align: center;">Material</p> <p>W/B : 0.40 Cement Type : Type I Cement : 390 kg/m³ SCM #1 : 0 kg/m³ SCM #2 : 0 kg/m³ SCM #3 : 0 kg/m³ Coarse Agg. : 1000 kg/m³ Fine Agg. : 790 kg/m³ Water Content : 156 kg/m³ Air Content : 6.0 % Porosity : 11.9 %</p>	<p style="text-align: center;">Experimental Data</p> <p>Temperature : 23 °C Avg. Thickness : 51.7 mm Eff. Diameter : 101.4 mm Upstream Cell : 300 mmol/L NaOH 500 mmol/L NaCl Downstream Cell : 300 mmol/L NaOH</p>	<p style="text-align: center;">Results</p> <p>OH Diff. Coef. : 8.37 e-11 m²/s Tortuosity : 0.0159</p>
 <p style="text-align: center;">M2-mig-91d : Simulation — M2-mig-91d : Exp. Data ▲</p>		
<p>Design Calculation</p> <p>Approved by:</p>		 <p>Simco Technologies Inc 2010 All right reserved STADIUM® IDC v3.0</p>

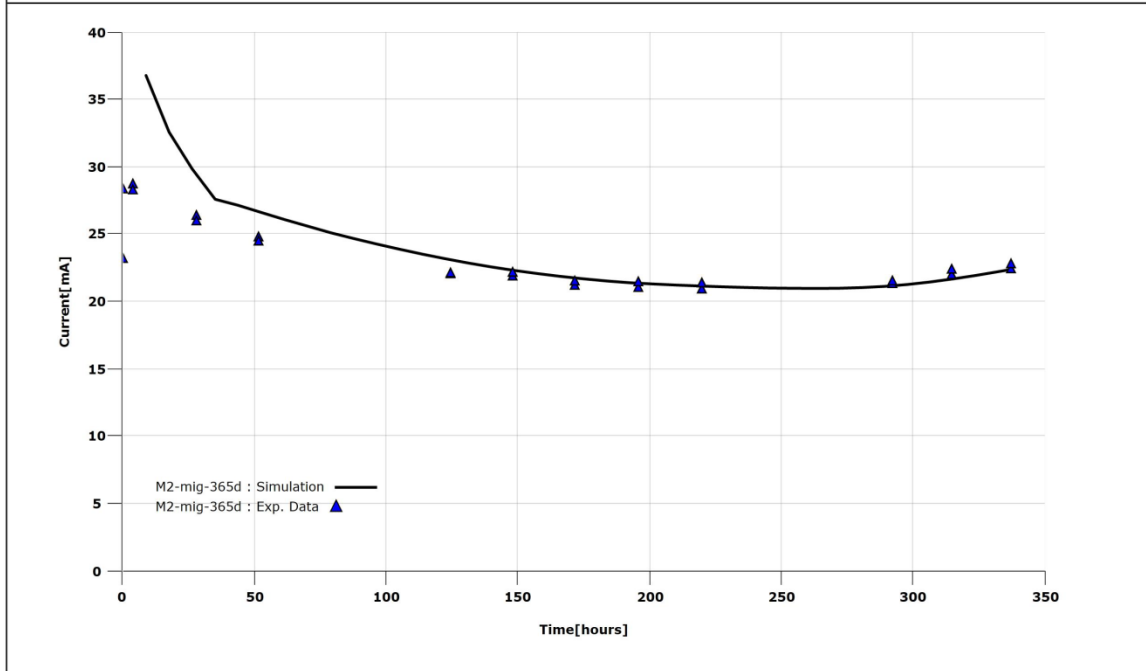

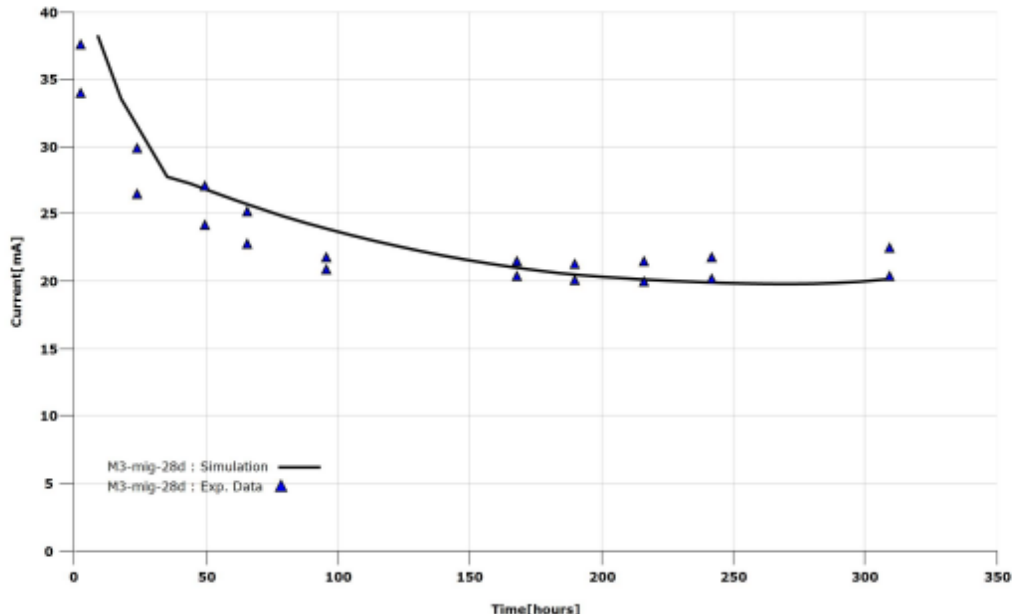

 <p>SIMCO Technologies inc.</p>	<p>This Product is Licensed to : tzhang Date : 23/02/2012 Contact : Client : Project : RD09024-Hycrete Project Ref. : Test : M2-mig-365d</p>	 <p>KNOW YOUR CONCRETE</p>
---	---	--

Material	Experimental Data	Results
<p>Mix : M2 W/B : 0.40 Cement Type : Type I Cement : 390 kg/m³ Coarse Agg. : 1000 kg/m³ Fine Agg. : 790 kg/m³ Water Content : 156 kg/m³ Air Content : 6.0 % CNI : 0 l/m³ Porosity : 12.6 %</p>	<p>Temperature : 23 °C Avg. Thickness : 51.2 mm Eff. Diameter : 102.0 mm Upstream Cell : 300 mmol/L NaOH 500 mmol/L NaCl Downstream Cell : 300 mmol/L NaOH</p>	<p>OH Diff. Coef. : 9.63 e-11 m²/s Tortuosity : 0.0183</p>

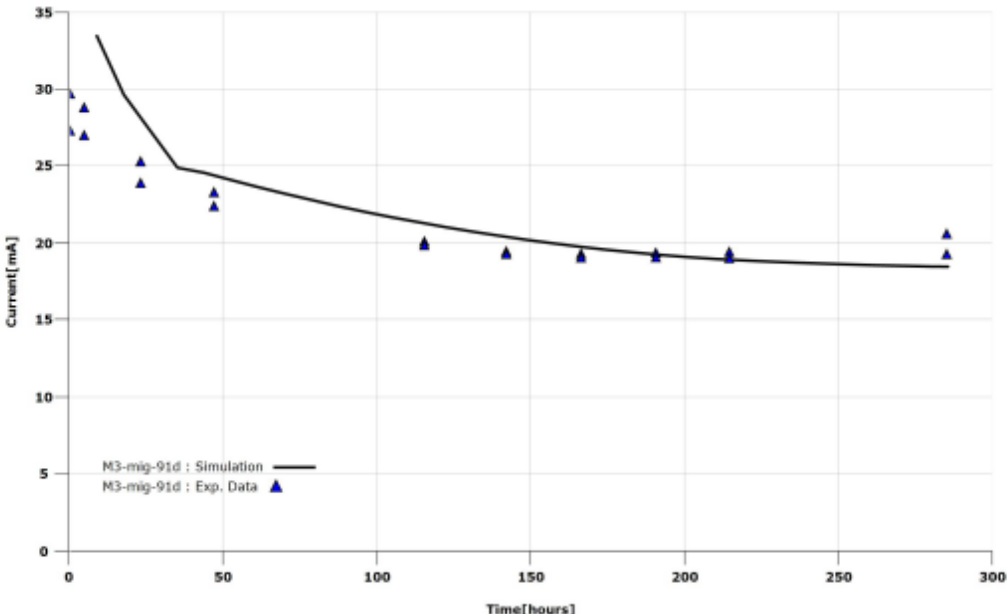

<p>Design Calculation</p> <p>Approved by:</p>		 <p>SIMCO Technologies Inc. 2012 All right reserved STADIUM® IDC v3.0 3.0.0.1067</p>
--	--	--

 <p>SIMCO Technologies inc.</p>	<p>This Product is Licensed to : tzhang Date : 05/08/11 Contact: Client : Project : RD09024-Hycrete Project Ref. : Test : M3-mig-28d</p>																																											
<table border="1"> <thead> <tr> <th>Material</th> <th>Experimental Data</th> <th>Results</th> </tr> </thead> <tbody> <tr> <td data-bbox="284 478 620 829"> W/B : 0.40 Cement Type : Type I Cement : 390 kg/m³ SCM #1 : 0 kg/m³ SCM #2 : 0 kg/m³ SCM #3 : 0 kg/m³ Coarse Agg. : 1000 kg/m³ Fine Agg. : 790 kg/m³ Water Content : 156 kg/m³ Air Content : 6.0 % Porosity : 12.3 % </td> <td data-bbox="641 478 977 829"> Temperature : 23 °C Avg. Thickness : 51.5 mm Eff. Diameter : 101.4 mm Upstream Cell : 300 mmol/L NaOH 500 mmol/L NaCl Downstream Cell : 300 mmol/L NaOH </td> <td data-bbox="998 478 1334 829"> OH Diff. Coef. : 9.44 e-11 m²/s Tortuosity : 0.0179 </td> </tr> </tbody> </table>			Material	Experimental Data	Results	W/B : 0.40 Cement Type : Type I Cement : 390 kg/m ³ SCM #1 : 0 kg/m ³ SCM #2 : 0 kg/m ³ SCM #3 : 0 kg/m ³ Coarse Agg. : 1000 kg/m ³ Fine Agg. : 790 kg/m ³ Water Content : 156 kg/m ³ Air Content : 6.0 % Porosity : 12.3 %	Temperature : 23 °C Avg. Thickness : 51.5 mm Eff. Diameter : 101.4 mm Upstream Cell : 300 mmol/L NaOH 500 mmol/L NaCl Downstream Cell : 300 mmol/L NaOH	OH Diff. Coef. : 9.44 e-11 m ² /s Tortuosity : 0.0179																																				
Material	Experimental Data	Results																																										
W/B : 0.40 Cement Type : Type I Cement : 390 kg/m ³ SCM #1 : 0 kg/m ³ SCM #2 : 0 kg/m ³ SCM #3 : 0 kg/m ³ Coarse Agg. : 1000 kg/m ³ Fine Agg. : 790 kg/m ³ Water Content : 156 kg/m ³ Air Content : 6.0 % Porosity : 12.3 %	Temperature : 23 °C Avg. Thickness : 51.5 mm Eff. Diameter : 101.4 mm Upstream Cell : 300 mmol/L NaOH 500 mmol/L NaCl Downstream Cell : 300 mmol/L NaOH	OH Diff. Coef. : 9.44 e-11 m ² /s Tortuosity : 0.0179																																										
 <p>Current [mA]</p> <p>Time [hours]</p> <p>M3-mig-28d : Simulation — M3-mig-28d : Exp. Data ▲</p> <table border="1"> <caption>Approximate data points from the graph</caption> <thead> <tr> <th>Time [hours]</th> <th>Current [mA]</th> </tr> </thead> <tbody> <tr><td>0</td><td>38</td></tr> <tr><td>10</td><td>34</td></tr> <tr><td>20</td><td>30</td></tr> <tr><td>30</td><td>28</td></tr> <tr><td>40</td><td>27</td></tr> <tr><td>50</td><td>26</td></tr> <tr><td>60</td><td>25</td></tr> <tr><td>70</td><td>24</td></tr> <tr><td>80</td><td>23</td></tr> <tr><td>90</td><td>22</td></tr> <tr><td>100</td><td>21.5</td></tr> <tr><td>150</td><td>21</td></tr> <tr><td>170</td><td>20.5</td></tr> <tr><td>190</td><td>20.5</td></tr> <tr><td>210</td><td>20</td></tr> <tr><td>220</td><td>21.5</td></tr> <tr><td>240</td><td>20.5</td></tr> <tr><td>250</td><td>20</td></tr> <tr><td>310</td><td>22</td></tr> <tr><td>315</td><td>20.5</td></tr> </tbody> </table>			Time [hours]	Current [mA]	0	38	10	34	20	30	30	28	40	27	50	26	60	25	70	24	80	23	90	22	100	21.5	150	21	170	20.5	190	20.5	210	20	220	21.5	240	20.5	250	20	310	22	315	20.5
Time [hours]	Current [mA]																																											
0	38																																											
10	34																																											
20	30																																											
30	28																																											
40	27																																											
50	26																																											
60	25																																											
70	24																																											
80	23																																											
90	22																																											
100	21.5																																											
150	21																																											
170	20.5																																											
190	20.5																																											
210	20																																											
220	21.5																																											
240	20.5																																											
250	20																																											
310	22																																											
315	20.5																																											
<p>Design Calculation</p> <p>Approved by:</p>		 <p>Simco Technologies Inc 2010 All right reserved STADIUM® IDC v3.0</p>																																										





 <p>SIMCO Technologies inc.</p>	<p>This Product is Licensed to : tzhang Date : 05/08/11 Contact : Client : Project : RD09024-Hycrete Project Ref. : Test : M3-mig-91d</p>							
<table border="1"> <thead> <tr> <th>Material</th> <th>Experimental Data</th> <th>Results</th> </tr> </thead> <tbody> <tr> <td data-bbox="284 478 618 829"> W/B : 0.40 Cement Type : Type I Cement : 390 kg/m³ SCM #1 : 0 kg/m³ SCM #2 : 0 kg/m³ SCM #3 : 0 kg/m³ Coarse Agg. : 1000 kg/m³ Fine Agg. : 790 kg/m³ Water Content : 156 kg/m³ Air Content : 6.0 % Porosity : 11.8 % </td> <td data-bbox="646 478 980 829"> Temperature : 23 °C Avg. Thickness : 51.3 mm Eff. Diameter : 100.5 mm Upstream Cell : 300 mmol/L NaOH 500 mmol/L NaCl Downstream Cell : 300 mmol/L NaOH </td> <td data-bbox="1008 478 1343 829"> OH Diff. Coef. : 9.39 e-11 m²/s Tortuosity : 0.0178 </td> </tr> </tbody> </table>			Material	Experimental Data	Results	W/B : 0.40 Cement Type : Type I Cement : 390 kg/m ³ SCM #1 : 0 kg/m ³ SCM #2 : 0 kg/m ³ SCM #3 : 0 kg/m ³ Coarse Agg. : 1000 kg/m ³ Fine Agg. : 790 kg/m ³ Water Content : 156 kg/m ³ Air Content : 6.0 % Porosity : 11.8 %	Temperature : 23 °C Avg. Thickness : 51.3 mm Eff. Diameter : 100.5 mm Upstream Cell : 300 mmol/L NaOH 500 mmol/L NaCl Downstream Cell : 300 mmol/L NaOH	OH Diff. Coef. : 9.39 e-11 m ² /s Tortuosity : 0.0178
Material	Experimental Data	Results						
W/B : 0.40 Cement Type : Type I Cement : 390 kg/m ³ SCM #1 : 0 kg/m ³ SCM #2 : 0 kg/m ³ SCM #3 : 0 kg/m ³ Coarse Agg. : 1000 kg/m ³ Fine Agg. : 790 kg/m ³ Water Content : 156 kg/m ³ Air Content : 6.0 % Porosity : 11.8 %	Temperature : 23 °C Avg. Thickness : 51.3 mm Eff. Diameter : 100.5 mm Upstream Cell : 300 mmol/L NaOH 500 mmol/L NaCl Downstream Cell : 300 mmol/L NaOH	OH Diff. Coef. : 9.39 e-11 m ² /s Tortuosity : 0.0178						
 <p>Current [mA]</p> <p>Time [hours]</p> <p>M3-mig-91d : Simulation — M3-mig-91d : Exp. Data ▲</p>								
<p>Design Calculation</p> <p>Approved by:</p>		 <p>Simco Technologies Inc 2010 All right reserved STADIUM® IDC v3.0</p>						

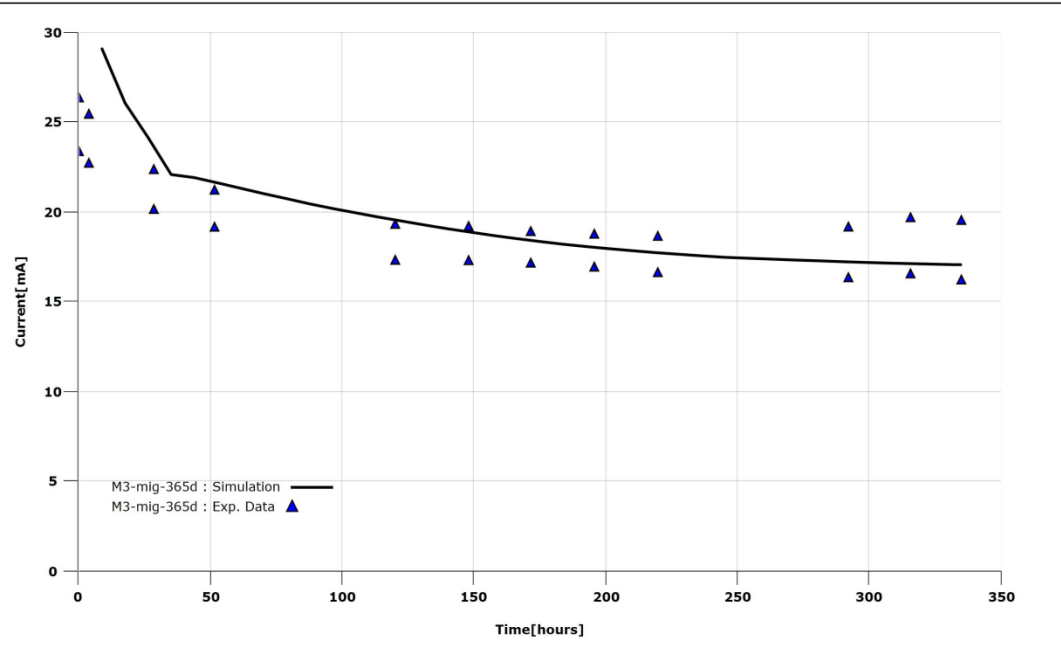

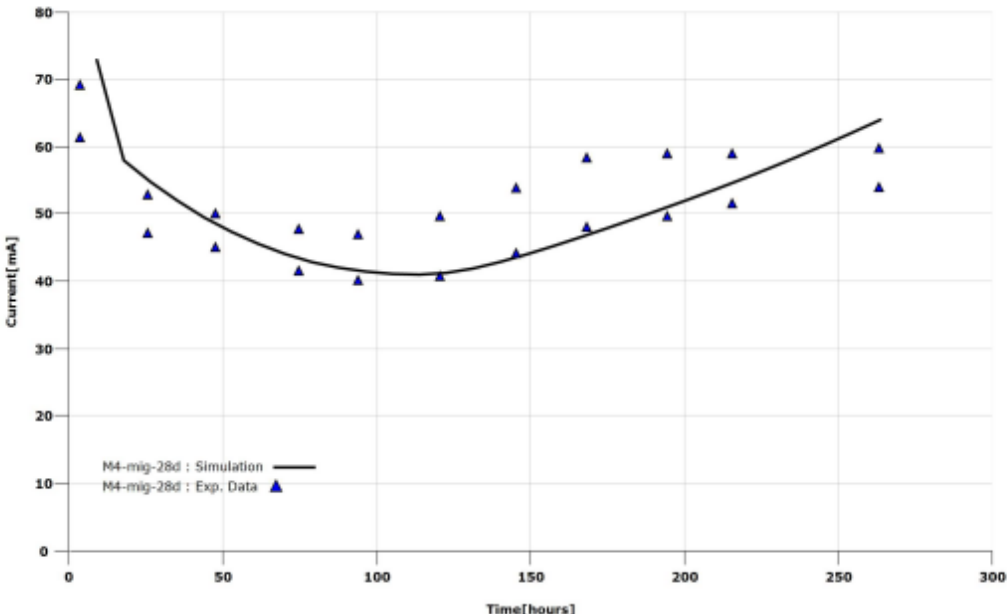

 <p>SIMCO Technologies inc.</p>	<p>This Product is Licensed to : tzhang Date : 15/02/2012 Contact : Client : Project : RD09024-Hycrete Project Ref. : Test : M3-mig-365d</p>	 <p>KNOW YOUR CONCRETE</p>
---	---	--

Material	Experimental Data	Results
<p>Mix : M3 W/B : 0.40 Cement Type : Type I Cement : 390 kg/m³ Coarse Agg. : 1000 kg/m³ Fine Agg. : 790 kg/m³ Water Content : 156 kg/m³ Air Content : 6.0 % CNI : 0 l/m³ Porosity : 11.3 %</p>	<p>Temperature : 23 °C Avg. Thickness : 51.0 mm Eff. Diameter : 101.6 mm Upstream Cell : 300 mmol/L NaOH 500 mmol/L NaCl Downstream Cell : 300 mmol/L NaOH</p>	<p>OH Diff. Coef. : 8.62 e-11 m²/s Tortuosity : 0.0163</p>

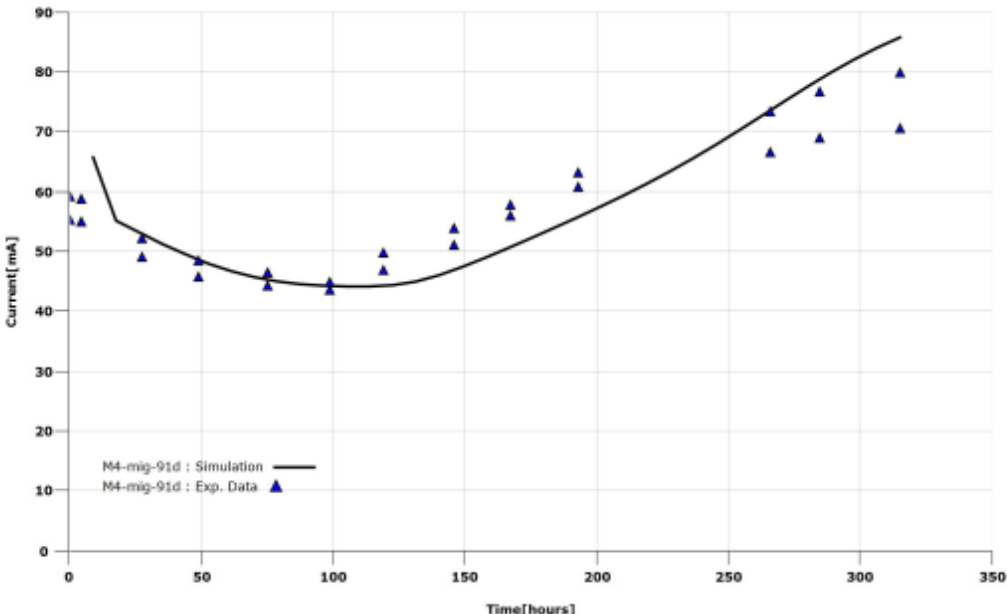

<p>Design Calculation</p> <p>Approved by:</p>		 <p>SIMCO Technologies Inc. 2012 All right reserved STADIUM® IDC v3.0 3.0.0.1067</p>
--	--	--

 <p>SIMCO Technologies inc.</p>	<p>This Product is Licensed to : tzhang Date : 05/08/11 Contact : Client : Project : RD09024-Hycrete Project Ref. : Test : M4-mig-28d</p>	 <p>KNOW YOUR CONCRETE</p>						
<table border="1" style="width: 100%; border-collapse: collapse;"> <thead> <tr> <th style="text-align: left;">Material</th> <th style="text-align: left;">Experimental Data</th> <th style="text-align: left;">Results</th> </tr> </thead> <tbody> <tr> <td style="padding: 2px;"> W/B : 0.55 Cement Type : Type I Cement : 330 kg/m³ SCM #1 : 0 kg/m³ SCM #2 : 0 kg/m³ SCM #3 : 0 kg/m³ Coarse Agg. : 920 kg/m³ Fine Agg. : 850 kg/m³ Water Content : 182 kg/m³ Air Content : 6.0 % Porosity : 14.3 % </td> <td style="padding: 2px;"> Temperature : 23 °C Avg. Thickness : 51.0 mm Eff. Diameter : 100.8 mm Upstream Cell : 300 mmol/L NaOH 500 mmol/L NaCl Downstream Cell : 300 mmol/L NaOH </td> <td style="padding: 2px;"> OH Diff. Coef. : 17.56 e-11 m²/s Tortuosity : 0.0333 </td> </tr> </tbody> </table>	Material	Experimental Data	Results	W/B : 0.55 Cement Type : Type I Cement : 330 kg/m ³ SCM #1 : 0 kg/m ³ SCM #2 : 0 kg/m ³ SCM #3 : 0 kg/m ³ Coarse Agg. : 920 kg/m ³ Fine Agg. : 850 kg/m ³ Water Content : 182 kg/m ³ Air Content : 6.0 % Porosity : 14.3 %	Temperature : 23 °C Avg. Thickness : 51.0 mm Eff. Diameter : 100.8 mm Upstream Cell : 300 mmol/L NaOH 500 mmol/L NaCl Downstream Cell : 300 mmol/L NaOH	OH Diff. Coef. : 17.56 e-11 m ² /s Tortuosity : 0.0333	<div style="text-align: center;">  <p>Current [mA]</p> <p>Time [hours]</p> <p>M4-mig-28d : Simulation — M4-mig-28d : Exp. Data ▲</p> </div>	
Material	Experimental Data	Results						
W/B : 0.55 Cement Type : Type I Cement : 330 kg/m ³ SCM #1 : 0 kg/m ³ SCM #2 : 0 kg/m ³ SCM #3 : 0 kg/m ³ Coarse Agg. : 920 kg/m ³ Fine Agg. : 850 kg/m ³ Water Content : 182 kg/m ³ Air Content : 6.0 % Porosity : 14.3 %	Temperature : 23 °C Avg. Thickness : 51.0 mm Eff. Diameter : 100.8 mm Upstream Cell : 300 mmol/L NaOH 500 mmol/L NaCl Downstream Cell : 300 mmol/L NaOH	OH Diff. Coef. : 17.56 e-11 m ² /s Tortuosity : 0.0333						
<p>Design Calculation</p> <p>Approved by:</p>	 <p>Simco Technologies Inc 2010 All right reserved STADIUM® IDC v3.0</p>							





 <p>SIMCO Technologies inc.</p>	<p>This Product is Licensed to : tzhang Date : 05/08/11 Contact : Client : Project : RD09024-Hycrete Project Ref. : Test : M4-mig-91d</p>							
<table border="1"> <thead> <tr> <th>Material</th> <th>Experimental Data</th> <th>Results</th> </tr> </thead> <tbody> <tr> <td data-bbox="284 478 618 829"> W/B : 0.55 Cement Type : Type I Cement : 330 kg/m³ SCM #1 : 0 kg/m³ SCM #2 : 0 kg/m³ SCM #3 : 0 kg/m³ Coarse Agg. : 920 kg/m³ Fine Agg. : 850 kg/m³ Water Content : 182 kg/m³ Air Content : 6.0 % Porosity : 13.3 % </td> <td data-bbox="646 478 980 829"> Temperature : 23 °C Avg. Thickness : 51.0 mm Eff. Diameter : 100.8 mm Upstream Cell : 300 mmol/L NaOH 500 mmol/L NaCl Downstream Cell : 300 mmol/L NaOH </td> <td data-bbox="1008 478 1343 829"> OH Diff. Coef. : 20.61 e-11 m²/s Tortuosity : 0.0391 </td> </tr> </tbody> </table>			Material	Experimental Data	Results	W/B : 0.55 Cement Type : Type I Cement : 330 kg/m ³ SCM #1 : 0 kg/m ³ SCM #2 : 0 kg/m ³ SCM #3 : 0 kg/m ³ Coarse Agg. : 920 kg/m ³ Fine Agg. : 850 kg/m ³ Water Content : 182 kg/m ³ Air Content : 6.0 % Porosity : 13.3 %	Temperature : 23 °C Avg. Thickness : 51.0 mm Eff. Diameter : 100.8 mm Upstream Cell : 300 mmol/L NaOH 500 mmol/L NaCl Downstream Cell : 300 mmol/L NaOH	OH Diff. Coef. : 20.61 e-11 m ² /s Tortuosity : 0.0391
Material	Experimental Data	Results						
W/B : 0.55 Cement Type : Type I Cement : 330 kg/m ³ SCM #1 : 0 kg/m ³ SCM #2 : 0 kg/m ³ SCM #3 : 0 kg/m ³ Coarse Agg. : 920 kg/m ³ Fine Agg. : 850 kg/m ³ Water Content : 182 kg/m ³ Air Content : 6.0 % Porosity : 13.3 %	Temperature : 23 °C Avg. Thickness : 51.0 mm Eff. Diameter : 100.8 mm Upstream Cell : 300 mmol/L NaOH 500 mmol/L NaCl Downstream Cell : 300 mmol/L NaOH	OH Diff. Coef. : 20.61 e-11 m ² /s Tortuosity : 0.0391						
 <p>Current [mA]</p> <p>Time [hours]</p> <p>M4-mig-91d : Simulation — M4-mig-91d : Exp. Data ▲</p>								
<p>Design Calculation</p> <p>Approved by:</p>		 <p>Simco Technologies Inc 2010 All right reserved STADIUM® IDC v3.0</p>						

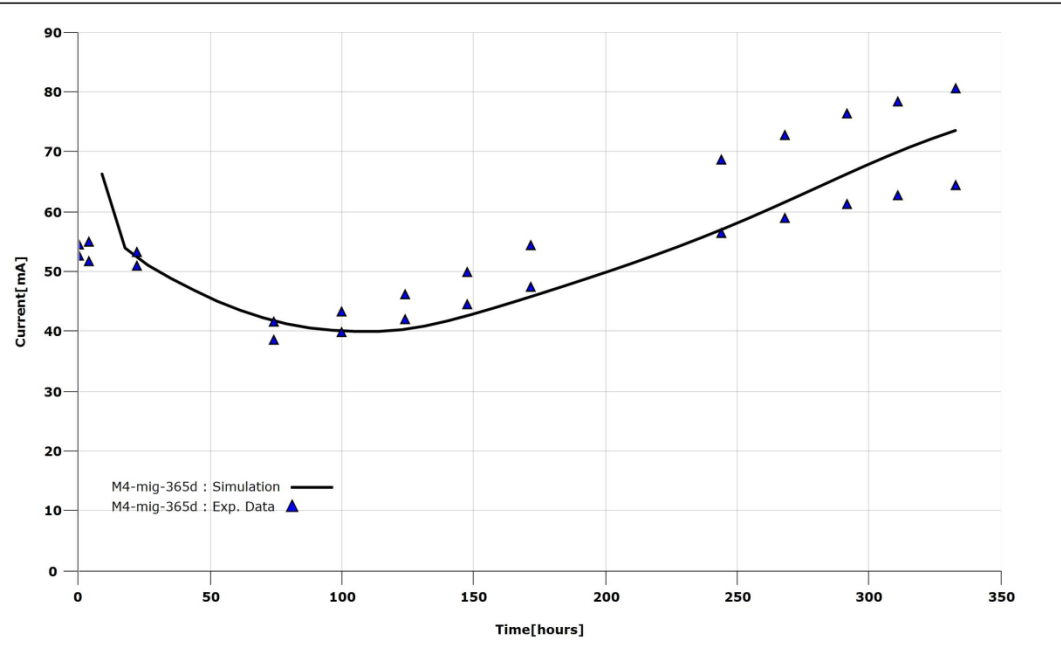

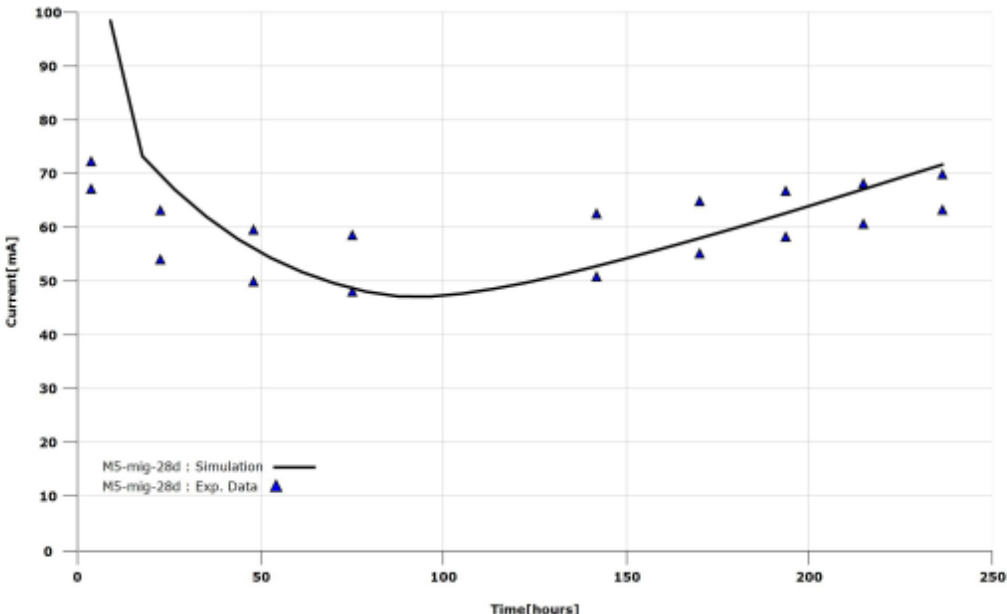

 <p>SIMCO Technologies inc.</p>	<p>This Product is Licensed to : tzhang Date : 05/01/2012 Contact : Client : Project : RD09024-Hycrete Project Ref. : Test : M4-mig-365d</p>	 <p>KNOW YOUR CONCRETE</p>
---	---	--

Material	Experimental Data	Results
<p>Mix : M4-Ref W/B : 0.55 Cement Type : Type I Cement : 330 kg/m³ Coarse Agg. : 920 kg/m³ Fine Agg. : 850 kg/m³ Water Content : 182 kg/m³ Air Content : 6.0 % CNI : 0 l/m³ Porosity : 14.3 %</p>	<p>Temperature : 23 °C Avg. Thickness : 51.0 mm Eff. Diameter : 102.0 mm Upstream Cell : 300 mmol/L NaOH 500 mmol/L NaCl Downstream Cell : 300 mmol/L NaOH</p>	<p>OH Diff. Coef. : 16.57 e-11 m²/s Tortuosity : 0.0314</p>

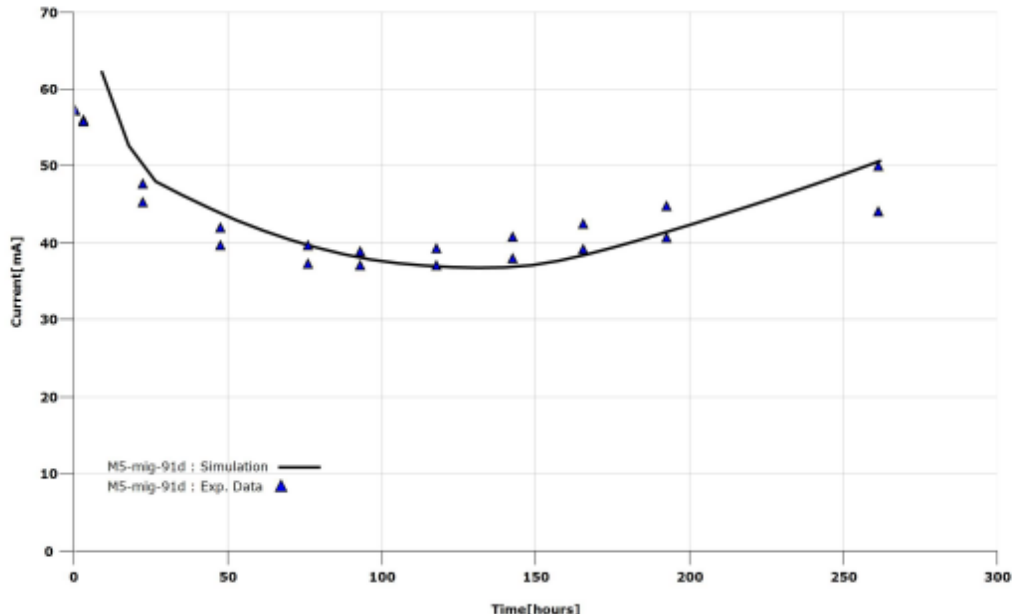

<p>Design Calculation</p> <p>Approved by:</p>		 <p>SIMCO Technologies Inc. 2012 All right reserved STADIUM® IDC v3.0 3.0.0.1067</p>
--	--	---

 <p>SIMCO Technologies inc.</p>	<p>This Product is Licensed to : tzhang Date : 05/08/11 Contact : Client : Project : RD09024-Hycrete Project Ref. : Test : M5-mig-28d</p>							
<table border="1"> <thead> <tr> <th>Material</th> <th>Experimental Data</th> <th>Results</th> </tr> </thead> <tbody> <tr> <td data-bbox="284 478 618 829"> W/B : 0.55 Cement Type : Type I Cement : 330 kg/m³ SCM #1 : 0 kg/m³ SCM #2 : 0 kg/m³ SCM #3 : 0 kg/m³ Coarse Agg. : 920 kg/m³ Fine Agg. : 850 kg/m³ Water Content : 182 kg/m³ Air Content : 6.0 % Porosity : 14.7 % </td> <td data-bbox="646 478 980 829"> Temperature : 23 °C Avg. Thickness : 51.2 mm Eff. Diameter : 100.4 mm Upstream Cell : 300 mmol/L NaOH 500 mmol/L NaCl Downstream Cell : 300 mmol/L NaOH </td> <td data-bbox="1008 478 1343 829"> OH Diff. Coef. : 18.05 e-11 m²/s Tortuosity : 0.0342 </td> </tr> </tbody> </table>			Material	Experimental Data	Results	W/B : 0.55 Cement Type : Type I Cement : 330 kg/m ³ SCM #1 : 0 kg/m ³ SCM #2 : 0 kg/m ³ SCM #3 : 0 kg/m ³ Coarse Agg. : 920 kg/m ³ Fine Agg. : 850 kg/m ³ Water Content : 182 kg/m ³ Air Content : 6.0 % Porosity : 14.7 %	Temperature : 23 °C Avg. Thickness : 51.2 mm Eff. Diameter : 100.4 mm Upstream Cell : 300 mmol/L NaOH 500 mmol/L NaCl Downstream Cell : 300 mmol/L NaOH	OH Diff. Coef. : 18.05 e-11 m ² /s Tortuosity : 0.0342
Material	Experimental Data	Results						
W/B : 0.55 Cement Type : Type I Cement : 330 kg/m ³ SCM #1 : 0 kg/m ³ SCM #2 : 0 kg/m ³ SCM #3 : 0 kg/m ³ Coarse Agg. : 920 kg/m ³ Fine Agg. : 850 kg/m ³ Water Content : 182 kg/m ³ Air Content : 6.0 % Porosity : 14.7 %	Temperature : 23 °C Avg. Thickness : 51.2 mm Eff. Diameter : 100.4 mm Upstream Cell : 300 mmol/L NaOH 500 mmol/L NaCl Downstream Cell : 300 mmol/L NaOH	OH Diff. Coef. : 18.05 e-11 m ² /s Tortuosity : 0.0342						
 <p>Current [mA]</p> <p>Time [hours]</p> <p>M5-mig-28d : Simulation — M5-mig-28d : Exp. Data ▲</p>								
Design Calculation Approved by:		 <p>Simco Technologies Inc 2010 All right reserved STADIUM® IDC v3.0</p>						





 <p>SIMCO Technologies inc.</p>	<p>This Product is Licensed to : tzhang Date : 05/08/11 Contact : Client : Project : RD09024-Hycrete Project Ref. : Test : M5-mig-91d</p>							
<table border="1"> <thead> <tr> <th>Material</th> <th>Experimental Data</th> <th>Results</th> </tr> </thead> <tbody> <tr> <td data-bbox="284 478 618 829"> W/B : 0.55 Cement Type : Type I Cement : 330 kg/m³ SCM #1 : 0 kg/m³ SCM #2 : 0 kg/m³ SCM #3 : 0 kg/m³ Coarse Agg. : 920 kg/m³ Fine Agg. : 850 kg/m³ Water Content : 182 kg/m³ Air Content : 6.0 % Porosity : 14.4 % </td> <td data-bbox="643 478 977 829"> Temperature : 23 °C Avg. Thickness : 51.5 mm Eff. Diameter : 101.9 mm Upstream Cell : 300 mmol/L NaOH 500 mmol/L NaCl Downstream Cell : 300 mmol/L NaOH </td> <td data-bbox="1002 478 1336 829"> OH Diff. Coef. : 15.30 e-11 m²/s Tortuosity : 0.0290 </td> </tr> </tbody> </table>			Material	Experimental Data	Results	W/B : 0.55 Cement Type : Type I Cement : 330 kg/m ³ SCM #1 : 0 kg/m ³ SCM #2 : 0 kg/m ³ SCM #3 : 0 kg/m ³ Coarse Agg. : 920 kg/m ³ Fine Agg. : 850 kg/m ³ Water Content : 182 kg/m ³ Air Content : 6.0 % Porosity : 14.4 %	Temperature : 23 °C Avg. Thickness : 51.5 mm Eff. Diameter : 101.9 mm Upstream Cell : 300 mmol/L NaOH 500 mmol/L NaCl Downstream Cell : 300 mmol/L NaOH	OH Diff. Coef. : 15.30 e-11 m ² /s Tortuosity : 0.0290
Material	Experimental Data	Results						
W/B : 0.55 Cement Type : Type I Cement : 330 kg/m ³ SCM #1 : 0 kg/m ³ SCM #2 : 0 kg/m ³ SCM #3 : 0 kg/m ³ Coarse Agg. : 920 kg/m ³ Fine Agg. : 850 kg/m ³ Water Content : 182 kg/m ³ Air Content : 6.0 % Porosity : 14.4 %	Temperature : 23 °C Avg. Thickness : 51.5 mm Eff. Diameter : 101.9 mm Upstream Cell : 300 mmol/L NaOH 500 mmol/L NaCl Downstream Cell : 300 mmol/L NaOH	OH Diff. Coef. : 15.30 e-11 m ² /s Tortuosity : 0.0290						
 <p>Current [mA]</p> <p>Time [hours]</p> <p>M5-mig-91d : Simulation — M5-mig-91d : Exp. Data ▲</p>								
<p>Design Calculation</p> <p>Approved by:</p>		 <p>Simco Technologies Inc 2010 All right reserved STADIUM® IDC v3.0</p>						

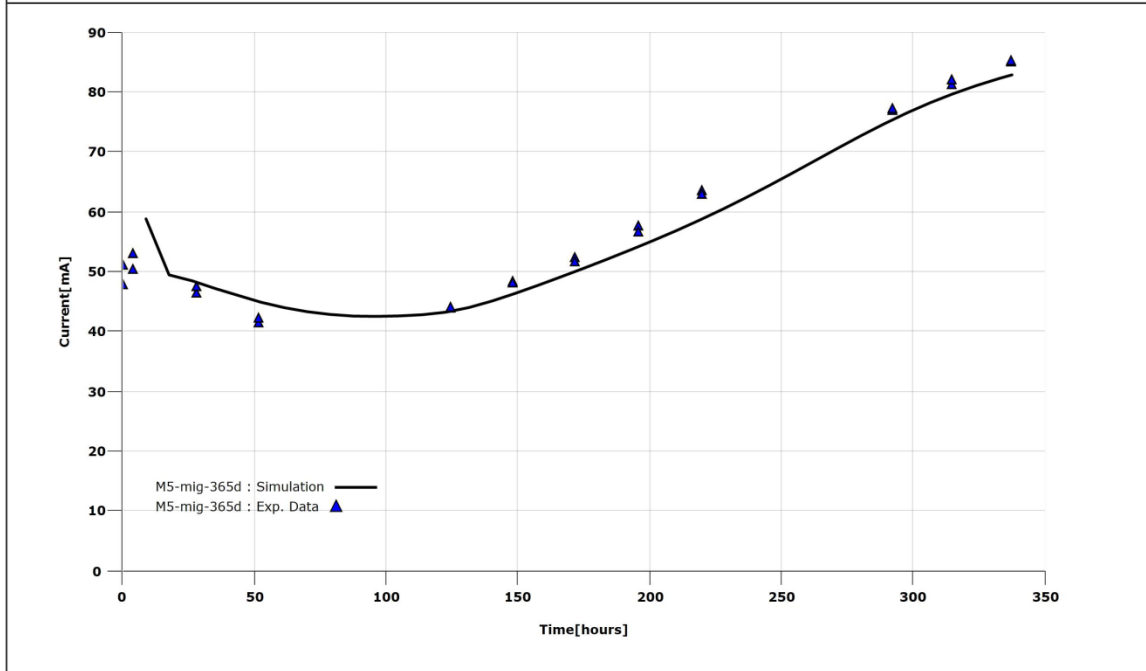

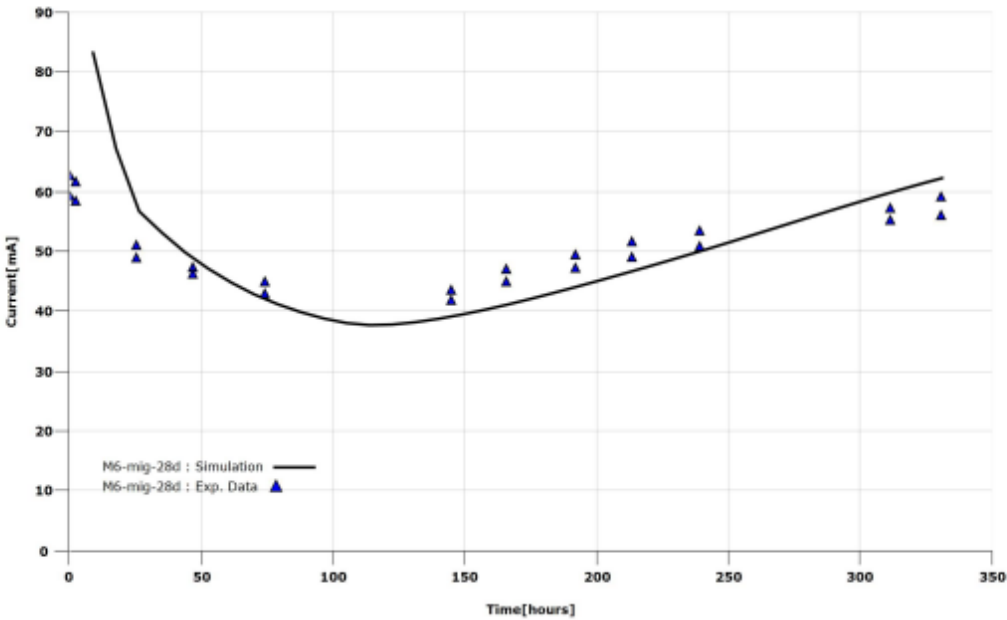

 <p>SIMCO Technologies inc.</p>	<p>This Product is Licensed to : tzhang Date : 23/02/2012 Contact: Client : Project : RD09024-Hycrete Project Ref. : Test : M5-mig-365d</p>	 <p>KNOW YOUR CONCRETE</p>
---	--	--

Material	Experimental Data	Results
<p>Mix : M5 W/B : 0.55 Cement Type : Type I Cement : 330 kg/m³ Coarse Agg. : 920 kg/m³ Fine Agg. : 850 kg/m³ Water Content : 182 kg/m³ Air Content : 6.0 % CNI : 0 l/m³ Porosity : 14.9 %</p>	<p>Temperature : 23 °C Avg. Thickness : 51.0 mm Eff. Diameter : 101.4 mm Upstream Cell : 300 mmol/L NaOH 500 mmol/L NaCl Downstream Cell : 300 mmol/L NaOH</p>	<p>OH Diff. Coef. : 17.37 e-11 m²/s Tortuosity : 0.0329</p>

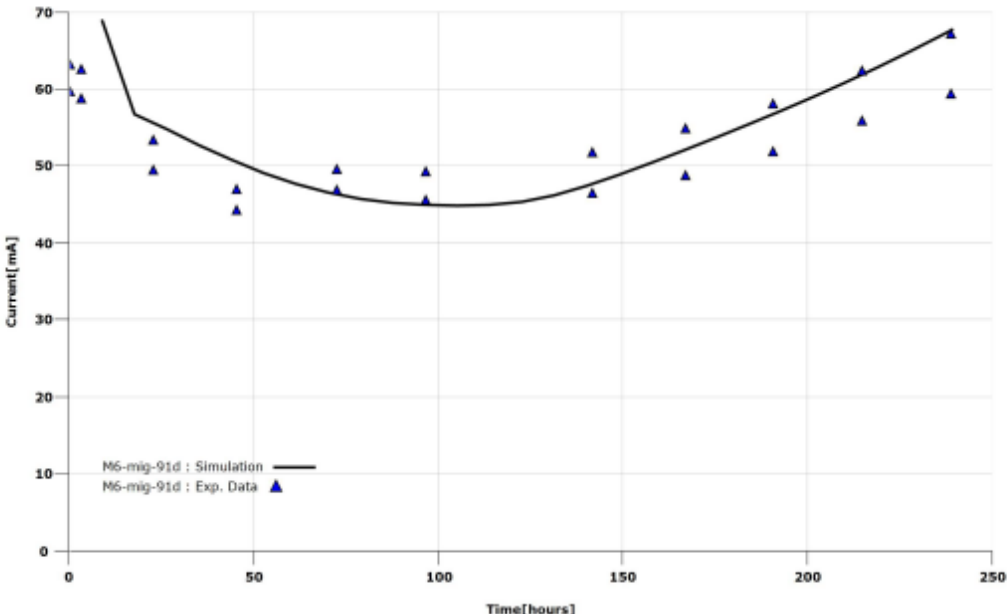

<p>Design Calculation</p> <p>Approved by:</p>		 <p>SIMCO Technologies Inc. 2012 All right reserved STADIUM® IDC v3.0 3.0.0.1067</p>
--	--	--

 <p>SIMCO Technologies inc.</p>	<p>This Product is Licensed to : tzhang Date : 05/08/11 Contact : Client : Project : RD09024-Hycrete Project Ref. : Test : M6-mig-28d</p>	
<p style="text-align: center;">Material</p> <p>W/B : 0.55 Cement Type : Type I Cement : 330 kg/m³ SCM #1 : 0 kg/m³ SCM #2 : 0 kg/m³ SCM #3 : 0 kg/m³ Coarse Agg. : 920 kg/m³ Fine Agg. : 850 kg/m³ Water Content : 182 kg/m³ Air Content : 6.0 % Porosity : 14.7 %</p>	<p style="text-align: center;">Experimental Data</p> <p>Temperature : 23 °C Avg. Thickness : 51.5 mm Eff. Diameter : 100.4 mm Upstream Cell : 300 mmol/L NaOH 500 mmol/L NaCl Downstream Cell : 300 mmol/L NaOH</p>	<p style="text-align: center;">Results</p> <p>OH Diff. Coef. : 15.00 e-11 m²/s Tortuosity : 0.0284</p>
 <p style="font-size: small;">M6-mig-28d : Simulation — M6-mig-28d : Exp. Data ▲</p>		
<p>Design Calculation</p> <p>Approved by:</p>		 <p>Simco Technologies Inc 2010 All right reserved STADIUM® IDC v3.0</p>





 <p>SIMCO Technologies inc.</p>	<p>This Product is Licensed to : tzhang Date : 05/08/11 Contact : Client : Project : RD09024-Hycrete Project Ref. : Test : M6-mig-91d</p>							
<table border="1"> <thead> <tr> <th>Material</th> <th>Experimental Data</th> <th>Results</th> </tr> </thead> <tbody> <tr> <td data-bbox="284 478 618 829"> W/B : 0.55 Cement Type : Type I Cement : 330 kg/m³ SCM #1 : 0 kg/m³ SCM #2 : 0 kg/m³ SCM #3 : 0 kg/m³ Coarse Agg. : 920 kg/m³ Fine Agg. : 850 kg/m³ Water Content : 182 kg/m³ Air Content : 6.0 % Porosity : 14.5 % </td> <td data-bbox="643 478 977 829"> Temperature : 23 °C Avg. Thickness : 51.5 mm Eff. Diameter : 101.4 mm Upstream Cell : 300 mmol/L NaOH 500 mmol/L NaCl Downstream Cell : 300 mmol/L NaOH </td> <td data-bbox="1002 478 1336 829"> OH Diff. Coef. : 18.57 e-11 m²/s Tortuosity : 0.0352 </td> </tr> </tbody> </table>			Material	Experimental Data	Results	W/B : 0.55 Cement Type : Type I Cement : 330 kg/m ³ SCM #1 : 0 kg/m ³ SCM #2 : 0 kg/m ³ SCM #3 : 0 kg/m ³ Coarse Agg. : 920 kg/m ³ Fine Agg. : 850 kg/m ³ Water Content : 182 kg/m ³ Air Content : 6.0 % Porosity : 14.5 %	Temperature : 23 °C Avg. Thickness : 51.5 mm Eff. Diameter : 101.4 mm Upstream Cell : 300 mmol/L NaOH 500 mmol/L NaCl Downstream Cell : 300 mmol/L NaOH	OH Diff. Coef. : 18.57 e-11 m ² /s Tortuosity : 0.0352
Material	Experimental Data	Results						
W/B : 0.55 Cement Type : Type I Cement : 330 kg/m ³ SCM #1 : 0 kg/m ³ SCM #2 : 0 kg/m ³ SCM #3 : 0 kg/m ³ Coarse Agg. : 920 kg/m ³ Fine Agg. : 850 kg/m ³ Water Content : 182 kg/m ³ Air Content : 6.0 % Porosity : 14.5 %	Temperature : 23 °C Avg. Thickness : 51.5 mm Eff. Diameter : 101.4 mm Upstream Cell : 300 mmol/L NaOH 500 mmol/L NaCl Downstream Cell : 300 mmol/L NaOH	OH Diff. Coef. : 18.57 e-11 m ² /s Tortuosity : 0.0352						
 <p>Current [mA]</p> <p>Time [hours]</p> <p>M6-mig-91d : Simulation — M6-mig-91d : Exp. Data ▲</p>								
<p>Design Calculation</p> <p>Approved by:</p>		 <p>Simco Technologies Inc 2010 All right reserved STADIUM® IDC v3.0</p>						

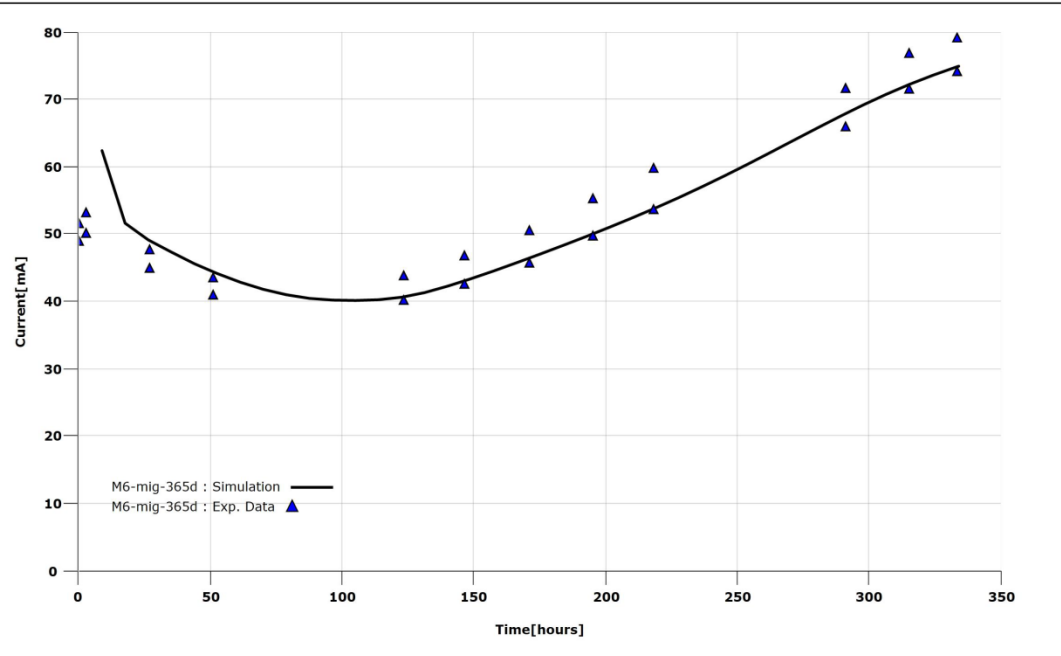



 <p>SIMCO Technologies inc.</p>	<p>This Product is Licensed to : tzhang Date : 23/02/2012 Contact : Client : Project : RD09024-Hycrete Project Ref. : Test : M6-mig-365d</p>	 <p>KNOW YOUR CONCRETE</p>
---	---	--

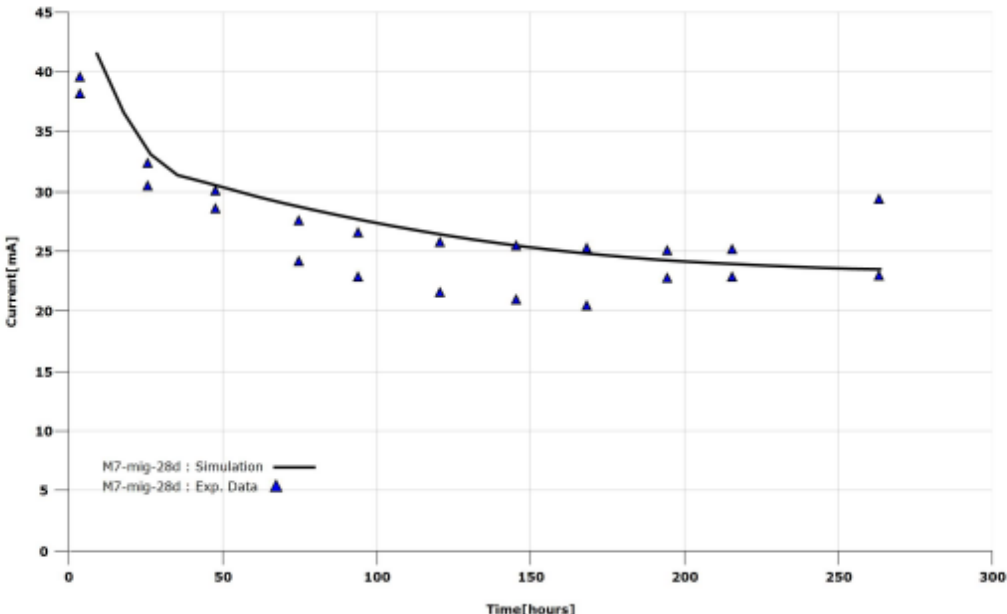

Material	Experimental Data	Results
<p>Mix : M6 W/B : 0.55 Cement Type : Type I Cement : 330 kg/m³ Coarse Agg. : 920 kg/m³ Fine Agg. : 850 kg/m³ Water Content : 182 kg/m³ Air Content : 6.0 % CNI : 0 l/m³ Porosity : 15.1 %</p>	<p>Temperature : 23 °C Avg. Thickness : 50.4 mm Eff. Diameter : 101.6 mm Upstream Cell : 300 mmol/L NaOH 500 mmol/L NaCl Downstream Cell : 300 mmol/L NaOH</p>	<p>OH Diff. Coef. : 15.62 e-11 m²/s Tortuosity : 0.0296</p>

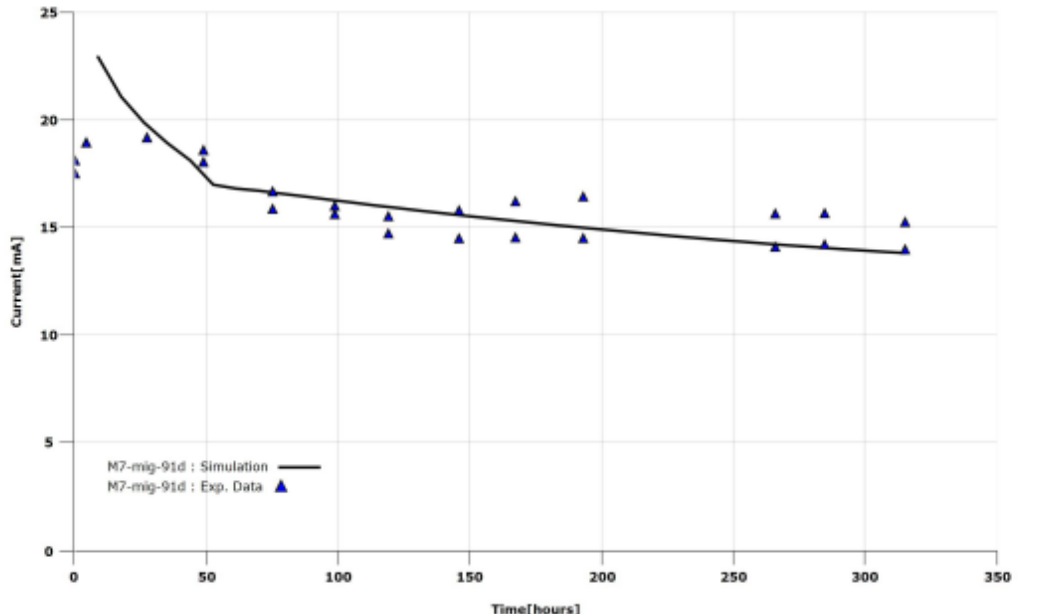

<p>Design Calculation</p> <p>Approved by:</p>		 <p>SIMCO Technologies Inc. 2012 All right reserved STADIUM® IDC v3.0 3.0.0.1067</p>
--	--	--

 <p>SIMCO Technologies inc.</p>	<p>This Product is Licensed to : tzhang Date : 05/08/11 Contact : Client : Project : RD09024-Hycrete Project Ref. : Test : M7-mig-28d</p>																																																									
<table border="1"> <thead> <tr> <th>Material</th> <th>Experimental Data</th> <th>Results</th> </tr> </thead> <tbody> <tr> <td data-bbox="284 478 620 829"> W/B : 0.45 Cement Type : Type I Cement : 300 kg/m³ SCM #1 : 75 kg/m³ SCM #2 : 0 kg/m³ SCM #3 : 0 kg/m³ Coarse Agg. : 950 kg/m³ Fine Agg. : 800 kg/m³ Water Content : 169 kg/m³ Air Content : 6.0 % Porosity : 13.6 % </td> <td data-bbox="641 478 977 829"> Temperature : 23 °C Avg. Thickness : 50.8 mm Eff. Diameter : 100.3 mm Upstream Cell : 300 mmol/L NaOH 500 mmol/L NaCl Downstream Cell : 300 mmol/L NaOH </td> <td data-bbox="998 478 1334 829"> OH Diff. Coef. : 10.40 e-11 m²/s Tortuosity : 0.0197 </td> </tr> </tbody> </table>			Material	Experimental Data	Results	W/B : 0.45 Cement Type : Type I Cement : 300 kg/m ³ SCM #1 : 75 kg/m ³ SCM #2 : 0 kg/m ³ SCM #3 : 0 kg/m ³ Coarse Agg. : 950 kg/m ³ Fine Agg. : 800 kg/m ³ Water Content : 169 kg/m ³ Air Content : 6.0 % Porosity : 13.6 %	Temperature : 23 °C Avg. Thickness : 50.8 mm Eff. Diameter : 100.3 mm Upstream Cell : 300 mmol/L NaOH 500 mmol/L NaCl Downstream Cell : 300 mmol/L NaOH	OH Diff. Coef. : 10.40 e-11 m ² /s Tortuosity : 0.0197																																																		
Material	Experimental Data	Results																																																								
W/B : 0.45 Cement Type : Type I Cement : 300 kg/m ³ SCM #1 : 75 kg/m ³ SCM #2 : 0 kg/m ³ SCM #3 : 0 kg/m ³ Coarse Agg. : 950 kg/m ³ Fine Agg. : 800 kg/m ³ Water Content : 169 kg/m ³ Air Content : 6.0 % Porosity : 13.6 %	Temperature : 23 °C Avg. Thickness : 50.8 mm Eff. Diameter : 100.3 mm Upstream Cell : 300 mmol/L NaOH 500 mmol/L NaCl Downstream Cell : 300 mmol/L NaOH	OH Diff. Coef. : 10.40 e-11 m ² /s Tortuosity : 0.0197																																																								
 <table border="1"> <caption>Approximate data points from the graph</caption> <thead> <tr> <th>Time [hours]</th> <th>Current [mA]</th> </tr> </thead> <tbody> <tr><td>0</td><td>40</td></tr> <tr><td>10</td><td>38</td></tr> <tr><td>20</td><td>33</td></tr> <tr><td>30</td><td>31</td></tr> <tr><td>40</td><td>30</td></tr> <tr><td>50</td><td>29</td></tr> <tr><td>60</td><td>28</td></tr> <tr><td>70</td><td>27</td></tr> <tr><td>80</td><td>26</td></tr> <tr><td>90</td><td>25</td></tr> <tr><td>100</td><td>24</td></tr> <tr><td>110</td><td>23</td></tr> <tr><td>120</td><td>22</td></tr> <tr><td>130</td><td>21</td></tr> <tr><td>140</td><td>21</td></tr> <tr><td>150</td><td>20</td></tr> <tr><td>160</td><td>20</td></tr> <tr><td>170</td><td>20</td></tr> <tr><td>180</td><td>20</td></tr> <tr><td>190</td><td>20</td></tr> <tr><td>200</td><td>20</td></tr> <tr><td>210</td><td>20</td></tr> <tr><td>220</td><td>20</td></tr> <tr><td>230</td><td>20</td></tr> <tr><td>240</td><td>20</td></tr> <tr><td>250</td><td>20</td></tr> <tr><td>260</td><td>20</td></tr> </tbody> </table>			Time [hours]	Current [mA]	0	40	10	38	20	33	30	31	40	30	50	29	60	28	70	27	80	26	90	25	100	24	110	23	120	22	130	21	140	21	150	20	160	20	170	20	180	20	190	20	200	20	210	20	220	20	230	20	240	20	250	20	260	20
Time [hours]	Current [mA]																																																									
0	40																																																									
10	38																																																									
20	33																																																									
30	31																																																									
40	30																																																									
50	29																																																									
60	28																																																									
70	27																																																									
80	26																																																									
90	25																																																									
100	24																																																									
110	23																																																									
120	22																																																									
130	21																																																									
140	21																																																									
150	20																																																									
160	20																																																									
170	20																																																									
180	20																																																									
190	20																																																									
200	20																																																									
210	20																																																									
220	20																																																									
230	20																																																									
240	20																																																									
250	20																																																									
260	20																																																									
<p>Design Calculation</p> <p>Approved by:</p>		 <p>Simco Technologies Inc 2010 All right reserved STADIUM® IDC v3.0</p>																																																								





 <p>SIMCO Technologies inc.</p>	<p>This Product is Licensed to : tzhang Date : 05/08/11 Contact : Client : Project : RD09024-Hycrete Project Ref. : Test : M7-mig-91d</p>							
<table border="1"> <thead> <tr> <th>Material</th> <th>Experimental Data</th> <th>Results</th> </tr> </thead> <tbody> <tr> <td data-bbox="284 478 618 829"> W/B : 0.45 Cement Type : Type I Cement : 300 kg/m³ SCM #1 : 75 kg/m³ SCM #2 : 0 kg/m³ SCM #3 : 0 kg/m³ Coarse Agg. : 950 kg/m³ Fine Agg. : 800 kg/m³ Water Content : 169 kg/m³ Air Content : 6.0 % Porosity : 13.1 % </td> <td data-bbox="646 478 980 829"> Temperature : 23 °C Avg. Thickness : 51.7 mm Eff. Diameter : 102.1 mm Upstream Cell : 300 mmol/L NaOH 500 mmol/L NaCl Downstream Cell : 300 mmol/L NaOH </td> <td data-bbox="1008 478 1343 829"> OH Diff. Coef. : 5.44 e-11 m²/s Tortuosity : 0.0103 </td> </tr> </tbody> </table>			Material	Experimental Data	Results	W/B : 0.45 Cement Type : Type I Cement : 300 kg/m ³ SCM #1 : 75 kg/m ³ SCM #2 : 0 kg/m ³ SCM #3 : 0 kg/m ³ Coarse Agg. : 950 kg/m ³ Fine Agg. : 800 kg/m ³ Water Content : 169 kg/m ³ Air Content : 6.0 % Porosity : 13.1 %	Temperature : 23 °C Avg. Thickness : 51.7 mm Eff. Diameter : 102.1 mm Upstream Cell : 300 mmol/L NaOH 500 mmol/L NaCl Downstream Cell : 300 mmol/L NaOH	OH Diff. Coef. : 5.44 e-11 m ² /s Tortuosity : 0.0103
Material	Experimental Data	Results						
W/B : 0.45 Cement Type : Type I Cement : 300 kg/m ³ SCM #1 : 75 kg/m ³ SCM #2 : 0 kg/m ³ SCM #3 : 0 kg/m ³ Coarse Agg. : 950 kg/m ³ Fine Agg. : 800 kg/m ³ Water Content : 169 kg/m ³ Air Content : 6.0 % Porosity : 13.1 %	Temperature : 23 °C Avg. Thickness : 51.7 mm Eff. Diameter : 102.1 mm Upstream Cell : 300 mmol/L NaOH 500 mmol/L NaCl Downstream Cell : 300 mmol/L NaOH	OH Diff. Coef. : 5.44 e-11 m ² /s Tortuosity : 0.0103						
 <p> M7-mig-91d : Simulation — M7-mig-91d : Exp. Data ▲ </p>								
<p>Design Calculation</p> <p>Approved by:</p>		 <p>Simco Technologies Inc 2010 All right reserved STADIUM® IDC v3.0</p>						

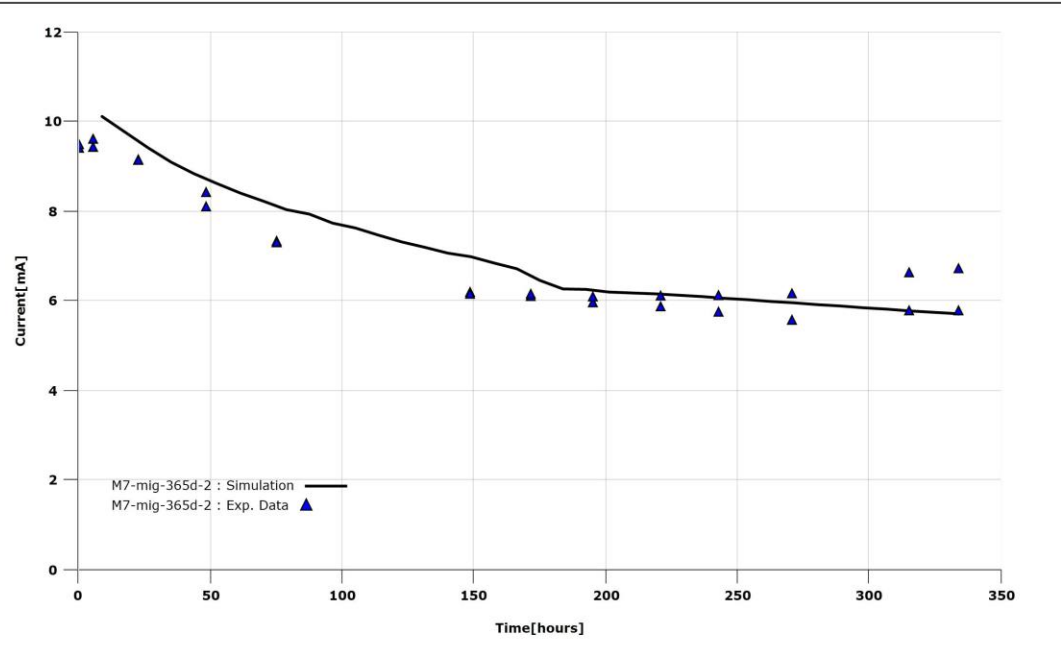

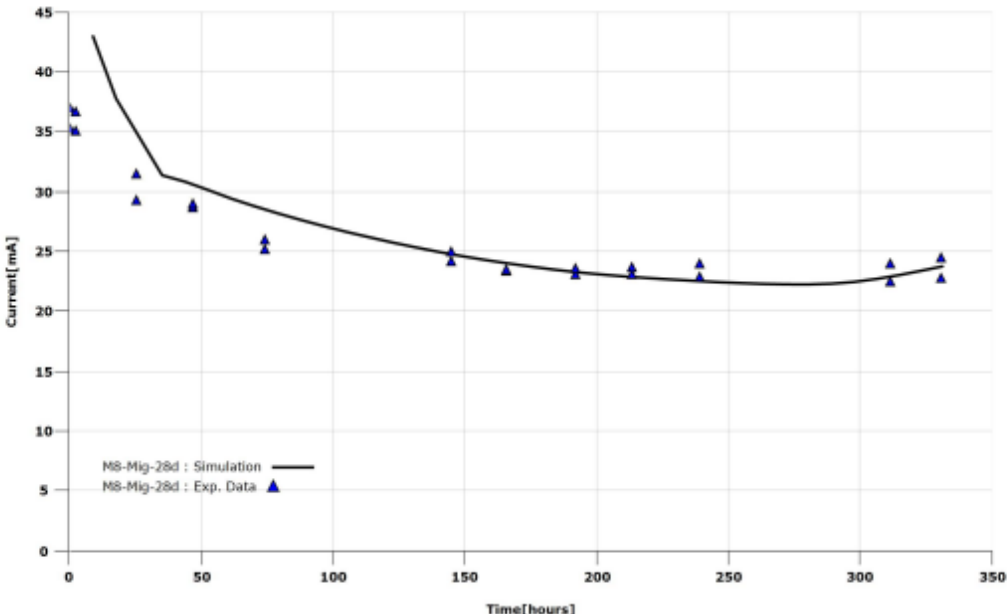

 <p>SIMCO Technologies inc.</p>	<p>This Product is Licensed to : tzhang Date : 27/01/2012 Contact : Client : Project : RD09024-Hycrete Project Ref. : Test : M7-mig-365d-2</p>	 <p>KNOW YOUR CONCRETE</p>
---	---	--

Material	Experimental Data	Results
<p>Mix : M7-Ref W/B : 0.45 Cement Type : Type I Cement : 300 kg/m³ Fly Ash F : 75 kg/m³ Coarse Agg. : 950 kg/m³ Fine Agg. : 800 kg/m³ Water Content : 169 kg/m³ Air Content : 6.0 % CNI : 0 l/m³ Porosity : 13.1 %</p>	<p>Temperature : 23 °C Avg. Thickness : 51.4 mm Eff. Diameter : 101.5 mm Upstream Cell : 300 mmol/L NaOH 500 mmol/L NaCl Downstream Cell : 300 mmol/L NaOH</p>	<p>OH Diff. Coef. : 1.64 e-11 m²/s Tortuosity : 0.0031</p>

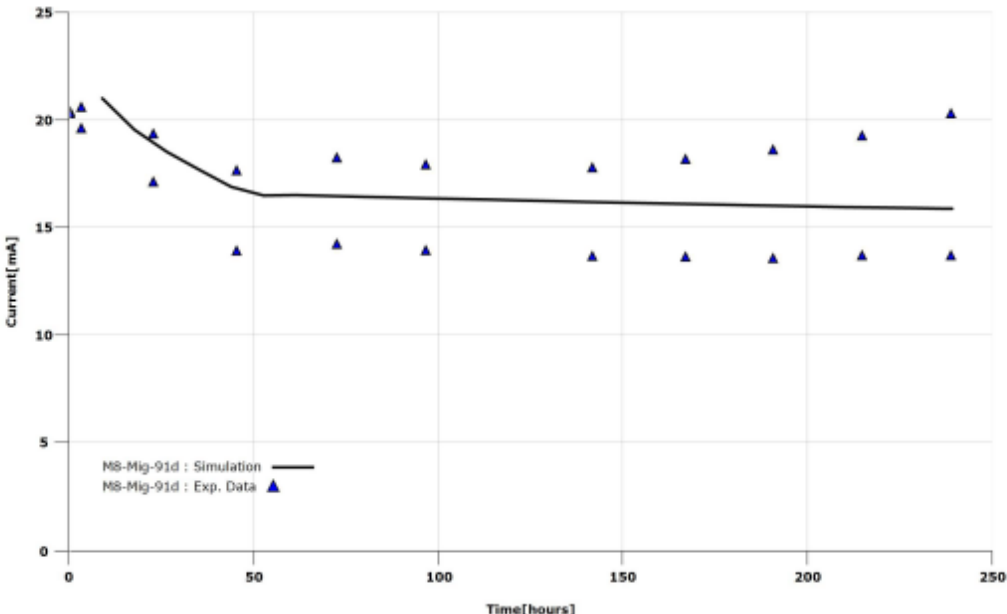

<p>Design Calculation</p> <p>Approved by:</p>		 <p>SIMCO Technologies Inc. 2012 All right reserved STADIUM® IDC v3.0 3.0.0.1067</p>
--	--	--

 <p>SIMCO Technologies inc.</p>	<p>This Product is Licensed to : tzhang Date : 05/08/11 Contact : Client : Project : RD09024-Hycrete Project Ref. : Test : M8-Mig-28d</p>																																														
<table border="1"> <thead> <tr> <th>Material</th> <th>Experimental Data</th> <th>Results</th> </tr> </thead> <tbody> <tr> <td data-bbox="284 478 620 829"> W/B : 0.45 Cement Type : Type I Cement : 300 kg/m³ SCM #1 : 75 kg/m³ SCM #2 : 0 kg/m³ SCM #3 : 0 kg/m³ Coarse Agg. : 950 kg/m³ Fine Agg. : 800 kg/m³ Water Content : 169 kg/m³ Air Content : 6.0 % Porosity : 14.0 % </td> <td data-bbox="646 478 982 829"> Temperature : 23 °C Avg. Thickness : 50.8 mm Eff. Diameter : 101.4 mm Upstream Cell : 300 mmol/L NaOH 500 mmol/L NaCl Downstream Cell : 300 mmol/L NaOH </td> <td data-bbox="1008 478 1344 829"> OH Diff. Coef. : 9.41 e-11 m²/s Tortuosity : 0.0178 </td> </tr> </tbody> </table>			Material	Experimental Data	Results	W/B : 0.45 Cement Type : Type I Cement : 300 kg/m ³ SCM #1 : 75 kg/m ³ SCM #2 : 0 kg/m ³ SCM #3 : 0 kg/m ³ Coarse Agg. : 950 kg/m ³ Fine Agg. : 800 kg/m ³ Water Content : 169 kg/m ³ Air Content : 6.0 % Porosity : 14.0 %	Temperature : 23 °C Avg. Thickness : 50.8 mm Eff. Diameter : 101.4 mm Upstream Cell : 300 mmol/L NaOH 500 mmol/L NaCl Downstream Cell : 300 mmol/L NaOH	OH Diff. Coef. : 9.41 e-11 m ² /s Tortuosity : 0.0178																																							
Material	Experimental Data	Results																																													
W/B : 0.45 Cement Type : Type I Cement : 300 kg/m ³ SCM #1 : 75 kg/m ³ SCM #2 : 0 kg/m ³ SCM #3 : 0 kg/m ³ Coarse Agg. : 950 kg/m ³ Fine Agg. : 800 kg/m ³ Water Content : 169 kg/m ³ Air Content : 6.0 % Porosity : 14.0 %	Temperature : 23 °C Avg. Thickness : 50.8 mm Eff. Diameter : 101.4 mm Upstream Cell : 300 mmol/L NaOH 500 mmol/L NaCl Downstream Cell : 300 mmol/L NaOH	OH Diff. Coef. : 9.41 e-11 m ² /s Tortuosity : 0.0178																																													
 <table border="1"> <caption>Approximate data points from the graph</caption> <thead> <tr> <th>Time [hours]</th> <th>Current [mA]</th> <th>Type</th> </tr> </thead> <tbody> <tr><td>0</td><td>43</td><td>Simulation</td></tr> <tr><td>5</td><td>37</td><td>Exp. Data</td></tr> <tr><td>10</td><td>35</td><td>Exp. Data</td></tr> <tr><td>20</td><td>32</td><td>Exp. Data</td></tr> <tr><td>30</td><td>30</td><td>Exp. Data</td></tr> <tr><td>40</td><td>29</td><td>Exp. Data</td></tr> <tr><td>75</td><td>26</td><td>Exp. Data</td></tr> <tr><td>145</td><td>25</td><td>Exp. Data</td></tr> <tr><td>165</td><td>24</td><td>Exp. Data</td></tr> <tr><td>190</td><td>24</td><td>Exp. Data</td></tr> <tr><td>215</td><td>24</td><td>Exp. Data</td></tr> <tr><td>240</td><td>24</td><td>Exp. Data</td></tr> <tr><td>310</td><td>24</td><td>Exp. Data</td></tr> <tr><td>330</td><td>24</td><td>Exp. Data</td></tr> </tbody> </table>			Time [hours]	Current [mA]	Type	0	43	Simulation	5	37	Exp. Data	10	35	Exp. Data	20	32	Exp. Data	30	30	Exp. Data	40	29	Exp. Data	75	26	Exp. Data	145	25	Exp. Data	165	24	Exp. Data	190	24	Exp. Data	215	24	Exp. Data	240	24	Exp. Data	310	24	Exp. Data	330	24	Exp. Data
Time [hours]	Current [mA]	Type																																													
0	43	Simulation																																													
5	37	Exp. Data																																													
10	35	Exp. Data																																													
20	32	Exp. Data																																													
30	30	Exp. Data																																													
40	29	Exp. Data																																													
75	26	Exp. Data																																													
145	25	Exp. Data																																													
165	24	Exp. Data																																													
190	24	Exp. Data																																													
215	24	Exp. Data																																													
240	24	Exp. Data																																													
310	24	Exp. Data																																													
330	24	Exp. Data																																													
<p>Design Calculation</p> <p>Approved by:</p>		 <p>Simco Technologies Inc 2010 All right reserved STADIUM® IDC v3.0</p>																																													





 <p>SIMCO Technologies inc.</p>	<p>This Product is Licensed to : tzhang Date : 05/08/11 Contact : Client : Project : RD09024-Hycrete Project Ref. : Test : M8-Mig-91d</p>	 <p>STADIUM A SIMCO SOLUTION KNOW YOUR CONCRETE</p>						
<table border="1"> <thead> <tr> <th>Material</th> <th>Experimental Data</th> <th>Results</th> </tr> </thead> <tbody> <tr> <td data-bbox="284 478 620 829"> W/B : 0.45 Cement Type : Type I Cement : 300 kg/m³ SCM #1 : 75 kg/m³ SCM #2 : 0 kg/m³ SCM #3 : 0 kg/m³ Coarse Agg. : 950 kg/m³ Fine Agg. : 800 kg/m³ Water Content : 169 kg/m³ Air Content : 6.0 % Porosity : 13.9 % </td> <td data-bbox="646 478 982 829"> Temperature : 23 °C Avg. Thickness : 50.8 mm Eff. Diameter : 102.1 mm Upstream Cell : 300 mmol/L NaOH 500 mmol/L NaCl Downstream Cell : 300 mmol/L NaOH </td> <td data-bbox="1008 478 1344 829"> OH Diff. Coef. : 5.92 e-11 m²/s Tortuosity : 0.0112 </td> </tr> </tbody> </table>			Material	Experimental Data	Results	W/B : 0.45 Cement Type : Type I Cement : 300 kg/m ³ SCM #1 : 75 kg/m ³ SCM #2 : 0 kg/m ³ SCM #3 : 0 kg/m ³ Coarse Agg. : 950 kg/m ³ Fine Agg. : 800 kg/m ³ Water Content : 169 kg/m ³ Air Content : 6.0 % Porosity : 13.9 %	Temperature : 23 °C Avg. Thickness : 50.8 mm Eff. Diameter : 102.1 mm Upstream Cell : 300 mmol/L NaOH 500 mmol/L NaCl Downstream Cell : 300 mmol/L NaOH	OH Diff. Coef. : 5.92 e-11 m ² /s Tortuosity : 0.0112
Material	Experimental Data	Results						
W/B : 0.45 Cement Type : Type I Cement : 300 kg/m ³ SCM #1 : 75 kg/m ³ SCM #2 : 0 kg/m ³ SCM #3 : 0 kg/m ³ Coarse Agg. : 950 kg/m ³ Fine Agg. : 800 kg/m ³ Water Content : 169 kg/m ³ Air Content : 6.0 % Porosity : 13.9 %	Temperature : 23 °C Avg. Thickness : 50.8 mm Eff. Diameter : 102.1 mm Upstream Cell : 300 mmol/L NaOH 500 mmol/L NaCl Downstream Cell : 300 mmol/L NaOH	OH Diff. Coef. : 5.92 e-11 m ² /s Tortuosity : 0.0112						
 <p>Current [mA]</p> <p>Time [hours]</p> <p>M8-Mig-91d : Simulation — M8-Mig-91d : Exp. Data ▲</p>								
<p>Design Calculation</p> <p>Approved by:</p>		 <p>Simco Technologies Inc 2010 All right reserved STADIUM® IDC v3.0</p>						

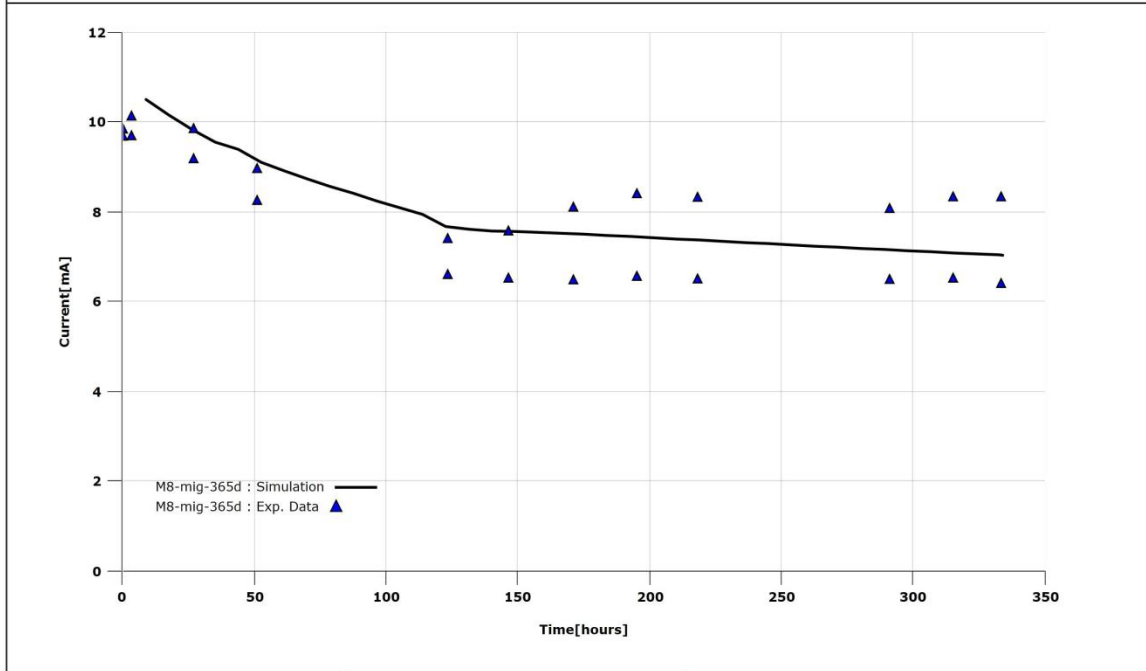

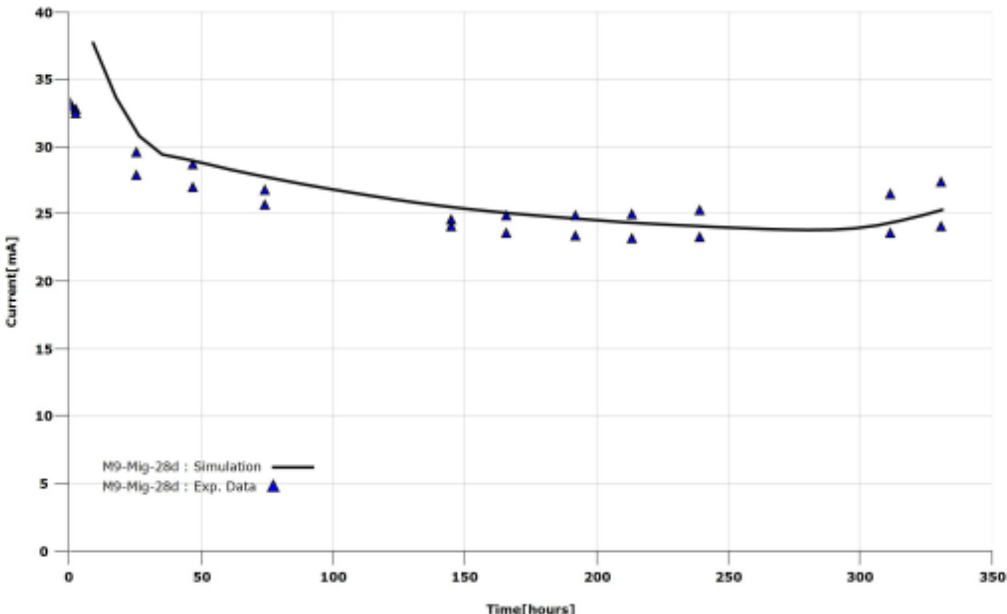

 <p>SIMCO Technologies inc.</p>	<p>This Product is Licensed to : tzhang Date : 23/02/2012 Contact : Client : Project : RD09024-Hycrete Project Ref. : Test : M8-mig-365d</p>	 <p>KNOW YOUR CONCRETE</p>
---	---	--

Material	Experimental Data	Results
<p>Mix : M8 W/B : 0.45 Cement Type : Type I Cement : 300 kg/m³ Fly Ash F : 75 kg/m³ Coarse Agg. : 950 kg/m³ Fine Agg. : 800 kg/m³ Water Content : 169 kg/m³ Air Content : 6.0 % CNI : 0 l/m³ Porosity : 14.7 %</p>	<p>Temperature : 23 °C Avg. Thickness : 50.6 mm Eff. Diameter : 102.0 mm Upstream Cell : 300 mmol/L NaOH 500 mmol/L NaCl Downstream Cell : 300 mmol/L NaOH</p>	<p>OH Diff. Coef. : 2.21 e-11 m²/s Tortuosity : 0.0042</p>

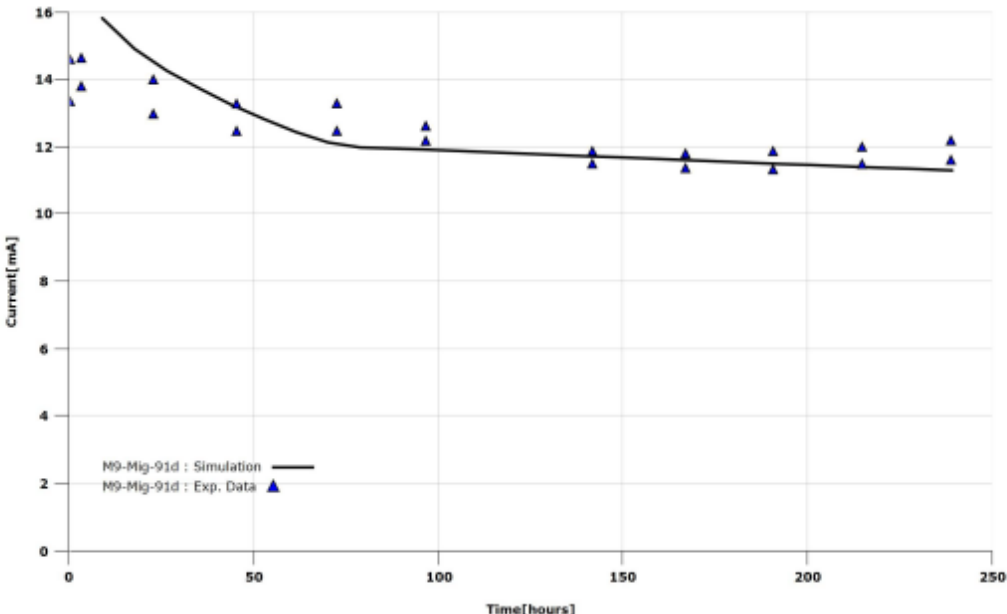

<p>Design Calculation</p> <p>Approved by:</p>		 <p>SIMCO Technologies Inc. 2012 All right reserved STADIUM® IDC v3.0 3.0.0.1067</p>
--	--	--

 <p>SIMCO Technologies inc.</p>	<p>This Product is Licensed to : tzhang Date : 05/08/11 Contact : Client : Project : RD09024-Hycrete Project Ref. : Test : M9-Mig-28d</p>							
<table border="1"> <thead> <tr> <th>Material</th> <th>Experimental Data</th> <th>Results</th> </tr> </thead> <tbody> <tr> <td data-bbox="284 478 618 829"> W/B : 0.45 Cement Type : Type I Cement : 300 kg/m³ SCM #1 : 75 kg/m³ SCM #2 : 0 kg/m³ SCM #3 : 0 kg/m³ Coarse Agg. : 950 kg/m³ Fine Agg. : 800 kg/m³ Water Content : 169 kg/m³ Air Content : 6.0 % Porosity : 13.8 % </td> <td data-bbox="643 478 977 829"> Temperature : 23 °C Avg. Thickness : 51.1 mm Eff. Diameter : 100.7 mm Upstream Cell : 300 mmol/L NaOH 500 mmol/L NaCl Downstream Cell : 300 mmol/L NaOH </td> <td data-bbox="1002 478 1336 829"> OH Diff. Coef. : 10.37 e-11 m²/s Tortuosity : 0.0197 </td> </tr> </tbody> </table>			Material	Experimental Data	Results	W/B : 0.45 Cement Type : Type I Cement : 300 kg/m ³ SCM #1 : 75 kg/m ³ SCM #2 : 0 kg/m ³ SCM #3 : 0 kg/m ³ Coarse Agg. : 950 kg/m ³ Fine Agg. : 800 kg/m ³ Water Content : 169 kg/m ³ Air Content : 6.0 % Porosity : 13.8 %	Temperature : 23 °C Avg. Thickness : 51.1 mm Eff. Diameter : 100.7 mm Upstream Cell : 300 mmol/L NaOH 500 mmol/L NaCl Downstream Cell : 300 mmol/L NaOH	OH Diff. Coef. : 10.37 e-11 m ² /s Tortuosity : 0.0197
Material	Experimental Data	Results						
W/B : 0.45 Cement Type : Type I Cement : 300 kg/m ³ SCM #1 : 75 kg/m ³ SCM #2 : 0 kg/m ³ SCM #3 : 0 kg/m ³ Coarse Agg. : 950 kg/m ³ Fine Agg. : 800 kg/m ³ Water Content : 169 kg/m ³ Air Content : 6.0 % Porosity : 13.8 %	Temperature : 23 °C Avg. Thickness : 51.1 mm Eff. Diameter : 100.7 mm Upstream Cell : 300 mmol/L NaOH 500 mmol/L NaCl Downstream Cell : 300 mmol/L NaOH	OH Diff. Coef. : 10.37 e-11 m ² /s Tortuosity : 0.0197						
 <p>Current [mA]</p> <p>Time [hours]</p> <p>M9-Mig-28d : Simulation — M9-Mig-28d : Exp. Data ▲</p>								
<p>Design Calculation</p> <p>Approved by:</p>		 <p>Simco Technologies Inc 2010 All right reserved STADIUM® IDC v3.0</p>						

 <p>SIMCO Technologies inc.</p>	<p>This Product is Licensed to : tzhang Date : 05/08/11 Contact : Client : Project : RD09024-Hycrete Project Ref. : Test : M9-Mig-91d</p>	 <p>STADIUM A SIMCO SOLUTION KNOW YOUR CONCRETE</p>						
<table border="1"> <thead> <tr> <th>Material</th> <th>Experimental Data</th> <th>Results</th> </tr> </thead> <tbody> <tr> <td data-bbox="284 478 620 829"> W/B : 0.45 Cement Type : Type I Cement : 300 kg/m³ SCM #1 : 75 kg/m³ SCM #2 : 0 kg/m³ SCM #3 : 0 kg/m³ Coarse Agg. : 950 kg/m³ Fine Agg. : 800 kg/m³ Water Content : 169 kg/m³ Air Content : 6.0 % Porosity : 13.7 % </td> <td data-bbox="641 478 977 829"> Temperature : 23 °C Avg. Thickness : 51.2 mm Eff. Diameter : 100.3 mm Upstream Cell : 300 mmol/L NaOH 500 mmol/L NaCl Downstream Cell : 300 mmol/L NaOH </td> <td data-bbox="998 478 1334 829"> OH Diff. Coef. : 4.28 e-11 m²/s Tortuosity : 0.0081 </td> </tr> </tbody> </table>			Material	Experimental Data	Results	W/B : 0.45 Cement Type : Type I Cement : 300 kg/m ³ SCM #1 : 75 kg/m ³ SCM #2 : 0 kg/m ³ SCM #3 : 0 kg/m ³ Coarse Agg. : 950 kg/m ³ Fine Agg. : 800 kg/m ³ Water Content : 169 kg/m ³ Air Content : 6.0 % Porosity : 13.7 %	Temperature : 23 °C Avg. Thickness : 51.2 mm Eff. Diameter : 100.3 mm Upstream Cell : 300 mmol/L NaOH 500 mmol/L NaCl Downstream Cell : 300 mmol/L NaOH	OH Diff. Coef. : 4.28 e-11 m ² /s Tortuosity : 0.0081
Material	Experimental Data	Results						
W/B : 0.45 Cement Type : Type I Cement : 300 kg/m ³ SCM #1 : 75 kg/m ³ SCM #2 : 0 kg/m ³ SCM #3 : 0 kg/m ³ Coarse Agg. : 950 kg/m ³ Fine Agg. : 800 kg/m ³ Water Content : 169 kg/m ³ Air Content : 6.0 % Porosity : 13.7 %	Temperature : 23 °C Avg. Thickness : 51.2 mm Eff. Diameter : 100.3 mm Upstream Cell : 300 mmol/L NaOH 500 mmol/L NaCl Downstream Cell : 300 mmol/L NaOH	OH Diff. Coef. : 4.28 e-11 m ² /s Tortuosity : 0.0081						
 <p>Current [mA]</p> <p>Time [hours]</p> <p>M9-Mig-91d : Simulation — M9-Mig-91d : Exp. Data ▲</p>								
<p>Design Calculation</p> <p>Approved by:</p>		 <p>Simco Technologies Inc 2010 All right reserved STADIUM® IDC v3.0</p>						

 <p>SIMCO Technologies inc.</p>	<p>This Product is Licensed to : tzhang Date : 23/02/2012 Contact : Client : Project : RD09024-Hycrete Project Ref. : Test : M9-mig-365d</p>	 <p>KNOW YOUR CONCRETE</p>
---	---	--

Material	Experimental Data	Results
<p>Mix : M9 W/B : 0.45 Cement Type : Type I Cement : 300 kg/m³ Fly Ash F : 75 kg/m³ Coarse Agg. : 950 kg/m³ Fine Agg. : 800 kg/m³ Water Content : 169 kg/m³ Air Content : 6.0 % CNI : 0 l/m³ Porosity : 14.3 %</p>	<p>Temperature : 23 °C Avg. Thickness : 51.1 mm Eff. Diameter : 100.3 mm Upstream Cell : 300 mmol/L NaOH 500 mmol/L NaCl Downstream Cell : 300 mmol/L NaOH</p>	<p>OH Diff. Coef. : 1.77 e-11 m²/s Tortuosity : 0.0034</p>

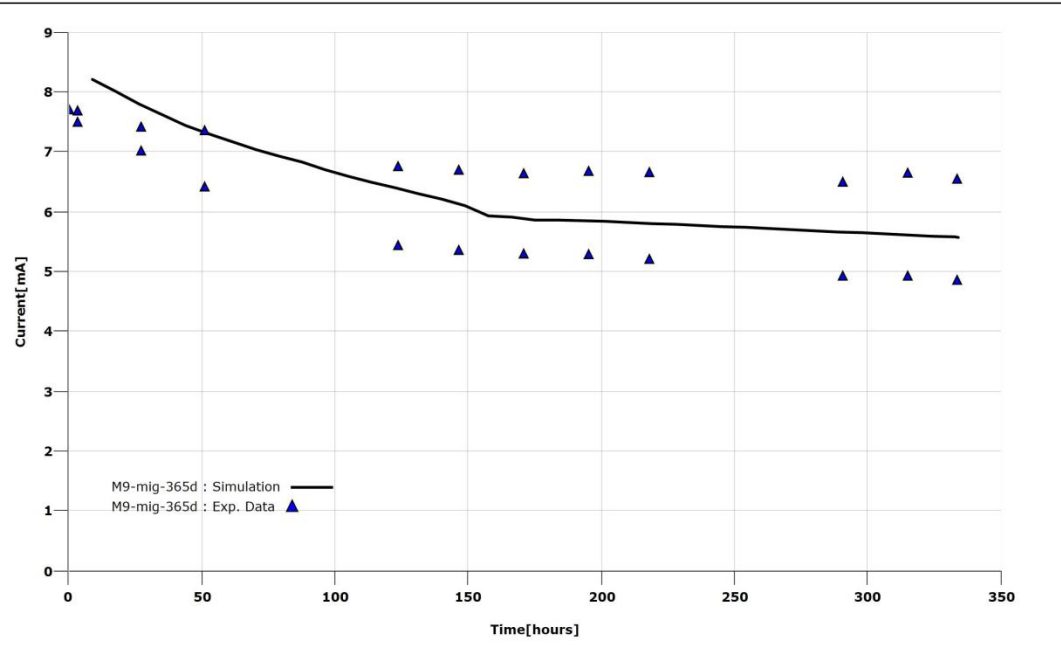

<p>Design Calculation</p> <p>Approved by:</p>		 <p>SIMCO Technologies Inc. 2012 All right reserved STADIUM® IDC v3.0 3.0.0.1067</p>
--	--	--

E. Results of drying-absorption cycles and drying at variable R.H.

The following pages provide the complete experimental results for drying/absorption cycles performed in 50% and 75% RH chambers, including the results on 10-mm samples used for the moisture isotherm tests. These results are plotted in groups according to the material characteristics and test conditions.

***NOTE:** negative masses are recorded in some cases during the absorption phase of the test. This indicates that these samples were not fully saturated when the test started. It is possible to take this into account in the analysis by setting the initial relative humidity of the material to a value lower than 1.0 (typically 0.98).*

Graphic number	Test condition	Mixture characteristics	Hydration (days)
1	Drying-50%RH/Absorption	M1 (0.4 w/c)	
2	Drying-50%RH/Absorption	M2 (0.4 w/c+Hycrete-1gal)	28
3	Drying-50%RH/Absorption	M3 (0.4 w/c+Hycrete-2gal)	
4	Drying-50%RH/Absorption	M1 (0.4 w/c)	
5	Drying-50%RH/Absorption	M2 (0.4 w/c+Hycrete-1gal)	91
6	Drying-50%RH/Absorption	M3 (0.4 w/c+Hycrete-2gal)	
7	Drying-50%RH/Absorption	M4 (0.55 w/c)	
8	Drying-50%RH/Absorption	M5 (0.55 w/c+Hycrete-1gal)	28
9	Drying-50%RH/Absorption	M6 (0.55 w/c+Hycrete-2gal)	
10	Drying-50%RH/Absorption	M4 (0.55 w/c)	91
11	Drying-50%RH/Absorption	M6 (0.55 w/c+Hycrete-2gal)	
12	Drying-50%RH/Absorption	M7 (0.45 w/c)	
13	Drying-50%RH/Absorption	M8 (0.45 w/c+Hycrete-1gal)	28
14	Drying-50%RH/Absorption	M9 (0.45 w/c+Hycrete-2gal)	
15	Drying-50%RH/Absorption	M7 (0.45 w/c)	
16	Drying-50%RH/Absorption	M8 (0.45 w/c+Hycrete-1gal)	91
17	Drying-50%RH/Absorption	M9 (0.45 w/c+Hycrete-2gal)	
18	Drying-75%RH/Absorption	M1 (0.4 w/c)	
19	Drying-75%RH/Absorption	M2 (0.4 w/c+Hycrete-1gal)	28
20	Drying-75%RH/Absorption	M3 (0.4 w/c+Hycrete-2gal)	
21	Drying-75%RH/Absorption	M1 (0.4 w/c)	91
22	Drying-75%RH/Absorption	M3 (0.4 w/c+Hycrete-2gal)	
23	Drying-75%RH/Absorption	M4 (0.55 w/c)	
24	Drying-75%RH/Absorption	M5 (0.55 w/c+Hycrete-1gal)	28
25	Drying-75%RH/Absorption	M6 (0.55 w/c+Hycrete-2gal)	
26	Drying-75%RH/Absorption	M4 (0.55 w/c)	91
27	Drying-75%RH/Absorption	M6 (0.55 w/c+Hycrete-2gal)	
28	Drying-75%RH/Absorption	M7 (0.45 w/c)	28

29	Drying-75%RH/Absorption	M8 (0.45 w/c+Hycrete-1gal)	
30	Drying-75%RH/Absorption	M9 (0.45 w/c+Hycrete-2gal)	
31	Drying-75%RH/Absorption	M7 (0.45 w/c)	91
32	Drying-75%RH/Absorption	M9 (0.45 w/c+Hycrete-2gal)	
33	Drying: 50%RH - 33%RH	M1 (0.4 w/c); M3 (0.4 w/c+Hycrete-2gal)	28
34	Drying: 50%RH - 33%RH	M4 (0.55 w/c); M6 (0.55 w/c+Hycrete-2gal)	28
35	Drying: 50%RH - 33%RH	M7 (0.45 w/c); M9 (0.45 w/c+Hycrete-2gal)	28
36	Drying: 50%RH - 75%RH	M1 (0.4 w/c); M3 (0.4 w/c+Hycrete-2gal)	28
37	Drying: 50%RH - 75%RH	M4 (0.55 w/c); M6 (0.55 w/c+Hycrete-2gal)	28
38	Drying: 50%RH - 75%RH	M7 (0.45 w/c); M9 (0.45 w/c+Hycrete-2gal)	28
39	Drying: 75%RH - 50%RH	M1 (0.4 w/c); M3 (0.4 w/c+Hycrete-2gal)	28
40	Drying: 75%RH - 50%RH	M4 (0.55 w/c); M6 (0.55 w/c+Hycrete-2gal)	28
41	Drying: 75%RH - 50%RH	M7 (0.45 w/c); M9 (0.45 w/c+Hycrete-2gal)	28
42	Drying: 75%RH - 85%RH	M1 (0.4 w/c); M3 (0.4 w/c+Hycrete-2gal)	28
43	Drying: 75%RH - 85%RH	M4 (0.55 w/c); M6 (0.55 w/c+Hycrete-2gal)	28
44	Drying: 75%RH - 85%RH	M7 (0.45 w/c); M9 (0.45 w/c+Hycrete-2gal)	28
45	50%RH - Absorption rates 75%RH - Absorption rates	M1, M2, M3 (0.4 w/c)	28, 91
46	50%RH - Absorption rates 75%RH - Absorption rates	M7, M8, M9 (0.45 w/c)	28, 91
47	50%RH - Absorption rates 75%RH - Absorption rates	M4, M5, M6 (0.55 w/c)	28, 91

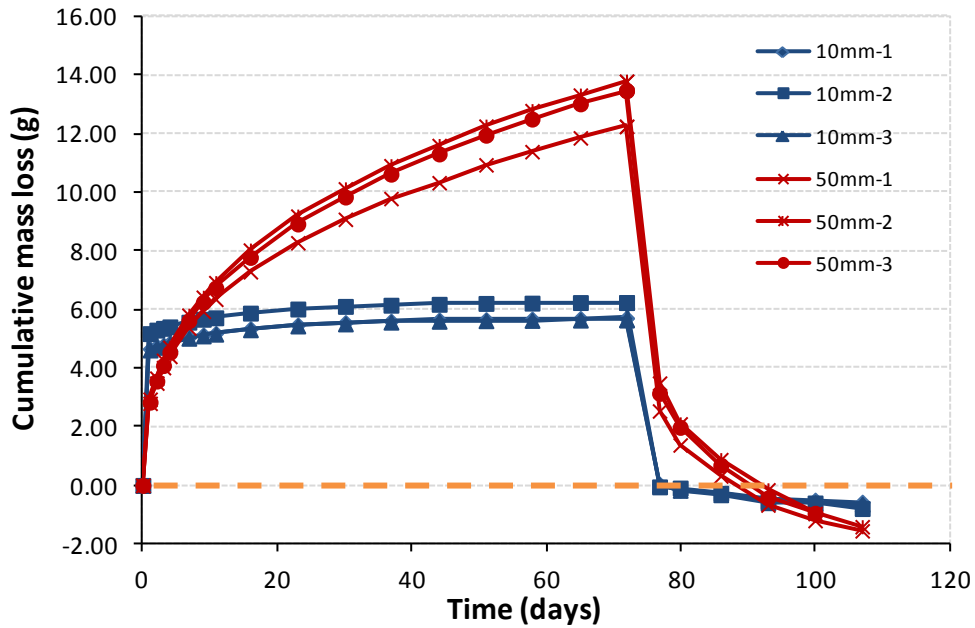

1 - Result of drying-50%RH/absorption for M1 (0.4 w/c) - 28d

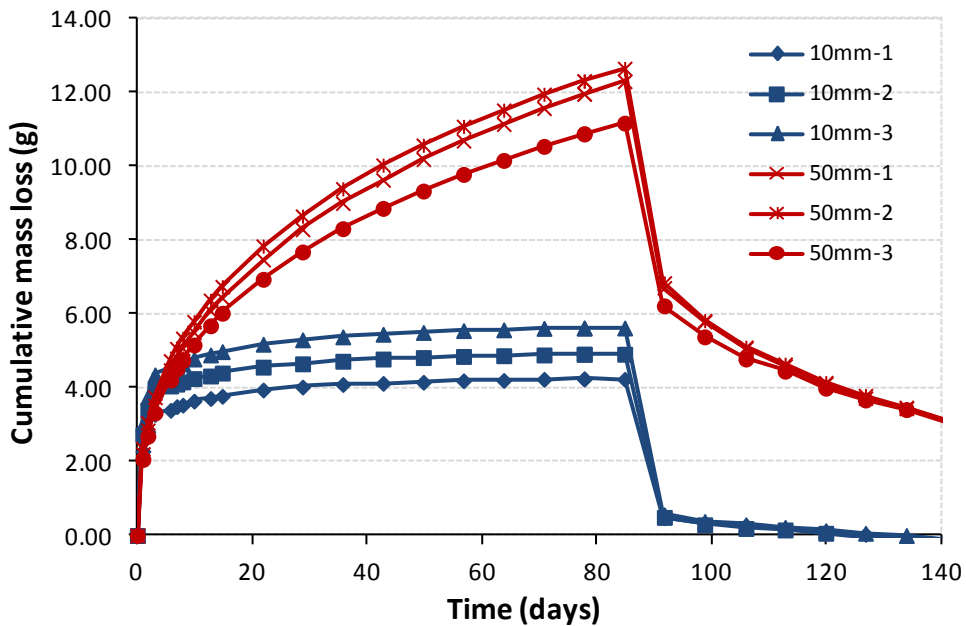

2 - Result of drying - 50%RH/absorption for M2 (0.4 w/c+Hycrete-1gal) - 28d

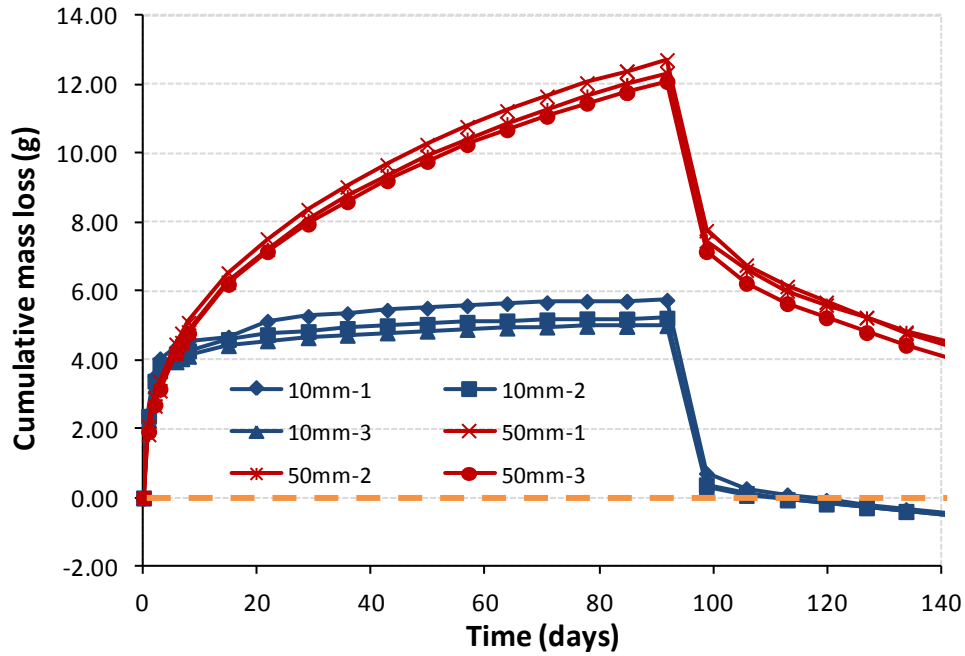

3 - Result of drying-50%RH/absorption for M3 (0.4 w/c+Hycrete-2gal)-28d

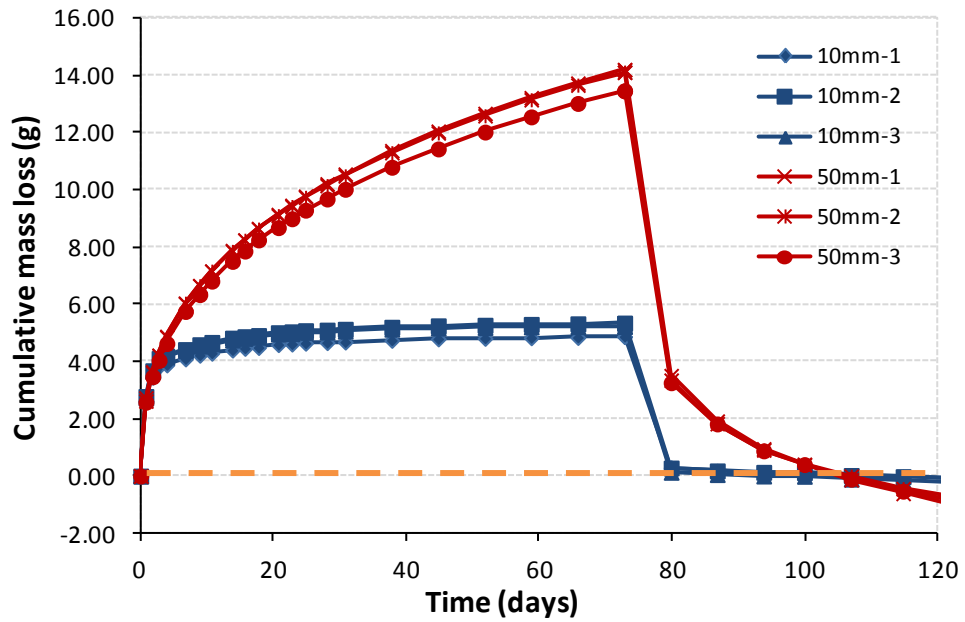

4 - Result of drying-50%RH/absorption for M1 (0.4 w/c)-91d

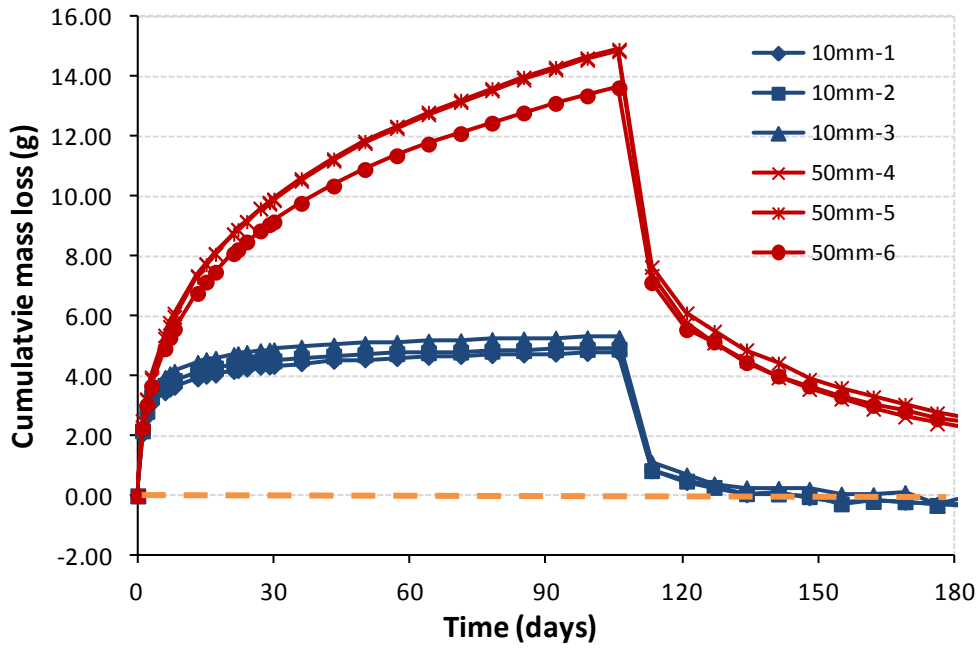

5 - Result of drying-50%RH/absorption for M2 (0.4 w/c+Hycrete-1gal)-91d

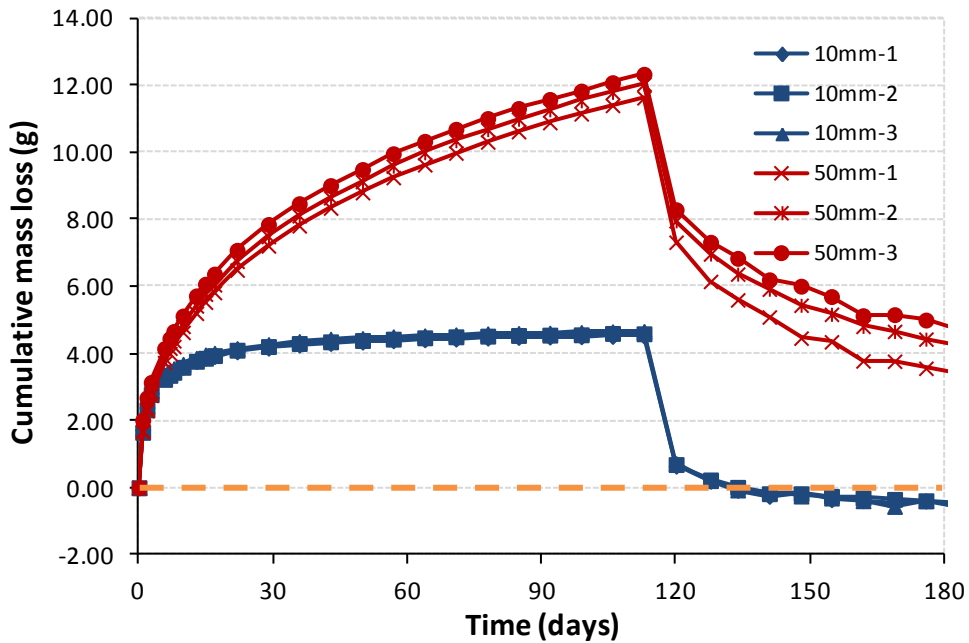

6 - Result drying-50%RH/absorption for M3 (0.4 w/c+Hycrete-2gal)-91d

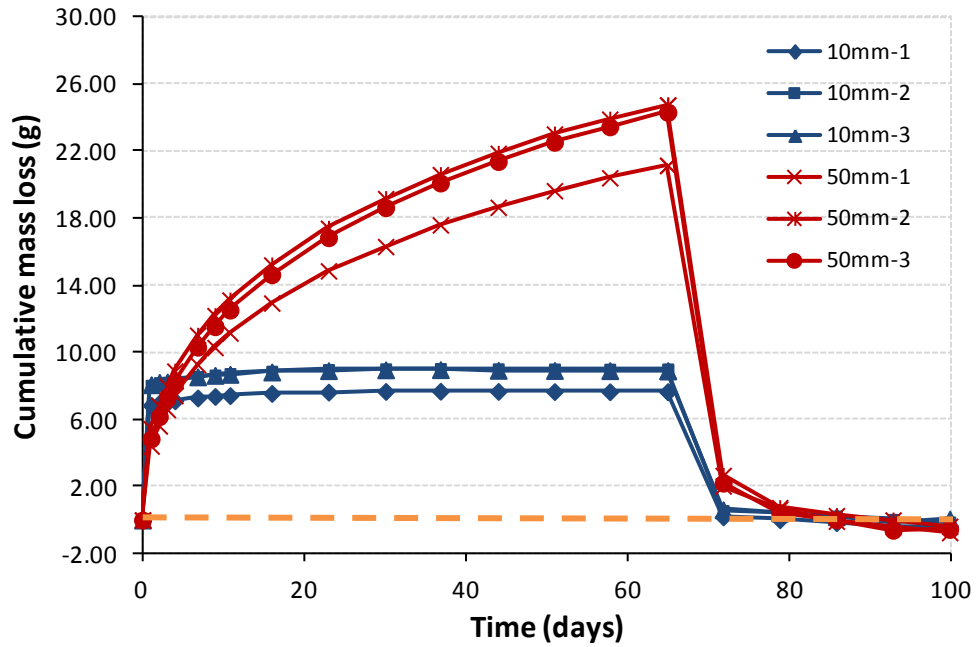

7 - Result of drying-50%RH/absorption for M4 (0.55 w/c)-28d

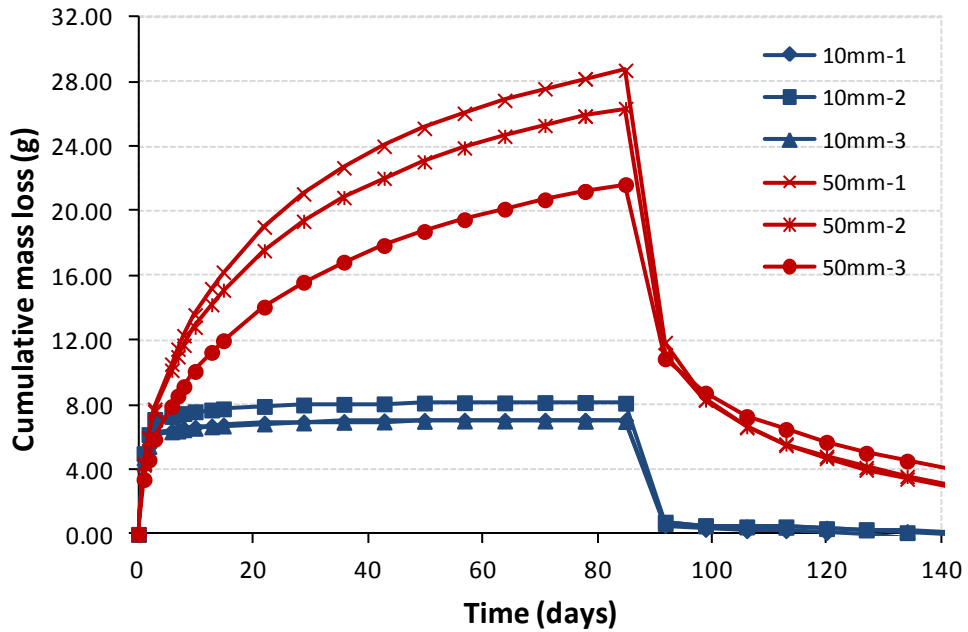

8 - Result of drying-50%RH/absorption for M5 (0.55 w/c+Hycrete-1gal)-28d

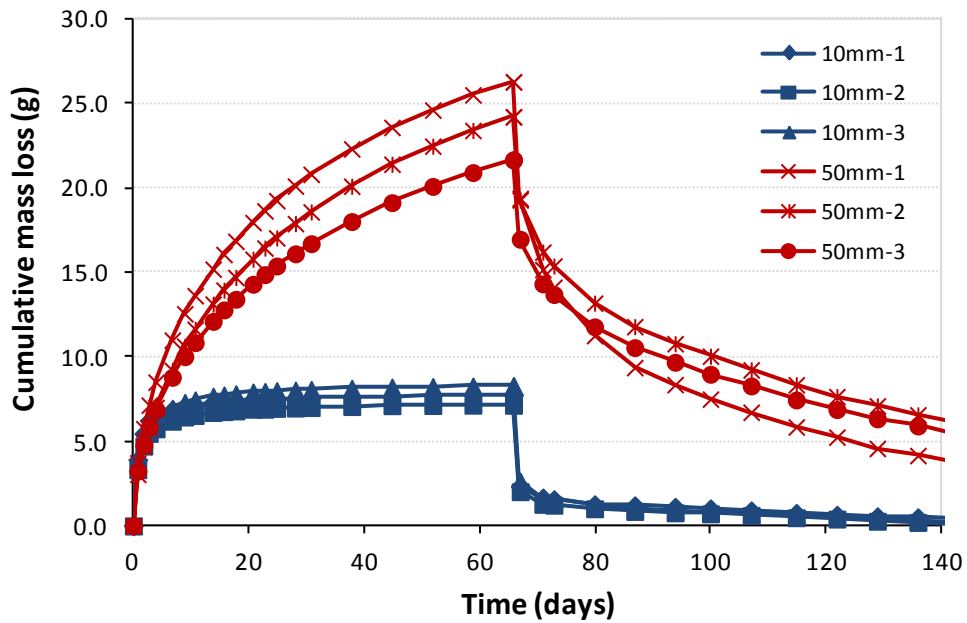

9 - Result of drying-50%RH/absorption for M6 (0.55 w/c+Hycrete-2gal)-28d

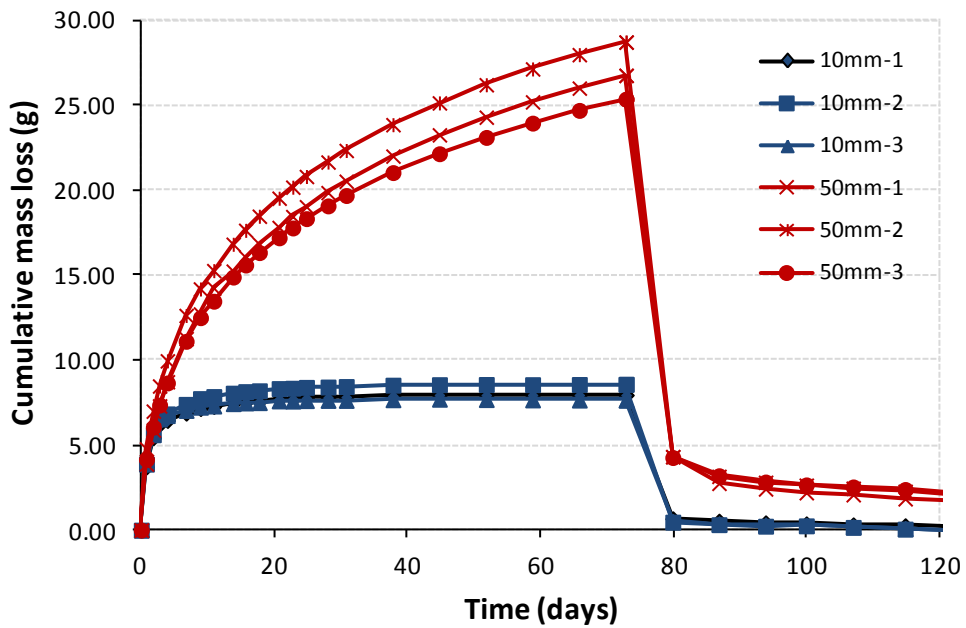

10 - Result of drying-50%RH/absorption for M4 (0.55 w/c)-91d

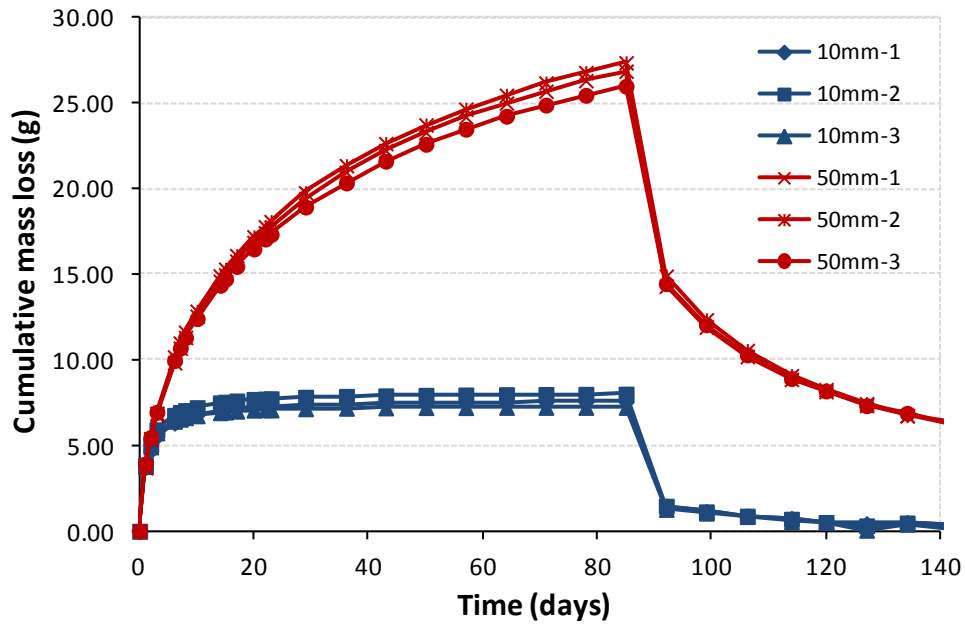

11 - Result of drying-50%RH/absorption for M6 (0.55 w/c+Hycrete-2gal)-91d

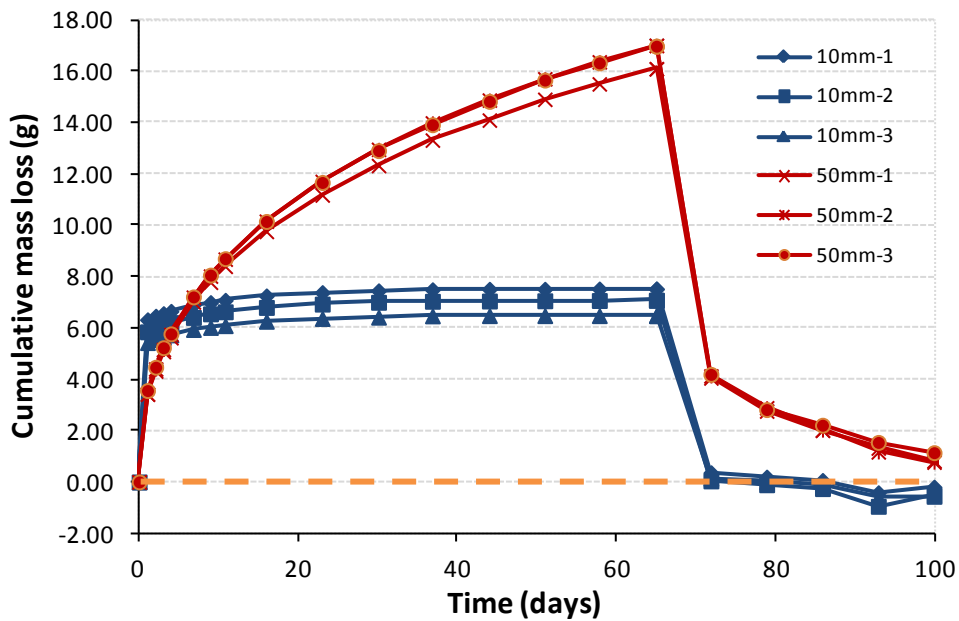

12 - Result of drying-50%RH/absorption for M7 (0.45 w/c)-28d

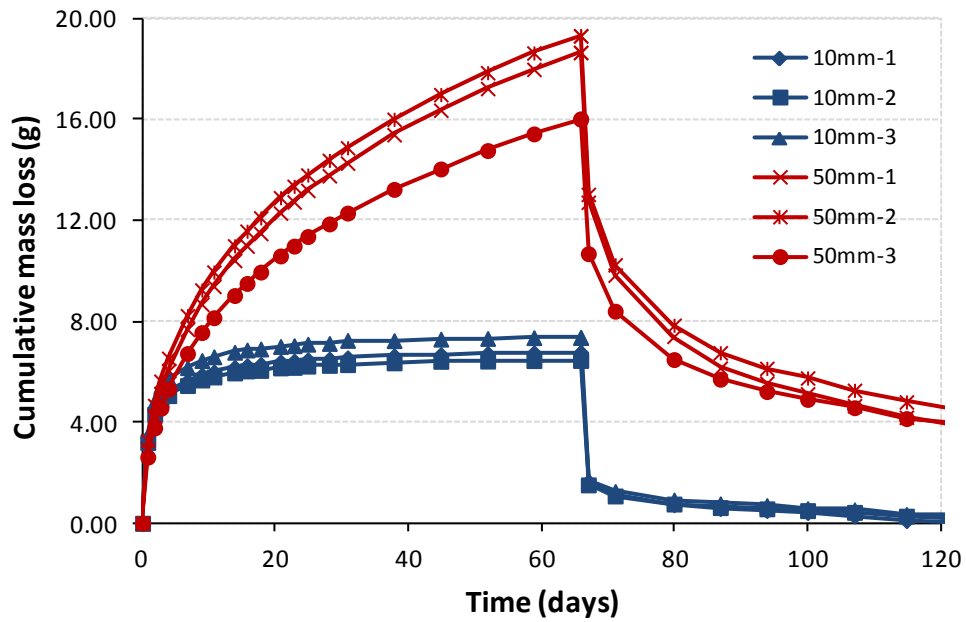

13 - Result of drying-50%RH/absorption for M8 (0.45 w/c+Hycrete-1gal)-28d

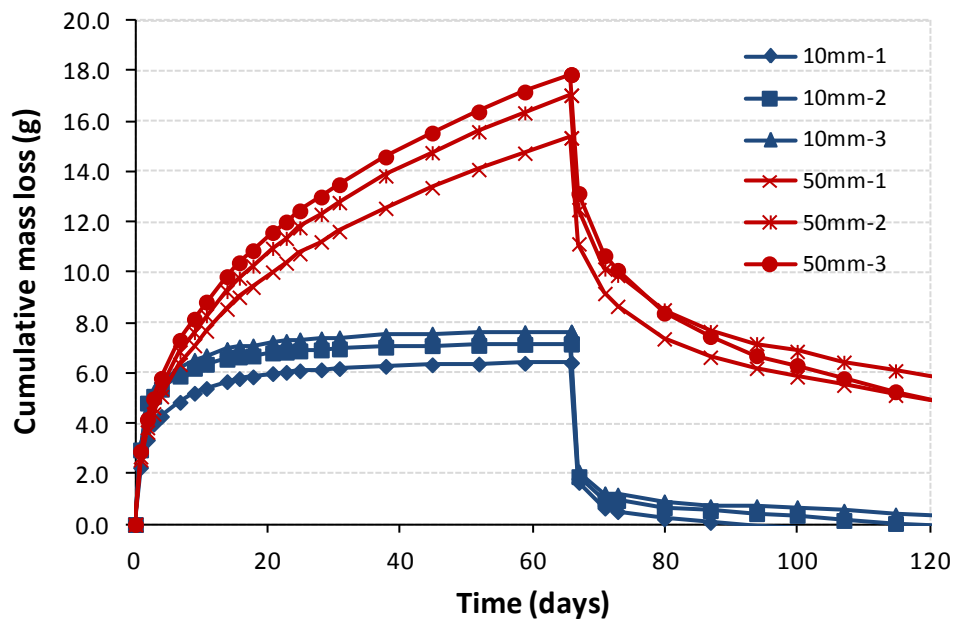

14 - Result of drying-50%RH/absorption for M9 (0.45 w/c+Hycrete-2gal)-28d

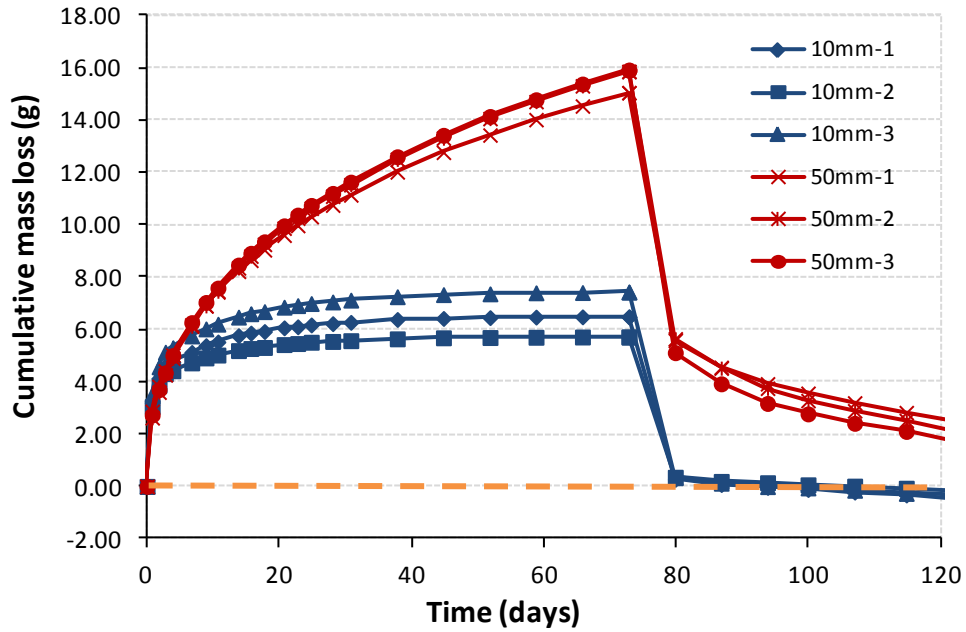

15 - Result of drying-50%RH/absorption for M7 (0.45 w/c)-91d

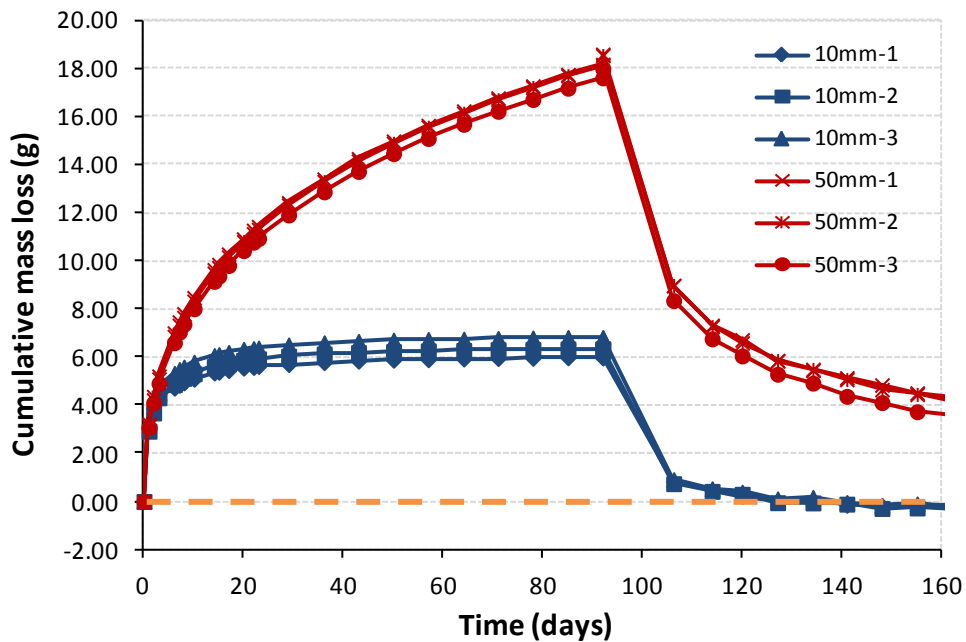

16 - Result of drying-50%RH/absorption for M8 (0.45 w/c+Hycrete-1gal)-91d

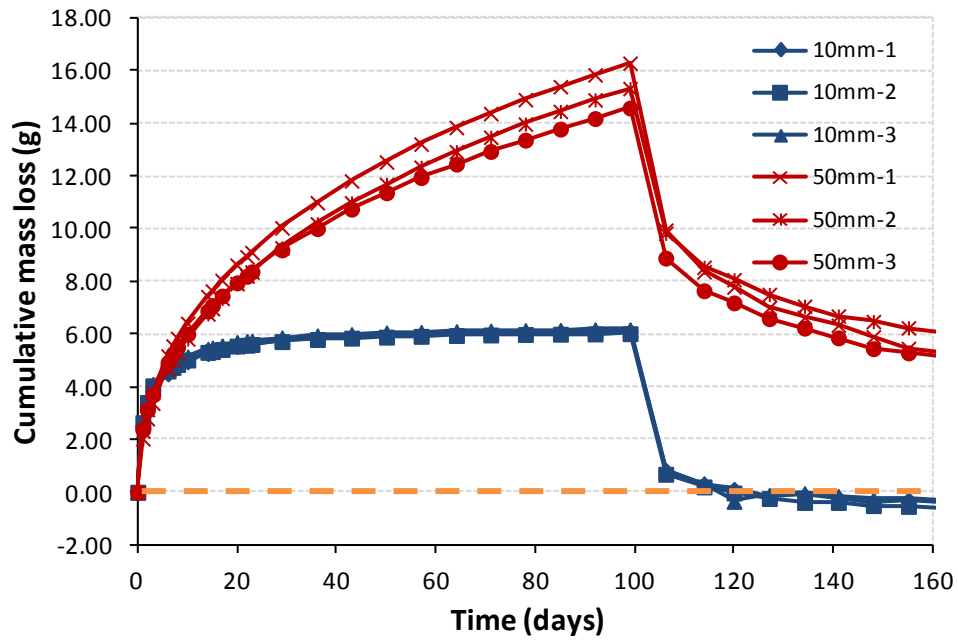

17 - Result of drying-50%RH/absorption for M9 (0.45 w/c+Hycrete-2gal)-91d

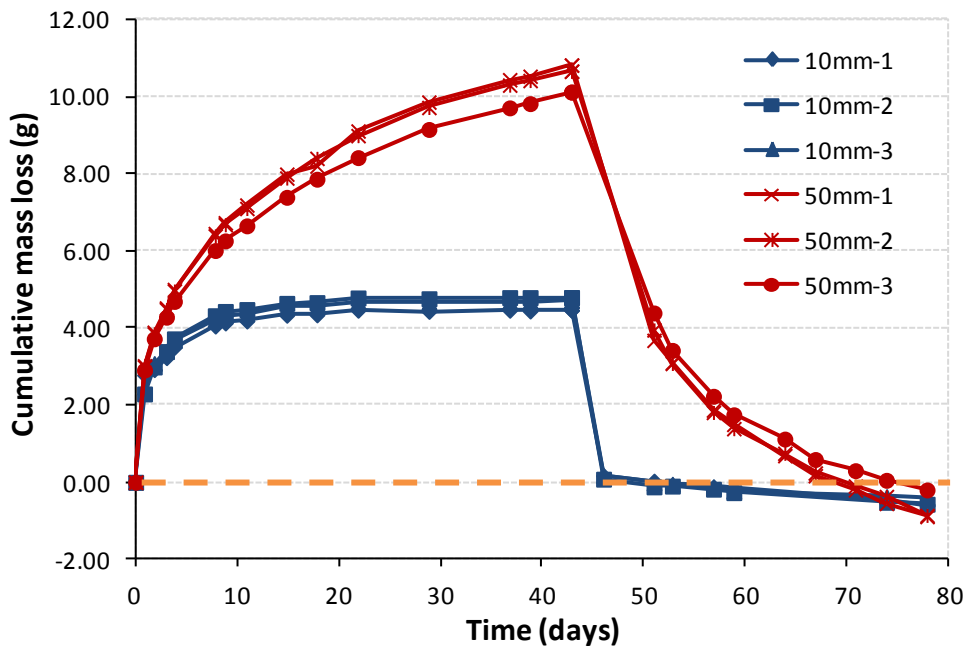

18 - Result of drying-75%RH/absorption for M1 (0.4 w/c)-28d

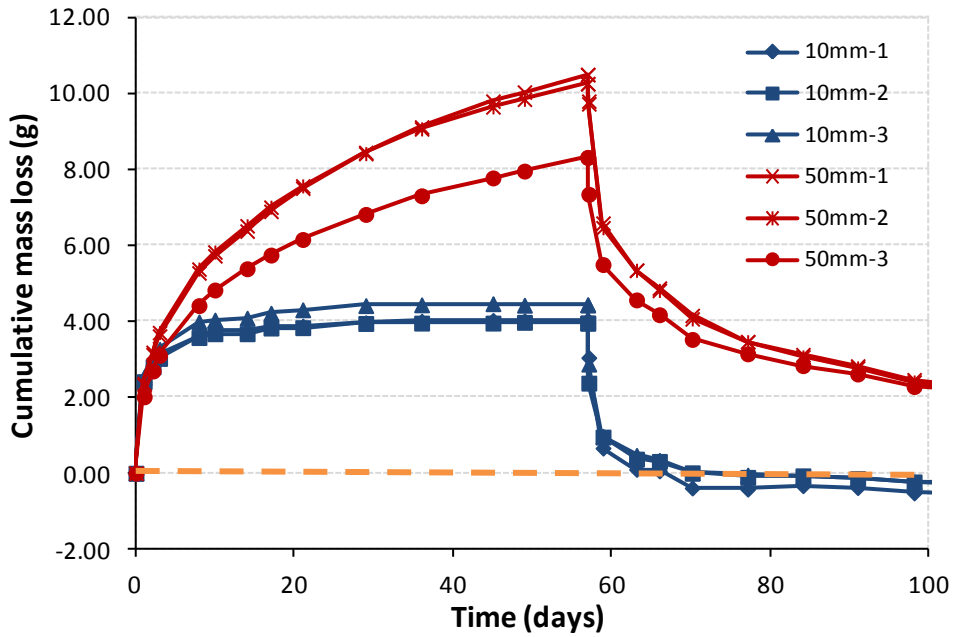

19 - Result of drying-75%RH/absorption for M2 (0.4 w/c+Hycrete-1gal)-28d

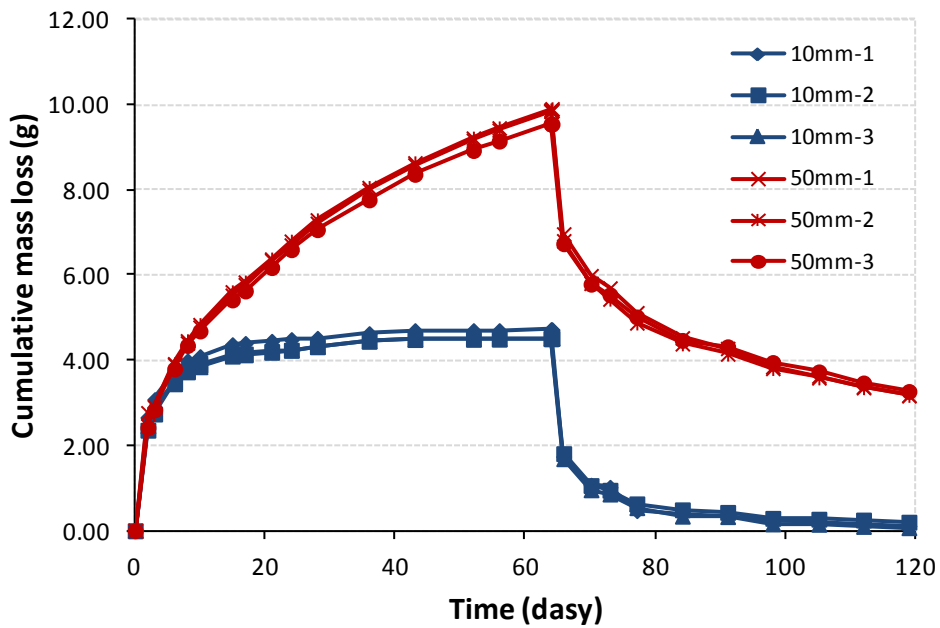

20 - Result of drying-75%RH/absorption for M3 (0.4 w/c+Hycrete-2gal)-28d

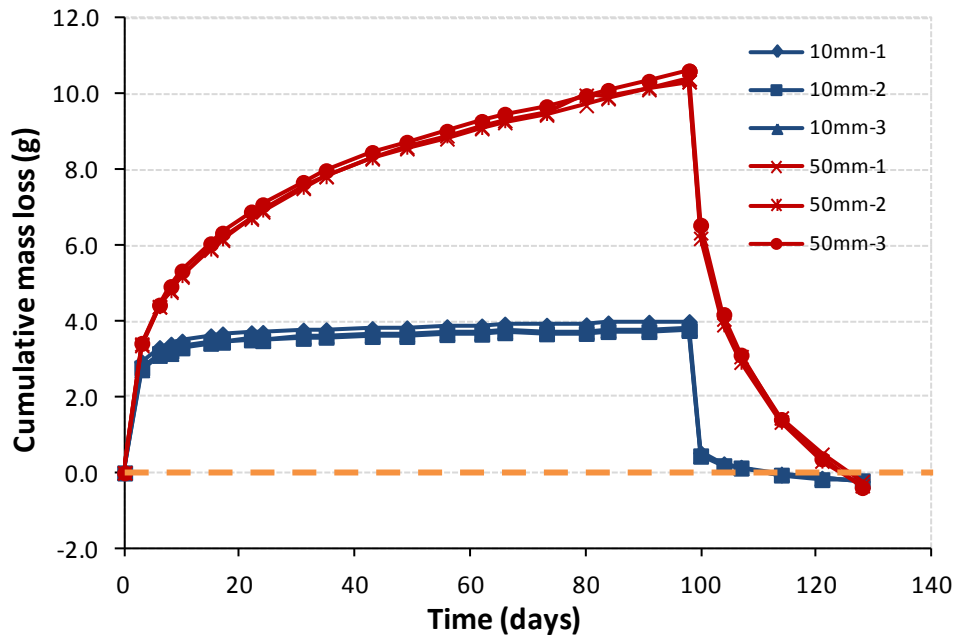

21 - Result of drying-75%RH/absorption for M1 (0.4 w/c)-91d

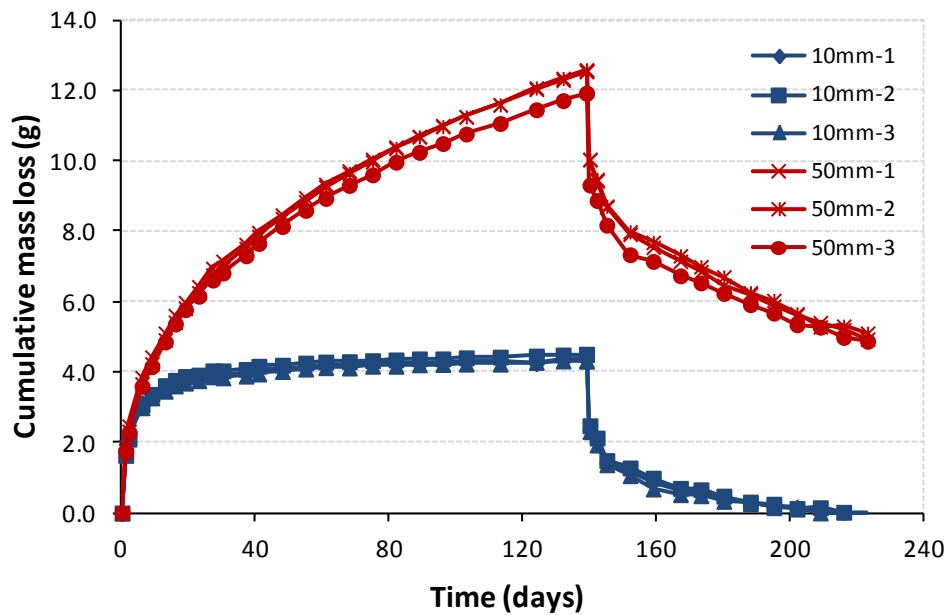

22 - Result of drying-75%RH/absorption for M3 (0.4 w/c+Hycrete-2gal)-91d

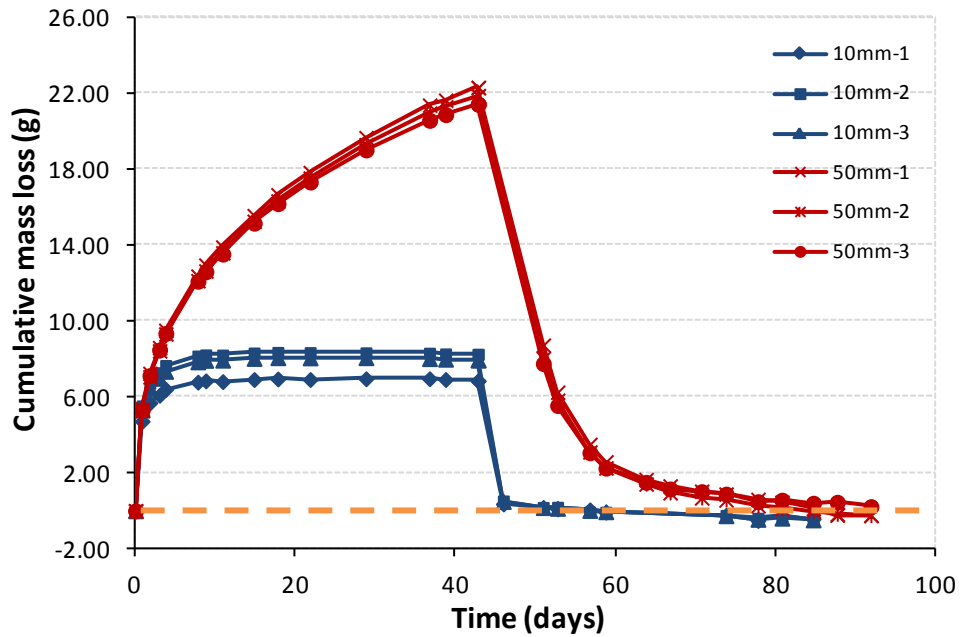

23 - Result of drying-75%RH/absorption for M4 (0.55 w/c)-28d

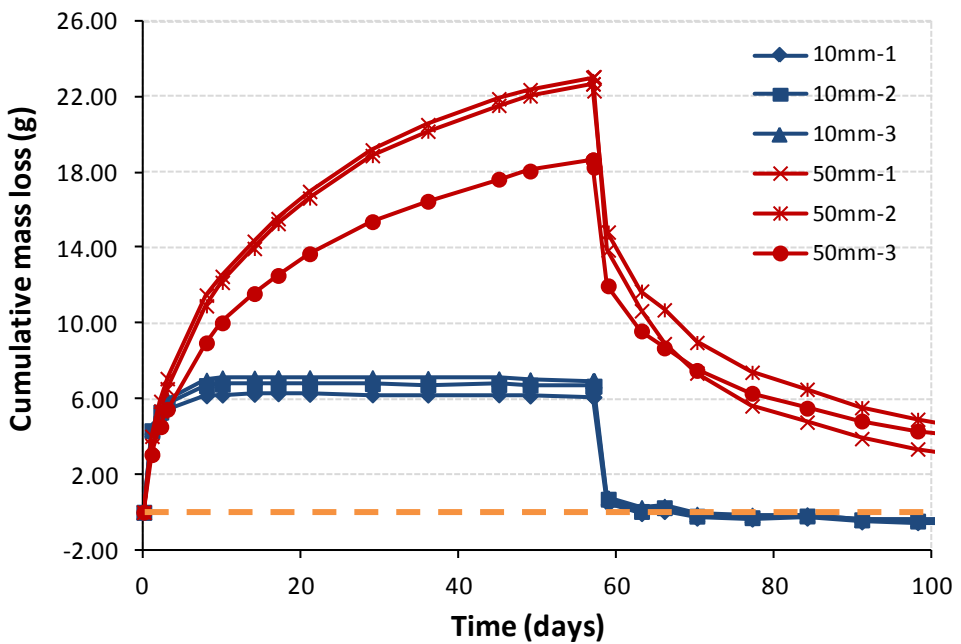

24 - Result of drying-75%RH/absorption for M5 (0.55 w/c+Hycrete-1gal)-28d

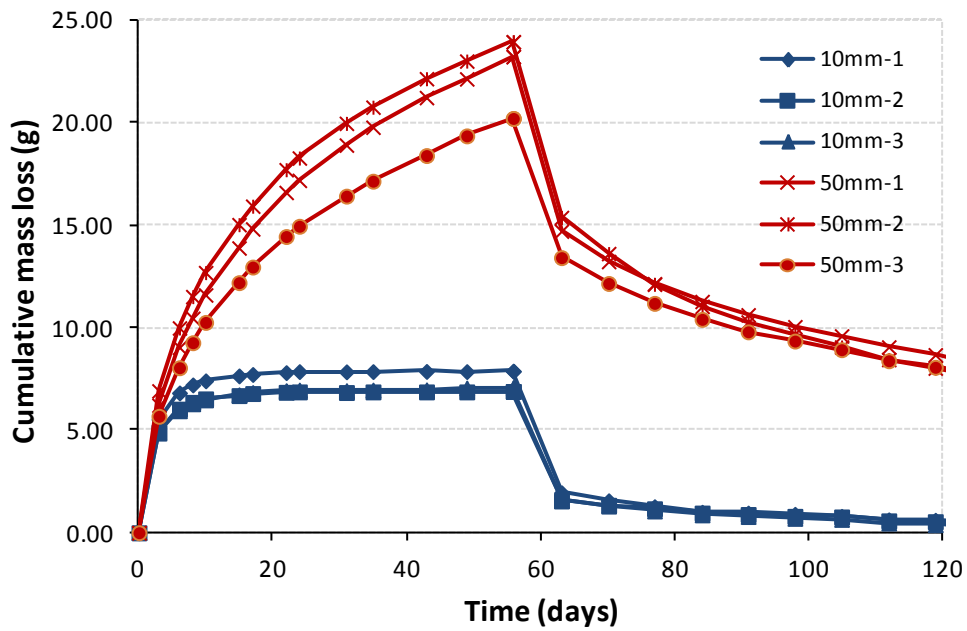

25 - Result of drying-75%RH/absorption for M6 (0.55 w/c+Hycrete-2gal)-28d

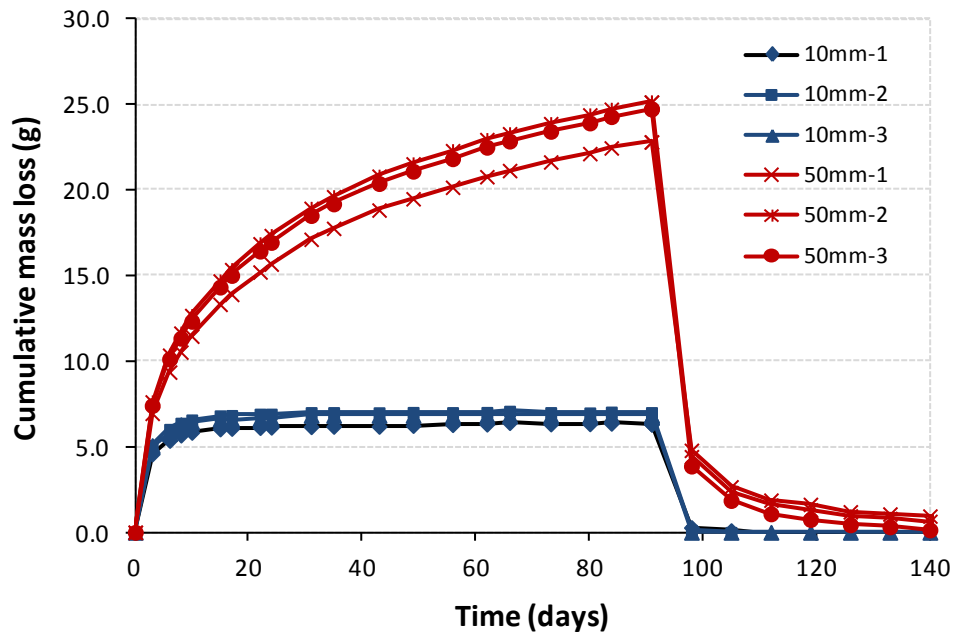

26 - Result of drying-75%RH/absorption for M4 (0.55 w/c)-91d

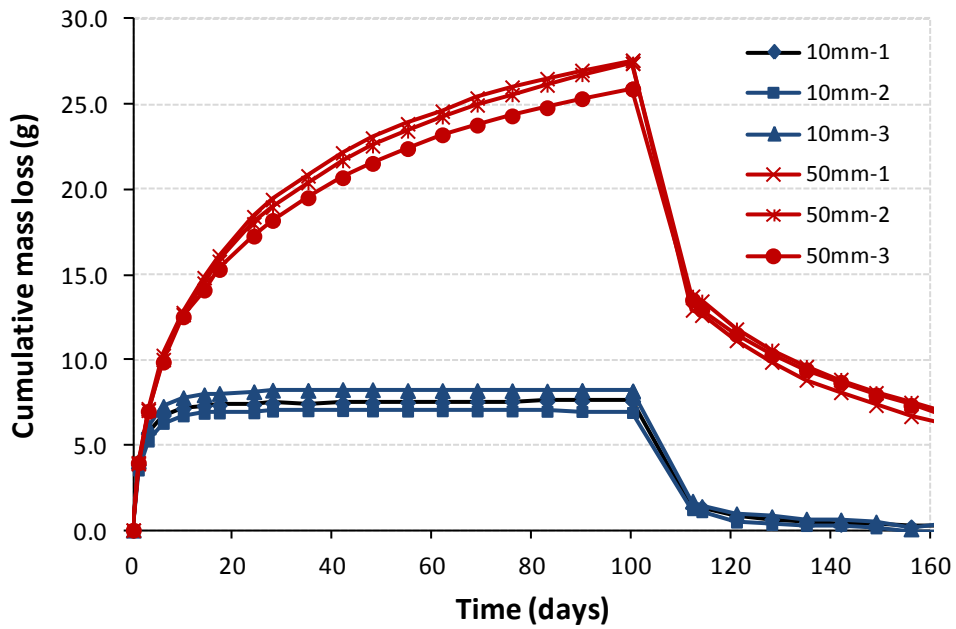

27 - Result of drying-75%RH/absorption for M6 (0.55 w/c+Hycrete-2gal)-91d

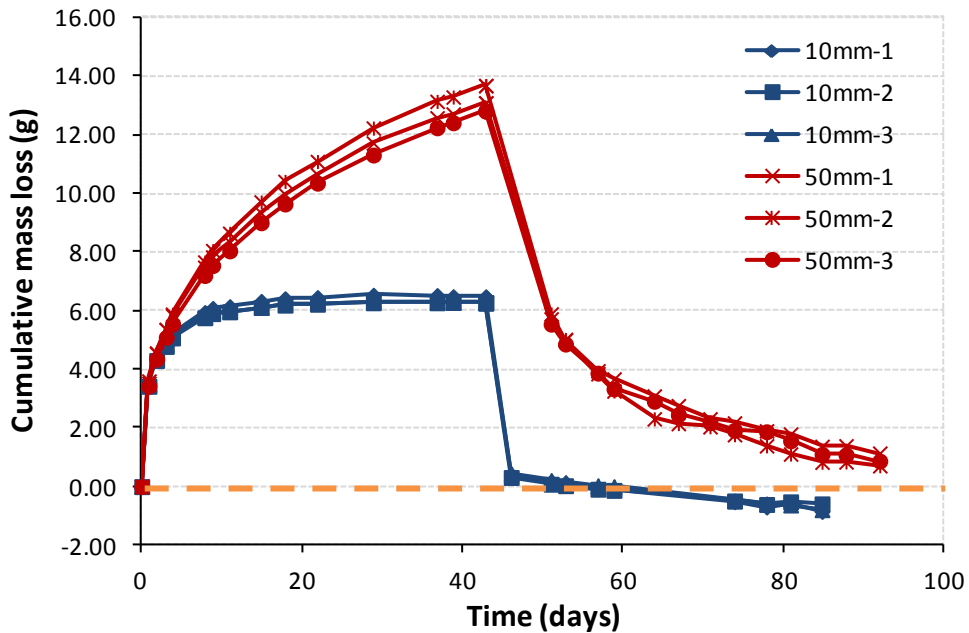

28 - Result of drying-75%RH/absorption for M7 (0.45 w/c)-28d

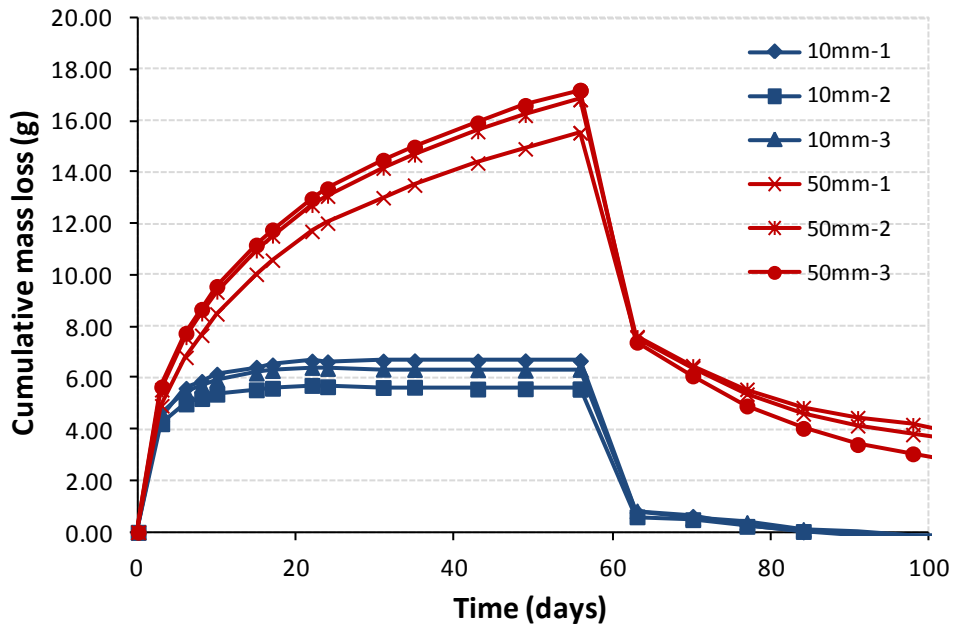

29 - Result of drying-75%RH/absorption for M8 (0.45 w/c+Hycrete-1gal)-28d

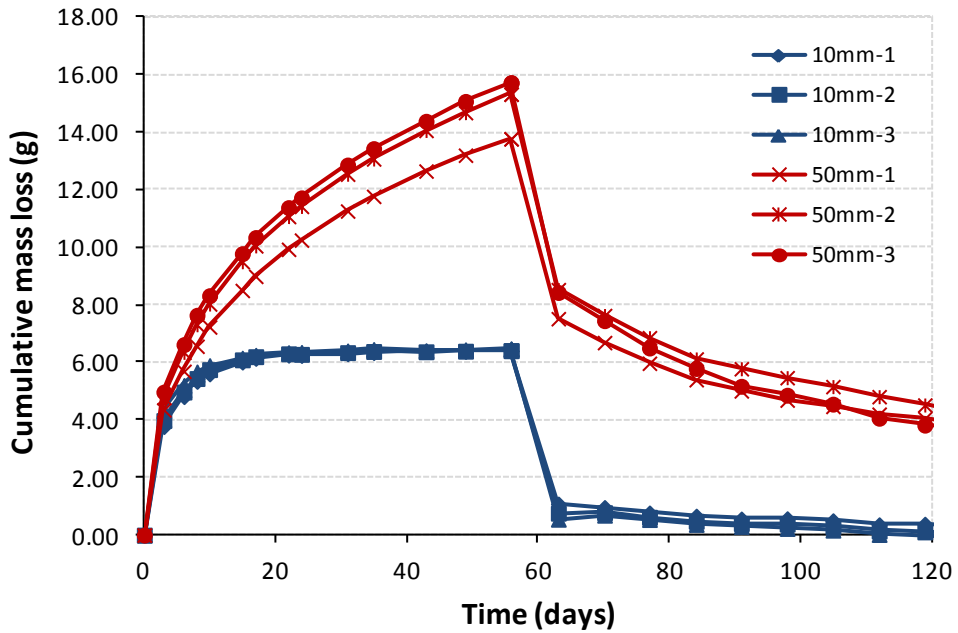

30 - Result of drying-75%RH/absorption for M9 (0.45 w/c+Hycrete-2gal)-28d

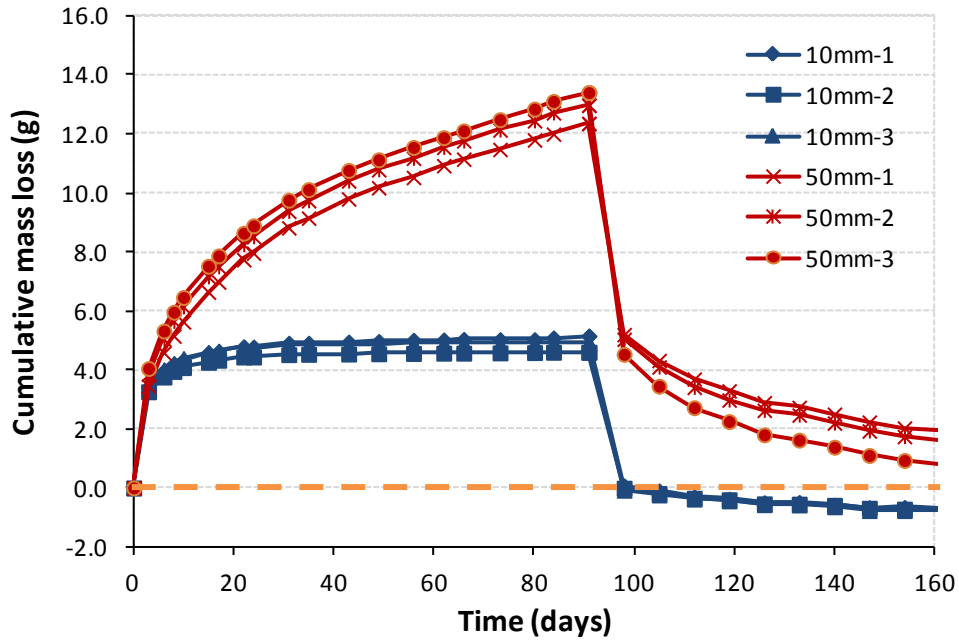

31 - Result of drying-75%RH/absorption for M7 (0.45 w/c)-91d

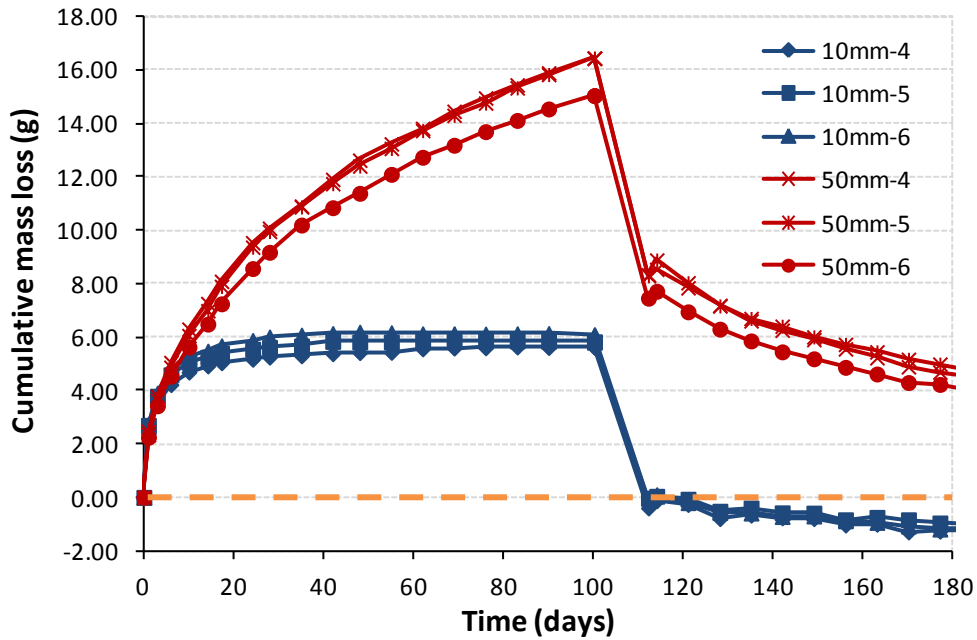

32 - Result of drying-75%RH/absorption for M9 (0.45 w/c+Hycrete-2gal)-91d

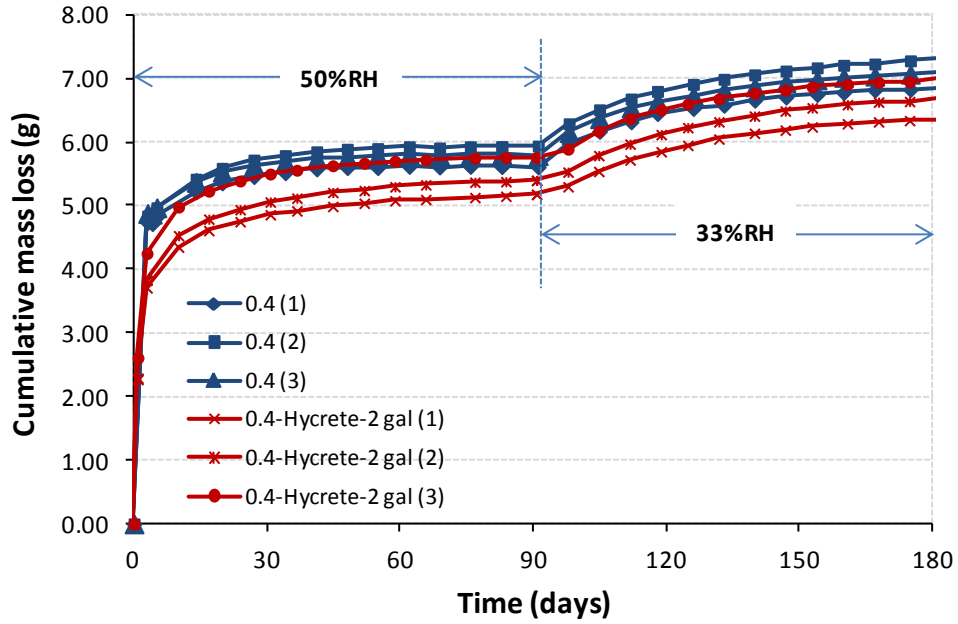

33 - Result for M1 & M3 (0.4 w/c): drying at 50%RH & 33%RH

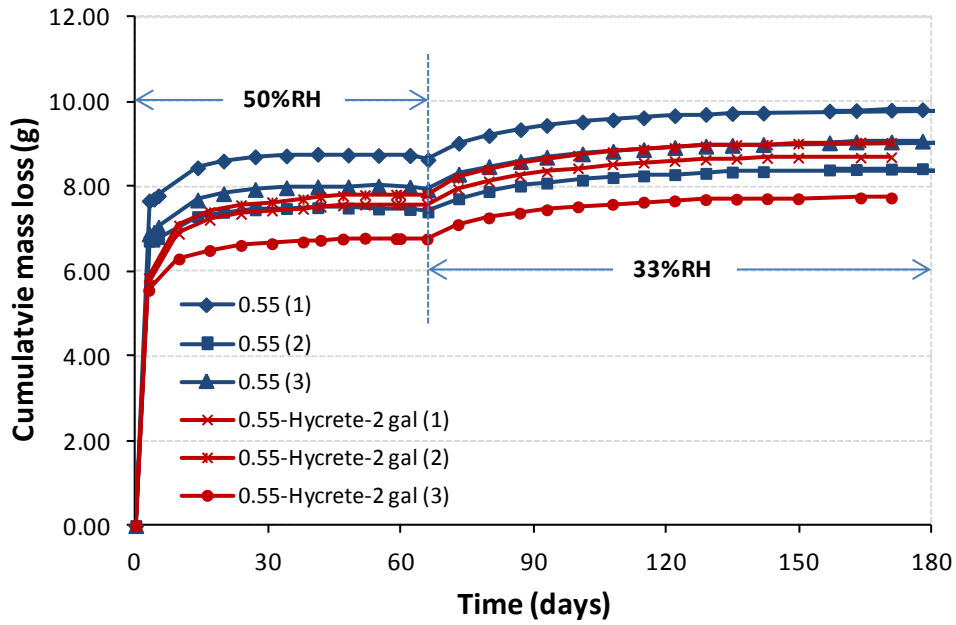

34 - Result for M4 & M6 (0.55 w/c): drying at 50%RH & 33%RH

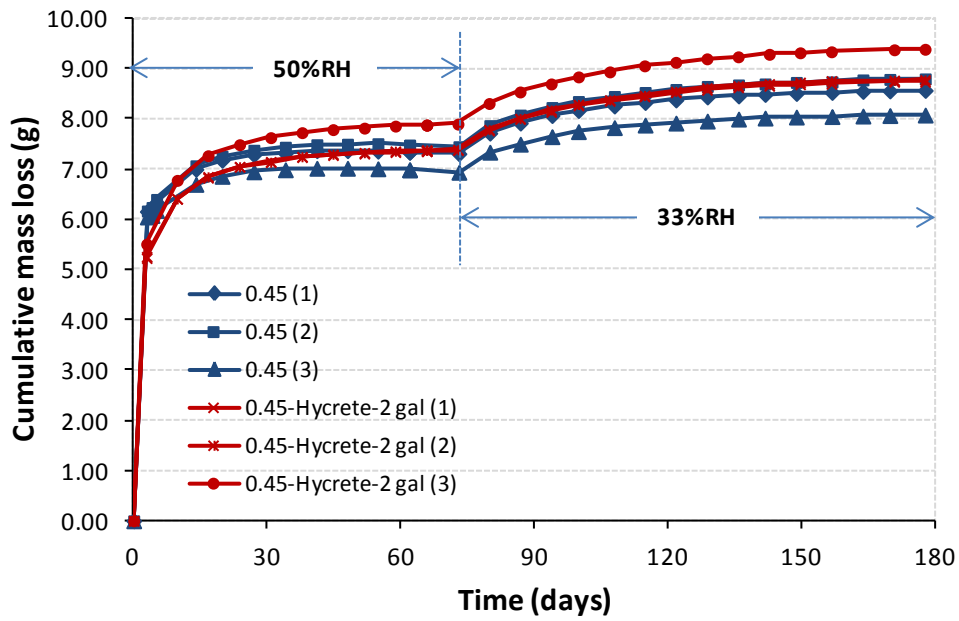

35 - Result for M7 & M9 (0.45 w/c): drying at 50%RH & 33%RH

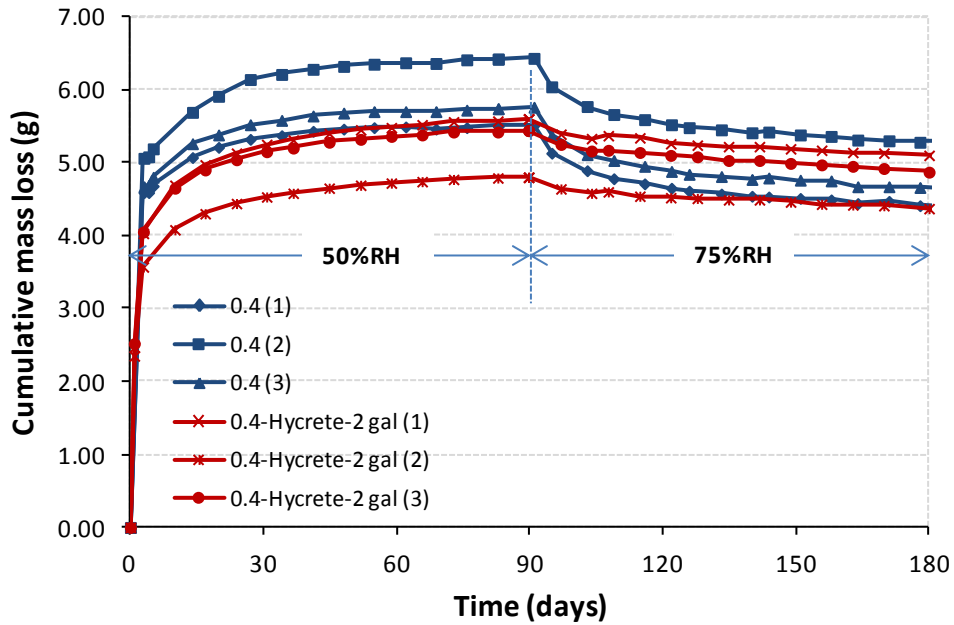

36 - Result for M1 & M3 (0.4 w/c): drying at 50%RH & 75%RH

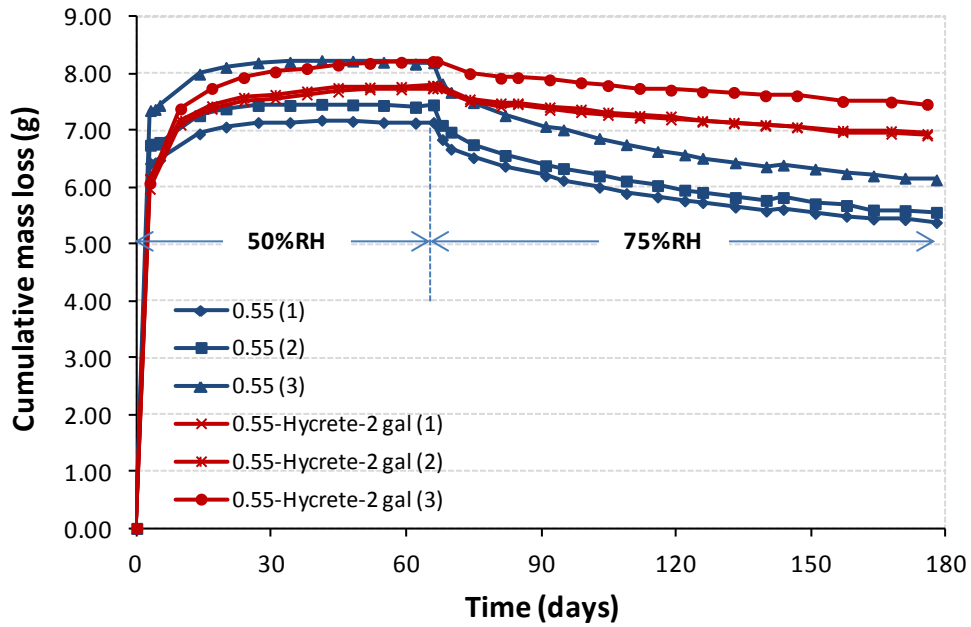

37 - Result for M4 & M6 (0.55 w/c): drying at 50%RH & 75%RH

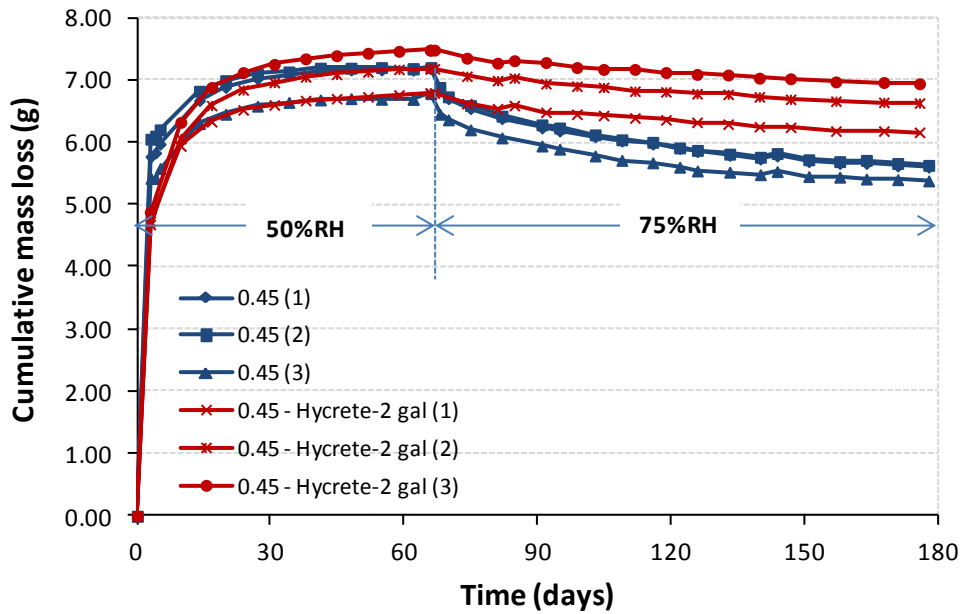

38 - Result for M7 & M9 (0.45 w/c): drying at 50%RH & 75%RH

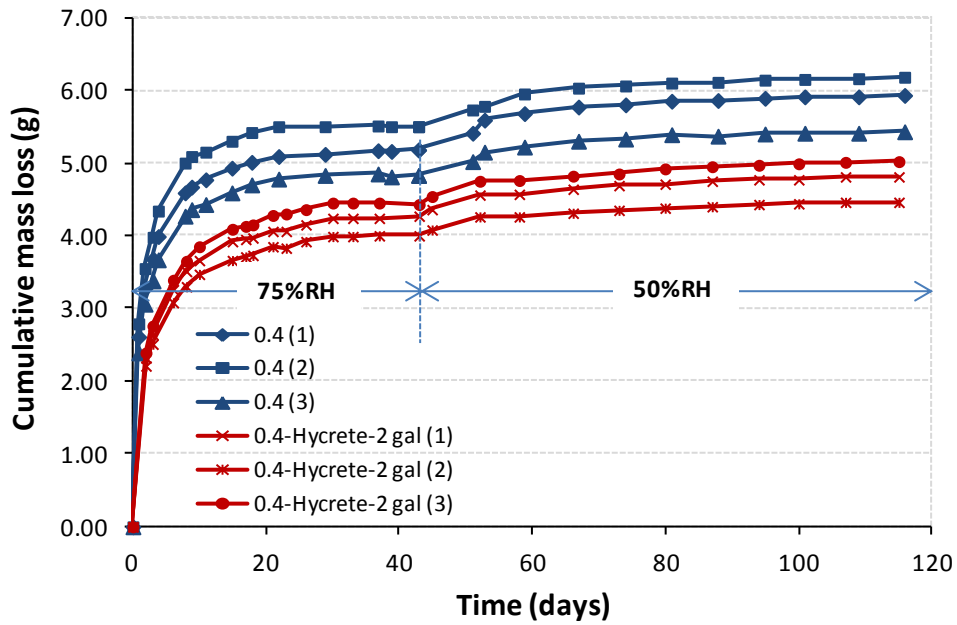

39 - Result for M1 & M3 (0.4 w/c): drying at 75%RH & 50%RH

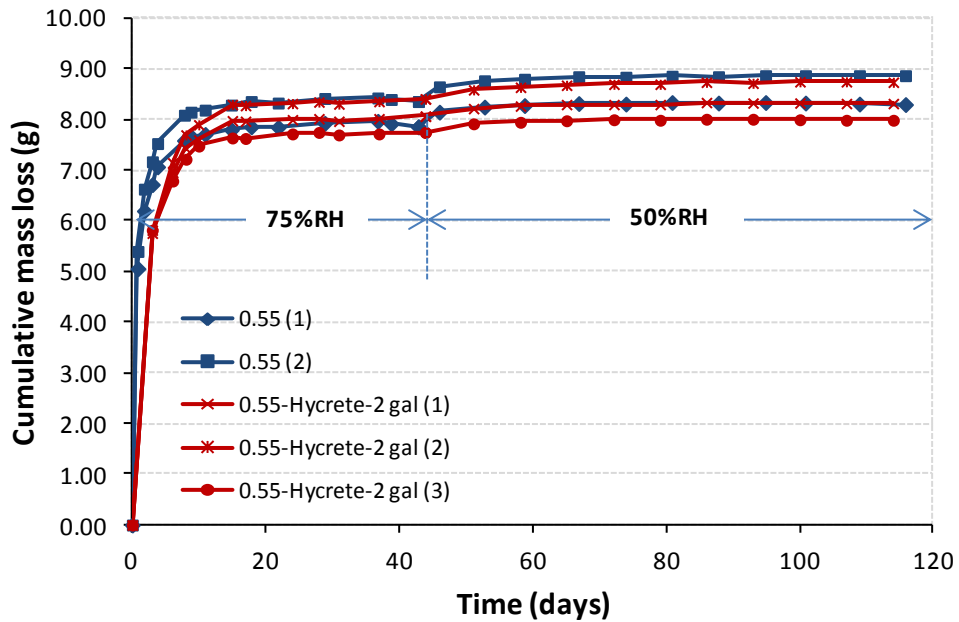

40 - Result for M4 & M6 (0.55 w/c): drying at 75%RH & 50%RH

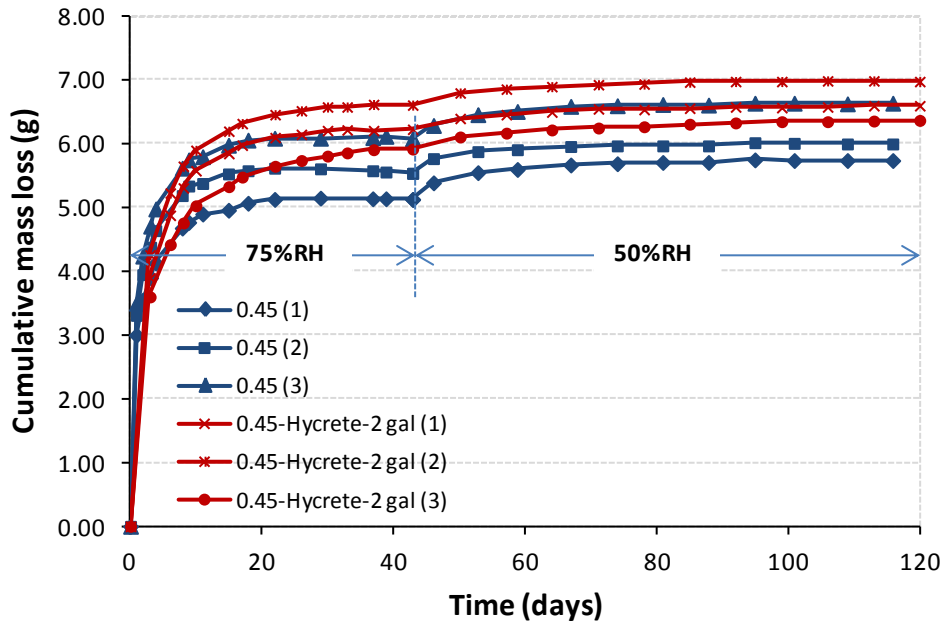

41 - Result for M7 & M9 (0.45 w/c): drying at 75%RH & 50%RH

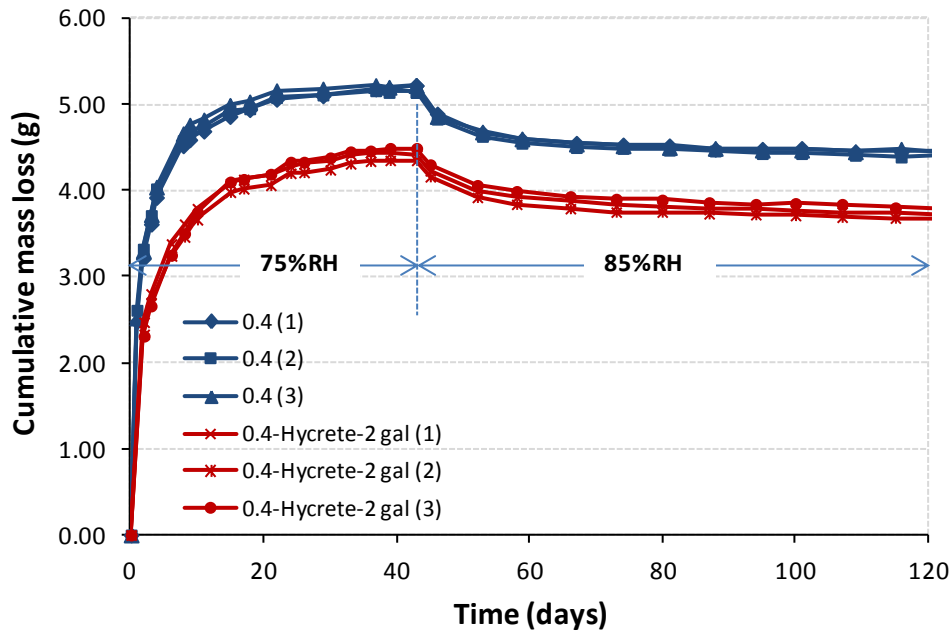

42 - Result for M1 & M3 (0.4 w/c): drying at 75%RH & 85%RH

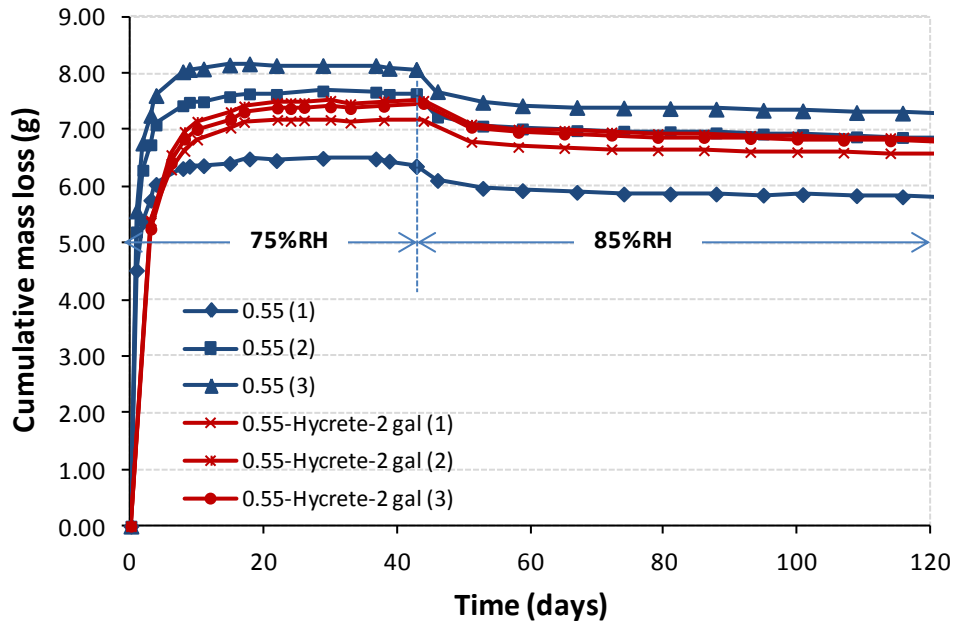

43 - Result for M4 & M6 (0.55 w/c): drying at 75%RH & 85%RH

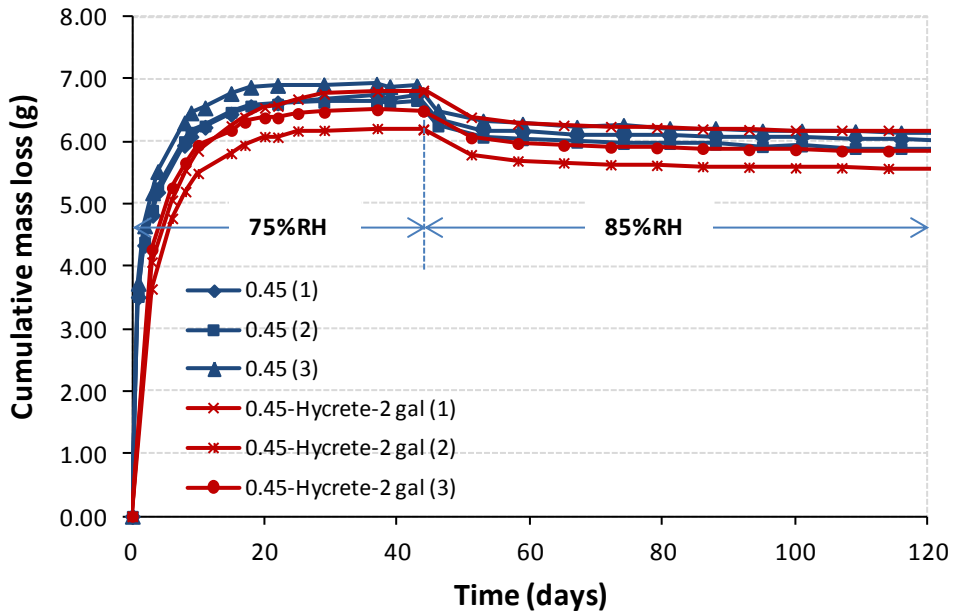

44 - Result for M7 & M9 (0.45 w/c): drying at 75%RH & 85%RH

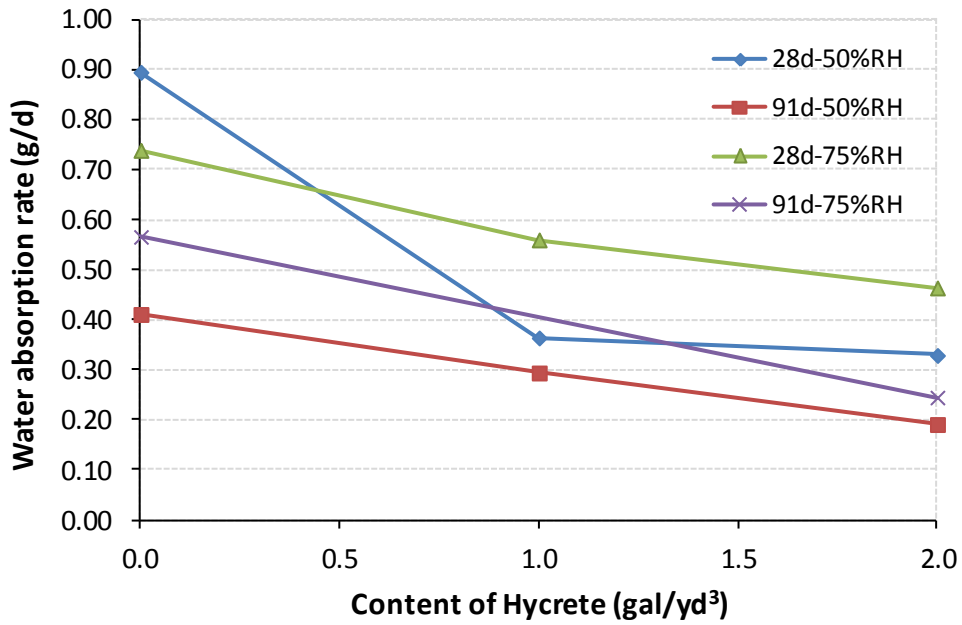

45 - Water absorption rates vs. Hycrete content for mixtures of 0.4 W/C

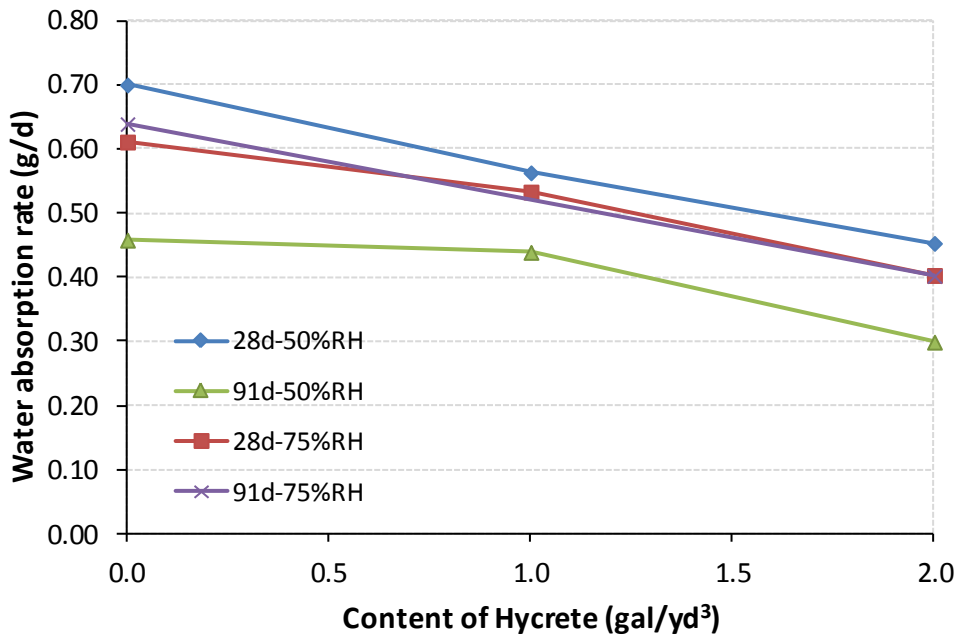

46 - Water absorption rates vs. Hycrete content for mixtures of 0.45 W/C

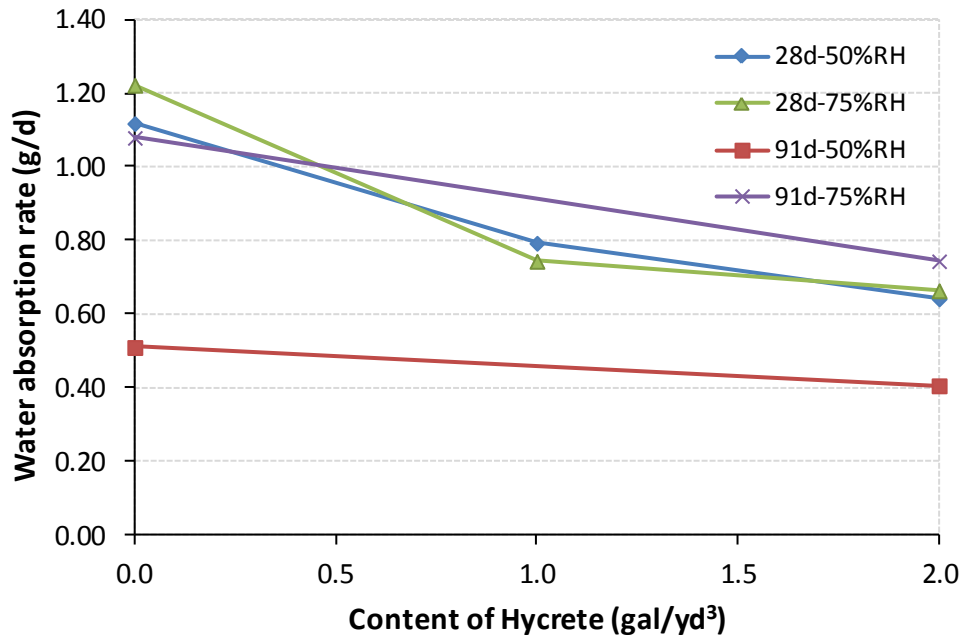

47 - Water absorption rates vs. Hycrete® content for mixtures of 0.55 W/C

F. Results of chloride ponding tests

The following pages provide the complete results of chloride ponding tests for the different concrete mixtures after both constant ponding and wet-dry cyclic ponding. These results are plotted in groups depending on the material characteristics and type of ponding.

Graphic order	Mixture ID	Hycrete® (gal/yd³)	Type of ponding	Duration of ponding
1	M1, M4, M7	0	Constant	180 days
2	M1, M4, M7	0	Cyclic	180 days
3	M1, M3	0, 2	Constant	91 days
4	M1, M2, M3	0, 1, 2	Constant	180 days
5	M4, M6	0, 2	Constant	91 days
6	M4, M5, M6	0, 1, 2	Constant	180 days
7	M7, M9	0, 2	Constant	91 days
8	M7, M8, M9	0, 1, 2	Constant	180 days
9	M1, M3	0, 2	Cyclic	91 days
10	M1, M2, M3	0, 1, 2	Cyclic	180 days
11	M4, M6	0, 2	Cyclic	91 days
12	M4, M5, M6	0, 1, 2	Cyclic	180 days
13	M7, M9	0, 2	Cyclic	91 days
14	M7, M8, M9	0, 1, 2	Cyclic	180 days
15	M3	2	Constant & Cyclic	91 days
16	M3	2	Constant & Cyclic	180 days
17	M6	2	Constant & Cyclic	91 days
18	M6	2	Constant & Cyclic	180 days
19	M9	2	Constant & Cyclic	91 days
20	M9	2	Constant & Cyclic	180 days

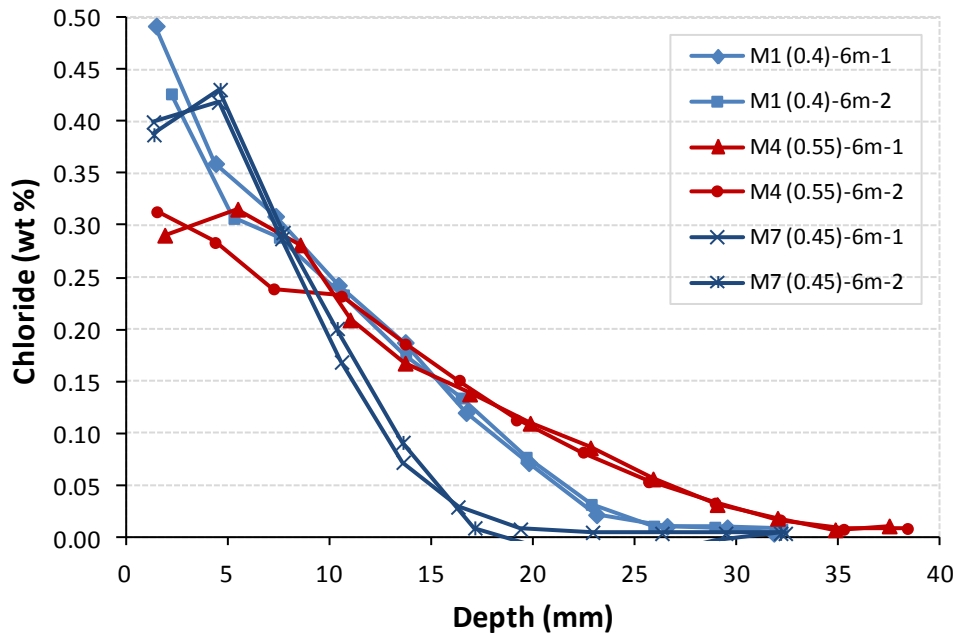

1 - Chloride profiles in the reference mixtures after six months' constant immersion

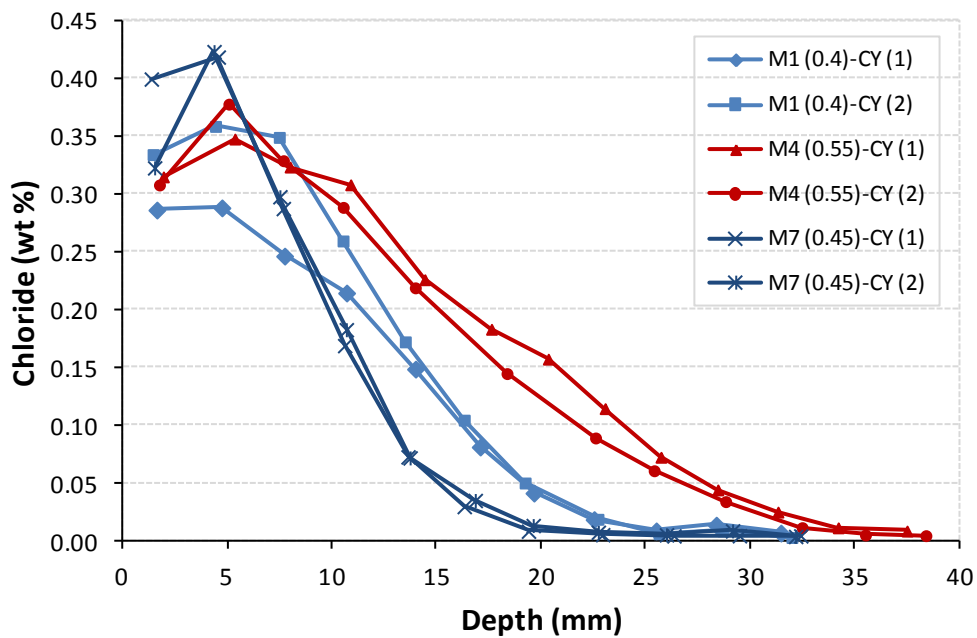

2 - Chloride profiles in the reference mixtures after six months' cyclic immersion

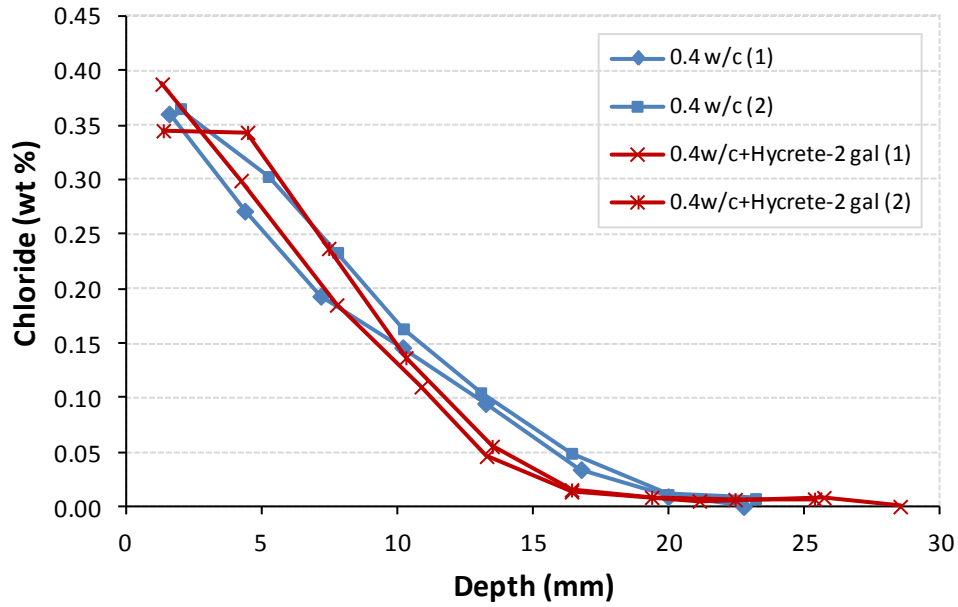

3 - Effect of Hycrete® on mixtures M1 and M3 after 3 months' constant immersion

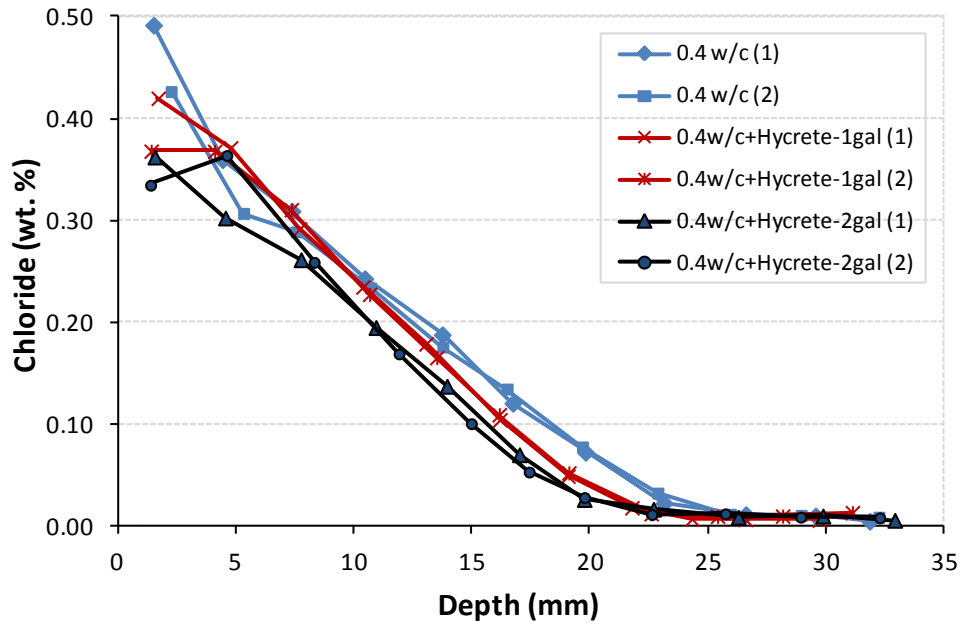

4 - Effect of Hycrete® on mixtures of M1 & M3 after 6 months' constant immersion

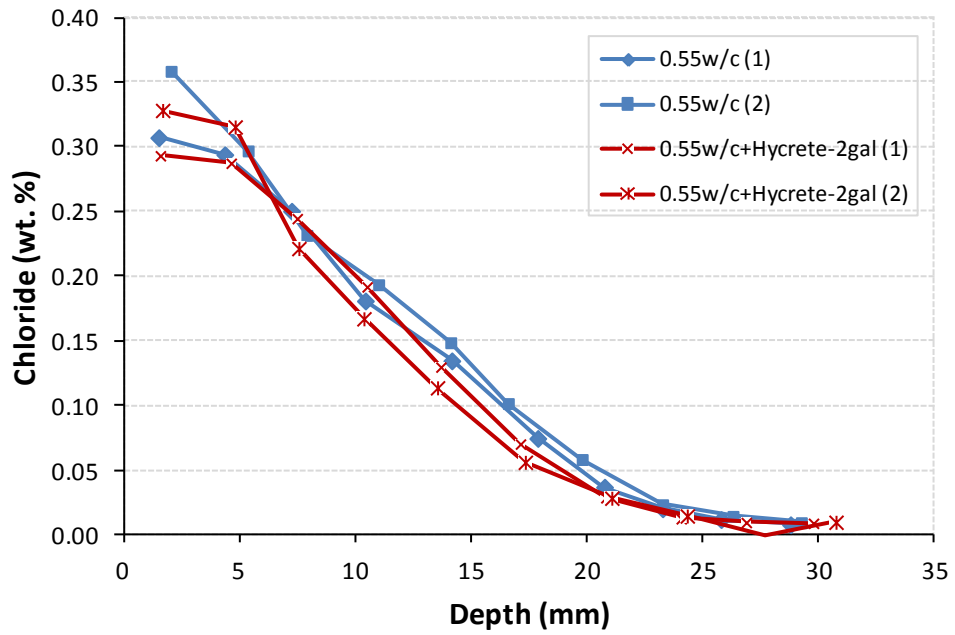

5 - Effect of Hycrete® on mixtures M4 & M6 after 3 months' constant immersion

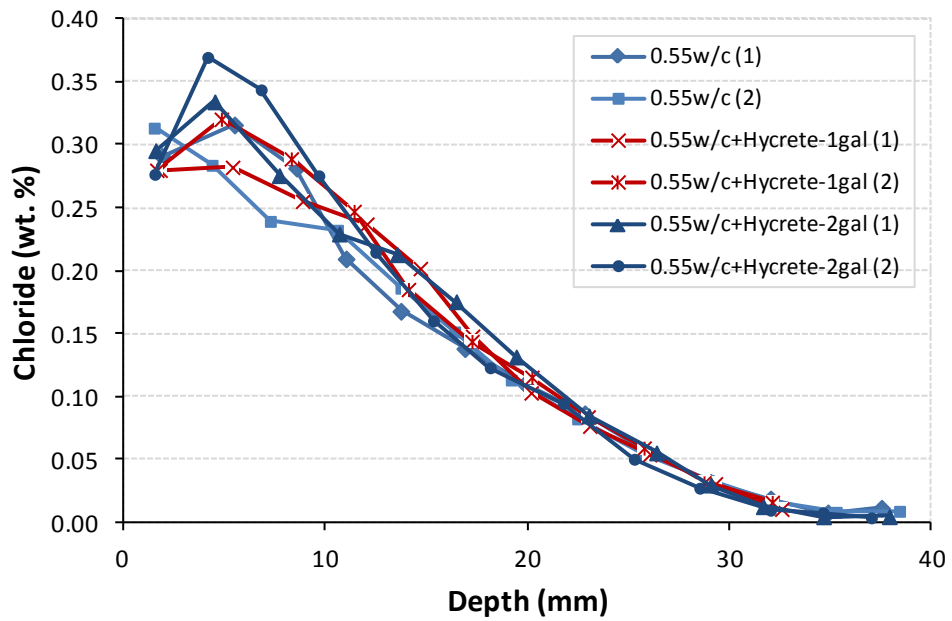

6 - Effect of Hycrete® on mixtures M4 & M6 after 6 months' constant immersion

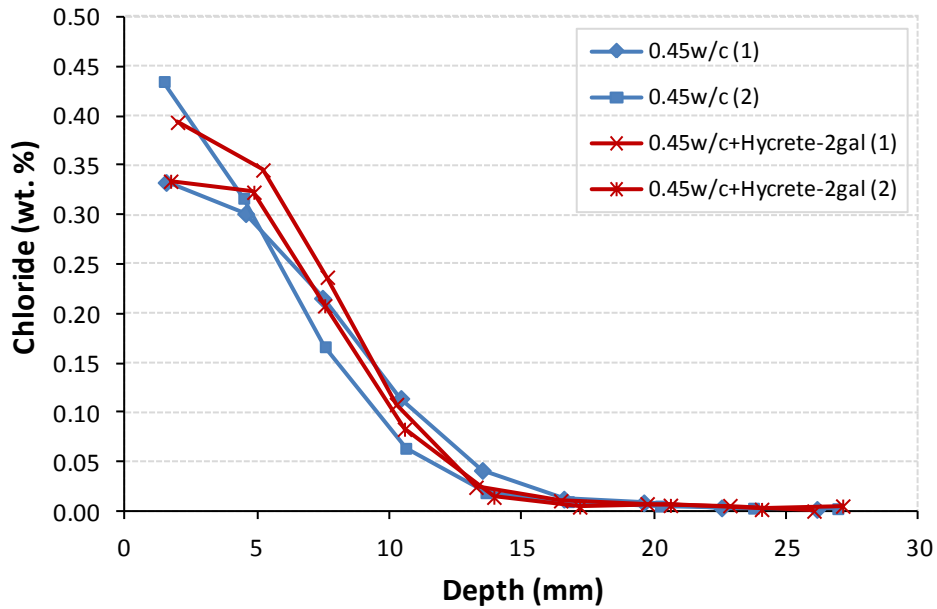

7 - Effect of Hycrete® on mixtures M7 & M9 after 3 months' constant immersion

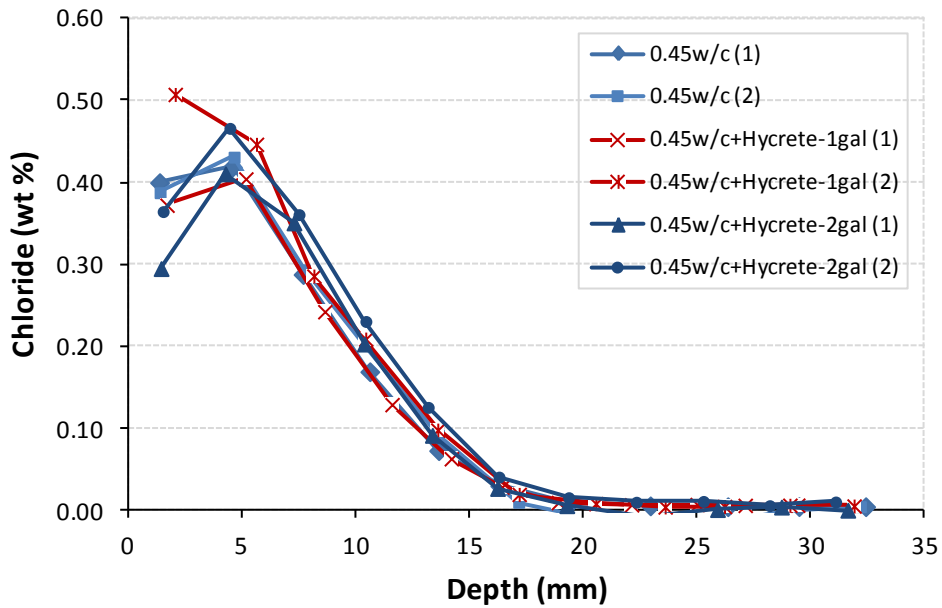

8 - Effect of Hycrete® on mixtures M7 & M9 after 6 months' constant immersion

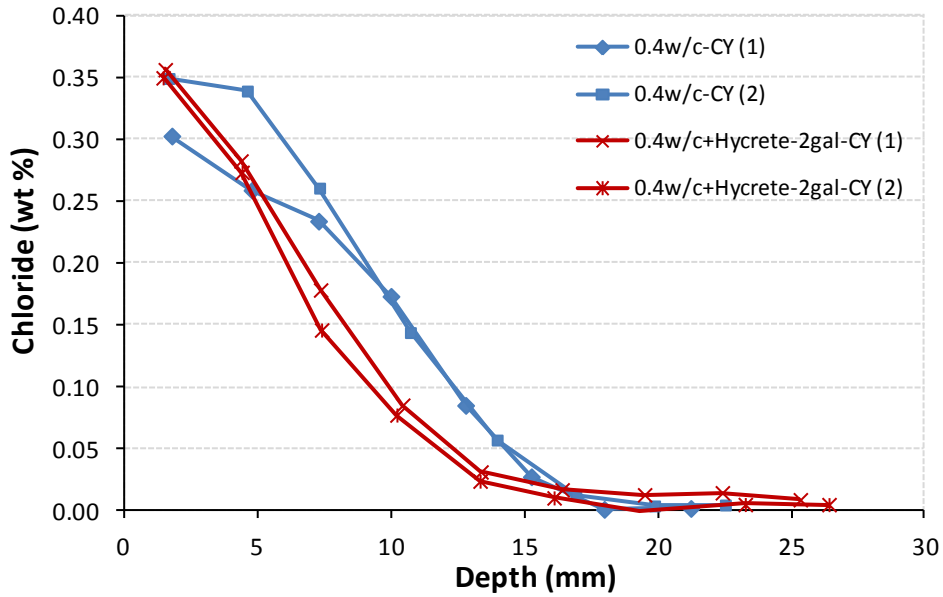

9 - Effect of Hycrete® on mixtures of 0.4 w/c after 91 days' cyclic ponding

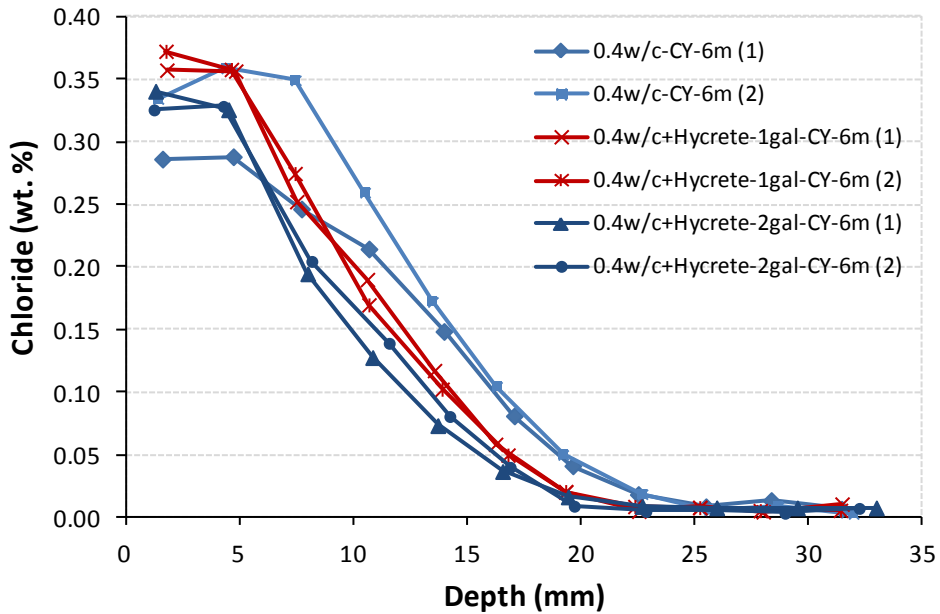

10 - Effect of Hycrete® on mixtures of 0.4 w/c after 180 days' cyclic ponding

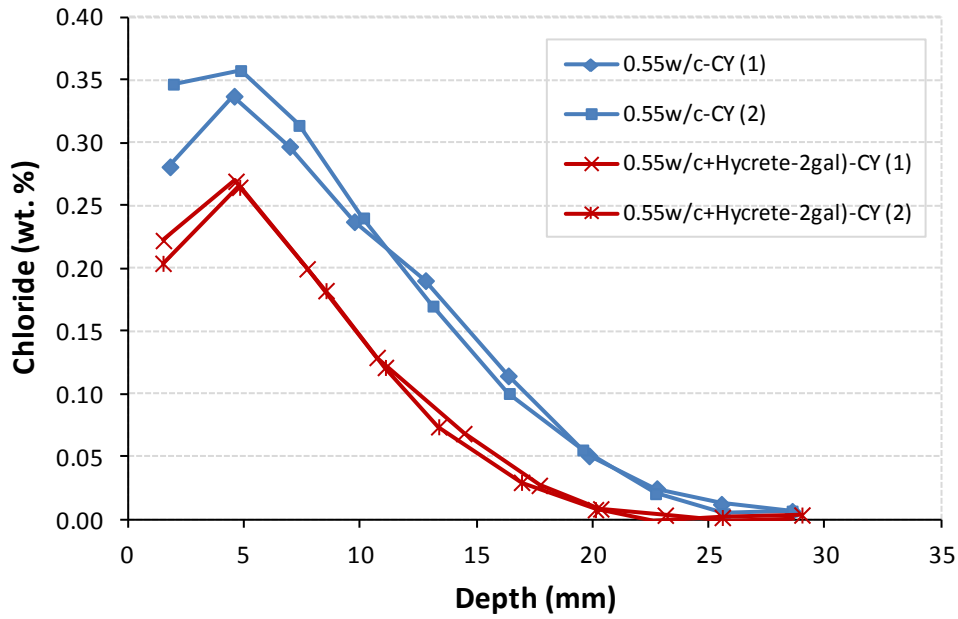

11 - Effect of Hycrete® on mixtures of 0.55 w/c after 91days' cyclic ponding

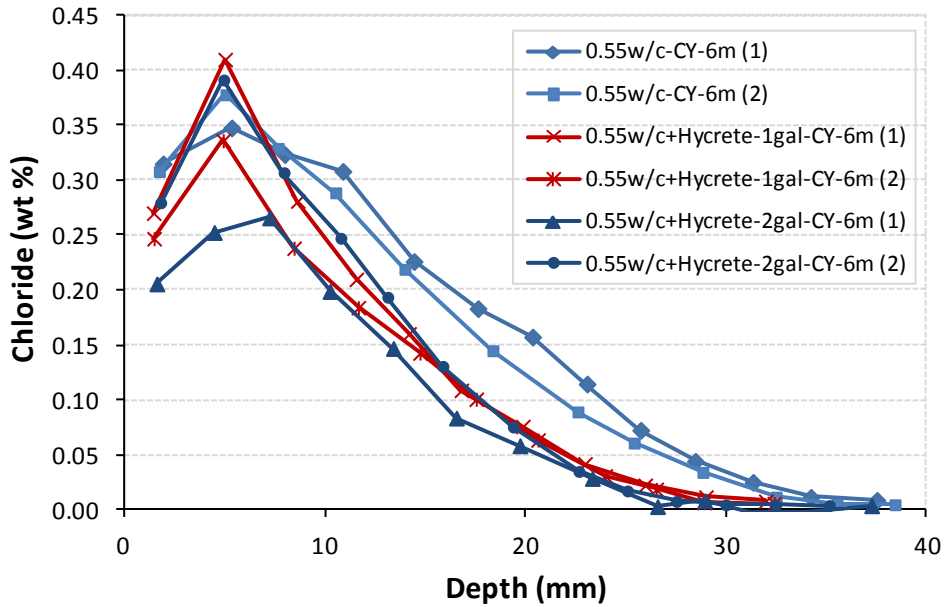

12 - Effect of Hycrete® on mixtures of 0.55 w/c after 180 days' cyclic ponding

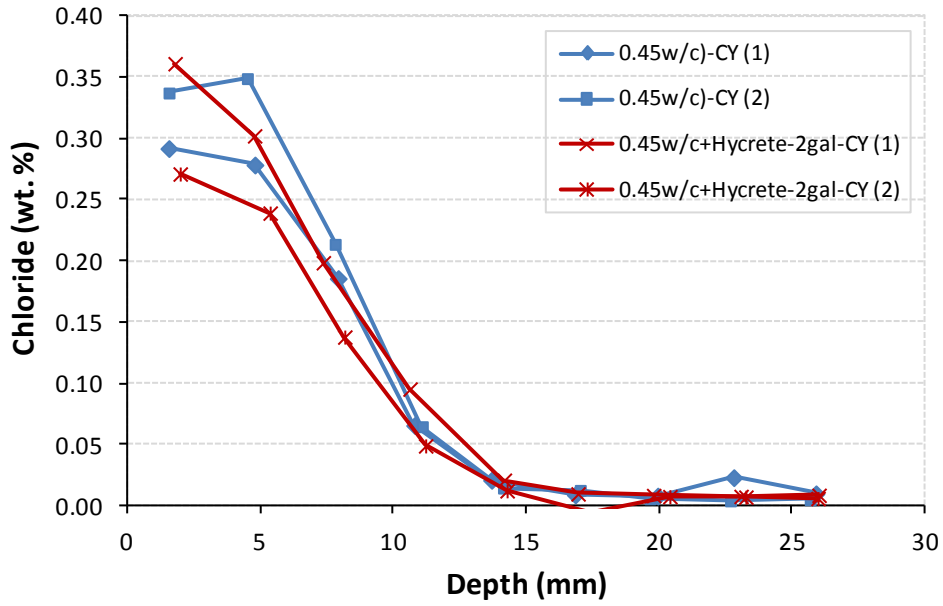

13 - Effect of Hycrete® on mixtures of 0.45 w/c after 91 days' cyclic ponding

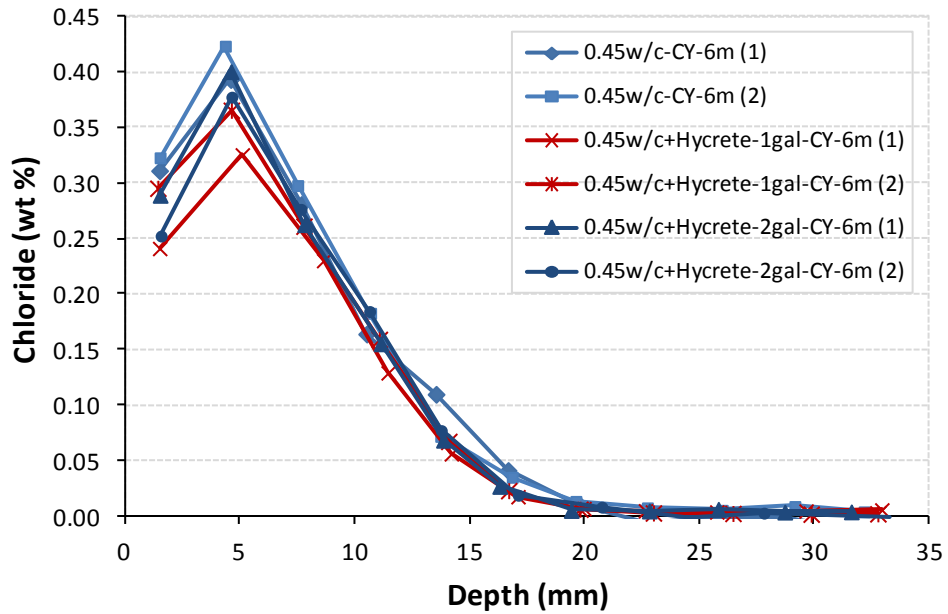

14- Effect of Hycrete® on mixtures of 0.45 w/c after 180 days' cyclic ponding

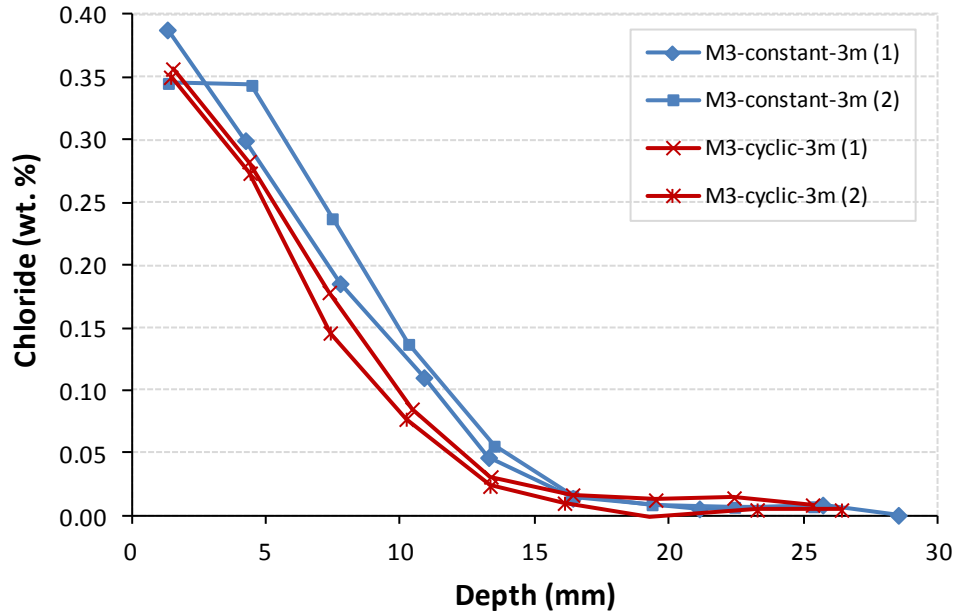

15 - Chloride profiles in Hycrete®-mixture M3 (0.4w/c+2 gal Hycrete) after 91 days' constant and cyclic ponding

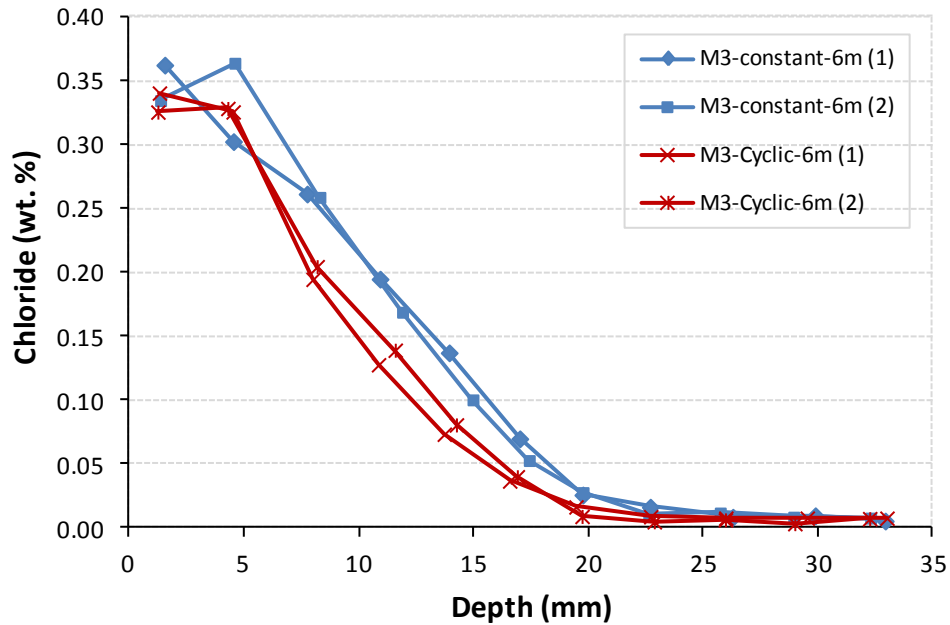

16 - Chloride profiles in Hycrete®-mixture M3 (0.4w/c+2 gal Hycrete) after 180 days' constant and cyclic ponding

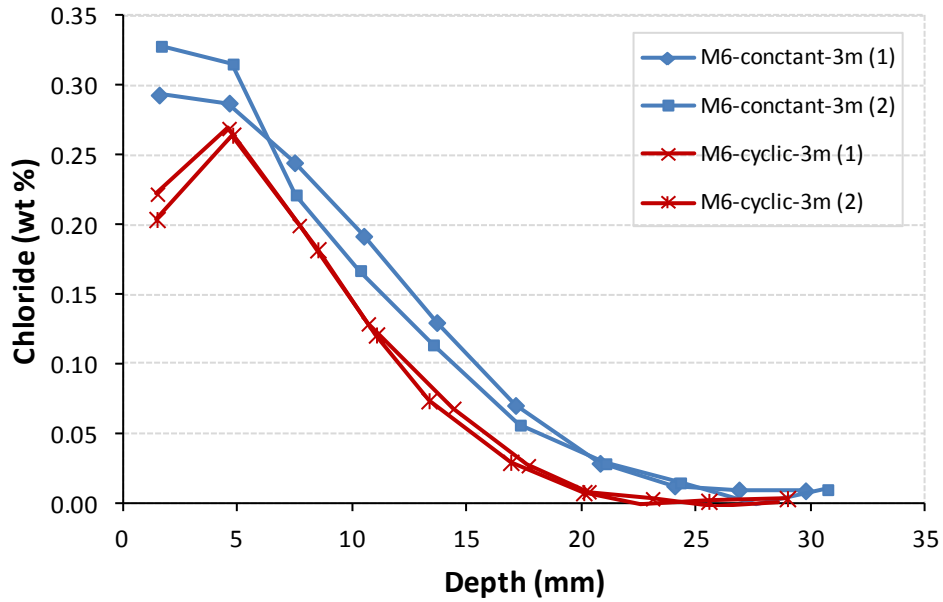

17 - Chloride profiles in Hycrete®-mixture of M6 (0.55w/c+2 gal Hycrete) after 91d' constant and cyclic ponding

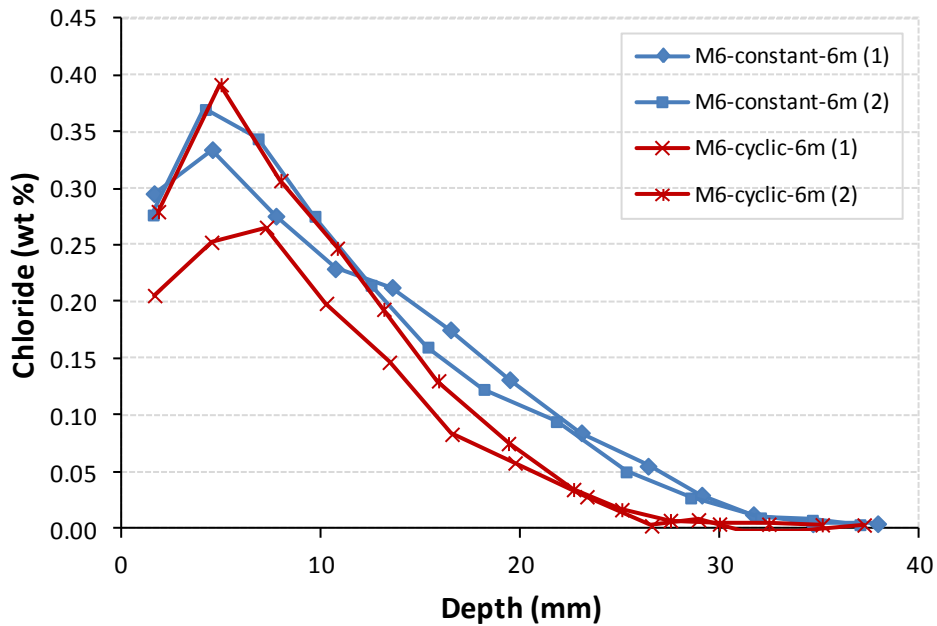

18 - Chloride profiles in Hycrete®-mixture of M6 (0.55w/c+2 gal Hycrete) after 180d' constant and cyclic ponding

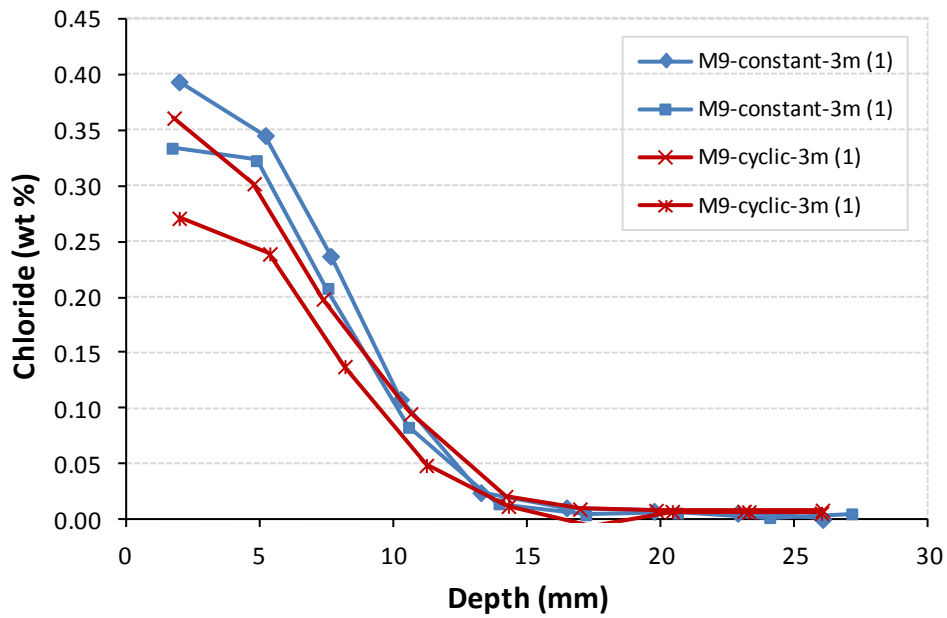

19 – Chloride profiles in Hycrete®-mixture of M9 (0.45 w/c+2gal Hycrete) after 91d' constant and cyclic ponding

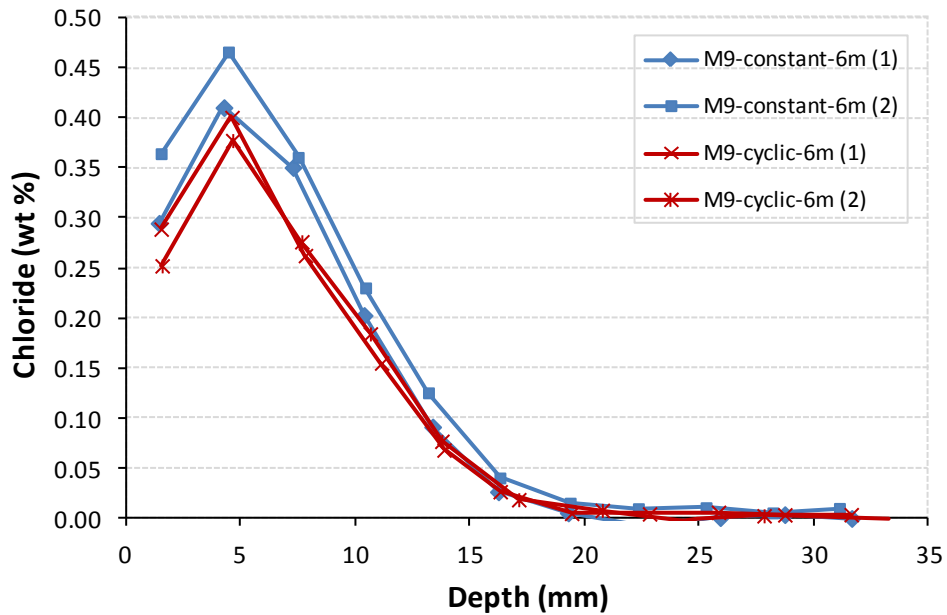

20 – Chloride profiles in Hycrete®-mixture of M9 (0.45w/c+ 2gal Hycrete) after 180d' constant and cyclic ponding

G. Statistical analysis results for isotherm tests

Table 21 – Equilibrium saturation at 33% RH

Mixture	28d			91d			AVG	STDEV	COV
	S-1	S-2	S-3	S-1	S-2	S-3			
1	0.246	0.273	0.224		N/A		0.248	0.024	0.098
2	0.269	0.277	0.277		N/A		0.274	0.004	0.016
3	0.310	0.319	0.358		N/A		0.329	0.026	0.078
4	0.150	0.165	0.174		N/A		0.163	0.012	0.074
5	0.212	0.211	0.236		N/A		0.220	0.014	0.065
6	0.201	0.169	0.211		N/A		0.194	0.022	0.114
7	0.246	0.231	0.256		N/A		0.244	0.012	0.051
8	0.277	0.266	0.169		N/A		0.237	0.060	0.252
9	0.206	0.232	0.331		N/A		0.256	0.066	0.257

Table 22 - Equilibrium saturation at 50% RH

Mixture	28d			91d			AVG	STDEV	COV
	S-1	S-2	S-3	S-1	S-2	S-3			
1	0.440	0.390	0.440	0.478	0.446	0.454	0.441	0.029	0.065
2	0.473	0.495	0.483	0.409	0.496	0.514	0.478	0.037	0.077
3	0.458	0.487	0.494	0.567	0.546	0.540	0.515	0.042	0.081
4	0.371	0.283	0.272	0.427	0.349	0.320	0.337	0.058	0.172
5	0.426	0.346	0.408	0.415	0.394	0.360	0.391	0.032	0.081
6	0.337	0.410	0.378	0.418	0.359	0.399	0.383	0.032	0.082
7	0.334	0.395	0.449	0.420	0.452	0.405	0.409	0.043	0.106
8	0.443	0.454	0.384	0.495	0.443	0.419	0.440	0.037	0.084
9	0.441	0.397	0.402	0.480	0.461	0.468	0.442	0.035	0.079

Table 23 - Equilibrium saturation at 75%RH

Mixture	28d			91d			AVG	STDEV	COV
	S-1	S-2	S-3	S-1	S-2	S-3			
1	0.512	0.486	0.522	0.620	0.592	0.610	0.557	0.057	0.102
2	0.575	0.584	0.538	0.586	0.593	0.562	0.573	0.020	0.036
3	0.528	0.570	0.559	0.598	0.582	0.593	0.572	0.026	0.045
4	0.409	0.399	0.353	0.498	0.471	0.428	0.427	0.052	0.122
5	0.464	0.463	0.432	0.461	0.436	0.438	0.449	0.015	0.033
6	0.380	0.415	0.431	0.389	0.441	0.397	0.409	0.024	0.060
7	0.572	0.510	0.481	0.560	0.595	0.558	0.546	0.042	0.077
8	0.460	0.447	0.491	0.444	0.460	0.478	0.463	0.018	0.039
9	0.449	0.446	0.445	0.502	0.457	0.431	0.455	0.024	0.054

Table 24 - Equilibrium saturation at 85%RH

Mixture	28d			91d			AVG	STDEV	COV
	S-1	S-2	S-3	S-1	S-2	S-3			
1	0.641	0.679	0.694		N/A		0.671	0.027	0.040
2	0.723	0.708	0.722		N/A		0.718	0.008	0.011
3	0.780	0.777	0.811		N/A		0.789	0.019	0.024
4	0.585	0.567	0.604		N/A		0.585	0.018	0.031
5	0.569	0.544	0.562		N/A		0.558	0.013	0.023
6	0.618	0.610	0.606		N/A		0.612	0.006	0.010
7	0.651	0.646	0.615		N/A		0.637	0.019	0.031
8	0.793	0.782	0.774		N/A		0.783	0.009	0.012
9	0.779	0.775	0.781		N/A		0.778	0.003	0.004

Table 25 - Equilibrium saturation at 92%RH

Mixture	28d			91d			AVG	STDEV	COV
	S-1	S-2	S-3	S-1	S-2	S-3			
1	0.850	0.871	0.856		N/A		0.859	0.011	0.012
2	0.891	0.900	0.897		N/A		0.896	0.005	0.005
3	0.916	0.915	0.911		N/A		0.914	0.003	0.003
4	0.820	0.798	0.777		N/A		0.798	0.021	0.027
5	0.783	0.780	0.788		N/A		0.784	0.004	0.006
6	0.719	0.748	0.733		N/A		0.734	0.014	0.020
7	0.853	0.803	0.862		N/A		0.839	0.032	0.038
8	0.859	0.857	0.870		N/A		0.862	0.007	0.008
9	0.889	0.895	0.888		N/A		0.891	0.004	0.004

REPORT DOCUMENTATION PAGE

Form Approved
OMB No. 0704-0188

Public reporting burden for this collection of information is estimated to average 1 hour per response, including the time for reviewing instructions, searching existing data sources, gathering and maintaining the data needed, and completing and reviewing this collection of information. Send comments regarding this burden estimate or any other aspect of this collection of information, including suggestions for reducing this burden to Department of Defense, Washington Headquarters Services, Directorate for Information Operations and Reports (0704-0188), 1215 Jefferson Davis Highway, Suite 1204, Arlington, VA 22202-4302. Respondents should be aware that notwithstanding any other provision of law, no person shall be subject to any penalty for failing to comply with a collection of information if it does not display a currently valid OMB control number. PLEASE DO NOT RETURN YOUR FORM TO THE ABOVE ADDRESS.

1. REPORT DATE (DD-MM-YYYY) December 2017			2. REPORT TYPE Final		3. DATES COVERED (From - To)	
4. TITLE AND SUBTITLE Modeling the Effect of a Hydrophobic Concrete Admixture on Chloride Ingress: Contractor's Supplemental Report for CPC Project F09-AR05A					5a. CONTRACT NUMBER W9132T-SIM-001	
					5b. GRANT NUMBER	
					5c. PROGRAM ELEMENT NUMBER	
6. AUTHOR(S) Eric Samson and Tiewei Zhang					5d. PROJECT NUMBER P2 321089	
					5e. TASK NUMBER MIPR DSAM00261	
					5f. WORK UNIT NUMBER	
7. PERFORMING ORGANIZATION NAME(S) AND ADDRESS(ES) SIMCO Technologies Incorporated 203-1400 Boul. du Parc-Technologique Québec City, QC G1P 4R7					8. PERFORMING ORGANIZATION REPORT NUMBER	
9. SPONSORING / MONITORING AGENCY NAME(S) AND ADDRESS(ES) Construction Engineering Research Laboratory U.S. Army Engineer Research and Development Center Champaign, IL 61822					10. SPONSOR/MONITOR'S ACRONYM(S) ERDC-CERL	
					11. SPONSOR/MONITOR'S REPORT NUMBER(S) ERDC/CERL CR-17-5	
12. DISTRIBUTION / AVAILABILITY STATEMENT Approved for public release. Distribution is unlimited.						
13. SUPPLEMENTARY NOTES						
14. ABSTRACT This study investigated the effects on concrete transport properties provided by a commercial hydrophobic admixture called Hycrete, and used the results in a proprietary reactive transport model called STADIUM®. This model, incorporated into Unified Facilities Guide Specification 03 31 29 (Marine Concrete), supports a performance-based approach for estimating the service life of a concrete-based system in a marine environment. The researchers developed specific laboratory modules to characterize the moisture and chloride transport properties of mixtures with and without Hycrete to serve as input parameters for estimating the service life of structures. Physical tests were performed on three different concrete mixtures, each prepared with 0 (reference case), 1, and 2 gal/yd ³ of admixture. One test series indicated that Hycrete has no effect on compressive strength and total pore volume or, in most cases, diffusion coefficients. Moisture-transport tests showed that the admixture mildly reduced drying rates and clearly reduced water-absorption rates. With the data implemented in STADIUM it was possible to reproduce the measured chloride profiles in samples exposed to wetting/drying cycles in sodium chloride solutions. The modeling results showed that a mixture prepared with Hycrete and exposed to exposure cycles exhibits a lower chloride-ingress rate, reasonably replicating the experimental observations.						
15. SUBJECT TERMS Corrosion and anti-corrosives; Corrosion resistant materials; Reinforced concrete-Corrosion; Concrete-Additives; Waterproofing; STADIUM reactive transport model; Hycrete						
16. SECURITY CLASSIFICATION OF:			17. LIMITATION OF ABSTRACT UU	18. NUMBER OF PAGES 158	19a. NAME OF RESPONSIBLE PERSON	
a. REPORT Unclassified	b. ABSTRACT Unclassified	c. THIS PAGE Unclassified			19b. TELEPHONE NUMBER (include area code)	