

FINAL REPORT

Rapid Assessment of Remedial Effectiveness and Rebound in Fractured Bedrock

ESTCP Project ER-201330

OCTOBER 2017

Charles Schaefer, Ph.D.
CDM Smith

David Lippincott, P.G.
CB&I Federal Services

Kirk Hatfield, Ph.D.
Harald Klammler, Ph.D.
University of Florida

Distribution Statement A

This document has been cleared for public release



Page Intentionally Left Blank

REPORT DOCUMENTATION PAGE			<i>Form Approved</i> <i>OMB No. 0704-0188</i>	
Public reporting burden for this collection of information is estimated to average 1 hour per response, including the time for reviewing instructions, searching existing data sources, gathering and maintaining the data needed, and completing and reviewing this collection of information. Send comments regarding this burden estimate or any other aspect of this collection of information, including suggestions for reducing this burden to Department of Defense, Washington Headquarters Services, Directorate for Information Operations and Reports (0704-0188), 1215 Jefferson Davis Highway, Suite 1204, Arlington, VA 22202-4302. Respondents should be aware that notwithstanding any other provision of law, no person shall be subject to any penalty for failing to comply with a collection of information if it does not display a currently valid OMB control number. PLEASE DO NOT RETURN YOUR FORM TO THE ABOVE ADDRESS.				
1. REPORT DATE (DD-MM-YYYY) 07-24-2017		2. REPORT TYPE Final Report		3. DATES COVERED (From - To) June 2013 to June 2017
4. TITLE AND SUBTITLE Rapid Assessment of Remedial Effectiveness and Rebound in Fractured Bedrock			5a. CONTRACT NUMBER W912HQ-13-C-0016	
			5b. GRANT NUMBER NA	
			5c. PROGRAM ELEMENT NUMBER NA	
			5d. PROJECT NUMBER NA	
6. AUTHOR(S) Schaefer, Charles E., Ph.D. Lippincott, David R. Lavorgna, Graig M. Klammler, Harald, Ph.D. Hatfield, Kirk Ph.D.			5e. TASK NUMBER NA	
			5f. WORK UNIT NUMBER NA	
			8. PERFORMING ORGANIZATION REPORT NUMBER ER-201330	
7. PERFORMING ORGANIZATION NAME(S) AND ADDRESS(ES) CB&I Federal Services, LLC. 17 Princess Road Lawrenceville, NJ 08648			9. SPONSORING / MONITORING AGENCY NAME(S) AND ADDRESS(ES) Environmental Security Technology Certification Program 4800 Mark Center Drive, Suite 17D08 Alexandria, VA 22350-3605	
9. SPONSORING / MONITORING AGENCY NAME(S) AND ADDRESS(ES) Environmental Security Technology Certification Program 4800 Mark Center Drive, Suite 17D08 Alexandria, VA 22350-3605			10. SPONSOR/MONITOR'S ACRONYM(S) ESTCP	
			11. SPONSOR/MONITOR'S REPORT NUMBER(S) ER-201330	
12. DISTRIBUTION / AVAILABILITY STATEMENT Distribution Statement A: Approved for Public Release, Distribution is Unlimited				
13. SUPPLEMENTARY NOTES None				
14. ABSTRACT An <i>in situ</i> field demonstration was performed in fractured rock impacted with trichloroethene (TCE) and <i>cis</i> -1,2-dichloroethene (DCE) to assess the impacts of contaminant rebound after removing dissolved contaminants within hydraulically conductive fractures. Using a bedrock well pair spaced 2.4 meters apart, TCE and DCE were first rapidly flushed with water to create a decrease in dissolved contaminant concentrations. While hydraulically isolating the well pair from upgradient contaminant impacts, contaminant rebound was observed between the well pair over 151 days. The rate of TCE rebound was reasonably described by a matrix back-diffusion screening model that employed an effective diffusion coefficient and first-order abiotic TCE dechlorination rate constant based on bench-scale testing. Furthermore, a shift in the TCE:DCE ratio and carbon isotopic enrichment was observed during the rebound, suggesting that both biotic and abiotic dechlorination were occurring within the rock matrix. Results of this field demonstration highlight the importance and applicability of rock matrix parameters determined at the bench-scale, and suggests that carbon isotopic enrichment can be used as a line of evidence for abiotic dechlorination within rock matrices.				
15. SUBJECT TERMS Bedrock, rebound, TCE				
16. SECURITY CLASSIFICATION OF:			17. LIMITATION OF ABSTRACT UU	18. NUMBER OF PAGES 123
a. REPORT U	b. ABSTRACT U	c. THIS PAGE U		
				19b. TELEPHONE NUMBER (include area code) 732-590-4633

Page Intentionally Left Blank

This report was prepared under contract to the Department of Defense Environmental Security Technology Certification Program (ESTCP). The publication of this report does not indicate endorsement by the Department of Defense, nor should the contents be construed as reflecting the official policy or position of the Department of Defense. Reference herein to any specific commercial product, process, or service by trade name, trademark, manufacturer, or otherwise, does not necessarily constitute or imply its endorsement, recommendation, or favoring by the Department of Defense.

Page Intentionally Left Blank

FINAL REPORT

Project: ER-201330

TABLE OF CONTENTS

	Page
EXECUTIVE SUMMARY	1
1.0 INTRODUCTION	1
1.1 BACKGROUND	1
1.2 OBJECTIVE OF THE DEMONSTRATION.....	2
1.3 REGULATORY DRIVERS	2
2.0 TECHNOLOGY	3
2.1 TECHNOLOGY DESCRIPTION	3
2.1.1 Background – Contaminant Rebound.....	3
2.1.2 Overall Approach for Rapidly Assessing Treatment	5
2.2 TECHNOLOGY DEVELOPMENT	7
2.2.1 Monitoring and Assessment Tools.....	7
2.2.2 Rapid Assessment Testing	8
2.2.3 Assessment of Rebound – Alameda Point, CA.....	8
2.3 ADVANTAGES AND LIMITATIONS OF THE TECHNOLOGY	9
2.3.1 Advantages.....	9
2.3.2 Limitations	10
3.0 PERFORMANCE OBJECTIVES	11
3.1 SUBSTANTIAL DECREASES IN CHLORINATED SOLVENT CONCENTRATIONS DURING THE INITIAL RAPID FLUSHING	11
3.1.1 Data Requirements for TCE Removal	11
3.1.2 Success Criteria for TCE/DCE Removal	12
3.1.3 Results for TCE/DCE Removal.....	12
3.2 REMOVAL OF PERMANGANATE FROM CONDUCTIVE FRACTURES DURING THE START OF THE REBOUND PHASE	12
3.2.1 Data Requirements for Permanganate Removal	12
3.2.2 Success Criteria for Permanganate Removal	12
3.2.3 Results for Permanganate Removal	12
3.3 EFFECTIVE MONITORING OF REBOUND DURING THE SECOND PHASE OF INJECTION (SLOW FLUSHING) TO ASSESS REMEDIAL PERFORMANCE	12
3.3.1 Data Requirements for Rebound Monitoring.....	13
3.3.2 Success Criteria for Rebound Monitoring	13
3.3.3 Results for Rebound Monitoring	13

TABLE OF CONTENTS (Continued)

	Page
3.4 EASE OF IMPLEMENTATION	13
3.4.1 Data Requirements to Assess Ease of Implementation.....	13
3.4.2 Success Criteria for Ease of Implementation.....	13
3.4.3 Results for Ease of Implementation	13
4.0 SITE DESCRIPTION	15
4.1 SITE SELECTION	15
4.2 SITE LOCATION AND HISTORY	16
4.2.1 Initial Screening Site - NAWC	16
4.2.2 Primary Demonstration Site - Calf Pasture Point (Site 07).....	18
4.3 SITE GEOLOGY AND HYDROGEOLOGY	19
4.3.1 NAWC	19
4.3.2 Calf Pasture Point	20
4.4 CONTAMINANT SOURCE AND DISTRIBUTION.....	21
4.4.1 NAWC	21
4.4.2 Calf Pasture Point	21
5.0 TEST DESIGN	23
5.1 CONCEPTUAL EXPERIMENTAL DESIGN.....	23
5.2 BASELINE CHARACTERIZATION ACTIVITIES	24
5.2.1 Borehole Drilling	24
5.2.2 Drilling and Rock Coring.....	25
5.2.3 Borehole Geophysical Logging	28
5.2.4 Borehole Discrete Interval Hydraulic Testing and Sampling	28
5.2.5 Permanent Packer Installation.....	29
5.2.6 Tracer Testing	30
5.2.7 Borehole Dilution Testing.....	32
5.3 LABORATORY TREATABILITY STUDY.....	34
5.3.1 Objectives	34
5.3.2 Sample Collection.....	34
5.3.3 Treatability Study Methodology	34
5.3.4 Treatability Study Results.....	36
5.3.5 Treatability Study Conclusions.....	36
5.4 DESIGN AND LAYOUT OF TECHNOLOGY COMPONENTS	36
5.5 FIELD TESTING	37
5.5.1 Baseline Sampling	39
5.5.2 Rapid Flushing and Sampling.....	39
5.5.3 Rebound Sampling.....	40
5.5.4 Demobilization.....	41

TABLE OF CONTENTS (Continued)

	Page
5.6 DATA ANALYSIS	41
5.6.1 Rebound Model – Rock Matrix	41
5.6.2 CSIA and Abiotic dechlorination.....	45
5.7 SAMPLING METHODS	46
5.7.1 Groundwater Sampling	46
5.7.2 Analytical and Sample Preservation	47
5.7.3 Groundwater Sampling Locations and Frequency.....	48
5.7.4 Quality Assurance for Groundwater Sampling and Analysis	49
5.8 RESULTS	52
5.8.1 Results of Baseline Sampling	52
5.8.2 Results of flushing	53
5.8.3 Results of Rebound.....	55
6.0 PERFORMANCE ASSESSMENT	57
6.1 SUBSTANTIAL DECREASES IN CHLORINATED SOLVENT CONCENTRATIONS FOLLOWING FAST FLUSHING.....	57
6.2 REMOVAL OF PERMANGANATE PRIOR TO REBOUND PHASE	57
6.3 EFFECTIVE REBOUND MONITORING TO ASSESS POTENTIAL REMEDIAL PERFORMANCE.....	57
6.4 EASE OF IMPLEMENTATION	57
6.5 RECOMMENDED TESTING PROTOCOL	58
7.0 COST ASSESSMENT.....	59
7.1 COST MODEL.....	59
7.1.1 Capital Costs	59
7.1.2 O&M Costs	59
7.1.3 Demonstration-Specific Costs	61
7.2 COST DRIVERS	61
7.2.1 General Considerations.....	61
7.2.2 Competing Treatment Technologies.....	61
7.3 COST ANALYSIS	62
7.3.1 Base Cost Template	62
7.3.2 Rapid Assessment Approach	63
7.3.3 Bioremediation Recirculation Pilot Study	65
8.0 IMPLEMENTATION ISSUES	67
9.0 REFERENCES	69
APPENDIX A INITIAL RAPID ASSESSMENT TESTING AT NAWC.....	A-1

TABLE OF CONTENTS (Continued)

	Page
APPENDIX B BORING LOG FOR MW07-05R	B-1
APPENDIX C BORING LOG FOR MW07-46R	C-1
APPENDIX D BOREHOLE GEOPHYSICAL REPORT FOR MW07-46R	D-1
APPENDIX E HYDRAULIC TESTING AT CALF PASTURE POINT	E-1
APPENDIX F RAPID ASSESSMENT PROTOCOL	F-1

LIST OF FIGURES

	Page
Figure 2.1.	Illustration Showing Possible TCE Rebound Mechanisms in Fractured Bedrock. 4
Figure 2.2.	Diffusion of Permanganate into the Rock Matrix of a Tan Sandstone Collected from the Former Naval Air Warfare Center in Trenton, NJ (Huang et al., 2014).. 5
Figure 2.3.	Conceptual Methodology for the Rapid Assessment Testing..... 6
Figure 2.4.	Conceptual Model and Data Obtained by Our Research at Alameda Point. 9
Figure 4.1.	Demonstration Location at the NAWC Site. 17
Figure 4.2.	Demonstration Location at Calf Pasture Point..... 18
Figure 4.3.	Close-up View of the Demonstration Location at CPP. 19
Figure 4.4.	Cross-sectional View of the Demonstration Location at Calf Pasture Point. 21
Figure 5.1.	CPP Demonstration Area (circled), with Location of Newly Installed Borehole (MW07-46R) Identified (approximately 8 feet from existing well MW07-05R). 24
Figure 5.2.	Newly Installed Well MW07-46R Shown in Proximity to Existing Well MW07-05R..... 25
Figure 5.3.	Generalized Geologic Cross Section of the CPP Demonstration Area..... 27
Figure 5.4.	Increases in Bromide Concentration in the Deep Interval of MW07-46R as a Function of Volume Injected into MW07-05R..... 31
Figure 5.5.	Results from the Borehole Dilution Testing Performed in the Injection Well (MW07-05R)..... 33
Figure 5.6.	Linear Regression of the Bromide Data from the Borehole Dilution Test Performed at MW07-05R. 34
Figure 5.7.	Abiotic Dechlorination of TCE in the Bench Scale Batch Testing. 36
Figure 5.8.	Conceptual Model of Transport by Fracture Flow Coupled with Matrix Diffusion (showing upper half of symmetric problem). 42
Figure 5.9.	Chain of Custody Form..... 51
Figure 5.10.	TCE and DCE Concentrations Measured Throughout the RA Demonstration. ... 54
Figure 5.11.	Increases of TCE and DCE Relative to their Baseline (prior to rapid flushing) Levels during Rebound at MW07-46R-D..... 55
Figure 7.1.	Base Plume Characteristics..... 62
Figure 7.2.	Rapid Assessment Technology Approach 64
Figure 7.3.	Bioremediation Recirculation Pilot Study 66

LIST OF TABLES

	Page
Table 1.1. Federal Maximum Contaminant Levels and New Jersey / Rhode Island Groundwater Quality Standards.....	2
Table 3.1. Performance Objectives	11
Table 4.1. Site Selection Criteria. NAWC Was Selected as the Initial (screening) Site, and CPP Was Selected as the Primary Set for Detailed Assessment.	16
Table 5.1. cVOC Concentrations Measured in Groundwater during the March 2015 Pump Testing at MW07-46R and MW07-05R.	29
Table 5.2. Timeline of CPP Field Operations.....	38
Table 5.3. Model Parameters Used for the CPP Site.	45
Table 5.4. Analytical Methods, Preservation, and Containers -Groundwater	47
Table 5.5. Total Number and Types of Samples Collected During RA Testing	48
Table 5.6. Chlorinated Solvent and Anion Levels Present in Groundwater during the April 4, 2016 Baseline Sampling at MW07-46R and MW07-05R.	53
Table 5.7. CSIA Baseline Data ($\delta^{13}\text{C}$).	53
Table 5.8. CSIA Results for TCE and DCE.....	56
Table 7.1. Demonstration Cost Components	60
Table 7.2. Summary of Base Case Site Characteristics and Design Parameters	63
Table 7.3. Cost Estimates for Treatment Approaches	65
Table 7.4. Summary of Costs for Treatment Alternatives	66

ACRONYMS AND ABBREVIATIONS

$\mu\text{g/L}$	micrograms per liter
μM	micromolar
AFB	Air Force Base
AFP	Air Force Plant
As	Arsenic
ASTM	American Society for Testing and Materials
bgs	below ground surface
$^{\circ}\text{C}$	degrees Celsius
^{13}C	A stable isotope of carbon with a nucleus containing six protons and seven neutrons
CB&I	Chicago Bridge and Iron Federal Services
cm	centimeter(s)
cm^2	square centimeter(s)
cm^3	cubic centimeters
cm^3/min	cubic centimeters per minute
cm^2/s	square centimeters per second
CO_2	carbon dioxide
COC	Chain of Custody
CPP	Calf Pasture Point
CSIA	Compound Specific Isotope Analysis
cVOC	Chlorinated Volatile Organic Compound
d	day(s)
DCE	<i>cis</i> -1,2-Dichloroethene
DHC	<i>Dehalococcoides</i> sp.
DNAPL	Dense Non-Aqueous Phase Liquid
DoD	U.S. Department of Defense
DOT	U.S. Department of Transportation
ESTCP	Environmental Security Technology Certification Program
EVO	Emulsified Vegetable Oil
Fe	Iron
ft	foot or feet
g	gram(s)
GC-FID	Gas Chromatography-Flame Ionization Detector
GWQS	Ground Water Quality Standards
h	hour(s)
HCl	hydrochloric acid
HgCl_2	mercuric chloride

HNO₃ nitric acid

ID Site identification
IDW Investigation Derived Waste
IPR In-Progress Review

kg kilogram

L liter(s)
LNAPL Light Non-Aqueous Phase Liquid

MCL Maximum Contaminant Level
mg/L milligrams per liter
min minute(s)
mL milliliters
mL/min milliliters per minute
MLS multi-level sampling
Mn Manganese
MNA Monitored Natural Attenuation

NaBr sodium bromide
NAWC Naval Air Warfare Center
NCBC Naval Construction Battalion Center
NJDEP New Jersey Department of Environmental Protection
NPV Net Present Value

O&M Operation and Maintenance
OU Operable Unit

PCE Tetrachloroethene
PFM passive flux meter
PPE Personal protective equipment

QA Quality Assurance
QC Quality Control
QED QED Environmental Systems
qPCR Polymerase Chain Reaction

RDG Reductive Dehalogenase Genes
RQD Rock Quality Designation

SEM Scanning electron microscopy
SERDP Strategic Environmental Research and Development Program
SO₄⁻ Sulfate
SOP Standard Operating Procedure

TCA 1,1,1-Trichloroethane
TCE Trichloroethene
TCL Target Compound List
tDCE *trans*-1,2,-dichloroethene
TeCA 1,1,2,2-Tetrachloroethane

USEPA/EPA U.S. Environmental Protection Agency
USGS United States Geological Survey

VC Vinyl Chloride
VFA Volatile Fatty Acid
VOA Volatile Organic Analysis
VOC Volatile Organic Compound

Page Intentionally Left Blank

ACKNOWLEDGEMENTS

We wish to thank the environmental staff at both the Naval Air Warfare Center (Trenton, NJ) and Calf Pasture Point (RI) for their support during this demonstration. In particular, special thanks to Jeffrey Dale, Naval Facilities Engineering Command, for his support of the project, and Pierre LaCombe at the USGS for assistance at the Naval Air Warfare Center. We wish to thank ESTCP for their financial support, and Dr. Andrea Leeson, the Environmental Restoration Program Manager at ESTCP, for her guidance. We would also like to thank Mr. Robert Shoemaker at AECOM for his on-sight logistical support during the demonstration at Calf Pasture Point. Finally, we wish to acknowledge the capable staff at CB&I that conducted site assessment, performed laboratory studies, and provided analytical support and data management.

Page Intentionally Left Blank

EXECUTIVE SUMMARY

Fractured rock sites impacted, with chlorinated solvents such as tetrachloroethene (PCE) or trichloroethene (TCE), remain a significant environmental challenge for the Department of Defense. Efforts to apply *in situ* remedial technologies, such as chemical oxidation or bioaugmentation, have often proved challenging and/or unsuccessful with respect to attaining remedial objectives in fractured rock aquifers. This is because contaminant rebound typically is observed due to processes such as DNAPL dissolution, matrix back-diffusion, and/or release of contaminants from low permeability/bypassed fracture zones. Unfortunately, recognition that these remedial technologies are ineffective is typically not realized until after substantial time and resources have been expended via *in situ* pilot testing, and the mechanism(s) controlling the observed contaminant rebound often remain unidentified. This lack of understanding in the conceptual site model hinders effective site management, particularly with respect to designing an appropriate remedial approach and identifying the practical limits of remediation.

In this project, a rapid assessment (RA) protocol is developed to assess the potential effectiveness of *in situ* treatment such as chemical oxidation or bioaugmentation. The RA protocol is intended to assess chlorinated ethene rebound, the potential of naturally occurring dechlorination reactions in low permeability zones, and remedial effectiveness using a pair of closely spaced bedrock wells. The RA technique involves identifying hydraulically conductive fracture zones, flushing contaminant from the fracture zones using water, then evaluating contaminant rebound within this zone while hydraulically isolating the zone from the surrounding contaminated aquifer (thereby preventing re-introduction of dissolved contaminant from the surrounding aquifer). The rate, composition, and isotopic signature of contaminant rebound is then used to evaluate the limits of remedial effectiveness, identify the local source/cause of any observed rebound, and provide improvement to the site conceptual model.

The demonstration of the RA protocol was performed in shallow bedrock at Calf Pasture Point in Rhode Island, where TCE was the primary groundwater contaminant. While nearly 99% of the TCE was removed from the conductive fracture zone during the initial flushing, substantial contaminant rebound (up to approximately 5% of the baseline TCE concentration) was observed over the ensuing 5-month rebound period. The rate and extent of observed contaminant rebound was reasonably described using a matrix back-diffusion model, thus serving as a line of evidence that the observed rebound was due to matrix back-diffusion. The back-diffusion model further predicts that over a decade of treatment likely would be needed to reduce TCE concentrations by 99% in the conductive fractures.

In addition to the back-diffusion model, compound specific isotope analysis (CSIA) on carbon for TCE and *cis*-1,2-dichloroethene (DCE) further confirmed the source of the observed rebound. The molar-average sum of TCE+DCE was isotopically (^{13}C) heavier at the end of rebound than at baseline conditions, thereby indicating that the “source” of the observed rebound could not be explained by any migration of contaminants from upgradient. The isotopic shift was consistent with TCE and DCE that had undergone abiotic dechlorination in the rock matrix; abiotic dechlorination of TCE in the rock matrix was confirmed in a separate bench-scale batch test using collected rock core. Thus, the CSIA testing not only served as a line of evidence demonstrating that the rock matrix was the source of the observed rebound, but also served as a useful tool for confirming that abiotic dechlorination of TCE and DCE were occurring within the rock matrix.

Page Intentionally Left Blank

1.0 INTRODUCTION

1.1 BACKGROUND

Management and remediation of fractured bedrock aquifers impacted with chlorinated solvents such as tetrachloroethene (PCE) and trichloroethene (TCE) are among the most pressing environmental challenges facing the Department of Defense (DoD). The DoD has a multitude of chlorinated solvent impacted bedrock sites, including Loring Air Force Base (AFB), Pease AFB, Edwards AFB, Air Force Plant 4 (AFP4), Anniston Army Depot, and the Tyson Valley Powder Farm facility. The challenges associated with management and remediation of fractured rock sites are due to a combination of the complex fracture flow field, uncertainties associated with contaminant distribution among fractures, microfractures, and the rock matrix, and ultimately the difficulties with understanding these complexities as they relate to remedial impacts on both short and long term groundwater quality. The costs associated with drilling, testing, and monitoring in fractured bedrock systems also contribute to the challenges of these systems. In many instances, the extent of investigation and monitoring needed to select, design, and assess a remedial technology is not performed due to limitations in resources, time, and/or availability of demonstrated tools and techniques.

The difficulties associated with addressing chlorinated solvents in fractured bedrock often are most realized when attempting to assess remedial performance, and when trying to determine if a selected remedial approach will be sufficient for attaining target groundwater concentrations. Several laboratory and field scale studies have demonstrated that there are several mechanisms present in fractured rock systems that can inhibit attainment of remedial goals within target timeframes, with contaminant persistence and rebound often frustrating remedial efforts. Often the failure of selected remedial approaches and the extent of rebound caused by the various mass transfer and flow mechanisms indigenous to fractured bedrock aquifers are not recognized or confirmed until after significant resources have been allocated to the project. It is quite common to see pilot or even full scale testing that takes several months to years to assess, often with multiple rounds of amendment injection and extensive monitoring. It is only after these efforts that the mass transfer mechanisms that impeded attainment of groundwater remedial goals are recognized and quantified.

While such failures in fractured rock systems are well documented and not uncommon, successful implementation of remedial technologies in fractured rock systems have occurred. One example includes Site 49 Operable Unit 1 (OU1) at Edwards AFB (Hansen et al., 2004). Thus, it becomes imperative to determine methods to rapidly assess potential remedial performance of a selected technology at fractured rock sites so that determination can be made at early stages as to whether or not the technology will be effective for attainment of remedial goals. In addition, a rapid remedial assessment technique is needed to rapidly determine what target groundwater contaminant levels are attainable within a reasonable treatment timeframe, considering the potential for post-treatment rebound.

Currently, a demonstrated and verified methodology for the rapid assessment (RA) of a remedial technology in fractured bedrock does not exist. Due to the complexities associated with bedrock systems, relationships between mass removal, groundwater quality, treatment quantity and timeframe, and the potential for post treatment rebound are not well understood, resulting in

prolonged pilot tests that often are unsuccessful and costly. Thus, demonstrating a methodology and developing a protocol to rapidly assess the extent to which an in situ remedial technology (e.g., bioremediation, chemical oxidation) can impact groundwater quality will serve as a useful tool to the DoD and its stakeholders.

1.2 OBJECTIVE OF THE DEMONSTRATION

The overall goal of this project was to develop and evaluate the use of a novel “Rapid Assessment” remedial evaluation technique, coupled with compound specific isotope analysis (CSIA), for use as a rapid and cost-effective means to assess the limits of *in situ* fractured bedrock remediation on long-term groundwater quality. Specifically, the objective was to develop a relatively small scale field testing approach and protocol for assessing the practical extent of remedial effectiveness that might be obtained by implementing *in situ* remedial technologies in fractured bedrock such as biostimulation/bioaugmentation and chemical oxidation. This demonstration was performed at two different sites: the former Naval Air Warfare Center (NAWC) in Trenton, New Jersey and the former Naval Construction Battalion Center (NCBC) Davisville (Site 07 - Calf Pasture Point) in North Kingston, Rhode Island. *The NAWC site was used as a preliminary test site to develop the methodology, while the Calf Pasture Point (CPP) site was used for more quantitative purposes and to fully evaluate the RA testing protocol.*

1.3 REGULATORY DRIVERS

TCE, along with its reductive dechlorination daughter products *cis*-1,2-dichloroethene (DCE), and vinyl chloride (VC), are regulated in drinking and ground water by both the U.S. Environmental Protection Agency (USEPA) and the states of New Jersey and Rhode Island. The applicable groundwater standards are provided in Table 1.1.

Expected TCE concentrations in the treatment areas are up to 3 orders of magnitude above both state and federal regulatory levels. TCE groundwater concentrations at the NAWC demonstration area are present up to 2,000 µg/L, while TCE concentrations at Calf Pasture Point are present up to approximately 5,000 µg/L. It is significant to note that partial dechlorination of TCE, resulting in near-stoichiometric accumulation of either DCE and/or VC, would result in regulatory exceedences of these compounds as well.

Table 1.1. Federal Maximum Contaminant Levels and New Jersey / Rhode Island Groundwater Quality Standards

Constituents	USEPA MCL (µg/L)	New Jersey GWQS (µg/L)	Rhode Island GWQS (µg/L)
Trichloroethene (TCE)	5	1	5
<i>cis</i> -1,2-dichloroethene (DCE)	70	70	70
Vinyl Chloride (VC)	2	1	2

2.0 TECHNOLOGY

2.1 TECHNOLOGY DESCRIPTION

2.1.1 Background – Contaminant Rebound

Although many technologies have been shown to be effective for reducing dissolved chlorinated solvent concentrations in bedrock during active treatment, contaminant rebound following active treatment has resulted (in many instances) in non-attainment of remedial objectives. For example, Schaefer et al. (2012) showed in bench-scale studies using chemical oxidants that residual DNAPL resulted in substantial rebound of PCE to near pre-treatment levels in fractured sandstone blocks. Kauffman et al. (2006) showed that substantial rebound in chlorinated solvents occurred following a field demonstration of chemical oxidation; the rebound was attributed to back diffusion from low permeability fractures and fracture zones. Another example of chlorinated solvent rebound in fractured bedrock aquifers was the rebound in carbon tetrachloride concentrations that was observed following injection of a chemical oxidant into fractured bedrock at Lowry AFB (<http://www.lowryafbcleanup.com/lowrymainplume.html>). While a substantial reduction in dissolved concentrations initially was observed at Lowry AFB, dissolved concentrations rebounded to near pre-injection levels.

The studies and sites listed above exemplify the challenges associated with contaminant rebound in fractured bedrock, as in all cases chlorinated solvent concentrations rebounded to near pre-treatment levels. At other sites, remedial amendment injection may be useful for attaining a substantial reduction in dissolved contaminant concentrations, but mass transfer controlled processes may prevent attainment of remedial goals by sustaining groundwater concentrations at levels above MCLs, thereby preventing site closure or a final monitored natural attenuation (MNA) remedy.

There are many mechanisms that can contribute to contaminant rebound and sustained groundwater impacts in fractured bedrock aquifers. As illustrated in Figure 2.1 on the following page, these mechanisms include matrix back diffusion (Lipson et al., 2005; Sterling et al., 2005; West and Kueper, 2010), slow migration of contaminants from small or microfractures (USEPA, 2006), and/or the presence of DNAPL (Schaefer et al., 2012). For many sites, it is difficult to determine which of these mechanisms is responsible for the observed rebound (if rebound occurs), as the complexities associated with the flow field, aperture distribution, and contaminant distribution within the bedrock aquifer are difficult to quantify. Furthermore, many pilot tests are impacted from upgradient sources that migrate into the treatment area prior to evaluating rebound mechanisms, thereby preventing proper assessment of rebound during the post-injection period of the pilot test. The ability to isolate the treatment area to eliminate upgradient impacts would improve the ability to assess remedial effectiveness during pilot tests. However, approaches for comprehensively and cost effectively characterizing fractured bedrock aquifers to quantify these impacts have hitherto not been demonstrated.

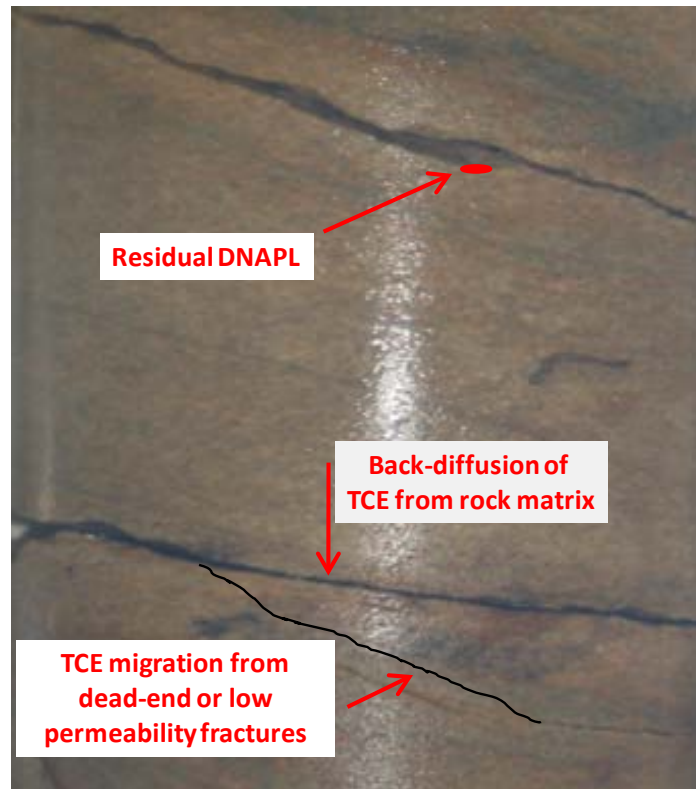

Figure 2.1. Illustration Showing Possible TCE Rebound Mechanisms in Fractured Bedrock.

In situ chemical oxidation and bioremediation are remedial technologies that have frequently been tested in fractured bedrock aquifers to assess their potential for full scale treatment. As part of our previous SERDP Project (ER-1685), we have shown that chemical oxidant are ineffective for treating contaminant mass present in the rock matrix, as the oxidant was shown to migrate only a few hundred microns into the rock matrix (Figure 2.2; Huang et al., 2014). Methodologies for pilot tests have, in general terms, typically consisted of injection of amendments over an areal extent of the plume or source area, followed by monitoring in a set of monitoring wells to determine amendment distribution and the extent of reaction. In many cases, the reason for the contaminant rebound that was observed was unclear, which resulted in additional rounds of amendment injection and further rebound monitoring. Based on the duration of the testing, the number of monitoring points, and the amendment injection volumes, the resources allocated to the remedial assessment often have been substantial, often with inconclusive results. Thus, tools and protocols are needed to provide a cost effective and rapid assessment of the potential for contaminant rebound.

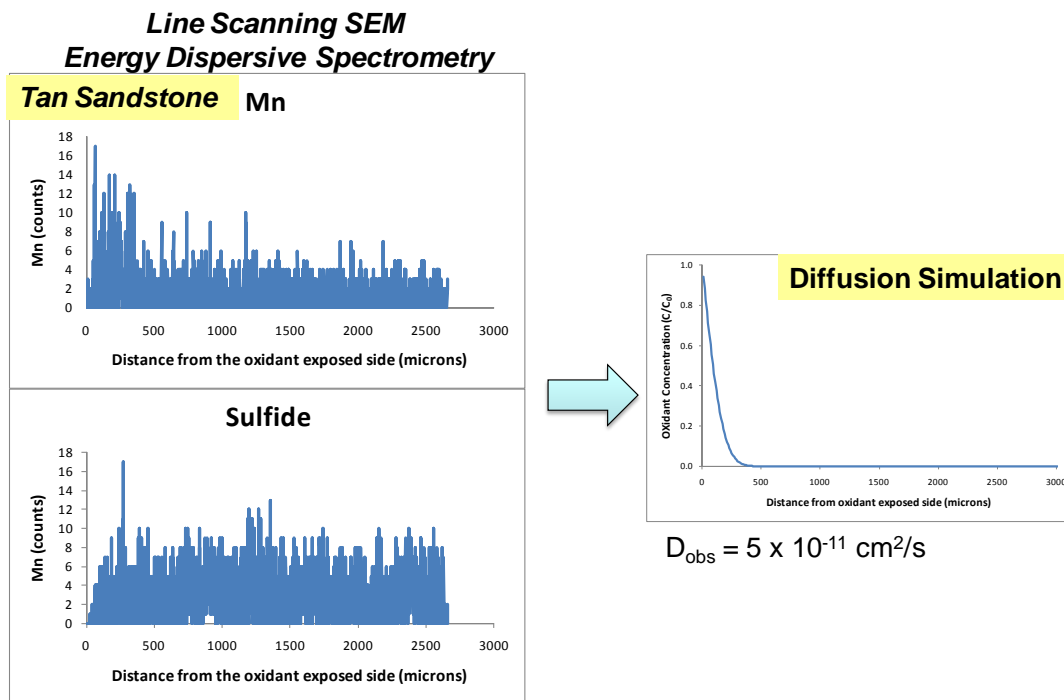

Figure 2.2. Diffusion of Permanganate into the Rock Matrix of a Tan Sandstone Collected from the Former Naval Air Warfare Center in Trenton, NJ (Huang et al., 2014).

Permanganate was in contact with the rock for 20 days. Line scanning SEM, which was able to show the diffusion profile via Mn deposition and sulfide depletion, showed that the oxidant migrated less than 400 microns into the rock. The observed diffusion coefficient was $5 \times 10^{-11} \text{ cm}^2/\text{s}$.

2.1.2 Overall Approach for Rapidly Assessing Treatment

A demonstration of a novel RA technique, coupled with the use of a multilevel sampling well and CSIA, was employed for use as a rapid and cost-effective means to assess the limits of *in situ* remediation in fractured rock systems. The proposed rapid assessment methodology is an adapted technique that is a hybrid of conventional push-pull tests coupled with our flushing and high-resolution sampling technique employed at Alameda Point (in conjunction with SERDP Project ER-1613). The overall approach is to rapidly remove TCE in conductive fractures in or near the source area, then measure the rate and extent of contaminant rebound after oxidant removal. This technique is best suited for source areas where substantial DNAPL is not present, as significant levels of DNAPL in the fractures might inhibit rapid treatment of TCE in the conductive fractures. However, the presence of residual DNAPL in low permeability regions (or, the low DNAPL levels measured as part of our recently completed ESTCP Project ER-201210) is acceptable for this testing. By limiting this testing to a relatively small region within the site, but by performing intensive and monitoring with high resolution, remedial limits and potential rebound can be assessed in a relatively short timeframe, and with minimal costs compared to conventional pilot test approaches.

A conceptual diagram of the process is provided in Figure 2.3. The RA technique involves the use of two wells: a standard injection well and a multi-level sampling (MLS) well located approximately 5 to 10 feet downgradient of the injection well. In the first step of the test, either a chemical oxidant (e.g., permanganate) or uncontaminated water is injected into the injection well to rapidly remove PCE/TCE from the hydraulically conductive fractures. For the NAWC site, permanganate was used, where the permanganate was injected and allowed to incubate for several weeks prior to subsequent water injection to remove the permanganate. However, due to the difficulties associated with the oxidant, water flushing only was used in the subsequent test performed at CPP, as illustrated in Figure 2.3. This initial step of removing the chlorinated solvents from the hydraulically conductive fractures is the first injection phase of the test.

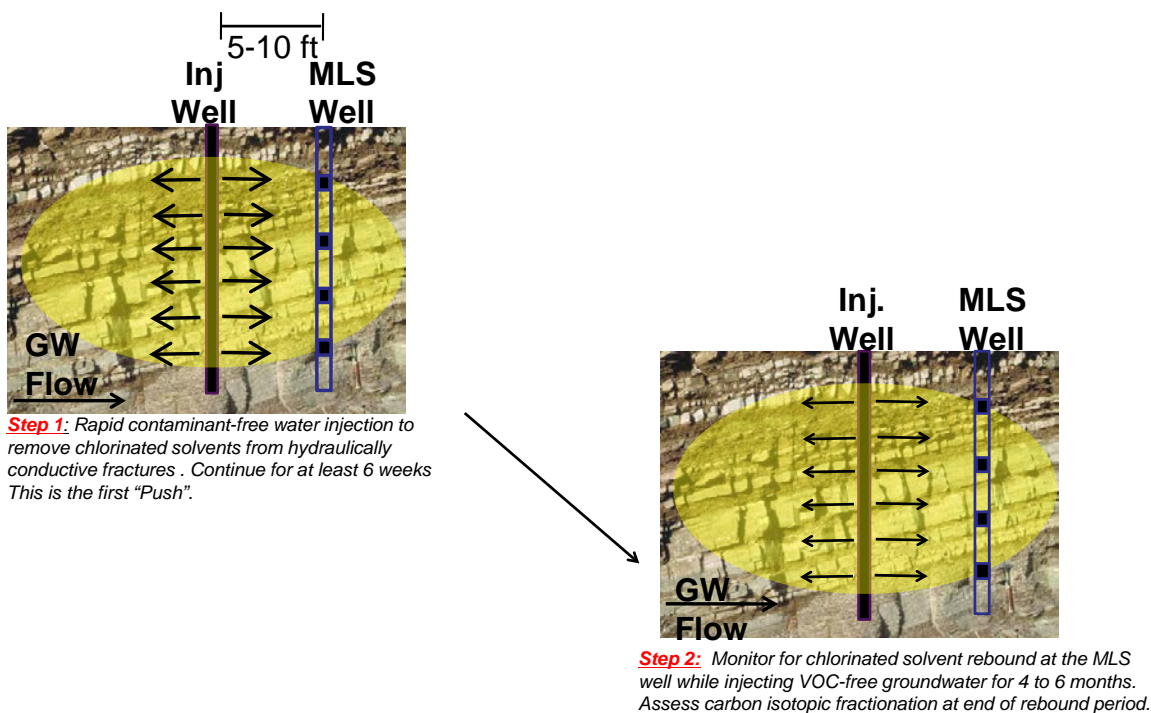

Figure 2.3. Conceptual Methodology for the Rapid Assessment Testing.

For simplicity of illustration, flow a simplified homogeneous flow regime is shown. The distance between the injection and MLS well may be increased depending upon the groundwater velocity, fracture connectivity, and fracture porosity. Initial efforts at NAWC employed the use of permanganate for step 1, where the permanganate was allowed to incubate in the fractures for several weeks prior to removal via water flushing.

After removal of the chlorinated solvents, non-contaminated water was slowly injected into the injection well at a rate sufficient to prevent upgradient chlorinated solvent contaminated groundwater from impacting the MLS well. However, the injection rate was limited so that the resulting groundwater velocity through the MLS well was only approximately 2- times greater than the ambient groundwater velocity, thereby limiting dilution effects.

Chlorinated solvent concentrations were monitored in the MLS well to assess the extent of rebound during the slow injection of clean water into the injection well. Testing continued for up to 5 months. At the end of the rebound, CSIA analyses was performed on the carbon isotopes for the chlorinated ethenes that were present. The changes in isotopic ratio, coupled with the observed contaminant rebound, provided information regarding rebound mechanisms, and the potential benefits of additional remedial amendment injection or contact time on groundwater quality. A more detailed discussion of the data interpretation during rebound, and the insights provided by CSIA, are provided in Section 5.8.

The 5 to 10 ft length scale of the RA approach balance the ability to ensure flow connectedness and relevant scale. The appropriateness and effectiveness of this length scale will likely vary for each site, and will be a function of the complexity of the geology and fracture flow field. For fractured rock sites where the length scale of the RA, due to complexity of the fracture flow field, is insufficient representative general site conditions, multiple RA tests (using multiple well pairs) may be required.

2.2 TECHNOLOGY DEVELOPMENT

2.2.1 Monitoring and Assessment Tools

Detailed understanding of the permeability field, coupled with both the contaminant and amendment distribution, often can provide useful insight into the potential for contaminant rebound and ultimately the time needed to attain remedial goals. To assess the effectiveness of *in situ* remedial technologies with respect to their distribution and contaminant mass removal, several tools have been developed and implemented. High resolution vertical multi-level sampling wells have shown to be very useful for understanding amendment and mass distribution in heterogeneous systems (Smith et al., 1991; Thomson et al., 2007). Such data often can be used to demonstrate the potential for rebound, particularly for cases when contaminants are not well contacted by remedial amendments. Similarly, the use of passive flux meters (PFMs), which allow for a high resolution vertical profile of both the hydraulic and contaminant fluxes, have proven to be useful in developing conceptual models of the flow field and contaminant distribution that can be used to assess remedial effectiveness and potential for rebound following treatment (Annable et al., 2005). Collection of soil or rock cores, with subsequent high density sampling to determine contaminant concentrations within the core relative to the apparent permeability field (as observed based on soil texture or the presence of conductive fractures), also has been used a means to assess the potential for rebound and overall remedial effectiveness (Chapman and Parker, 2005).

CSIA has become a useful tool for evaluating treatment effectiveness, and for identifying where amendment reactions (chemical or biological) with contaminants are occurring (Morrill et al., 2009; Hunkeler et al., 2011). Identification of reactive zones via CSIA relative to the permeability field and contaminant distribution can be a powerful tool for assessing the extent to which contaminant rebound might occur following treatment.

2.2.2 Rapid Assessment Testing

Several researchers have employed the use of “Push-Pull” tests to assess mass transfer in subsurface systems (Haggerty et al., 2001; Istok et al., 2002; Singha et al., 2007; Doughty, 2010). Push-Pull tests typically involve injection of tracers and/or other amendments to assess hydraulic, physical, and/or biochemical properties of the aquifer in the vicinity of the injection well. This injection is the “push” portion of the test. After a measured incubation period, groundwater is then extracted from the same well (the “pull” portion of the test). Extracted groundwater is analyzed to assess the fate and transport of injected amendments and/or any changes to the dissolved contaminants.

While the majority of Push-Pull testing has been performed in unconsolidated media, this approach has been successfully applied in fractured bedrock. Doughty (2010) used a series of push-pull tests to assess the impacts of solute diffusion and sorption in rock matrices. Haggerty et al. (2001) used push-pull tests to assess mass transfer in fractured dolomite, noting that diffusion length scales may substantially impact solute tailing. By extension, each of these studies suggest that such testing could be useful in assessing the potential for contaminant rebound due to back-diffusion following remedial treatment.

2.2.3 Assessment of Rebound – Alameda Point, CA

Our field research at Alameda Point, CA (in cooperation with SERDP Project ER-1613) focused on evaluating DNAPL architecture and dissolved flux from a DNAPL source area in *overburden materials*. The overall goal was to attain an understanding of the dissolution behavior, including rebound and mass transfer from low permeability regions, so that an effective remedial strategy can be designed and implemented. This project is discussed herein because our findings relate to the development of our proposed rapid assessment approach.

At Alameda Point, we employed the use of MLS wells and recirculation of “clean” groundwater through the DNAPL source area to assess dissolution and rebound. Our results have shown that information collected from a single MLS well along with the dissolution and rebound information obtained during and after recirculating the clean groundwater have provided essential information that has led to development of a site conceptual model. The conceptual model and key results are illustrated in Figure 2.4, and in a recent publication (Wang et al., 2014).

The information obtained from the testing approach at Alameda Point could not be attained from a conventional pilot study approach. The generalized approach used at Alameda Point serves, in part, as the basis for the RA approach proposed for fractured bedrock systems.

While the tools and approaches described in the previous sections have been shown to be useful for understanding mass transfer and reaction processes at the field scale, a demonstrated assessment approach and protocol has yet to be developed for attainment of a rapid and cost-effective means to assess the limits of *in situ* remediation on long-term groundwater quality in fractured bedrock. Our RA approach and corresponding protocol, which were built upon the tools described above, provide such an assessment approach.

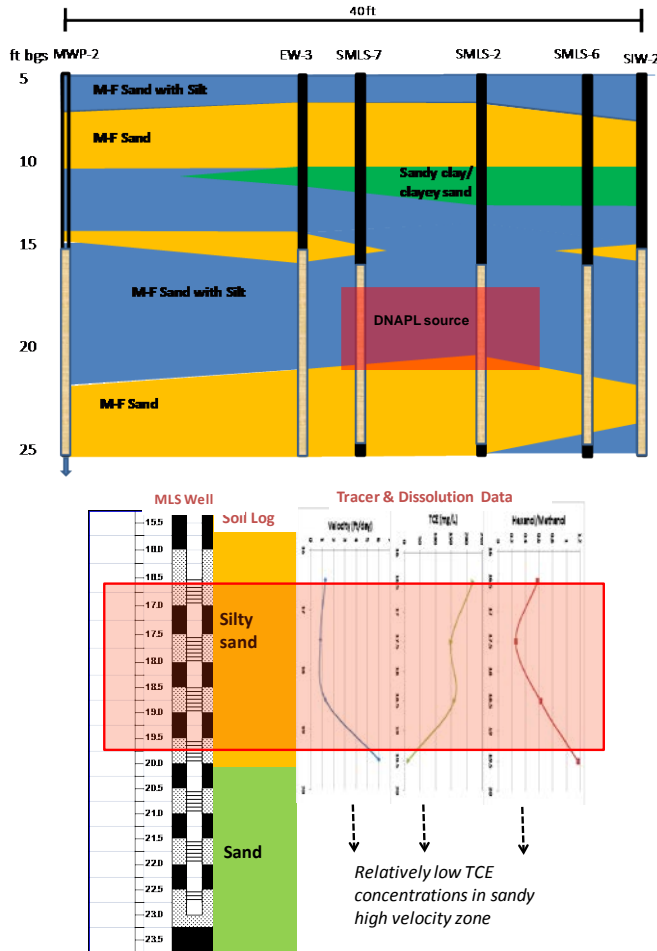

Conceptual cross section showing the TCE DNAPL source area at Alameda. Clean groundwater was recirculated through the system to enhance DNAPL dissolution using the injection and extraction wells that bounded the DNAPL source. Groundwater was passed through carbon to ensure that TCE-free groundwater was re-injected.

Using data from a single MLS well, along with results from conservative and partitioning tracer tests, a conceptual model for the system could be developed. DNAPL sources were located in the low flow zone, as indicated by tracer partitioning (low ratio of hexanol to methanol). Use of the MLS wells allowed the impacts of DNAPL dissolution on groundwater quality to be quantified, as VOC rebound was observed following recirculation.

Figure 2.4. Conceptual Model and Data Obtained by Our Research at Alameda Point.

Note that the use of the MLS well indicated that the groundwater velocity was much less, but the dissolved TCE concentrations were much greater, in the low permeability silty sand zone than in the underlying sand zone. The partitioning tracer test verified that DNAPL existed in the silty sand zone, which caused rebound in the sandy zone after the water flushing was completed. This work was performed with Professor Mike Annable as part of SERDP Project ER-1613.

2.3 ADVANTAGES AND LIMITATIONS OF THE TECHNOLOGY

2.3.1 Advantages

The primary advantages of developing the proposed assessment approach are as follows:

1. Limits to remedial success via *in situ* technologies such as biostimulation/bioaugmentation, chemical oxidation, and *in situ* chemical reduction will be identified early in the remedial evaluation process, and the potential for contaminant rebound will be assessed without the need for long term and costly testing;
2. Ability to attain improved insight into the causes and mechanisms of rebound;

3. Performance of a field pilot demonstration using minimal resources (e.g., minimal well installations), while still answering the critical question as to the implementability and overall effectiveness of the in situ rapid assessment technique.

In addition, by limiting this testing to a relatively small region within the site, but by performing intensive monitoring with high resolution, we expect that remedial limits and potential rebound can be assessed in a short timeframe, and with minimal costs compared to conventional pilot test approaches.

2.3.2 Limitations

As with all technologies, there are also limitations with the proposed assessment approach:

1. Understanding the natural flow field in fractured rock can be challenging. Use of closely spaced wells coupled with intensive geophysical characterization can mitigate this limitation.
2. Fractures with a very high linear velocity would require large injection volume (oxidant or water), thereby likely making application of the technology impractical.
3. Fractured rock sites with multiple geologic units will likely require multiple RA tests to provide the necessary information.

3.0 PERFORMANCE OBJECTIVES

Performance objectives are summarized in Table 3.1, and details are provided in Sections 3.1-3.3.

Table 3.1. Performance Objectives

Performance Objective	Data Requirements	Success Criteria	Results
Quantitative Performance Objectives			
Substantial decreases in chlorinated solvent concentrations during the initial fast flushing	Measured TCE/DCE concentrations in discrete intervals before and during fast water flushing or oxidant delivery	>99% reduction in TCE and DCE concentration in the monitoring well prior to initiation of the rebound period	At least 98.6% reduction was achieved at each site
Removal of permanganate from conductive fractures during the start of the rebound phase	Measured permanganate concentrations during the rebound phase (during the second slow injection phase)	Permanganate concentrations less than 5 mg/L	Achieved at NAWC (permanganate not used at CPP)
Effective monitoring of rebound during the second slow injection phase to assess remedial performance	Measured TCE/DCE concentrations in the discrete intervals, and CSIA values	Quantitative interpretation of the rebound data, as discussed in detail in Section 5.8	Attained for CPP (challenges are discussed for NAWC)
Qualitative Performance Objectives			
Ease of Implementation	Time needed to maintain system during testing Feedback from field technician	Fouling due to oxidant byproducts Effectiveness of packer system Minimal costs	Use of permanganate was discontinued, and determining the fracture flow field was the greatest challenge

3.1 SUBSTANTIAL DECREASES IN CHLORINATED SOLVENT CONCENTRATIONS DURING THE INITIAL RAPID FLUSHING

The ability to access rebound (or lack thereof) during this test hinged on substantially decreasing dissolved TCE/DCE concentrations in conductive fractures during the initial phase of testing, whether the initial phase of testing was rapid water flushing (CPP site) or permanganate injection (NAWC site).

3.1.1 Data Requirements for TCE Removal

During the initial rapid flushing, TCE (and other organic contaminants present) concentrations were periodically measured in the MLS well. These concentrations will be compared to baseline (pre-injection) levels.

3.1.2 Success Criteria for TCE/DCE Removal

The objective for TCE/DCE removal was 99% prior to the rebound (during the second phase of slow injections, as shown in Figure 2.3) phase of the test.

3.1.3 Results for TCE/DCE Removal

This result was readily attained at the NAWC site where permanganate injection was employed. At CPP, the success criterion was effectively reached (98.6%). It is noted that direct water injection into the MLS well was performed to expedite the water flushing. As discussed in Section XX, complexities in the fracture flow field proved to be challenging and prolonged the time needed for flushing.

3.2 REMOVAL OF PERMANGANATE FROM CONDUCTIVE FRACTURES DURING THE START OF THE REBOUND PHASE

Following oxidant treatment at NAWC, injected water (containing no volatile organic carbon (VOC)) was used to remove any un-reacted permanganate from conductive fractures within the treatment zone. This step is critical, as any residual permanganate in the conductive fractures could mask TCE rebound.

3.2.1 Data Requirements for Permanganate Removal

Following injections to flush the TCE/DCE from the system, periodic groundwater samples were collected from the multi-level sampling well to verify permanganate removal.

3.2.2 Success Criteria for Permanganate Removal

The success criterion for removal of permanganate was less than 5 milligrams per liter (mg/L) in conductive fractures. *NOTE: This criterion only applied to the NAWC site, since permanganate was not used at CPP.*

3.2.3 Results for Permanganate Removal

This success criterion for removal of permanganate achieved at the NAWC site, although permanganate concentrations were observed at approximately 6 mg/L at two of the rebound monitoring events. In addition, as discussed in Appendix A, the permanganate was not readily flushed from demonstration area, which is one of the reasons why permanganate was not used at CPP.

3.3 EFFECTIVE MONITORING OF REBOUND DURING THE SECOND PHASE OF INJECTION (SLOW FLUSHING) TO ASSESS REMEDIAL PERFORMANCE

Following TCE/DCE removal via water flushing or permanganate injection, VOC rebound and changes in TCE/DCE carbon isotopic signature compared to baseline were monitored. These data were used to determine the extent and rate of rebound, and the extent to which *in situ* treatment could be effective.

3.3.1 Data Requirements for Rebound Monitoring

During the rebound phases, periodic groundwater samples were collected from the MLS well to measure increases in VOCs and changes in isotopic signature from baseline (using CSIA carbon analysis).

3.3.2 Success Criteria for Rebound Monitoring

While it is not possible to give a specific success criterion for this evaluation, success will be based on our ability to interpret that data using the approaches described in Section 5.8.

3.3.3 Results for Rebound Monitoring

While difficulties associated with permanganate hindered assessment of chlorinated solvent rebound at NAWC, results from CPP provided detailed insight into the rebound mechanism.

3.4 EASE OF IMPLEMENTATION

The level of effort needed to implement the RA test was used to determine, in part, the plausibility of this approach as an effective and efficient means to rapidly assess contaminant rebound in fractured rock, and to gain insight into the practical limits of treatment effectiveness.

3.4.1 Data Requirements to Assess Ease of Implementation

Information such as required labor time, effort needed to install and utilize the packer system, and effort needed to mitigate upgradient impacts was considered when assessing the overall ease of implementation of this approach.

3.4.2 Success Criteria for Ease of Implementation

The success criteria are qualitative, but the level of effort was compared (to the extent possible) to other pilot testing approaches with respect to time, resources, and effectiveness.

3.4.3 Results for Ease of Implementation

Results showed that the testing approach was readily implementable, and could be performed with significantly less resources than conventional pilot testing approaches. The primary challenges were:

- The use of permanganate, which was discontinued for the testing at CPP; and
- Complexities associated with the fracture flow field, as flow paths between the injection and MLS wells could not be readily predicted.

Page Intentionally Left Blank

4.0 SITE DESCRIPTION

4.1 SITE SELECTION

Two bedrock sites were selected for the RA demonstration. Site selection was performed by first attaining a list of potential sites with known PCE or TCE contamination in fractured rock. This list, which was developed during the proposal phase of the project, was further developed based on the PI's experience at DoD sites, a literature review, and by discussions with site contractors, regulators, and DoD personnel. The list of sites that was initially screened with respect to suitability for this project included: the former Naval Air Warfare Center (NAWC), Pease AFB (Site 32 source area), Loring AFB (GMZ4 Quarry area), AFP4 (Landfill 3 area), AFP6 (Building B-76 area), Edwards AFB (Site 37 source area, which is part of the South Air Force Research Laboratory), and Calf Pasture Point (which is part of the Northern Division Naval Construction Battalion Center (NCBC, Site 07) (RI). Of these sites, AFP6 was excluded because of the depth to bedrock (~170 ft) and due to the planned implementation of *in situ* chemical oxidation. Pease AFB was excluded because of there is an ongoing groundwater extraction system impacting shallow bedrock and TCE concentrations are relatively low. Loring AFB was excluded due to site access issues, as often the site is inaccessible due to snow. The site selection criteria for which the remaining 4 sites (NAWC, Edwards AFB, AFP4, and NCBC) were evaluated included the following:

- DCE, TCE or PCE concentration >500 µg/L
- Shallow depth to saturated bedrock (<100 feet below ground surface (ft bgs))
- Low natural oxidant demand (<25 grams per kilogram (g/kg))
- No mobile product
- Conductive fractures (>10⁻⁴ ft/day)
- Well-connected network of conductive fractures
- Presence of existing monitoring wells and site data
- Site accessibility
- Location relative to CB&I offices

Because of the substantial costs associated with implementing a bedrock investigation, particular care and attention were given to the site selection phase of this ESTCP project. Applying the Site Selection Criteria to CPP, NAWC, AFP4, and Edwards AFB, and ranking each site with respect to attainment of each of these criteria, Table 4.1 below provides an overall assessment of site suitability. Based on the overall ranking, NAWC and CPP are the most suitable locations for this demonstration. Thus, NAWC and CPP are the two selected sites for the demonstration. The Navy has expressed an interest and willingness to host this demonstration at their respective sites. Site selection criteria and the corresponding data from potential demonstration sites are provided in Table 4.1.

Due to the close proximity of the NAWC site to CB&I's research laboratory, as well as our intimate knowledge of the bedrock attained through ongoing SERDP Project ER-1685 and close collaborations with the USGS, initial project efforts will focus on the NAWC site. **It is noted that the initial testing performed at the NAWC site was for screening purposes only, as the knowledge gained during implementation of the testing as NAWC was used to refine the RA**

testing protocol outlined in Figure 2.3. For example, our experience at NAWC taught us to discontinue the use of oxidant injection. Results for the second demonstration performed at CPP are the focus of this Final Report.

Table 4.1. Site Selection Criteria. NAWC Was Selected as the Initial (screening) Site, and CPP Was Selected as the Primary Set for Detailed Assessment.

Parameter	Preferred Value(s)	Relative Importance (1-5, with 1 being highest)	Calf Pasture Point	NAWC	AFP4	Edwards AFB
TCE/DCE levels	>500 µg/L	1	Yes	Yes	Yes	Yes
Shallow depth to bedrock	< 100 ft	2	Yes	Yes	Yes	Yes
Low natural oxidant demand	<25 g/kg	4	<i>likely</i>	Yes	?	<i>likely</i>
No mobile DNAPL/LNAPL	NA ¹	1	Yes	Yes	No	Yes
Conductive fractures	>10 ⁻⁴ ft/day	2	Yes	Yes	Yes	No
Well-connected fractures	NA ¹	3	Yes	Yes	Yes	Yes
Existing site data and bedrock wells	NA ¹	3	Yes	Yes	Yes	Yes
Site accessibility	NA ¹	2	Yes	Yes	Yes	Yes
Location relative to CB&I Offices	<100 miles	3	Yes	Yes	Yes	No

¹ NA; Not Applicable

4.2 SITE LOCATION AND HISTORY

4.2.1 Initial Screening Site - NAWC

The NAWC is located in West Trenton, NJ. The approximate size of the site is 67 acres. The site was formerly used as a jet-engine test facility beginning in the 1950s, and was decommissioned in 1998 (http://nj.usgs.gov/nawc/site_description.html). Past activities at the site lead to the release of TCE, jet fuel, and other chemicals into the subsurface. Portions of the site have been sold to commercial developers, but the majority of the site remains undeveloped.

NAWC has been used as a demonstration and test facility for several ongoing and former technology demonstrations. Currently, several extraction wells are operating at the site to treat the chlorinated ethene plume within the fractured bedrock. However, none of these wells were located adjacent to our test location, nor were they screened within the target interval. Testing was performed during site characterization to assess any potential impacts from the extraction wells. This included turning off the extraction system to determine if there a significant impact on the measured hydraulic head in the test wells. Results of the testing indicated that while there was some nominal response in the measured hydraulic head within the test wells when the extraction system was shut down, the observed changes were insignificant when compared to measured changes in monitoring wells that were screened within in the same lithologic unit (bedrock layer) as the extraction wells. Therefore, it was determined that the extraction system would not have a significant impact on the demonstration. The demonstration location is shown in Figure 4.1.

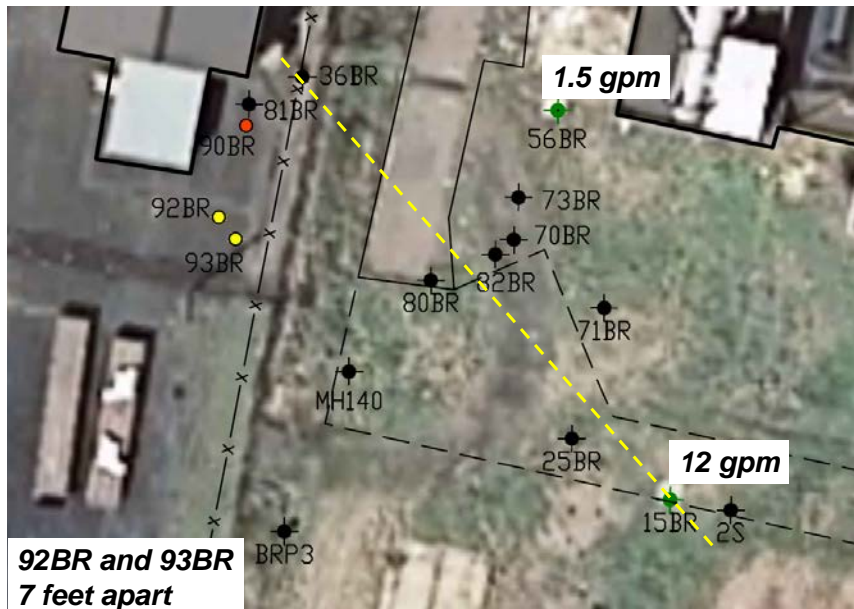
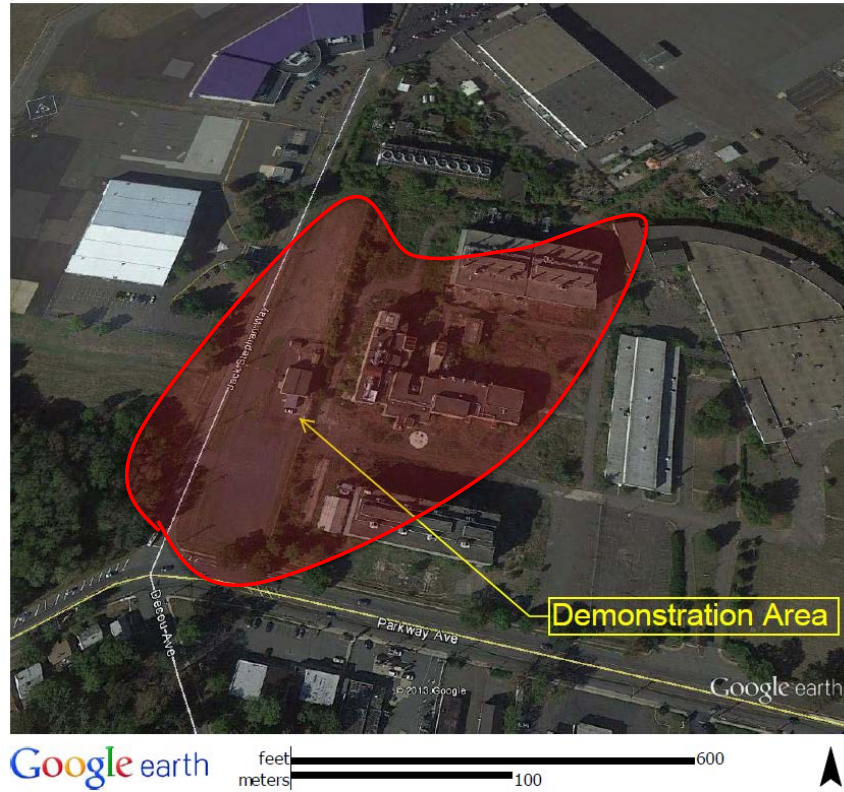

Figure 4.1. Demonstration Location at the NAWC Site.

The shaded area represents the bedrock TCE plume, where TCE is present at detectable concentrations (top). Demonstration wells (92BR and 93BR) and other local bedrock wells also are shown (bottom).

4.2.2 Primary Demonstration Site - Calf Pasture Point (Site 07)

The Calf Pasture Point Site 07 is part of the former U.S. NCBC Davisville, which is located in North Kingston, RI. Calf Pasture Point is bordered by Narragansett Bay and Allen Harbor (Figure 4.2). The facility originated as a Rhode Island militia encampment in 1893, and was eventually transferred to the Navy in 1939. While CPP was briefly inactive between World War II and the Korean War, the facility remained active until its decommissioning in 1994 (EA Engineering Science & Technology, 1999).

The current remedy for the contaminated bedrock aquifer at Calf Pasture Point Site 07 is MNA. Thus, there were no remedial activities being performed in the portion of the site in which we performed the demonstration. The demonstration location is shown in Figures 4.2 and 4.3.

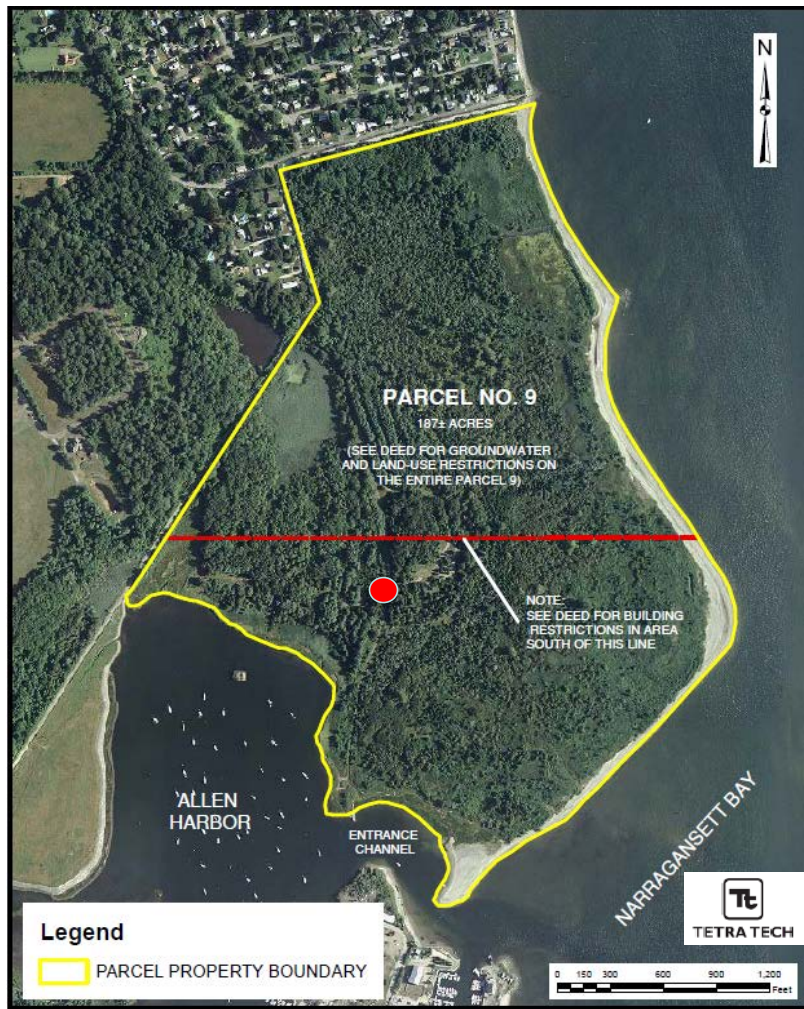

Figure 4.2. Demonstration Location at Calf Pasture Point.

The red dot shows the approximate location of the test wells.

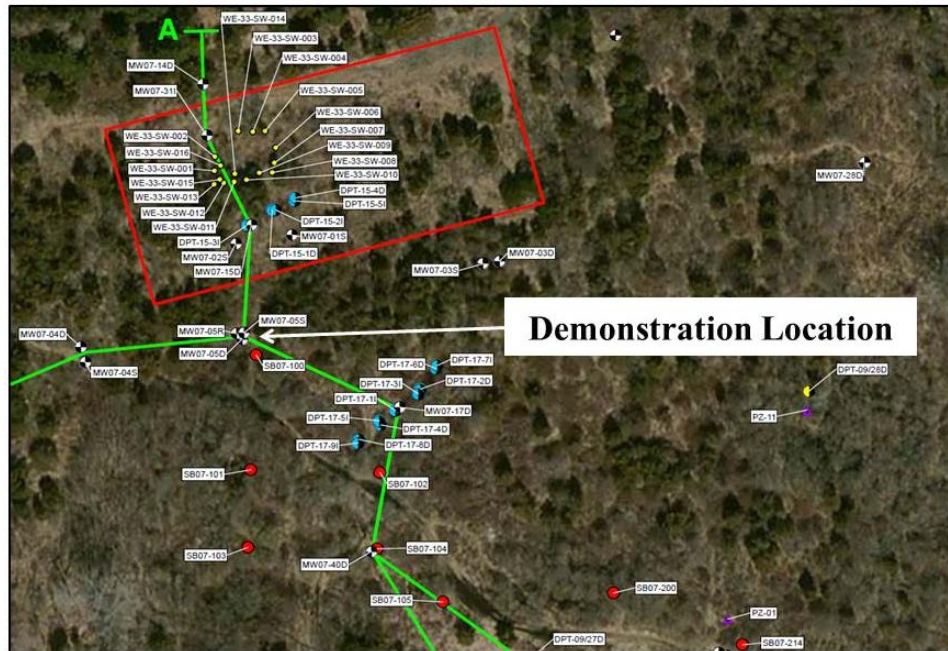

Figure 4.3. Close-up View of the Demonstration Location at CPP.
Centered at existing bedrock well MW07-05R.

4.3 SITE GEOLOGY AND HYDROGEOLOGY

4.3.1 NAWC

The geology and hydrogeology of the NAWC has been extremely well-characterized by the U.S. Geological Survey (USGS) and others. The NAWC site lies within the Newark Basin and is underlain by Triassic-age clastic sedimentary rocks, consisting primarily of mudstone in the Lockatong Formation, and sandstone in the Stockton Formation (http://nj.usgs.gov/nawc/site_description.html). The general strike and dip of these rock units is approximately N50°E and 30°NW. As shown on Figure 4.4, a fault that strikes approximately N50°E and dips approximately 60°SE separates rocks of the Lockatong and Stockton Formations at the site. The study site lies to the west of the fault, within the mudstone rocks of the Lockatong Formation.

The NAWC site is underlain by approximately 0 to 10 ft of unconsolidated sediments, consisting primarily of fill or heavily weathered rock, and behaves like an unconsolidated aquifer (http://nj.usgs.gov/nawc/site_description.html). Bedrock from approximately 10 to 50 feet below grade ranges from very weathered to unweathered, with groundwater being primarily transmitted in heavily weathered zones and in fractures and bedding planes. At depths greater than 50 ft below land surface, the bedrock is generally unweathered, and groundwater is primarily transmitted via fractures or bedding planes. The unstressed regional hydraulic gradient in the bedrock aquifer is to the south, while the groundwater preferential flow direction in bedrock is generally towards the west, along bedding, strike, and dip.

Our previous work as part of SERDP Project ER-1685 has shown that the matrix porosity of the rock is 6 to 8%, and that abiotic reactions in the rock likely limit the impacts of matrix back-diffusion. Rock materials contain visible pyrite minerals. Hydraulically conductive fractures show visible signs of chemical weathering. The pH of the groundwater is approximately 7. Some of the mudstones present at the site are very organic carbon rich; these zones will not be targeted for our demonstration.

4.3.2 Calf Pasture Point

CPP is located within the Narragansett Basin, a large structural syncline approximately 12 miles wide, and up to 12,000 ft deep. The bedrock unit underlying the site is the Pennsylvanian age Rhode Island Formation, which consists of quartzite, phyllite, gneiss, and schist, with quartzite and phyllite being observed in the rock cores collected during this demonstration (Section 5.2.2). The color of the rock varies from light to dark gray, and greenish (EA Engineering, 1998). The depth of the bedrock varies across the site, with weathered bedrock being observed at approximately 50 ft bgs, and competent bedrock being observed at approximately 58 ft bgs in the demonstration area (Site 07). Overlying the weathered bedrock is approximately 50 ft of anthropogenic fill (dredged material) and Quaternary glacial deposits (EA Engineering, 1998). A geologic cross-section of the demonstration location is provided in Figure 4.4.

The soil and bedrock stratigraphy at Site 07 has been divided into three hydrogeologic zones (EA Engineering, 1998):

1. **Shallow Groundwater Zone:** A saturated shallow sand unit which is under unconfined aquifer conditions, and is underlain by a low-permeability silt unit;
2. **Deep Groundwater Zone:** A deeper sand unit underlying the silt unit which is under confined/semi-confined aquifer conditions; and
3. **Bedrock Groundwater Zone:** The upper 25-50 ft of the competent bedrock, which responds like a confined aquifer.

Our demonstration was performed within the competent bedrock of the Bedrock Groundwater Zone. Groundwater in this unit is interpreted to flow generally southeast in this unit, with minor groundwater elevation impacts resulting from tidal influence (EA Engineering, 1998). Generally downward vertical gradients have been measured between the Shallow and Deep Groundwater Zones (well pairs MW07-05S/D), and the Deep and Bedrock Groundwater Zones (well pairs MW07-05D/05R) in the demonstration area (EA Engineering, 1998).

The majority of groundwater is transmitted through secondary openings, including joints, fractures, and openings along bedding planes, with fracture density generally decreasing with depth. Due to low groundwater yield, the bedrock is not the principal aquifer in the CPP area (TRS, 1993).

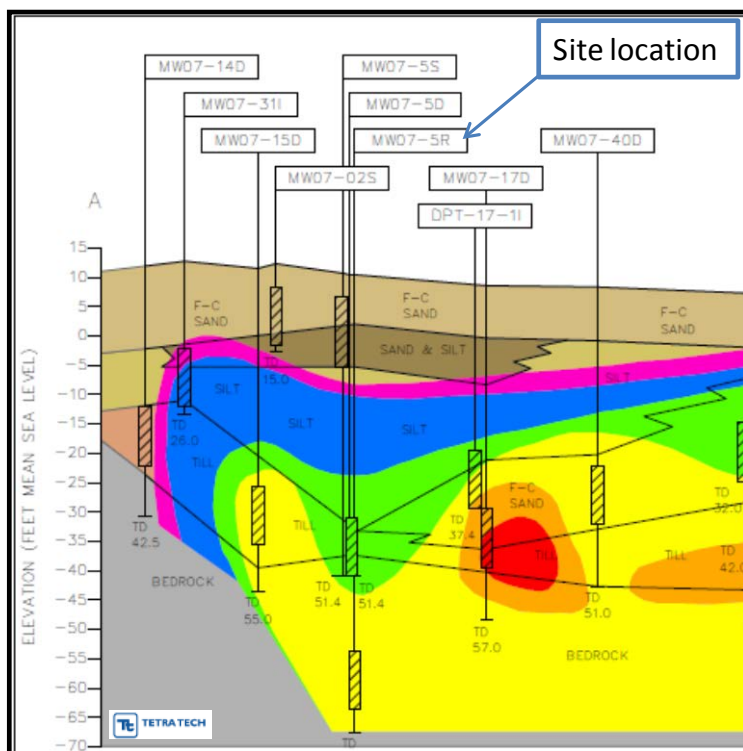

Figure 4.4. Cross-sectional View of the Demonstration Location at Calf Pasture Point.

4.4 CONTAMINANT SOURCE AND DISTRIBUTION

4.4.1 NAWC

Investigations of the groundwater contamination at the site began in the late 1980's. The primary contaminants in bedrock at NAWC were determined to be TCE, along with its dechlorination daughter products DCE and VC. The TCE plume is shown in Figure 4.1. By the mid-1990's, a pump and treat facility was in operation to remove contaminant mass and to limit the off-site migration of contaminants. As part of our SERDP Project ER-1685, discrete interval TCE concentrations at nearby borehole location 90BR (location shown in Figure 4.1) were determined; concentrations ranged from 200 to 25,000 $\mu\text{g/L}$ at depth intervals similar to those targeted for the rapid assessment testing.

4.4.2 Calf Pasture Point

The bedrock contamination in the vicinity of the demonstration location consists primarily of TCE, 1,1,2,2-tetrachloroethane (TeCA), and 1,1,1-trichloroethane (TCA). The 2012 groundwater data at bedrock monitoring well MW07-05R showed TCE, PCA, and TCA concentrations of 4800, 410, and 80 $\mu\text{g/L}$, respectively. The cross-section shown in Figure 4.4 shows the distribution of TCE measured at that time. Concentrations of cVOCs measured within isolated zones of the open borehole well (MW07-46R) installed during this demonstration are discussed in Section 5.2.4.

Page Intentionally Left Blank

5.0 TEST DESIGN

The testing, design, and results attained for the preliminary test site (NAWC) are provided in Appendix A. It is noted that results from the preliminary testing at NAWC were used to refine the approach used for CPP. Most notable, the use of permanganate was discontinued and the contaminant removal step (step 1 in Figure 2.3) at CPP was performed via water flushing only.

The following subsections provide detailed descriptions of the system design and testing conducted at CPP to address the performance objectives described in Section 3.0.

5.1 CONCEPTUAL EXPERIMENTAL DESIGN

As discussed in Section 2.1, the demonstration of a novel RA technique, coupled with the use of a multilevel sampling well and CSIA analyses, was evaluated for use as a rapid and cost-effective means to assess the limits of *in situ* remediation in fractured rock systems. This adapted technique is a hybrid of conventional push-pull tests coupled with our flushing and high-resolution sampling technique employed at Alameda Point. The RA test concept is illustrated in Figure 2.3. The overall approach is to rapidly remove TCE/DCE in conductive fractures, then measure the rate and extent of contaminant rebound. Coupled with assessing the change in carbon isotopic enrichment (i.e., assessing the difference at baseline compared to at the end of rebound), the nature and extent the mechanisms controlling rebound were assessed. This approach is an improvement on conventional fractured rock pilot testing approaches in that only limited bedrock wells are required, the duration of the test is relatively short, and the mechanisms controlling contaminant mass transfer and rebound are carefully assessed, thereby further developing the conceptual site model.

The RA technique involves the use of two wells: a standard injection well and an MLS well located approximately 5 to 10 feet downgradient of the injection well; the distance between the injection and extraction well will depend, in part, upon the groundwater velocity and fracture connectivity. The proposed RA approach relies on high resolution sampling within a limited portion of the contaminated aquifer. Care must be taken to ensure that the selected location is representative, with respect to contamination and hydrogeology, of the site as a whole; thus, adequate site characterization is required. It is significant to note that previous studies have shown that the processes that likely control contaminant rebound in fractured rock can be properly assessed at the scale of used in this demonstration (Le Borgne and Gouze, 2008; Kauffman et al., 2006; Chapman and Parker, 2005). As an example, several soil cores and hydraulic profiles were collected at our Alameda Point location to verify that the location of our test was representative of the site; we found that data collected from a single MLS well located approximately 7 feet from an injection well was sufficient for characterizing dissolution and rebound processes. For a fractured rock site, an understanding of the fracture network and bedrock geology are required to ensure the test is performed in a representative location. Geologic features such as diabase dikes or faults would need to be identified, and either excluded or evaluated independently, if needed.

For fractured rock, the MLS well consisted of a packer system within the borehole to discretely sample multiple water bearing zones within the targeted treatment interval. Sampling intervals were determined by various geophysical and hydraulic testing, as described in Section 5.2.

The depth interval used for the MLS wells was selected based on the anticipated fracture flow path emanating from the injection well. Monitoring of rebound at the MLS wells facilitated assessment of the contaminant distribution within the treatment zone.

5.2 BASELINE CHARACTERIZATION ACTIVITIES

Prior to site selection, CB&I reviewed existing site investigation documents and all available hydrogeologic and contaminant distribution data for chlorinated solvent impacted zone at CPP Site 07. It is noted that the amount of bedrock data available for review was limited, which is one of the primary reasons that the demonstration was performed at the location of an existing bedrock monitoring well (bedrock monitoring well MW07-05R shown in Figure 4.4). Thus, initial characterization activities were focused within the immediate vicinity of this existing bedrock well.

5.2.1 Borehole Drilling

Characterization activities included drilling and coring one borehole located approximately 8 feet downgradient from existing bedrock well MW07-05R. This bedrock well was installed in August, 2014. The newly installed open borehole well was designated MW07-46R, and its location is shown in Figures 5.1 and 5.2. Details of the well installation, rock core collection, and borehole testing are provided in the following sections.

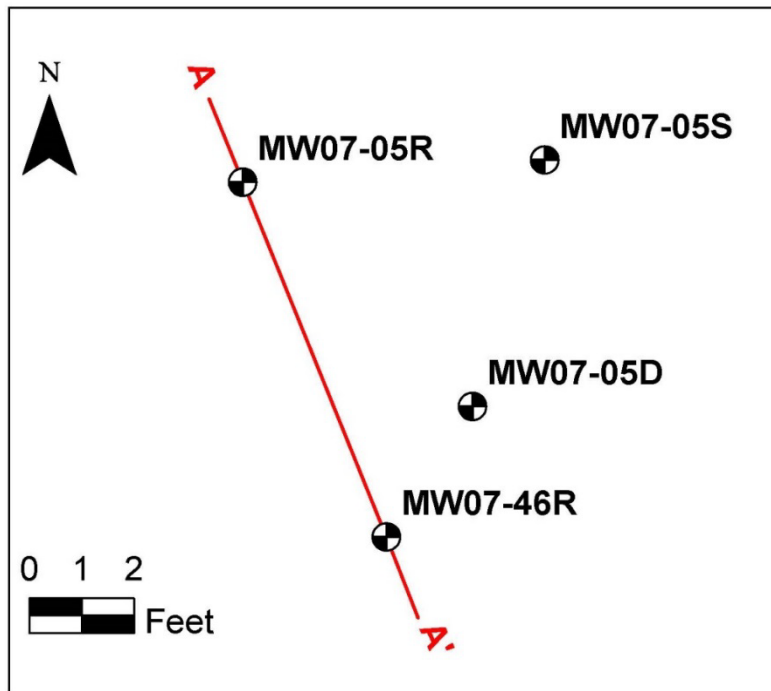

Figure 5.1. CPP Demonstration Area (circled), with Location of Newly Installed Borehole (MW07-46R) Identified (approximately 8 feet from existing well MW07-05R).



Figure 5.2. Newly Installed Well MW07-46R Shown in Proximity to Existing Well MW07-05R.

5.2.2 Drilling and Rock Coring

Existing bedrock well MW07-05R at Site 07 was used as the injection well for this ESTCP demonstration. Boring and well installation logs indicate that this well was advanced using a 5 7/8-inch roller bit to 64 feet bgs (6-inch casing installed into weathered bedrock at 48 feet bgs) and HX rock core collected from 64 feet to 78 feet bgs. A 2-inch stainless steel well, screened from 64 to 74 feet bgs, was installed within the borehole. A filter pack was installed from 63.5 ft to 74.5 ft bgs, and the remainder of the borehole was sealed with a bentonite seal and cement/bentonite grout. Therefore, the monitoring (and injection) zone for this well is isolated from 63.5 ft to 74.5 ft bgs, and to the water bearing fractures that intercept this 11-foot interval. The log for this well is provided in Appendix B.

Prior to coring the new open borehole well (MW07-46R) that was used as the demonstration multi-level monitoring well, substantial effort was required with respect to clearing so that the drill rig and other work vehicles could access the demonstration location. In addition, prior to drilling activities, utility clearances were performed, and the borehole was pre-cleared by hand for utilities to a depth of 5 ft bgs.

During installation of monitoring well MW07-46R, sonic drilling techniques were used to advance 10-inch diameter temporary casing to 10 ft-bgs, and 7.6-inch temporary casing to 58.3 ft-bgs, the depth at which the bedrock was determined to be sufficiently competent to begin rock coring. Continuous soil and weathered bedrock core were collected to this depth using a 6-inch diameter sonic core barrel. Permanent 5-inch diameter steel casing was then installed to a depth of 58.3 ft-bgs, and pressure-grouted in place using cement/bentonite grout. Once the grout had set, rock cores were collected in 5-foot lengths from 58.3 to 80.6 ft-bgs using a moderate drilling speed, with moderate, steady down-pressure and sufficient circulation to cool the drilling bit.

A triple tube wire line PQ Core Barrel system was used. This system allows for the collection of minimally-disturbed 3.25-inch diameter rock cores that can be collected in a minimally disturbed condition. Rather than extruding the rock core from the inner tube (as with traditional dual tube methods), the triple tube system contains a third tube made of stainless steel that is split lengthwise and nested inside the second tube. When the rock core was retrieved from the subsurface, the split tube was removed from the second tube. The upper half of the split tube was carefully lifted off, revealing the core in a minimally disturbed condition for inspection and transfer. The PQ coring system created a nominal 4.8-inch diameter core hole.

Drill and rock coring was performed by ADT, a Rhode Island licensed driller, and supervised by a CB&I geologist. The following standards were used during rock coring:

- ASTM D 2113-99: *Standard Practice for Rock Core Drilling and Sampling Rock for Site Investigation*
- ASTM D 5079-02: *Standard Practices for Preserving and Transporting Rock Core Samples*

Logging of the rock cores was performed in the field by a CB&I geologist. To the extent possible, visual inspection and core logging was used to assess the fracture network and identify conductive zones. The following standards were used during rock logging:

- ASTM D 5434: *Standard Guide for Field Logging of Subsurface Exploration of Rock Core Samples*
- ASTM D 6032: *Standard Test Method for Determining Rock Quality Designation (RQD) of Rock Core*

The boring log for MW07-46R is provided in Appendix C, and indicates that the competent bedrock between 58.3 and 80.6 ft bgs consisted of interbedded quartzite and phyllite. A generalized geologic cross section of the demonstration area is provided in Figure 5.3. Visual logging of the rock core indicated that several water bearing fractures were located between 58.3 and 63 ft bgs. Very few fractures were noted between 63 and 80.6 ft bgs; the absence of mineral staining on the fractures in this deeper interval suggested that the fractures may not be water-bearing.

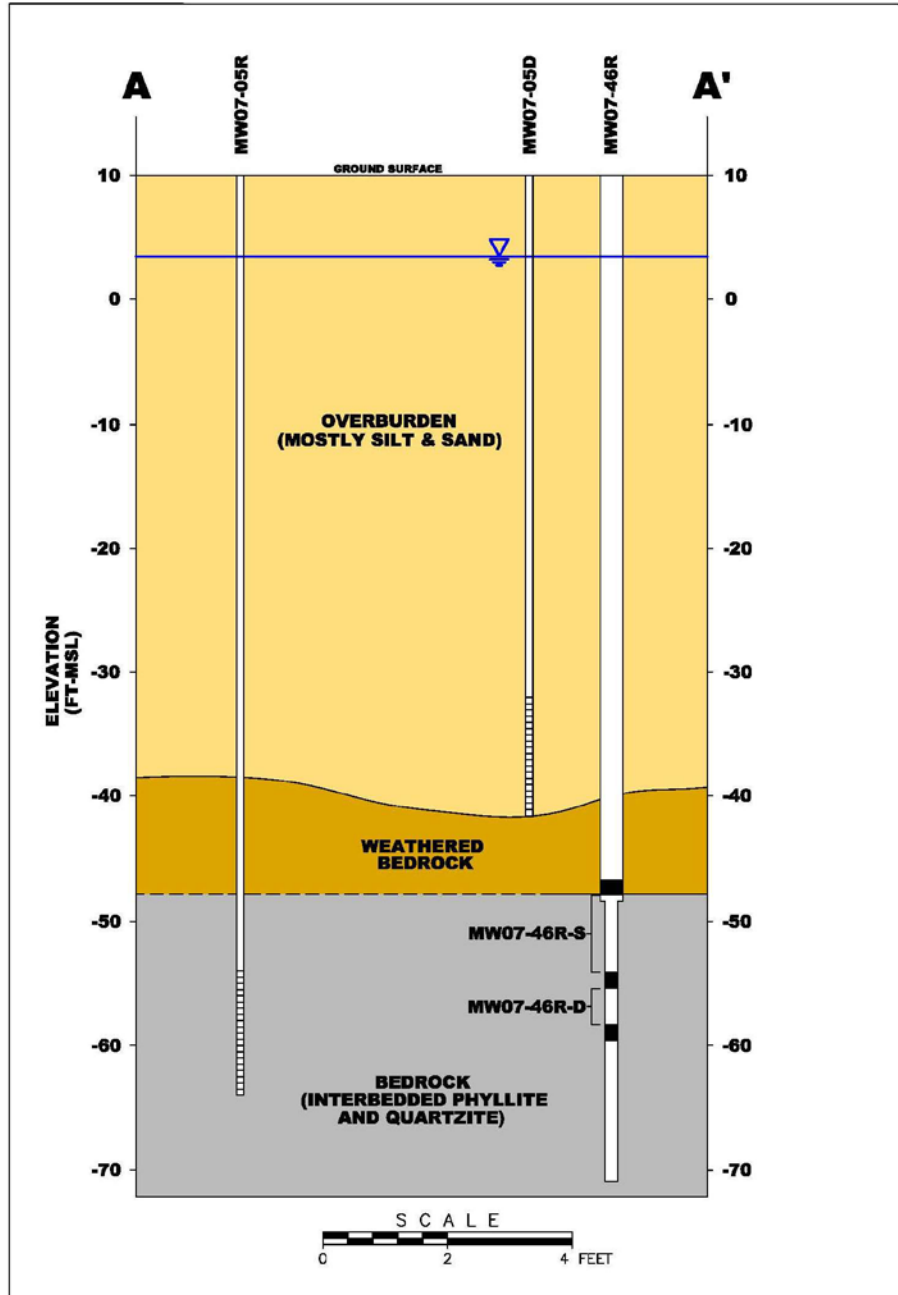

Figure 5.3. Generalized Geologic Cross Section of the CPP Demonstration Area.

Upon completion of rock coring, the open borehole well was finished by cutting the 5-inch diameter steel casing approximately 18 inches above the ground surface, installing a concrete pad around the casing, and installing a locking aluminum cap. A single packer was temporarily installed and inflated at 64.5 ft bgs to isolate the hydraulically conductive fractures located between 58 and 63 from fractures residing in the deeper portion of the borehole.

All drilling equipment was decontaminated in accordance with Rhode Island state regulations and CB&I Standard Operating Procedures (SOPs). A temporary decontamination pad was constructed and maintained at the staging area during well installation activities. The well was developed using a submersible pump. Groundwater was pumped from the well until it was relatively clear and free of sediment. No surging was performed, and no water was added to the well during development. All investigation derived waste, including soil cuttings, development water and decontamination fluids, were placed into DOT approved 55-gallon drums and transported to a staging area at the site. CB&I subsequently coordinated the characterization, profiling and off-site disposal of all investigation derived waste with the appropriate US Navy personnel.

5.2.3 Borehole Geophysical Logging

Borehole geophysical logging was performed by Hager-Richter Geoscience, Inc. under subcontract to CB&I. The geophysical logging was performed to facilitate the identification of transmissive fractures and fracture zones. Borehole logging included optic and acoustic borehole imaging, caliper logging, and heat-pulse flow meter testing.

Results of the borehole geophysical testing for MW07-46R are provided in Appendix D. Consistent with the field observations on the collected rock core, several fractures were identified between approximately 58 and 63 ft bgs. Results of the heat-pulse flow meter testing suggested that these fractures were transmissive. In addition, the borehole geophysical testing identified two closely spaced fractures at approximately 67 ft bgs that also (based on the heat-pulse flow meter data) also appeared to be transmissive. Thus, both a shallow (58 to 63 ft bgs) and deep (~67 ft bgs) transmissive zones were identified.

5.2.4 Borehole Discrete Interval Hydraulic Testing and Sampling

Bedrock characterization activities performed in March of 2015 at CPP included borehole discrete zone pump testing and groundwater sampling performed at well MW07-46R to assess the flow field and contaminant distribution throughout the open borehole interval (~58-80 feet bgs). Using data collected during drilling activities and multiple borehole geophysical logging techniques, potential water bearing fractures were identified in open bedrock corehole MW07-46R. A custom designed straddle packer system was used to sequentially isolate discrete intervals (4 feet, or greater) within the open corehole for individual short term pump tests. The packer system consisted of two inflatable packers, with a submersible pump between the packers, and water level transducers for collecting water levels above, below and between the straddle packers. The packers were inflated, isolating the target zone from zones above and below, and short term pump and recharge tests (< 2 hours each) were performed at 4 separate intervals.

During two of the pump tests, groundwater samples were collected from the target intervals and analyzed for Target Compound List Volatile Organic Compounds (TCL VOCs) via USEPA Method 8260B. Two of the target zones did not produce sufficient water to collect representative samples. Sampling results, including groundwater samples collected from well MW07-05R during testing activities, are provided in Table 5.1. The data show that TCE was the primary chlorinated solvent present. Chlorinated solvent levels in the newly installed MW07-46R open borehole were in reasonable agreement with the chlorinated solvent levels in the existing bedrock well, although chlorinated solvent levels were generally 3 to 5 times greater in the deep interval of MW07-46R than in the other two monitoring locations.

During each of the four pump tests, groundwater levels were monitored in nearby wells, including well MW07-05R, which was used as the injection well during the rapid assessment testing. While pumping two of the discrete intervals at MW07-46R (58.3-64.7 and 65.0-69.0 ft bgs), drawdown was observed in well MW07-05R, indicating a direct hydraulic connection between select water-bearing fractures in each of these wells. Once groundwater levels recovered in these two wells, the packers were left in place in well MW07-46R, and a second pump test was performed with well MW07-05R at the pumping well to better quantify the connection to the zone being isolated in well MW07-46R (and zones above and below the isolated zone). Based on the recovery data observed while pumping the shallow and deep intervals at MW07-46R (Appendix E), the estimated hydraulic conductivities were 1.7 and 0.93 ft/day in the shallow and deep intervals, respectively.

Table 5.1. cVOC Concentrations Measured in Groundwater during the March 2015 Pump Testing at MW07-46R and MW07-05R.

Concentrations are shown in µg/L.

Constituents	MW07-46R (58.3-64.7 ft bgs)	MW07-46R (65.0-69.0 ft bgs)	MW07-05R
Vinyl Chloride	<525	<525	320 J
<i>trans</i> -1,2-Dichlorethene	77 J	490 J	200 J
<i>cis</i> -1,2-Dichlorethene	210 J	1,000	3,500
Trichloroethene	9,800	26,000	7,700
1,1,2-Trichloroethane	<525	170 J	76 J
Tetrachloroethene	100 J	62 J	<525
1,1,2,2-Tetrachloroethane	620	2,000	350 J

Notes:

J=Estimated value greater than the MDL but less than PQL.

5.2.5 Permanent Packer Installation

The discrete zone pump test and contaminant concentration data, along with the previously collected borehole geophysical data and rock core data were analyzed to determine discrete zones within corehole MW07-46R to be targeted for monitoring. Based on these data, the following intervals were selected to be isolated for monitoring during the rapid assessment testing:

- MW07-46R-S: 57.8' to 64.0' bgs (6.2 ft)
- MW07-46R-D: 65.3' to 68.2' bgs (2.9 ft)

Straddle packer assemblies were designed, constructed and installed in open borehole well MW07-46R on April 14, 2015 to isolate these two target intervals. Dedicated sampling pumps were installed within each of the isolated intervals. Pump intakes were set at 60.0 and 67.8 ft bgs, respectively.

Existing 2-inch diameter monitoring well MW07-05R (Figures 5.1 through 5.3) was used as the injection well for rapid assessment testing. A single packer and dedicated sampling pump were installed in this well on April 27, 2015 to isolate the 10 foot screen interval in this well (64' to 74' bgs) after tracer testing was performed (Section 5.2.6), and prior to borehole dilution testing at this well (Section 5.2.7). The packer was installed at 63 ft bgs (1 foot above the top of the screen), and the pump intake was set at 65.5 ft bgs, in a zone where three weathered fractures were reported on the boring log. The equipment installed allowed for measurement of water levels within and above each of the isolated intervals in both of these wells.

5.2.6 Tracer Testing

Based on the results of the testing described in Sections 5.2.1 through 5.2.5 a tracer test was performed to further assess hydraulic connectivity and travel time between the injection well (MW07-05R) and the monitoring well (shallow and deep intervals of MW07-46R). On April 15, 2015, A tracer solution (250 mL) containing 27 grams of sodium bromide was added to the injection well MW07-05R (prior to installing the packer discussed in Section 5.2.5). The target bromide tracer concentration in the water column within the well was 500 mg/L. Immediately following the addition of the sodium bromide tracer, water was recirculated within the well using a submersible pump to facilitate tracer mixing throughout the water column. This was accomplished by pumping groundwater from the bottom of the 10-foot screen interval up to the ground surface. The water was continuously re-injected into the upper portion of the water column within the well. Approximately 33 gallons (3 well volumes) were recirculated to sufficiently mix the bromide tracer within the water column, to achieve the target bromide concentration of 500 mg/L within the well column.

Once the bromide was mixed in the water column within injection well MW07-05R, a bromide injection tracer test was initiated. A 100-gallon batch of 500 mg/L bromide solution (244 grams of sodium bromide (NaBr)) was mixed within a 100-gallon conical bottom poly tank located adjacent to the injection well; the measured bromide solution in the tank was 506 mg/L. The solution was injected at a rate of approximately 75 milliliters per minute (mL/min) for 8.5 hours on the first day of testing. Groundwater samples were collected from shallow and deep packer intervals in MW07-46R every hour during this injection. As detailed in Section 5.7.1, samples were collected by recirculating ~600 mL of water (1.2 pump and tubing volumes) from the dedicated sample pump, to the surface, and back into the sampling interval (just below the bottom of the top-bounding packer). Approximately 10 mL of sample were collected at the end of each 600 mL recirculation (5 mL for on-site analysis, and 5 mL for laboratory analysis). Sampling was performed in this manner to minimize the removal of groundwater from the expected small fracture volume between the injection and monitoring well. Approximately 10 gallons of bromide solution was injected during the first day of testing.

Injection of bromide solution resumed on the second day of testing at a rate of 75 mL/min, and was increased to 200 mL/min 3.3 hours into the second day of injection. The injection continued overnight, and concluded the morning of April 17, 2015. Groundwater samples were collected from the two MLS well intervals every hour during the second day (during business hours) and once on the morning of the last day (April 17th). A total of approximately 80 gallons of 500 mg/L bromide solution was injected during the tracer test.

Bromide data for the shallow and deep intervals for MW07-46R are provided in Figure 5.4. No measurable bromide was observed in the shallow, indicating that no significant flow path (despite observing a hydraulic connection during the short term pumping tests) exists between the injection well (MW07-05R) and the shallow interval of MW07-46R.

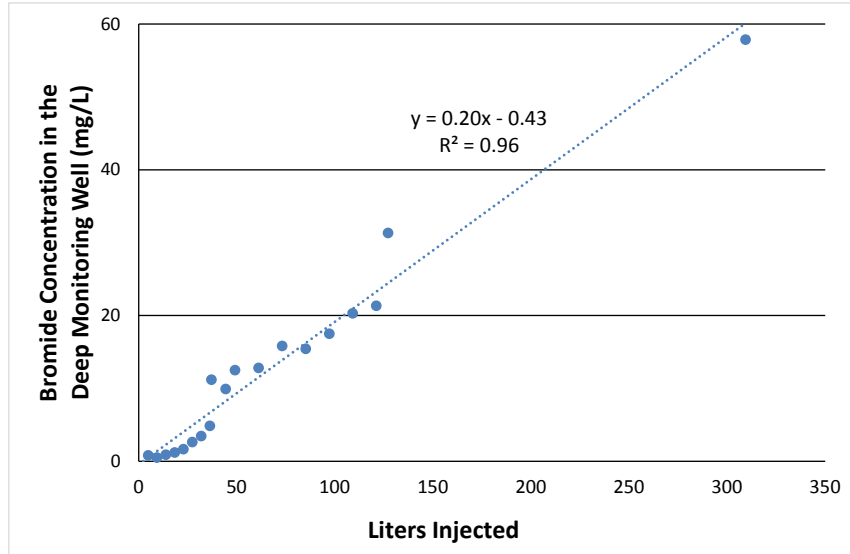

Figure 5.4. Increases in Bromide Concentration in the Deep Interval of MW07-46R as a Function of Volume Injected into MW07-05R.

The dashed line shows the linear regression to the data.

Bromide tracer results indicated that bromide appeared rapidly (approximately 3.5 hours) in the deep interval of MW07-05R. The bromide concentration in the deep interval increased linearly with the injected volume. The fraction (f) of injected flow that entered the deep monitoring interval during bromide injection is estimated assuming plug flow by calculating the slope in Figure 5.4 as follows:

$$C_{Br} = \left[\frac{C_{Br,inj}}{V} \right] V_e + C_{Br,0} \quad \text{Eq. 1}$$

$$V_e = fV_T \quad \text{Eq. 2}$$

where C_{Br} is the measured bromide concentration in the well, $C_{Br,inj}$ is the injected bromide concentration (500 mg/L), V is the estimated borehole volume isolated in the deep interval of MW07-46R (10 L), V_e is the volume (L) of injected water that has entered the deep interval of monitoring well MW07-46R, $C_{Br,0}$ is the initial bromide concentration in the groundwater (<0.5 mg/L), and V_T is the total volume injected into the injection well at a given time (L). Linear regression (Figure 5.4) and application of Eqs. 1 and 2 the fraction f of injected flow entering the borehole of 0.004.

To estimate the fracture aperture along the fracture flow path from the injection well to the deep interval of MW07-46R, radial fracture flow emanating from the injection well is assumed. The fracture aperture (a) is calculated as follows:

$$a = \frac{V_b}{nr^2} \quad \text{Eq. 3}$$

where V_b is the volume of tracer injected until breakthrough of the tracer in the monitoring well (16,000 cm³), n is the number of fractures in the deep interval (3, based on visual and geophysical boring logs), and r is the radial distance between the injection and monitoring well (240 cm). Eq. 3 results in an estimated fracture aperture of 0.029 cm. Assuming 3 hydraulically conductive fractures with an aperture of 0.029 cm each intersect the injection well along its 330 cm interval), the effective porosity in the deep interval is 0.00026.

At the completion of the bromide tracer tests, approximately 48 gallons of groundwater were extracted from the injection well to reduce the concentration of bromide in the groundwater to 61 mg/L in preparation of the borehole dilution testing (Section 5.2.7).

5.2.7 Borehole Dilution Testing

A borehole dilution tracer test (Pitrak et al., 2007) was performed to verify the ambient groundwater flow rate through the injection well. The borehole dilution test was performed at injection well MW07-05R, beginning on April 30, 2015. The borehole dilution test was performed after the single packer and dedicated sampling pump were installed in this well (Section 5.2.5). The packer was installed to isolate the 10 foot screen interval in this well (64' to 74' bgs), and to limit the volume of water in borehole dilution testing interval. As discussed in Section 5.2.5, the packer was installed at 63 ft bgs (1 foot above the top of the screen), and the pump intake was set at 65.5 ft bgs.

A 250 mL solution containing 8.9 grams of NaBr was added to the 11-foot interval below the packer to achieve a target bromide tracer concentration in the water column of 500 mg/L. Immediately following the addition of the sodium bromide tracer, water was recirculated within the well using the dedicated bladder pump installed below the packer to facilitate tracer mixing throughout the 11-ft interval. This was accomplished by pumping groundwater from near the top of the interval up to the ground surface. The water was continuously re-injected back through the packer to the top of the packer interval. Approximately 5.5 gallons (3 isolated interval volumes) was recirculated to sufficiently mix the bromide tracer within the interval. Bromide samples were collected from MW07-05R after recirculation (time=0), and on days 4, 11, 19 and 25. As with the tracer testing detailed in Section 5.2.6, samples were collected by recirculating ~600 mL (1.2 pump and tubing volumes) of water from the dedicated sample pump, to the surface, and back into the sampling interval to minimize the removal of groundwater from the expected small fracture volume between the injection and monitoring well. Approximately 10 mL of sample were collected for laboratory analysis at the end of each 600 mL recirculation. These data are presented in Figure 5.5.

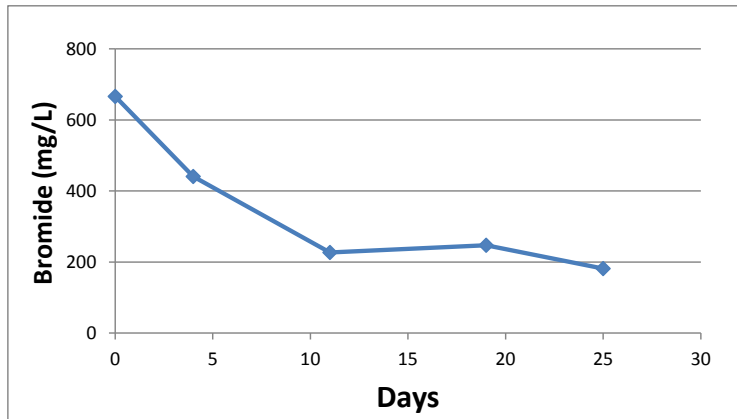

Figure 5.5. Results from the Borehole Dilution Testing Performed in the Injection Well (MW07-05R).

The rate of decay of bromide from the injection well provides an estimate of the Darcy velocity. The Darcy velocity is calculated as follows (Pitrak et al., 2007; Nordqvist et al., 2008):

$$\ln(C/C_0) = -\frac{Q}{V_{IW}} t \quad \text{Eq. 4}$$

where C is the bromide concentration at time t , C_0 is the initial bromide concentration in the borehole, Q is ambient flow rate into the well, and t is the time. V_{IW} is the water volume of the injection well, including the porosity within the sandpack, which is approximately $12,000 \text{ cm}^3$. Linear regression of the data to Eq. 4 is shown in Figure 5.6, with a resulting ambient flow rate into the well (Q) of $564 \text{ cm}^3/\text{day}$; $0.39 \text{ cm}^3/\text{minute}$). The Darcy flow of the aquifer is subsequently calculated as:

$$q_D = -\frac{Q}{2r_{IW}L\alpha} \quad \text{Eq. 5}$$

where q_D is the Darcy velocity, r_{IW} is the borehole radius of injection well MW07-05R, L is the length interval of the sand pack (11 feet), and α is flow convergence correction factor estimated at 2. The calculated value of q_D is 0.091 cm/day (average over the 11-ft interval of MW07-05R). Using the calculated effective porosity of 0.00026 (Section 5.2.6), the linear velocity is 350 cm/day , resulting in a travel time of 16 hours between the injection and extraction wells under ambient (no injecting) conditions; this residence time assumes all the flow moves towards the deep interval of MW07-46R, and thus may underestimate the actual ambient residence time.

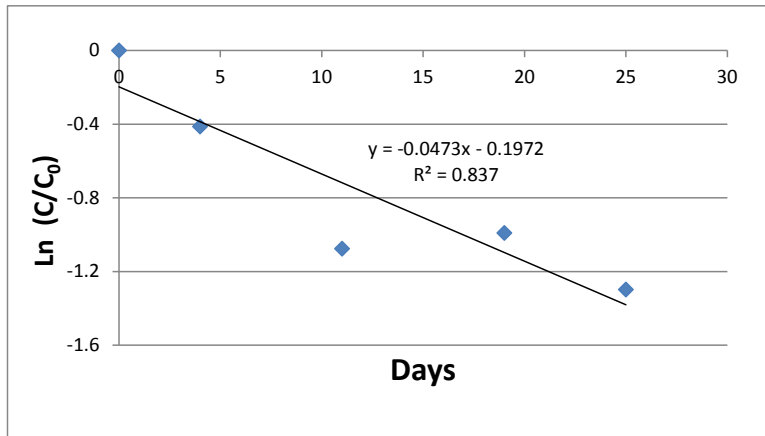

Figure 5.6. Linear Regression of the Bromide Data from the Borehole Dilution Test Performed at MW07-05R.

The bromide data are plotted in the form of Eq. 4 to facilitate determination of the ambient water flow rate into the borehole via linear regression. The linear regression to the data is represented by the solid line.

5.3 LABORATORY TREATABILITY STUDY

5.3.1 Objectives

Laboratory treatability studies were conducted with rock samples collected during coring of borehole MW07-46R in August 2014 (described in Section 5.2.2). The overall goal of the laboratory treatability testing was to assess the rock matrix at the CPP site to attain the parameters necessary to model the coupled diffusion and reaction of TCE through the rock matrix. Specifically, laboratory testing entailed: 1) measurement of the rock porosity and 2) determination of the abiotic TCE dechlorination rate constant within the rock matrix.

5.3.2 Sample Collection

Rock samples were collected during coring activities for MW07-46R (Section 5.2.2). Rock core from a depth interval of 60.4-61 ft bgs was collected from the bedrock. Water-bearing fractures were present at the collected core depth; the collected rock was located within the interval of the shallow monitoring zone of MW07-46R. Rock core adjacent to water bearing zones was targeted for testing and shipped to CB&I's laboratory in Lawrenceville, NJ. Rock samples were stored under anaerobic conditions until the initiation of testing.

5.3.3 Treatability Study Methodology

The treatability study for this project consisted of a simple water uptake test to estimate the water-accessible rock matrix porosity, and a batch test to determine the naturally abiotic dechlorination of TCE within the rock matrix. *It is noted that the testing to determine both the rock porosity and abiotic dechlorination were performed as screening tests only.*

5.3.3.1 Porosity Estimation

The water-accessible porosity of the rock matrix was determined using the water uptake method, as performed on rock cores during our previous SERDP Project (ER-1685) where diffusion in the rock matrix as a function of bedding orientation was studied (Schaefer et al., 2012b). The water accessible porosity of a slice of rock collected from CPP (Section 5.3.2) was determined by measuring the water uptake within the rock. A small slice of rock core (approximately 40 g) was oven dried at 105 degrees °C. The rock was subsequently placed in a water bath, with the very top of the rock face above the waterline to allow for escape of air during imbibition. The water uptake experiment continued until moisture equilibrium was established. The effective porosity was estimated by the mass of water taken up by the rock.

5.3.3.2 Batch Testing to Estimate Abiotic TCE Dechlorination

Batch tests to determine the abiotic dechlorination of TCE by naturally-occurring ferrous minerals within the rock matrix were performed as previously described (Schaefer et al., 2015). Samples of rock core were cut into “rods” to facilitate batch abiotic testing. The rods were typically 1 cm wide x 1.5 cm tall x 5 cm long. While rocks were stored and ultimately prepared in batch systems within an anaerobic chamber, the rock-cutting was performed outside of the anaerobic chamber. Previous studies have shown that short term exposure (hours to days) of rocks to air did not have a measureable impact on abiotic dechlorination rates (Schaefer et al., 2013). All the cut rock rods were carefully measured and weighed to determine the exposed surface area and overall mass.

Batch reaction vessels were prepared in an anaerobic chamber. Each cut rock was placed in a glass vial (40 mL) with screw-top lid and Mininert sampling cap. A total of 38 mL of deionized water also was delivered to each vial; the deionized water contained 300 mg/L of mercuric chloride (HgCl₂) to inhibit microbial activity. Parallel batches were prepared, in which one set of vials received TCE (final aqueous concentration of approximately 200 mg/L) and the other set received no TCE spike. Evaluating TCE-spiked and non-spiked samples serve as a means to determine if generation of expected TCE transformation products were in fact derived from TCE in the vials. Both the spiked and un-spiked samples were prepared in triplicate.

Vial headspaces were monitored for both VOCs and reduced gases (including methane, ethane, ethene, propane, and acetylene) at 19 and 40 days following set-up. Headspace analyses were analyzed using a gas chromatograph with a flame ionization detector, as described previously (Schaefer et al., 2015). Aqueous concentrations were calculated based on the headspace data using Henry’s Law. A previously developed model, which incorporates the coupled diffusion and first order abiotic transformation of TCE, was used to estimate the first-order abiotic dechlorination rate constant based on the observed TCE transformation products; this transformation rate constant was ultimately used in the model to simulate the observed TCE rebound from the rock matrix (Section 5.6.1).

5.3.4 Treatability Study Results.

5.3.4.1 Porosity Estimation

Results from the water-uptake method showed that the rock matrix porosity was approximately 3.9%. This value is within the range expected for the meta-sandstone at CPP. This value of the rock porosity was used to model TCE migration within the rock matrix (Section 5.6.1).

5.3.4.2 Abiotic TCE Dechlorination

Results of the abiotic batch dechlorination testing showed that abiotic dechlorination transformation products ethane and propane were generated in the TCE-spiked vials, consistent with previous abiotic testing in bedrock (Schaefer et al., 2013, 2015). Results plotted as total millimoles of TCE per g rock transformed are provided in Figure 5.7. Using a trial-and-error approach to estimate (within a factor of 2) the first-order TCE transformation rate constant via application of a coupled diffusion and first-order TCE transformation model (Schaefer et al., 2013) yield a rate constant of $2.7 \times 10^{-8} \text{ s}^{-1}$.

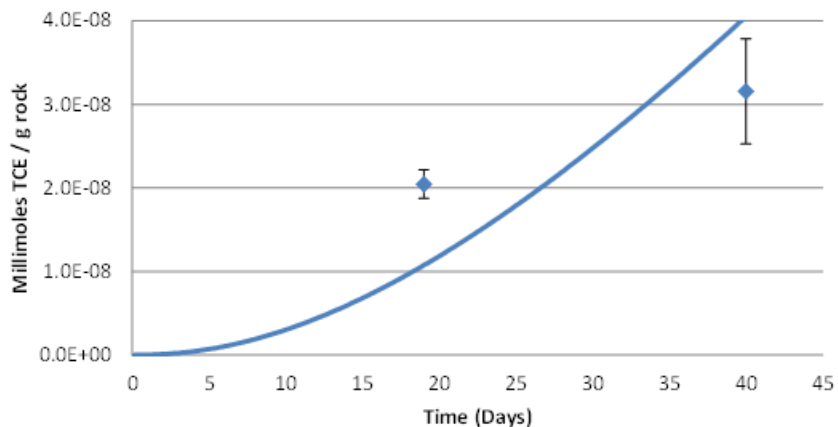

Figure 5.7. Abiotic Dechlorination of TCE in the Bench Scale Batch Testing.

Total TCE transformation was based on the generation of ethane and propane. Error bars represent 95% confidence intervals. Only data from two of the three replicates was used, as one of the replicates exhibited clear indications of leakage. The solid line represents the model regression (Schaefer et al., 2013, 2015) to the data. Error bars represent 95% confidence intervals of the triplicate data.

5.3.5 Treatability Study Conclusions

Results from the treatability study indicate that abiotic dechlorination of TCE occurs within the rock matrix. This information was used to develop the model, and to provide insight regarding observations made during the field demonstration.

5.4 DESIGN AND LAYOUT OF TECHNOLOGY COMPONENTS

As discussed in Section 5.1, the demonstration of a novel RA technique, coupled with the use of a multilevel sampling well and CSIA analyses, was evaluated for use as a rapid and cost-effective means to assess the limits of *in situ* remediation in fractured rock systems.

The RA test approach, as illustrated in Figure 2.3, was designed to rapidly remove TCE/DCE in conductive fractures, then measure the rate and extent of contaminant rebound. Coupled with assessing the change in carbon isotopic enrichment (i.e., assessing the difference at baseline compared to at the end of rebound), the nature and extent the mechanisms controlling contaminant rebound were assessed.

As shown on Figures 5.1 through 5.3, the RA technique at CPP involved the use of two wells: existing bedrock monitoring well MW07-05R that was used as the injection well and bedrock MLS well MW07-46R located approximately 7.5 ft downgradient of the injection well. As detailed in Section 5.2.5, the MLS well consisted of a packer system within the borehole to discretely sample two water bearing zones within the targeted treatment interval. Sampling intervals were determined by various geophysical and hydraulic testing, as described in Section 5.2. The depth interval used for the MLS wells was selected based on the anticipated fracture flow path emanating from the injection well. Monitoring of rebound at the MLS wells facilitated assessment of the contaminant distribution within the treatment zone. Existing 2-inch diameter monitoring well MW07-05R was used as the injection well for the RA testing. As detailed in Section 5.2.5, a single packer and dedicated sampling pump were installed to isolate the 10 foot screen interval in this well (64' to 74' bgs).

Temporary 6-foot high chain-link fencing with barbed wire was installed around the demonstration area for security purposes. Two vertical poly tanks (3,200 and 2,500 gallons) were installed within the fenced area to the site to hold the potable water used during testing. Ball valves were installed at the bottom of each of the tanks to allow for delivery of water from one tank at a time. Potable water was delivered to the site by a local pool water supply company. The tanks were connected to a flow meter assembly with ¼-inch ID tubing. The flow meter assembly included rotameters that could measure the flow of injected potable water in the desired range, and allowed for the adjustment of flow rates via needle valves. The flow meters were connected to the tops wells MW07-05R and MW07-46R with ¼-inch ID tubing. A valve assembly was installed at the top of each well to allow for either injection or potable water, or sampling of the well. Nitrogen cylinders used for maintaining the inflation of the packer systems in both wells were housed within a small vinyl shed that was constructed on site.

5.5 FIELD TESTING

The field testing at CPP was performed in 3 phases, including 1) Baseline sampling and analysis, 2) Rapid flushing and sampling, and 3) Rebound sampling. This sequence of testing allowed for assessment of the mass transfer mechanisms that could contribute to observed contaminant rebound following implementation of *in situ* remedial technologies such as bioaugmentation and chemical oxidation, thereby proving information regarding the practical limits of remediation. In addition, as discussed in Section 5.8, the field testing provided insight into abiotic dechlorination processes occurring in the rock matrix. The timeline of field activities at CPP is provided in Table 5.2.

Table 5.2. Timeline of CPP Field Operations

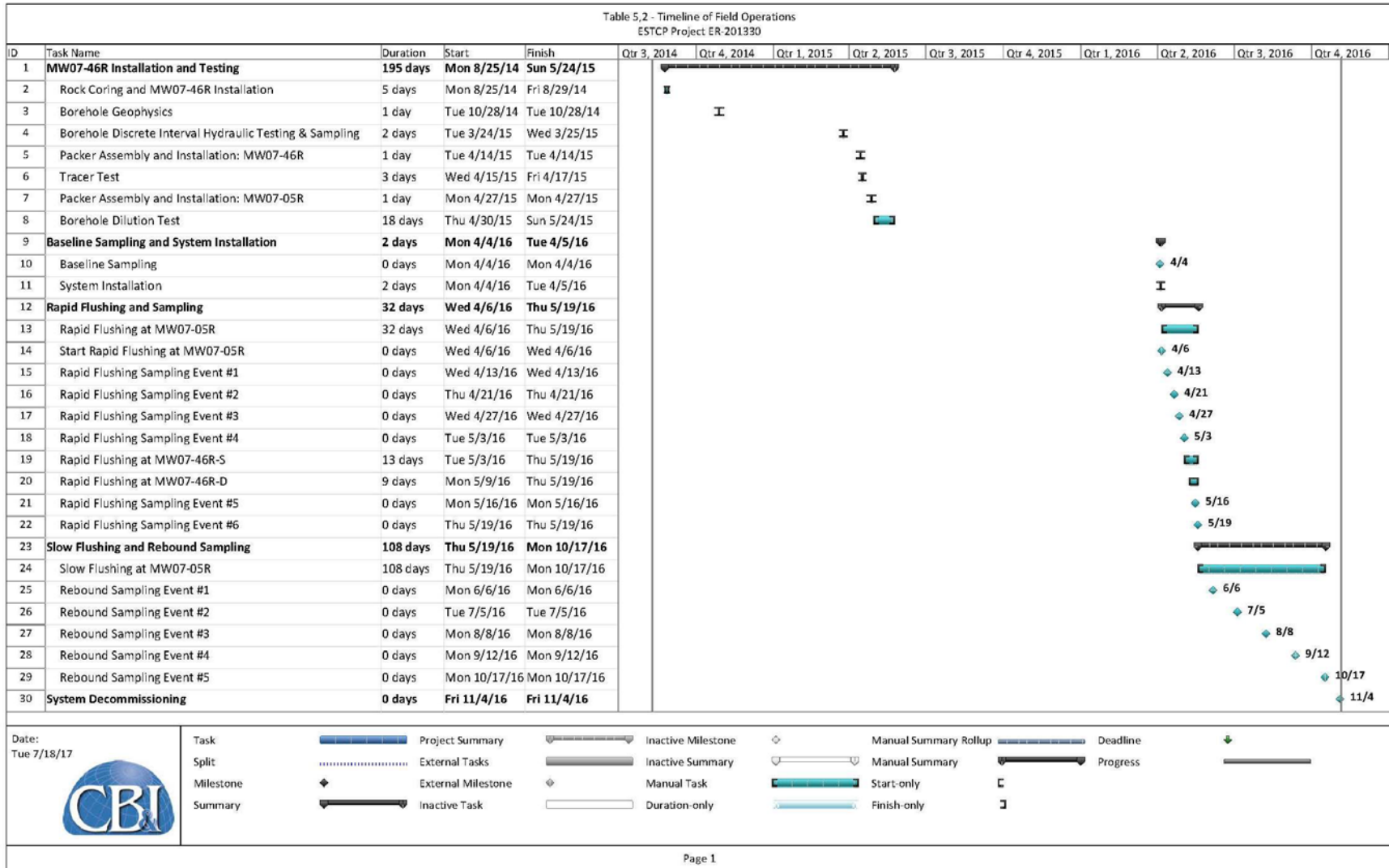

5.5.1 Baseline Sampling

Baseline sampling was performed to determine VOC concentrations and to perform CSIA on TCE, DCE and TeCA. Baseline groundwater sampling was performed at both the injection well (MW07-05R) and the shallow and deep intervals of the monitoring well (MW07-46R). A preliminary baseline sampling event was performed on April 17, 2015 to ensure that TCE concentrations were sufficiently high (as expected) in the monitoring locations. The formal baseline sampling event, which occurred just prior to initiation of the rapid flushing (Section 5.5.2) and included the CSIA, was performed on April 4, 2016.

VOC and anion samples were analyzed by CB&I's NJDEP-certified analytical laboratory, located in Lawrenceville, NJ. CSIA analysis was performed by Pace Analytical, located in Pittsburgh, PA. Details related to the sample collection and analytical methods related to this sampling are described in Section 5.7.

5.5.2 Rapid Flushing and Sampling

Once baseline sampling was complete, the field testing was started. As indicated conceptually in Figure 2.3, the initial rapid flushing step was intended to remove dissolved chlorinated solvent mass from the hydraulically conductive fractures, with a target of 99% decrease in concentration. Rapid flushing began on April 6, 2016, and was performed by injecting potable water into injection well MW07-05R at a constant rate of approximately 300 mL/min for a total of 43 days. The two MLS well intervals (MW07-46R-S and MW07-46R-D) were monitored to assess contaminant flushing from the water bearing fractures between the wells.

Groundwater samples were collected from the two MLS well intervals for VOCs and anions on days 7, 15, 21, 27, 40 and 43 of rapid water injection. After 27 days of potable water injection at well MW07-05R, cVOC concentrations did not decrease sufficiently in either of the MLS well intervals, although contaminant removal in the deep interval was substantially greater than that in the shallow interval. On days 27 and 33, potable water injections were started at MLS well interval MW07-46R-S and MW07-46R-D, respectively. The injection rate at each of these well intervals was maintained at a constant rate of between 100 to 200 mL/min for the remainder of the rapid flushing phase. Potable water injection at MW07-05R was continued at a rate of approximately 150 mL/min during this period. Groundwater samples were collected again from the two MLS well intervals for VOCs and anions twice (day 40 and 43) during simultaneous potable water injections at all three wells.

VOC and anion samples were analyzed by CB&I's NJDEP-certified analytical laboratory, located in Lawrenceville, NJ. Details related to the sample collection and analytical methods related to this sampling are described in Section 5.7. These data indicated a 98.6 percent decrease in TCE at MW07-46R-D, which was the focus of the demonstration, as the tracer test data showed that only the deep interval was well-connected to the injection well. A volume of 4,550 gallons of potable water was injected during this rapid flushing phase.

5.5.3 Rebound Sampling

Following the rapid flushing described above, the rebound phase of the demonstration was initiated. As indicated in Figure 2.3, the rebound phase of the testing was accompanied by a slow injection of clean (potable) water into injection well MW07-05R. The purpose for injecting water without VOCs was to prevent the migration of chlorinated solvents from upgradient to monitoring well MW07-46R, thereby assuring that any observed increase in chlorinated solvents in the monitoring well was from contaminant mass residing between the injection well and the extraction well.

The injection rate used during the rebound phase was intended to limit excessive dilution, while at the same time preventing upgradient impacts to the monitoring well from the low angle fractures intersecting the deep monitoring interval. Based on the ambient Darcy flow (0.091 cm/day) determined during the borehole dilution testing (Section 5.2.7), the ambient flow intersecting the open interval in MW07-05R (11 ft) and out a radial distance of 8 feet is approximately 10 cm³/min. To hydraulically isolate MW07-46R, located at a radial distance of 8 ft away from the injection well, the injection flow rate would need to be at least equal to 10 cm³/min. Thus, the target injection flow rate during the rebound phase was 20 cm³/min. At twice the ambient volumetric flow, the residence time between the injection and monitoring well during the rebound injection phase was approximately half that as under ambient conditions. Based on the 3.5 hour residence time observed during the 75 cm³/min injection that occurred during the first day of the rapid flushing, the residence time during the 20 cm³/min was estimated to proportionally increase to approximately 13 hours.

On May 19, 2016, following the rapid flushing of cVOCs at the injection well and MLS well intervals, potable water injection was halted at the two MLS well intervals, and a significantly reduced flow rate of approximately 20 mL/min (28.8 liters per day) was initiated at injection well MW07-05R. The slow water injection continued for 151 days (until day 194 of field testing) to allow for assessment of contaminant rebound. Bromide tracer (in the form of NaBr) was added to the potable water tanks at a concentration of approximately 200 mg/L. Bromide concentrations were measured at the MLS well intervals during this phase to verify that hydraulic influence was maintained during testing.

Five sets of groundwater samples were collected from the MLS well intervals approximately once per month and analyzed for VOCs and anions (including bromide) during this phase. Additionally, CSIA analysis to determine the carbon isotopic enrichment of TCE and DCE was performed during the final sampling event (October 17, 2016). Groundwater sampling was performed by recirculating approximately one MLS well interval volume of groundwater through the dedicated sample pump and tubing, back into the well, and collecting minimal sample volumes for groundwater analysis. This sampling method was intended to minimize the influence of groundwater extraction on the bedrock fracture system during sampling.

VOC and anion samples were analyzed by CB&I's NJDEP-certified analytical laboratory, located in Lawrenceville, NJ. CSIA analysis was performed by Pace Analytical, located in Pittsburgh, PA. Details related to the sample collection and analytical methods related to this sampling are described in Section 5.7. The slow injection of potable water during this rebound phase was stopped on October 17, 2016, after the final sampling event was completed.

5.5.4 Demobilization

Decommissioning at CPP was performed during November, 2016. These activities included removal of the temporary fence, the two vertical poly water storage tanks, the vinyl shed, the flow meter assembly and associated tubing, custom well heads, and all ancillary equipment. The packer assemblies were removed from wells MW07-05R and MW07-46R, and the nitrogen cylinders used for maintaining packer inflation were returned to the local gas vendor. With the exception of the well packers, all equipment used during the demonstration was disposed of during decommissioning. The well packers were decontaminated and shipped to CB&I's warehouse in Lawrenceville, NJ for storage. The US Navy took possession of well MW07-46R that was installed during the demonstration. Therefore, abandonment of this well was not required.

5.6 DATA ANALYSIS

5.6.1 Rebound Model – Rock Matrix

Results from the rebound evaluation were carefully assessed so as to provide insight into the mechanisms potentially responsible for the increases in any observed TCE concentrations. To determine if the observed TCE rebound during the demonstration (as part of the rebound testing phase as described in Section 5.5.3) could be attribute to matrix back-diffusion, a numerical model was developed to describe the back-diffusion of TCE from the rock matrix into the 3 fracture planes connecting the injection well MW07-05R to the deep interval of the monitoring well (MW07-46R).

As illustrated in Figure 5.8, the model considers a well mixed fracture network of volume V_f [L^3] conveying a volumetric groundwater flow Q [L^3/T] entering from the left (injection well side) with aqueous contaminant source concentration C_1 [M/L^3] and leaving on the right (monitoring well side) with contaminant plume concentration C_2 [M/L^3]. In the rock matrix extending, there is no flow, but there is diffusive one-dimensional transport with diffusion coefficient D_m [L^2/T]. At the fracture-matrix interface of length L and located at $z = 0$ a diffusive mass flux J_m [M/T] occurs, which is taken positive for transport into the matrix. The dissolved contaminant concentrations in the fracture and the matrix are denoted by C_f [M/L^3] and C_m [M/L^3], respectively. The corresponding linearly and instantaneously sorbed contaminant masses per unit fracture or matrix pore volume are denoted by S_f and S_m [M/L^3]. Note that $C_f(t)$ and $S_f(t)$ are functions of time t [T] only, whereas $C_m(z,t)$ and $S_m(z,t)$ are functions of both z and t . Finally, retardation factors (defined as the total contaminant mass in the dissolved and sorbed phases, divided by the dissolved contaminant mass) are denoted by R_f [-] and R_m [-], respectively. First order degradation rates of contaminants in fracture and matrix are denoted by d_f [$1/T$] and d_m [$1/T$]. Note that d_f is applied to the dissolved phase, while d_m is applied to the sorbed phase (in contact with reactive rock material). For dimensional consistency, a transverse width (perpendicular to the plane shown in Figure 5.8) of the model was adopted as W [L]. As discussed in Section 5.2, 3 fractures are present connecting the injection well to the monitoring well, so the overall contaminant and water flux into the monitoring side well are multiplied by 3 in the model. It is noted that, due to the low value of D_m coupled with the value of d_m , model results shown that contaminant (TCE) migration into the rock matrix is very limited (< 3 cm), and thus assuming an infinite medium in the z direction for the rock matrix was shown to be a reasonable assumption.

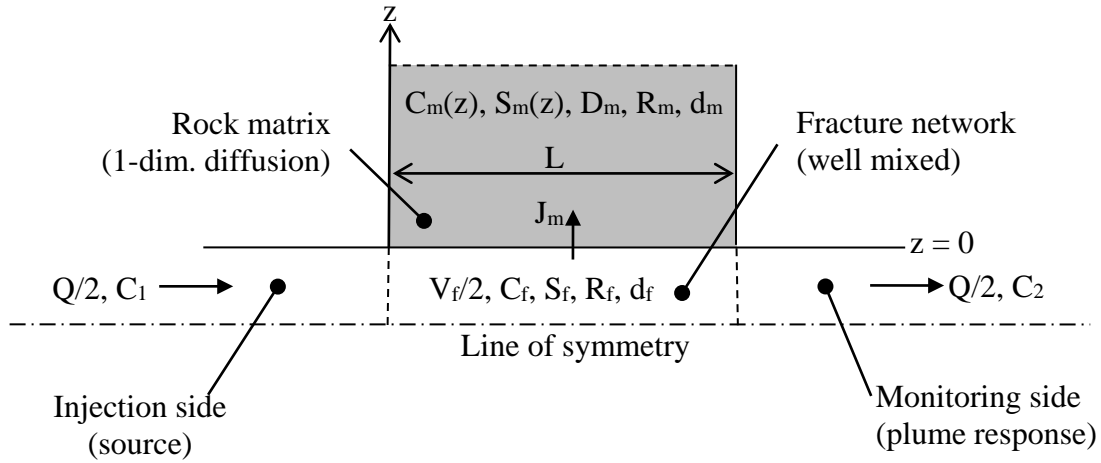

Figure 5.8. Conceptual Model of Transport by Fracture Flow Coupled with Matrix Diffusion (showing upper half of symmetric problem).

The fracture network is assumed to be well mixed, while transport in the rock matrix is purely diffusive in the vertical (z) direction. Retardation and first order degradation can be present to different degrees in both fracture and matrix.

Applying continuity of mass in $V_f/2$ and knowing that $S_f = (R_f - 1)C_f$ and $C_2 = C_f$ we obtain

$$\frac{V_f}{2} \left(\frac{dC_f}{dt} + \frac{dS_f}{dt} \right) = \frac{V_f}{2} R_f \frac{dC_f}{dt} = \frac{Q}{2} C_1 - \frac{Q}{2} C_f - J_m - d_f \frac{V_f}{2} C_f \quad (6)$$

In the rock matrix we adopt the one-dimensional diffusion equation with degradation, while again using $S_m = (R_m - 1)C_m$, to arrive at

$$\frac{\delta C_m}{\delta t} + \frac{\delta S_m}{\delta t} = R_m \frac{\delta C_m}{\delta t} = D_m \frac{\delta^2 C_m}{\delta z^2} - d_m (R_m - 1) C_m \quad (7)$$

Across the interface between fracture and matrix located at $z = 0$, we adopt the condition that fracture / pore water concentration has to be continuous at all times, i.e.,

$$C_m(0, t) = C_f(t) \quad (8)$$

The diffusive mass flux J_m into the matrix is derived from Fick's first law as

$$J_m = -LWD_m \left. \frac{\delta C_m}{\delta z} \right|_{z=0} \quad (9)$$

We take the Laplace transform of Eq. 7 as

$$R_m (C_m^* p - C_{m,0}) = D_m \frac{\delta^2 C_m^*}{\delta z^2} - d_m (R_m - 1) C_m^* \quad (10)$$

where p [1/T] is the Laplace variable, $C_{m,0}(z)$ [M/L³] is the initial pore water concentration distribution in the matrix, and superscript asterisk denotes variables in Laplace space. The solution to Eq. 10 is found as

$$C_m^* = Ae^{-z\sqrt{p'}} + \frac{R_m}{2D_m\sqrt{p'}} \left(\int_0^\infty e^{-\sqrt{p'}|z-\xi|} C_{m,0} d\xi - \int_0^\infty e^{-\sqrt{p'}|z+\xi|} C_{m,0} d\xi \right) \quad (11)$$

where A is a constant and

$$p' = \frac{R_m p + d_m (R_m - 1)}{D_m} \quad (12)$$

The first term on the right-hand-side of Equation 11 represents the homogeneous solution under the condition that $C_m^*(\infty, t) = 0$ (Boyce and DiPrima, 2000; Polyanin and Zaitsev, 2003). The final term is the particular solution (Zill and Wright, 2014) consisting of the superimposed effects of a non-zero initial concentration distribution $C_{m,0}$, while imposing a zero concentration boundary at the fracture through the method of images.

Using Eq. 11 in the Laplace transform of Eq. 8, A is found to be

$$A = C_f^* \quad (13)$$

With this, by differentiating equation 6 the concentration gradient at $z = 0$ is obtained as

$$\left. \frac{\delta C_m^*}{\delta z} \right|_{z=0} = -C_f^* \sqrt{p'} + \frac{R_m}{D_m} \int_0^\infty e^{-\sqrt{p'}\xi} C_{m,0} d\xi \quad (14)$$

Combining Eq. 14 with the Laplace transforms of Eqs. 6 and 9 yields

$$\frac{V_f}{2} R_f (C_f^* p - C_{f,0}) = \frac{Q}{2} C_1^* - \frac{Q}{2} C_f^* - LWD_m C_f^* \sqrt{p'} + LWR_m \int_0^\infty e^{-\sqrt{p'}\xi} C_{m,0} d\xi - d_f \frac{V_f}{2} C_f^* \quad (15)$$

where $C_{f,0}$ [M/L³] is the initial aqueous concentration in the fracture. With this,

$$C_f^* = \frac{\frac{1}{T_f} C_1^* + \frac{2}{a_f} R_m \int_0^\infty e^{-\sqrt{p'}\xi} C_{m,0} d\xi + R_f C_{f,0}}{\frac{1}{T_f} + d_f - d_m (R_m - 1) \frac{R_f}{R_m} + \frac{2}{a_f} D_m \sqrt{p'} + D_m \frac{R_f}{R_m} p'} \quad (16)$$

where $T_f = V_f/Q$ [T] is the mean advective travel time through the fracture and $a_f = V_f/(LW)$ [L] is the equivalent aperture of a perfectly plane and rectangular fracture. Using Eq. 16 with Eqs. 11 and 13 gives

$$C_m^* = C_f^* e^{-z\sqrt{p'}} + \frac{R_m}{2D_m\sqrt{p'}} \left(\int_0^\infty e^{-\sqrt{p'}|z-\xi|} C_{m,0} d\xi - \int_0^\infty e^{-\sqrt{p'}|z+\xi|} C_{m,0} d\xi \right) \quad (17)$$

Eqs. 16 and 17 are the solutions to the flow and transport problem of Figure 5.8 in Laplace space. Analytical back transformation into the time domain seems possible, especially if the polynomial in $p^{1/2}$ in the denominator of Eq. 16 possesses real roots to allow for partial fraction expansion. The final term in Eq. 17 corresponds to the Laplace transform of instantaneous point sources. Numerically inverting these equations using the Stehfest algorithm ([Villinger, 1985; Stehfest, 1970.](#)).

During field testing, the fracture exit concentration $C_2 = C_f$ cannot be directly sampled. Instead, C_f enters the monitoring interval of a sampling well of radius and length equal to 6.1 and 87 cm, respectively. This translates into a volume $V_w = 10000 \text{ cm}^3$ and a cylindrical surface area (exposed to rock) of $A_w = 3300 \text{ cm}^2$. We assume that V_w is another well mixed reservoir receiving flow Q and concentration C_f . Taking advantage of the fact that matrix diffusion into the rock is limited by degradation to a distance much smaller than the well radius, we further convert the cylindrical monitoring interval into an equivalent fracture of aperture $a_w = V_w/(A_w/2) = 6.1 \text{ cm}$ and mean advective travel time $T_w = V_w/Q = T_f V_w/V_f = 20T_f$. Hereby, $V_f = 500 \text{ cm}^3$ is calculated from $a_f = 0.029 \text{ cm}$, 3 fractures, and a distance of $L = 240 \text{ cm}$ between injection and monitoring well, as well as a transverse width $W = 24 \text{ cm}$. The latter is estimated as twice the borehole diameter, corresponding to the flow convergence factor used for borehole dilution tests. Thus, the shown in Figure 5.8 is again applicable, and equations 11 and 12 remain valid in the forms

$$C_w^* = \frac{\frac{1}{T_w} C_f^* + \frac{2}{a_w} R_m \int_0^\infty e^{-\sqrt{p'} \xi} C_{wm,0} d\xi + R_w C_{w,0}}{\frac{1}{T_w} + d_w - d_m (R_m - 1) \frac{R_w}{R_m} + \frac{2}{a_w} D_m \sqrt{p'} + D_m \frac{R_w}{R_m} p'} \quad (18)$$

$$C_{wm}^* = C_w^* e^{-z\sqrt{p'}} + \frac{R_m}{2D_m \sqrt{p'}} \left(\int_0^\infty e^{-\sqrt{p'}|z-\xi|} C_{wm,0} d\xi - \int_0^\infty e^{-\sqrt{p'}|z+\xi|} C_{wm,0} d\xi \right) \quad (19)$$

where C_w [M/L^3] is the dissolved concentration in the sampling interval with initial value $C_{w,0}$, while C_{wm} is the aqueous concentration distribution in the surrounding rock with initial distribution $C_{wm,0}$. Furthermore, $d_w = d_f$ [$1/T$] is adopted as the degradation rate in V_w and $R_w = 1 + (R_f - 1)a_f/a_w$ [-] as the respective retardation factor. The conversion from R_f to R_w represents a simple adjustment for the different volume to surface area ratio between fracture and sampling interval. By substituting equation 11 into 13, C_w is found as a function of C_1 and the initial conditions. In what follows, it is assumed that the monitoring well is installed at time $t = 0$, which is when the source is turned off (C_1 set to zero) and the rapid flushing phase starts. Consequently, and knowing that matrix diffusion results in only very short penetration distances from the fracture, it is assumed that the rock matrix around the well is clean ($C_{wm,0} = 0$ for all z). We further assume that fracture water initially fills up V_w resulting in $C_{w,0} = C_f(t=0)$. Additional model parameters are provided in Table 5.3.

Table 5.3. Model Parameters Used for the CPP Site.

T_f^a	a_f^b	R_f	d_f	R_m^c	d_m^d	D_m^e	T_w	a_w	R_w	d_w
d	cm	-	1/d	-	1/d	cm ² /d	d	cm	-	1/d
0.54	0.029	1	0	2.5	2.3e-3	1.4e-3	20 T_f	6.1	1	0

^a Calculated based on the observed travel time of 0.15 d (3.5 h) observed during the bromide tracer test where in injection flowrate of 75 cm³/min was used, and proportionally increasing the travel time based on the injection flowrate of 20 cm³/min during the rebound phase to 0.54 d (13 h).

^b Based on the calculation presented in Section 5.2. Three fractures of this aperture were present.

^c Based on sorption coefficient $K_d = 0.021$ cm³/g (based on bench scale adsorption testing, coupled diffusion and reaction modeling in the laboratory batch experiment, and based on the fraction of organic carbon present in the rock), matrix porosity $n = 0.039$ and matrix bulk density $\rho = 2.6$ g/cm³.

^d Based on results of the bench scale testing, as described in Section 5.3.3.

^e From $D_m = D_{\text{aqueous}}n^{2.2}$ (Boving and Gratwohl, 2001), with n as the measured matrix porosity of 0.039 (Section 5.3.4.1) and an aqueous TCE diffusion coefficient (D_{aqueous}) of 2.3 cm²/d.

The model simulation was performed in 3 phases: (1) The source-on phase, where incoming fracture concentrations were set to one for a sufficiently long time such that fracture and matrix concentrations approach steady state; this initial phase creates the starting conditions for (2), the rapid flushing phase, where fracture concentrations rapidly decrease. Finally (3), the rebound phase, where the clean water injection rate is set to 20 cm³/min.

5.6.2 CSIA and Abiotic dechlorination

Compound specific isotope analysis (CSIA) for carbon was performed on both TCE and DCE in the deep interval of the monitoring well (MW07-46R). This testing was performed immediately prior to initiation of the rapid flushing, and again at the last rebound sampling point at the completion of the demonstration. Samples were collected for TCE and DCE concentrations at the same time samples were collected for CSIA analysis. DCE was included with TCE because DCE likely was present as a result of biotic reductive dechlorination of TCE; vinyl chloride concentrations were negligible compared to TCE and DCE

The purpose for collecting these samples for CSIA analysis was to assess the nature of the source responsible for the contaminant rebound. Specifically, CSIA testing was used to interrogate the source of the rebound to determine if it was enriched in ¹³C relative to the water migrating through the hydraulically conductive fractures prior to the rapid flushing. An enriched (heavier) TCE+DCE at the end of rebound, without significant accumulation of vinyl chloride, would serve as a line of evidence that these contaminants had migrated from a low permeability zone (i.e., the rock matrix) where abiotic dechlorination was enhanced relative to the fracture zones. Previous studies have shown that ferrous mineral induced abiotic dechlorination can result in ¹³C enrichment (e.g., Zwank, 2005). Furthermore, a recent field study by Damgaard et al. (2013) in a clay till demonstrated that naturally-occurring abiotic dechlorination reactions could be identified via carbon isotopic enrichment. In contrast, Morrill et al. (2009) suggest that rebound caused by DNAPL sources is unlikely to exhibit significant isotopic enrichment.

Thus, it is plausible that carbon isotopic enrichment during post-treatment contaminant rebound can be used as a line of evidence for both identifying abiotic dechlorination in the rock matrix (thus verifying what may be an important natural attenuation mechanism at the site) and for determining the mechanisms (i.e., DNAPL sources or matrix back-diffusion) responsible for the observed rebound.

Enrichment of the combined TCE and DCE was determined based on the following molar isotopic balance:

$$\delta^{13}\text{C}_{\text{TCE+DCE}} = x_{\text{TCE}} \delta^{13}\text{C}_{\text{TCE}} + x_{\text{DCE}} \delta^{13}\text{C}_{\text{DCE}} \quad \text{Eq. 20}$$

where $\delta^{13}\text{C}$ represents the ^{13}C enrichment (per mil) and x represents the molar fraction of either TCE or DCE. An increase in $\delta^{13}\text{C}_{\text{TCE+DCE}}$ after rebound in the absence of vinyl chloride generation suggests that further dechlorination of TCE and/or DCE likely has occurred via an abiotic pathway, with transformation products (e.g., acetylene, propane, ethene) that are amenable to biotic or abiotic oxidation to CO_2 (Schaefer et al., 2015). Since such processes have been shown to occur in the rock matrix of CPP (Section 5.3), observation of such enrichment provides a strong line of evidence that the observed rebound is due to matrix back-diffusion, and that abiotic dechlorination is occurring within the rock matrix.

5.7 SAMPLING METHODS

Groundwater sampling was conducted in order to characterize the distribution of chemical constituents in groundwater, to evaluate rebound and changes in the isotopic ratio of cVOCs in the MLS well, and to determine fracture connectivity between the injection and MLS wells (tracer testing). The varied objectives of the sampling required multiple sampling schemes: each analytical suite and sequencing reflecting the individual goals. The need to minimize the impact of sampling on the bedrock fracture system also necessitated variations in sampling protocol.

5.7.1 Groundwater Sampling

Groundwater samples during tracer testing, borehole dilution testing, and rapid assessment testing were collected by CB&I personnel using modified low-flow purging and sampling techniques. As discussed in Section 5.2.5, dedicated groundwater sampling pumps were installed in injection well MW07-05R and in both of the isolated sample intervals within MLS well MW07-46R. Dedicated sampling pumps and tubing installed into the wells with were left in place the entire duration of the RA testing and therefore did not require decontamination. The groundwater sampling setup consisted of the following pieces of equipment:

- Bladder Pumps-QED Well Wizard T1250 (one per sampling interval);
- Polyethylene air supply tubing (1/4-inch);
- Teflon groundwater discharge/sampling tubing (3/8-inch);
- A Pump Controller-QED MP10 MicroPurge Low-Flow Pump Control; and
- An Air compressor

As discussed above, the varied objectives of the sampling required multiple sampling schemes that reflected individual goal of specific testing. Therefore sampling procedures varied during tracer testing, borehole dilution testing, and the RA testing. These procedures are detailed as follows:

Tracer Testing

Groundwater sampling at the two MLS well intervals (MW07-46R-S/D) was performed by recirculating groundwater within the isolated zone prior to sample collection. Recirculation volumes for each sampling interval were calculated based on the internal volume of the sample tubing and the volume of the pump bladder. A volume equal to 120 percent of the tubing and pump bladder was recirculated to remove stagnant water from the sampling tubing. Groundwater was pumped through the dedicated sample pump and tubing, back into the well. Groundwater recirculation was performed at a pressure and pump controller settings established to provide the desired flow rate of 300 mL/min. Once recirculation was complete a 5 mL sample was collected for on-site bromide analysis, and an additional 5 mL sample was collected for laboratory analysis. This low volume (10 mL) sampling method was performed to minimize the removal of groundwater from the expected small fracture volume between the injection and monitoring well, thus minimizing the influence of groundwater extraction on the bedrock fracture system during sampling. Twenty-two bromide samples were collected from each of the MW07-46R well intervals during the 3 days of tracer testing.

Borehole Dilution Testing

Groundwater sampling methods at injection well MW07-05R during borehole dilution testing were the same as those conducted at MW07-46R-S/D during tracer testing, with the exception of only one 10 mL sample for bromide being collected for laboratory analysis during each sampling event. No on-site bromide analysis was performed. Bromide samples were collected from MW07-05R after bromide addition (time=0), and on days 4, 11, 19 and 25 of testing.

RA Testing

Groundwater sampling at injection well MW07-05R and the two MLS well intervals (MW07-46R-S/D) was performed as described above. Groundwater samples were analyzed for VOCs, anions (bromide), and CSIA as detailed in the following two subsections.

5.7.2 Analytical and Sample Preservation

The analytical methods and sample preservation used for the analyses that were part of this demonstration are summarized in Table 5.4 below. Groundwater samples were submitted to CB&I's Analytical and Testing Laboratory in Lawrenceville, NJ for analysis of VOCs and anions (including bromide). CSIA (¹³C) sample analyses were performed by Pace Analytical, located in Pittsburgh, PA.

Table 5.4. Analytical Methods, Preservation, and Containers -Groundwater

Analyte	Method/ Laboratory	Preservative	Bottle
VOCs	EPA 8260 CB&I	4°C with HCl	8.8 mL VOA vial (x3)
Anions	EPA 300.0 CB&I	4°C	15 mL polypropylene conical tube (x1)
CSIA (Carbon 13 Isotope)	AM24 Pace Analytical	4°C with HCl	40 mL VOA vial (x9)

5.7.3 Groundwater Sampling Locations and Frequency

The numbers and types of groundwater samples collected during RA testing are provided in Table 5.5. Two days prior to the start of testing, baseline groundwater samples were collected at MW07-05R and MW07-46RS/D (see Section 5.5.1). Six rounds of groundwater samples were collected during the rapid flushing phase (Section 5.5.2), and five rounds of groundwater samples were collected during the rebound phase of RA testing (Section 5.5.3).

Table 5.5. Total Number and Types of Samples Collected During RA Testing

Phase	Event	Date	Occurrence	Number of Samples	Analysis	Location
Baseline Sampling	Baseline Sampling	4/4/2016	Day -2	3	VOCs	MW07-05R, MW07-46R-S, MW07-46R-D
					Anions	
					CSIA	
Rapid Flushing and Sampling	Rapid Flush Sampling Event #1	4/13/2016	Day 7	3	VOCs	MW07-05R, MW07-46R-S, MW07-46R-D
					Anions	
	Rapid Flush Sampling Event #2	4/21/2016	Day 15	3	VOCs	MW07-05R, MW07-46R-S, MW07-46R-D
					Anions	
	Rapid Flush Sampling Event #3	4/27/2016	Day 21	2	VOCs	MW07-46R-S, MW07-46R-D
	Rapid Flush Sampling Event #4	5/3/2016	Day 27	2	VOCs	MW07-46R-S, MW07-46R-D
	Rapid Flush Sampling Event #5	5/16/2016	Day 40	3	VOCs	MW07-05R, MW07-46R-S, MW07-46R-D
				Anions		
	Rapid Flush Sampling Event #6	5/19/2016	Day 43	3	VOCs	MW07-05R, MW07-46R-S, MW07-46R-D
Rebound Sampling	Rebound Sampling Event #1	6/6/2016	Day 61	3	VOCs	MW07-05R, MW07-46R-S, MW07-46R-D
					Anions	
	Rebound Sampling Event #2	7/5/2016	Day 90	2	VOCs	MW07-46R-S, MW07-46R-D
					Anions	
	Rebound Sampling Event #3	8/8/2016	Day 124	1	VOCs	MW07-46R-D
					Anions	
	Rebound Sampling Event #4	9/12/2016	Day 159	1	VOCs	MW07-46R-D
					Anions	
	Rebound Sampling Event #5 (final)	10/17/2016	Day 194	2	VOCs	MW07-46R-S, MW07-46R-D
					Anions	
CSIA						

5.7.4 Quality Assurance for Groundwater Sampling and Analysis

5.7.4.1 Calibration Procedures and Frequency

Calibration refers to the checking of physical measurements of both field and laboratory instruments against accepted standards. It also refers to determining the response function for an analytical instrument, which is the measured net signal as a function of the given analyte concentration. These determinations have a significant impact on data quality and are performed regularly. In addition, preventative maintenance is important to the efficient collection of data. For preventative maintenance purposes, critical spare parts were obtained from the instrument manufacturer.

All field and laboratory instruments were calibrated according to manufacturers' specifications. All CB&I laboratory instruments were calibrated in accordance with established Standard Operating Procedures (SOPs). Calibration was performed prior to initial use, during periods of extended use, and after periods of non-use. Certified standards were used for all calibrations and calibration check measurements. A calibration logbook was maintained by CB&I field and laboratory QA personnel.

5.7.4.2 Quality Control Samples

Internal quality control (QC) data provides information for identifying and defining qualitative and quantitative limitations associated with measurement data. Analysis of the following types of field QC samples provided the primary basis for quantitative evaluation of field data quality:

- Trip blanks to evaluate the presence of contamination from handling errors or cross-contamination during transport;
- Field duplicates to assess the homogeneity of samples received by the laboratory as well as the homogeneity of contaminants in the matrix.

Trip Blanks. Trip blanks were prepared by the analytical laboratory with purified water for groundwater samples. The water was sent to the site in the same containers to be used for collection of the samples. Trip blanks were submitted at a frequency of one trip blank per shipment of samples for VOC analysis. For non-VOC analyses, no trip blanks were deemed necessary and none were submitted.

Field Duplicate Samples. Field duplicate samples were analyzed for all VOCs and anions to evaluate the accuracy of the analytical process. Each duplicate was run at a frequency of at least 5 percent of the total number of environmental samples. A comparison of the detected concentrations in the duplicate samples was performed to evaluate precision.

5.7.4.3 Sample Documentation

CB&I Lawrenceville, NJ project staff coordinated shipment and receipt of sample bottles, coolers, ice packs, chain of custody (COC) forms, and custody seals. Upon completion of sampling, the COC was filled out and returned with the samples to the CB&I and Pace Analytical laboratories. An electronic copy of each COC form was placed in the project database.

An important consideration for the collection of environmental data is the ability to demonstrate that the analytical samples have been obtained from predetermined locations and that they have reached the laboratory without alteration. Evidence of collection, shipment, laboratory receipt, and laboratory custody until disposal must be documented to accomplish this. Documentation was accomplished through a COC Record that recorded each sample and the names of the individuals responsible for sample collection, transport, and receipt. A sample is considered in custody if it is:

- In a person's actual possession;
- In view after being in physical possession;
- Sealed so that no one can tamper with it after having been in physical custody; or
- In a secured area, restricted to authorized personnel.

Sample custody was initiated by field personnel upon collection of samples. Samples were packaged appropriately to prevent breakage or leakage during transport, and shipped to the laboratory via either hand delivery or commercial carrier.

5.7.4.4 Sample Identification

A discrete well number was assigned to each sample. This discrete identifier was placed on each bottle and was recorded, along with other pertinent data in a field notebook dedicated to the project. The sample identification number designated the sample location (e.g., "MW07-05R" for this specific monitoring well). The bottle label also contained the site name, the sampling date and time, any preservatives added to the bottle, and the initials of the sampler.

5.7.4.5 Chain-of Custody Forms

The COC Record used by CB&I's laboratory is shown in Figure 5.9. All samples collected for off-site analysis were physically inspected by the Field Technician prior to shipment.

Each individual who had sample in their possession signed the COC Record. Preparation of the COC Record was as follows:

- The COC Record was initiated in the field by the person collecting the sample, for every sample. Every sample was assigned a unique identification number entered on the COC Record.
- The record was completed in the field to indicate project, sampling person, etc.
- If the person collecting the samples did transport the samples to the laboratory or ship the samples directly, the first block for "Relinquished By _____, Received By _____" was completed in the field.
- The person transporting the samples to the laboratory or delivering them for shipment signed the record for as "Relinquished By _____".
- The original COC Record was sealed in a watertight container, taped to the top (inside) of the shipping container, and the shipping container sealed prior to being given to the commercial carrier.

The commercial waybill served as an extension of the COC Record between the final field custodian and receipt by the off-site laboratory.

- Upon receipt by the off-site laboratory, the laboratory QC Coordinator, or designated representative, opened the shipping container(s), compared the contents with the COC Record, and signed and dated the record. Any discrepancies were noted on the COC Record.
- COC Records were maintained with the records for the project, and became part of the data package.

The form is titled "CHAIN OF CUSTODY" and includes the following sections:

- Header:** CBI logo, address (17 Princess Rd, Lawrenceville, NJ 08648), phone/fax numbers, and company name (CB&I - Federal Services, LLC). It also includes a "Ref. Document #", "Page" number, and "of" pages.
- Project Information:** Project Number/Cost code, Project Name / Location, and Purchase Order #.
- Contact Information:** Project Contact (Name & phone #), Lab ID # (with R&D checkbox), and Lab Contact Name / ph. #.
- Shipping Details:** Shipment Date, Waybill/Airbill Number, and Lab Destination.
- Analyses Requested:** A grid for recording requested analyses.
- Collection Information Table:**

Lab No.	Sample ID Number	Sample Description	Date	Time	G/C	Matrix	# of containers	Container size	Preservative						Any Additional Information	Turn Around Time Requested
									HCL	NaOH	HNO ₃	H ₂ SO ₄	Ice			
- Special Instructions:** Includes "Known Waste Stream Circle" (RCRA, PCB/dioxin, PAH/oil, RAD, Corrosive, Flammable, Reactive), "QC Data Package Level Required" (I, II, III, IV, NJ EDD, GIS EDD, Preliminary data), and "G/C Codes" (C = Composite, G = Grab).
- QC Package Codes:** Level I = data summary; Level II = data summary + basic QC; Level III = New Jersey QC reduced deliverable; Level IV = Full deliverable CLP package.
- Signature/Date Section:** Requisitioned By (Date, Time) and Received By (Date, Time) for each sample.
- Instructions:** Do not fill shaded areas; Check R&D Box if R&D samples Only.

Figure 5.9. Chain of Custody Form

5.7.4.6 Laboratory Sample Receipt

Following sample receipt, the Laboratory Manager or qualified personnel:

- Examined all samples and determined if proper temperature has been maintained during transport. If samples had been damaged during transport, the remaining samples were carefully examined to determine whether they were affected. Any samples affected were considered damaged. It was noted on the COC record that specific samples were damaged and that those samples were removed from the sampling program.

- Compared samples received against those listed on the COC record.
- Verified that sample holding times were not exceeded.
- Signed and dated the COC record.
- Recorded samples in the laboratory sample log-in book containing, at a minimum, the following information:
 - Project identification number
 - Sample numbers
 - Type of samples
 - Date and time received.

The COC Record was placed in the project file.

5.7.4.7 Other Documentation

Following sample receipt at the laboratory, the Laboratory Manager or sample custodian clearly documented the processing steps applied to the sample. The analytical data from laboratory QC samples were identified with each batch of related samples. The laboratory log book includes the time, date, and name of the person who logged each sample into the laboratory system. This documentation is thorough enough to allow tracking of the sample analytical history without aid from the analyst. At a minimum, laboratory documentation procedures provide the following:

- Recording in a clear, comprehensive manner using indelible ink.
- Corrections to data and logbooks made by drawing a single line through the error and initialing and dating the correction.
- Consistency before release of analytical results by assembling and cross-checking the information on the sample tags, custody records, bench sheets, personal and instrument logs, and other relevant data to verify that data pertaining to each sample are consistent throughout the record.
- Observations and results identified with the project number, date, and analyst and reviewer signatures on each line, page, or book as appropriate.
- Data recorded in bound books or sheaf of numbered pages, instrument tracings or hard copy, or computer hard copy.
- Data tracking through document consolidation and project inventory of accountable documents: sample logbook, analysis data book, daily journal, instrument logbook, narrative and numerical final reports, etc.

5.8 RESULTS

5.8.1 Results of Baseline Sampling

Results of the baseline sampling for chlorinated VOCs and anions are provided in Table 5.6. Baseline CSIA data are provided in Table 5.7. Chlorinated VOC data are in general agreement with the preliminary data collected in March 2015 (Table 5.1), and show that contaminant levels are slightly greater in the deep interval of MW07-46R than in the other monitoring locations.

TCE is the primary contaminant present. The DCE is more enriched in ¹³C than TCE, likely owing to the fact that DCE is a biotic transformation product of TCE. The trace levels of vinyl chloride present suggest that the continued biotic dechlorination of DCE to vinyl chloride is negligible.

Table 5.6. Chlorinated Solvent and Anion Levels Present in Groundwater during the April 4, 2016 Baseline Sampling at MW07-46R and MW07-05R.

Constituents	Unit	MW07-46R-S (57.8-64 ft bgs)	MW07-46R-D (65.3-68.2 ft bgs)	MW07-05R
Vinyl Chloride	µg/L	15 J	23 J	627
1,1-Dichloroethene	µg/L	32 J	26 J	39 J
<i>trans</i> -1,2-Dichloroethene	µg/L	101 J	342	234
<i>cis</i> -1,2-Dichloroethene	µg/L	769	2690	5360
Trichloroethene	µg/L	7110	14,620	8850
1,1,2-Trichloroethane	µg/L	57 J	123	88 J
Tetrachloroethene	µg/L	40 J	36 J	33 J
1,1,2,2-Tetrachloroethane	µg/L	351	1230	434
Chloride	mg/L	76	126	125
Sulfate as SO ₄	mg/L	36	51	41
Bromide	mg/L	0.4	2.0	3.8

Notes:

J – Estimated value greater than the MDL but less than the PQL.

Table 5.7. CSIA Baseline Data (δ¹³C).

Constituents	MW07-46R (65.3-68.2 ft bgs)	MW07-46R (57.8-64 ft bgs)	MW07-05R
Trichloroethene	-26.26	-20.82	-24.20
<i>cis</i> -1,2-Dichloroethene	-19.38	-16.79	-19.95
1,1,2,2-Tetrachloroethane	49.84	38.74	46.09

5.8.2 Results of flushing

Results of the rapid flushing are summarized in Figure 5.10 below. Rapid flushing was initiated on April 5, 2016 and terminated on May 19, 2016. The rapid flushing was effective in removing >90% of the cVOCs in both the shallow and deep monitoring locations (approximately 98.6% of the TCE was removed in the deep monitoring interval). However, the shallow monitoring location only showed substantial cVOC removal after water was injected directly into the monitoring interval. This result was not unexpected, as the tracer testing showed that the injection well and shallow monitoring interval were poorly connected. As described in Section 5.8.3, evaluation of rebound was therefore limited to the deep interval.

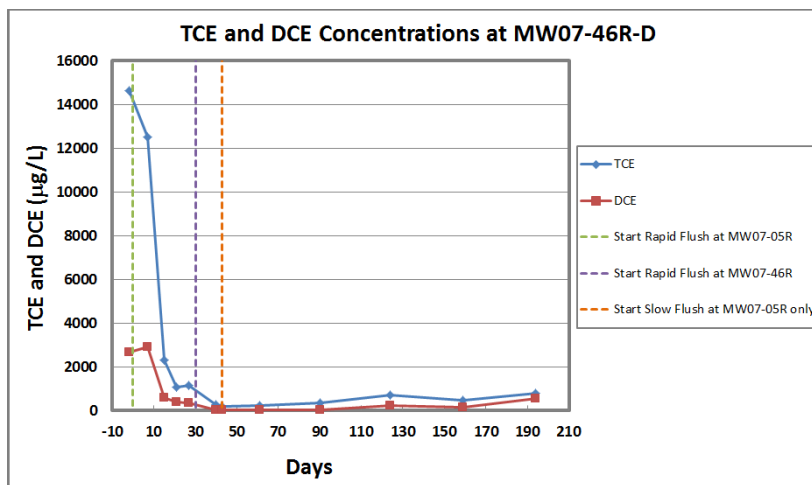
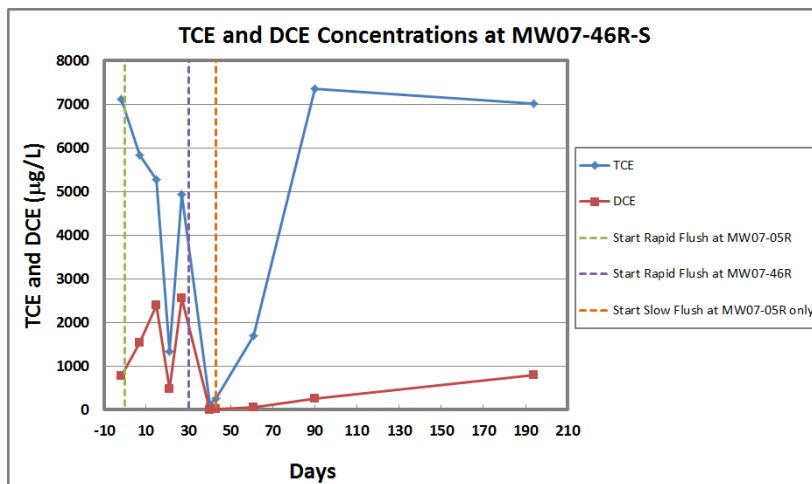
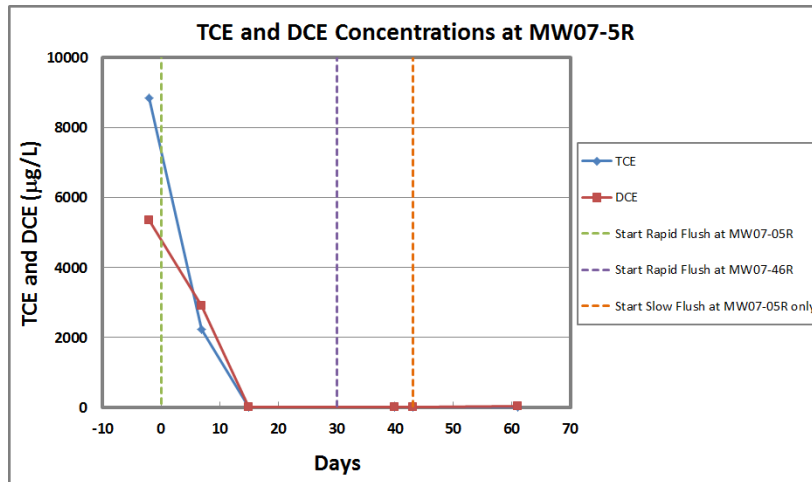

Figure 5.10. TCE and DCE Concentrations Measured Throughout the RA Demonstration.

5.8.3 Results of Rebound

The slow injection (rebound) phase of the demonstration was initiated on May 19, 2016 and continued until October 31, 2016. Based on the results of the bromide tracer testing (Section 5.2.6) that showed the shallow monitoring interval had a poor hydraulic connection to the injection well, assessment of rebound during the slow injection phase was focused on the deep interval of monitoring well MW07-46R.

Increases in TCE and DCE relative to baseline (Table 5.6) plotted as a function of time are shown in Figure 5.11. Results show that TCE and DCE concentrations increased with time, indicating that there was a persistent contaminant mass present between the demonstration wells that was not removed during the rapid flushing.

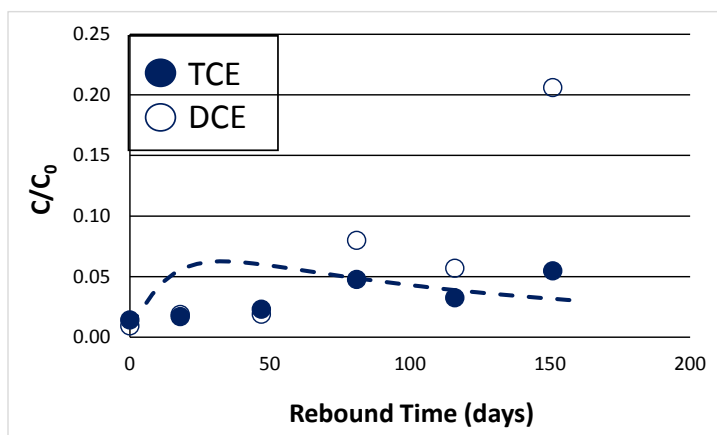

Figure 5.11. Increases of TCE and DCE Relative to their Baseline (prior to rapid flushing) Levels during Rebound at MW07-46R-D.

The dashed line represents the TCE model prediction (Section 5.6.1).

Results of the CSIA analysis, along with the TCE and DCE concentrations just prior to rapid flushing and at the end of the rebound phase, are provided in Table 5.8.

Comparison of the molar averaged ¹³C enrichment shows that the sum of TCE+DCE was enriched at the end of rebound compared to baseline conditions. This result provides a line of evidence for the following:

- The observed rebound was not simply from improper hydraulic control and migration of upgradient contaminated water. If this was the case, no enrichment would be expected due to this dilution.
- That the origin of the TCE and DCE that was observed during rebound had undergone further dechlorination than what was originally present in the hydraulically conductive fractures. Thus, the TCE and DCE were emanating from a location where there was enhanced dechlorination of these compounds.
- Since the absence of appreciable levels of vinyl chloride indicates that biotic reactions likely were not responsible for the continued TCE and DCE dechlorination, abiotic dechlorination serves as a plausible explanation for the enhanced transformation.

- Bench scale testing showed that abiotic dechlorination occurs in the rock matrix, thus the CSIA results provide a line of evidence that the observed contaminant rebound is due to matrix back-diffusion.

Table 5.8. CSIA Results for TCE and DCE.

Contaminant	Baseline (Prior to Rapid Flushing)		End of Rebound	
	Concentration (μM)	$\delta^{13}\text{C}$ (per mil)	Concentration (μM)	$\delta^{13}\text{C}$ (per mil)
TCE	111	-26.3	6.1	-16.6
DCE	27	-15.6	5.6	-21.6
$\delta^{13}\text{C}_{\text{TCE+DCE}}$ (Eq. 20)	-24.2		-19.0	

In addition to the CSIA data, the diffusion model (Section 5.6.1) serves as another line of evidence that the observed rebound is due to matrix back-diffusion. As shown in Figure 5.11, the model provides a generally reasonable prediction of the observed TCE rebound.

The ratio of DCE to TCE increased following rebound. This ratio increase was likely due to biotransformation of TCE to DCE that occurred within the rock matrix, suggesting that biotic transformation of TCE to DCE also was enhanced within the rock matrix. While DCE can be generated from the biotic degradation of 1,1,2,2-tetrachloroethane, such biodegradation has been shown to be accompanied by significant generation of *trans*-1,2,-dichloroethene (tDCE) (Chen et al., 1996); no significant increasing trend in the ratio of tDCE to TCE was observed during rebound, suggesting that biodegradation of the relatively low concentrations of 1,1,2,2-tetrachloroethane (Table 5.6) were not responsible for the observed increasing ratio of DCE to TCE during rebound.

Based on the increase in DCE to TCE ratio observed during rebound, approximately 20% (on average) of the TCE that back-diffused was transformed to DCE. Thus the TCE plotted in Figure 5.11 would be approximately 20% greater in absence of biotic transformation to DCE. This increase in the DCE to TCE ratio may have also been due, in part, to the fact that DCE abiotic dechlorination likely is less than that of TCE (Lee and Batchelor, 2002).

6.0 PERFORMANCE ASSESSMENT

6.1 SUBSTANTIAL DECREASES IN CHLORINATED SOLVENT CONCENTRATIONS FOLLOWING FAST FLUSHING

As discussed in Section 5, rapid flushing resulted in a substantial (nearly 99%) decrease in TCE at the completion of the fast flushing stage in both the injection well and the deep monitoring well. A 96% decrease was attained in the shallow monitoring interval.

6.2 REMOVAL OF PERMANGANATE PRIOR TO REBOUND PHASE

Trace levels of permanganate persisted at the NAWC site, and may have impacted the observed rebound rate. No oxidant was used for the subsequent demonstration performed at CPP.

6.3 EFFECTIVE REBOUND MONITORING TO ASSESS POTENTIAL REMEDIAL PERFORMANCE

As discussed in Section 5.8.3, the rate of rebound, the TCE:DCE ratio, and CSIA analyses all provided useful information regarding the likely source of the observed TCE rebound, and were useful in developing a conceptual model for the site. It is important to note that the extent of rebound observed during the RA testing is not necessarily proportional to the extent of rebound that would be observed following remedial treatment. The RA testing provides a rate of contaminant increase (or, equilibrium contaminant concentration) for a given residence time, and for a given “treatment” time that is equal to the duration of the rapid flushing. Results from the RA testing would need to be scaled to the residence time and length scales of the targeted treatment zone. For the case where matrix back diffusion is identified as the mechanism for the observed rebound, based on the model and CSIA evaluations discussed in Section 5.8.3, use of models such as CRAFLUSH (Sudicky and Frind, 1982; Davis and Johnston, 1984; Sudicky and Frind, 1984) can be used to scale results accordingly. The model presented in Section 5.6.1 also could be readily scaled to the appropriate aquifer treatment scale. What is key is that the results of the rebound testing provide the critical mass transfer parameters needed to assess the impacts of the rock matrix, and any dechlorination reactions therein, on groundwater quality. For the case where matrix back diffusion is not responsible (based on application of the model) for the observed rebound, DNAPL sources and/or contaminant mass in lower transmissivity fractures would be the suspected cause of the rebound. Additional tracer testing, as described in Schaefer et al. (2016) would need to be implemented to provide additional characterization.

6.4 EASE OF IMPLEMENTATION

As discussed in Appendix A, the initial efforts for the demonstration using permanganate were problematic due to permeability loss in fractures and the persistence of trace levels of permanganate despite aggressive water flushing. Implementation of the demonstration at CPP using only water flushing (no permanganate injection) was more effective and did not suffer from implementation issues. Relying on gravity drainage from the tank required regular O&M efforts; if power was available, use of a small pump would have alleviated much of the labor efforts needed to maintain a relatively constant injection flow rate.

6.5 RECOMMENDED TESTING PROTOCOL

Based on the findings attained from this demonstration, a generalized protocol has been developed for potential future applications of this rapid assessment technique in fractured rock. This protocol is meant to serve as an incremental approach for planning and implementation of this testing method, but is not meant to serve as an exhaustive or constrictive guidance under the wide range of site specific conditions that may be encountered. The protocol is provided in Appendix F.

7.0 COST ASSESSMENT

7.1 COST MODEL

In order to evaluate the cost of the RA remedial evaluation technique, and compare it against other remedial approaches, costs associated with various aspects of the demonstration were tracked throughout the course of the project. Table 7.1 summarizes the various cost elements and total cost of the demonstration project. The costs have been grouped by categories as recommended in the Federal Remediation Technologies Roundtable Guide to Documenting Cost and Performance for Remediation Projects (FRTR, 1998). Many of the costs shown on this table are a product of the innovative and technology validation aspects of this project, and would not be applicable to a typical site application. Therefore, a separate “discounted costs” column that excludes or appropriately discounts these costs has been included in Table 7.1 to provide a cost estimate for implementing this technology at the same scale as the demonstration (i.e., pilot scale).

Costs associated with the demonstration were tracked from June 2013 to June 2017. The total cost of the demonstration was \$696,880, which included \$181,785 in capital costs, \$173,190 in operation and maintenance (O&M) costs, and \$341,905 in demonstration-specific costs (cost related to ESTCP requirements, site selection and characterization).

7.1.1 Capital Costs

Capital costs (primarily system design and installation) accounted for \$181,785 (or 26 percent) of the total demonstration costs. As indicated in Table 7.1, these costs exceed what would be expected during a typical remediation project mainly due to the demonstration being performed at two separate sites.

7.1.2 O&M Costs

O&M costs accounted for \$173,190 (or 25 percent) of the total demonstration cost. These costs consisted primarily of groundwater monitoring (including analytical), system O&M, and reporting costs. System O&M costs were \$112,491, or 16 percent of total demonstration costs. Extensive performance monitoring activities were conducted to effectively validate this technology; including 1 baseline, 11 demonstration monitoring groundwater sampling events.

Table 7.1. Demonstration Cost Components

Cost Element	Details	Tracked Demonstration Costs	Discounted Costs ¹
CAPITAL COSTS			
System Design	Labor	\$17,752	\$8,000
Well Installation & Development, site prep	Labor & Travel	\$52,098	\$20,000
	Materials	\$11,210	\$5,600
	Subcontracts (driller)	\$44,012	\$30,000
	Subcontracts (waste T&D)	\$2,451	\$2,451
System Installation (inc. system components and materials)	Labor & Travel	\$29,977	\$19,000
	Equipment & Materials	\$24,284	\$14,000
Subtotal		\$181,785	\$99,051
OPERATION AND MAINTENANCE COSTS			
System O&M (inc. groundwater sampling)	Labor	\$74,941	\$37,500
	Materials & Equipment	\$34,378	\$17,200
	Travel	\$3,171	\$1,600
Analytical	In-House Labor	\$22,145	\$0
	Outside Labs	\$3,275	\$15,000
Quarterly Reporting & Data Management	Labor	\$29,977	\$10,000
	Subcontractor (CDM Smith)	\$5,302	\$0
Subtotal		\$173,190	\$81,300
OTHER TECHNOLOGY-SPECIFIC COSTS			
Site Selection	Labor & Travel	\$12,612	\$0
Site Characterization (geophysical logging, packer testing, pump tests, borehole dilution and tracer testing)	Labor (including in-house analytical)	\$59,424	\$28,200
	Travel	\$5,802	\$3,000
	Materials & Equipment	\$20,373	\$10,200
	Outside Lab	\$2,387	\$2,387
	Subcontractor (geophysical)	\$5,082	\$5,082
Treatability Studies	Labor (including in-house analytical)	\$6,765	\$0
Demonstration Plan/Work Plan	Labor	\$29,755	\$15,000
IPR Meetings	Labor	\$7,494	\$0
	Subcontractor (CDM Smith)	\$7,954	\$0
Project Management (financial/administrative)	Labor	\$26,128	\$17,000
Data Evaluation and Model Development	Labor	\$16,429	\$10,000
	Subcontractor (CDM Smith)	\$7,954	\$0
	Subcontractor (Univ. of Florida)	\$46,936	\$0
Technology Transfer (presentations, papers)	Labor & Travel	\$20,240	\$0
	Subcontractor (CDM Smith)	\$13,256	\$0
Final Report and Cost & Performance Report	Labor	\$34,756	\$20,000
	Subcontractor (CDM Smith)	\$18,559	\$0
Subtotal		\$341,905	\$110,869
TOTAL COSTS		\$696,880	\$291,220

Notes:

¹Discounted costs are defined as estimated costs to implement this technology at the same scale as the demonstration. These costs do not include the technology validation aspects of this ESTCP demonstrations, such as site selection, treatability studies, extensive groundwater sampling, ESTCP demonstration reporting and meeting (IPR) requirements, and preparation of technical and cost and performance reports.

7.1.3 Demonstration-Specific Costs

Other demonstration-specific costs (those costs not expected to be incurred during non-research-oriented remediation projects) accounted for \$341,905 (or 49 percent) of the total demonstration cost. These costs included site selection, laboratory treatability studies, laboratory buffer testing, laboratory electrode testing, hydrogeologic testing, tracer tests, ESTCP demonstration reporting and meeting (IPR) requirements, and preparation of extensive technical and cost and performance reports.

7.2 COST DRIVERS

7.2.1 General Considerations

The expected cost drivers for performing the RA remedial evaluation technique, and those that will contribute to determining the cost/selection of this technology over other options, include the following:

- Depth of the treatment area below ground surface;
- Aquifer lithology and hydrogeology;
- Duration of testing;
- Number of RA test locations needed, which will be dependent on site geology, contaminant distribution, and targeted treatment area; and
- Site logistics (accessibility, availability of utilities, etc.).
- Length scale (i.e., distance between injection and monitoring well), which is controlled by fracture connectivity and system heterogeneity

7.2.2 Competing Treatment Technologies

Though the RA remedial evaluation technique is unique based on the information that can be obtained over a short duration, its cost can be compared to conducting a pilot study of a more conventional technology such as a bioremediation with groundwater recirculation (with the understanding that less information will likely be obtained).

Bioremediation (active, passive, or semi-passive approaches) can be utilized to treat source areas and diffuse plumes or as a barrier to protect downgradient receptors. The plume characteristics and those of the local aquifer will play an important role in the cost and applicability of the technology for remediation of VOC-contaminated groundwater. For shallow overburden groundwater plumes (< 50 ft bgs), passive *in situ* options, such as installation of a PRB consisting of either injection well or direct-push applied slow-release substrates (like EVO) are likely to be cost effective options, providing the selected substrate(s) have been shown to stimulate indigenous microorganisms capable of degrading target contaminants at the treatment site. These passive systems require little O&M after installation, and have the ability to prevent plumes from spreading or leaving a site. However, they may be less suitable at sites where concerns about secondary groundwater contaminants (e.g. reduction and mobilization of Fe, Mn, and As, sulfide from sulfate reduction, etc.) exist.

For deeper plumes (e.g. >50 ft. bgs), those in fractured bedrock, or those that are large or very thick, passive approaches are often not technically feasible and are cost-prohibitive (e.g., injecting passive substrates at closely spaced intervals to >50 ft bgs). Active or semi-passive treatment systems may be technically and economically more attractive under these conditions. Active treatment approaches may also be better suited for heterogeneous geologies or sites where pH adjustment is required, as groundwater recirculation improves mixing and distribution of injected amendments within the subsurface. Longer treatment time frames, high contaminant concentrations, and secondary reactions may also present conditions favorable for utilizing an active approach, since amendment addition and mixing rates can be adjusted more easily than with passive approaches, which often utilize less frequent injection of amendments at high concentrations. However, these approaches may be limited where re-injection of contaminated water with amendments is either prohibited or subject to regulatory injection permits.

7.3 COST ANALYSIS

A cost analysis of the RA remedial evaluation technique and one of the traditional cVOC groundwater treatment approaches (active bioremediation with recirculation) was performed. Cost estimates for the RA remedial evaluation technique and a pilot scale application of active bioremediation with recirculation were developed. The cost analyses comparing the above approaches are presented below based on a 3-year operating scenario.

7.3.1 Base Cost Template

The base case presented in Krug et al. (2009) is modified as a template for the cost analysis of the above technologies/approaches. The base case presents a situation where a bedrock aquifer contains a dissolved TCE source area extending to 75 feet bgs, and is 60 feet long and 30 feet wide, perpendicular to groundwater flow (Figure 7.1). The specific base case site characteristics, including aquifer characteristics and design parameters for each of the remedial assessment approaches analyzed are summarized in Table 7.2.

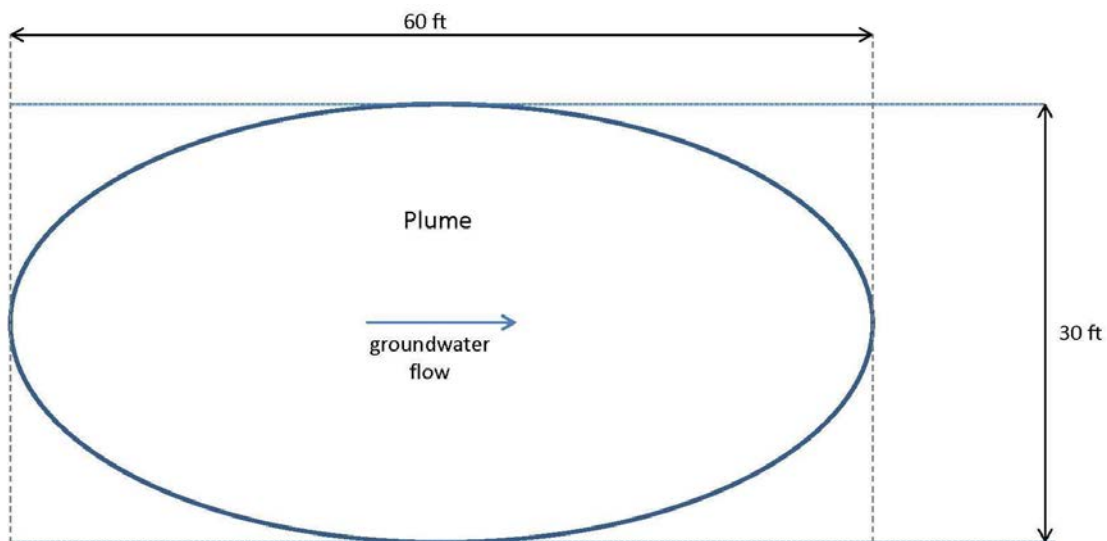

Figure 7.1. Base Plume Characteristics

The following subsections provide cost estimates for implementation of each of the two remedial assessment approaches for the base case. The cost estimates provide insight into the comparative capital, O&M, and long term monitoring costs to better identify cost drivers for each technology/approach. Total costs for each of the assessment approaches were calculated. Net Present Value (NPV) of future costs were not calculated, as these assessment approaches are short-term tests, with no long term monitoring costs. Specifically excluded from consideration are the costs of pre-assessment site characterization activities, assuming the costs for these activities would be similar for each alternative.

Table 7.2. Summary of Base Case Site Characteristics and Design Parameters

Design Parameter	Units	Alternative	
		Rapid Assessment Technology	Bioaugmentation Recirculation Pilot Test
Width of Source Area	feet	N/A	30
Length of Source Area	feet	10	60
Treatment Area	sq. ft.	N/A	1,800
Depth to Top of Treatment Zone	feet	25	25
Depth to Bottom of Treatment Zone	feet	75	75
Thickness of Overburden in Treatment Area	feet	10	10
Thickness of Bedrock in Treatment Area	feet	65	65
Depth to Water	feet	25	25
Vertical Saturated Thickness in Treatment Area	feet	50	50
Porosity	dimensionless	0.05	0.05
Treatment Zone Volume	cu. ft.	N/A	4,500
Number of Injection Wells	each	1	1
Diameter of Injection Well Borehole	inches	4	8
Number of Extraction Wells	each	0	1
Diameter of Extraction Well Borehole	inches	N/A	8
Number of Monitoring Wells	each	1	2
Diameter of Monitoring Well Borehole	inches	4	8
Recirculation System Required	Yes/No	No	Yes
Treatment Timeframe	months	6	12
Rebound Assessment Period	months	N/A	6

7.3.2 Rapid Assessment Approach

The RA alternative assumes that one injection and one monitoring well will be installed in the source area as shown in Figure 7.2. The alternative will be operated as it was at the Calf Pasture Point site, discussed earlier in this document, with an operational period of 6 months.

As summarized in Table 7.3, the estimated total cost for this alternative over the 1 year project duration is \$284,400. The capital cost including design, work plan, installation of the two bedrock wells, site characterization (including packer testing, pump testing, borehole dilution testing, and tracer testing), construction of the water delivery system, system start up and testing, data evaluation, and final reporting is approximately \$214,000. The cost of O&M is estimated at approximately \$45,900 for the 6 months of active treatment. The O&M costs include the labor associated with system O&M, equipment repair and replacement, utilities/fuel, waste disposal, and well abandonment. Groundwater monitoring costs are estimated at approximately \$24,500 over the 6 months of testing. The estimate assumes that five groundwater monitoring events occur during that time period, including one baseline round, followed by three monthly rounds and one quarterly round.

This alternative ranks lower in estimated total remedy cost (see Table 7.4) when compared to the bioremediation recirculation pilot test (see Section 7.3.3). This is mainly due to the lower capital costs associated with the well drilling and system components, as well as the lower O&M and groundwater monitoring costs.

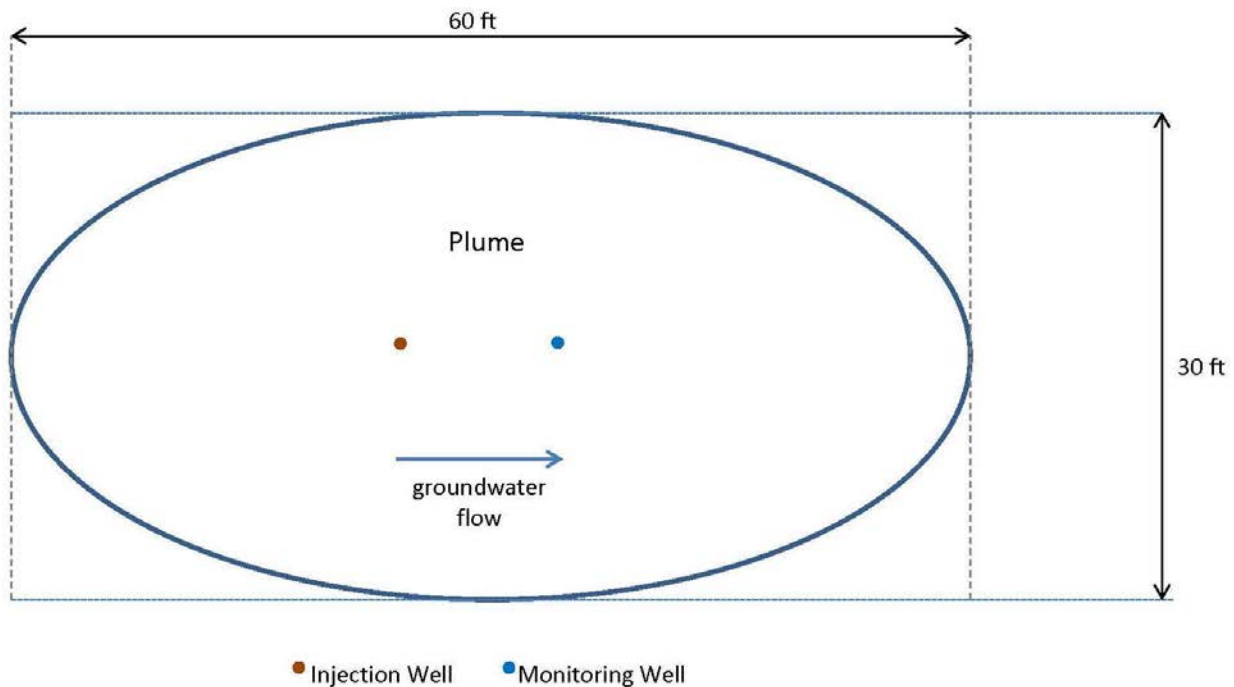

Figure 7.2. Rapid Assessment Technology Approach

Table 7.3. Cost Estimates for Treatment Approaches

Rapid Assessment Approach			Bioremediation Recirculation Pilot Study		
<i>Capital Costs</i>		<i>\$214,000</i>	<i>Capital Costs</i>		<i>\$364,000</i>
System Design	\$8,000		System Design	\$15,000	
Workplan	\$15,000		Workplan	\$15,000	
Site Planning/Permitting	\$2,000		Site Planning/Permitting	\$2,000	
Project Management	\$31,200		Project Management	\$62,400	
Well Installation			Well Installation		
	Mobilization	\$3,000		Mobilization	\$3,000
	Oversight Labor	\$6,000		Oversight Labor	\$12,000
	Travel/Per Diem	\$1,000		Travel/Per Diem	\$2,000
	Subcontract Driller	\$36,000		Subcontract Driller	\$72,000
	Subcontract Surveyor	\$3,000		Subcontract Surveyor	\$3,000
	Materials/Consumables	\$1,000		Materials/Consumables	\$1,000
	Utilities/Fuel	\$1,000		Utilities/Fuel	\$1,000
	Waste Disposal	\$2,000		Waste Disposal	\$5,000
Site Characterization			Site Characterization		
	Packer/Pump/Dilution/Tracer Testing Labor	\$28,000		Packer/Pump Testing Labor	\$15,000
	Travel/Per Diem	\$3,000		Travel/Per Diem	\$3,000
	Geophysics	\$5,000		Geophysics	\$5,000
	Materials/Equipment	\$6,000		Materials/Equipment	\$6,000
System Installation			System Installation		
	Oversight Labor	\$12,000		Oversight Labor	\$24,000
	Travel/Per Diem	\$2,000		Travel/Per Diem	\$4,000
	Shed System	\$10,000		Conex Box System	\$75,000
	Subcontract System Install	\$0		Subcontract System Install	\$5,000
	Materials/Consumables	\$1,000		Materials/Consumables	\$1,000
	Utilities/Fuel	\$3,000		Utilities/Fuel	\$3,000
System Start-Up Testing	\$4,800		System Start-Up Testing	\$9,600	
Data Evaluation/Final Report	\$30,000		Data Evaluation/Final Report	\$20,000	
<i>Operation and Maintenance Costs</i>		<i>\$45,900</i>	<i>Operation and Maintenance Costs</i>		<i>\$93,800</i>
	Labor (System Operation)	\$24,960		Labor (System Operation)	\$49,920
	Labor (Data Management)	\$6,240		Labor (Data Management)	\$12,480
	Travel/Per Diem	\$5,200		Travel/Per Diem	\$10,400
	Subcontractor (well abandon)	\$4,000		Subcontractor (well abandon)	\$8,000
	Equipment/Parts	\$500		Equipment/Parts	\$1,000
	Materials/Consumables	\$2,000		Materials/Consumables	\$5,000
	Utilities/Fuel	\$2,500		Utilities/Fuel	\$5,000
	Waste Disposal	\$500		Waste Disposal	\$2,000
<i>Groundwater Monitoring Costs</i>		<i>\$24,500</i>	<i>Groundwater Monitoring Costs</i>		<i>\$74,700</i>
	Labor (Sample Crew)	\$12,000		Labor (Sample Crew)	\$43,200
	Analytical	\$10,000		Analytical	\$27,000
	Sampling Equipment	\$2,500		Sampling Equipment	\$4,500
TOTAL		\$284,400	TOTAL		\$532,500

7.3.3 Bioremediation Recirculation Pilot Study

The Bioremediation Recirculation System alternative assumes that one injection and one extraction well will be installed in the source area as shown in Figure 7.3, with two monitoring wells in between along the groundwater flow path. Groundwater will be recirculated between the extraction and injection wells, and substrate added periodically over a period of 1 year, after which time the system will be shut down and a 6 month long rebound assessment period will commence.

As summarized in Table 7.3, the estimated total cost for this alternative over 2 years is \$532,500. The capital cost including design, work plan, installation of recirculation and monitoring wells, site characterization (including packer and pump testing), construction of the groundwater recirculation and amendment mixing systems, system start up and testing, data evaluation, and final reporting is approximately \$364,000. The cost of O&M is estimated at approximately \$93,800 for the 1 year of active treatment. The O&M costs include the labor associated with system O&M, equipment repair and replacement, substrate (electron donor/nutrient), utilities/fuel, waste disposal, and well abandonment.

Groundwater monitoring costs are estimated at approximately \$74,700 over 18 months (1 year of active treatment and 6 months for rebound assessment). The estimate assumes that nine groundwater monitoring events occur during that time period, including one baseline round, followed by three monthly rounds and five quarterly rounds.

This alternative has an estimated total remedy cost almost double that of the Rapid Assessment approach, mainly due to the higher capital costs associated with the well drilling and higher O&M and groundwater monitoring costs during the 1 year active treatment period (see Table 7.4). *It also is critical to note that the bioremediation recirculation study likely will not provide the mechanistic information that the RA approach provides.*

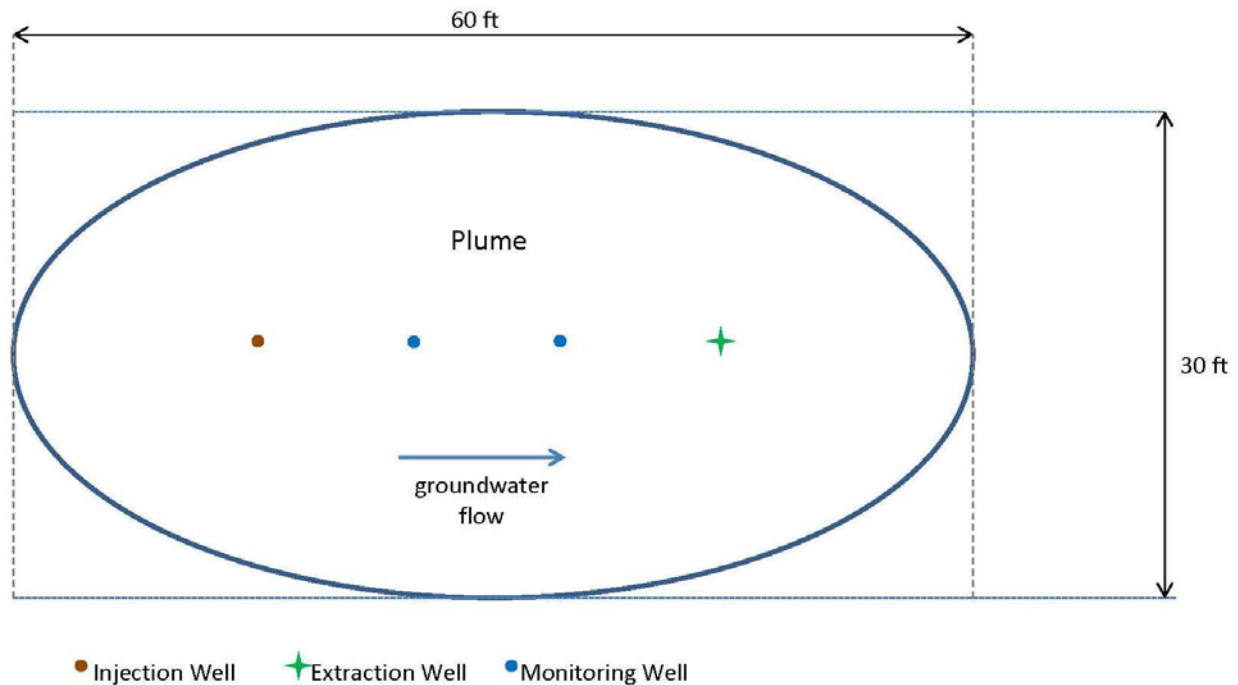

Figure 7.3. Bioremediation Recirculation Pilot Study

Table 7.4. Summary of Costs for Treatment Alternatives

Alternative	Capital Costs	O&M Costs	Groundwater Monitoring Costs	Total Alternative Costs
Rapid Assessment Approach	\$214	\$46	\$25	\$284
Bioremediation Recirculation Pilot Test	\$364	\$94	\$75	\$533

Notes:

All costs are in thousands of dollars

O&M - Operation and Maintenance

8.0 IMPLEMENTATION ISSUES

The primary issues related to implementation of the RA testing were as follows:

- ***Complexity of the fracture flow paths.*** Despite the close distance and identification of (apparently) connected fracture planes at the CPP site (as indicated by the hydraulic response during the short-term pump testing), injected tracer and amendments did not appreciably migrate to the monitoring shallow. The likely cause was that the injected flow moved along preferential flow paths, and did not intersect the shallow zone. Such flow complexities would complicate the rapid assessment testing, and would likely require the use of a more complex forced-gradient approach (e.g., use of both an injection and extraction well, with the monitoring well located in between).

The complexity of the fracture flow path is will impact the length scale of the RA test (i.e., the distance between the injection well and monitoring well). If this length scale is insufficient to capture a representative zone of the bedrock hydrogeology, then additional RA tests (using additional well pairs) may be needed to assess the site.

- ***Long-term injection into the injection well.*** Delivery of water into the injection well was maintained using gravity feed coupled with a flow controller. While some variability in the flow was expected as the feed tank slowly trained, the flow controller required constant adjustment to maintain a relatively steady flow (much more adjustment than could be explained by the hydraulic head variability). For future implementation of this approach, use of a chemical feed pump to maintain a consistent low injection flow is recommended to overcome this issue. These pumps typically have low power requirements, which could be supplied via battery and/or solar sources. Additionally, they require limited maintenance and their operation, as well as water levels within the feed tank, could be remotely observed through solar-powered telemetry.

Page Intentionally Left Blank

9.0 REFERENCES

- Annable, M.D., K. Hatfield, J. Cho, H. Klammler, B.L. Parker, J.A. Cherry, and P.S.C. Rao. 2005. Field-Scale Evaluation of the Passive Flux Meter for Simultaneous Measurement of Groundwater and Contaminant Fluxes. *Environ. Sci. Technol.* 39:7194-7201.
- Boving, T.B. and P. Gratwohl. 2001. Tracer diffusion coefficients in sedimentary rocks: correlation to porosity and hydraulic conductivity. *J. Contam. Hydrol.* 53:85-100.
- Boyce, W.E., DiPrima, R.C., 2000. Elementary Differential Equations, 7th Edition. Wiley, New York.
- Chapman, S.W. and B.L. Parker. 2005. Plume persistence due to aquitard back diffusion following dense nonaqueous phase liquid source removal or isolation. *Water Resour. Res.* 41: 1-16.
- Chen, C., J. Puhakka, and J.F. Ferguson. 1996. Transformations of 1,1,2,2-tetrachloroethane under methanogenic conditions. *Environ. Sci. Technol.* 30:542-547.
- Damgaard, I., P.L. Bjerg, J. Baelum, C. Scheutz, D. Hunkeler, C.S. Jacobsen, N. Tuxen, and M.M. Broholm. 2013. Identification of chlorinated solvents degradation zones in clay till by high resolution chemical, microbial and compound specific isotope analysis. *J. Contam. Hydrol.* 146:37-50.
- Davis, G.B. and C.D. Johnston. 1984. Comments on "Contaminant Transport in Fractured Porous Media: Analytical Solutions for a System of Parallel Fractures" by E. A. Sudicky and E.O. Frind". *Water Resour. Res.* 20:1321-1322.
- Doughty, C. 2010. Analysis of three sets of SWIW tracer-test data using a two-population complex fracture model for matrix diffusion and sorption. Lawrence Berkeley National Laboratory, LBNL-3006E.
- EA Engineering, Science & Technology, 1998. Final IR Program Site 07, Calf Pasture Point, Phase III Remedial Investigation, Volume I: Technical Report. Naval Construction Battalion Center Davisville, Rhode Island. September 1998.
- EA Engineering Science & Technology, 1999. Final ROD. Site 07 – Calf Pasture Point.
- Haggerty, R., S.W. Fleming, L.C. Meigs, and S.A. McKenna. 2001. Tracer tests in a fractured dolomite. 2. Analysis of mass transfer in single-well injection-withdrawal tests. *Water Resour. Res.* 37:1129-1142.
- Hansen, M.W., T. MacHarg, J. Specht, and M. Pehlivan. 2004. Results from a Two-phase Extraction Pilot Study with Low-level Chlorinated Hydrocarbons and Aromatics. The Fourth International Conference on Remediation of Chlorinated and Recalcitrant Compounds (Monterey, California). Paper 3C-14. May 24-27.
- Huang, Q., H. Dong, R.M. Towne, T.B. Fischer, and C.E. Schaefer. 2014. Permanganate diffusion and reaction in sedimentary rocks. *J. Contam. Hydrol.* 159:36-46.

- Hunkeler, D., Y. Abe, M.M. Broholm, S. Jeannotat, C. Westergaard, C.S. Jacobsen, R. Aravena, and P.L. Bjerg. 2011. Assessing chlorinated ethene degradation in a large scale contaminant plume by dual carbon-chlorine isotope analysis and quantitative PCR. *J. Contam. Hydrol.* 119:69-79.
- Istok, J.D., J.A. Field, M.H. Schroth, B.M. Davis, and V. Dwarakanath. 2002. Single-well "Push-Pull" partitioning tracer test for NAPL detection in the subsurface. *Environ. Sci. Technol.* 36: 2708-2716.
- Kauffman, M., A. Traviglia, J. Vernon, and J. LaChance. 2006. CVOC source identification through *in situ* chemical oxidation in fractured bedrock. *Contam. Soil Sediments Water* 7: 277-285.
- Krug, T.A., C. Wolfe, R.D. Norris, and C.J. Winstead. 2009. Cost Analysis of In Situ Perchlorate Bioremediation Technologies. In *In Situ Remediation of Perchlorate in Groundwater*. H.F. Stroo and C.H. Ward, Eds. SERDP/ESTCP Environmental Remediation Technology.
- Lee, W., and B. Batchelor. Abiotic reductive dechlorination of chlorinated ethylenes by iron-bearing soil minerals. 1. Pyrite and magnetite. *Environ. Sci. Technol.* 36:5147-5154.
- Lipson, D.S., B.H. Kueper, and M.J. Gefell. 2005. Matrix diffusion-derived plume attenuation in fractured bedrock. *Ground Water* 43:30-39.
- NJDEP. 2005. Field Sampling Procedures Manual. Online: <http://www.nj.gov/dep/srp/guidance/fspm/>.
- Morrill, P.L., B.E. Sleep, D.J. Seepersad, M.L. McMaster, E.D. Hood, C. LeBron, D.W. Major, E.A. Edwards, and B.S. Lollar. 2009. Variations in expression of carbon isotope fractionation of chlorinated ethenes during biologically enhanced PCE dissolution close to a source zone. *J. Contam. Hydrol.* 110:60-71.
- Nordqvist, R., E. Gustafsson, P. Andersson, and P. Thur. 2008. Groundwater flow and hydraulic gradients in fractures and fracture zones at Forsmark and Oskarshamn. Swedish Nuclear Fuel and Waste Management Co. Report R-08-103. Online: <http://www.skb.com/publication/1784919/R-08-103.pdf>.
- Pitrak, M., Mares, S., Kobr, M., 2007. A simple borehole dilution technique in measuring horizontal ground water flow. *Ground Water* 45, 89-92.
- Polyanin, A.D., Zaitsev, V.F., 2003. *Handbook of Exact Solutions for Ordinary Differential Equations*, 2nd Edition. Chapman & Hall/CRC, Boca Raton.
- Schaefer, C.E., R.M. Towne, S. Vainberg, J.E. McCray, and R.J. Steffan. 2012. Assessment of chemical oxidation for treatment of DNAPL in fractured sandstone blocks. *J. Environ. Engin.*, 138:1-7.
- Schaefer, C.E., Towne, R.M., Lazouskaya, V., Bishop, M.E., and Dong, H., 2012b. Diffusive flux and pore anisotropy in sedimentary rocks. *J. Contam. Hydrol.* 131, 1-8.

- Schaefer, C.E., R.M. Towne, D.R. Lippincott, V. Lazouskaya, T.B. Fischer, M.E. Bishop, and H. Dong. 2013. Coupled diffusion and abiotic reaction of trichloroethene in minimally disturbed rock matrices. *Environ. Sci. Technol.* 47:4291-4298.
- Schaefer, C.E., Towne, R.M., Lippincott, D.R., Lacombe, P., Bishop, M.E., Dong, H. 2015. Abiotic Dechlorination in Rock Matrices Impacted by Long-Term Exposure to TCE. *Chemosphere* 119, 744-749.
- Schaefer, C.E., E.B. White, G.M. Lavorgna, and M.D. Annable. 2016. Dense nonaqueous-phase liquid architecture in fractured bedrock: implications for treatment and plume longevity. *Environ. Sci. Technol.* 50:207-213.
- Singha, K., F.D. Day-Lewis, and J.W. Lane Jr. 2007. Geoelectrical evidence of bicontinuum transport in groundwater. *Geophys. Res Letters* 34:1-5.
- Smith, R.L., R.W. Harvey, and D.R. LeBlanc. 1991. Importance of closely spaced vertical sampling in delineating chemical and microbiological gradients in groundwater studies. *J. Contam. Hydrol.* 7:285-300.
- Stehfest, H., 1970, Algorithm 368: Numerical inversion of Laplace transform, Communication of the ACM, vol. 13 no. 1 p. 47-49.
- Sterling, S.N., B.L. Parker, J.A. Cherry, J.H. Williams, J.W. Lane Jr., and F.P. Haeni. 2005. Vertical cross contamination of trichloroethylene in a borehole in fractured sandstone. *Ground Water* 43:557-573.
- Sudicky, E.A. and E.O. Frind. 1982. Contaminant transport in fractured porous media: analytical solutions for a system of parallel fractures. *Water Resour. Res.* 18:1634-1642.
- Sudicky, E. A. and E.O. Frind. 1984. Reply, *Water Resour. Res.* 20:1323-1324.
- Thomson, N.R., E.D. Hood, and G.J. Farquhar. 2007. Permanganate treatment of an emplaced DNAPL source. *Ground Water Monitor. Remed.* 27:74-85.
- TRC, 1993. Draft Phase II Remedial Investigation Report – Volume I, Naval Construction Battalion Center, Davisville, Rhode Island. Contract No. N62472-85-C-1026. November 1993.
- USEPA. 1991. Management of Investigation-Derived Wastes During Site Inspections. EPA/540/G-91/009. OERR Directive 9345.3-02. Online:
<https://nepis.epa.gov/Exe/ZyNET.exe/10001WN4.TXT?ZyActionD=ZyDocument&Client=EPA&Index=1991+Thru+1994&Docs=&Query=&Time=&EndTime=&SearchMethod=1&TocRestrict=n&Toc=&TocEntry=&QField=&QFieldYear=&QFieldMonth=&QFieldDay=&IntQFieldOp=0&ExtQFieldOp=0&XmlQuery=&File=D%3A%5Czyfiles%5CIndex%20Data%5C91thru94%5CTxt%5C00000000%5C10001WN4.txt&User=ANONYMOUS&Password=anonymous&SortMethod=h%7C-&MaximumDocuments=1&FuzzyDegree=0&ImageQuality=r75g8/r75g8/x150y150g16/i425&Display=hpfr&DefSeekPage=x&SearchBack=ZyActionL&Back=ZyActionS&BackDesc=Results%20page&MaximumPages=1&ZyEntry=1&SeekPage=x&ZyPURL>.

- USEPA. 2006. Microfracture surface characterizations: implications for in situ remedial methods in fractured rock, EPA/600/R-05/121.
- Villinger, H., 1985, Solving cylindrical geothermal problems using Gaver-Stehfest inverse Laplace transform, *Geophysics*, vol. 50 no. 10 p.1581-1587.
- Wang, F., Annable, M.D., Schaefer, C.E., Ault, T.D., Cho, J., Jawitz, J.W.,2014. [Enhanced Aqueous Dissolution of a DNAPL Source to Characterize the Source Strength Function](#). *J. Contam. Hydrol.* 169, 75-89
- West, M.R. and B.H. Kueper. 2010. Plume detachment and recession times in fractured rock. *Ground Water*. 48:416-426.
- Zill, D.G., Wright, W.S., 2014. *Advanced Engineering Mathematics*. Jones & Bartlett Learning, Burlington, Massachusetts.
- Zwank, L., M. Elsner, A. Aeberhard, and Rene P. Schwartzenbach. 2005. Carbon isotope fractionation in the reductive dehalogenation of carbon tetrachloride at iron (hydr)oxide and iron sulfide minerals. *Environ. Sci. Technol.* 39:5634-5641.

APPENDIX A INITIAL RAPID ASSESSMENT TESTING AT NAWC

1.0 INTRODUCTION

This appendix provides a summary of the demonstration activities and preliminary Push-Push testing performed at the former Naval Air Warfare Center (NAWC), located in West Trenton, NJ. Results and lessons learned from this testing were used to refine the approach used for rapid assessment testing at Site 07, Calf Pasture Point (CPP), located in Rhode Island.

The overall objective of this project was to develop and evaluate the use of a novel “Push-Push” remedial assessment technique, coupled with compound specific isotope analysis (CSIA), for use as a rapid and cost-effective means to assess the limits of in situ remediation on long-term groundwater quality. This evaluation will be most relevant to evaluating the extent to which biological and chemical amendment delivery (e.g., biostimulation, chemical oxidation) can reduce groundwater concentrations for a given contact time and/or dosage. By carefully evaluating amendment distribution, rebound (in chlorinated solvent and isotopic signature), and isotopic analysis in both transmissive and low permeability zones, limits to remedial success can be identified early in the process, and the potential for contaminant rebound can be assessed without the need for long term and costly testing.

2.0 TREATABILITY STUDY TESTING

Laboratory treatability testing was performed on Rock cores collected from within the bedrock TCE plume at NAWC. The overall goal of the laboratory treatability study was to evaluate the effectiveness of permanganate for treatment of TCE under site conditions. The specific objectives of the treatability studies were as follows: 1) Estimate oxidant demand of the rock, and 2) Verify contaminant removal via permanganate oxidation under site specific conditions.

Results from the study indicated that permanganate reagent was effective for the rapid removal of TCE under site specific conditions. All treatability performance objectives were met. Thus the results of the treatability study supported our approach to continue forward with the novel Push-Push remedial assessment technique at this site. A Treatability Study Report was submitted to ESTCP on April 7, 2014.

3.0 FRACTURED BEDROCK CHARACTERIZATION

Characterization activities performed at the NAWC during the demonstration included the drilling of and coring of two boreholes, borehole geophysical logging, borehole discrete interval testing and sampling, permanent packer assembly installation, and tracer testing. These activities are summarized in the following subsections.

3.1 DRILLING AND CORING

Characterization activities included drilling and coring two boreholes (92BR and 93BR) located approximately 7 feet apart (**Figure 1**) to 80 feet below ground surface (ft-bgs) and 75 feet bgs, respectively. Clearance of all underground utilities was arranged with the property owner and local utility companies prior to initiating intrusive site activities. Additionally, each boring location was pre-cleared for utilities to 5 ft-bgs using an air-knife and vacuum equipment.

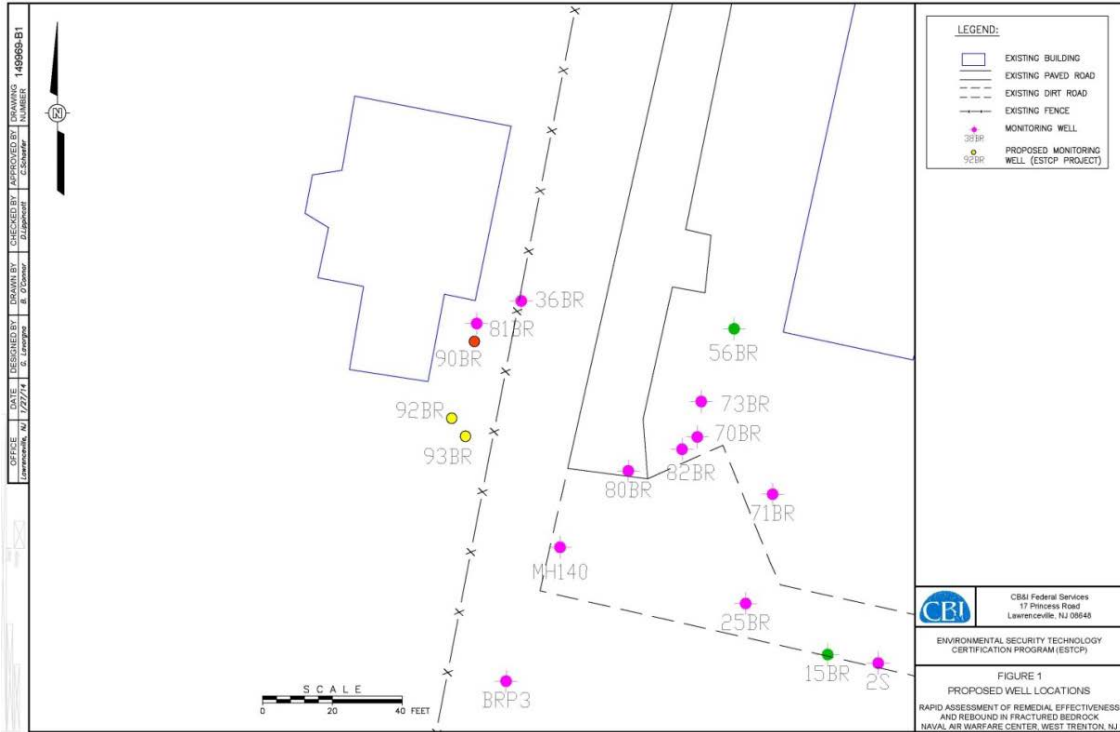

Figure 1. NAWC Site Map Showing the Location of Test Wells 92BR and 93BR

At each of the two borehole locations, a nominal 10-inch diameter borehole was advanced using air an rotary drilling technique through the overburden material and into the weathered bedrock (approximately 15 feet bgs), and 10-inch steel casing was installed to prevent the borehole from collapsing. A nominal 10-inch diameter borehole was then advanced using an air rotary drilling technique into competent bedrock (approximately 40 ft-bgs), and 6-inch steel casing was installed and pressure-grouted into place. Rock cores were collected in 5-foot lengths from approximately 40 ft-bgs to the bottom of the borehole using a triple tube wire line PQ Core Barrel system. This system allowed for the collection of minimally-disturbed 3.25-inch diameter rock cores. Rather than extruding the rock core from the inner tube (as with traditional dual tube methods), the triple tube system contains a third tube made of stainless steel that is split lengthwise and nested inside the second tube. When the rock core is retrieved from the subsurface, the split tube is removed from the second tube. The upper half of the split tube is carefully lifted off, revealing the core in a minimally disturbed condition for inspection and transfer. The PQ coring system creates a nominal 4.8-inch diameter core hole.

Logging of the rock cores was performed in the field by a CB&I geologist. To the extent possible, visual inspection and core logging were used to assess the fracture network and identify conductive zones. Upon completion of rock coring, each of the two boreholes was finished at grade using flush-mount well vaults that are 24-inches square. Well 92BR was used as an injection well and well 93BR was used as a multi-level sampling (MLS) well. All drilling equipment was decontaminated between borings, and decontamination fluids were pumped to a nearby temporary storage tank for subsequent processing through the Site groundwater treatment plant.

3.2 BOREHOLE GEOPHYSICAL LOGGING

Once the test wells were complete, the USGS (under subcontract to CB&I), deployed multiple borehole logging techniques to help identify the locations of the water bearing fractures, and to estimate the transmissivity of these zones within both boreholes. Borehole logging included optic and/or acoustic (borehole televiewer) borehole imaging, caliper logging, heat-pulse flow meter testing, and electrical resistivity and gamma logging.

3.3 BOREHOLE DISCRETE INTERVAL HYDRAULIC TESTING AND SAMPLING

Once water bearing fractures were identified in each borehole, borehole discrete zone pump testing and groundwater sampling was performed at wells 92BR and 93BR to assess the flow field and contaminant distribution throughout the open borehole intervals (~40-80 feet bgs). A custom designed straddle packer system was used to sequentially isolate discrete intervals (approximately 4 feet each) within one of the boreholes for individual short term pump tests and groundwater sampling. The packer system consists of two inflatable packers, with a submersible pump and a port for collecting water levels between the packers. The packers were inflated, isolating the target zone from zones above and below. Short term pump and recharge tests (approximately 2 hours each) were performed at three discrete zones within well 92BR and four discrete intervals within well 93BR. During the pump testing, groundwater samples were collected from each interval and analyzed for Target Compound List Volatile Organic Compounds (TCL VOCs) via USEPA Method 8260B. Borehole discrete zone pump testing and groundwater sampling for well 93BR is scheduled for the week of April 28, 2014.

3.4 PERMANENT PACKER ASSEMBLY INSTALLATION

Site characterization data including borehole geophysical, discrete zone pump test, and contaminant concentration data were analyzed to determine discrete zones within each of the boreholes to be targeted for injection (at well 92BR) and monitoring (at well 93BR). Straddle packer assemblies were designed, constructed, and installed in each of the two wells to isolate the target intervals. The assembly installed in injection well 92BR isolated a zone from 66.0 feet and 76.0 feet bgs. This straddle packer assembly included a dedicated bladder pump located near the bottom of the 10-foot interval, and a port injection amendments and/or measuring water levels within the isolated zone. \The assembly installed in monitoring well 93BR isolated zones from 63.0 feet and 67.1 feet bgs and 68.8 feet and 75.0 feet bgs (the bottom of the borehole). \The straddle packer assemblies in this well included dedicated bladder pumps located near the middle of each of the discrete intervals, and ports for measuring water levels within the isolated zones. \The equipment installation also allowed for water levels to be measured in the borehole above the packer assembly in each of the wells.

3.5 TRACER TESTING

Tracer testing was performed to verify the groundwater velocity, estimate the effective (fracture) porosity, and confirm that the injection well and monitoring well reside along the groundwater flow path. Following the packer installation, baseline groundwater samples were collected from the injection well (92BR) and from both of the multi-level sampling (MLS) well intervals (93BR-S and 93BR-D) (Figure 1). Samples were analyzed for TCL VOCs via USEPA Method 8260B and bromide via USEPA Method 300.0.

A tracer solution (250 mL) containing 46 grams of sodium bromide was added to the 10-foot interval between the straddle packers in injection well 92BR through the injection port. The target sodium bromide tracer concentration in the well was 1,000 mg/L. Immediately following the addition of the sodium bromide tracer, groundwater was recirculated within the 10-foot interval using the dedicated bladder pump to facilitate tracer mixing throughout the interval. This was accomplished by pumping a low flow of groundwater (<500 milliliters per minute, mL/min) from the bottom of the 10-foot interval up to the ground surface. The water, now containing the tracer solution, was then re-injected into the upper portion of the 10-foot injection interval. Approximately 10 gallons (1 well volume) was recirculated to sufficiently mix the bromide tracer within the 10-foot interval.

Groundwater samples were collected from both the injection well and MLS well intervals a total of eight times over the 65-day passive phase of the borehole dilution/tracer test to monitor tracer concentration. Low volume sampling (<500 mL per sample interval) was performed because of the expected small fracture volume between the injection and MLS wells. Samples were analyzed for bromide via USEPA Method 300.0. Results of the passive phase of the tracer test showed a very slow decrease in bromide concentrations within the injection well (approximately 25 percent) (Figure 2), and a measurable steady increase in bromide concentrations (>1 mg/L) within the deep interval of the monitoring well during the initial 65 days of testing (**Figure 2**). No tracer was observed in samples collected from the shallow interval of the monitoring well. These results indicated that groundwater flow velocity within this portion of the bedrock (i.e. intervals that are packered off in the injection and monitoring wells) is relatively slow.

In order to verify connectivity between the wells and to better estimate the effective fracture porosity, pumping was performed within the shallow and deep intervals of the monitoring well using the dedicated sampling pumps installed in those intervals. The deep monitoring well interval was pumped at approximately 75 mL/min for approximately 11 hours, and the shallow monitoring well interval was pumped at increasing steps between 75 mL/min and 450 mL/min for approximately 35 hours. Pumping was performed during the day, and discontinued at the end of each work day. Bromide samples were collected every 20 to 60 minutes to determine the time of breakthrough, and to develop a bromide curve for estimating effective fracture porosity. During this groundwater extraction phase, bromide concentrations in the injection well showed a steady decrease from 704 mg/L to 273 mg/L (**Figure 3**). The deep monitoring interval showed a steady increase and flattening of bromide concentrations at approximately 15 mg/L, while the shallow monitoring well interval showed a relatively steady increase and flattening of bromide concentrations at approximately 0.7 mg/L (**Figure 3**). Results from the deep interval confirmed that the flow path from the injection well to the MLS well was sufficient for the demonstration. The very low bromide levels measured in the shallow zone suggested that the majority of the flow into this shallow zone was not emanating along the flow path connected to the bromide tracer.

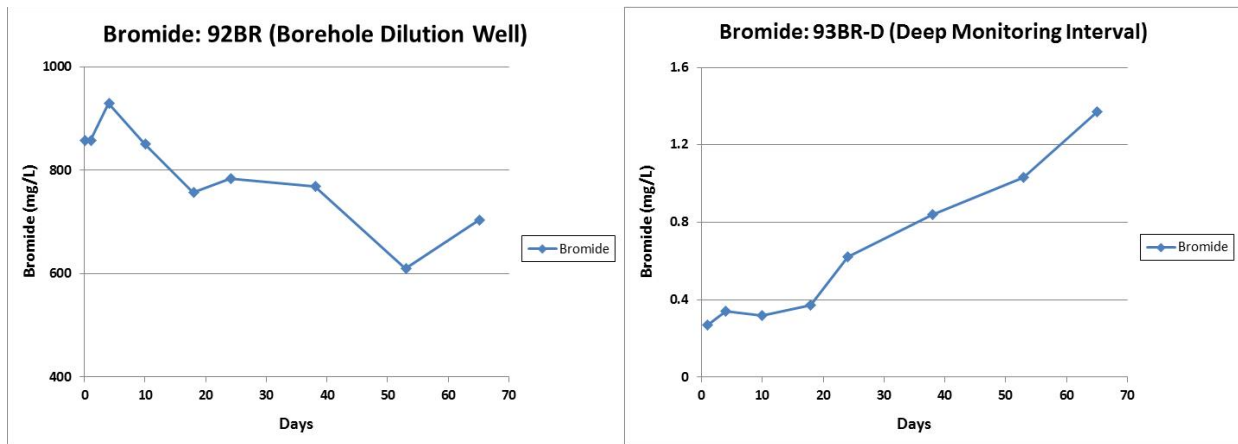

Figure 2: Bromide Concentrations in the Injection Well (Panel A) and MLS Well Deep Interval Well (Panel B) during the Passive Phase of Borehole Dilution/Tracer Testing.

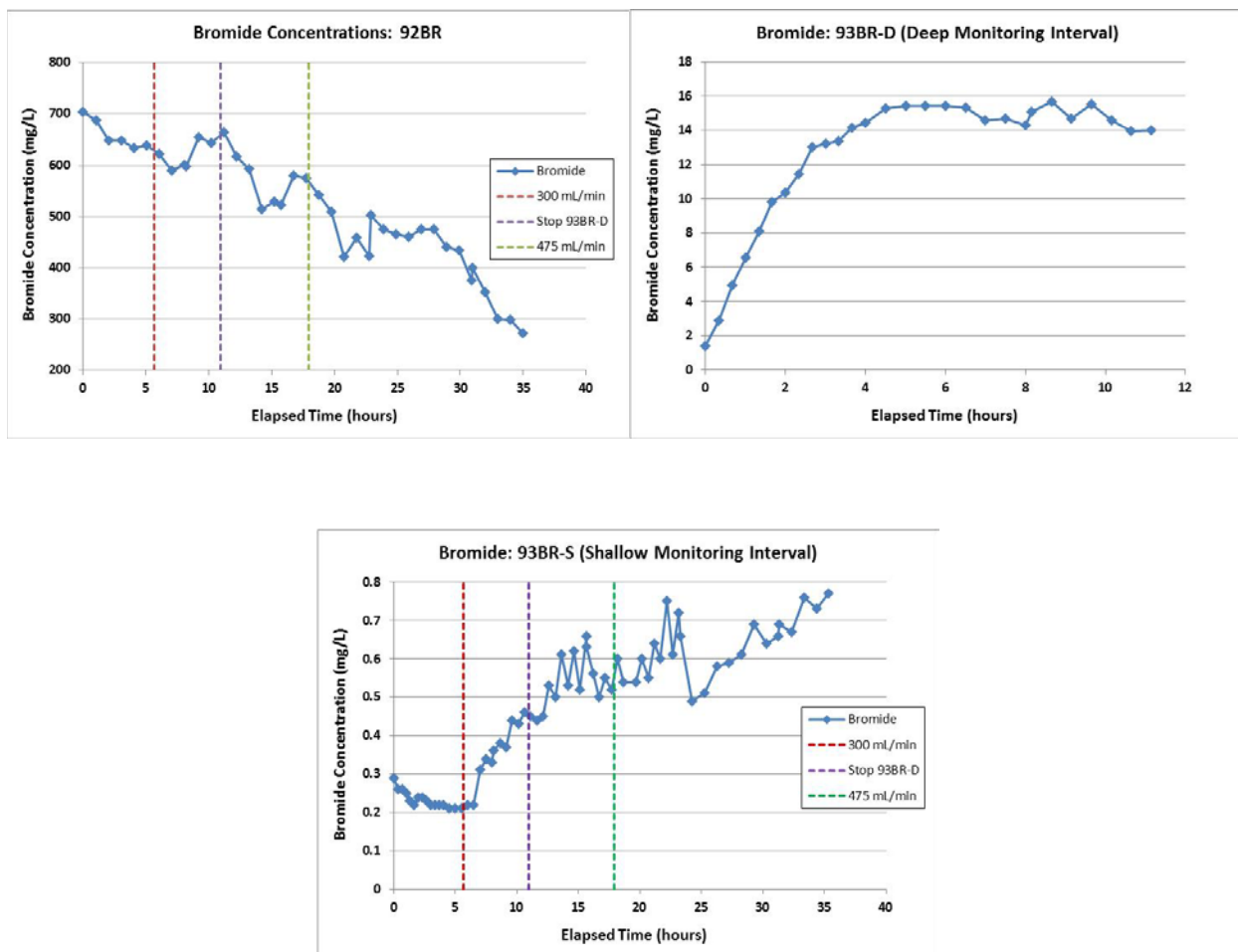

Figure 3: Bromide Concentrations in the Injection Well (Panel A), MLS Well Deep Interval Well (Panel B), and MLS Well Shallow Interval Well (Panel C) during the Pumping Phase of Borehole Dilution/Tracer Testing.

A second bromide tracer test was performed in the competent bedrock interval above the inflated packers in injection well 92BR. A tracer solution (500 mL) containing 150 grams of sodium bromide was added to the 53-foot water column (10' to 63' bgs) above the top of the straddle packers in injection well 92BR. This well has permanent 6-inch steel casing installed through the overburden and weathered bedrock to a depth of 45 feet bgs, leaving an 18 foot open interval from 45' to 63' bgs. The target sodium bromide tracer concentration in the well was 600 mg/L. Immediately following the addition of the sodium bromide tracer, water was recirculated within the 53-foot interval using a submersible pump to facilitate tracer mixing throughout the interval. This was accomplished by pumping approximately 1 gpm of groundwater from the bottom of the interval up to the ground surface. The water, now containing the tracer solution, was then re-injected into the upper portion of the water column. Approximately 115 gallons (2 well volumes) was recirculated to sufficiently mix the bromide tracer within the 53-foot water column.

Groundwater samples were collected for bromide from above the inflated packers in wells 92BR and 93BR, and from the shallow interval of the MLS prior to bromide addition, and 7 days after bromide addition. Low volume sampling (1,900 mL in the intervals above the packers, and <500 mL in the MLS well shallow interval) was performed because of the expected small fracture volume between the injection and MLS well. Samples were analyzed for bromide via USEPA Method 300.0. Results of the second tracer test indicated that greater than 99 percent of the bromide was flushed from well 92BR within seven days. No increase in bromide was observed above the packers in the MLS well, or in the MLS well shallow interval. These testing results confirm that the flow velocities in these highly fractured zones are extremely elevated, and would make implementing the proposed Push-Push testing difficult. Based on these data, and the other bedrock characterization data collected, it was determined that the Push-Push testing would be performed within the less fractured portion of the bedrock unit that was being isolated by the packer assembly.

4.0 RAPID ASSESSMENT (RA) TESTING

The field testing of the RA technique was performed in a series of 3 steps at the NAWC site.

Step 1

Step 1 involved the delivery of chemical oxidant. Step 2 was the treatment period, where the permanganate was expected to distribute and treat the TCE in the fractures. Step 3 was the second final injection phase of the test, where non-contaminated (potable) water was injected into the injection well to displace the permanganate. During this step, TCE rebound was monitored.

RA testing activities at the NAWC site began on November 5, 2014. The goal of Step 1 was to deliver sufficient permanganate solution (in concentration and quantity) so that permanganate concentrations remained >500 mg/L at both the injection to the MLS wells during a 4-6 week treatment period. Just prior to injection, a final round of baseline groundwater samples was collected from the injection well and each discrete interval of the MLS well. Samples were analyzed for VOCs, and CSIA analysis was performed for TCE, DCE, and vinyl chloride. Samples were also analyzed for metals (Fe, Mn, and As).

Approximately 2,270 liters of a 1.4% sodium permanganate solution was gravity fed into the injection well (92BR) (Figure 4) within the straddle packer interval between November 5 and November 6, 2014. Injection rates ranged from approximately 1.0 to 1.7 L/min. The two MLS well (93BR) sampling intervals were periodically sampled and visually inspected for permanganate during the injection. Permanganate was observed in both MLS intervals during 2-day the injection period. Permanganate and VOC concentrations in the MLS and injection wells were monitored periodically (every one to two weeks) during a 33-day week treatment period. VOC concentrations were below detection at the injection well and MLS well intervals throughout the treatment period.

Step 2

Following the 33-day treatment period, injection of potable water (step 2) was initiated at the injection well on December 8, 2014. The purpose of this injection step was to displace any remaining permanganate in the interval between the injection well and the MLS well. The MLS well intervals were monitored to confirm that permanganate has been displaced (< 5 mg/L) in each interval. This injection phase was initially anticipated to last approximately 2 days. However, clean water injection was extended at the injection well, and low flow (< 50 mL/min) clean water injections were started at both MLS well intervals on January 6, 2015, due to the persistence permanganate concentrations > 5 mg/L within these wells. These injections were stopped on February 6, 2015, when permanganate concentrations were measured to be < 5 mg/L at both MLS well intervals.

Step 3

The rebound phase (Step 3) began when clean water injections were stopped at the MLS wells, and clean water injection at the injection well was reduced to approximately 15 mL/min (slow flush). The injection and MLS wells were sampled every 4-8 weeks for VOCs and permanganate concentrations, with the final sampling event being performed on September 9, 2015.

5.0 ADDITIONAL TRACER TESTING

A second borehole dilution tracer test was initiated at the NAWC on September 24th, 2015. The purpose of this second borehole dilution test was to verify what the Darcy flow into the monitoring well was during the rebound testing. As shown in Figure 4, bromide flushing from the well under ambient conditions was negligible. This lack of flow was assumed to be due to a loss in permeability resulting from precipitation of manganese oxides.

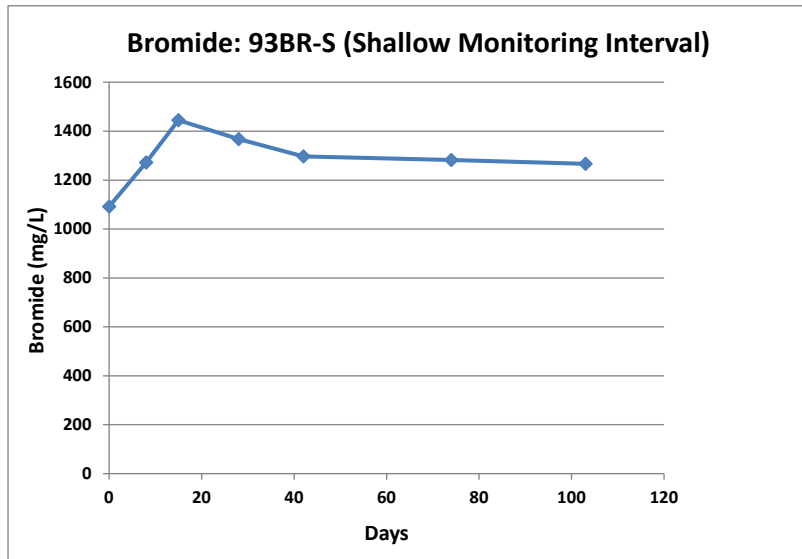

Figure 3: Bromide Concentrations in the MLS Well Shallow Interval during Borehole Dilution Testing Performed at the End of the RA Test.

6.0 DEMOBILIZATION

Demobilization of all equipment from the NAWC site was completed in January 2016. The U.S. Navy (Site owner) and USGS (site caretaker) have agreed to take possession of the two bedrock wells installed for the demonstration. Therefore, abandonment of the wells was not required.

7.0 RESULTS & DISCUSSION

While the success criterion for removal of permanganate to less than 5 mg/L were achieved during Step 2 at the NAWC site, permanganate concentrations were observed at well 93BR at approximately 6 mg/L during two of the rebound monitoring events (Step 3). Unfortunately, low concentrations of permanganate persisted during the rebound phase of testing, making potential contaminant rebound difficult to quantify. Groundwater data indicated that limited contaminant rebound was observed during Step 3 of the Push-Push testing. The lack of rebound observed is likely the result of continued oxidation of contaminants by the remaining permanganate.

A comparison of borehole dilution testing results performed at injection well 92BR before and after testing indicated a decrease in permeability, likely caused by manganese oxide from the chemical oxidation with permanganate during Step 1. Furthermore, there was a measurable reduction in potable water injection rates at well 93BR during Step 2 of the testing, indicating a decrease in permeability at the MLS well.

Results from the preliminary testing at NAWC were used to refine the approach used for rapid assessment testing at CPP, Site 07. Most notable, the use of permanganate was discontinued and the contaminant removal step (Step 1) at CPP was performed via water flushing only.

APPENDIX B BORING LOG FOR MW07-05R



EA Engineering, Science,
and Technology, Inc.

LOG OF SOIL BORING

Coordinates: N:137588.42 E:524597.83
 Surface Elevation: 10.3 ft msl
 Well Riser Elevation: 11.62 ft msl

Job. No. 29600.32	Client: NORDIV, NAVFAC NCBC Davisville	Location: IR Program Site 07
Drilling Method: Mobile B-61 rig using 6" ID flush-joint casing with 5.875" rollerbit.		Boring No. MW07-05R
Sampling Method: 2" OD split-barrel sampler, driven by 140-lb hammer falling 30" (SS)		Sheet 1 of 4
Drilling Water Level:	Date:	Start 08/16/95
Time:	Time:	Drilling Times
Surface Conditions: Grassy		Finish 08/17/95 1230 1640

Sample Type	Inches Driven/In. Recvrd	Dpth Csg.	Samp # / depth (ft)	PID (ppm) <small>As per lab.</small>	Blows per 6"	Strat. Unit	Ft bgs	USCS Log	SOIL DESCRIPTION
SS	24	18	0	S-1 0-2	NR*		0	[Shaded]	0-3.5" Light to olive gray silty fine to medium SAND, trace coarse sand, with organics (grass, roots) in top 5", dry to moist at bottom. 3.5-18" Dark gray silty fine SAND, trace coarse SAND, moist.
							1		
							2		
							3		
SS	24	11	4	S-2 4-6	NR*		4	[Shaded]	Yellowish-orange and light to medium gray medium SAND, trace to little fine sand, trace coarse sand, color banding from 3-6", wet.
							5		
							6		
							7		
SS	24	15	8	S-3 8-10	NR*		8	[Shaded]	Olive to medium gray clayey SILT, trace fine and coarse sand, little organics in top 5", wet.
							9		
							10		
SS	24	14	8	S-4 10-12	NR*		10	[Shaded]	Light gray, dark gray and little yellowish-orange very fine to fine SAND, silt lens at 10", wet.
							11		
							12		
SS	24	20	8	S-5 12-14	NR*		12	[Shaded]	Dark gray and olive gray very fine to fine SAND, lens of light brown and yellowish-orange very fine to fine sand at 7-7.5", wet.
							13		
							14		
SS	24	14	14	S-6 14-16	NR*	upper Sand	14	[Shaded]	0-11" Olive gray to light gray very fine SAND and SILT, lens of dark gray clayey silt at 9-10", wet. 11-14" Dark gray SILT, wet.
							15		
							16		
SS	24	21	14	S-7 16-18	NR*	Silt	16	[Shaded]	Olive gray clayey SILT, wet
							17		
							18		
SS	24	16	16	S-8 18-20	NR*		18	[Shaded]	Olive gray clayey SILT, partings of light brown and yellowish-orange fine sand from 3-5", lens of yellowish-orange very fine sand and silt from 1-2.5", wet.
							19		
							20		

NOTES: Sample interval
 Sample interval submitted for analysis
 NR* = No reading due to excessive moisture



Logged by: R. Clark
 Drilling Contractor: M&R Environmental Drilling
 Driller: P. Thornsbury

WELL SPECIFICATIONS:

Dis. Screen/Riser: 2" stainless steel Screen Interval: 64 - 74 ft bgs Sandpack: 63.5 - 74.5 ft bgs Grout: 0 - 59 ft bgs
 Bottom of Hole: 78 ft bgs Riser Interval: 1.3 ft bgs - 64 ft bgs Bentonite: 59 - 63.5 ft bgs Cover: 6" ID steel



EA Engineering, Science,
and Technology, Inc.

LOG OF SOIL BORING

Coordinates: N:197588.42 E:524597.83
 Surface Elevation: 10.3 ft msl
 Well Riser Elevation: 11.62 ft msl

Job No. 29600.32	Client: NORDIV, NAVFAC NCBC Davisville	Location: IR Program Site 07
Drilling Method: Mobile B-61 rig using 6" ID flush-joint casing with 5.875" rollerbit.		Boring No. MW07-05R
Sampling Method: 2" OD split-barrel sampler, driven by 140-lb hammer falling 30" (SS)		Sheet 2 of 4
Drilling Water Level: Date: _____ Time: _____	Start 08/16/95 1230	Finish 08/17/95 1640
Surface Conditions: Grassy		

Sample Type	Inches Driven/In. Recvrd	Dpth Csg.	Samp # / depth (ft)	PID (ppm)	Blows per 6"	Strat. Unit	Ft bgs	USCS Log	SOIL DESCRIPTION
	24	18	S-9 20-22	NR*	9 11 12 13		20		Dark gray dense SILT, wet.
SS							21		
	24	16	S-10 22-24	NR*	11 14 16 17		22		As above.
SS							23		
	24	13	S-11 24-26	NR*	11 12 14 15		24		As above.
SS							25		
							26		
							27		
							28		
	24	18	S-12 29-31	7.7	14 15 11		29		As above.
SS							30		
							31		
							32		
							33		
	24	20	S-13 34-36	53	2 3 3		34		Dark gray SILT with olive gray clay laminae, wet.
SS							35		
							36		
							37		
							38		
	24	17	S-14 39-41	110	1 1		39		As above.
SS									

NOTES: Sample interval
 Sample interval submitted for analysis
 NR* = No reading due to excessive moisture

Logged by: R. Clark
 Drilling Contractor: M&R Environmental Drilling
 Driller: P. Thornsbury

WELL SPECIFICATIONS:

Dia. Screen/Riser: 2" stainless steel Screen Interval: 64 - 74 ft bgs Sandpack: 63.5 - 74.5 ft bgs Grout: 0 - 59 ft bgs
 Bottom of Hole: 78 ft bgs Riser Interval: 1.3 ft bgs - 64 ft bgs Bentonite: 59 - 63.5 ft bgs Cover: 6" ID steel



EA Engineering, Science,
and Technology, Inc.

LOG OF SOIL BORING

Coordinates: N:197588.42 E:524597.83
 Surface Elevation: 10.3 ft msl
 Well Riser Elevation: 11.62 ft msl

Job. No. 29600.32	Client: NORDIV, NAVFAC NCBC Davisville	Location: IR Program Site 07
Drilling Method: Mobile B-61 rig using 6" ID flush-joint casing with 5.875" rollerbit.		Boring No. MW07-05R
Sampling Method: 2" OD split-barrel sampler, driven by 140-lb hammer falling 30" (SS)		Sheet 3 of 4
Drilling Water Level:	Date: _____ Time: _____	Start 08/16/95 1230
Surface Conditions: Grassy		Drilling Times
		Finish 08/17/95 1640

Sample Type	Inches Driven/In. Recvrd	Dpth Csg.	Samp # / depth (ft)	PID (ppm)	Blows per 6"	Strat. Unit	Ft bgs	USCS Log	SOIL DESCRIPTION
			S-14 39-41		2 2		40 41		
							42		
							43		
SS	24	11 24	S-15 44-46	113	6 22 23 24	Silt Till	44 45		0-3" As above. 3-8" Dark gray SILT with coarse sand and angular gravel up to 1.5". 3-11" Yellowish-orange, light brown and medium gray SILT and subangular weathered GRAVEL up to 1".
SS	24	19 24	S-16 46-48	79	23 26 29 120		46 47		Dark gray SILT to platy, weathered, subangular GRAVEL up to 1.25", some yellowish-orange and light brown color, wet, tight.
SS	6	6 24	S-17 48-48.5	21	135	Till Rock	48		As above, dark gray with yellowish-orange band at 1", rock is fissile.
							49		
							50		6" casing to 48 ft bgs
							51		Rollerbit to 64 ft bgs
							52		HX Core to 78' (see core log description)
							53		Bottom of hole = 78 ft bgs
							54		
							55		
							56		
							57		
							58		
							59		

NOTES: Sample interval _____
 Sample interval submitted for analysis _____

Logged by: R. Clark

Drilling Contractor: M&R Environmental Drilling

Driller: P. Thornsbury

WELL SPECIFICATIONS:

Dia. Screen/Riser: 2" stainless steel Screen Interval: 64 - 74 ft bgs Sandpack: 63.5 - 74.5 ft bgs Grout: 0 - 59 ft bgs
 Bottom of Hole: 78 ft bgs Riser Interval: 1.3 ft bgs - 64 ft bgs Bentonite: 59 - 63.5 ft bgs Cover: 6" ID steel



EA Engineering, Science,
and Technology, Inc.

LOG OF CORE BORING

Coordinates: N:197588.42 E:524597.83
 Surface Elevation: 10.3 ft msl
 Well Riser Elevation: 11.62 ft msl

Job No. 29600.32	Client: NORDIV, NAVFAC NCBC Davisville	Location: IR Program Site 07
Drilling Method: Mobile B-61 rig		Boring No. MW07-05R
Core Barrel used: HX Core (3.65" OD)		Sheet 4 of 4
Packer Test		Start Drilling Finish
Tested	Yes; 08/21/95	Times
Interval	64-36' and 69-74'	08/21/95 08/21/95
K-Value		0950 1120

Core Run (ft)	Stratigraphy	Bedding / Fractures (dip & angl)	Filling	Depth in feet	Graphic Log	LITHOLOGIC LOG	DRILLING LOG
				60			
				61			
				62			
				63			
Run #1 64.0-69.0				64		0.0-4.7' Interbedded light gray QUARTZITE and dark gray PHYLLITE, granoblastic texture, thin banding throughout, few vertical quartz filled veins, some biotite and calcite	Core Run Drill Core Depth Time/ft Depth (ft) (min:sec) (ft bgs)
Rec = 84% = 4.7/5.0				65		3 weathered low angle fractures at 0.9', 1.1', and 1.1'	0-1 1:55 64-65
RQD = 36% = 4.5/4.7				66			1-2 4:00 65-66
				67			2-3 4:00 66-67
				68			3-4 4:00 67-68
							4-5 4:00 68-69
Run #2 69.0-74.0				69		0.0-5.3' Interbedded light gray QUARTZITE and dark gray PHYLLITE, granoblastic texture, thin banding throughout, few vertical quartz filled veins, some biotite and calcite	0-1 3:55 69-70
Rec = 105% = 5.3/5.0				70		1 medium angle fracture at 0.8-1.0'	1-2 3:10 70-71
RQD = 100% = 5.3/5.3				71			2-3 3:00 71-72
				72			3-4 3:00 72-73
				73			4-5 2:55 73-74
Run #3 74.0-77.5				74		0.0-3.6' Interbedded light gray QUARTZITE and dark gray PHYLLITE, granoblastic texture, thin banding throughout, few vertical quartz filled veins, some biotite and calcite	0-1 2:40 74-75
Rec = 100% = 3.6/3.6				75			1-2 2:18 75-76
RQD = 100% = 3.6/3.6				76			2-3 2:35 76-77
				77			3-3.5 4:28 77-77.5
				78			
				79			

NOTES:

Core Run Interval



Logged by:

R. Clark & J. Shapiro

Drilling Contractor:

M&R Environmental Drilling

Driller:

P. Thornsby

MONITORING WELL CONSTRUCTION

MW07-05R

CLIENT/SITE NAME: NORDIV, NAVFAC NCBC DAVISVILLE, SITE 07, PHASE III RI	
DATE INSTALLED: 8/24/95	PROJECT No. 29600.32
ELEVATION OF GROUND SURFACE: 10.3' MSL ELEVATION TOP OF WELL RISER: 11.62' MSL	COORDINATES: N: 197588.42 E: 524597.83
DEPTH TO WATER: 7.88' (BELOW TOP OF RISER) DATE/TIME 12/1/96 1220	EA INSPECTOR: J. SHAPIRO
DRILLING METHOD & DEPTH: 6" FLUSH-JOINT CASING WITH 5.875" ROLLERBIT TO 64'/ HX-CORE 64'-77.5'	

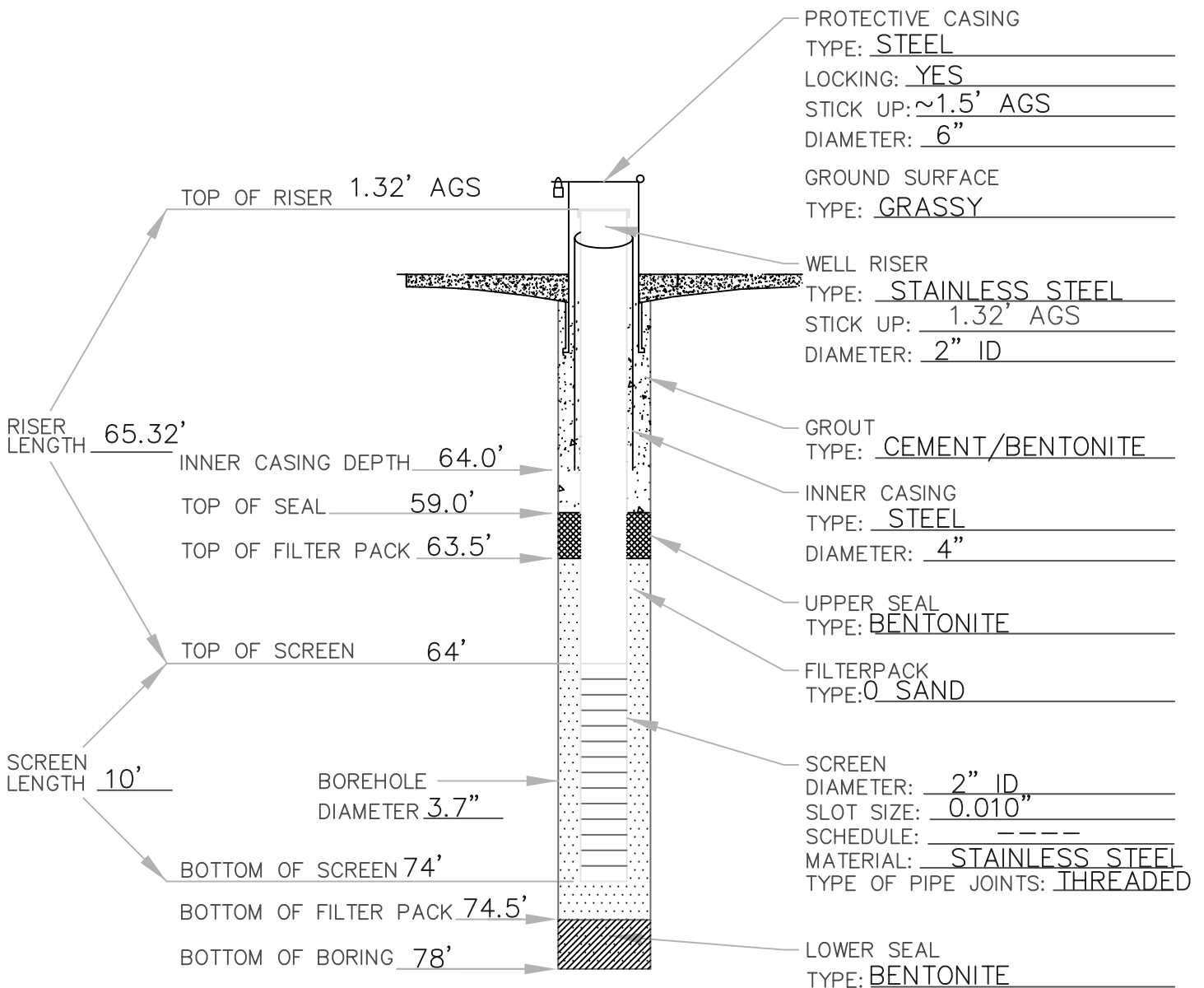

MONITORING WELL CONSTRUCTION
(ALL DEPTH MEASUREMENTS IN FT. BELOW GROUND SURFACE)

EA® EA ENGINEERING,
SCIENCE, AND
TECHNOLOGY

Page Intentionally Left Blank

APPENDIX C BORING LOG FOR MW07-46R



Drilling Log

Monitoring Well

MW07-46R

Page: 1 of 3

Project ESTCP - Rapid Assessment of Bedrock Owner US Navy
 Location Calf Pasture Point Proj. No. 136333
 Surface Elev. NA Total Hole Depth 80.6 ft. North _____ East _____
 Top of Casing NA Water Level Initial ▽ 8.0 ft. Static NA Diameter 10/8/4.8 in.
 Screen: Dia NA Length NA Type/Size NA
 Casing: Dia 5 in. Length 59.5 ft. Type steel
 Fill Material Cemnet - Bentonite Grout Rig/Core Geoprobe 8140LS/PQ Core Barrel
 Drill Co. ADT Method Roto-Sonic/Rotary (rock coring)
 Driller Jason Log By Jessica Crispin Date 8/29/14 Permit # NA
 Checked By Dave Lippincott License No. _____

COMMENTS
 10" temporary outer casing set to 10' BGS; 7.6" temporary outer casing set to 58.3' BGS; 6" sonic sample barrel used for continuous soil core collection to 58.3' BGS; 5" permanent casing set to 58.3' BGS; 4.8" open core hole from 58.3' to 80.6' BGS

Depth (ft.)	Well Completion	PID (ppm)	Sample ID % Recovery	% RQD	Graphic Log	USCS Class.	Description (Color, Texture, Structure) Geologic Descriptions are Based on the USCS.
0							
0-5'						SP	0-5': SAND, 100% f-m, loose, dry, dark gray
5-7.5'		0	60%			SP	5-7.5': SAND, 100% f-m, trace shells, loose, dry, brown-gray
7.5-10'						ML	7.5-10': SILT, sandy, 70% silt, 30% f sand, trace clay, trace shells, loose, moist-wet, non-plastic
10-12'		0	70%			SP	10-12': SAND, 100% f sand, trace c sand and f gravel, subrounded, loose, wet, dark gray
12-15'						SP	12-15': SAND, 100% f sand, trace silt, laminae of f orange-brown sand, loose, wet, dark gray
15-16'		0	80%			ML	15-16': SILT, sandy, 60% silty fines, 40% f sand, laminae of f-c sand, slightly dense, wet, dark gray
16-30'						ML	16-30': SILT, 100% silty fines, wet, non-plastic, dark gray
18							
20		0	80%			ML	
22							
24							

PASTURE Rev. 2/2/16 PASTURE.GPJ IT_CORP.GDT 2/17/16

Continued Next Page



Drilling Log

Monitoring Well

MW07-46R

Page: 2 of 3

Project ESTCP - Rapid Assessment of Bedrock Owner US Navy

Location Calf Pasture Point Proj. No. 136333

Depth (ft.)	Well Completion	PID (ppm)	Sample ID % Recovery	% RQD	Graphic Log	USCS Class.	Description (Color, Texture, Structure) Geologic Descriptions are Based on the USCS.
24	[Well Completion Bar]	0	90%		[Graphic Log]	ML	<i>Continued</i>
26							
28							
30		0	80%		[Graphic Log]	SM	30-32': SAND, silty, 75% f sand, 25% silty fines, wet, non-plastic, dark gray
32							32-39': SILT, 95% silty fines, 5% clayey fines, slightly dense, wet, non-plastic, dark gray, light gray lenses of clay
34							
36		0	80%			ML	
38							
40		0				ML	39-40': SILT, sandy, 75% silty fines, 25% f sand, thin laminae of orange brown f sand, wet, non-plastic, dark gray 40-46': SILT, 100% silty fines, wet, dark gray
42						ML	
44							
46							
48					[Graphic Log]	GM	46-50': GRAVEL, silty, with weathered rock, 55% f-c angular gravel, 30% non-plastic silty fines, 10% weathered angular rock, 5% f-m sand, orange brown
50		0			[Graphic Log]		50-52': Weathered rock, 50% rock (1-3"), 50% silt and clay, non-plastic, gray, little orange/brown staining on gravel
52					[Graphic Log]		52-58': Weathered rock and non-plastic Silt/Clay, dark gray
54							
56		0					<i>Continued Next Page</i>

PASTURE Rev. 2/2/16 PASTURE.GPJ IT_CORP.GDT 2/17/16



Drilling Log

Monitoring Well

MW07-46R

Page: 3 of 3

Project ESTCP - Rapid Assessment of Bedrock Owner US Navy

Location Calf Pasture Point Proj. No. 136333

Depth (ft.)	Well Completion	PID (ppm)	Sample ID % Recovery	% RQD	Graphic Log	USCS Class.	Description (Color, Texture, Structure) Geologic Descriptions are Based on the USCS.
56							<i>Continued</i>
58		0	100%				RUN 1 - 58-63': BEDROCK, phyllite, v. thin foliation, slight weathering, slightly fractured, moderate-hard, trace pyrite, thin quartz veins at 40-80 degrees, thin bands of light gray quartzite, light green/yellow discoloration on phyllite
60							58-58.6': 1-4" pieces of phyllite
62							58.6': fracture, weathered surface, green/yellow discoloration on uneven surface
64		0	100%	72			58.6-58.8': high angle fracture, 80 degrees, no discoloration, silty surface, rough
66							59.1': medium-high angle fractures, rough surface, silty surface, little green discoloration
68		0	100%	90			59.4-59.6': fracture high angle 80 degrees, orange and green discoloration
70							60.4-61': near horizontal fracture, planar, yellow discoloration
72							61': ~40 degree fracture, rough, yellow/green discoloration
74		0		100			61.7': horizontal fracture coated with red clay
76		0					RUN 2 - 63-68.4': (63-64.5') BEDROCK, phyllite, fresh, sound, moderate-hard, dark gray, very thin foliation; (64.5-68.4') Bedrock, quartzite, fresh, sound, moderately hard, fine-grained, gray-light gray
78		0	100%				63.2': 40 degree fracture coated with clay, rough
80							63.4-64': 40 degree fracture
82							65.75': near horizontal fracture
84							67.3': 40 degree fracture, smooth
86							68-68.4': mechanical breaks
88							RUN 3 - 68.4-73.4': BEDROCK, quartzite, fresh, fine grained, moderately hard, dark gray
							70': 30 degree fracture, planar, smooth, little clay coating
							71.2': 30 degree fracture, planar, smooth, little clay coating
							RUN 4 - 73.4-74.4': BEDROCK, quartzite, sound, fresh, fine grained, moderately hard, dark gray, mechanical breaks
							73.65': mechanical break
							73.98': mechanical break
							RUN 5 - 74.4-78.4': BEDROCK, quartzite, sound, fresh, fine grained, moderately hard, biotite, dark gray
							76.6': 20 degree fracture
							RUN 6 - 78.4-80.6': BEDROCK, quartzite, sound, fresh, fine grained, moderately hard, biotite
							78.4-78.6': near vertical joint, healed, calcite filling
							80.6': End of boring

PASTURE Rev. 2/2/16 PASTURE.GPJ IT_CORP.GDT 2/17/16

Page Intentionally Left Blank

APPENDIX D BOREHOLE GEOPHYSICAL REPORT FOR MW07-46R

CLIENT: CB&I Federal Services, LLC
 PROJECT: Site 7 - Calf Pasture Point - Borehole Geophysical Logging
 LOCATION: North Kingstown, Rhode Island
 LOGGING GEOPHYSICIST(S): Robert Garfield & Nick DeCristofaro
 PROJECT REP(S) ON-SITE: Matthew Sieger
 LOGS PROCESSED BY: Robert Garfield

HAGER-RICHTER FILE: 14RG73
 LOG DATUM: Ground Surface
 CASING STICK-UP: 1.6 Feet Above the Ground Surface
 ORIENTATION REFERENCE: True North (Magnetic Declination = 15° West)
 BOREHOLE DIAMETER: 4.8 Inches (PQ-Cored)
 WATER LEVEL DEPTH: 8.0 Feet

STRUCTURE LEGEND

- ◆ Fracture Rank 1
- ◆ Fracture Rank 2
- ◆ Fracture Rank 3

NOTE: Flow was not detected with the heat pulse flow meter under ambient conditions.

PT-BRMW-1 - Borehole Geophysical Logs

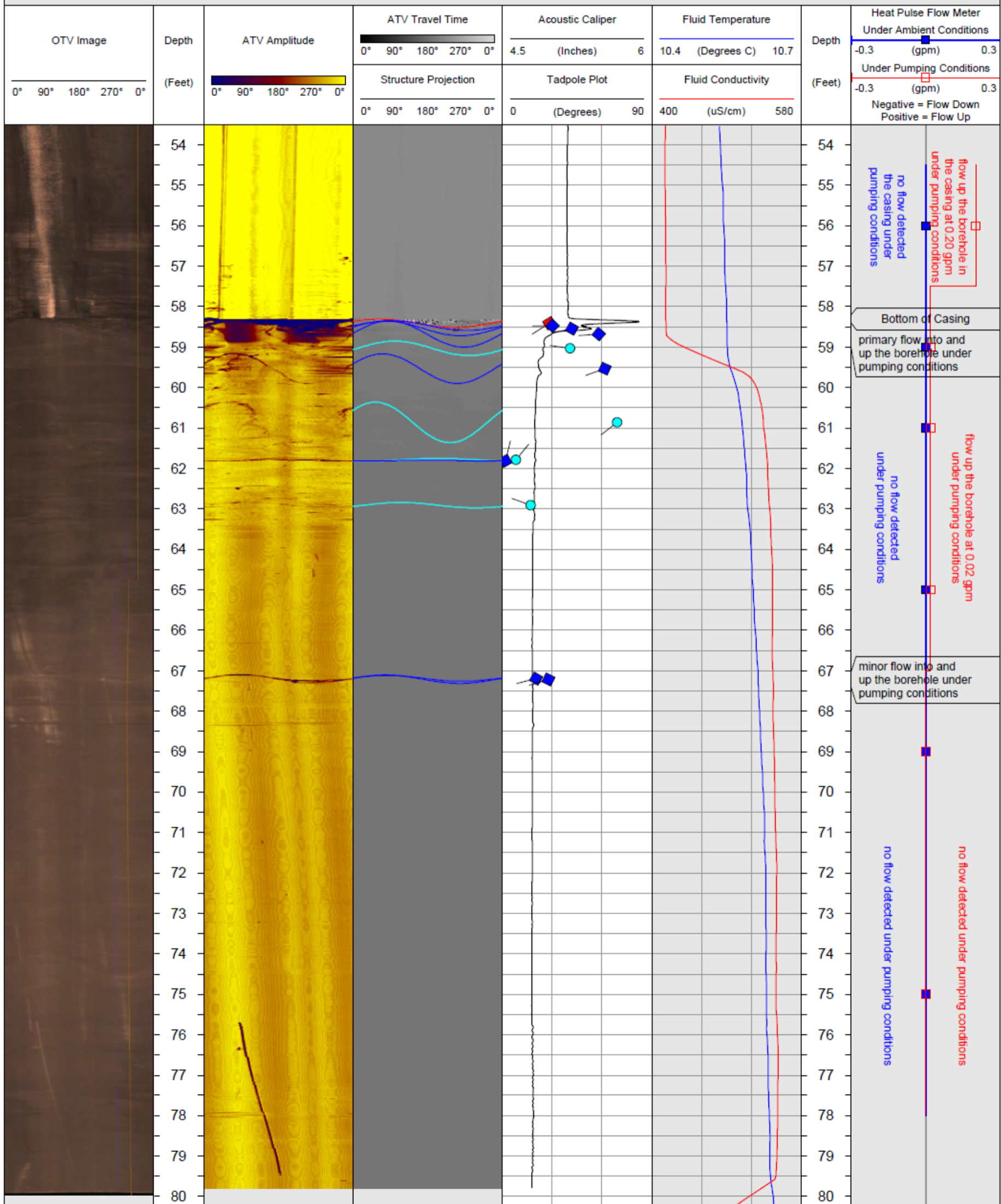

HAGER-RICHTER GEOSCIENCE, INC.

846 Main Street
Fords, NJ 08863
Phone: 732-661-0555
Fax: 732-661-0123

PT-BRMW-1 - BEDROCK FRACTURE STATISTICS PLOTS

DATE(S) LOGGED: October 28, 2014

CLIENT: CB&I Federal Services, LLC

HAGER-RICHTER FILE: 14RG73

PROJECT: Site 7 - Calf Pasture Point

ORIENTATION REFERENCE: True North

LOCATION: North Kingstown, Rhode Island

MAGNETIC DECLINATION: 15° West

STRUCTURE LEGEND

● Fracture Rank 1 ■ Fracture Rank 2 ◆ Fracture Rank 3

Stereogram - Lower Hemisphere
of Fractures

Schmidt Plot - LH - Bedrock Structures

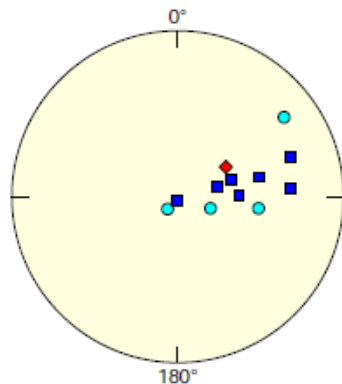

	Counts	Dip[deg]	Azi[deg]
Mean	12	33.66	269.18
◆	1	28.23	237.95
■	7	34.57	267.42
●	4	33.49	287.51

Dip Azimuth Rose Diagram
of Fractures

Azimuth - Absolute (Count)

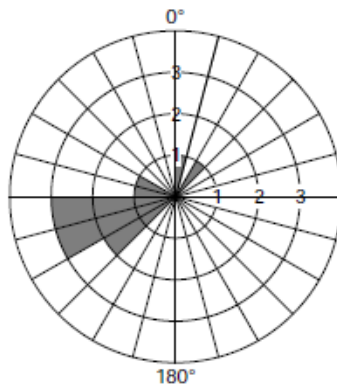

Counts:	12.00
Mean:	269.18
Std.Dev.:	47.30
Min:	13.88
Max:	290.10

Dip Angle Histogram
of Fractures

Dip Histogram (Count)

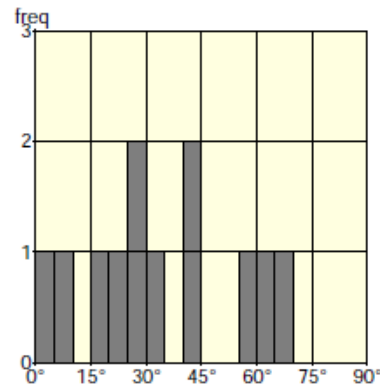

Counts:	12.00
Mean:	33.66
Std.Dev.:	20.37
Min:	1.87
Max:	69.04

HAGER-RICHTER GEOSCIENCE, INC.	
PT-BRMW-1 - TABLE OF BEDROCK FRACTURES	
CLIENT	CB&I Federal Services, LLC
PROJECT	Site 7 - Calf Pasture Point - Borehole Geophysical Logging
LOCATION	North Kingstown, Rhode Island
H-R FILE	14RG73
DATE LOGGED	October 28, 2014
LOG DATUM	Ground Surface
DIP AZIMUTH	True North (Magnetic Declination = 15° West)
DIP ANGLE	Measured from Horizontal

PT-BRMW-1 - TABLE OF BEDROCK FRACTURES

Depth (Feet)	Dip Azimuth (Degrees)	Dip Angle (Degrees)	Bedrock Structure Category
58.4	238	28	Fracture Rank 3
58.5	269	30	Fracture Rank 2
58.5	256	42	Fracture Rank 2
58.7	266	58	Fracture Rank 2
59.0	278	41	Fracture Rank 1
59.5	250	62	Fracture Rank 2
60.9	233	69	Fracture Rank 1
61.8	39	8	Fracture Rank 1
61.8	14	2	Fracture Rank 2
62.9	290	17	Fracture Rank 1
67.2	255	20	Fracture Rank 2
67.2	253	28	Fracture Rank 2

Page Intentionally Left Blank

APPENDIX E HYDRAULIC TESTING AT CALF PASTURE POINT

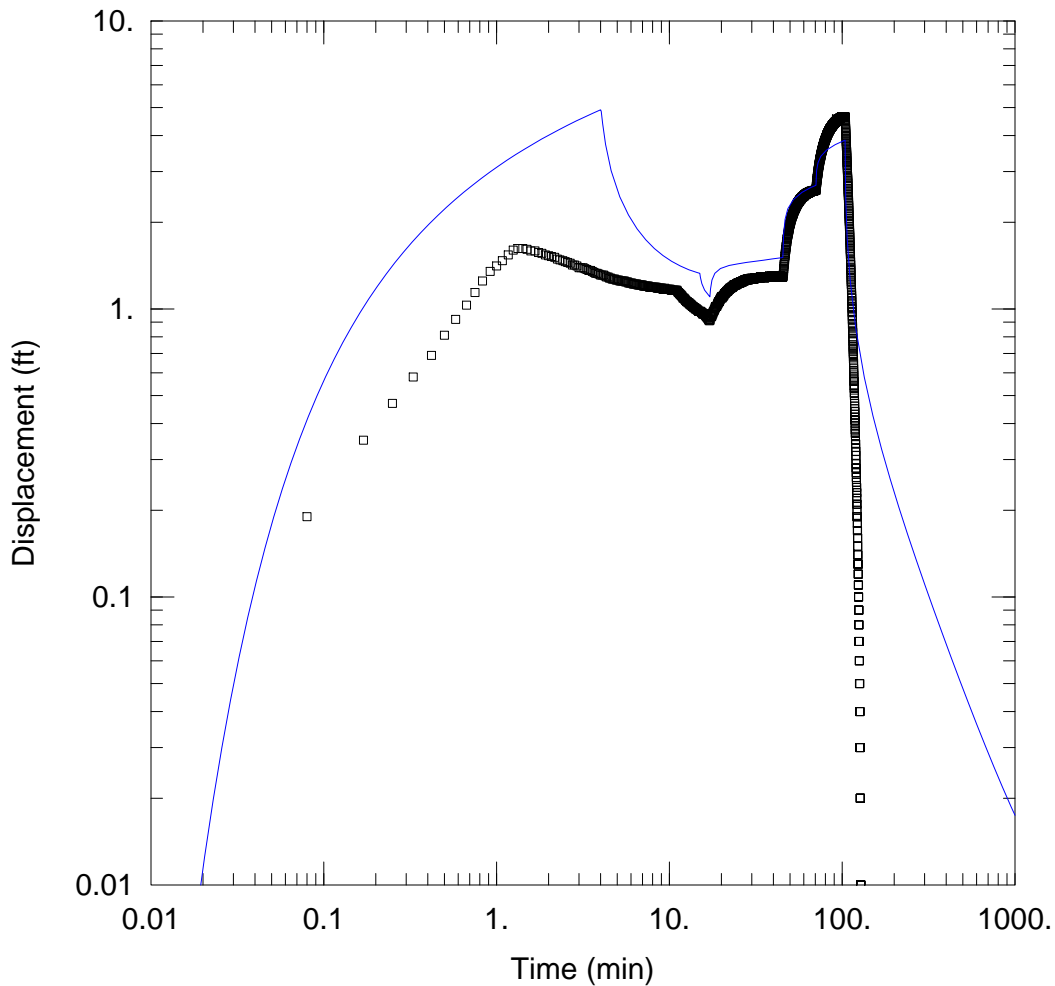

TEST #1: RESPONSE AT MW07-46R 58.3'-64.7' BGS TO PUMPING AT MW07-46R 58.3'-64.7'

Data Set: C:\...\Test1 Pumping and Recovery at MW07-46R Theis Hantush Confined.aqt
 Date: 11/05/15 Time: 11:24:23

PROJECT INFORMATION

Company: CBI
 Client: ESCTCP-Rapid Assessment
 Project: Calf Pasture Point
 Location: North Kingstown, Rhode Island
 Test Well: MW07-46R 58.3' to 64.7' bgs
 Test Date: 3/24/2015

WELL DATA

Pumping Wells			Observation Wells		
Well Name	X (ft)	Y (ft)	Well Name	X (ft)	Y (ft)
MW07-46R 58.3-64.7' bgs	0	0	□ MW07-46R 58.3-64.7' bgs	0	0

SOLUTION

Aquifer Model: Confined Solution Method: Theis
 $T = 56.93 \text{ ft}^2/\text{day}$ $S = 0.27$
 $Kz/Kr = 0.9926$ $b = 22.2 \text{ ft}$

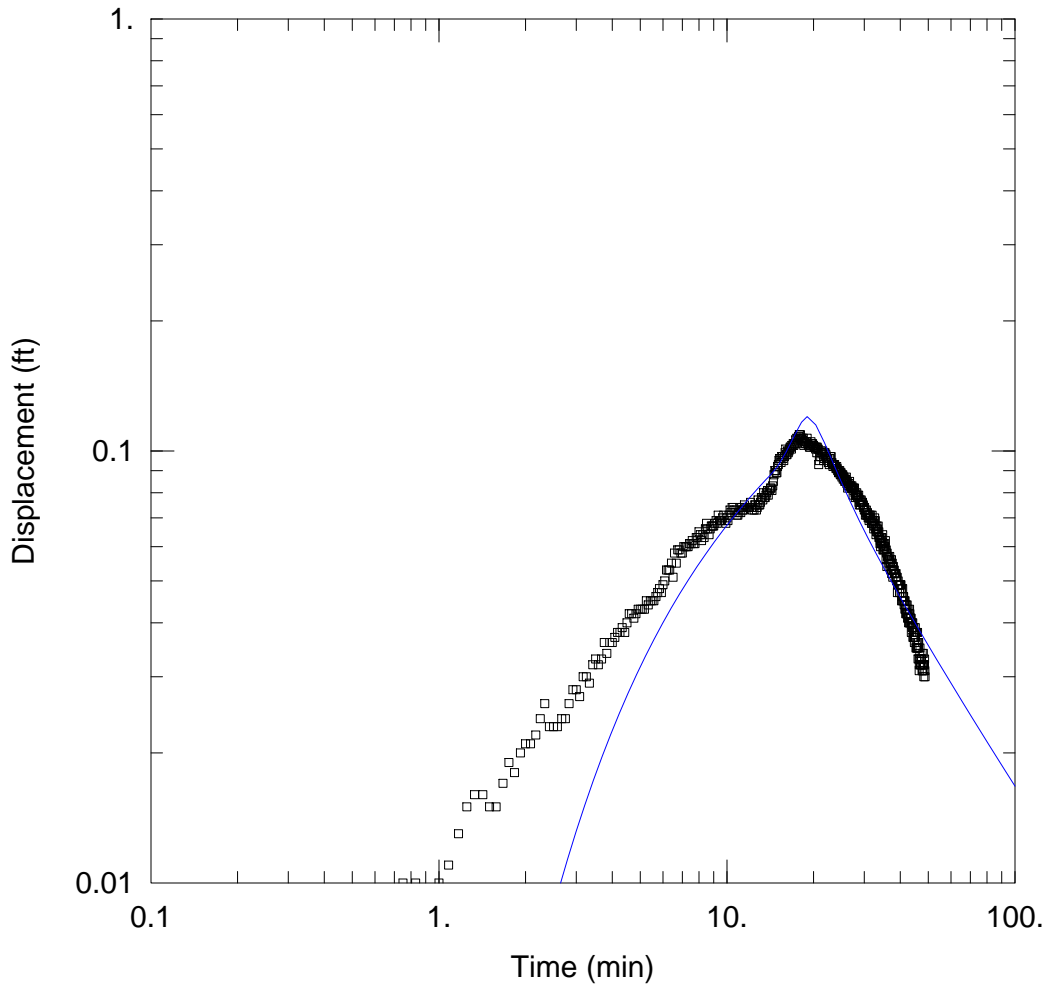

TEST5: RESPONSE AT MW07-46R 65'-69" BGS TO PUMPING AT MW07-05R 64'-74' BGS

Data Set: C:\...\Test5 Response at MW07-46R 65-69', Pumped well MW07-05R Thisis Hantush Confined aqt
 Date: 11/05/15 Time: 13:38:21

PROJECT INFORMATION

Company: CBI
 Client: ESCTCP-Rapid Assessment
 Project: Calf Pasture Point
 Location: North Kingstown, Rhode Island
 Test Well: MW07-05R 64' to 74' bgs
 Test Date: 3/25/2015

WELL DATA

Pumping Wells			Observation Wells		
Well Name	X (ft)	Y (ft)	Well Name	X (ft)	Y (ft)
MW07-05R	7.5	0	□ MW07-46R	0	0

SOLUTION

Aquifer Model: Confined

Solution Method: Thisis

T = 37.19 ft²/day

S = 0.008432

Kz/Kr = 1.

b = 22.2 ft

Page Intentionally Left Blank

APPENDIX F RAPID ASSESSMENT PROTOCOL

The following protocol is intended to serve as a general guidance for designing, implementing, and evaluating the rapid assessment (RA) technique developed as part of ESTCP Project #ER-201330.

I. Overall Approach and Testing Location

The RA protocol is intended to assess chlorinated solvent, particularly chlorinated ethene, rebound, the potential of naturally occurring dechlorination reactions in low permeability zones, and remedial effectiveness using a pair of closely spaced bedrock wells. This protocol is designed to assess the remedial effectiveness of *in situ* technologies such as such as bioaugmentation and chemical oxidation that target and biotically or abiotically degrade contaminants in hydraulically conductive fracture zones. The RA technique involves identifying hydraulically conductive fracture zones, flushing contaminant from the fracture zones using water, then evaluating contaminant rebound within this zone while hydraulically isolating the zone from the surrounding contaminated aquifer. The rate, composition, and isotopic signature of contaminant rebound is then used to evaluate the limits of remedial effectiveness, identify the local source/cause of any observed rebound, and provide improvement to the site conceptual model.

The protocol described herein will describe the general methodology for one location (i.e., one well pair). However, depending on the site characteristics, multiple well locations/well pairs may be needed. For example, if the areal extent being considered for remediation consists of multiple geologic units, or if both a source area (with potential DNAPL sources) and the downgradient plume are being considered for *in situ* treatment, then multiple locations should be considered.

For the RA testing, a pair of open borehole wells spaced 5 to 15 ft apart is recommended. The boreholes should be isolated from overburden materials. One borehole will serve as the injection well, and the other borehole will serve as the monitoring well. Following the characterization described in Section II, up to 3 chlorinated solvent impacted fracture zones (maximum) should be targeted and isolated using either packers or other borehole tools to isolate specific fracture intervals; isolated intervals should not exceed 10 ft. For sites where treatment in multiple hydraulically conductive fracture zones with multiple (>3) geologic layers, multiple sets of RA test well pairs may be considered.

II. Initial Characterization

Information regarding the fracture flow field, contaminant distribution, and rock matrix properties are needed to perform the RA testing. Specifically, this information is needed to determine which interval(s) to isolate for the RA test, and to provide information needed to interpret the rebound data via matrix back-diffusion simulations. Much of this information may be readily available based on site information attained from previous testing and investigations; however, additional testing may be required to properly design, implement, and interpret RA test results. The initial characterization information discussed below is required for each fracture zone of each well targeted for potential treatment.

Fracture Identification

Identification of potentially conductive fractures or fracture zones serves as one of the initial steps of the RA approach. Numerous borehole geophysical tools are available for this identification, as well as visual core logging; a detailed discussion of these tools are beyond the scope of this protocol. It is noted that identifying the number of fracture planes within a targeted test interval is useful for estimating the potential contribution from the rock matrix during rebound (Section V).

Rock Matrix

A measure of the rock matrix porosity is needed to estimate the effective aqueous phase diffusion coefficient through the rock matrix, via use of readily applied correlations (e.g., Boving and Grathwohl, 2001). More complex models and/or experimental approaches also can be employed in anisotropic matrices that contain bedding planes (Schaefer et al., 2012). Rock containing ferrous minerals may also facilitate abiotic dechlorination of chlorinated ethenes; bench-scale batch testing methods have been developed to quantify these dechlorination reactions (Schaefer et al., 2015). Together, this information can be used in a screening-level matrix back-diffusion model (e.g., CRAFLUSH model (Sudicky and Frind, 1982; Davis and Johnston, 1984; Sudicky and Frind, 1984)) to interpret RA testing results.

Contaminant Characterization

Baseline concentrations of chlorinated solvents in each of the identified hydraulically conductive fracture zones need to be determined. These baseline concentrations should initially be made both prior to the hydraulic and tracer testing (described in the section below) to facilitate identification of the relevant fracture zones for testing, and then just prior to the rapid flushing phase (described in Section III). This characterization should be performed using discrete interval sampling (e.g., packers) with the target fracture zone(s) isolated. The contaminant characterization performed immediately prior to the rapid flushing also should consist of compound specific isotope analysis (CSIA) for carbon, as carbon isotopic shifts during rebound can provide insight into the rebound mechanism (discussed in greater detail in Section V).

Hydraulic and Tracer Testing

Using the isolated fracture intervals, hydraulic testing should be performed for each target interval. Short term pump or drawdown testing should be used to estimate the hydraulic conductivity within each interval, and to confirm a hydraulic connection between the injection and monitoring well intervals. A borehole dilution test is needed in the injection well across the entire injection interval. The injection interval of the injection well can be a single zone extending across the multiple discrete intervals of the monitoring well, or multiple injection intervals corresponding to fracture zones in the monitoring well (see Figure 1 below). This information is used to determine the ambient flow into the injection well, and ultimately the injection rate needed to provide the hydraulic control needed during the slow injection (rebound) phase of the RA testing (Section IV). Borehole sampling should be performed to limit the volume of water removed from the borehole via strategies such as in-well recirculation of fluids.

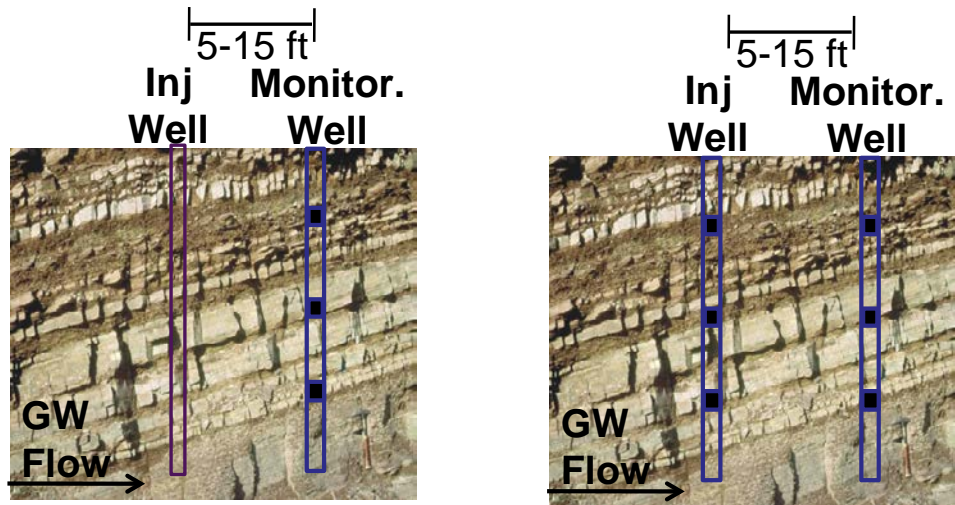

Figure 1. The injection well can be configured such that the open borehole injection interval spans the interval of the multi-level monitoring well (left), or the injection well can be configure as a multi-level injection well (right).

If the option on the right is selected, borehole dilution and tracer testing should be performed for each of the injection well intervals. The shaded zones in the wells represent packers.

To confirm the fracture flowpath and estimate the effective fracture porosity and aperture (via a radial plug flow along identified fractures), a tracer test is required. The tracer injection should be performed in the same interval(s) used for the injection well borehole dilution testing, and monitored in each of the target intervals in the monitoring well. Sampling in the monitoring well locations during the tracer testing should be performed in a way that limits the volume of water removed, thereby limiting any induced hydraulic gradients during the ambient flow tracer test.

III. Rapid Flushing

After completion of the testing described in Section II, and immediately after the final baseline sampling and CSIA analysis, the rapid flushing phase of the RA testing should commence. The objective of the rapid flushing is to remove contaminants (a minimum of 99% removal) from hydraulically conductive fractures in the test intervals by injecting “clean” (i.e., non-contaminated) water into the injection well, thereby simulating the effects of *in situ* treatment. A period of 1 to 3 months is recommended for the rapid flushing. Periodic monitoring of both the injection well and monitoring well intervals should be performed to determine the extent to which the target contaminants have been flushed from the system. The injection flow will be dependent upon the capacity of the injection well, as well as how quickly the monitoring well intervals are being flushed. If needed, direct injection into the monitoring well intervals can be performed to enhance the flushing of contaminants from the test zone. Fast flushing should continue (at least) until dissolved contaminant concentrations decrease to less than 1% of baseline levels.

A minimum of 1 month of flushing is recommended so that rebound can be more effectively evaluated. During rapid flushing, care should be taken to ensure the borehole intervals are sufficiently mixed so that stagnant zones do not impede flushing. If continued flushing and direct flushing into the monitoring well do not result in concentrations decreasing by 99%, DNAPL may be present within or adjacent to the boreholes.

IV. Slow Flushing / Rebound

Immediately following the rapid flushing, the slow flushing (rebound) phase of the testing will commence. The objective of the slow flushing phase of the RA testing is to observe and quantify the rate of any contaminant rebound following the rapid flushing while controlling the flow field between the injection well and monitoring well so that chlorinated solvent-impacted groundwater from upgradient does not impact the monitoring well. Thus, any increases in contaminant concentrations observed at the monitoring well during the slow flushing phase are attributable to contaminant mass along the flow path between the injection and monitoring well, and not from contaminants migrating into the “treatment zone” from upgradient.

Clean water used for the slow injection phase should be delivered into the injection well using the same configuration (i.e., Figure 1) used during the rapid flushing phase. The injection rate during the slow flushing will be based upon the Darcy flow into the injection well (or, injection well interval) measured as part of the testing described in Section II.

The injection rate used during the rebound phase is intended to limit excessive dilution, while at the same time prevent upgradient impacts to the monitoring well from fractures intersecting the well pair. Using the calculated Darcy flow (Section II), the total ambient groundwater flow rate passing through the cross-section area defined by the injection well depth interval and the radial distance r from the injection well (where r is the distance between the injection and monitoring wells) is calculated. The injection well flow rate during the slow flushing phase should be approximately twice this ambient rate, thereby providing a reasonable level of confidence that groundwater flow from upgradient is not entering the targeted intervals of the monitoring well.

Periodic monitoring for target contaminants should be performed at monitoring well locations during the rebound period. The rebound period should last a minimum of 3 months, or until either a clear trend or stability has been attained. Sampling for CSIA (carbon) should be performed on all target contaminants; this sampling should be (at least) performed at the final rebound sampling event.

V. Data Evaluation

Both the rate and extent of rebound, as well as the CSIA data, can be used to provide insight into the contaminant mass distribution and the extent to which *in situ* treatment may be effective. If the CSIA carbon data show isotopic enrichment at the end of baseline, then the source of the rebound is likely due to enhanced dechlorination reactions occurring in either the rock matrix or lower transmissivity fractures zones (rebound from DNAPL is unlikely to exhibit isotopic enrichment). As discussed in Section II, bench scale testing using rock core can also be used to determine if dechlorination reactions are occurring within the rock matrix.

Using a matrix back-diffusion model such as CRAFLUSH, along with parameters determined during the testing described in Section II (effective diffusion coefficient through the rock, number of fractures, fracture aperture, travel time through the fractures, dechlorination rate constant within the rock matrix), the expected rebound during the slow flushing phase of the RA testing (Section IV) can be predicted. Comparison of the model rebound data to the model prediction should be used to assess whether or not the observed rebound is reasonably explained

by matrix back-diffusion. For the case where matrix back diffusion is identified as the mechanism for the observed rebound, a model such as CRAFLUSH can be used to scale results to the intended treatment zone, which would likely extend beyond the 5 to 15 feet that separate the injection and monitoring well for most site applications. What is key is that the results of the rebound testing provide the critical mass transfer parameters needed to assess the impacts of the rock matrix, and any dechlorination reactions therein, on groundwater quality. If matrix back diffusion is not responsible (based on comparison of the model) for the observed rebound, DNAPL sources and/or contaminant mass in lower transmissivity fractures would be the suspected cause of the rebound. Additional tracer testing, as described in Schaefer et al. (2016) would need to be implemented to provide additional characterization.

References

- Boving, T.B. and Grathwohl, P. 2001. Tracer diffusion coefficients in sedimentary rocks: correlation to porosity and hydraulic conductivity. *J. Contam. Hydrol.* 53, 85-100.
- Davis, G.B. and Johnston, C.D. 1984. Comments on “Contaminant Transport in Fractured Porous Media: Analytical Solutions for a System of Parallel Fractures” by E. A. Sudicky and E.O. Frind”, *Water Resources Research*, Vol. 20, No. 9, pages 1321-1322.
- Schaefer, C.E.; Towne, R.M.; Lazouskaya, V.; Bishop, M.E.; Dong, H. 2012. Diffusive flux and pore anisotropy in sedimentary rocks. *J. Contam. Hydrol.* 131, 1-8.
- Schaefer, C.E., Towne, R.M., Lippincott, D.R., Lacombe, P., Bishop, M.E., Dong, H. 2015. Abiotic Dechlorination in Rock Matrices Impacted by Long-Term Exposure to TCE. *Chemosphere* 119, 744-749.
- Schaefer, C.E., White, E.B., Lavorgna, G.M., Annable, M.D. 2016. Dense nonaqueous-phase liquid architecture in fractured bedrock: implications for treatment and plume longevity. *Environ. Sci. Technol.* 50, 207-213.
- Sudicky, E.A. and Frind, E.O. 1982. Contaminant transport in fractured porous media: analytical solutions for a system of parallel fractures. *Water Resources Research* 18, 1634-1642.
- Sudicky, E. A. and Frind, E.O. 1984. Reply, *Water Resources Research*, Vol. 20, No. 9, pages 1323-1324.