

# REPORT DOCUMENTATION PAGE

Form Approved  
OMB No. 0704-0188

Public reporting burden for this collection of information is estimated to average 1 hour per response, including the time for reviewing instructions, searching existing data sources, gathering and maintaining the data needed, and completing and reviewing this collection of information. Send comments regarding this burden estimate or any other aspect of this collection of information, including suggestions for reducing this burden to Department of Defense, Washington Headquarters Services, Directorate for Information Operations and Reports (0704-0188), 1215 Jefferson Davis Highway, Suite 1204, Arlington, VA 22202-4302. Respondents should be aware that notwithstanding any other provision of law, no person shall be subject to any penalty for failing to comply with a collection of information if it does not display a currently valid OMB control number. **PLEASE DO NOT RETURN YOUR FORM TO THE ABOVE ADDRESS.**

<b>1. REPORT DATE (DD-MM-YYYY)</b> 09 January 2017		<b>2. REPORT TYPE</b> Briefing Charts		<b>3. DATES COVERED (From - To)</b> 15 December 2016 – 11 January 2017	
<b>4. TITLE AND SUBTITLE</b> Temperature Jump Pyrolysis Studies of RP-2 Fuel				<b>5a. CONTRACT NUMBER</b>	
				<b>5b. GRANT NUMBER</b>	
				<b>5c. PROGRAM ELEMENT NUMBER</b>	
<b>6. AUTHOR(S)</b> Owen M. Pryor, Steven D. Chambreau, Ghanshyam L. Vaghjiani, and Subith Vasu				<b>5d. PROJECT NUMBER</b>	
				<b>5e. TASK NUMBER</b>	
				<b>5f. WORK UNIT NUMBER</b> QORA	
<b>7. PERFORMING ORGANIZATION NAME(S) AND ADDRESS(ES)</b> Air Force Research Laboratory (AFMC) AFRL/RQRP 9 Antares Road Edwards AFB, CA 93524-7401				<b>8. PERFORMING ORGANIZATION REPORT NO.</b>	
<b>9. SPONSORING / MONITORING AGENCY NAME(S) AND ADDRESS(ES)</b> Air Force Research Laboratory (AFMC) AFRL/RQR 5 Pollux Drive Edwards AFB, CA 93524-7048				<b>10. SPONSOR/MONITOR'S ACRONYM(S)</b>	
				<b>11. SPONSOR/MONITOR'S REPORT NUMBER(S)</b> AFRL-RQ-ED-VG-2016-427	
<b>12. DISTRIBUTION / AVAILABILITY STATEMENT</b> Approved for Public Release; Distribution Unlimited. The U.S. Government is joint author of the work and has the right to use, modify, reproduce, release, perform, display, or disclose the work.					
<b>13. SUPPLEMENTARY NOTES</b> For presentation at AIAA SciTech; Grapeville, TX, USA (January 9-11, 2017) PA Case Number: 17026; Clearance Date: 01/13/2017 Prepared in collaboration with University of Central Florida					
<b>14. ABSTRACT</b> Viewgraph/Briefing Charts					
<b>15. SUBJECT TERMS</b> N/A					
<b>16. SECURITY CLASSIFICATION OF:</b>			<b>17. LIMITATION OF ABSTRACT</b>	<b>18. NUMBER OF PAGES</b>	<b>19a. NAME OF RESPONSIBLE PERSON</b>
<b>a. REPORT</b>	<b>b. ABSTRACT</b>	<b>c. THIS PAGE</b>			S. Schneider
Unclassified	Unclassified	Unclassified	SAR	16	<b>19b. TELEPHONE NO (include area code)</b> N/A

# TEMPERATURE JUMP PYROLYSIS STUDIES OF RP-2 FUEL

**Owen Pryor<sup>1</sup>, Steven D. Chambreau<sup>2</sup>, Ghanshyam L. Vaghjiani<sup>2</sup>,  
Subith Vasu<sup>1</sup>**

<sup>1</sup> **Center for Advanced Turbomachinery and Energy Research,  
Mechanical and Aerospace Engineering Department,  
University of Central Florida, Orlando, FL 32816**

<sup>2</sup> **Propellants Branch, Rocket Propulsion Division  
Aerospace Engineering Directorate, Air Force Research Laboratory,  
AFRL/RQRP, Edwards AFB, CA 93524**

Distribution A: Approved for public release; distribution unlimited. PA Clearance 17026

# Understanding RP-2: A Complex Mixture

RP-2 is a real fuel consisting of hundreds of different compounds; comprised primarily of kerosene

There is little sulfur containing compounds and almost no aromatics in the fuel

Type of Compound	RP-2 wt%	Jet A wt%
Aromatics	0.28	18.66
iso-Paraffins	36.61	29.45
N-Paraffins	2.42	20.03
Cycloparaffins	60.69	31.86

Distribution A: Approved for public release; distribution unlimited. PA Clearance 17026



# Understanding RP-2: A Complex Mixture

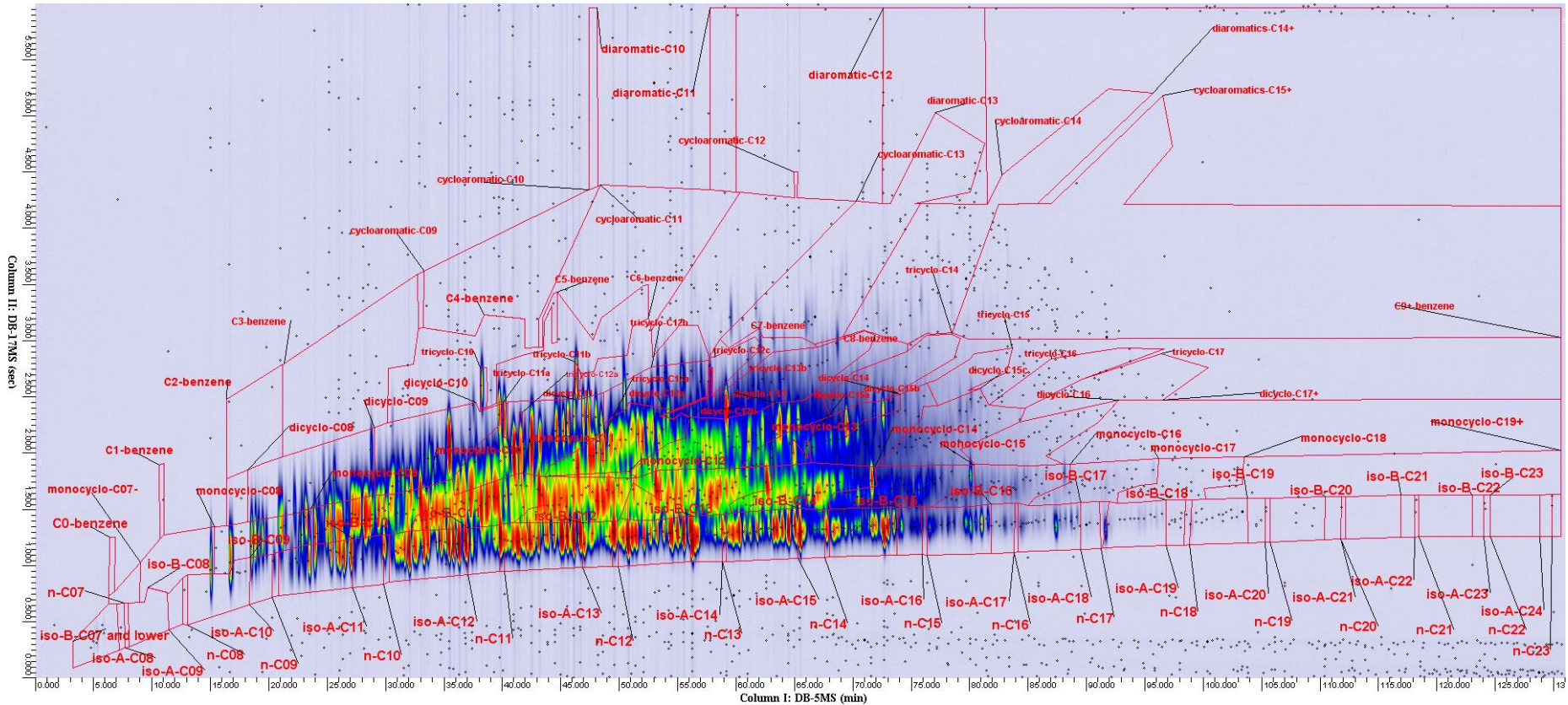

Distribution A: Approved for public release; distribution unlimited. PA Clearance 17026

# RP-2 Pyrolysis/Combustion Chemistries?

- Recent studies have focused on the understanding of real fuel chemistry
  - MacDonald et al. (JPP, 2007): e.g., RP-1, RP-2, JP-7
  - Fortin and Bruno (Energy Fuels, 2013): e.g., Thermally stressed RP-1 and RP-2
- We are interested in coking kinetics
  - Allows fundamental modeling of the chemical kinetics involved during thermal stressing
  - Data also useful for engine performance modeling

Distribution A: Approved for public release; distribution unlimited. PA Clearance 17026



# Motivation: Understand Coking Mechanisms

## Coking:

Deposits are formed along the walls of the cooling channels

Causes restricted fuel flow

Leads to increased exposure to thermal stressing

## Fuel Composition Changes:

Liquid to gas transition in cooling channels

Causes break down due to gas-phase pyrolysis and surface chemistry

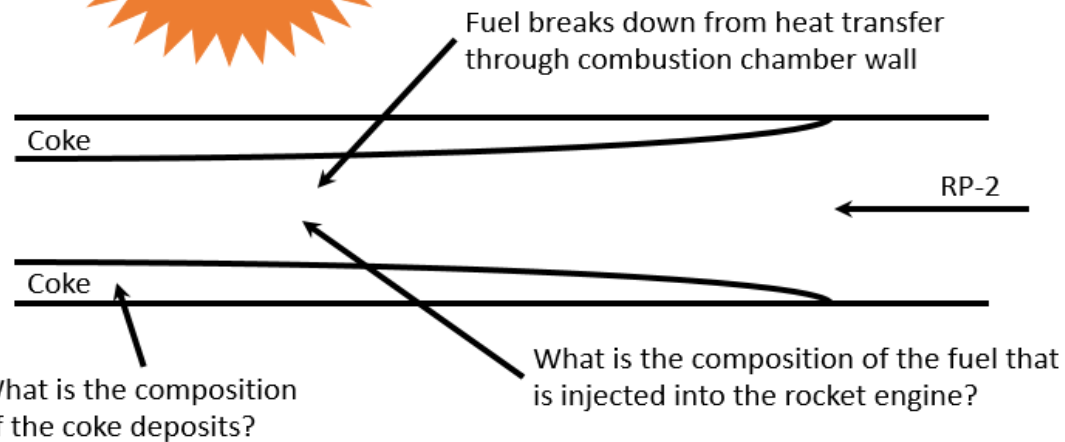
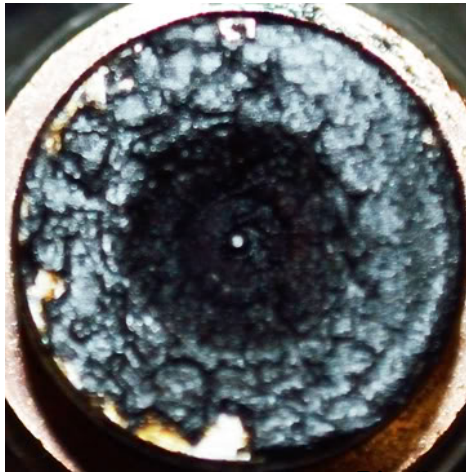

Distribution A: Approved for public release; distribution unlimited. PA Clearance 17026

# Objectives of This Work

---

What is actually being burned in the engine?

What is the effect of the channel wall material on coking?

How accurate are the measurements being performed when burning real fuels in experiments?

Distribution A: Approved for public release; distribution unlimited. PA Clearance 17026

# Temperature Jump Pyrolysis at AFRL Edwards

Rapid heating of a metal filament at a rate of 600 – 800 K/s, and the set temperature is held for around 20 seconds

The method has been used to understand the decomposition of a variety of different compounds

The method is commonly attached to an FTIR spectrometer to measure the products of pyrolysis under different conditions

Distribution A: Approved for public release; distribution unlimited. PA Clearance 17026



# FTIR Experimental Setup

System powered through a 40V/15 A power supply

- Up to 600 K/s
- $T = 300 - 600 \pm 20 \text{ } ^\circ\text{C}$
- $P = 1 - 30 \text{ atm}$
- Nichrome Filament

Rapid-scan FTIR

- $590 - 3850 \text{ cm}^{-1}$   
with  $4 \text{ cm}^{-1}$  res
- 256 Scans at  
180 kHz

Labview controlled  
PID controller  
and FTIR trigger

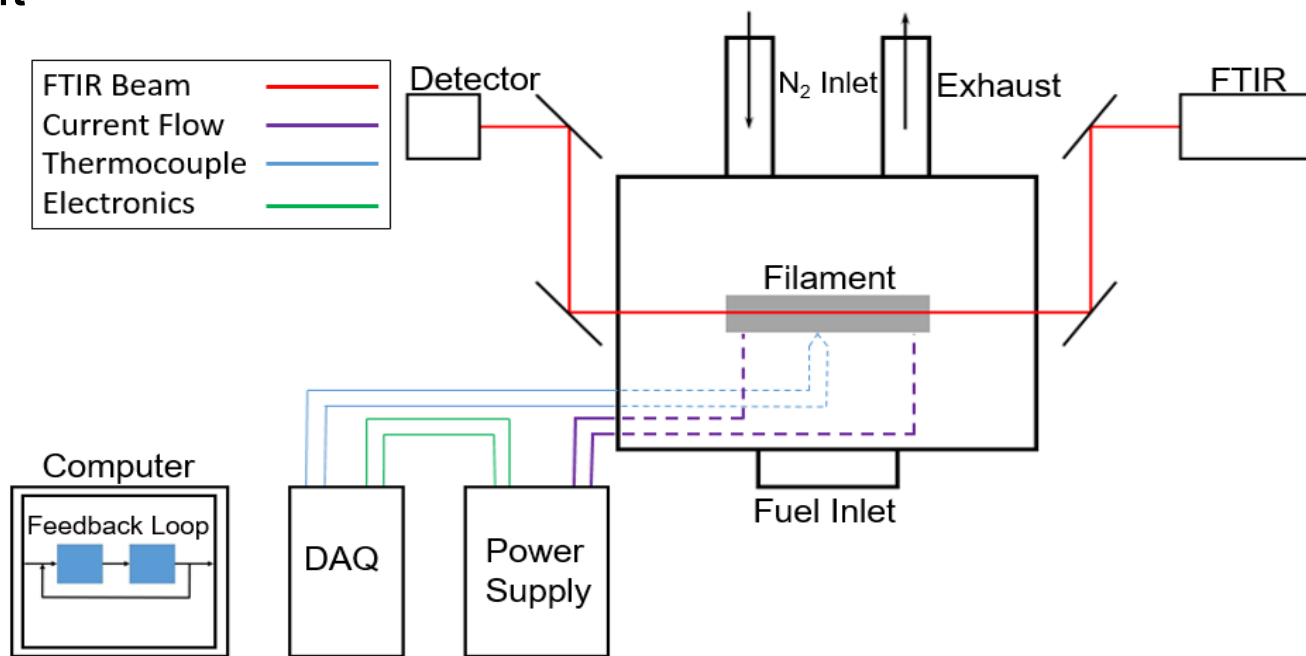

Distribution A: Approved for public release; distribution unlimited. PA Clearance 17026

# Results and Discussion: Temperature Rise Measurement

## Water experiment

- $T = 500 \text{ }^\circ\text{C}$
- $dT/dt = 200 \text{ }^\circ\text{C}$

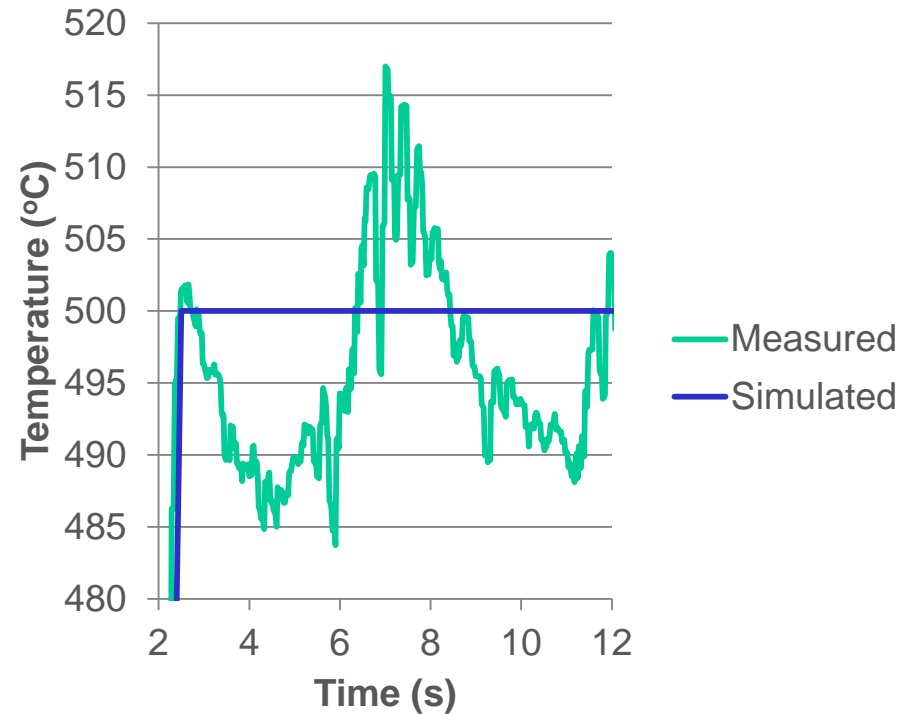
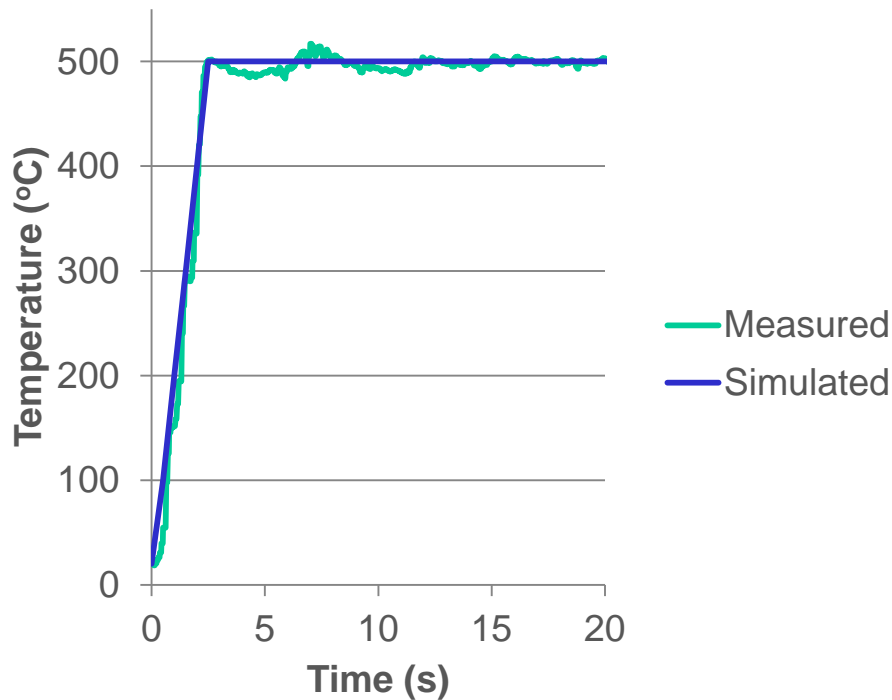

Distribution A: Approved for public release; distribution unlimited. PA Clearance 17026



# Results and Discussion: RP-2 Spectrum

C-H Stretch at  $\sim 2950 \text{ cm}^{-1}$

C-C Stretch at  $\sim 1450 \text{ cm}^{-1}$

$\text{C}\equiv\text{C}$  Stretch at  $\sim 2235 \text{ cm}^{-1}$

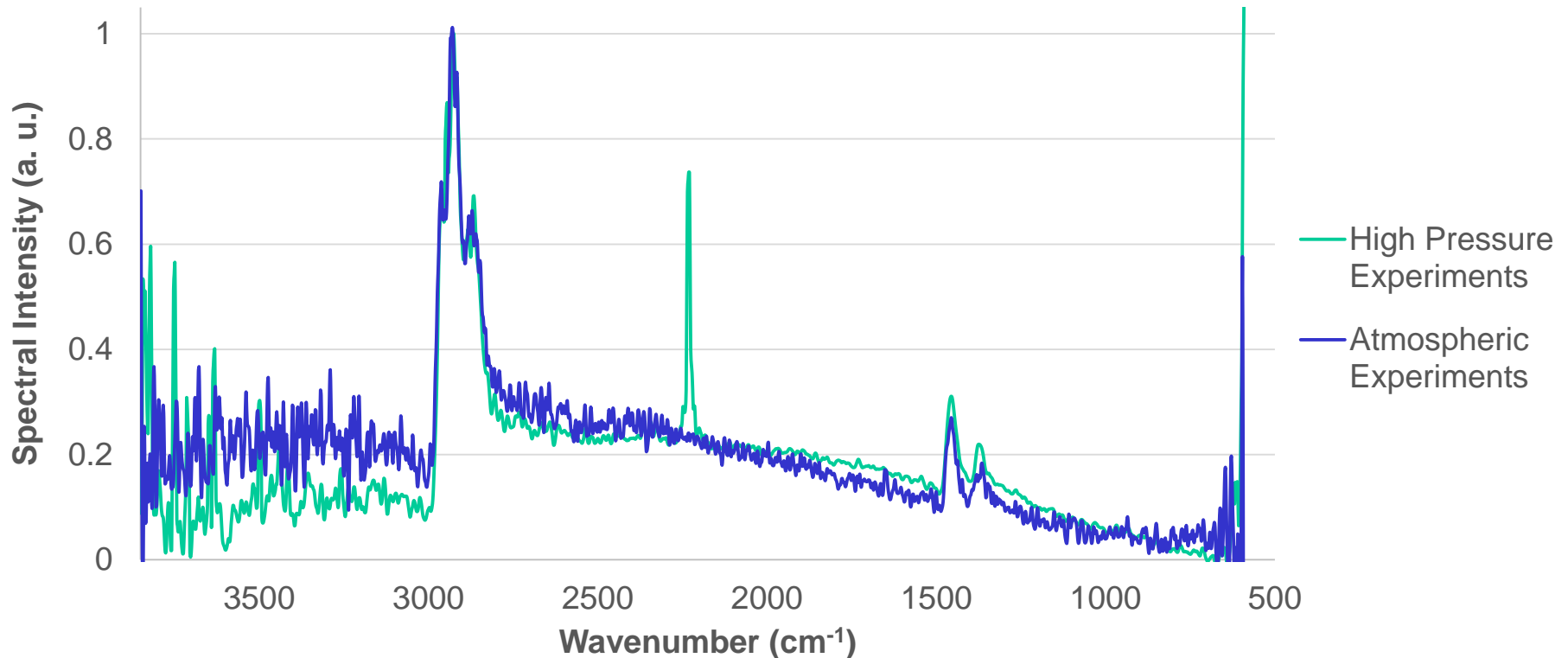

Distribution A: Approved for public release; distribution unlimited. PA Clearance 17026

# Results and Discussions: Time Histories

Time-history of 2 major wavelengths compared to temperature

C-H Stretch:  $2927\text{ cm}^{-1}$

C-C Stretch:  $1514\text{ cm}^{-1}$

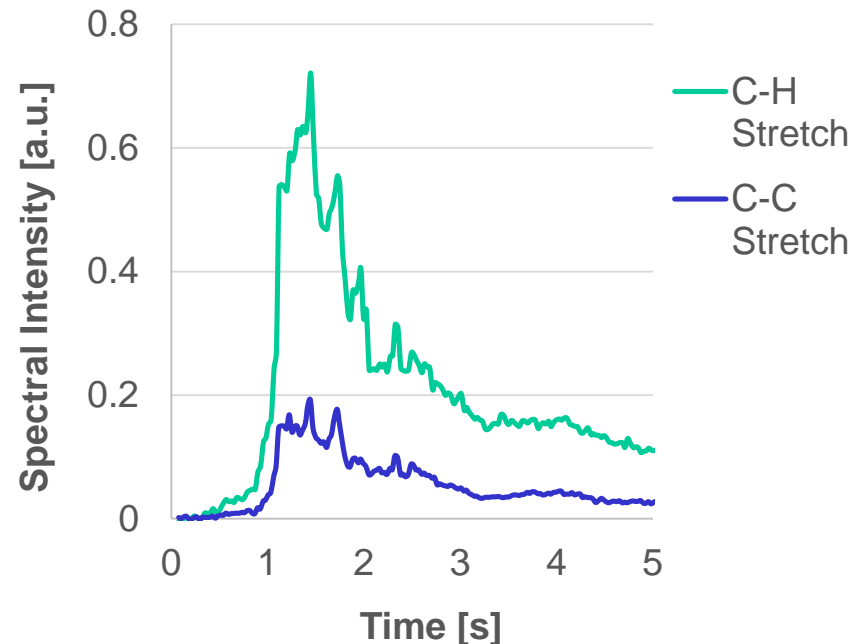
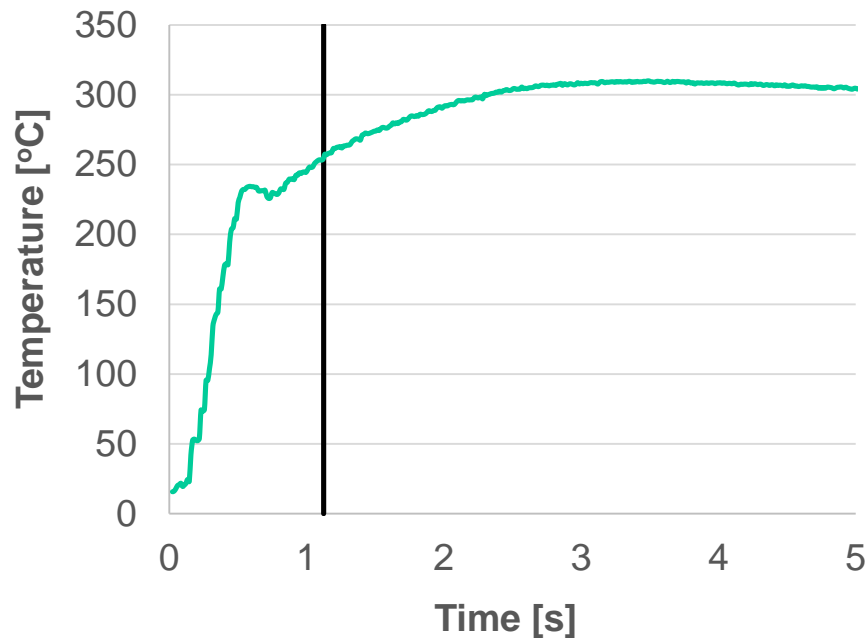

Distribution A: Approved for public release; distribution unlimited. PA Clearance 17026



# Results and Discussion: Boiling vs. Pyrolysis

The temperature rate increase slowed with addition of RP-2 to the system

The inflection point shows the location of the boiling point

The Clausius-Clapeyron equation is able to match the boiling below 10 atm

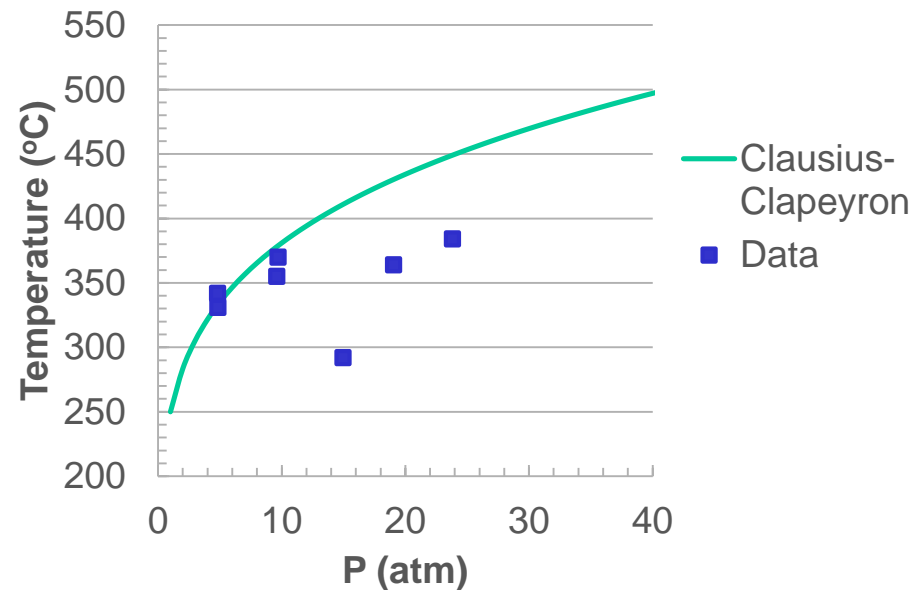
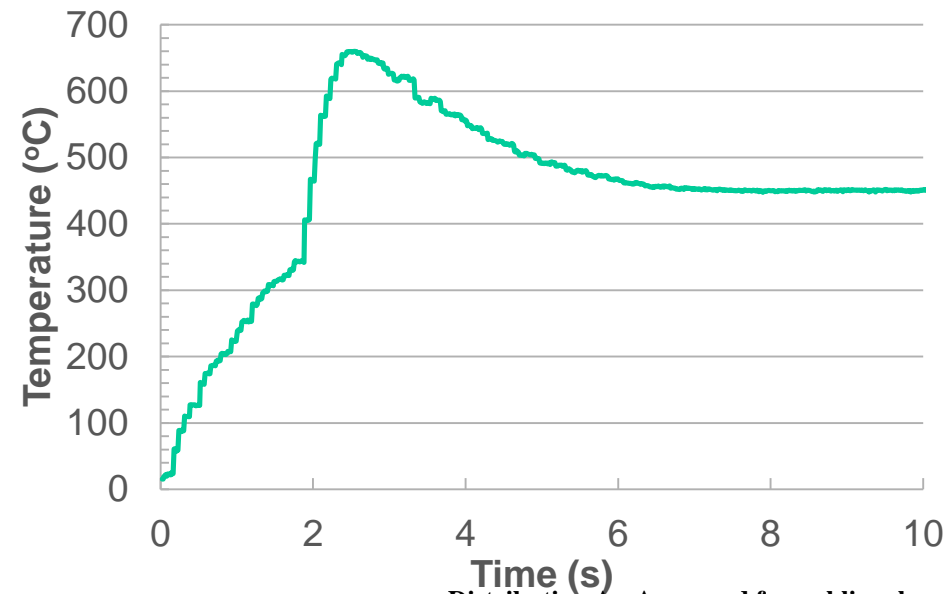

Distribution A: Approved for public release; distribution unlimited. PA Clearance 17026



# Future Work and Improvements

Accelerate the rate of temperature increase to avoid boiling

Perform measurements with different surfaces

Perform measurements at elevated pressures

Identify the different compounds that are being produced at different pressures

Examine any solid compounds left behind upon RP-2 pyrolysis

Distribution A: Approved for public release; distribution unlimited. PA Clearance 17026



# Conclusions

---

T-Jump / Rapid-scan FTIR experiments were performed at elevated pressures

A new spectral line is observed at elevated pressures

Issue of boiling of RP-2 on the surface of filament needs further investigations

More studies need to be done to understand how different surfaces affect the breakdown of RP-2

Distribution A: Approved for public release; distribution unlimited. PA Clearance 17026



# Acknowledgments

OMP and SV are grateful for the support of the Summer Faculty Fellowship Program under Contract # FA9550-12-d-0001 from AFRL, and SDC for funding from AFOSR under Contract # FA9300-06-C-0023

Distribution A: Approved for public release; distribution unlimited. PA Clearance 17026