

REPORT DOCUMENTATION PAGE

Form Approved
OMB No. 0704-0188

The public reporting burden for this collection of information is estimated to average 1 hour per response, including the time for reviewing instructions, searching existing data sources, gathering and maintaining the data needed, and completing and reviewing the collection of information. Send comments regarding this burden estimate or any other aspect of this collection of information, including suggestions for reducing this burden, to Department of Defense, Washington Headquarters Services, Directorate for Information on Operations and Reports (0704-0188), 1215 Jefferson Davis Highway, Suite 1204, Arlington, VA 22202-4302. Respondents should be aware that notwithstanding any other provision of law, no person shall be subject to any penalty for failing to comply with a collection of information if it does not display a currently valid OMB control number.
PLEASE DO NOT RETURN YOUR FORM TO THE ABOVE ADDRESS.

1. REPORT DATE (DD-MM-YYYY) 28-09-2016			2. REPORT TYPE Final		3. DATES COVERED (From - To)	
4. TITLE AND SUBTITLE Test Operations Procedure (TOP) 02-2-606 Testing of Military Towbars				5a. CONTRACT NUMBER		
				5b. GRANT NUMBER		
				5c. PROGRAM ELEMENT NUMBER		
6. AUTHORS				5d. PROJECT NUMBER		
				5e. TASK NUMBER		
				5f. WORK UNIT NUMBER		
7. PERFORMING ORGANIZATION NAME(S) AND ADDRESS(ES) Automotive Directorate (TEDT-AT-AD) U.S. Army Aberdeen Test Center 400 Colleran Rd Aberdeen Proving Ground, MD 21005				8. PERFORMING ORGANIZATION REPORT NUMBER TOP 02-2-606		
9. SPONSORING/MONITORING AGENCY NAME(S) AND ADDRESS(ES) Policy and Standardization Division (CSTE-TM) U.S. Army Test and Evaluation Command 2202 Aberdeen Boulevard Aberdeen Proving Ground, MD 21005-5001				10. SPONSOR/MONITOR'S ACRONYM(S)		
				11. SPONSOR/MONITOR'S REPORT NUMBER(S) Same as item 8		
12. DISTRIBUTION/AVAILABILITY STATEMENT Distribution Statement A. Approved for public release; distribution is unlimited.						
13. SUPPLEMENTARY NOTES Defense Technical Information Center (DTIC), AD No.:						
14. ABSTRACT This TOP describes accepted methods used to measure, analyze, and report the component and vehicle level testing of recovery towbars used for flat towing, and lift and tow operations. Procedures include performance and durability testing. Accelerated durability test methods are employed.						
15. SUBJECT TERMS towbar, tow bar, towing, vehicle recovery, towing a like vehicle						
16. SECURITY CLASSIFICATION OF:			17. LIMITATION OF ABSTRACT SAR	18. NUMBER OF PAGES 36	19a. NAME OF RESPONSIBLE PERSON	
a. REPORT Unclassified	b. ABSTRACT Unclassified	c. THIS PAGE Unclassified			19b. TELEPHONE NUMBER (include area code)	

Standard Form 298 (Rev. 8-98)
Prescribed by ANSI Std. Z39-18

(This page is intentionally blank.)

US ARMY TEST AND EVALUATION COMMAND
TEST OPERATIONS PROCEDURE

*Test Operations Procedure 02-2-606
DTIC AD No.

28 September 2016

TESTING OF MILITARY TOWBARS

		<u>Page</u>
Paragraph	1. SCOPE.....	2
	1.1 Purpose	2
	1.2 Background	2
	1.3 Limitations.....	2
	2. FACILITIES AND INSTRUMENTATION.....	3
	2.1 Calibration	3
	2.2 Recommended Criteria.....	3
	2.3 Definitions	5
	2.4 Instrumentation.....	6
	3. REQUIRED TEST CONDITIONS.....	13
	3.1 General Inspections	13
	3.2 Towbar Preparation	14
	3.3 Towing and Towed Vehicle Preparation.....	14
	3.4 Test Controls	15
	4. TEST PROCEDURES	15
	4.1 Towbar Specific/Component Level Testing.....	15
	4.2 Vehicle Level Tests	18
	4.3 Off-Road Site Characterization	20
	5. DATA REQUIRED.....	20
	5.1 Component Level/Towbar Specific.....	20
	5.2 Vehicle Level Tests	21
	5.3 Off-Road Site Characterization	23
	6. PRESENTATION OF DATA	24
	6.1 Component Level/Towbar Specific.....	24
	6.2 Vehicle Level Tests	24
	6.3 Off-Road Site Characterization	27
APPENDIX	A. ABBREVIATIONS.....	A-1
	B. REFERENCES.....	B-1
	C. APPROVAL AUTHORITY.....	C-1

1. SCOPE.

1.1 Purpose.

This Test Operations Procedure (TOP) describes accepted methods used to measure, analyze, and report the component and vehicle level testing of recovery towbars used for flat towing, and lift and tow operations. Procedures include performance and durability testing. Accelerated durability test methods are employed.

1.2 Background.

a. The military towbar has a much different use compared to their commercial counterparts. Commercial towbars are used primarily for driveaway-towaway operations. They see a small percentage of use compared to other commercially accepted methods of towing and recovery. Rarely are they used off-road and towed vehicle damage is typically limited to powertrain failures where the towing resistance is not significantly increased.

b. Military operations are varied and can require towing/recovery over a wide variety of terrain features and environmental conditions. Towed vehicle damage can be significant where a loss of tires, wheel, suspension components, or tracks is common. This type of damage can create a large increase in towing resistance. Coupled with terrain features like significant grades and low soil strength, the towbar forces can be significant.

c. Military towbars are typically designed for a specific weight range of vehicles and for the type of towing vehicle. Some vehicles are mission specific and have attributes designed specifically for recovery such as heavy duty cooling systems, larger capacity axles, suspension lockouts, etc. All tactical vehicles have a requirement to be able to tow a “like” vehicle. Specific attention should be given to this requirement as the vehicle family’s mission profile, terrain, and speed profiles can dictate a robust towbar design.

d. Specific design criteria do not exist for the military towbar. Commercial designs used in a military recovery environment have had limited and sometimes disastrous results. This TOP provides some design criteria recommendations as well as logical component and vehicle level tests, that when followed, will assure adequate performance in the field.

1.3 Limitations.

a. The procedures outlined in this TOP apply to conventional designs of wheeled and tracked vehicles operating on test courses such as those described in TOP 01-1-011A (Vehicle Test Facilities at Aberdeen Test Center and Yuma Test Center)^{1**}. Additional natural and prepared test environments may be required to analyze unique vehicle designs and attributes, or to address specialized mobility test requirements or mission profiles.

** Superscript numbers correspond to Appendix B, References.

b. Component specific fixtures will be required to provide simulated towbar leg spacing and height adjustment for the component level testing. These tests will be nondestructive in nature.

2. FACILITIES AND INSTRUMENTATION.

2.1 Calibration.

a. All measuring tools and instrumentation will be calibrated against a higher order standard at periodic intervals not to exceed twelve months. Records, showing the calibration traceability to the National Institute of Standards and Technology (NIST), will be maintained for all measuring and test equipment.

b. All measuring and test equipment and measuring standards will be labeled with the following information:

- (1) Date of calibration.
- (2) Date of next scheduled calibration.
- (3) Name of the organization and technician who calibrated the equipment.

c. A written calibration report will be provided that includes as a minimum the following information for all measurement and test equipment:

- (1) Type of equipment, manufacturer, model number, etc.
- (2) Measurement range.
- (3) Accuracy.
- (4) Calibration interval.
- (5) Type of standard used to calibrate the equipment (calibration traceability of the standard must be evident).

2.2 Recommended Criteria.

Title 49, Transportation Federal Motor Carrier Safety Regulation (FMCSR) 393.71 Subpart F - Coupling Devices and Towing Methods² provides basic design criteria for towbars. Per FMCSR 393.71, towbars shall comply with the following requirements:

a. Structural adequacy and mounting.

(1) Every towbar shall be structurally adequate and properly installed and maintained. The required strength of towbars for towed vehicles of 5,000 pounds and over gross weight shall

be computed by means of the following formulae: Longitudinal strength = gross weight of towed vehicle \times 1.3. Strength as a beam = gross weight of towed vehicle \times 0.6.

(2) Because of the extreme operational environments and expectations for the military towbar, the commercial structural adequacy quoted in FMCSR 393.71 is not considered sufficient. The longitudinal strength and strength as a beam factors should be increased to at least 1.5. The application definitions presented in Table 1 are provided from the Machinery's Handbook³ to define the proper factor of safety.

TABLE 1. CONSIDERATIONS FOR STRUCTURAL ADEQUACY

FACTOR OF SAFETY	APPLICATION DEFINITION
1.3 – 1.5	For use with highly reliable materials where loading and environmental conditions are not severe, <i>and</i> where weight is an important consideration.
1.5 – 2.0	For applications using reliable materials where loading and environmental conditions are not severe.
2.0 – 2.5	For use with ordinary materials where loading and environmental conditions are not severe.
2.5 – 3.0	For less tried and for brittle materials where loading and environmental conditions are not severe.
3.0 – 4.0	For applications in which material properties are not reliable and where loading and environmental conditions are not severe, <i>or</i> where reliable materials are to be used under difficult loading and environmental conditions.

b. Towbars, jointed. The towbar shall be so constructed as to freely permit motion in both horizontal and vertical planes between the towed and towing vehicles. The means used to provide the motion shall be such as to prohibit the transmission of stresses under normal operation between the towed and towing vehicles, except along the longitudinal axis of the tongue or tongues.

c. Towbar fastenings. The means used to transmit the stresses to the chassis or frames of the towed and towing vehicles may be either temporary structures, or bumpers or other integral parts of the vehicles: Provided, however, that the means used shall be so constructed, installed, and maintained that when tested as an assembly, failure in such members shall not occur when the weakest new towbar which is permissible, is subjected to the tests given therein.

d. Means of adjusting length. On towbars, adjustable as to length, the means used to make such adjustment shall fit tightly and not result in any slackness or permit the towbar to bend. With the towbar supported rigidly at both ends and with a load of 50 pounds at the center, the sag (measured at the center) in any direction shall not exceed 0.25 of an inch under any condition of adjustment as to length.

e. Method of clamping. Adequate means shall be provided for securely fastening the towbar to the towed and towing vehicles.

f. Towbar connection to steering mechanism. The towbar shall be provided with suitable means of attachment to and actuation of the steering mechanism, if any, of the towed vehicle. The attachment shall provide for sufficient angularity of movement of the front wheels of the towed vehicle so that it may follow substantially in the path of the towing vehicle without cramping the tow-bar. The towbar shall be provided with suitable joints to permit such movement.

g. Tracking. The towbar shall be so designed, constructed, maintained, and mounted as to cause the towed vehicle to follow substantially in the path of the towing vehicle. Towbars of such design or are in condition as to permit the towed vehicle to deviate more than 3 inches to either side of the path of a towing vehicle moving in a straight line as measured from the center of the towing vehicle are prohibited.

h. Marking towbars. Every towbar acquired and used in driveaway-towaway operations by a motor carrier shall be plainly marked with the following certification of the manufacturer thereof (or words of equivalent meaning): This towbar complies with the requirements of the Federal Motor Carrier Safety Administration for (maximum gross weight for which towbar is manufactured) vehicles. Allowable Maximum Gross Weight Manufactured (month and year) by (name of manufacturer) Towbar certification manufactured before the effective date of this regulation must meet requirements in effect at the time of manufacture.

i. Safety devices in case of tow-bar failure or disconnection. The towed vehicle shall be connected to the towing vehicle by a safety device to prevent the towed vehicle from breaking loose in the event the tow-bar fails or becomes disconnected. When safety chains or cables are used as the safety device for that vehicle, at least two safety chains or cables shall be used. The tensile strength of the safety device and the means of attachment to the vehicles shall be at least equivalent to the corresponding longitudinal strength for towbars. If safety chains or cables are used as the safety device, the required strength shall be the combined strength of the combination of chains and cables.

j. If chains or cables are used as the safety device, they shall be crossed and attached to the vehicles near the points of bumper attachments to the chassis of the vehicles. The length of chain used shall be no more than necessary to permit free turning of the vehicles. The chains shall be attached to the towbar at the point of crossing or as close to that point as is practicable.

2.3 Definitions.

a. Breaking load. The amount of load that exceeds the yield strength of the towbar or any towbar component. The breaking load will be extrapolated from the component tests and the material properties of the towbar.

- b. Design load. The amount of load that the towbar was designed for as predicted by analysis. The design load is to be used as a starting point for applying loads during component testing.
- c. Gross Vehicle Weight (GVW). The weight of the vehicle when fully mission capable plus payload.
- d. Preliminary Towbar Rating. The calculated maximum GVW that the towbar can safely tow. This is estimated from the extrapolated force at the yield stress and the applicable factor of safety.
- e. Towbar Rating. The actual maximum GVW that the towbar can safely tow. This is determined through vehicle level and component test comparisons, where the field measured proof load does not exceed the proof load determined during the component testing.

2.4 Instrumentation.

<u>Devices for Measuring</u>	<u>Maximum Error of Measurement^a</u>
True ground speed (velocity)	± 0.2 kilometers per hour (km/hr) (± 0.2 miles per hour (mph))
Global Positioning System (GPS)	± 2.5 meters (m) (8.2 feet (ft))
Wheel or sprocket speed	± 0.5% of full-scale range
Engine speed	± 0.5% of full-scale range
Drawbar/pintle force	± 0.5% of full-scale range
Loadcell (towing force)	± 1% of full-scale range
Temperature measuring devices	± 2 °Celsius (°C) (4 °Fahrenheit (°F))
Angular velocity	± 0.5% of full-scale range
Acceleration	± 5% of measurement

^a Values may be assumed to represent ± 2 standard deviations. Thus, the stated tolerances should not be exceeded in more than one measurement out of 20.

2.4.1 Load Cell Construction.

- a. In addition to the forces measured in the towbar legs a direct measurement of the pintle force is often requested. Providing a load cell for this measurement is application specific and often requires modification to the pintle or the pintle attachment hardware. Custom load

cells can be fabricated but require additional planning and lead time for design, construction and calibration. Figure 1 shows the modifications (in red) required for the M88A2 recovery vehicle.

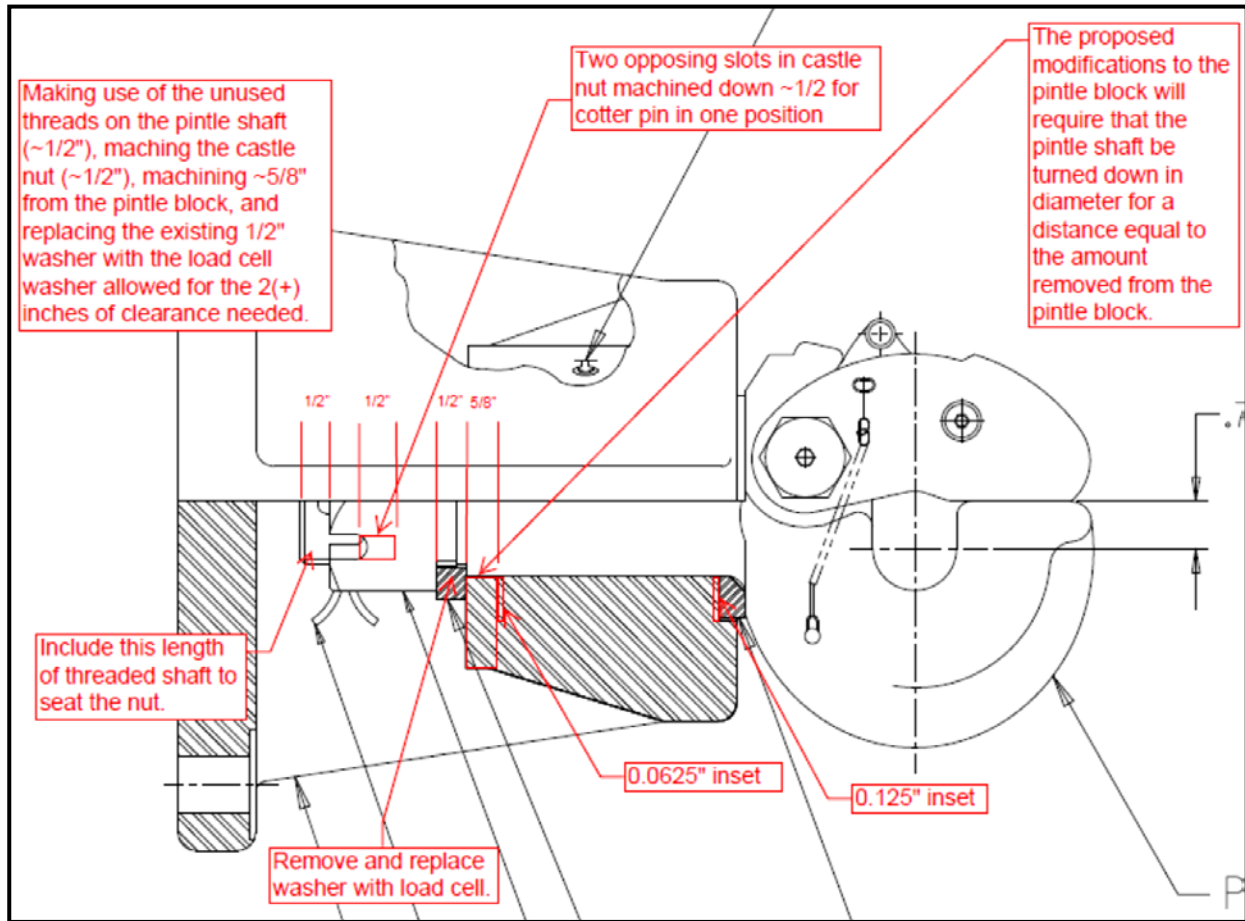

Figure 1. Pintle assembly modifications diagram - M88A2.

b. In order to specify a working range for a load cell the towed vehicle weight, gradeability limits, wheel or track and suspension losses, a shock overload value must be measured and/or estimated. In the case of the M88A2, the maximum towing value expected was 70,000 pound (lb) but was rounded up to 100,000 lb. The towing vehicle manufacturer should be consulted before any modifications are made. Figure 2 shows the final assembly of the pintle with the load cell in place.



Figure 2. Modified pintle mount assembly with custom load cell installed.

c. Calibration of the completed load cell can be accomplished using a number of accepted methods. The calibration should be conducted using the modified hardware installed on the towing vehicle. The preferred method is to use the calibrated front load cell and hydraulic system on the front of the mobile field dynamometer. Incremental loads are applied with the dynamometer while maintaining a level pull. Loading up to 80% of the rating of the towing load cell is recommended. An alternate method is to use a separate load cell of the appropriate range placed in line with the pintle. The angle, measured from the horizontal should be measured and minimized. Figure 3 shows an example of the field calibration method.



Figure 3. Vehicle setup for calibration of pintle load cell.

2.4.2 Towbar Instrumentation.

a. Towbar transducer preparation involves the application of strain gages to measure axial and bending strain. Surface coatings are removed, and the towbar surface is prepared by successive sanding/polishing with fine grain emery cloth. Ninety-degree rosette gages are typically used for the towbar tube and end connections. When cured the strain gages are coated with protective polyurethane, covered with butyl rubber, and then finally covered with adhesive backed aluminum foil heavy gage tape. Small aluminum plates are mounted adjacent to the gage locations for further protection. Figure 4 shows typical gage locations for the single bar strength test. Figure 5 shows a typical gage location for axial loading, and Figure 6 shows gage locations for bending.

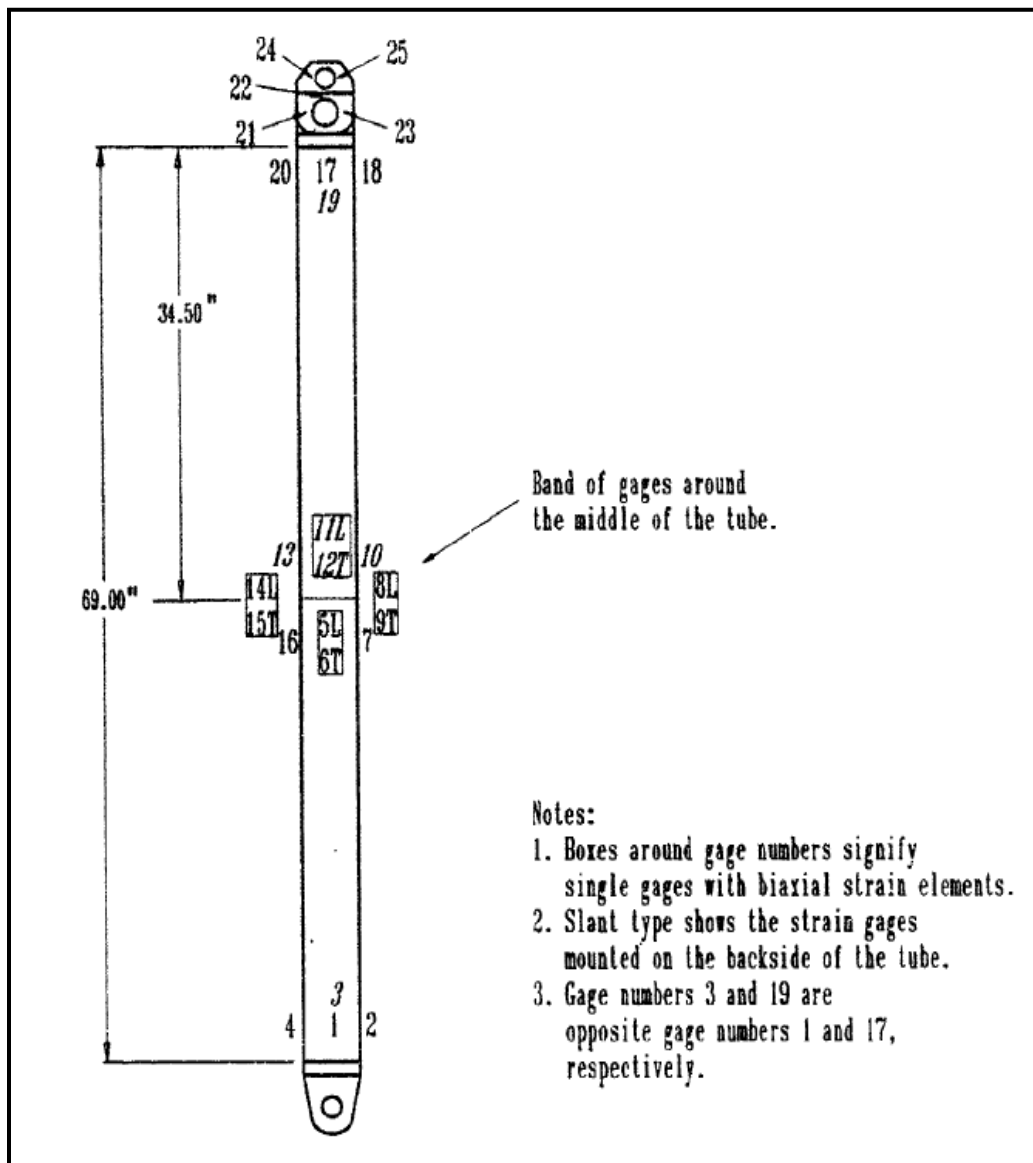

Figure 4. Towbar leg strain gage locations.

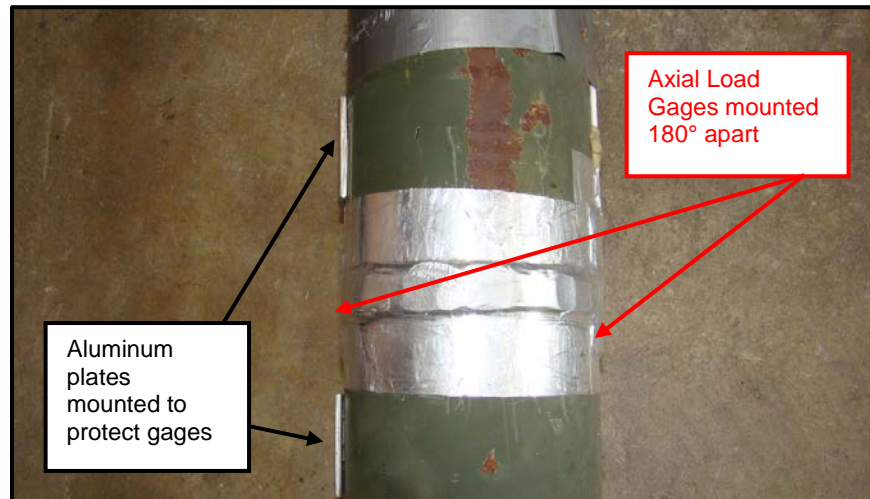

Figure 5. Gage locations for axial loading.

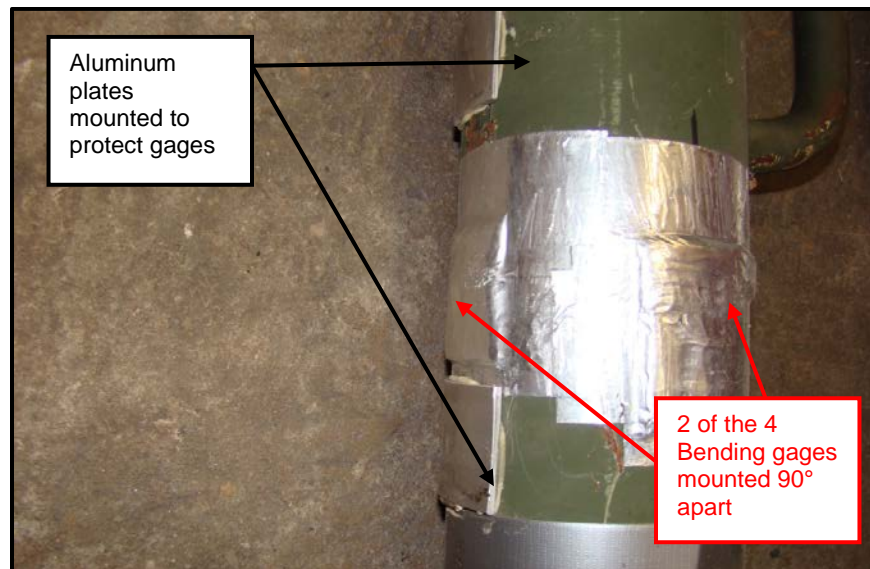

Figure 6. Gage locations for bending.

b. For calibration of the towbar components, each leg of the towbar assembly is loaded individually to determine the scale factors to be used in the data acquisition system. Three methods of force application are acceptable. A force calibration of each leg can be performed concurrent with single leg tensile strength test. The use of a properly sized bedplate and an overhead crane is the second method. A “deadman” anchor and a mobile field dynamometer or recovery vehicle winch is the third method. Towbar specific fixtures are fabricated and used in the tensile test machine, bolted to a bedplate or fastened to the deadman anchor. One end of the towbar leg is pinned to the fixture, and the other end of the tow bar leg is connected to a

calibrated load cell. Using the predetermined material properties an equivalent strain is computed equal to 80% of the yield value of the tube material. The calibration process should not exceed this calculated value. Depending on gage placement/alignment and the component stress gradient, the applied load versus the measured strain should be a linear relationship. Incremental tensile loads are applied using an overhead crane, mobile dynamometer, or recovery vehicle winch. Force readings from the calibrated load cell and strain gage responses are recorded by the data acquisition system. The scale factors are then determined for each towbar leg. A typical calibration curve is shown in Figure 7.

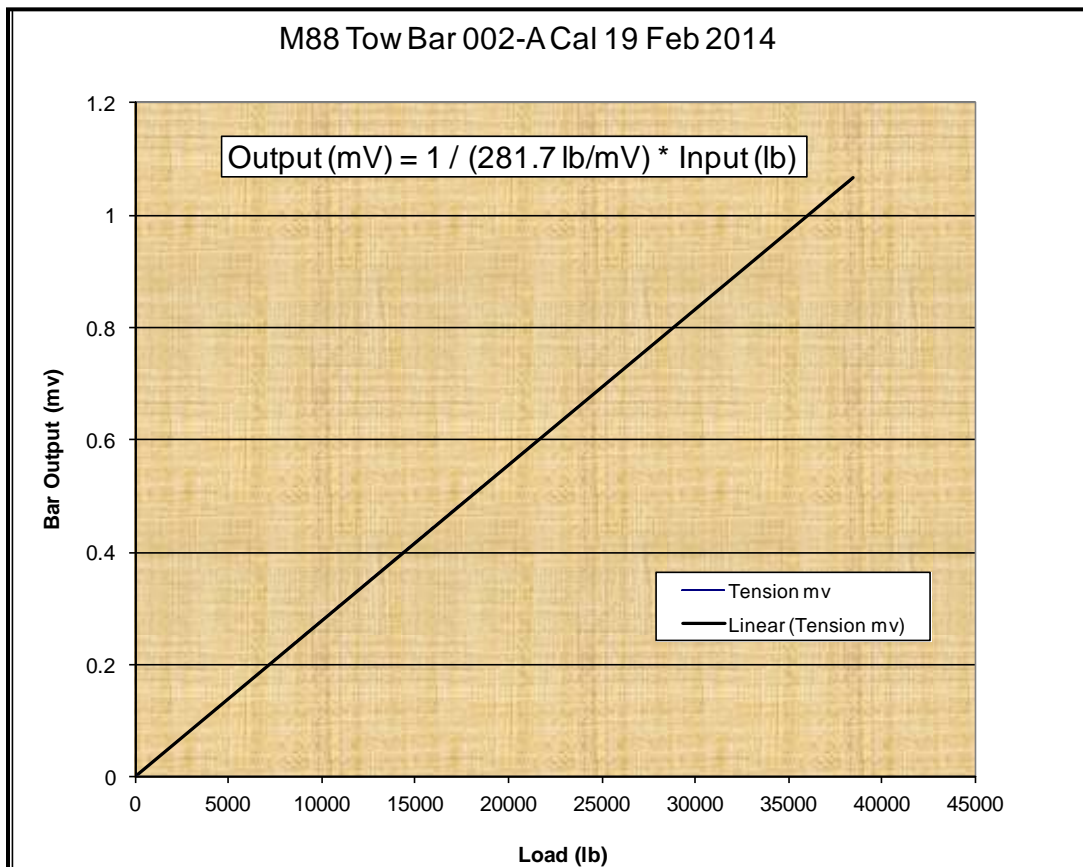

Figure 7. Typical strain-force calibration data.

c. The strain gages to measure bending are generally not calibrated with a physical load, as these gages are installed to determine whether plastic deformation occurs to a given towbar leg during the course of testing. This is evident by a DC shift, or offset in the measured strain values of the bending gages.

d. Figures 8 and 9 show a typical setup of the fixture and the load cell ends of the tow bar leg for calibration.



Figure 8. Tow bar calibration fixture fastened to a bedplate.

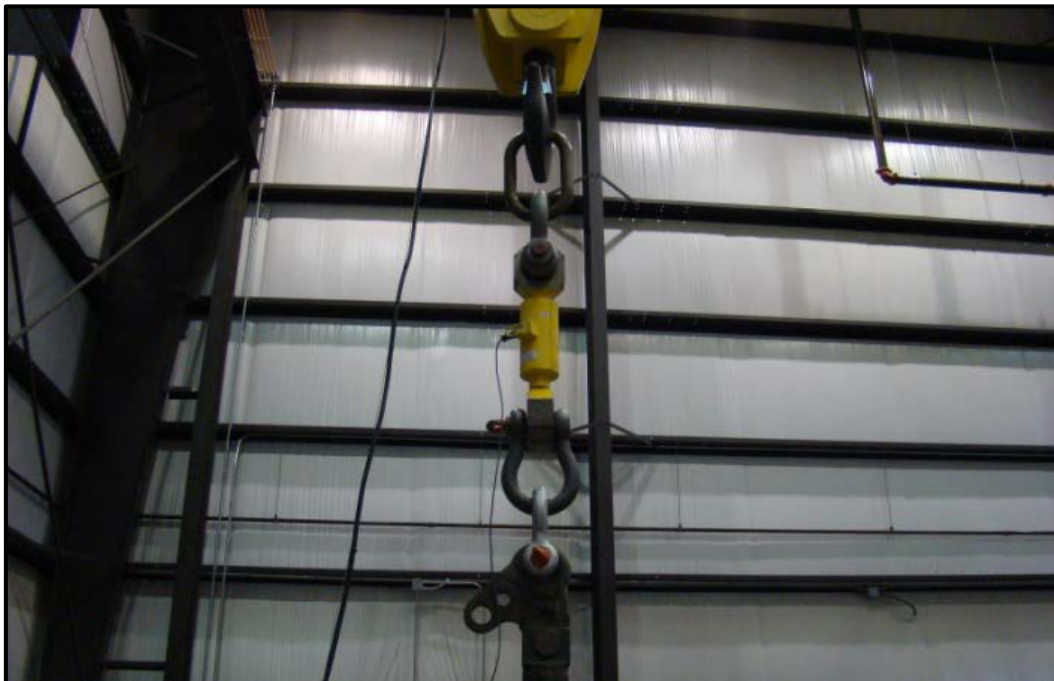

Figure 9. Towbar calibration fixture and load cell.

2.4.3 Vehicle Instrumentation.

a. Specific performance TOP's should be consulted for vehicle specific instrumentation required for each performance test. Performance tests required for a complete towing analysis include the following:

- (1) Physical Characteristics (TOP 02-2-500⁴).
- (2) Weight Distribution and Ground Pressure (TOP 02-2-801⁵).
- (3) Center of Gravity (TOP 02-2-800⁶).
- (4) Acceleration; Maximum and Minimum Speed (TOP 02-2-602⁷).
- (5) Maximum Effort Braking (TOP 02-2-608⁸).
- (6) Gradeability and Side Slope Operation (TOP 02-2-610⁹).
- (7) Standard Obstacles (TOP 02-2-611¹⁰).
- (8) Resistance to Towing (TOP 02-2-605¹¹).
- (9) Soft Soil Mobility (TOP 02-2-619A¹²).
- (10) Steering and Handling (TOP 02-2-718¹³).

b. Vehicle reactions are measured using a 6-degree of freedom (6-DOF) inertial measurement system to record pitch (θ), roll (ϕ), and yaw (Ψ) rates and longitudinal (x), lateral (y), and vertical (z) acceleration of the chassis. The inertial transducer should be mounted as close as practical to the center of gravity of the towing and towed vehicle. Any offsets should be measured and provided in the report. The axis and coordinate systems specified in Society of Automotive Engineers (SAE) International Surface Vehicle Recommended Practice, J670, Vehicle Dynamics Terminology¹⁴ should be used when installing vehicle instrumentation and analyzing and presenting the results.

c. If the test vehicle is equipped with a data bus, the serial data should be monitored and recorded. The data bus can provide key information including gear ranges selected and attained, torque converter status, throttle position, relative power and torque values, traction control status, etc. The validity of the data bus information must be verified or the source of data documented.

3. REQUIRED TEST CONDITIONS.

3.1 General Inspections.

a. The key towbar features should be measured at the end of each series of tests and should be within design tolerances specified on the provided drawings or system specifications.

Key characterization features of the towbar and associated hardware should include component weights, hole/pin diameters, lunette diameter, clevis end details, cross section, and overall tube length and straightness.

b. Weld failures, voids, cracks, etc., should be considered failures if they are identified visually or using a nondestructive weld inspection test method, per the applicable American Welding Society standard for the specific material being inspected.

c. Broken or cracked components, or catastrophic damage should be considered failures. Any elongation, permanent deformation, or wear on any surface exceeding 2 millimeter (mm) should be considered a failure.

d. Lunette and pintle wear should be uniform and the pintle should rotate smoothly within its mounting throughout the test.

e. At the discretion of the validating authority, towbar failures during abuse testing may not necessarily constitute a failed towbar. Data may be used to determine the towbar and/or vehicle limitations.

3.2 Towbar Preparation.

a. Inventory and photograph all towbars and associated brackets, as received.

b. Nondestructive weld inspections will be performed on all tow bars to validate all welded connections prior to any test.

c. All key features will be measured and recorded for each towbar candidate. Key characterization features of the towbar and associated hardware should include component weights, hole/pin diameters, lunette diameter, clevis end details, cross section, and overall tube length, wall thickness, and straightness.

d. Apply strain gages and calibrate them for axial loading as described in paragraph 2.4.2.

3.3 Towing and Towed Vehicle Preparation.

a. Initial inspection of the test vehicles should be conducted as described in TOP 02-2-505, with emphasis given to the condition of the powertrain, suspension, tires or tracks. The towing provisions of the towed vehicle should be given a non-destructive inspection to insure weld quality. Bolted provisions should have all fasteners checked for proper torque and marked to allow for future visual checks. The pintle and associated mounting hardware should be inspected for weld quality, proper fastener torque and preload. The pintle should rotate without binding or excessive torque within its' mounting provision.

b. New tires or track are usually provided, but often worn tires and grousers are used to analyze the loss of towing performance due to wear. In all cases the exact condition of the components are documented. Simulated vehicle damage can be introduced to the towed vehicle to analyze any increase in motion resistance and its impact to the towbar and/or towing vehicle.

c. Record the inspection data on a report form appropriate to the vehicle (e.g., Department of the Army (DA) Form 2404). Adjust the vehicle test weight to the specified combat or gross vehicle weight by the addition of on-vehicle equipment and additional weights, paying attention to axle weight, tire load limits, and center of gravity. Take characteristic photographs of the towing combination and record weights and dimensions of the vehicles using TOP 02-2-500 as a guide. Record the weight distributions using TOP 02-2-801 as a guide. Measure the center of gravity of the towing and towed vehicles using TOP 02-2-800 as a guide.

3.4 Test Controls.

a. Design and proof loads of the towbar and associated hardware require validation prior to field testing.

b. All safety Standard Operating Procedures (SOPs) shall be observed throughout test operations.

c. Using the material properties of the towbar and associated components, calculate the maximum allowable strain based on the yield stress. If the values are exceeded at any point in the test, the towbar should be removed from service.

d. Modified tow pintles and their mounting hardware should be marked as test assets and removed from service when tests are completed.

e. Correct levels of lubricant, hydraulic fluid, coolant, etc., shall be maintained throughout the tests for the towing vehicle.

f. Vehicles will be operated until their normal operating temperatures are reached before initiating each test

g. Critical fluid temperatures should be monitored during the test. The high loads placed on the drive train from towing operations could potentially result in overheating of fluids.

4. TEST PROCEDURES.

4.1 Towbar Specific/Component Level Testing.

4.1.1 Towbar Characterization.

The towbar dimensions will be determined with standard measuring instruments. If the towbar design provides adjustment features, a range of measurements should be taken. Nondestructive test methods should be used where practical to determine towbar construction details to include

tube wall thickness, end connection design and material properties. Material properties should include the chemical composition, modulus of elasticity, yield, and ultimate strengths at a minimum.

4.1.2 Single Leg Tensile and Compressive Strength.

This test will be conducted in a laboratory setting using a tensile testing machine.

- a. Apply strain gages to towbar as described in paragraph 2.4.2 to measure force versus micro-strain.
- b. Initially apply 25% of the intended design load in tension, pause and hold the load for 30 seconds. The load should be applied to the pintle attachment side of the tow bar leg and the fixture should restrain the tow bar by simulating the attachment points (i.e., use pins sized to simulate the leg attachment to the pintle end and the leg attachment to the adapter end).
- c. Remove the load and visually inspect the towbar leg for failure. Discontinue the test if a failure is identified and document the failure.
- d. Repeat the loading by incrementally increasing the load by no more than 25% of the intended design load in tension until the strain equivalent to the yield strength is achieved. Do not exceed the calculated yield strain for the material(s).
- e. Measure the key features and photograph the towbar, including failure details.
- f. Tests should be repeated in compression.
- g. If the tow bar legs are not identical or symmetrical, apply tensile and compressive loads to the opposite tow bar leg.

4.1.3 Towbar Assembly Longitudinal Strength.

This test can be conducted in a laboratory setting using a tensile testing machine or in a field environment with a “deadman” style anchor and mobile field dynamometer, or a heavy recovery vehicle winch with the appropriate loadcell in series with the towbar leg. It is used to analyze a complete tow bar assembly, including all adapters, joints, and pins.

- a. Apply strain gages to towbar as described in paragraph 2.4.2 to measure load versus micro-strain.
- b. Determine the maximum angle of towbar spread using NATO STANAG 4478¹⁵, based on the intended towed vehicles’ towing provisions. With each tow bar leg fixed to this *maximum* angle, set up the test fixture to apply the load to the lunette longitudinally. Load to the lunette should be applied with a fixture that simulates the appropriate tow pintle dimensions. The adapter pins should be connected to the test fixture to simulate the attachment to a vehicle’s tow eyes.

- c. Slowly apply the load in tension until the towbar leg strain gage reading matches the value recorded from the Single Leg Tensile Strength test. Pause and hold the load for 30 seconds.
- d. Remove the load and visually inspect each towbar component. Discontinue the test if a failure is identified and document the failure.
- e. Slowly apply load in compression until the tow bar leg strain gage reading matches the value recorded from the Single Leg Compression Strength test. Pause and hold the load for 30 seconds. Do not exceed the calculated yield stress for the material.
- f. Remove the load and visually inspect each component for failure. Discontinue the test if a failure is identified and document the failure.
- g. Increase the loading to match the strain gage values observed in the single leg tests. If the towbar assembly strength exceeds the single leg tow bar strength, testing may be discontinued.
- h. Measure the key features and photograph the towbar, including failure details.

4.1.4 Towbar Assembly Lateral Strength.

Using the test fixture developed to determine the longitudinal assembly strength apply the force laterally in tension with the *minimum* tow bar spread. During this test, one leg will be in compression, and the other in tension. Slowly apply the load incrementally until either the strain gage reading on the tensioned leg matches the value recorded from the single leg test, *or* the strain gage reading on the compressed leg matches the value recorded from the single leg test.

4.1.5 Measuring Sag On Adjustable Towbars.

For towbars with adjustable legs, the means used to make the adjustment should fit tightly and not result in any slackness or permit the towbar to bend. With the towbar supported rigidly at both ends and with a load of 50 pounds at the center, the sag will be measured at the center, in any direction, and should not exceed 0.25 inch under any condition of adjustment.

4.1.6 Towbar Handle Strength.

Apply a load to each towbar handle approximately equal to the weight of the towbar and hold for 1 minute. A distributed load may be applied using a block that is no greater than 3 inches in width with rounded edges to simulate a female bare human hand, assuming a one-hand bar design. If mechanical assist aids are to be used to pick up the towbar from the grab handles, the more severe load application shall be tested. Military Standard (MIL-STD)-1472G¹⁶ provides appropriate handle design criteria.

4.2 Vehicle Level Tests.

4.2.1 Physical Characteristics.

a. With the towbar connected between the towing and towed vehicles, record the physical measurements impacted by the towbar connection. These include vehicle length measurements, pintle, and towing eye provisions. Use TOP 02-2-500 as a guide. Connections of safety chains, electrical and brake provisions should be validated.

b. The center of gravity locations are used to position instrumentation. Vehicle reactions are measured using a 6-degree of freedom (6-DOF) inertial measurement system to record pitch (θ), roll (ϕ), and yaw (Ψ) rates, and longitudinal (x), lateral (y), and vertical (z) acceleration of the towing vehicle and towed load. The transducer should be mounted as close as practical to the center of gravity of the test vehicle.

4.2.2 Field Performance Tests.

a. Specific performance tests are conducted while towing with the objective of measuring the towbar loading and vehicle reactions to specific maneuvers. Data should be sampled at a minimum of 1000 hertz (Hz) and digitally low pass filtered at 200 Hz. Eight-pole Butterworth filters are typically used and filtering is performed forward and backward to preserve the phase information.

b. Towing speed limits/criteria and operational terrain should be determined prior to testing. A variety of potential sources can be consulted to include the towing vehicle system specification, SOPs for Motor Transport, and Field Manual (FM) 20-22, Vehicle Recovery Operations¹⁷. Towing speed limits are often significantly less than the individual towing vehicle requirements. Slope climbing, obstacle negotiation, and steering performance are also degraded while towing.

c. Where test objectives are to determine the performance limits of the towing combination, vehicle and/or towbar interference should be determined for the horizontal and vertical directions. Limits to steering maneuvers, grades, or obstacles should be documented. Traction limitations of the prime mover should be determined. TOP 02-2-604, Drawbar Pull¹⁸ is used as a guide. The motion resistance of the towing and towed vehicle should also be determined in accordance with TOP 02-2-605. Gradeability predictions based on the available drawbar pull, motion resistance, and wheel/track slip are used to set the upper limits for gradeability and obstacle negotiation test scenarios.

d. The following tests/performance maneuvers should be conducted:

- (1) Acceleration to maximum safe speed on a level paved surface (TOP 02-2-602).
- (2) Maximum pedal effort brake events from low speed to maximum safe speed (TOP 02-2-608).

- (3) Downhill braking from slow controllable speeds on longitudinal grades (TOP 2-2-610).
- (4) Sine wave steering maneuvers on side slopes (TOP 02-2-610).
- (5) Vertical steps of increasing height in the forward direction, both ascending and descending the obstacle (TOP 02-2-611).
- (6) 90-degree left and right hand turns (TOP 02-2-718).
- (7) Negotiation of the standard 24 foot North Atlantic Treaty Organization (NATO) “T” intersection (TOP 02-2-718).
- (8) Munson standard steering course (or equivalent).
- (9) Towing in reverse (maneuverability).
- (10) Towing and steering in low soil strength (off road) environments (TOP 02-2-619A).

4.2.3 Field Endurance Tests.

Complete a limited endurance test using one towbar sample for each towing vehicle combination or configuration. Record the strain gage and force data for at least the first and last lap of each course. Using the same time base, record the vehicle speed profile and 3-axis inertial rates and acceleration of the towing and towed vehicle. The towbar will be inspected and photographed, as appropriate, after completing each course. Test course speeds and operational limitations will be determined from the field performance test results, the appropriate SOP, or field manual. The mission profile of the system under test will be considered when determining test course types and mileage. In the absence of specific guidance the following test scenario is provided.

- a. Paved road (50 miles).
- b. Level gravel road (30 miles).
- c. Hilly secondary road (30 miles).
- d. Level cross-country (25 miles).
- e. Hilly cross-country (40 miles).
- f. Trails (25 miles).
- g. Belgian block (8 miles).
- h. Urban rubble (500 feet).

4.3 Off-Road Site Characterization.

Refer to TOP 02-2-619A for appropriate test methods for characterization of off-road low soil strength test sites.

5. DATA REQUIRED.

5.1 Component Level/Towbar Specific.

5.1.1 Towbar Characterization.

The following is a list of physical measurements and material properties required for every towbar design. Measurements that can change due to towbar use/wear should be checked at regular intervals throughout testing.

- a. Component and assembled towbar weights.
- b. Leg length range (if adjustable).
- c. Overall assembled length.
- d. Tube sag (if adjustable).
- e. Tube diameter.
- f. Tube wall thickness.
- g. Lunette diameter.
- h. Pin diameter(s) and length(s).
- i. Chemical composition (material identification).
- j. Modulus of elasticity.
- k. Yield strength.
- l. Ultimate strength.

5.1.2 Towbar Specific/Component Level Testing.

a. For each of the following towbar component tests below, identify the maximum measured force. If the yield stress was not achieved during the test, plot the measured microstrain versus the applied load so that the force values for the yield and ultimate stress can be extrapolated.

- (1) Single Leg Tensile and Compressive Strength.
- (2) Towbar Assembly Longitudinal Strength.
- (3) Towbar Assembly Lateral Strength.

b. Calculate a preliminary tow bar rating using the engineering application definitions defined in Table 1. The preliminary tow bar rating = extrapolated force at yield stress/factor of safety. Field test data are required to further validate this towbar rating.

c. Each towbar handle will be inspected for deformation after the application of the handle force. Still photographs will be used to document handle integrity.

5.2 Vehicle Level Tests.

5.2.1 Physical Characteristics.

Refer to NATO STANAG 4478 for dimensions of tow provisions, and for towbar horizontal and vertical articulation angles. Document the towbar connection process to the towed vehicle with photographs and video. Include connection of safety chains, electrical, and brake provisions, where applicable. The following measurements are required to characterize the towing combination.

- a. Overall combination length.
- b. Axle or roadwheel spacing of towing and towed vehicle.
- c. Weight distribution of towing and towed load by wheel/roadwheel position.
- d. Pintle overhang (distance from rearmost axle/roadwheel to pintle centerline).
- e. Pintle height above ground plane.
- f. Towing provisions overhang (distance from front axle/roadwheel to towing provision centerline).
- g. Towing provision height above ground plane.
- h. Towing provision dimensions per STANAG 4478.
- i. Towbar horizontal and vertical articulation angles from recovery vehicle eye/lug.
- j. Lateral distance between towing provisions.
- k. Towing vehicle center of gravity (CG):

- (1) Longitudinal location (CG to rear axle or sprocket centerline).
 - (2) Vertical location (above ground plane).
 - (3) Lateral location (left or right of longitudinal centerline of the vehicle).
- l. Towed vehicle center of gravity.
 - (1) Longitudinal location (CG to rear axle or sprocket centerline).
 - (2) Vertical location (above ground plane).
 - (3) Lateral location (left or right of longitudinal centerline of the vehicle).
 - m. Towbar projected length between vehicles.
 - n. Towbar spread.
 - o. Static towbar connection angle.

5.2.2 Field Performance Tests.

a. Strain and towbar force data are recorded as time histories for each conducted test/maneuver. Fatigue damage for each gage location is computed using commercial fatigue analysis software. For each gage location and each data run, the available strain time history data are converted from an ASCII format to that required by the software package. Any offset in the data is removed by digitally filtering out any influence occurring at less than 0.5 Hz. A static load value for each gage is obtained before acquiring dynamic data. Since the mean stress affects fatigue life, each strain time history is adjusted to account for the static mean strain prior to fatigue analysis. Each arm of each gage is then digitally low-pass filtered at 200 Hz to eliminate any spurious noise. For both filters, an eight-pole Butterworth filter is used and filtering is performed forward and backward to preserve the phase information. A typical time history of a strain gage is shown in Figure 10.

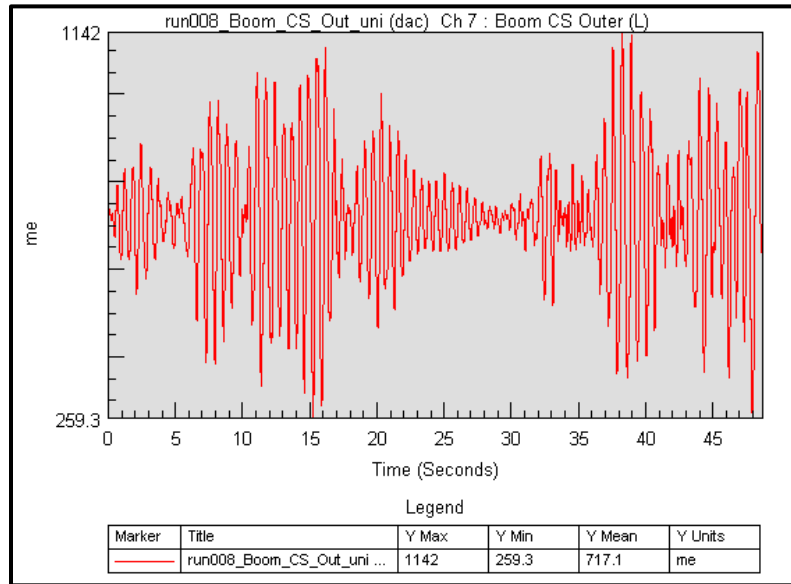

Figure 10. Sample strain time history.

b. A strain life fatigue analysis is then performed on the total strain data for each course, each performance maneuver, and each speed. This analysis is used to predict the number of "repeats" of the load history being analyzed to initiate an engineering-size macroscopic crack (usually 2 mm). It differs from a stress-based fatigue analysis in that crack growth to failure is not included. A strain life fatigue computation includes both elastic and plastic components (rather than the simply elastic computation for a stress life calculation).

5.2.3 Field Endurance Tests.

a. The data collection requirements for the limited endurance tests should be separated by test course and by lap prior to processing. Strain gage and force data are recorded for at least the first and last lap of each course. Using the same time base, record the vehicle speed profile and 3-axis inertial rates and acceleration of the towing and towed vehicle. GPS data can be used to manage speed variations due to driver variability, changes in terrain and course roughness, and their impact on the towbar forces. The endurance test course may be broken down to sub-section to capture the towing performance on specific grades and/or turns.

b. Fatigue damage for each gage location on the towbar is calculated using the same techniques presented for the field performance tests.

5.3 Off-Road Site Characterization.

a. The following data are required for soft soil towing tests. Soil strength should be characterized in the upper 36 inches of the soil profile, the typical zone of stress influence under vehicles, regardless of the anticipated vehicle sinkage depth. For relatively high soil strength conditions (CI > 200 psi), cone penetrometer measurements down to 18 inches (or to penetration refusal) are normally sufficient. When penetration refusal occurs consistently in a test lane at a

relatively shallow depth, it can be assumed that the strength is equal to or higher than 300 psi (or 750 psi with the 0.2 sq.in. cone) below the depth of refusal. The objective should be to quantify the average soil strength in 6-inch layers (e.g., 0-6, 6-12, and 12-18) for each test lane. Sufficient data are collected to characterize each test site. Spot checks are conducted during testing to assure that the soil conditions are not changing. The cone penetrometer and remolding test soil strength profile measurements are recorded on Department of Defense (DD) Form 2641. Sieve analysis data are recorded using DD Form 1206 and the grain size distribution - aggregate grading chart. DD Form 1207 will be used to present the data graphically. A soil classification based on the Unified Soil Classification System (USCS) will be determined from the soil data for each test site.

b. A minimum of 10 moisture samples will be taken, distributed along the length of each test lane. Additional samples are obtained periodically during the testing. Moisture sampling should also be performed at 15 cm (6 in.) depth intervals at each location. This is to ensure the moisture is consistent throughout the soil depth and in the critical layer.

6. PRESENTATION OF DATA.

6.1 Component Level/Towbar Specific.

6.1.1 Towbar Characterization.

The physical dimensions and material properties will be presented in a tabular format. If drawings are provided, the appropriate physical dimensions will be verified or added to the drawings. All towbar components will be photographed as packaged for shipping and as assembled for use. The stowage location for each specified vehicle will be photographed.

6.1.2 Towbar Specific/Component Level Testing.

a. The measured micros-strain versus force will be presented in tabular and graphic format for each gage location. The principal strain and orientation will be calculated and presented for each strain gage location as a function of the applied loading. The force at the yield and ultimate stress values will be extrapolated from the data and shown graphically on each plot.

b. Each test setup will be documented using still photography. The loading process for each test will be captured using appropriate video techniques. All failures will be documented using still photography.

6.2 Vehicle Level Tests.

6.2.1 Physical Characteristics.

Characteristic photographs will be taken of the vehicle combination. Photographs of all instrumentation will be taken prior to conducting field performance tests. The physical characteristics will be presented in a tabular format.

6.2.2 Field Performance Tests.

a. Fatigue life is a function of the number of cyclic reversals at a given strain range level. Laboratory tests to develop fatigue life curves for materials are usually performed by subjecting the specimens to constant amplitude loads. Actual service loads have complex waveforms, and some form of strain cycle counting is necessary to resolve the strain time history into a series of strain ranges and associated number of cycles. A standard rainflow cycle extraction technique is used for this analysis. The technique provides a histogram with variable strain range and mean value. An example is shown in Figure 11.

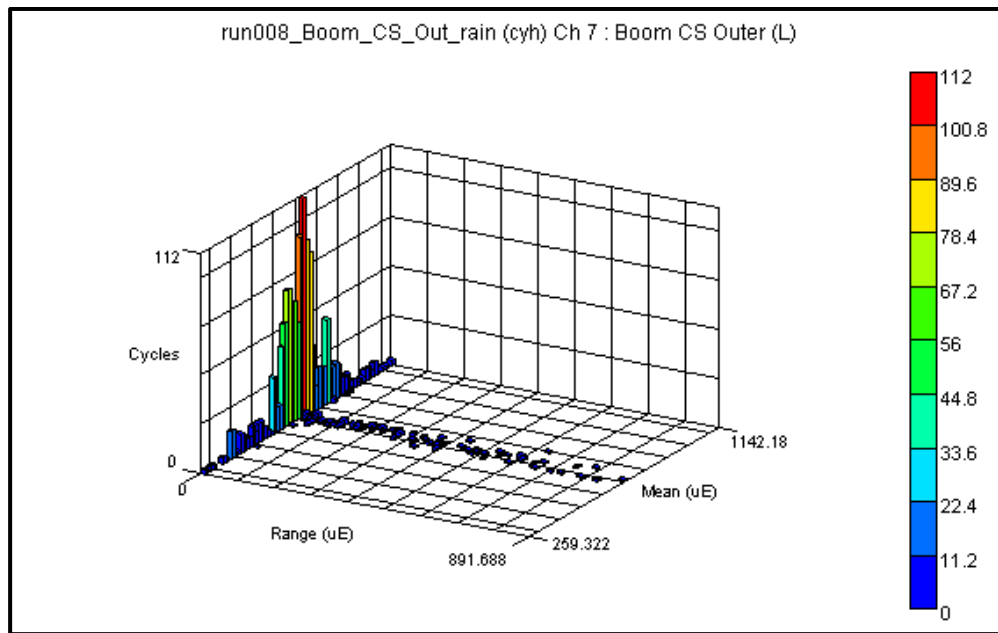

Figure 11. Sample rainflow range-mean histogram.

b. A damage histogram is computed from the cycle counting histogram and represents the fatigue damage accrued by each bin in the histogram. The conversion of a rainflow histogram to a damage histogram is shown in Figure 12.

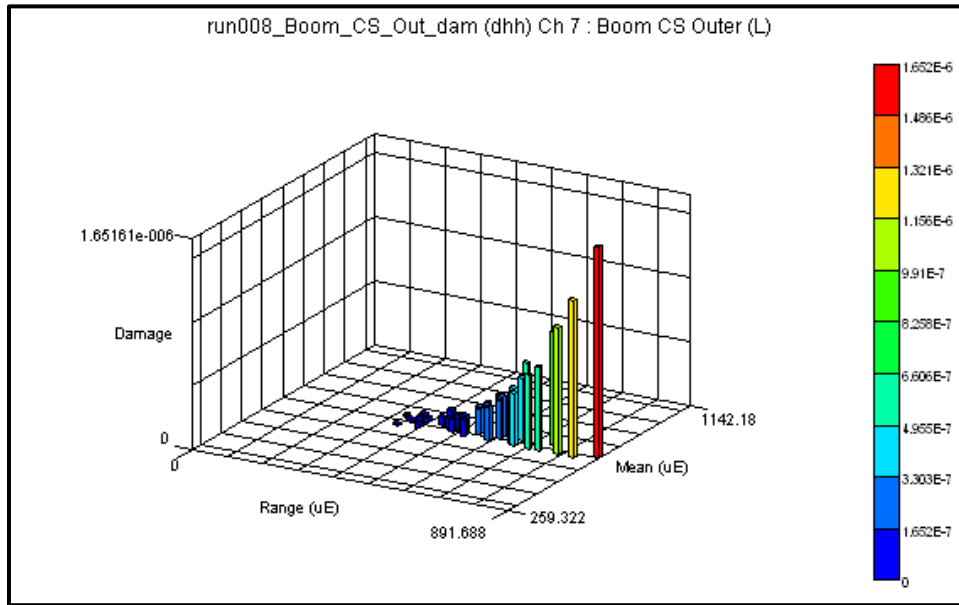

Figure 12. Sample damage histogram.

c. Histogram bins representing large strain ranges have a significant contribution to fatigue damage, even if the number of cycles accrued in those bins is low. Bins that have numerous cycles of small strain ranges have little contribution to overall fatigue damage. Thus, the damage histogram has an appearance of the inverse of the cycle counting histogram. The sum of the individual damage values in the damage histogram is the overall damage value for the load history. Other factors that affect fatigue life are the material properties, the surface treatment and finish, and the local geometry (stress concentration factor).

d. The type of analysis described is often used for absolute predictions of “repeats” (repeated exposure to an identical environment) to failure. Dependence upon exact material properties, which are probabilistic but used in a deterministic manner, accurate stress concentration factors, and the assumption that a particular environment can be repeated identically for many iterations (perhaps thousands) cast doubt on absolute predictions. For this procedure, comparisons are made on a relative basis (one test condition compared to another or to some baseline test condition), which minimizes and/or eliminates the problem areas discussed above.

e. To account for the fact that the data runs were of different lengths, the damage per mile value is calculated for each applicable data set. Fatigue damage is sensitive to the total number of stress reversals seen in a record and, thus, the length of the record. Mileage accrued while towing can then be compared to mission specific towing requirements.

6.2.3 Field Endurance Tests.

Strain data are presented as rainfall range-mean and damage histograms in conjunction with the field performance tests. Speed variations as a function of grades, turns, and test course severity are presented as color-coded speed traces overlaid on the GPS path of the vehicle. The highest road speeds are represented by dark red color, the lower road speeds are represented by dark blue color, and the shades of color in between indicate magnitude of road speed. The figure represents the speed trace for a single lap. Figure 13 shows a typical example.

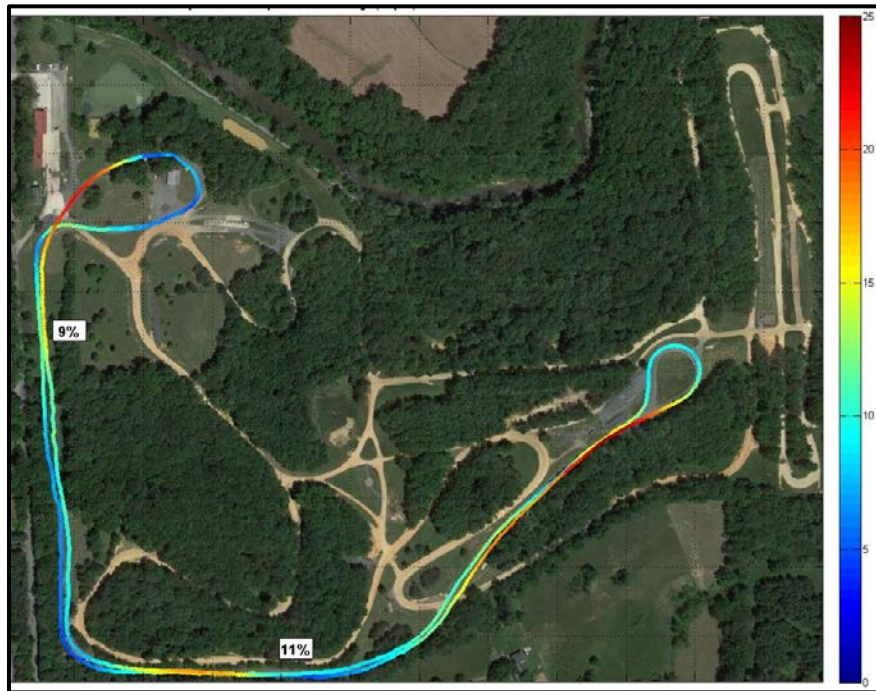

Figure 13. Hilly secondary road speed and trajectory overlay.

6.3 Off-Road Site Characterization.

The measured soil strength profile and average moisture content will be presented in tabular format for each off-road test location. The USCS designation will be determined from the grain size distribution - aggregate grading data.

(This page is intentionally blank.)

APPENDIX A. ABBREVIATIONS.

C	Celsius
CG	center of gravity
cm	centimeter
DA	Department of the Army
DD	Department of Defense
DOF	degree of freedom
F	Fahrenheit
FM	Field Manual
FMCSR	Federal Motor Carrier Safety Regulation
ft	feet
GPS	Global Positioning System
GVW	gross vehicle weight
Hz	hertz
in.	inch
km/hr	kilometers per hour
lb	pound
m	meter
MIL-STD	Military Standard
mm	millimeter
mph	miles per hour
NATO	North Atlantic Treaty Organization
NIST	National Institute of Standards and Technology
SAE	Society of Automotive Engineers
SOP	Standard Operating Procedure
STANAG	Standardization Agreement
TOP	Test Operations Procedure
USCS	Unified Soil Classification System

(This page is intentionally blank.)

APPENDIX B. REFERENCES.

1. TOP 01-1-011A, Vehicle Test Facilities at Aberdeen Test Center and Yuma Test Center, 27 February 2012.
2. FMSCR 393.71, Subpart F - Coupling Devices and Towing Methods, 1 October 2015.
3. Machinery's Handbook: A Reference Book for the Mechanical Engineer, Draftsman, Toolmaker, and Machinist, 29th Edition, January 2012.
4. TOP 02-2-500, Vehicle Characteristics, 14 February 2008.
5. TOP 02-2-801, Weight Distribution and Ground Pressure (Wheeled and Tracked Vehicles), 26 September 2006.
6. TOP 02-2-800, Center of Gravity, 26 September 2006.
7. TOP 02-2-602 w/CH1, Acceleration; Maximum and Minimum Speeds, 28 January 1981.
8. TOP 02-2-608, Braking, Wheeled Vehicles, 20 May 2008.
9. TOP 02-2-610, Gradeability and Side Slope Performance, 3 December 2009.
10. TOP 02-2-611, Standard Obstacles, 17 March 2010.
11. TOP 02-2-605, Wheeled Vehicle Towing Resistance, 29 July 1993.
12. TOP 02-2-619A, Soft-Soil Vehicle Mobility, 11 February 2016.
13. TOP 02-2-718, Electronics Stability Control, 5 December 2013.
14. SAE J670, Vehicle Dynamics Terminology, 24 January 2008.
15. NATO STANAG 4478, Emergency Towing and Recovery Facilities for Tactical Land Vehicles, 8 October 2004.
16. MIL-STD-1472G, Department of Defense Design Criteria Standard: Human Engineering, 11 January 2012.
17. FM 20-22, Vehicle Recovery Operations, 31 October 1962.
18. TOP 02-2-604, Drawbar Pull, 26 September 2007.

(This page is intentionally blank.)

APPENDIX C. APPROVAL AUTHORITY.

CSTE-TM

28 September 2016

MEMORANDUM FOR

Commanders, All Test Centers
Technical Directors, All Test Centers
Directors, U.S. Army Evaluation Center
Commander, U.S. Army Operational Test Command

SUBJECT: Test Operations Procedure (TOP) 02-2-606 Testing of Military Towbars,
Approved for Publication

1. TOP 02-2-606 Testing of Military Towbars, has been reviewed by the U.S. Army Test and Evaluation Command (ATEC) Test Centers, the U.S. Army Operational Test Command, and the U.S. Army Evaluation Center. All comments received during the formal coordination period have been adjudicated by the preparing agency. The scope of the document is as follows:

This TOP describes accepted methods used to measure, analyze, and report the component and vehicle level testing of recovery towbars used for flat towing, and lift and tow operations. Procedures include performance and durability testing, and accelerated durability test methods are employed.

2. This document is approved for publication and will be posted to the Reference Library of the ATEC Vision Digital Library System (VDLS). The VDLS website can be accessed at <https://vdl.s.atc.army.mil/>.

3. Comments, suggestions, or questions on this document should be addressed to U.S. Army Test and Evaluation Command (CSTE-TM), 2202 Aberdeen Boulevard-Third Floor, Aberdeen Proving Ground, MD 21005-5001; or e-mailed to usarmy.apg.atc.mbx.atc-standards@mail.mil.



RAYMOND G. FONTAINE
Associate Director, Test Management Directorate (G9)

FOR

MICHAEL J. ZWIEBEL
Director, Test Management Directorate (G9)

(This page is intentionally blank.)

Forward comments, recommended changes, or any pertinent data which may be of use in improving this publication to the following address: Policy and Standardization Division (CSTE-TM), US Army Test and Evaluation Command, 2202 Aberdeen Boulevard, Aberdeen Proving Ground, Maryland 21005-5001. Technical information may be obtained from the preparing activity: Automotive Directorate (TEDT-AT-AD), U.S. Army Aberdeen Test Center, 400 Colleran Road, Aberdeen Proving Ground, Maryland. Additional copies can be requested through the following website: <http://www.atec.army.mil/publications/topsindex.aspx>, or through the Defense Technical Information Center, 8725 John J. Kingman Rd., STE 0944, Fort Belvoir, VA 22060-6218. This document is identified by the accession number (AD No.) printed on the first page.