



AFRL-RY-WP-TR-2016-0108

**INTERNATIONAL FIELD REVERSIBLE THERMAL
CONNECTOR (RevCon) CHALLENGE**

Chung-Lung Chen

**University of Missouri, Columbia
Mechanical & Aerospace Engineering**

**JULY 2016
Final Report**

Approved for public release; distribution unlimited.

See additional restrictions described on inside pages

STINFO COPY

**AIR FORCE RESEARCH LABORATORY
SENSORS DIRECTORATE
WRIGHT-PATTERSON AIR FORCE BASE, OH 45433-7320
AIR FORCE MATERIEL COMMAND
UNITED STATES AIR FORCE**

NOTICE AND SIGNATURE PAGE

Using Government drawings, specifications, or other data included in this document for any purpose other than Government procurement does not in any way obligate the U.S. Government. The fact that the Government formulated or supplied the drawings, specifications, or other data does not license the holder or any other person or corporation; or convey any rights or permission to manufacture, use, or sell any patented invention that may relate to them.

This report is the result of contracted fundamental research deemed exempt from public affairs security and policy review in accordance with SAF/AQR memorandum dated 10 Dec 08 and AFRL/CA policy clarification memorandum dated 16 Jan 09. This report is available to the general public, including foreign nationals.

Copies may be obtained from the Defense Technical Information Center (DTIC)
(<http://www.dtic.mil>).

AFRL-RY-WP-TR-2016-0108 HAS BEEN REVIEWED AND IS APPROVED FOR
PUBLICATION IN ACCORDANCE WITH ASSIGNED DISTRIBUTION STATEMENT.

// Signature//

JOHN D. BLEVINS
Program Manager
Devices for Sensing Branch
Aerospace Components & Subsystems Division

// Signature//

ROSS W. DETTMER, Chief
Devices for Sensing Branch
Aerospace Components & Subsystems Division

// Signature//

TODD W. BEARD, Lt Col, USAF
Deputy Division Chief
Aerospace Components & Subsystems Division
Sensors Directorate

This report is published in the interest of scientific and technical information exchange, and its publication does not constitute the Government's approval or disapproval of its ideas or findings.

*Disseminated copies will show “//Signature//” stamped or typed above the signature blocks.

REPORT DOCUMENTATION PAGE				Form Approved OMB No. 0704-0188	
The public reporting burden for this collection of information is estimated to average 1 hour per response, including the time for reviewing instructions, searching existing data sources, gathering and maintaining the data needed, and completing and reviewing the collection of information. Send comments regarding this burden estimate or any other aspect of this collection of information, including suggestions for reducing this burden, to Department of Defense, Washington Headquarters Services, Directorate for Information Operations and Reports (0704-0188), 1215 Jefferson Davis Highway, Suite 1204, Arlington, VA 22202-4302. Respondents should be aware that notwithstanding any other provision of law, no person shall be subject to any penalty for failing to comply with a collection of information if it does not display a currently valid OMB control number. PLEASE DO NOT RETURN YOUR FORM TO THE ABOVE ADDRESS.					
1. REPORT DATE (DD-MM-YY) July 2016		2. REPORT TYPE Final		3. DATES COVERED (From - To) 07 November 2013 – 15 March 2016	
4. TITLE AND SUBTITLE INTERNATIONAL FIELD REVERSIBLE THERMAL CONNECTOR (RevCon) CHALLENGE				5a. CONTRACT NUMBER FA8650-14-1-7403	
				5b. GRANT NUMBER	
				5c. PROGRAM ELEMENT NUMBER 61101E	
6. AUTHOR(S) Chung-Lung Chen				5d. PROJECT NUMBER 1000	
				5e. TASK NUMBER N/A	
				5f. WORK UNIT NUMBER Y134	
7. PERFORMING ORGANIZATION NAME(S) AND ADDRESS(ES) University of Missouri, Columbia Mechanical & Aerospace Engineering Columbia, MO 65201				8. PERFORMING ORGANIZATION REPORT NUMBER	
9. SPONSORING/MONITORING AGENCY NAME(S) AND ADDRESS(ES) Air Force Research Laboratory Sensors Directorate Wright-Patterson Air Force Base, OH 45433-7320 Air Force Materiel Command United States Air Force				10. SPONSORING/MONITORING AGENCY ACRONYM(S) AFRL/RVDD	
				11. SPONSORING/MONITORING AGENCY REPORT NUMBER(S) AFRL-RY-WP-TR-2016-0108	
12. DISTRIBUTION/AVAILABILITY STATEMENT Approved for public release; distribution unlimited.					
13. SUPPLEMENTARY NOTES This report is the result of contracted fundamental research deemed exempt from public affairs security and policy review in accordance with SAF/AQR memorandum dated 10 Dec 08 and AFRL/CA policy clarification memorandum dated 16 Jan 09. This material is based on research sponsored by Air Force Research Laboratory (AFRL) and the Defense Advanced Research Agency (DARPA) under agreement number FA8650-14-1-7403. The U.S. Government is authorized to reproduce and distribute reprints for Governmental purposes notwithstanding any copyright notation thereon. The views and conclusions contained herein are those of the authors and should not be interpreted as necessarily representing the official policies or endorsements, either expressed or implied, of AFRL and DARPA or the U.S. Government. Report contains color.					
14. ABSTRACT The University of Missouri hosted the DARPA Field Reversible Thermal Connector (RevCon) Challenge – International RevCon Challenge for encouraging world-wide, driving college students to tackle challenging design problems in electronic thermal management. This event has expanded by creating better judgment on thermal performance with the combination of vibration and vacuum testing by experts from DARPA, AFRL, Rockwell Collins, Honeywell, Raytheon Integrated Defense Systems, BAE Systems, HRL, Lockheed Martin Space Systems Company, and Advanced Cooling Technologies Corp. Progressively challenging metrics were set for participating teams to achieve in subsequent challenges, leading to unique and novel prototype concepts from the teams. The thermal performance of the prototypes is generally outstanding: the majority outperforming advanced commercial-off-the-shelf (COTS) thermal connectors with thermal resistance values as low as 0.1°C/W. A manuscript, entitled “Field-Reversible Thermal Connector (RevCon) Challenges: A Review” has been submitted to IEEE- Transactions on Components, Packaging and Manufacturing Technology, and is currently under review.					
15. SUBJECT TERMS thermal connector, electronic thermal management, RevCon Challenge					
16. SECURITY CLASSIFICATION OF:			17. LIMITATION OF ABSTRACT: SAR	18. NUMBER OF PAGES 102	19a. NAME OF RESPONSIBLE PERSON (Monitor) John D. Blevins
a. REPORT Unclassified	b. ABSTRACT Unclassified	c. THIS PAGE Unclassified			19b. TELEPHONE NUMBER (Include Area Code) N/A

Table of Contents

Section	Page
List of Figures	iii
List of Tables	vi
1.0 INTRODUCTION	1
2.0 2015 REVCON IV	2
2.1 Thermal Test during RevCon Competition in October 2015	5
2.2 Thermal Test for 2 nd Prototypes Delivered by 9 October 2015	8
2.2.1 Thermal Test at Four Power Input: 50W, 100W, 150W, and 200W	8
2.2.2 Thermal Test at 100W during Random Excitation (5 to 2,000Hz).....	10
2.2.3 Thermal Test at 100W at 5 Major Resonant Frequencies (5 to 2,000Hz)	10
2.2.4 Thermal Test at 100W during Sweep Frequency Input (5 to 50Hz).....	11
2.2.5 Thermal Test with/without Vacuum	11
2.2.6 Clamping Force Analysis.....	12
2.2.6.1 National Tsinghua University.....	14
2.2.6.2 University of California - Merced	15
2.2.6.3 University of Maryland	15
2.2.6.4 University of Missouri.....	16
2.2.6.5 Georgia Institute of Technology.....	17
2.2.6.6 Ozyegin University.....	18
2.2.6.7 Donghua University.....	19
2.3 Thermal Test for 1 st Prototypes Delivered in May 2015.....	20
2.3.1 Thermal Test at Four Power Input: 50W, 100W, 150W, and 200W	22
2.3.2 Thermal Test with/without Vacuum	23
2.3.3 Thermal Test at 100W during Random Excitation (5 to 2,000Hz).....	24
2.3.4 Thermal Test at 100W at 5 Major Resonant Frequencies (5 to 2,000Hz)	25
2.3.5 Thermal Test at 100W during Sweep Frequency Input (5 to 50Hz).....	25
2.3.6 Clamping Force Analysis.....	26
2.3.6.1 National Tsing Hua University.....	27
2.3.6.2 University of California - Merced	28
2.3.6.3 University of Maryland	29
2.3.6.4 University of Missouri.....	30
2.3.6.5 University of Baghdad.....	31
2.3.6.6 Georgia Institute of Technology.....	32
2.3.6.7 University of Notre Dame	33
2.3.6.8 Ozyegin University.....	34
2.3.6.9 Mississippi State University	35
2.3.6.10 Donghua University.....	35
2.4 Comments on each Device (RevCon IV).....	35
2.4.1 Donghua University	35
2.4.2 Georgia Institute of Technology	38
2.4.3 University of Missouri	40
2.4.4 National Tsinghua University	42
2.4.5 University of Maryland.....	44

Section	Page
2.4.6	Ozyegin University 47
2.4.7	University of California – Merced 49
2.4.8	University of Baghdad 51
2.4.9	University of Notre Dame 52
2.4.10	Mississippi State University 53
3.0	2014 REVCON III 55
3.1	Thermal Test during RevCon Competition in October 2014 55
3.2	Performance Testing 55
3.3	Thermal Test during RevCon Competition on 31 October and 1 November 2014 58
3.4	Thermal Test for 2 nd Prototypes Delivered by 1 October 2014 61
3.4.1	Thermal Test at Four Power Input: 50W, 100W, 150W, and 200W 61
3.4.2	Thermal Test at 100W during Random Excitation (5 to 2,000Hz) 63
3.4.3	Thermal Test at 100W at 5 Major Resonant Frequencies (5 to 2,000Hz) 64
3.4.4	Thermal Test at 100W during Sweep Frequency Input (5 to 50Hz) 65
3.5	Thermal Test for 1 st Prototypes 65
3.5.1	Thermal Test at Four Power Input: 50W, 100W, 150W, and 200W 65
3.5.2	Thermal Test at 100W during Random Excitation (5 to 2,000Hz) 68
3.5.3	Thermal Test at 100W at 5 Major Resonant Frequencies (5 to 2,000Hz) 68
3.5.4	Thermal Test at 100W during Sweep Frequency Input (5 to 50Hz) 69
3.5.5	Clamping Force Analysis 70
3.5.5.1	Donghua University 70
3.5.5.2	Georgia Institute of Technology 72
3.5.5.3	University of Missouri 73
3.5.5.4	National Tsinghua University 75
3.5.5.5	University of California-Merced 76
3.5.5.6	University of Maryland 76
3.5.5.7	University of Illinois at Urbana-Champaign 77
3.5.5.8	Mississippi State University 77
3.6	Comments on each Device (RevCon III) 78
3.6.1	Donghua University 78
3.6.2	Georgia Institute of Technology 79
3.6.3	Mississippi State University 81
3.6.4	University of Missouri 82
3.6.5	National Tsinghua University 83
3.6.6	University of Maryland 84
3.6.7	University of Illinois at Urbana Champaign 85
3.6.8	University of California – Merced 86
4.0	CONCLUSIONS 87
	APPENDIX 88
	LIST OF ACRONYMS, ABBREVIATIONS, AND SYMBOLS 91

List of Figures

Figure	Page
Figure 1: Comparison Temperature History of T_3 from each Thermal Connector.....	6
Figure 2: Comparison Thermal Resistance R from each Thermal Connector.....	6
Figure 3: Comparison Thermal Resistance R^* from each Thermal Connector.....	7
Figure 4: Comparison Chart of Thermal Resistance R from each Thermal Connector.....	8
Figure 5: Comparison chart of Thermal Resistance R^* from each Thermal Connector	9
Figure 6: Comparison Chart of Thermal Resistance R from each Thermal Connector.....	12
Figure 7: Pressure Analysis with Low Film – NTHU	14
Figure 8: Pressure Analysis with Low Film – UC Merced.....	15
Figure 9: Pressure Analysis with Low Film – MU	16
Figure 10: Pressure Analysis with Low Film – GIT.....	17
Figure 11: Pressure Analysis with Low Film – Ozyegin U	18
Figure 12: Pressure Analysis with Low Film – DHU.....	19
Figure 13: Comparison Chart of Thermal Resistance R from each Prototype, as well as Two Commercially Available Thermal Connectors	22
Figure 14: Pressure Analysis with Low Film – NTHU	27
Figure 15: Pressure Analysis with Low Film – UC Merced.....	28
Figure 16: Pressure Analysis with Low Film – U of Maryland.....	29
Figure 17: Pressure Analysis with Low Film – MU	30
Figure 18: Pressure Analysis with Low Film – U of Baghdad	31
Figure 19: Pressure Analysis with Low Film – GIT.....	32
Figure 20: Pressure Analysis with Low Film – U of Notre Dame.....	33
Figure 21: Pressure Analysis with Low Film – Ozyegin U	34
Figure 22: Concept of DHU’s Thermal Connectors	35
Figure 23: Thermal Connector Delivered from Donghua University.....	36
Figure 24: Frequency Response for Donghua University’s Design	36
Figure 25: “Box” Thermal Connector Delivered by Donghua University	37
Figure 26: Thermo-hydraulic Design Proposed by GIT	38
Figure 27: Hydraulic Thermal Connector Delivered by GIT	38
Figure 28: Hydraulic Thermal Connector Delivered by GIT	39
Figure 29: 3D Wedge Design Proposed by MU	40
Figure 30: Three-wedge Design Delivered by MU Team	40
Figure 31: Frequency Response for MU's Design	41
Figure 32: Thermal Connector Delivered by MU.....	41
Figure 33: Wedge Design with Loading/Unloading Tool Proposed by NTHU	42
Figure 34: Side View of NTHU’s Wedge Thermal Connector and its Auxiliary Tool for Loading and Unloading.....	43
Figure 35: Frequency Response for NTHU's Design	43
Figure 36: Three-wedge Thermal Connector Delivered from NTHU	44
Figure 37: Evolution of Maryland’s Prototypes	45
Figure 38: Single-piece Two-wedge Designed by University of Maryland Team.....	45
Figure 39: Frequency Response for Maryland’s Design	46
Figure 40: Two-wedge Thermal Connector Delivered by Maryland	47

Figure	Page
Figure 41: Another Two-piece Wedge Design Delivered by Ozyegin University	48
Figure 42: Up-down Wedge Design Delivered by Ozyegin University	49
Figure 43: Three-wedge Thermal Connector Delivered by UCM.....	50
Figure 44: Frequency Response for UCM's Design.....	50
Figure 45: Thermal Connector Delivered by UCM.....	51
Figure 46: Sandwich Thermal Connector Designed by the University of Baghdad.....	52
Figure 47: Interface Material Coated on Al Board, Delivered by U of Notre Dame	53
Figure 48: OHP Thermal Connector Delivered by MissStateU	54
Figure 49: Comparison Temperature History of T_1 from each Thermal Connector.....	59
Figure 50: Comparison Thermal Resistance R from each Thermal Connector.....	59
Figure 51: Comparison Thermal Resistance R^* from each Thermal Connector.....	60
Figure 52: Comparison Thermal Resistance R^{**} from each Thermal Connector.....	60
Figure 53: Comparison Chart of Thermal Resistance R from each Thermal Connectors	62
Figure 54: Comparison Chart of Thermal Resistance R^* from each Thermal Connector.....	63
Figure 55: Comparison Chart of Thermal Resistance R from each Thermal Connector (1 st prototype).....	66
Figure 56: Comparison Chart of Thermal Resistance R^* from each Thermal Connectors (1 st prototype).....	67
Figure 57: Sweep Vibration Profile	69
Figure 58: Pressure Analysis with Superlow Film – DHU.....	70
Figure 59: Pressure Analysis with Low Film – DHU.....	71
Figure 60: Pressure Analysis with Low Film – GIT.....	72
Figure 61: Pressure Analysis with Superlow Film – MU.....	73
Figure 62: Pressure Analysis with Low Film – MU.....	74
Figure 63: Pressure Analysis with Superlow film – NTHU	75
Figure 64: Pressure Analysis by UCM Team	76
Figure 65: Pressure Paper Tests Results for Prototype # 1, Obtained using Superlow Film.....	76
Figure 66: Pressure Paper Tests Results for Prototype # 3, Obtained using Low and Superlow Film.....	76
Figure 67: Pressure Paper Tests Results for a Commercial Thermal Connector, Obtained using Low Film.....	77
Figure 68: Pressure Distribution for Original Double-sided Wedgelock	77
Figure 69: Pressure Distribution for Improved Double-sided Wedgelock, with Two Iterations	77
Figure 70: Thermal Connector Delivered from Donghua University.....	78
Figure 71: Frequency Response for DHU's Design.....	79
Figure 72: Hydraulic Thermal Connector Delivered by GIT	80
Figure 73: Frequency Response for GIT's Design.....	80
Figure 74: Pulsating-heat-pipe Embedded Design Delivered by MissStateU	81
Figure 75: Frequency Response for MissStateU's Design.....	81
Figure 76: Two-wedge Design Delivered by MU Team	82
Figure 77: Frequency Response for MU's Design.....	82
Figure 78: Side View of NTHU's Wedge Thermal Connector and its Auxiliary Tool for Loading and Unloading.....	83

Figure	Page
Figure 79: Seamless Wedge Designed by UMD Team	84
Figure 80: Frequency Response for UMD's Design	84
Figure 81: Improved Double-sided Wedglock Designed by UIUC Team.....	85
Figure 82: Frequency Response for UIUC's Design.....	85
Figure 83: Thickness of the TEC	86
Figure 79: Thermally Efficient Connector Designed by UCM Team	86
Figure A1: Testbed Assembly	88
Figure A2: Schematic of Temperature Monitoring and Vibration Detection Setup for RevCon IV	89
Figure A3: Schematic of Temperature Monitoring and Vibration Detection Setup for RevCon III	90

List of Tables

Table	Page
Table 1. Delivery Record and Participation for each RevCon Team during the Competition	3
Table 2. Summary of MU's Loading/Unloading Experience	4
Table 3. Summary of R, R*, and T ₃ under 50W at the 30 th Minute	7
Table 4. Comparison Table of Thermal Resistance R (°C/W) within the last Minute of 30 Minutes	8
Table 5. Comparison Table of Thermal Resistance R* (°C/W) within the last Minute of 30 Minutes	9
Table 6. Comparison of Thermal Performance with Random Vibration ON and OFF.....	10
Table 7. Comparison of Thermal Performance (thermal resistance R) with Single Frequency Excitation and without Vibration.....	11
Table 8. Comparison of Thermal Performance with Sweep Excitation and without Vibration	11
Table 9. Comparison of Thermal Performance with Vacuum ON and OFF.....	12
Table 10. Clamping Force Predicted by the Pressure Film Tests	13
Table 11. Delivery Record for each RevCon Team.....	20
Table 12. Summary of MU's Loading/Unloading Experience.....	21
Table 13. Comparison Table of Thermal Resistance R (°C/W)	22
Table 14. Comparison Table of Temperature Monitored at T ₃ (°C).....	23
Table 15. Comparison of Thermal Performance with Vacuum ON and OFF.....	24
Table 16. Comparison of Thermal Performance with Random Vibration ON and OFF.....	24
Table 17. Comparison of Thermal Performance with Single Frequency Excitation and without Vibration	25
Table 18. Comparison of Thermal Performance with Sweep Excitation and without Vibration	25
Table 19. Clamping Force Predicted by the Pressure Film Tests	26
Table 20. Delivery Record and Participation for each RevCon Team	56
Table 21. Summary of MU's Loading/Unloading Experience.....	57
Table 22. Summary of R, R*, R**, and T ₁ under 50W at the 17 th Minute.....	61
Table 23. Comparison Table of Thermal Resistance R (°C/W) within the last 1.5 Minutes of 20 Minutes	62
Table 24. Comparison Table of Thermal Resistance R* (°C/W) within the last 1.5 Minutes of 20 Minutes	63
Table 25. Comparison of Thermal Performance with Random Vibration ON and OFF.....	64
Table 26. Comparison of Thermal Performance (thermal resistance R) with Single Frequency Excitation and without Vibration.....	64
Table 27. Comparison of Thermal Performance with Sweep Excitation and without Vibration	65
Table 28. Comparison Table of Thermal Resistance R (°C/W)	66
Table 29. Comparison Table of Thermal Resistance R* (°C/W)	67
Table 30. Comparison Table of Temperature Monitored at T ₁ (°C).....	67
Table 31. Comparison of Thermal Performance with Random Vibration ON and OFF.....	68

Table	Page
Table 32. Comparison of Thermal Performance with Single Frequency Excitation and without Vibration	68
Table 33. Comparison of Thermal Performance with Sweep Excitation and without Vibration	69

1.0 INTRODUCTION

Thermal connectors have played a critical thermal management role for decades for electronic components. The University of Missouri hosts the Defense Advanced Research Projects Agency (DARPA) Field Reversible Thermal Connector (RevCon) Challenge III and IV – International RevCon Challenge for encouraging world-wide, driving college students to tackle challenging design problems in electronic thermal management. This two-phase program aims to solicit student design teams to pursue novel design concepts which can repeatedly assemble and disassemble an electronic module to/from an electronic enclosure, while providing a constant connector thermal resistance lower than $0.1^{\circ}\text{C}/\text{W}$ over multiple thermal cycles in a specified temperature range under vacuum, vibration environment, and contact pressure.

2.0 2015 REVCON IV

We accomplished the following tests for all prototypes using the testbed developed at University of Missouri (MU):

- Thermal measurements based on four heating conditions: 50W, 100W, 150W and 200W
- Thermal measurements with vacuum down to 162mTorr
- Clamping force analysis
- Thermal measurements with single frequency (sweep) excitation
- Random frequency test to identify system resonant frequencies
- Thermal measurements with both random and resonant frequency excitation

All the test results listed above were completed for the 1st and 2nd phases by 9 October 2015. On 23 October, seven teams, including University of California – Merced (UCM or UC – Merced), University of Maryland (UMD), University of Missouri – Columbia, Donghua University (DHU) from China, Georgia Institute of Technology (GIT), National Tsinghua University (NTHU) from Taiwan, and Ozyegin University from Turkey, came to MU-Columbia campus for a one-day conference. Detailed performance test and comments for both the on-site competition and preliminary tests for both the 1st and 2nd prototypes can be found in the sections of “Thermal Test” and “Comments on each device”. See Appendix for more information regarding the experimental setup and the definition of R and R*.

During the 1st phase in 2015, ten teams fabricated and delivered their thermal connectors with unique features. Those universities are: DHU, GIT (including team members from India), Mississippi State University (MissStateU), NTHU, UCM, University of Notre Dame, UMD, University of Baghdad, Ozyegin University, and UM. During the 2nd phase, seven teams have fabricated and delivered their 2nd prototype of thermal connectors with unique features. The thermal connectors should be 15 cm in length. The delivery record for each student team and their participation during the competition is shown in Table 1:

Table 1. Delivery Record and Participation for each RevCon Team during the Competition

	Device (Competition)	2nd device	Pressure Films (2nd device)	Final Report
Ozyegin U*	X	X	X	X
Donghua U*	X	X	X	X
MU	X	X	X	X
NTHU*	X	X	X	X
GIT	X	X	X	X
UC - Merced	X	X	X	X
U of Maryland	X	X		X







*2nd device provided is different from the one in competition

After receiving materials from each team, the MU team performed the following tests:

1. Thermal tests at four power inputs: 50W, 100W, 150W, and 200W (30 minutes for each power input, 120 minutes in total)
2. Thermal test at 50W under vacuum (from 760 Torr to 0.16 Torr)
3. Resonant frequency identification through random excitation (5 to 2,000Hz)
4. Thermal tests at 100W during random excitation (5 to 2,000Hz, 5 minutes total)
5. Thermal tests at 100W at 5 major resonant frequencies (5 to 2,000Hz, 5 minutes for each frequencies, 25 minutes total)
6. Thermal tests at 100W during sweep frequency input (5 to 50Hz, ~7 minutes in total)
7. Clamping force analysis from returned pressure films

Loading/unloading from the MU testing staff's experience is summarized in Table 2. Detail comments and suggestions can be found in "Comments on each device".

Table 2. Summary of MU's Loading/Unloading Experience

	Appearance	Comments during 2nd Round
NTHU		<ul style="list-style-type: none"> • Easy to load and unload • 2 pieces, (3pieces for 1st prototype) • Separate device, loading tool large • Magnets to hold pieces together, may cause magneto-electric problems
UC Merced		<ul style="list-style-type: none"> • Easy loading • Got stuck and uneasy to be unloaded
Ozyegin U		<ul style="list-style-type: none"> • 2 different prototypes • One prototype too thick • Workable one easy to load, but not easy to unload
Donghua U		<ul style="list-style-type: none"> • 2 almost identical prototypes • Soldering edges too thick • Got stuck
MU		<ul style="list-style-type: none"> • Easy to load, uneasy to unload • Oscillating phenomenon unclear
Maryland		<ul style="list-style-type: none"> • Revised unloading, smaller than NTHU • Single device • Hex nuts too small for handling
GIT		<ul style="list-style-type: none"> • No clamping force • Leaking issue remained

2.1 Thermal Test during RevCon Competition in October 2015

Because of the time limitation during this single-day event, with only about 6 hours to schedule 7 separate experiments, we compromised to set up a demo site in front of all the judges and participants, and a separate 30 minute heating test:

1. Each team loads and unloads their unique thermal connector in front of the judges and all the participants.
2. Team members then bring their thermal connector to the testbed in a different room for heating test.
3. The thermal connector is loaded by himself/herself from each team, assisted by the on-site tester who is familiar with the testbed (Simon Chen).
4. After loading, the heater is on and set to be 50W.
5. The temperature T_3 (closest to the resistive heater) will start increasing from $\sim 19^\circ\text{C}$ (Chiller temperature is set to 18°C). The heating history for each temperature monitoring is recorded all the time.
6. T_3 and the estimated R at the 30th minute are then provided to the judges.

Among all the temperature monitoring, T_3 is the most representative as this temperature reading is placed closest to the heater. Lower temperature at T_3 should represent better performance resulted from a better design of thermal connector. On 23 October, the chiller temperature was set to 18°C with coolant flowrate ranging ~ 13.5 lpm (or 3.57gpm) for all thermal tests. The comparison results of T_3 are shown in Figure 1. The legend corresponds to the order of the temperature curves (thermal resistance in Figures 2 and 3) for each device. For example, blue diamond represents the lowest temperature curve (DHU), while green triangle (MU) represents the 4th lowest temperature in the figure. The comparison results of the thermal resistance, R and R^* are shown in Figures 2 and 3, respectively. The overall data are compared and listed in Table 3. "std" represents the standard deviation. Detail experimental setup, and the definition of R and R^* , can be found in the Appendix.

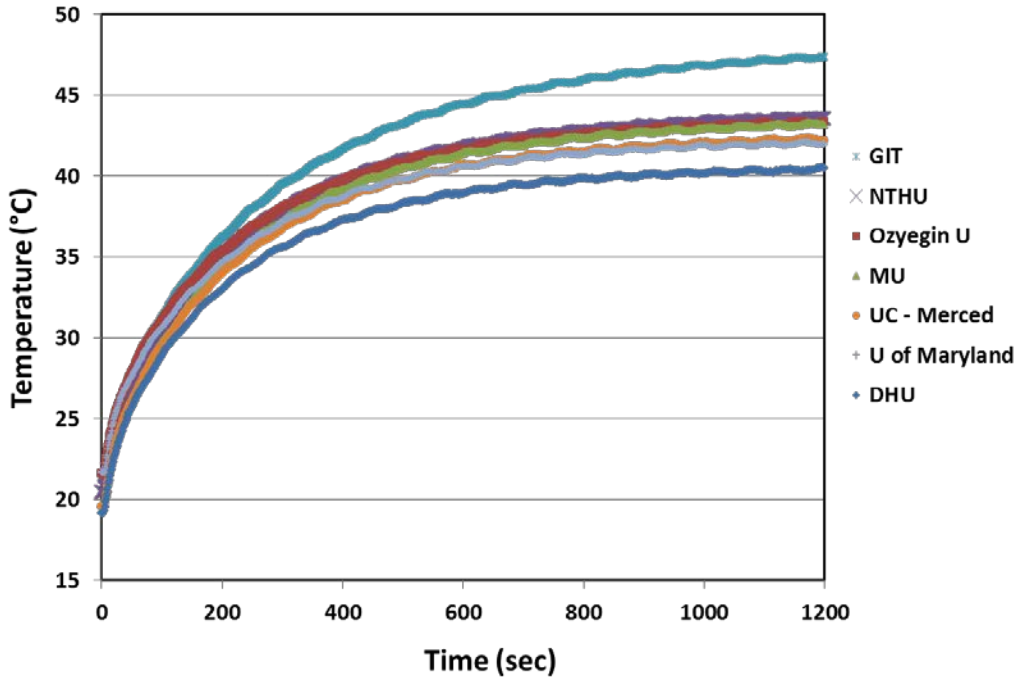

Figure 1: Comparison Temperature History of T₃ from each Thermal Connector

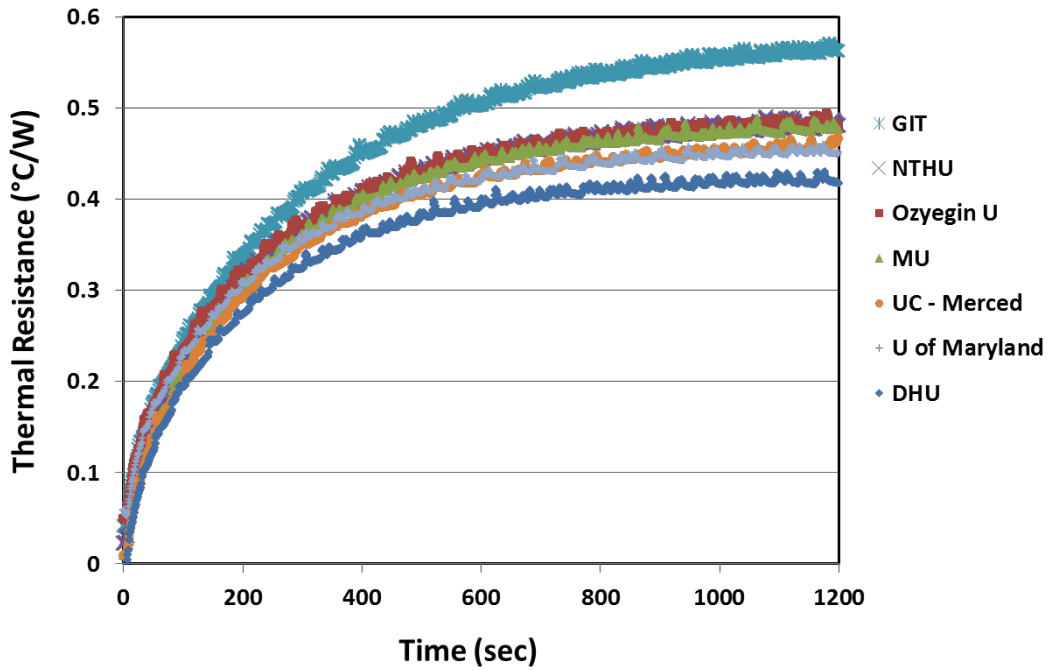

Figure 2: Comparison Thermal Resistance R from each Thermal Connector

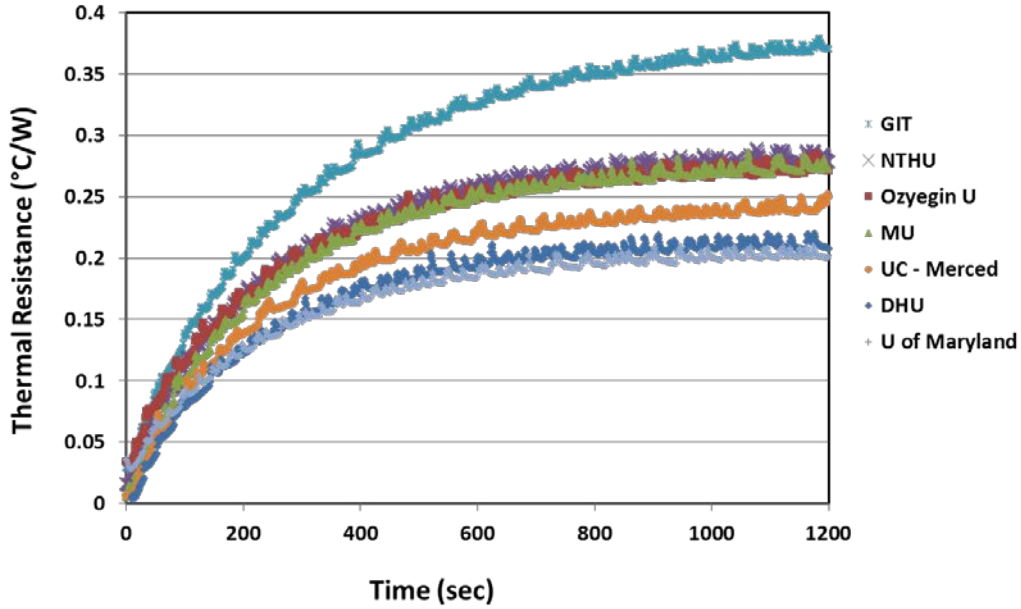

Figure 3: Comparison Thermal Resistance R^* from each Thermal Connector

Table 3. Summary of R , R^* , and T_3 under 50W at the 30th Minute
Wakefield wedgelock (422C-480UMB, .225'x.225'x4.8') and Calmark Card-lok (230-4.80H, .220'x.225'x4.8') were tested for benchmark comparison.

	R ($^{\circ}\text{C}/\text{W}$)		R^* ($^{\circ}\text{C}/\text{W}$)		T_3 ($^{\circ}\text{C}$)	
	During Competition	2nd Prototype	During Competition	2nd Prototype	During Competition	2nd Prototype
DHU	0.42	0.63	0.21	0.43	40.4	50.6
U of Maryland	0.45	0.70	0.20	0.49	41.9	53.8
UC - Merced	0.46	0.50	0.24	0.29	42.2	43.7
MU	0.48	0.64	0.27	0.45	43.1	50.9
Ozyegin U	0.48	0.52	0.27	0.31	43.3	44.7
NTHU	0.48	0.49	0.28	0.30	43.5	43.3
GIT	0.56	0.85	0.37	0.66	47.3	61.6
Calmark	0.63	0.63	0.45	0.45	50.5	50.5
Wakefiled	0.53	0.53	0.30	0.30	45.8	45.8

According to the collected temperature readings, DHU has the lowest R , and T_3 among all the student teams and two commercial thermal connectors. Performance of Maryland's device performed similar with that of UC-Merced's. Performance of NTHU during the competition and the preliminary tests is close in R and T . Other tested results obtained on 23 October (columns of "During Competition") exceeded their previous performance (columns of "2nd Prototype", tested between 9 and 22 October). GIT's 2nd prototype did not seem to provide clamping force. They provided another device on 22 October but the device was leaking during the competition. One thing needs to be brought out is the consequences of the way thermal resistance is estimated.

Based on two of our estimation methods, the ranking of corresponding R varies. For R, all thermal connectors from student teams outperformed commercial devices, except for GIT's. And the ranking of R matches the ranking of T_3 . For R^* , U of Maryland's devices performed better than DHU's device.

2.2 Thermal Test for 2nd Prototypes Delivered by 9 October 2015

2.2.1 Thermal Test at Four Power Input: 50W, 100W, 150W, and 200W

In this section, we demonstrated the tests MU completed for all students teams on their 2nd prototypes. In this fixed-power test, each device was run for 30 minutes for each power input. The corresponding thermal resistances were calculated from the temperatures obtained within the last minute. The comparison results for R are shown in Figure 4.

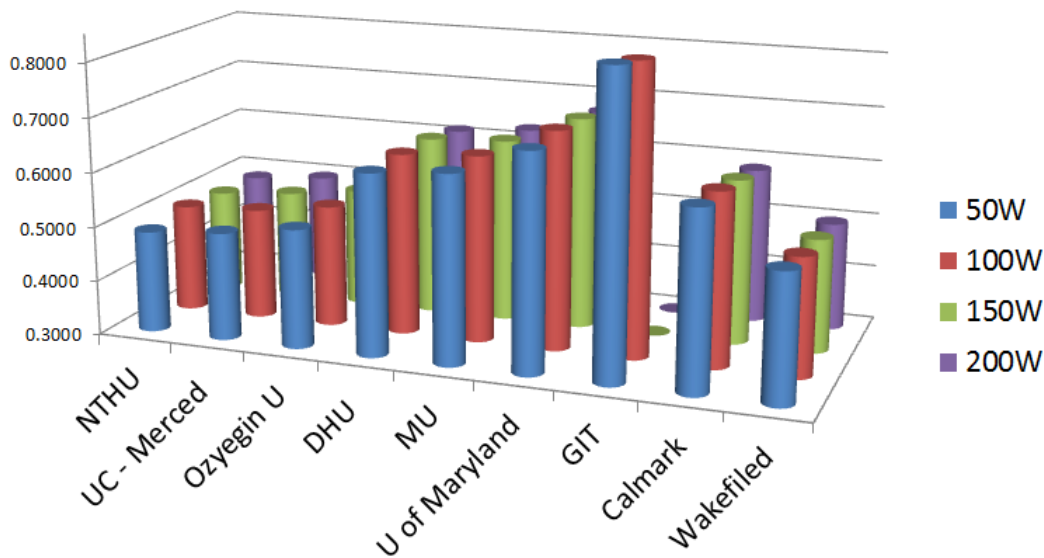

Figure 4: Comparison Chart of Thermal Resistance R from each Thermal Connector

Table 4. Comparison Table of Thermal Resistance R ($^{\circ}\text{C}/\text{W}$) within the last Minute of 30 Minutes

	50W	std	100W	std	150W	std	200W	std
NTHU	0.4866	0.0036	0.4976	0.0014	0.4883	0.0016	0.4849	0.0009
UC - Merced	0.4978	0.0024	0.5038	0.0024	0.5004	0.0005	0.4967	0.0016
Ozyegin U	0.5187	0.0034	0.5235	0.0026	0.5175	0.0014	0.5044	0.0007
DHU	0.6331	0.0046	0.6334	0.0026	0.6298	0.0013	0.6137	0.0009
MU	0.6448	0.0046	0.6424	0.0023	0.6375	0.0013	0.6270	0.0009
U of Maryland	0.6965	0.0041	0.6995	0.0014	0.6899	0.0015	0.6720	0.0011
GIT	0.8544	0.0045	0.8315	0.0028	-	-	-	-
Calmark	0.6263	0.0051	0.6176	0.0027	0.6020	0.0018	0.5857	0.0013
Wakefiled	0.5337	0.0025	0.5176	0.0030	0.5081	0.0038	0.4980	0.0004

-Tests were dropped because the testbed was hot already on 100W around T_3 .

When R^* (method based on bottom temperature readings) is considered, the ranking is slightly different (for UC-Merced and NTHU). The comparison results of R^* are shown and Figure 5. The results with standard deviation are listed in Table 5.

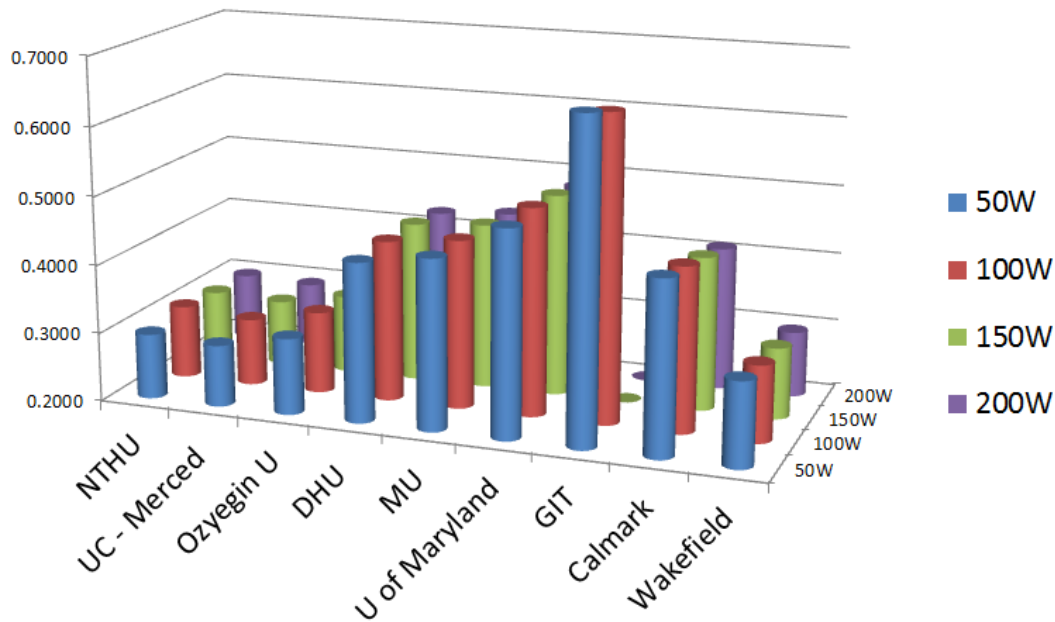

Figure 5: Comparison chart of Thermal Resistance R^* from each Thermal Connector

Table 5. Comparison Table of Thermal Resistance R^* ($^{\circ}\text{C}/\text{W}$) within the last Minute of 30 Minutes

	50W	std	100W	std	150W	std	200W	std
NTHU	0.2952	0.0036	0.3066	0.0014	0.2992	0.0016	0.2975	0.0009
UC - Merced	0.2900	0.0024	0.2978	0.0020	0.2954	0.0006	0.2932	0.0016
Ozyegin U	0.3115	0.0033	0.3193	0.0024	0.3138	0.0014	0.3036	0.0007
DHU	0.4321	0.0045	0.4349	0.0023	0.4342	0.0013	0.4252	0.0009
MU	0.4480	0.0028	0.4462	0.0021	0.4423	0.0015	0.4331	0.0007
U of Maryland	0.4998	0.0039	0.5025	0.0014	0.4951	0.0015	0.4827	0.0012
GIT	0.6635	0.0045	0.6442	0.0028	-	-	-	-
Calmark	0.4516	0.0073	0.4397	0.0025	0.4242	0.0034	0.4095	0.0010
Wakefield	0.3229	0.0022	0.3116	0.0026	0.3037	0.0031	0.2953	0.0002

-Tests were dropped because the testbed was over 100°C already on 100W around T_3 .

2.2.2 Thermal Test at 100W during Random Excitation (5 to 2,000Hz)

Thermal tests during random vibration excitation were carried out on each device while 100W heat was being loaded. The results (averaged from the last 100 seconds) are listed in Table 6. Only R is demonstrated here.

Vibration (along gravitational direction) seems to play ignorable roles on thermal performance along gravity direction in our current setup. This sounds like good news for those thermal connectors used in the vibrational environment (5 to 2,000Hz).

Table 6. Comparison of Thermal Performance with Random Vibration ON and OFF

	100W Random ON	std	100W Random OFF	std
NTHU	0.4308	0.0006	0.4320	0.0015
UC - Merced	0.4466	0.0017	0.4481	0.0021
DHU	0.4700	0.0015	0.4694	0.0013
MU	0.5411	0.0013	0.5404	0.0017
Ozyegin U	0.7369	0.0014	0.7373	0.0018
U of Maryland	-	-	-	-
GIT	-	-	-	-

-Device is either not available or not appropriate for vibration test.

GIT's 2nd device did not provide enough clamping force (with the screw to the extreme position). Therefore the corresponding tests were dropped. UMD's 2nd device was delivered on 22 October, right before the competition, and was broken during the competition. Therefore, its vibration tests could not be performed.

2.2.3 Thermal Test at 100W at 5 Major Resonant Frequencies (5 to 2,000Hz)

Thermal tests under five resonant frequency excitations were carried out on each device while 100W of heat was being loaded. The results (averaged from the last 60 seconds) are listed in Table 7. Two frequencies for NTHU's device and one frequency for MU's device were dropped automatically by the program, probably due to the large amplitude of the shaker heads, which exceeds the maximum allowable amplitude, at those frequencies. The corresponding frequency response for each device is provided in "Comments on each device".

Table 7. Comparison of Thermal Performance (thermal resistance R) with Single Frequency Excitation and without Vibration

	100W w/o vibration	std	f1	std	f2	std	f3	std	f4	std	f5	std
NTHU	0.4320	0.0015	0.4330	0.0021	0.4342	0.0020	0.4356	0.0019	-	-	-	-
UC - Merced	0.4481	0.0021	0.4484	0.0010	0.4474	0.0011	0.4461	0.0012	0.4459	0.0012	0.4472	0.0014
DHU	0.4694	0.0013	0.4710	0.0011	0.4708	0.0031	0.4705	0.0022	0.4688	0.0018	0.4690	0.0011
MU	0.5404	0.0017	0.5420	0.0023	0.5397	0.0010	0.5397	0.0015	0.5392	0.0014	-	-
Ozyegin U	0.7373	0.0018	0.7361	0.0019	0.7355	0.0024	0.7356	0.0021	0.7353	0.0021	0.7348	0.0012
U of Maryland	-	-	-	-	-	-	-	-	-	-	-	-
GIT	-	-	-	-	-	-	-	-	-	-	-	-

- Device is either not available or not appropriate for vibration test.

2.2.4 Thermal Test at 100W during Sweep Frequency Input (5 to 50Hz)

A sweep vibration test from 5Hz to 50Hz was performed on each device. Part of this profile (5 to 33Hz) is suggested to RevCon participants. We realized that most resonant frequencies from the participant teams are located higher than the 100Hz frequency range, and therefore have a minor effect on the thermal performance and clamping mechanism. The results (averaged from the last 60 seconds) are listed in Table 8.

Table 8. Comparison of Thermal Performance with Sweep Excitation and without Vibration

	on		off	
	Sweep 5Hz to 50Hz	std	100W w/o vibration	std
NTHU	0.4320	0.0008	0.4320	0.0015
UC - Merced	0.4482	0.0010	0.4481	0.0021
DHU	0.4699	0.0019	0.4694	0.0013
MU	0.5422	0.0014	0.5404	0.0017
Ozyegin U	0.7372	0.0025	0.7373	0.0018
U of Maryland	-	-	-	-
GIT	-	-	-	-

- Device is either not available or not appropriate for vibration test.

2.2.5 Thermal Test with/without Vacuum

Thermal tests during vacuum were carried out on each device while 50W heat was being loaded. The results (averaged from the last 60 seconds) are listed in Table 9, and shown in Figure 6. The chamber where vacuum is carried out started from the atmospheric pressure (~760 Torr) to the ending pressure under 2-hour vacuum. The ending pressure is ranging from 162 mTorr to 236 mTorr (GIT's device, probably due to the leaking). According to this result, it is apparent that low pressure environment does affect the performance of thermal connectors tested here: UC-Merced's prototype has the minimal increase (45.3%) for thermal resistance, while GIT's prototype has the highest increase of 156.2%. This increase is mainly due to the amount of air

trapped in the contacting areas between the connector and the walls. It should be noted that (1) leaking may further deteriorate R due to the reducing liquid inside the device (for GIT), and (2) evacuated air inside the device (for DHU) may further deteriorate R as conducting air is getting less. The thermal resistance increase will be a good and important reference for thermal connector designers when they plan to design their connectors that would end up being used in low pressure environment or in deep space (closed-to-vacuum).

Table 9. Comparison of Thermal Performance with Vacuum ON and OFF

	on		off		
	50W w/ vacuum	std	50W w/o vacuum	std	Increase (%)
NTHU	0.6614	0.0038	0.4362	0.0060	51.62
UC Merced	0.5830	0.0030	0.4013	0.0040	45.30
Ozyegin U	0.6940	0.0026	0.3668	0.0028	89.21
MU	0.8877	0.0042	0.4584	0.0040	93.64
DHU	1.0545	0.0037	0.5103	0.0035	106.64
GIT	1.8592	0.0111	0.7256	0.0036	156.24
Maryland	-	-	-	-	-
Calmark	0.6583	0.0011	0.3915	0.0132	68.16
Wakefield	0.4545	0.0003	0.2791	0.0117	62.84

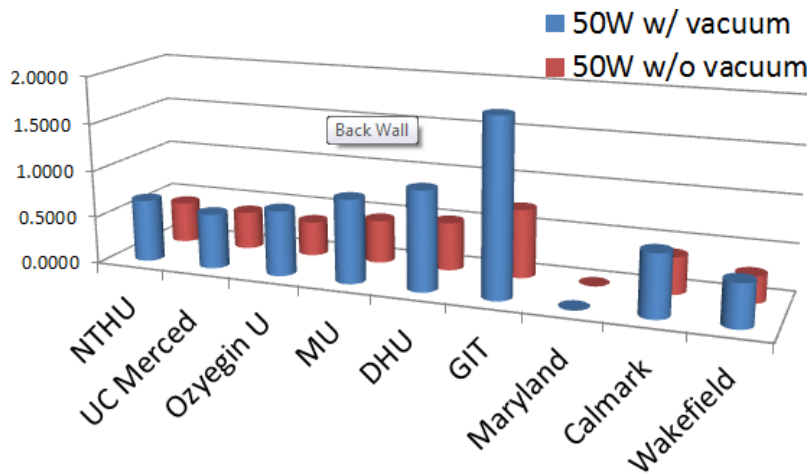

Figure 6: Comparison Chart of Thermal Resistance R from each Thermal Connector

2.2.6 Clamping Force Analysis

Fujifilm Prescale pressure indicator films were sent out to the student teams. Each team is able to test and evaluate the interface condition of their prototypes. Five prototypes from: MU, NTHU, GIT, UC Merced, and Ozyegin U were tested after they delivered their 2nd devices. “Width” and “Length” represent the dimension for the device. If “Contact Area” (provided by the pressure analysis software) is larger than Width x Length, the number of Width x Length will be used. The analyses were carried out by Sensor Production Inc. Table 10 provides a summary.

It should be noted that the clamping force were tested on MU side this time, as pressure film is not a required in the delivery list during the 2nd phase. Only NTHU's prototype provided over 600lbf clamping force. The effective contact area, ranging from 0.18 in² to 0.69² which is counted for clamping force calculation, is generally small for every devices. The real contact area could be as large as 3.07 in². Therefore, if all the contact area can be effectively utilized, the corresponding clamping force would potentially be larger. On the other hand, the clamping force is exceeding 600lbf for all participating teams, except MU's device, during the 1st phase (refer to the report sent in June 2015).

Table 10. Clamping Force Predicted by the Pressure Film Tests

	width (mm)	length (mm)	Ave. Pressure (psi)	contact area (in ²)	force (contact area, lbf)
NTHU	12.70	150.00	1138.00	0.69	785.22
UC Merced	12.70	150.00	898.68	0.37	332.51
Maryland	13.20	150.00	-	-	-
MU	13.00	150.00	764.41	0.19	145.24
Donghua U	13.20	150.00	1038.00	0.41	425.58
GeorgiaTech	13.10	150.00	580.97	0.17	98.76
Ozyegin University	12.00	150.00	810.46	0.18	145.88

2.2.6.1 National Tsinghua University

Total Clamping Force: 785lbf.

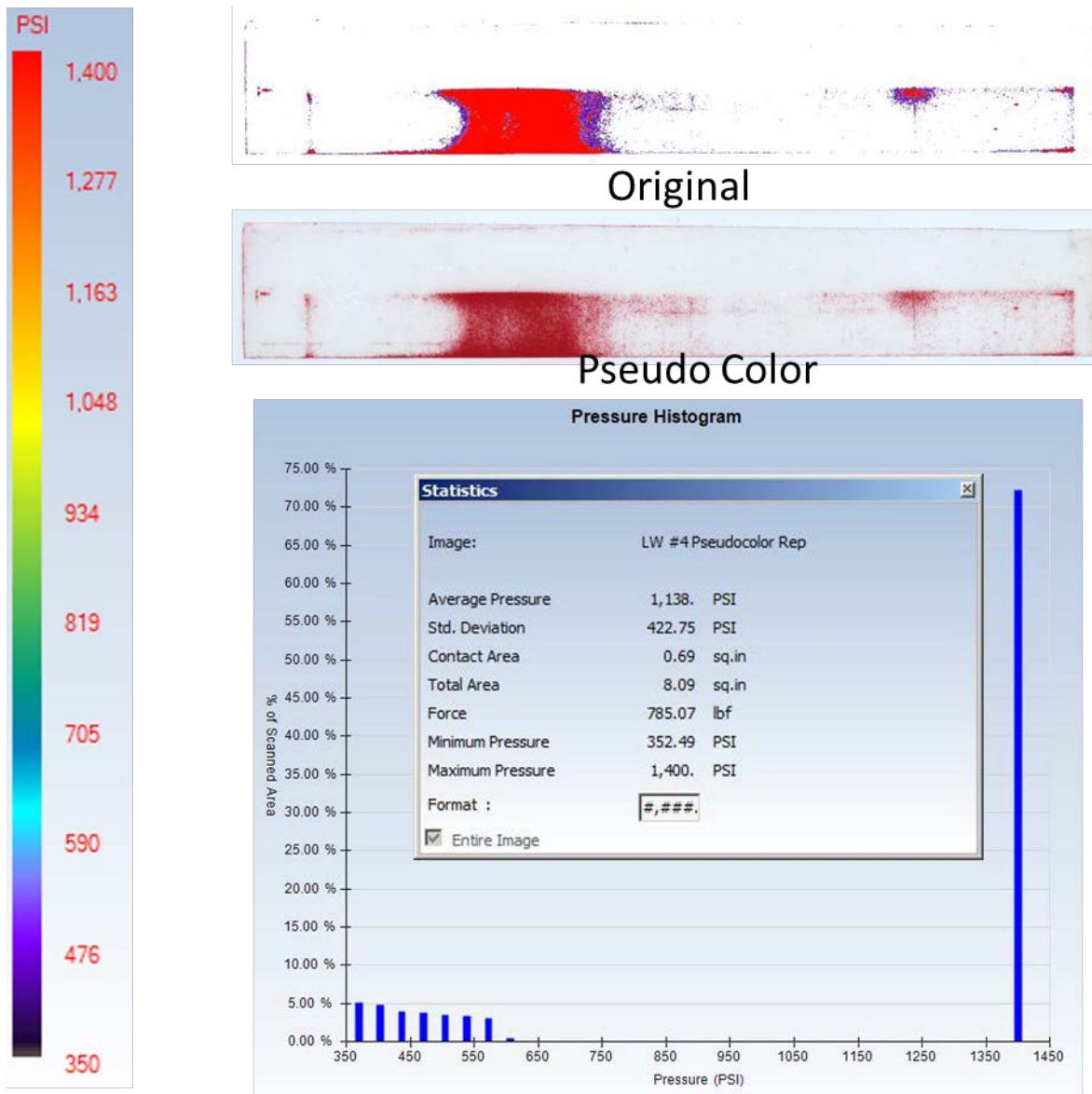

Figure 7: Pressure Analysis with Low Film – NTHU

2.2.6.2 University of California - Merced

Total Clamping Force: 328lbf.

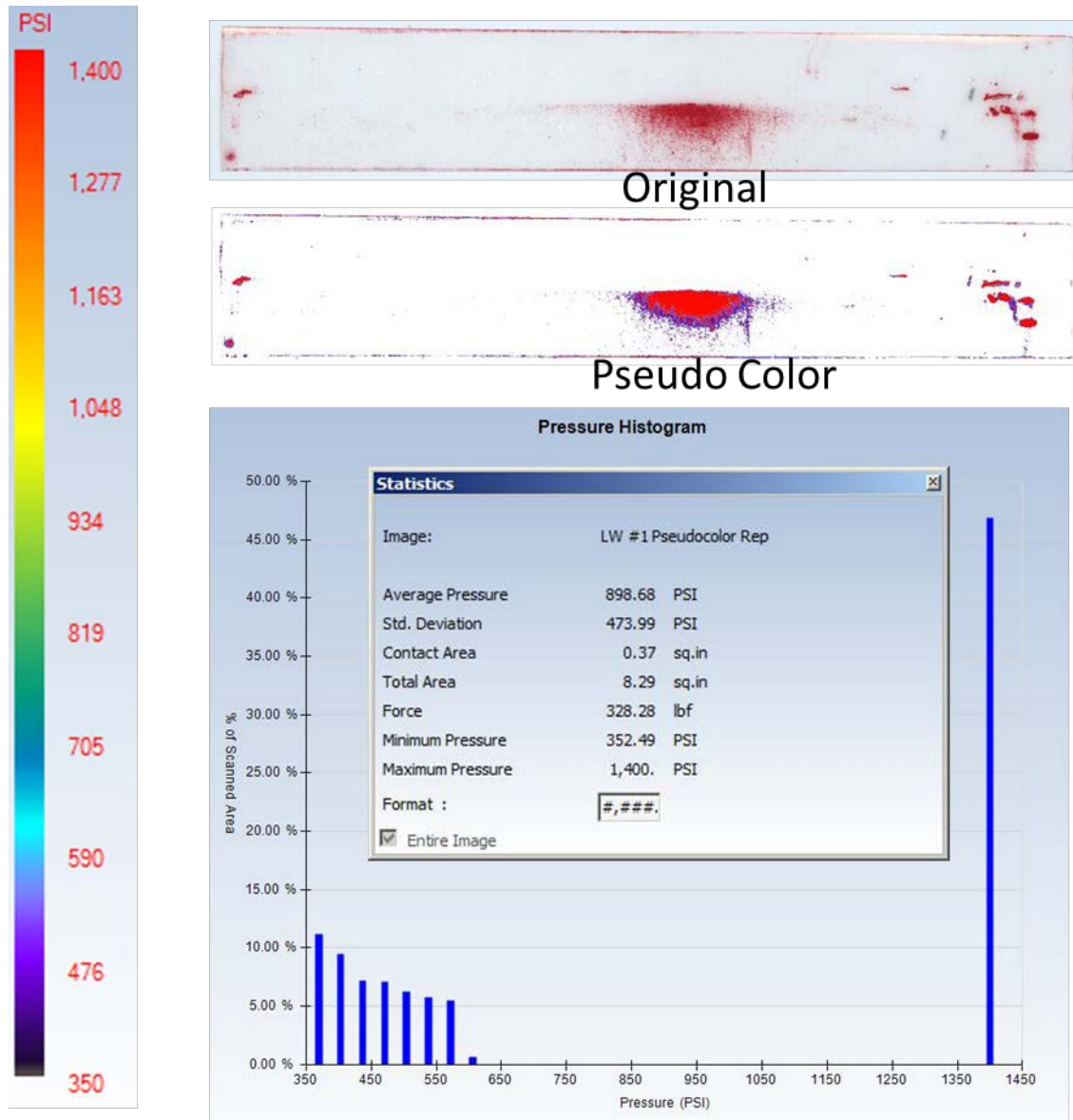

Figure 8: Pressure Analysis with Low Film – UC Merced

2.2.6.3 University of Maryland

- No pressure film was available.

2.2.6.4 University of Missouri

Total Clamping Force: 149lbf.

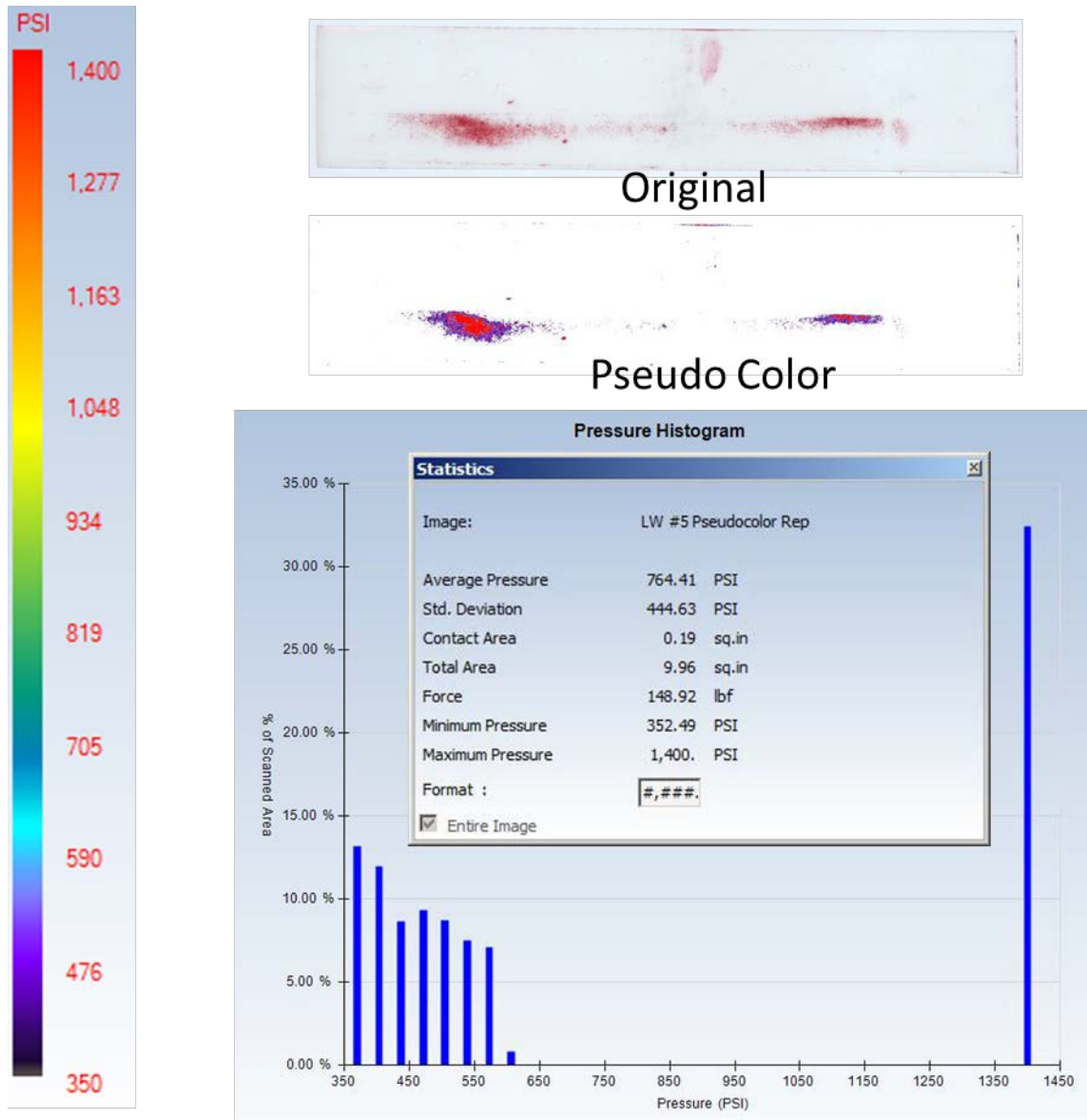

Figure 9: Pressure Analysis with Low Film – MU

2.2.6.5 Georgia Institute of Technology

Total Clamping Force: 100lbf.

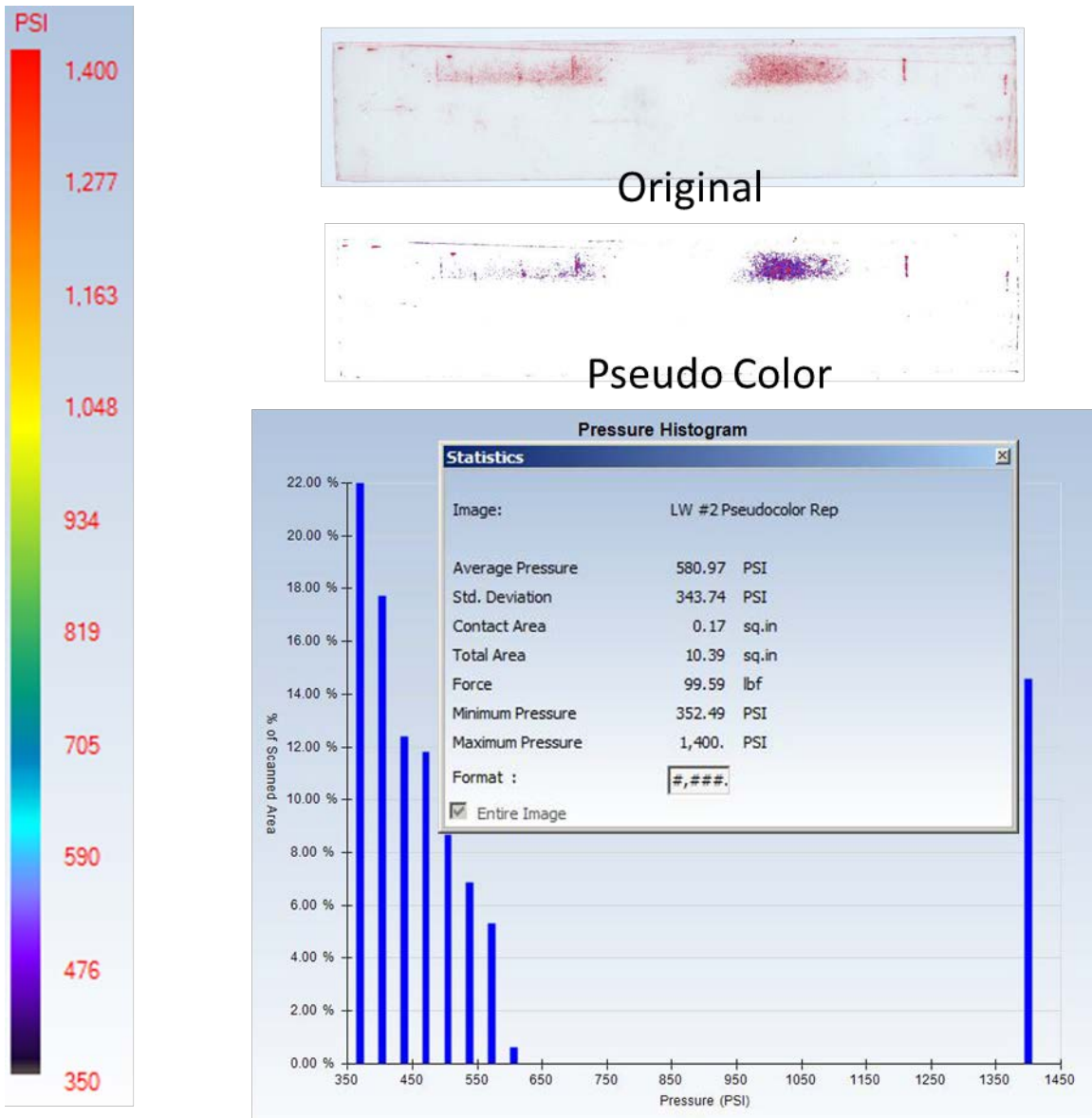

Figure 10: Pressure Analysis with Low Film – GIT

2.2.6.6 Ozyegin University

Total Clamping Force: 144lbf.

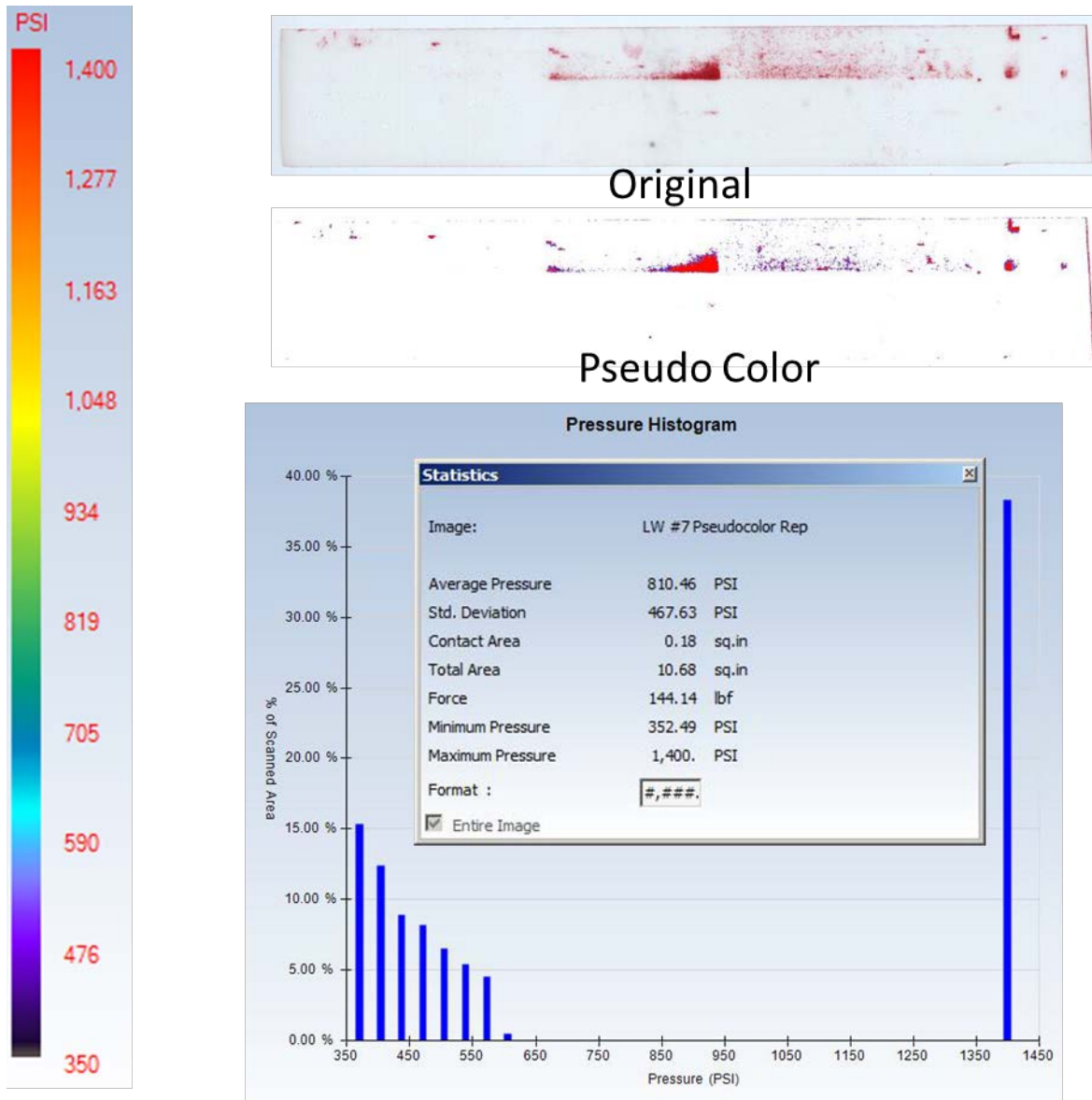

Figure 11: Pressure Analysis with Low Film – Ozyegin U

2.2.6.7 Donghua University

Total Clamping Force: 427lbf.

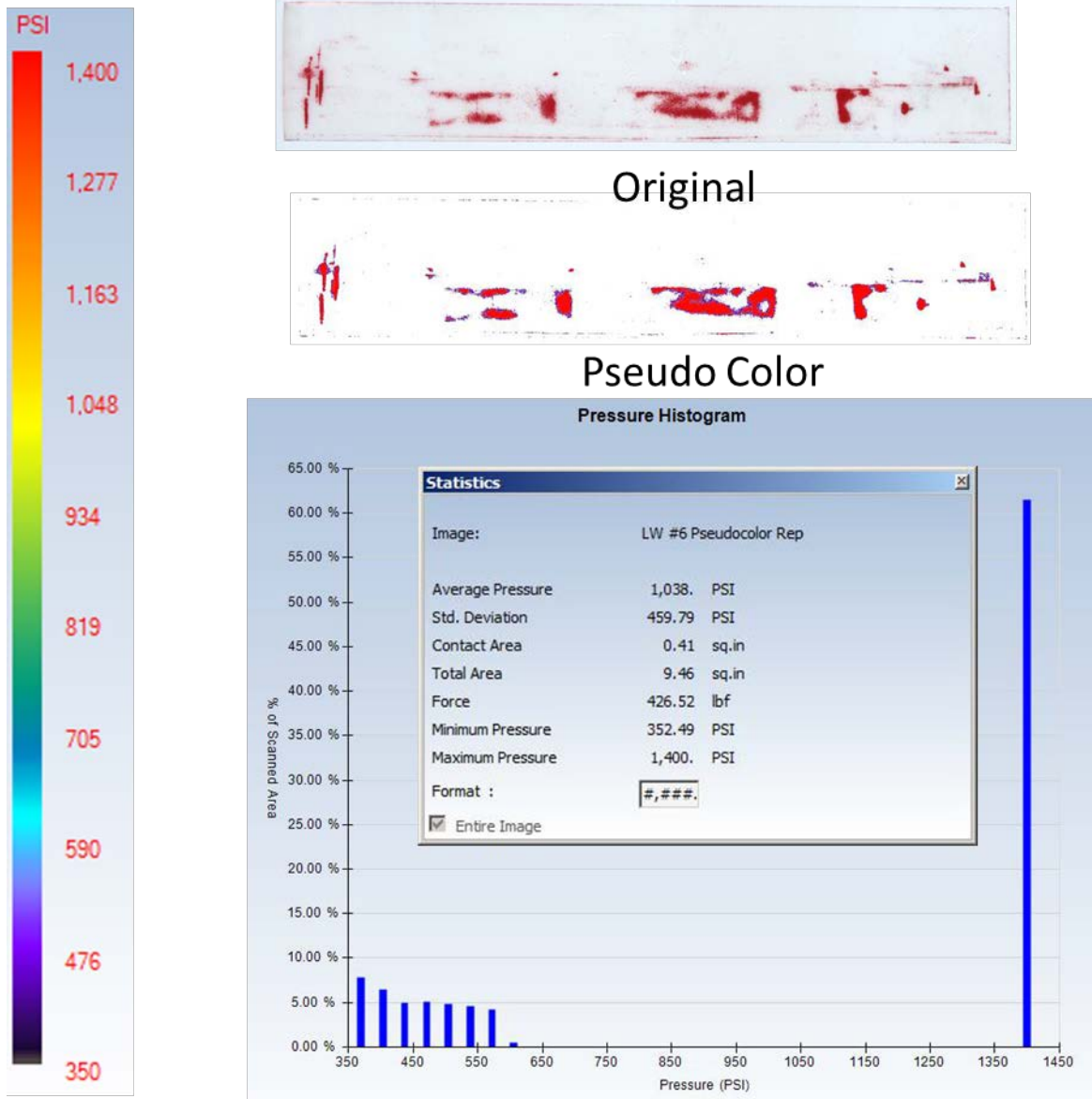

Figure 12: Pressure Analysis with Low Film – DHU

2.3 Thermal Test for 1st Prototypes Delivered in May 2015

During the 1st phase, ten teams fabricated and delivered their thermal connectors with unique features. Those universities were: Donghua University from China, Georgia Institute of Technology including team members from India, Mississippi State University, National Tsinghua University from Taiwan, University of California - Merced, University of Notre Dame, University of Maryland, University of Baghdad from Iraq, Ozyegin University from Turkey, and University of Missouri. The thermal connectors should be 15 cm in length. The requested materials include: a device, pressure films (either ranges of low or super-low, or both), and a report. The delivery record for each student team is listed Table 11:

Table 11. Delivery Record for each RevCon Team

	Device	Report	Pressure Film
U Notre Dame	√*	√	√
Donghua U	√**	√	
MU	√	√	√
NTHU	√	√	√
GIT	√**	√	√
UCMerced	√	√	√
U of Maryland	√	√	√
MissStateU	√**	√	
University of Baghdad	√**	√	√
Ozyegin University	√**	√	√

*U Notre Dame delivered an Al plate coated with their interface material

**Devices delivered by universities which were unable to load onto the test-bed (too thick)









After receiving materials from each team, the MU team performed:

1. Thermal tests at four power inputs: 50W, 100W, 150W, and 200W (20 minutes for each power input, 80 minutes in total)
2. Thermal test at 50W under vacuum (from 760 Torr to 0.167 Torr)
3. Resonant frequency identification through random excitation (5 to 2,000Hz)
4. Thermal tests at 100W during random excitation (5 to 2,000Hz, 5 minutes in total)
5. Thermal tests at 100W at 5 major resonant frequencies (5 to 2,000Hz, 5 minutes for each frequencies, 25 minutes in total)
6. Thermal tests at 100W during sweep frequency input (5 to 50Hz, ~7 minutes in total)

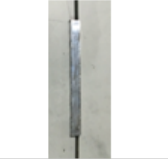
7. Clamping force analysis from returned pressure films

Loading/unloading from the MU testing staff’s experience is summarized in Table 12. Detail comments and suggestions can be found in “Comments on each device”.

Table 12. Summary of MU’s Loading/Unloading Experience

	Appearance	Easiness of loading/unloading	Comments & Suggestions
U of Maryland		<ul style="list-style-type: none"> Easy to load to and unload from the slot repeatedly 	<ul style="list-style-type: none"> Sophisticated and robust Multiple loading/unloading processes without any noticeable wearing The first piece (L-shaped) that connects the end screw on the side and the top wedges seems to have too much freedom of movement
MU		<ul style="list-style-type: none"> Loading is fairly easy Found not be able to retreat and would stick inside the slot 	<ul style="list-style-type: none"> Unloading mechanism needs improvement Surfaces do not look smooth (DMLS surfaces from powder sintering) and probably cannot slide against each other easily Device falls apart since there is no holding mechanism to keep all parts together
Donghua U		<ul style="list-style-type: none"> Fairly easy to load/unload in/out of the slot During unloading, wiggling needed to loosen the contact surfaces 	<ul style="list-style-type: none"> Surfaces look uneven No clear indication of how deep end screws should/can go Graphite powders seem to come out with end screws After multiple runs, certain amount of powders may get lost
MissStateU		<ul style="list-style-type: none"> Insertion procedure is tricky Have to tweak the center part (Cu-TC piece) in order to have both slanted surface balanced 	<ul style="list-style-type: none"> Retreat procedures need improvement Screw wider than the width of the slot The need to tweak the center piece makes the loading/unloading a hassle
GIT		<ul style="list-style-type: none"> Easy to load/unload in/out of the test rig An Allen wrench is enough to complete the operation During unloading, the pistons seemed not to retreat 	<ul style="list-style-type: none"> Leave enough clearance for loading/unloading. Leaking while running experiments Leaking has to be fixed. Otherwise potentially harmful to the electronic board/system Seem not to exert enough force, presumably due to leaking Pistons could not function normally to help clamp the board
NTHU		<ul style="list-style-type: none"> Leaves no clearance for loading and unloading Slide-in mode is impossible to perform Board unable to fully insert into the slot 	<ul style="list-style-type: none"> DC motor in this design is not practical With a simple push-in procedure, one still could push another wedge into the slot and lock the Al board No holding mechanism to keep all parts together
UIUC		<ul style="list-style-type: none"> Reliable with easy loading/unloading procedures 	<ul style="list-style-type: none"> End screw wider than the width of the slot Relatively large gains under random excitation among all the tested devices Number of pieces may play a role on frequency response of the system. Chosen material (SS 304) may improve the deformation and scratch problems, but sacrifice the overall thermal performance
UCMerced		N/A	<ul style="list-style-type: none"> Leave no clearance for loading/unloading Easily fall apart when two end screws are loosened

Detail experimental setup and the definition of R can be found in the Appendix.

2.3.1 Thermal Test at Four Power Input: 50W, 100W, 150W, and 200W

The chiller temperature was set to 18°C with the flowrate (13.33±0.05 L/min) for all thermal tests. Each device was run for 20 minutes for each power input. The corresponding thermal resistances were calculated from the temperatures obtained within the last 3min. The comparison results of the thermal resistance, R, is shown in Table 13 and Figure 13. "std" represents the standard deviation.

Table 13. Comparison Table of Thermal Resistance R (°C/W)

	50W	std	100W	std	150W	std	200W	std
NTHU	0.2239	0.0096	0.2303	0.0019	0.2288	0.0012	0.2285	0.0015
UC Merced	0.3213	0.0029	0.3143	0.0021	0.3098	0.0010	0.3025	0.0012
Maryland	0.4051	0.0042	0.3912	0.0526	0.3784	0.0377	0.3613	0.0010
MU	0.4997	0.0108	0.4910	0.0018	0.4850	0.0004	0.4741	0.0007
U of Baghdad	-	-	-	-	-	-	-	-
Donghua U	-	-	-	-	-	-	-	-
GeorgiaTech	-	-	-	-	-	-	-	-
MissStateU	-	-	-	-	-	-	-	-
U Notre Dame	-	-	-	-	-	-	-	-
Ozyegin University	-	-	-	-	-	-	-	-
Calmark	0.4516	0.0073	0.4397	0.0025	0.4242	0.0034	0.4095	0.0010
Wakefield	0.3229	0.0022	0.3116	0.0026	0.3037	0.0031	0.2953	0.0002

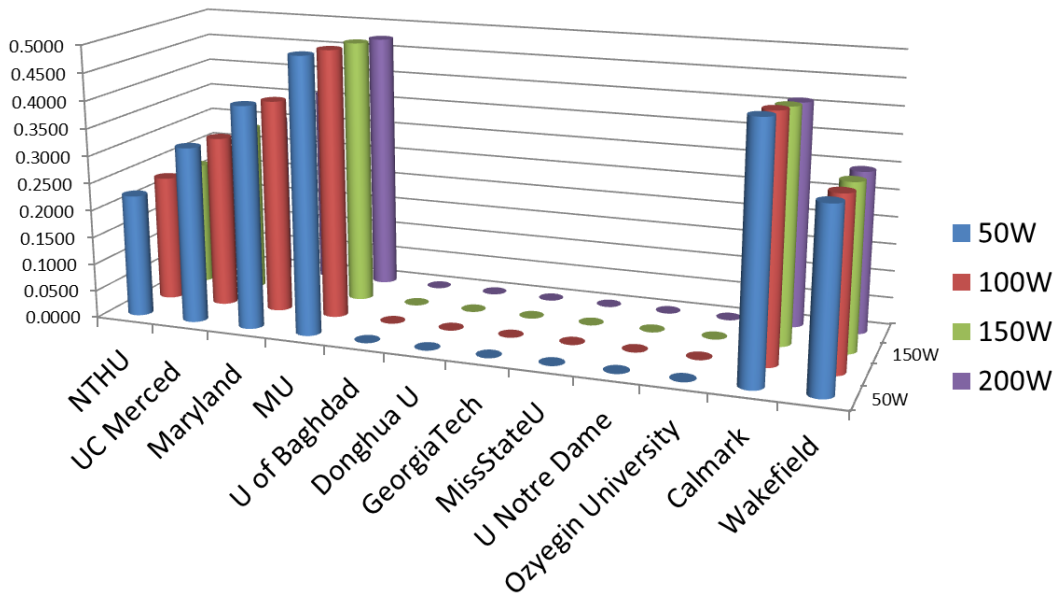

Figure 13: Comparison Chart of Thermal Resistance R from each Prototype, as well as Two Commercially Available Thermal Connectors

The results are sorted by the value of overall thermal resistance in four power input cases. For those prototypes which cannot be loaded to the test bed, their results are present as well. The prototype fabricated by NTHU demonstrated lowest in thermal resistance. This performance is also lower than two of the commercial thermal connectors, one from Calmark, and the other one from Wakefield.

Temperature rise at T3 (closest monitoring point to the heater): Another number that can be referred as a judging point is through the monitoring of temperature rise, when all the initial condition is kept the same. The average temperature in the last 3 minutes of a 20 minute run for each power input is listed in Table 14.

Table 14. Comparison Table of Temperature Monitored at T3 (°C)
This is the closest point from the resistive heater (lower means better)

	50W	std	100W	std	150W	std	200W	std
NTHU	40.2888	0.0417	61.8164	0.0514	82.9225	0.0809	103.6737	0.0548
UC Merced	44.9648	0.0712	69.9903	0.1010	94.5778	0.0992	118.0721	0.0873
Maryland	49.0204	0.0940	77.9007	0.0933	105.3820	0.1014	130.1803	0.1043
MU	53.3228	0.2957	86.7258	0.0936	119.5144	0.0638	149.9169	0.0500
U of Baghdad	-	-	-	-	-	-	-	-
Donghua U	-	-	-	-	-	-	-	-
GeorgiaTech	-	-	-	-	-	-	-	-
MissStateU	-	-	-	-	-	-	-	-
Notre Dame U	-	-	-	-	-	-	-	-
Ozyegin University	-	-	-	-	-	-	-	-
Calmark	50.4578	0.1752	80.9480	0.1748	109.5167	0.1583	136.3647	0.1066
Wakefield	45.8222	0.0722	70.9200	0.0915	95.4537	0.0646	118.9459	0.0595

2.3.2 Thermal Test with/without Vacuum

Thermal tests during vacuum were carried out on each device while 50W heat was being loaded. The results (averaged from the last 100 seconds) are listed in Table 15. The chamber where vacuum is carried out started from the atmospheric pressure (~760 Torr) to the ending pressure under 2-hour vacuum. The ending pressure is ranging from 161 mTorr to 168 mTorr. According to this result, it is apparent that low pressure environment does affect the performance of thermal connectors tested here: NTHU’s prototype has the minimal increase on thermal resistance, while MU’s prototype has the highest increase of 172.4%. The thermal resistance increase will be a good and important reference for thermal connector designers when they plan to design their connectors that would end up being used in low pressure environment or in deep space (closed-to-vacuum).

Table 15. Comparison of Thermal Performance with Vacuum ON and OFF

	Vacuum On		Vacuum Off		Increase (%)
	50W w/ vacuum	std	50W w/o vacuum	std	
NTHU	0.2412	0.0054	0.1716	0.0030	40.6
UC Merced	0.5687	0.0051	0.2560	0.0015	122.2
Maryland	0.7525	0.0073	0.4051	0.0042	85.8
MU	1.1040	0.0005	0.4052	0.0008	172.4
U of Baghdad	-	-	-	-	-
Donghua U	-	-	-	-	-
GeorgiaTech	-	-	-	-	-
MissStateU	-	-	-	-	-
U Notre Dame	-	-	-	-	-
Ozyegin University	-	-	-	-	-
Calmark	0.6583	0.0011	0.3915	0.0132	68.2
Wakefield	0.4545	0.0003	0.2791	0.0117	62.8

2.3.3 Thermal Test at 100W during Random Excitation (5 to 2,000Hz)

Thermal tests during random vibration excitation were carried out on each device while 100W heat was being loaded. The results (averaged from the last 100 seconds) are listed in Table 16.

Table 16. Comparison of Thermal Performance with Random Vibration ON and OFF

	on		off	
	100W Random ON	std	100W Random OFF	std
NTHU	0.2323	0.0025	0.2303	0.0019
UC Merced	0.3180	0.0016	0.3143	0.0021
Maryland	0.3739	0.0026	0.3912	0.0526
MU	0.4749	0.0025	0.4910	0.0018
U of Baghdad	-	-	-	-
Donghua U	-	-	-	-
GeorgiaTech	-	-	-	-
MissStateU	-	-	-	-
U Notre Dame	-	-	-	-
Ozyegin University	-	-	-	-

Maryland's prototype has 4% decrease in thermal resistance, which is the largest performance difference among all tested device. Other prototypes performed similarly before and after the vibration.

2.3.4 Thermal Test at 100W at 5 Major Resonant Frequencies (5 to 2,000Hz)

Thermal tests under five resonant frequency excitations were carried out on each device while 100W of heat was being loaded. The results (averaged from the last 100 seconds) are listed in Table 17. It should be noted that resonant frequency #5 (some also with #4 and/or #3), if determined, could not be tested if the previous actuation gain (used for last RevCon) was kept. This is partially because the resonant gain is too large so that the system automatically stopped due to the auto-protection. On the other hand, vibration along gravitational direction seems to impose a minor effect on thermal resistance.

Table 17. Comparison of Thermal Performance with Single Frequency Excitation and without Vibration

	100W w/o vibration	f1	f2	f3	f4	f5
NTHU	0.2303	0.2306	0.2326	0.2311	0.2340	-
UC Merced	0.3143	0.3230	0.3203	0.3200	-	-
Maryland	0.3912	0.3890	0.3907	-	-	-
MU	0.4910	0.4852	0.4869	0.4885	-	-
U of Baghdad	-	-	-	-	-	-
Donghua U	-	-	-	-	-	-
GeorgiaTech	-	-	-	-	-	-
MissStateU	-	-	-	-	-	-
U Notre Dame	-	-	-	-	-	-
Ozyegin University	-	-	-	-	-	-

2.3.5 Thermal Test at 100W during Sweep Frequency Input (5 to 50Hz)

A sweep vibration test from 5Hz to 50Hz was also performed on each device. We realized that most resonant frequencies from the participant teams are located higher than the 100Hz frequency range, and therefore have a minor effect on the thermal performance and clamping mechanism. The results (averaged from the last 100 seconds) are listed in Table 18.

Table 18. Comparison of Thermal Performance with Sweep Excitation and without Vibration

	Sweep 5Hz to 50Hz	std	100W w/o vibration	std
NTHU	0.2330	0.0020	0.2303	0.0019
UC Merced	0.3201	0.0017	0.3143	0.0021
Maryland	0.3840	0.0032	0.3912	0.0526
MU	0.4864	0.0027	0.4910	0.0018
U of Baghdad	-	-	-	-
Donghua U	-	-	-	-
GeorgiaTech	-	-	-	-
MissStateU	-	-	-	-
U Notre Dame	-	-	-	-
Ozyegin University	-	-	-	-

Similar to the previous results under vibration excitation, vibration (5 to 50Hz) along gravitational direction seems to impose a minor effect on thermal resistance.

2.3.6 Clamping Force Analysis

Fujifilm Prescale pressure indicator films were sent out to the student teams. Each team was requested to test and send back their pressure film for further analysis. Eight teams: U Notre Dame, MU, NTHU, GIT, UC Merced, U of Maryland, U of Baghdad and Ozyegin U returned their films. “Width” and “Length” represent the dimension for the device. If “Contact area” (provided by the pressure analysis software) is larger than Width x Length, the number of Width x Length will be used. The analyses were carried out by Sensor Production Inc. A summary can be found in Table 19.

Table 19. Clamping Force Predicted by the Pressure Film Tests

	Width (mm)	Length (mm)	Ave. Pressure (psi)	Contact area (in ²)	Force (lbf)
NTHU	12.65	150.00	789.92	0.83	655.63
UC Merced	12.70	150.00	897.23	2.95	2646.83
Maryland	11.36	150.00	682.69	1.89	1290.28
MU	12.00	150.00	469.98	0.70	328.99
U of Baghdad	13.00	250.00	869.61	1.50	1304.42
Donghua U	13.20	150.00	-	-	-
GeorgiaTech	12.56	150.00	1019.30	2.92	2976.36
MissStateU	12.75	140.00	-	-	-
U Notre Dame	12.70	150.00	868.08	2.61	2265.69
Ozyegin University	12.35	150.00	683.87	1.06	724.90

2.3.6.1 National Tsing Hua University

Total Clamping Force: 655.63lbf.

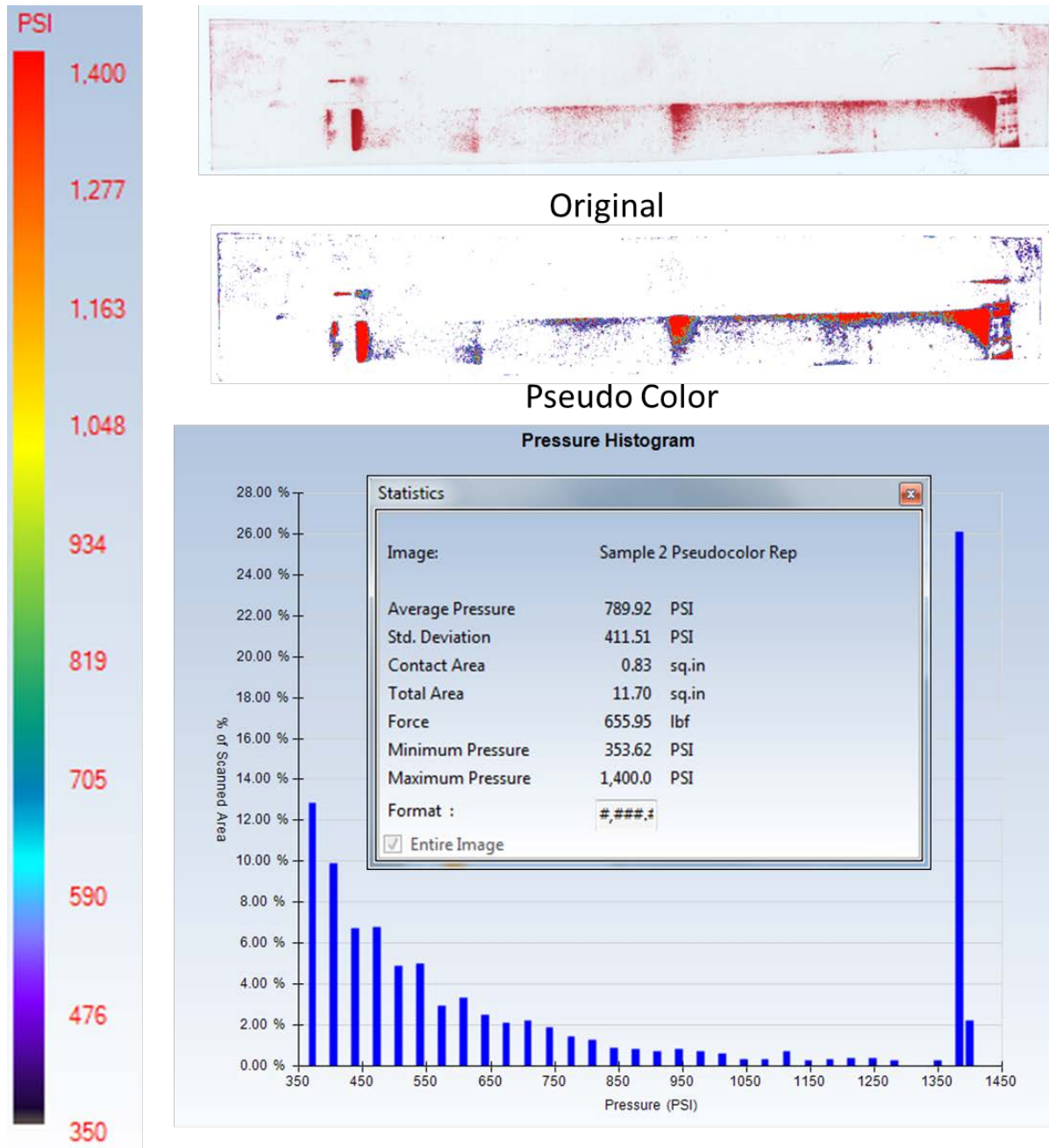

Figure 14: Pressure Analysis with Low Film – NTHU

2.3.6.2 University of California - Merced

Total Clamping Force: 2646.83lbf.

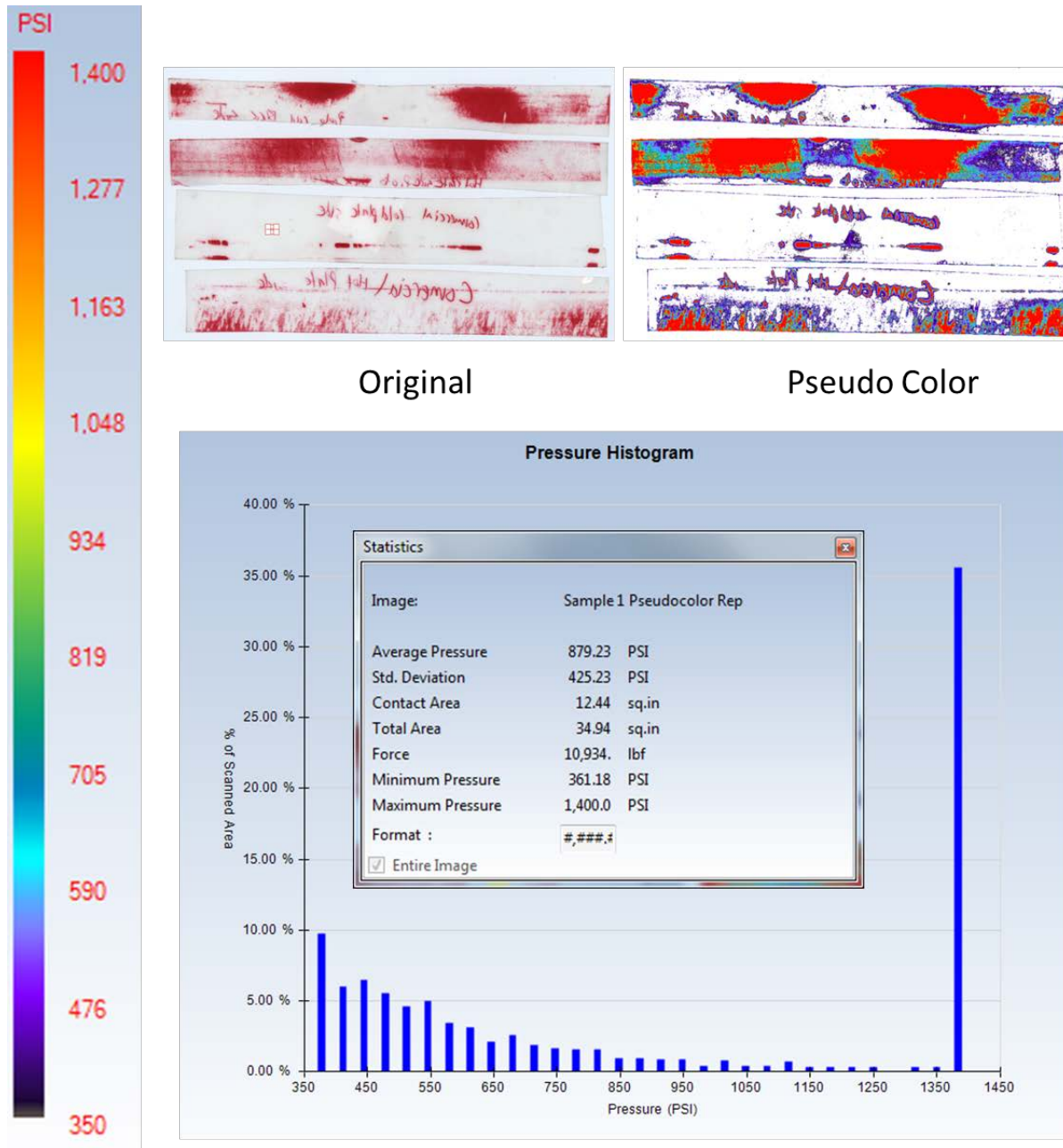

Figure 15: Pressure Analysis with Low Film – UC Merced

2.3.6.3 University of Maryland

Total Clamping Force: 1,290.28lbf.

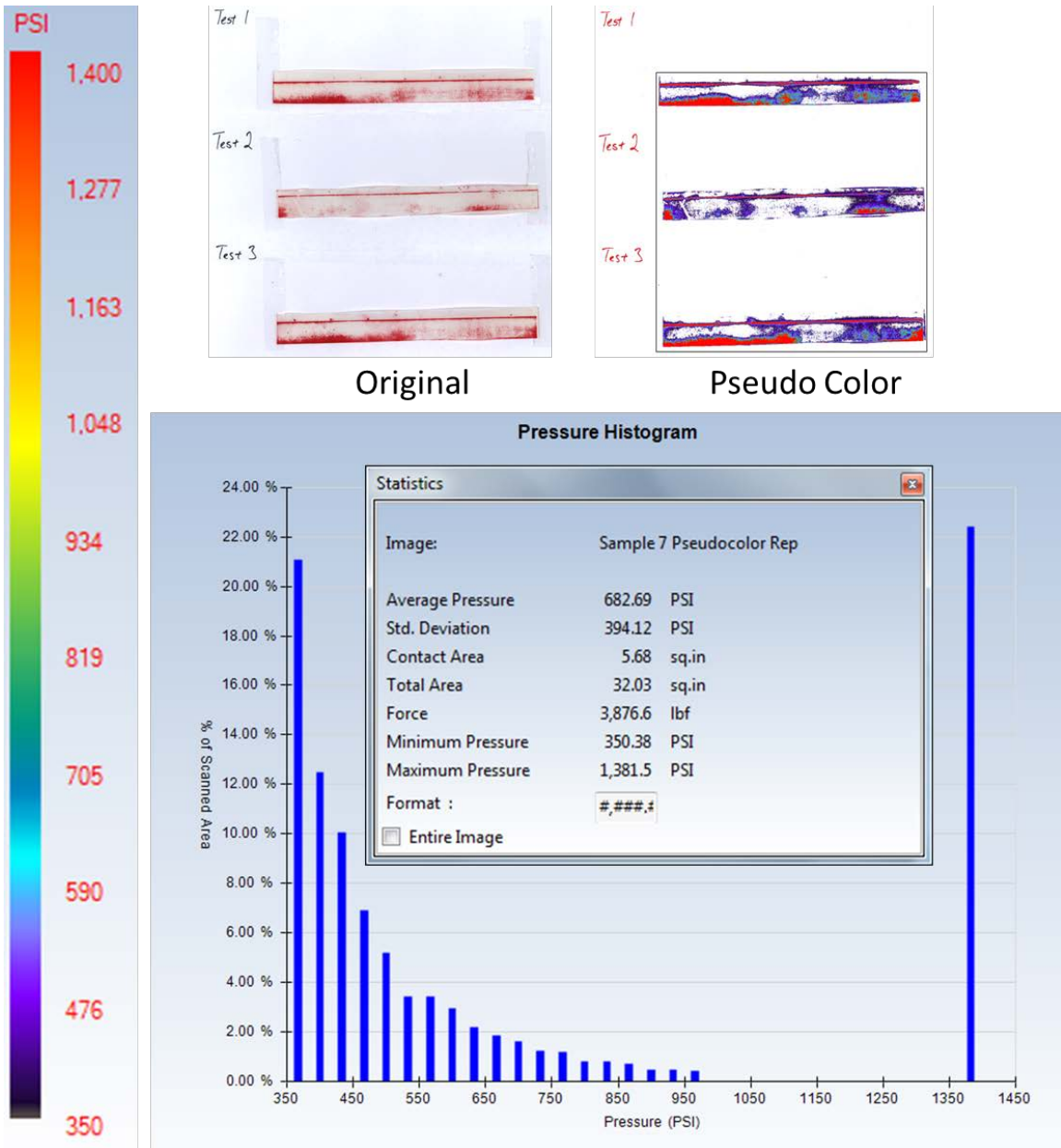

Figure 16: Pressure Analysis with Low Film – U of Maryland

2.3.6.4 University of Missouri

Total Clamping Force: 328.99lbf.

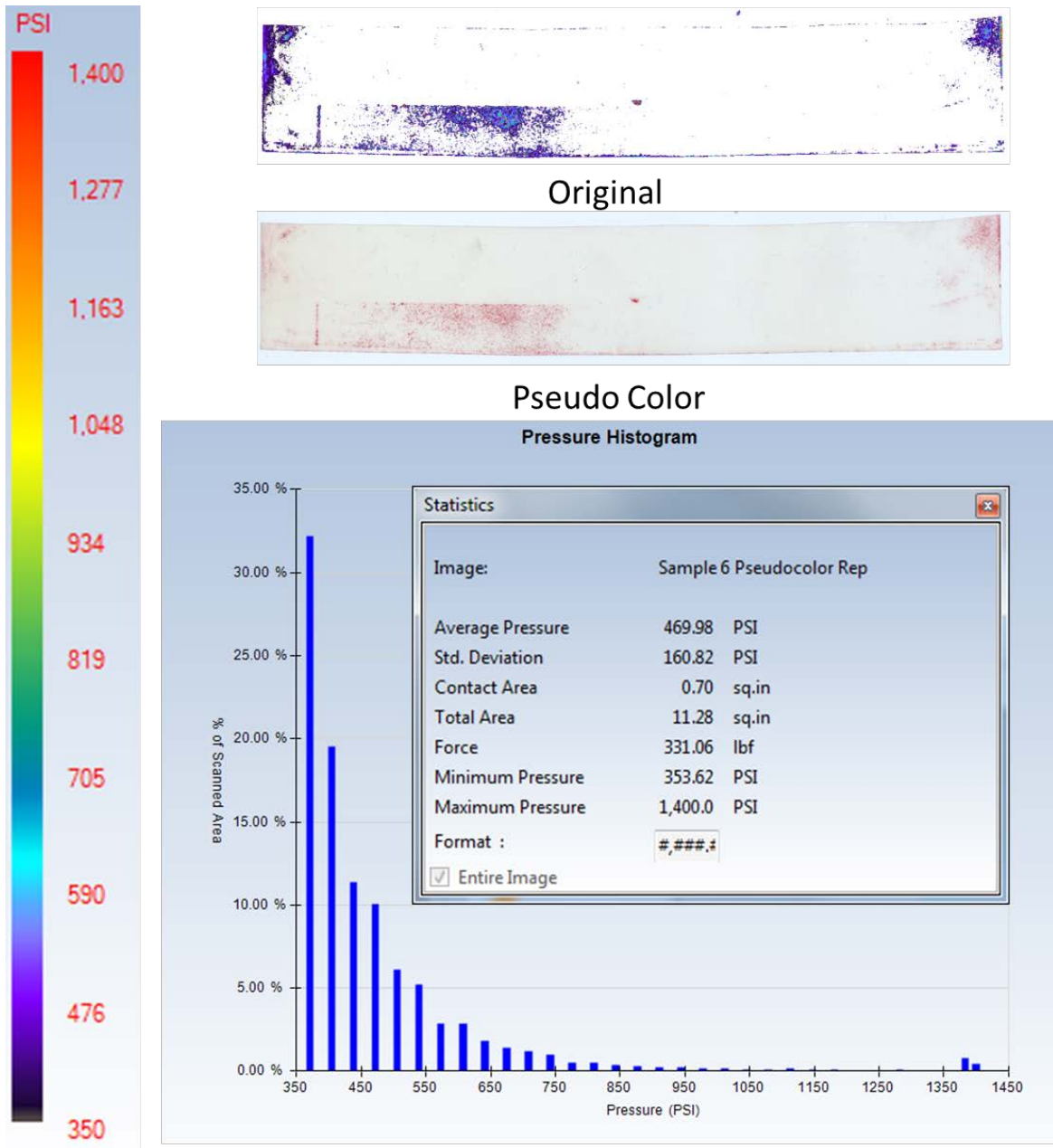

Figure 17: Pressure Analysis with Low Film – MU

2.3.6.5 University of Baghdad

Total Clamping Force: 1304.42lbf.

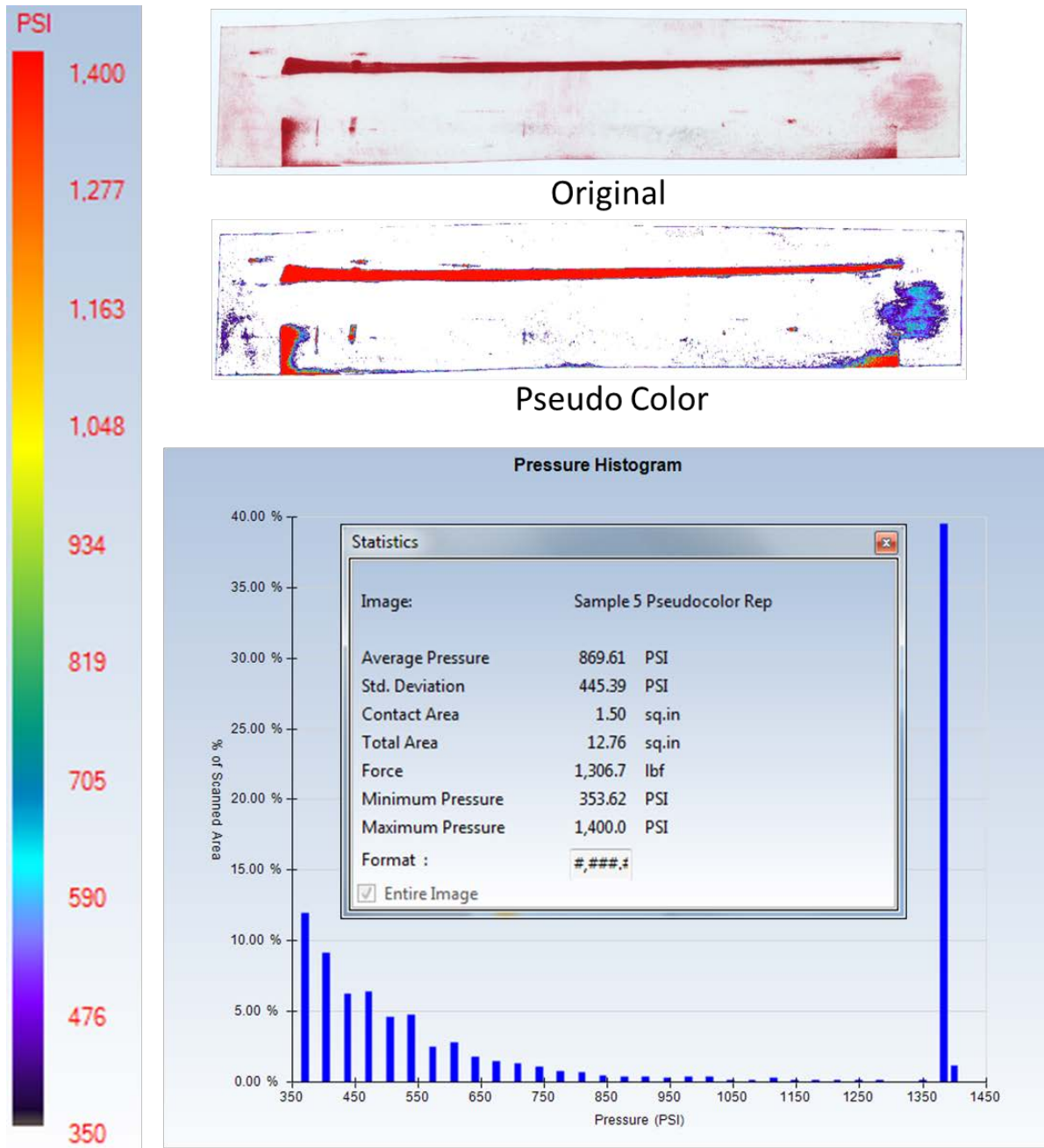

Figure 18: Pressure Analysis with Low Film – U of Baghdad

2.3.6.6 Georgia Institute of Technology

Total Clamping Force: 2,976.32lbf.

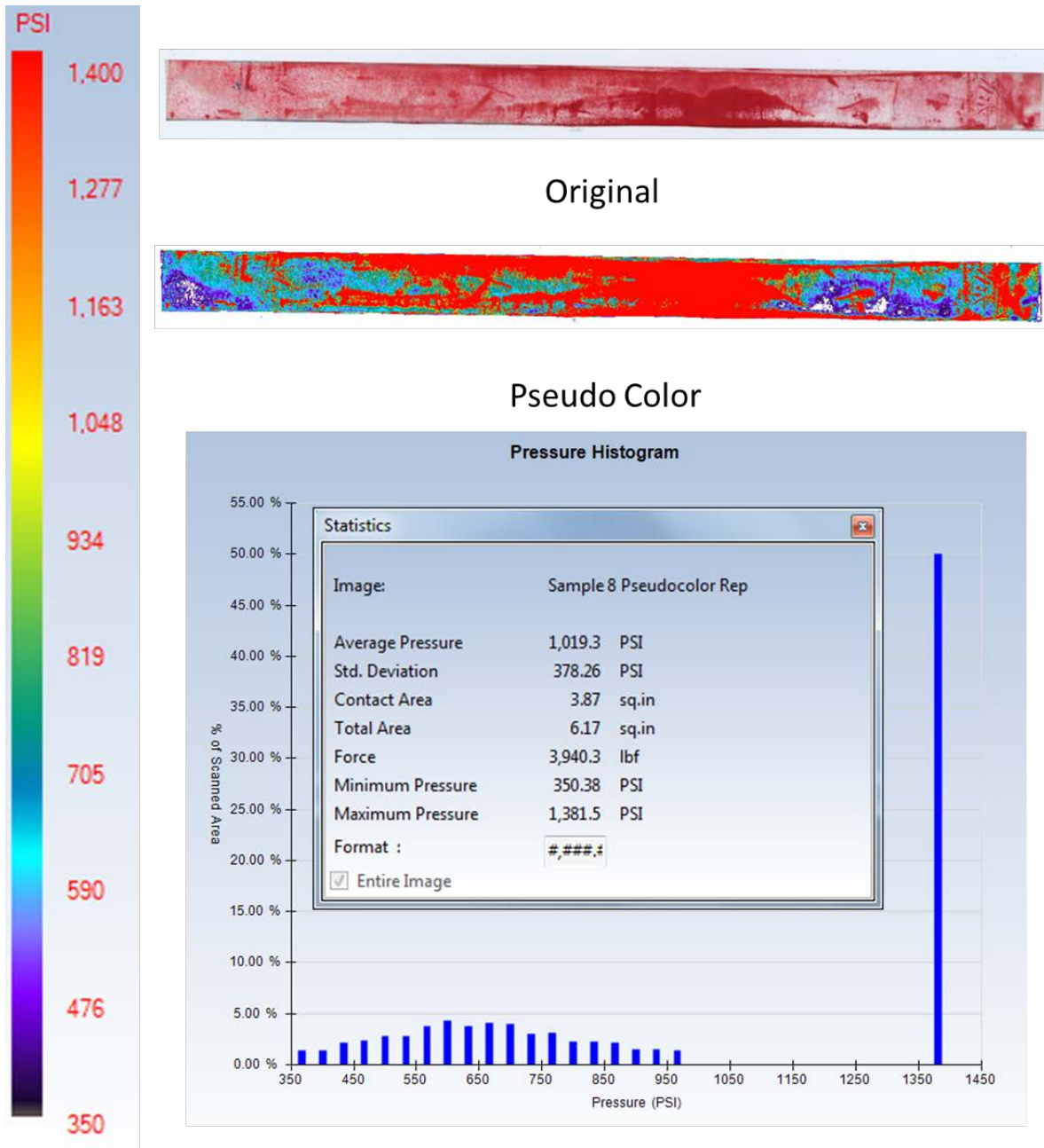

Figure 19: Pressure Analysis with Low Film – GIT

2.3.6.7 University of Notre Dame

Total Clamping Force: 2265.69lbf.

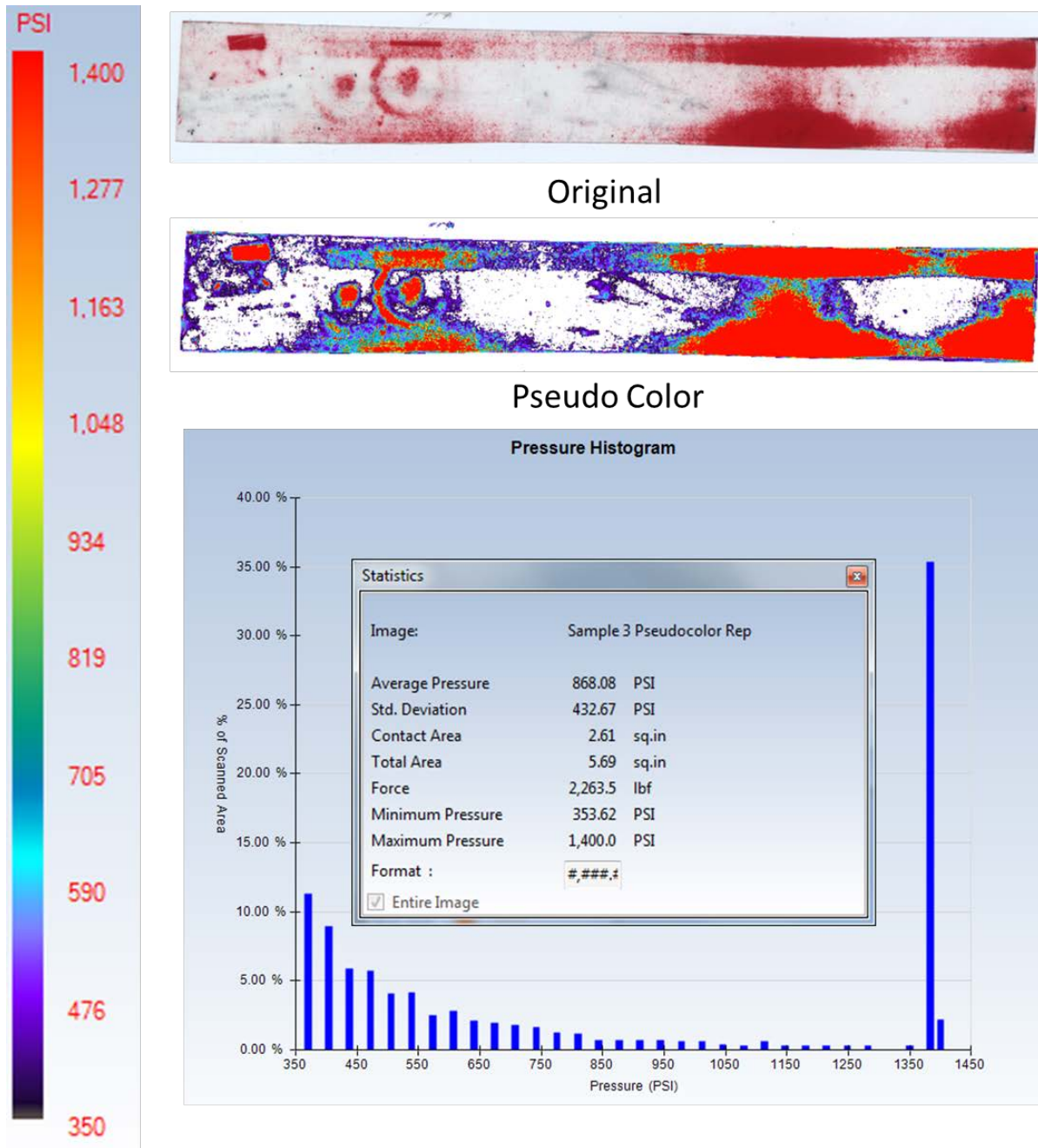

Figure 20: Pressure Analysis with Low Film – U of Notre Dame

2.3.6.8 Ozyegin University

Total Clamping Force: 724.9lbf.

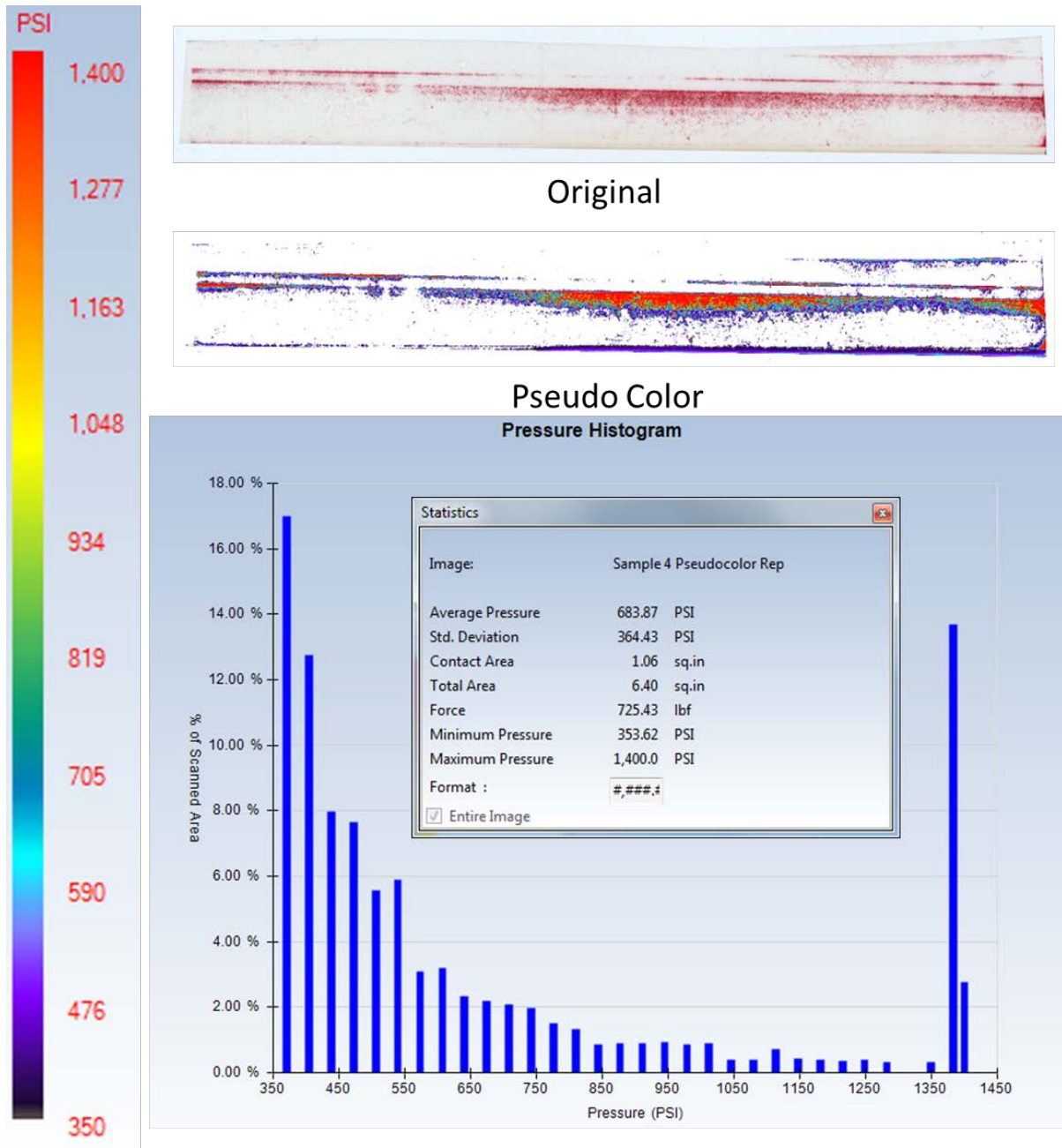

Figure 21: Pressure Analysis with Low Film – Ozyegin U

2.3.6.9 Mississippi State University

- No pressure film was provided.

2.3.6.10 Donghua University

- No pressure film was provided.

2.4 Comments on each Device (RevCon IV)

This year, thermal performance in vacuum environment has been added to the new RevCon competition broad agency announcement. The corresponding R analyses have been reported in the section of thermal test. In addition, RevCon aims to encourage student teams to pursue novel designs, which can repeatedly assemble and disassemble an electronic module to/from an electronic enclosure (easiness), while providing a constant connector thermal resistance lower than $0.1^{\circ}\text{C}/\text{W}$ over multiple thermal cycles in a specified temperature range, vibration environment, and contact pressure (lower thermal resistance R). We not only evaluated their thermal performance before and during the competition, but also evaluated the easiness of assembling and disassembling. The thermal performance for each device has been summarized in the previous section. We address some comments regarding our user experience and suggestions for further improvement.

2.4.1 Donghua University

Most current prototype: Donghua University participated in the RevCon competition since 2014. The innovation delivered by DHU is appreciated: hydraulic clamping force provided by graphite powder. A solid rod (Figure 22(a)) and be screwed into the closed chamber (full of graphite powder) and makes the chamber deformed along the perpendicular direction of the rod, shown in Figure 22(b)). In 2015, DHU replaced a single-rod design with a rod-wedge design shown in Figure 22(c).

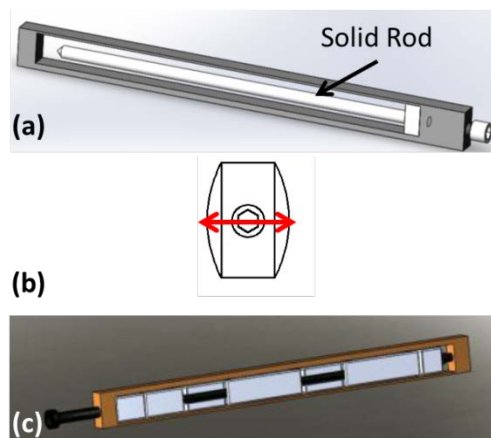

Figure 22: Concept of DHU's Thermal Connectors
Images are adopted from DHU's report.

DHU's design is again a metal box filled with graphite powder. DHU delivered 2 prototypes. Both have screws from one end of the connector, which can move into the device and squeeze the powder. The screw results in the deformation of the copper housing of the metal box which exerts a clamping force to the AI Board. Figure 23 shows the side view of their design and the image when the connector is inserted into the aluminum slot. Unfortunately, it cannot be smoothly unloaded after unloading (rippled surface shown on the right image) during the preliminary tests.



Figure 23: Thermal Connector Delivered from Donghua University

Frequency response for the 1st prototype and 2nd prototype determined from A_2 over A_1 and the corresponding resonant frequencies can be found in Figure 24. Since none of their 1st prototype (3 in total) can be loaded onto our testbed, the figure only shows the frequency response for the 2nd prototype.

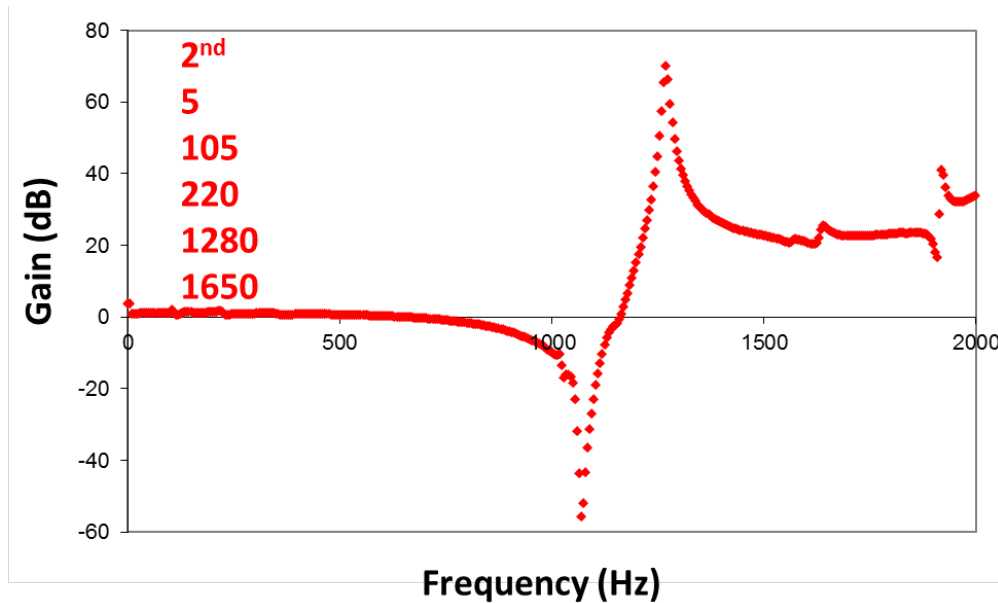

Figure 24: Frequency Response for Donghua University's Design

Easiness of loading and unloading: The design delivers a straightforward way (but lousy, takes longer time to screw/unscrew) to assemble and disassemble in and out of the slot during the competition. Different from their 2nd prototype, the device they brought over for the competition had better load/unload experience.

Comments and Suggestions

- 2 almost identical prototypes.
- Soldering edges slightly thicker than the Al slot.
- Got jammed on their 2nd devices (not happened on their competition device).

1st Prototype: DHU's design is a metal box filled with graphite powder during the 1st phase. They delivered 3 prototypes: one of them is broken before it is delivered (Figure 25). One screw/thin-plate from one end of the connector can move into the device and squeezes the powder, resulting in the deformation of the copper housing of the metal box which exerts a clamping force to the Al Board. Unfortunately none of them can be inserted/loaded to the testbed.

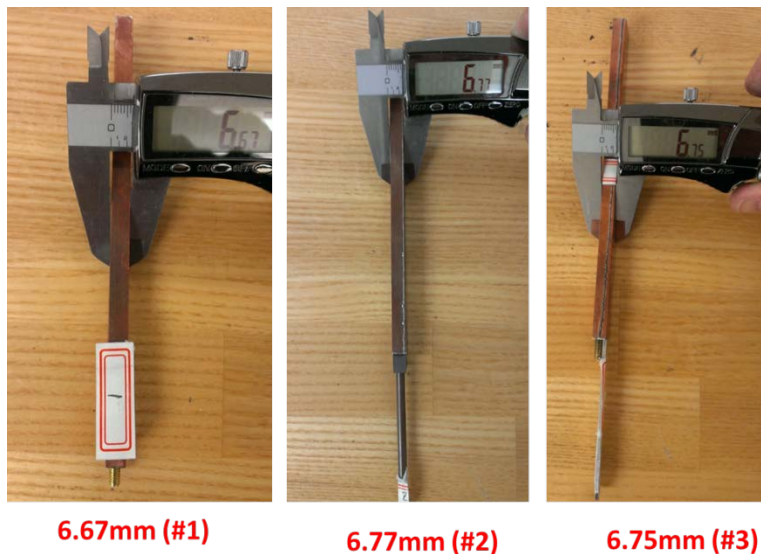

Figure 25: “Box” Thermal Connector Delivered by Donghua University

Easiness of loading and unloading: Too thick for all three prototypes: unable to load and unload on MU side. Prototype #3 was broken before being delivered to MU.

Comments and Suggestions

- Student’s efforts can be clearly noticed.
- Unfortunately all three prototypes cannot be loaded because of the clearance issue.
- Please do not use the smooth side (prepared for pressure film) for thermal testing as this smooth end is 0.1 to 0.15mm thinner. Use the other without any smooth surface for thermal testing.

2.4.2 Georgia Institute of Technology

Most current prototype: GIT's design is similar to their previous thermal connector with hydraulic pressure inside a copper series. In 2014, GIT used piston design to exert hydraulic force (Figure 26(a)). This time in 2015, a screw-plunger system is adopted (Figure 26(b)). In addition, a flexible diaphragm (in copper) covers the hydraulic fluid (water and glycerin mixture).

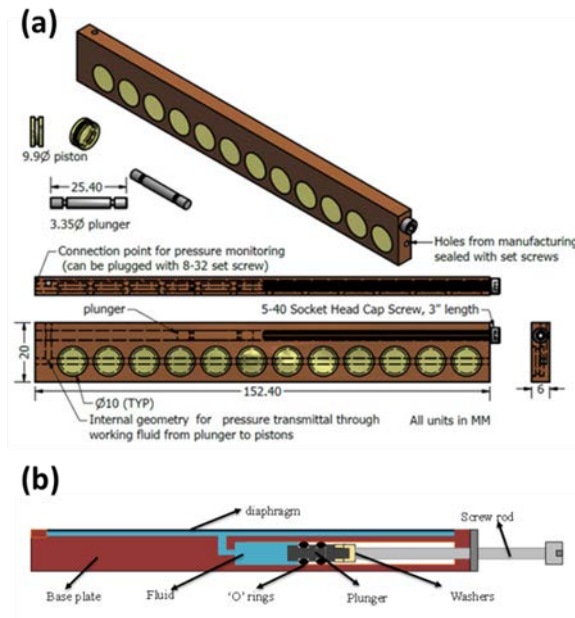

Figure 26: Thermo-hydraulic Design Proposed by GIT

(a) 2014 version with pistons and (b) 2015 version with copper diaphragm. Images are adopted from GIT's report.

Easiness of installation and removal: Figure 27 displays the complete insertion of the device. GIT's device was still leaking during this competition. This may tell why the corresponding R was large (the largest among all prototypes) and its increase of R (+156%) when vacuum is present. The adhesives did not seem to work well to seal the hydraulic fluid.



Figure 27: Hydraulic Thermal Connector Delivered by GIT

Frequency response is not available because: (1) prototype #1 did not fit into the testbed (not enough clearance), (2) prototype #2 did not provide enough clamping force to hold Al board, and (3) the new device brought for the competition was leaking.

Comments and Suggestions

- Almost no clamping force was observed on their 2nd prototype (competition device did provide enough clamping force to hold the Al plate).
- Leaking issue remained.
- Hydraulic design has to have good sealing in order to fight for harsh environment such as vacuum.

1st Prototype: GIT's 1st design is similar to their previous thermal connector with hydraulic pressure inside a copper housing. This time they design two rectangular windows capable of deforming while a screw is tightened, instead of a series of circular piston during deformation. As can be seen from Figure 28, the thickness of the device does not leave enough clearance (6.33mm at the center, left). Therefore, the device cannot be loaded completely.



Figure 28: Hydraulic Thermal Connector Delivered by GIT

Easiness of installation and removal: Too thick: unable to load and unload on MU side.

Comments and Suggestions

- The device is well built.
- Leaking (honey used in their previous version) seems to be solved.
- The clamping force predicts its low R. Unfortunately the device is too thick to load. Clearance issue needs to be addressed.
- Please do not use the smooth side (prepared for pressure film) for thermal testing as this smooth end is 0.1 to 0.15mm thinner. Use the other without any smooth surface for thermal testing.

2.4.3 University of Missouri

Most current prototype: MU participated in 2014 RevCon with a 3D wedge design (Figure 29(a)). The interface between the base piece and the moving piece is angled both horizontally and vertically, resulting in both horizontal and vertical movements. In 2015, MU incorporated oscillating heat pipes (OHPs) (Figure 29(b)) in order to further improve the thermal conductivity of the device itself. For both prototypes, direct metal laser sintering (DMLS) is chosen to fabricate the sophisticated wedge surfaces with metal powders. The device surface seemed to be sanded before being delivered. This could improve the surface smoothness and improve R during operation.

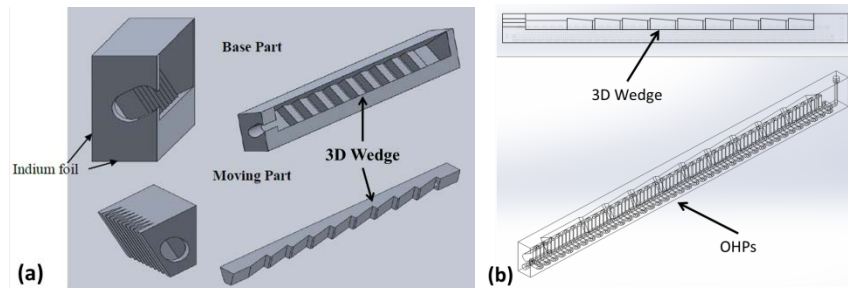

Figure 29: 3D Wedge Design Proposed by MU

(a) 2014 version, and (b) 2015 version with additional OHPs. Images are adopted from MU's report.

MU did not have their wedge-OHP prototype delivered by 22 October. Instead, MU sent a three-wedge device made of stainless steel (Figure 30(a)). MU did use indium at the interface area. This should improve the thermal performance by reducing the air pockets. The 2nd prototype still got jammed during unloading since this three-wedge device did not have a simple mechanism to unload the wedges once the thin wedge (middle in (b)) is punched into the other two wedges. In Figure 9(b), MU's device with OHPs was loaded onto the testbed with no difficulty.

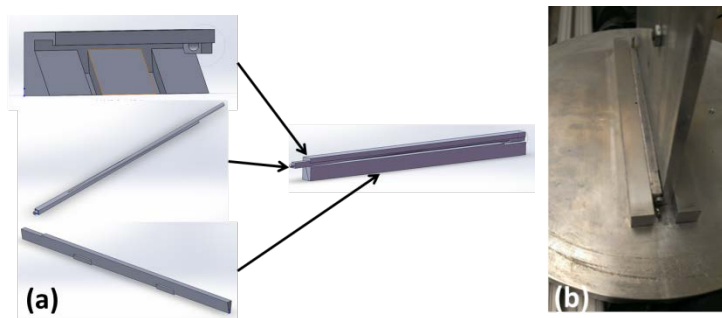

Figure 30: Three-wedge Design Delivered by MU Team

(a) Concept drawings and (b) loaded device on the testbed. Images in (a) are adopted from MU's report.

Frequency response determined from A_2 over A_1 and the major resonant frequencies can be found in Figure 31.

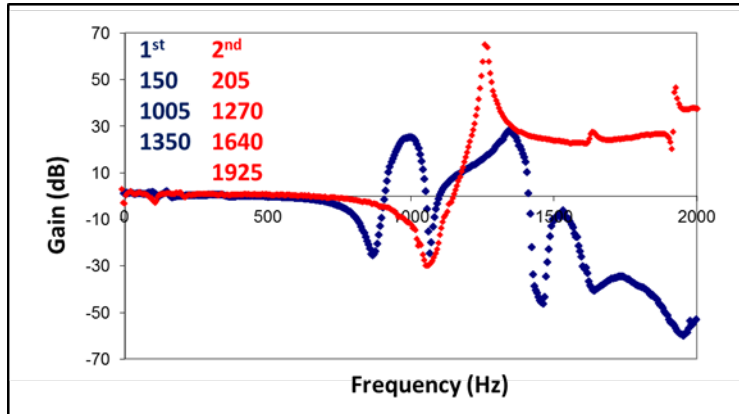

Figure 31: Frequency Response for MU's Design

Easiness of installation and removal: The loading procedure for MU's device for competition is fairly easy as the relaxation thickness of their design has enough clearance against the slot width. The oscillating heat pipes did not seem to function during the competition (no significant pulsating dynamics observed in temperature history). The cause is remained unknown.

Comments and Suggestions

- The design of the device leaves enough clearance for loading.
- Larger screws can be considered in order to exert larger clamping force.
- Easy to load, uneasy to unload for their 2nd prototype made in stainless steel.
- Oscillating phenomenon unclear.

1st Prototype: MU's has delivered two prototypes at the end of 1st phase: one with oscillating heat pipes, and the one with a special design of wedge pieces (Figure 32, left). Unfortunately, the one with oscillating heat pipes cannot be assembled; therefore there is no testing result. The other prototype can be loaded to the test bed (Figure 32, right).

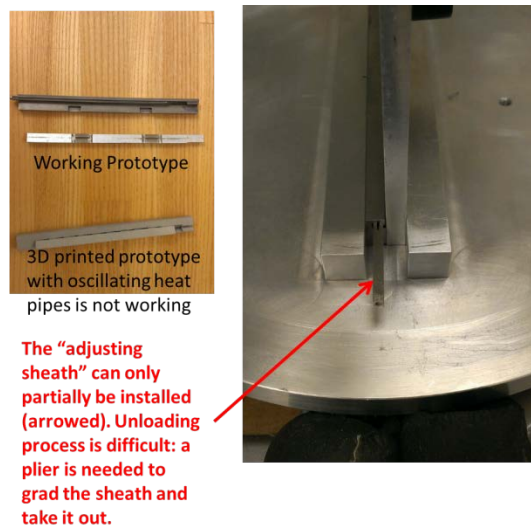

Figure 32: Thermal Connector Delivered by MU

Easiness of installation and removal: Should have been easy for loading if more clearance is left. Once being loaded tightly, pliers is needed for unloading

Comments and Suggestions

- One of the prototypes (with oscillating heat pipe) cannot be assembled. This needs to be addressed.
- Retreat procedures for the prototype made in stainless steel needs improvement.
- Please do not use the smooth side (prepared for pressure film) for thermal testing as this smooth end is 0.1 to 0.15mm thinner. Use the other without any smooth surface for thermal testing.

2.4.4 National Tsinghua University

Most current prototype: In 2014, NTHU delivered a two-wedge device, made in copper and coated with nickel. The device performed well during 2014 competition, conceptually shown in Figure 33(a). In 2015, NTHU delivered a three-wedge device during the 1st phase (Figure 33(b)). A tool that can facilitate the loading and unloading process is design and provided (Figure 33(c)). Magnetic buttons were used to secure and hold wedge pieces, which is novel but somehow created unknown impacts on the electronic boards.

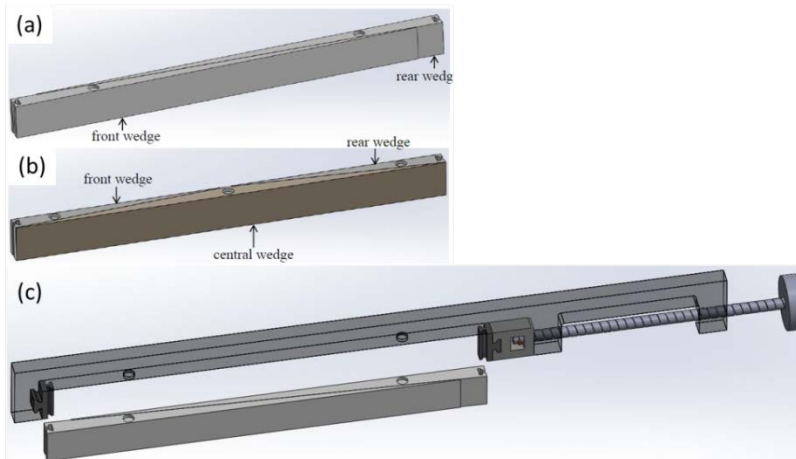

Figure 33: Wedge Design with Loading/Unloading Tool Proposed by NTHU
(a) Two-wedge design, (b) three-wedge design, and (c) the tool provided to load/unload the device. Images are adopted from NTHU's report

NTHU delivered a neat device with fine surfaces. Their 2nd prototype can be loaded onto our testbed easily. NTHU brought another device for competition. Both of these two prototypes demonstrated consistent R.

Easiness of installation and removal: Figure 34 displays the side views of the device and its loading/unloading tool. During the competition, the device can be loaded from the side of the slot. However, the loading tool somehow limits its application in real world: it will not be able to slide all the way from one side to the other when an electronic board has elements/chip sets occupying the space where the loading tool has to cross.

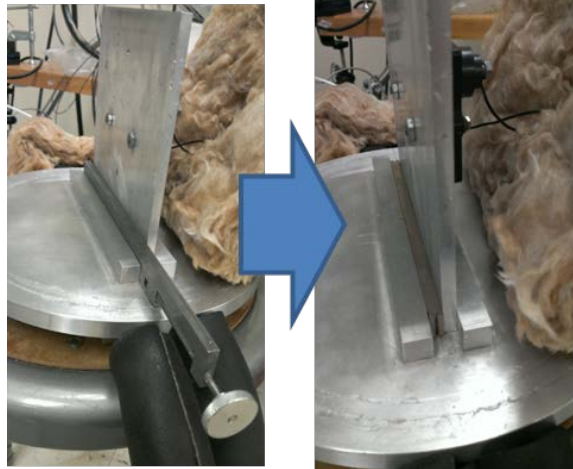

Figure 34: Side View of NTHU's Wedge Thermal Connector and its Auxiliary Tool for Loading and Unloading

Frequency response determined from A_2 over A_1 and the major resonant frequencies are shown in Figure 35.

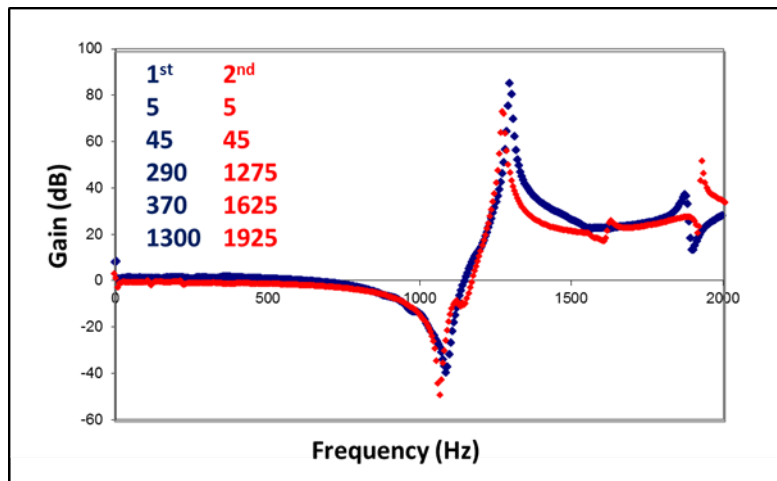

Figure 35: Frequency Response for NTHU's Design

Comments and Suggestions

- Easy to load and unload.
- 2-piece wedge (3-piece design for the 1st prototype).
- Separate device with magnets.
- Loading tool is large.
- Magnets to hold pieces together: may cause magneto-electric problems on board-chips.

1st Prototype: NTHU delivered their 1st prototype: a delicate three-wedge device (Figure 36). The auxiliary fastening tool helps to load the device onto the testbed. During loading and unloading, the three-wedge device stays together by permanent magnets holding them. The fastening tool is also hold the three-wedge device through magnetic force.

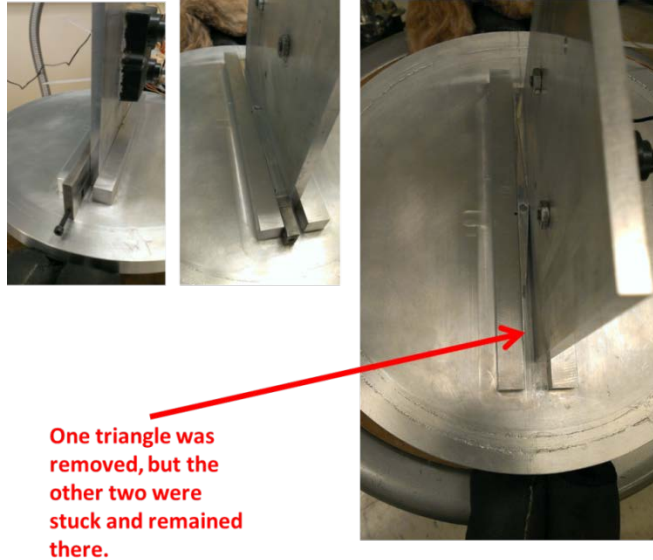

Figure 36: Three-wedge Thermal Connector Delivered from NTHU

Easiness of installation and removal: Easy to load from the slot repeatedly. Unclear about unloading: partially got stuck after loading

Comments and Suggestions

- Robust and well fabricated.
- Magnet mating design is neat, but can also be nasty: RF circuits might be affected.
- The unloading mechanism needs to be improved.

2.4.5 University of Maryland

Most current prototype: In 2014, University of Maryland delivered a unique device: wedge movement along two directions (Figure 37(a)). When tightening from the right screw, the top bolts will transfer such horizontal movement (same as the tightening direction) into the perpendicular movement for the bottom two-wedge pieces. In RevCon IV, Maryland delivered a two-wedge prototype (made in Al alloy) without bolts on the top (Figure 37(b)). This device can theoretically be loaded onto the testbed (if clearance is enough). However, unloading mechanism is unclear. Later in the 2015 competition, Maryland delivered a two-wedge device (Figure 37 (c)) and provided an unloading mechanism (Figure 37(d)).

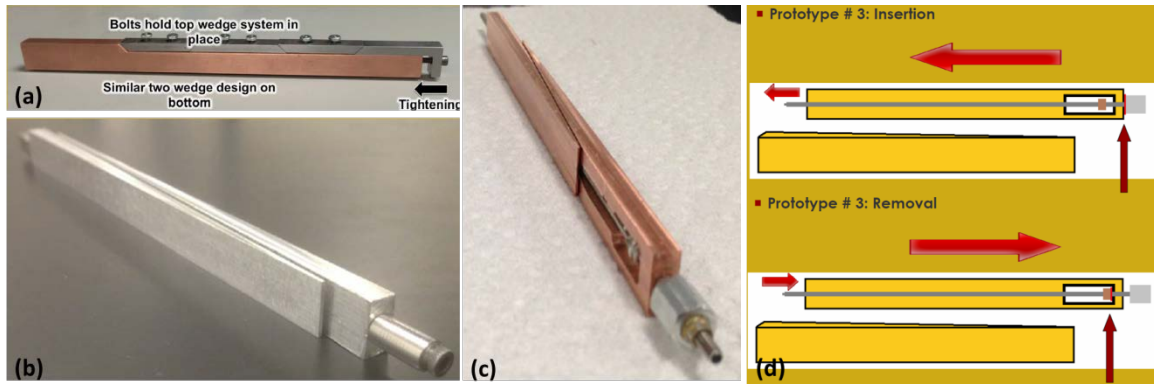

Figure 37: Evolution of Maryland's Prototypes

(a) 2014 version, (b) 2015 version for the 1st phase, (c) 2015 version for the competition, and (d) loading/unloading mechanism. Images are adopted from Maryland's report.

This prototype #3 is capable of tightening the end screw that results in pushing two wedges laterally for clamping purpose (Figure 38). Different from their 2nd prototype (Figure 37(b)), which is made of aluminum alloy, the prototype for competition is made of copper alloy. This material improvement in K may result in reducing R.

The prototype ended up with the second lowest R among all devices during the competition. Unfortunately, the tightening screw was necking and broken during the unloading process.



Figure 38: Single-piece Two-wedge Designed by University of Maryland Team

Frequency response for the 1st prototype determined from output over input and the corresponding resonant frequencies can be found in Figure 39. The frequency response for the 2nd prototype is not available because the device is delivered late and broken during the competition.

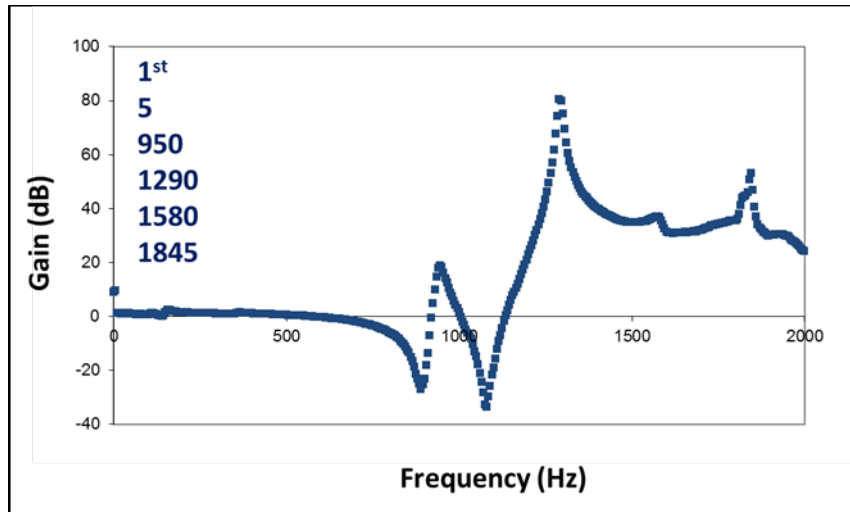

Figure 39: Frequency Response for Maryland's Design

Easiness of installation and removal: The 2nd prototype is easy to load onto and unload from the slot without the issue arisen for the 1st prototype (unfit screw size). The clearance is made enough.

Comments and Suggestions

- Revised unloading mechanism.
- Single device with the size smaller than NTHU's.
- Hex nuts too small for handling (broken at the end of the competition).

1st Prototype: Maryland delivered their 1st prototype: a two-wedge device, held by a threaded rod through the pieces. The wedge seems to be made of aluminum alloy. Even though the screws were loosening thoroughly on both ends, the thickness of the device is still larger than 1/4" (or 6.35mm, shown in Figure 40, right). Therefore, one needs to remove one screw in order to slide the device into the slot (Figure 40, left).



The original thickness is 6.43mm. The device needs to be loaded with the end screw removed (arrowed).

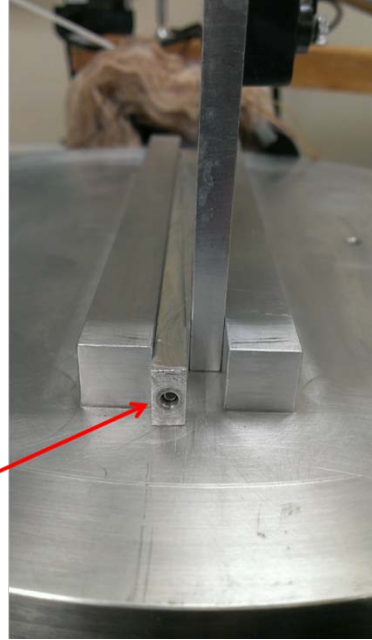

Figure 40: Two-wedge Thermal Connector Delivered by Maryland

Easiness of installation and removal: Not enough clearance: should have been easy for loading. Once being loaded tightly, hammering seems to be needed for unloading.

Comments and Suggestions

- Similar to previous NTHU design with simple tightening mechanism.
- More clearance is needed.
- Unloading mechanism needs improvement.
- Please do not use the smooth side (prepared for pressure film) for thermal testing as this smooth end is 0.1 to 0.15mm thinner. Use the other without any smooth surface for thermal testing.

2.4.6 Ozyegin University

Most current prototype: This is the first time for Ozyegin University (Turkey) to participate in this competition. During the 1st phase, OU delivered a top-down wedge design, and had it fastened through three screws (Figure 41(a)). However, the device is too thick to fit into our testbed. For the 2nd phase modification, OU considered the reviewer's comments and thinned the thickness of their original design. Unfortunately, OU's top-down wedge device is still too thick (~50 micrometer thicker). The team delivered another two piece wedge (uneven: one is smaller than the other), which are connected by a thin rectangular aluminum piece (impractical in the field), shown in Figures 41(b) and (c). Both devices are sophisticated; however, they both have rooms for improvement: impractical top-down loading/unloading, and small rectangular piece for fastening purpose.

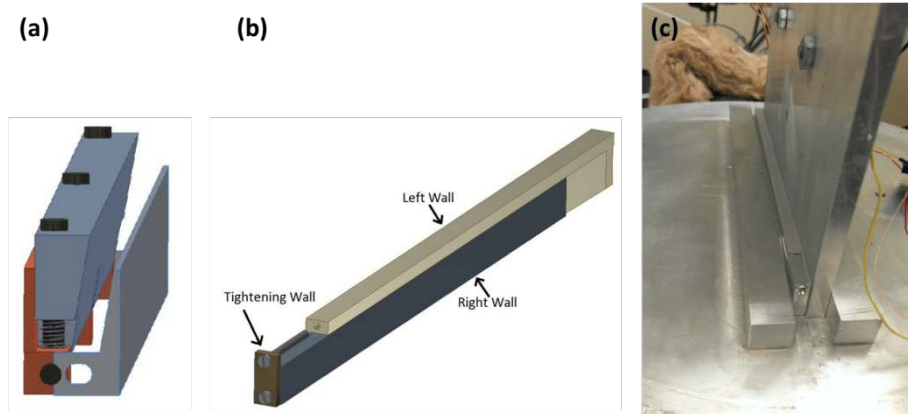

Figure 41: Another Two-piece Wedge Design Delivered by Ozyegin University
Images are adopted from OU's report.

Easiness of installation and removal: Loading and unloading are impractical for both delivered device. The working device was broken during the competition when unloading was undergoing: the screw was tightened too much during loading and broken during unloading.

Comments and Suggestions

- Two different prototypes were delivered.
- Both built with quality.
- One prototype is too thick.
- Workable one was easy to load, but not easy to unload.
- The room on top of the device (or inside the chassis) is so limited. If the device could be successfully loaded, the tightening mechanism from the top three screws would be difficult and impractical.

1st Prototype: OU proposed a top-down wedge design, and had it fastened through three screws (Figure 42) for their 1st prototype. This is somehow impractical in the field. The device looks sophisticated; however, it is too thick (6.45mm at the center) for loading.

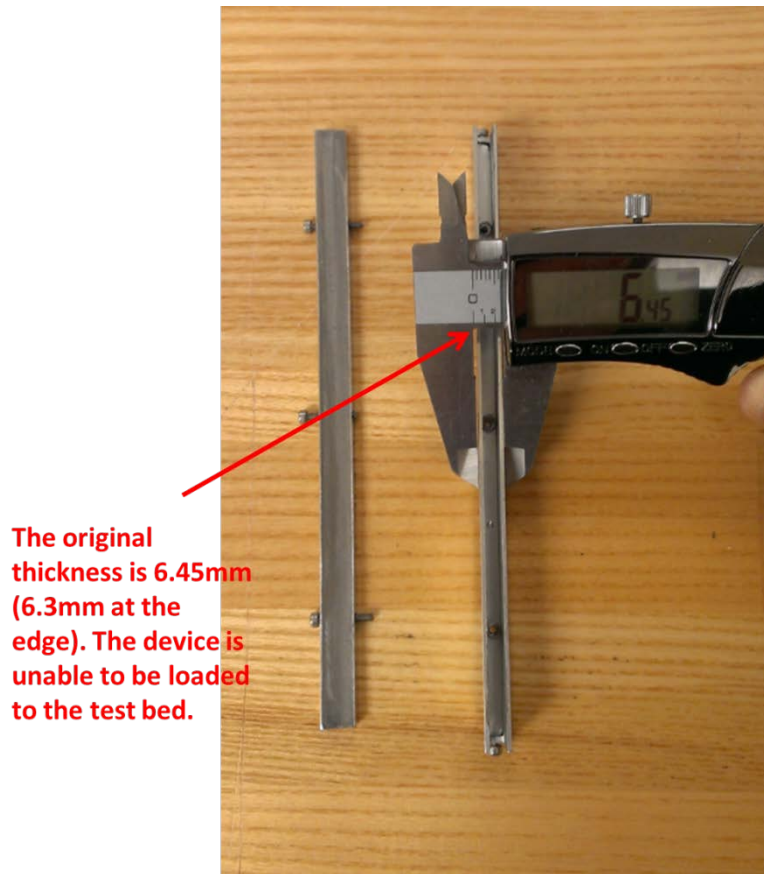

Figure 42: Up-down Wedge Design Delivered by Ozyegin University

Easiness of installation and removal: Too thick: unable to load and unload on MU side.

Comments and Suggestions

- The device is built with quality.
- The room on top of the device (or inside the chassis) is so limited. If the device could be successfully loaded, the tightening mechanism from the top three screws would be difficult and impractical.
- Please do not use the smooth side (prepared for pressure film) for thermal testing as this smooth end is 0.1 to 0.15mm thinner. Use the other without any smooth surface for thermal testing.

2.4.7 University of California – Merced

Most current prototype: UCM delivered a three-wedge device in the 2nd phase, same as their 1st prototype (Figure 43). The mechanism of providing clamping force is simple: force provided by the adjustable screws (Figure 43(a)) is transferred to the clamping force along the direction across the device, from the cold block to the electronic component. UCM also provided a tool to unload their device from the unloading sites shown in Figure 43(b). The tool is impractical because it has to be applied from the top, not from the side.

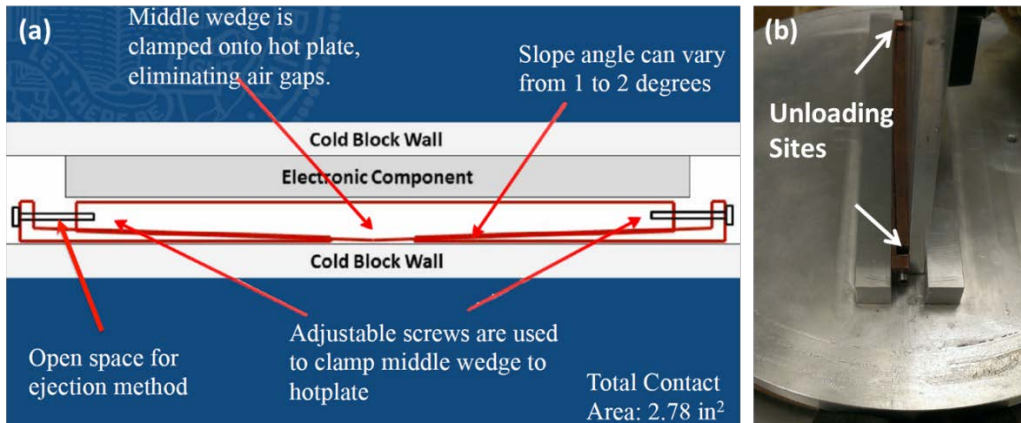

Figure 43: Three-wedge Thermal Connector Delivered by UCM

(a) Design and (b) the device loaded onto the testbed. (a) Is adopted from UCM's report.

The prototype can be loaded through the slot easily during the competition because the clearance is made enough. Once fastened tightly, unloading might be an issue as they also delivered a broken piece due to the unloading failure.

Frequency response determined from output over input and the corresponding resonant frequencies can be found in Figure 44.

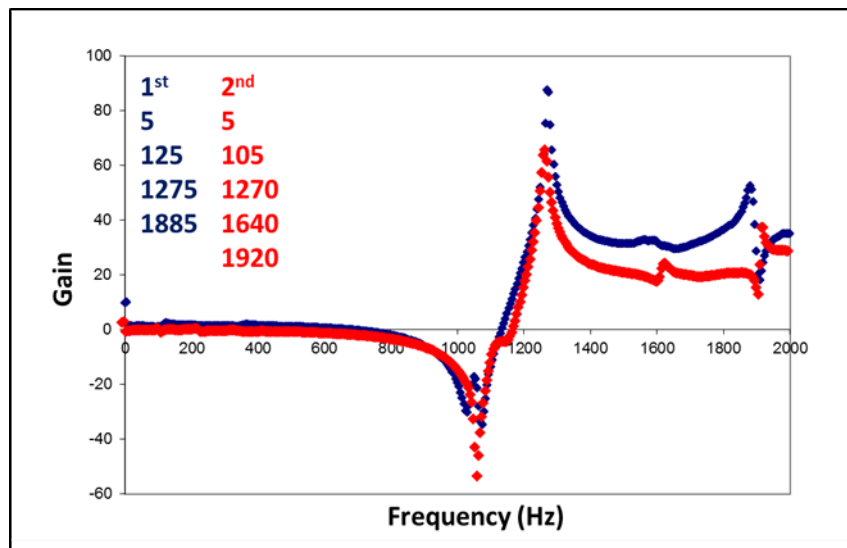

Figure 44: Frequency Response for UCM's Design

Generally speaking:

Easiness of installation and removal: Loading is straightforward and easy. Unloading could be easy as long as the fastening is not tight.

Comments and Suggestions

- Clearance is made enough.
- Top unloading tool is not practical.

1st Prototype: UCM also delivered a three-wedge device for their 1st prototype. Instead, their device is held through a threaded rod penetrating and connecting the three pieces (very left in Figure 45).

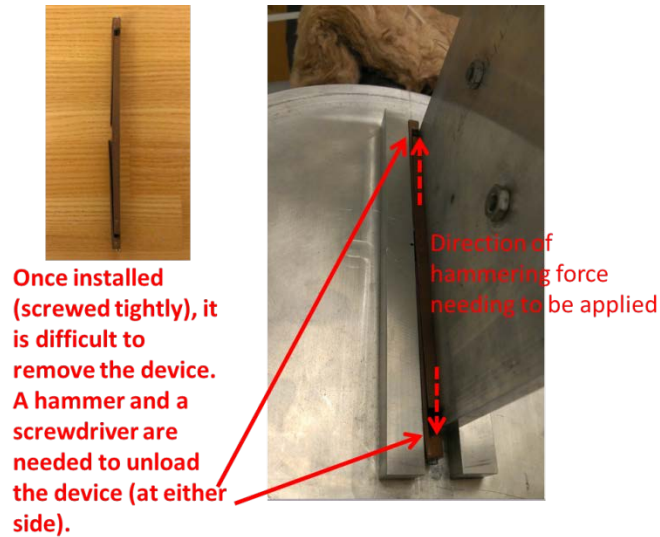

Figure 45: Thermal Connector Delivered by UCM

The prototype can be loaded through the slot easily because the clearance is made enough. After the test, unloading seems to be an issue (indicated in Figure 45 with red marks).

Generally speaking:

Easiness of installation and removal: Loading is fairly easy. Apparently got stuck and uneasy to be unloaded.

Comments and Suggestions

- Compared with the prototype delivered last year, clearance issue is solved this time.
- Unloading mechanism needs improvement.

2.4.8 University of Baghdad

1st Prototype: University of Baghdad, first time in participation, delivered a long and sandwich device (longer than 20cm). According to their concept, the thin copper sheets (or foils) can be used to adjust the thickness of the device (Figure 46). However, during operation (loading/unloading), thicker-than-slot device, even though with only 1 mil or 2, is hardly loaded to the slot. The issue is not only the thickness of the device, but also the loading/unloading mechanism which is unclear.

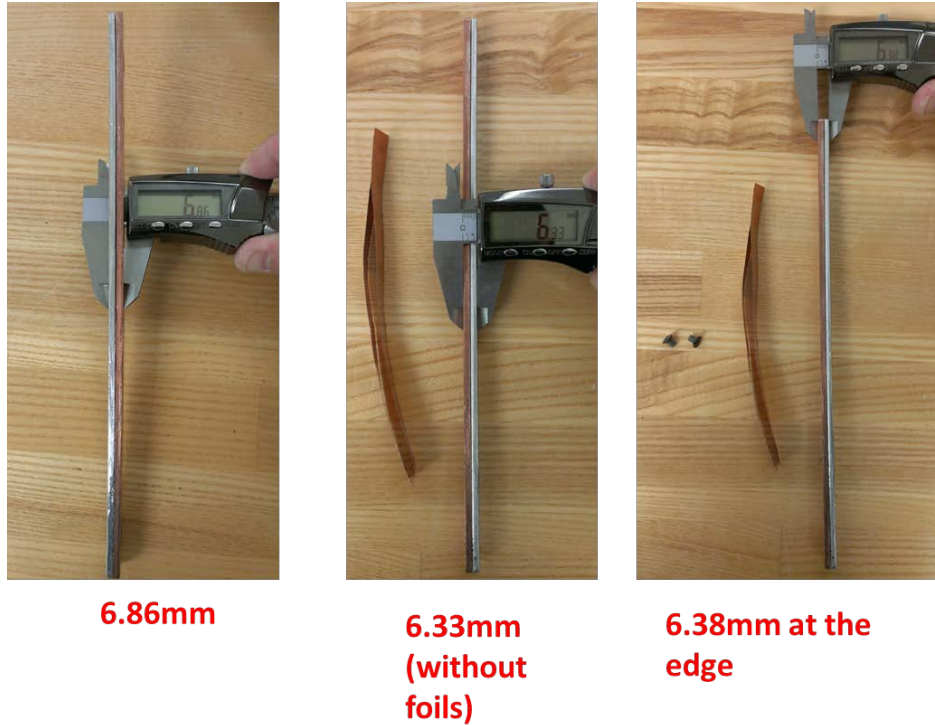

Figure 46: Sandwich Thermal Connector Designed by the University of Baghdad

Easiness of installation and removal: Loading/unloading mechanism is unclear.

Comments and Suggestions

- The device has an unclear clamping mechanism.
- The thickness makes the device impossible to be loaded on to the test bed.

2.4.9 University of Notre Dame

1st Prototype: U of Notre Dame, first time participant, delivered an Al plate coated with interface material (Figure 47). This is not what this competition is asked for in the first place. Therefore, the delivered sample cannot be tested and compared with other prototypes. However, the interface material can presumably improve the contact resistance.

Improve the interfacial area by applying a coating is a right track. However, this should have been done on the surface of a thermal connector, not on the board in this competition.



Figure 47: Interface Material Coated on Al Board, Delivered by U of Notre Dame

Easiness of installation and removal: Unable to load and unload on MU side.

Comments and Suggestions

- The team seems to misunderstand the goal of this competition.
- However, the concept (to reduce the interfacial resistance) should play a role for the future improvement.

2.4.10 Mississippi State University

1st Prototype: MissStateU delivered a laser metal direct sintering (LMDS) piece, with oscillating heat pipes embedded in the device. The device is assumed to be fastened by a thin wedge piece, after the main piece (with OHP) is loaded. Unfortunately, the main piece cannot be loaded (too thick, 6.35mm shown Figure 48).



6.35mm

The original thickness is 6.35mm. The board can only be partially loaded (arrowed), vice versa.

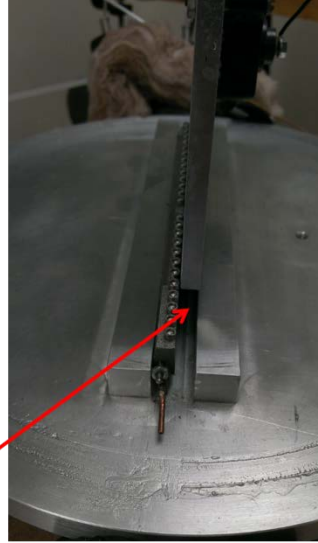

Figure 48: OHP Thermal Connector Delivered by MissStateU

Easiness of installation and removal: Too thick: unable to load and unload on MU side.

Comments and Suggestions

- The device looks sophisticated. Unfortunately, the device cannot be loaded on our side.
- Although not being completed on our side, the unloading mechanism is unclear.
- More clearance is needed. Please do not use the smooth side (prepared for pressure film) for thermal testing as this smooth end is 0.1 to 0.15mm thinner. Use the other without any smooth surface for thermal testing.

3.0 2014 REVCON III

Program Summary Regarding RevCon International Competition - 2014:

By 1 October 2014, we have received prototypes from seven competitors. We accomplished the following tests for all prototypes using the testbed developed in MU:

- Thermal measurements based on four heating conditions: 50W, 100W, 150W, and 200W
- Thermal measurements with single frequency (sweep) excitation
- Random frequency test to identify system resonant frequencies
- Thermal measurements with both random and resonant frequency excitation

3.1 Thermal Test during RevCon Competition in October 2014

All the test results listed above were completed. On 31 October and 1 November, seven teams (aforementioned previously) came to MU-Columbia campus for a two-day conference. Detailed performance test and comments for both the on-site competition and preliminary tests before the competition can be found in the sections of “Thermal test” and “Comments on each device”. The Appendix has more information regarding the experimental setup and the definition of R, R*, and R**.

3.2 Performance Testing

The University of Missouri hosted the DARPA RevCon Challenge III – International RevCon Challenge for encouraging world-wide, driven college students to tackle challenging design problems in electronic thermal management. This two-phase program aims to solicit student design teams to pursue novel design concepts which can repeatedly assemble and disassemble an electronic module to/from an electronic enclosure, while providing a constant connector thermal resistance lower than 0.2°C/W over multiple thermal cycles in a specified temperature range, vibration environment, and contact pressure. During the 2nd phase, seven teams have fabricated and delivered their 2nd prototype of thermal connectors with unique features. The thermal connectors should be 15 cm in length. The delivery record for each student team and their participation during the competition is listed in Table 20:

Table 20. Delivery Record and Participation for each RevCon Team

	Device Delivered	Present at Competition	Final Report
UIUC	X	X	X
Donghua U	X	X	X
MU	X	X	X
NTHU	X	X	X
GIT	X	X	X
U of Maryland	X	X	X
MissStateU	X	X	X

After receiving materials from each team, the MU team performed the following tests during the period of 1 October and 15 October:

1. Thermal tests at four power inputs: 50W, 100W, 150W, and 200W (20 minutes for each power input, 80 minutes total)
2. Resonant frequency identification through random excitation (5 to 2,000Hz)
3. Thermal tests at 100W during random excitation (5 to 2,000Hz, 5 minutes total)
4. Thermal tests at 100W at 5 major resonant frequencies (5 to 2,000Hz, 5 minutes for each frequencies, 25 minutes total)
5. Thermal tests at 100W during sweep frequency input (5 to 50Hz, ~7 minutes total)

Loading/unloading from the MU testing staff's experience is summarized in Table 21. Detail comments and suggestions can be found in "Comments on each device".

Table 21. Summary of MU's Loading/Unloading Experience

	Appearance	Comments during 2 nd Round
U of Maryland		<ul style="list-style-type: none"> New prototype leaves less clearance, compared with the previous prototype Solder at the wedge interface seems to get hardened during loading
MU		<ul style="list-style-type: none"> Loading is fairly easy Retreat is still an issue
Donghua U		<ul style="list-style-type: none"> Fairly easy to load/unload in/out of the slot Second prototype has a much larger screw. This modification seems to cooperate the rule of "single-side loading/unloading"
MissStateU		<ul style="list-style-type: none"> They finally made a "heat pipe" type of their thermal connector as they promised in their proposal. Clearance is not made enough.
GIT		<ul style="list-style-type: none"> Second prototype seems to have too much liquid so that the last piston can not be fully inserted
NTHU		<ul style="list-style-type: none"> Beautifully made. Leaves no clearance for loading and unloading Slide-in mode is still impossible to perform for this 2nd prototype
UIUC		<ul style="list-style-type: none"> Reliable with easy loading/unloading procedures Most commercially potential, from the tester's point of view

3.3 Thermal Test during RevCon Competition on 31 October and 1 November 2014

Because of the time limitation during this two-day event, with only 6 hours to schedule 7 separate experiments, we compromise to set up a simple demo in front of all the judges and participants, and a separate 20 minute heating test:

1. Each team load and unload their unique thermal connector in front of the judges and all the participants.
2. One of the team members bring their thermal connector to the testbed in a different room for heating test.
3. The thermal connector is loaded by himself/herself from each team, assisted by the on-site tester who is familiar with the testbed (Simon Chen).
4. After loading, the heater is on and set to be 50W.
5. The temperature of T_1 (closest to the resistive heater) will start increasing from $\sim 19^\circ\text{C}$ (Chiller temperature is set to 17°C). When it reaches 23°C , time 20 minutes. The heating history for each temperature monitoring is recorded all the time.
6. T_1 and the estimated R at the 17th minute are then provided to the judges.

Among all the temperature monitoring, T_1 is the most representative as this temperature reading is placed closest to the heater. Lower temperature at T_1 should represent better performance resulted from a better design of thermal connector. Wakefield wedgelock (422C-480UMB, .225'x.225'x4.8') and Calmark Card-lok (230-4.80H, .220'x.225'x4.8') were tested (three times, data shown in averaged numbers) for benchmark comparison.

On 31 October, the chiller temperature was set to 17°C with coolant flowrate of ~ 3.4 gallon/minute for all thermal tests. Due to the mistake made by the tester at the 18th minute in one team, all the thermal resistances were calculated from the temperatures obtained in the 17th minute in order to show fairness. The comparison results of T_1 are shown in Figure 49. The legend corresponds to the order of the temperature curves (thermal resistance in Figures 50-52) for each device. For example, black dotted line (Calmark) represents the highest temperature curve, while green triangle (Maryland) represents the 4th lowest temperature in the figure. The comparison results of the thermal resistance, R , R^* , and R^{**} are shown in Figures 50-52, respectively. The overall data are compared and listed in Table 22. "std" represents the standard deviation. Detail experimental setup and the definition of R , R^* and R^{**} can be found in the Appendix.

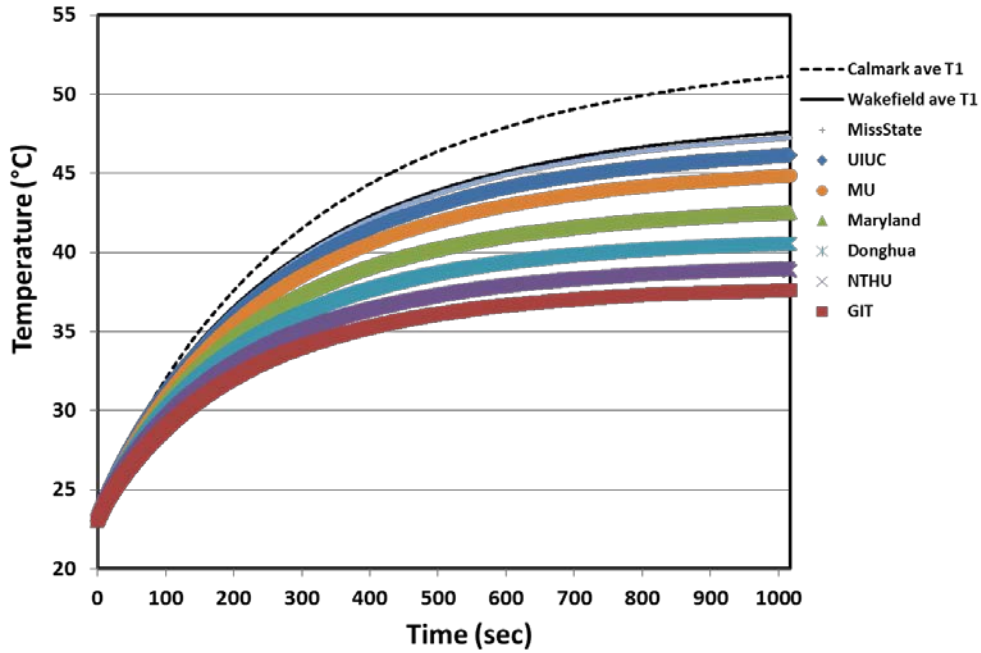

Figure 49: Comparison Temperature History of T_1 from each Thermal Connector
Wakefield wedgelock (422C-480UMB in black solid line) and Calmark Card-lok (230-4.80H in black dotted line) are shown for comparison.

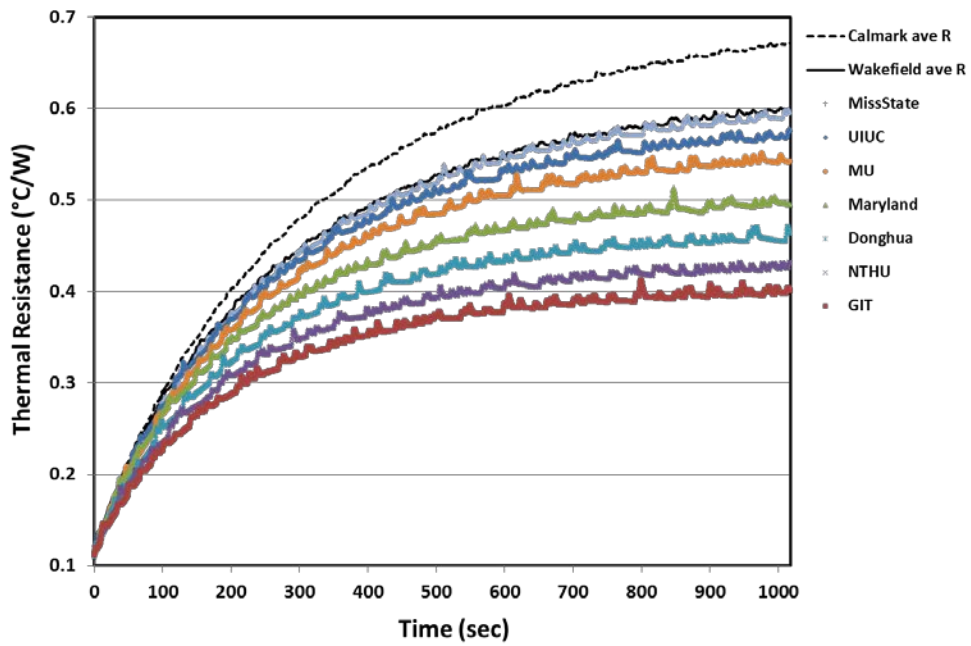

Figure 50: Comparison Thermal Resistance R from each Thermal Connector

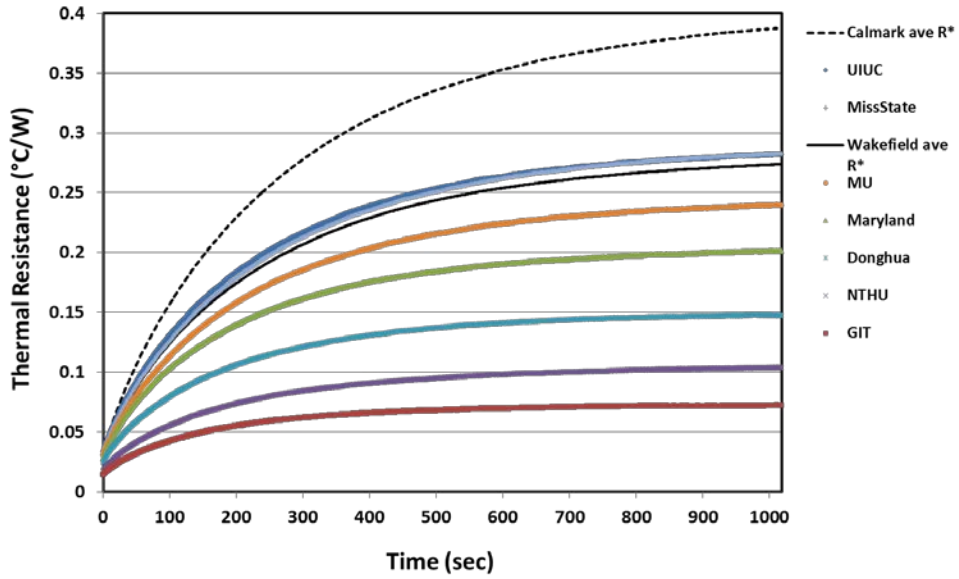

Figure 51: Comparison Thermal Resistance R^* from each Thermal Connector

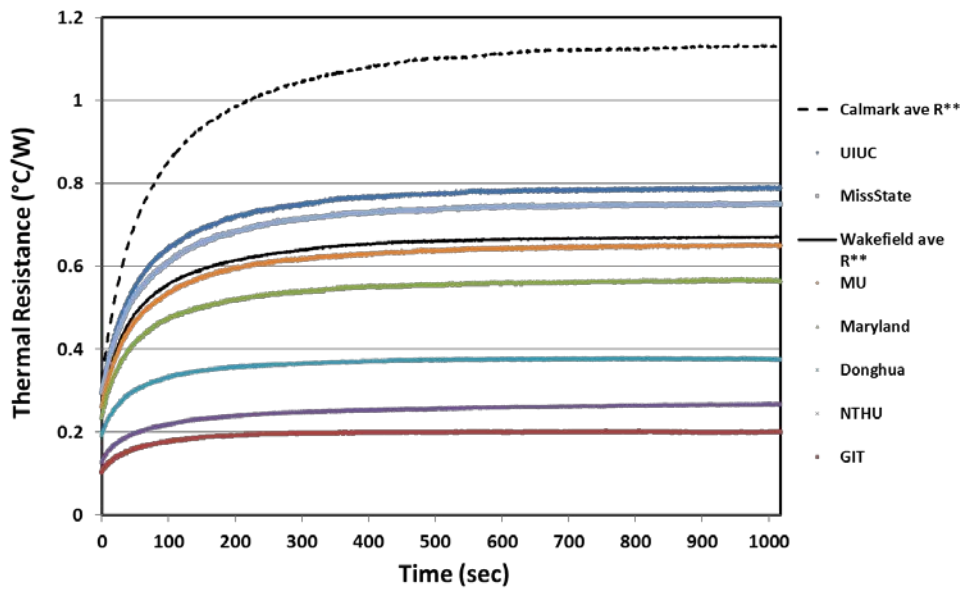

Figure 52: Comparison Thermal Resistance R^{**} from each Thermal Connector

Table 22. Summary of R, R*, R, and T₁ under 50W at the 17th Minute**

	R (°C/W)		R* (°C/W)		R** (°C/W)		T ₁ (°C)	
	During Competition	2nd Prototype	During Competition	2nd Prototype	During Competition	2nd Prototype	During Competition	2nd Prototype
GIT	0.3992	0.7516	0.0720	0.4570	0.1990	1.2839	37.57	55.07
NTHU	0.4258	-	0.1034	-	0.2657	-	38.92	-
Donghua U	0.4589	0.6109	0.1474	0.3066	0.3754	0.8580	40.52	48.03
U of Maryland	0.4959	0.5620	0.2007	0.2425	0.5649	0.6607	42.44	45.69
MU	0.5433	0.5695	0.2391	0.2443	0.6496	0.6311	44.79	46.14
UIUC	0.5677	0.6066	0.2814	0.3060	0.7877	0.8286	46.04	48.02
MissStateU	0.5904	0.5994	0.2817	0.2841	0.7492	0.7634	47.08	47.67
Calmark	0.6686	0.6686	0.3865	0.3865	1.1308	1.1308	51.03	51.03
Wakefiled	0.5974	0.5974	0.2731	0.2731	0.6703	0.6703	47.51	47.51

According to the collected temperature readings, GIT has the lowest R, R*, R**, and T₁ among all the student teams and two commercial thermal connectors. However, due to its leaking problem, the best thermal performance award was given to NTHU (2nd lowest for all indicators mentioned before).

Performance of MU between the two tests is close in R and T. Similar outcomes happened on MissStateU’s device. Other tested results obtained on 31 October (columns of “During Competition”) exceeded their previous performance (columns of “2nd Prototype”, tested between 1 and 15 October). NTHU’s device was not able to load onto our testbed before the competition. Therefore there was no number displayed. One thing needs to be brought out is the consequences of the way thermal resistance is estimated. Based on our three different estimation methods, the order of corresponding R varies. For R, all thermal connectors from student teams outperformed commercial devices. And the ranking of R matches the ranking of T₁. For R* and R**, University of Illinois at Urbana-Champaign (UIUC) and MissStateU’s devices performed poorer than commercial ones.

3.4 Thermal Test for 2nd Prototypes Delivered by 1 October 2014

3.4.1 Thermal Test at Four Power Input: 50W, 100W, 150W, and 200W

In this section, we demonstrated the tests MU done for all students teams on their 2nd prototype. In this fixed-power test, each device was run for 20 minutes for each power input. The corresponding thermal resistances were calculated from the temperatures obtained within the last 1.5 minutes. The comparison results for R are shown in Figure 53.

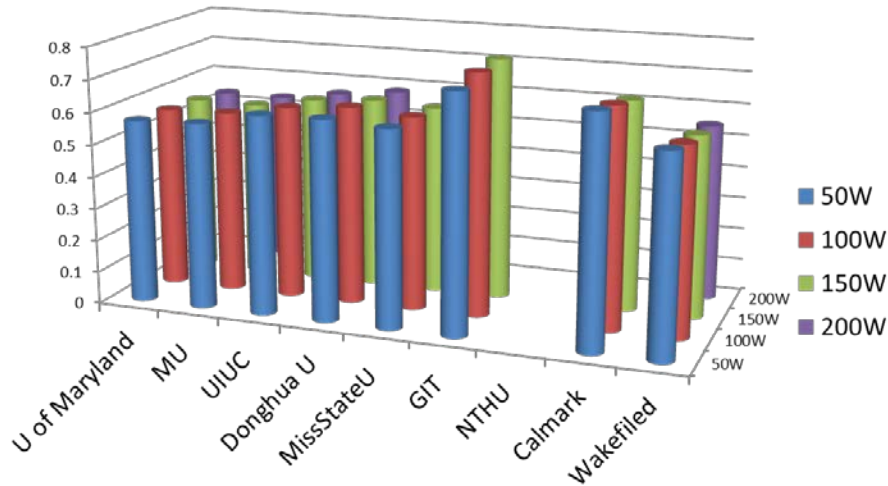

Figure 53: Comparison Chart of Thermal Resistance R from each Thermal Connectors

The results with standard deviation are listed in Table 23.

Table 23. Comparison Table of Thermal Resistance R (°C/W) within the last 1.5 Minutes of 20 Minutes

	50W	std	100W	std	150W	std	200W	std
U of Maryland	0.5686	0.0031	0.5617	0.0016	0.5531	0.0023	0.5372	0.0006
MU	0.5758	0.0034	0.5664	0.0019	0.5513	0.0009	0.5360	0.0007
UIUC	0.6162	0.0042	0.5990	0.0019	0.5819	0.0007	0.5621	0.0009
MissStateU	0.6079	0.0036	0.6000	0.0020	0.5860	0.0011	0.5700	0.0008
Donghua U	0.6198	0.0035	0.6154	0.0129	0.5957	0.0011	0.5830	0.0008
GIT	0.7326	0.0126	0.7487	0.0082	0.7517	0.0050	/	/
NTHU	-	-	-	-	-	-	-	-
Calmark	0.7062	0.0060	0.6817	0.0032	0.6547	0.0012	/	/
Wakefiled	0.6121	0.0035	0.5845	0.0022	0.5659	0.0012	0.5492	0.0007

-Device cannot be inserted into the slot to test.

/Tests were dropped because the testbed was too hot (over 130°C) around T₁.

When R* (method based on bottom temperature readings) is considered, the ranking is slightly different. The comparison results of R* are shown and Figure 54. The results with standard deviation are listed in Table 24.

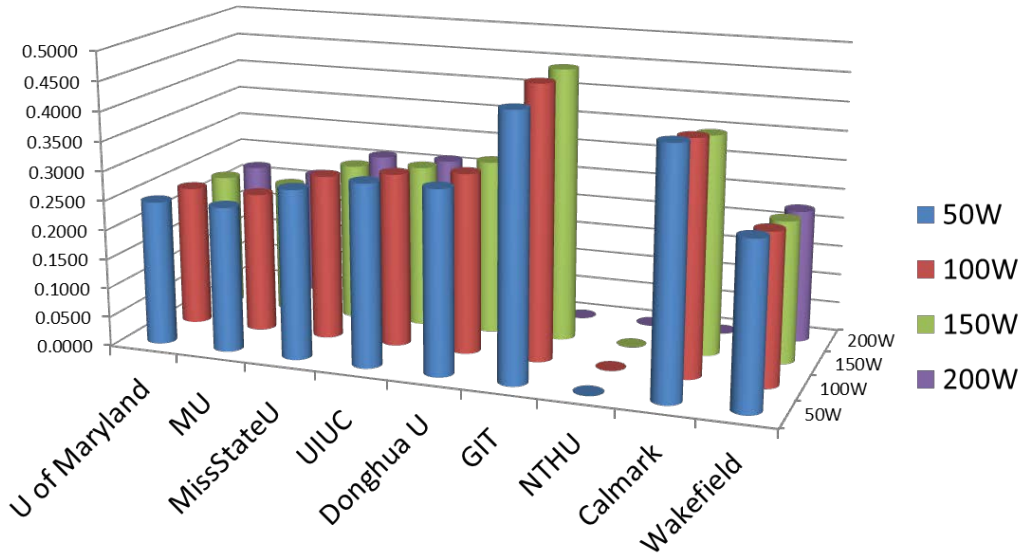

Figure 54: Comparison Chart of Thermal Resistance R* from each Thermal Connector

Table 24. Comparison Table of Thermal Resistance R* (°C/W) within the last 1.5 Minutes of 20 Minutes

	50W	std	100W	std	150W	std	200W	std
U of Maryland	0.2447	0.0020	0.2383	0.0010	0.2288	0.0004	0.2188	0.0004
MU	0.2464	0.0022	0.2384	0.0013	0.2259	0.0006	0.2143	0.0005
MissStateU	0.2875	0.0027	0.2806	0.0015	0.2699	0.0008	0.2588	0.0007
UIUC	0.3088	0.0032	0.2946	0.0014	0.2777	0.0004	0.2614	0.0007
Donghua U	0.3107	0.0024	0.3061	0.0029	0.2972	0.0009	0.2884	0.0007
GIT	0.4456	0.0101	0.4631	0.0065	0.4638	0.0041	/	/
NTHU	-	-	-	-	-	-	-	-
Calmark	0.4134	0.0044	0.3946	0.0017	0.3725	0.0009	/	/
Wakefield	0.2781	0.0027	0.2566	0.0016	0.2412	0.0009	0.2262	0.0005

-Device cannot be inserted into the slot to test.

/Tests were dropped because the testbed was too hot (over 130°C) around T₁.

3.4.2 Thermal Test at 100W during Random Excitation (5 to 2,000Hz)

Thermal tests during random vibration excitation were carried out on each device while 100W heat was being loaded. The results (averaged from the last 100 seconds) are listed in Table 25. Only R is demonstrated here.

Table 25. Comparison of Thermal Performance with Random Vibration ON and OFF

	100W Random ON	std	100W Random OFF	std
U of Maryland	0.5674	0.0053	0.5617	0.0016
MU	0.5493	0.0016	0.5664	0.0019
UIUC	0.6012	0.0019	0.5990	0.0019
MissStateU	0.5921	0.0073	0.6000	0.0020
Donghua U	0.5994	0.0051	0.6154	0.0129
GIT	0.7693	0.0077	0.7487	0.0082
NTHU	-	-	-	-

-Device cannot be inserted into the slot to test.

GIT's 2nd device started to leak again. The performance from MU, MissStateU, and DHU's devices demonstrated a smaller R after vibration is turned on. This result is interesting and needs further investigation.

3.4.3 Thermal Test at 100W at 5 Major Resonant Frequencies (5 to 2,000Hz)

Thermal tests under five resonant frequency excitations were carried out on each device while 100W of heat was being loaded. The results (averaged from the last 100 seconds) are listed in Table 26. The corresponding frequency response for each device is provided in "Comments on each device".

Table 26. Comparison of Thermal Performance (thermal resistance R) with Single Frequency Excitation and without Vibration

	100W w/o vibration	std	f1	std	f2	std	f3	std	f4	std	f5	std
U of Maryland	0.5617	0.0016	0.5824	0.0025	0.5839	0.0031	0.5818	0.0006	0.5840	0.0026	0.5859	0.0063
MU	0.5664	0.0019	0.5619	0.0000	0.5628	0.0006	0.5625	0.0005	0.5653	0.0011	0.5681	0.0027
MissStateU	0.6000	0.0020	0.6019	0.0003	0.6056	0.0025	0.6071	0.0029	0.6072	0.0032	0.6070	0.0003
UIUC	0.5990	0.0019	0.6125	0.0019	0.6119	0.0002	0.6134	0.0007	0.6130	0.0021	0.6144	0.0026
Donghua U	0.6154	0.0129	0.6190	0.0017	0.6182	0.0003	0.6223	0.0014	0.6219	0.0021	0.6206	0.0007
GIT	0.7487	0.0082	0.8052	0.0012	0.8095	0.0027	0.8104	0.0006	0.8089	0.0005	0.8101	0.0017
NTHU	-	-	-	-	-	-	-	-	-	-	-	-

-Device cannot be inserted into the slot to test.

3.4.4 Thermal Test at 100W during Sweep Frequency Input (5 to 50Hz)

A sweep vibration test from 5Hz to 50Hz was performed on each device. Part of this profile (5 to 33Hz) is suggested to RevCon participants. We realized that most resonant frequencies from the participant teams are located higher than the 100Hz frequency range, and therefore have a minor effect on the thermal performance and clamping mechanism. The results (averaged from the last 100 seconds) are listed in Table 27.

Table 27. Comparison of Thermal Performance with Sweep Excitation and without Vibration

	on		off	
	Sweep 5Hz to 50Hz	std	100W w/o vibration	std
U of Maryland	0.5862	0.0044	0.5617	0.0016
MU	0.5638	0.0012	0.5664	0.0019
UIUC	0.5638	0.0012	0.5990	0.0019
MissStateU	0.6057	0.0018	0.6000	0.0020
Donghua U	0.6211	0.0012	0.6154	0.0129
GIT	0.8096	0.0031	0.7487	0.0082
NTHU	-	-	-	-

-Device cannot be inserted into the slot to test.

3.5 Thermal Test for 1st Prototypes

3.5.1 Thermal Test at Four Power Input: 50W, 100W, 150W, and 200W

The chiller temperature was set to 15°C with the pressure in the circulation tubes fixed to 33psi for all thermal tests. Each device was run for 20 minutes for each power input. The corresponding thermal resistances were calculated from the temperatures obtained within the last 3 minutes. The comparison results of the thermal resistance, R, is shown in Table 28 and Figure 55. "std" represents the standard deviation.

Table 28. Comparison Table of Thermal Resistance R (°C/W)

	50W	std	100W	std	150W	std	200W	std
U of Maryland	0.22	0.0016	0.21	0.0004	0.20	0.0005	0.18	0.0001
MU	0.32	0.0025	0.30	0.0023	0.29	0.0004	0.23	0.0005
Donghua U	0.37	0.0036	0.36	0.0019	0.36	0.0013	0.35	0.0009
MissStateU	0.40	0.0034	0.39	0.0014	0.37	0.0027	0.34	0.0006
NTHU	0.43	0.0006	0.41	0.0017	0.39	0.0010	0.36	0.0050
GIT	0.49	0.0059	0.45	0.0001	0.40	0.0005	0.35	0.0003
UIUC	0.66	0.0002	0.60	0.0027	0.52	0.0021	0.49	0.0015
UCMerced*	-		-		-		-	

*Device cannot be inserted into the slot to test.

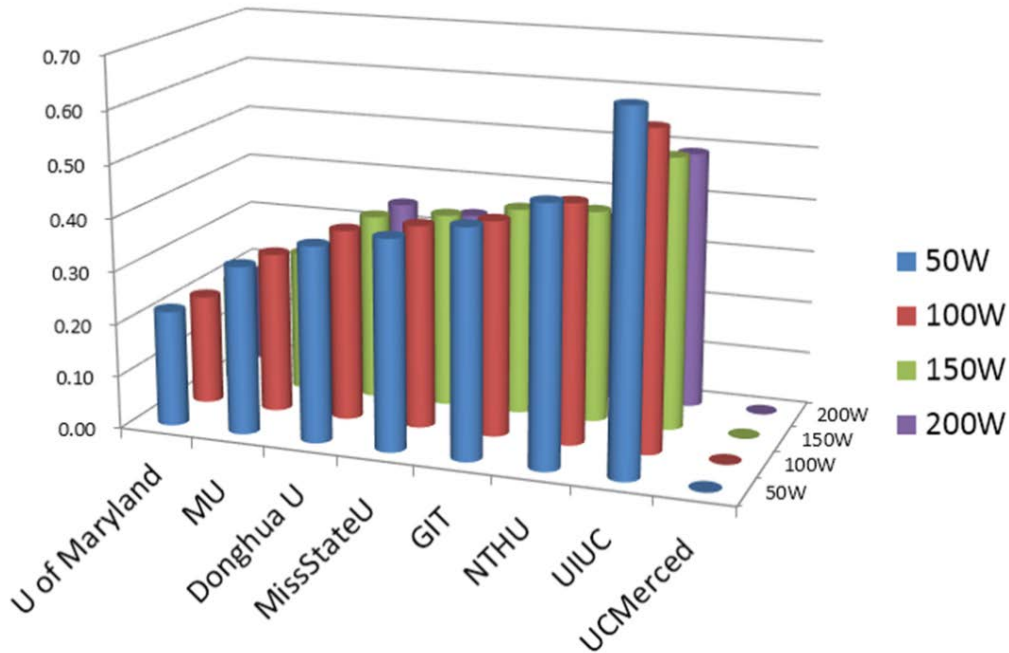

Figure 55: Comparison Chart of Thermal Resistance R from each Thermal Connector (1st prototype)

The results are sorted by the value of overall thermal resistance in four power input cases. Therefore, there might be cases that one particular device may have lower ranking overall but has smaller R than the higher ranking device in some particular power input. For example, GIT's device outperformed NTHU's in the case at 200W. But overall NTHU's R was smaller than GIT's.

When R* (method based on separate heat flux through thermal connectors) is considered, the ranking is slightly different. The comparison results (sorted) of thermal resistance R* are shown in Table 29 and Figure 56.

Table 29. Comparison Table of Thermal Resistance R* (°C/W)

	50W	std	100W	std	150W	std	200W	std
U of Maryland	0.68	0.0006	0.66	0.0001	0.65	0.0001	0.64	0.0008
MU	0.95	0.0005	0.95	0.0016	0.94	0.0010	0.92	0.0007
Donghua U	1.17	0.0026	1.20	0.0012	1.20	0.0003	1.18	0.0012
MissStateU	1.34	0.0015	1.36	0.0025	1.31	0.0264	1.30	0.0004
GIT	1.66	0.0018	1.56	0.0045	1.37	0.0015	1.27	0.0029
NTHU	1.65	0.0006	1.70	0.0009	1.67	0.0027	1.63	0.0013
UIUC	2.27	0.0038	2.25	0.0024	2.18	0.0451	2.13	0.0018
UCMerced*	-	-	-	-	-	-	-	-

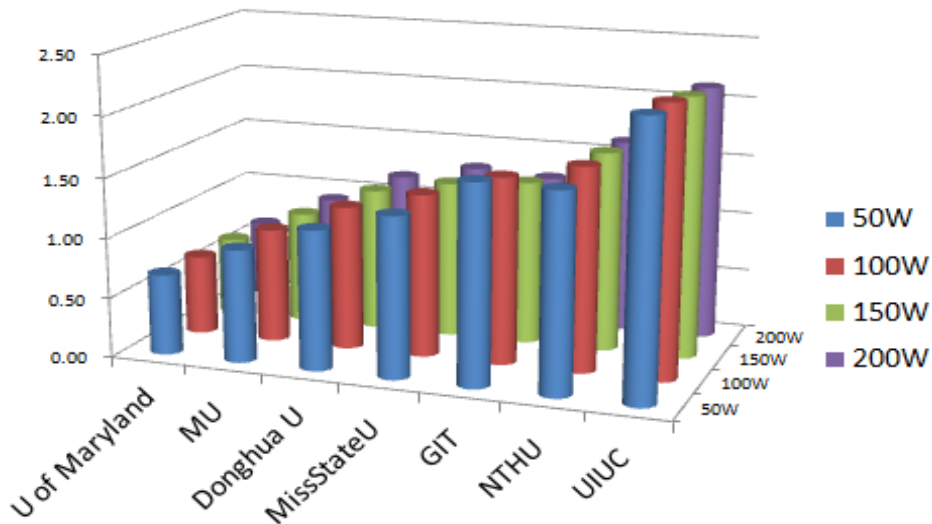

Figure 56: Comparison Chart of Thermal Resistance R* from each Thermal Connectors (1st prototype)

Another number that can be referred as a judging point is through the monitoring of temperature rise, when all the initial condition is kept the same. The average temperature in the last 3 minutes of a 20 minute run for each power input is listed in Table 30.

Table 30. Comparison Table of Temperature Monitored at T1 (°C)

This is the closest point from the resistive heater (lower means better).

	50W	std	100W	std	150W	std	200W	std
U of Maryland	40.07	0.12	63.05	0.07	85.43	0.13	101.62	0.07
MU	46.12	0.17	73.96	0.35	102.24	0.11	127.16	0.15
Donghua U	46.16	0.18	75.62	0.19	103.59	0.19	129.76	0.18
MissStateU	48.30	0.25	79.45	0.18	109.60	1.40	129.87	0.17
NTHU	49.21	0.02	79.21	0.22	109.73	0.19	131.21	0.14
GIT	52.24	0.40	86.17	0.07	114.47	0.13	134.94	0.07
UIUC	61.47	0.01	98.79	0.33	124.41	1.11	154.86	0.37
UCMerced	-	-	-	-	-	-	-	-

3.5.2 Thermal Test at 100W during Random Excitation (5 to 2,000Hz)

Thermal tests during random vibration excitation were carried out on each device while 100W heat was being loaded. The results (averaged from the last 100 seconds) are listed in Table 31.

Table 31. Comparison of Thermal Performance with Random Vibration ON and OFF

	100W Random ON	std	100W Random OFF	std
U of Maryland	0.65	0.0008	0.66	0.0001
MU	1.01	0.0005	0.95	0.0016
Donghua U	1.20	0.0047	1.20	0.0012
GIT	1.27	0.0010	1.56	0.0045
MissStateU	1.48	0.0006	1.36	0.0025
NTHU	1.72	0.0040	1.70	0.0009
UIUC	2.24	0.0009	2.25	0.0024
UCMerced	-	-	-	-

GIT's device started to leak (honey). This somehow increased the performance, presumably due to the better interface conductivity from honey than from air. Other than GIT's, the performance from MissStateU's device demonstrated a relatively larger discrepancy (8% larger R) than other teams. MU's device performed 6.3% higher in thermal resistance when under random vibration.

3.5.3 Thermal Test at 100W at 5 Major Resonant Frequencies (5 to 2,000Hz)

Thermal tests under five resonant frequency excitations were carried out on each device while 100W of heat was being loaded. The results (averaged from the last 100 seconds) are listed in Table 32. It should be noted that when loaded with GIT's device, there are only three obvious resonant frequencies which can be identified. The corresponding frequency response for each device is provided in "Comments on each device".

Table 32. Comparison of Thermal Performance with Single Frequency Excitation and without Vibration

	100W w/o vibration	std	f1	std	f2	std	f3	std	f4	std	f5	std
U of Maryland	0.66	0.0001	0.65	0.0017	0.65	0.0002	0.65	0.0007	0.65	0.0001	0.65	0.0007
MU	0.95	0.0016	1.01	0.0005	1.01	0.0008	1.01	0.0014	1.01	0.0005	1.01	0.0003
Donghua U	1.20	0.0012	1.20	0.0003	1.21	0.0010	1.21	0.0013	1.21	0.0003	1.21	0.0004
GIT	1.56	0.0045	1.25	0.0013	1.25	0.0010	1.24	0.0013				
MissStateU	1.36	0.0025	1.49	0.0018	1.48	0.0005	1.48	0.0004	1.48	0.0006	1.48	0.0007
NTHU	1.70	0.0009	1.71	0.0018	1.72	0.0040	1.72	0.0000	1.72	0.0012	1.72	0.0001
UIUC	2.25	0.0024	2.24	0.0022	2.24	0.0004	2.25	0.0029	2.25	0.0009	2.25	0.0033
UCMerced	-	-	-	-	-	-	-	-	-	-	-	-

3.5.4 Thermal Test at 100W during Sweep Frequency Input (5 to 50Hz)

A sweep vibration test from 5Hz to 50Hz was performed on each device. The sweep profile is shown in Figure 57. The blue and green lines represent monitor and control readings from accelerometers. Part of this profile (5 to 33Hz) is suggested to RevCon participants. We realized that most resonant frequencies from the participant teams are located higher than the 100Hz frequency range, and therefore have a minor effect on the thermal performance and clamping mechanism.

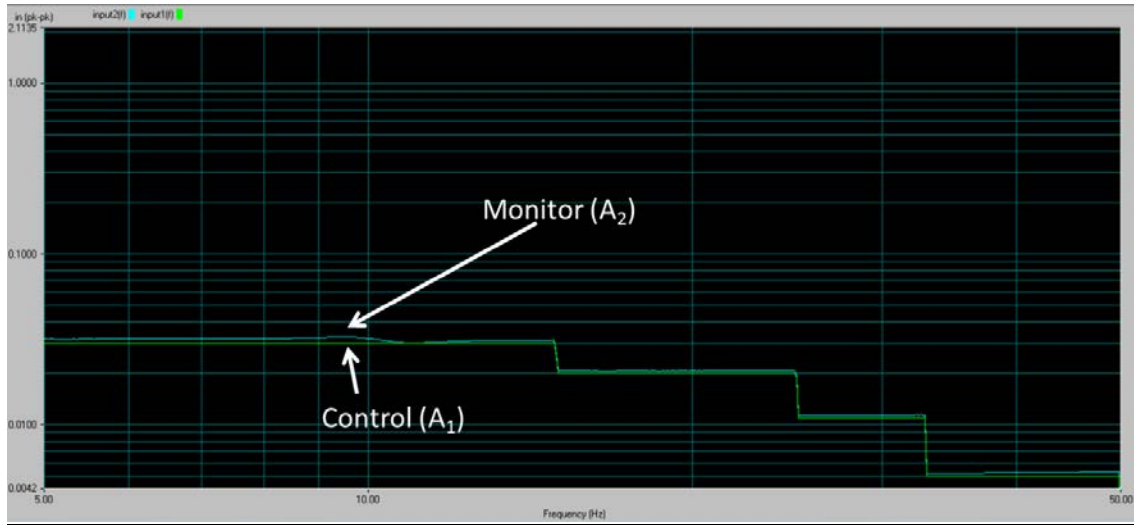

Figure 57: Sweep Vibration Profile

The results (averaged from the last 100 seconds) are listed in Table 33.

Table 33. Comparison of Thermal Performance with Sweep Excitation and without Vibration

	Sweep 5Hz to 50Hz	std	100W w/o vibration	std
U of Maryland	0.65	0.0017	0.66	0.0001
MU	1.01	0.0002	0.95	0.0016
Donghua U	1.20	0.0009	1.20	0.0012
GIT	1.24	0.0005	1.56	0.0045
MissStateU	1.48	0.0000	1.36	0.0025
NTHU	1.71	0.0025	1.70	0.0009
UIUC	2.24	0.0015	2.25	0.0024
UCMerced	-	-	-	-

Similar to the previous results under vibration excitation, GIT's device outperformed its own results when no excitation was present. This, again, may come from the leaking honey filling out the gap of air, resulting in lower contact resistance among interfaces.

3.5.5 Clamping Force Analysis

Fujifilm Prescale pressure indicator films were sent out to the student teams. Each team was requested to test and send back their pressure film for further analysis. Four teams: DHU, MU, NTHU, and GIT returned their films. The analyses were carried out by Sensor Production Inc.

3.5.5.1 Donghua University

Total Clamping Force: 825.75lbf (by Superlow film) to 1,142.75lbf (by Low film).

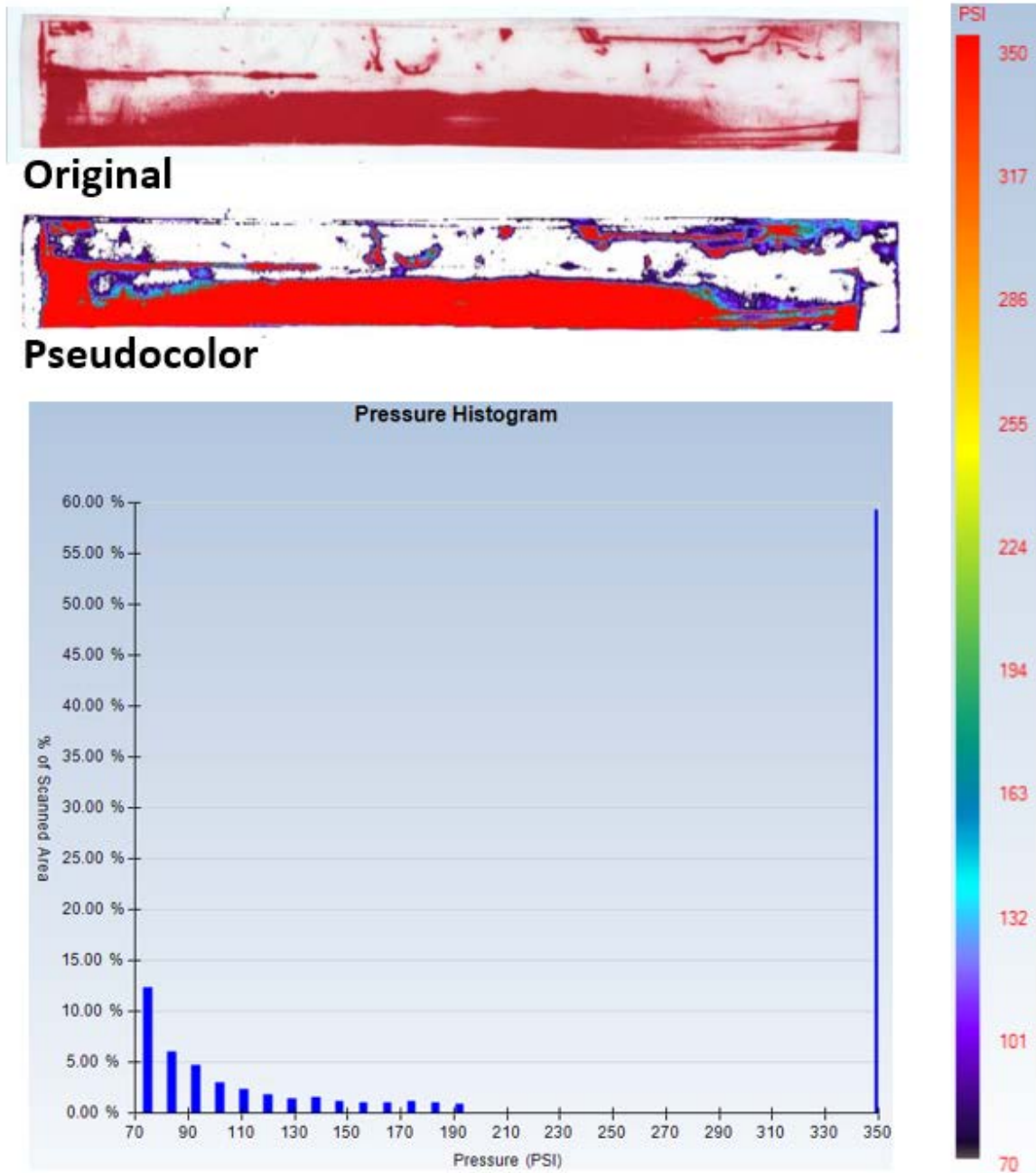

Figure 58: Pressure Analysis with Superlow Film – DHU

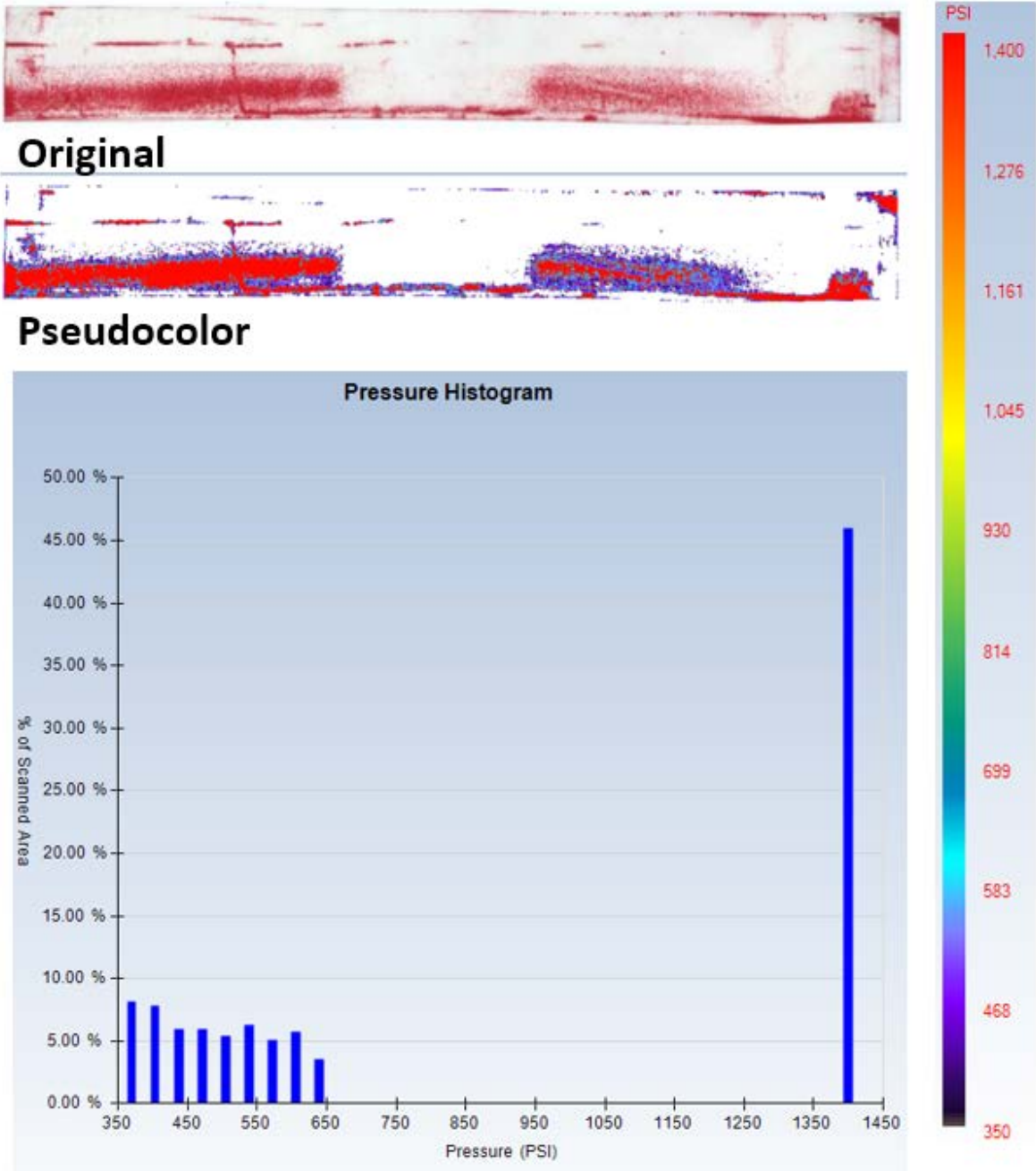

Figure 59: Pressure Analysis with Low Film – DHU

3.5.5.2 Georgia Institute of Technology

Total Clamping Force: 1,325.68lbf (by Low film).

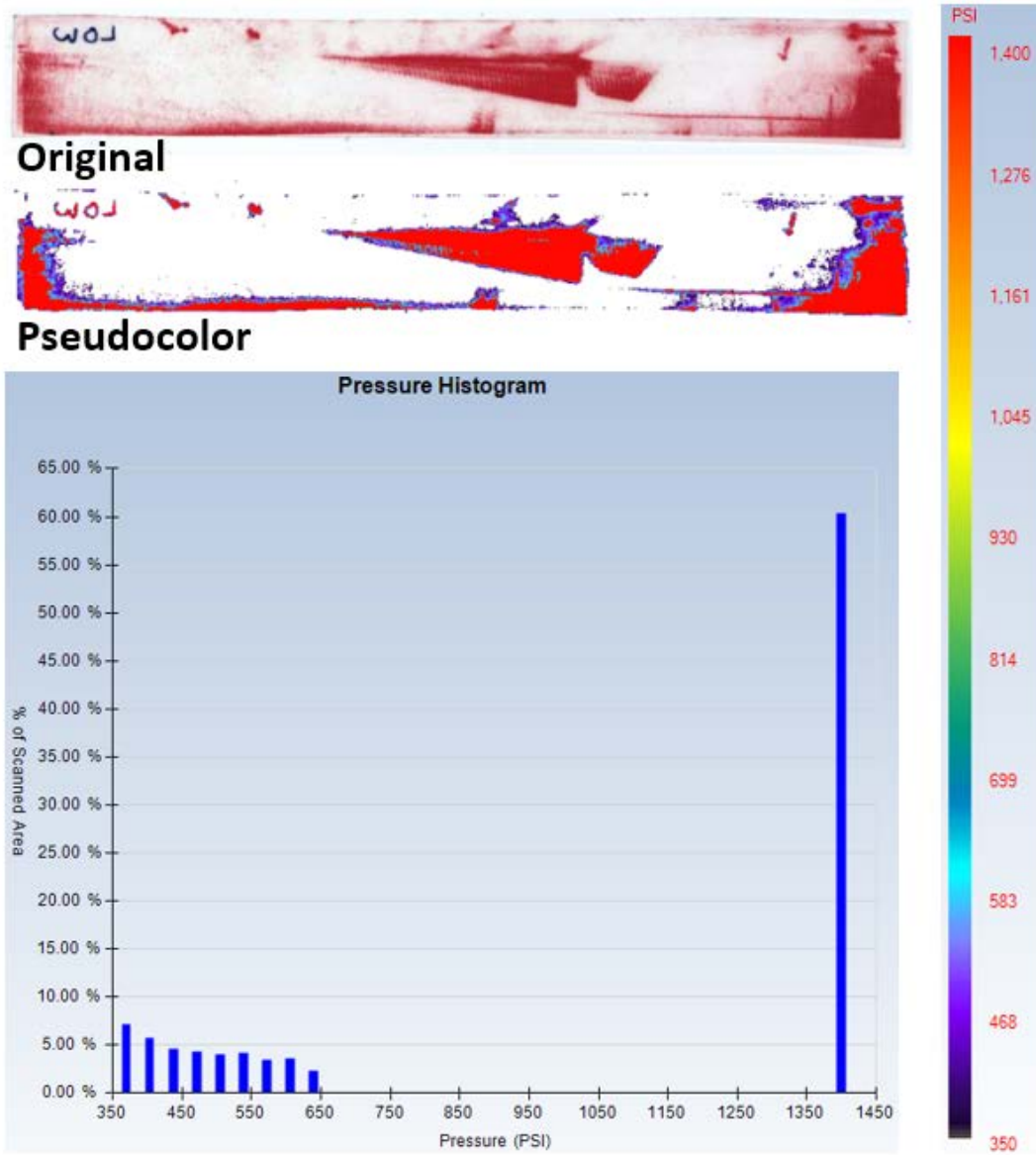

Figure 60: Pressure Analysis with Low Film – GIT

3.5.5.3 University of Missouri

Total Clamping Force: 192.11bf (by Superlow film) to 527.80bf (by Low film).

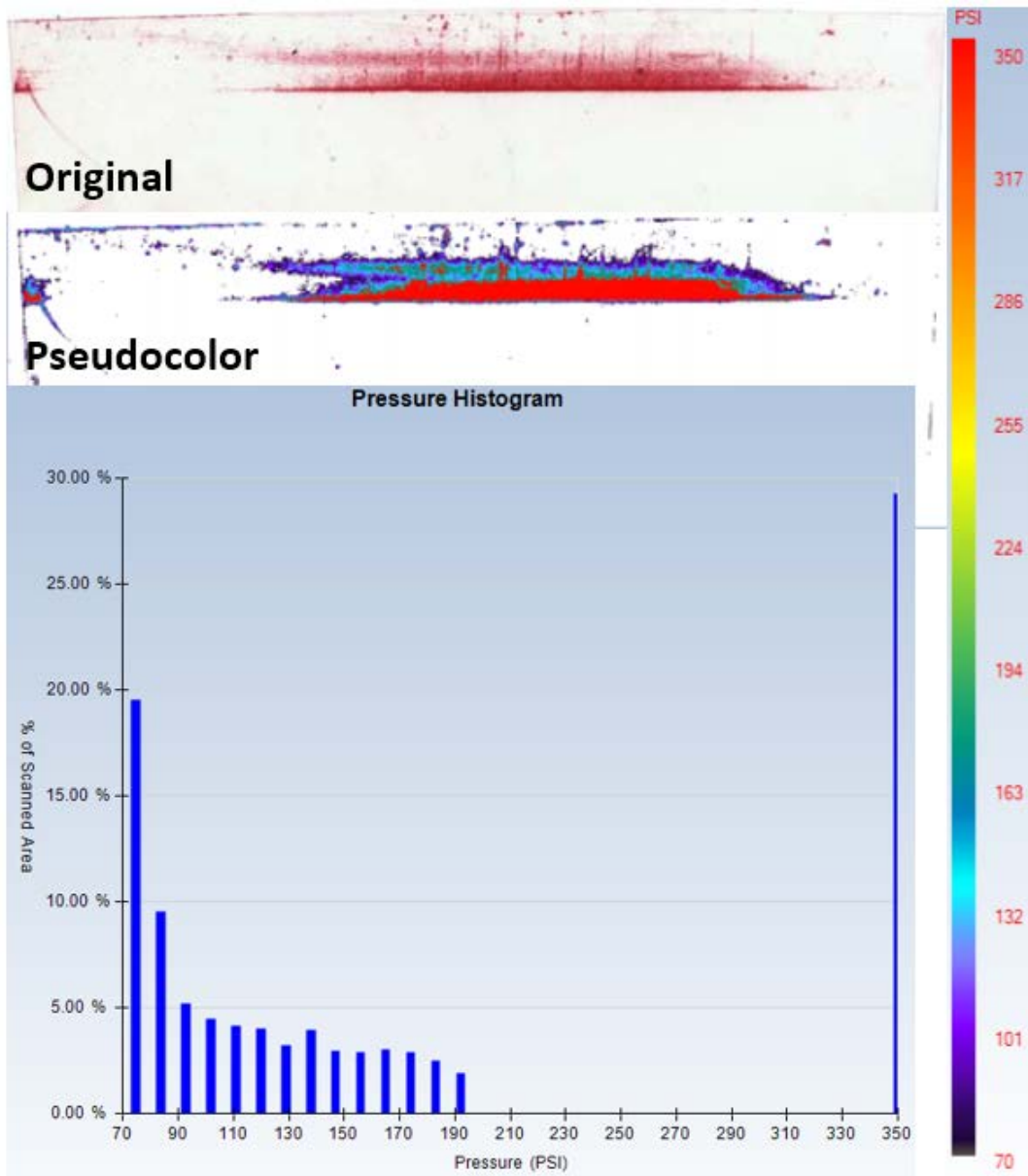

Figure 61: Pressure Analysis with Superlow Film – MU

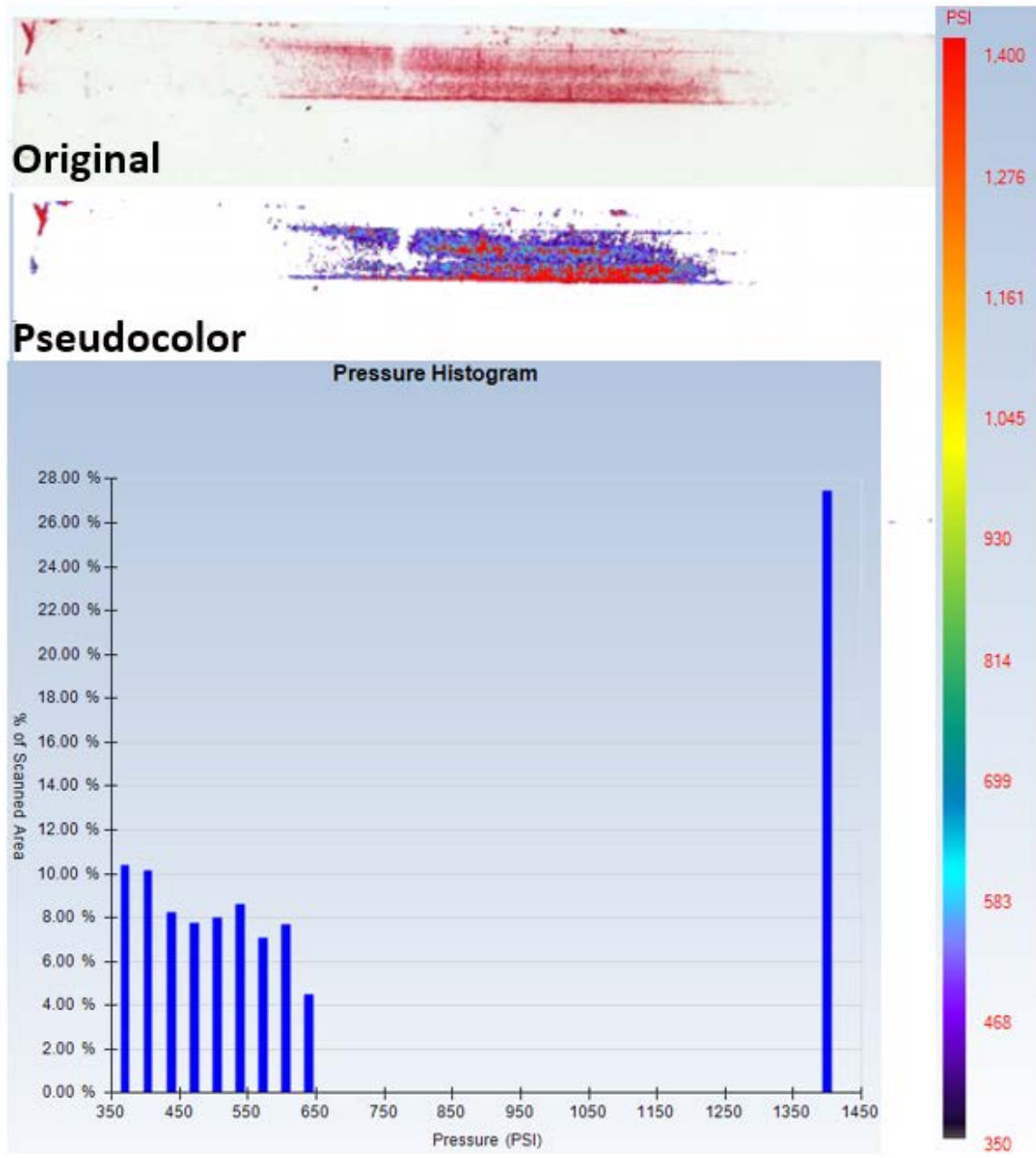

Figure 62: Pressure Analysis with Low Film – MU

3.5.5.4 National Tsinghua University

Total Clamping Force: 240.05lbf (by Superlow film).

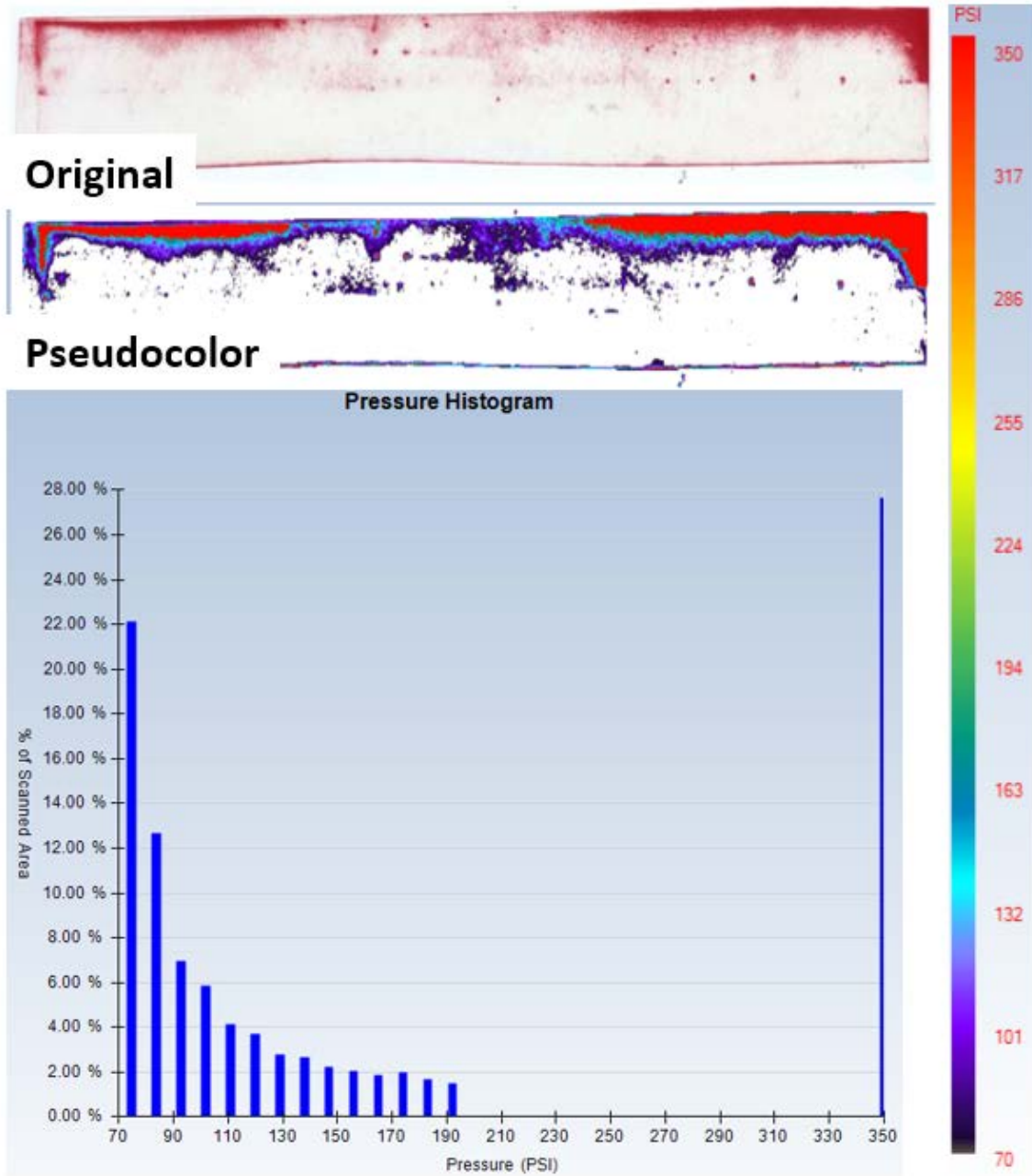

Figure 63: Pressure Analysis with Superlow film – NTHU

3.5.5.5 University of California-Merced

The UCM team discussed their analysis in 5.2 of their report and provided film images after their pressure test, shown in Figure 64.



Figure 64: Pressure Analysis by UCM Team

3.5.5.6 University of Maryland

Figures 65-67 are from UMD report.

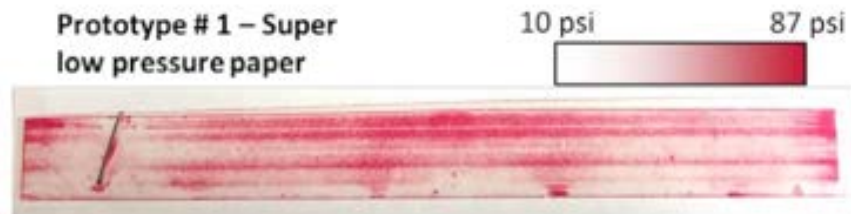

Figure 65: Pressure Paper Tests Results for Prototype # 1, Obtained using Superlow Film



Figure 66: Pressure Paper Tests Results for Prototype # 3, Obtained using Low and Superlow Film



Figure 67: Pressure Paper Tests Results for a Commercial Thermal Connector, Obtained using Low Film

3.5.5.7 University of Illinois at Urbana-Champaign

UIUC team did not send in their pressure films. Instead, they analyzed the results in their report (Figures 68-69).



Figure 68: Pressure Distribution for Original Double-sided Wedgelock

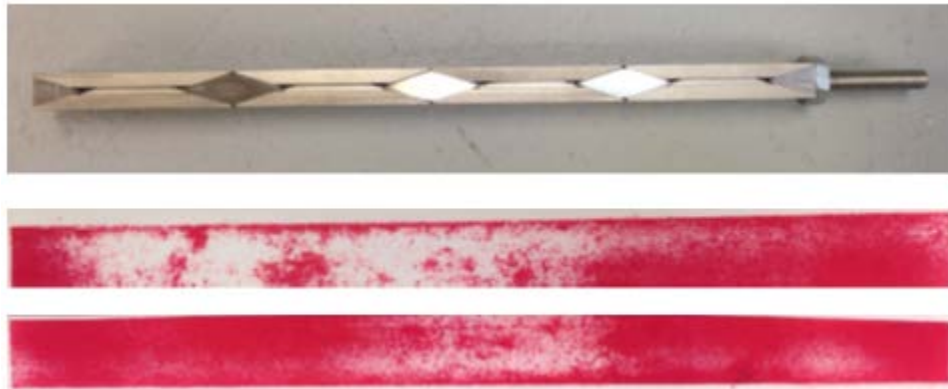

Figure 69: Pressure Distribution for Improved Double-sided Wedgelock, with Two Iterations

3.5.5.8 Mississippi State University

- No discussion or images of pressure film was provided.

3.6 Comments on each Device (RevCon III)

This International RevCon competition aims to encourage student teams to pursue novel designs, which can repeatedly assemble and disassemble an electronic module to/from an electronic enclosure (easiness), while providing a constant connector thermal resistance lower than $0.2^{\circ}\text{C}/\text{W}$ over multiple thermal cycles in a specified temperature range, vibration environment, and contact pressure (lower thermal resistance R). We not only evaluated their thermal performance before and during the competition, but also evaluated the easiness of assembling and disassembling. The thermal performance for each device has been summarized in the previous section. We address some comments regarding our user experience and suggestions for further improvement.

3.6.1 Donghua University

DHU's design is still a metal box filled with graphite powder. Only one screw from one end of the connector (improvement, two screws from both ends for the 1st prototype) push the powder inside, resulting in the deformation of two copper plates inside the metal box which exert a clamping force to the Al Board. Figure 70 shows the side view of their design and the image when the connector is inserted into the aluminum slot.

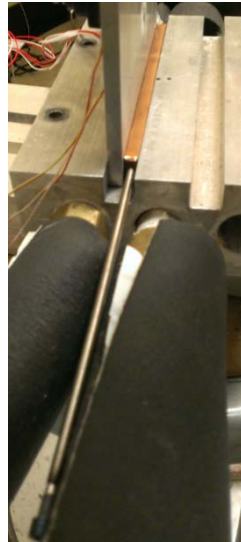

Figure 70: Thermal Connector Delivered from Donghua University

Frequency response for the 1st prototype and 2nd prototype determined from A_2 over A_1 and the corresponding resonant frequencies can be found in Figure 71.

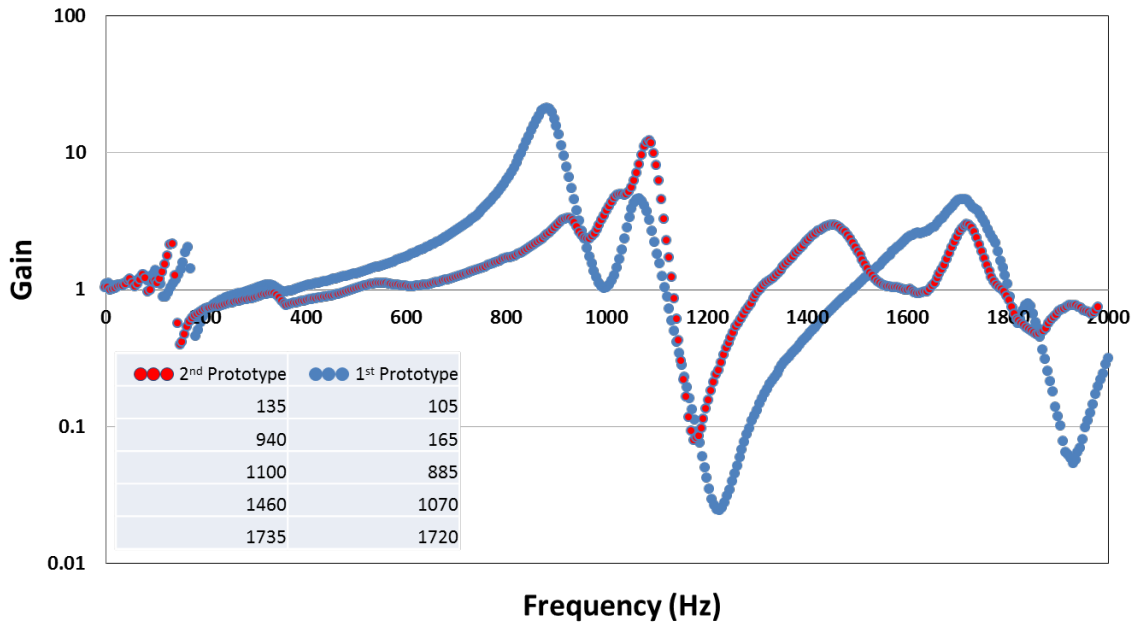

Figure 71: Frequency Response for DHU's Design

Easiness of loading and unloading: The design delivers a straightforward way (but lousy, takes more than 10 minutes) to assemble and disassemble in and out of the slot. During removal, one does not need to wiggle the device this time to loosen the contact surfaces. This is another improvement.

Comments and Suggestions

- Fairly easy to load/unload in/out of the slot.
- Electric screw driver can speed up the load/unload procedure.
- Second prototype has a much larger screw. This modification seems to cooperate the rule of “single-side loading/unloading”.
- Most innovative design according to the judges.

3.6.2 Georgia Institute of Technology

GIT's design is similar to their previous thermal connector with hydraulic pressure inside a copper series of larger pistons than the 1st prototype to exert clamping force.

Easiness of installation and removal: GIT spent about 30 minutes on-site to load their device onto the testbed. It should have provided an easy way to assemble and disassemble in and out of the test rig, if the designer/manufacture leaves more clearance next time. During removal, the pistons seemed not to retreat smoothly. Plus, it leaked and contaminated the slot. Figure 72 shows the size and the assembly photo.

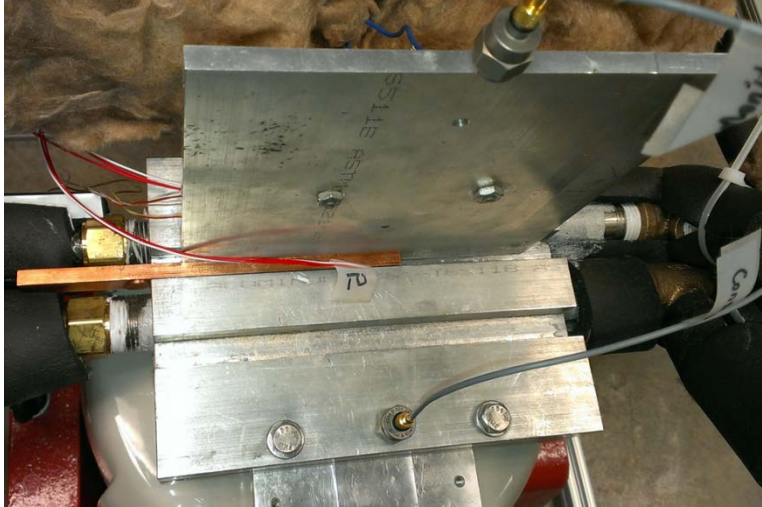

Figure 72: Hydraulic Thermal Connector Delivered by GIT

Frequency response determined from A_2 over A_1 and the associated resonant frequencies can be found in Figure 73. The system does not have obvious resonant frequencies over 1,000Hz.

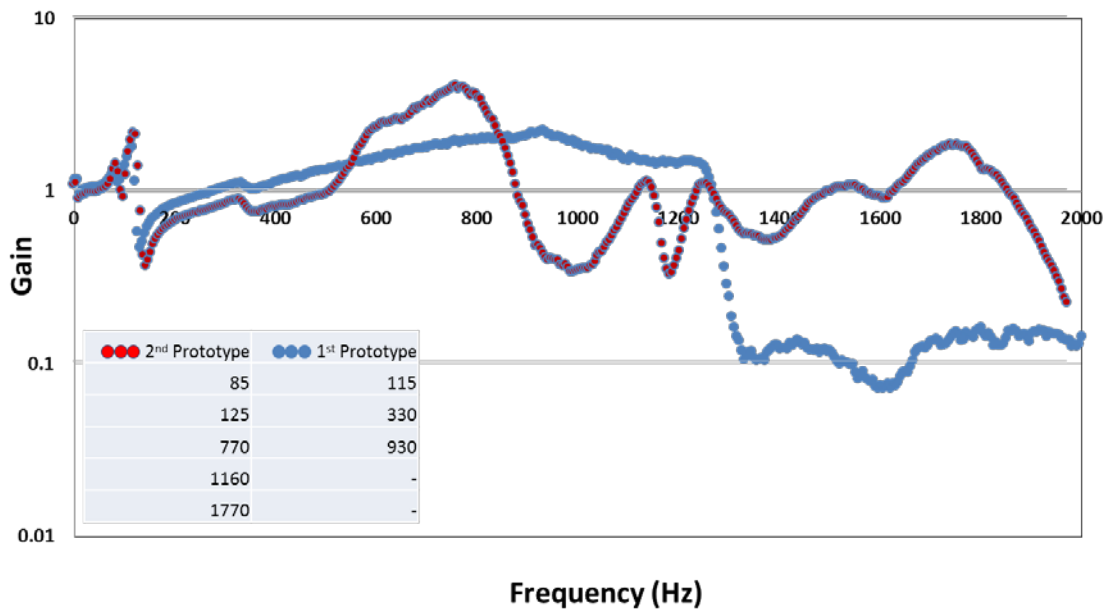

Figure 73: Frequency Response for GIT's Design

Comments and Suggestions

- Although leaking is still a problem, the thermal performance is outstanding.
- 2nd prototype seems to have too much liquid so that the last piston cannot be fully inserted during the preliminary test, and during the competition.

3.6.3 Mississippi State University

MissStateU finally delivered a pulsating-heat-pipe thermal connector. However, the performance did not amaze the audiences. The size and the assembly can be seen in Figure 74.

Easiness of installation and removal: The insertion is not complete, as can be seen in Figure 74. MissStateU seemed not to leave enough clearance. We still performed all the thermal tests but the results, as can be expected, did not outperform other teams. We also cannot observe any oscillating dynamics during heating.



Figure 74: Pulsating-heat-pipe Embedded Design Delivered by MissStateU

Frequency response determined from A_2 over A_1 and the corresponding resonant frequencies can be found in Figure 75. Two devices have similar pattern before 1000Hz.

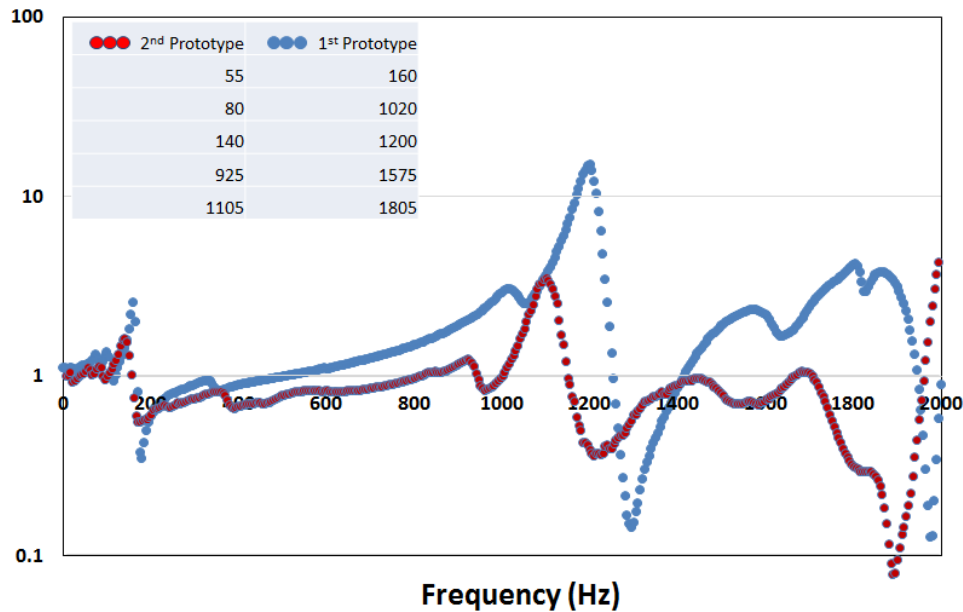

Figure 75: Frequency Response for MissStateU's Design

Comments and Suggestions

- They finally made a “heat pipe” type of their thermal connector as they promised in their proposal.
- Clearance is not made enough.

3.6.4 University of Missouri

MU modified their two-wedge and did use indium at interfaces can be seen in Figure 76 (rippled surface). This should, theoretically, improve the thermal performance. Their thermal performance showed consistent before and during the competition. They improved their load/unload procedures and did not have the “stuck” problem during unloading (happened in their 1st prototype).



Figure 76: Two-wedge Design Delivered by MU Team

Frequency response determined from A_2 over A_1 and the major resonant frequencies can be found in Figure 77.

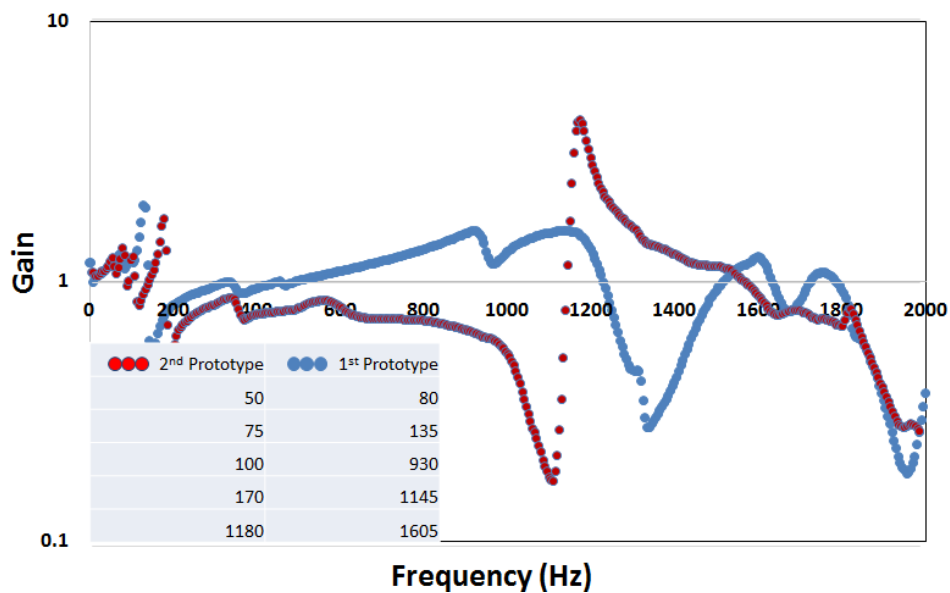

Figure 77: Frequency Response for MU's Design

Easiness of installation and removal: The loading procedure for MU's device is fairly easy as the relaxation thickness of their design has enough clearance against the slot width. They demonstrate this loading/unloading procedure in front of the judges and showed smoothness.

Comments and Suggestions

- The design of the device leaves enough clearance for loading.
- They can consider larger screws in order to exert larger clamping force.
- They demonstrate no problem in retreat their device in front of the judges; however, their retreat (or unloading) is still an issue by MU team.

3.6.5 National Tsinghua University

NTHU delivered a sophisticated device with fine surfaces. Their 1st prototype cannot be loaded onto our testbed. Their 2nd prototype still has the similar problem: not enough clearance. However, before the competition, they somehow reduce the thickness of their device and successfully loaded/unloaded onto our testbed and made very good thermal performance (2nd to GIT's results).

Easiness of installation and removal: Figure 78 displays the side view of the device and its loading/unloading tool. During the competition, the device can be loaded from the top (not from the side) of the slot. This somehow limits its application in real world. One easy way to fix this problem is to reduce the thickness of all of the pieces in their system.

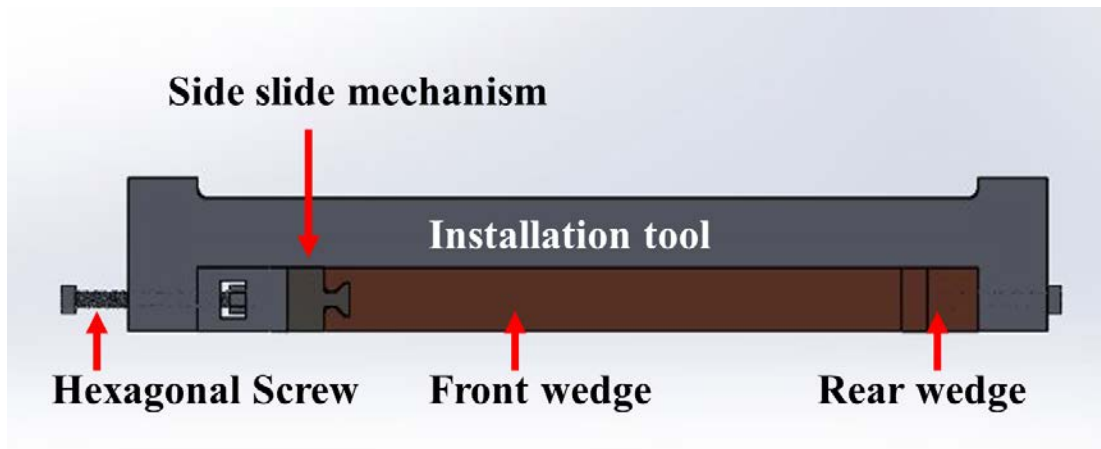

Figure 78: Side View of NTHU's Wedge Thermal Connector and its Auxiliary Tool for Loading and Unloading
(Photo from NTHU report)

Frequency response determined from A_2 over A_1 and the major resonant frequencies was not performed on NTHU's thermal connector.

Comments and Suggestions

- The device leaves no clearance for loading, nor for unloading for their 1st and 2nd prototype, but their device tested during the competition has this problem solved.
- Made beautifully.
- Slide-in mode is still impossible to perform for this 2nd prototype.

3.6.6 University of Maryland

UMD modified their seamless, two-piece wedge capable of tightening the end screw that results in pushing two wedges laterally for clamping purpose (Figure 79). In their 2nd prototype, they reduced the top pieces to 3. The side movement is still transferred to upward/downward movement through another set of wedges on top.

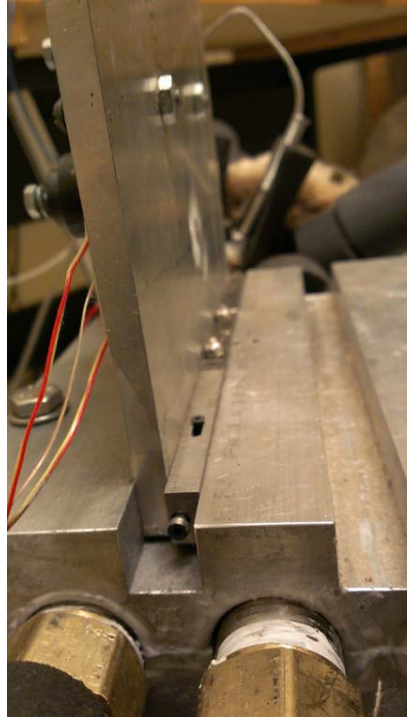

Figure 79: Seamless Wedge Designed by UMD Team

Frequency response determined from A_2 over A_1 and the major resonant frequencies can be found in Figure 80.

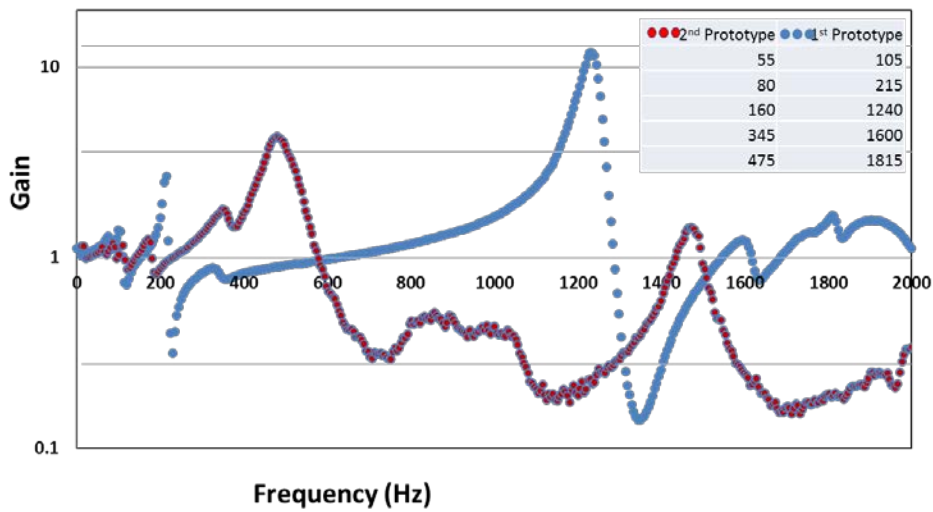

Figure 80: Frequency Response for UMD's Design

Easiness of installation and removal: Unlike their 1st prototype, which is simple to load to and unload from the slot, they seem to have thicker copper wedges. The clearance is not made enough for the 2nd device. Fortunately, they have this problem fixed before the competition.

Comments and Suggestions

- New prototype leaves less clearance, compared with the previous prototype.
- Solder at the wedge interface seems to get hardened during loading (the testbed is about 17-19°C before heating).

3.6.7 University of Illinois at Urbana Champaign

UIUC’s thermal connector is the closest design to commercial products. Made of aluminum this time, the device can be easily slid into the slot, as shown in Figure 81. Too many interface may make it less competitive in thermal performance, compared with other design.



Figure 81: Improved Double-sided Wedgelock Designed by UIUC Team

Frequency response determined from A_2 over A_1 and the major resonant frequencies can be found in Figure 82.

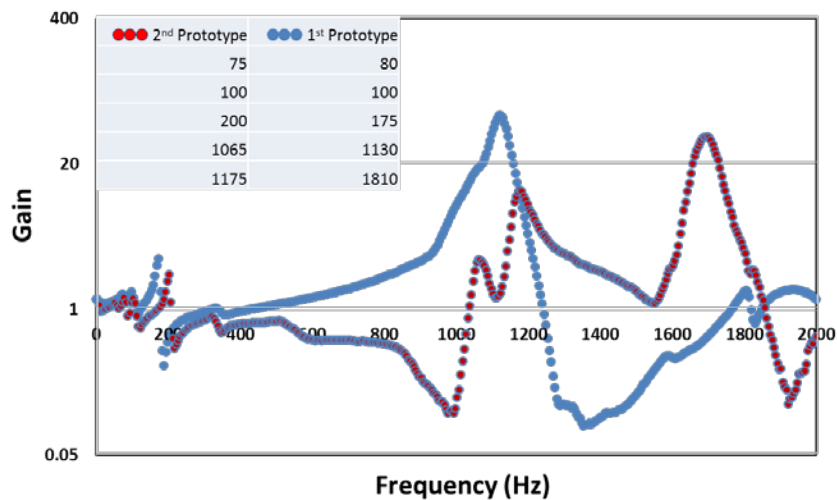

Figure 82: Frequency Response for UIUC's Design

Easiness of installation and removal: The UIUC's design is reliable with easy loading and unloading procedures.

Comments and Suggestions

- Reliable with easy loading/unloading procedures.
- Too many interfaces, as can be seen in the figure.
- Most commercially potential, from the tester's point of view.

3.6.8 University of California – Merced

The thermally efficient connector (TEC) has a simple yet practical mechanism. A series of wedge surfaces provide sliding movement capability and exert clamping forces to hold the Al board. Unfortunately, the device barely leaves clearance (thickness of slightly over 1/4" shown in Figure 84); therefore, it is unable to insert into the slot. The device was not tested.

The physical length can be found in Figure 83(a). The device can only partially be inserted into the slot, shown in Figure 83(b).

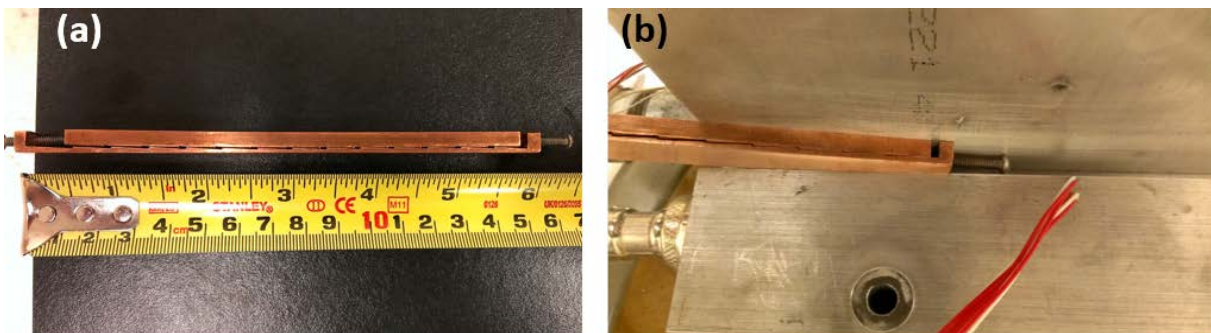

Figure 83: Thickness of the TEC
Some local thickness is even larger than 1/4".



Figure 79: Thermally Efficient Connector Designed by UCM Team

Comments and Suggestions

- The design does not leave enough clearance for loading and unloading.
- The device easily falls apart when two end screws are loosened.

4.0 CONCLUSIONS

The RevCon challenge has successfully attracted student teams from around the world. The goal in hosting this event was to encourage domestic and foreign college students to tackle challenging design problems in electronic thermal management. There have been inspiring designs and sophisticated manufacturing processes recorded for over twenty unique connectors, all accomplished by student teams. Designs made utilizing the available test measurements, adequate material selection, and a large clamping force usually resulted in lower thermal resistances. Of course, ease of loading and unloading is no doubt a critical design factor when considering commercialization. Jamming occurs more easily during unloading when the mating surfaces of the wedges are long, although this design may reduce the number of wedge pieces. On the other hand, the importance of contact surfaces between the connector and the chassis cannot be emphasized more, because in a few select cases inadequate interfaces would worsen the flow of heat flux and could even double the thermal resistance (e.g. vacuum environment). Vibration along the gravitational axis was shown to play a minimal role in thermal performance; however, vibration in general might play a more important role if (a) the vibration is along the other two axes, and (b) if the device includes springs in their design of locking mechanism. For a rectangular slot like that used in this event, and in most other commercial applications, the thermal transport route normal to the cold wall-connector-cold wall route will likely be one of the next critical design points.

APPENDIX

The MU test bed composes of a data acquisition system, a shaker (LDS 456) with a fixture and a cooling block, and a chiller. Figure A1(a) shows an aluminum fixture fastened on top of the shaker head. A vacuum pump (Welch 1402B01) is used to perform vacuum. A cooling block is assembled with the fixture (Figure A1(a), not seen here). Two accelerometers are attached on the cold block (control), and aluminum board, respectively. Temperature monitoring (through thermocouples) are attached on the aluminum board and the outlets of cooling ducts for further analysis of thermal resistance. Insulation material is used to prevent heat loss to the ambient and for more accurate predictions (Figure A1(b)). An acrylic tube, covered by another aluminum plate (TCs/heating/Acc communication cords) consist of the vacuum chamber (Figure A1(b)). Insulation material was not used during the vacuum/no vacuum experiments. Therefore, the estimated R (and R^*) would be smaller than the case when the same heating condition is performed with insulation.

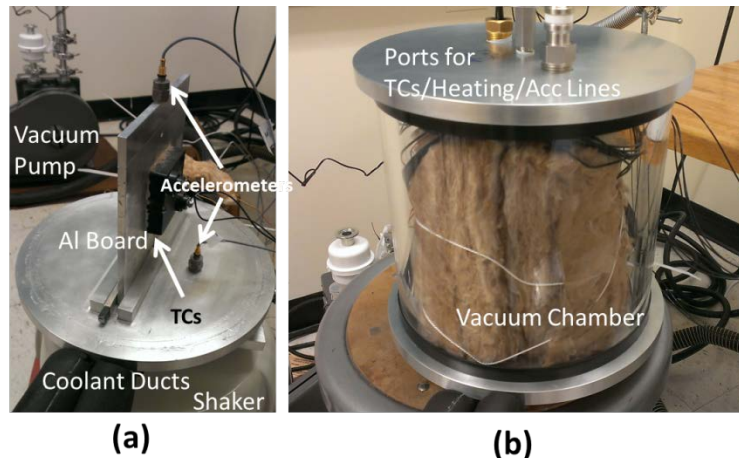

Figure A1: Testbed Assembly

(a) An aluminum fixture fastened on top of the shaker head and (b) a chamber designed to perform vacuum test is mounted on top of the fixture shown in (a).

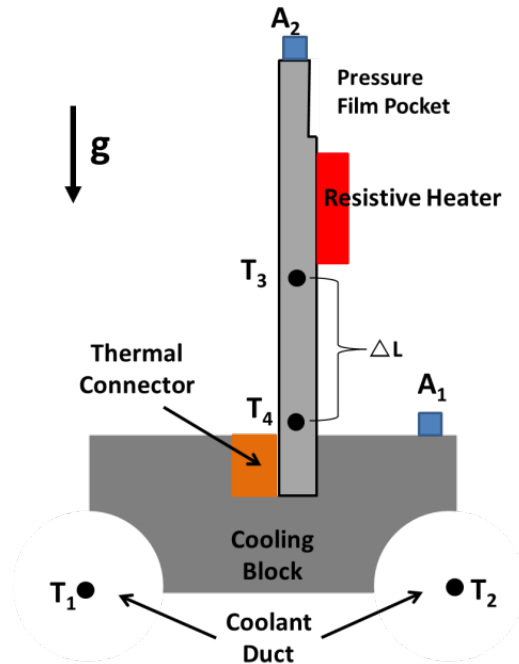

Figure A2: Schematic of Temperature Monitoring and Vibration Detection Setup for RevCon IV

Heat (Q) is assumed to be the power input to the resistive heater. Vibration is controlled and monitored through accelerometers A_1 and A_2 along a single axis (parallel to gravity).

Thermal resistance(R) is defined below and is provided for judges' reference:

$$R = \Delta T / Q = [T_3 - (T_1 + T_2) / 2] / Q$$

where R represents the estimation of the overall thermal resistance of thermal connectors with the outlet of the coolant temperature, estimated by averaging T_1 and T_2 .

Thermal resistance(R^*) is defined below and is provided for judges' reference:

$$R^* = \Delta T / Q = [T_4 - (T_1 + T_2) / 2] / Q$$

In RevCon III, the MU test bed composes of additional temperature monitoring position. Figure A3 schematically demonstrates the temperature monitoring setup and vibration detection.

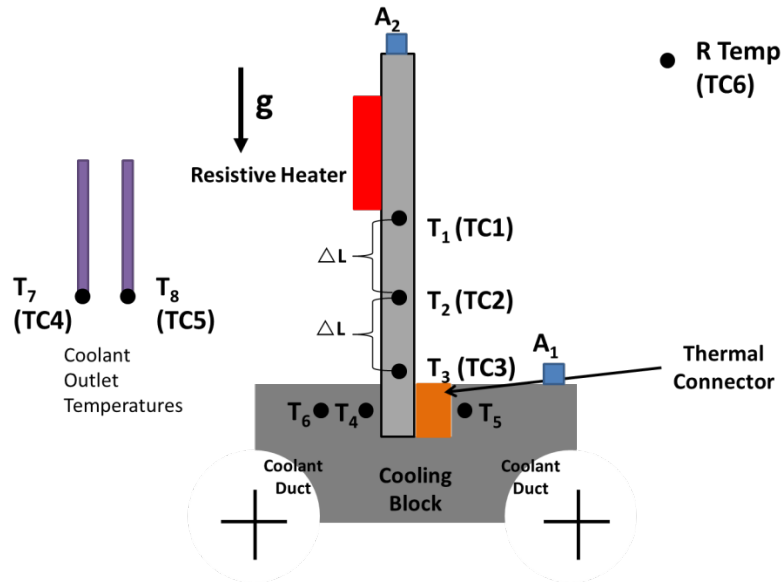

Figure A3: Schematic of Temperature Monitoring and Vibration Detection Setup for RevCon III

Heat flux can be estimated through T_1 , T_2 and T_3 . Vibration is controlled and monitored through accelerometers A_1 and A_2 along a single axis (parallel to gravity).

Three kinds of thermal resistance are provided for judges' reference:

$$1. R = \Delta T/Q = [T_1 - (T_7 + T_8)/2]/Q$$

R represent the estimation of the overall thermal resistance of thermal connectors with the T_1 temperature readings, all the way to the coolant outlet temperature, averaged T_7 and T_8 .

$$2. R^* = \Delta T/Q = [T_3 - (T_4 + T_5)/2]/Q$$

R^* represent the estimation of the overall thermal resistance of thermal connectors with the bottom temperature, estimated by averaging T_4 and T_5 .

$$3. R^{**} = \Delta T/Q' = (T_3 - T_4) / [0.3 K_{Al} A (T_2 - T_3) / \Delta L]$$

where A is the cross-section area of the Al board (15cm x 0.63cm), and K_{Al} is the board's thermal conductivity. According to empirical experience, the heat flux flowing through the thermal connector side accounts for approximately 30% of the total heat flux. Therefore, we estimated the heat flow through T_2 and T_3 and multiplied by 30% to better estimate the real thermal resistance of the thermal connector.

Resonant frequency identification through random excitation (5 to 2,000Hz) is performed under the same procedure before. Every device (loadable) was installed onto our testbed. Their corresponding resonant frequencies were determined for the required thermal tests.

A manuscript, entitled "Field-Reversible Thermal Connector (RevCon) Challenges: A Review" has been submitted to IEEE- Transactions on Components, Packaging and Manufacturing Technology, and is currently under review.

LIST OF ACRONYMS, ABBREVIATIONS, AND SYMBOLS

ACRONYM	DESCRIPTION
DARPA	Defense Advanced Research Projects Agency
DHU	Donghua University
DMLS	direct metal laser sintering
GIT	Georgia Institute of Technology
LMDS	laser metal direct sintering
MissStateU	Mississippi State University
MU	University of Missouri
NTHU	National Tsinghua University
OHP	oscillating heat pipe
OU	Ozyegin University
RevCon	Field Reversible Thermal Connector
std	standard deviation
TEC	thermally efficient connector
UCM or UC – Merced	University of California – Merced
UIUC	University of Illinois at Urbana-Champaign
UMD	University of Maryland