



*Files are in Adobe format.
Download the newest version from Adobe.*

Missile Defense Information Technology Small Business Conference

Colorado Springs, CO

August 31 - September 1, 2009

Agenda

Tuesday, 1 September, 2009

OVERVIEW OF SMALL BUSINESS OPPORTUNITIES & INTRODUCTION OF KEYNOTE SPEAKER

- Mr. Lee Rosenberg, Director, Office of Small Business Programs, Missile Defense Agency

KEYNOTE SPEAKER

- Dr. Jim Armstrong, CIO/Director, Information and Technology Operations (DOC), Missile Defense Agency

OVERVIEW OF ENTERPRISE ARCHITECTURE (DOCA)

- Mr. Stu Strong, Deputy CIO, Enterprise Architecture, Missile Defense Agency

OVERVIEW OF IMPLEMENTATION ENGINEERING (DOCE)

- Mr. Carter Elmore, Chief, Implementation and Engineering, Missile Defense Agency

OVERVIEW OF IT OPERATIONS (DOCO)

- SMSgt Jeff Baca, USAF, Superintendent, Enterprise Network Operations, Missile Defense Agency

OVERVIEW OF INFORMATION ASSURANCE (DOCV)

- Dr. Theodore Mueller, Deputy Director, DOCV, Missile Defense Agency

OVERVIEW OF TELECOMMUNICATIONS (DOCT)

- Mr. Kenneth Neuhaus, DCIO, Telecommunications, Missile Defense Agency

CONTRACTING (DAC)

- Mr. Barney Klehman, Director, Contracting, Missile Defense Agency

MISSILE DEFENSE INTEGRATION AND OPERATIONS CENTER (MDIOC) CONTRACTING (DACJ)

- Ms. Roxanne Banks, Director, MDIOC Contracting, Missile Defense Agency



SCHEDULE AT A GLANCE

MONDAY, AUGUST 31

- 12:00 pm - 6:00 pm REGISTRATION OPEN
- 3:00 pm - 4:30 pm GENERAL SESSION
- 4:30 pm - 6:00 pm NETWORKING RECEPTION

TUESDAY, SEPTEMBER 1

- 7:00 am - 5:15 pm REGISTRATION OPEN
- 8:00 am - 12:00 pm GENERAL SESSION
- 12:00 pm - 1:00 pm KEYNOTE LUNCHEON
- 1:00 pm - 5:00 pm ONE-ON-ONE MATCHMAKING

MISSILE DEFENSE INFORMATION TECHNOLOGY SMALL BUSINESS CONFERENCE

MONDAY, AUGUST 31, 2009

12:00 pm - 6:00 pm REGISTRATION OPEN & MATCHMAKING SIGN UPS

3:00 pm - 3:30 pm CONFERENCE WELCOME

- ▶ Mr. Lee Rosenberg, *Director, Office of Small Business Programs, Missile Defense Agency*
- ▶ Ms. Britt Bommelje, *Director, Operations, NDIA*

3:30 pm - 4:30 pm MDA BUSINESS COUNCIL PANEL

Moderator: Ms. Judy Hardin, *Manager, Small Business and Community Partnering, Raytheon*

Panelist:

- ▶ Ms. Rhonda Range-Ealy, *Business Development Manager, BAE Systems*
- ▶ Mr. Bradley Bruce, *Small Business Liaison Officer, The Boeing Company*
- ▶ Ms. Brenda DuVall, *Computer Sciences Corporation*
- ▶ Ms. Ludmilla Parnell, *Director, Business Development, General Dynamics Information Technology*
- ▶ Mr. Robert Watson, *Small Business Liaison Officer, Northrop Grumman Space & Mission Systems Corporation*

4:30 pm - 6:00 pm NETWORKING RECEPTION

TUESDAY, SEPTEMBER 1, 2009

7:00 am - 5:00 pm REGISTRATION OPEN & MATCHMAKING SIGNUPS

7:00 am - 8:00 am CONTINENTAL BREAKFAST

8:00 am - 8:05 am ADMINISTRATIVE REMARKS

- ▶ Mr. Jerrol Sullivan, *Outreach Program Manager, Office of Small Business Programs, Missile Defense Agency*

8:05 am - 8:35 am OVERVIEW OF SMALL BUSINESS OPPORTUNITIES & INTRODUCTION OF KEYNOTE SPEAKER

- ▶ Mr. Lee Rosenberg, *Director, Office of Small Business Programs, Missile Defense Agency*

8:35 am - 9:25 am KEYNOTE SPEAKER

- ▶ Dr. Jim Armstrong, *CIO/Director, Information and Technology Operations (DOC), Missile Defense Agency*

9:25 am - 9:45 am OVERVIEW OF ENTERPRISE ARCHITECTURE (DOCA)

- ▶ Mr. Stu Strong, *Deputy CIO, Enterprise Architecture, Missile Defense Agency*

9:45 am - 10:05 am OVERVIEW OF IMPLEMENTATION ENGINEERING (DOCE)

- ▶ Mr. Carter Elmore, *Chief, Implementation and Engineering, Missile Defense Agency*

10:05 am - 10:25 am OVERVIEW OF IT OPERATIONS (DOCO)

- ▶ SMSgt Jeff Baca, *USAF, Superintendent, Enterprise Network Operations, Missile Defense Agency*

10:25 am - 10:40 am NETWORKING BREAK

10:40 am - 11:00 am OVERVIEW OF INFORMATION ASSURANCE (DOCV)

- ▶ Dr. Theodore Mueller, *Deputy Director, DOCV, Missile Defense Agency*

11:00 am - 11:20 am OVERVIEW OF TELECOMMUNICATIONS (DOCT)

- ▶ Mr. Kenneth Neuhaus, *DCIO, Telecommunications, Missile Defense Agency*

11:20 am - 11:40 am CONTRACTING (DAC)

- ▶ Mr. Barney Klehman, *Director, Contracting, Missile Defense Agency*

11:40 am - 12:00 pm MISSILE DEFENSE INTEGRATION AND OPERATIONS CENTER (MDIOC) CONTRACTING (DACJ)

- ▶ Ms. Roxanne Banks, *Director, MDIOC Contracting, Missile Defense Agency*

12:00 pm - 1:00 pm KEYNOTE LUNCHEON

- ▶ Ms. Tina Ballard, *Executive Director of the Committee for Purchase From People Who Are Blind or Severely Disabled*

1:00 pm - 5:00 pm ONE-ON-ONE MATCHMAKING

5:00 pm - 5:15 pm CLOSING CONFERENCE REMARKS

- ▶ Mr. Lee Rosenberg, *Director, Office of Small Business Programs, Missile Defense Agency*

THANK YOU TO OUR SPONSOR!

NORTHROP GRUMMAN



Northrop Grumman Information Systems is a leading global provider of advanced solutions that deliver timely, enabling information to where its needed most for its military, intelligence, civilian, state and local and commercial customers. We are a \$10 billion business employing approximately 35,000 employees with offices in 50 states and 18 countries.

Our customers look to us for large-scale enterprise solutions. We support commanders who manage far-flung forces via global command, control and communications systems; police and firefighters who will access high-speed data and video over a new broadband wireless network; battlefield commanders who use a tactical Internet to lead their troops; Department of Homeland Security staffers who rely on their classified network infrastructure; intelligence analysts who rely on their systems to get actionable information into the right hands at the right time; missile defense analysts who model and simulate scenarios at the Joint National Integration Center; states, counties and cities who rely on the management of their information infrastructures to deliver responsive services to their citizens; and businesses that adopt new software solutions to make their enterprise processes run more smoothly and efficiently.

**Missile Defense
Information Technology
Small Business Conference**



1 September 2009

James E. Armstrong, Jr., Ph.D.

**Chief Information Officer
Missile Defense Agency**



Agenda

- **MDA Org / Director's Mission, Values, Vision**
- **CIO Strategy Statement**
- **CIO Themes & Goals**
- **IT Priorities**
- **CIO Organizational Structure**
- **Small Business Areas under contract**
- **Key Focus Areas for Industry**
- **IA Workforce Training**
- **IT Infrastructure Library (ITIL) Framework**
- **MDIOC**
- **Summary**



Missile Defense Agency

Patrick J. O'Reilly
PATRICK J. O'REILLY
 Lieutenant General, USA
 Director

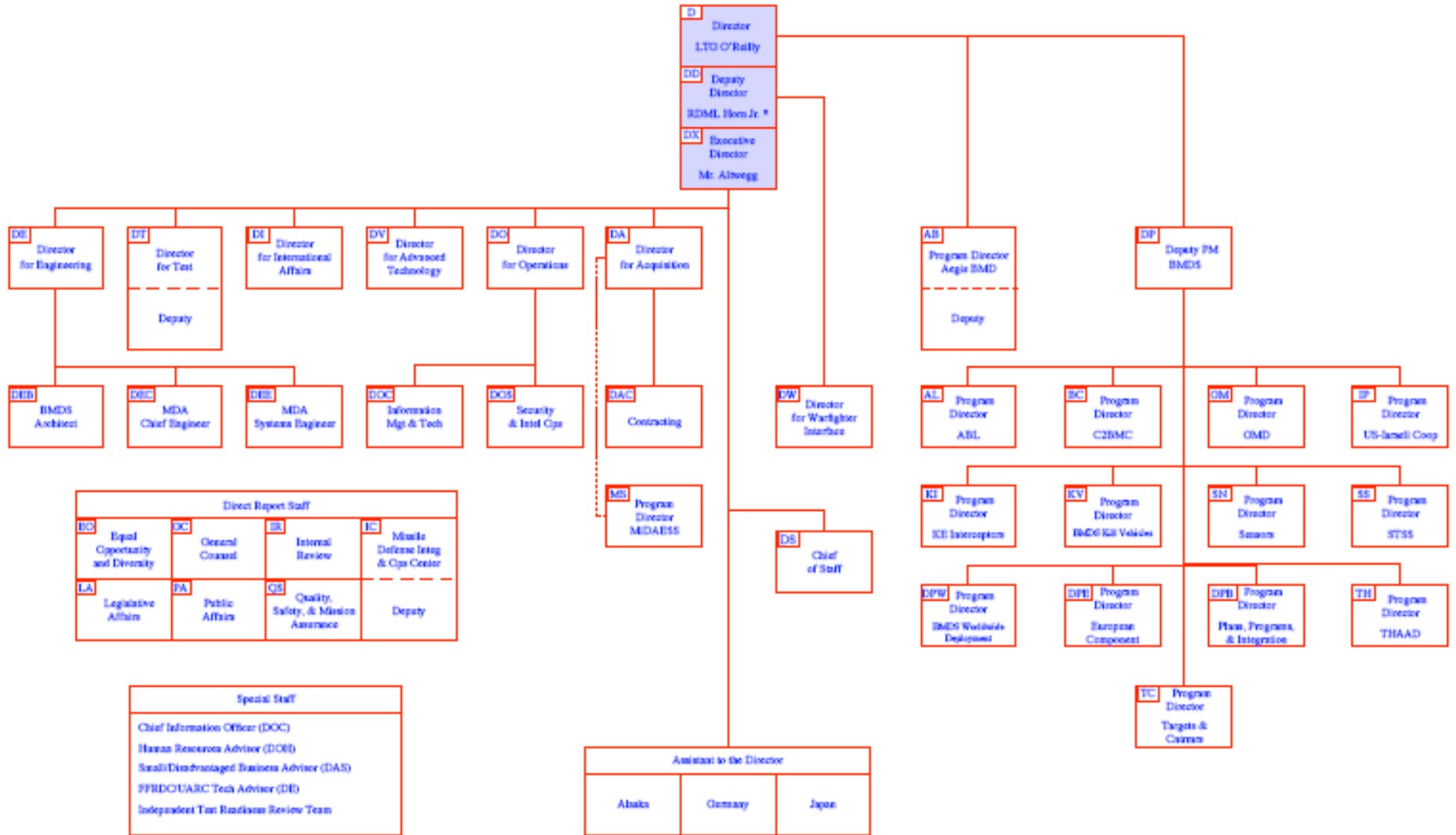

* Dual Hat

05/14/2009



MDA Director's Mission, Values and Vision

- **MDA Mission:** To develop and field an integrated, layered ballistic missile defense system to defend the United States, its deployed forces, allies, and friends against all ranges of enemy ballistic missiles in all phases of flight

- **MDA Values:**
 - **Dedication to the Nation**
 - **Empowered teamwork**
 - **Professional excellence**
 - **Personal integrity**

- **Director's Vision:**

Seamless integration of technologies, operational concepts, and highly skilled professionals to create an overwhelming advantage against enemies who would use ballistic missiles to threaten or even attack us



CIO Strategy Statement

Provide secure, high speed, high availability access to easy-to-use voice, video, and data anytime, anywhere with unlimited, replicated storage for all authorized MDA users and offices



CIO Major Themes and Goals

Themes

1. Provide excellence in IT services and support
2. Consolidate IT infrastructure in support of MDA re-engineering goals
3. Implement a robust Information Assurance program for mission, test, and administrative IT systems
4. Implement an integrated MDA Information Grid to support BMDS information sharing
5. Implement federally-mandated IM/IT initiatives

Goals

1. Optimize IT service delivery
2. Proactively manage demand for IT products and services
3. Layered IT defenses
4. Recoverable data
5. Universal access to data
6. Global collaboration thru integrated IT

Objective is to increase overall quality of service while simultaneously gaining workforce efficiencies through solid engineering, operational and contracting strategies



2009/2010 DOC Priorities

	CIO / Information Technology
Priority	Task Area
1	SharePoint
2	Decision Support System (DSS)
3	Exchange 2007 / Office 2007 / Vista / Windows 7
4	Service Management / RBA
5	VTC / E-Collaboration / Unified Comms
6	Portal / E-Applications / IM
7	BRAC Migration
8	Enterprise Storage
9	Last Mile Integration
10	VBIII & HQCC IT Infrastructure



DOC Organizational Structure facilitates increased customer service focus

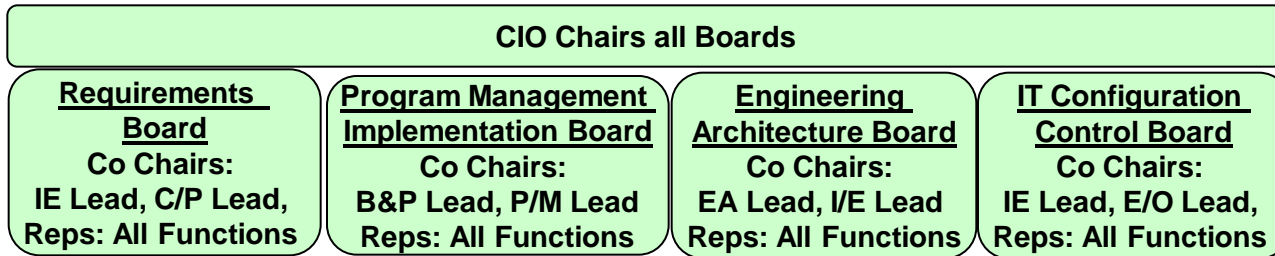
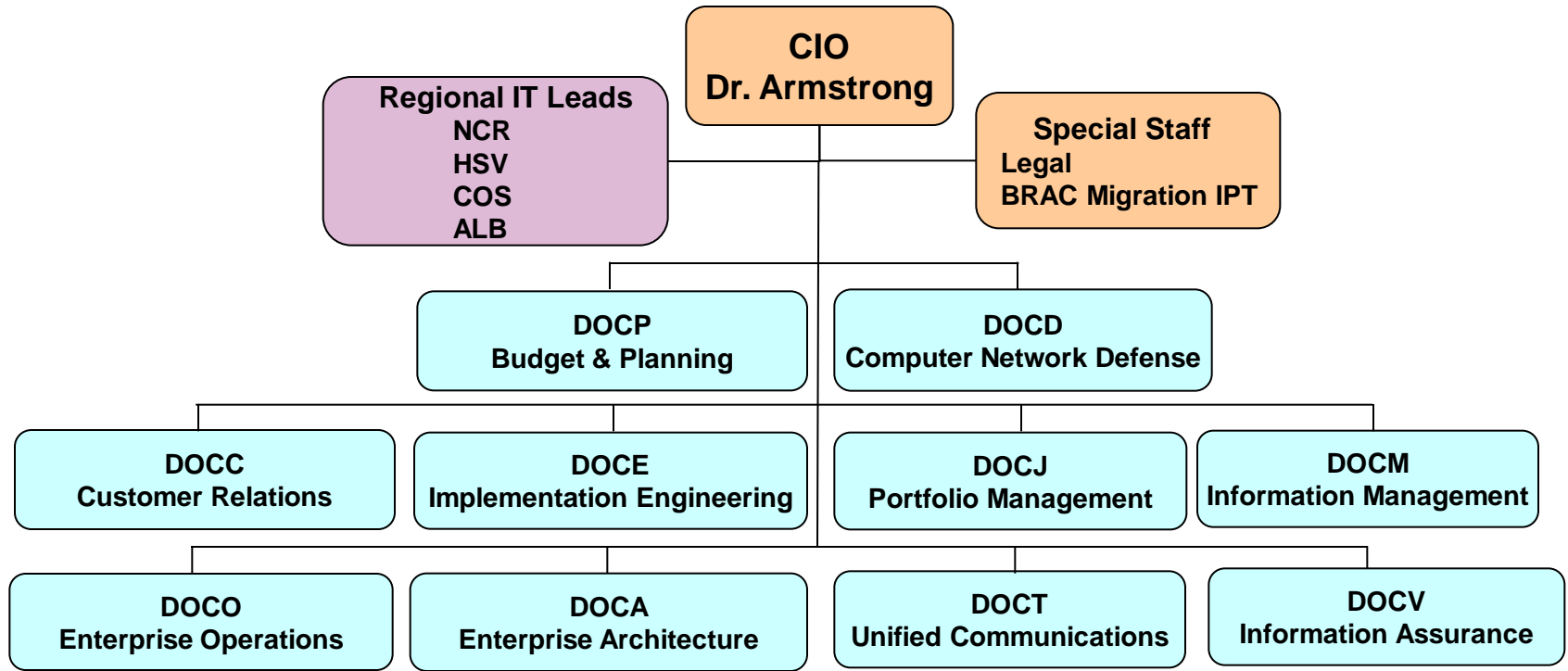



Small Business Areas under Contract

Small Business Primes % of work by Function

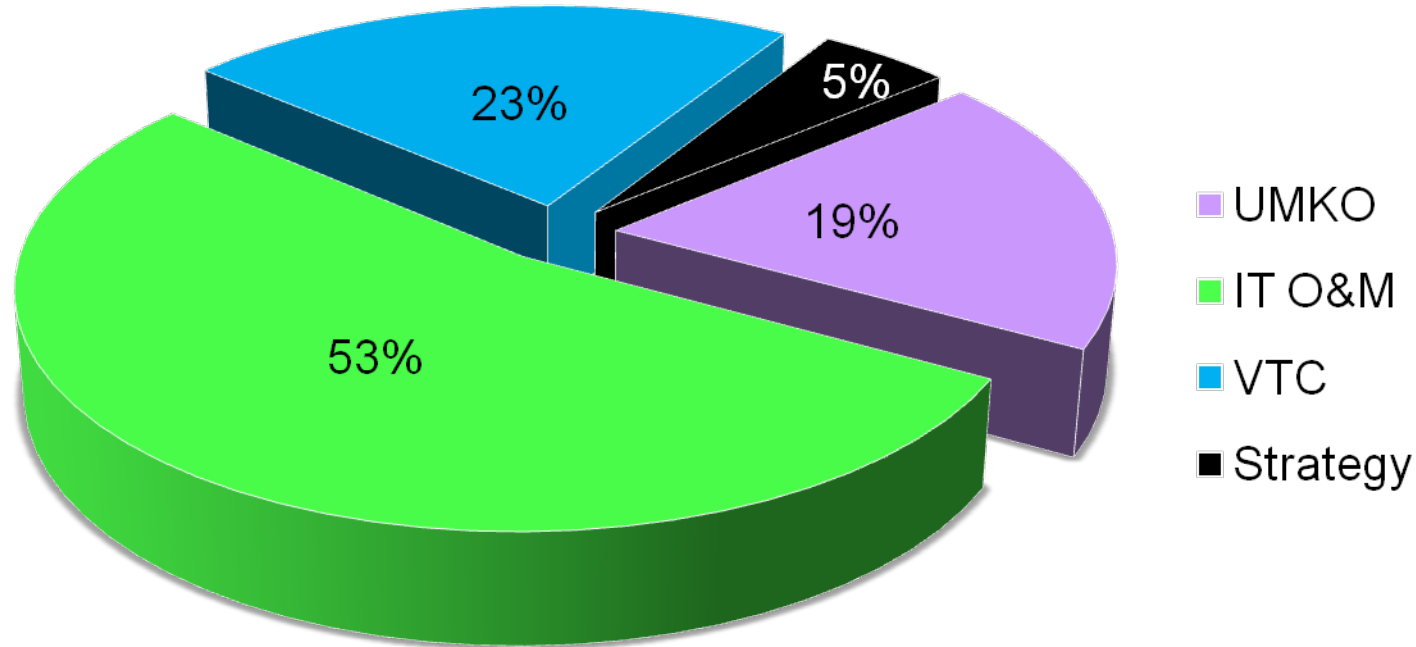

Four Small Businesses performing IT support tasks for DOC



Small Business Areas under Contract

Small Business Subs % of work by Function

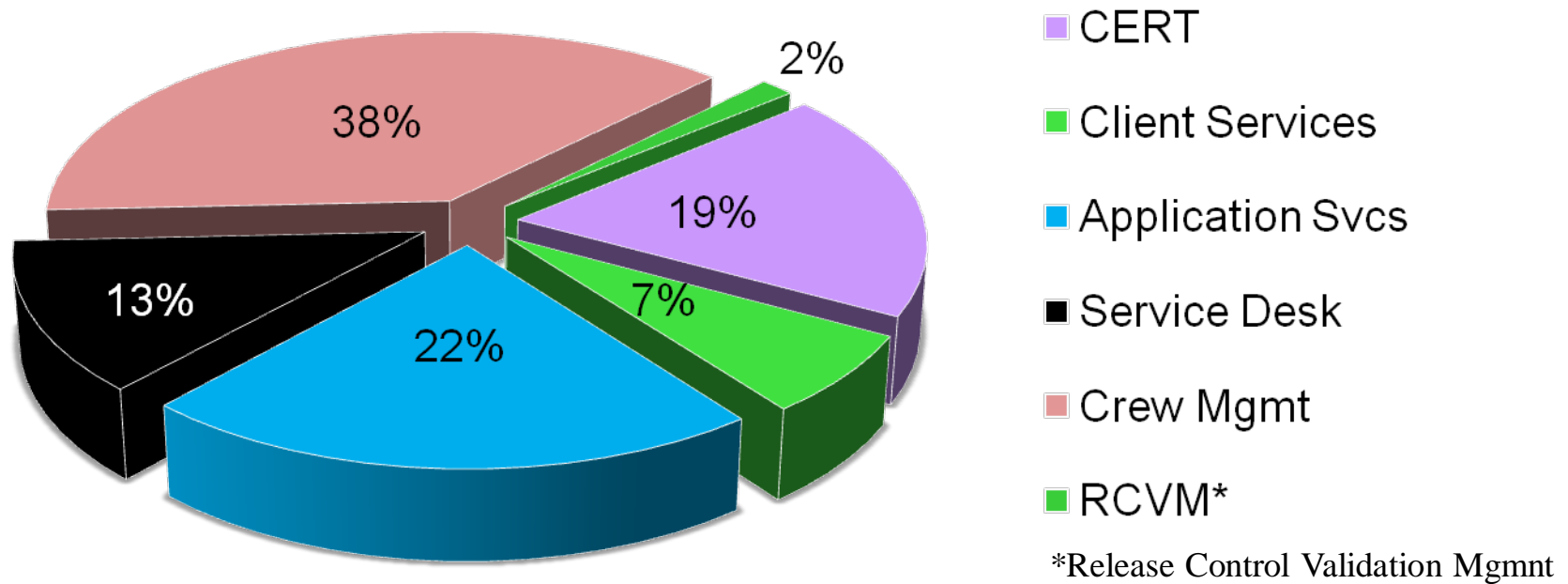

Twelve Small Businesses performing as sub in IT support tasks for DOC



Small Business Performance Issues

- **Focusing on customer needs and stated requirements**
- **Financial Management**
- **Middle management**
- **Staffing**



Key Focus Areas for Small Business

- **Monitoring health and status of IT services**
- **Fix before failure**
- **Build knowledge in critical expertise for:**
 - **Exchange**
 - **Active Directory**
 - **PKI-CAC**
 - **WAN-MAN-LAN networks**
 - **Office Automation**
 - **Unified Communications**
 - **Storage and backup solutions**



8570.1M IA Workforce Training

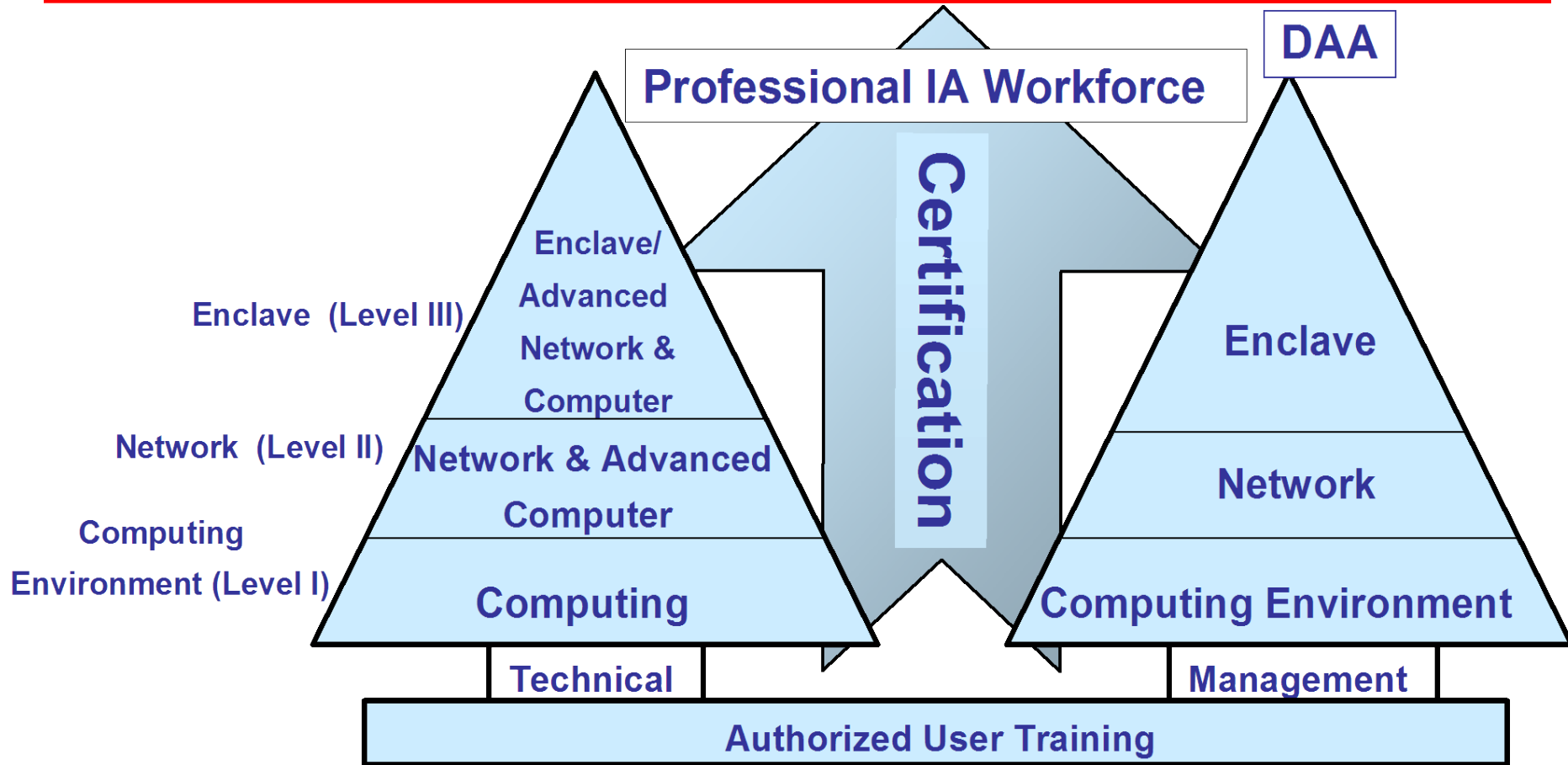

- FISMA Metric “Ensure that all employees with significant IA responsibilities (IA professionals) are trained and certified IAW DoD 8570”
- DoD requires 70% of the workforce to be trained by end of CY09 / 100% by FY10



ITIL Phases

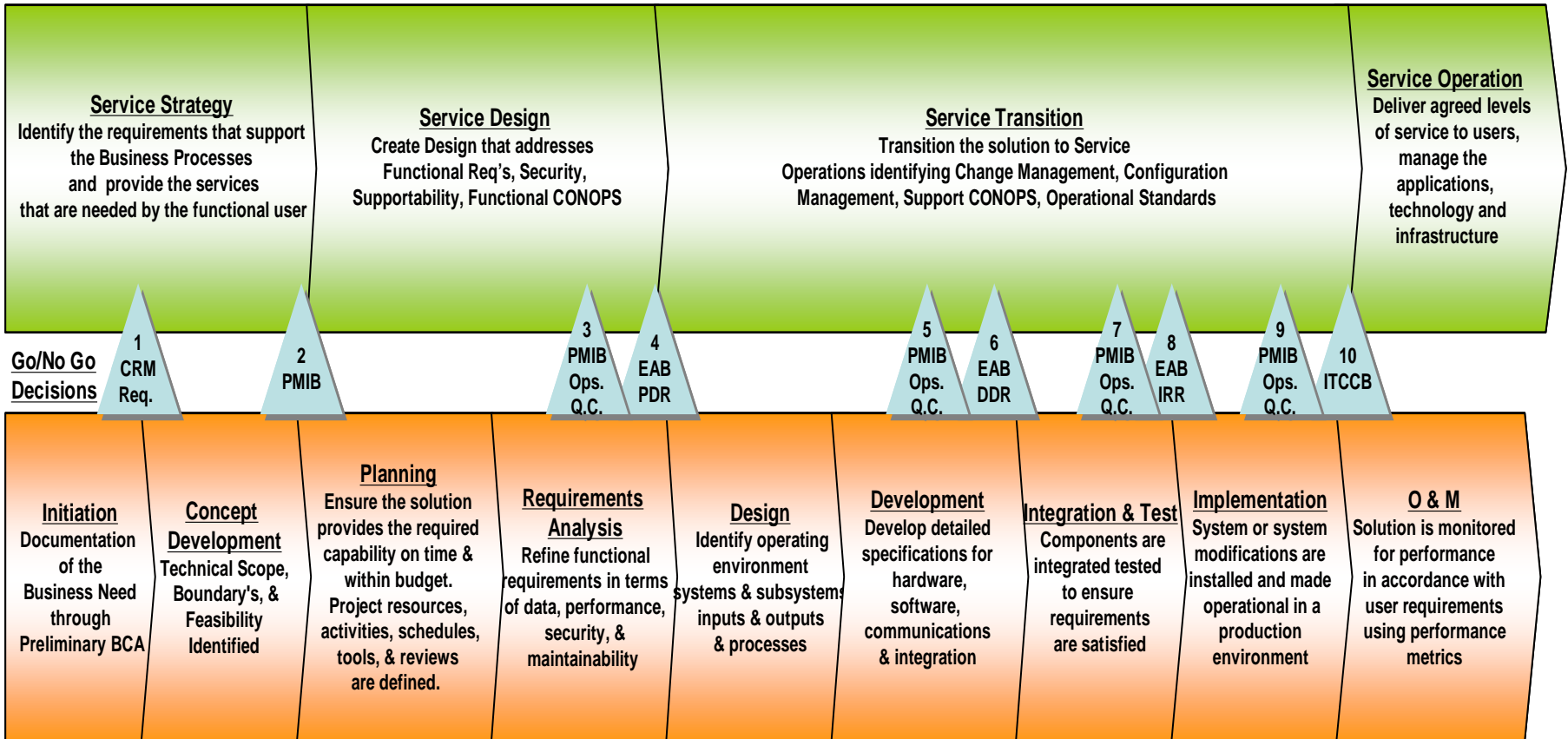

MDA Uses ITIL Framework to Deliver Effective Service Management



MDA Operational Work Flow

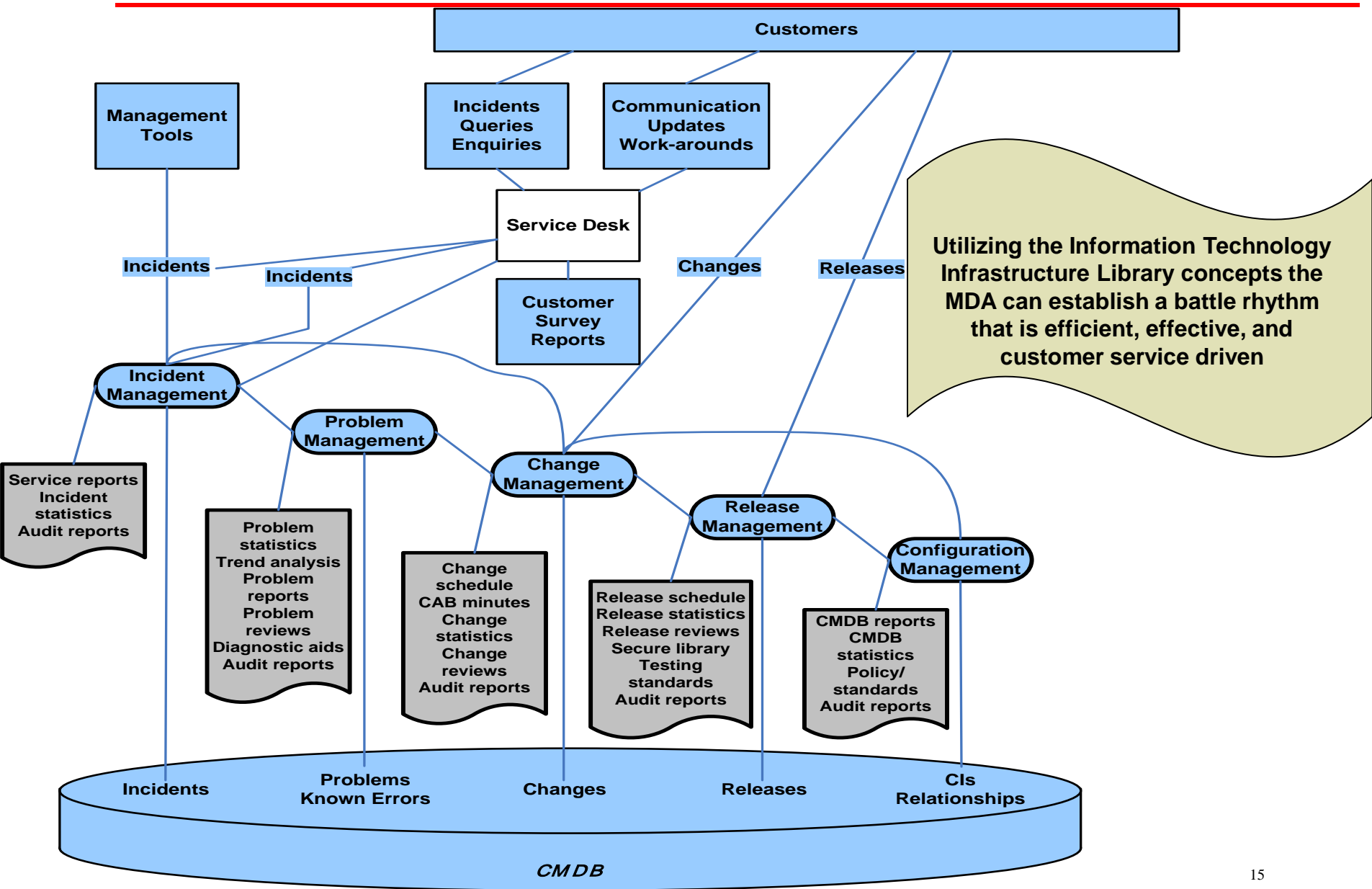



MDIOC

The MDIOC is a shared communications and computing utility that is leveraged across multiple MDA programs executing concurrent events

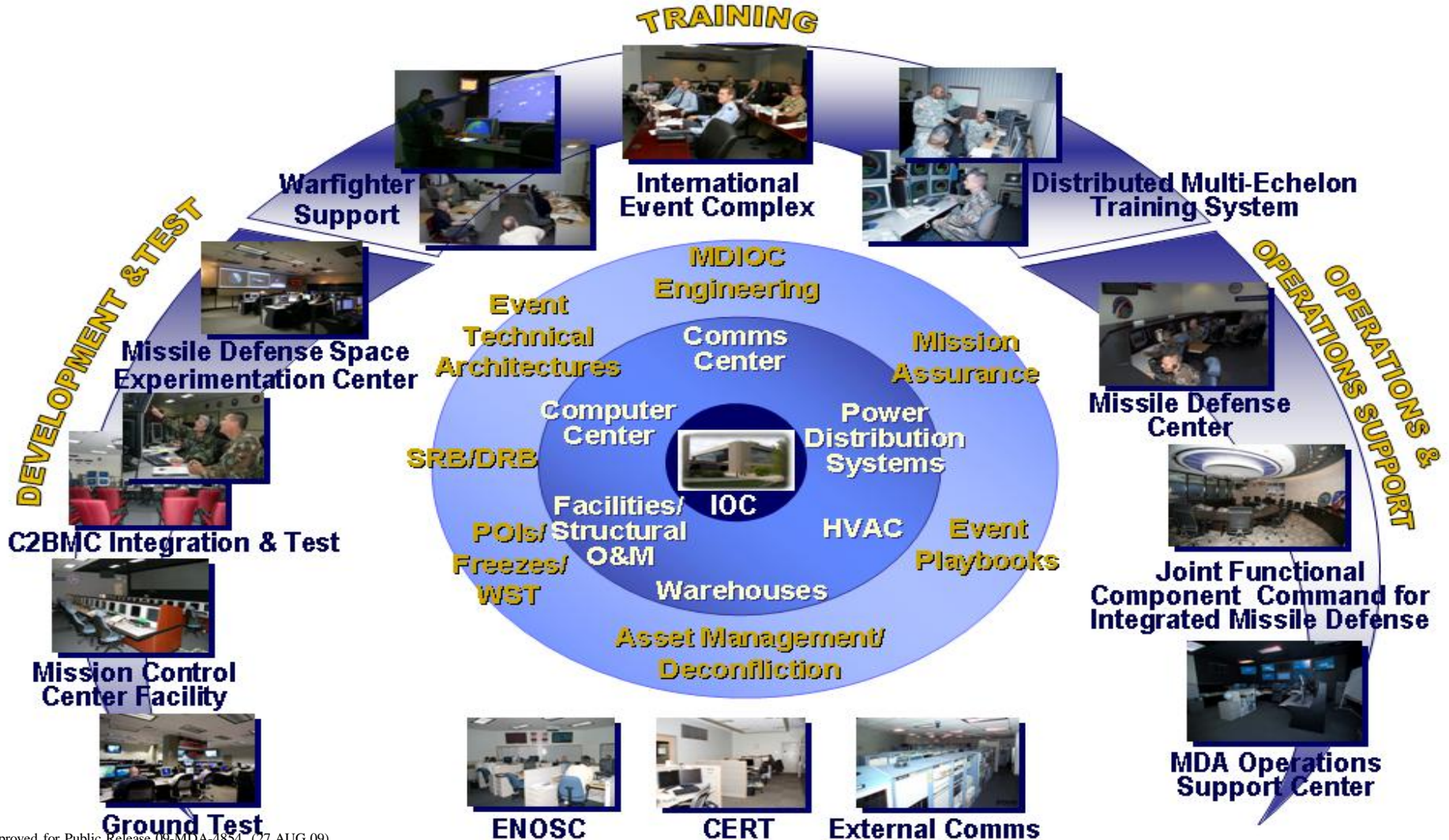



Summary

- **Small businesses provide critical support to the Missile Defense Agency and are considered a value added partner**
- **Opportunity exists for continued Small business work in both the MDIOC and the Information Management & Information Technology operations areas**
- **DOC has several focused technology research efforts to support Information Assurance in the Agency**



Questions

UNCLASSIFIED

Operations Overview (U)

Approved for Public Release
09-MDA-4855 (27 AUG 09)



September 1, 2009

SMSgt Jeffrey Baca
Superintendent, Enterprise Network Operations
Missile Defense Agency

UNCLASSIFIED



MDA DOCO Mission

MDA Enterprise Network Operations (NetOps) delivers enterprise IT capabilities including:

- Integrated service delivery
- Support transparent information access
- Incident resolution
- Provide information confidentiality, integrity and availability



MDA DOCO Goals

- **Centralized General Services Network Management**
 - Common Toolset - Standardized Enterprise Processes
 - Application and Storage Management
 - Incident Management and Problem Resolution
 - Change Management
 - Network Load Balancing, Bandwidth Management
- **Single Authoritative Source for Status Reporting For Business and General IT Services**
 - Vulnerability Assessment Reporting
 - Situational Awareness
 - Internal Status Reporting
 - Confidentiality, Integrity, and Availability of NetOps Information
- **Provide Robust, Redundant, and Reliable Monitoring**
 - Executive Dashboard
- **NetOps Survivability**



Support Profile

- **Supported User Base** **10,000**
- **Number of Workstations** **9,600**
- **Number of Servers** **1,100**
- **Number of Special Circuits** **493**
- **Number of Sites** **150**
- **Number of Supported Applications** **86**

- **Major IT Services Supported**

- IT Service Desk
- Event Management
- Application Management
- Systems Management
- Network Management
- Telecommunications Management
- Information Assurance
- Enterprise Web/E-Mail Services

- **IT Service Management Functions**

- Incident Management
- Problem Management
- Change Management
- Release Management
- Configuration Management
- Availability & Capacity Management
- IT Asset Management



Project Examples

- **Remedy 7.5 Upgrade**
 - Change Management
 - Asset Management
- **HP Open View Suite (NetOps Situational Awareness)**
 - Universal Configuration Management Database (UCMDB)
- **Network Discovery**
 - Discovery and Dependency Mapping Inventory (DDMI)
- **Intrusion Detection System Tech Refresh**
 - McAfee Host Intrusion Prevention System (HIPS)



Small Business Integration

- **Prime Contractor – Northrop Grumman**
 - Joint National Integration Center Research & Development Contract (JRDC)
- **Small Business are engaged via JRDC Prime**
 - Sub-contracting arrangements
 - Outsourced efforts
 - Northrop Grumman mentoring program
- **IT Equipment Procurement**
 - JRDC procures through multiple business sources





Primary Missile Defense Integration and Operations (MDIOC) Contract Vehicles

**Roxanne Banks
Director of Contracts, MDIOC**

Approved for Public Release
09-MDA-4867 (28 AUG 09)



Briefing Overview

- **MDIOC Contracting Department (DACJ)**
- **Primary MDIOC Contract Vehicles**
 - **Joint National Integration Center (JNIC) Research and Development Contract (JRDC)**
 - **JNIC Technical Advisory and Assistance Services**
 - **Warfighter Support SETA**
- **DACJ Contracting Challenges**

Approved for Public Release
09-MDA-4867 (28 AUG 09)



MDA/DACJ Organization

The DACJ mission is to provide contract management and business advice for missile defense integration and operations activities conducted within the MDIOC facility

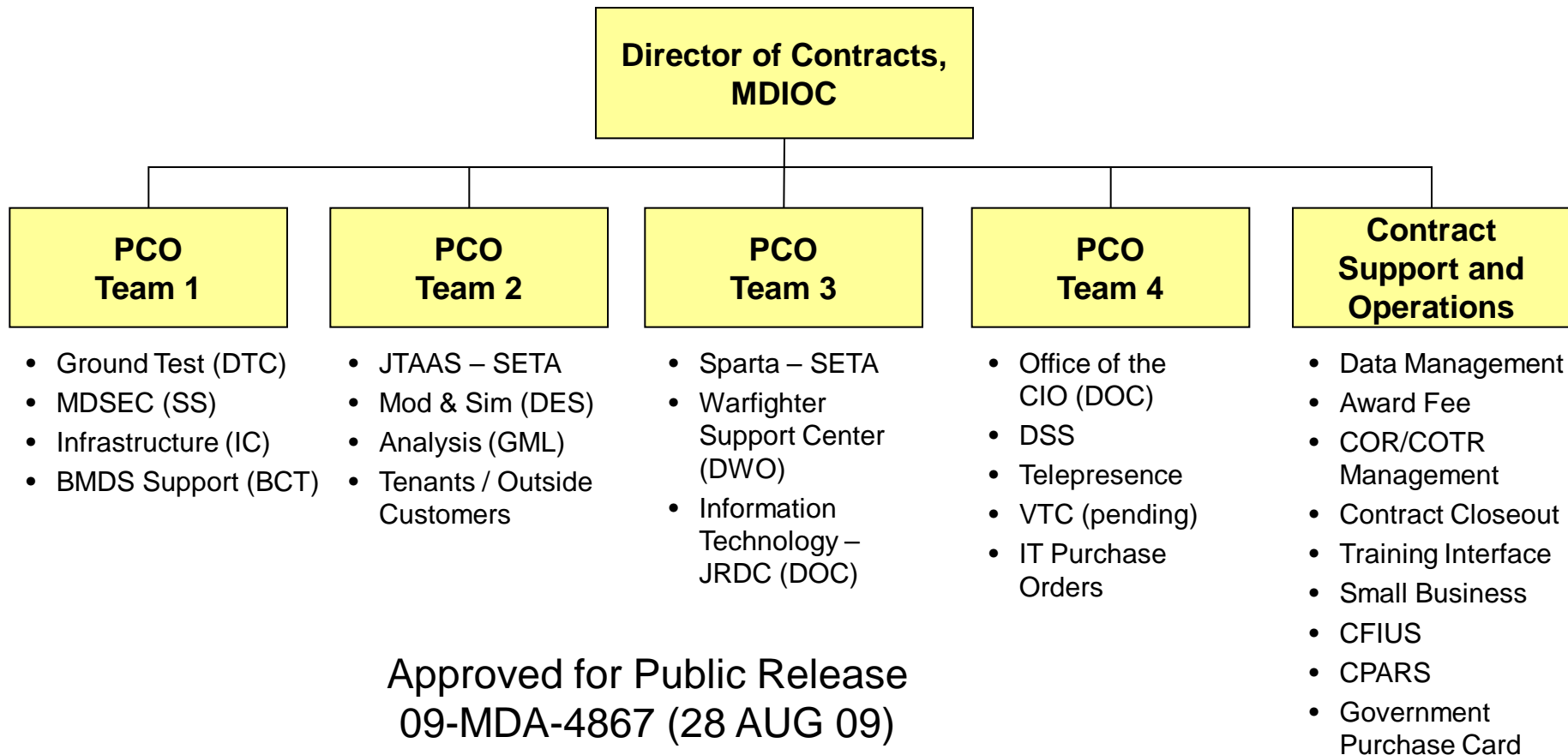



JNIC Research & Development Contract (JRDC)

NORTHROP GRUMMAN



- Analex
- ARES
- Boecore
- Boeing
- Booz Allen Hamilton
- CAS
- COACT
- CollaborX
- COLSA
- CSC
- Davidson Tech
- ITT Industries
- L3 Communications
- LC Wright
- Lockheed Martin
- Marzen Group
- MEI
- Metron
- Phacil
- Raytheon
- RNB Tech
- SAIC
- SPARTA
- TBE



JNIC Research and Development Contract

- **Contract # H95001-05-D-0002**
- **Prime Contractor is Northrop Grumman**
 - **~24 subcontractors**
- **~40 active Task Orders providing:**
 - **Design, development, experiment, analysis, engineering services and management programs and controls to support current and evolving missions at the JNIC**
 - **Operations and maintenance, support services, engineering services, of the common support system**
- **Some work may transition to MiDAES upon contract awards**

Approved for Public Release
09-MDA-4867 (28 AUG 09)



JRDC Contract Fact Sheet

Program Name	JRDC
PCOs	Ms. Roxanne Banks Mr. Art O'Dea Ms. Darlene Smith Ms. Sandra Yaden
Contract Number	H95001-05-D-0002
Contractor	Northrop Grumman
Contract Type	IDIQ
Contract Value	\$2.5B / all options exercised Roughly \$250M per year
Current Period of Performance	Contract Year 3 – Feb 1, 2008 – Jan 31, 2010
Max Period of Performance	31 Jan 2016

Approved for Public Release
09-MDA-4867 (28 AUG 09)



JNIC Technical Assistance & Advisory Services (JTAAS) Contract

JOINT NATIONAL INTEGRATION CENTER
TECHNICAL ADVISORY & ASSISTANCE SERVICES

- **Prime Contractor is ManTech International**
 - **6 subcontractors: SI International, ASI, AEGis, Axiom, BAE Systems, and DCS Corporation**
- **Contract Scope**
 - **Assist Government personnel with oversight of performance and execution of the JRDC**
 - **Direct technical, infrastructure, and administrative support to the MDA Government staff at MDIOC**
- **Strict organization Conflict of Interest Clause prohibiting companies on the JTAAS contract from performing on the JRDC, thus enabling the JTAAS Team to assist the Government with all contractual actions and provide objective oversight of the JRDC Tasks**
- **Will transition to MiDAES upon contract awards**



JTAAS Contract Fact Sheet

Program Name	JTAAS
PCO	Ms. Darlene Smith
Contract Number	H95001-07-F-0001
Prime Contractor	ManTech International
Contract Type	FFP / Cost Plus
Contract Value	Roughly \$12M per year \$110M / all options exercised
Current Period of Performance	Award Term 2: Sep 1, 2009 – Aug 31, 2011
Max Period of Performance	31 Aug 2013

Approved for Public Release
09-MDA-4867 (28 AUG 09)



Warfighter Support Contract

- **Prime Contractor is SPARTA, Inc., dba Cobham Analytic Solutions**
 - **9 Subcontractors**
 - **Major Subcontractors include: NG TASC; SAIC; General Dynamics and CSC**
- **Contract Scope**
 - **Provide Technical and Administrative support to the Warfighter Support Center/DWO, Joint Staff/Service Integration Cell/DWR, and Material Readiness Management/DWL, and the Operations Support Functional Area**
- **Will transition to MiDAES upon contract awards**



Warfighter Support Contract Fact Sheet

Program Name	Warfighter Support
PCO	Mr. Art O'Dea
Contract Number	H95001-07-F-0002
Prime Contractor	SPARTA, Inc., dba Cobham Analytic Solutions
Contract Type	FFP / T&M
Contract Value	Roughly \$15.5M per year \$31,882,374M / all options exercised
Current Period of Performance	Feb 1, 2008 – Jan 31, 2009
Max Period of Performance	31 Jan 2014

Approved for Public Release
09-MDA-4867 (28 AUG 09)



Decision Support System

www.FBO.gov

- **Solicitation # H95001-09-R-0002**
- **Full & Open Procurement (excludes BMDS primes)**
- **NAICS Code 541 (Professional, Scientific, and Technical Services) / 541512 (Computer Systems Design Services)**
- **30% Subcontracting Business Goal**
- **Synopsis**
 - **The Decision Support System is a complex system comprised of people, business processes, workflows, system automation, and decision models, with governance and standards to support MDA leadership in synchronizing and integrating the BMDS Baselines (Resource, Schedule, Technical, Contracts, Test, and Operations) for rapid development of decision options and trade-offs for program cost, schedule, and performance.**

Published Milestones

- **Industry Day #1**
12-14 August 2009
- **Draft RFP**
9 September 2009
- **Pre-Solicitation Industry Day**
25 September 2009
- **Final RFP**
14 October 2009
- **Pre-Proposal Industry Day**
23 October 2009
- **Proposals Due**
25 November 2009
- **Contract Award**
2nd Quarter FY 2010
- **Start Performance**
1 April 2010

Approved for Public Release
09-MDA-4867 (28 AUG 09)



Issues for the MDIOC Contracting Directorate

- **Workforce recruitment and retention**
 - **Difficulty in finding qualified Contract Specialist**
 - **Government-wide problem**
 - **Impacts ability to support operations**
- **Contracting Officer Representatives (CORs) and Contracting Officer Technical Representatives (COTRs)**
 - **Critical to contract surveillance process and basic project management**
 - **Communication**
 - **Training and certification**
- **Addressing Organizational Conflict of Interest (OCI) concerns**
 - **Ensuring the perception of an OCI is thoroughly investigated and negated**

Approved for Public Release
09-MDA-4867 (28 AUG 09)



Questions?

Approved for Public Release
09-MDA-4867 (28 AUG 09)



MDA IT Small Business Conference

**1 September 2009
Colorado Springs, CO**

MDA Implementation Engineering

**Presented by:
Mr. Carter Elmore (MDA/DOCE)**



Agenda

- **Mission / Goal**
- **Scope of Responsibility**
- **Engineering Functions**
- **Staff Composition**
- **Past Successes**
- **Future Focus Areas**



MDA DOCE Mission and Goal

- **Mission**

- **MDA/DOCE, the Implementation Engineering (IE) organization, oversees the day-to-day and strategic execution of NetOps Configuration Management, including Change Management, Release Management, and Asset Management.**

- **Goal**

- **The goal of systematic implementation engineering is to standardize procedures and processes to promptly handle all changes in order to minimize the impact of change-related activities and, therefore, improve day-to-day stability of the MDA business networks.**



MDA DOCE Scope of Responsibility

- **The scope of Implementation Engineering encompasses the MDA general services and test networks which include both the Classified and Unclassified networks plus any associated devices and services under the MDA CIO's purview.**
 - **Management of changes to baseline service assets and configuration items throughout the entire service lifecycle**
 - **Development of processes, systems, and functions to package, build, test, and release into production new products, components, and services**
 - **Establishment of services specified in the Service Catalog before final transition/handover to service operations**



MDA DOCE Engineering Functions

- **Design Engineers**
 - Develop detailed design artifacts based on architectural specifications
 - Coordinate with vendors for best practice analysis and configuration detail
 - Provides bill of material and detailed costing data
- **Implementation Engineers**
 - Conduct test and evaluation of detailed design within lab construct
 - Develop detailed implementation and integration plans
 - Coordinates and supervises release packages through O&M assets
- **Sustainment Engineers**
 - Perform performance tuning and optimization of operational services
 - Responsible for the operation of the “service” rather than the “server”
 - Executes changes based on “well-crafted RFCs” in support of projects, O&M Tasks, and Sustainment Engineering efforts



MDA DOCE Staff Composition

- **Baseline Level of Effort Sustainment Engineering**
 - Level of Effort staffing focused on improving existing services
 - Capacity Management, Performance Tuning and Optimization, Lifecycle Refresh of Existing Systems
 - MDA Test and Integration support for exercises and events
 - Ground Test, Flight Test, Real World Contingencies
- **Discrete Project Engineering Services**
 - Dynamic staffing levels and expertise used to deliver discretely funded engineering services to projects
 - Exchange 2007 Deployment
 - SharePoint 2007 Service Implementation
 - Office Communication Services
- **Base Realignment and Closure (BRAC)**
 - Temporary staff surge to manage BRAC transitions from NCR
 - IT Service Transition, Decommissioning, Von Braun III Stand-up



Previous Successes

- **BRAC migration to COS**
- **Unclassified Exchange 2007 Stand-up and Migration**
- **Technical Refresh of Intrusion Detection Systems**
- **Enterprise Remedy ITSM Deployment**
- **Core Site Connectivity**
- **Consolidated NetOps Tools Deployment**
- **Multiple Tailsite and MANsite Implementations**



Future Focus Areas

- **Microsoft Office SharePoint Services**
- **Exchange 2007 Implementation and Migration**
- **Microsoft Office Communication Services**
- **802.1x Network Access Control**
- **Integrated Test Lab**
- **Unclassified BRAC Migration**
- **MDIOC Transport Refresh**
- **HQCC Standup**
- **Von Braun III Buildout**



Questions?

UNCLASSIFIED

Small Business At MDA: A Contracting Perspective (U)



Barney Klehman
Director of Contracting

Missile Defense Agency
NDIA Small Business IT Conference

01 September 2009



UNCLASSIFIED

Agenda (U)



09T-1148.02

- **Defining a Small Business**
- **Political Issues**
- **Business Issues**
- **Potential Frameworks for the Future**
- **A Few Final Thoughts**



What Is A Small Business? (U)

09T-1148.03

- **A Business Entity – But “Small” is Relative**
 - Relatively Smaller than Other Competitors in the Same Field (American Motors vs Ford, GM)
 - May Fit “Traditional” Paradigm of a Small Company with Limited Resources; Or
 - May Actually be a Large Company with Substantial Resources – Just Smaller than Others in Field
 - It Can All Depend on the NAICS Code
 - Question: Are You Really “Small” When Your Company has Hundreds of Employees?
- **A Political Entity**
 - Substantial Socioeconomic Support from Congress and the “Public”



Defining A Small Business (U)

09T-1148.04

- **The Key Issue: Selection of a NAICS Code**
 - This is Done Very Carefully; We Realize the Impact
 - Reflects the “Real” Type of Work Anticipated
 - No “Games” are Played to Ensure that Specific Contractors or Vendors are Included
 - If Two or More NAICS Codes Overlap, MDA will Choose the Code Which Enables the Widest Amount of Competition to Meet the Reqt
 - Size Status is Based on Current Staffing or Earnings, Not Determinations Made Years Ago
 - May be Limited by NAICS Code Definitions Even Though They Appear to be Unrealistic
 - **The Code Descriptions and \$/Size Stds Need Change**
- **MDA Goal: Fair Competition for Everyone!!**



UNCLASSIFIED



Political Issues (U)

09T-1148.05

- **How Much of the Pie should go to Small Business?**
 - Congressional Oversight/Expectations - % Goals
 - OSD Oversight/Expectations - % Goals
 - Internal Agency Oversight/Expectations - % Goals
 - Senior Leadership
 - Small Business Office
 - Program Manager Expectations/Concerns – Different?
- **Key Question: How Good is “Good Enough?”**
 - Must Match Mission Complexity vs Resources Required
 - Mission Accomplishment = All Four Prog Mgmt Criteria
 - Is/Should The Standard be Different for Small Business?
- **How Can The Equation be Changed?**
 - Externally – Small Business Demonstrates Its Value
 - Internally – Willingness to “Take a Chance”
- **What is Really Reasonable? Achievable?**



UNCLASSIFIED



Business Issues (U)

09T-1148.06

- **There are *Three* Types of Competition**
 - Small Business vs Large Business
 - Small Business vs Small Business
 - Challenger vs Incumbent (“Why Change?”)
 - **This is Often the Most Important!**
 - **Critical Choice During Acquisition Strategy**

- **What Is Small Business’s Advantage?**
 - Initiative?
 - Better Technical Capability?
 - Resourcefulness?
 - Cheaper Overhead/Cost of Doing Business?
 - There must be Good, Definable Advantages



UNCLASSIFIED



Business Issues (U)

09T-1148.07

- **Four Blocks of Program Management**
 - Technical Performance
 - Cost
 - Schedule
 - Risk

- **Past Performance is the Most Important**
 - Provides Confidence Level for Program Mgr
 - Demonstrated Performance vs Promises
 - Includes Past Subcontract Performance
 - Transition to Prime Status Considered Less Risky
 - Even Better if Past Perf is on “MDA” Prime Contracts

- **Small Business Set-asides**
 - Two or More SB’s that have the Likelihood of Meeting the Four Criteria of Program Mgmt Above



UNCLASSIFIED



Business Issues (U)

09T-1148.08

- **Risk**
 - The Salient Factor in Acquisition Strategy
 - Most Program Managers are Risk Averse
 - Especially if Incumbent has Performed Well
 - Especially if PM Fears SB Challenger will have Limited Resources, Expertise, Experience
 - Is Failure Affordable? The SB must Overcome Fear of the Unknown – the Key Barrier
- **Incumbent's Perspective**
 - Good Performance Shouldn't Equal a Loss of Business to Satisfy a Political Agenda
- **Small Business Perspective**
 - Above may be True, Unless the Small Business can Offer Better Performance!



What Does The Future Hold? (U)

- **More Emphasis on Small Business Strategy**
 - Particularly in the Services and IT Areas
 - Seta Support (Can Be IT – E.G. MIDAESS Acquisition)
 - Infrastructure Support (Key IT Opportunities)
 - More Emphasis in Individual Elements
 - But Only as Part of Integrated BMDS
 - Global BMDS Support Contracts?
 - By Location
 - Across Locations
 - May be Mixture of LB and SB
- **Much More Emphasis on SB Subcontracting**
 - Less Emphasis on “Corporate” Plans
 - More Incentives in Contracts – With Teeth!!
 - Some RFPs may have SB Subcontracting Reqt
 - Idea is to Emphasize Total Overall \$ To SB



UNCLASSIFIED



A Few Final Thoughts (U)

09T-1148.010

- **The Barriers are NOT Impenetrable, But:**
 - No “Entitlement” for Small Business
 - Emphasis is on Performance Versus Promises
 - If You have Facts and a Good Argument, Your Chances Increase Dramatically
 - Increasing SB Share = Overcoming Inertia
 - Increasing SB Share = Overcoming Fear
- **For Program Managers, Mission is Priority**
 - Internal Agency Acquisition Planning Process Ensures that Small Business Gets a Fair Hearing
- **There is Only So Much “Pie” Available to be Eaten; So Pick The Right Slice!**

Overview of Information Assurance (U)



Dr. Theodore Mueller
Deputy Director, DOCV
Missile Defense Agency

September 1, 2009

Approved for Public Release 09-MDA-4860 (28 AUG 09) Material cleared for public release can be reused in its original form any time, any place. Any updating, changing or combining of previously cleared material will form a new document that requires the material be re-submitted for a new public release clearance. Please re-submit any new material with the past clearance documentation. A marked copy of the document indicating where new information is placed will help speed the review.



Information Assurance (U)

- **Definition** – Measures that **protect** and **defend** information and information systems by **ensuring** their **availability, integrity, authentication, confidentiality, and non-repudiation**. This includes providing for **restoration** of information systems by incorporating **protection, detection, and reaction** capabilities

Three MDA Networks:

1. **Mission** – Network directly supporting the missile defense operational mission, i.e., directly contributes to target identification and missile launch
2. **Test** – Network indirectly supporting the operational mission, i.e., test network, assists the Warfighter
3. **GENSER** – Network supporting administrative classified and unclassified users



BMDS View

Legend
 SA: Strategic Awareness
 FC: Fire Control
Phase of BMDS
Goal of Protection

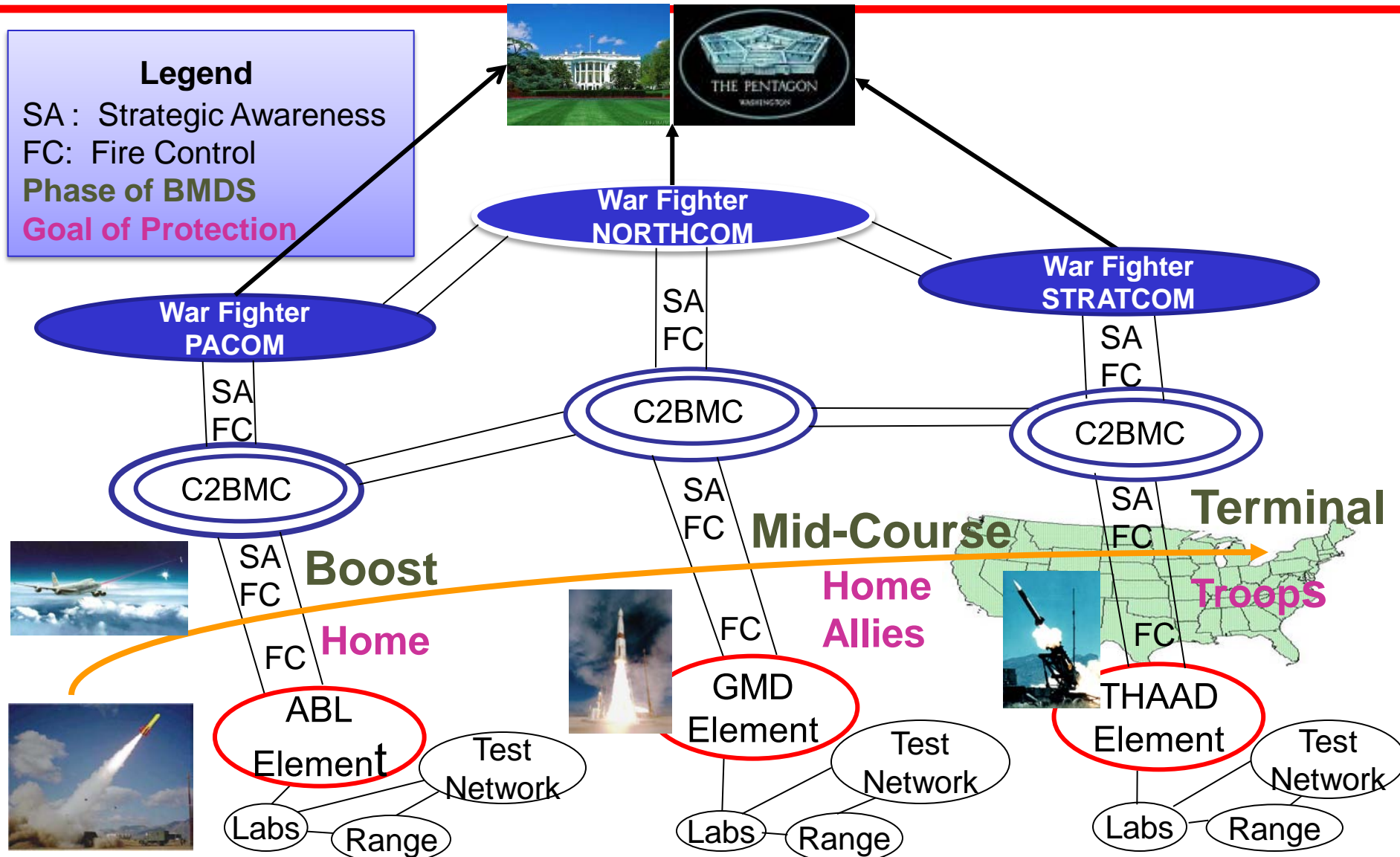



MDA Mission is Worldwide (GMD Example)

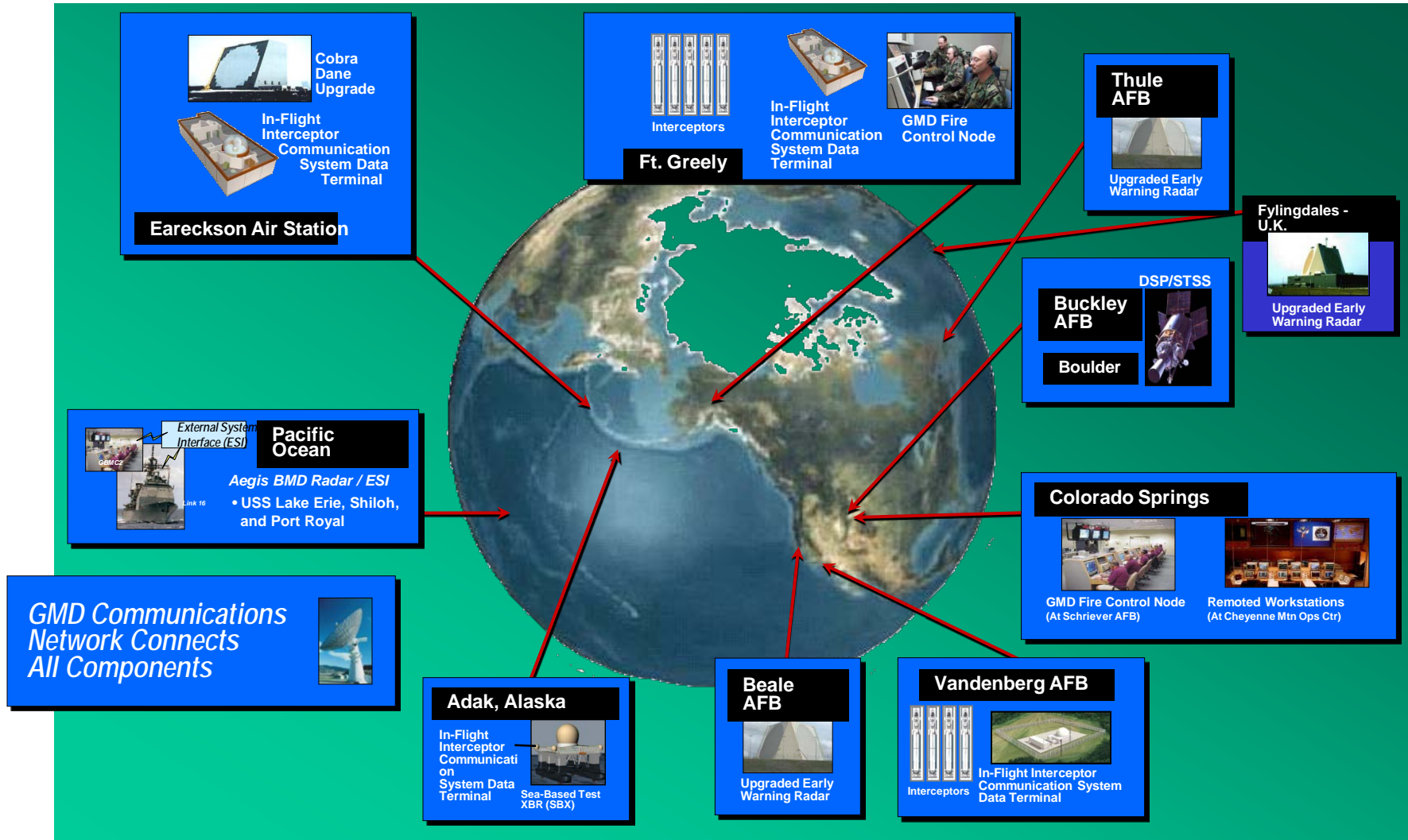



MDA C&A Process Concept

IA Capability Maturity Model Integrated (CMMI)

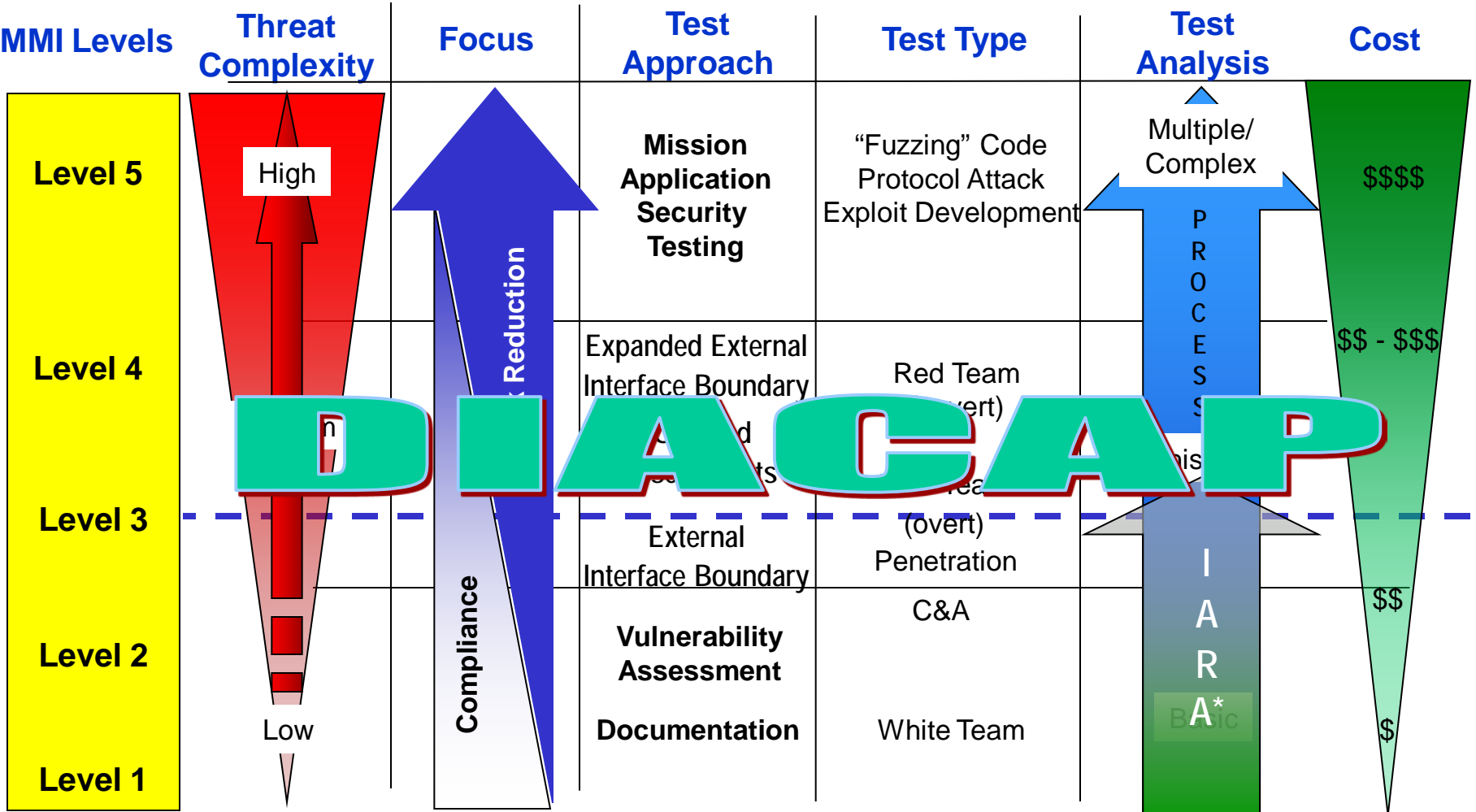

Defined, Disciplined, Repeatable, and Defendable Process



Potential Business Opportunities

Current Contractor: Dynetics – value at approximately \$6.5m

Key requirement – perform functions better, cheaper, and more efficiently:

Testing (Defense Information Assurance Certification and Accreditation Process (DIACAP)) –

Better – more sophisticated test tools, scenario driven tests, tools that identify malicious code

Cheaper – remote testing tools instead of deploying test teams

Efficient – tools that combine results of other tools, automated analysis

Training (DoD 8570.01) –

Better – combine classroom, hand's-on, tailored, multi-levels

Cheaper – distant learning, export via CD or Web

Efficient – centralized management, decentralized execution



Summary

- **Information Assurance is mandated, growing in importance and here to stay**
- **Business opportunities exist in identifying key IA activities or processes and offering a way to perform them better, cheaper, and more efficiently**
- **Key activities include:**
 - **Testing**
 - **Analysis**
 - **Develop IA certification & Accreditation packages**
 - **Training**
 - **Tools**
 - **Archiving artifacts, findings, etc.**

Cost Benefit Analysis must justify Government action to contact



BACKUP



Controls Validation Testing

- **Mandatory legal requirement under Title 10, US Code, Section 2224, OMB Circular A-130, and DOD regulations and policies**
- **110 Information Assurance (IA) Controls are tested resulting in:**
 - **No finding – Tested IA Control is compliant**
 - **CAT I allows primary security protections to be bypassed, allowing immediate access by unauthorized personnel. Any identified weaknesses must be mitigated within 30 days**
 - **CAT II – has the potential to lead to unauthorized system access or activity**
 - **CAT III – may impact IA posture but are not required to be mitigated in order to receive an Authority to Operate**



Certification and Accreditation Decisions

• Interim Authorization to Test - IATT

- Special case for authorizing testing in an operational informational environment (pre-deployment / test environment)
- Specified period of time

• Authorization to Operate - ATO

- Applies only to operationally ready information systems (operational environment)

• Interim Authorization to Operate - IATO

- Issued by CIO when CAT I weaknesses exist
- IATO must be accompanied by Plan of Actions and Milestones (POA&M)
- Intended to manage IA security weaknesses

• Denial of Authorization to Operate – DATO

- Remains in effect until all corrective actions identified in the POA&M are implemented



Risk Assessment Methodology

Aggregating Individual Issue Risk to Type, Site, Element Risks

Process is standardized across MDA Mission, Test, and GENSER networks

Type & Site Risks Aggregated to GMD Element Risk

GMD Element SSAA and Risk Assessment

Technical Interchange Meetings (TIMs)

- C&A Team
- Government
- Developer
- Warfighter



Multiple Issue Risks Aggregated to Type or Site Risk

Type X to Element Y to BMDS RAP Sheet		
Consequence	Weight	Likelihood
Type X Criticality vis-a-vis Element Y		
Imported Risk Rating from Type X		
Low With Redundancy	100	Type Carries a Low Risk Rating
Low Without Redundancy	150	Type Carries a Medium Risk Rating
Medium With Redundancy	150	Type Carries a High Risk Rating
Medium Without Redundancy	200	
High With Redundancy	200	
High Without Redundancy	250	
Intelligence Factors		
Medium Without Redundancy	200	No known information suggesting a targeted exploit
High With Redundancy	200	Known information suggests potential of a targeted exploit
High Without Redundancy	250	
Site Factors		
Medium Without Redundancy	200	No known information at Site Hosting Type X impacts Risk
High With Redundancy	200	Known information exists at Site Hosting Type X. Report Site RAP value
High Without Redundancy	250	
Functionality of Type X		
Low With Redundancy	100	Role is contained within the Element
Low Without Redundancy	150	Role is critical to BMDS Interconnectivity / Communication
Medium With Redundancy	150	
Medium Without Redundancy	200	
High With Redundancy	200	
High Without Redundancy	250	
Element Y Weighting Within BMDS		
Boost	150	
Missiles	200	
Terminator	150	
Element Role is critical to BMDS Interconnectivity / Communication	200	

Single Type or Site Issue Risks

Multiple Issues for Single Component Aggregate to Component Risk		
Consequence	Weight	Likelihood
Low With Redundancy	100	Type Carries a Low Risk Rating
Low Without Redundancy	150	Type Carries a Medium Risk Rating
Medium With Redundancy	150	Type Carries a High Risk Rating
Medium Without Redundancy	200	
High With Redundancy	200	
High Without Redundancy	250	

GMD Type & Site Test Results and Risk Assessments

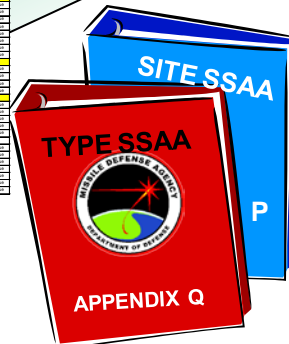



MDA IT Small Business Conference

1 September 2009
Colorado Springs, CO

MDA Unified Communications

Presented by:

Mr. Ken Neuhaus (MDA/DOCT)

Approved for Public Release 09-MDA-4858 (27 AUG 09)



Overview

- **Mission**
- **Contracts**
- **Projects**
- **Small Business Success**
- **Small Business Needs**



Mission

Provide telecommunications services to the MDA community, including; Land Mobile Radio, Telephone, Video Telecommunications, Secure Communications, Wireless Communication Systems, and Defense Red Switch Management





DOCT Contracts

- **Secure Communications**

- Government Accountable and Maintained
- Limited JRDC O&M Support
- Primarily Vendor Supported
- Procurement thru NSA



- **Administrative Telephone System**

- COS: JRDC O&M and Engineering Support
- HSV: ASD/CIMMS O&M and Engineering Support
- NCR: InfoStructure
- Vendor Support From Nortel and Avaya
- Procurement Via Vendors
- NCR Contracted Thru: Jan 2011



- **Land Mobile Radio**

- 50th CS: MCOM O&M Contract
- Procurement thru DAC





DOCT Contracts (Cont.)

- **Wireless Communications**

- Government Accountable and Maintained
- Primarily Vendor Supported
- Procurement Thru Vendors (AT&T, Verizon, Sprint)
- Contracted Thru: BPA/Varies



- **Defense Red Switch Network (DRSN)**

- 50th CS: MCOM O&M Contract
- JRDC Engineering Support Contract
- Vendor Support From Raytheon
- Procurement Via MIPR to Hill AFB, UT
- Contracted Thru: Sep 2009



- **Video Teleconferencing**

- MicroTech O&M and Engineering Support
- Contracted Thru: Nov 2010





Current Projects

- **TelePresence System Procurement**
 - RFI/RFP To Go Out This Year
- **VB III and HQCC Buildouts**
 - Procurement Thru JRDC & ASD/CIMS Contracts





Small Business Success

- **MCOM DRSN O&M Contract**
- **JRDC Engineering Support Contract (With It's Many Small Business Partners)**
- **MicroTech Video Teleconferencing Contract**



Small Business Needs

- **TelePresence System Procurement**
- **VTC O&M Contract Re compete**
- **HQCC & VBIII Buildouts**

Presentation For Missile Defense Information Technology Small Business Conference



September 1, 2009

Lee R. Rosenberg
Director for Small Business Programs
Missile Defense Agency



Missile Defense Agency Mission (U)

Develop an **integrated, layered** Ballistic Missile Defense System (BMDS):

- To defend the United States, its deployed forces, friends and allies
- From ballistic missiles of **all ranges**
- Capable of engaging them in **all phases of flight**



Missile Defense Goals (U)

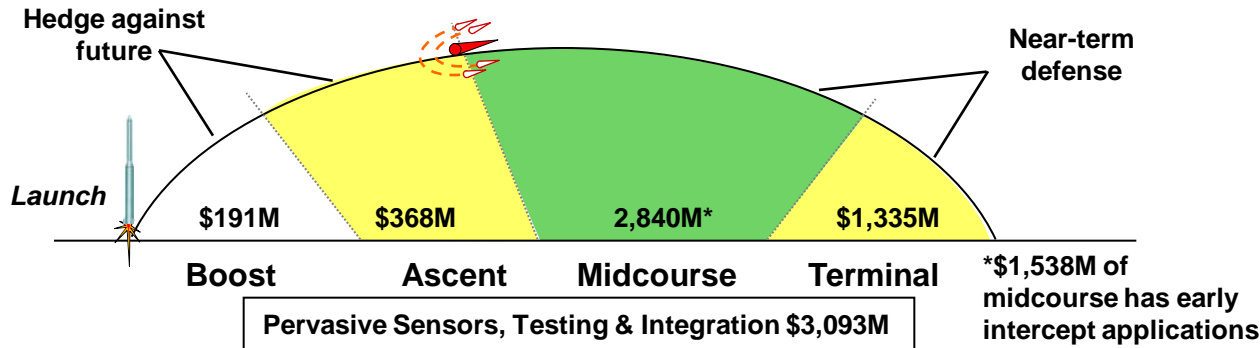

TY\$ in Millions	FY10
Development	4,162.4
Test	1,458.0
Fielding	1,491.1
Sustainment	714.9
Total	7,826.4

- **Enhance protection of deployed forces, allies and friends against existing threats**
 - Field more Terminal High Altitude Area Defense (THAAD) and Standard Missile-3 (SM-3) interceptors
 - Begin conversion of 6 additional Aegis ships
- **Maintain a long-range midcourse capability to defeat rogue state threats against U.S.**
 - Complete emplacement of 26 Ground-Based Interceptors (GBIs) at Fort Greely and 4 at Vandenberg Air Force Base
 - Extensive development to enhance GMD capability continues
 - Plan for a European Missile Defense to the extent allowed by law*
- **Balance midcourse Research & Development with early intercept Research & Development**
 - Terminate midcourse Multiple Kill Vehicle
 - Terminate Kinetic Energy Interceptor program
 - Cancel Air-Borne Laser (ABL) Tail #2 and focus program on Research & Development
 - Demonstrate early intercept technologies to hedge against threat growth

* European Missile Defense and other missile defense policies are under QDR cognizance



New Missile Defense Initiatives (U)



**Precision Tracking
Satellite System
Planning**



**Airborne Infrared
System To
Support BMD**

Transportable VLS



Land-Based SM-3



**Risk Reduction For
Extended Range
THAAD**

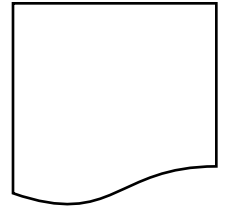

Other

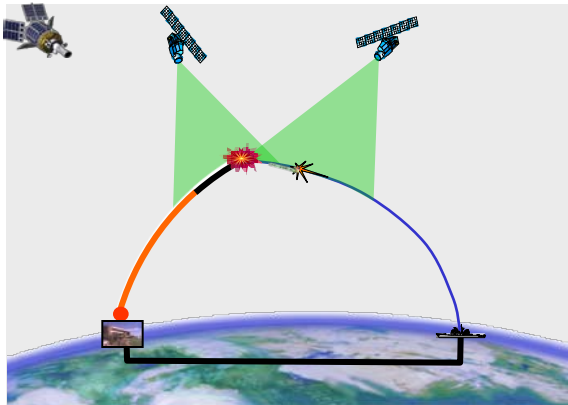

Engage on STSS

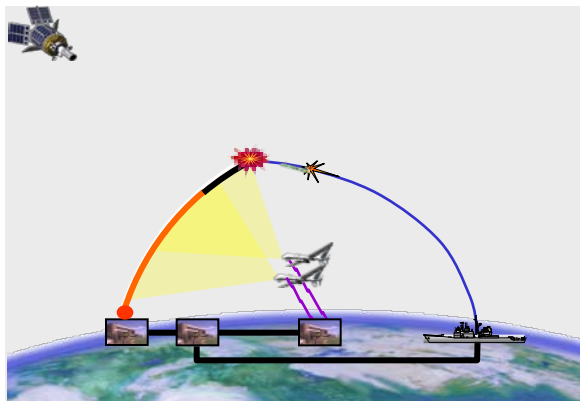

**Engage on Airborne Infrared (sea-based
SM-3)**

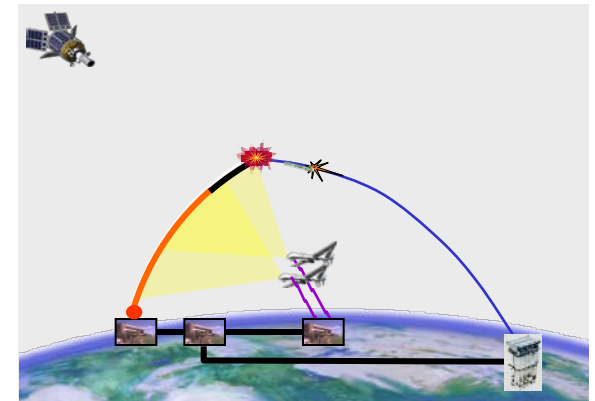

**Engage on Airborne Infrared
(land-based SM-3)**

*New Initiatives Will Increase MDA Government
Large And Small Business Opportunities Starting In FY10*



MDA Office of Small Business Programs Mission/Vision (U)

- The **Mission** of the Office of Small Business Programs (OSBP) is to enable the Missile Defense Agency to gain access to the efficiency, innovation, and creativity offered by small businesses
- OSBP has a **Vision** to remain an integral player and value added advisor in the development of MDA acquisition strategies to ensure compliance with laws, directives, goals, and objectives related to small business initiatives; to serve as a facilitator for accessing untapped small business resources; and to serve as an advocate for small business in MDA procurements



Small Business Utilization In MDA (U)

Statutory Small Business Goals for DoD:

- Total Small Business 23%
- Small Disadvantaged Business 5%
- Woman Owned Business 5%
- Service Disabled Veteran Owned 3%
- Historically Underutilized Business Zones 3%

➤ MDA estimates that 34.1% of its acquisition dollars eventually flows to small businesses

- 6.0% of MDA acquisition dollars are awarded as prime contracts to small businesses*
- 9.3% are awarded to small businesses as 1st tier subcontractors*
- MDA estimates another 18.8% of its acquisition dollars flow to small businesses through 2nd tier and below subcontracts**

15.3%
To SB's
documented*

MDA Total Acquisition Dollars*

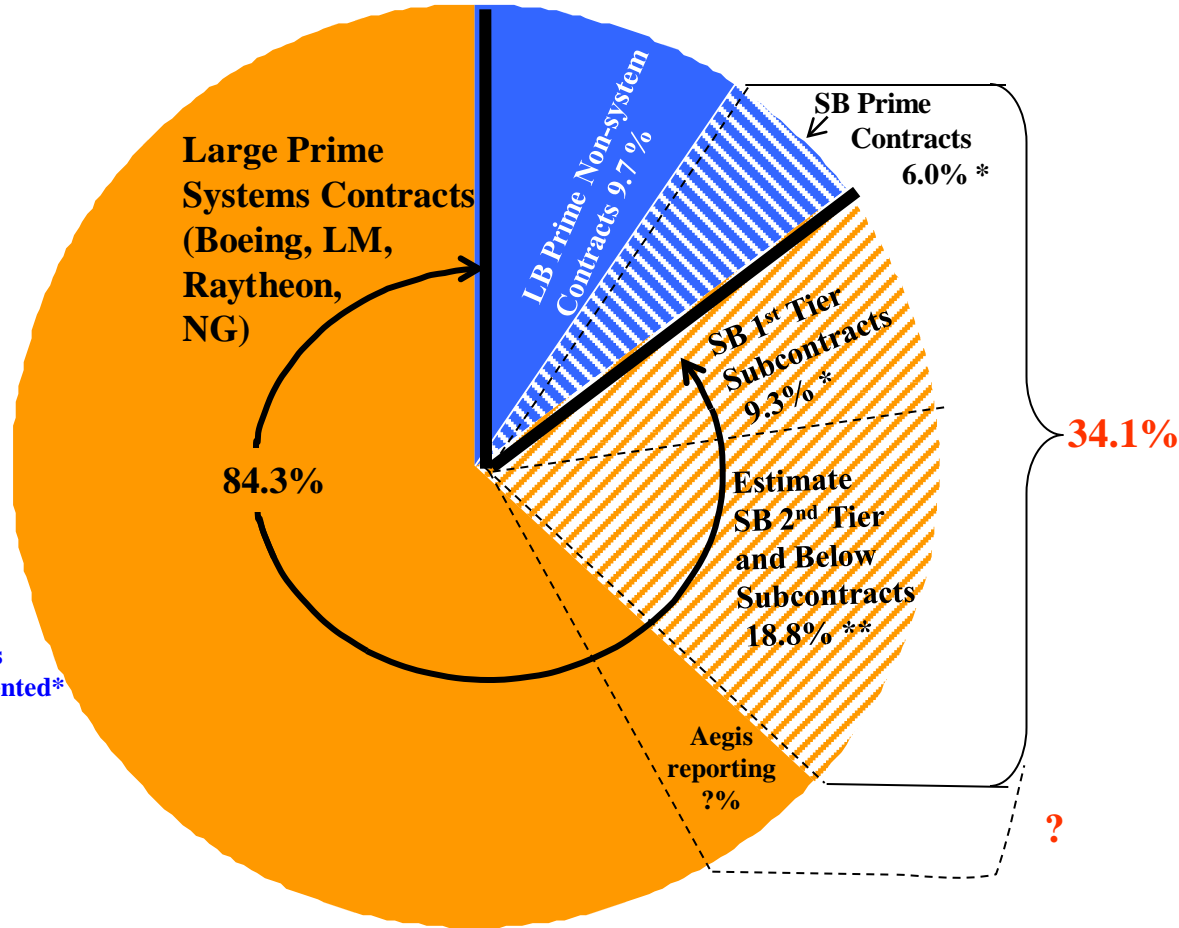

* Based on FY 08 reporting

** Based on FY 07 reporting



Small Businesses and MDA (U)

- **MiDAESS is the vehicle for future A&AS service contracting in MDA, so:**
 - Stay engaged (FBO, PSC, Draft RFPs, etc)
 - Identify your market within the Agency
 - Respond to sources sought
 - Find teammates
 - Performance counts
 - Look at both prime and subcontracting opportunities
- **Many subcontracting opportunities with LB Primes:**
 - Opportunities at all tiers
 - Engage SBLO's
 - Mentor-Protégé Program
- **SBIR/STTR Program**
- **Other prime/subcontracting opportunities lie in Infrastructure Support (e.g. facilities support, IT, etc)**



MiDAESS Advisory & Assistance Support (A&AS) Scope And Schedule (U)

- Work is aligned functionally for better BMDS “integration” and “sharing of expertise” across the Agency
- MDA will administer contract vice paying other government agencies’ administrative costs
- A&AS augments expanding MDA government workforce
- Two competitions in MiDAESS
 - Small Business Set Aside – 38%
 - Full and open – 62%
- Schedule
 - 17 JUN RFP released
 - 8 JUL final review with all offerers to include sample task orders
 - 17 AUG industry proposals due to MDA
 - ~ 90 days for source selection
 - 1st awards in 1st quarter FY2010

Functional Capability Group	Scope
Group 1: QSMA Support	<ul style="list-style-type: none"> • Quality, Safety, & Mission Assurance (QSMA) - 100% small business set aside
Group 2: Acquisition Support	<ul style="list-style-type: none"> • Acquisition • Readiness Management • International Affairs • Business and Financial Management • Legislative Affairs
Group 3: Engineering Support	<ul style="list-style-type: none"> • Systems Engineering • Test • Advanced Technology • Information Management & Technology Operations
Group 4: Infrastructure & Deployment Support	<ul style="list-style-type: none"> • Infrastructure and Environment • Warfighter Support Center
Group 5: Agency Operations Support	<ul style="list-style-type: none"> • Executive Administrative Support • Human Resources • Public Affairs
Group 6: Security and Intelligence Support	<ul style="list-style-type: none"> • Security and Intelligence Support - No small business set aside



Small Business and Advanced Technology Exploration (U)

- **Small Business Innovative Research (SBIR) and Small Business Technology Transfer (STTR) programs**
 - Fourth largest program in DoD
 - 160 SBIR Phase I awards, 90 Phase II awards in FY08
 - \$137 million SBIR/STTR funding in FY08
- **SBIR/STTR focus areas**
 - Reduce time from threat launch to intercept
 - Detect
 - Acquire
 - Track
 - Battle Management
 - Assured Communications
 - Fire Control
 - Interceptor fly out time (miniaturization)
 - Hit Assessment
 - System lifetime operational readiness and reliability



KEYNOTE SPEAKER INTRODUCTION (U)

Dr. Jim Armstrong

*CIO/Director, Information and Technology Operations (DOC),
Missile Defense Agency*





MDA IT Small Business Conference

**1 September 2009
Colorado Springs, CO**

MDA Enterprise Architecture

**Presented by:
Mr. Stuart Strong (MDA/DOCA)**



Introduction

- **Mission & Functions**
- **Project Examples**
 - **Architecture Standards**
 - **Wide Area Network Project Management**
 - **Facility IT Design**
 - **Event Communications Coordination**
- **Current Focus**
 - **Sharepoint Infrastructure**
 - **Storage Architecture**
 - **HQCC IT Design**
- **Summary**



Mission & Functions

- **The MDA Enterprise Architecture Team provides the following support to the Office of CIO and the agency:**
 - **Architecture Standards and Guidance**
 - **Wide Area Network Project Management**
 - **Communications Security Management**
 - **Facility IT Infrastructure Design**
 - **Headquarters Command Center**
 - **Von Braun III**
 - **Dahlgren Expansion**
 - **European Sites**
 - **MDA Event Communications Coordination**

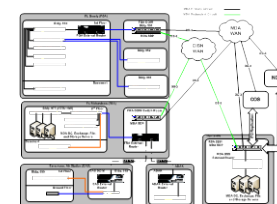
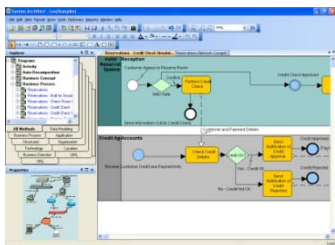



MDA Architecture Standards

- **MDA leverages key principles of the DoD Business Enterprise Architecture (BEA) v. 6.0**
- **DoD BEA is directly tied to the Federal Enterprise Architecture through the DoD EA Reference Models, compliant with DoDAF 2.0**
- **Close partnership with the Business Transformation Agency (embedded personnel)**
- **Evaluating Defense Acquisition Initiatives for:**
 - **Manpower Management**
 - **Facilities and Asset Management**
 - **Financial Management**



Wide Area Network Project Management

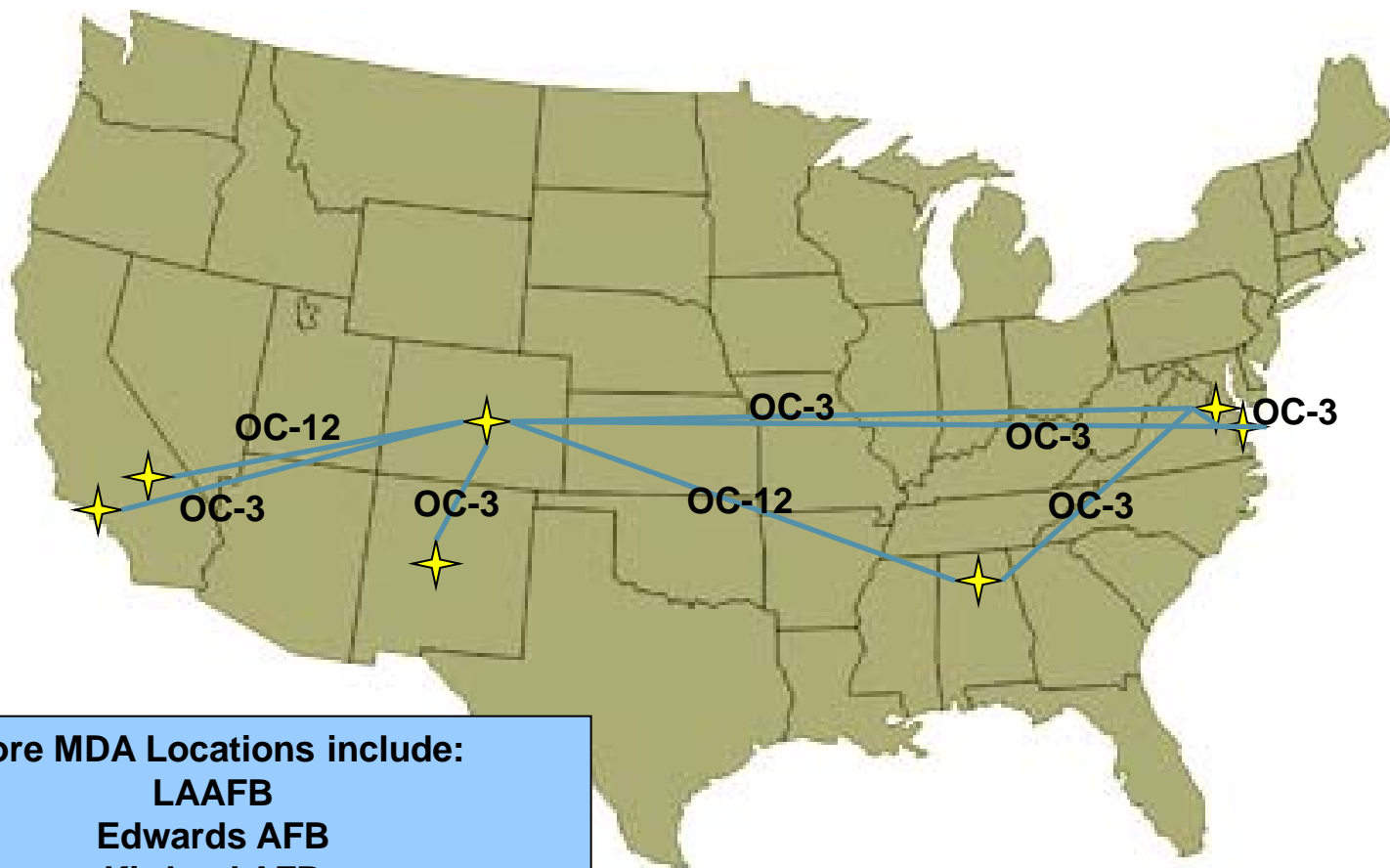

Core MDA Locations include:

LAAFB

Edwards AFB

Kirtland AFB

Schriever AFB

Redstone Arsenal

National Capital Region

Dahlgren



Facility IT Infrastructure Design



Von Braun III



HQCC



Event Communications Coordination

Event: AR 08A COCOM Ex (TTP) Data Architecture
 Dates: 22 – 27 June 2008
 Mission: Homeland/Theater/Regional Defense
 Scenarios: 4 WF and 6 SE

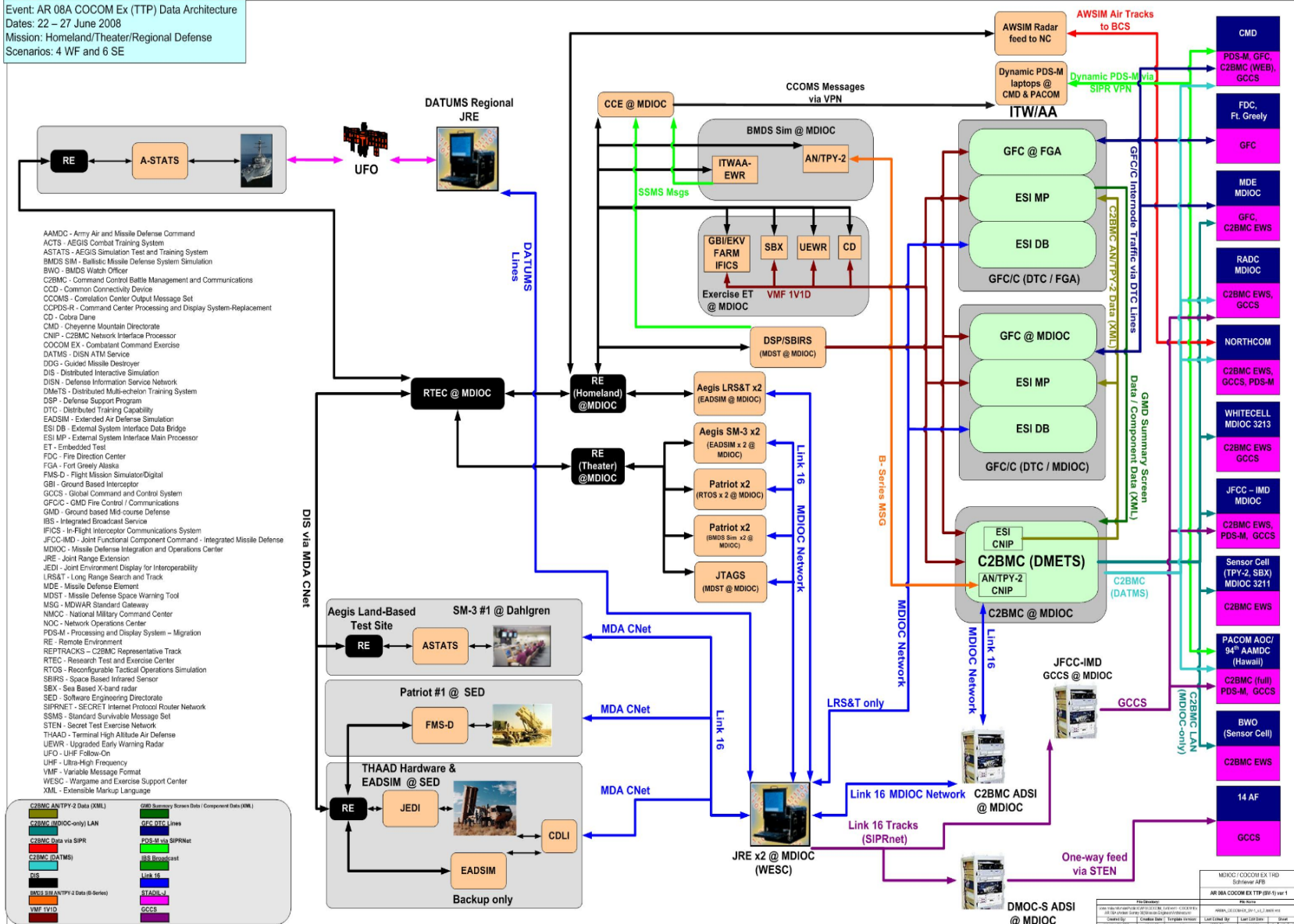



Current Focus: Sharepoint Topology

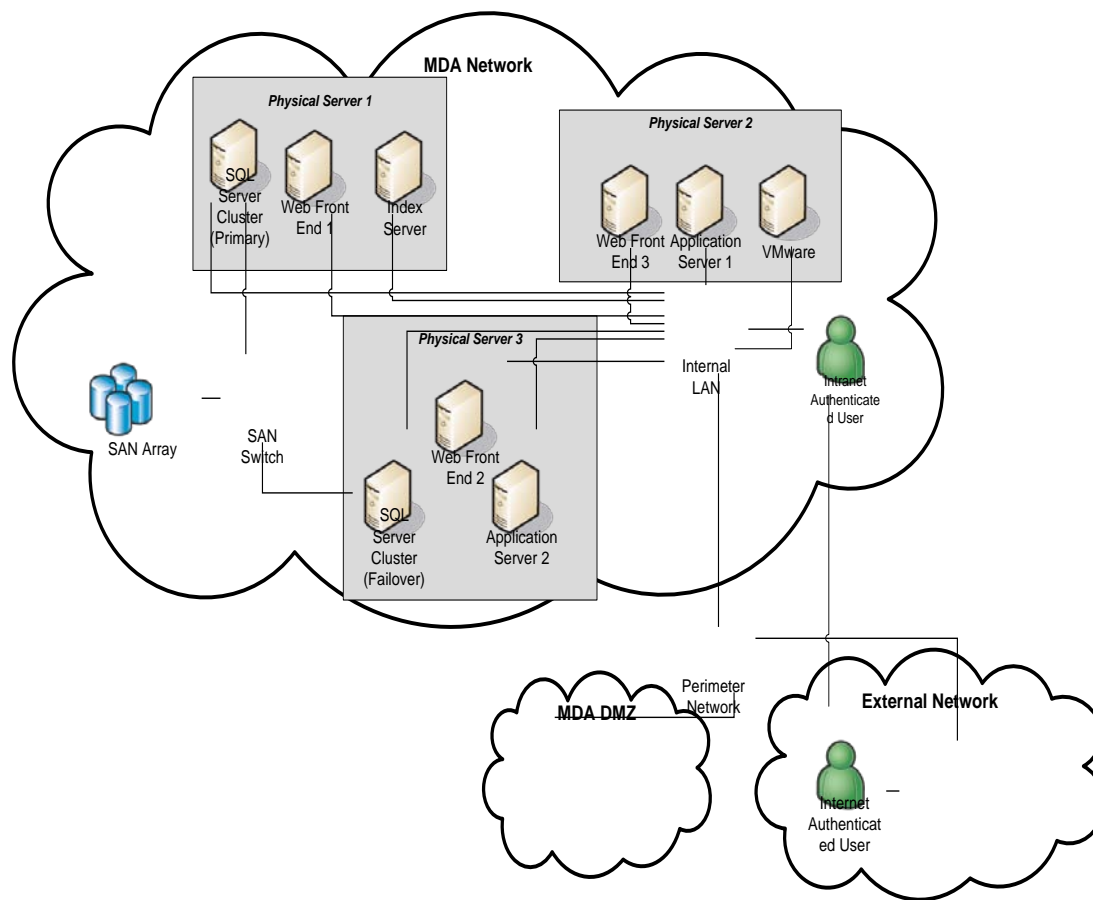

Sharepoint 2007 is the foundation of the Classified and Unclassified MDA Knowledge Online (v. 3.0)



Current Focus: Storage Architecture

Centralized Enterprise Storage Management System
EMC ControlCenter (ECC)
Unclassified Core Site Servers and Remote Site Agents
(Classified is similar with COS & HSV reversed)

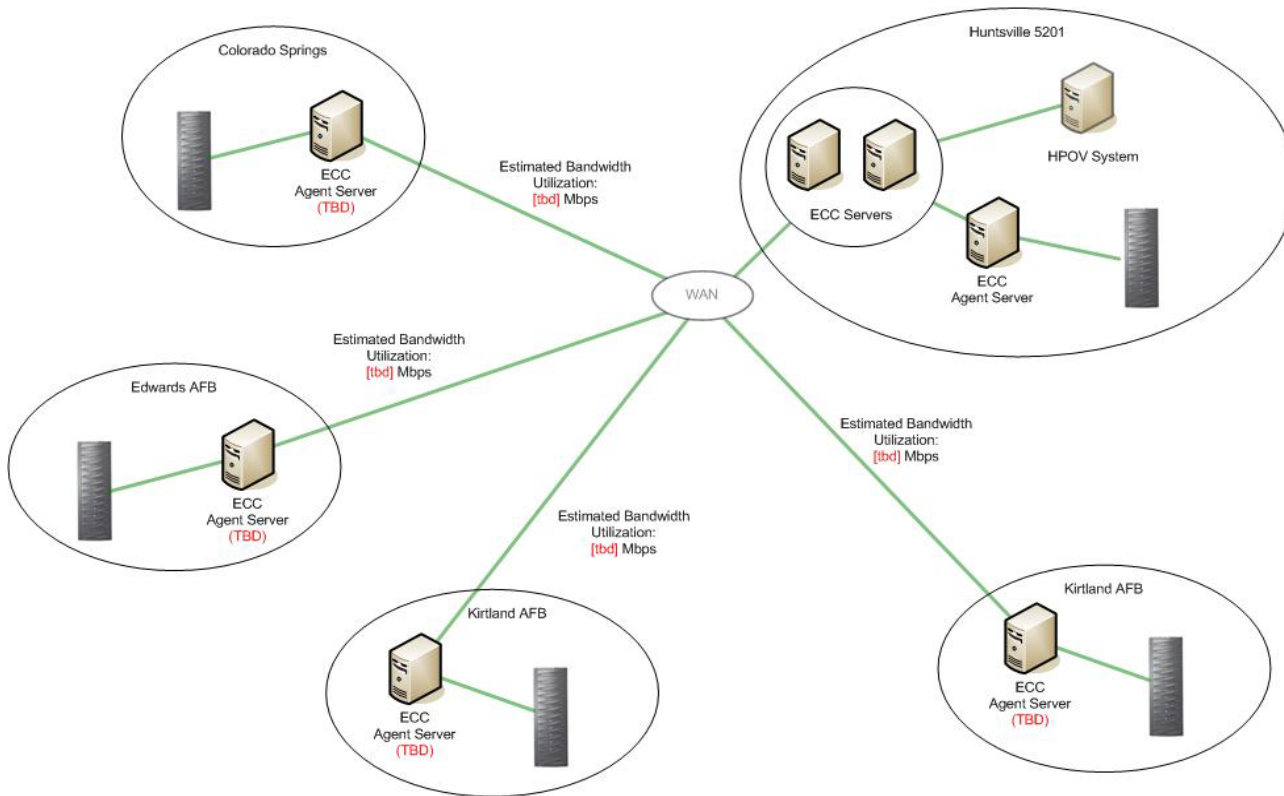

dh 6 May 2009

Storage Architecture Supports BRAC Services Migration, Core Applications, User Files, and DR/COOP Functionality



Current Focus: Facility IT Design



MISSILE
DEFENSE
AGENCY

IT MISSION SUPPORT FACILITIES DESIGN GUIDE

3 February, 2009

Office of Primary Responsibility: Information Management and Technology
Operations
Directorate (MDA/DOC)

- C11.4.3.1.3.4 Document lessons learned.
- C14.1.2.12 No major building mechanical, electrical systems and the associated conduits and ducts are to reside within Computer Room footprint.
- C14.1.2.13 No water piping or conduits subject to condensate shall be located in the ceiling of the data center. Limit any chilled water piping under raised floor.
- C14.1.2.14 Walls shall have a 2 hour fire rating with a vapor barrier. Walls shall consist of two sheets layers of 5/8" drywall on each side and a vapor barrier shall be placed between layers. Wall surface shall be covered with two coats of fire resistant semi gloss white paint.
- C14.1.2.15 Any penetrations in perimeter wall between slab to slab shall be sealed fire stopped. Technology spaces with chemical fire suppression shall have a positive pressurization test as part of the commissioning process.

Figure C14.F1 Hot Aisle-Cold Aisle Rack Layout

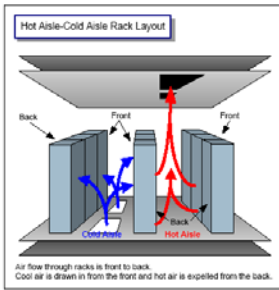
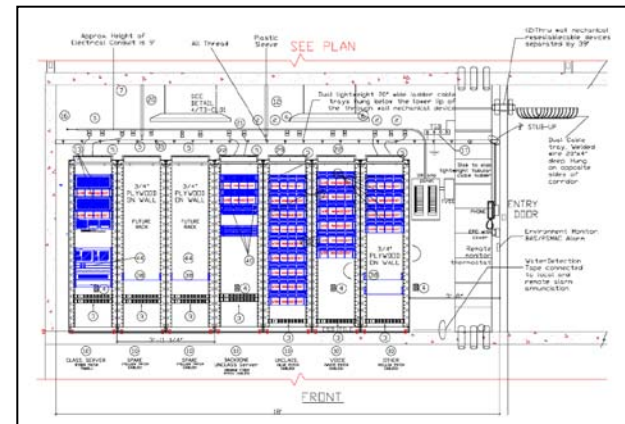
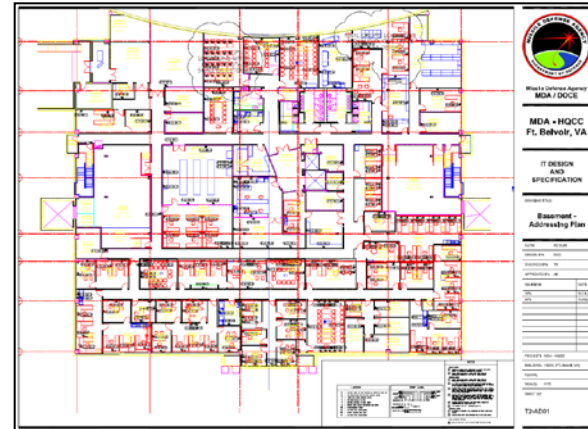

Figure C14.F2 Computer Room Floor Hot Aisle-Cold Aisle, Plan View



Standard Architectures Coupled with Interior Design Plans Yield Interoperable, Highly available IT distribution and Core Services



Summary

- **The MDA IT Architecture Office supports the CIO through Enterprise Architecture Design and Standardization, Wide Area Network Project Management, COMSEC Management, Facility IT Infrastructure design and coordination, and Event Communications Coordination**
- **Current 2010 focus on IT infrastructure supporting MS Sharepoint implementation, storage architecture, and VBIII and HQCC IT infrastructure**
- **Questions?**