

UNCLASSIFIED

AD

AD-E403 716

Technical Report ARMET-TR-15036

HEAT SINK DESIGN AND OPTIMIZATION

I. Mehmedagic
J. Krug

December 2015



U.S. ARMY ARMAMENT RESEARCH, DEVELOPMENT AND
ENGINEERING CENTER

Munitions Engineering Technology Center

Picatinny Arsenal, New Jersey

Approved for public release; distribution is unlimited.

UNCLASSIFIED

UNCLASSIFIED

The views, opinions, and/or findings contained in this report are those of the author(s) and should not be construed as an official Department of the Army position, policy, or decision, unless so designated by other documentation.

The citation in this report of the names of commercial firms or commercially available products or services does not constitute official endorsement by or approval of the U.S. Government.

Destroy this report when no longer needed by any method that will prevent disclosure of its contents or reconstruction of the document. Do not return to the originator.

UNCLASSIFIED

UNCLASSIFIED

REPORT DOCUMENTATION PAGE			Form Approved OMB No. 0704-01-0188		
<p>The public reporting burden for this collection of information is estimated to average 1 hour per response, including the time for reviewing instructions, searching existing data sources, gathering and maintaining the data needed, and completing and reviewing the collection of information. Send comments regarding this burden estimate or any other aspect of this collection of information, including suggestions for reducing the burden to Department of Defense, Washington Headquarters Services Directorate for Information Operations and Reports (0704-0188), 1215 Jefferson Davis Highway, Suite 1204, Arlington, VA 22202-4302. Respondents should be aware that notwithstanding any other provision of law, no person shall be subject to any penalty for failing to comply with a collection of information if it does not display a currently valid OMB control number.</p> <p>PLEASE DO NOT RETURN YOUR FORM TO THE ABOVE ADDRESS.</p>					
1. REPORT DATE (DD-MM-YYYY) December 2015		2. REPORT TYPE Final		3. DATES COVERED (From - To)	
4. TITLE AND SUBTITLE HEAT SINK DESIGN AND OPTIMIZATION			5a. CONTRACT NUMBER		
			5b. GRANT NUMBER		
			5c. PROGRAM ELEMENT NUMBER		
6. AUTHORS I. Mehmedagic and J. Krug			5d. PROJECT NUMBER		
			5e. TASK NUMBER		
			5f. WORK UNIT NUMBER		
7. PERFORMING ORGANIZATION NAME(S) AND ADDRESS(ES) U.S. Army ARDEC, METC Fuze & Precision Armaments Technology Center (RDAR-MEF-E) Picatinny Arsenal, NJ 07806-5000			8. PERFORMING ORGANIZATION REPORT NUMBER		
9. SPONSORING/MONITORING AGENCY NAME(S) AND ADDRESS(ES) U.S. Army ARDEC, ESIC Knowledge & Process Management (RDAR-EIK) Picatinny Arsenal, NJ 07806-5000			10. SPONSOR/MONITOR'S ACRONYM(S)		
			11. SPONSOR/MONITOR'S REPORT NUMBER(S) Technical Report ARMET-TR-15036		
12. DISTRIBUTION/AVAILABILITY STATEMENT Approved for public release; distribution is unlimited.					
13. SUPPLEMENTARY NOTES					
14. ABSTRACT Heat sinks are devices that are used to enhance heat dissipation from hot surfaces to cooler ambient air. Typically, the fins are oriented in a way to permit a natural convection air draft to flow upward through rectangular U-channels, or ducts, formed by the fins. Heat sink design goals may vary, but in this report, optimization of the vertical heat sink is the main objective. Heat transfer from the heat sink consists of radiation and convection from both the intra-fin passages and the unshielded surfaces of two outer fins. In this report, both parts are considered separately. The resulting model is coded in a Microsoft Excel spreadsheet program agrees with published experimental and numerical results. A sample problem of an electronic box dissipating 250 W of heat with an attached rectangular sink was considered in this report. The design and optimization of the heat sink to meet requirements was performed and the results are discussed. A parametric study of the heat sink was also performed to assess geometric influence on its performance.					
15. SUBJECT TERMS Heat sink Natural convection Radiation Design Modeling Optimization					
16. SECURITY CLASSIFICATION OF:			17. LIMITATION OF ABSTRACT SAR	18. NUMBER OF PAGES 29	19a. NAME OF RESPONSIBLE PERSON Igbal Mehmedagic
a. REPORT U	b. ABSTRACT U	c. THIS PAGE U			19b. TELEPHONE NUMBER (Include area code) (973) 724-4489

CONTENTS

	Page
Introduction	1
Model Formulation	2
Intra-fin Passages	2
Unshielded Surfaces	6
Model Validation	7
Problem Statement	8
Results	8
Parametric Study	12
Conclusions	17
References	19
Glossary	21
Distribution List	23

FIGURES

1 Heat sink with vertical orientation	2
2 U-channel interior surface identification	4
3 Simplified thermal network for U-channel radiation	5
4 Heat sink heat dissipation and conductance as a function of spacing	9
5 Conductance of intra-fin passages as a function of the fin number	9
6 Conductance of intra-fin passages as function of spacing	10
7 Heat transfer and conductance of the heat sink	10
8 Temperature at the base of the heat sink	11
9 Temperature at the base of the heat sink as a function of fin spacing	12
10 Conductance of the heat sink for different fin thicknesses	13
11 Temperature at the base of the heat sink for different fin thickness	13
12 Heat transfer from the heat sink for different fin thicknesses	14
13 Conductance of the heat sink for different fin height	14

FIGURES

	Page
14 Temperature at the base of the heat sink for different fin height	15
15 Heat transfer from the heat sink for different fin height	15
16 Conductance of the heat sink for different fin length	16
17 Temperature at the base of the heat sink for different fin length	16
18 Heat transfer from the heat sink for different fin length	17

UNCLASSIFIED

ACKNOWLEDGMENTS

The authors appreciate the helpful comments from U.S. Army peer reviewer Dr. Donald Carlucci.

Approved for public release; distribution is unlimited.

UNCLASSIFIED

INTRODUCTION

Natural convection and radiation modes of heat transfer are commonly applied cooling techniques for electronic equipment of low to moderate power density, such as computer chips, electronics, and telecommunication boxes. The main advantages of natural convection are high reliability, low noise, and low power consumption. Air movement in a naturally ventilated cabinet is induced by a pressure difference between the interior and exterior of the cabinet. This pressure difference occurs due to a density gradient in the air, which produces a force that pushes the air upward and out. The thermal design of the electronic equipment must be optimized because of the relatively low efficiency. To generate airflow that results in the appropriate temperature rise inside the enclosure, special attention must be paid to the geometrical configuration of the heat source and the ventilated enclosure.

Heat sinks are devices that are used to enhance heat dissipation from hot surfaces to cooler air. Typically, the fins are oriented in a way to permit a natural convection air draft to flow upward through the rectangular U-channels, or ducts, formed by the fins. Heat sink design goals may vary, but in this particular case, optimization of the heat sink is the main concern. One of the most frequently quoted references for heat sinks is Elenbass's study (ref. 1) of flow between parallel plates. Elenbass found that optimal spacing for natural convection between parallel plates was:

$$\frac{S_{opt}}{H} = \frac{50}{GrPr} \quad (1)$$

Considering the case of a vertical heat sink with rectangular fins, equation 1 could not be used without modifications. Additionally, radiant heat transfer also has to be considered due to a big part of heat being transferred from the heat sink by that mode. The optimization of the heat sink has become an essential practice for optimum performance. In present cases, optimization of the heat sink consisting of an array of straight, vertical, and rectangular fins is performed (fig. 1).

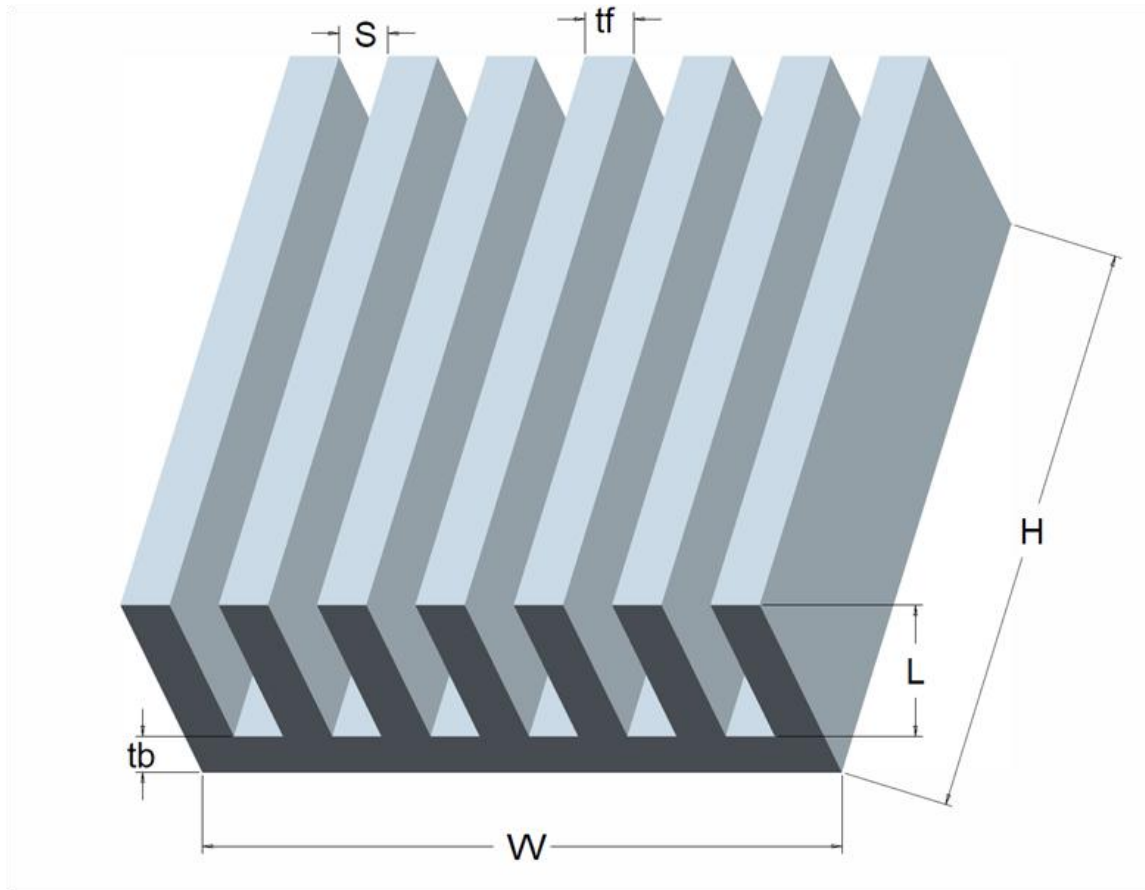

Figure 1
Heat sink with vertical orientation

MODEL FORMULATION

Heat transfer from the heat sink consists of radiation and convection from both the intra-fin passages and the unshielded surfaces of two outer fins. In this report, both parts are considered separately.

Intra-fin Passages

Convection

For the U-channels formed by rectangular vertical fins, the Nusselt number is calculated with a modified Elenbass's equation proposed by Van De Pol and Tierney (ref. 2):

$$Nu_r = \frac{Ra^*}{\Psi} \left\{ 1 - e^{\left[-\Psi \left(\frac{0.5}{Ra^*} \right)^{3/4} \right]} \right\} \quad (2)$$

$$\Psi = \frac{24(1 - 0.483e^{-\frac{0.17}{a}})}{\left\{ \left[1 + \frac{a}{2} \right] \left[1 + (1 - e^{-0.83a}) (9.14a^{1/2} e^{VS} - 0.61) \right] \right\}^3}$$

where:

$$Ra^* = \frac{r}{H} Gr_r Pr$$

$$r = \frac{2LS}{(2L + S)}$$

$$a = \frac{S}{L}$$

$$V = -11.8(in^{-1})$$

All physical properties except β are evaluated at the surface temperature; β is evaluated at the ambient fluid temperature.

Once the Nusselt number is obtained using equation 2, the convective heat transfer coefficient for the U-channels can be calculated by:

$$h_{ci} = \frac{Nu_r k}{r} \quad (3)$$

Fin efficiency may be calculated as:

$$\eta = \sqrt{\frac{kHt_f}{2h_{ci}HL^2}} \tanh \sqrt{\frac{2h_{ci}HL^2}{kHt_f}} \quad (4)$$

Conductance of the inter-fin passages now can be calculated as:

$$C_{ci} = \eta h_{ci} A_i \quad (5)$$

where A_i is inter-fin passage area given as:

$$A_i = WH \left[1 + \frac{2(N-1)}{W} L \right] \quad (6)$$

Radiation

The procedure for calculating the radiative heat transfer coefficient for the U-channels is outlined in the book by Ellison (ref. 3). It is assumed that all surfaces of the heat sink are gray and reflective with the base and fins at a uniform temperature. Figure 2 shows a single U-channel with numbered interior surfaces. Numerals 1, 3, and 4 identify the heat sink surfaces while numerals 2, 5, and 6 refer to the nonreflecting ambient air. A simplified thermal network for the U-channels is shown in figure 3.

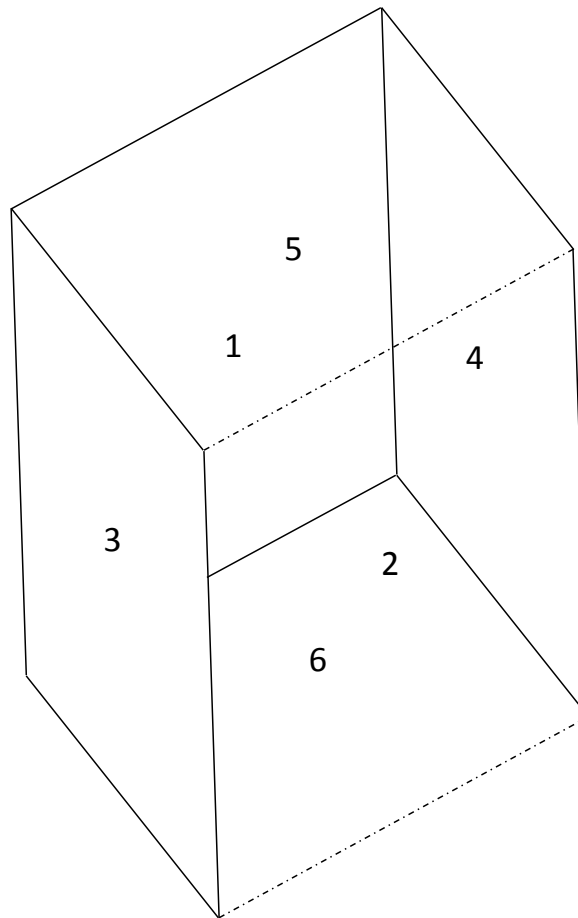

Note: Numbers are centered in the surface that they represent.

Figure 2
U-channel interior surface identification

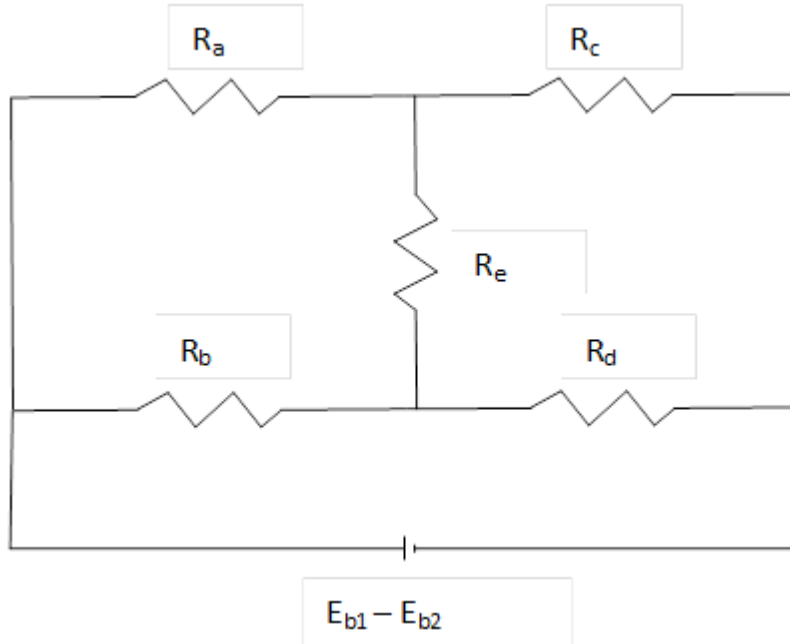

Figure 3
Simplified thermal network for U-channel radiation

The net shape factor, F , for the gray-body U-channel interior is given as:

$$F = \frac{2C_{NET}}{[H(S + 2L)]} \quad (7)$$

where:

$$C_{NET} = \frac{[(R_a + R_b + R_e)(R_c + R_d + R_e) - R_e^2]}{\left\{ (R_b + R_d)[(R_a + R_b + R_e)(R_c + R_d + R_e) - R_e^2] - \right. \\ \left. R_b[R_b(R_c + R_d + R_e) + R_e R_d] - R_d[R_d(R_a + R_b + R_e) + R_b R_e] \right\}}$$

is the overall conductance for the U-channel, and resistances in the simplified thermal network are given in the following form:

$$R_a = \frac{1 - \varepsilon}{\varepsilon A_3}$$

$$R_b = \frac{2(1 - \varepsilon)}{\varepsilon A_1}$$

$$R_c = \frac{1}{A_1 F_{13} + 2A_3 F_{35}}$$

$$R_d = \frac{2}{A_1 F_{12} + 2A_1 F_{15}}$$

$$R_e = \frac{1}{A_1 F_{13}}$$

The view (shape or configuration) factors F_{12} , F_{13} , F_{15} , and F_{35} are computed using the appropriate parallel and perpendicular formulae for two rectangles. These formulae can be found in any heat transfer book [e.g., A.F. Mills (ref. 4)].

Now, using the result obtained by equation 7, the radiation conductance can be calculated as:

$$C_{ri} = 3.657 \times 10^{-11} F A_i \frac{(T_s + 273)^4 - (T_a + 273)^4}{T_s - T_a} \quad (8)$$

The overall conductance for the inter-fin passages now can be calculated as:

$$C_i = C_{ci} + C_{ri} \quad (9)$$

Unshielded Surfaces

The outer surfaces of the heat sink must be considered in order to obtain more realistic results. Their surface conductance is typically given as:

$$C_{so} = h_o A_o \quad (10)$$

where:

$$h_o = h_{co} + \varepsilon h_r$$

and:

$$A_o = 2HL$$

UNCLASSIFIED

The convective heat transfer coefficient for the vertical fins is defined as:

$$h_{co} = 0.0024 \left(\frac{\Delta T}{H} \right)^{0.25} \quad (11)$$

while the radiation heat transfer coefficient may be calculated by:

$$h_r = 3.657 \times 10^{-11} \frac{(T_s + 273)^4 - (T_a + 273)^4}{T_s - T_a} \quad (12)$$

Overall conductance for the heat sink now is:

$$C_s = C_i + C_o \quad (13)$$

A parametric study of the heat sink also should be performed to determine the effects of various design parameters on thermal performance. The formulated procedure previously shown can be coded into the computer program using various programming languages such as Fortran, C++, Pascal or, in this case, it can be done with Microsoft Excel.

MODEL VALIDATION

Validation of the heat sink model without enclosure was done using the following parameters:

- Geometry
 - Equipment box
 - Height $H_s = 3.94$ in.
 - Width $W_s = 5.42$ in.
 - Fins
 - Height $H_f = 0.98$ in.
 - Length $L_f = 3.94$ in.

Fin thickness and conductivity vary depending on the heat sink material as shown in table 1.

Table 1
Varying fin thicknesses and conductivities based on material

Fin material	Thickness of the fin, t_f (in.)	Fin conductivity, k (W/in.K)
Aluminum	0.021	4.84
Steel	0.046	1.625
Porcelain	0.094	0.267

- Ambient temperature: $T_a = 20^\circ\text{C}$
- Fin temperature: $T_f = 50^\circ\text{C}$
- Fin emissivity: $\epsilon = 0.82$

Table 2 gives a comparison of the number of fins and heat dissipation by fin between the present analysis and the results obtained from Aihara (ref. 5).

Approved for public release; distribution is unlimited.

UNCLASSIFIED

Table 2
Comparison of results for optimal number of fins

Material of heat sink	No. of fins		Q dissipation/fin, W	
	Aiharas	Present	Aiharas	Present
<i>Aluminum</i>	<i>19</i>	<i>18</i>	<i>17.9</i>	<i>17.7</i>
<i>Steel</i>	<i>17</i>	<i>16</i>	<i>16.8</i>	<i>16.6</i>
<i>Porcelain</i>	<i>15</i>	<i>14</i>	<i>15.1</i>	<i>14.6</i>

The results of table 2 agree with the results from Aiharas, and the differences are actually due to the efficiencies being accounted for in this present calculation.

PROBLEM STATEMENT

An electronic box of the dimensions 24 in. by 18 in. by 10 in. (H x W x D) dissipates 250 W of heat. Natural convection and radiation are used to cool the external surfaces of the box. The maximum expected ambient temperature is 46°C, and the maximum allowable box surface temperature is 81°C. It is assumed that all heat is dissipated only through the wall with dimensions of 24 in. by 18 in. A heat sink with rectangular fins of dimensions 24 in. by 1.77 in. by 0.12 in. [H x L x fin thickness (tf)] is attached to the box. The fin material is aluminum ($k=4.84$ W/in.K) with fin emissivity $\epsilon=0.9$. The objective is to optimize the rectangular heat sink to meet design requirements. Additionally, a parameterization study should be performed to assess heat sink efficiency.

RESULTS

Figure 4 depicts the average heat sink heat dissipation and conductance as a function of spacing. While the fin spacing is large, the conductance of the heat sink stays relatively constant. By decreasing the spacing between the fins, more fins can be added to the base plate, thereby increasing the total surface area for heat transfer. Since the total heat flow is proportional to conductance and total surface area, decreasing the spacing further still improves total heat transfer until optimum spacing is reached. At the point of optimum spacing, heat transfer from the sink reaches its maximum value. Below optimum spacing, the total heat transfer falls rapidly due to fin interference and choked air flow.

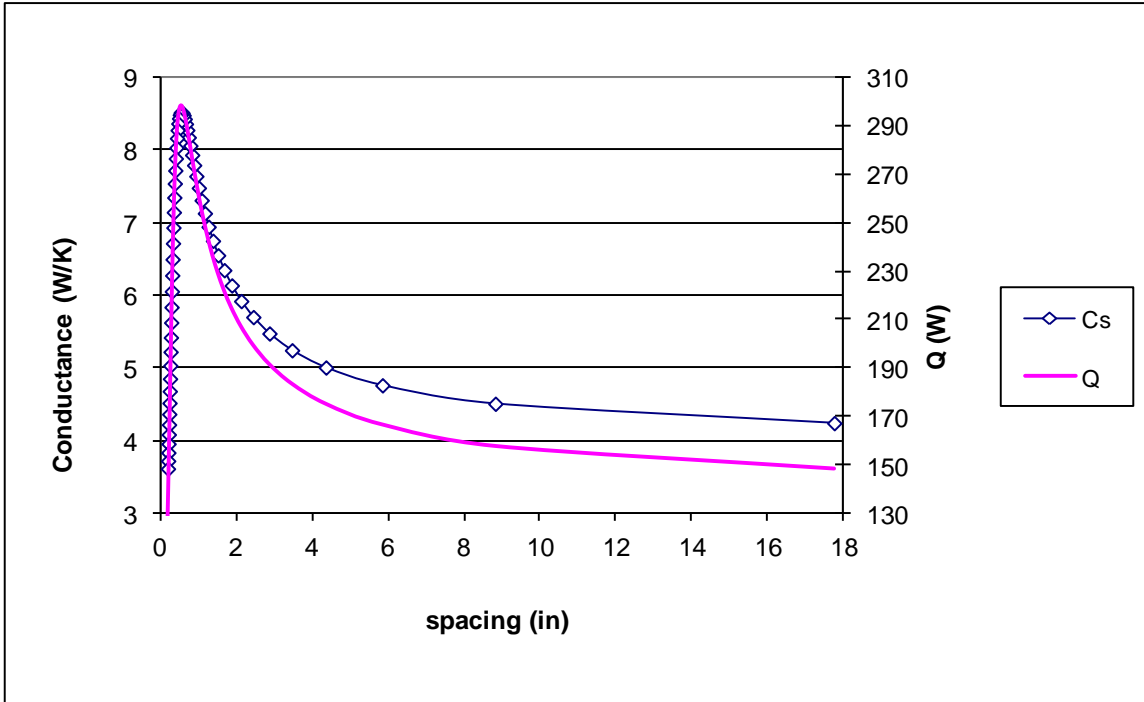

Figure 4
Heat sink heat dissipation and conductance as a function of spacing

The conductance of heat sink intra-fin passages is shown in figure 5 for different numbers of fins. By increasing the number of fins, conduction due to convection (cci) steadily increases until an optimum number of fins is reached. Beyond that number, the convection conductance falls steadily. Conduction due to radiation (cri) declines with an increase in the number of fins as well. Overall, intra-fin conductance is obtained by adding conductance due to both radiation and convection.

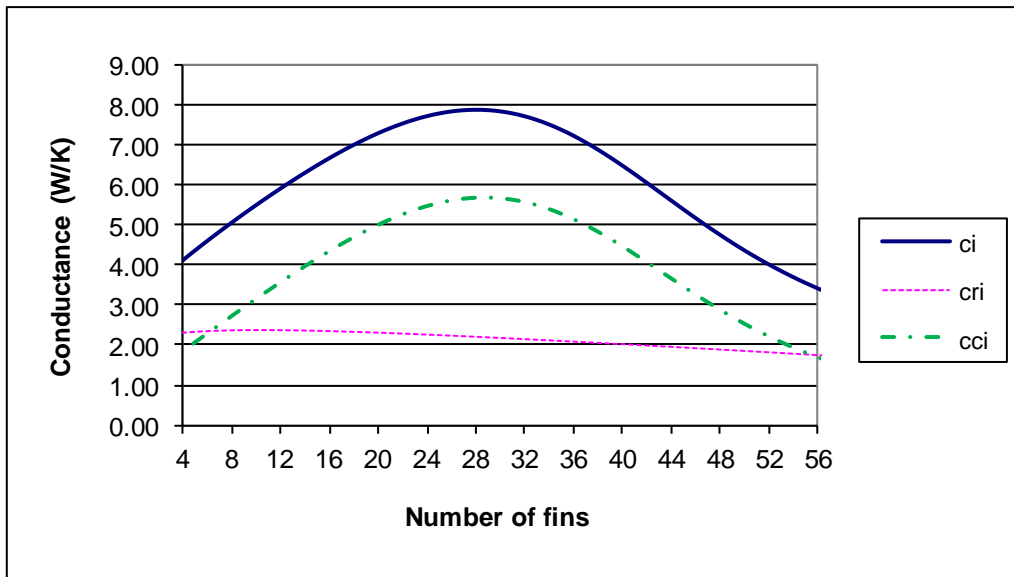

Figure 5
Conductance of intra-fin passages as a function of the fin number

Approved for public release; distribution is unlimited.

Figure 6 shows the dependence of the heat sink's intra-fin passages conductance on spacing. As shown, large spacing conductance stays relatively constant until a certain limit is reached. By continuing to decrease the fin spacing, conductance starts to increase rapidly until the optimum spacing is reached. At this point, the highest conductance and heat dissipation from the heat sink is achieved. Decreasing the fin spacing further causes a sudden fall in both conductance and heat dissipation, and the advantages of the heat sink loses its significance.

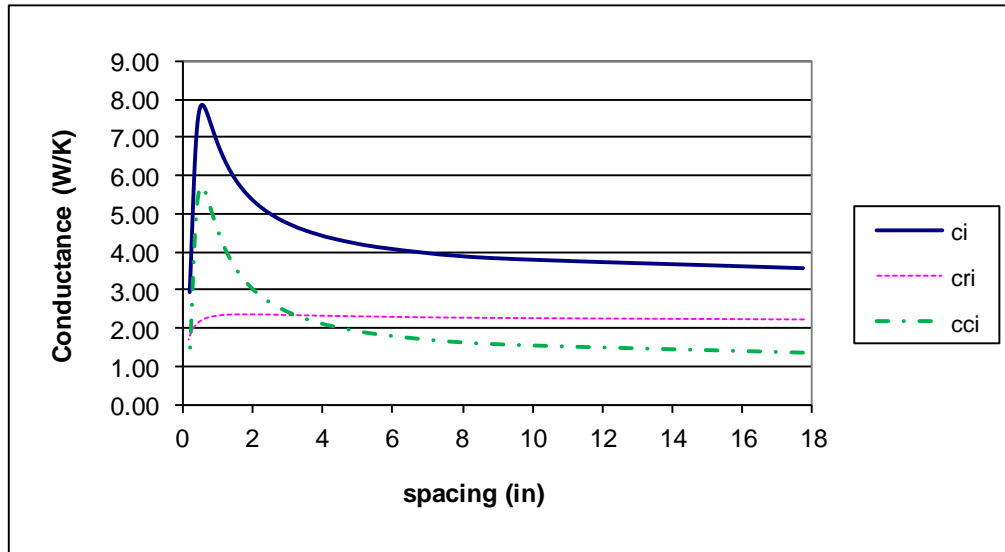

Figure 6
Conductance of intra-fin passages as function of spacing

Considering total heat sink conductance and heat transfer (fig. 7), the optimal number of fins is 28 with a maximum heat transfer of 298.28 W and conductance of 8.52 W/K.

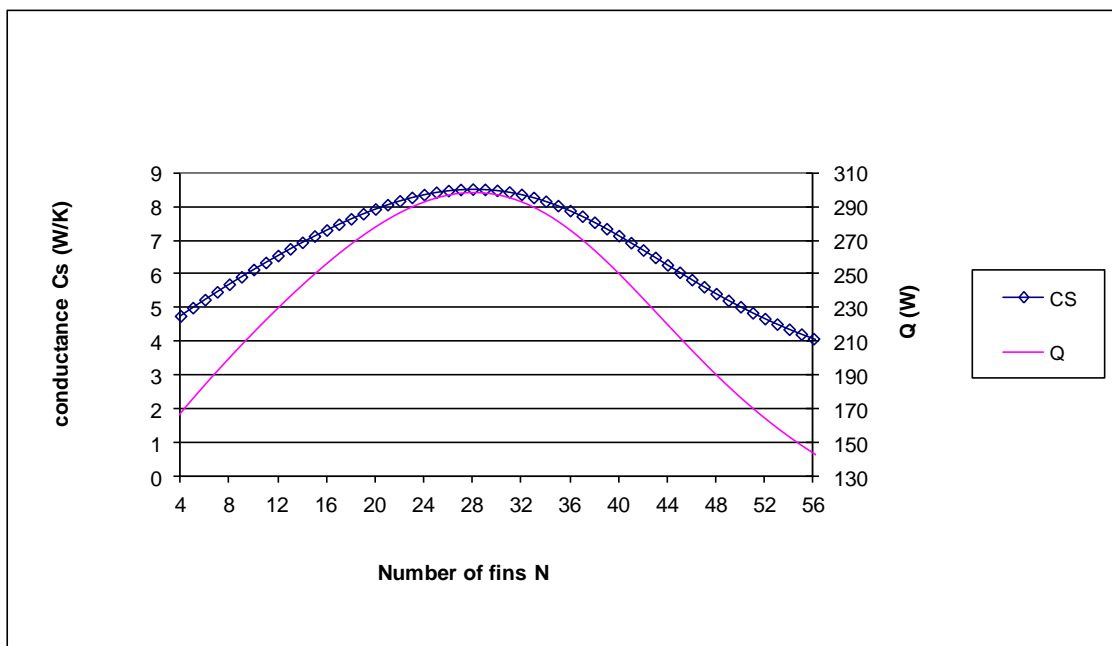

Figure 7
Heat transfer and conductance of the heat sink
Approved for public release; distribution is unlimited.

Figure 8 shows the lowest temperature of $\sim 75^{\circ}\text{C}$ is achieved with 28 fins, which is well below the design requirement of 81°C .

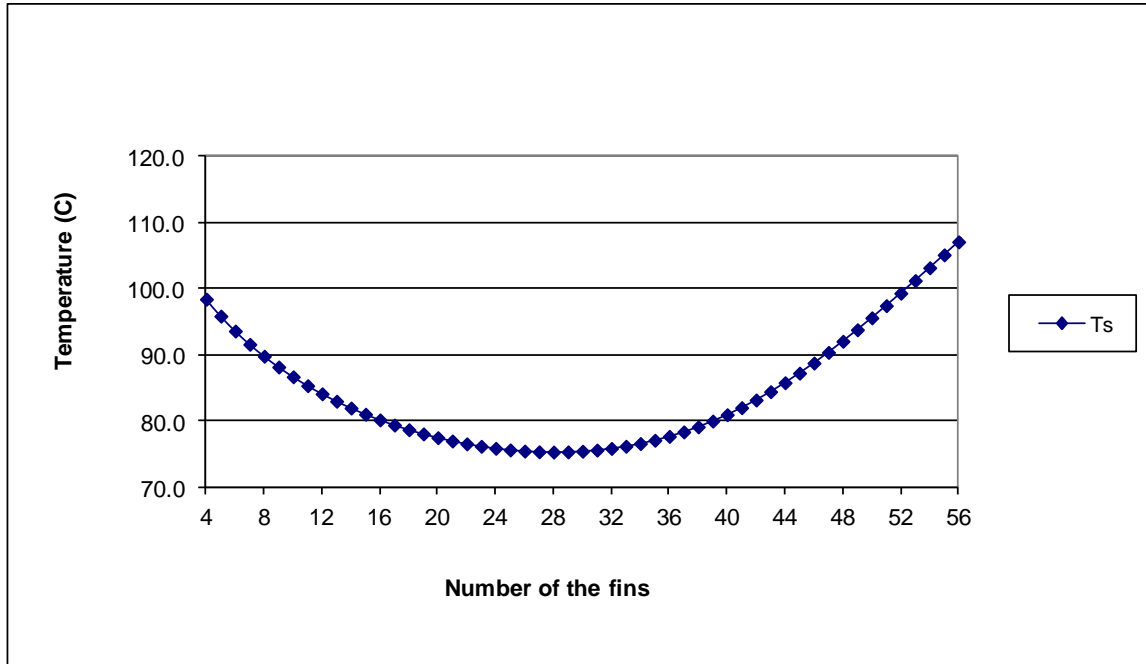

Figure 8
Temperature at the base of the heat sink

Figure 9 represents the dependence of the heat sink base temperature on spacing. Again, as the fin spacing is reduced, the base temperature changes slowly at first and ramps rapidly. This trend reaches its limit at the point of optimal spacing when the minimum temperature of the heat sink base occurs. If the decrease in spacing is continued, sudden increase in temperature of the base occurs due to choked air flow and fin interference. The lowest temperature appears at the spacing of 0.5422 in.

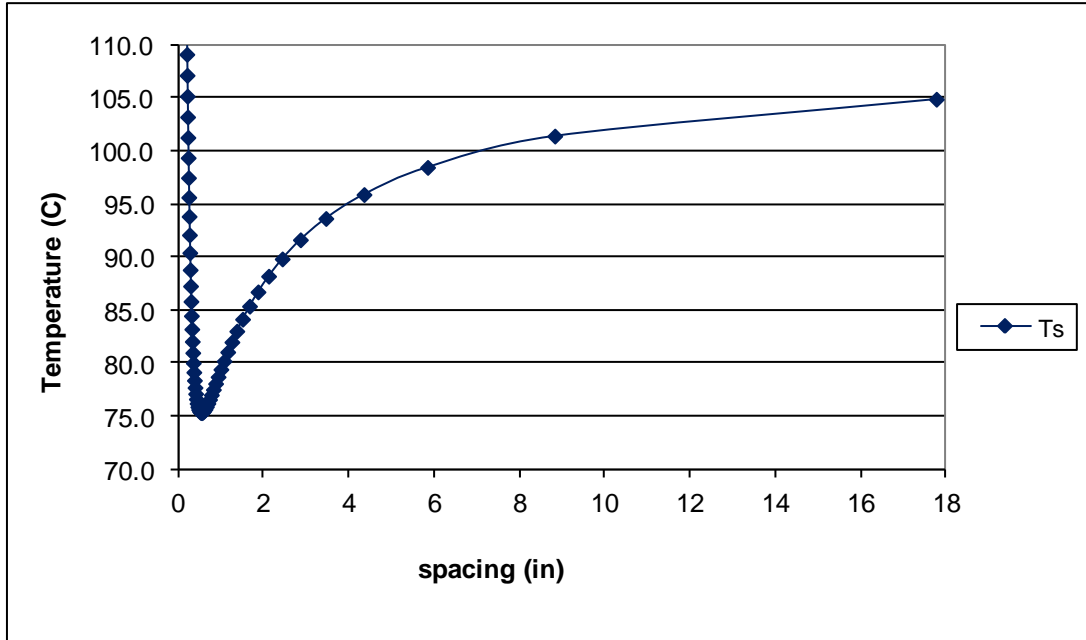

Figure 9
Temperature at the base of the heat sink as a function of fin spacing

Parametric Study

An extensive parametric study of the heat sink is now performed to investigate possible material and space savings in the design process. The first parameter considered was the thickness of the fin. Starting with a small number of fins, overall conductance of the heat sink was the same regardless of fin thickness. By increasing the number of fins, the conductance of the heat sink becomes larger for thinner fins (fig. 10). Also, the optimal number of fins increases when compared to the thicker fins. The temperature of the base decreased with a decrease in fin thickness (fig. 11), and the heat transfer from the heat sink increased with the decreased thickness (fig. 12). From these findings, it can be concluded that thinner fins transferred more heat due to the increased number of fins.

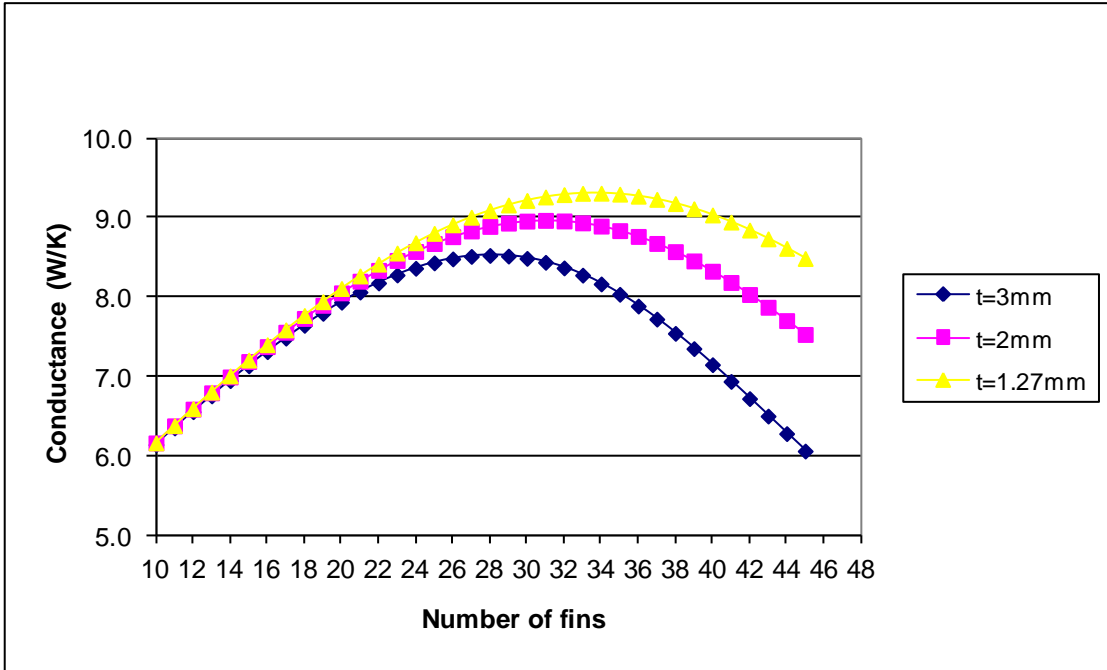

Figure 10
Conductance of the heat sink for different fin thicknesses (tf)

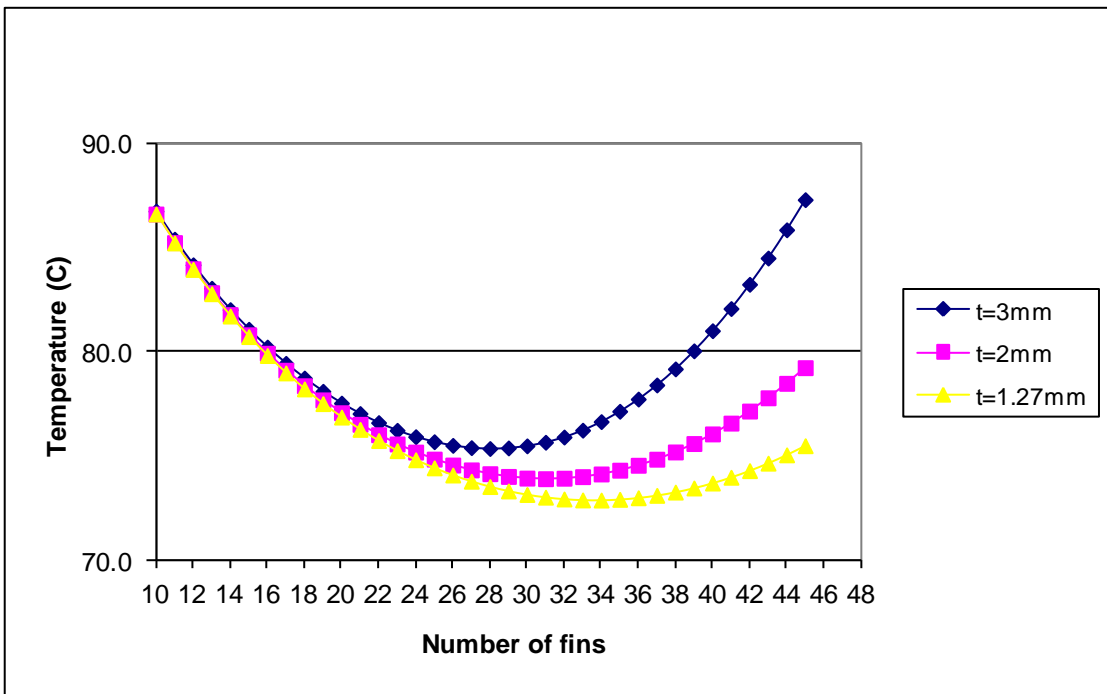

Figure 11
Temperature at the base of the heat sink for different fin thickness (tf)

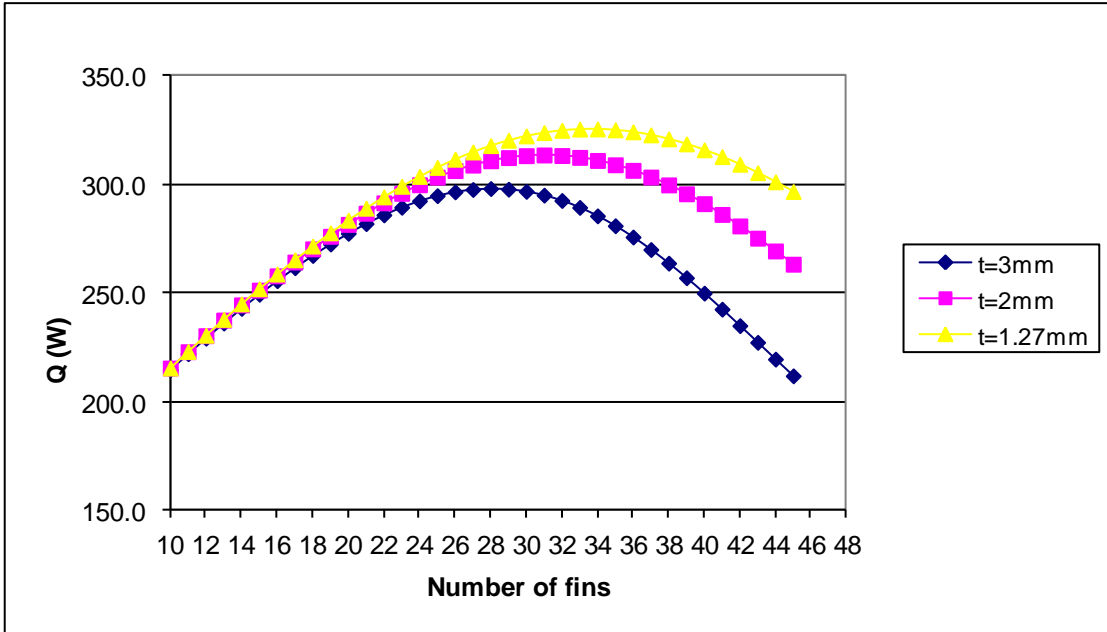

Figure 12
Heat transfer from the heat sink for different fin thicknesses (tf)

The next parameter considered was fin height, H_f . Smaller height has a negative influence on overall heat sink conductance (fig. 13) causing an increase in fin base temperature (fig. 14) and decreases the overall heat transfer from the sink (fig. 15). It is impossible to meet the design temperature at the base of the heat sink by decreasing the height of the fin too much (in this case, decreasing H_f below 18 in.).

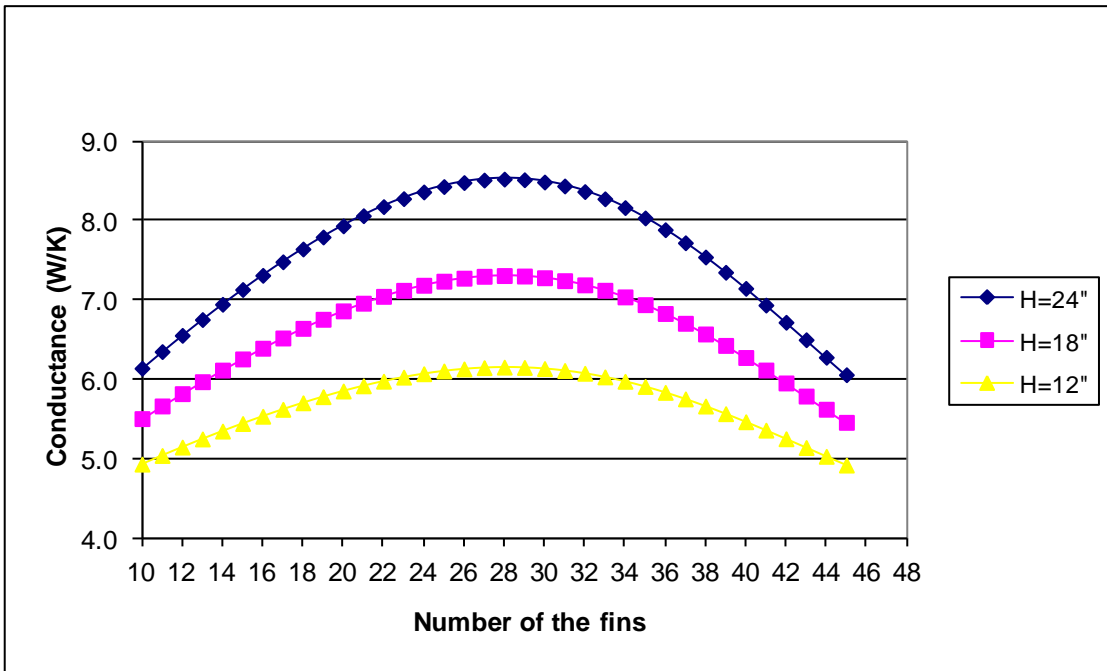

Figure 13
Conductance of the heat sink for different fin height (L)

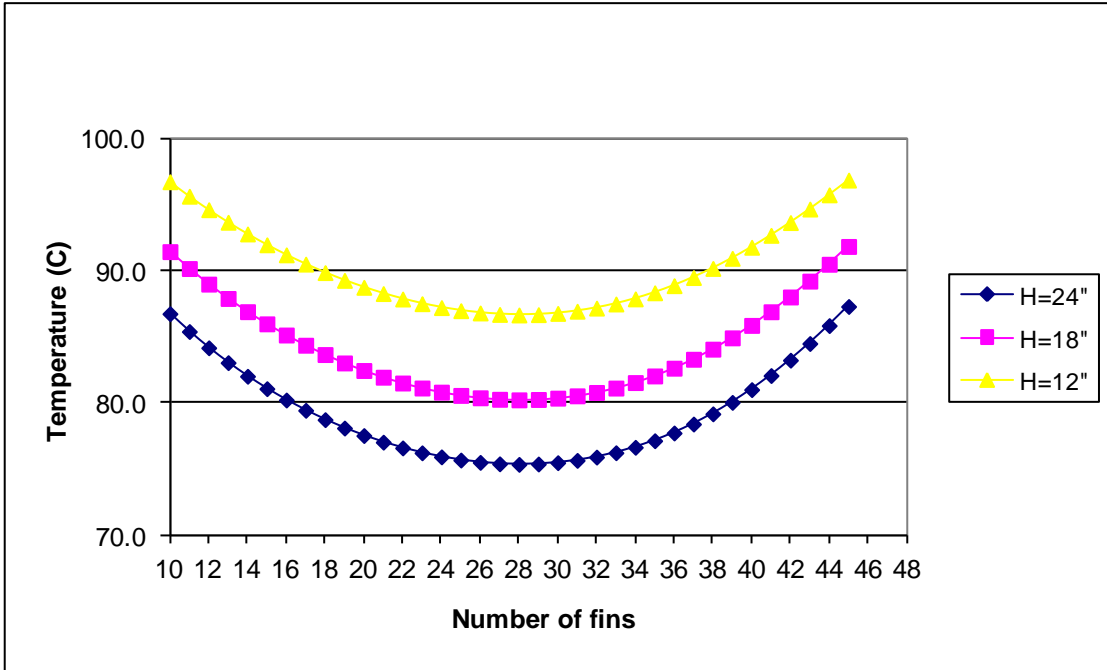

Figure 14
Temperature at the base of the heat sink for different fin height (L)

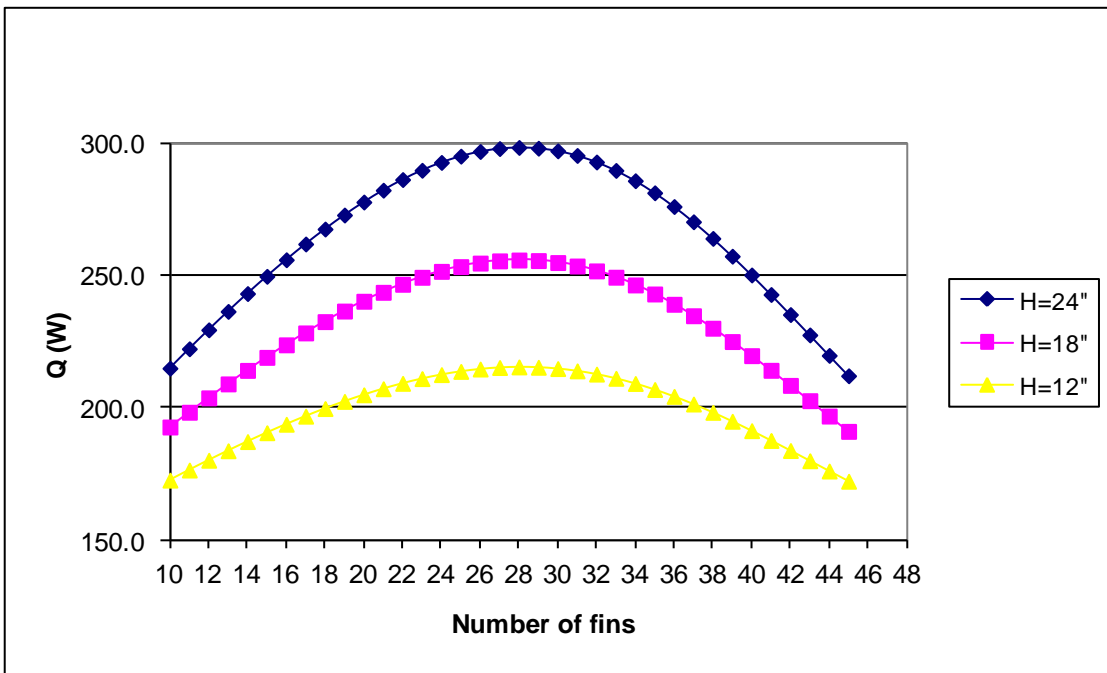

Figure 15
Heat transfer from the heat sink for different fin height (L)

The last parameter to consider was fin length, L. Fin length has an even more negative influence on the behavior of the heat sink than the height. Decreasing the length of a fin significantly reduces overall heat sink conductance (fig. 16), and as a result, the temperature of the base

increases above the required design temperature of 81°C (fig. 17). The heat sink's ability to dissipate heat from the chip or electronics is also greatly reduced (fig. 18).

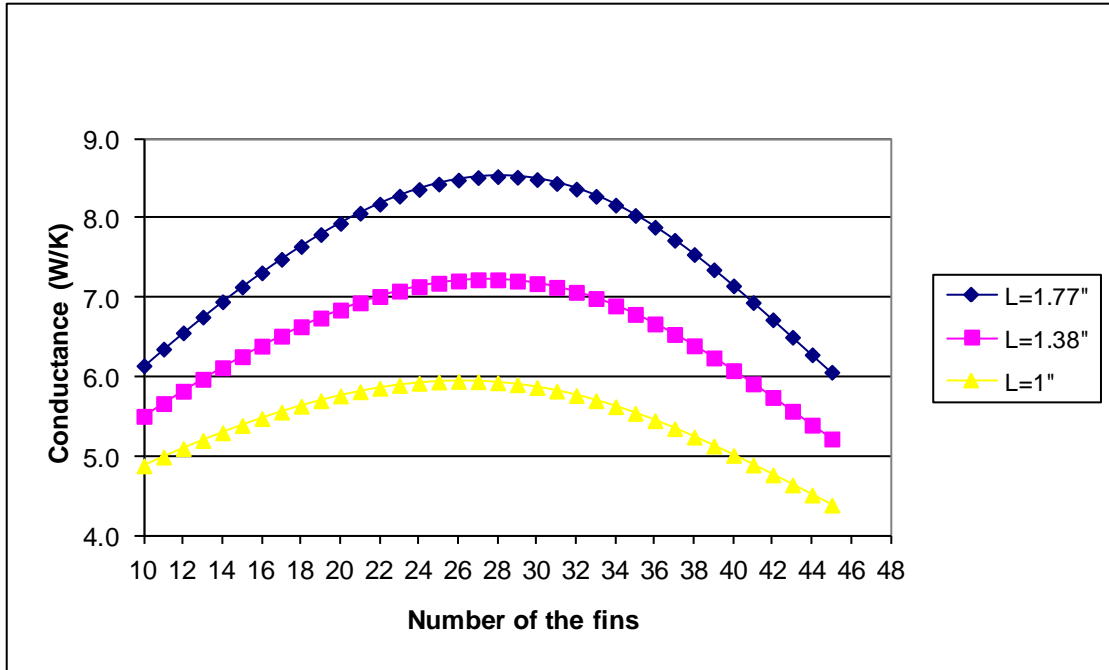

Figure 16
Conductance of the heat sink for different fin length (H)

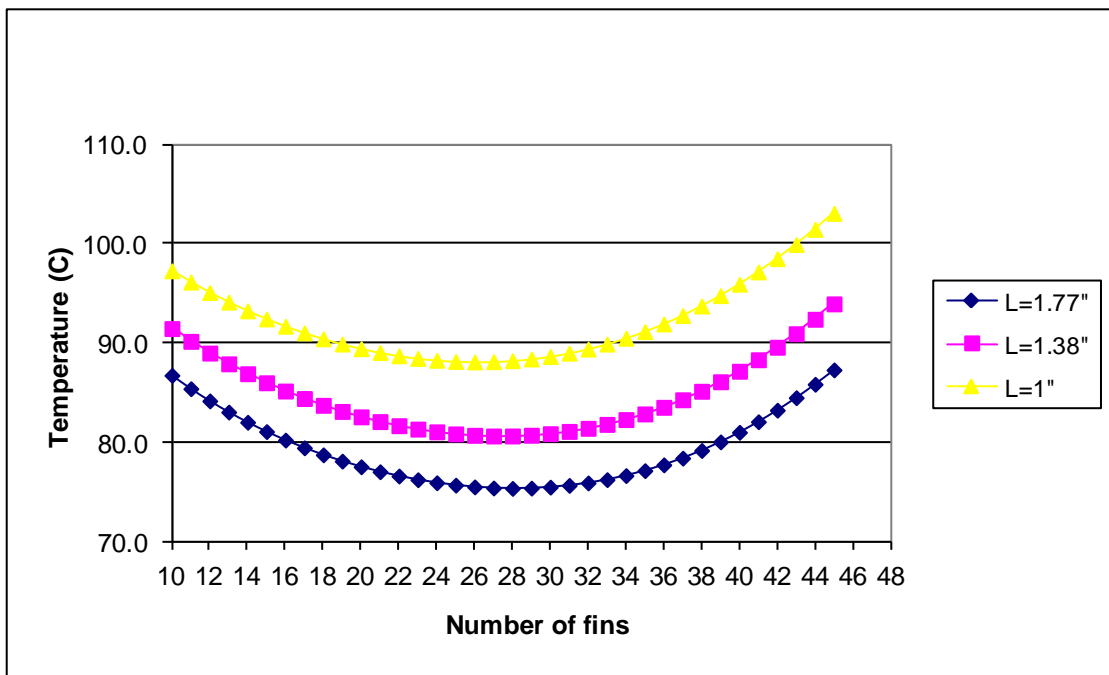

Figure 17
Temperature at the base of the heat sink for different fin length (H)

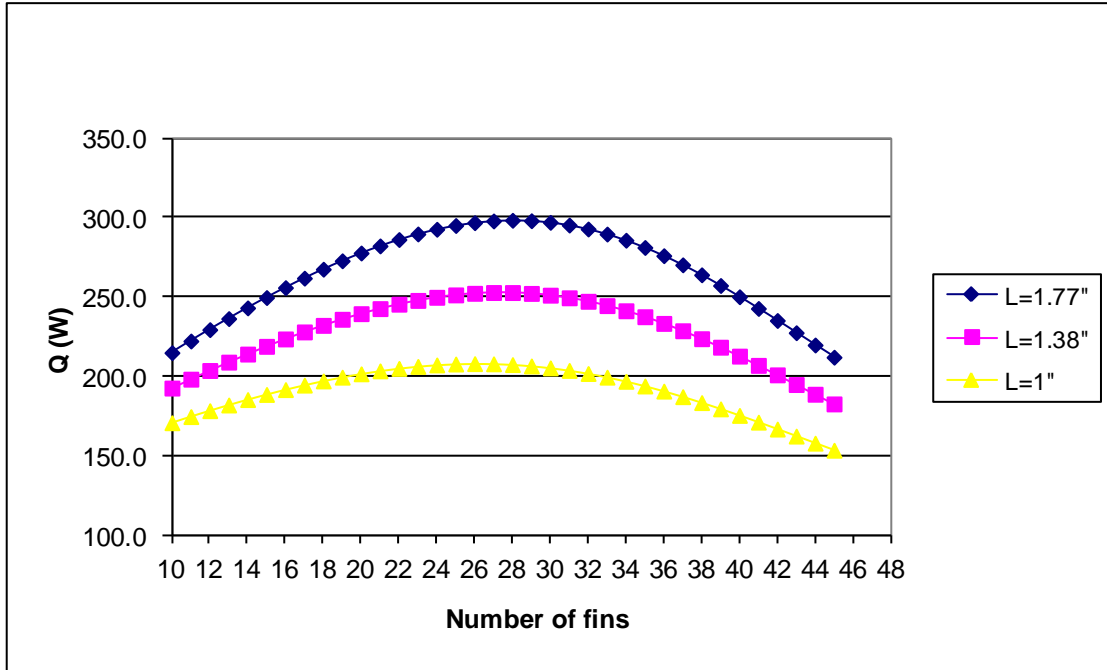

Figure 18
Heat transfer from the heat sink for different fin length (H)

CONCLUSIONS

Heat sink optimization helps us to determine the dimensions, weight, and thermal performance in order to meet design requirements. As shown, finding the optimal number of fins determines the best solution for temperature at the base of the sink. Also, it became clear that when the number of fins was increased past an optimal value, the thermal performance of the sink would worsen, leading to choked flow inside the U-channels and, eventually, electronic box failure. The goal is to determine the optimal number of fins in order to maximize heat transfer. Thickness of the fin is the major parameter to heat sink performance. Although thinner fins increase the optimum number of the fins, they actually decrease the weight of the heat sink and improve the heat sink's thermal performance.

It can be concluded that although all assumptions (uniform temperature at the base and the fins, gray surfaces, etc.) made in the model formulation are not satisfied perfectly, they are more than satisfactory for most engineering calculations.

UNCLASSIFIED

REFERENCES

1. Elenbass, W., "Dissipation of Heat by Free Convection," Parts I and II, Philips Research Report, vol. 3, N.V. Philips, Gloeilampenfabrieken, Eindhoven, Netherlands, pp. 338-360, 450-465, 1948.
2. Van de Pol, D. W. and Tierney, J. K., "Free Convection Heat Transfer from Vertical Fin Arrays," IEEE Trans. Parts, Hybrids, and Packaging, vol. PHP-10, no. 4, pp. 267-271, December 1974.
3. Ellison, G. N., "Thermal Computation for Electronic Equipment," Van Nostrand Reinhold Company, New York, 1984.
4. Mills, A.F., "Heat Transfer," 2nd edition, Prentice Hall, New Jersey, 1999.
5. Aihara, T. and Maruyama, S., "Optimum Design of Natural Cooling Heat Sinks with Vertical Rectangular Fin Arrays," International Symposium on Cooling Techniques for Electronic Equipment, Honolulu, Hawaii, 1987.

GLOSSARY

β	Thermal coefficient of volume expansion
ϵ	Emissivity
F	Shape factor
Gr	Grashof number
H	Fin height, (in.)
k	Thermal conductivity, (W/in.-K)
η	Fin efficiency
Nu	Nusselt number
Pr	Prandtl number
Q	Heat dissipation, (W)
Ra	Rayleigh number
R	Thermal resistances, (K/W)
S	Fin spacing, (in.)
tf	Fin thickness, (in.)
Ta	Ambient temperature, (K)
Ts	Surface temperature, (K)
Hf	Fin height

UNCLASSIFIED

DISTRIBUTION LIST

U.S. Army ARDEC
ATTN: RDAR-EIK
RDAR-MEF-E, I. Mehmedagic
J. Krug
Picatinny Arsenal, NJ 07806-5000

Defense Technical Information Center (DTIC)
ATTN: Accessions Division
8725 John J. Kingman Road, Ste 0944
Fort Belvoir, VA 22060-6218

GIDEP Operations Center
P.O. Box 8000
Corona, CA 91718-8000
gidep@gidep.org

REVIEW AND APPROVAL OF ARDEC TECHNICAL REPORTS

Heat Sink Design and Optimization
Title

Date received by LCSD

Igbal Mehmedagic
Author/Project Engineer

Report number (to be assigned by LCSD)

x4489
Extension

94
Building

RDAR-MEF-E
Author's/Project Engineers Office
(Division, Laboratory, Symbol)

PART 1. Must be signed before the report can be edited.

- a. The draft copy of this report has been reviewed for technical accuracy and is approved for editing.
- b. Use Distribution Statement A , B , C , D , E , F or X for the reason checked on the continuation of this form.
 - 1. If Statement A is selected, the report will be released to the National Technical Information Service (NTIS) for sale to the general public. Only unclassified reports whose distribution is not limited or controlled in any way are released to NTIS.
 - 2. If Statement B, C, D, E, F, or X is selected, the report will be released to the Defense Technical Information Center (DTIC) which will limit distribution according to the conditions indicated in the statement.
- c. The distribution list for this report has been reviewed for accuracy and completeness.

Robert Lee
Division Chief

4/3/2014
(Date)

PART 2. To be signed either when draft report is submitted or after review of reproduction copy.

This report is approved for publication.

Douglas Troast

Division Chief

10 Dec 15
(Date)

Andrew Pskowski

RDAR-CTS

4/9/2014
Date

SMCAR Form 49, 20 Dec 08 supersedes SMCAR Form 49, 1 Nov 94.