

UNCLASSIFIED

AD NUMBER
AD893104
NEW LIMITATION CHANGE
TO Approved for public release, distribution unlimited
FROM Distribution authorized to U.S. Gov't. agencies only; Administrative/Operational Use; FEB 1972. Other requests shall be referred to Picatinny Arsenal, Dover, NJ.
AUTHORITY
USAARC ltr, 22 Mar 1989

THIS PAGE IS UNCLASSIFIED

THIS REPORT HAS BEEN DELIMITED  
AND CLEARED FOR PUBLIC RELEASE  
UNDER DOD DIRECTIVE 5200.20 AND  
NO RESTRICTIONS ARE IMPOSED UPON  
ITS USE AND DISCLOSURE.

DISTRIBUTION STATEMENT A

APPROVED FOR PUBLIC RELEASE;  
DISTRIBUTION UNLIMITED.

*(Handwritten circled number 2)*

AD \_\_\_\_\_

COPY NO. *(Handwritten mark)*

TECHNICAL REPORT 4321

IN - BORE PREMATURE  
MALFUNCTION INVESTIGATIONS  
OF THE  
81 MM HIGH EXPLOSIVE MORTAR CARTRIDGES  
WITH THE  
M526, M524A5 AND XM176  
POINT DETONATING FUZES

JOHN MCPARTLAND  
WILLIAM PICK

FEBRUARY 1972

893104



AM 414

D D C  
APR 6 1972  
*(Handwritten initials)*

PICATINNY ARSENAL  
DOVER, NEW JERSEY

COESSION for

WHITE SECTION

BUFF SECTION

LAB. GEO.

IDENTIFICATION

AVAILABILITY

ST.	AVAIL.	SPECIAL
B		

The findings in this report are not to be construed as an official Department of the Army position, unless so designated by other authorized documents.

DISPOSITION

Destroy this report when no longer needed. Do not return it to the originator.

1473

14

PA-TR-

9 TECHNICAL REPORT #321

6 IN-BORE PREMATURE MALFUNCTION INVESTIGATIONS OF THE 81MM HIGH EXPLOSIVE MORTAR CARTRIDGES WITH THE M526, M524A5 AND XM716 POINT DETONATING FUZES.

10 JOHN/McPARTLAND WILLIAM/PICK

11 FEBRUARY 1972

13 SH P.

AMMUNITION DEVELOPMENT & ENGINEERING DIRECTORATE PICATINNY ARSENAL DOVER, NEW JERSEY, 07801

D D C  
APR 6 1972



Distribution limited to U.S. Government agencies only; Test and Evaluation (February 1972). Other requests for this document must be referred to Picatinny Arsenal.

MJ 1289 400 ✓

TABLE OF CONTENTS

Section	Page
ACKNOWLEDGMENT	(ii)
SUMMARY	1
CONCLUSIONS	3
RECGMMENDATIONS	5
BACKGROUND	
Purpose	7
History	7
Description	7
STUDY	9
REFERENCES	17
APPENDICES	
A. Figures	19
B. Test Data Tables	51
C. Correspondence	67
TABLE OF DISTRIBUTION	81
ABSTRACT DATA	85

### ACKNOWLEDGMENT

Results compiled in this report are based on malfunction investigations conducted by various personnel. The authors gratefully acknowledge their contributions in these investigations and, in particular, the work of the following personnel in the areas shown:

Charles K. Fabel -- Fuzes with rivet head protruding above striker will cause premature if ammunition is double loaded.

An M374 Cartridge, with a loose base plug, fired at high charge can cause in-bore premature.

The Navy Mk1 and Mk2 Mortars are of marginal design.

Sidney Glassman -- Firing rounds with an armed fuze, resulting from handling ammunition after removal of safety wires, is most common cause of in-bore prematures.

Tests to determine if the fuze can become armed in trigger-fired mode or when a misfire occurs.

## SUMMARY

A series of malfunction investigations were conducted by the Ammunition Development & Engineering Directorate's Ammunition Maintenance Division from October 1966 to 1970 to determine the causes of in-bore prematures of various types of 81mm ammunition. Tests indicated that in-bore prematures can result from missing bore riding pin, double loading, voids in high explosive (HE) filler, porosity in shell body or loose base plugs. It was also found that Mk1 and Mk2 Navy Mortars are of marginal design, and that M362, M370, M374 and M375 Cartridges should not be fired above Charge 5 with these weapons.



## CONCLUSIONS

Firing 81mm HE mortar rounds with an armed fuze -- resulting from handling and transporting the ammunition after the safety wires are removed -- is probably the most common cause of high order in-bore prematures. The XM716 Fuze is the most drop-sensitive mortar fuze.

Five of the 17 incidents of in-bore prematures covered by these investigations were proven, or evidence indicated, to be caused by double loading (misfired round not removed, next round dropped into tube). Fuzes with a protruding rivet head on the striker will probably cause a low order, in-bore premature at a rate of 1:1 if the ammunition is double loaded. Fuzes with a flush rivet head, or no rivet on the striker (such as the M524A5 Fuze), probably will not result in an in-bore premature.

The Navy Mk1 and Mk2 Mortars are of marginal design. The M362, M370, M374 and M375 Mortar Cartridges should not be fired above Charge 5 with these two Navy weapons.

Ammunition fired at high charge -- with a large void at the base of the HE filler -- can result in an in-bore premature.

Ammunition fired at high charge, with a substantial size hole completely through the shell body (behind the obturator), can result in a low order, in-bore premature.

An M374 Cartridge, with a loose base plug, fired at high charge, can result in an in-bore premature.

An excessively deep obturator groove or cavitation on the inside wall in an M374 Cartridge will probably not cause an in-bore premature.



RECOMMENDATIONS

Safety wires should not be removed from the fuze until just prior to firing the 81mm mortar ammunition (letter dated 25 June 1970, Appendix C).

Fuzes should not be manufactured with head protruding from the striker (Reference 2 and 3).

M362, M370, M374 and M375 Mortar Cartridges should not be fired from the Navy's Mk1 or Mk2 Mortars at greater than Charge 5 (Letters dated 23 December 1967, 17 December 1968 and 16 July 1970, Appendix C).

## BACKGROUND

### Purpose

This series of investigations was conducted to:

1. Determine the cause of in-bore prematures reported by the User.
2. Recommend disposition of ammunition lots involved.
3. Determine the corrective action necessary to prevent recurrences of the malfunctions.

### History

The malfunction covered by these investigations are listed by Malfunction Investigation File (MIF) numbers in Table 1, Appendix A. The in-bore prematures that occurred during acceptance tests were not investigated by the Ammunition Maintenance Engineering Division, but the information generated by the investigations of the in-bore prematures during acceptance tests was used in conjunction with the malfunction investigation covered in this report. Some malfunction reports indicated that the User did not know which round, from two ammunition lots stored at the site, actually malfunctioned. In these cases, both lot numbers were investigated and are listed in Table 1. Where more than one fuze lot was assembled to one complete round lot, both fuze lots were investigated (these are also listed in Table 1). Four types of 81mm rounds experienced in-bore prematures since October 1966 and the investigations are included in this report:

Cartridge, 81mm, HE, M362, w/fuze, PD, M526  
Cartridge, 81mm, HE, M374, w/fuze, PD, M524A5  
Cartridge, 81mm, HE, M374, w/fuze, PD, M526  
Cartridge, 81mm, HE, M374, w/fuze, PD, XM716

### Description

The ammunition and fuzes involved in these investigations are illustrated in Figures 1-6. A complete description of each item is in Reference 1.

## STUDY

Ballistic tests were conducted to determine if the possible causes of the 81mm HE mortar cartridges in-bore prematures were:

Voids in the HE Filler Near the Base -- An in-bore premature occurred at Jefferson Proving Ground, during an acceptance test of an M374 Cartridge. The round was fired at Charge 9. An x-ray of the round, taken before the malfunction, indicated a large void in the HE filler near the base. Test rounds were specially prepared to duplicate the malfunctioned round, and fired at various charges. The test data (Table 2) confirms that an in-bore premature can occur with this condition at high charge. The fragments of the mortar tubes used in the tests are shown in Figures 7 and 8.

Porosity in the Shell Body -- Previous tests, conducted at a low propellant charge, indicated that the HE filler in 81mm mortar ammunition cannot be initiated by propellant gases in the weapon (Reference 4). Additional tests were conducted by the Ammunition Engineering Laboratory by preparing sample rounds with 3 holes, 1/16-inch diameter through the wall between the obturating band and the base and sample rounds with three holes, 1/16-inch diameter, through the base of the shell. Cartridge housing pressure plates were not installed in these rounds. All rounds were HE-loaded and assembled with dummy fuzes. The test data indicated that high propellant charges are necessary to cause functioning of the HE filler when the shell body has a substantial size hole completely through the shell body (Table 3). The shell fragments recovered indicated that they were low-order detonations (Figures 9-14).

Loose-Fitting Base Plug in Cast Shell Body of the M374 Cartridge -- Previous tests, conducted with a low propellant charge, indicated that the HE filler in 81mm mortar ammunition cannot be initiated by propellant gases in the weapon as a result of loose-fitting base plugs (Reference 4). Additional tests were conducted by the Ammunition Maintenance Engineering Division by preparing sample rounds with loose-fitting base plugs. All rounds were HE-loaded and assembled with dummy fuzes. The test data indicated that a loose fitting base plug is a more serious defect than 1/16-inch holes through the shell base and will cause in-bore prematures (Table 3).

Excessively Deep Obturator Groove in the Shell Body of the M374 Cartridge -- 100 sample rounds were prepared by deepening the obturator groove. 34 samples had a 2.813-inch diameter instead of a 2.933-inch diameter, as allowed. The wall thickness under the groove on these samples was measured, and the average of the 34 samples was 0.047-inch. All rounds were HE-loaded and assembled with dummy fuzes. All samples were fired at Charge 9. The test data indicated that propellant gases, at high pressure, did not break through a thin wall (with the high stress concentration) and contact the HE filler to cause an in-bore premature (Table 3).

Cavity in the Inside of the Shell Body at the Base -- 100 sample rounds were prepared by drilling a 3/16-inch diameter hole into the inside base of the shell body, approximately 3/8-inch deep, 30° from the longitudinal axis (Figure 15) before loading with Composition B and assembling with dummy fuzes. All samples were x-rayed to assure that Composition B had filled the cavities. All samples were fired at Charge 9. The tests indicated that cavities in the inside wall of the shell body did not cause the HE filler to be "pinched" -- when setback forces were developed during ignition -- sufficiently to cause an in-bore premature.

Missing Bore Riding Pin in the Fuze (M526 or XM716) -- Malfunction reports, reports from the Southeast Asia (SEA) U.S. Army Munitions Command (MUCOM) Liaison Officer and evidence found from ammunition returned from SEA indicates that it is common practice to handle and transport 81mm mortar ammunition after the safety wires are removed from the fuzes. Tests were conducted to determine the drop sensitivity of the M526 and XM716 Fuzes with the safety wire removed and to determine the functioning mode of the fuze when the bore riding pin is missing. The test data indicated that the bore riding pin will eject approximately 30% of the time when rounds are dropped from as low as four feet on a hard surface -- completely arming the XM716 Fuze (Table 4). Test data also indicated that the bore riding pin will eject at approximately the same rate when the M526 Fuze is dropped from a height of four feet on a hard surface. However, approximately 28% of the time that the bore riding pin does eject, the T336E7 Fuze head assembly is damaged and the fuze does not arm (Table 5). When the T336E7 head assembly is not damaged and setback causes it to arm and the bore riding pin has ejected, the M526 Fuze is completely armed. These tests indicate that the M526 Fuze will arm at a lower rate than the XM716 Fuze if the ammunition is dropped after the safety wires are removed. When the fuzes are armed, they will function in the tube at a 1:1 rate (Table 6).

Tests were conducted to determine if a fuze could be initiated by propellant gases if the bore riding pin is missing. 15 M52A2 Fuzes were modified by filing off the firing pin, inserting a metal disc over the detonator and replacing the booster charge with propellant increments. The fuzes were assembled to inert M43A1B1 Cartridges. The bore riding pin was removed prior to firing to provide an opening for the propellant gases to enter the fuze. The M43A1B1 Cartridge allows considerably more propellant gas blow-by than either the M362 or M374 Cartridges. The 15 rounds were fired at Charge 3 and none functioned in the tube. The test results are applicable to the M526 and XM716 Fuzes since they are similar to the M52A2 Fuze. It is concluded from these tests that the functioning mode of ammunition fired with an armed fuze (including a missing bore riding pin) is by actuation of the firing pin and will result in a high-order detonation in the tube.

Assembly Defect in M524A5 Fuze ("Limbo") -- An in-bore premature occurred at Jefferson Proving Ground during an acceptance test of an M524A5 Fuze. The round had been fired at Charge 0. An x-ray of the fuze, taken before the malfunction, indicated an assembly defect known as "limbo." Limbo occurs when the segment in the setback assembly is positioned close to the point where it will release the lever (Figure 16). The segment was held in this position, against the action of the torsion spring, by the lever resting on the corner of the flat on the segment shaft. Figure 17 shows the segment in its normal position. This sequence of events was believed to have occurred:

A shock or vibration disturbed the lever resting on the corner of the flat on the segment shaft and the lever moved to a position where it no longer restrained the escapement mechanism.

The escapement mechanism functioned, but not for sufficient time to rotate the plunger assembly far enough to engage and jam the plunger safety pin. There were defects which could cause a binding action during rotation of the plunger assembly. (An alternate sequence, without the binding action, could have occurred; the safety pins may have been removed before shock or vibration disturbed the lever.)

The safety pins were removed.

The round was dropped down the tube.

Setback force moved the firing pin into contact with the primer.

The explosive train in the fuze functioned, and the round detonated in the tube.

Several setback device assemblies were rejected during manufacture because of limbo malassembly. It is likely that a few defective setback assemblies were not discovered. If the escapement mechanism in a malassembled fuze functions during handling or transportation and the plunger assembly engages the plunger safety pin, it will be

impossible to remove the pin without breaking the pin. The fuze will not function if the round is fired in this condition. Tests were conducted by the Ammunition Engineering Laboratory to study the effect of vibration and jolt on fuzes with the limbo defect. The test data indicated that fuzes with arming mechanisms assembled in limbo position could remain in this hazardous condition after handling and transportation (Table 7).

Double Loading (Misfired Round Not Removed; Next Round Dropped into Tube) -- An on-site investigation of an in-bore premature of an M374 Cartridge with an M526 Fuze at Fort Bragg, North Carolina proved to be caused by double loading (letter dated 12 November 1968, Appendix C). Aberdeen Proving Ground reported that two inert-loaded M374 Cartridges with M78 dummy fuzes were accidentally double loaded during a test firing (Reference 5). The mortar tube was destroyed by the propellant charges (10 on the bottom round, 12 on the top round). The bottom shell body was crushed and the top round traveled down range (Figure 18). Three in-bore prematures of M374 Cartridge with an XM716 Fuze in SEA were attributed to being caused by double loading (letters dated 17 December 1968, 19 November 1970 and 7 December 1971, Appendix C).

These incidents are evidence that double loading is a significant factor in the in-bore premature rate experienced with 81mm mortars. Tests were conducted to determine under which conditions double loading would cause an in-bore premature (Table 8). The test data indicated that fuzes with a rivet head protruding above the striker will probably cause a low order, in-bore premature (Figure 19) at a rate of 1:1 if the ammunition is double loaded. Fuzes with the rivet head flush with the striker, or no rivet on the striker will probably not result in an in-bore premature.

Tests also were conducted to simulate a condition where the first round loaded "hangs up" in the tube (due to residue) and the second round loaded forces the round down the tube to strike the firing pin, both rounds having flat strikers. The condition was simulated by dropping the first round down the tube of a trigger-fired weapon, then the second round was dropped down the tube and when it struck the first round, the first round was immediately fired by trigger action. The test was conducted five times with standard service M374 Cartridges and in all tests both rounds were projected down range without a premature functioning.

Fuze Arming in Trigger-Fired Mortars -- Tests were conducted to determine if a T336E7 head assembly in an M525 or M526 Fuze could arm when dropped into the tube of a trigger-fired weapon. If the fuze were to arm in this way, the bore-riding pin would keep the detonator out-of-line while the fuze is in the tube, but a muzzle burst could occur as the fuze leaves the tube and the pin is ejected. Test data indicated that arming of a fuze head assembly was not probable by this mode (Table 9).

Screening of Suspect Lots -- Samples from the cartridge and fuze lots involved, or suspected to be involved, in in-bore prematures were inspected and tested. Samples from these lots were available and included in the program:

Quantity (Rounds)	MIF No.	M374 Cartridge Lot	XM716 Fuze Lot
324	A-41-69	MA-112-7	MA-10-70 and MA-10-71
324	A-175-69	KN-6-2	KN-3-32
324	A-175-69	KN-9-16	KN-6-10
324	A-213-69	MA-60-2B	MA-1-3
324	A-91-70	KN-11-36	KN-6-108
432	A-129-70	KN-9-80A	KN-6-49

In addition, 100 samples of factory-reject cast shell bodies and 100 samples of factory-reject forged shell bodies were inspected and tested for instrumentation indexing and for correlation of quality. Samples from Cartridge Lot MA-112-8 (MIF A-41-69) were not included in the program because shell fragments returned from the malfunction site were examined and found to be from a forged shell body. Cartridge Lot MA-112-8 is made up of cast shell bodies. Samples from Cartridge Lot MA-105-22 (MIF A-319-70) have not been received to date, but will be inspected and tested when available.

Visual inspection of each fuze showed that all safety wire and bore riding pins were properly installed. Each fuze was removed from the projectile and x-rayed from two views, 90° apart. Examination of the x-rays indicated that all internal parts (slider, setback pin, springs, etc.) were in place. There were no abnormal conditions noted in the x-rays.

60 fuzes from each lot were disassembled. The width of the slot in the slider, the slider diameter, slider guide pin diameter, various critical dimensions in the body and overall length of the bore riding pin in each fuze were inspected for proper dimensions. All dimensions were found to be within safe tolerances.

15 fuzes each from five lots were used in the drop tests previously described. The tests indicated no significant difference in drop sensitivity between the five lots tested (Table 4).

Samples of booster lead, booster and auxiliary booster were taken from 10 fuzes from each lot and subjected to a sensitivity test in accordance with Reference 6. These tests indicated normal or less than normal sensitivity for these components.



All projectile samples, including factory rejects, were tested for Rockwell hardness (Table 10) and x-rayed along the longitudinal axis. A minimum of 40 samples from each lot were x-rayed twice, 90° apart. There were no cracks in the shell or voids in the HE filler. Some x-rays showed dark spots which indicated thin material in the wall of some shells. The thin material (pits) also were detected in the ultrasonic test. A cutaway section of a shell showing pit marks is in Figure 20.

After washout of HE filler, 30 shells from each lot, 30 factory-reject cast shell and 30 factory-reject forged shell were subjected to these four tests:

Each shell was subjected to an ultrasonic test. The pits observed in x-rays were recorded in these tests. The pits measured from 0.021-0.032 inch deep. The wall thickness adjacent to the pits measured 0.208-0.212 inch thick.

Each shell was subjected to 5,000 psi hydrostatic tests. No defects were observed.

Each shell was subjected to 150 psi air pressure. Three samples of factory-reject cast shell showed cracks in the obturator groove.

Each shell was subjected to magnetic particle inspection. No cracks or flaws of any type were observed, including the three samples that were observed to have cracks during the air pressure test.

Four rounds from each lot, four factory-reject cast shell and four factory-reject forged shell were subjected to dye penetrant inspection. Two samples of factory-reject cast shell showed porosity in the forward area.

Two rounds from each lot, two factory-reject cast shell and two factory-reject forged shell were selected from the cartridges used in the dye penetrant inspection. These rounds were cut into sections and two test samples were made from each shell for tensile strength tests. The test results are in Table 11. Material samples from one shell from each lot also were subjected to spectrographic analysis (Table 12) and to impact strength tests (Table 13).

Chemical analysis of the in-line explosives from each cartridge lot was conducted. These observations are noted in Table 14 and 15.

REFERENCES

1. Artillery Ammunition, Department of the Army Technical Manual 9-1300-203, April 1967.
2. Engineering Order 55576-1, Fuze Engineering Laboratory, Picatinny Arsenal, 13 March 1970.
3. Engineering Order 55577-1, Fuze Engineering Laboratory, Picatinny Arsenal, 13 March 1970.
4. V. H. McCoy, Production Engineering Test of Cartridge, HE, XM374E1, with Fuze, PD, M524, for 81mm Mortar, Aberdeen Proving Ground Firing Report DDS-810, January 1963.
5. Acceptance Test of 81mm Mortar M29E1, Aberdeen Proving Ground Record M-87435, 8 September 1969.
6. Military Explosives, Department of the Army Technical Manual 9-1300-214, November 1967.

APPENDICES

APPENDIX A

Figures

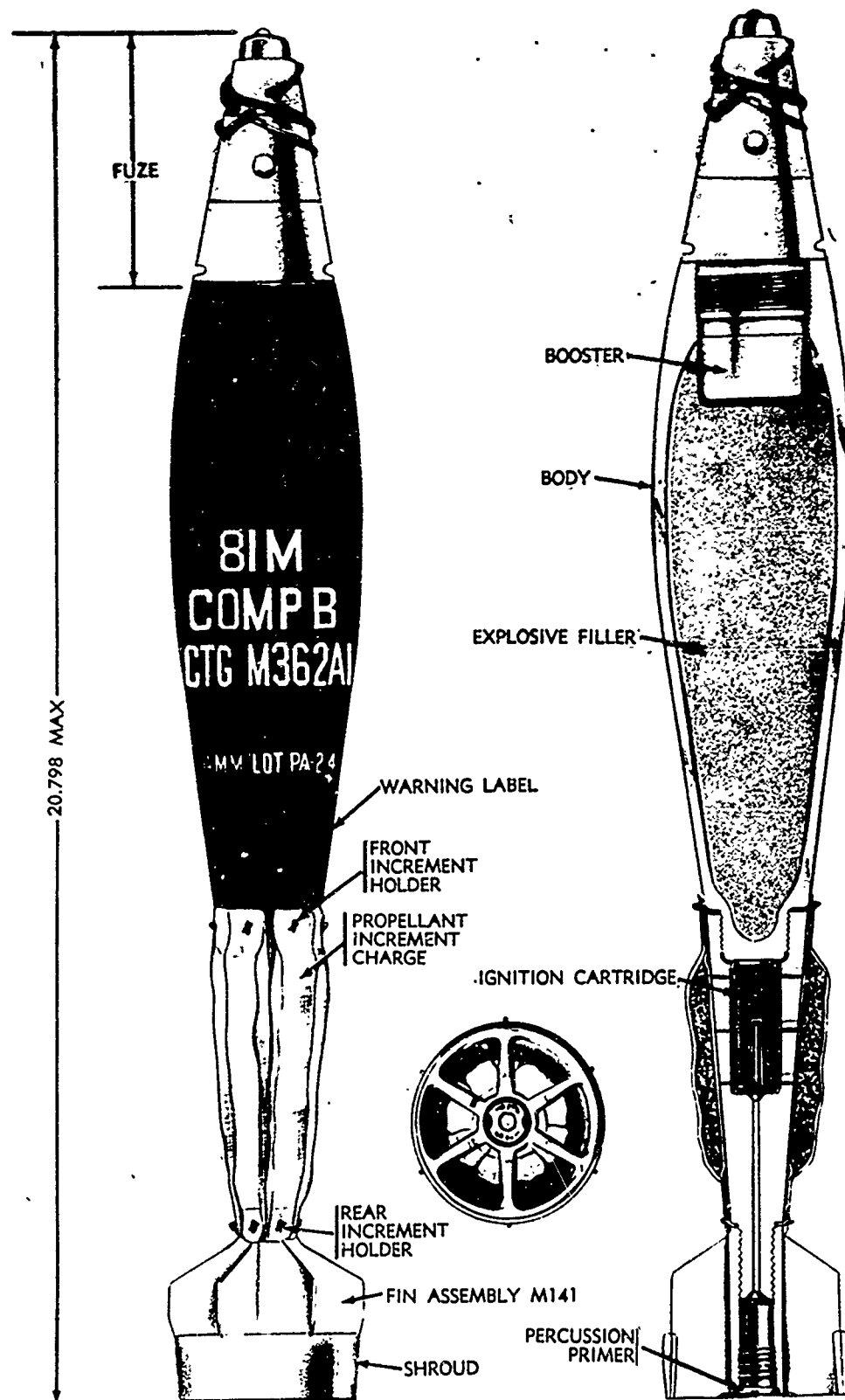

ORD D1481

Figure 1. Cartridge, 81 MM, HE, M362

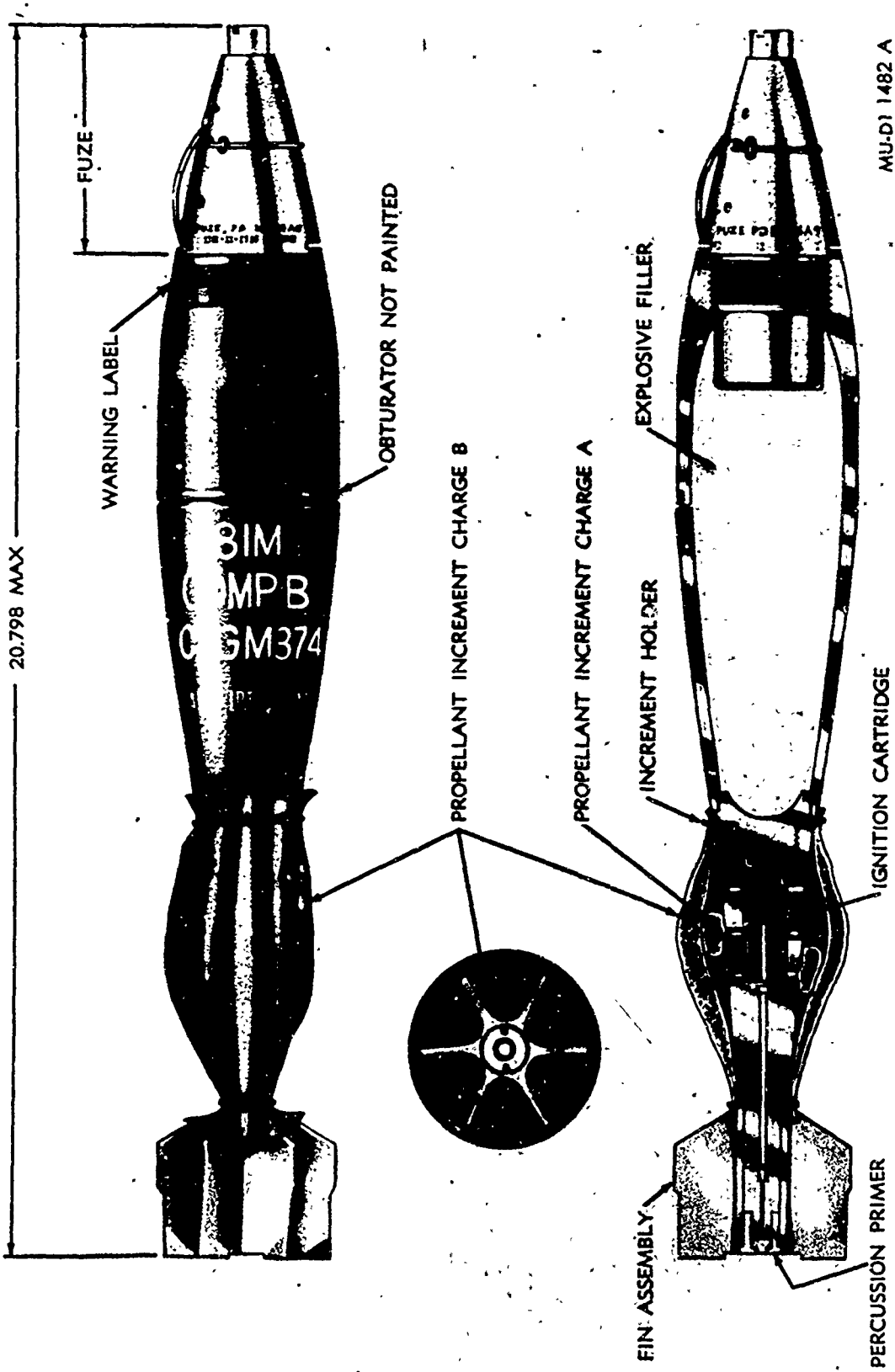

Figure 2. Cartridge, 81 MM: HE, M374

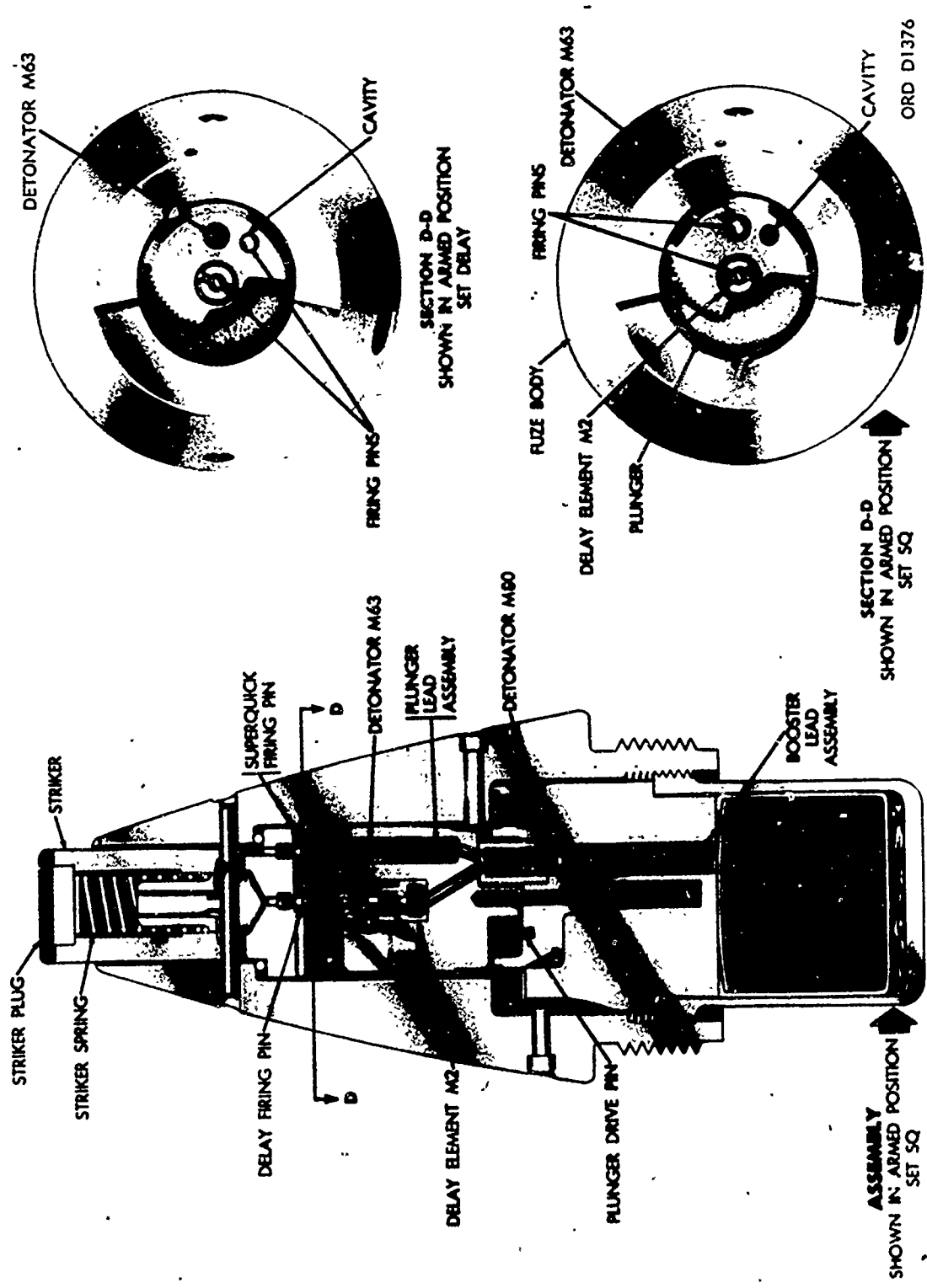

Figure 3. Fuze, PD, M524A5 in armed position



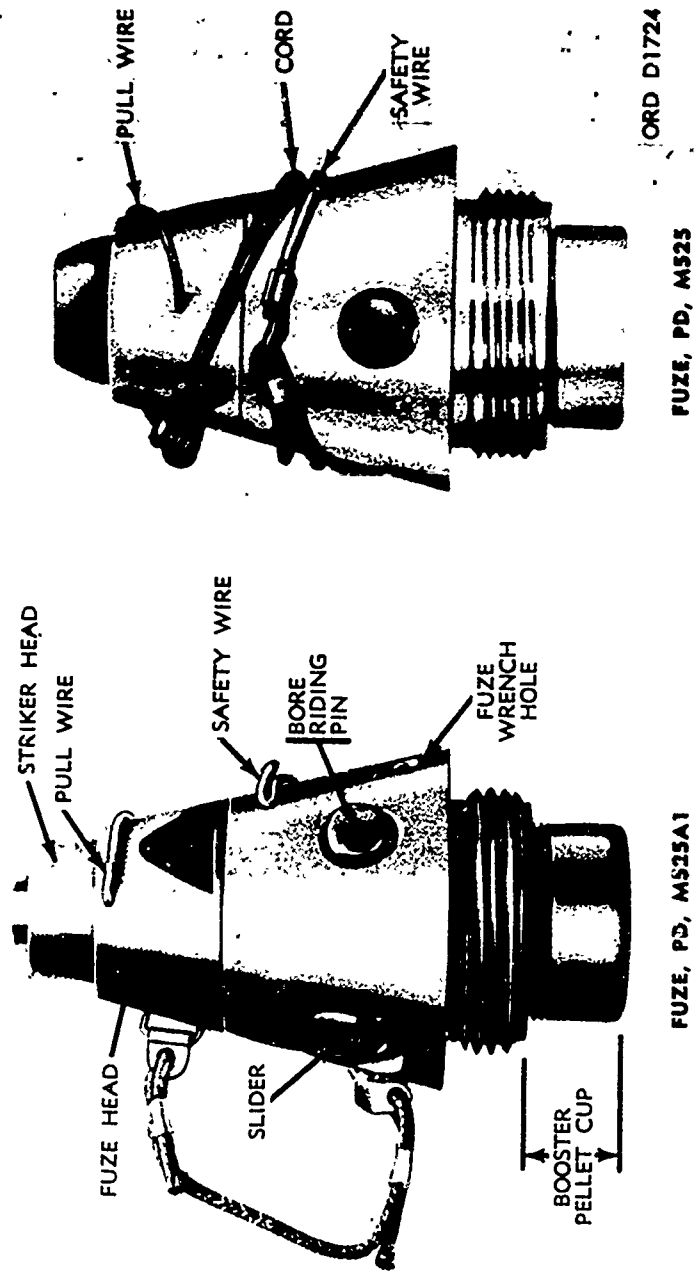

Figure 4. Fuze, PD, M525 and M525A1

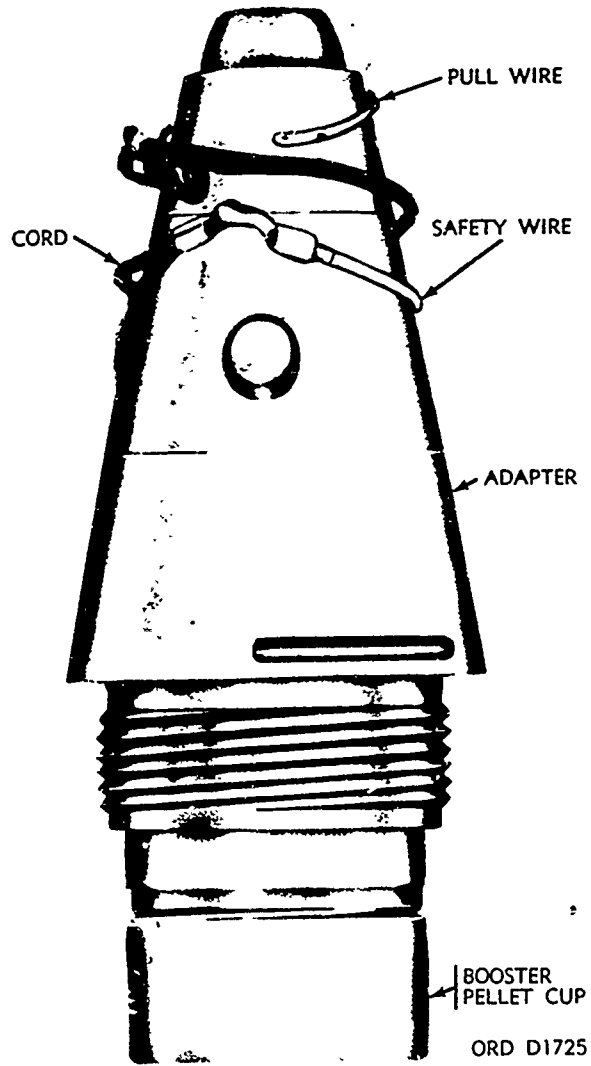

Figure 5. Fuze, PD, M526

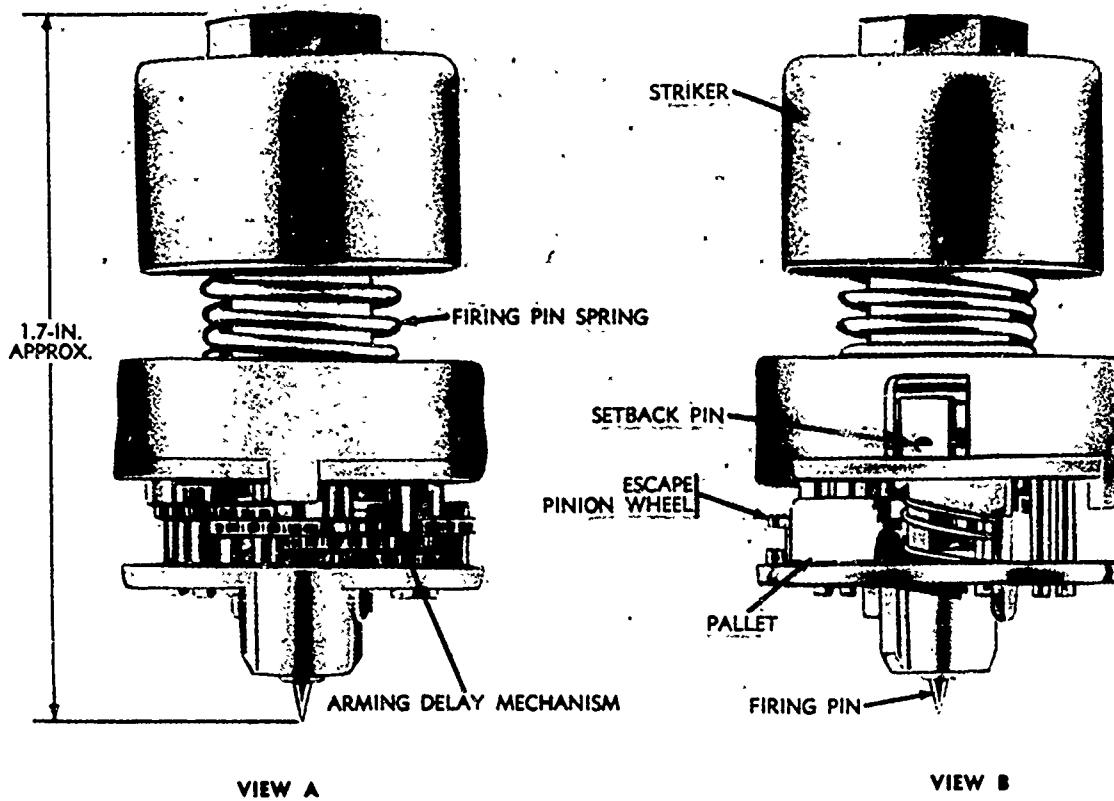

Figure 6. Head assembly, T336E7 for Fuzes, PD, M525 and M526



Figure 7. Mortar tube before and after premature functioning of test round with void in HE filler and fired at charge 11



Figure 8 Mortar tube before and after premature functioning of test round with void in HE filler and fired at charge 12



Figure 9. Tube and shell fragments from test round  
with holes through side wall of shell (front view)

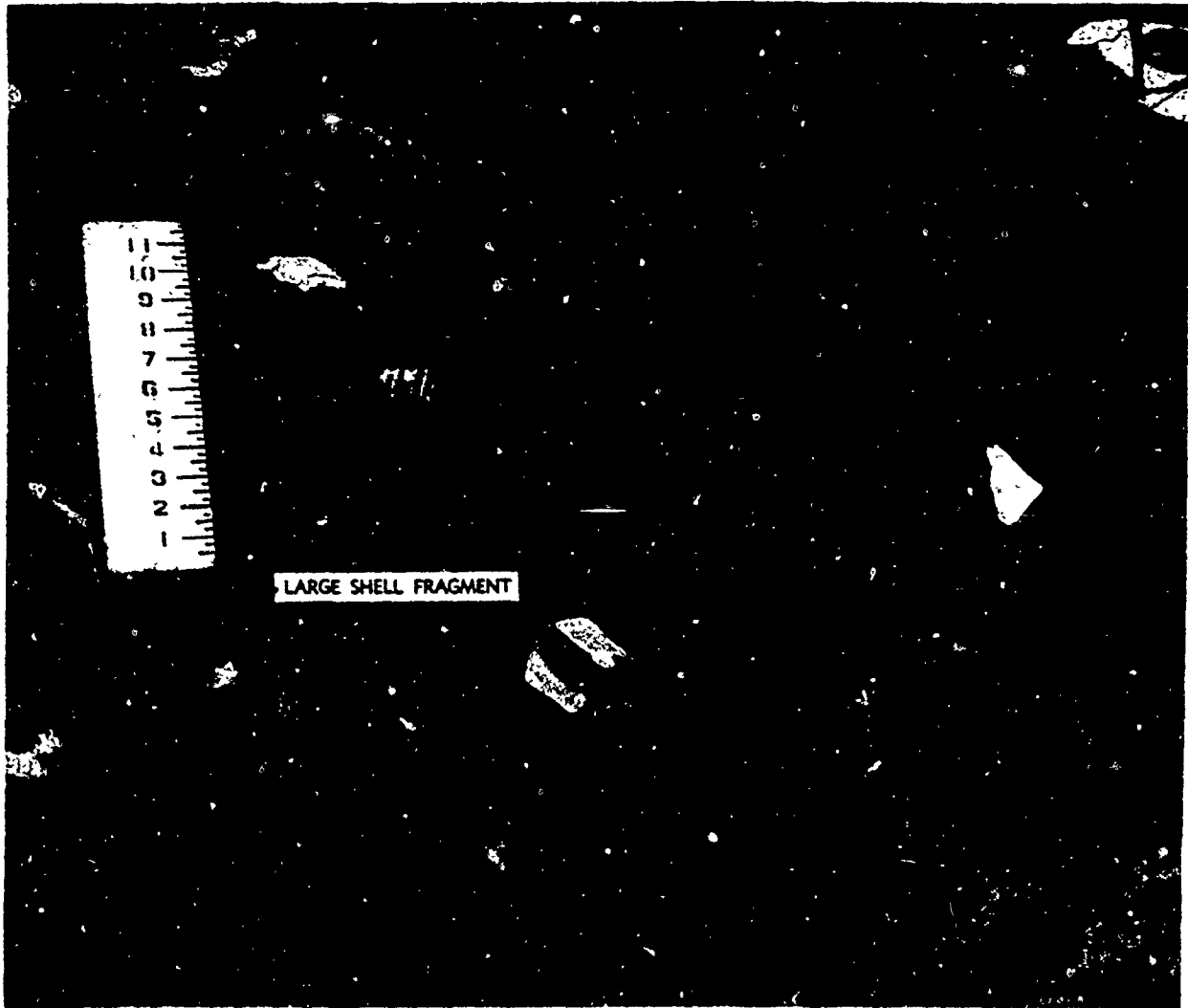

Figure 10. Tube and shell fragments from test round with holes through side wall of shell (side view)



Figure 11. Tube fragments after premature functioning  
of test round with holes through side wall of shell



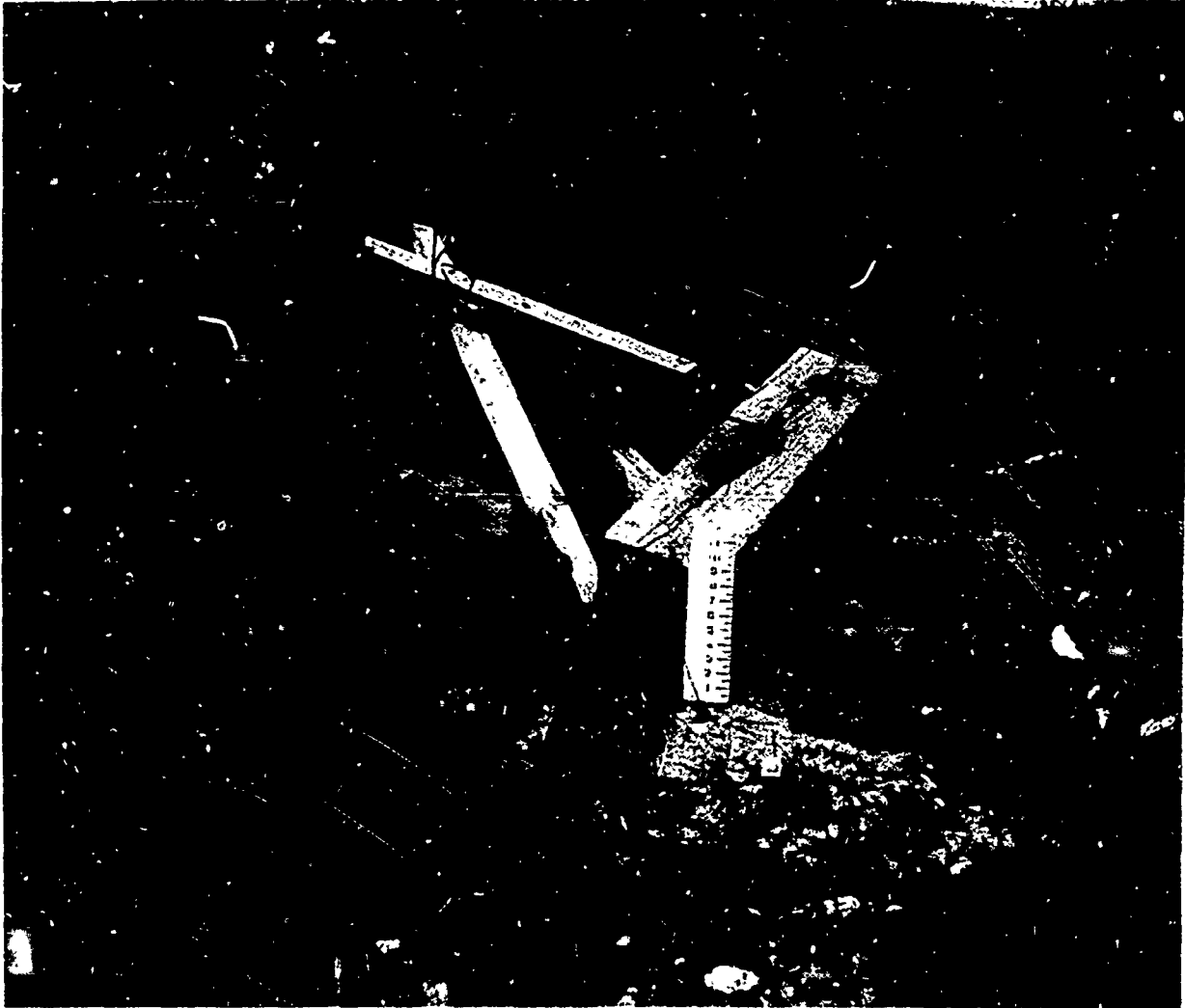

Figure 12. Tube fragments after premature functioning of test round with holes through base of shell



Figure 13. Tube fragments after premature functioning of test round with holes through base of shell



FIELD MALFUNCTION  
(MIF A-155-68)

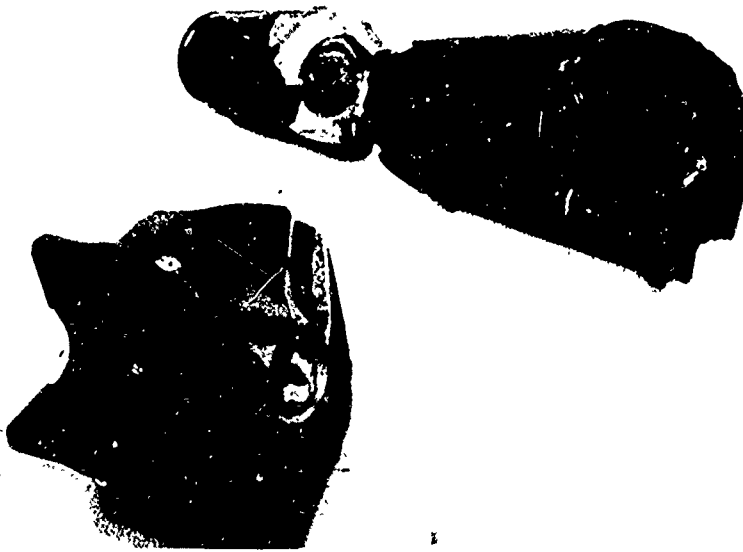
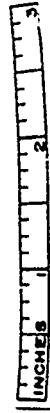

TEST ROUND WITH HOLES  
THROUGH BASE

Figure 14. Large fragments from base of shell and fin assemblies

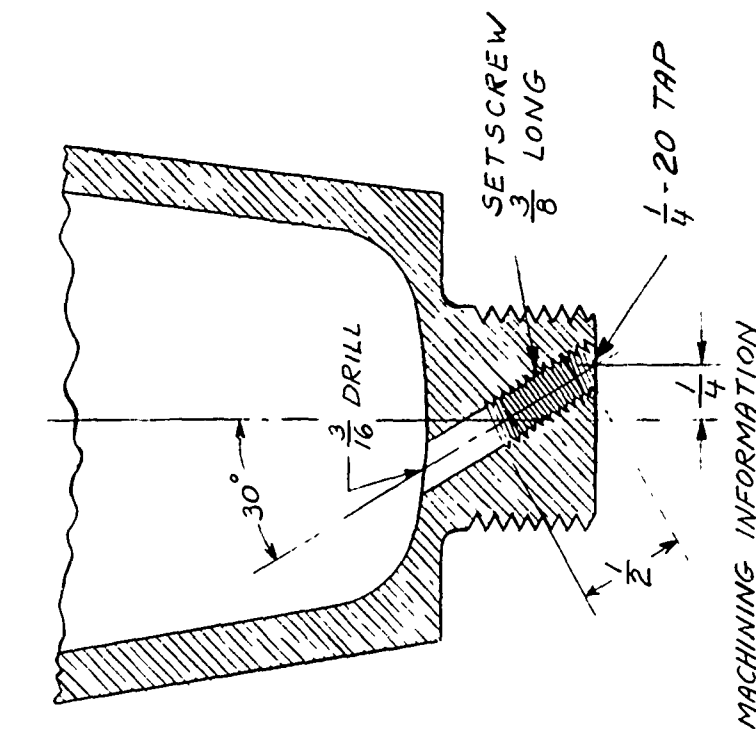
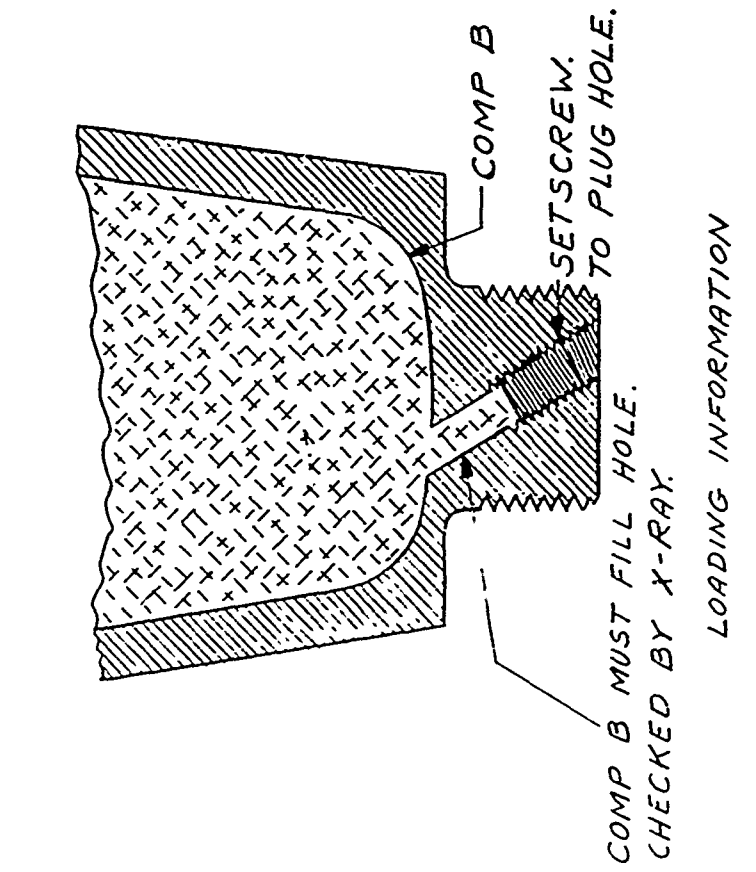
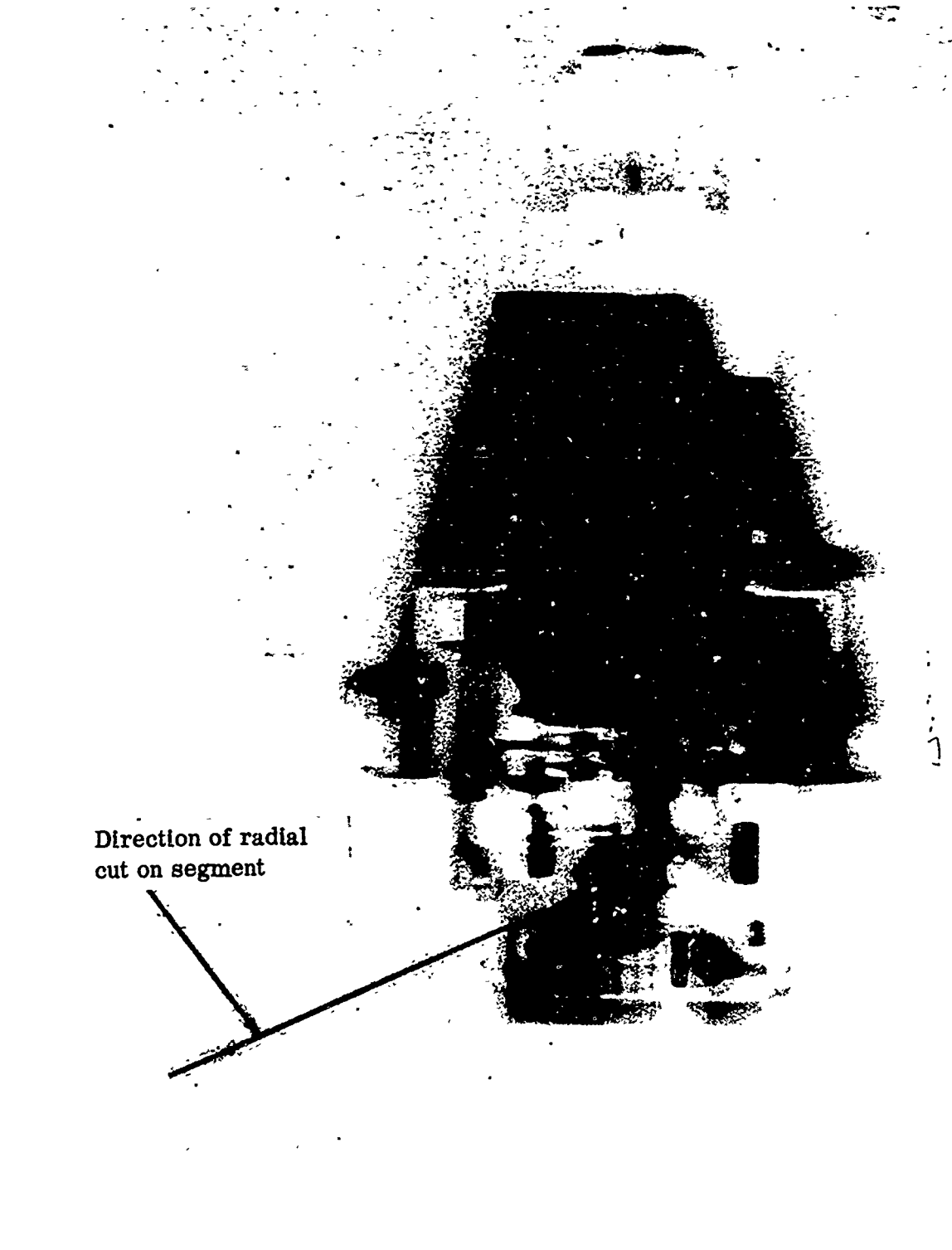

Figure 15. Test rounds prepared with cavity in the inside of the shell body at the base



Direction of radial  
cut on segment

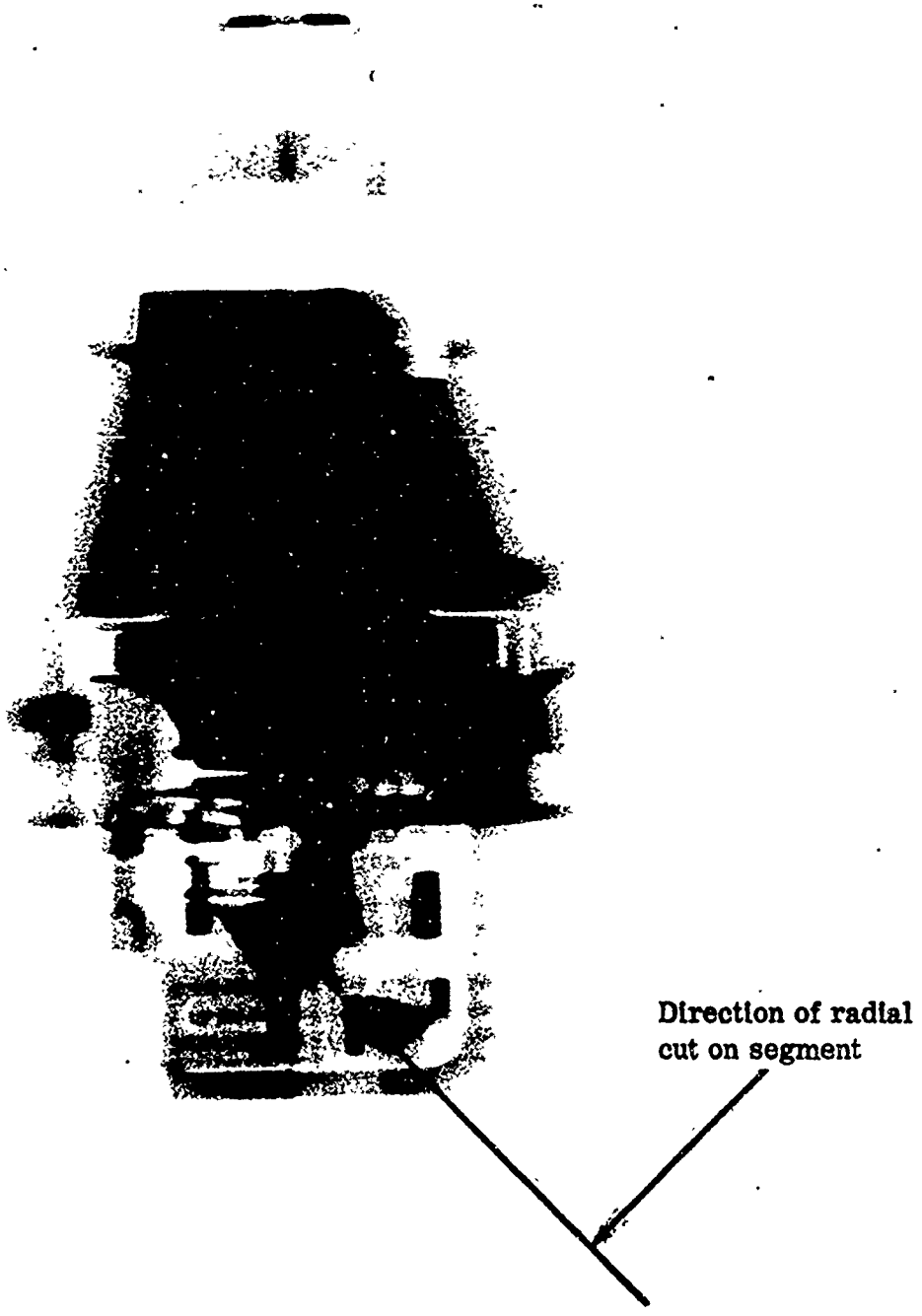

Figure 17. X-ray showing normal M524A5 fuze

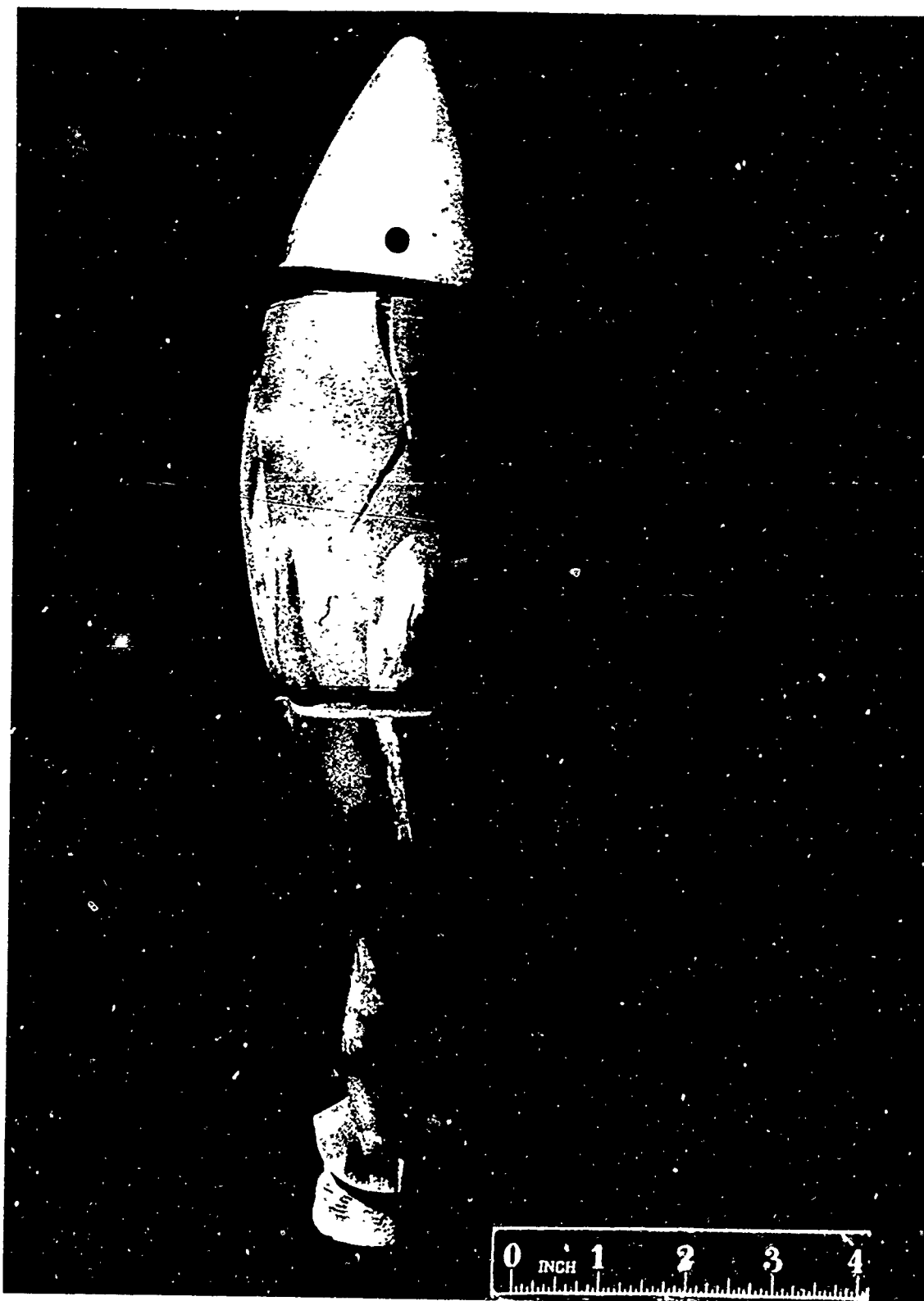

Figure 18. Bottom round from double loading (inert)

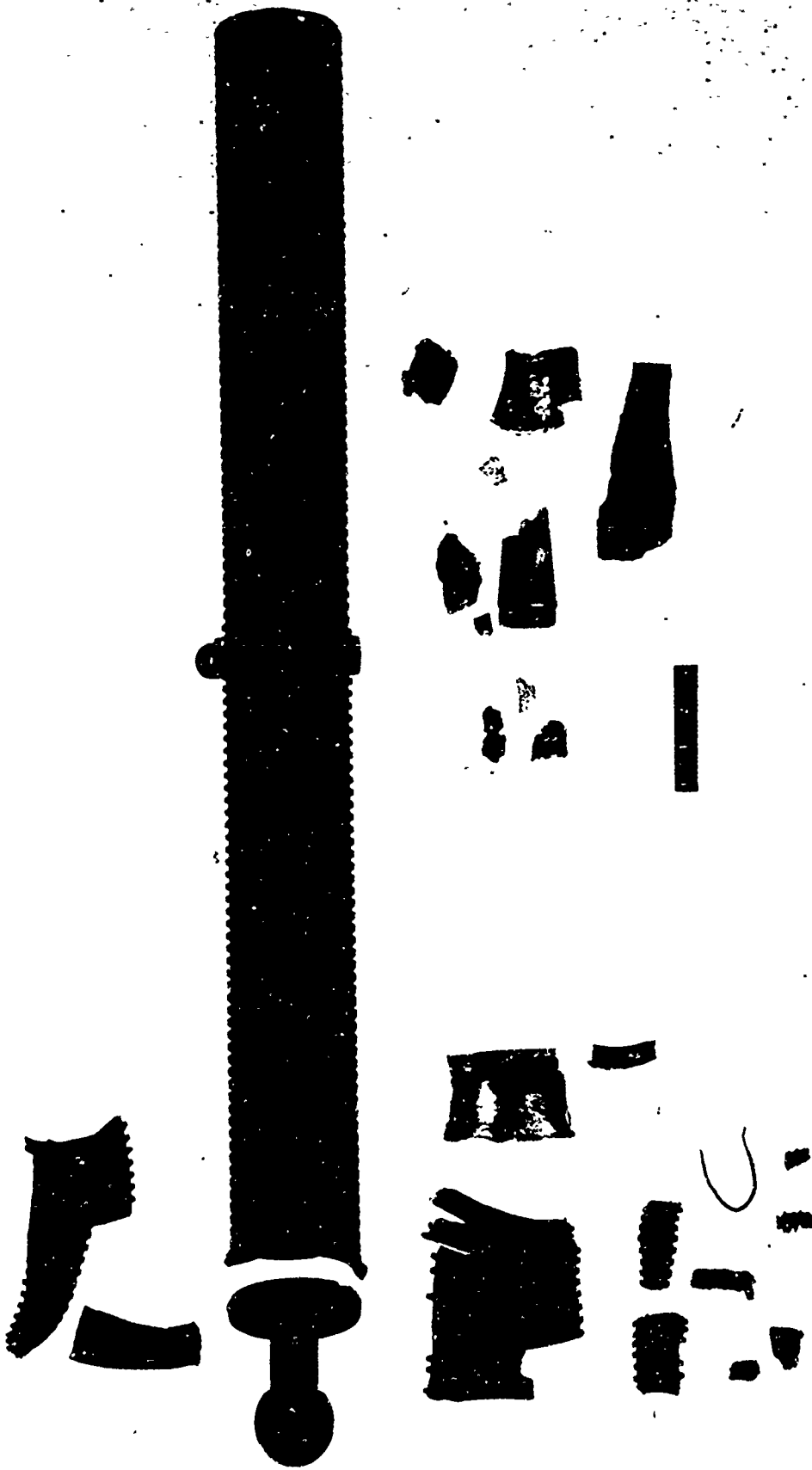

Figure 19. Tube and shell fragments from double loading test of HE ammunition



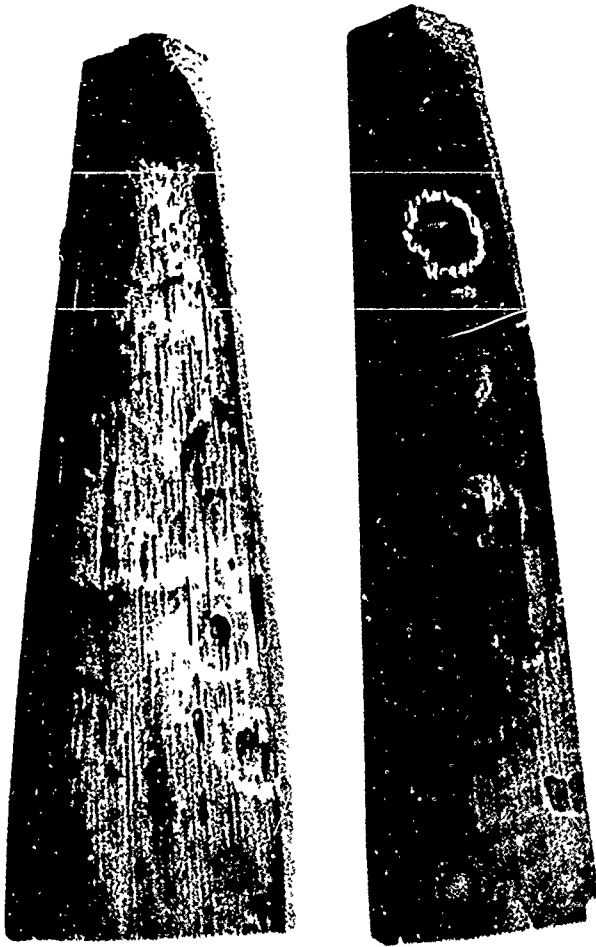

Figure 20. Sections of shell bodies with pits on inside surface

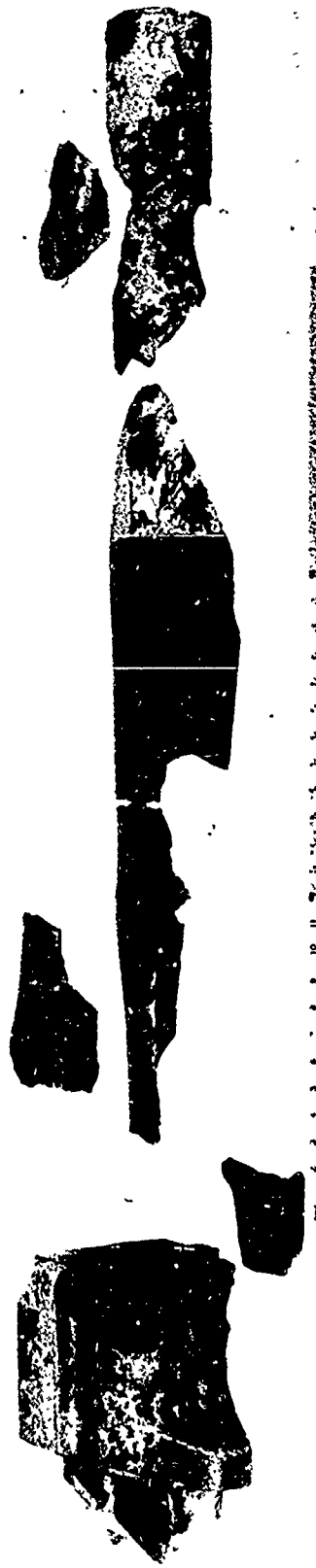

Figure 21 Fragments of tube involved in in-bore premature malfunction (MIF A-278-66)

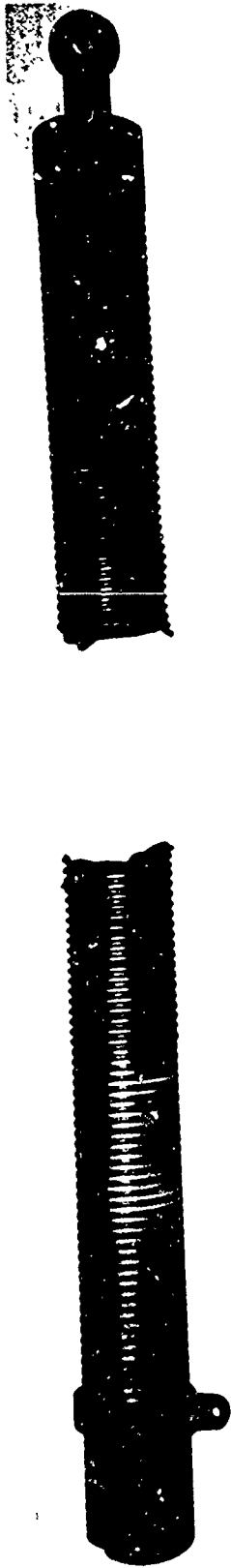

Figure 22. Fragments of tube involved in in-bore premature malfunction (MIF A-155-68)

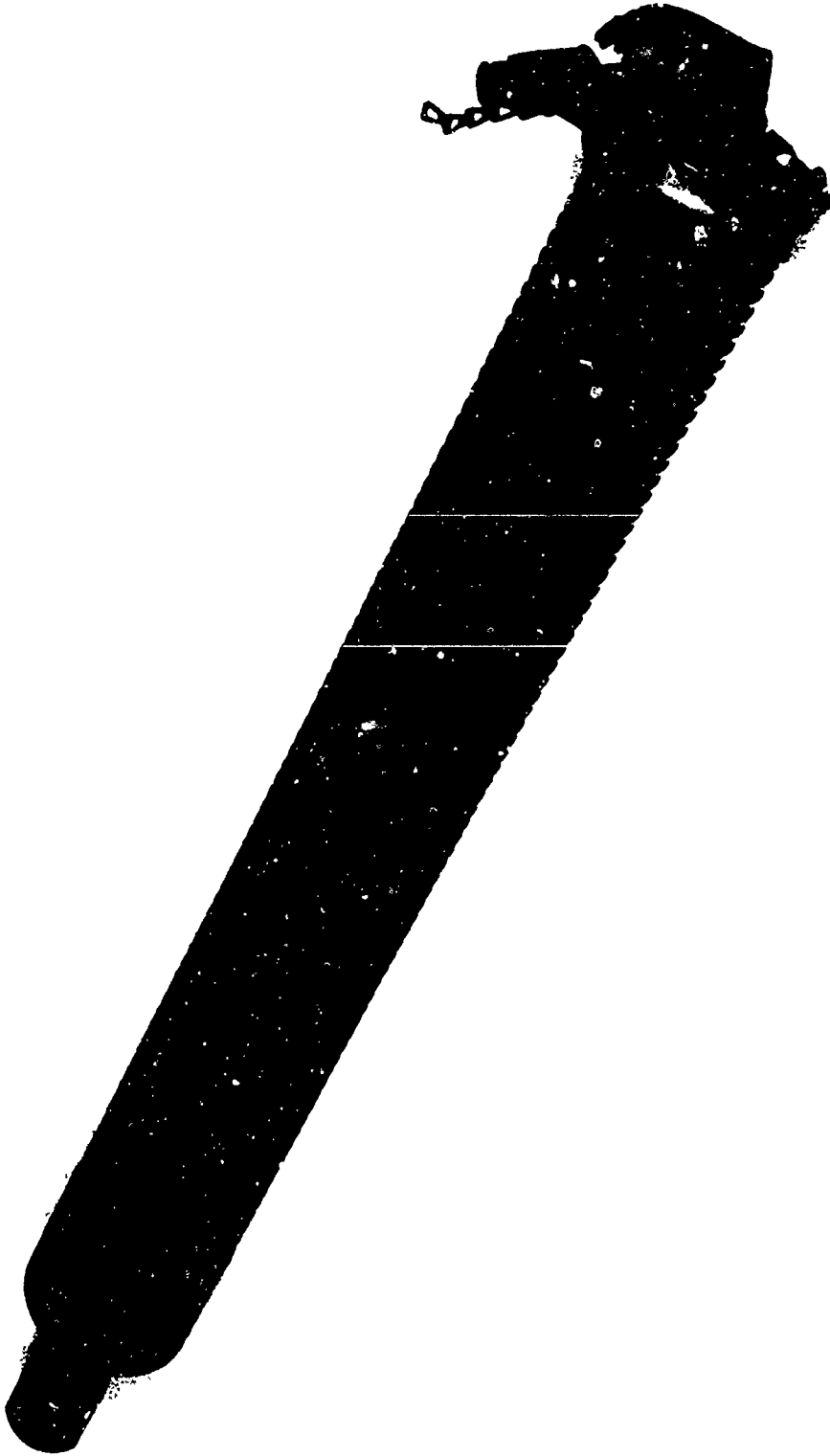

Figure 23. Lower part of tube involved in in-bore premature malfunction (MIF A-453-68)

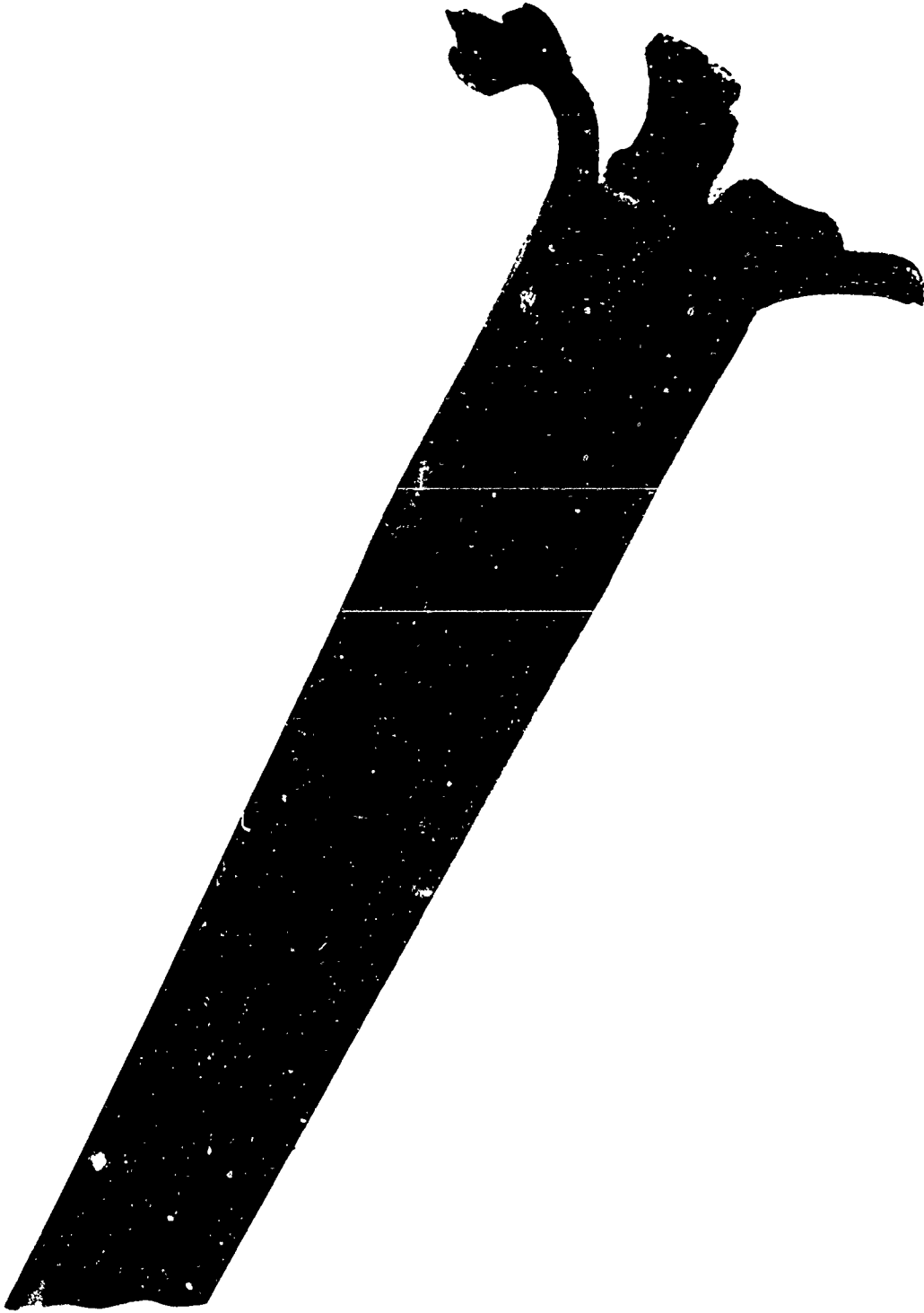

Figure 24. Fragment of tube involved in in-bore premature malfunction (MIF A-496-68)



Figure 25. Shell fragments from in-bore premature malfunction (MIF A-41-69)

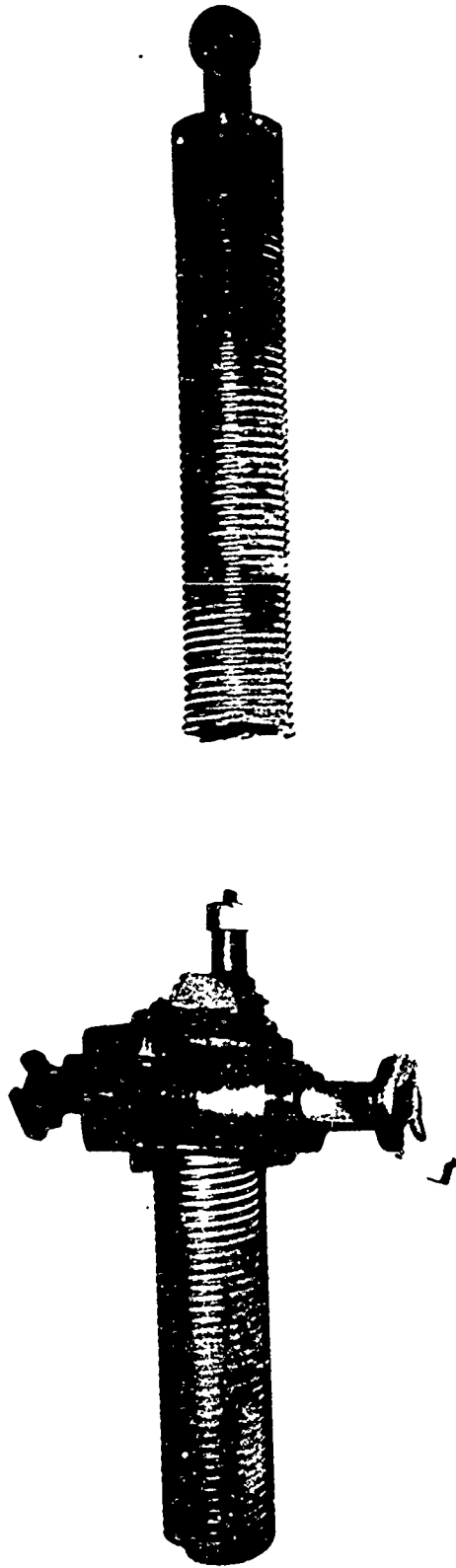

Figure 26. Fragments from tube involved in in-bore premature malfunction (MIF A-41-69)



Figure 27. Fragments from tube involved in in-bore premature malfunction (MIF A-91-70)



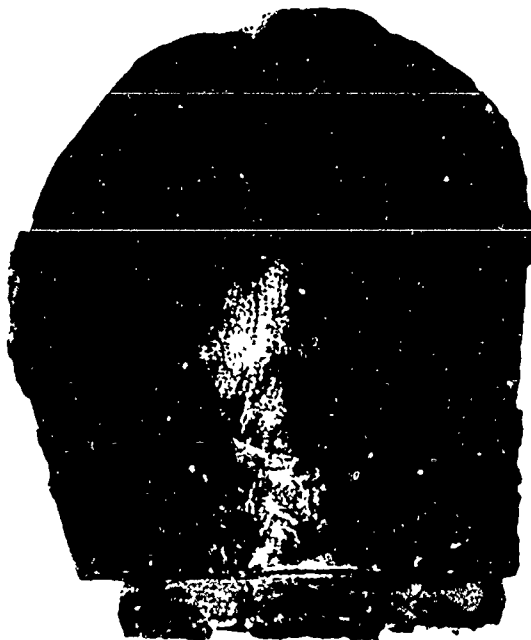

Figure 28. Shell fragment from in-bore premature malfunction (MIF A-129-70)

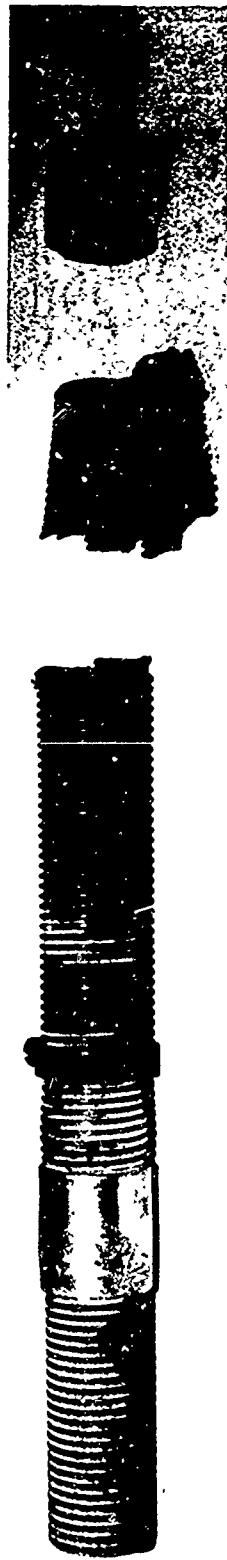

Figure 29. Fragments from tube involved in in-bore malfunction (MIF A-129-70)

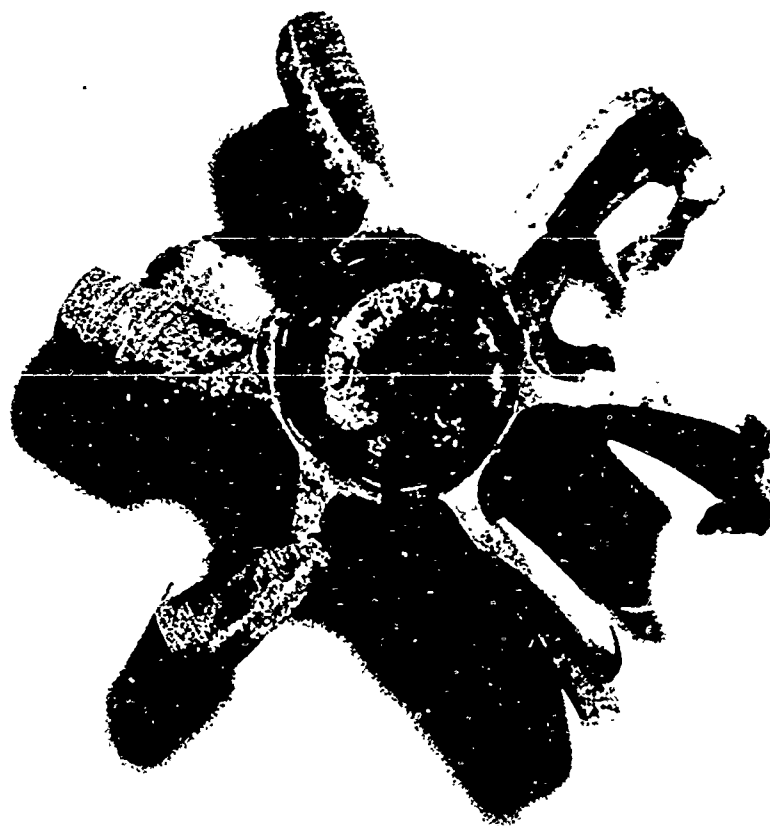

Figure 30. Fin fragment from in-bore premature malfunction (MIF A-129-70)

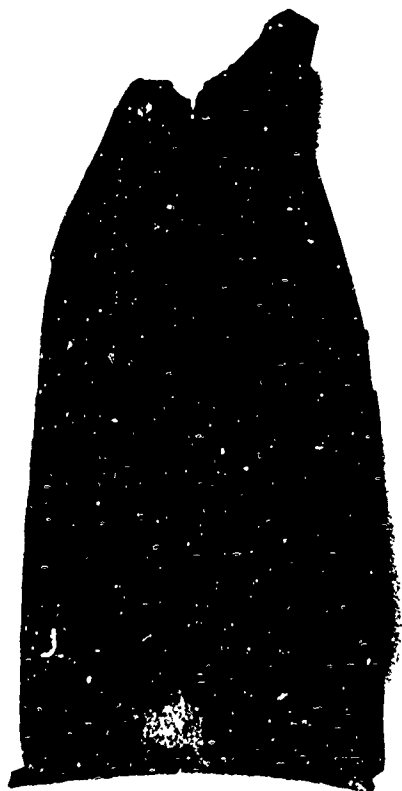

Figure 31. Fin and shell fragment from in-bore premature malfunction (MIF A-128-71).

APPENDIX B  
Test Data Tables

TABLE 1

HISTORY OF 81MM MORTAR IN-BORE PREMATURES

MIF No.	Date of Occurrence	Unit	Weapon	Cartridge Lot	Fuze Lot	Shell Body Manufacturer	Shell Body Material	Charge Fired	Deaths	Injuries
A-81-67	11 Mar 61	Navy Swift Boat (SEA)	Mk1	Cartridge, 81mm, HE, M362, with fuze, M526 MA-18-4D	MA-2-2A MA-2-13	Rheem	Steel	Un-known	1	1
A-278-66	10 Oct 66	Navy Swift Boat (SEA)	Mk1	MA-17-19G MA-20-14B	MA-1-2 MA-2-2	Rheem Rheem	Steel Steel	Un-known	3	2
Acceptance Test of Tube, S/N 14333	14 Aug 69	Aberdeen Proving Ground	M29E1	Cartridge, 81mm, Inert, M374, with fuze, Inert, CP, M78 Modified, Inert	Modified, Inert	N/A	N/A	10 bottom round, 12 top round	0	0
Acceptance Test	17 Oct 67	Jefferson Proving Ground	M29	Cartridge, 81mm, HE, M374, with fuze, M524A5 MA-14-1	LS-41-11 (Arm Mech Lot CAR-1-9)	General Motors	Cast Iron	0	0	0
A-155-68	13 Apr 68	Marines (SEA)	M29	MA-14-68	MA-60-179 (Arm Mech Lot CMZ-3-9 and 10)	AVCO	Cast Iron	8	1	2
A-310-70	4 Nov 70	ROK Marines	M29	MA-105-22	MA-64-247	Hayes-Albion	Cast Iron	5 or 6	1	1
Acceptance Test		Jefferson Proving Ground	M29	Cartridge, 81mm, HE, M374, with fuze, M526 MA-17-37		Burlington	Steel	9	0	0
A-114-68	4 Mar 68	Marines (SEA)	M29	MA-17-50 MA-17-63	MA-40-74 MA-40-83	Burlington Burlington	Steel	5	1	1
A-453-68	2 Oct 68	Ft. Bragg	M29	MA-600-2 (Hybrid Fr. MA-2-45, 45 & 47)	MA-40-111	General	Cast Iron	3	2	1

A-310-70	4 Nov 70	ROK Marines	M29	MA-105-22	MA-64-247	Hayes-Albton	Cast Iron	5 or 6	1
Acceptance Test				Cartridge, 81mm, HE, M374, with fuze, M526					
A-114-68	4 Mar 68	Jefferson Proving Ground Marines (SEA)	M29	MA-17-50 MA-17-63	MA-40-74 MA-40-83	Burlington	Steel	9	0
A-453-68	2 Oct 68	Ft. Bragg	M29	MA-600-2 (Hybrid Fr. MA-2-45, 45 & 47)	MA-40-111	General	Cast Iron	3	2
A-496-68	7 Nov 68	Navy Swift Boat (SEA)	Mk2	Cartridge, 81mm, HE, M374, with fuze, XM716					
A-41-69	25 Feb 69	Marines	M29	MA-112-7 MA-112-8	KN-9-27 KN-500-5 KN-500-6	Burlington	Steel	7	3
A-175-69	2 Jul 69	Navy Swift Boat (SEA)	Mk2	KN-6-2 KN-9-16	MA-10-10 MA-10-71 MA-10-72	Norris AVCO	Steel Cast Iron	6	0
A-192-69	17 Jul 69	5th Special Forces (SEA)	M29	KN-2-23A	KN-4-2	Burlington	Steel	9	1
A-213-69	8 Aug 69	1st Inf. Div (SEA)	M29	MA-60-2B KN-2-17	MA-1-3 KN-2-19	Burlington General Motors	Steel Cast Iron	2	3
A-91-70	24 Mar 70	11th ACR (SEA)	M125A1 APC	KN-11-36	KN-6-108	Burlington	Steel	Un-known	3
A-129-70	10 May 70	5th Inf. Div (SEA)	M29	KN-9-80A	KN-6-49	Burlington	Steel	6	1
A-128-71	8 Jul 71	101st AB Div (SEA)	M29	KN-9-69	KN-7-1	Riverbank	Steel	6	1

Fragments that were recovered after the above malfunctions are shown in Figures 18-31, Appendix A, and are identified by MIF numbers.

2

TABLE 2

81MM M374 HE CARTRIDGES WITH DUMMY FUZE  
VOIDS IN HE FILLED

An in-bore premature occurred during acceptance test of M374 Cartridges at Charge 9. An x-ray showed a large void in the HE filler at the base of the shell. Rounds were specially prepared to duplicate the malfunctioned round and fired with the following results:

No. of Rounds Fired	Charge Fired	No. of In-Bore Prematures
3	5	0
3	7	0
3	8	0
5	9	0
1	12	1

Additional rounds were modified by filling with a mixture of Composition B and filler E and fired with the following results:

No. of Rounds Fired	Charge Fired	No. of In-Bore Prematures
4	10	0
5	11	1
3	12	0



TABLE 3

81MM M374 HE CARTRIDGE WITH DUMMY FUZE  
DEFECTIVE SHELL BODY

Rounds were prepared by drilling three holes, 1/16-inch diameter, through the wall between the obturating band groove and the base before loading with Composition B. The rounds were fired with the following results:

No. of Rounds Fired	Charge Fired	No. of In-Bore Prematures
10	2	0
4	9	2

Rounds were prepared by drilling three holes, 1/16-inch diameter, through the base before loading with Composition B. Ignition cartridge housing pressure plates were not assembled with these rounds. The rounds were fired with the following results:

No. of Rounds Fired	Charge Fired	No. of In-Bore Prematures
35	9	2

Rounds were prepared by removing the obturater band and machining the groove deeper than allowed by the Technical Data Package. The rounds were fired with the following results:

No. of Rounds Fired	Diameter at Base of Groove (Inches)	Charge Fired	No. of In-Bore Prematures
33	2.893 <sup>-010</sup>	9	0
33	2.853 <sup>-010</sup>	9	0
34	2.813 <sup>-010</sup>	9	0

Rounds were prepared by drilling a 3/16-inch diameter hole into the inside base of the shell body, approximately 3/8-inch deep, 30° from the longitudinal axis, before loading with Composition B. The rounds were fired with the following results:

No. of Rounds Fired	Charge Fired	No. of In-Bore Prematures
100	9	0

Rounds were prepared with base plugs loosely assembled, without brazing to shell body. The rounds were fired with the following results:

No. of Rounds Fired	Charge Fired	No. of In-Bore Prematures
5	9	2

TABLE 4

DROP TEST OF XM716 PD FUZE  
(WITH THE 81MM M374 HE CARTRIDGE)

Fuzes were assembled to inert M374 Cartridges, the safety wire removed, and dropped fin end down on 3/4-inch steel plate on concrete with the following results:

Height Dropped (Feet)	Fuze Lot No.	No. of Rounds Dropped	No. of Times Dropped	No. of Bore Riding Pins Ejected
3	KN-3-32	2	2	1*
3	MA-1-3	4	2	2*
4	KN-3-32	2	1	0
4	KN-6-10	2	1	2
4	MA-1-3	2	1	1
4	MA-10-70	2	1	0
4	MA-10-71	2	1	0
5	KN-3-32	2	1	2
5	KN-6-10	2	1	0
5	MA-1-3	2	1	1
5	MA-10-70	2	1	0
5	MA-10-71	2	1	0
6	KN-3-32	2	1	0
6	KN-6-10	2	1	2
6	MA-1-3	2	1	2
6	MA-10-70	2	1	1
6	MA-10-71	2	1	0
7	KN-3-32	2	1	1
7	KN-6-10	2	1	1
7	MA-1-3	2	1	0
7	MA-10-70	2	1	0
7	MA-10-71	2	1	1
8	KN-3-32	2	1	1
8	KN-6-10	2	1	1
8	MA-1-3	2	1	1
8	MA-10-70	1	1	1
8	MA-10-71	2	1	1

\*Bore riding pins ejected on second drop; none ejected on first drop.

TABLE 5

DROP TEST OF M526 PD FUZE  
(WITH THE 81MM M374 HE CARTRIDGE)

No. of Samples Tested	No. of Heads Did Not Arm	No. of Bore Riding Pins Ejected	No. of Samples Where Pin Ejected and Head Did Not Arm
45	9	21	6

Samples were dropped from four feet, base down, on 4-inch steel plate.

TABLE 6

M52A2 PD FUZE WITHOUT BORE RIDING PINS

The test samples represent M525 or M526 Fuzes with armed heads and missing bore riding pins (completely armed). The fuzes were assembled to M43A1 1P Cartridges and fired, with the following results:

No. Fired	Charge	Elevation	No. Functioning	Location of Fuze at Time of Functioning
11	1	74°	11*	13 inches from bottom of tube**
1	0	74°	1*	13 inches from bottom of tube**

\*Muzzle flash and fuze break-up was observed at each firing. Recovery of fired rounds indicated that each fuze had functioned.

\*\*Barescope revealed a ring of fused aluminum 13 inches from bottom of tube, indicating that fuzes functioned immediately upon setback.

TABLE 7

M524A5 PD FUZE  
EFFECT OF HANDLING AND TRANSPORTATION  
ON FUZES WITH SEGMENT IN SETBACK ASSEMBLY  
POSITIONED NEARLY TO POINT WHERE LEVER IS RELEASED (LIMBO)

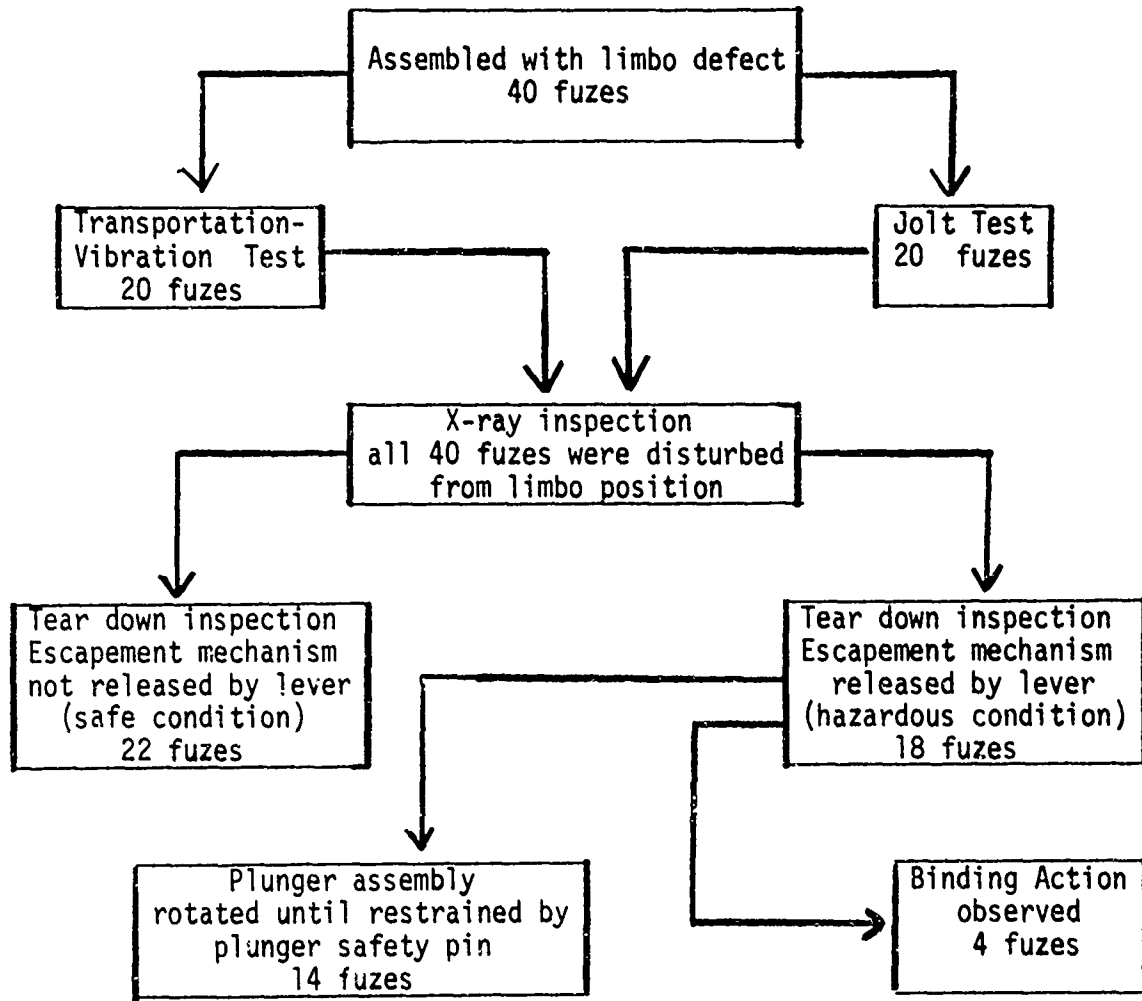

TABLE 8

81MM M374 HE CARTRIDGE WITH M524A5 AND M526 FUZES  
DOUBLE LOADING

Test was conducted by placing inert-loaded cartridges with fuzes being studied in bottom of tube and then dropping inert M374 Cartridges with live M71A1 Primers down tube.

M524A5 Fuze		M526 Fuze With Rivet on Striker Filed Flush	
1.		1.	
2.		2.	
3.		3.	
4.		4.	
5.	Primers did not function	5.	Primers did not function
6.		6.	
7.		7.	
8.		8.	
M526 Fuze With Protruding Rivet Head			
	4. Primers functioned		

One HE-loaded M374 Cartridge with XM716 Fuze (protruding rivet head), without primer was loaded into bottom of tube, then a second HE round (with primer) was dropped on the round in bottom of tube with following results:

	Charge	Functioning Distance	Functioning Mode
Bottom Round	9	12 inches from bottom of tube	low order
Top Round	9	800 meters downrange	dud*

\*Large fragments were recovered from the round (Figure 19, Appendix A).

TABLE 9

M525 AND M526 PD FUZE  
HEAD ASSEMBLY ARMING IN TRIGGER-FIRED MORTAR

The following tests were conducted using unmodified 81mm mortar tubes held in a vertical position:

Cartridge	Fuze	No. of Trials	Mortar	Results
M362	M526	4	M1	T336E7 head did not arm
M374	M526	1	M1	
M374	M526	1	M29	
M43A1	M525	4	M1	
M43A1	M525	7	M29	

The following tests were conducted using an M1 Mortar with one or two 0.453 inch-diameter holes near the bottom of a tube held in a vertical position:

Cartridge	Fuze	Mortar Modification	No. of Trials	Results
M362	M526	One hole	8	T336E7 head did not arm
M362	M526	Two holes	1	
M374	M526	One hole	6	
M374	M526	Two holes	1	
M43A1	M525	One hole	1	

The following tests were conducted using a 60mm M19 Mortar with one or two 0.453-inch-diameter holes near the bottom of the tube which was held in a vertical position:

Cartridge	Fuze	Mortar Modification	No. of Trials	Results
M49A2	M525	One hole	4	T336E7 head did not arm
M49A2	M525	Two holes	4	

TABLE 10

81MM M374 HE CARTRIDGE  
SHELL BODY HARDNESS TESTS

Cartridge Lot No.	Body Manufacturer	Body Material	Rockwell Reading** (Brinell C Scale)		
			Highest	Lowest	Average
KN-6-2	Burlington	Forged Steel	38	18	31
KN-9-16	Burlington	Forged Steel	33	17	24
MA-60-2B	Burlington	Forged Steel	31	20	29
MA-112-7	Norris	Forged Steel	31	19	27
KN-11-36	Burlington	Forged Steel	37	25	30
KN-9-80B	Burlington	Forged Steel	37	24	30
Factory Reject*	Pristulite	Cast Iron	31	8	16
Factory Reject*	General Motors	Cast Iron	23	14	17
Factory Reject*	Burlington	Forged Steel	35	28	33
Factory Reject*	Norris	Forged Steel	35	30	33

\*Shell bodies were rejected for causes other than hardness.

\*\*Hardness readings were taken at the base of each shell body.

**TABLE 11**  
**81MM M374 HE CARTRIDGE**  
**PHYSICAL PROPERTIES OF SHELL BODIES**

Cartridge Lot No.	Cartridge Sample No.	Specimen No.	Original Area (sq in)	Yield Point (lbs)	Maximum Load (lbs)	Yield Point (psi)	Tensile Strength (psi)	Elongation	
								Gage (in)	Percent
KN-3-32	2	1	0.0302	3,350	3,500	110,930	115,890	2	14
KN-3-32	2	2	0.0248	2,700	2,870	108,870	115,730	2	11
KN-3-32	3	1	0.0207	*	2,360	*	114,010	2	11
KN-3-32	3	2	0.0182	*	1,970	*	108,240	2	10
KN-9-16	2	1	0.0315	3,100	3,360	98,410	106,670	2	11.5
KN-9-16	2	2	0.0328	3,030	3,510	92,380	107,010	2	14
KN-9-16	229	1	0.0314	*	3,560	*	113,380	2	13
KN-9-16	229	2	0.0324	3,100	3,590	95,680	110,800	2	13
MA-60-2B	1	1	0.0170	*	2,050	*	120,590	2	9
MA-60-2B	1	2	0.0197	*	2,360	*	119,800	2	9
MA-60-2B	8	1	0.0213	2,300	2,400	107,980	112,680	2	14.5
MA-60-2B	8	2	0.0206	2,150	2,250	104,370	109,220	2	13
MA-112-7	1	1	0.0358	*	4,340	*	121,230	2	15.5
MA-112-7	1	2	0.0300	3,370	3,500	112,330	116,670	2	13
MA-112-7	115	1	0.0154	*	1,780	*	115,580	2	12.5
MA-112-7	115	2	0.0182	*	2,190	*	119,670	2	11.5
KN-9-80A	241	1	0.052	4,400	6,000	84,610	115,380	2	12.5
KN-9-80A	241	2	0.052	4,300	6,000	82,700	115,850	2	13
KN-9-80A	185	1	0.051	4,100	5,930	80,390	116,270	2	13
KN-9-80A	185	2	0.051	4,250	5,880	83,330	115,290	2	12.5
KN-9-80A	317	1	0.051	4,200	5,890	82,350	115,500	2	**
KN-9-80A	317	2	0.052	4,300	5,940	82,690	114,230	2	12
KN-11-36	7	1	0.051	4,300	5,880	84,310	115,300	2	12
KN-11-36	7	2	0.052	4,150	5,870	79,800	112,900	2	13
KN-11-36	100	1	0.051	4,300	6,050	84,310	118,630	2	**
KN-11-36	100	2	0.051	4,200	6,100	82,350	119,610	2	**
KN-11-36	128	1	0.052	4,300	6,150	82,690	118,260	2	12.5
KN-11-36	128	1	0.052	4,200	6,150	80,760	118,260	2	12.5
Factory Reject (Prestulite)	10	1	0.308	2,250	2,410	73,050	78,250	2	4
do	10	2	0.0340	2,480	2,750	72,940	80,880	2	5
Factory Reject (General Motors)	5	1	0.0324	*	2,140	*	66,050	2	2
do	5	2	0.0324	*	2,400	*	74,070	2	3.5



MA-60-2B	8																		14.5
MA-60-2B	8																		13
MA-112-7	1																		15.5
MA-112-7	1																		13
MA-112-7	115																		12.5
MA-112-7	115																		11.5
MA-112-7	241																		12.5
KN-9-80A	241																		13
KN-9-80A	185																		13
KN-9-80A	185																		12.5
KN-9-80A	317																		**
KN-9-80A	317																		12
KN-11-36	7																		12
KN-11-36	7																		13
KN-11-36	100																		**
KN-11-36	100																		**
KN-11-36	128																		12.5
KN-11-36	128																		12.5
Factory Reject (Prestulite)	10																		4
do	10																		5
Factory Reject (General Motors)	5																		2
do	5																		3.5
Factory Reject (Burlington)	41																		10
do	41																		11
Factory Reject (Norris)	34																		12.5
do	34																		15

\*Not able to determine yield point.  
\*\*Brake outside of gage marks.

2

TABLE 12

81MM M374 HE CARTRIDGE  
 QUALITATIVE ANALYSIS OF SHELL BODIES

	KN-6-2	KN-9-16	MA-60-2B	MA-112-7	KN-9-80A	KN-11-36	Factory Reject (General Motors)	Factory Reject (Burlington)
Carbon (%)	0.38	0.40	0.38	0.40	0.36	0.40	2.52	0.39
Manganese (%)	1.76	1.62	1.68	1.70	1.68	1.68	0.44	1.70
Phosphorous (%)	0.026	0.026	0.024	0.025	0.017	0.012	0.025	0.021
Sulfur (%)	0.025	0.021	0.025	0.015	0.016	0.026	0.128	0.015
Silicon (%)	0.26	0.22	0.26	0.33	0.25	0.28	1.95	0.27
Qualitative Spectrographic Analysis Without Standards								
Aluminum (%)	0.02	0.02	0.02	0.04	0.01	0.01	0.01	0.01
Vanadium (%)	0.01	0.01	0.01	0.01	0.001	0.001	0.01	0.01
Titanium (%)	0.10	0.12	0.06	0.04	0.001	0.001	0.08	0.04
Molybdenum (%)	0.03	0.02	0.03	0.03	0.03	0.03	0.02	0.03
Cobalt (%)	<0.01	<0.01	<0.01	<0.01	0.001	0.001	<0.01	<0.01
Copper (%)	0.02	0.02	0.01	0.02	---	---	0.01	<0.01
Nickel (%)	<0.01	<0.01	<0.01	<0.01	0.01	0.01	<0.01	<0.01
Chromium (%)	0.03	0.03	0.03	0.03	0.03	0.03	0.02	0.03

TABLE 13

81MM M374 HE CARTRIDGE  
CHARPY IMPACT TEST

Cartridge Lot No.	Size of Specimen	Impact Foot-Pounds
KN-6-2 (Sample #129)	10mm x 2.5mm	10
	10mm x 2.5mm	10
	10mm x 2.5mm	10
KN-9-16 (Sample #106)	10mm x 2.5mm	7
	10mm x 2.5mm	7
	10mm x 2.5mm	10
MA-60-2B (Sample #2)	10mm x 2.5mm	11
	10mm x 2.5mm	10
	10mm x 2.5mm	9
MA-112-7 (Sample #15)	10mm x 2.5mm	15
	10mm x 2.5mm	13
	10mm x 2.5mm	13
KN-11-36 (Sample #100)	10mm x 2.5mm	6
	10mm x 2.5mm	6
	10mm x 2.5mm	6
KN-11-36 (Sample #128)	10mm x 2.5mm	7
	10mm x 2.5mm	8
	10mm x 2.5mm	7
KN-11-36 (Sample #7)	10mm x 2.5mm	8
	10mm x 2.5mm	6
	10mm x 2.5mm	6
KN-9-80A (Sample #185)	10mm x 2.5mm	5
	10mm x 2.5mm	5
	10mm x 2.5mm	5
KN-9-80A (Sample #317)	10mm x 2.5mm	7
	10mm x 2.5mm	7
	10mm x 2.5mm	7
KN-9-80A (Sample #241)	10mm x 2.5mm	7
	10mm x 2.5mm	8
	10mm x 2.5mm	7
Factory Reject (General Motors)	10mm x 2.5mm	1
	10mm x 2.5mm	1
	10mm x 2.5mm	1
Factory Reject (Burlington)	10mm x 2.5mm	11
	10mm x 2.5mm	7
	10mm x 2.5mm	9

TABLE 14

 XM716 PD FUZE  
 CHEMICAL ANALYSIS OF IN-LINE EXPLOSIVES

Title	Fuze Lot No.	% Moisture	% Tetryl	% Binder Lubricant	Binder Lubricant As				
					% Graphite	% Stearate			
Pellet, Booster Part #8800261	KN-3-32	0.0058	98.57	1.43	1.40	0.03			
	KN-3-32	0.0117	98.58	1.42	1.40	0.02			
	KN-6-10	0.0060	98.62	1.38	1.35	0.03			
	KN-6-10	0.0076	98.44	1.56	1.45	0.11			
	MA-1-3	0.0107	98.93	1.07	0.49	0.58			
	MA-1-3	0.0100	98.89	1.11	0.54	0.57			
	MA-10-70	0.0098	98.26	1.74	1.20	0.54			
	MA-10-70	0.0151	98.14	1.86	1.15	0.71			
	Pellet, Auxiliary Booster (2 Pellets) Part #8800260	KN-3-32	0.0045	98.50	1.50	1.47	0.03		
		KN-3-32	0.0048	98.51	1.49	1.43	0.06		
KN-3-32		0.0039	98.49	1.51	1.49	0.02			
KN-3-32		0.0078	98.53	1.47	1.44	0.03			
KN-6-10		0.0041	98.78	1.22	1.19	0.03			
KN-6-10		0.0045	98.70	1.30	1.27	0.03			
KN-6-10		0.0049	98.66	1.34	1.32	0.02			
KN-6-10		0.0052	98.76	1.24	1.22	0.02			
MA-1-3		0.0088	98.85	1.15	1.12	0.03			
MA-1-3		0.0093	98.82	1.13	1.14	0.04			
MA-1-3		0.0091	98.97	1.03	0.51	0.52			
MA-1-3		0.0101	98.96	1.04	0.62	0.42			
MA-10-70		0.0085	98.34	1.66	1.25	0.31			
MA-10-70		0.0098	98.60	1.40	1.28	0.12			
MA-10-70		0.0084	98.50	1.50	0.81	0.69			
MA-10-70		0.0083	98.46	1.54	0.99	0.55			
Pellet, Booster Part #8798659		KN-3-32	0.0058	98.66	1.34	1.31	0.03		
		KN-3-32	0.0060	98.62	1.38	1.35	0.03		
	KN-6-10	0.0045	98.78	1.22	1.20	0.02			
	KN-6-10	0.0042	98.74	1.26	1.24	0.02			
	MA-1-3	0.0099	98.58	1.42	0.92	0.50			
	MA-1-3	0.0087	98.81	1.19	0.82	0.37			
	MA-10-70	0.0048	98.81	1.19	1.16	0.03			
	MA-10-70	0.0051	98.68	1.31	1.28	0.03			
	Cup, Booster Lead	(Weight of Tetryl in Grams)				Not Determined			
		KN-3-32	0.3022	98.69	1.31	↓	↓		
KN-3-32		0.3009	98.40	1.60					
KN-6-10		0.2968	98.70	1.30					
KN-6-10		0.2937	98.66	1.34					
MA-1-3		0.2813	98.81	1.19					
MA-1-3		0.2859	98.59	1.41					
MA-10-70		0.2905	98.37	1.63					
MA-10-70		0.3002	98.72	1.28					
Cup, Detonator Part #7548254		KN-3-32	0.0921						
		KN-3-32	0.0981						
		KN-6-10	0.0927						
		KN-6-10	0.0938						
		MA-1-3	0.0959						
	MA-1-3	0.0891							
	MA-10-70	0.0837							
	MA-10-70	0.0915							

TABLE 15

81MM M374 HE CARTRIDGE  
 CHEMICAL ANALYSIS OF COMPOSITION B CORE SAMPLES

(Two Results Per Sample -- Except Moisture)

Cartridge Lot No.	% Moisture	% TNT	% RDX	% Desensitizer
KN-6-2 (Sample #306)	Nil	38.38	60.25	1.37
		38.40	60.37	1.23
Average .....		38.39	60.31	1.30
KN-6-2 (Sample #317)	0.0082	39.91	59.55	0.54
		39.72	59.80	0.48
Average .....		39.82	59.67	0.51
KN-9-16 (Sample #154)	0.0103	38.81	60.12	1.07
		39.37	59.54	1.09
Average .....		39.09	59.83	1.08
KN-9-16 (Sample #192)	0.0163	39.91	59.01	1.08
		38.44	60.58	0.98
Average .....		39.18	59.79	1.03
MA-60-2B (Sample #174)	0.0028	36.60	62.69	0.71
		36.54	62.77	0.69
Average .....		36.57	62.73	0.70
MA-60-2B (Sample #188)	0.0108	37.35	61.49	1.16
		37.54	61.28	1.18
Average .....		37.45	61.38	1.17
MA-112-7 (Sample #43)	0.0060	39.06	60.18	0.76
		39.49	59.69	0.83
Average .....		39.28	59.93	0.79
MA-112-7 (Sample #73)	0.0033	36.30	62.58	0.62
		37.40	61.96	0.64
Average .....		37.10	62.27	0.63
KN-9-80A (Sample #131)	0.0300	41.435	58.269	0.296
		41.469	58.113	0.418
Average .....		41.452	58.191	0.357
KN-9-80A (Sample #133)	0.0254	45.236	64.556	0.208
		44.779	55.054	0.167
Average .....		45.008	54.805	0.187
KN-11-36 (Sample #229)	0.0067	40.113	59.697	0.190
		40.022	59.800	0.178
Average .....		40.068	59.749	0.183
KN-11-36 (Sample #230)	0.0227	40.429	59.399	0.172
		40.941	58.875	0.184
Average .....		40.685	59.137	0.178

APPENDIX C  
Correspondence

DEPARTMENT OF THE ARMY  
Headquarters, United States Army Munitions Command  
Dover, New Jersey 07801

COPY

25 Jun 1970

AMSMU-RE-F

SUBJECT: Handling of Mortar Ammunition

Commanding General  
U.S. Army Materiel Command  
ATTN: AMCPT-T  
Washington, DC 20315

1. Reports from Southeast Asia indicate that several casualty-producing incidents have occurred while personnel were handling 81mm mortar ammunition assembled with the M524 Series PD Fuze.
2. Subsequent investigations, which included inspection of remaining ammunition at mortar sites and ammunition supply points, have revealed the following conditions:
  - a. Complete rounds with fuze pull wire and attached setback and plunger safety pins removed.
  - b. Fuzes with plungers either in partially armed or completely armed position.
3. The above conditions, which can contribute to a subsequent casualty-producing and/or weapon loss incident, are considered to be directly attributable to failure of personnel to follow preparation for firing procedures and precautions contained in applicable publications (e.g., TM9-1300-203 "Artillery Ammunition" and FM 23-90 "81mm Mortar M29"). Despite repeated warnings in information disseminated to the field, the practice of removing safety pins too early (as evidenced by rounds without safety pins being found on ready racks) rather than just prior to loading the complete round into the weapon tube coupled with the failure to immediately reinsert the safety pins when the round is not fired continues.
4. In view of the above, it is recommended that US Continental Army Command be requested to take appropriate actions to assure procedures utilized at all camps, posts and stations conducting Army infantry training comply with safe practices enumerated in applicable publications. As required, existing troop training

COPY

AMSMU-RE-F

SUBJECT: Handling of Mortar Ammunition

instructions should be revised to provide additional emphasis. Should additional information or clarification be required, contact with Picatinny Arsenal, ATTN: SMUPA-DC, is suggested.

FOR THE COMMANDER:

Cy Furn:  
SMUAP-MAK

S/Carroll H. Staley

Technical Director  
Research, Dev & Engr Dir.





DEPARTMENT OF THE ARMY  
PICATINNY ARSENAL  
DOVER, NEW JERSEY 07801

Mr. CKFabel/11e  
328-2477

Dec 23 1967

**COPY**

SMUPA-DC5

SUBJECT: Malfunction Investigation of Cartridge, 81MM, HE,  
M362 w/Fuze, PD, M526 (MIFs A-278-66 and A-81-67)-  
In-Bore Prematures

TO: Commanding General  
Ammunition Procurement and Supply Agency  
ATTN: SMUAP-RSA  
Joliet, Illinois 60436

1. During firing in Southeast Asia, the following malfunctions occurred aboard PCF gunboats 9 and 39 with U.S. Navy 81MM Mortar (MK1):

a. PCF boat 9 (MIF A-278-66): On 18 October 1966, one round of subject item from Lot MA-17-19G or MA-20-14B prematured in-bore, injuring two men and killing three men. An extensive amount of damage was done to the PCF boat. The fuze lots involved in this malfunction were MA-1-2, MA-2-2 and MA-2-4.

b. PCF boat 39 (MIF A-81-67): On 11 March 1967, one round of subject item from Lot MA-18-4D prematured in-bore, injuring one man and killing one man. An extensive amount of damage was done to the PCF boat. The fuze lots involved in this malfunction were MA-2-13 and MA-2-2A.

2. An investigation was conducted by this Arsenal to determine the possibility of a fuze arming in a trigger fired mortar. Test results (Inclosure 1) show that in no case does a T336E7 Head Assembly arm under normal use with a serviceable tube. A mortar was modified by opening holes in the bottom of the tube. This excessive ventilation increases the acceleration of the round such that it receives excessive setback upon bottoming. In only one case, under this most exaggerated condition, did a T336E7 Head Assembly arm. Sample rounds were received, x-rayed and examined and no adverse conditions were noted by this Arsenal. The M526 Fuze has a history of being safe. The occurrences of in-bore prematures with the M526 Fuze is zero in all 81MM, M362 Series firing. In view of this, action was taken to investigate the Navy

COPY

SMUPA-DC5

SUBJECT: Malfunction Investigation of Cartridge, 81MM,  
HE, M362 w/Fuze, PD, M526 (MIFs A-278-66 and  
A-81-67) - In-Bore Prematures

81MM Mortar. Watervliet Arsenal was called upon to conduct this investigation. Results of this investigation are inclosed (Inclosure 2). They concluded that the failure was not due to a material fault, but to an apparent overload. This was caused by the fracture stress, which exceeded the yield stress, causing a rupture at the drilled and tapped holes in the tube. Watervliet Arsenal recommended that the maximum charge used in the U.S. Navy mortar be reduced to charge 5.

3. In view of the above, it is recommended that the U.S. Navy 81MM Mortar Mkl not be fired above charge 5. It is further recommended that complete round Lots MA-17-19G, MA-20-14B and MA-18-4D with Fuze Lots MA-1-2, MA-2-2, MA-2-4, MA-2-13 and MA-2-2A be released for issue and use.

4. No change to the Technical Data Package is required by this investigation.

5. MIFs A-278-66 and A-81-67 are herewith returned to your Agency as completed.

FOR THE COMMANDER:

S/Seymour Fleischnick  
Technical Assistant Ammo Prod  
and Maint Engr Div

4 Incls  
as

Copies furnished: w/o Incls 2, 3 & 4  
Naval Ord Syst Comd (ORD-084L)  
CMC (CSX-8, CSY-7)  
MUCOM, AMSMU-LM, AMSMU-RE-E  
Ships Parts Control Center  
(Code 7304)



DEPARTMENT OF THE ARMY  
PICATINNY ARSENAL  
DOVER, NEW JERSEY 07801

Mr. CKFabel/11e  
328-2477

**COPY**

17 Dec 68

SMUPA-DC5

SUBJECT: Malfunction Investigation of Cartridge, 81MM, HE,  
M374 w/Fuze, PD, XM716 (MIF A-496-68) - In-Bore  
Premature

Commanding General  
U.S. Army Ammunition Procurement and Supply Agency  
ATTN: SMUAP-RSA  
Joliet, Illinois 60436

1. Reference is made to letter, SMUPA-DC5, Picatinny Arsenal, 28 December 1967, subject: Malfunction Investigation of Cartridge, 81MM, HE, M362 w/Fuze, PD, M526 (MIFs A-278-66 and A-81-67) - In-Bore Prematures.
2. During firing in Southeast Asia on 7 November 1968, one round of subject item from Lot KN-9-27 prematured in-bore. The round was fired at charge 7 aboard Navy gunboat PCF-89. Three men were killed and one man was wounded. Two hundred and thirteen (213) rounds were stored on board and a fragment of the malfunction round was found which identified the lot as KN-9-27. The report further stated that there was a possibility of a double loading in the weapon at the time of the malfunction. The ammunition was being trigger fired, but the round functioned immediately when dropped in the tube.
3. Upon evaluation of this report, it is considered that the most probable cause of the malfunction was a double loading. Tests conducted at Picatinny Arsenal show that the rivet on top of the fuze serves as a firing pin when one round is dropped on top of another. This would substantiate the immediate functioning as reported. It should be further noted that the fire mission was at charge 7, and previous recommendations furnished in the referenced letter indicates that this weapon should not be used to fire ammunition above charge 5. The storage and transportation environment aboard Navy gunboats is considered severe when compared to normal use of the item on land. The in-bore premature rate of the M374 Cartridge during land operations since June 1967, that

**COPY**

SMUPA-DC5

SUBJECT: Malfunction Investigation of Cartridge, 81MM, HE,  
M374 w/Fuze, PD, XM716 (MIF A-496-68) - In-Bore  
Premature

could be attributed to the ammunition, is less than one  
in four million.

4. In view of the above, it is concluded that subject  
malfunction was not caused by defective ammunition. It  
is recommended that Lot KN-9-27 be released for issue  
and use. It is further recommended that the U.S. Navy  
81MM Mortar not be fired above charge 5.

5. The Technical Data Package is being changed to remove  
the protruding rivet on top of the XM716 Fuze.

6. MIF A-496-68 is returned to your Agency as completed.

FOR THE COMMANDER:

1 Incl  
as

S/H.D. Rutkovsky  
Ch, Ammo Engr Lab

Copies Furnished: w/o Incl  
Naval Ord Syst Comd (ORD-084L)  
CMC (CSX-8, CSY-7)  
MUCOM, AMSMU-LM, AMSMU-RE-E,  
AMSMU-Q, AMOPM-MT  
Ships Parts Control Center  
(Code 7304)  
Naval Wpns Serv Ofc, SSOA



DEPARTMENT OF THE ARMY  
PICATINNY ARSENAL  
DOVER, NEW JERSEY 07801

Mr. WPick/ic  
328-2377

**COPY**

Jul 16 1970

SMUPA-DC5

SUBJECT: Malfunction Investigation of Cartridge, 81MM, HE,  
M374 w/Fuze, PD, XM716 (MIF A-175-69) - In-bore  
Premature

Commanding General  
U.S. Army Ammunition Procurement and Supply Agency  
ATTN: SMUAP-RSA  
Joliet, Illinois 60436

1. During firings in Southeast Asia, on 2 July 1969, one round of subject item functioned in the tube of a Mk2, Mod O, Mortar aboard a Navy swift boat. Two men were killed and one man was injured. The mortar was destroyed and the boat was damaged. It is not known if the ammunition was from cartridge Lot KN-6-2 with fuze Lot KN-3-32 or from cartridge Lot KN-9-16 with fuze Lot KN-6-10. The ammunition was being fired by trigger mode, elevation 30°, charge 7. Three rounds had been fired prior to the malfunction.

2. Fuze Lot KN-6-10 was used on cartridge Lots KN-9-16, KN-9-17 and KN-9-18. Cartridge Lots KN-9-17 and KN-9-18 were not involved in the malfunction but were suspended so that appropriate action could be taken if the investigation determined that the cause of the malfunction was oriented to fuze Lot KN-6-10.

3. The following causes of in-bore premature malfunctions were investigated: fuze functioned prematurely; double loading (misfire not removed, next round dropped down tube); HE filler initiated by propellant gases; and HE filler functioned spontaneously. Rounds from cartridge Lots KN-6-2 and KN-9-16 were examined and no defects were found. Details of the investigation are presented in Inclosure 1.

SMUPA-DC5

SUBJECT: Malfunction Investigation of Cartridge, 81MM, HE  
M374 w/Fuze, PD, XM716 (MIF A-175-69) - In-bore  
Premature

4. Two in-bore prematures (MIF A-278-66 and MIF A-81-67) occurred when firing Cartridge, 81MM: HE, M362 with Fuze, PD, M526 in Mark 1 Mod 0 tubes. The cause was attributed to insufficient strength of the tubes and Watervliet Arsenal recommended that firing above charge 5 be prohibited. The Mark 2 Mod 0 tube involved in the subject malfunction is comparable to the Mark 1 Mod 0 tube with respect to strength. The chamber pressure in the subject malfunction was created by firing an M374 cartridge at charge 7 which produces higher chamber pressure and stress than firing an M362 cartridge at charge 5.

5. It is concluded that the malfunction was not caused by an ammunition defect. The most probable causes are accidental dropping of the round after removal of the safety wire or firing the ammunition with charges that produced chamber pressures that exceeded the allowable stresses of the mortar tube.

6. It is recommended that cartridge Lots KN-6-2, KN-9-16, KN-9-17, and KN-9-18 be released for issue and use. It is further recommended that the Navy be advised that it is important to leave the safety wires on until just before firing and to prohibit firing the M374 cartridge above Charge 5 when using Mark 1 or Mark 2 tubes.

7. No change to the Technical Data Package is required by this investigation.

8. MIF A-175-69 is returned to your Agency as completed (Inclosure 2).

FOR THE COMMANDER:

S/H.D. Rutkovsky  
Ch, Ammo Engr Lab

2 Incl  
as  
Cys furn: w/o incl 2  
Naval Ord Syst Cind (ORD-084L)  
CMC (CSX-8, CSY-7)  
MUCOM, AMSMU-LM, AMSMU-RE-E,  
AMSMU-Q  
Ships Parts Control Center  
(Code 7304)



DEPARTMENT OF THE ARMY  
PICATINNY ARSENAL  
DOVER, NEW JERSEY 07801

Mr. CKFabel/11e  
328-2477  
Nov 19 1968

**JOPY**

SMUPA-DC5

SUBJECT: Malfunction Investigation of Cartridge, 81MM,  
HE, M374 w/Fuze, PD, M526 (MIF A-453-68) -  
In-Bore Premature

Commanding General  
U.S. Army Ammunition Procurement and Supply Agency  
ATTN: SMUAP-RSA  
Joliet, Illinois 60436

1. During firing at Fort Bragg, North Carolina, on 2 October 1968, one round of subject item from Lot MA-600-2 with Fuze Lot MA-40-111 prematured in the bore of the weapon. The round was fired at charge 3 with an expected range of 1400 meters. Two men were killed and one was injured. The mortar tube was destroyed. Thirty-nine rounds remain on hand at the site.
2. An on-site investigation was made by a Picatinny Arsenal representative. Statements from witnesses and a review of the evidence indicated that a double loading took place. Witnesses stated that the round, when placed in the tube, had no time to reach the bottom when the malfunction occurred. Prior to the malfunction a salvo firing was conducted, and evidently the men were unaware that this weapon did not fire. Later a round from the same lot was found 343 meters downrange on a road. The round was not there a few hours before the malfunction when trucks had ridden over the road. Shell fragments found at the site indicate that a second round was involved and went low order.
3. A test was performed to determine if the rivet head on the M526 Fuze could fire the primer of a round that was dropped on top, as occurred in the malfunction. In every test with inert rounds and live primers, the primer functioned. The rivet was then filed smooth and on repeated tests the primer did not fire.

COPY

SMUPA-DC5

SUBJECT: Malfunction Investigation of Cartridge, 81MM,  
HE, M374 w/Fuze, PD, M526 (MIF A-453-68) -  
In-bore Premature

4. Based on the evidence of a double loading, it is concluded that the primer of the top round functioned when it struck the fuze head on the bottom round. The propellant gases of the top round drove the top round up the tube at a low velocity because of the large chamber volume. The gas pressure also drove the bottom round into the firing pin, functioning the primer on the bottom round. (The gases from the top round could have ignited the propellant charge on the bottom round if it had been a misfire.) As the bottom round was being expelled, gas leakage from the top round entered the fuze and caused low order detonation of the in-line explosive components of the bottom round. The tail of the top round was damaged by shrapnel as it left the tube.

5. The Technical Data Package is being changed to remove the protruding rivet in the design of the fuze head assembly.

6. The conditions contributing to the malfunction do not reflect any defects characteristic of the fuze or complete round lots involved. It is recommended that Lots MA-600-1 and MA-600-2 with Fuze Lot MA-40-111 be released for issue and use.

7. MIF A-453-68 is returned to your Agency as completed.

FOR THE COMMANDER:

1 Incl  
as

S/Seymour Fleischnick  
Acting Chief, Mun Eng Div

Copies furnished: w/o Incl  
Naval Ord Syst Comd (ORD-084L)  
CMC (CSX-8, CSY-7)  
MUCOM, AMSMU-LM, AMSMU-RE-E,  
AMSMU-Q  
Ships Parts Control Center  
(Code 7304)  
Naval Wpns Serv Ofc, SSOA





DEPARTMENT OF THE ARMY  
PICATINNY ARSENAL  
DOVER, NEW JERSEY 07801

Mr. WPick/ic  
328-2477

Nov 19, 1970

SMUPA-DC5

SUBJECT: Malfunction Investigation of Cartridge, 81MM: HE,  
M374 w/Fuze, PD, XM716 (MIF-A-129-70) - In-Bore  
Premature

Commanding General  
U.S. Army Ammunition Procurement  
and Supply Agency  
ATTN: SMUAP-RSA  
Joliet, Illinois 60436

1. During firing in Southeast Asia on 10 May 1970, one round of subject item from Cartridge Lot KN-9-80A functioned prematurely in the bore of the weapon. One man was killed, 5 men were wounded, and the weapon was destroyed. Firing was at charge 6 and range to target was 3000 meters. Thirty-five rounds were fired prior to the malfunction.
2. Fuze Lot KN-6-49 was used on Cartridge Lots KN-9-79, KN-9-80A, and KN-9-81. Cartridge Lots KN-9-79 and KN-9-81 were also suspended because of the possibility that a defect oriented to Fuze Lot KN-6-49 might have caused the malfunction.
3. Fragments from the malfunction were received and compared with fragments from other in-bore premature malfunctions. Rounds from Cartridge Lot KN-9-80A were received and examined. The following causes of in-bore premature malfunctions were considered: fuze functioned prematurely, high order; fuze functioned prematurely, low order; void or foreign material in HE filler; shell body defect (porosity, cracks, holes); and double loading (misfired round not removed, next round dropped down tube). Details of the investigation are presented in Inclosure 1. The fragments from the shell body are large, which indicates that the detonation was low order. The primer area shows a deep indentation from the firing pin boss at the bottom of the tube, which indicates that the round was pushed downward by a large force (Inclosure 2). No defects were found in the inspection and test outlined in Inclosure 1. Therefore, it is concluded that double loading was the most probable cause of the malfunction.

SMUPA-DC5

SUBJECT: Malfunction Investigation of Cartridge, 81MM: HE,  
M374 w/Fuze, PD, XM716 (MIF-A-129-70) - In-Bore  
Premature

4. It is recommended that Cartridge Lots KN-9-79, KN-9-80A, and KN-9-81 be released for issue and use. The investigation determined that the malfunction was not caused by an ammunition defect.

5. The Technical Data Package has been changed to eliminate double loading as a cause of in-bore premature malfunctions. The shape of the riveting in the nose of the fuze has been changed by EO-PA-55577-2 dated 13 June 1969.

6. Malfunction Investigation Folder A-129-70 is being returned to your Agency as completed (Inclosure 2).

FOR THE COMMANDER:

H.D. RUTKOVSKY  
Ch, Ammo Engr Lab

2 Incl  
as  
Cy Furn:w/o Incl 2  
Naval Ord Syst Comd  
ORD-084L, ORD-084B21  
CMC, CSX-3, CSY-7  
MUCOM, AMSMU-XM, RE-ES, Q  
Ships Parts Control Center  
Code 7304  
WECOM, AMSWE-REE

**COPY**

DEPARTMENT OF THE ARMY  
PICATINNY ARSENAL  
DOVER, NEW JERSEY

Mr. JCLamb/km  
328-2477

Dec 7 1971

SMUPA-AD-M-A

SUBJECT: Malfunction Investigation of Cartridge, 81MM: HE,  
M374 w/Fuze, PD, XM716 (MIF A-128-71) - In-bore  
Premature

Commanding General  
U.S. Army Ammunition Procurement  
and Supply Agency  
ATTN: SMUAP-PA-SC  
Joliet, Illinois 60436

1. Reference is made to Letter, AVDG-AD-E, 327th INF, 101st Airborne Division, 27 September 1971, subject: Malfunction Investigation (12-71).
2. During firing in Southeast Asia, 8 July 1971, one round of Cartridge, 81MM, HE, M374 (Lot KN9-69) functioned prematurely in the bore of the weapon. As a result of the incident, one person was killed, three others were wounded and the weapon ruptured 15 inches from the muzzle end. Firing was at Charge 6, elevation 1358 mils, and a range of 2425 meters.
3. Referenced letter indicates the most probable cause of the incident is double loading. The investigating officer gives the following explanation for the incident:
  - (a) The first round was dropped by the gunner in the tube and was a misfire.
  - (b) The second round was dropped by the squad leader, the explosion occurred at that instant.
  - (c) Neither of the men recalled hearing the first round fire.

SMUPA-AD-M-A

SUBJECT: Malfunction Investigation of Cartridge, 81MM: HE,  
M374 w/Fuze, PD, XM716 (MIF A-128-71) - In-bore  
Premature

4. Based on the above, it is concluded that the incident was due to human error; the ammunition is not at fault and is therefore serviceable. It is recommended that Cartridge Lot KN-9-69 and KN-9-71 be released for issue and use.
5. The pointed rivet on the M716 Fuze striker head was changed by EOPA 55577-2, 13 June 1969.
6. It is recommended that your Agency take action to disseminate worldwide the following warning:

Double loading mortar rounds may produce in-bore prematures. Care should be taken to assure that each round has fired before dropping a second round into the tube.

This warning will be incorporated into all applicable mortar publications.

7. MIF A-128-71 is being returned to your Agency as completed.

FOR THE COMMANDER:

S/F.L.SEDLACEK  
Ch, Ammo Maint Engr Br. A

1 Incl  
as

Cy Furn: w/o Incl  
Naval Ord Syst Comd, ORD-084L  
Naval Ammo Prod Engr Ctr  
ORD-084B21  
CMC (Code CSX-3)  
MUCOM, AMSMU-XM, RE-ES, Q  
Ships Parts Cont Ctr  
(Code 7304)  
WECOM, AMSWE-REE  
Naval Wpns Sta  
(Code 30214MH)

UNCLASSIFIED

Security Classification

DOCUMENT CONTROL DATA - R & D

(Security classification of title, body of abstract and indexing annotation must be entered when the overall report is classified)

1. ORIGINATING ACTIVITY (Corporate author) Picatinny Arsenal Dover, New Jersey		2a. REPORT SECURITY CLASSIFICATION UNCLASSIFIED	
		2b. GROUP	
3. REPORT TITLE IN-BORE PREMATURE MALFUNCTION INVESTIGATIONS OF THE 81MM HIGH EXPLOSIVE MORTAR CARTRIDGES WITH THE M526, M524A5 AND XM716 POINT DETONATING FUZES			
4. DESCRIPTIVE NOTES (Type of report and inclusive dates)			
5. AUTHOR(S) (First name, middle initial, last name) John McPartland William Pick			
6. REPORT DATE February 1972		7a. TOTAL NO. OF PAGES 86	7b. NO. OF REFS 6
8a. CONTRACT OR GRANT NO.		9a. ORIGINATOR'S REPORT NUMBER(S) Technical Report 4321	
b. PROJECT NO.			
c.		9b. OTHER REPORT NO(S) (Any other numbers that may be assigned this report)	
d.			
10. DISTRIBUTION STATEMENT Distribution limited to U.S. Government agencies only; Test and Evaluation (February 1972). Other requests for this document must be referred to Picatinny Arsenal.			
11. SUPPLEMENTARY NOTES		12. SPONSORING MILITARY ACTIVITY Picatinny Arsenal U.S. Army Munitions Command Dover, New Jersey	
13. ABSTRACT  A series of malfunction investigations were conducted by the Ammunition Development & Engineering Directorate's Ammunition Maintenance Engineering Division from October 1966 to 1970 to determine the causes of in-bore prematures of various types of 81mm ammunition. Tests indicated that in-bore prematures can result from missing bore riding pin, double loading, voids in high explosive (HE) filler, porosity in shell body or loose base plugs. It was also found that Mk1 and Mk2 Navy Mortars are of marginal design, and that M362, M370, M374 and M375 Cartridges should not be fired above Charge 5 with these weapons.			

S

DD FORM 1473 1 NOV 66

REPLACES DD FORM 1473, 1 JAN 60, WHICH IS OBSOLETE FOR ARMY USE.

UNCLASSIFIED

Security Classification

UNCLASSIFIED

Security Classification

KEY WORDS	LINK A		LINK B		LINK C	
	ROLE	WT	ROLE	WT	ROLE	WT
81mm mortar ammunition High explosive mortar cartridges In-bore prematures Malfunction investigation M526 Point Detonating Fuze M524A5 Point Detonating Fuze XM716 Point Detonating Fuze Limbo malassembly Double loading Mk1 Mortar (Navy) Mk2 Mortar (Navy) M362 Mortar Cartridge M370 Mortar Cartridge M374 Mortar Cartridge M375 Mortar Cartridge Loose-fitting base plugs Bore riding pin						

UNCLASSIFIED

Security Classification