

UNCLASSIFIED

AD NUMBER

AD878792

LIMITATION CHANGES

TO:

Approved for public release; distribution is unlimited.

FROM:

Distribution authorized to U.S. Gov't. agencies and their contractors;  
Administrative/Operational Use; OCT 1970. Other requests shall be referred to Air Force Armament Lab., Eglin AFB, FL.

AUTHORITY

AFATL ltr 21 May 1979

THIS PAGE IS UNCLASSIFIED

THIS REPORT HAS BEEN DELIMITED  
AND CLEARED FOR PUBLIC RELEASE  
UNDER DOD DIRECTIVE 5200.20 AND  
NO RESTRICTIONS ARE IMPOSED UPON  
ITS USE AND DISCLOSURE.

DISTRIBUTION STATEMENT A

APPROVED FOR PUBLIC RELEASE;  
DISTRIBUTION UNLIMITED.

AD878792

AFATL-TR-70-110

215  
6

**THEORETICAL SENSITIVITY ANALYSIS  
AND SYSTEM DELIVERY ACCURACY  
COMPUTATIONS FOR HIGH  
AND LOW DRAG WEAPONS  
AT SEVERAL SUBSONIC AND  
SUPERSONIC DELIVERY CONDITIONS**

AD No. \_\_\_\_\_  
DDC FILE COPY

EXTERIOR BALLISTICS BRANCH  
ANALYSIS DIVISION

D D C  
RECEIVED  
JAN 20 1971  
RECEIVED

TECHNICAL REPORT AFATL-TR-70-110

OCTOBER 1970

This document is subject to special export controls and each transmittal to foreign governments or foreign nationals may be made only with prior approval of the Air Force Armament Laboratory (DLYE), Eglin AFB, Florida 32542.

**AIR FORCE ARMAMENT LABORATORY**

AIR FORCE SYSTEMS COMMAND • UNITED STATES AIR FORCE

**EGLIN AIR FORCE BASE, FLORIDA**

**THEORETICAL SENSITIVITY ANALYSIS  
AND SYSTEM DELIVERY ACCURACY  
COMPUTATIONS FOR HIGH AND LOW DRAG  
WEAPONS AT SEVERAL SUBSONIC AND  
SUPERSONIC DELIVERY CONDITIONS**

**Jesse M. Gonzalez  
Arthur R. Denny, Lt, USAF**

This document is subject to special export controls and each transmittal to foreign governments or foreign nationals may be made only with prior approval of the Air Force Armament Laboratory (DLYE), Eglin AFB, Florida 32542.

## FOREWORD

Work on the analysis of weapon trajectory sensitivities by means of numerically integrated trajectories with incremented delivery parameters was begun on a part-time basis in July 1969 in support of the Close Air Support System (CLASS). The results of this preliminary analysis were documented in Air Force Armament Laboratory Armament Memorandum Report 69-20 (December 1969). In April 1970, work was re-initiated and greatly expanded in support of studies associated with the Modular Weapon Series. This work has also continued on a part-time basis and its results are documented in this technical report.

The primary contributors to this report were Lt Arthur R. Denny (DLYE), Mr. Jesse M. Gonzalez (DLYE), Mr. William S. Hattaway (DLYE), and Mr. Dennis E. Glendenning (DLII).

Information in this report is embargoed under the Department of State International Traffic in Arms Regulation. Releases to foreign governments by departments or agencies of the U. S. Government are subject to approval of the Air Force Armament Laboratory (DLYE), Eglin Air Force Base, Florida 32542 or higher authority within the Air Force. Private individuals or firms require a Department of State export license.

This technical report has been reviewed and is approved.

  
THOMAS P. CHRISTIE  
Chief, Analysis Division

## ABSTRACT

The purpose of this report is threefold: (1) To examine the sensitivity of weapon impact position to errors in pertinent delivery parameters; (2) to examine the combined effect of these delivery errors on overall system accuracy for eight different mil-systems; and (3) to compare the relative accuracy of different delivery conditions (level versus dive, subsonic versus supersonic, high-drag weapon versus low-drag weapon) for each of the eight different mil-systems.

This report not only extends the sensitivity analysis (purpose 1) presented in Air Force Armament Laboratory Armament Memorandum Report 69-20 to high-drag weapons and to a much larger range of release conditions, but also includes system accuracy data (purpose 2) and relative accuracy data for different delivery conditions (purpose 3), neither of which was considered in the previous report.

Although many assumptions are necessitated by the severe lack of test data for determining errors in delivery parameters and correlation coefficients between pairs of these parameters, this is believed to be the best possible analysis which can be performed under the above restrictions to determine the delivery accuracy of conventional free-fall weapon delivery systems. Even though the assumptions at times seem fairly restrictive, all qualitative and most quantitative conclusions presented in this report are considered valid.

This document is subject to special export controls and each transmittal to foreign governments or foreign nationals may be made only with prior approval of the Air Force Armament Laboratory (DLYE), Eglin AFB, Florida 32542.

## TABLE OF CONTENTS

Section	Title	Page
I	INTRODUCTION .....	1
	General Description of the Analysis .....	1
	Delivery Parameters, Conditions and Systems Studied .....	2
II	CONTEXT AND LIMITATIONS OF THE SYSTEM ACCURACY STUDY .....	5
	Relationship of Mils, CEP, REP, DEP and Miss Distance .....	5
	Methodology .....	10
	Assumptions and Their Consequences .....	12
III	SENSITIVITY GRAPHS .....	18
IV	SYSTEM ACCURACY ANALYSIS .....	101
	Sample Data Computations for System Accuracy Study .....	101
	System Accuracy Data Table .....	105
	System Accuracy Graphs .....	116
V	CONCLUSIONS .....	122
	Quantitative Conclusions .....	122
	Qualitative Conclusions .....	123
APPENDICES I	GENERAL EXPLANATION OF ERROR PROPAGATION .....	127
II	SAMPLE CONVERSION OF SYSTEM REP VALUES TO MILS .....	133

## LIST OF FIGURES

Figure	Title	Page
1	Nominal Weapon Trajectories	23
2	Weapon Angular Perturbation Trajectories Mk-82, 450 Kts, 5000 Ft Alt, 0° Dive	24
3	Weapon Angular Perturbation Trajectories BLU-58, 450 Kts, 5000 Ft Alt, 0° Dive	25
4	Weapon Angular Perturbation Trajectories Mk-82, 860 Kts, 5000 Ft Alt, 0° Dive	26
5	Weapon Angular Perturbation Trajectories BLU-58, 860 Kts, 5000 Ft Alt, 0° Dive	27
6	Weapon Angular Perturbation Trajectories Mk-82, 450 Kts, 8000 Ft Alt, 45° Dive	28
7	Weapon Angular Perturbation Trajectories BLU-58, 450 Kts, 8000 Ft Alt, 45° Dive	29
8	Weapon Angular Perturbation Trajectories Mk-82, 860 Kts, 8000 Ft Alt, 45° Dive	30
9	Weapon Angular Perturbation Trajectories BLU-58, 860 Kts, 8000 Ft Alt, 45° Dive	31
10	Release Altitude Sensitivity Mk-82 LDGP, 5000 Ft Rel Alt, 0° Dive	32
10a	Release Altitude Sensitivity Mk-82 LDGP, 5000 Ft Rel Alt, 0° Dive (Pipper is on Target)	33
11	Release Altitude Sensitivity BLU-58, 5000 Ft Rel Alt, 0° Dive	34
11a	Release Altitude Sensitivity BLU-58, 5000 Ft Rel Alt, 0° Dive (Pipper is on Target)	35
12	Release Altitude Sensitivity Mk-82 LDGP, 8000 Ft Rel Alt, 45° Dive	36
12a	Release Altitude Sensitivity Mk-82 LDGP, 8000 Ft Rel Alt, 45° Dive (Pipper is on Target)	37



LIST OF FIGURES (Continued)

Figure	Title	Page
13	Release Altitude Sensitivity BLU-58, 8000 Ft Rel Alt, 45° Dive	38
13a	Release Altitude Sensitivity BLU-58, 8000 Ft Rel Alt, 45° Dive (Pipper is on Target)	39
14	Release Speed Sensitivity Mk-82 LDGP, 5000 Ft Rel Alt, 0° Dive	40
15	Release Speed Sensitivity BLU-58, 5000 Ft Rel Alt, 0° Dive	41
16	Release Speed Sensitivity Mk-82 LDGP, 8000 Ft Rel Alt, 45° Dive	42
17	Release Speed Sensitivity BLU-58, 8000 Ft Rel Alt, 45° Dive	43
18	Release Dive Angle Sensitivity Mk-82 LDGP, 5000 Ft Rel Alt, 0° Dive	44
18a	Release Dive Angle Sensitivity Mk-82 LDGP, 5000 Ft Rel Alt, 0° Dive (Pipper is on Target)	45
19	Release Dive Angle Sensitivity BLU-58, 5000 Ft Rel Alt, 0° Dive	46
19a	Release Dive Angle Sensitivity BLU-58, 5000 Ft Rel Alt, 0° Dive (Pipper is on Target)	47
20	Release Dive Angle Sensitivity Mk-82 LDGP, 8000 Ft Rel Alt, 45° Dive	48
20a	Release Dive Angle Sensitivity Mk-82 LDGP, 8000 Ft Rel Alt, 45° Dive (Pipper is on Target)	49
21	Release Dive Angle Sensitivity BLU-58, 8000 Ft Rel Alt, 45° Dive	50
21a	Release Dive Angle Sensitivity BLU-58, 8000 Ft Rel Alt, 45° Dive (Pipper is on Target)	51

LIST OF FIGURES (Continued)

Figure	Title	Page
22	Ejection Velocity Sensitivity Mk-82 LDGP, 5000 Ft Rel Alt, 0° Dive	52
23	Ejection Velocity Sensitivity BLU-58, 5000 Ft Rel Alt, 0° Dive	53
24	Ejection Velocity Sensitivity Mk 82 LDGP, 8000 Ft Rel Alt, 45° Dive	54
25	Ejection Velocity Sensitivity BLU-58, 8000 Ft Rel Alt, 45° Dive	55
26	Bomb Weight Sensitivity Mk-82 LDGP, 5000 Ft Rel Alt, 0° Dive	56
27	Bomb Weight Sensitivity BLU-58, 5000 Ft Rel Alt, 0° Dive	57
28	Bomb Weight Sensitivity Mk-82 LDGP, 8000 Ft Rel Alt, 45° Dive	58
29	Bomb Weight Sensitivity BLU-58, 8000 Ft Rel Alt, 45° Dive	59
30	Bomb Maximum Diameter Sensitivity Mk-82 LDGP, 5000 Ft Rel Alt, 0° Dive	60
31	Bomb Maximum Diameter Sensitivity BLU-58, 5000 Ft Rel Alt, 0° Dive	61
32	Bomb Maximum Diameter Sensitivity Mk-82 LDGP, 8000 Ft Rel Alt, 45° Dive	62
33	Bomb Maximum Diameter Sensitivity BLU-58, 8000 Ft Rel Alt, 45° Dive	63
34	Atmospheric Air Density Sensitivity Mk-82 LDGP, 5000 Ft Rel Alt, 0° Dive	64
35	Atmospheric Air Density Sensitivity BLU-58, 5000 Ft Rel Alt, 0° Dive	65
36	Atmospheric Air Density Sensitivity Mk-82 LDGP, 8000 Ft Rel Alt, 45° Dive	66

LIST OF FIGURES (Continued)

Figure	Title	Page
37	Atmospheric Air Density Sensitivity BLU-58, 8000 Ft Rel Alt, 45° Dive	67
38	Bomb Axial Force Coefficient Sensitivity Mk-82 LDGP, 5000 Ft Rel Alt, 0° Dive	68
39	Bomb Axial Force Coefficient Sensitivity BLU-58, 5000 Ft Rel Alt, 0° Dive	69
40	Bomb Axial Force Coefficient Sensitivity Mk-82 LDGP, 8000 Ft Rel Alt, 45° Dive	70
41	Bomb Axial Force Coefficient Sensitivity BLU-58, 8000 Ft Rel Alt, 45° Dive	71
42	Release Heading Sensitivity 0° Dive, 5000 Ft Rel Alt	72
43	Release Heading Sensitivity 45° Dive, 8000 Ft Rel Alt	73
44	Initial Angular Velocity Sensitivity 0° Dive, 5000 Ft Alt	74
45	Initial Angular Velocity Sensitivity 45° Dive, 8000 Ft Alt	75
46	Initial Pitch Angle Sensitivity 0° Dive, 5000 Ft Rel Alt	76
47	Initial Pitch Angle Sensitivity 45° Dive, 8000 Ft Rel Alt	77
48	Initial Bomb Yaw Angle Sensitivity (Downrange) 0° Dive, 5000 Ft Rel Alt	78
49	Initial Bomb Yaw Angle Sensitivity (Downrange) 45° Dive, 8000 Ft Rel Alt	79
50	Initial Bomb Yaw Angle Sensitivity (Crossrange) 0° Dive, 5000 Ft Rel Alt	80
51	Initial Bomb Yaw Angle Sensitivity (Crossrange) 45° Dive, 8000 Ft Rel Alt	81

LIST OF FIGURES (Continued)

Figure	Title	Page
52	Bomb Transverse Moment of Inertia Sensitivity 0° Dive, 5000 Ft Rel Alt	82
53	Bomb Transverse Moment of Inertia Sensitivity 45° Dive, 8000 Ft Rel Alt	83
54	Bomb Normal Force Coefficient Sensitivity 0° Dive, 5000 Ft Rel Alt	84
55	Bomb Normal Force Coefficient Sensitivity 45° Dive, 8000 Ft Rel Alt	85
56	Bomb Side Force Coefficient Sensitivity (Downrange) 0° Dive, 5000 Ft Rel Alt	86
57	Bomb Side Force Coefficient Sensitivity (Downrange) 45° Dive, 8000 Ft Rel Alt	87
58	Bomb Side Force Coefficient Sensitivity (Crossrange) 0° Dive, 5000 Ft Rel Alt	88
59	Bomb Side Force Coefficient Sensitivity (Crossrange) 45° Dive, 8000 Ft Rel Alt	89
60	Bomb Pitching Moment Coefficient 0° Dive, 5000 Ft Rel Alt	90
61	Bomb Pitching Moment Coefficient 45° Dive, 8000 Ft Rel Alt	91
62	Bomb Yawing Moment Coefficient (Downrange) 0° Dive, 5000 Ft Rel Alt	92
63	Bomb Yawing Moment Coefficient (Downrange) 45° Dive, 8000 Ft Rel Alt	93
64	Bomb Yawing Moment Coefficient (Crossrange) 0° Dive, 5000 Ft Rel Alt	94
65	Bomb Yawing Moment Coefficient (Crossrange) 45° Dive, 8000 Ft Rel Alt	95
66	Bomb Pitch Damping Moment Coefficient 0° Dive, 5000 Ft Rel Alt	96
67	Bomb Pitch Damping Moment Coefficient 45° Dive, 8000 Ft Rel Alt	97

## LIST OF FIGURES (Concluded)

Figure	Title	Page
68	Bomb Yaw Damping Moment Coefficient (Downrange) 0° Dive, 5000 Ft Rel Alt	98
69	Bomb Yaw Damping Moment Coefficient (Downrange) 45° Dive, 8000 Ft Rel Alt	99
70	Bomb Yaw Damping Moment Coefficient (Crossrange) 0° Dive, 5000 Ft Rel Alt 45° Dive, 8000 Ft Rel Alt	100
71	REP vs Nominal Release Velocity 5000 Ft Rel Alt, Level	116
72	REP vs Nominal Release Velocity 8000 Ft Rel Alt, 45° Dive	117
73	REP vs Nominal Release Velocity 450 Kts, 5000 Ft Rel Alt	118
74	REP vs Nominal Release Velocity 860 Kts, 5000 Ft Rel Alt	119
75	REP vs Nominal Release Altitude 450 Kts, Level	120
76	REP vs Nominal Release Altitude 860 Kts, Level	121

## SECTION I

### INTRODUCTION

#### General Description of the Analysis

The purpose of this report is threefold: (1) To examine the sensitivity of weapon impact position to errors in pertinent delivery parameters, (2) to examine the combined effect of these delivery errors on overall system accuracy for eight different mil-systems, and (3) to compare the relative accuracy of different delivery conditions (level versus dive, subsonic versus supersonic, high-drag weapon versus low-drag weapon) for each of the eight different mil-systems<sup>1</sup>.

This report not only extends the sensitivity analysis (purpose 1) presented in Air Force Armament Laboratory Armament Memorandum Report 69-20 to high-drag weapons and to a much larger range of release conditions, but also includes system accuracy data (purpose 2) and relative accuracy data for different delivery conditions (purpose 3), neither of which was considered in the previous report. The nature of the delivery parameters involved, along with a brief explanation of the manner in which errors are propagated through these parameters, is presented in Appendix I. Appendix II examines the relationship between Range Error Probable (REP)<sup>2</sup> and mil error for some of the actual data generated for this study. The purpose is to emphasize that contradictory conclusions can result from the same data if both concepts are not fully understood.

The sensitivities were obtained from a five-degree-of-freedom computer program developed especially for this purpose. The computer program simulates a five-degree-of-freedom trajectory for the nominal release conditions under consideration. The program then automatically increments a specified independent variable by a certain amount, computing a new trajectory for each incremented value of the variable. The impact point of each new trajectory is then compared to that of the nominal trajectory, thereby giving the desired sensitivity. Once the computations are completed for a particular variable, it is restored to its nominal value and a new variable is chosen.

The Mk-82 low-drag bomb and BLU-58 high-drag bomb were chosen for this analysis because of their readily accessible aerodynamic coefficients. The BLU-58 possesses an axial force coefficient roughly five times greater than that for the Mk-82. The data in this report are for the BLU-58 without the tail fin retarders. Other nominal characteristics for the two bombs are:

- 
1. The concept of mil-system as used in this report is explained in Section II.
  2. See Section II for explanation of significance of REP.

	<u>Mk-82</u>	<u>BLU-58</u>
Maximum Diameter	10.75 inches	15.00 inches
Weight	530.00 pounds	563.00 pounds
Transverse Inertia	36.73 sl-ft <sup>2</sup>	16.56 sl-ft <sup>2</sup>
Longitudinal Inertia	1.49 sl-ft <sup>2</sup>	3.56 sl-ft <sup>2</sup>

Sensitivities are generated for a standard atmospheric structure with a target temperature of 30°C (86°F).

### Delivery Parameters, Conditions and Systems Studied

The following definitions are basic because the terminology is used throughout this report.

Release errors are errors in those parameters (release parameters) which determine the initial conditions of the weapon trajectory. These parameters are altitude, speed, dive angle, and ejection velocity.

Weapon errors are errors in those parameters (weapon parameters) which affect the net forces and moments acting on the weapon. These parameters are weight, diameter, air density, and aerodynamic coefficients. (For system accuracy studies, the only aerodynamic coefficient considered is axial force).

Pipper placement errors are errors resulting from the pilot's inability to release the weapon when the target is exactly at the desired position in his sight.

Delivery parameters are release parameters plus weapon parameters plus pipper placement.

There are basically two types of graphs presented in this report: sensitivity graphs and system accuracy graphs. The sensitivity graphs examine miss-distance<sup>3</sup> as a function of error variations in nineteen delivery parameters. These delivery parameters include both those which affect a nonperturbed weapon trajectory (i.e., the weapon experiences no oscillatory angular motion) and those which cause and influence the perturbed trajectory. The trajectory sensitivities to the eight delivery parameters which do not affect weapon perturbations are given for the following nominal release conditions:

- 
3. Miss-distance is the distance in the ground plane between the desired weapon impact point (target) and the actual weapon impact point resulting from deviations in the planned delivery parameters.

<u>BOMB TYPE</u>	<u>DIVE ANGLE (DEGREES)</u>	<u>RELEASE VELOCITY (KNOTS)</u>	<u>RELEASE ALTITUDE (FEET)</u>
Low Drag (Mk-82)	0	450	5,000
		660	5,000
		860	5,000
		960	5,000
High Drag (BLU-58)	0	450	5,000
		660	5,000
		860	5,000
		960	5,000
Low Drag (Mk-82)	45	450	8,000
		660	8,000
		860	8,000
		960	8,000
High Drag (BLU-58)	45	450	8,000
		660	8,000
		860	8,000
		960	8,000

Since the trajectory sensitivities to the ten delivery parameters<sup>4</sup> affecting weapon perturbations seem to be less dependent upon release velocity, the nominal release conditions were reduced to the following:

<u>BOMB TYPE</u>	<u>DIVE ANGLE (DEGREES)</u>	<u>RELEASE VELOCITY (KNOTS)</u>	<u>RELEASE ALTITUDE (FEET)</u>
Low Drag (Mk-82)	0	450	5,000
		860	5,000
High Drag (BLU-58)	0	450	5,000
		860	5,000
Low Drag (Mk-82)	45	450	8,000
		860	8,000
High Drag (BLU-58)	45	450	8,000
		860	8,000

The system accuracy graphs examine the system REP for eight different mil-systems as a function of release velocity, release altitude, release

- 
4. Release heading is included in this group as an eleventh parameter even though it does not depend on weapon perturbations. It was not included in the non-perturbed parameters since it was not considered as a parameter affecting downrange system accuracy.



angle, and bomb type. Since it is difficult to determine what percent of the weapon dispersion is caused by release disturbances, the system accuracy analysis considers only those parameters which affect a non-perturbed weapon trajectory. However, the miss-distances caused by various types of weapon oscillations are included to permit verification of their small magnitudes when compared to most system REP values. The following range of delivery conditions are considered:

<u>VARIABLE DELIVERY PARAMETERS</u>	<u>VALUE RANGE</u>	<u>CONSTANT DELIVERY PARAMETERS</u>	<u>VALUE</u>
Velocity	200-960 kts	Altitude Dive Angle	5,000 ft 0 deg
Velocity	200-960 kts	Altitude Dive Angle	8,000 ft 45 deg
Dive Angle	0-30 deg	Velocity Altitude	450 kts 5,000 ft
Dive Angle	0-30 deg	Velocity Altitude	860 kts 5,000 ft
Altitude	500-10,000 ft	Dive Angle Velocity	0 deg 450 kts
Altitude	500-10,000 ft	Dive Angle Velocity	0 deg 860 kts

The above outline is included to display an overall view of the type of information contained in this report. Section II will further clarify the data contained in Sections III and IV. In particular, Section II should be studied carefully for a thorough understanding of the methodology and assumptions on which the system accuracy analysis in Section IV is based.

## SECTION II

### CONTEXT AND LIMITATIONS OF THE SYSTEM ACCURACY STUDY

#### Relationship of Mils, CEP, REP and Miss Distance

There are eight basic mil-systems considered in this report: The 7-mil level system, the 7-mil dive system, the 14-mil level system, the 14-mil dive system, the 30-mil level system, the 30-mil dive system, the 50-mil level system, and the 50-mil dive system. The basic differences inherent in these systems should be clarified by the following definitions:

● A basic 7-mil level system is a system which, when delivering the Mk-82 in a level mode at 450 knots, 5,000 feet altitude, has an error of 7 mils in a plane perpendicular to the line-of-sight from release point to target.

● A basic 7-mil dive system is a system which, when delivering the Mk-82 in a 45 degree dive at 450 knots, 8,000 feet altitude, has an error of 7 mils in a plane perpendicular to the line-of-sight from release point to target.

● The 14-, 30- and 50-mil level and dive systems are defined in an analogous manner.

These eight basic systems are all defined for the Mk-82 at 450 knots and a specific altitude and dive angle. They are then used as standards to measure the degradation or improvement of each system as a result of changing the release speed, altitude, or dive angle, or of delivering a high-drag (BLU-58) rather than a low-drag (Mk-82) weapon. Before this can be done, however, the error for each mil-system must be converted to some type of error measurement in the ground plane. There are two very important reasons for doing this.

First, the real measure of delivery accuracy should be how far a weapon impacts from the target. For example, if two identical weapons are released level at the same altitude but their release velocities differ significantly and if, without further explanation, a 7-mil system accuracy is given for both weapons, the conclusion might be reached that the delivery accuracy for both deliveries was equal. However, since the weapon released at the higher speed has a larger slant range and a shallower line-of-sight angle, 7 mils error causes a much greater miss-distance in the ground plane for this release than for the weapon released at the lower speed. This is only one of many examples which could cause invalid conclusions to be reached. (Appendix II treats this problem in much more detail and uses examples based upon actual data resulting from this study.)

Secondly, the sensitivities themselves are expressed in terms of miss-distance in the ground plane. When a release parameter (e.g., dive angle) is incremented and a new trajectory is generated, the resulting sensitivity is expressed in terms of the distance between this weapon impact and the nominal weapon impact. If, for example, a one degree increment in dive angle causes the new impact point to be 380 feet from the nominal impact point, then it can be concluded that the sensitivity to dive angle for this particular release condition is 380 feet per degree. There is no logical basis for arbitrarily terminating the incremented weapon trajectory when it reaches a plane perpendicular to the line-of-sight and calling that separation distance the true measurement of delivery accuracy. The concept of mil error may prove useful in allowing system accuracy to be expressed independently of the particular delivery conditions; however, it could very well be misleading when trying to evaluate the relative merits of those delivery conditions and individual weapon types.

The mil error really defines the radius of a circle  $[(CEP)_N]$  which contains 50 percent of the bombs in a plane perpendicular to the line-of-sight from release to target (see Diagram 1). Implicit in a theoretically useful mil representation is the assumption that the bomb positions in the plane perpendicular to the line-of-sight follow a circular normal distribution. (This assumption of circular normal distribution applies only to the eight basic mil systems.) If this circular normal distribution is transformed to the ground plane, a bi-variate normal distribution represented by an ellipse which still contains 50 percent of the weapon impacts (but now in the ground plane) is obtained. The minor axis of this ellipse would be equal to the  $(CEP)_N$  and the major axis would be equal to  $(DEP)_N \times \csc \phi$ , where  $\phi$  represents the line-of-sight angle.

In the system accuracy portion of this analysis, only those parameters which affect the downrange travel of a non-perturbed weapon are considered. The reason for restricting the analysis to downrange travel is that little is known about the parameters which cause deflection error. It is believed that winds, release disturbances, and heading errors are the major contributors; however, with present capabilities, only heading errors can be effectively analyzed. For this reason, CEP (Circular Error Probable) must be subdivided into two components: REP (Range Error Probable) and DEP (Deflection Error Probable) (see Diagram 2).

In the plane normal to the line-of-sight,  $(REP)_N$  is equal to half the distance between two lines which are drawn perpendicular to the aircraft track, are equidistant from the target, and contain half the impact points. It can be proven that, for a circular normal distribution,  $(REP)_N = 0.87 (CEP)_N$ . In the ground plane,  $REP = (REP)_N \csc \phi$ . After consideration, it should be obvious that REP is also equal to half the distance between two lines in the ground plane which are drawn perpendicular to the aircraft track, are equidistant from the target, and contain 50 percent of the impact points.

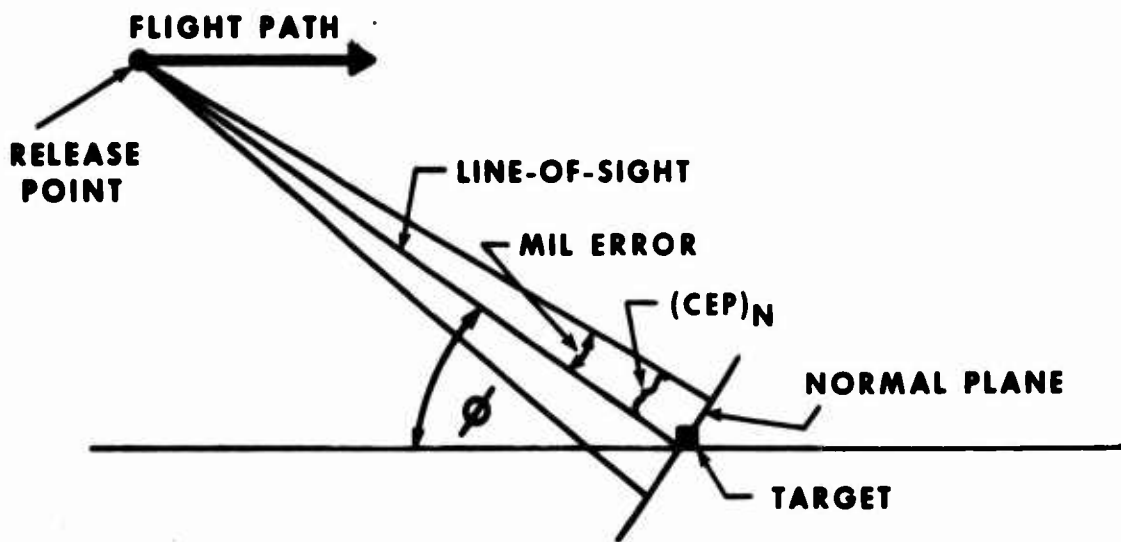

Diagram 1a. Representation of Mil Error and  $(CEP)_N$

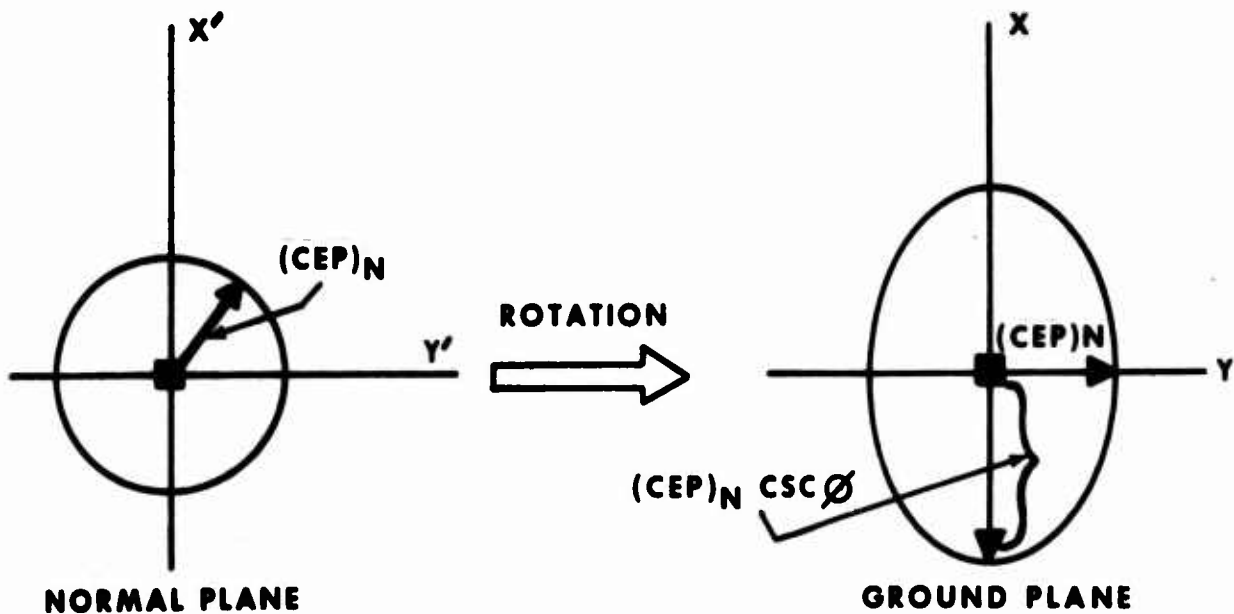

Diagram 1b. Projection of Mil Error into Ground Plane

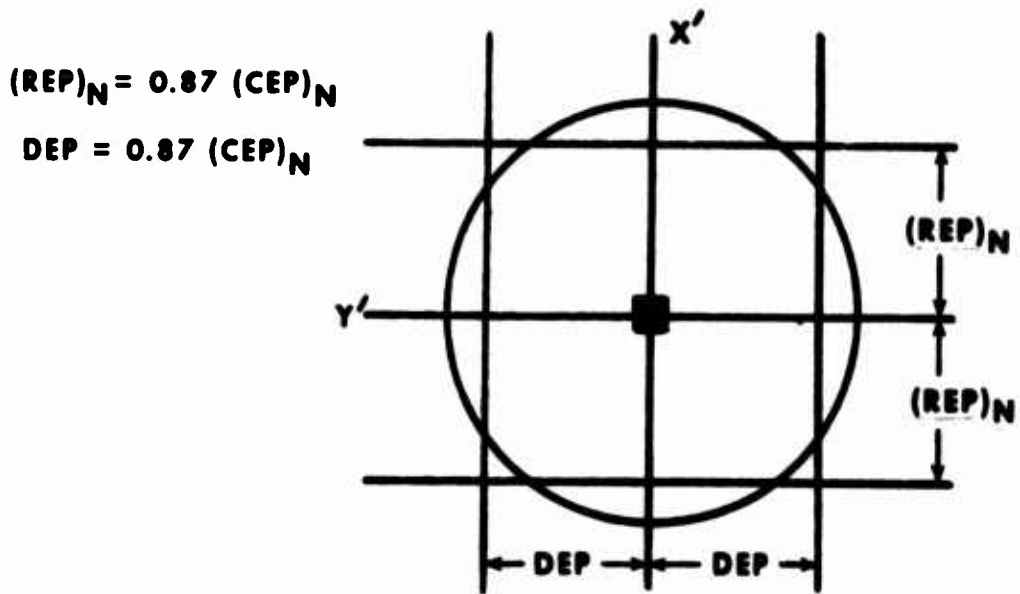

Diagram 2a. REP and DEP in Normal Plane

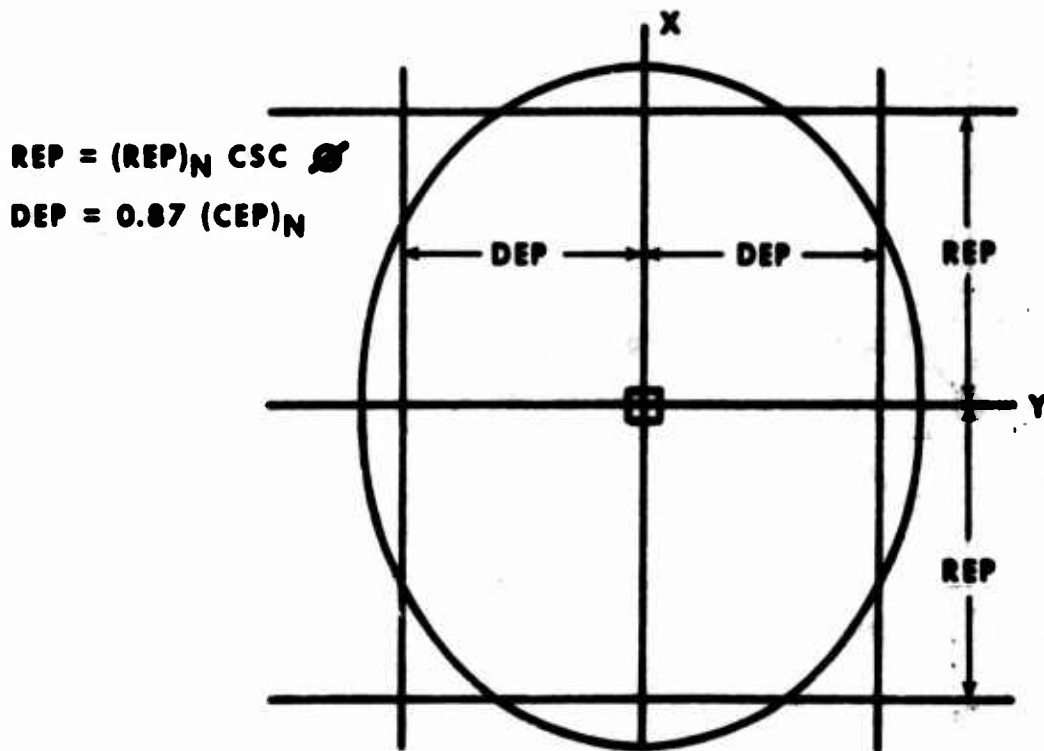

Diagram 2b. REP and DEP in Ground Plane

Thus, each of the eight basic mil-systems will have a corresponding value of REP associated with it. It will be these values which will increase or decrease as delivery conditions and bombs, other than those associated with the eight basic mil systems, are considered. This increase or decrease no longer depends upon any distributional assumptions. The effect of different delivery conditions on DEP will not be considered due to the limited knowledge concerning its causes.

## Methodology

In order to clarify the assumptions made in this analysis, a brief presentation of the methodology follows. The total system REP is considered to be a combination of three independent error sources:

$$\text{REP} = \sqrt{(\Delta X_R)^2 + (\Delta X_W)^2 + (\Delta X_P)^2}, \quad \text{where}$$

$\Delta X_R$  = release error contribution

$\Delta X_W$  = weapon error contribution

$\Delta X_P$  = pipper placement error contribution

REP = range error probable (ground plane)

Each of these three error contributors are in turn functions of (a) errors in the particular delivery parameters associated with that error group, and (b) the sensitivity of miss distance to these delivery parameters.

$$\begin{aligned} (\Delta X_R)^2 &= \left( \frac{\partial x}{\partial \theta} \Delta \theta \right)^2 + \left( \frac{\partial x}{\partial v} \Delta v \right)^2 + \left( \frac{\partial x}{\partial h} \Delta h \right)^2 + \left( \frac{\partial x}{\partial V_e j} \Delta V_e j \right)^2 \\ &+ \frac{\partial x}{\partial \theta} \frac{\partial x}{\partial v} \rho_{12} \Delta \theta \Delta v + \frac{\partial x}{\partial \theta} \frac{\partial x}{\partial h} \rho_{13} \Delta \theta \Delta h + \dots \end{aligned}$$

$$\begin{aligned} (\Delta X_W)^2 &= \left( \frac{\partial x}{\partial W} \Delta W \right)^2 + \left( \frac{\partial x}{\partial d} \Delta d \right)^2 + \left( \frac{\partial x}{\partial \rho} \Delta \rho \right)^2 + \left( \frac{\partial x}{\partial C_A} \Delta C_A \right)^2 \\ &+ \frac{\partial x}{\partial W} \frac{\partial x}{\partial d} \rho_{45} \Delta W \Delta d + \frac{\partial x}{\partial W} \frac{\partial x}{\partial \rho} \rho_{46} \Delta W \Delta \rho + \dots \end{aligned}$$

$$(\Delta X_P)^2 = \left( \frac{\partial x}{\partial \phi} \Delta \phi \right)^2$$

Where:

$x$  = weapon horizontal range

$\frac{\partial x}{\partial P_i}$  = sensitivity of  $x$  to any parameter  $P_i$

$\rho_{ij}$  = correlation coefficient between any two parameters  $P_i$  and  $P_j$

$\Delta P_i$  = error in any parameter  $P_i$

$\theta$  = dive angle at release ( $P_1$ )

$V$  = release velocity ( $P_2$ )

$h$  = release altitude ( $P_3$ )

$V_{ej}$  = ejection velocity ( $P_4$ )

$w$  = weapon weight ( $P_5$ )

$d$  = weapon diameter ( $P_6$ )

$\rho$  = air density ( $P_7$ )

$C_A$  = weapon axial force coefficient ( $P_8$ )

$\phi$  = pipper placement ( $P_9$ )



### Assumptions and Their Consequences

1. The first major assumption is that all sensitivities are constant within the expected error range for a given set of delivery conditions. This simply means that the value of the sensitivity is independent of the delivery error magnitude and dependent only upon the nominal delivery conditions.

2. The second assumption implies that the terms in the  $\Delta X_R$ ,  $\Delta X_W$ , and  $\Delta X_P$  equations are the only significant ones which affect downrange delivery error. When the mechanics of a weapon delivery are considered, it becomes apparent that the essential factors involved in predicting a weapon trajectory are the initial conditions (release position and velocity) and the net forces and moments acting on the weapon at each point in its trajectory. It is believed that the nine parameters included in these three equations sufficiently encompass the pertinent parameters for an unperturbed weapon. A significant factor which has not been considered is the effect of winds on weapon trajectories. This effect was not considered because the unpredictable nature of winds would not result in a constant mil error for a given system. Furthermore, since cross-range error was not considered in this study, system error would also become a function of wind direction. However, it can be said with certainty that unpredictable winds would degrade system accuracy and, in the case of high-drag weapons, become a significant factor in determining system error.

3. The third major assumption is that all correlations are zero (i.e., all error sources are independent). This assumption is necessitated by the fact that no meaningful information exists concerning the correlation among delivery parameters. The consequence of such an assumption depends upon the magnitudes and signs of the various correlation coefficients, as well as the amount of error expected in each delivery parameter. The total effect of such correlations on REP will be small if they are random in the sense that their signs and magnitudes cause cancellation of the correlated terms. Equations for the REP components now become:

$$(\Delta X_R)^2 = \left( \frac{\partial x}{\partial \theta} \Delta \theta \right)^2 + \left( \frac{\partial x}{\partial v} \Delta v \right)^2 + \left( \frac{\partial x}{\partial h} \Delta h \right)^2 + \left( \frac{\partial x}{\partial v_e j} \Delta v_e j \right)^2$$

$$(\Delta X_W)^2 = \left( \frac{\partial x}{\partial w} \Delta w \right)^2 + \left( \frac{\partial x}{\partial d} \Delta d \right)^2 + \left( \frac{\partial x}{\partial \rho} \Delta \rho \right)^2 + \left( \frac{\partial x}{\partial C_A} \Delta C_A \right)^2$$

$$(\Delta X_P)^2 = \left( \frac{\partial x}{\partial \phi} \Delta \phi \right)^2$$

4. The fourth set of assumptions becomes apparent when an attempt is made to predict a new Range Error Probable (REP)' from a previous REP. This new REP could be a result of either changing one or more release conditions or changing the drag characteristics of the weapon. Thus:

$$(\text{REP})' = \sqrt{(\Delta X_R')^2 + (\Delta X_W')^2 + (\Delta X_\phi')^2}, \quad \text{where}$$

$$(\Delta X_R')^2 = \left( K_1 \frac{\partial x}{\partial \theta} \right)^2 (\Delta \theta')^2 + \left( K_2 \frac{\partial x}{\partial v} \right)^2 (\Delta v')^2 + \left( K_3 \frac{\partial x}{\partial h} \right)^2 (\Delta h')^2 \\ + \left( K_4 \frac{\partial x}{\partial V_{ej}} \right)^2 (\Delta V_{ej}')^2$$

$$(\Delta X_W')^2 = \left( K_5 \frac{\partial x}{\partial w} \right)^2 (\Delta w')^2 + \left( K_6 \frac{\partial x}{\partial d} \right)^2 (\Delta d')^2 + \left( K_7 \frac{\partial x}{\partial \rho} \right)^2 (\Delta \rho')^2 \\ + \left( K_8 \frac{\partial x}{\partial C_A} \right)^2 (\Delta C_A')^2$$

$$(\Delta X_\phi')^2 = \left( K_9 \frac{\partial x}{\partial \phi} \right)^2 (\Delta \phi')^2, \quad \text{where}$$

$K_1$  = ratio of the new sensitivity to the old sensitivity for the  $i$ th parameter

$\Delta P'_i$  = the new error in the  $i$ th parameter

Now, if it is assumed that

a.  $K_1 = K_2 = K_3 = K_4 = K_R$

b.  $K_5 = K_6 = K_7 = K_8 = K_W$

c.  $\Delta P_i = \Delta P_i^5$  (i.e., the magnitude of the error in each delivery parameter does not change with a change in delivery conditions).

Then,

$$(\Delta X'_R)^2 = K_R^2 \left[ \left( \frac{\partial x}{\partial \theta} \Delta \theta \right)^2 + \left( \frac{\partial x}{\partial v} \Delta v \right)^2 + \left( \frac{\partial x}{\partial h} \Delta h \right)^2 + \left( \frac{\partial x}{\partial V_{ej}} \Delta V_{ej} \right)^2 \right]$$

$$= K_R^2 (\Delta X_R)^2$$

$$(\Delta X'_W)^2 = K_W^2 \left[ \left( \frac{\partial x}{\partial w} \Delta w \right)^2 + \left( \frac{\partial x}{\partial d} \Delta d \right)^2 + \left( \frac{\partial x}{\partial \rho} \Delta \rho \right)^2 + \left( \frac{\partial x}{\partial C_A} \Delta C_A \right)^2 \right]$$

$$= K_W^2 (\Delta X_W)^2$$

$$(\Delta X'_p)^2 = K_p^2 \left( \frac{\partial x}{\partial \phi} \right)^2 \left( \frac{\Delta \phi'}{\Delta \phi} \right)^2 (\Delta \phi)^2$$

$$\Delta X'_R = K_R \Delta X_R$$

$$\Delta X'_W = K_W \Delta X_W$$

$$\Delta X'_p = K_p \Delta X_p \frac{\Delta \phi'}{\Delta \phi}$$

- 
5. The one exception to this is pipper error. In going from 450 knots to 660 knots, pipper placement error is assumed to increase by a factor of 1.5. In going from 450 knots to 860 knots or 960 knots, pipper placement error is assumed to increase by a factor of 2. However, this presents no difficulty since  $\Delta X_p$  contains only this one term.

Thus, within the constraints imposed by these assumptions, a new REP value can be computed from a previous one for a different weapon type or release condition without any knowledge of the errors in the delivery parameters.

The assumption that the K's for any group of delivery parameters are equal is somewhat justified by the data. If this assumption were not made, it would be impossible to perform this analysis without a knowledge of the delivery errors because the K's could not be factored out of the component error equations. However, the nature of the weapon errors is such that their sensitivity ratios are always close in value. For the release errors, the sensitivity ratios of altitude and dive angle are usually close but release velocity and ejection velocity sensitivity ratios follow an irregular pattern. Fortunately, their overall error contribution is small when compared to typical dive angle and altitude errors. In any event, an average value of K is used in the computations and is given by

$$K_R = \frac{K_1 + K_2 + K_3 + K_4}{4} \qquad K_W = \frac{K_5 + K_6 + K_7 + K_8}{4}$$

Of course, this type of averaging would be exactly correct if the contribution of each term in the  $\Delta X_R$  (and  $\Delta X_W$ ) equation were the same.

The assumption that  $\Delta P_1 = \Delta P_1'$  requires much more scrutiny. If the difference between the two types of delivery conditions is solely one of weapon type (high drag versus low drag), then the assumption seems to be extremely good. For example, errors in the release parameters would not be expected to be affected by the type of weapon which is being delivered. Secondly, it seems reasonable that errors in the weapon parameters are largely independent of the weapon drag. For example, two 750-pound bombs would be expected to possess the same degree of uncertainty in weight regardless of their drag coefficient. Likewise, when the difference between the two types of delivery conditions is release speed, the errors in weapon parameters would not be expected to be affected (e.g., increased speed would not change the weight inaccuracy of the weapon being carried). However, the delivery conditions would be expected to affect the magnitude of the release parameter errors and pipper placement errors. As mentioned in Footnote 5, pipper placement error ( $\Delta\phi$ ) is degraded with increased delivery speed. In order not to invalidate the results of this study, such degradation factors were not guessed at for the release parameters since insufficient data exist to justify educated guesses. However, the pilot's (or computer's) ability to hit the release parameters is certainly not believed to improve with increased airspeed. Thus, the degraded REP values for increased airspeed presented in this report are considered conservative estimates. Therefore, the validity of the assumption concerning constant delivery errors can be summarized in the following manner:

<u>PARTICULAR CHANGE IN DELIVERY SYSTEM</u>	<u>VALIDITY OF ASSUMPTION FOR:</u>	
	<u>CONSTANT RELEASE ERRORS</u>	<u>CONSTANT WEAPON ERRORS</u>
New Weapon	Very Good	Good
New Release Condition	Invalid, but is probably conservative for increased release speed	Very Good

5. The fifth and final set of major assumptions concerns the manner in which each of the eight basic mil-systems are further sub-divided into their component error types.

**BASIC LEVEL OR DIVE MIL-SYSTEM<sup>6</sup>**

	<u>PIPPER</u>	<u>RELEASE</u>	<u>WEAPON</u>
7-Mil-System	2 mils	6.0 mils	3 mils
14-Mil-System	6 mils	12.3 mils	3 mils
30-Mil-System	10 mils	28.1 mils	3 mils
50-Mil-System	15 mils	47.6 mils	3 mils

Total mil-system =  $\sqrt{(\text{pipper mil error})^2 + (\text{rel mil error})^2 + (\text{wpn mil error})^2}$  since the three error sources are being treated as mutually independent. The rationale for such a division of system component errors resulted from a mixture of fact and educated guessing. For example, it is known that, no matter how bad a delivery system performs, the amount of system error due to errors in low-drag subsonic weapon characteristics (ballistic dispersion) remains relatively constant at 3 mils. This constitutes the factual part of the rationale. Now the problem becomes that of dividing the remaining system error between pipper placement and release errors. The pipper placement error was chosen to be estimated because more information was

6. It should be recalled that the basic mil-systems (level or dive) refer only to the Mk-82 (low drag) subsonic (450 kts) releases. The errors (REP values) for any other delivery conditions and/or bombs are computed from the basic systems. If these REP values for other systems are expressed in mils (which is not recommended), then any similarity between these new mil values and those for the basic mil-systems is purely coincidental.

available concerning its nature and magnitude. Of course, once the weapon and pipper placement errors were fixed, the release error for a given mil-system assumed a fixed value.

It should be emphasized at this point that even though all the system accuracy graphs and conclusions in this report are based upon these eight mil-systems and their corresponding error budgets, sufficient data are available in the report to compute REP values for any mil-system and any error budget. The computational procedures to be used are presented in Section IV.

Finally, it should be noted that the 7-mil dive system and the 7-mil level system are not equivalent in terms of REP even though they have the same error budget. The rationale may be questioned for having both a basic dive and a basic level mil-system rather than computing the REP values for the dive deliveries from the basic level mil-system. The reason for this results from the assumption of constant release error. There is some evidence to substantiate the belief that nominal release parameters are more easily obtained in level delivery than in dive delivery. Thus it is necessary to construct both a basic dive and a basic level mil-system so that the data will be more meaningful.

Considering that the above assumptions are necessitated by the severe lack of test data for determining errors in delivery parameters and correlation coefficients between pairs of these parameters, this is believed to be the best possible analysis which can be performed to determine the delivery accuracy of conventional free-fall weapon delivery systems. Even though the assumptions at times seem fairly restrictive, all qualitative and most quantitative conclusions presented in this report are considered valid.

### SECTION III

#### SENSITIVITY GRAPHS

This section includes graphs of the nominal trajectories, sensitivity graphs for the eight delivery parameters which are considered in the system accuracy study, and sensitivity graphs for other pertinent delivery parameters which were not considered in the system accuracy study. The following graphs (Figures 1 through 70) are presented:

#### 1. Nominal Trajectory Graphs

<u>Description</u>	<u>Figure</u>
Eight Unperturbed Trajectories (Altitude versus Downrange)	1
Eight Perturbed Trajectories (Pitch Attitude versus Time)	
Mk-82, 450 kts, 0° dive	2
BLU-58, 450 kts, 0° dive	3
Mk-82, 860 kts, 0° dive	4
BLU-58, 860 kts, 0° dive	5
Mk-82, 450 kts, 45° dive	6
BLU-58, 450 kts, 45° dive	7
Mk-82, 860 kts, 45° dive	8
BLU-58, 860 kts, 45° dive	9

#### 2. Sensitivity Graphs for the Eight Parameters Considered in the System Accuracy Study (Miss Distance versus Delivery Parameter)

<u>Parameter</u>	<u>Figure</u>
Altitude	10-13
Velocity	14-17
Dive Angle	18-21
Ejection Velocity	22-25
Weight	26-29
Diameter	30-33
Air Density	34-37
Axial Force Coefficient ( $C_A$ )	38-41

### 3. Sensitivity Graphs for the Remaining Pertinent Parameters (Miss Distance versus Delivery Parameter)

<u>Parameter</u>	<u>Figure</u>
Heading	42-43
Initial Angular Vel ( $W_i$ )	44-45
Initial Pitch Ang	46-47
Initial Yaw Ang	48-51
Transverse Moment of Inertia ( $I_O$ )	52-53
Normal Force Coeff ( $C_N$ )	54-55
Side Force Coeff ( $C_Y$ )	56-59
Pitching Moment Coeff ( $C_m$ )	60-61
Yawing Moment Coeff ( $C_n$ )	62-65
Pitch Damping Coeff ( $C_{m\dot{\theta}}$ )	66-67
Yaw Damping Coeff ( $C_{m\dot{\psi}}$ )	68-70

The remainder of this section is devoted to general observations concerning these graphs. (Appendix I contains an explanation of the mechanics of the weapon delivery problem and could serve to clarify these observations.) Although there are many plausible explanations for the various trends which appear, no attempt has been made in this report to go beyond the observation that the trends do indeed exist. This policy is necessary because (a) most explanations would require a technical knowledge of kinematics, dynamics, and aerodynamics, and (b) to enumerate and satisfactorily explain all of the variables which influence the trajectory dependence on each delivery parameter would require considerably more time and space than would be warranted by the benefits derived therefrom.

#### 1. Nominal Trajectory Graphs

Figure 1 is presented to show the effect of weapon drag and release velocity on the horizontal and slant range from release to weapon impact. The obvious result is that level supersonic deliveries at moderate altitudes must occur at release slant ranges of from four to five miles. Of course, target detection would have to occur several miles previous to that since the aircraft is advancing at speeds greater than 1,400 feet per second. Supersonic delivery does not significantly increase release slant range in a 45-degree dive delivery, but the minimum release altitude is restricted to roughly 8,000 feet due to the distance required for dive recovery.

Figures 2 through 9 show the effect of supersonic delivery on weapon perturbations resulting from unpredictable release disturbances. If it is assumed that the nature and magnitude of the initial cause of the disturbance remain constant regardless of weapon type, release speed, or dive angle, then three trends become noticeable. First, the high-drag



weapon experiences slightly larger oscillation amplitudes and longer periods. Subsonically, the two weapon oscillations have about the same half-life. Supersonically, however, the high-drag weapon has a much longer half-life. Secondly, supersonic delivery results in much smaller oscillation amplitudes and much shorter periods and half-lives. Finally, the only significant effect of releasing in a 45-degree dive seems to be a shorter oscillation half-life, which is probably caused by the higher velocity which a dive trajectory maintains. The overall conclusion seems to be that weapon stability is greatly enhanced by supersonic delivery, provided that the initial release disturbances do not become greater. However, it should not necessarily be concluded that delivery accuracy is greatly enhanced. Even though the perturbations are smaller and shorter lived, the effect of a given perturbation on miss-distance becomes greater because the higher velocity results in more induced drag for a given perturbation. The following table presents the net effect of an initial 71-degree-per-second downward angular velocity on overall weapon miss-distance:

<u>BOMB TYPE</u>	<u>RELEASE ANGLE (DEGREES)</u>	<u>RELEASE VELOCITY (KNOTS)</u>	<u>MISS DISTANCE (FEET)</u>
Mk-82	0	450	81
BLU-58	0	450	256
Mk-82	0	860	113
BLU-58	0	860	66
Mk-82	45	450	33
BLU-58	45	450	80
Mk-82	45	860	26
BLU-58	45	860	21

## 2. Sensitivity Graphs for the Eight Parameters Considered in the System Accuracy Study

Figures 10 through 13 and Figures 18 through 21 show that weapon miss-distance becomes more sensitive to errors in delivery altitude and dive angle as the delivery speed is increased. These figures also show that the BLU-58 is less sensitive to these two parameters than the Mk-82, and that level trajectories are more sensitive than dive trajectories. Figures 14 through 17 show that weapon miss-distance becomes less sensitive to errors in release speed as the delivery speed is increased. The other two trends do not change. Ejection velocity (Figures 22 through 25) follows no trend.

The weapon parameters all show common trends (with two minor exceptions) because they are all factors in the same drag equation (e.g., a 10 percent error in  $\rho$  is approximately equivalent to a 10 percent error in  $C_A$ ). Figures 26 through 41 show that the weapon miss-distance becomes more sensitive

to errors in weight, axial force coefficient, maximum diameter, and air density as the delivery speed is increased. The most dramatic trend is that miss-distance sensitivity is much greater for a high-drag weapon than for a low-drag weapon. Finally, miss-distance shows a significant decrease for a 45-degree dive delivery. The two minor exceptions noted above occur only in a 45-degree dive delivery. Under certain conditions the miss-distance sensitivity is slightly less for a 960 knot delivery than for an 860 knot delivery. This can be explained by the fact that in high velocity dives the trajectory approximates a straight line, thereby reducing its dependence upon weapon drag.

### 3. Sensitivity Graphs for the Remaining Pertinent Parameters

Trends here follow an irregular pattern due to the complex force and moment relationships present in trajectories where the bomb is both translating and oscillating simultaneously. However, two trends do occur with enough frequency to warrant mentioning. With few exceptions, the sensitivity is less for the higher velocities and for the lower drag weapon. Such a trend is consistent with earlier observations that the amplitude and period of an oscillating weapon were smaller and shorter at the higher velocities and for the low-drag weapon. The fact that the trend is not true in all cases (Figures 44 through 70) can be explained by the previous observation that smaller amplitudes and shorter frequencies do not always result in smaller miss-distances due to the fact that the induced drag increases for the higher velocities.

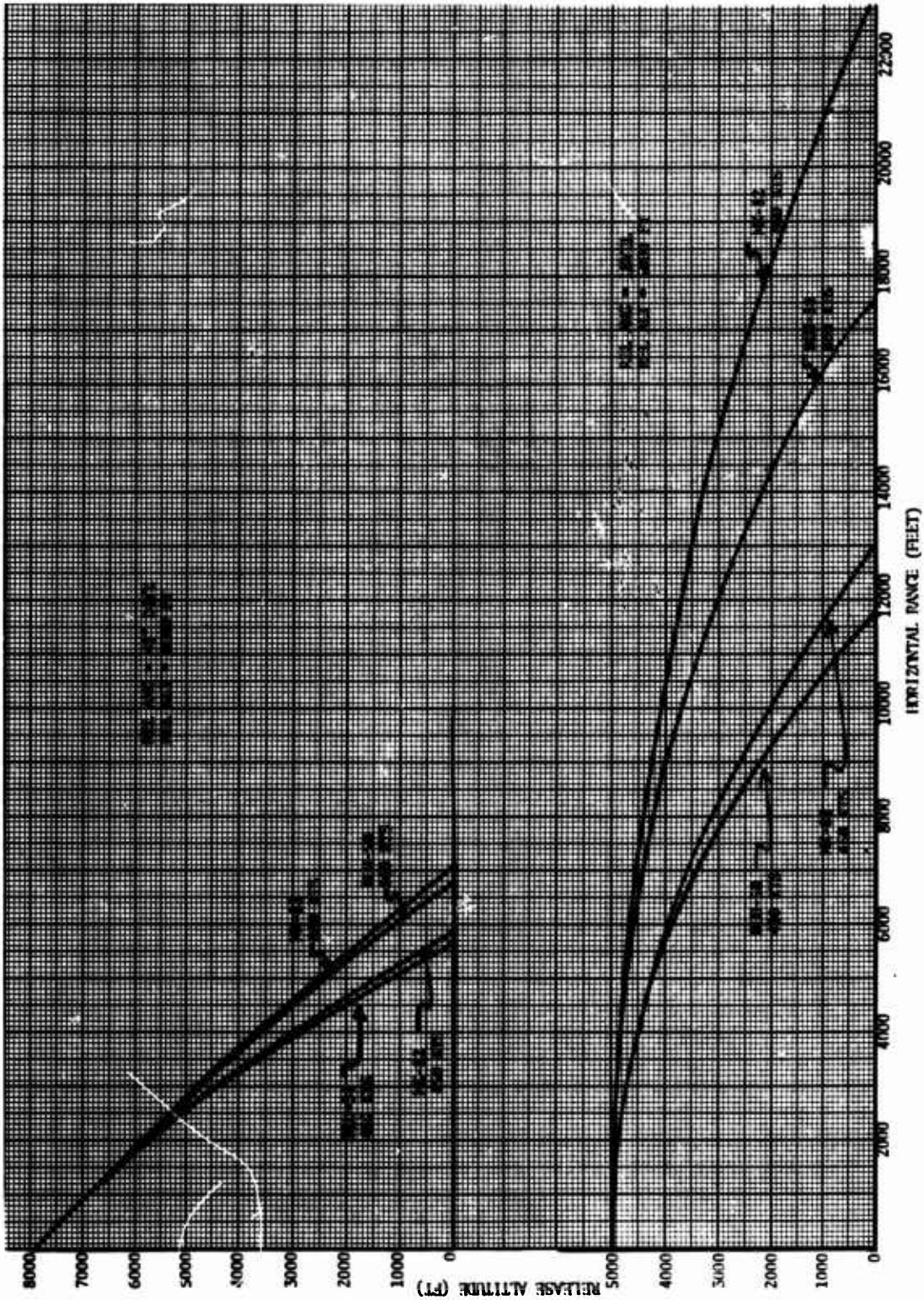

Figure 1. Nominal Weapon Trajectories

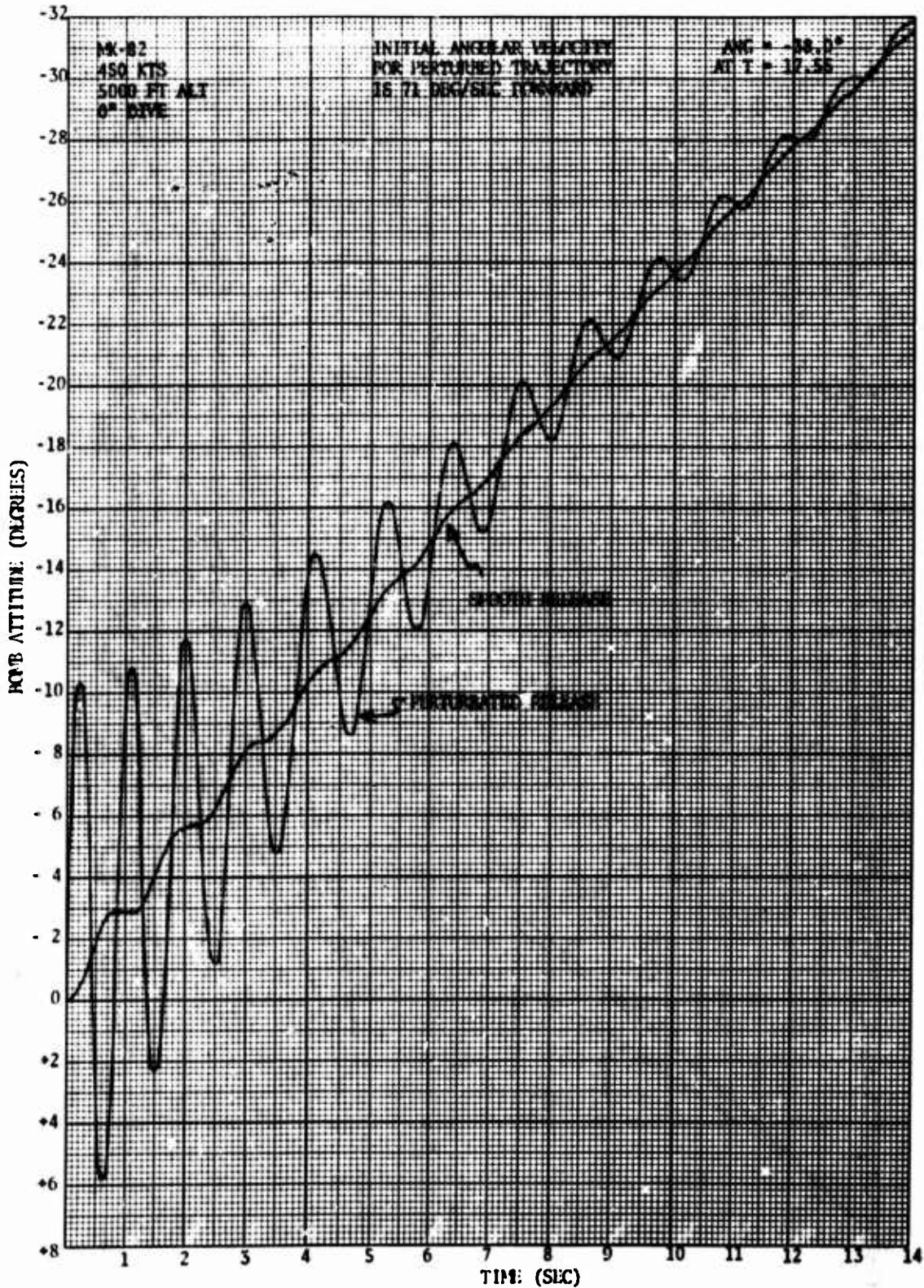

Figure 2. Weapon Angular Perturbation Trajectories Mk-82, 450 kts, 5000 Ft Alt, 0° Dive

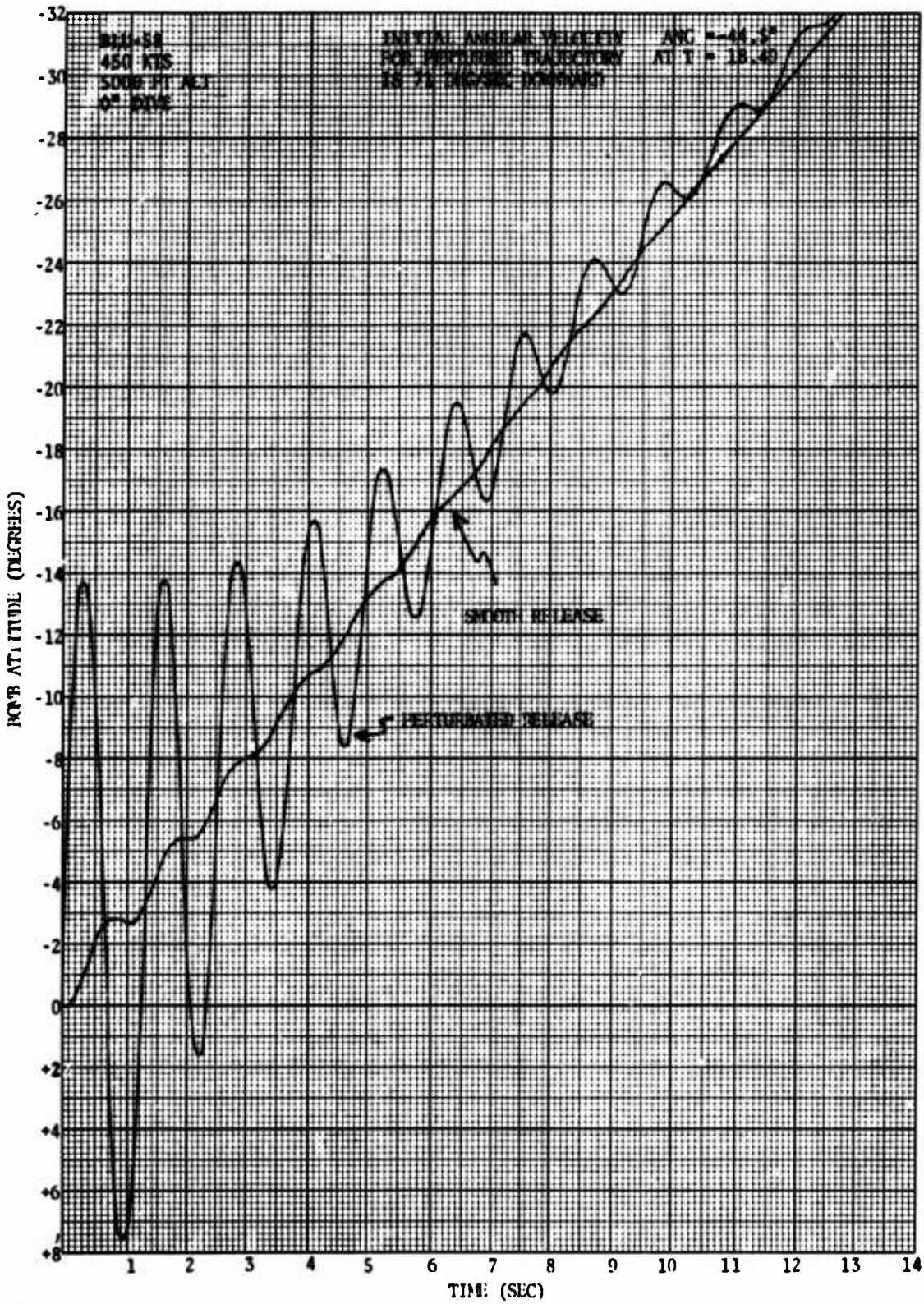

Figure 3. Weapon Angular Perturbation Trajectories BLU-58, 450 Kts, 5000 Ft Alt, 0° Dive

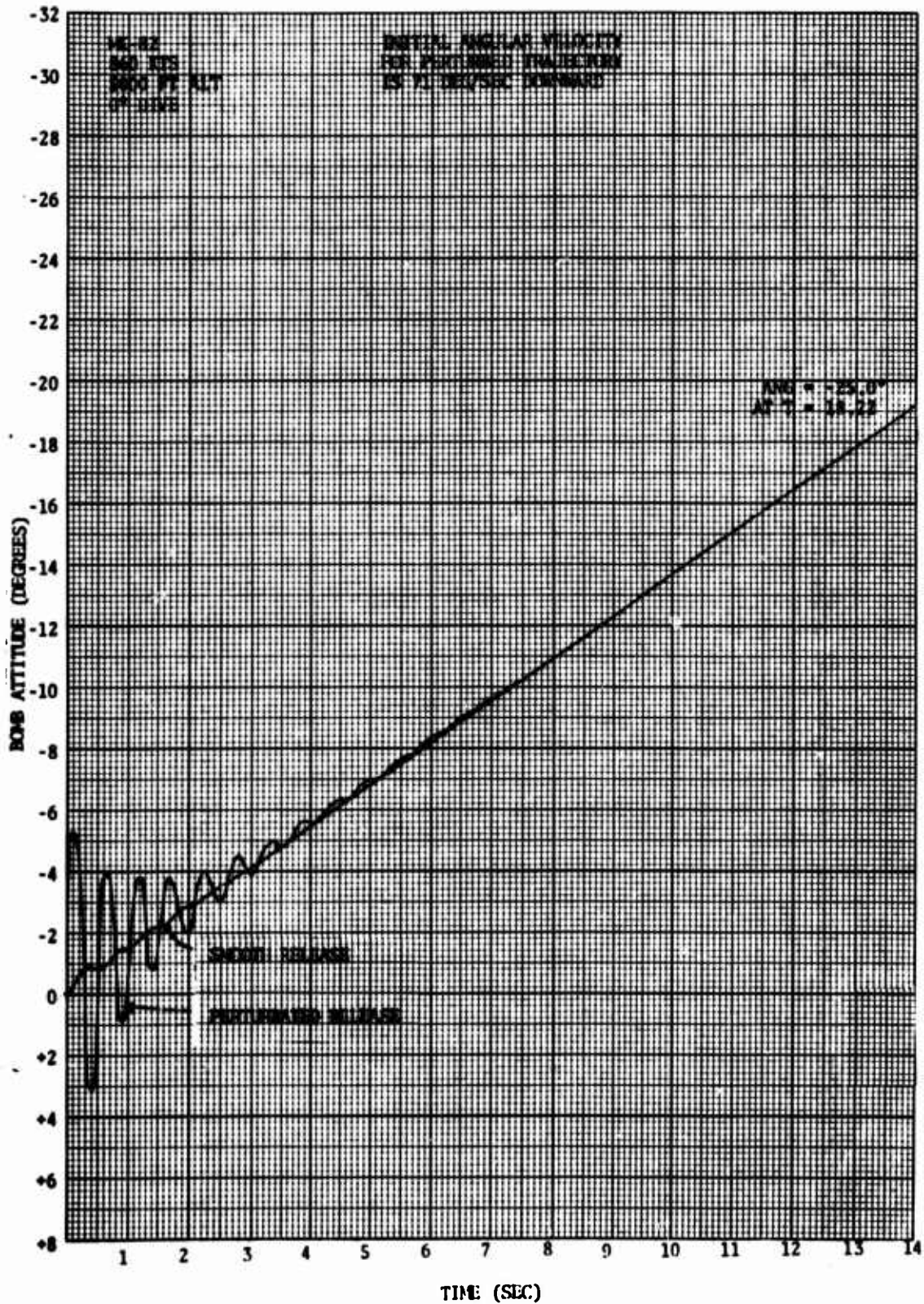

Figure 4. Weapon Angular Perturbation Trajectories Mk-82, 860 Kts, 5000 Ft Alt, 0° Dive

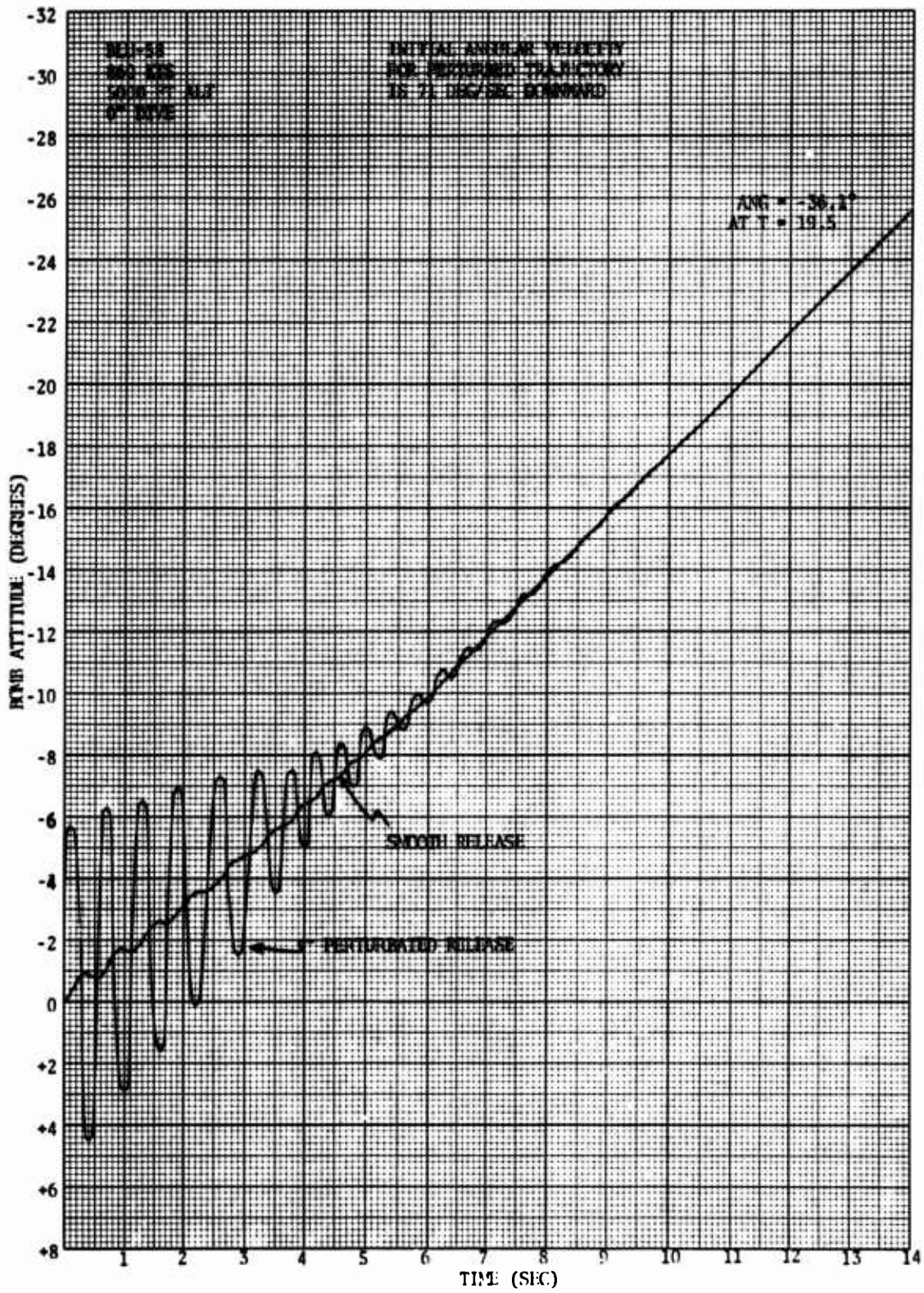

Figure 5. Weapon Angular Perturbation Trajectories BLU-58, 860 Kts, 5000 Ft Alt, 0° Dive

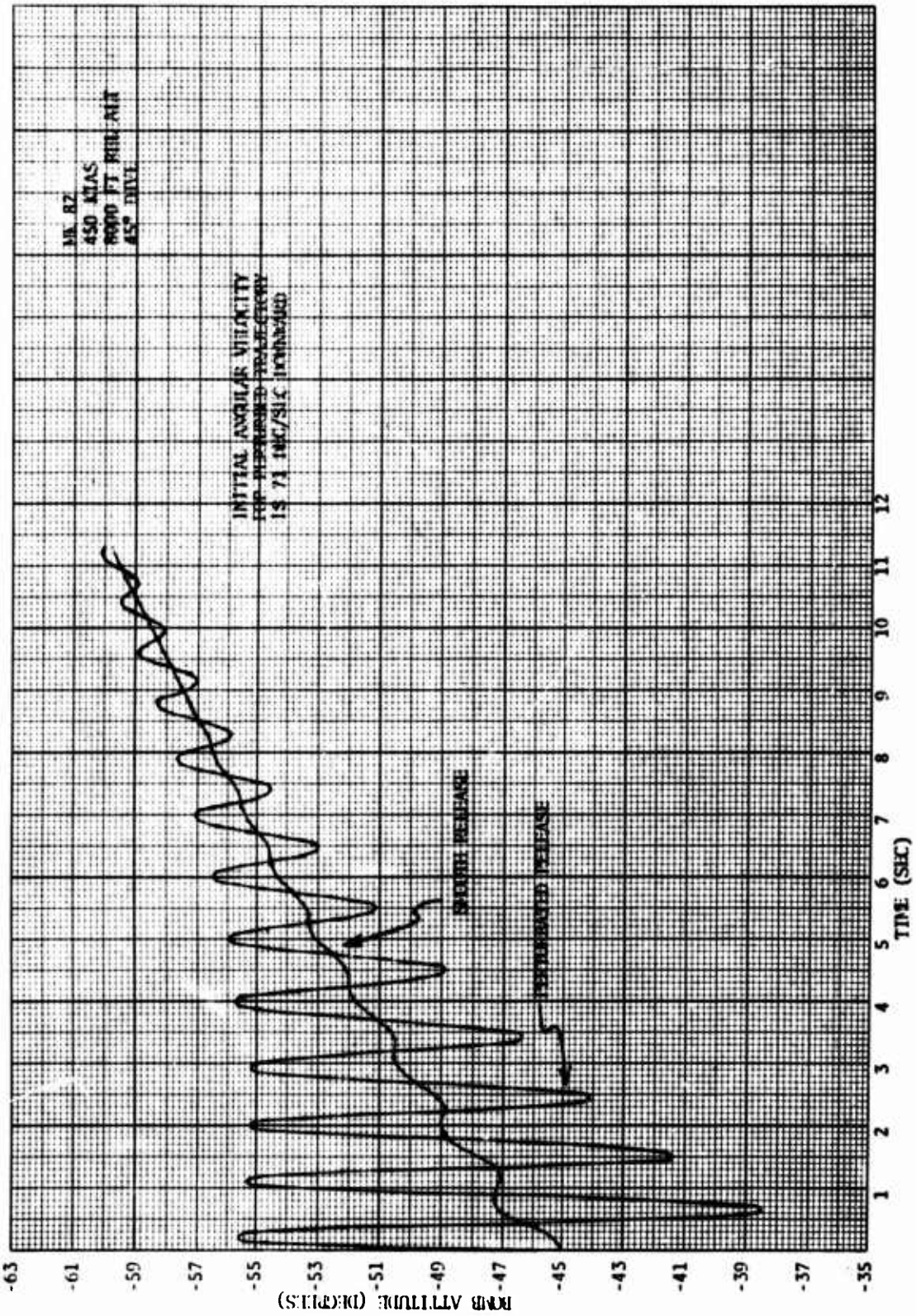

Figure 6. Weapon Angular Perturbation Trajectories Mk-82, 450 Kts, 8000 Ft Alt, 45° Dive



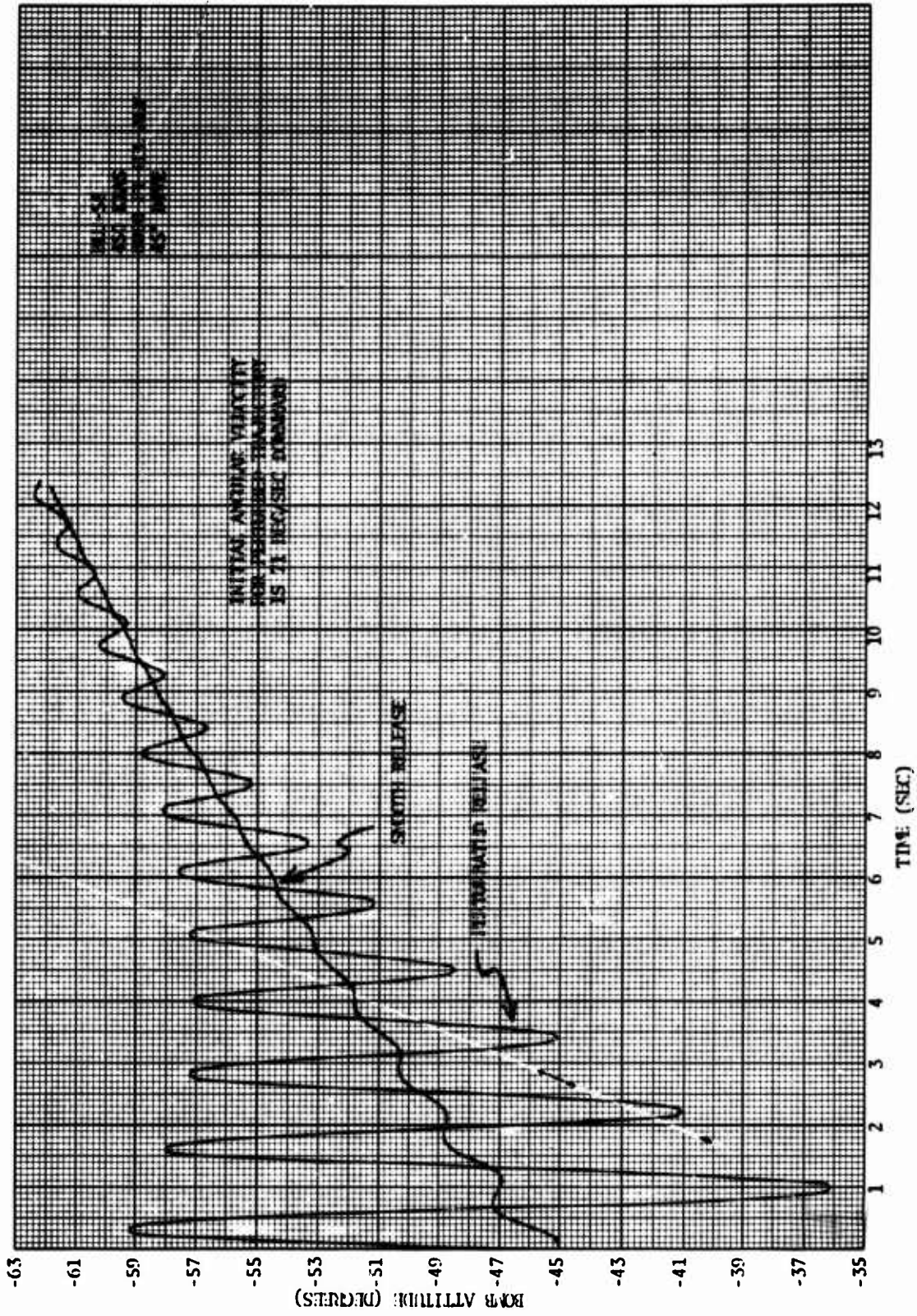

Figure 7. Weapon Angular Perturbation Trajectories BLU-58, 450 Kts, 8000 Ft Alt, 45° Dive

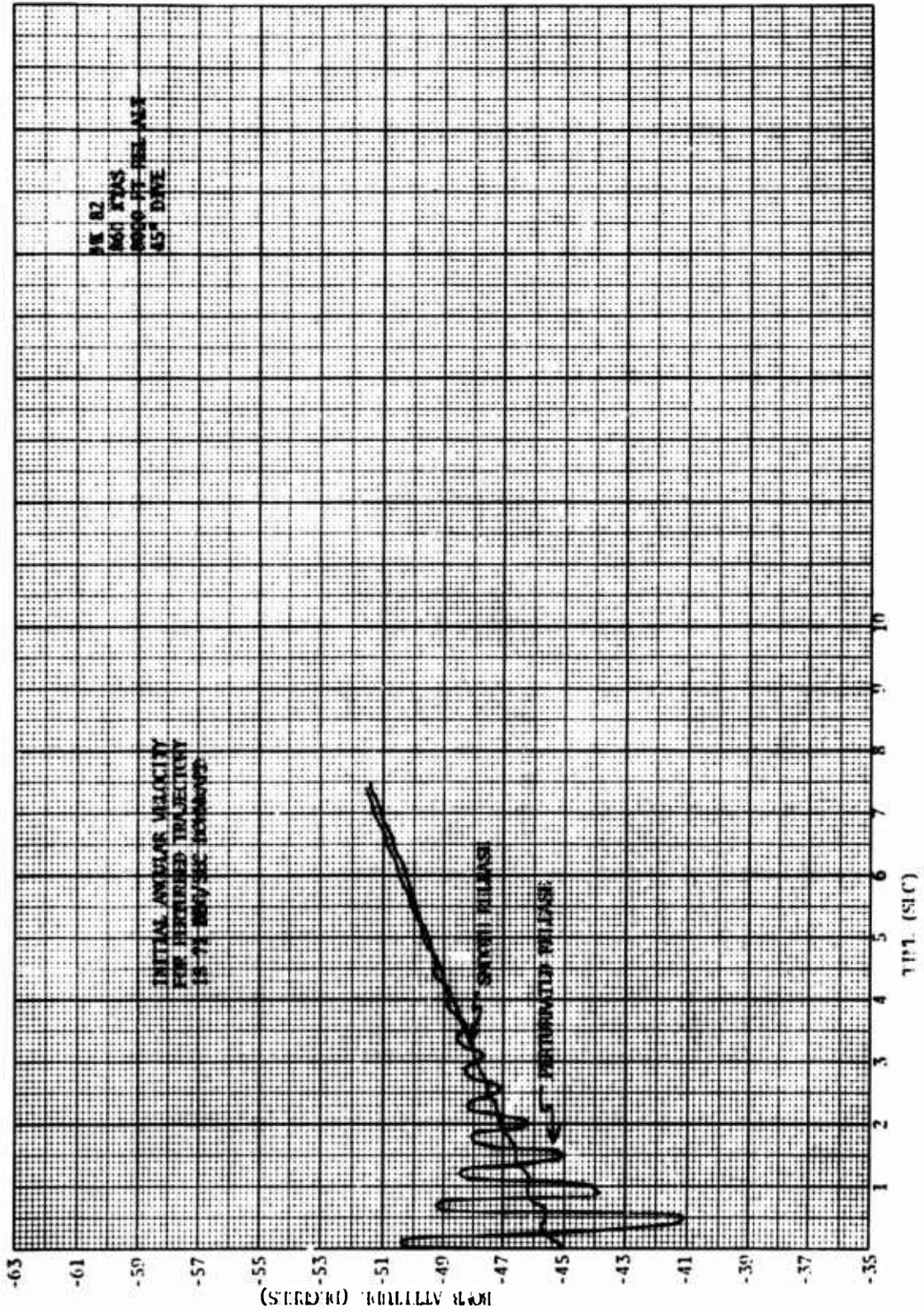

Figure 8. Weapon Angular Perturbation Trajectories Mk-82, 860 Kts, 8000 Ft Alt, 45° Dive

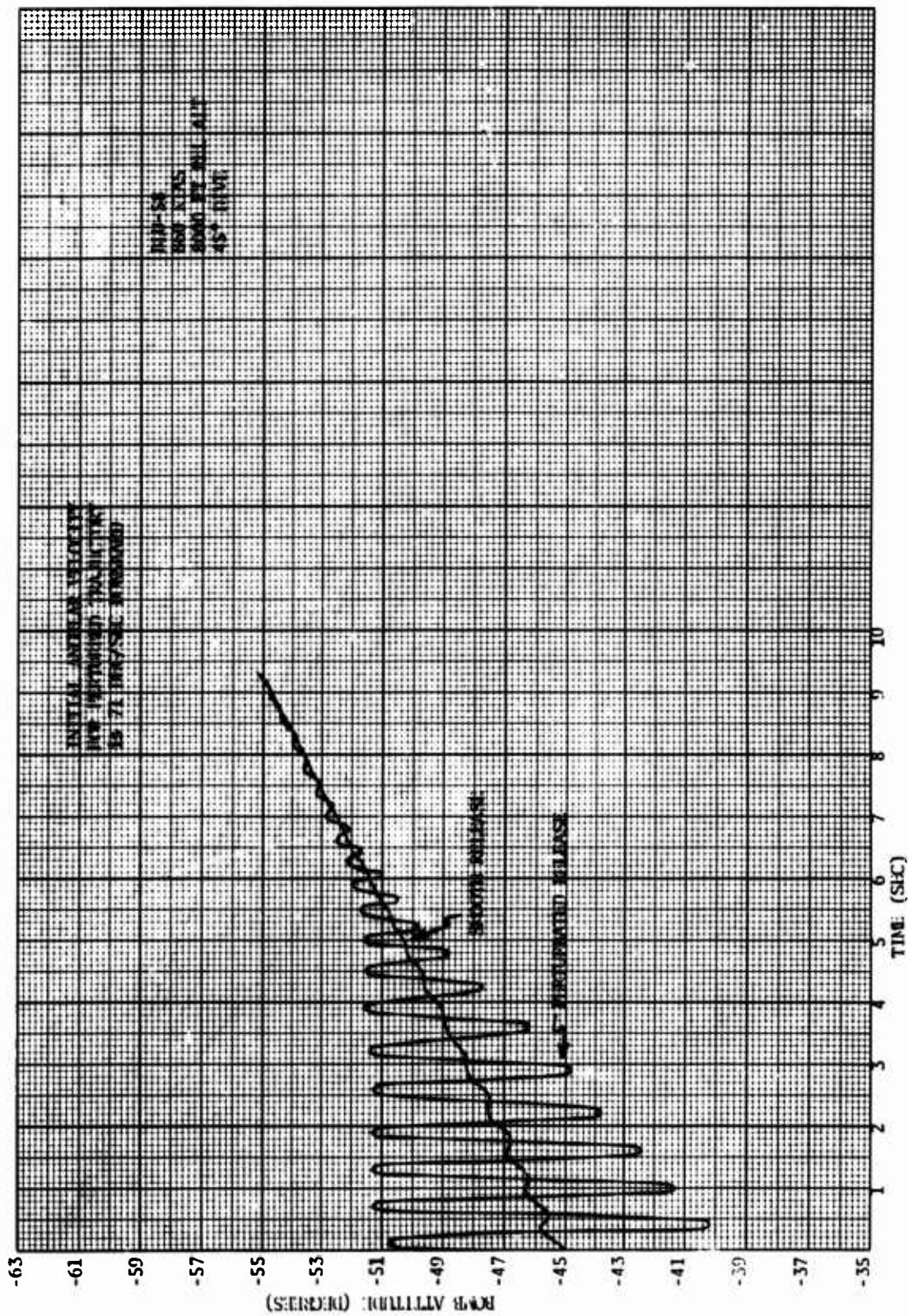

Figure 9. Weapon Angular Perturbation Trajectories BLU-58, 860 Kts, 8000 Ft Alt, 45° Dive

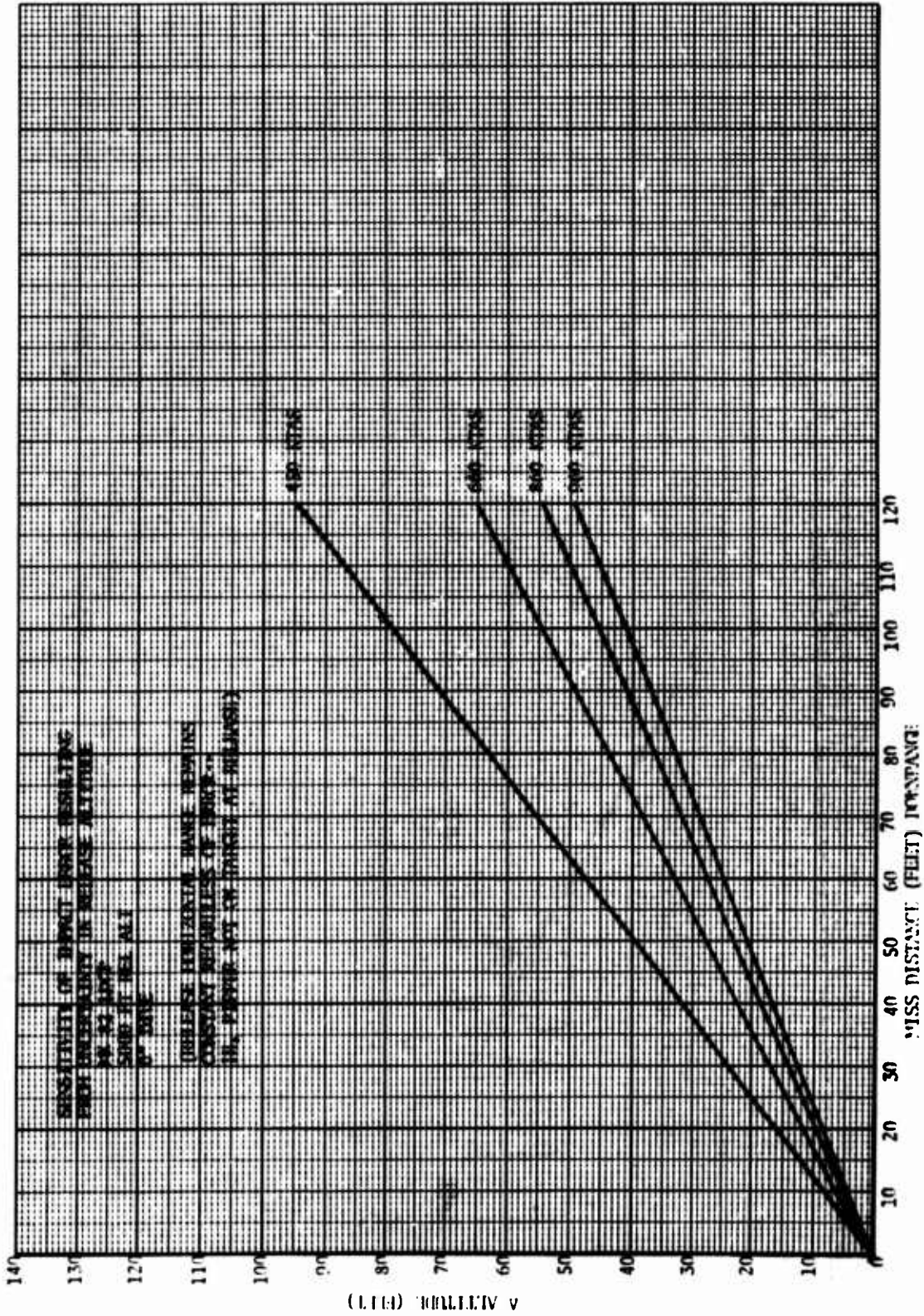

Figure 10. Release Altitude Sensitivity Mk-82, LDGP, 5000 Ft Rel Alt, 0° Dive

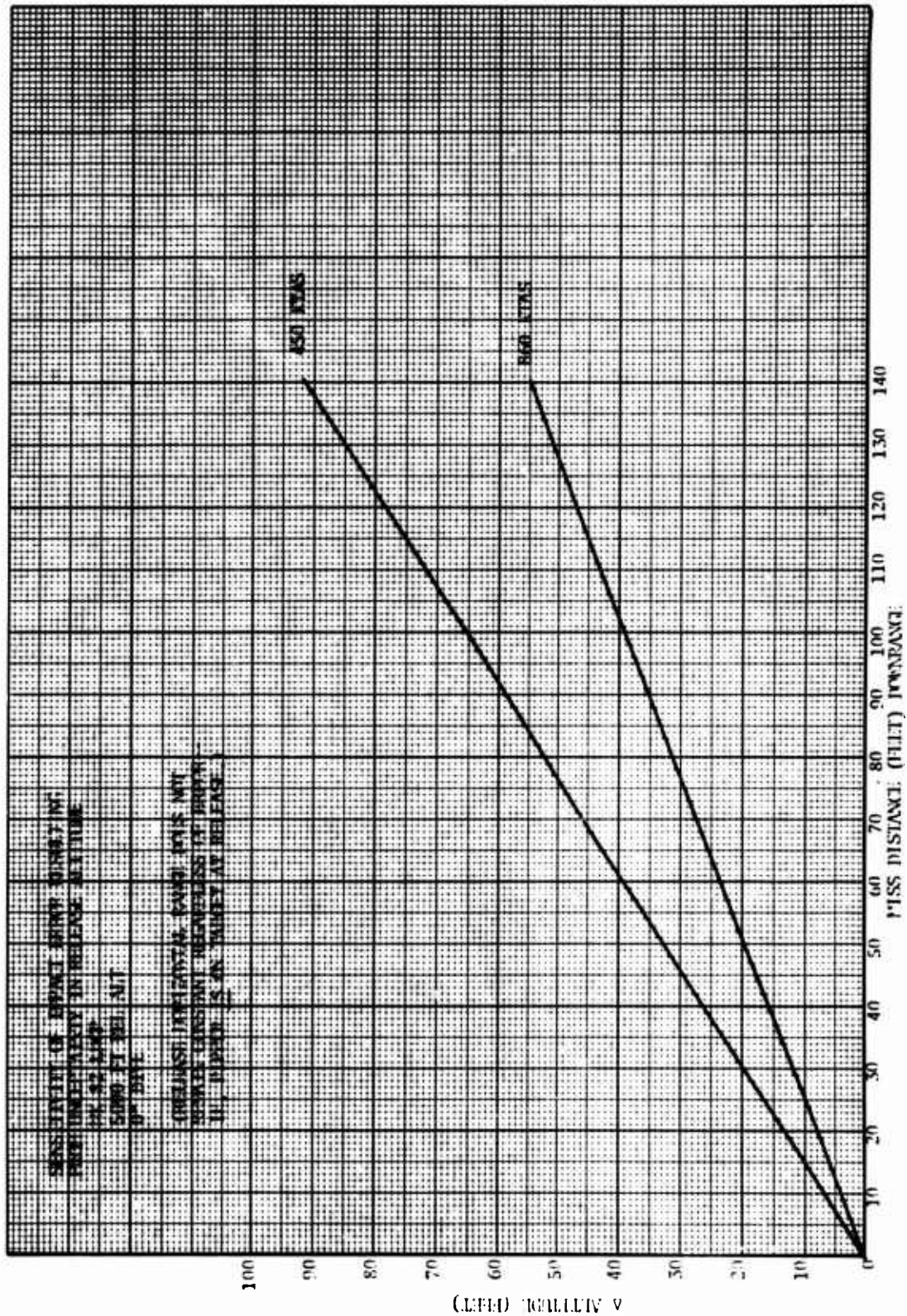

Figure 10a. Release Altitude Sensitivity Mk-82 LDGP, 5000 Ft Rel Alt, 0° Dive (Pipper is on Target)

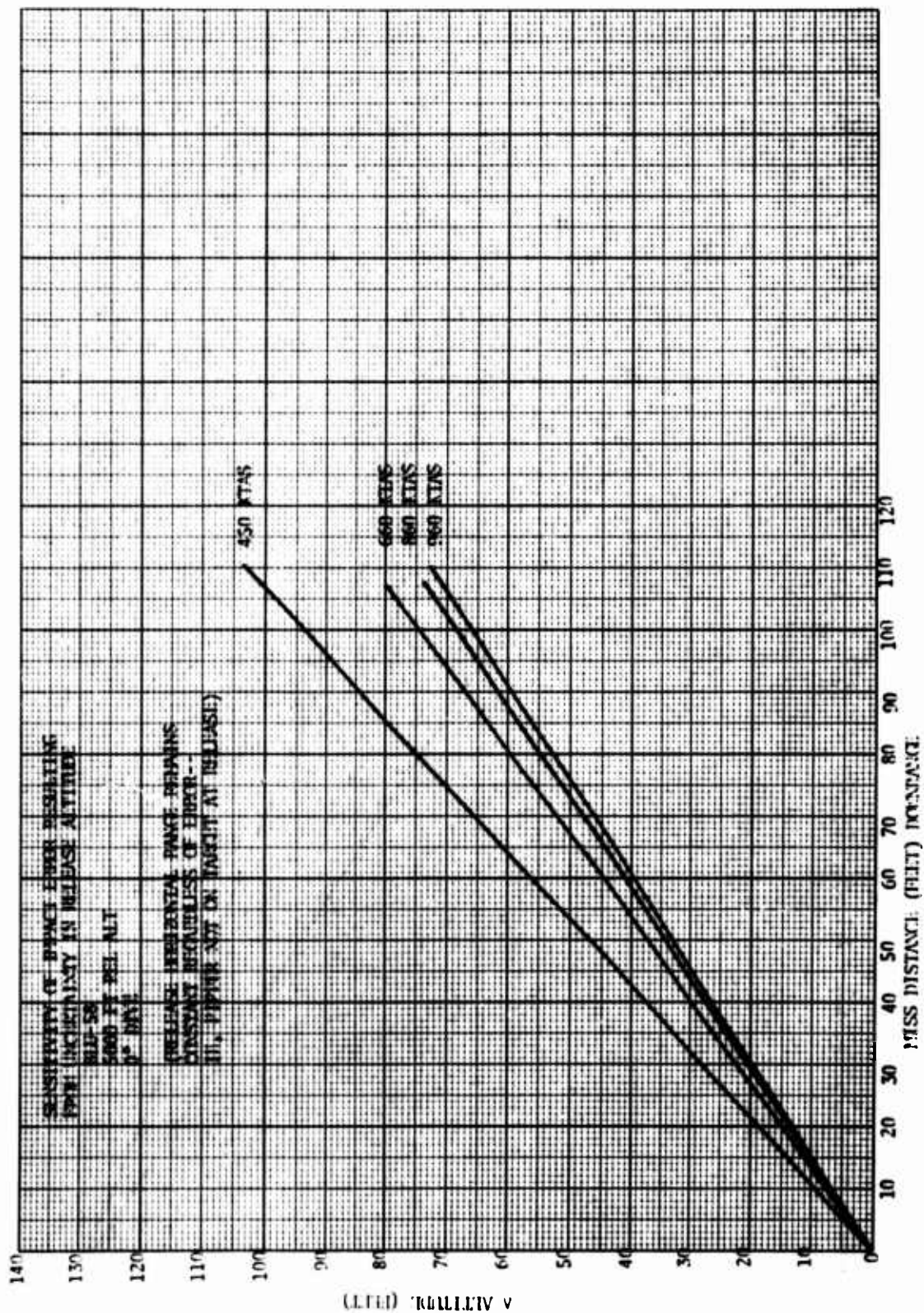

Figure 11. Release Altitude Sensitivity BLU-58, 5000 Ft Rel Alt, 0° Dive

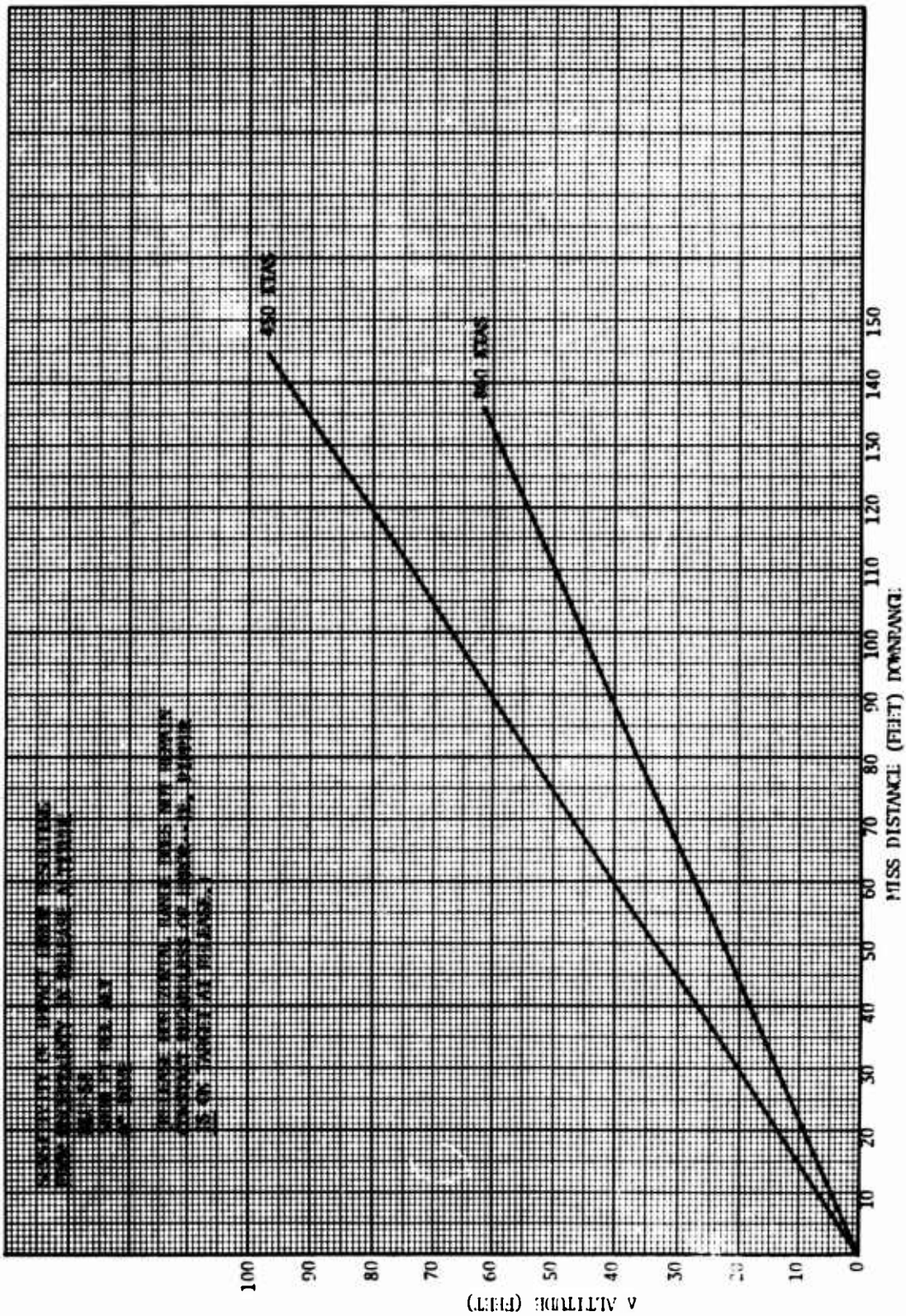

Figure 11a. Release Altitude Sensitivity BLU-58, 5000 Ft Rel Alt, 0° Dive (Pipper is on Target)

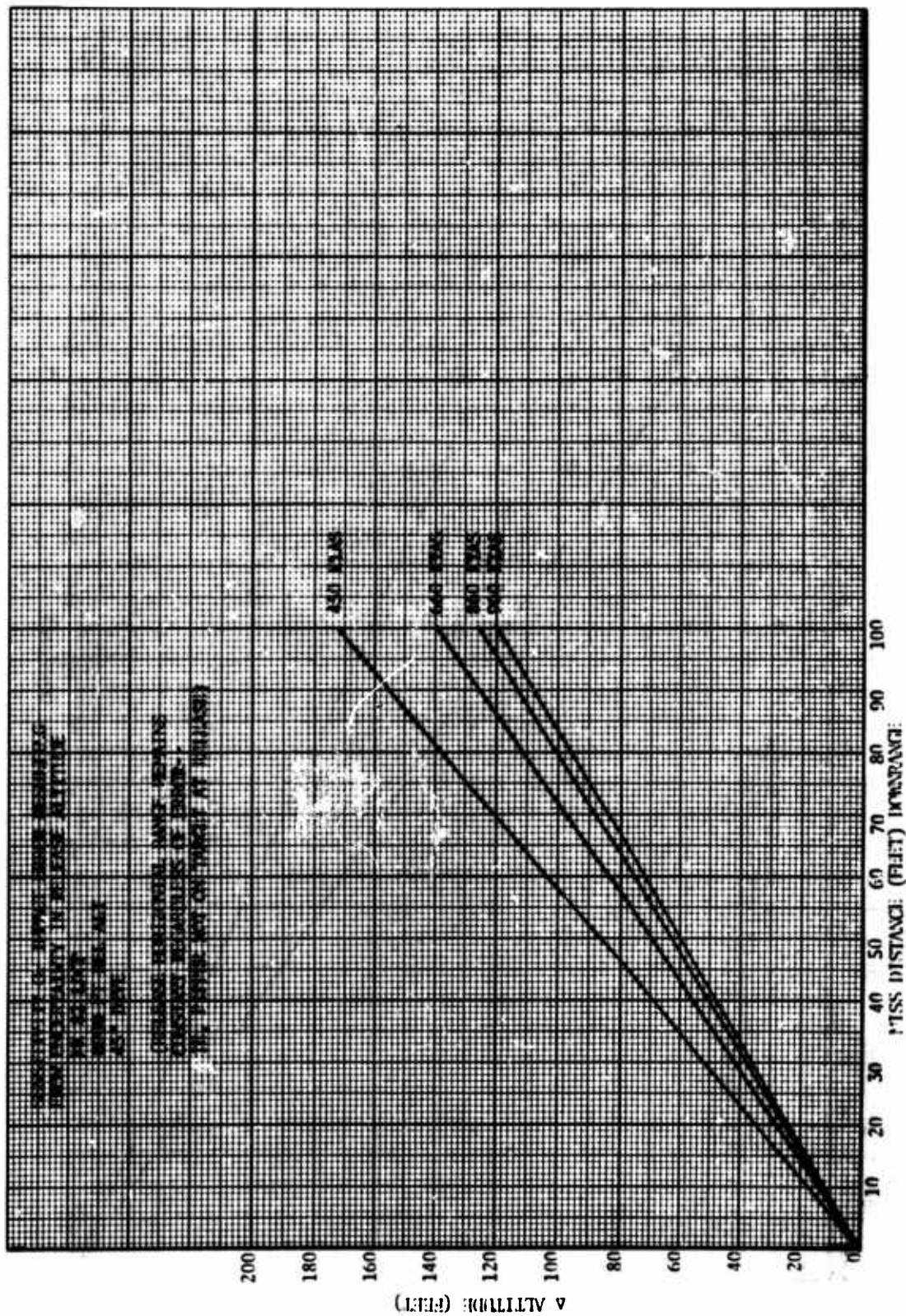

Figure 12. Release Altitude Sensitivity Mk-82 LDGP, 8000 Ft Rel Alt, 45° Dive



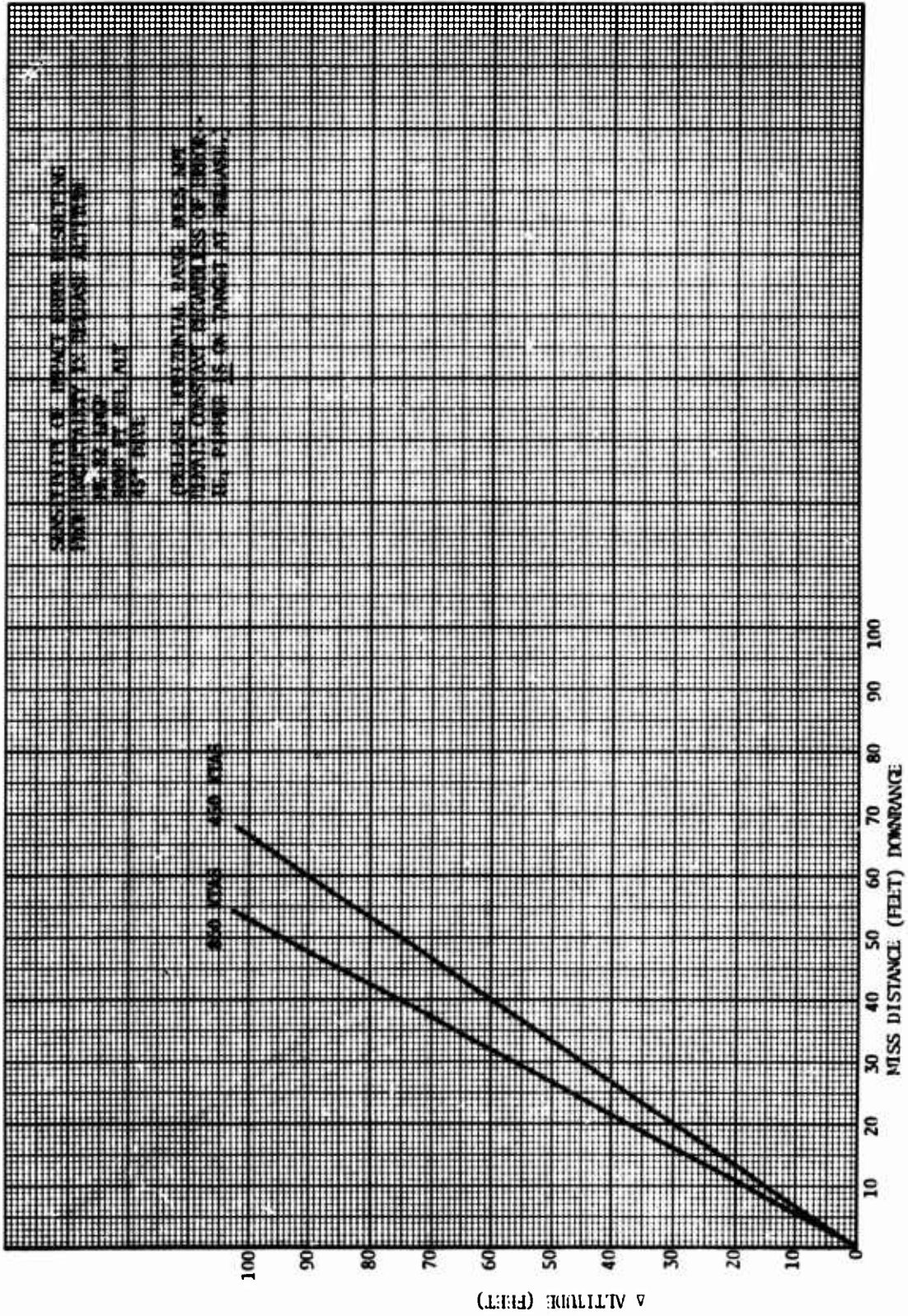

Figure 12a. Release Altitude Sensitivity Mk-82 LDGP, 8000 Ft Rel Alt, 45° Dive (Pipper is on Target)

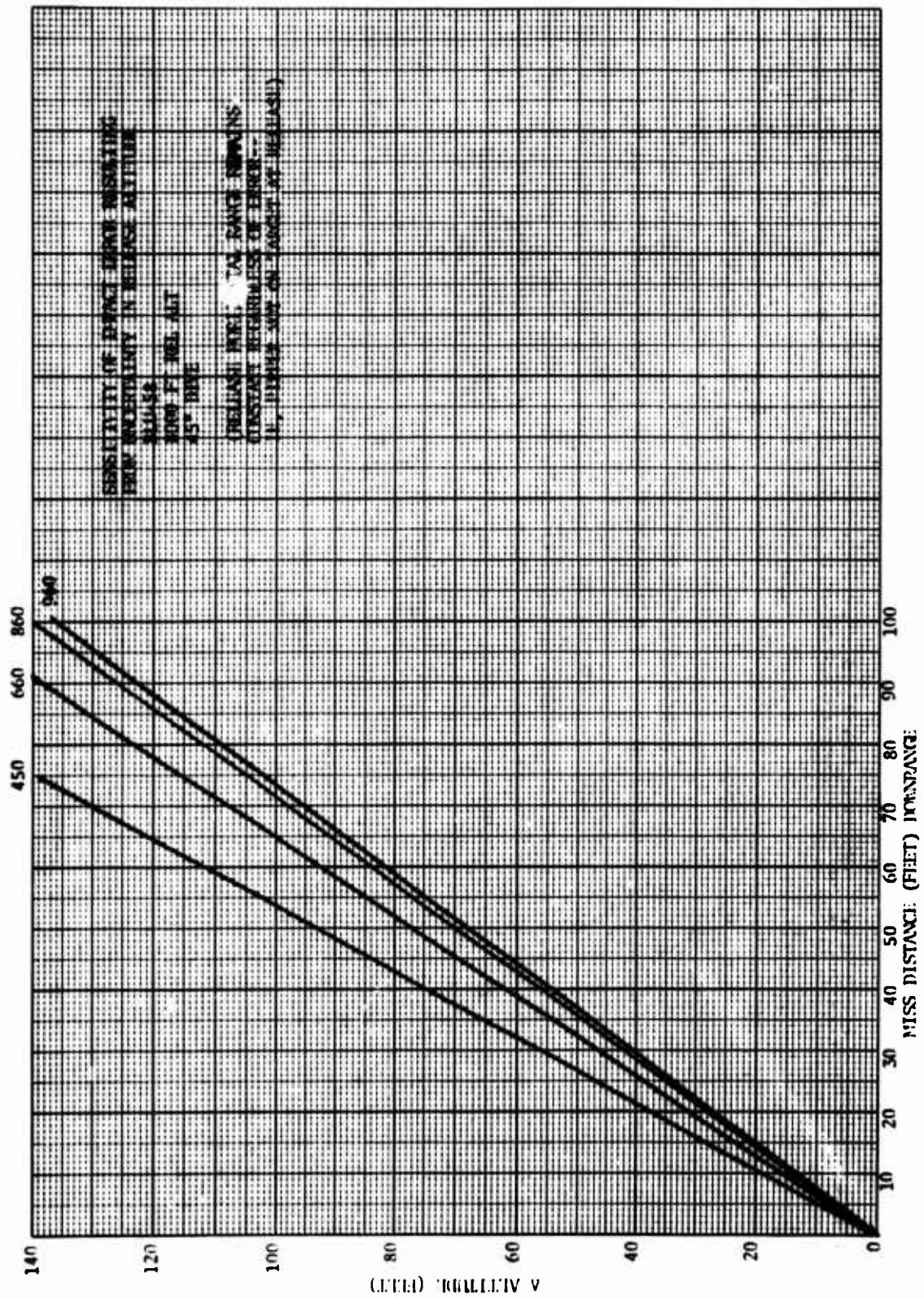

Figure 13. Release Altitude Sensitivity BLU-58, 8000 Ft Rel Alt, 45° Dive

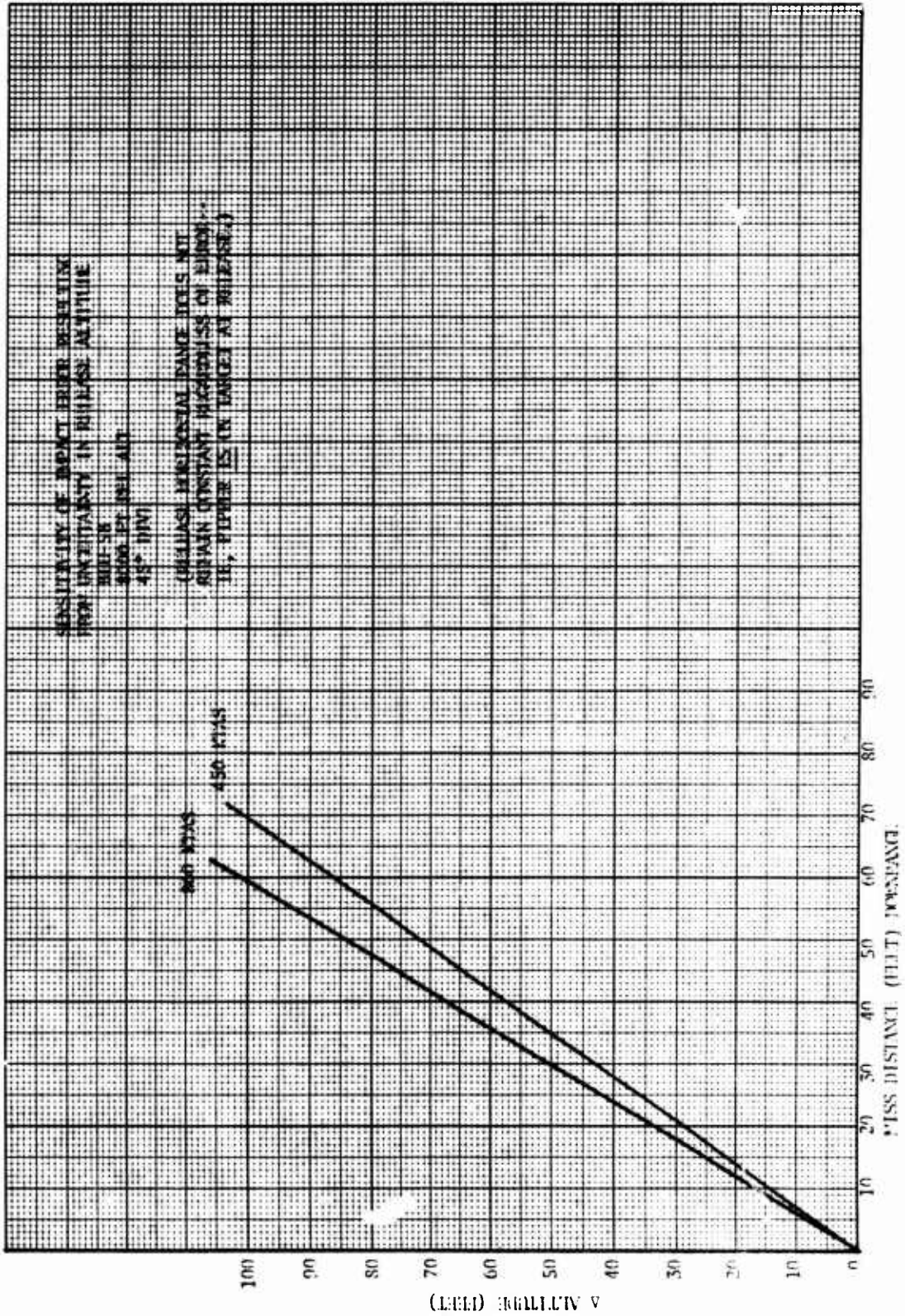

Figure 13a. Release Altitude Sensitivity BLU-58, 8000 Ft Rel Alt, 45° Dive (Pipper is on Target)

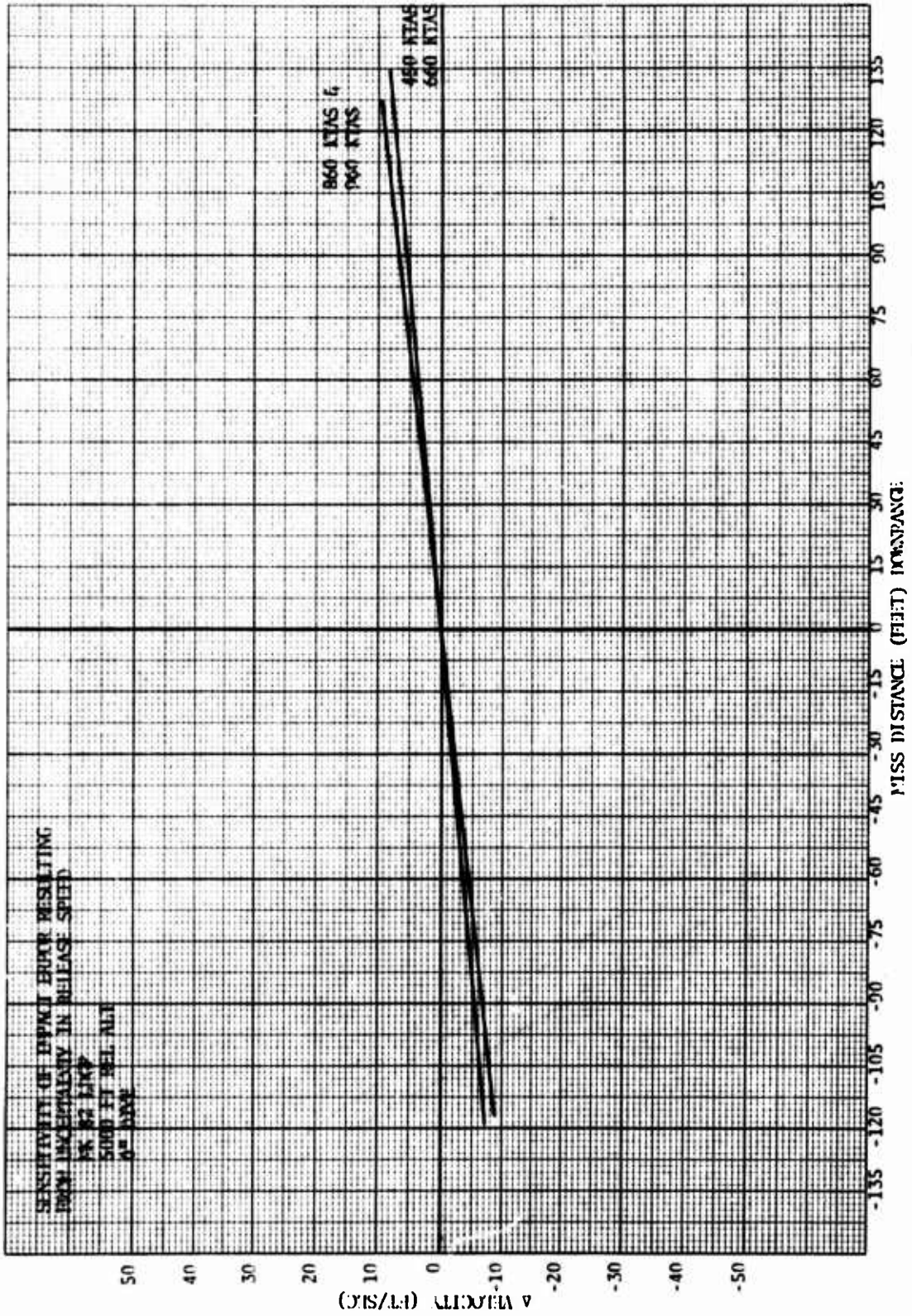

Figure 14. Release Speed Sensitivity Mk-82 LDGP, 5000 Ft Rel Alt, 0° Dive

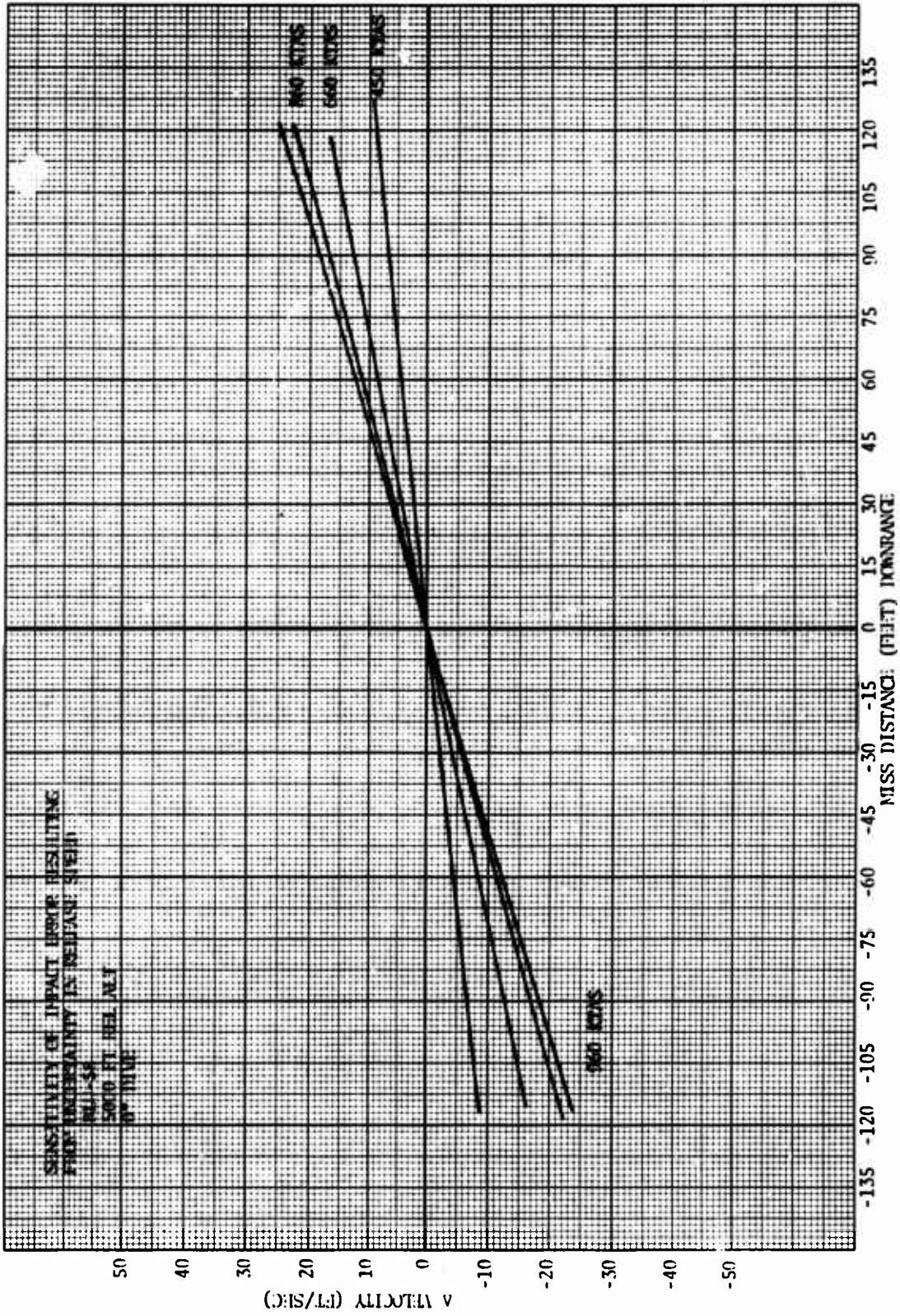

Figure 15. Release Speed Sensitivity BLU-58, 5000 Ft Rel Alt, 0° Dive

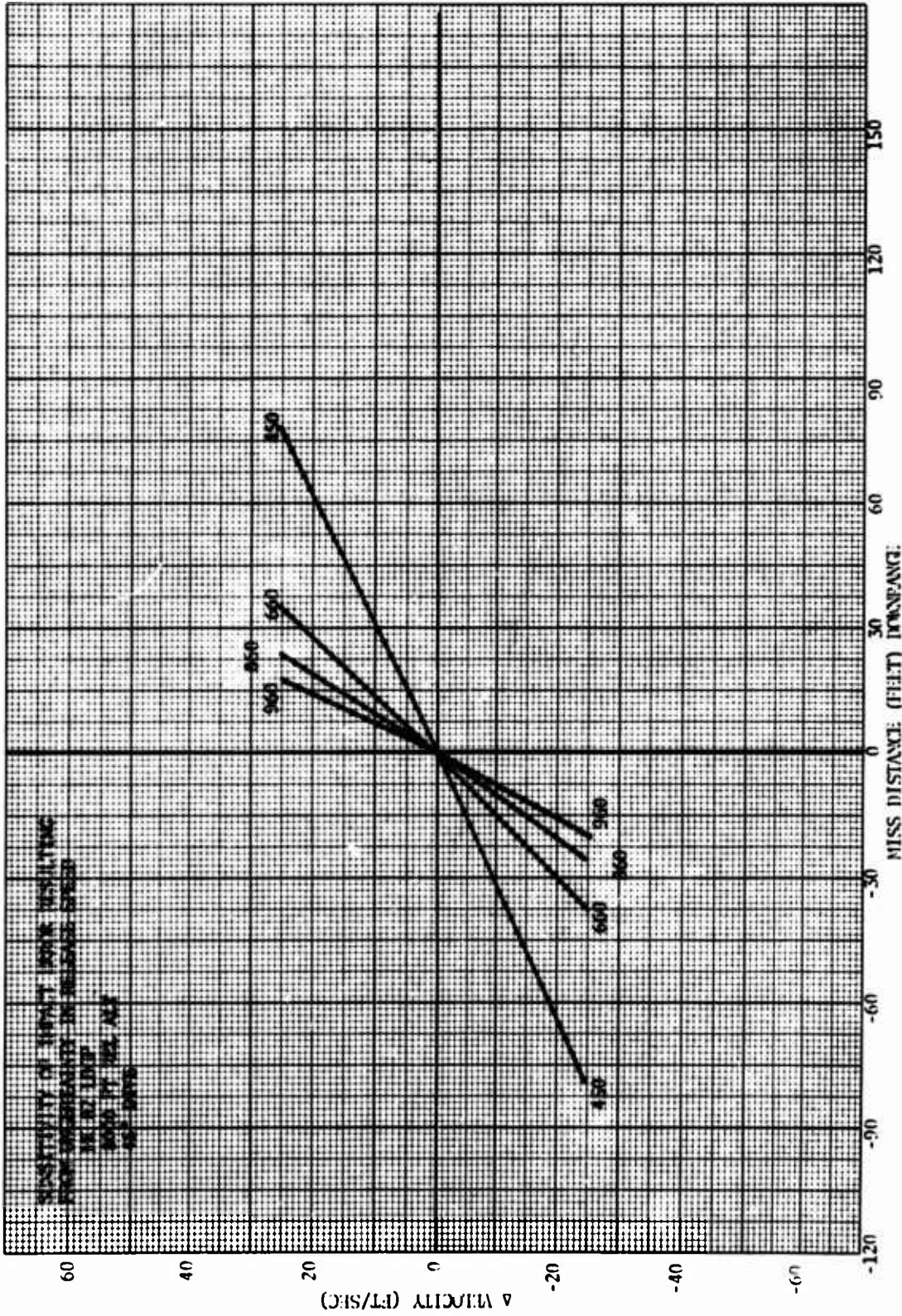

Figure 16. Release Speed Sensitivity Mk-82 LDGP, 8000 Ft Rel Alt, 45° Dive

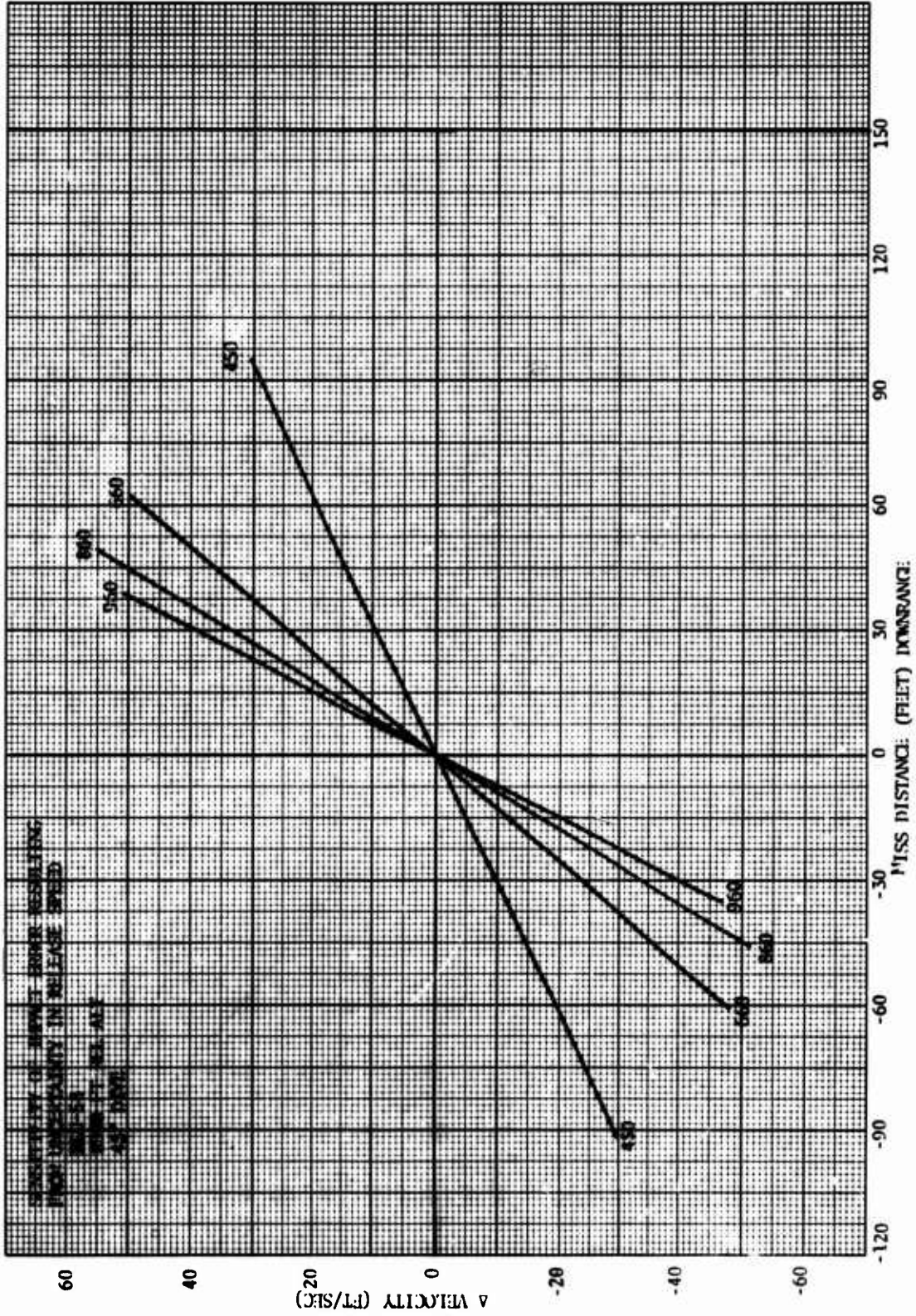

Figure 17. Release Speed Sensitivity BLU-58, 8000 Ft Rel Alt, 45° Dive

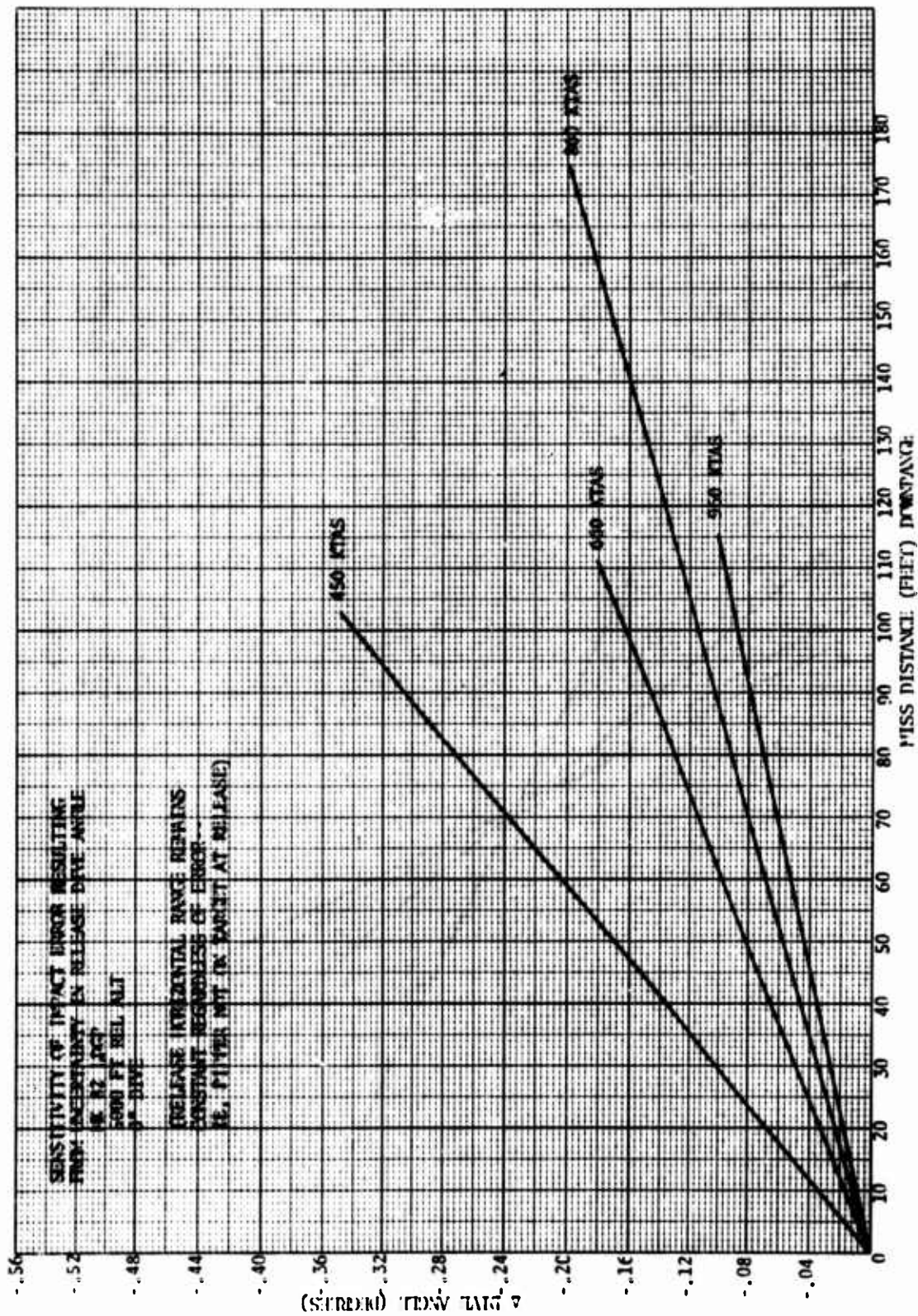

Figure 18. Release Dive Angle Sensitivity Mk-82, LDGP, 5000 Ft Rel Alt, 0° Dive



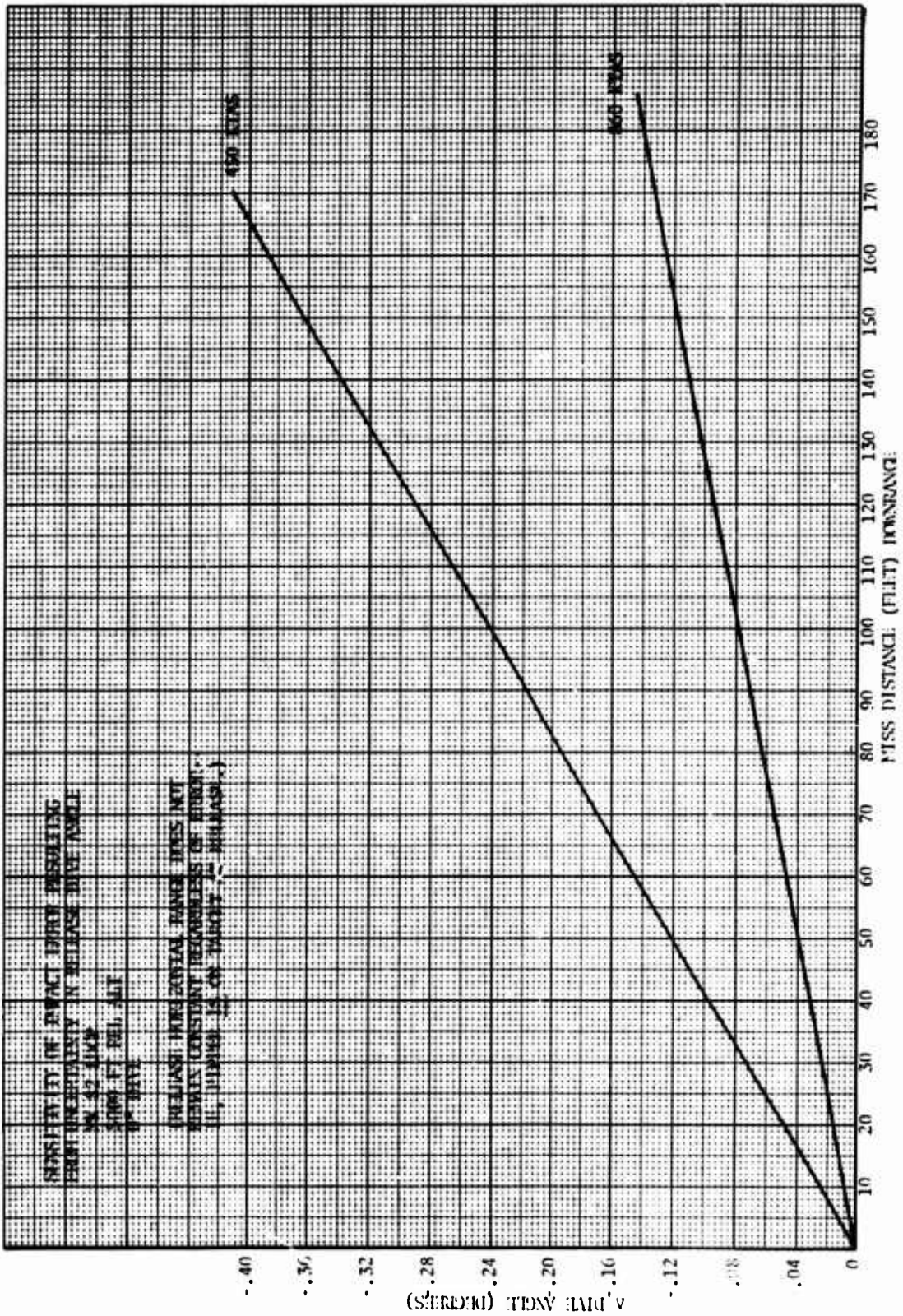

Figure 18a. Release Dive Angle Sensitivity MK-82 LDGP, 5000 Ft Rel Alt, 0° Dive (Pipper is on Target)

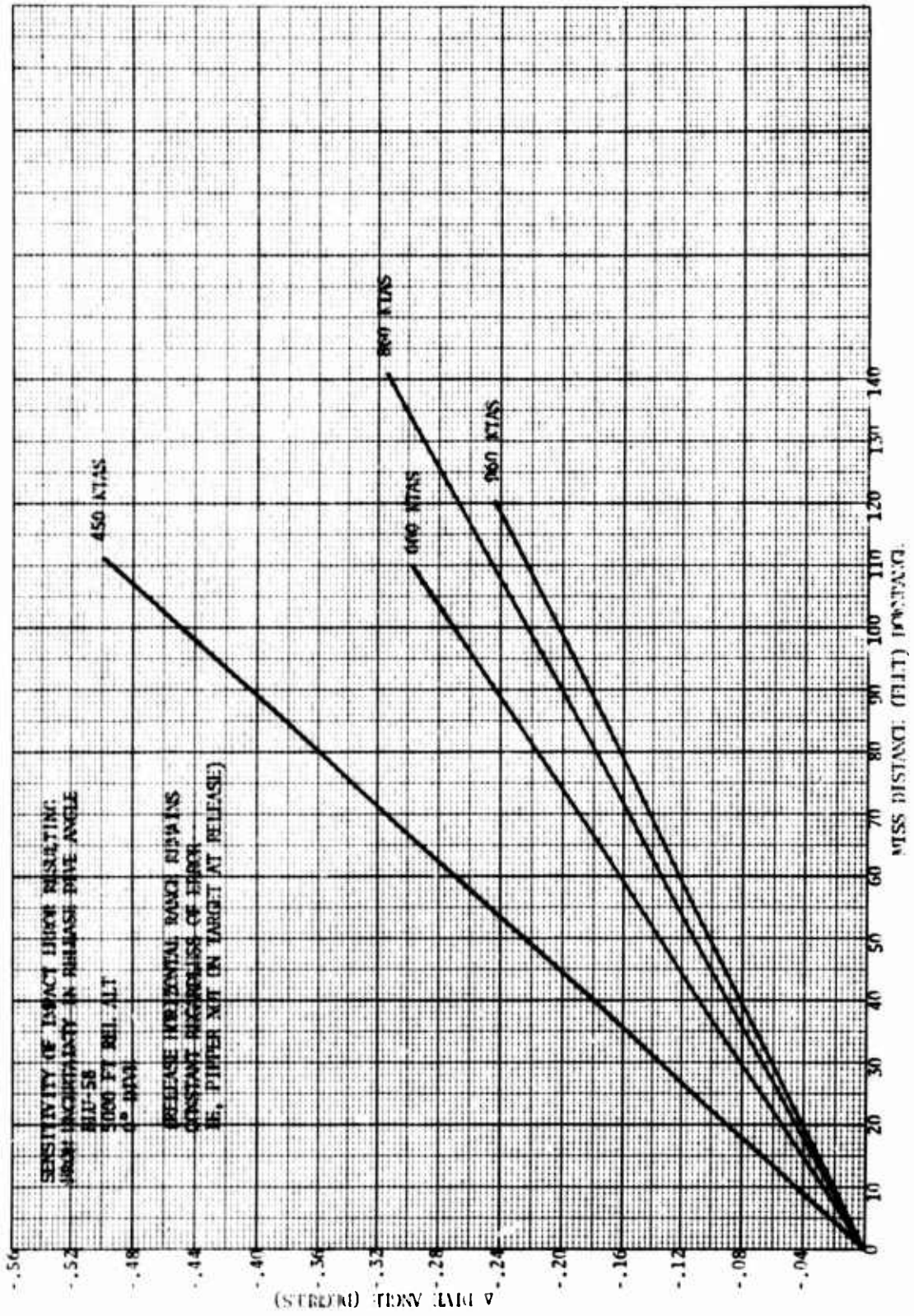

Figure 19. Release Dive Angle Sensitivity BLU-58, 5000 Ft Rel Alt, 0° Dive

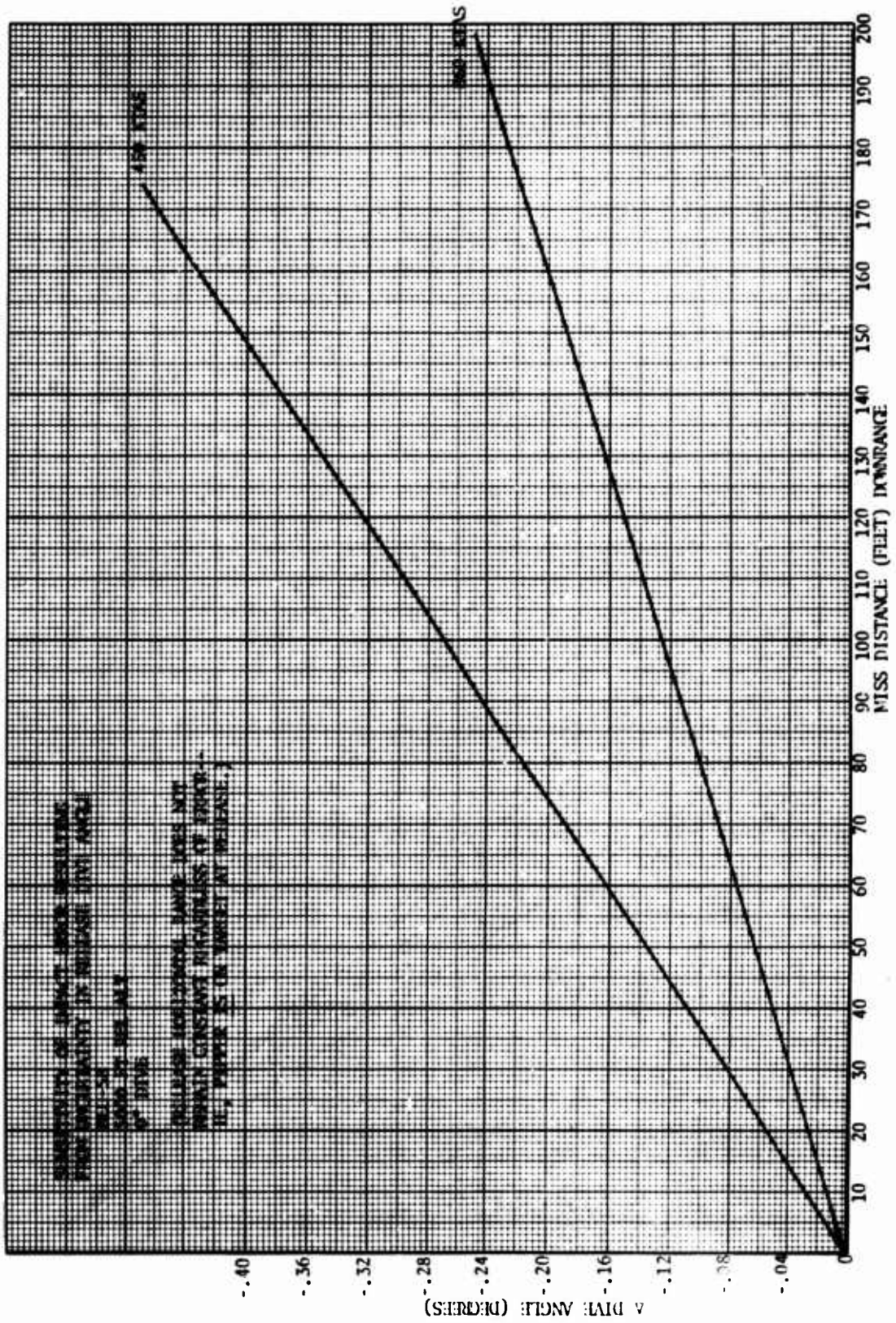

Figure 19a. Release Dive Angle Sensitivity BLU-58, 5000 Ft Rel Alt, 0° Dive (Pipper is on Target)

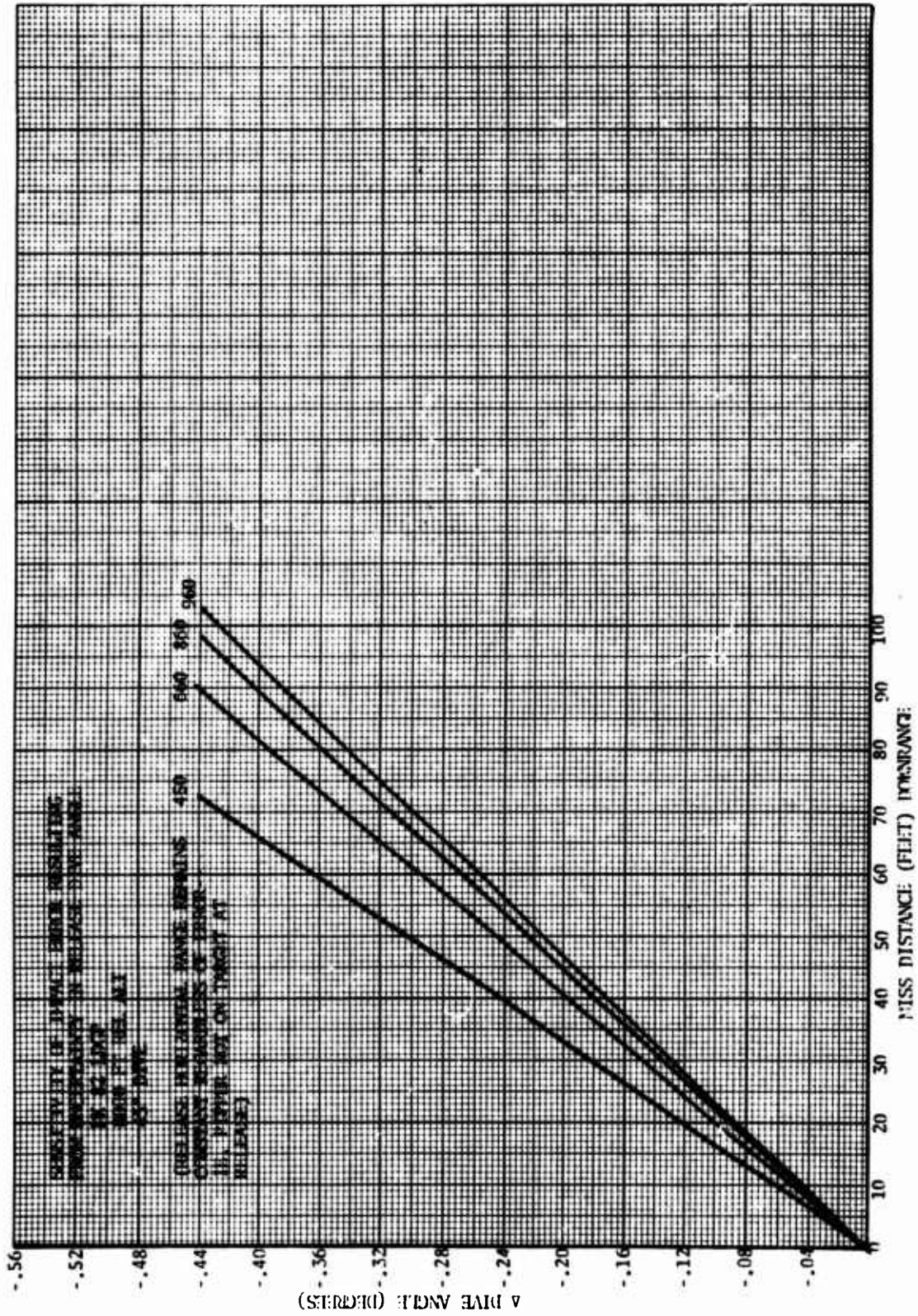

Figure 20. Release Dive Angle Sensitivity Mk-82 LDGP, 8000 Ft Rel Alt, 45° Dive

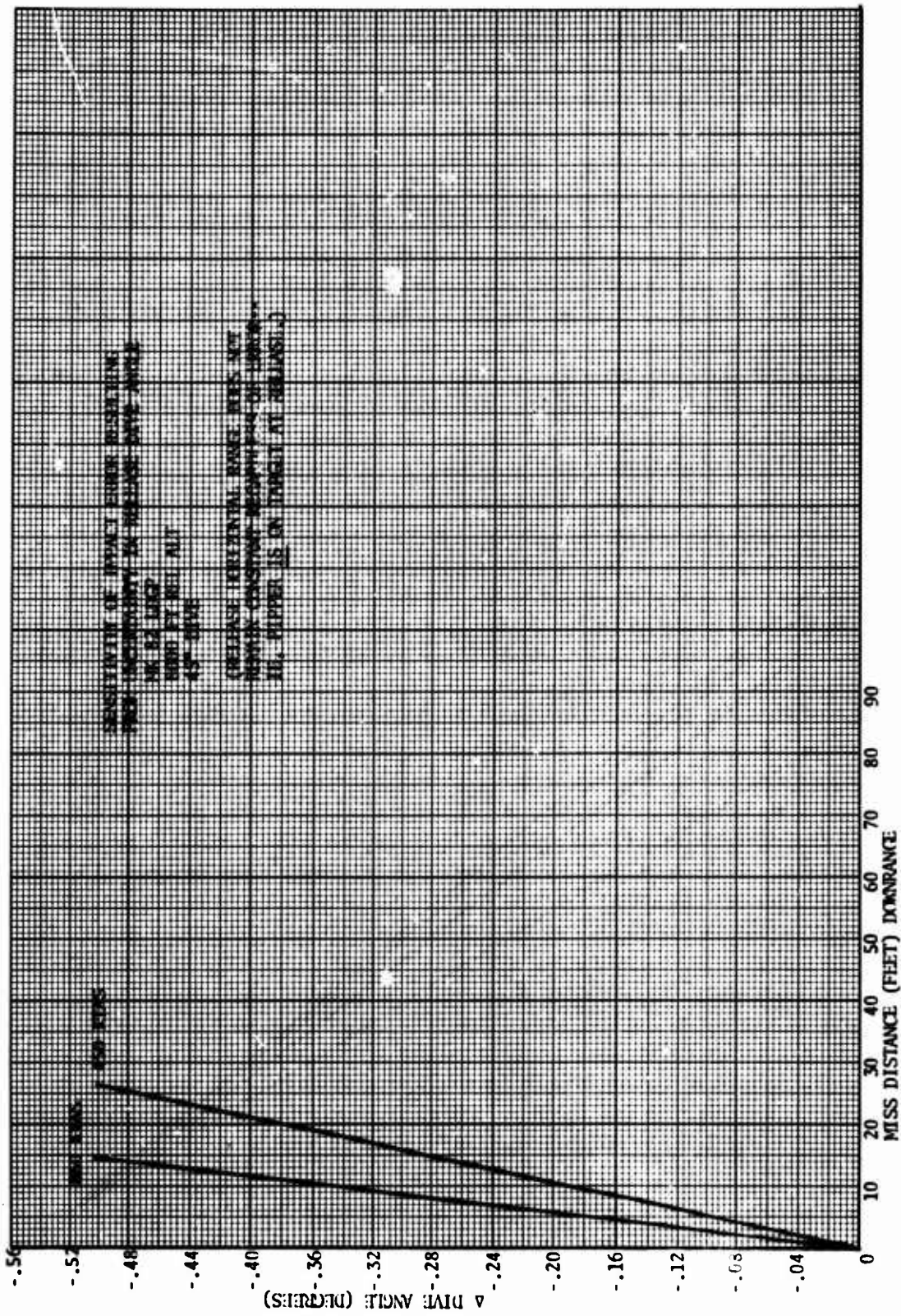

Figure 20a. Release Dive Angle Sensitivity Mk-82 LDGP, 8000 Ft Rel Alt, 45° Dive (Pipper is on Target)

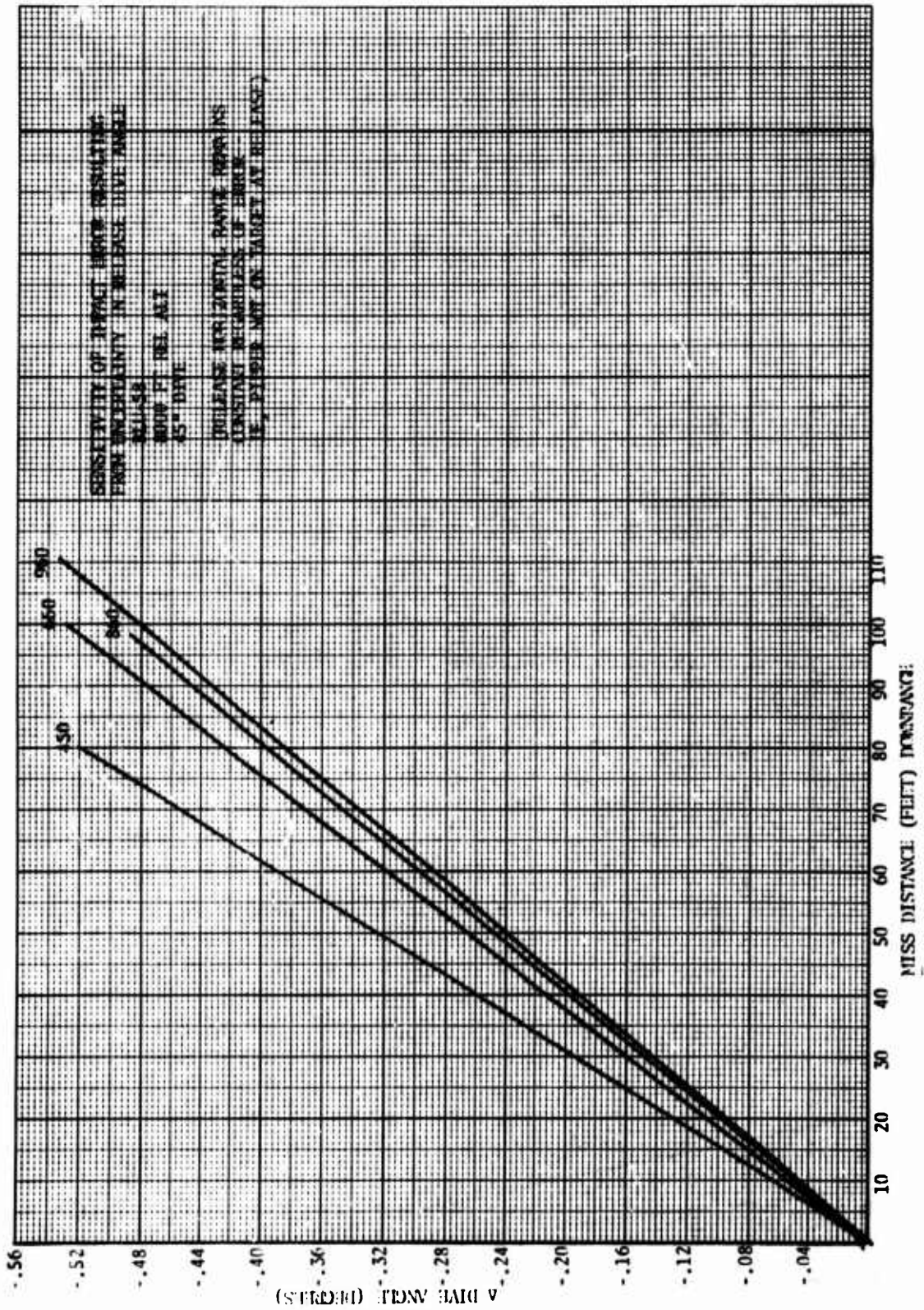

Figure 21. Release Dive Angle Sensitivity BLU-58, 8000ft Rel Alt, 45° Dive

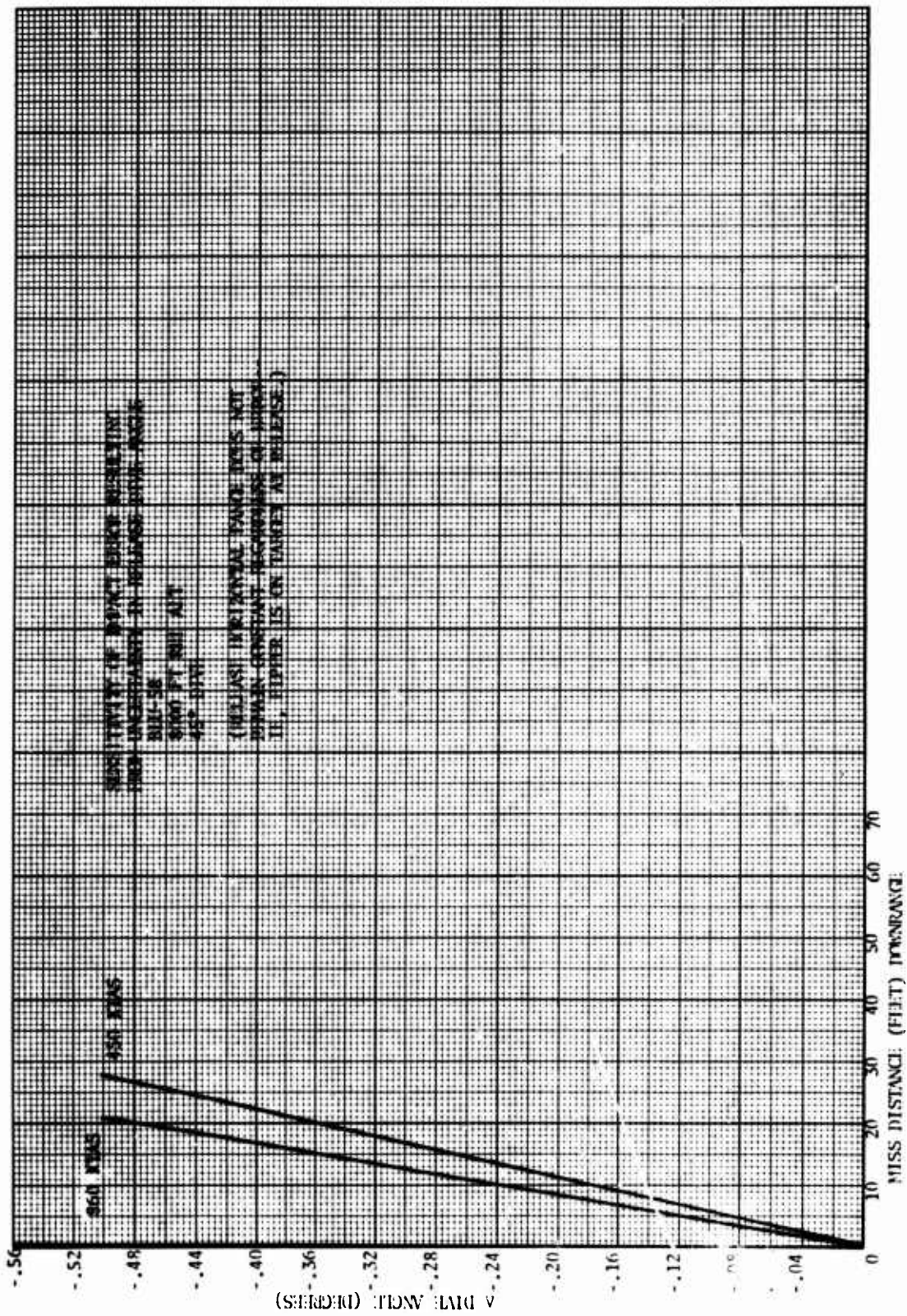

Figure 21a. Release Dive Angle Sensitivity BLU-58, 8000 Ft Rel Alt, 45° Dive (Pipper is on Target)

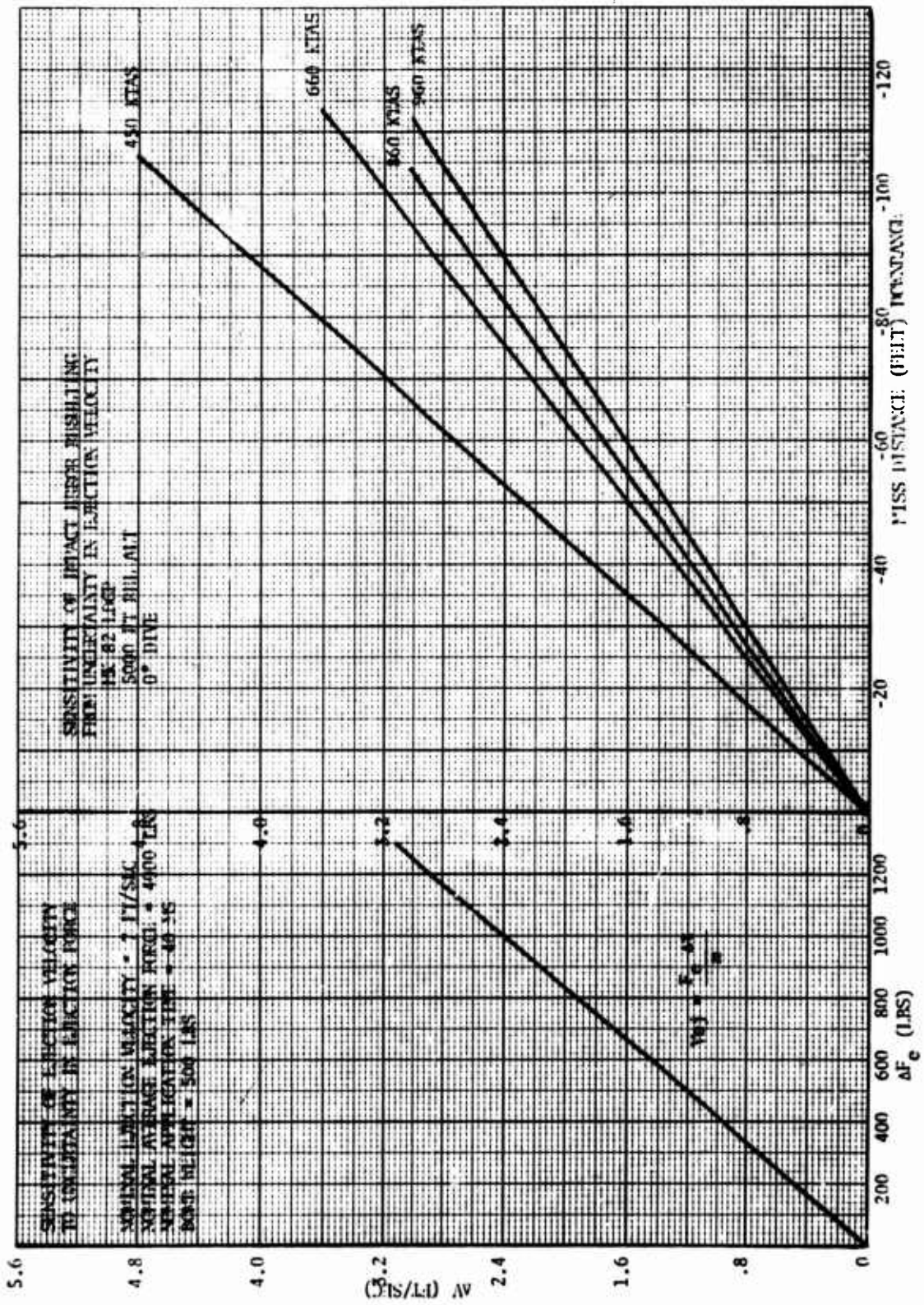

Figure 22. Ejection Velocity Sensitivity Mk-82 LDGP, 5000 Ft Rel Alt, 0° Dive



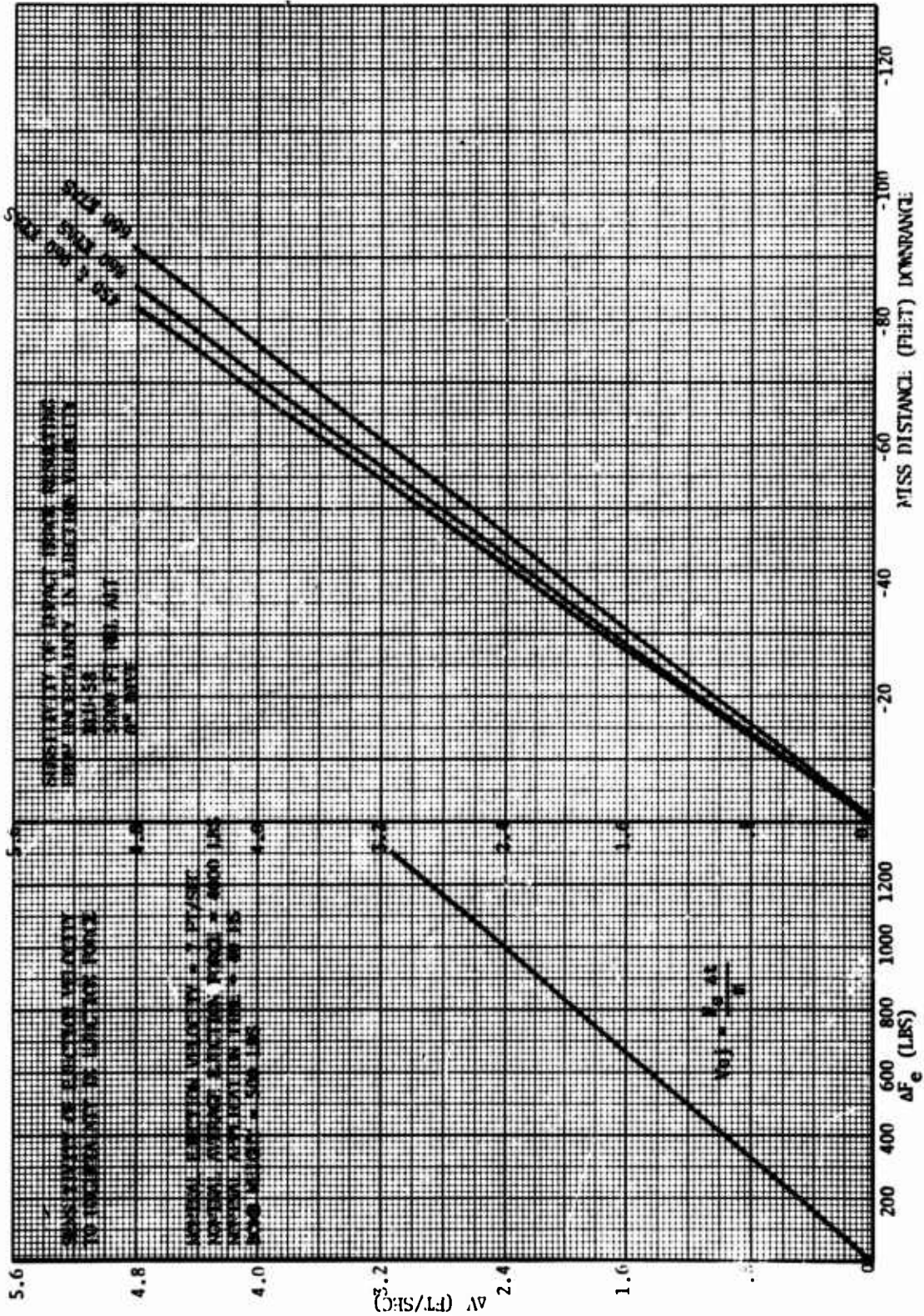

Figure 23. Ejection Velocity Sensitivity BLU-58, 5000 Ft Rel Alt, 0° Dive

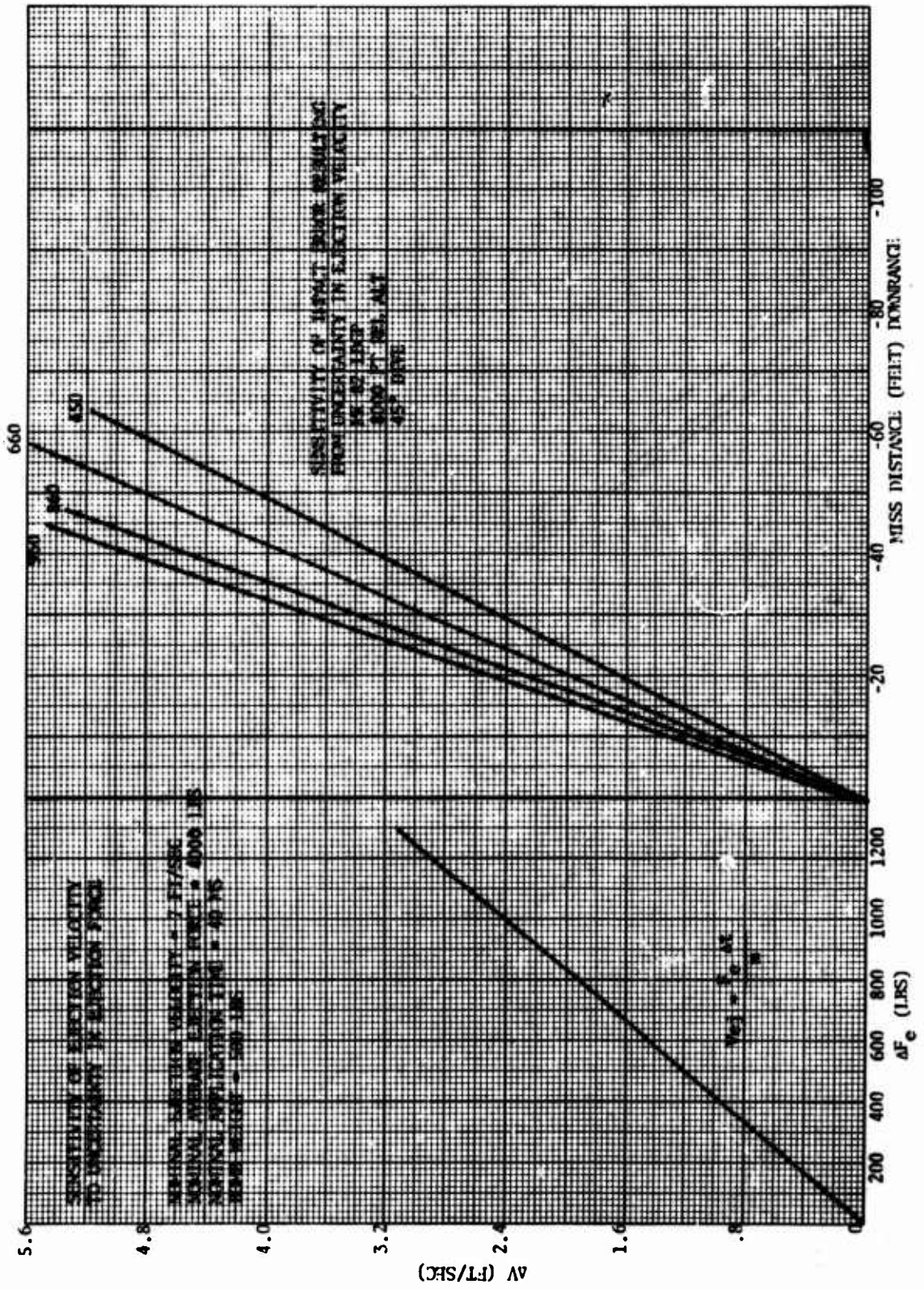

Figure 2-4. Ejection Velocity Sensitivity Mk 82 LDGP, 8000 Ft Rel Alt, 45° Dive

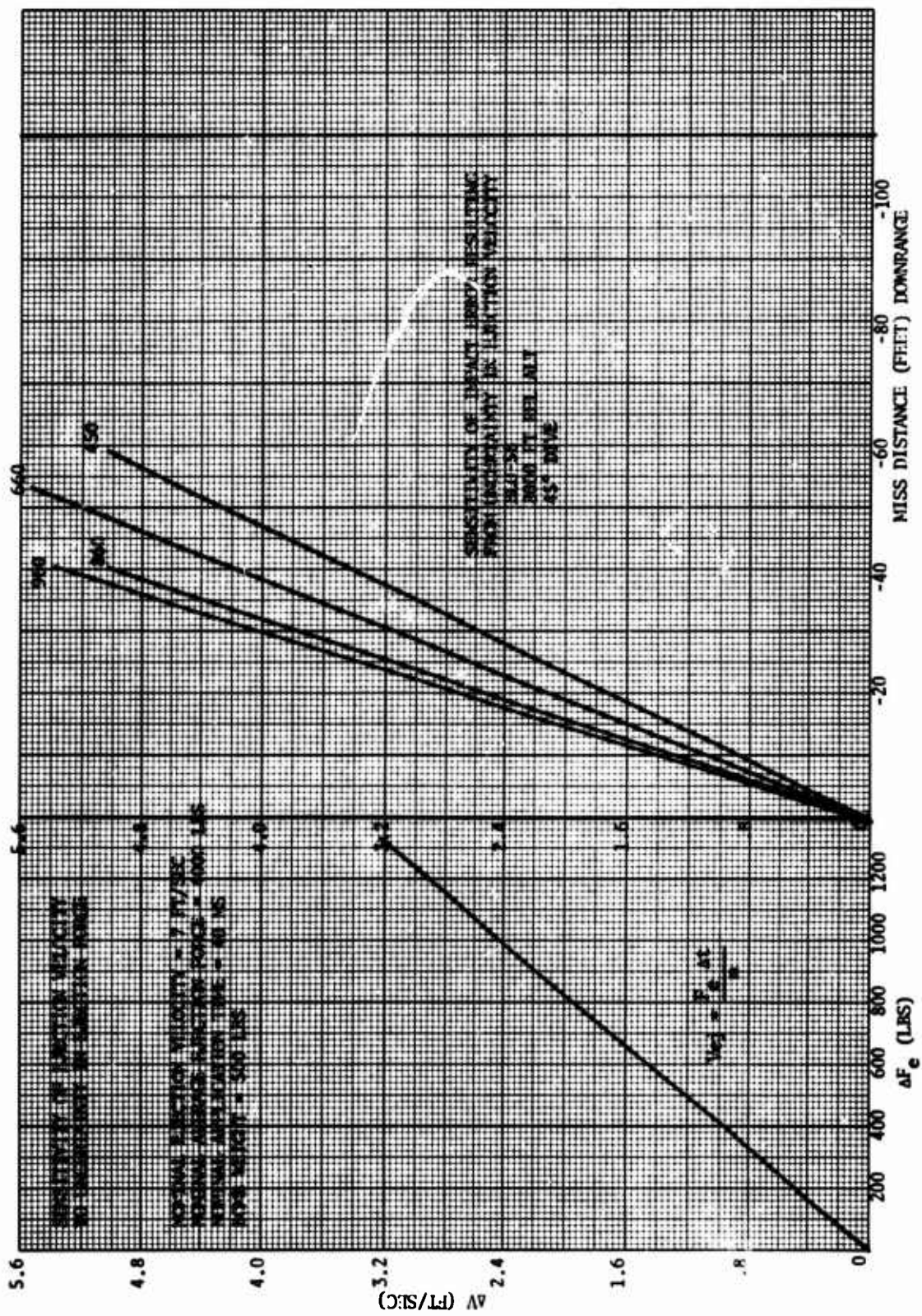

Figure 25. Ejection Velocity Sensitivity BLU-58, 8000 Ft Rel Alt, 45° Dive

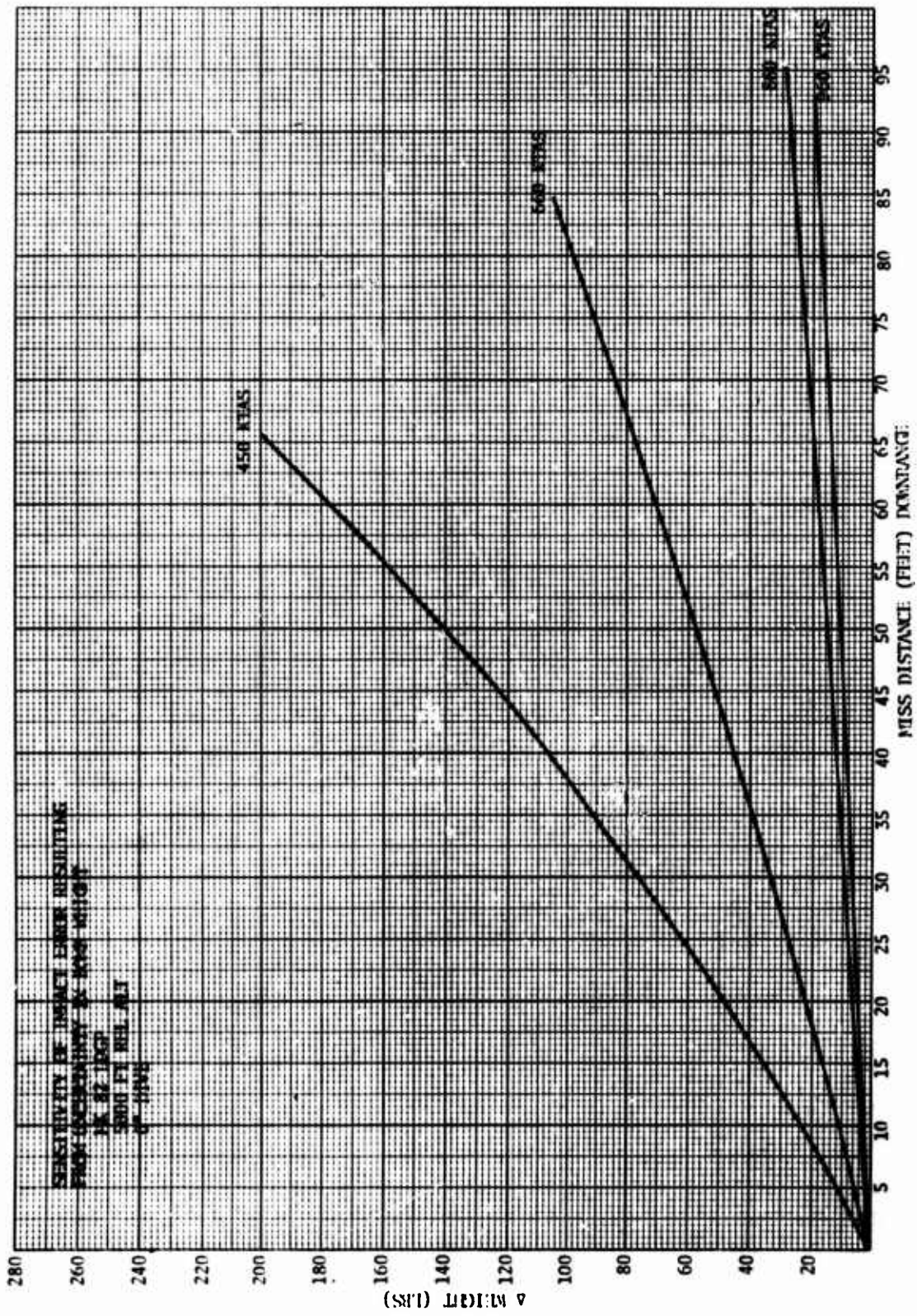

Figure 26. Bomb Weight Sensitivity Mk-82 LDGP, 5000 Ft Rel Alt, 0° Dive

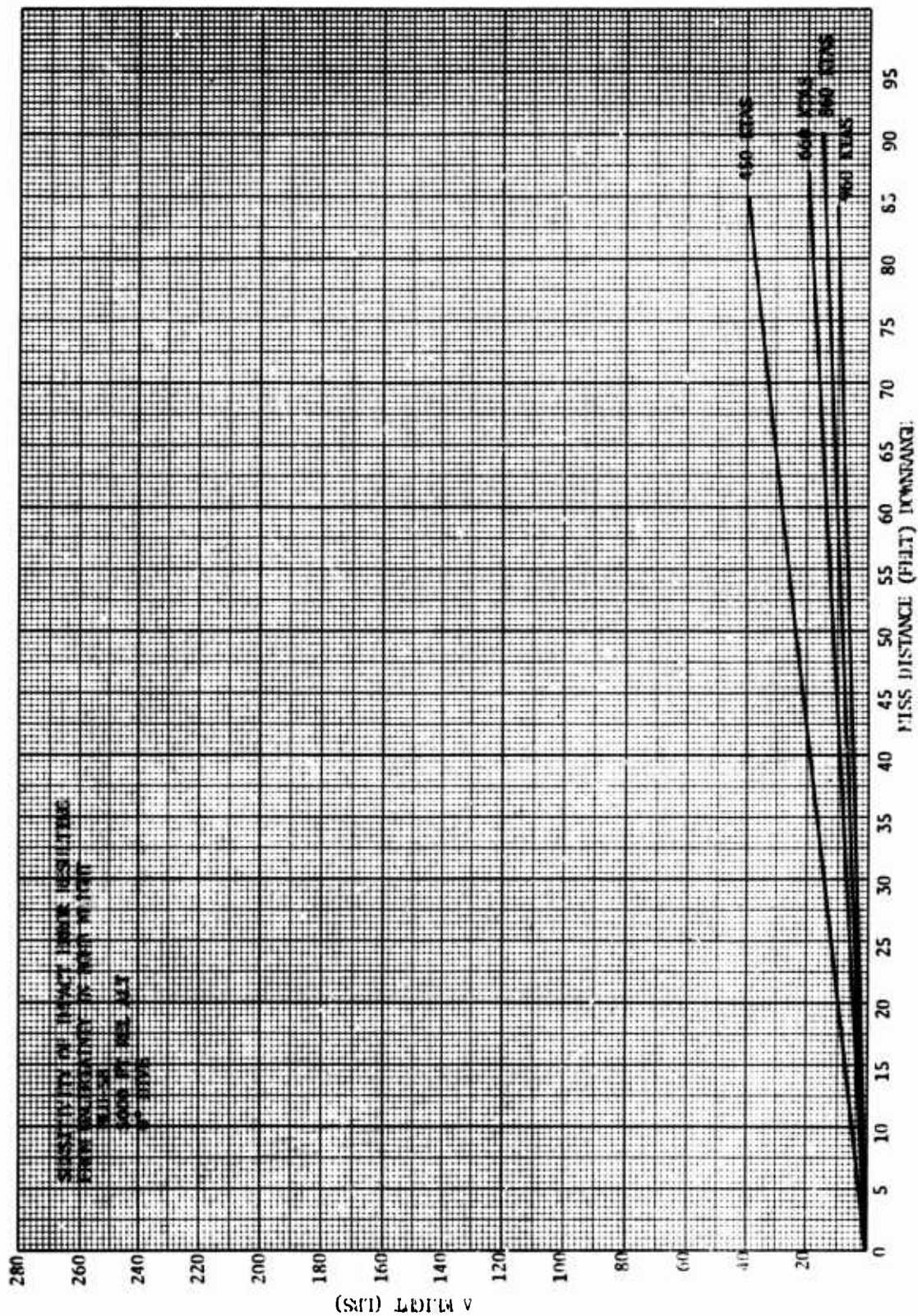

Figure 27. Bomb Weight Sensitivity BLU-58, 5000 Ft Rel Alt, 0° Dive

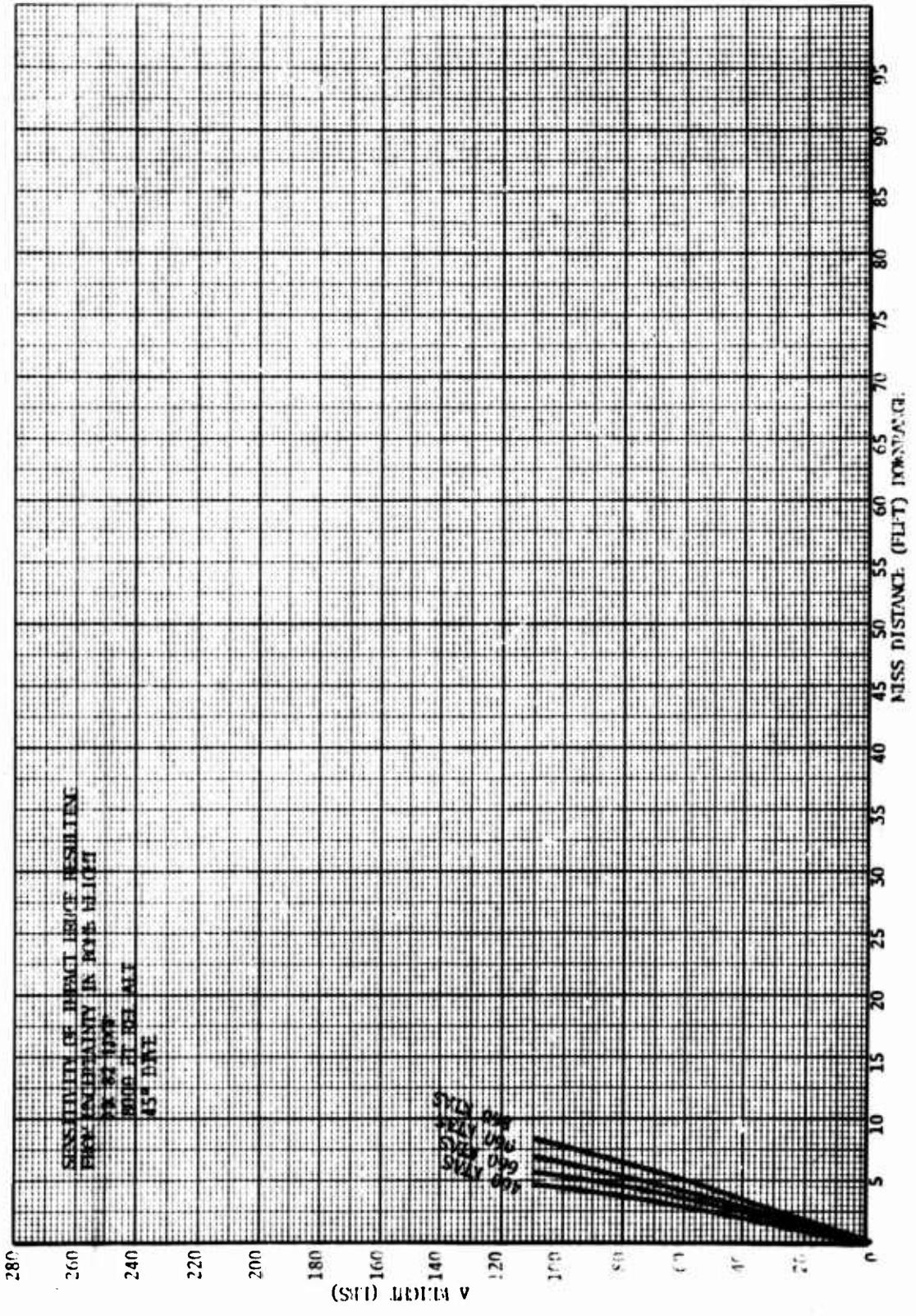

Figure 25. Bomb Weight Sensitivity Mk-82 LDGP, 8000 Ft Rel Alt, 45° Dive

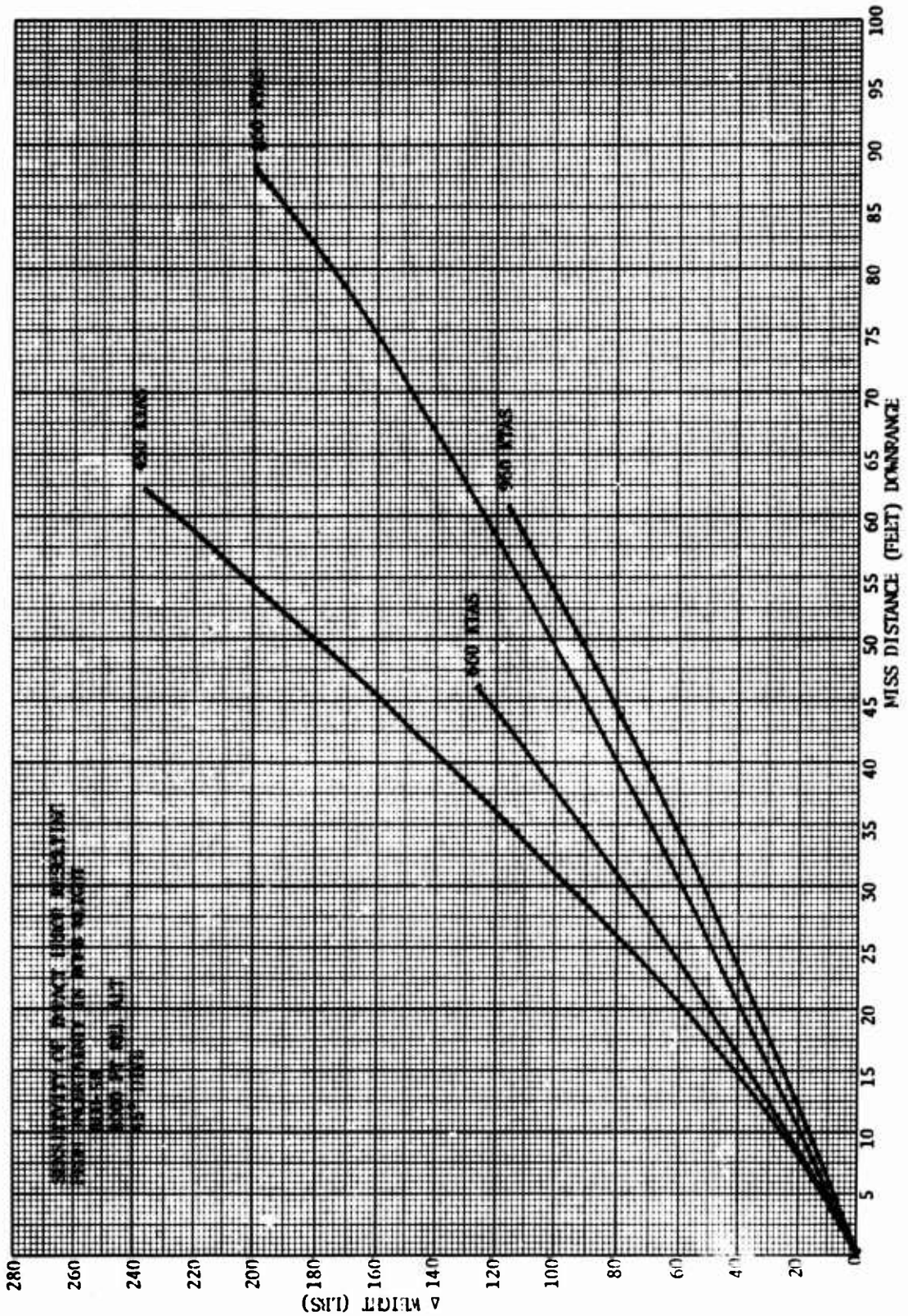

Figure 29. Bomb Weight Sensitivity BLU-58, 8000 Ft Rel Alt, 45° Dive

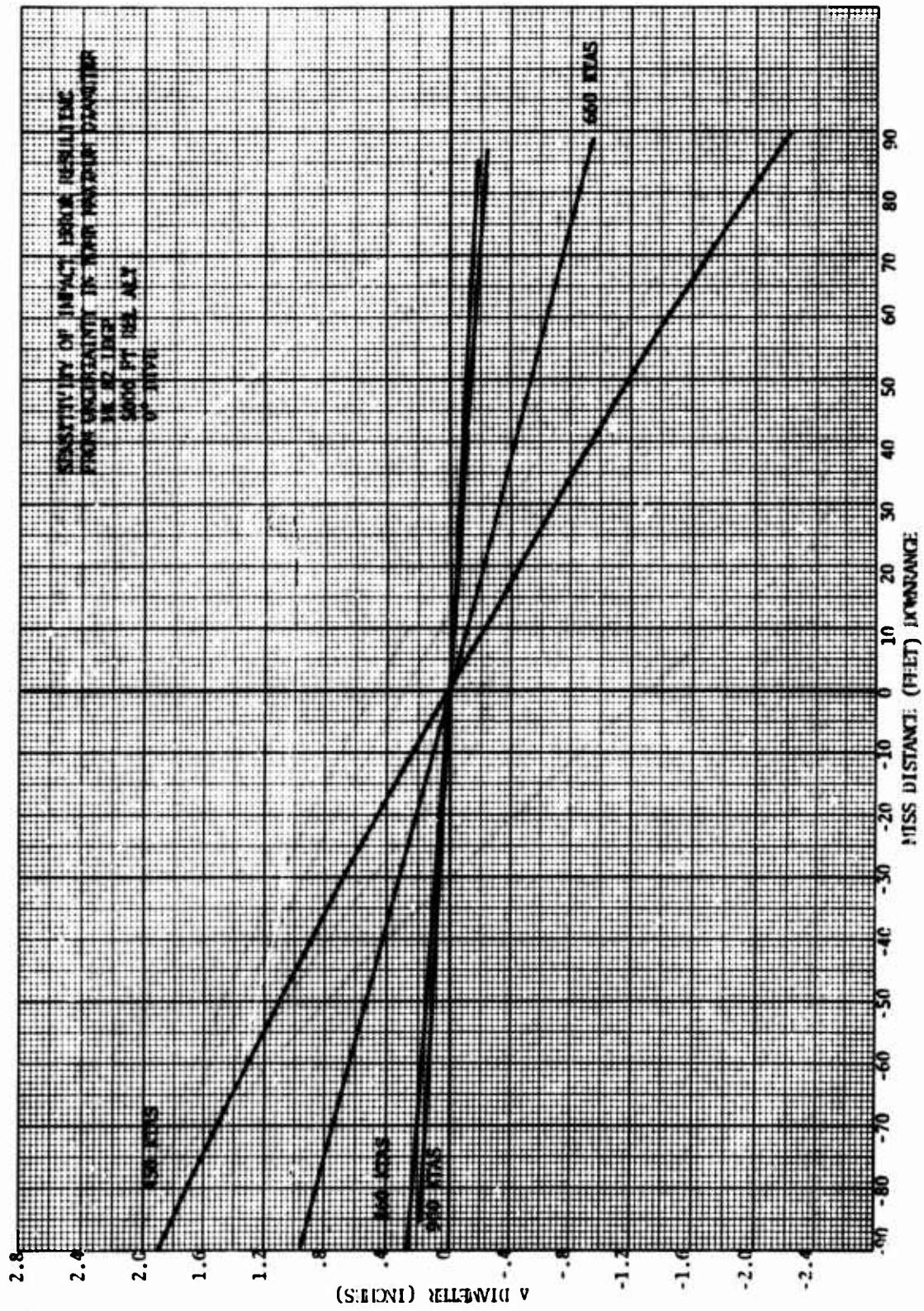

Figure 3C. Bomb Maximum Diameter Sensitivity Mk-82 LDGP, 5000 Ft Rel Alt, 0° Dive



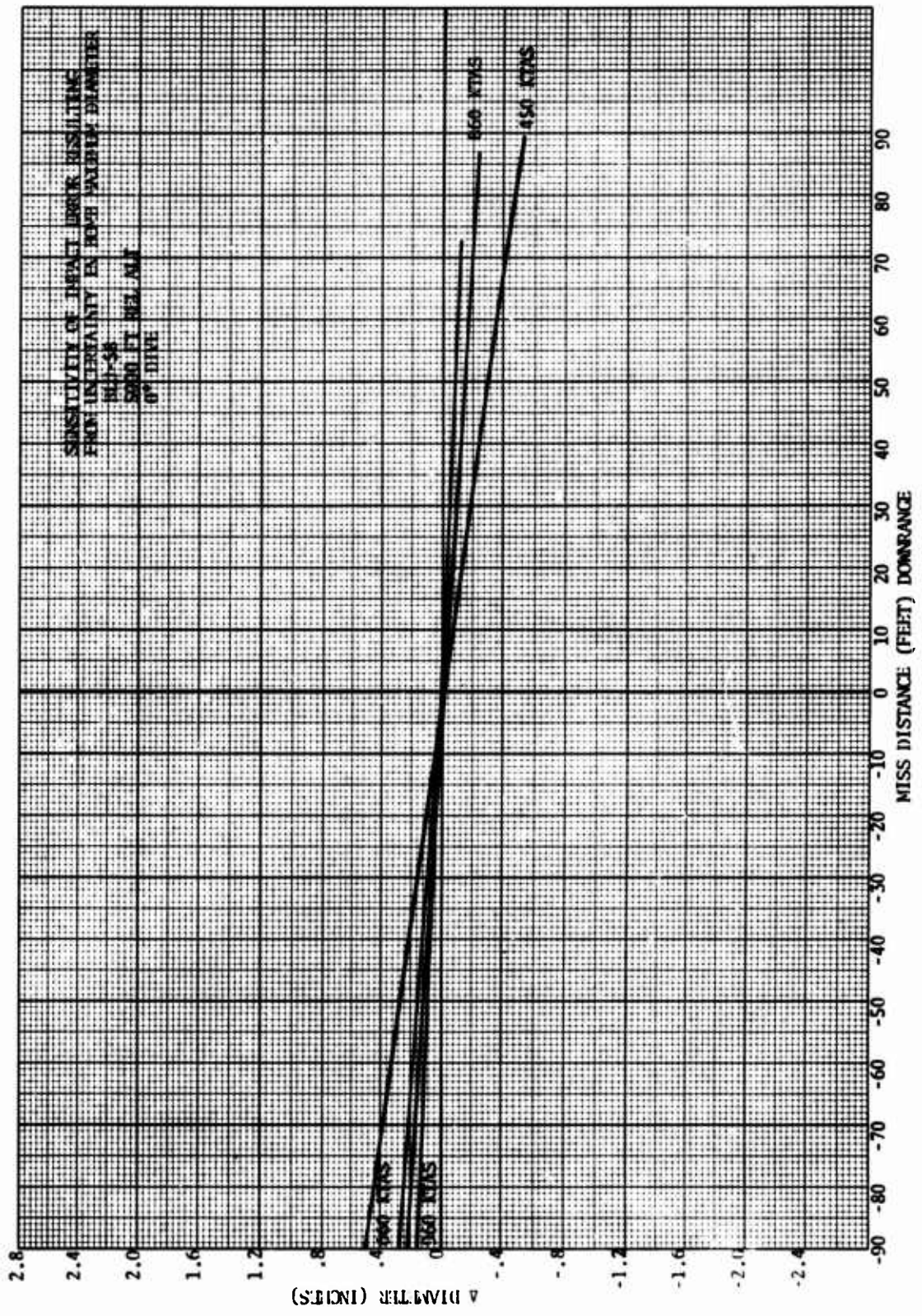

Figure 31. Bomb Maximum Diameter Sensitivity BLU-58, 5000 Ft Rel Alt, 0° Dive

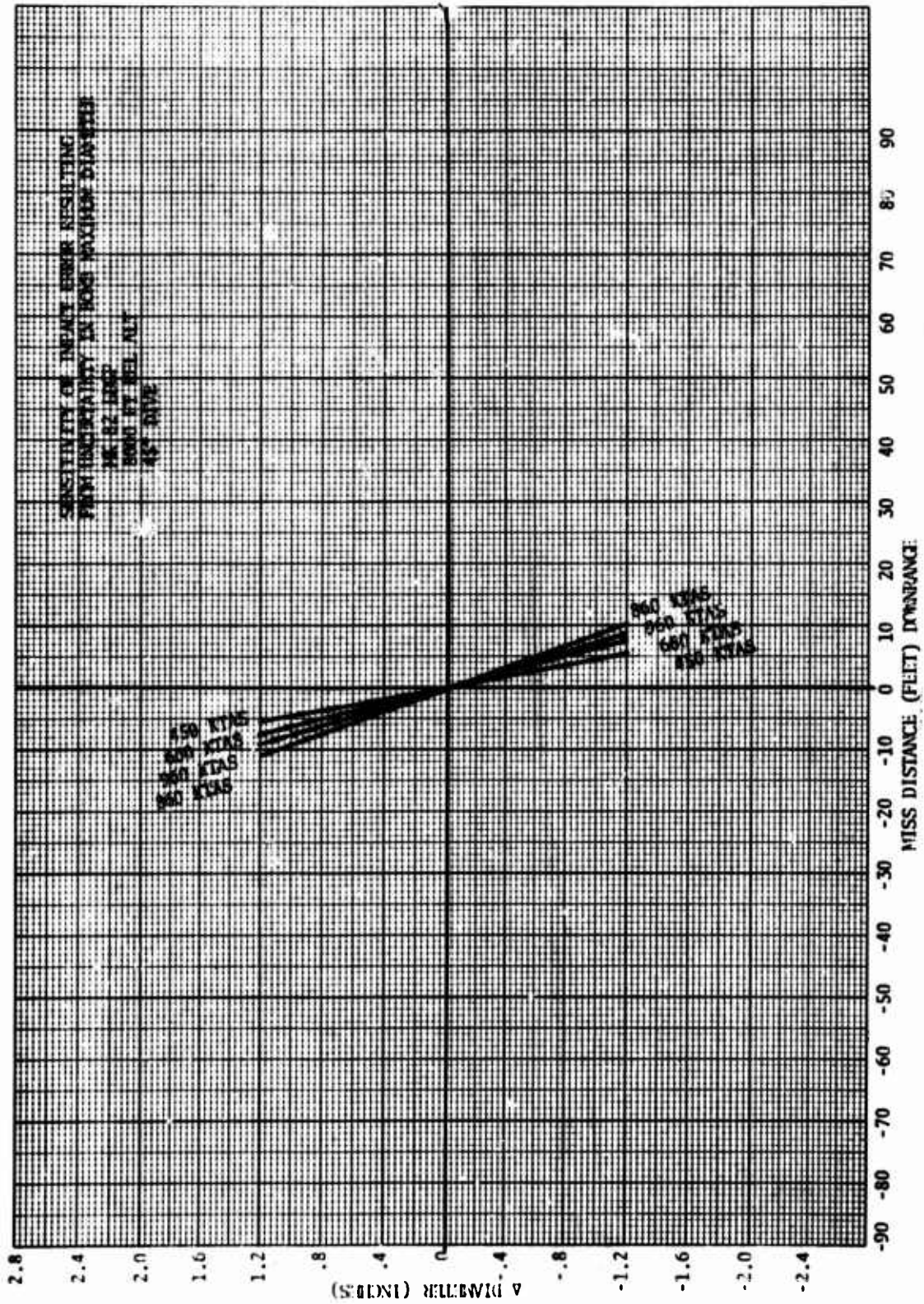

Figure 32. Bomb Maximum Diameter Sensitivity Mk-82 LDGP, 8000 Ft Rel Alt, 45° Dive

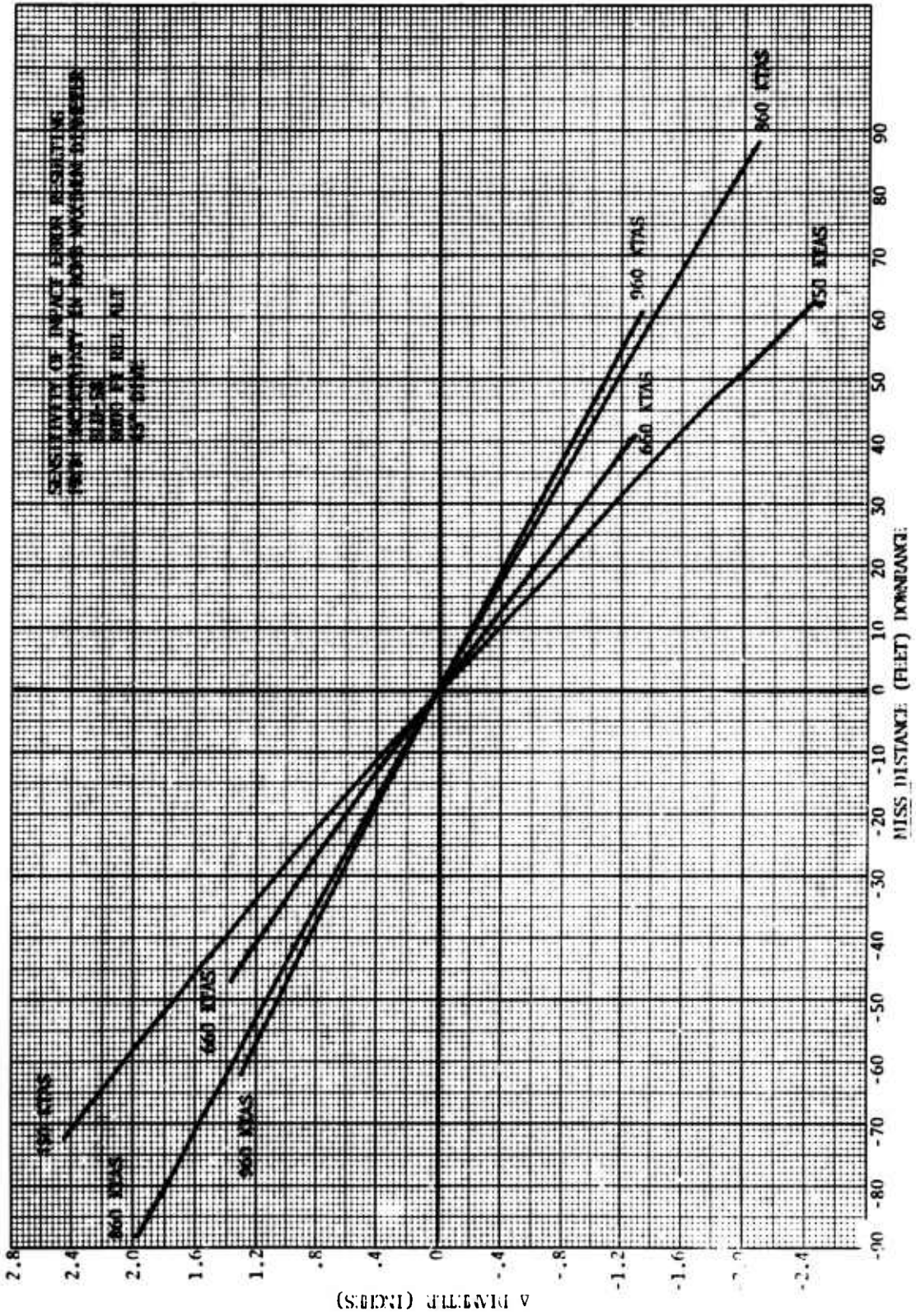

Figure 33. Bomb Maximum Diameter Sensitivity BLU-58, 8000 Ft Rel Alt, 45° Dive

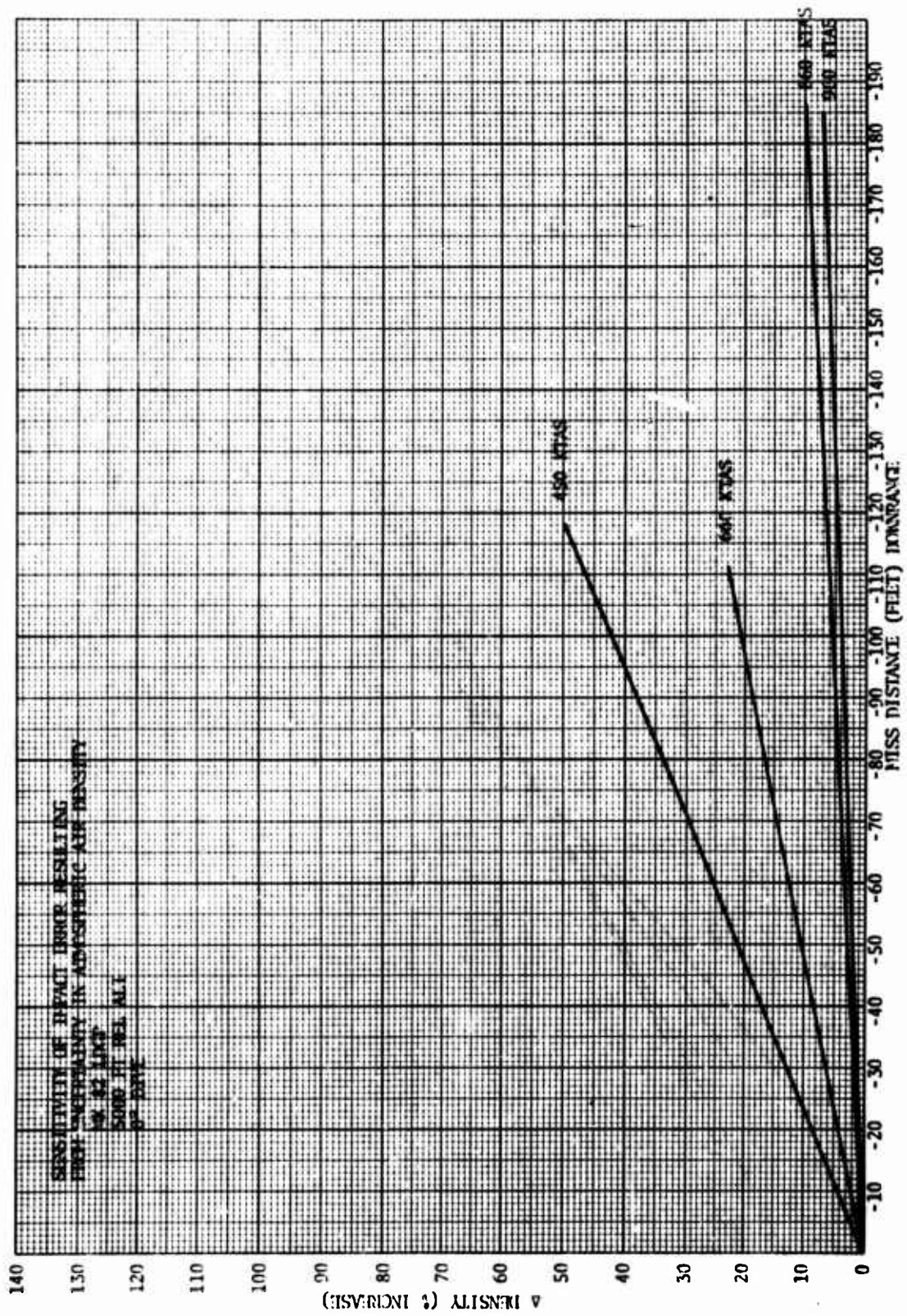

Figure 54. Atmospheric Air Density Sensitivity Mk-82 LDGP, 5000 Ft Rel Alt, 0° Dive

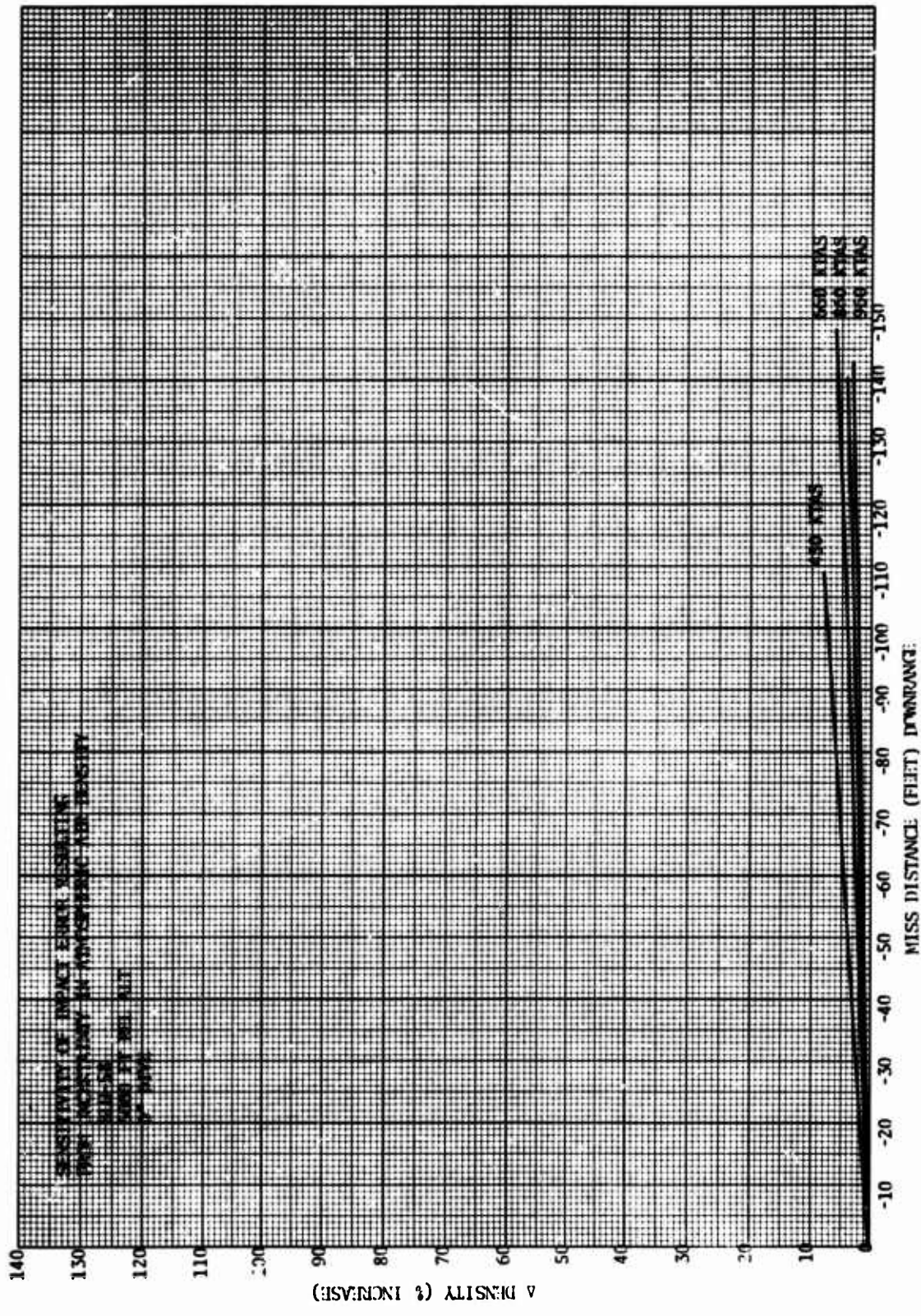

Figure 35. Atmospheric Air Density BLU-58, 5000 Ft Rel Alt, 0° Dive

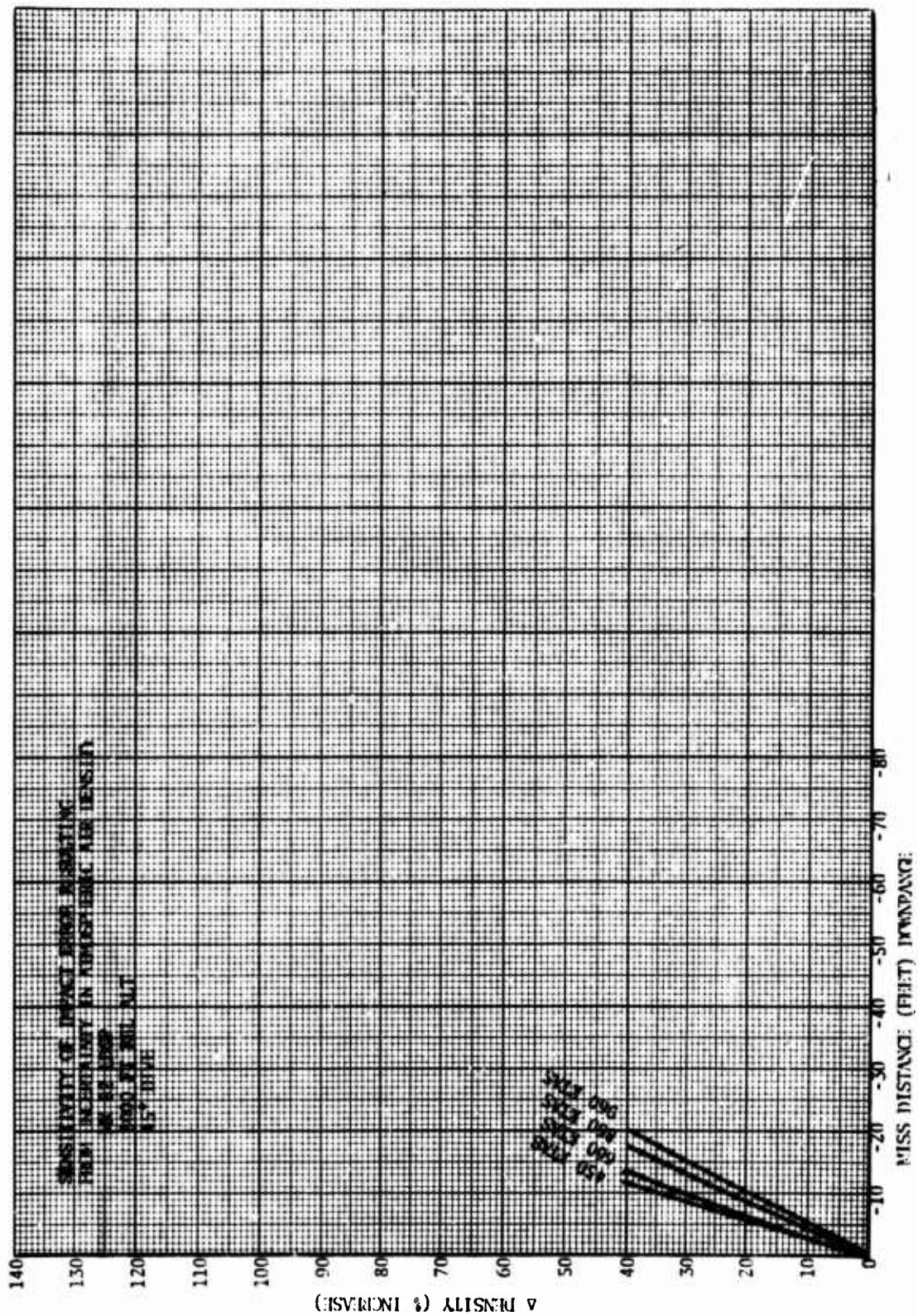

Figure 36. Atmospheric Air Density Sensitivity Mk-82 LDGP, 8000 Ft Rel Alt, 45° Dive

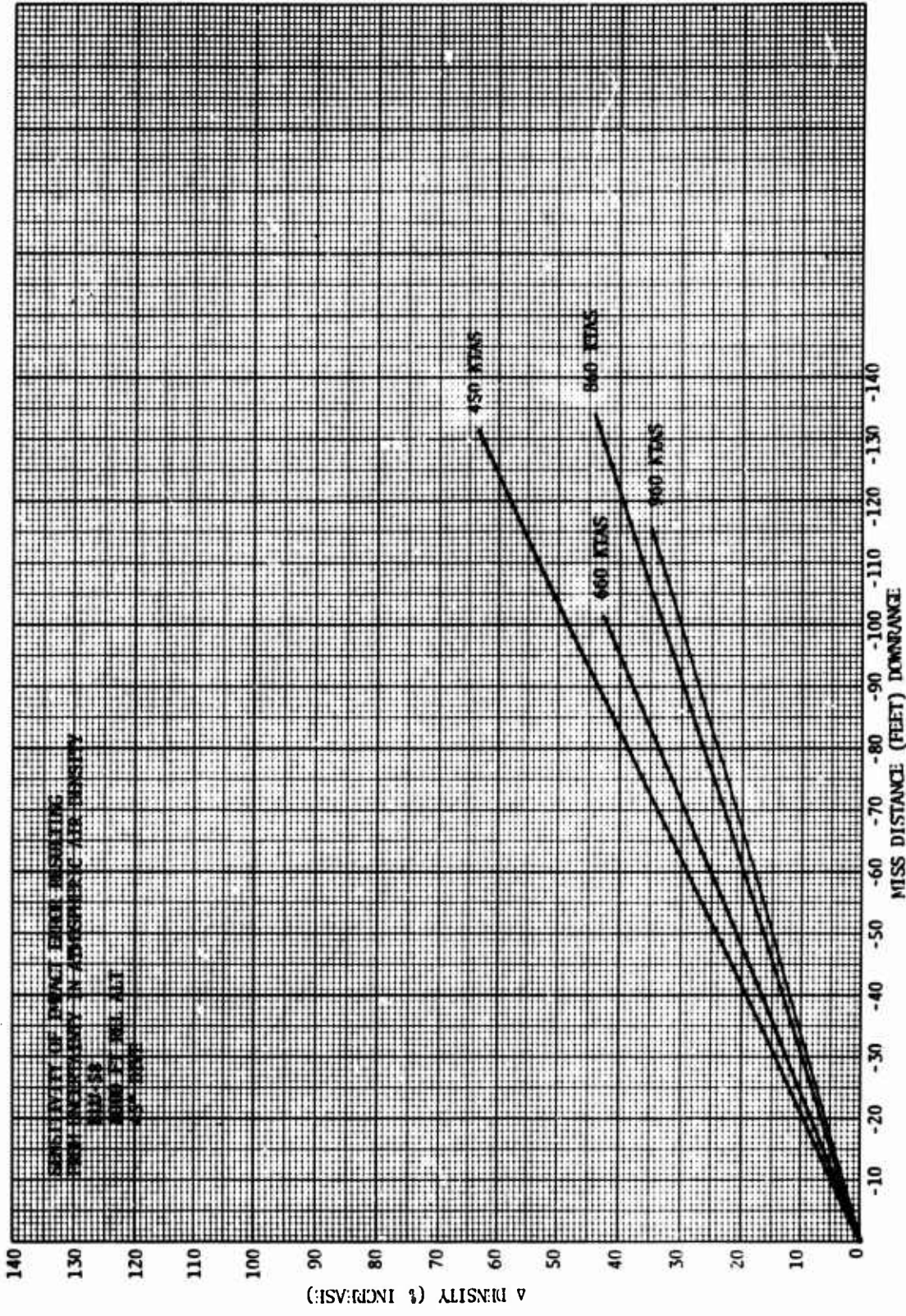

Figure 37. Atmospheric Air Density Sensitivity BLU-58, 8000 Ft Rel Alt, 45° Dive

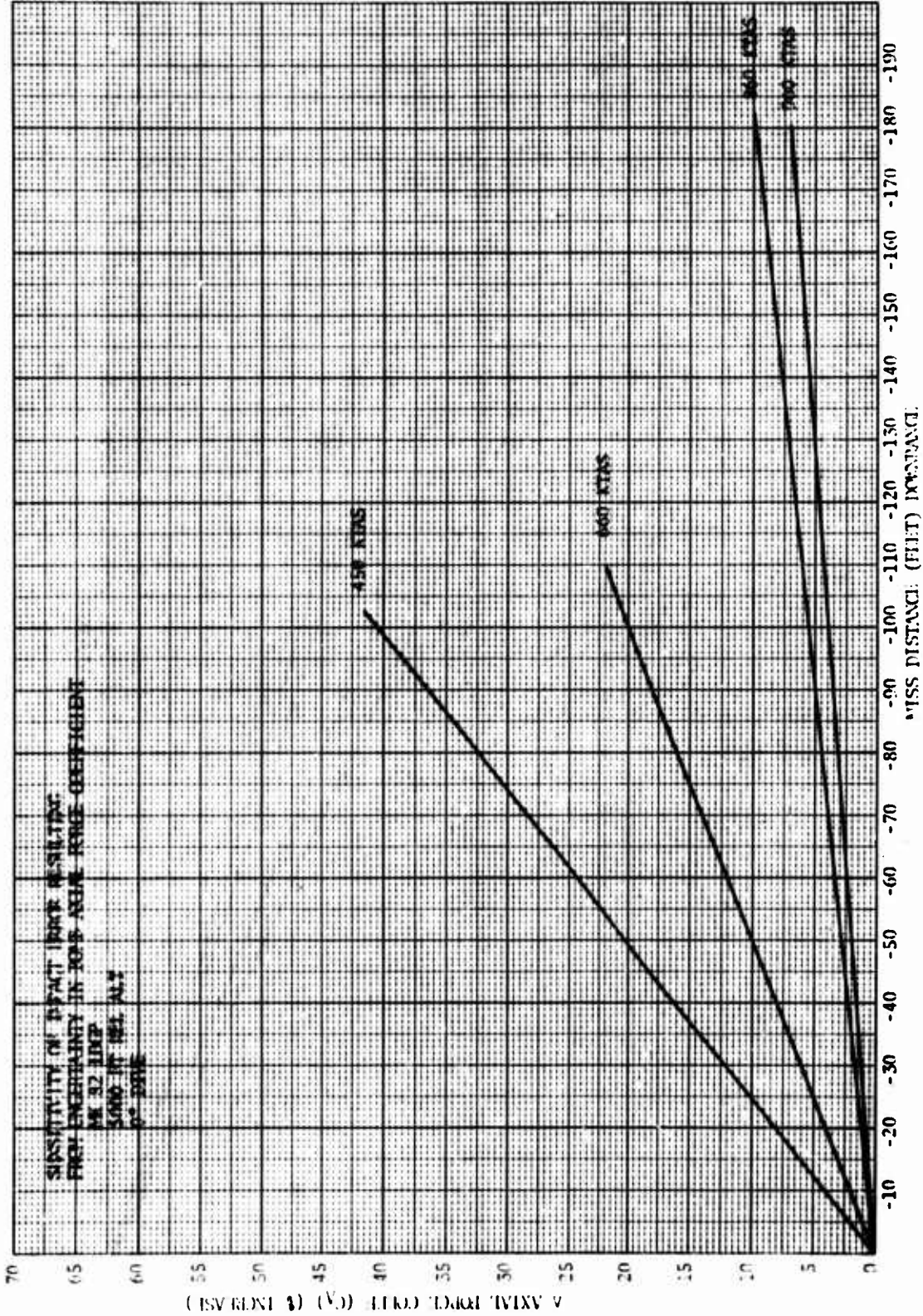

Figure 38. Bomb Axial Force Coefficient Sensitivity Mk-82 LDGP, 5000 Ft Rel Alt, 0° Dive



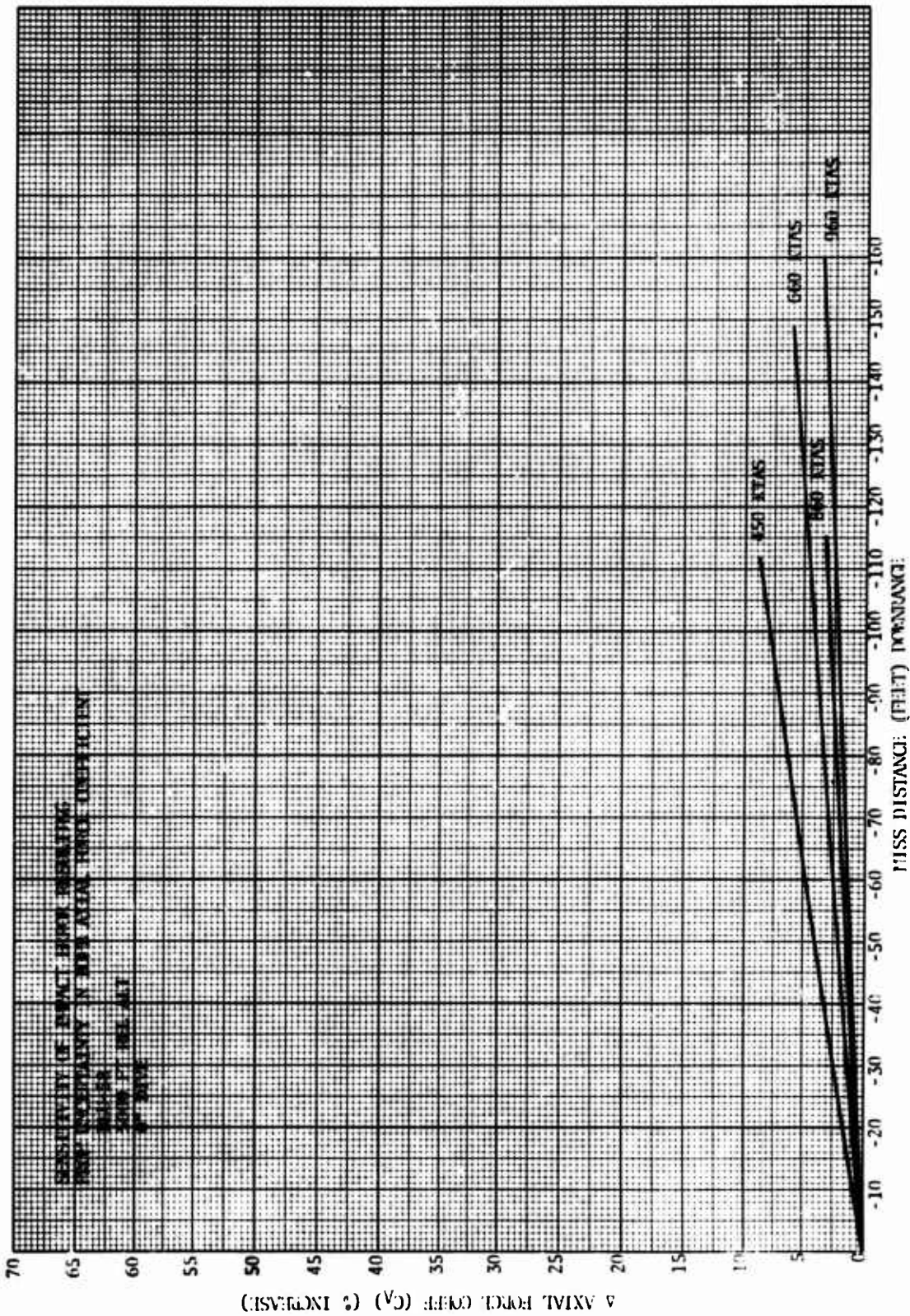

Figure 39. Bomb Axial Force Coefficient Sensitivity BLU-58, 5000 Ft Rel Alt, 0° Dive

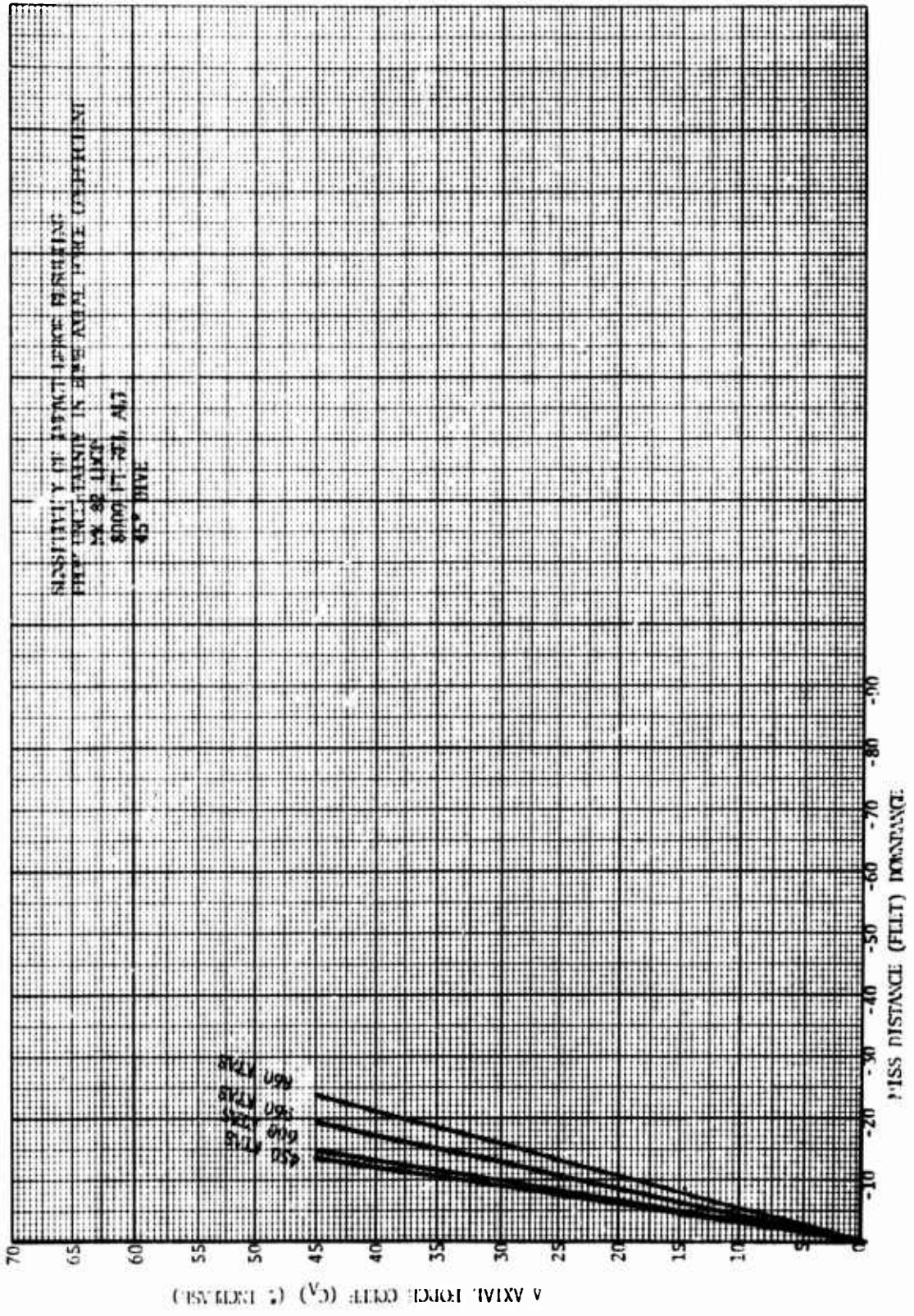

Figure 40. Bomb Axial Force Coefficient Sensitivity Mk-82 LDGP, 8000 Ft Rel Alt, 45° Dive

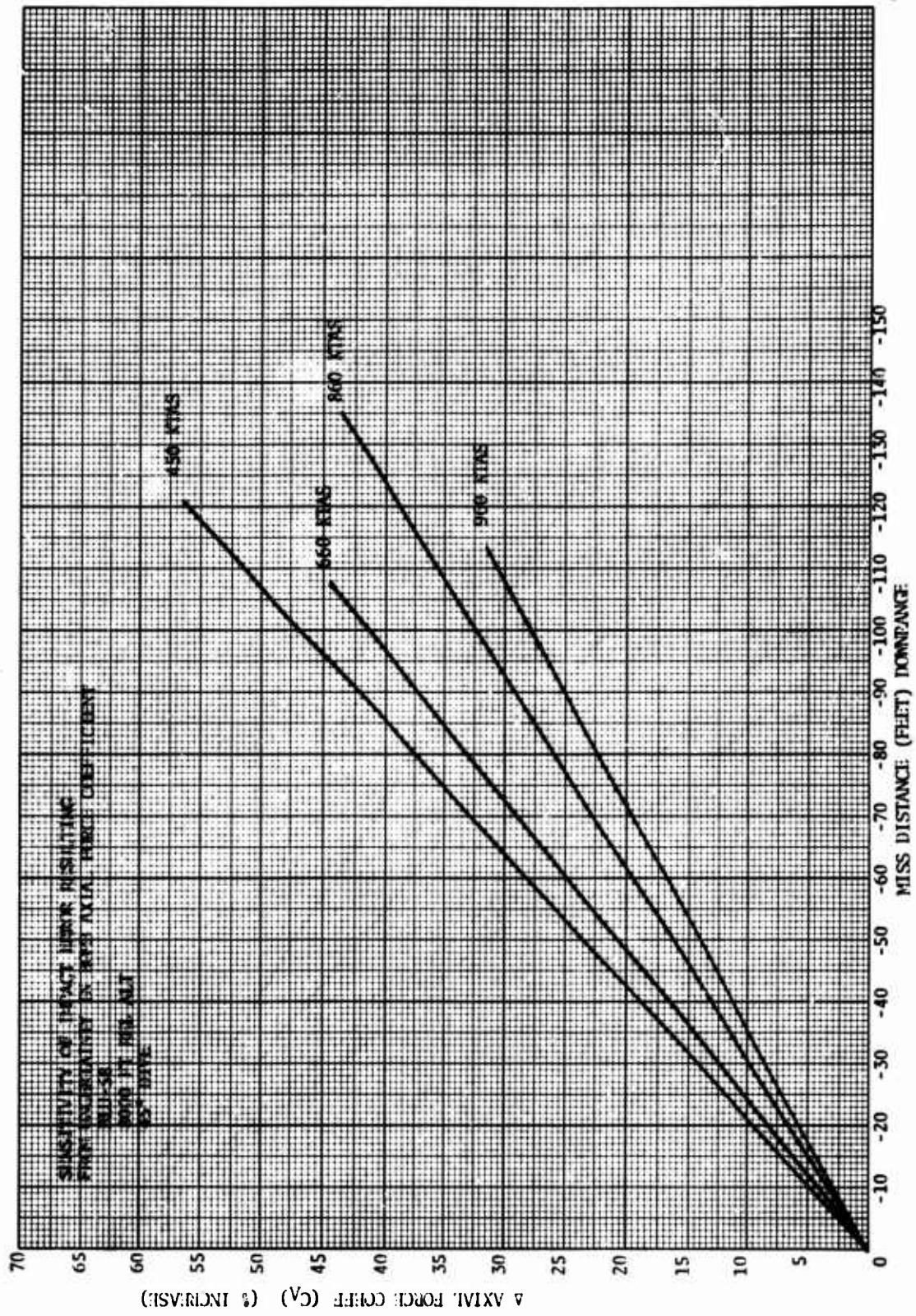

Figure 41. Bomb Axial Force Coefficient Sensitivity BLU-58, 8000 Ft Rel Alt, 45° Dive

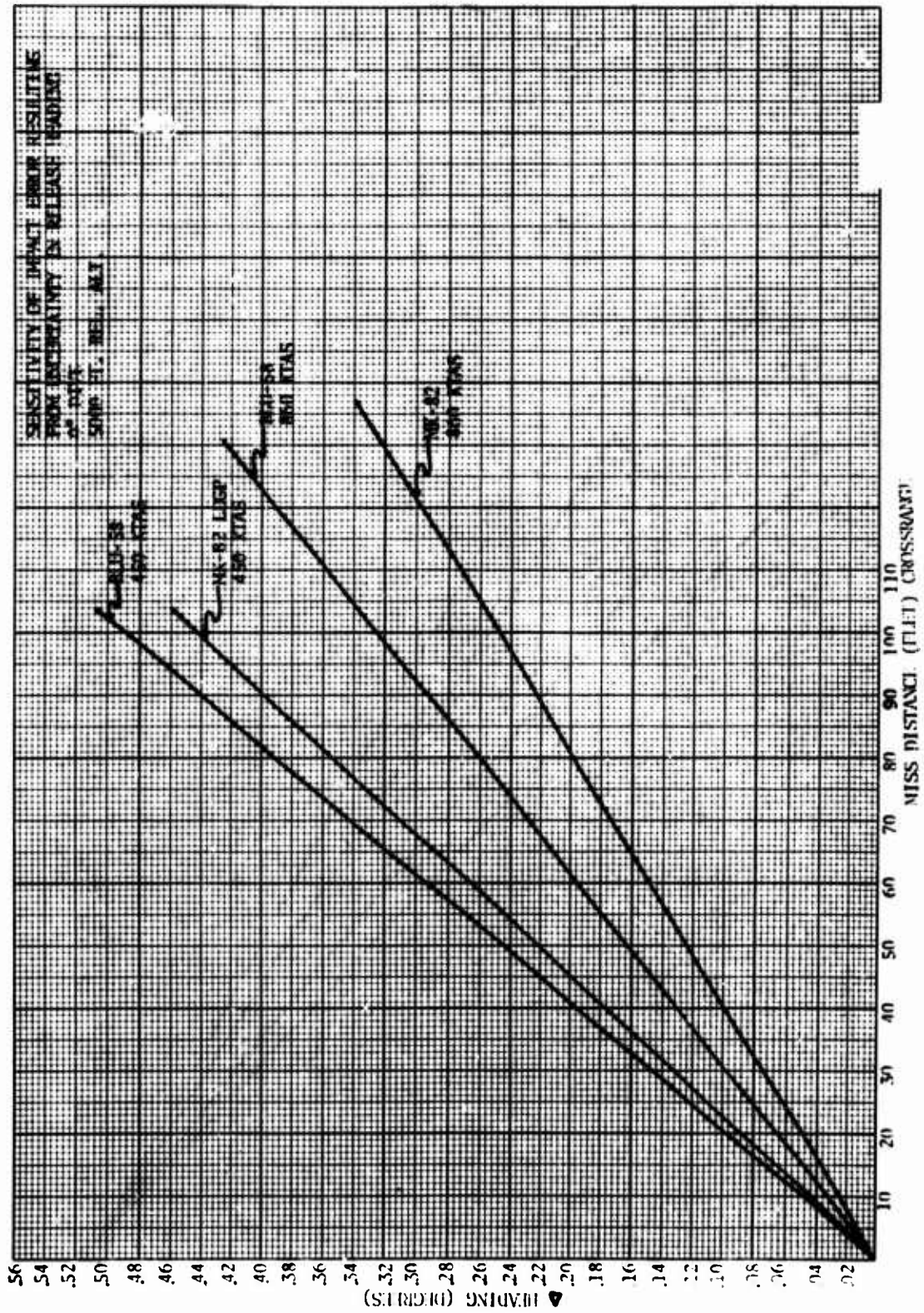

Figure 42. Release Heading Sensitivity 0° Dive, 5000 Ft Rel Alt

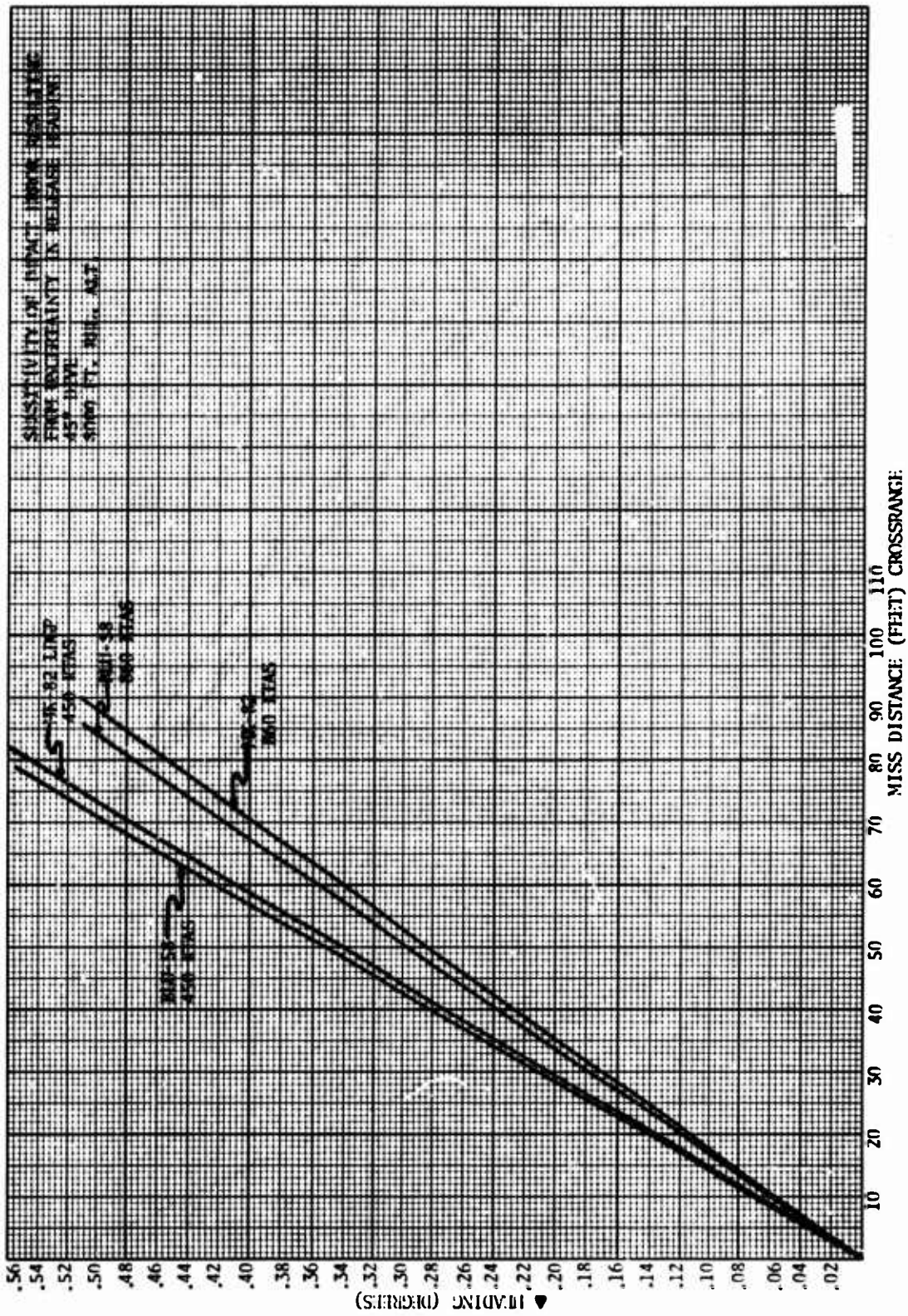

Figure 43. Release Heading Sensitivity 45° Dive, 8000 Ft Rel Alt

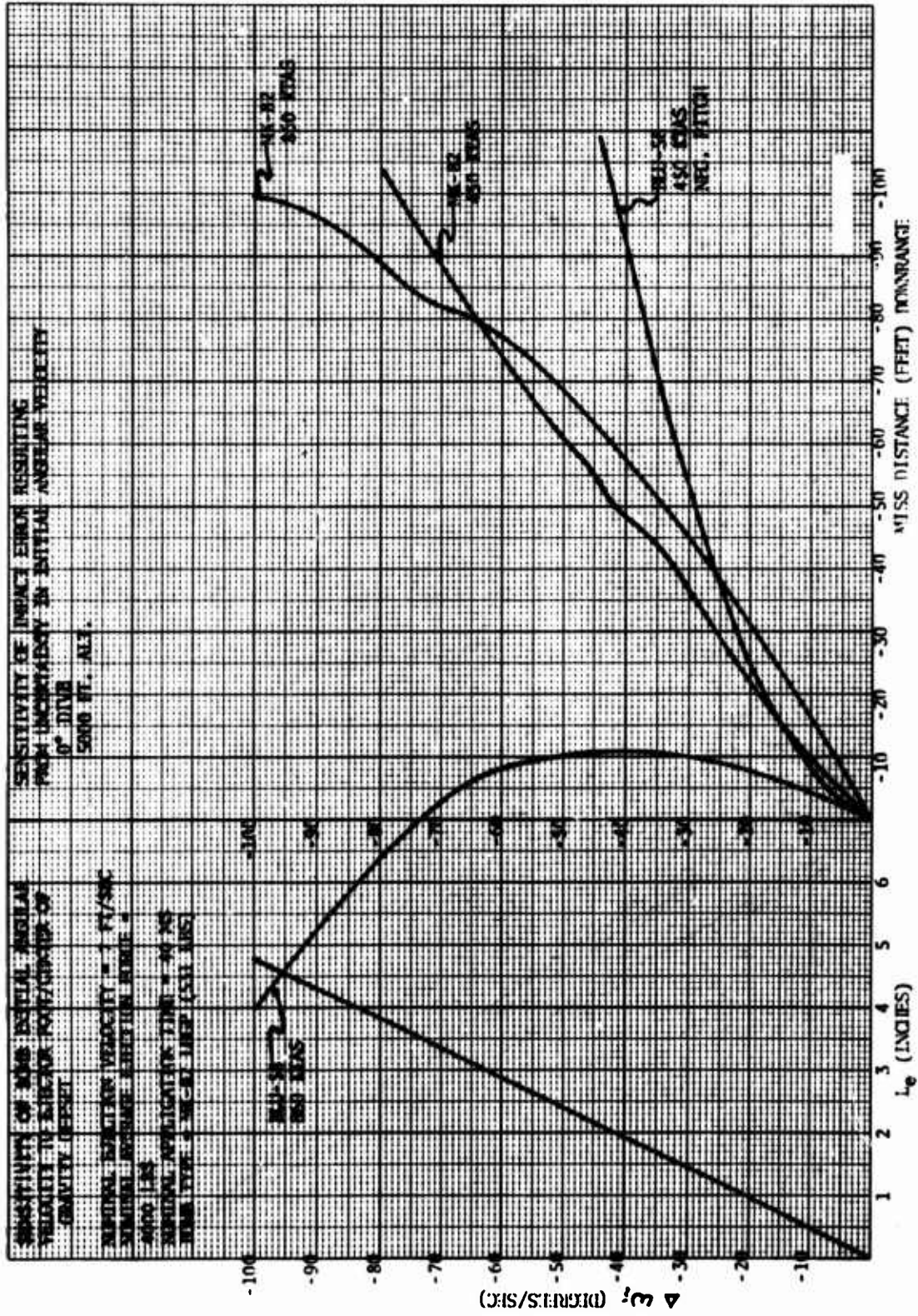

Figure -4. Initial Angular Velocity Sensitivity 0° Dive, 5000 Ft Alt

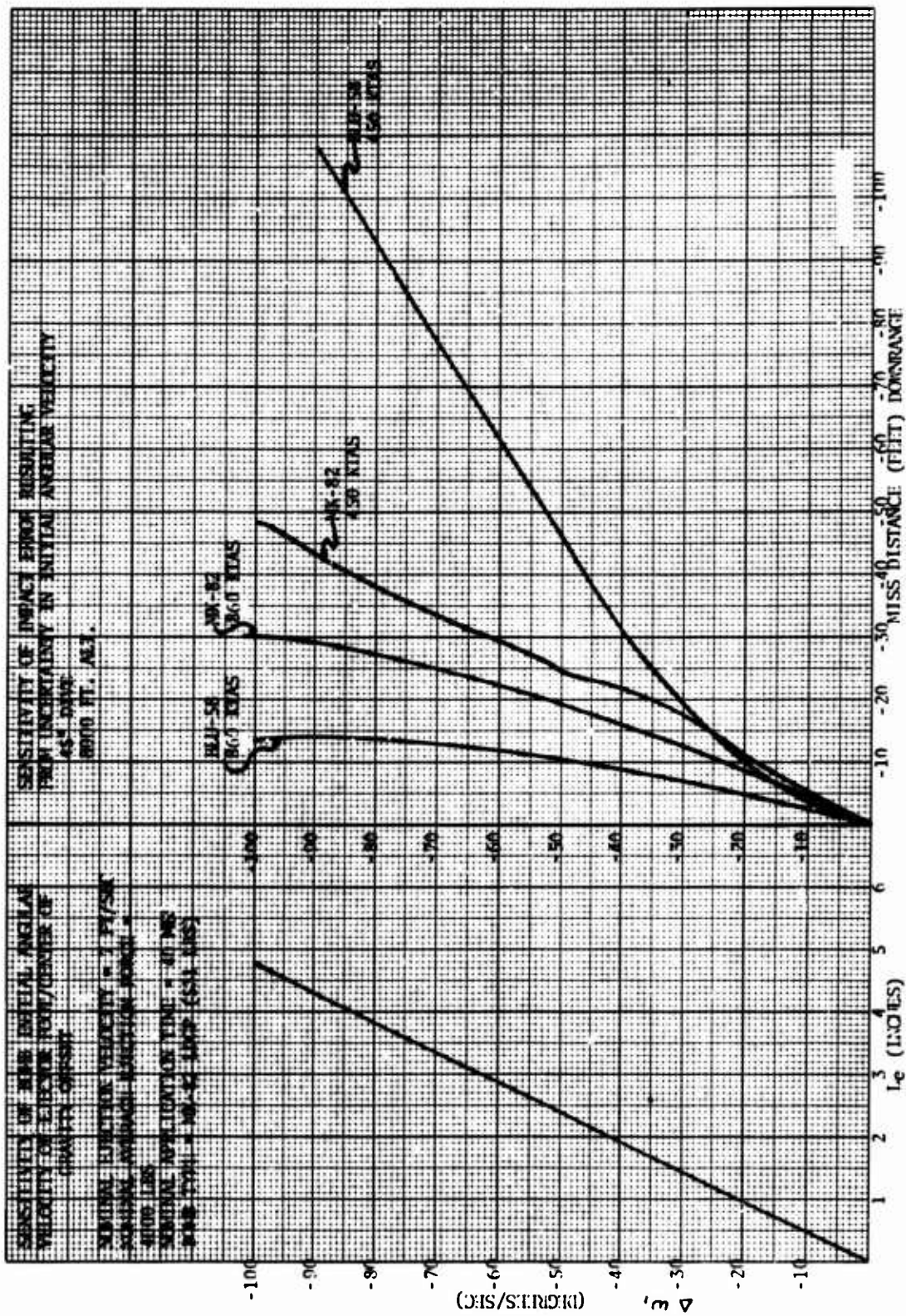

Figure 45. Initial Angular Velocity Sensitivity 45° Dive, 8000 Ft Alt

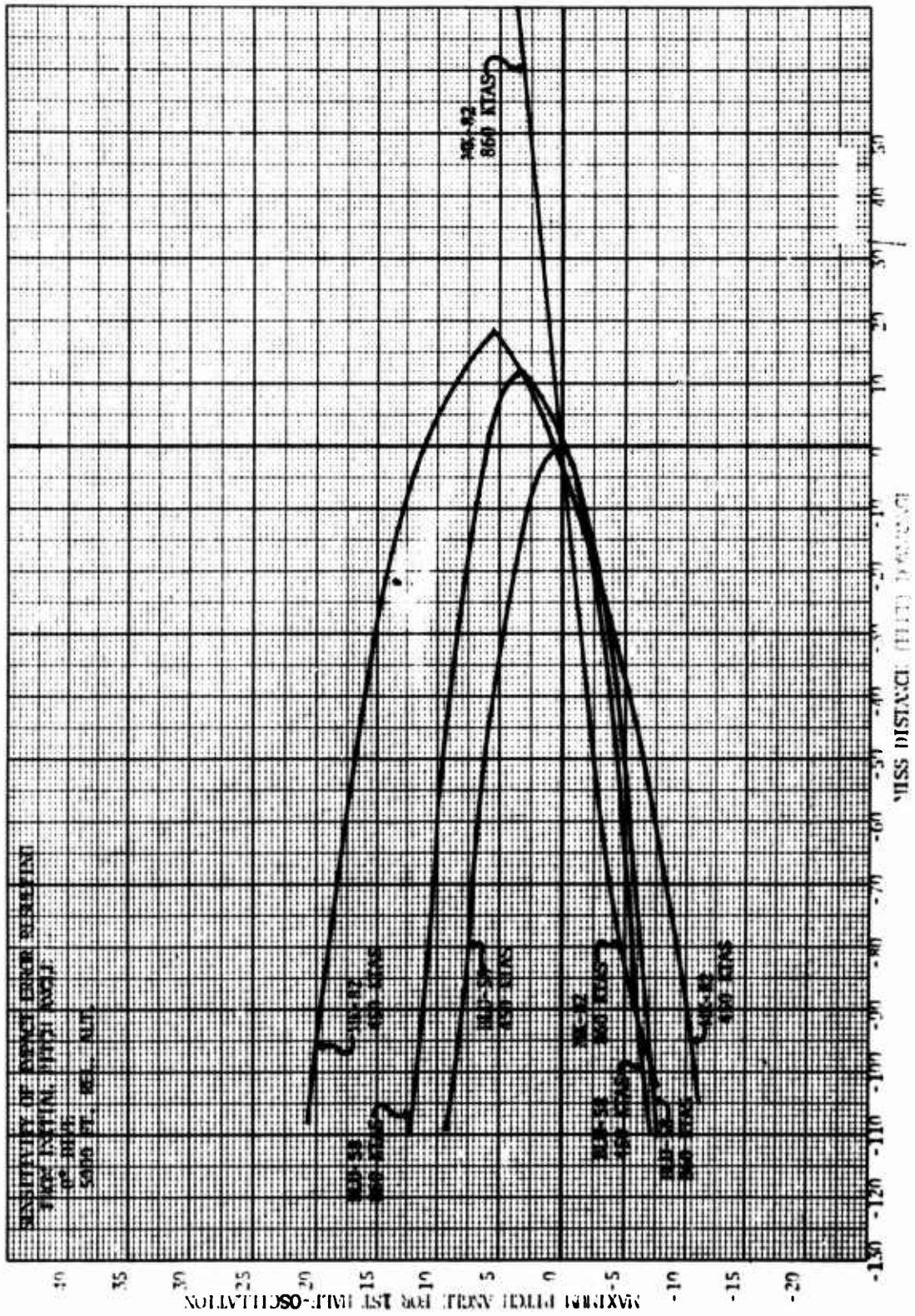

Figure 46. Initial Pitch Angle Sensitivity 0° Dive, 5000 Ft Rel Alt



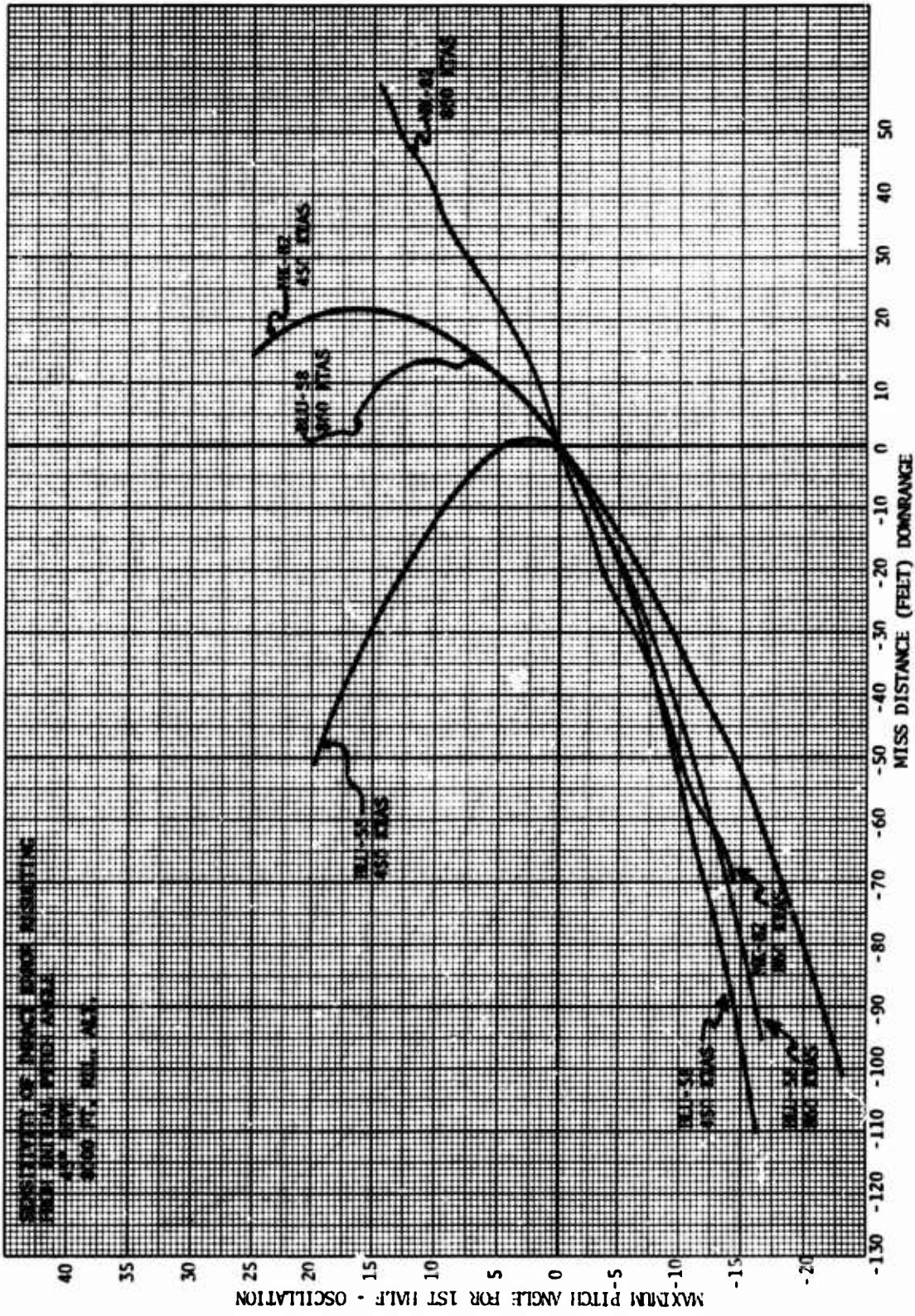

Figure 47. Initial Pitch Angle Sensitivity 45° Dive, 8000 Ft Rel Alt

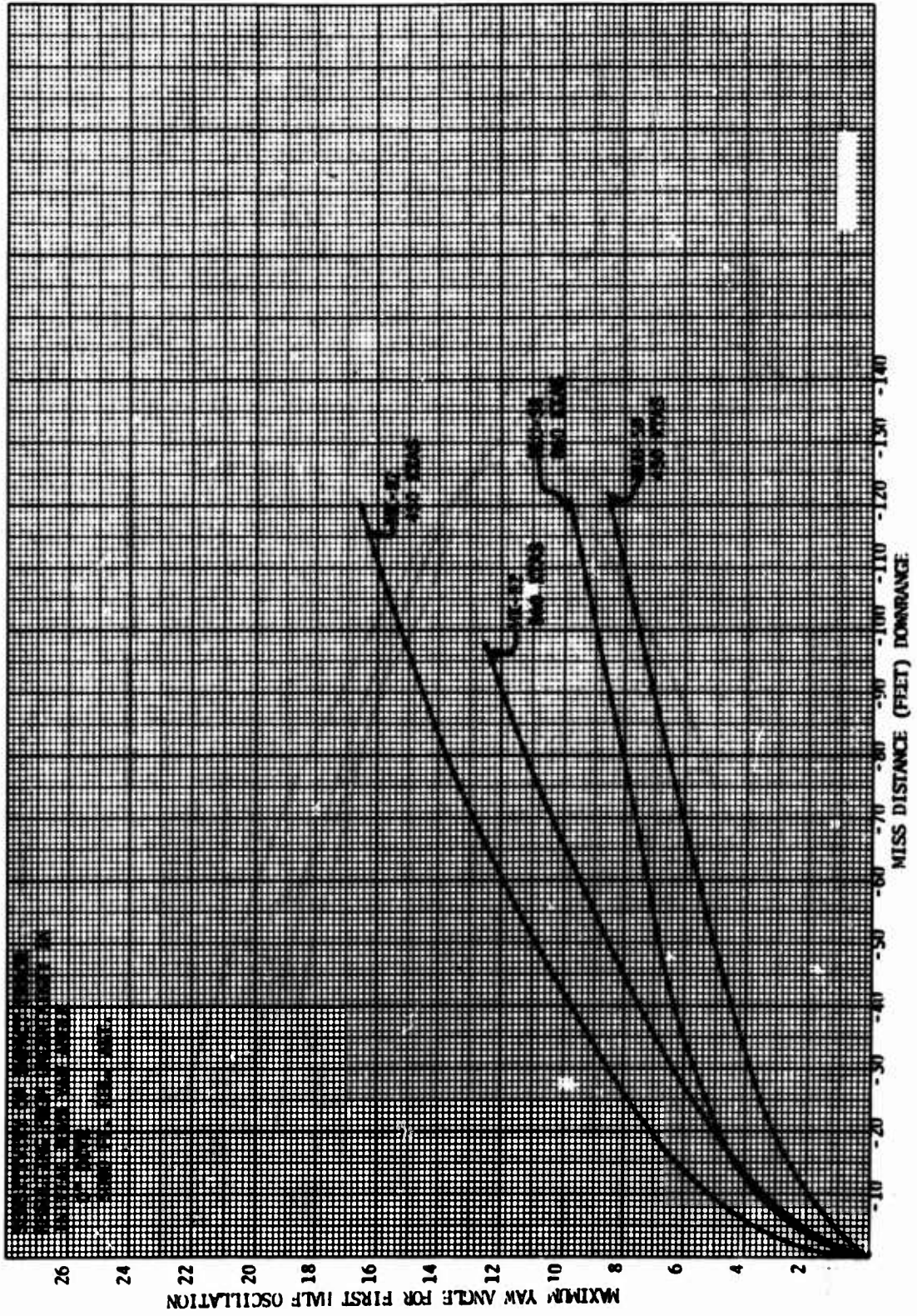

Figure 48. Initial Bomb Yaw Angle Sensitivity (Downrange) 0° Dive, 5000 Ft. Rel Alt

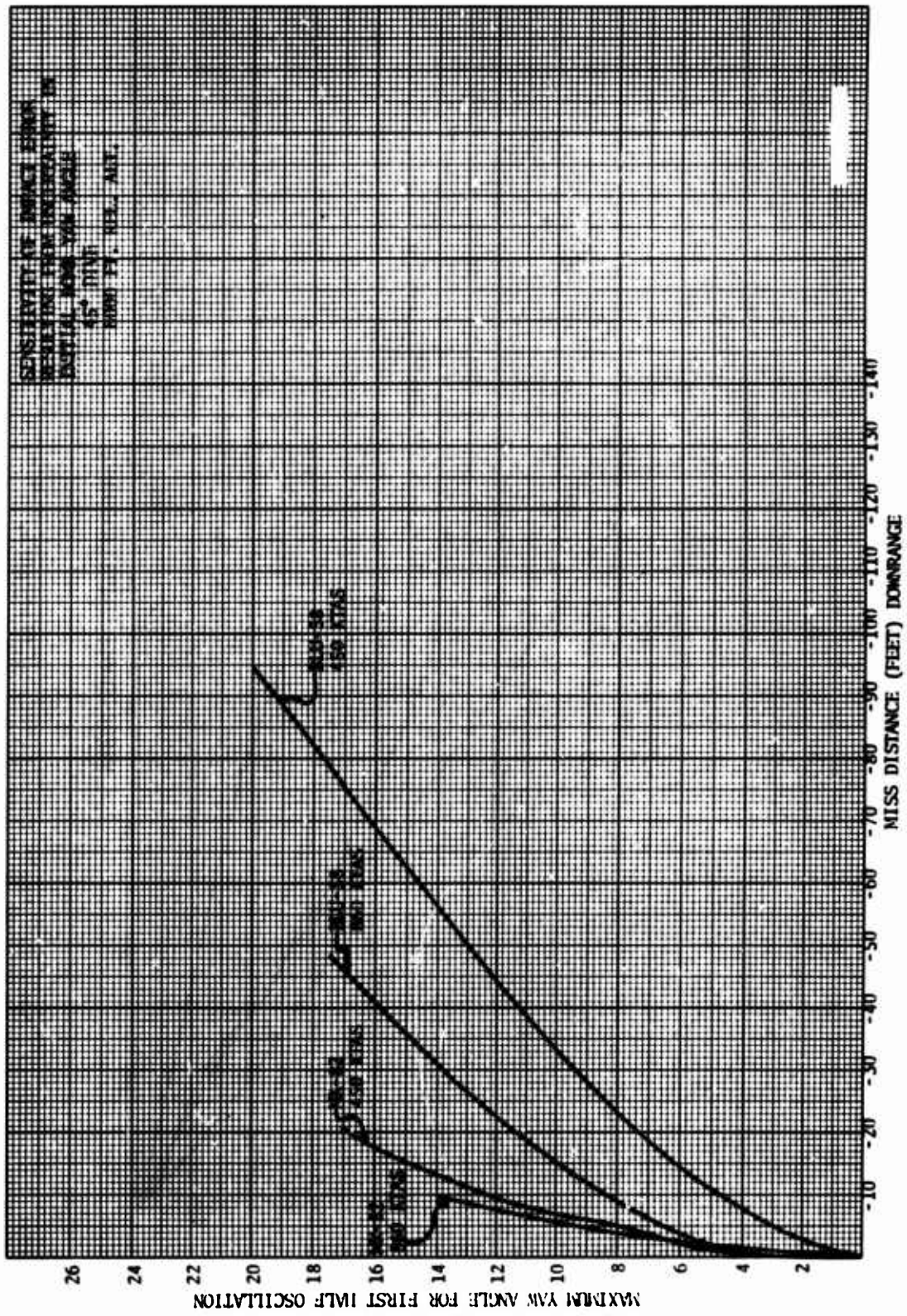

Figure 49. Initial Bomb Yaw Angle Sensitivity (Downrange) 45° Dive, 8000 Ft Rel Alt

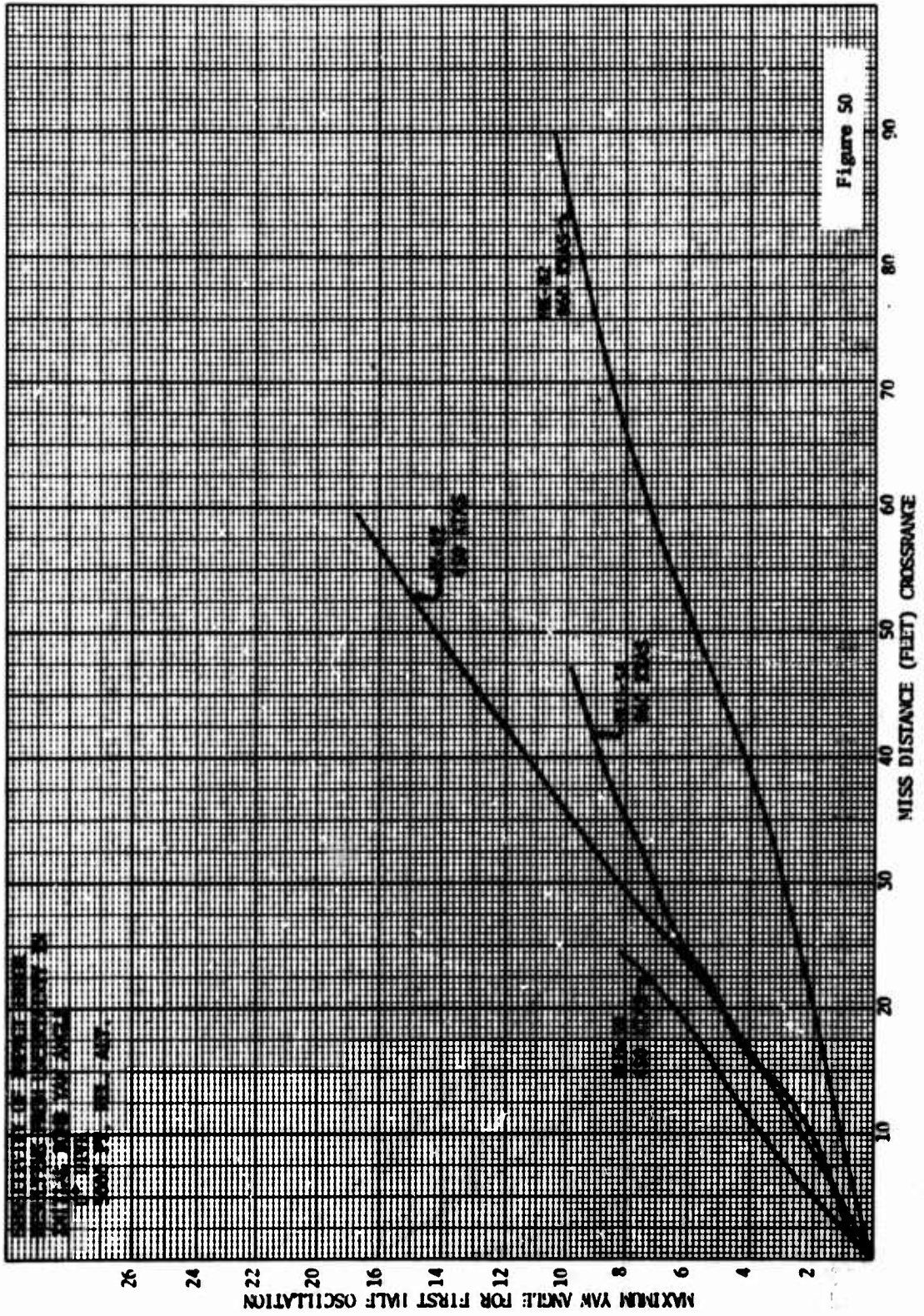

Figure 5C. Initial Bomb Yaw Angle Sensitivity (Crossrange) 0° Dive, 5000 Ft Rel Alt

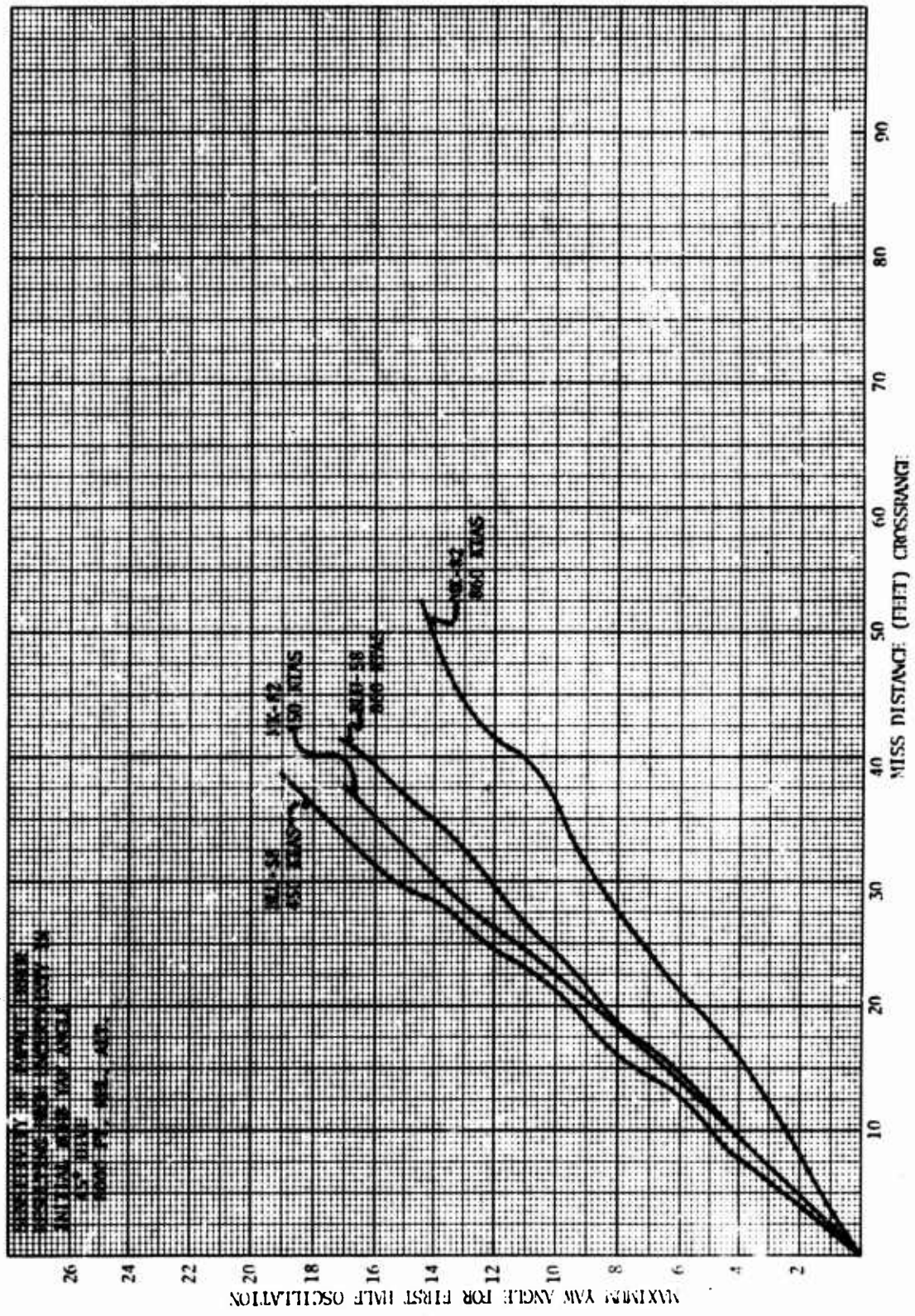

Figure 51. Initial Bomb Yaw Angle Sensitivity (Crossrange) 45° Dive, 8000 Ft Rel Alt

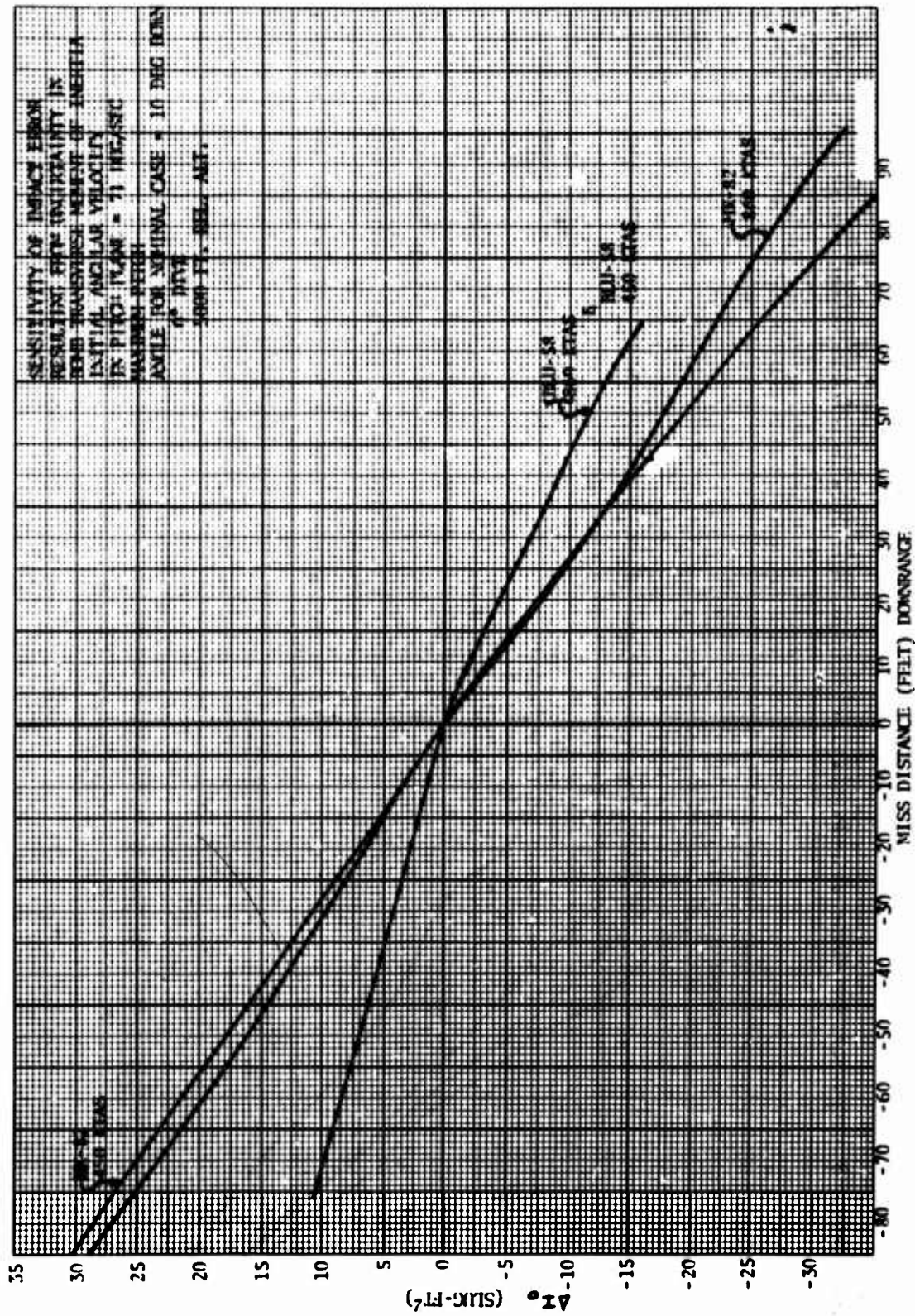

Figure 52. Bomb Transverse Moment of Inertia Sensitivity 0° Dive, 5000 Ft Rel Alt

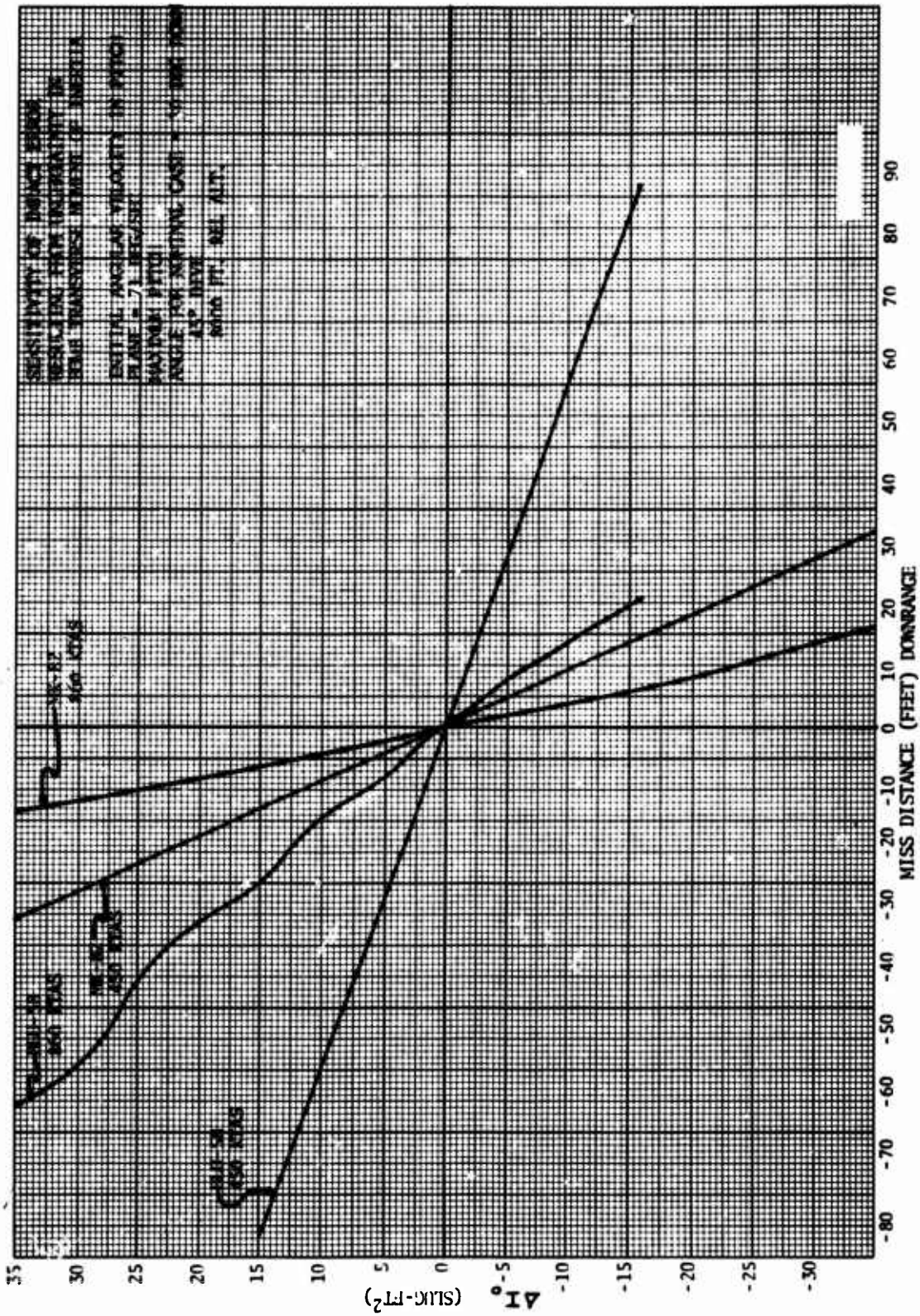

Figure 53. Bomb Transverse Moment of Inertia Sensitivity 45° Dive, 8000 Ft Rel Alt

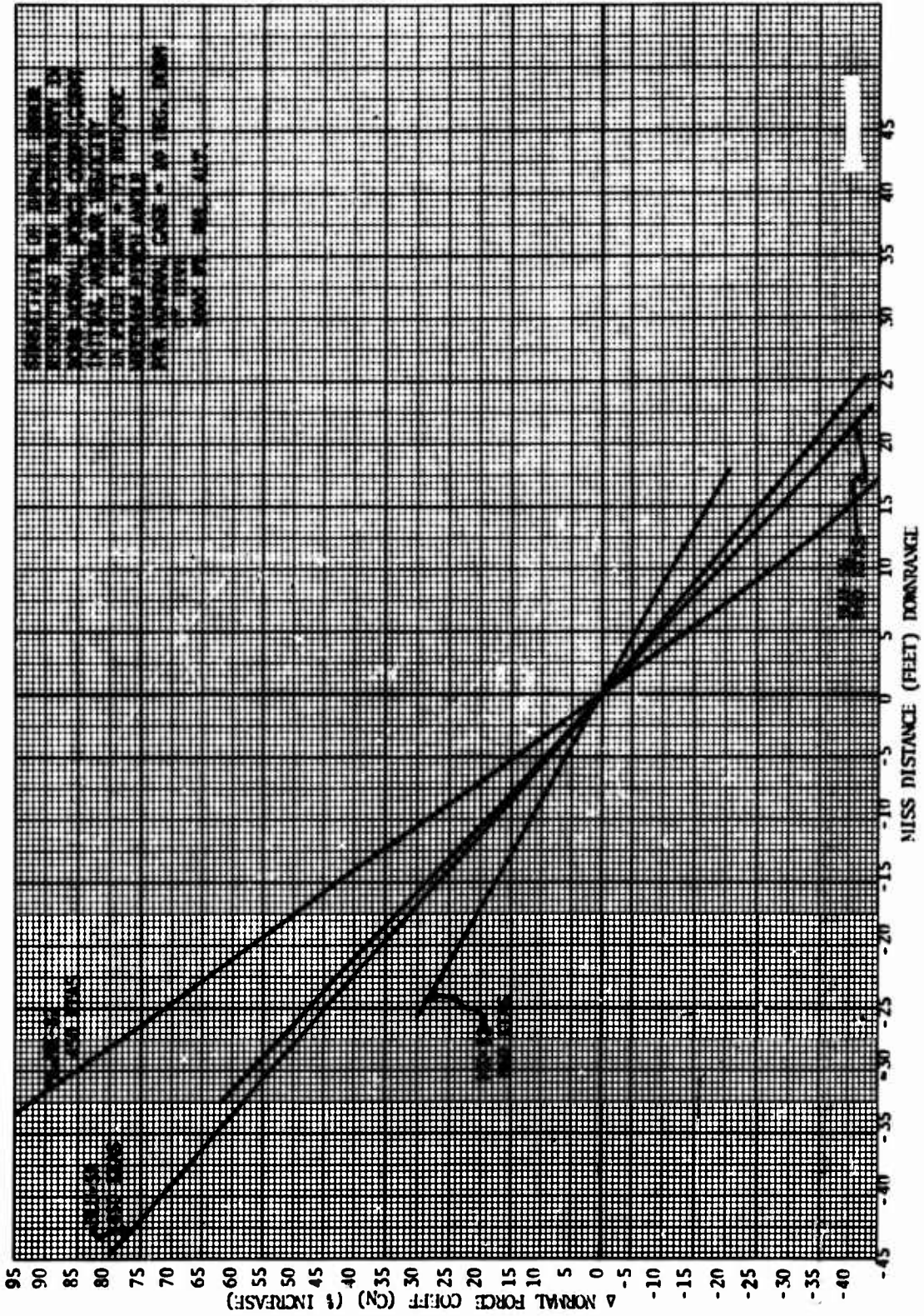

Figure 54. Bomb Normal Force Coefficient Sensitivity 0° Dive, 5000 Ft Rel Alt



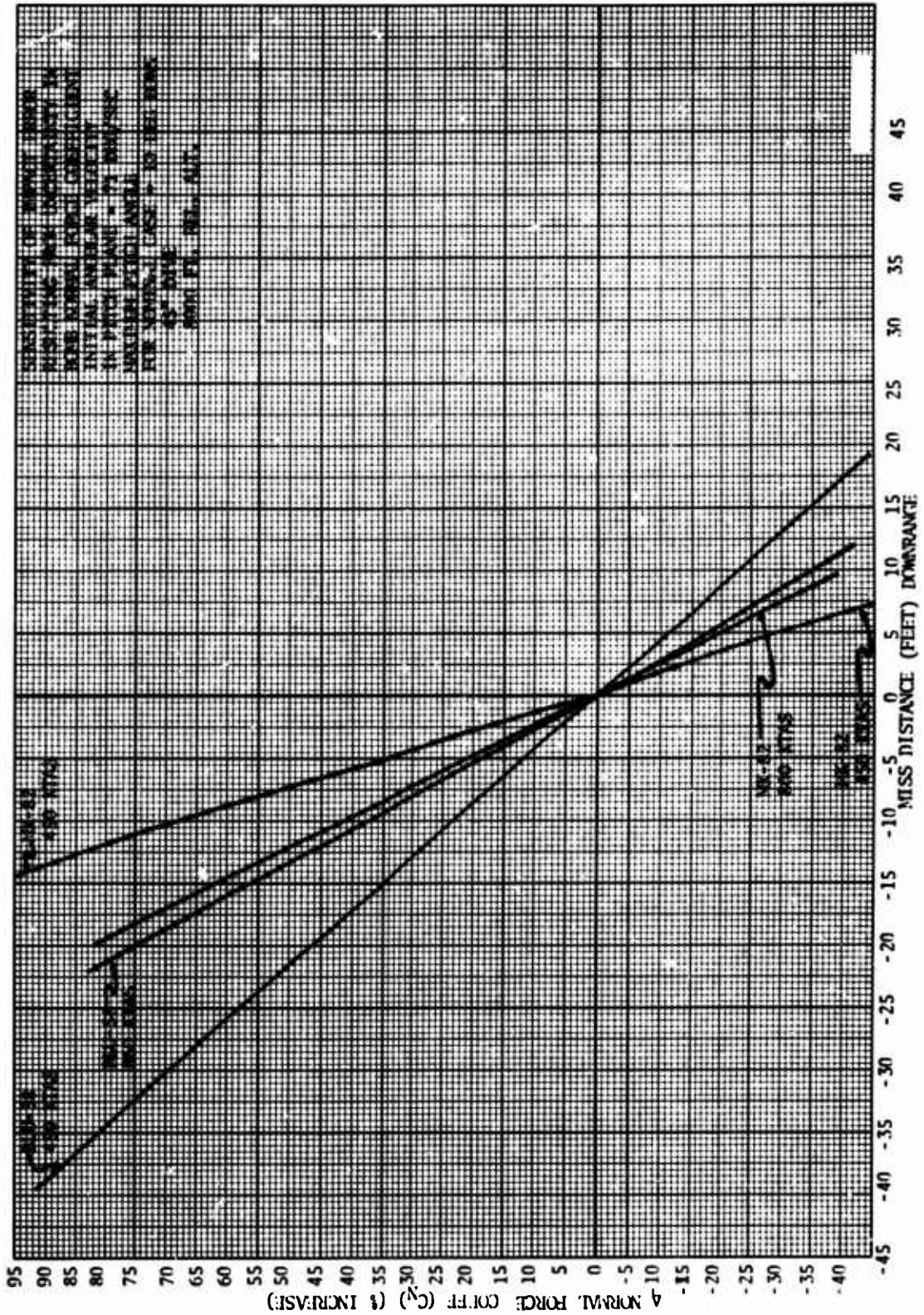

Figure 55. Bomb Normal Force Coefficient Sensitivity 45° Dive, 8000 Ft Rel Alt

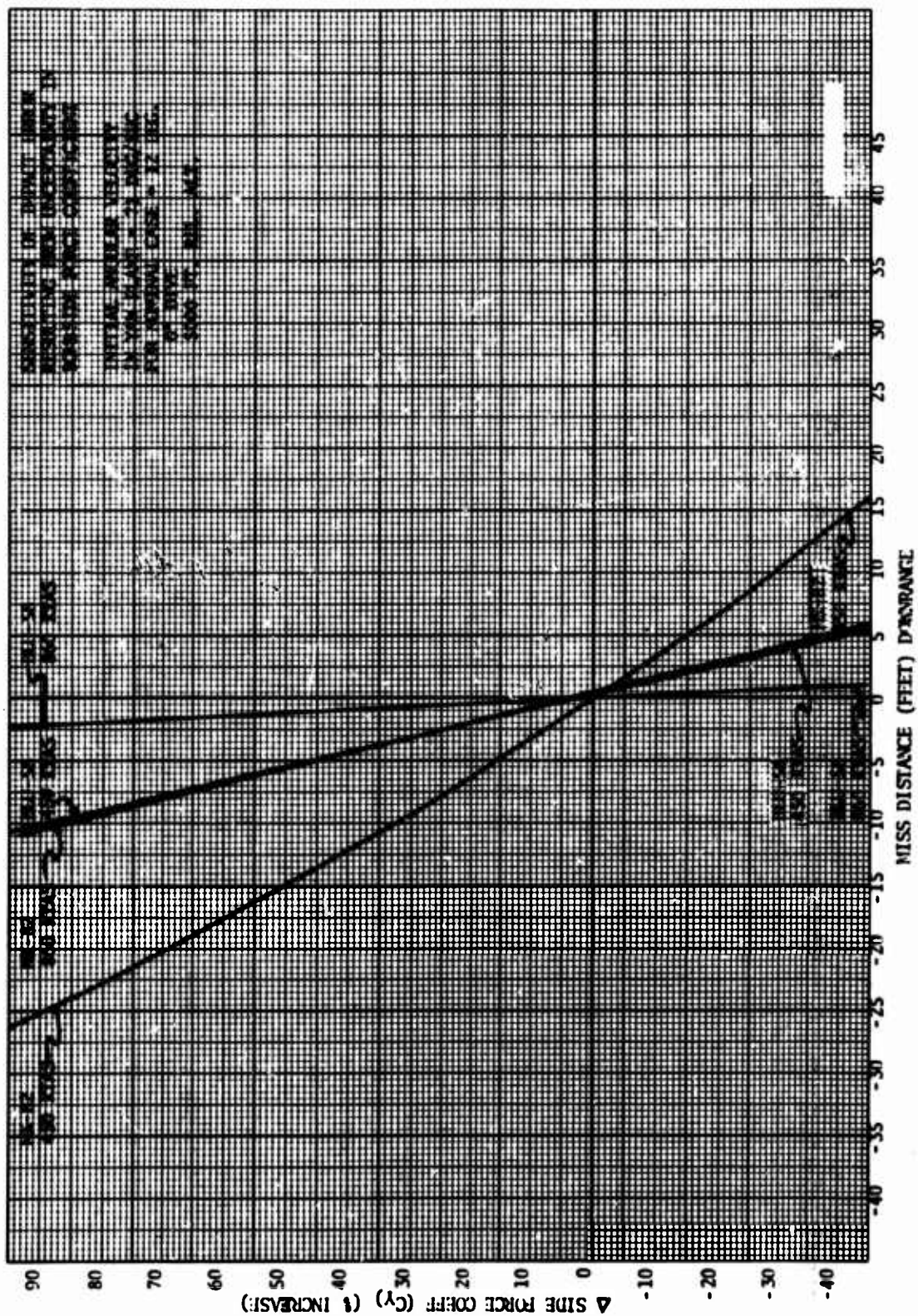

Figure 56. Bomb Side Force Coefficient Sensitivity (Downrange) 0° Dive, 5000 Ft Rel Alt

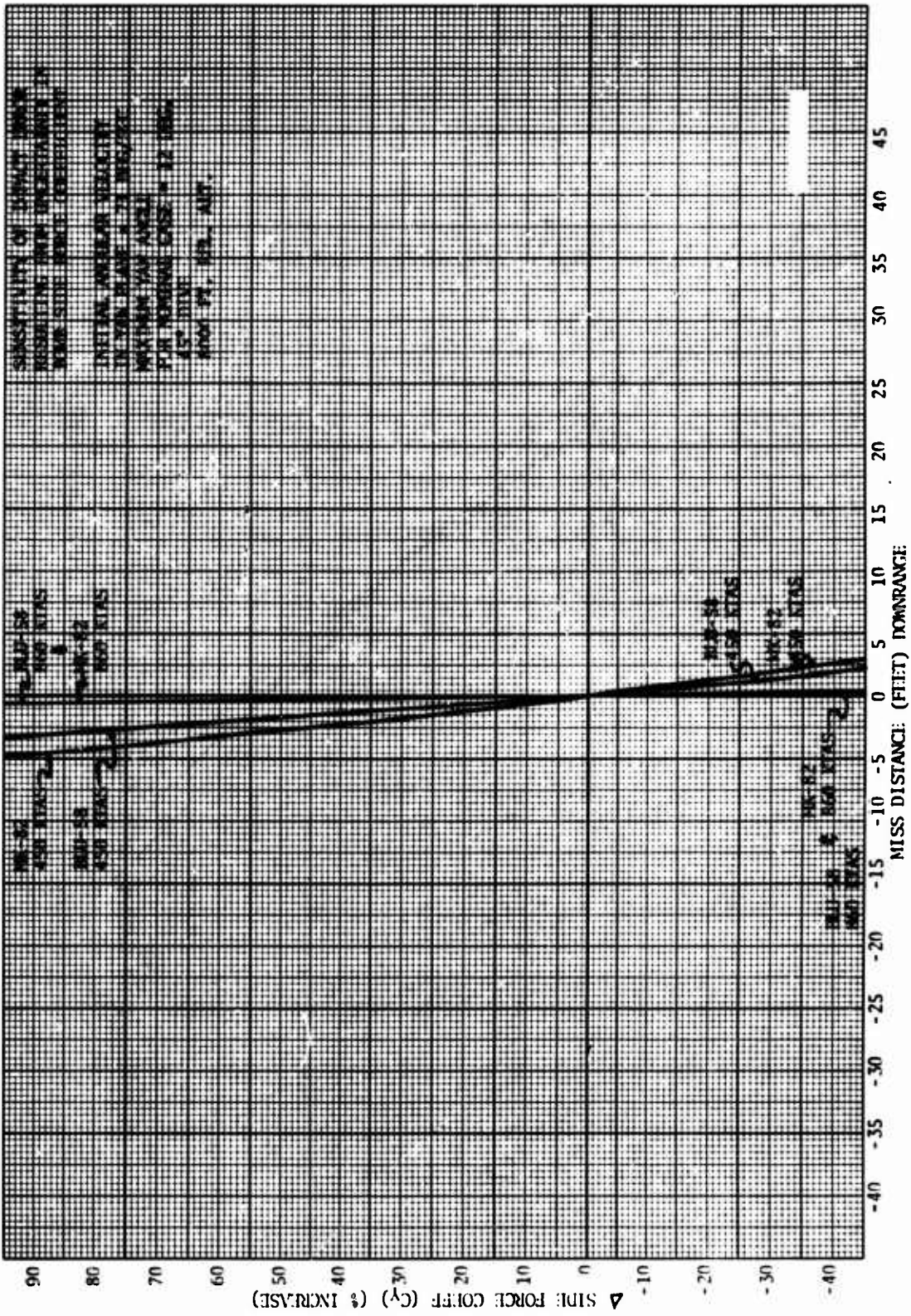

Figure 57. Bomb Side Force Coefficient Sensitivity (Downrange) 45° Dive, 8000 Ft Rel Alt

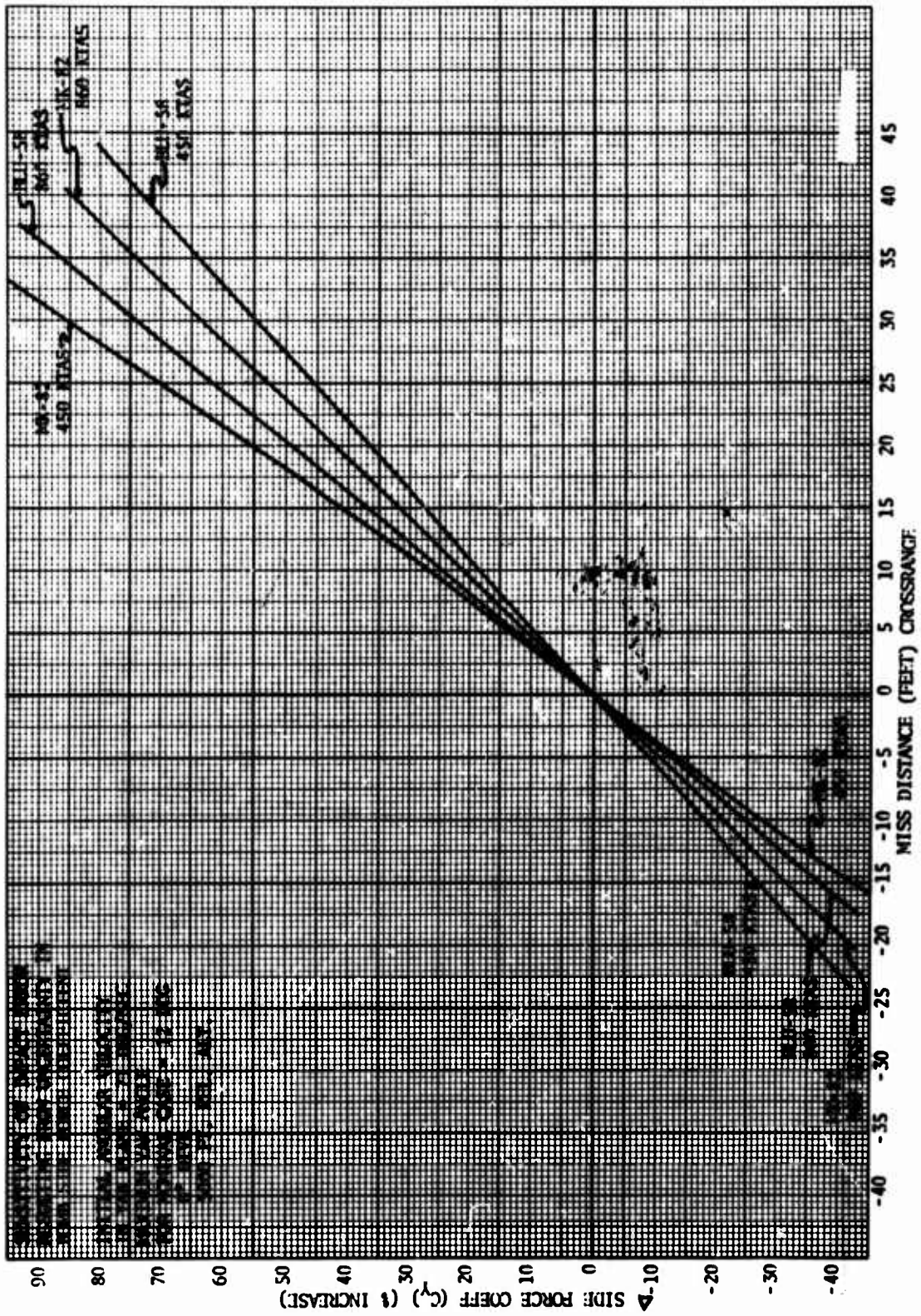

Figure 58. Bomb Side Force Coefficient Sensitivity (Crossrange) 0° Dive, 5000 Ft Rel Alt

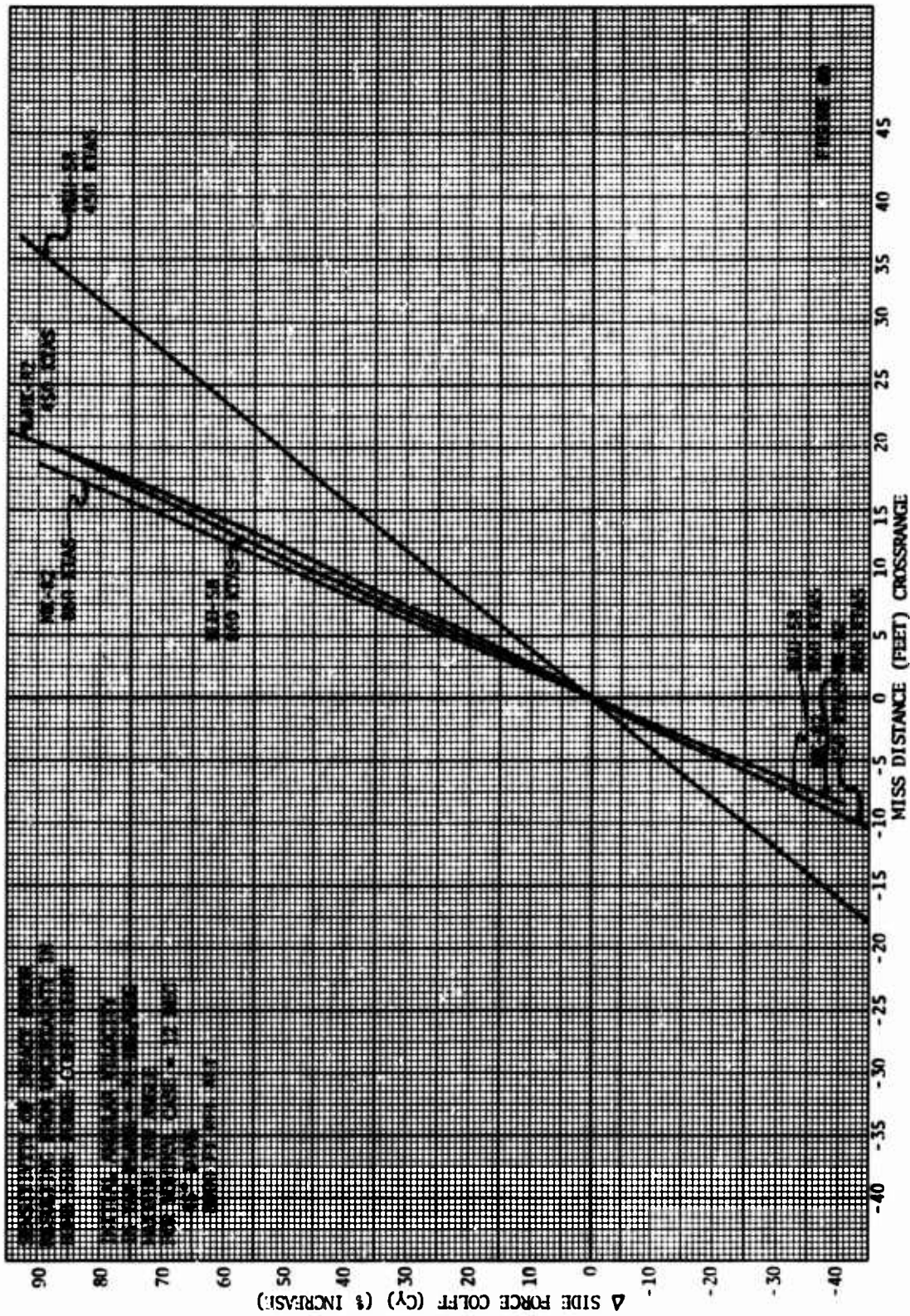

Figure 59. Bomb Side Force Coefficient Sensitivity (Crossrange) 45° Dive, 8000 Ft Rel Alt

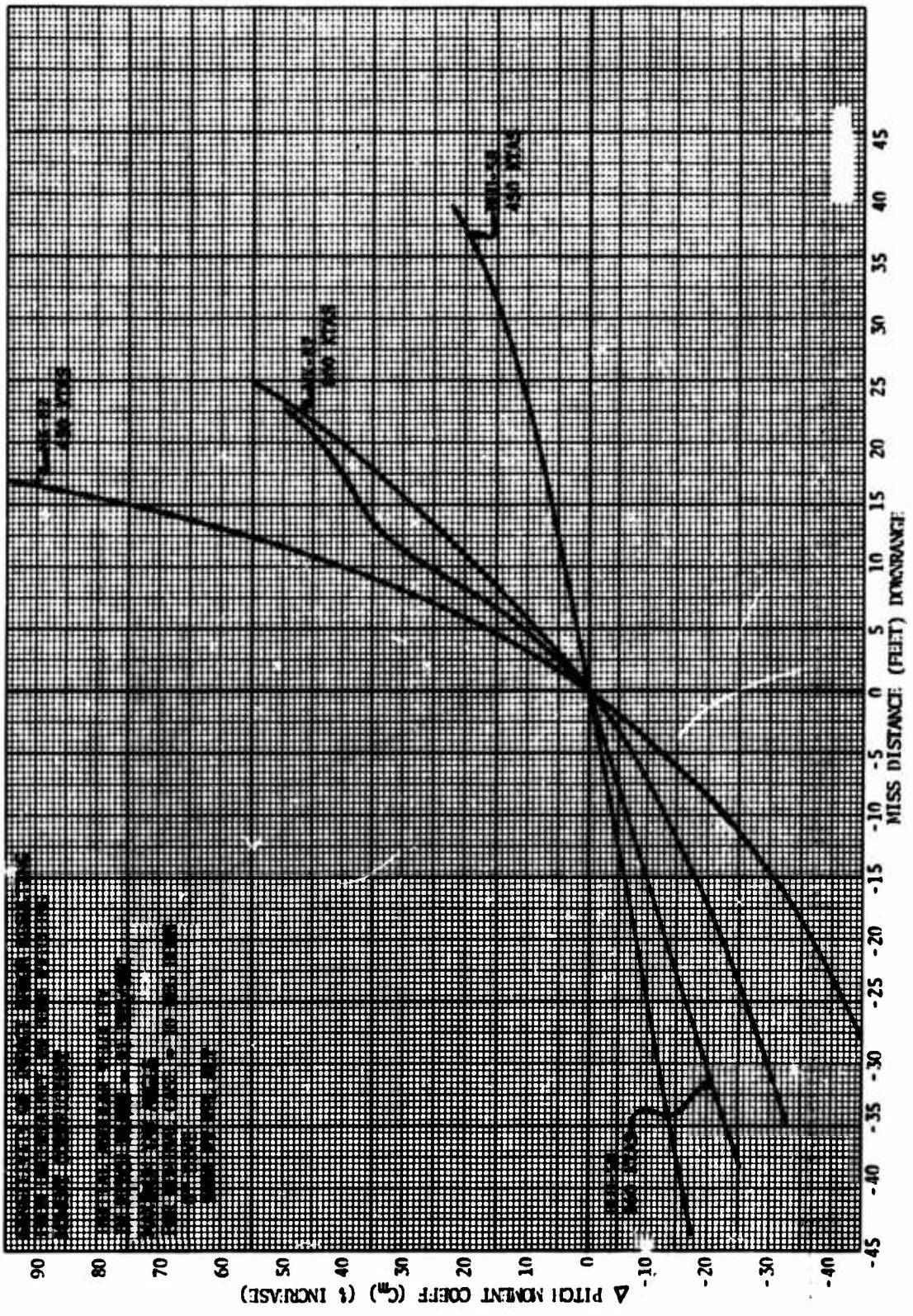

Figure 60. Bomb Pitching Moment Coefficient 0° Dive, 5000 Ft Rel Alt

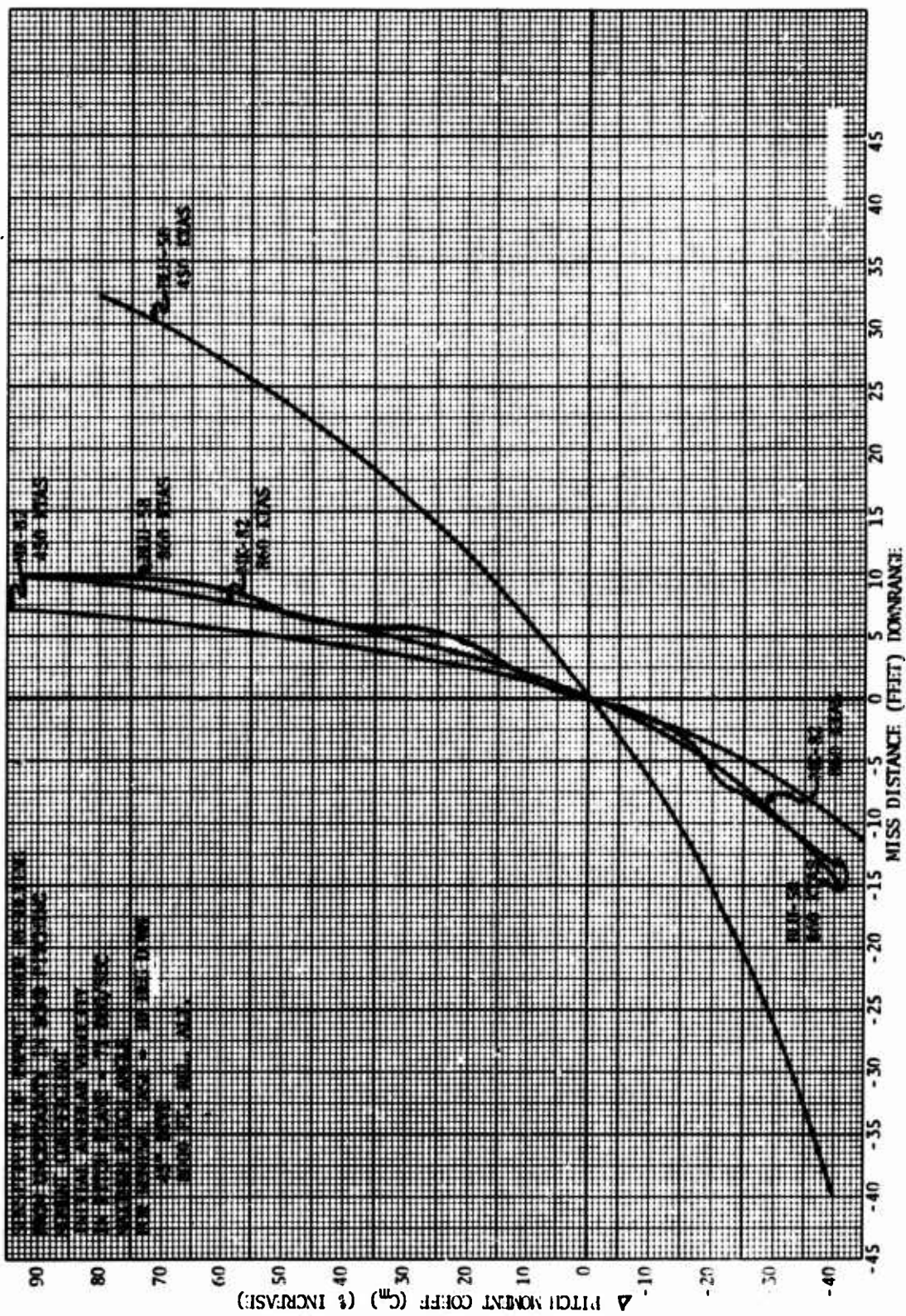

Figure 61. Bomb Pitching Moment Coefficient 45° Dive, 8000 Ft Rel Alt

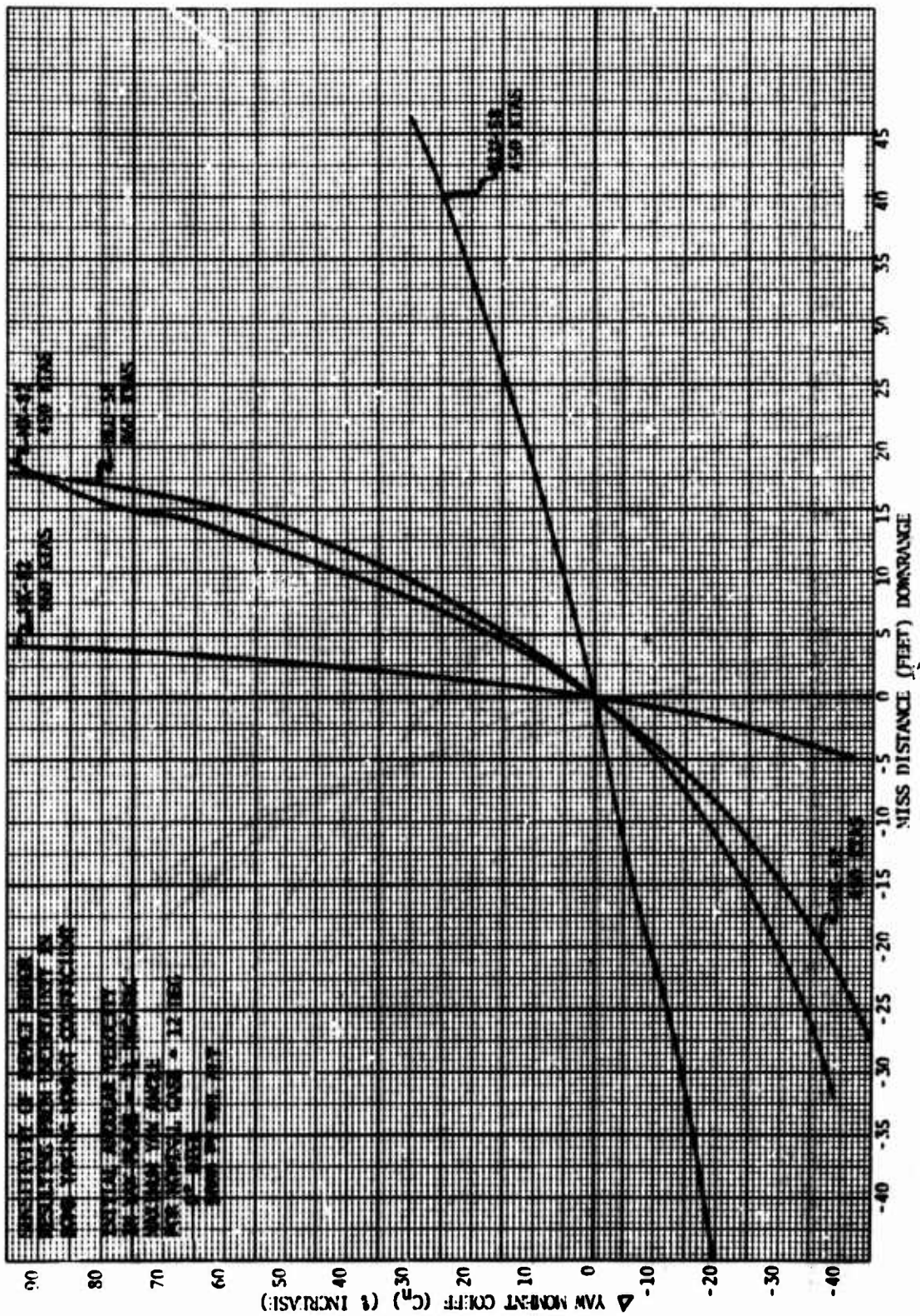

Figure 62. Bomb Yawing Moment Coefficient (Downrange) 0° Dive, 5000 Ft Rel Alt



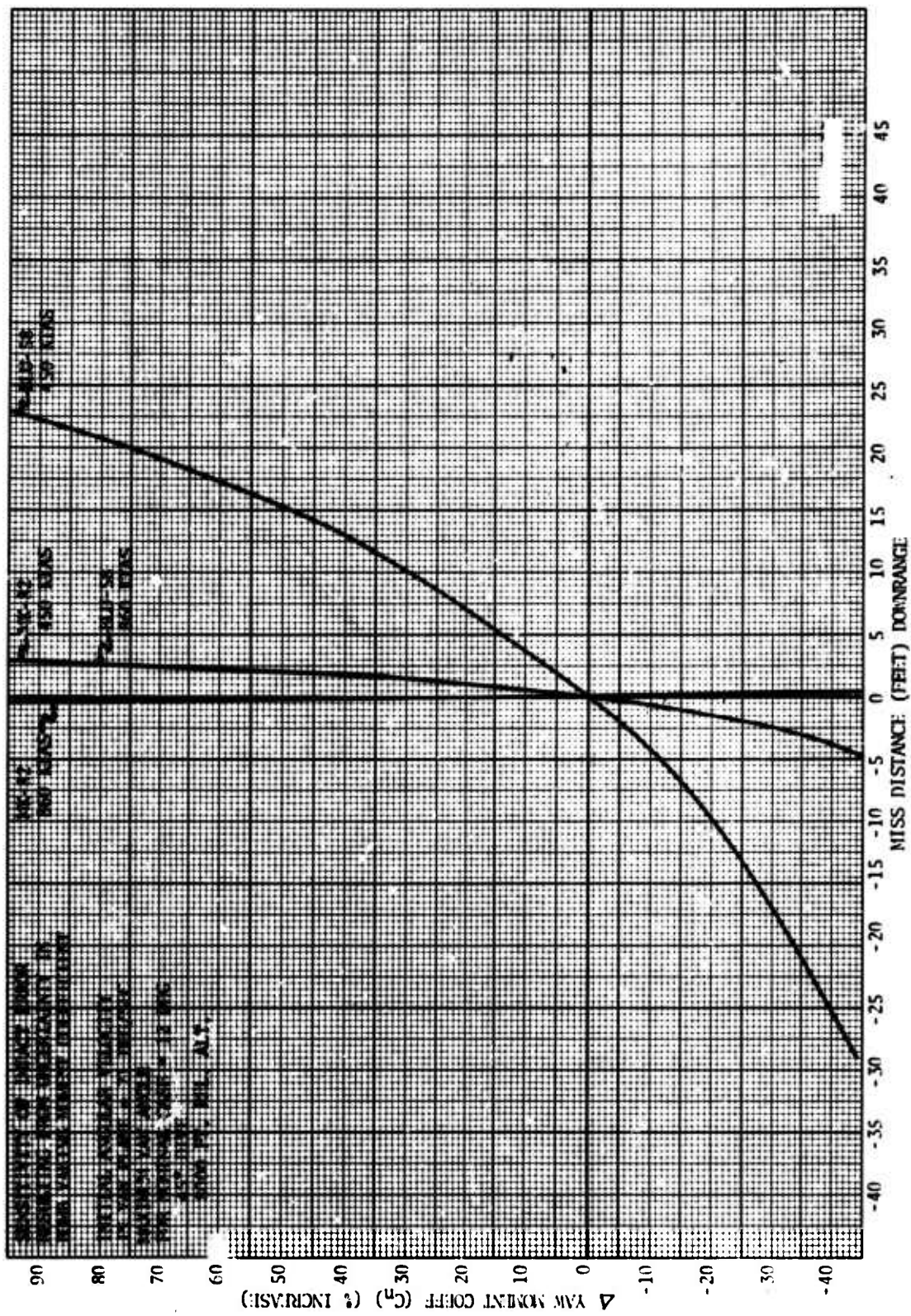

Figure 63. Bomb Yawing Moment Coefficient (Downrange) 45° Dive, 8000 Ft Rel Alt

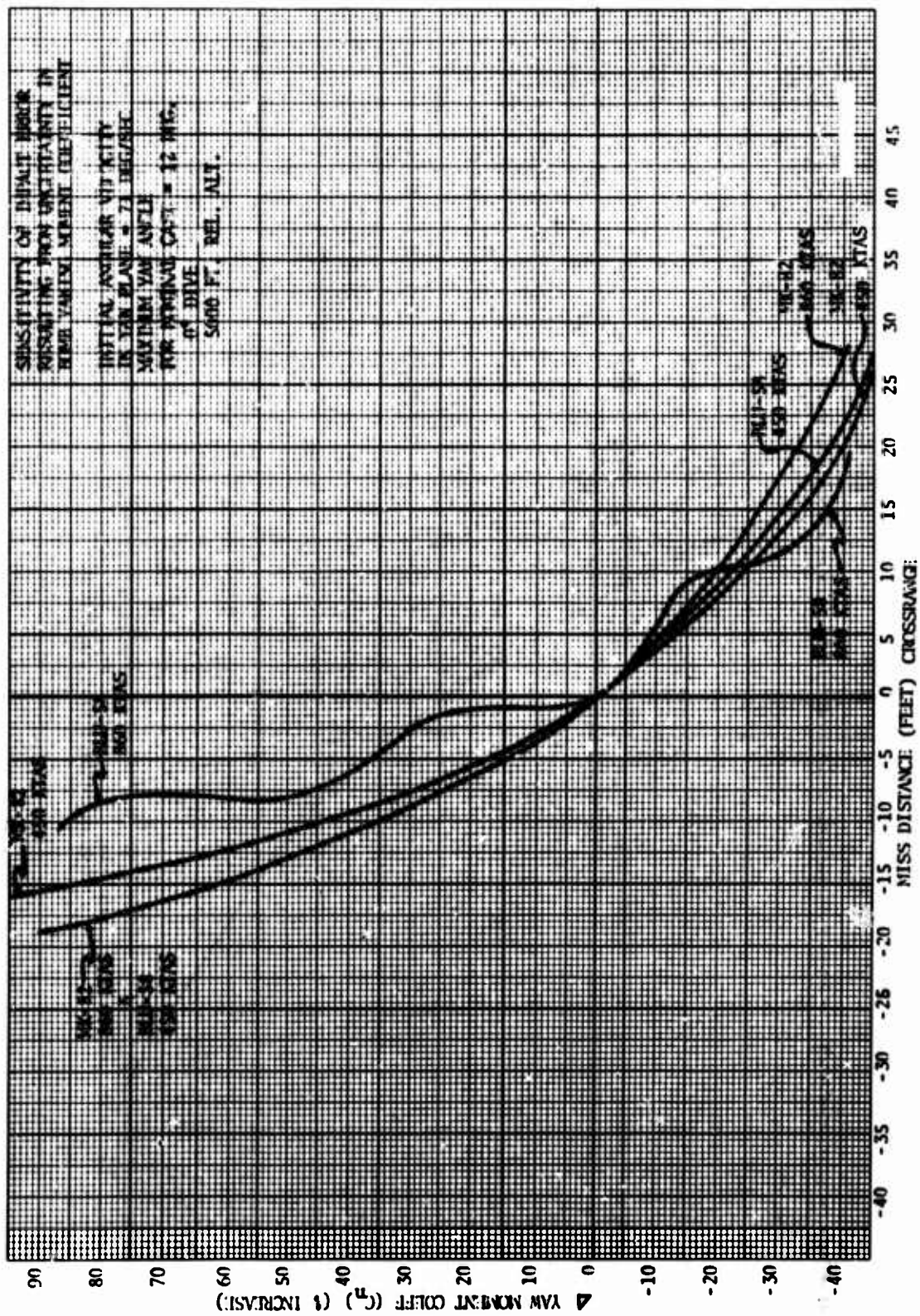

Figure 64. Bomb Yawing Moment Coefficient (Crossrange) 0° Dive, 5000 Ft Rel Alt

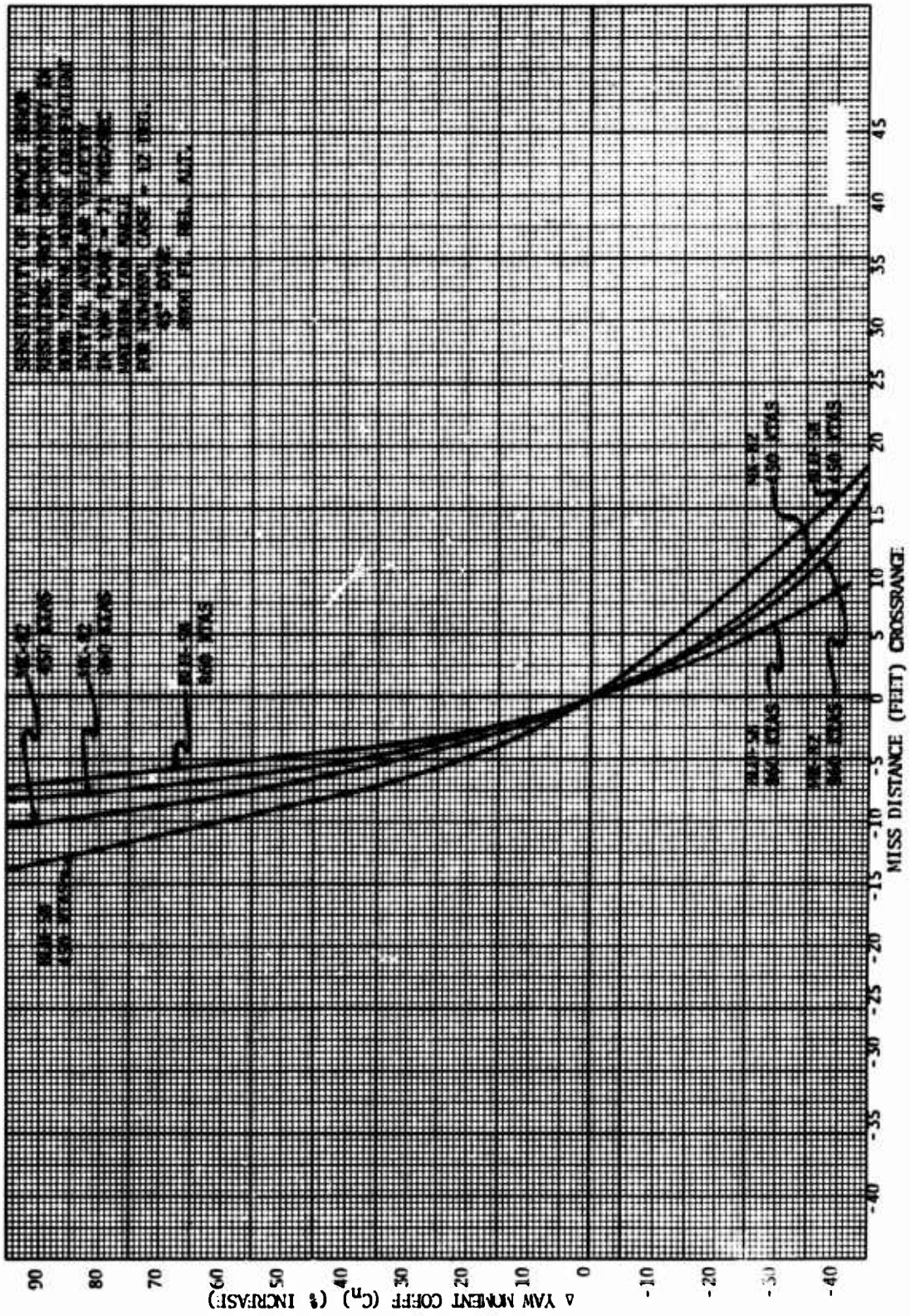

Figure 65. Bomb Yawing Moment Coefficient (Crossrange) 45° Dive, 8000 Ft Rel Alt

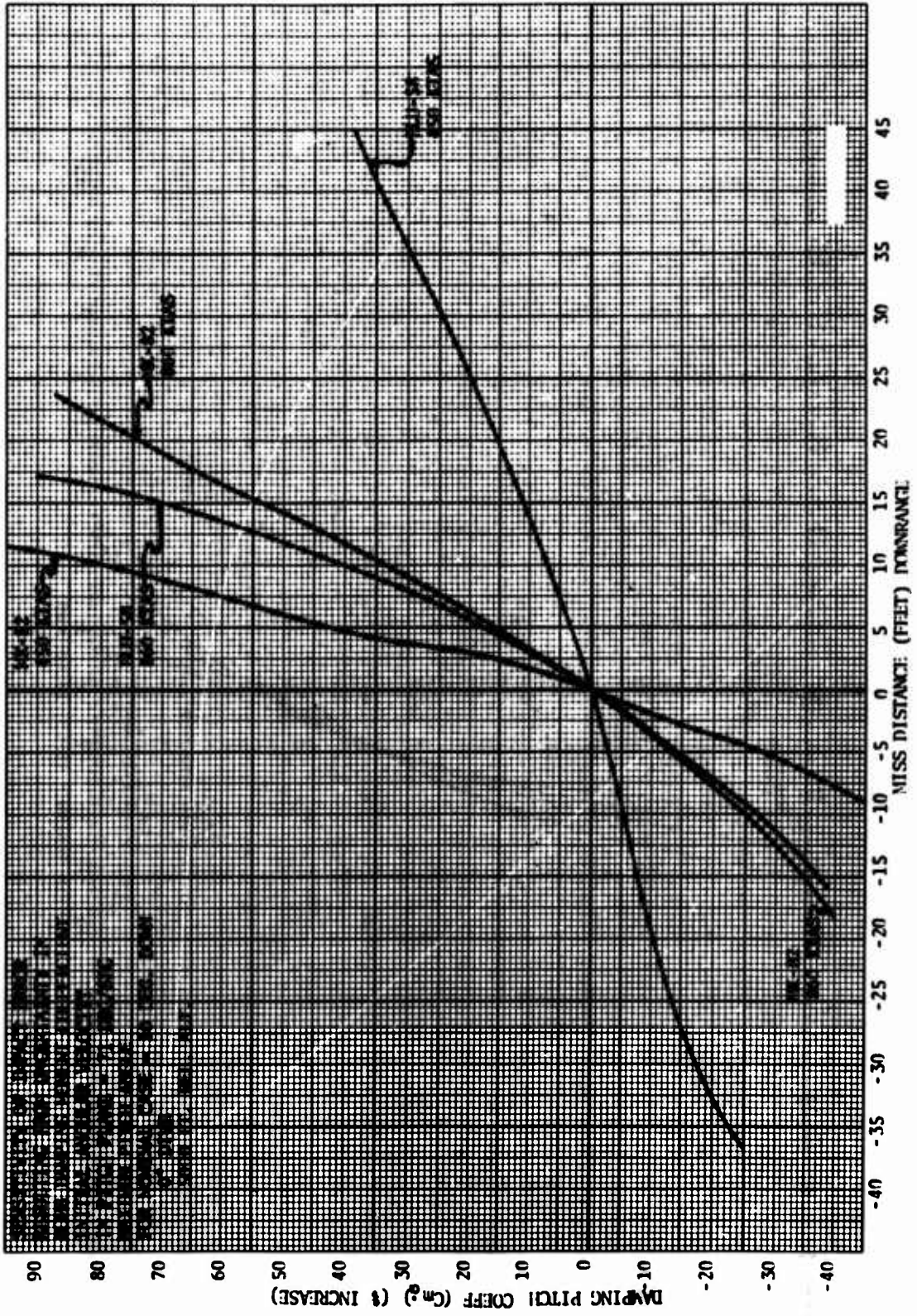

Figure 66. Bomb Pitch Damping Moment Coefficient 0° Dive, 5000 Ft Rel Alt

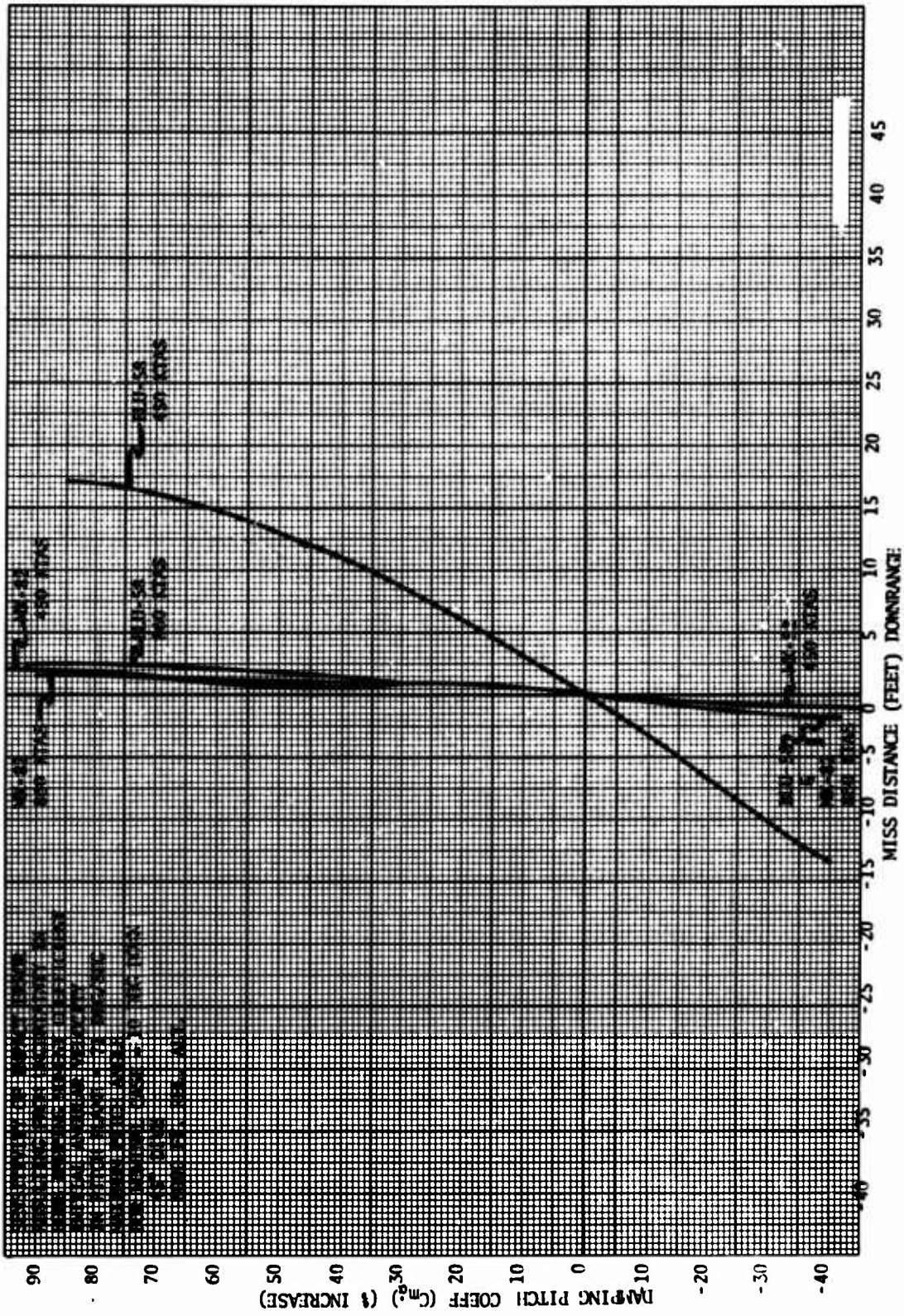

Figure 67. Bomb Pitch Damping Moment Coefficient 45° Dive, 8000 Ft Rel Alt

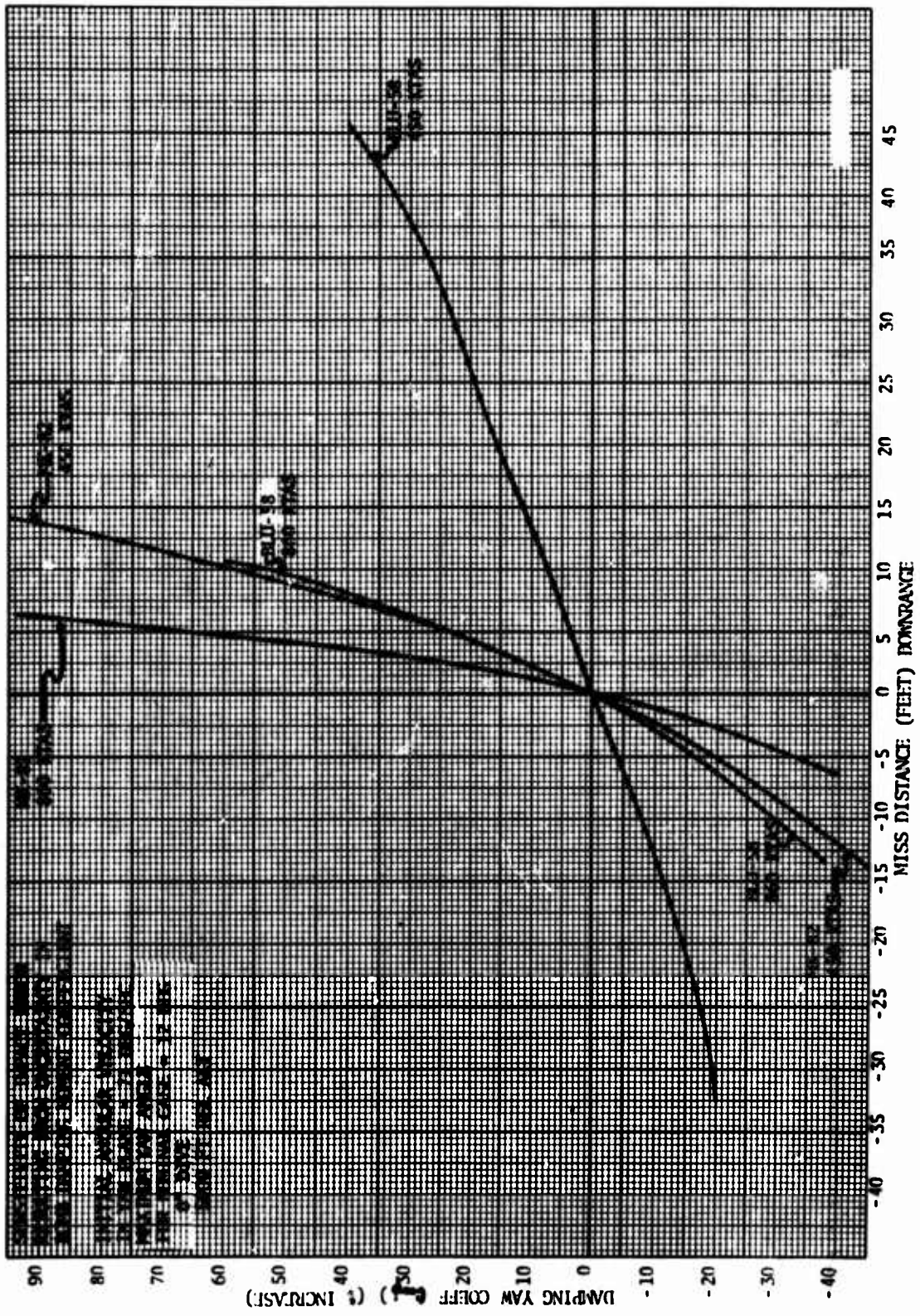

Figure 68. Bomb Yaw Damping Moment Coefficient (Downrange) 0° Dive, 5000 Ft Rel Alt

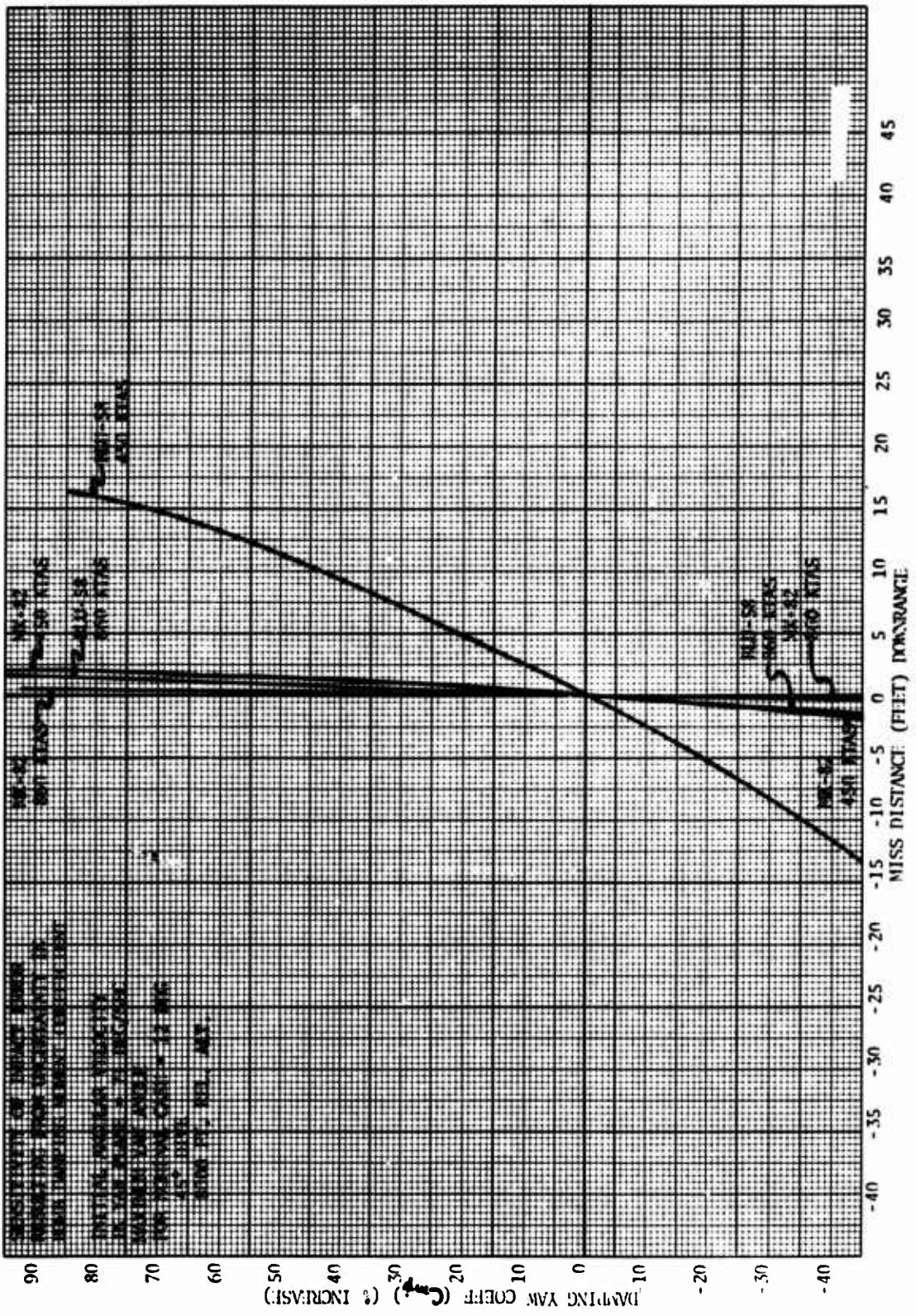

Figure 69. Bomb Yaw Damping Moment Coefficient (Downrange) 45° Dive, 8000 Ft Rel Alt

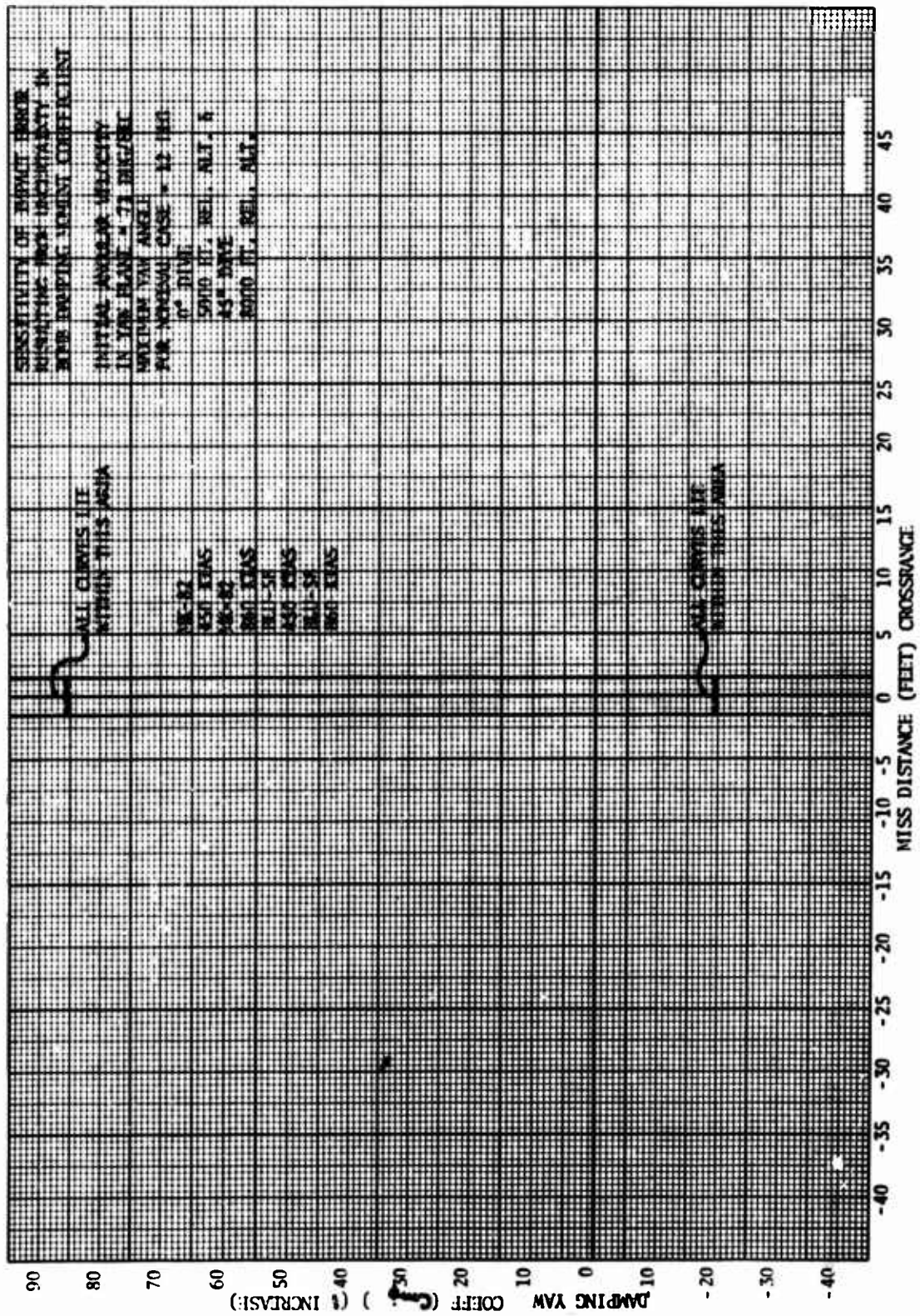

Figure 70. Bomb Yaw Damping Moment Coefficient (Crossrange) 0° Dive, 5000 Ft Rel Alt, 45° Dive, 8000 Ft Rel Alt



## SECTION IV

### SYSTEM ACCURACY ANALYSIS

#### Sample Data Computations for System Accuracy Study

In Section II, the overall methodology for this study was explained without reference to actual numbers used in the various computations. This section presents two sample groups of system accuracy computations (one for the basic 7-mil-level-system and one for the basic 7-mil-dive-system) in order to further clarify the process used in obtaining the results of the system accuracy portion of the study.

1. Computation of high-drag subsonic REP values, assuming a basic 7-mil-level-system:

a. Common Conditions

Release Angle = level  
Release Velocity = 450 kts  
Release Altitude = 5,000 ft

Variable Conditions

BOMB = Mk-82 for low drag  
BOMB = BLU-58 for high drag

b. First, the sensitivities and their ratios for the release parameters are computed. (These are obtained from the sensitivity graphs for this particular delivery condition.)

<u>RELEASE PARAMETERS</u>	<u>HIGH-DRAG SENSITIVITY</u>	<u>LOW-DRAG SENSITIVITY</u>	<u>H/L-DRAG SENSITIVITY RATIO</u>
Altitude	1.08	1.30	0.83
Velocity	13.20	16.78	0.79
Dive Angle	222.86	294.29	0.76
Ejection Velocity	17.05	22.00	<u>0.77</u>

Average Ratio = 0.79

c. Next, the sensitivities and their ratios for the weapon parameters are computed. (These are also obtained from the sensitivity graphs.)

<u>RELEASE PARAMETERS</u>	<u>HIGH-DRAG SENSITIVITY</u>	<u>LOW-DRAG SENSITIVITY</u>	<u>H/L-DRAG SENSITIVITY RATIO</u>
Weight	2.12	0.40	5.33
Diameter	171.83	45.48	3.78
Axial Force Coeff	12.81	2.47	5.18
Air Density	12.69	2.39	<u>5.32</u>

Average Ratio = 4.90

d. The sensitivity ratios are now ready to be converted to REP values for each system.

(1) Basic 7-Mil-Level-System (450 Knots, Mk-82)

<u>ERROR SOURCE</u>	<u>MILS</u>	<u>(CEP)<sub>N</sub></u>	<u>(CEP)<sub>N</sub> csc <math>\phi</math></u>	<u>REP</u>
Pipper Placement	2	28	77	67
Release Parameters	6	84	232	202
Weapon Parameters	3	42	116	101
Root Mean Square	7	97	271	236

(2) High-Drag System (450 Knots, BLU-58)

<u>ERROR SOURCE</u>	<u>HIGH-DRAG REP COMPUTATION</u>	<u>REP</u>
Pipper Placement	2 mils <sup>7</sup>	57
Release Parameters	(79%) (202 ft)	159
Weapon Parameters	(490%) (101 ft)	495

Root Mean Square = 523

<sup>7</sup> Even though the pipper placement error is 2 mils for both systems and the release conditions are identical, the REP values differ because the high-drag weapon has a shorter slant range and steeper line-of-sight angle.

e. All of the above computations result in two points on the appropriate graph. One point represents the root mean square REP value for the Mk-82, 450 knots, 5,000 feet, level release system, and one point represents the root mean square REP value for the BLU-58, 450 knots, 5,000 feet, level release system.

2. Computation of low-drag supersonic REP values, assuming a basic 7-mil-dive-system:

a. Common Conditions

BOMB = Mk-82

Variable Conditions

{ Release Angle = 45-degree dive  
 { Release Velocity = 450 knots  
 { Release Altitude = 8,000 feet  
 { Release Angle = 45-degree dive  
 { Release Velocity = 860 knots  
 { Release Altitude = 8,000 feet

b. <u>RELEASE PARAMETERS</u>	<u>SUPERSONIC SENSITIVITY</u>	<u>SUBSONIC SENSITIVITY</u>	<u>860 KT/450 KT SENSITIVITY RATIO</u>
Altitude	0.80	0.59	1.36
Velocity	0.96	3.17	0.30
Dive Angle	223.21	164.29	1.36
Ejection Velocity	8.77	12.30	<u>0.71</u>

Average Ratio = 0.94

c. <u>WEAPON PARAMETERS</u>	<u>SUPERSONIC SENSITIVITY</u>	<u>SUBSONIC SENSITIVITY</u>	<u>860 KT/450 KT SENSITIVITY RATIO</u>
Weight	0.08	0.05	1.75
Diameter	9.29	5.36	1.73
Axial Force Coeff	0.52	0.30	1.73
Air Density	0.49	0.28	<u>1.75</u>

Average Ratio = 1.74

d. (1) Basic 7-Mil-Dive-System (450 Knots, Mk-82)

<u>ERROR SOURCE</u>	<u>MILS</u>	<u>(CEP)<sub>N</sub></u>	<u>(CEP)<sub>N</sub> csc <math>\phi</math></u>	<u>REP</u>
Pipper Placement	2	20	25	22
Release Parameters	6	59	74	64
Weapon Parameters	3	30	37	32
Root Mean Square	7	69	86	75

(2) Supersonic System (860 Knots, Mk-82)

<u>ERROR SOURCE</u>	<u>SUPERSONIC REP COMPUTATION</u>	<u>REP</u>
Pipper Placement	4 mils	50
Release Parameters	(94%) (64)	60
Weapon Parameters	(174%) (32)	56

Root Mean Square = 96

e. All of the above computations result in two points on the appropriate graph. One point represents the root mean square REP value for the Mk-82, 450 knots, 8,000 feet, 45-degree dive release system, and one point represents the root mean square REP value for the Mk-82, 860 knots, 8,000 feet, 45-degree dive release system.

System Accuracy Data Table

1. 7-mil-level-systems(5000 feet release altitude, level release)

a. Low Drag

RELEASE VELOCITY kts	PIPPER		RANGE ERROR PROBABLE (REP) RELEASE WEAPON PARAMETERS PARAMETERS		ROOT MEAN SQUARE feet	PERCENTAGE OF BASE SYSTEM
	mils	feet	feet	feet		
200	2	24	108	21	113	48%
450	2	67	202	101	236	100%
660	3	197	292	208	409	173%
860	4	391	359	784	947	401%
960	4	476	407	1014	1191	505%

b. High Drag

200	2	19	93	122	158	67%
450	2	57	159	495	523	222%
660	3	139	182	975	1001	424%
860	4	232	191	1433	1464	620%
960	4	255	196	1670	1700	720%

2. 14-mil-level-systems(5000 feet release altitude, level release)

a. Low Drag

200	6	71	222	21	234	50%
450	6	202	414	101	472	100%
660	9	593	598	203	868	184%
860	12	1173	736	784	1591	337%
960	12	1428	833	1014	1939	411%

b. High Drag

200	6	58	201	122	242	51%
450	6	170	326	495	617	131%
660	9	417	372	975	1124	238%
860	12	698	392	1433	1641	348%
960	12	764	401	1670	1879	398%

System Accuracy Data Table (Continued)

RELEASE VELOCITY	PIPPER		RANGE ERROR PROBABLE (REP)		ROOT MEAN SQUARE	PERCENTAGE OF BASE SYSTEM
kts	mils	feet	RELEASE PARAMETERS	WEAPON PARAMETERS	feet	

3. 30-mil-level-systems (5000 feet release altitude, level release)

a. Low Drag

200	10	118	508	21	522	52%
450	10	337	947	101	1010	100%
660	15	989	1369	208	1701	168%
860	20	1954	1683	784	2696	267%
960	20	2379	1907	1014	3213	318%

b. High Drag

200	10	97	460	122	486	48%
450	10	283	746	495	940	93%
660	15	695	852	975	1469	131%
860	20	1162	895	1433	2051	203%
960	20	1274	917	1670	2291	227%

4. 50-mil-level-systems (5000 feet release altitude, level release)

a. Low Drag

200	15	177	860	21	878	52%
450	15	505	1603	101	1684	100%
660	22.5	1484	2316	208	2759	164%
860	30	2931	2849	784	4163	247%
960	30	3570	3227	1014	4918	292%

b. High Drag

200	15	145	780	122	802	48%
450	15	425	1264	495	1423	85%
660	22.5	1042	1441	975	2028	120%
860	30	1743	1516	1433	2719	161%
960	30	1910	1552	1670	2974	177%

System Accuracy Data Table (Continued)

RELEASE VELOCITY	PIPPER		RANGE ERROR PROBABLE (REP)		ROOT MEAN SQUARE feet	PERCENTAGE OF BASE SYSTEM
	kts	mils	feet	feet		

5. 7-mil-dive-systems (8000 feet release altitude, 45° dive angle)

a. Low Drag

200	2	17	75	25	81	108%
450	2	22	64	32	75	100%
660	3	36	60	37	79	105%
860	4	50	60	56	96	128%
960	4	50	60	46	91	121%

b. High Drag

200	2	17	72	154	171	228%
450	2	21	61	216	225	300%
660	3	35	55	254	262	349%
860	4	48	54	329	337	449%
960	4	49	55	355	362	483%

6. 14-mil-dive-systems (8000 feet release altitude, 45° dive angle)

a. Low Drag

200	6	50	153	25	163	108%
450	6	64	132	32	151	100%
660	9	106	124	37	167	111%
860	12	150	124	56	202	134%
960	12	152	123	46	201	133%

b. High Drag

200	6	50	147	154	219	145%
450	6	63	124	216	257	170%
660	9	104	112	254	297	197%
860	12	144	111	329	376	249%
960	12	146	111	355	399	264%

System Accuracy Data Table (Continued)

RELEASE VELOCITY	RANGE ERROR PROBABLE (REP)					PERCENTAGE OF BASE SYSTEM
	PIPPER	RELEASE PARAMETERS		WEAPON PARAMETERS	ROOT MEAN SQUARE	
kts	mils	feet	feet	feet	feet	
<b>7. 30-mil-dive systems (8000 feet release altitude, 45° dive angle)</b>						
<b>a. Low Drag</b>						
200	10	84	351	25	362	112%
450	10	107	302	32	322	100%
660	15	177	284	37	336	104%
860	20	249	282	56	380	119%
960	20	253	281	46	381	118%
<b>b. High Drag</b>						
200	10	84	337	154	380	118%
450	10	105	285	216	373	116%
660	15	172	258	254	401	125%
860	20	239	255	329	480	149%
960	20	244	255	355	500	155%
<b>8. 50-mil-dive-systems (8000 feet release altitude, 45° dive angle)</b>						
<b>a. Low Drag</b>						
200	15	127	593	25	608	113%
450	15	161	510	32	536	100%
660	22.5	266	479	37	550	103%
860	30	373	478	56	609	114%
960	30	380	475	46	610	114%
<b>b. High Drag</b>						
200	15	125	670	154	602	112%
450	15	157	483	216	552	103%
660	22.5	258	436	254	567	106%
860	30	359	432	329	650	121%
960	30	365	432	355	667	124%



System Accuracy Data Table (Continued)

	PIPPER		RANGE ERROR PROBABLE (REP)		ROOT MEAN SQUARE feet	PERCENTAGE OF BASE SYSTEM
	mils	feet	RELEASE PARAMETERS feet	WEAPON PARAMETERS feet		
<b>9. 7-mil-level-systems (5000 feet release altitude)</b>						
<b>a. Low Drag, 450 knots</b>						
Level	2	67	202	101	236	100%
15° Dive	2	37	150	35	158	67%
30° Dive	2	22	104	11	106	45%
<b>b. High Drag, 450 knots</b>						
Level	2	57	162	498	526	223%
15° Dive	2	34	131	204	244	103%
30° Dive	2	21	97	77	125	53%
<b>c. Low Drag, 860 knots</b>						
Level	4	391	358	777	940	398%
15° Dive	4	132	217	129	284	120%
30° Dive	4	57	121	23	135	57%
<b>d. High Drag, 860 knots</b>						
Level	4	232	187	1318	1351	572%
15° Dive	4	108	158	461	499	211%
30° Dive	4	53	107	130	176	75%
<b>10. 14-mil-level-systems (5000 feet release altitude)</b>						
<b>a. Low Drag, 450 knots</b>						
Level	6	202	414	101	472	100%
15° Dive	6	110	305	35	327	67%
30° Dive	6	64	211	11	221	47%
<b>b. High Drag, 450 knots</b>						
Level	6	170	331	501	621	132%
15° Dive	6	102	268	204	352	75%
30° Dive	6	63	198	77	222	47%

System Accuracy Data Table (Continued)

	PIPPER	RANGE ERROR PROBABLE (REP)		WEAPON	ROOT MEAN	PERCENTAGE
	mils	feet	feet	PARAMETERS	SQUARE	OF BASE
				feet	feet	SYSTEM
<b>c. Low Drag, 860 knots</b>						
Level	12	1173	733	777	1586	336%
15° Dive	12	396	443	129	608	129%
30° Dive	12	170	247	23	301	64%
<b>d. High Drag, 860 knots</b>						
Level	12	698	384	1318	1540	326%
15° Dive	12	325	324	461	650	138%
30° Dive	12	160	218	130	300	64%
<b>11. 30-mil-level-systems (5000 feet release altitude)</b>						
<b>a. Low Drag, 450 knots</b>						
Level	10	337	947	101	1010	100%
15° Dive	10	184	699	35	724	72%
30° Dive	10	108	484	11	496	49%
<b>b. High Drag, 450 knots</b>						
Level	10	283	756	498	948	94%
15° Dive	10	170	614	204	669	66%
30° Dive	10	104	453	77	472	47%
<b>c. Low Drag, 860 knots</b>						
Level	20	1954	1676	777	2689	266%
15° Dive	20	660	1014	129	1217	120%
30° Dive	20	284	566	23	633	63%
<b>d. High Drag, 860 knots</b>						
Level	20	1162	877	1318	1964	194%
15° Dive	20	540	741	461	1027	102%
30° Dive	20	266	500	130	581	58%

System Accuracy Data Table (Continued)

	RANGE ERROR PROBABLE (REP)				ROOT MEAN SQUARE feet	PERCENTAGE OF BASE SYSTEM
	PIPPER		RELEASE	WEAPON		
	mils	feet	PARAMETERS feet	PARAMETERS feet		
<b>12. 50-mil-level-systems (5000 feet release altitude)</b>						
<b>a. Low Drag, 450 knots</b>						
Level	15	505	1603	101	1684	100%
15° Dive	15	277	1184	35	1217	72%
30° Dive	15	162	820	11	835	50%
<b>b. High Drag, 450 knots</b>						
Level	15	425	1281	498	1438	85%
15° Dive	15	255	1039	204	1089	65%
30° Dive	15	157	767	77	787	47%
<b>c. Low Drag, 860 knots</b>						
Level	30	2931	2839	777	4151	246%
15° Dive	30	990	1717	129	1986	118%
30° Dive	30	425	957	23	1048	62%
<b>d. High Drag, 860 knots</b>						
Level	30	1743	1485	1318	2642	157%
15° Dive	30	811	1255	461	1563	93%
30° Dive	30	399	847	130	945	56%
<b>13. 7-mil-level-systems (level release)</b>						
<b>a. Low Drag, 450 knots</b>						
10000 ft	2	87	207	137	263	111%
8000 ft	2	83	204	152	268	114%
5000 ft	2	67	202	101	236	100%
3000 ft	2	64	206	63	225	95%
1000 ft	2	60	240	21	248	105%
500 ft	2	58	272	10	279	118%

System Accuracy Data Table (Continued)

	PIPPER		RANGE ERROR PROBABLE (REP)		ROOT MEAN SQUARE	PERCENTAGE OF BASE SYSTEM
	mils	feet	RELEASE PARAMETERS feet	WEAPON PARAMETERS feet		
<b>b. High Drag, 450 knots</b>						
10000 ft	2	72	156	860	877	372%
8000 ft	2	69	155	725	745	316%
5000 ft	2	57	159	495	523	223%
3000 ft	2	55	170	318	365	155%
1000 ft	2	54	213	116	249	106%
500 ft	2	54	259	59	272	115%
<b>c. Low Drag, 860 knots</b>						
10000 ft	4	454	339	1349	1463	620%
8000 ft	4	451	343	1136	1269	538%
5000 ft	4	391	359	784	947	401%
3000 ft	4	393	386	510	751	318%
1000 ft	4	399	482	186	653	277%
500 ft	4	402	576	93	708	300%
<b>d. High Drag, 860 knots</b>						
10000 ft	4	261	166	2154	2176	922%
8000 ft	4	261	172	1892	1918	813%
5000 ft	4	232	191	1433	1464	620%
3000 ft	4	244	221	1047	1098	465%
1000 ft	4	278	320	517	669	283%
500 ft	4	300	418	318	604	256%
<b>14. 14-mil-level-systems (level release)</b>						
<b>a. Low Drag, 450 knots</b>						
10000 ft	6	262	424	137	517	110%
8000 ft	6	250	418	152	510	108%
5000 ft	6	202	414	101	472	100%
3000 ft	6	191	423	63	468	99%
1000 ft	6	179	492	21	524	111%
500 ft	6	174	559	10	585	124%

System Accuracy Data Table (Continued)

	PIPPER		RANGE ERROR PROBABLE (REP)		ROOT MEAN SQUARE feet	PERCENTAGE OF BASE SYSTEM
	mils	feet	RELEASE PARAMETERS feet	WEAPON PARAMETERS feet		
<b>b. High Drag, 450 knots</b>						
10000 ft	6	216	319	860	942	200%
8000 ft	6	207	318	725	819	174%
5000 ft	6	170	326	495	617	131%
3000 ft	6	165	347	318	499	106%
1000 ft	6	163	437	116	480	102%
500 ft	6	163	532	59	559	118%
<b>c. Low Drag, 860 knots</b>						
10000 ft	12	1363	695	1349	2040	432%
8000 ft	12	1353	703	1136	1901	403%
5000 ft	12	1173	736	784	1591	337%
3000 ft	12	1180	792	510	1510	320%
1000 ft	12	1199	987	186	1564	331%
500 ft	12	1205	1179	93	1688	358%
<b>d. High Drag, 860 knots</b>						
10000 ft	12	782	340	2154	2316	491%
8000 ft	12	782	352	1892	2077	440%
5000 ft	12	698	392	1433	1641	348%
3000 ft	12	734	452	1047	1356	287%
1000 ft	12	836	656	517	1182	250%
500 ft	12	900	854	318	1281	271%
<b>15. 30-mil-level-systems (level release)</b>						
<b>a. Low Drag, 450 knots</b>						
10000 ft	10	436	971	137	1073	106%
8000 ft	10	416	957	152	1055	104%
5000 ft	10	337	947	101	1010	100%
3000 ft	10	319	967	63	1021	101%
1000 ft	10	299	1125	21	1164	115%
500 ft	10	290	1278	10	1311	130%

System Accuracy Data Table (Continued)

	PIPPER		RANGE ERROR PROBABLE (REP)		ROOT MEAN SQUARE feet	PERCENTAGE OF BASE SYSTEM
	mils	feet	RELEASE PARAMETERS feet	WEAPON PARAMETERS feet		
<b>b. High Drag, 450 knots</b>						
10000 ft	10	360	729	860	1183	117%
8000 ft	10	345	728	725	1084	107%
5000 ft	10	283	746	495	940	93%
3000 ft	10	275	795	318	899	89%
1000 ft	10	271	1000	116	1042	103%
500 ft	10	271	1217	59	1248	124%
<b>c. Low Drag, 860 knots</b>						
10000 ft	20	2272	1591	1349	3084	305%
8000 ft	20	2254	1609	1136	2993	296%
5000 ft	20	1954	1683	784	2696	267%
3000 ft	20	1967	1811	510	2722	270%
1000 ft	20	1998	2258	186	3021	299%
500 ft	20	2008	2698	93	3364	333%
<b>d. High Drag, 860 knots</b>						
10000 ft	20	1303	779	2154	2635	261%
8000 ft	20	1303	806	1892	2434	241%
5000 ft	20	1162	895	1433	2051	203%
3000 ft	20	1223	1035	1047	1914	190%
1000 ft	20	1394	1502	517	2114	209%
500 ft	20	1499	1956	318	2485	246%
<b>16. 50-mil-level-systems (level release)</b>						
<b>a. Low Drag, 450 knots</b>						
10000 ft	15	654	1644	137	1775	105%
8000 ft	15	625	1620	152	1743	104%
5000 ft	15	505	1603	101	1684	100%
3000 ft	15	479	1638	63	1708	101%
1000 ft	15	449	1904	21	1956	116%
500 ft	15	435	2164	10	2207	131%

System Accuracy Data Table (Concluded)

	RANGE ERROR PROBABLE (REP)				ROOT MEAN SQUARE feet	PERCENTAGE OF BASE SYSTEM
	PIPPER		RELEASE	WEAPON		
	mils	feet	PARAMETERS feet	PARAMETERS feet		
<b>b. High Drag, 450 knots</b>						
10000 ft	15	540	1234	860	1598	95%
8000 ft	15	517	1232	725	1521	90%
5000 ft	15	425	1264	495	1423	85%
3000 ft	15	412	1346	318	1443	86%
1000 ft	15	407	1691	116	1744	104%
500 ft	15	405	2060	59	2104	125%
<b>c. Low Drag, 860 knots</b>						
10000 ft	30	3409	2693	1349	4548	270%
8000 ft	30	3382	2723	1136	4488	267%
5000 ft	30	2931	2849	784	4163	247%
3000 ft	30	2950	3067	510	4285	254%
1000 ft	30	2998	3821	186	4861	289%
500 ft	30	3011	4566	93	5471	325%
<b>d. High Drag, 860 knots</b>						
10000 ft	30	1955	1318	2154	3193	190%
8000 ft	30	1954	1364	1892	3043	181%
5000 ft	30	1743	1516	1433	2719	161%
3000 ft	30	1835	1752	1047	2744	163%
1000 ft	30	2091	2542	517	3332	198%
500 ft	30	2248	3310	318	4014	238%

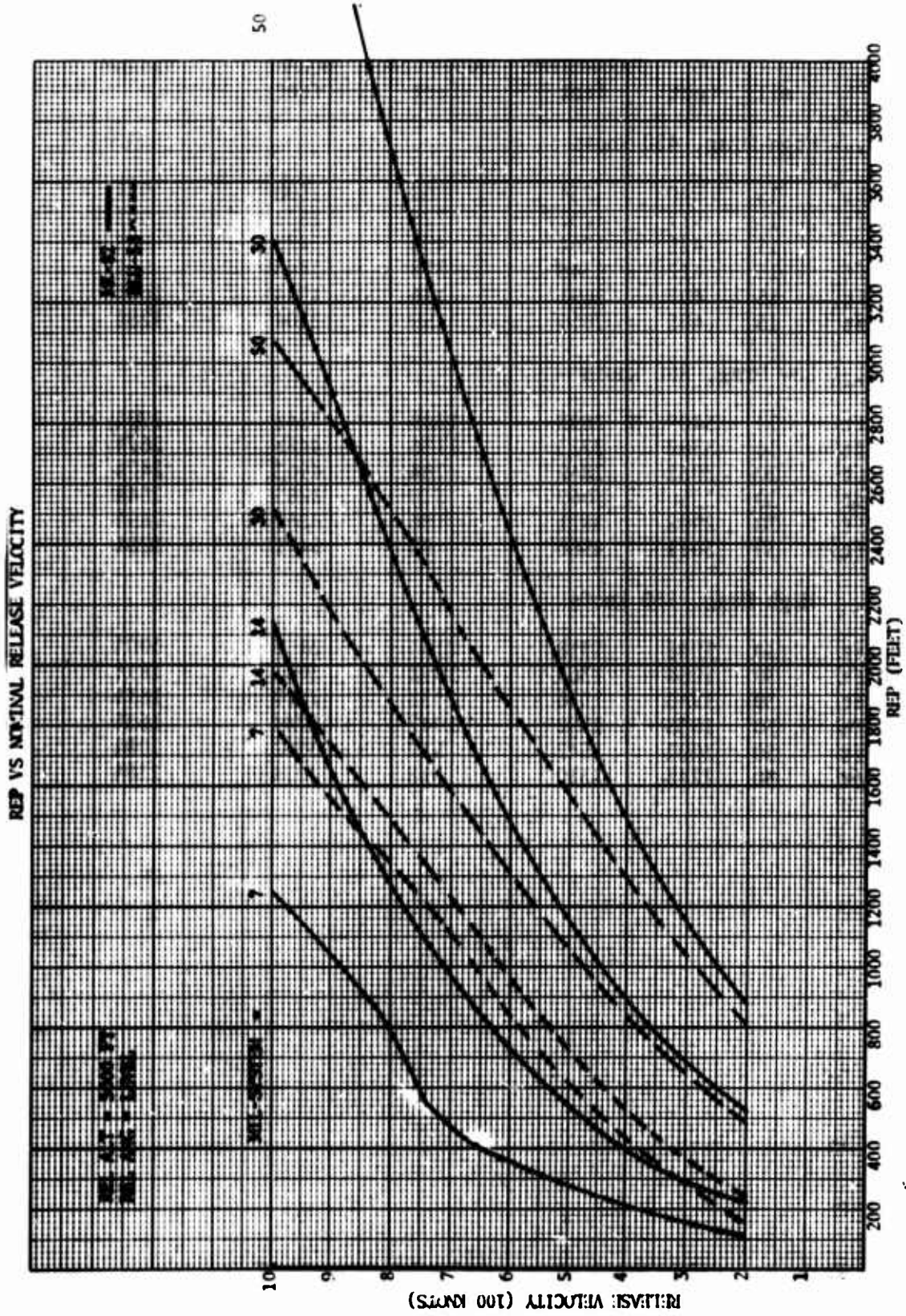

Figure 71. REP vs Nominal Release Velocity 5000 Ft Rel Alt, Level



REP VS NOMINAL RELEASE VELOCITY

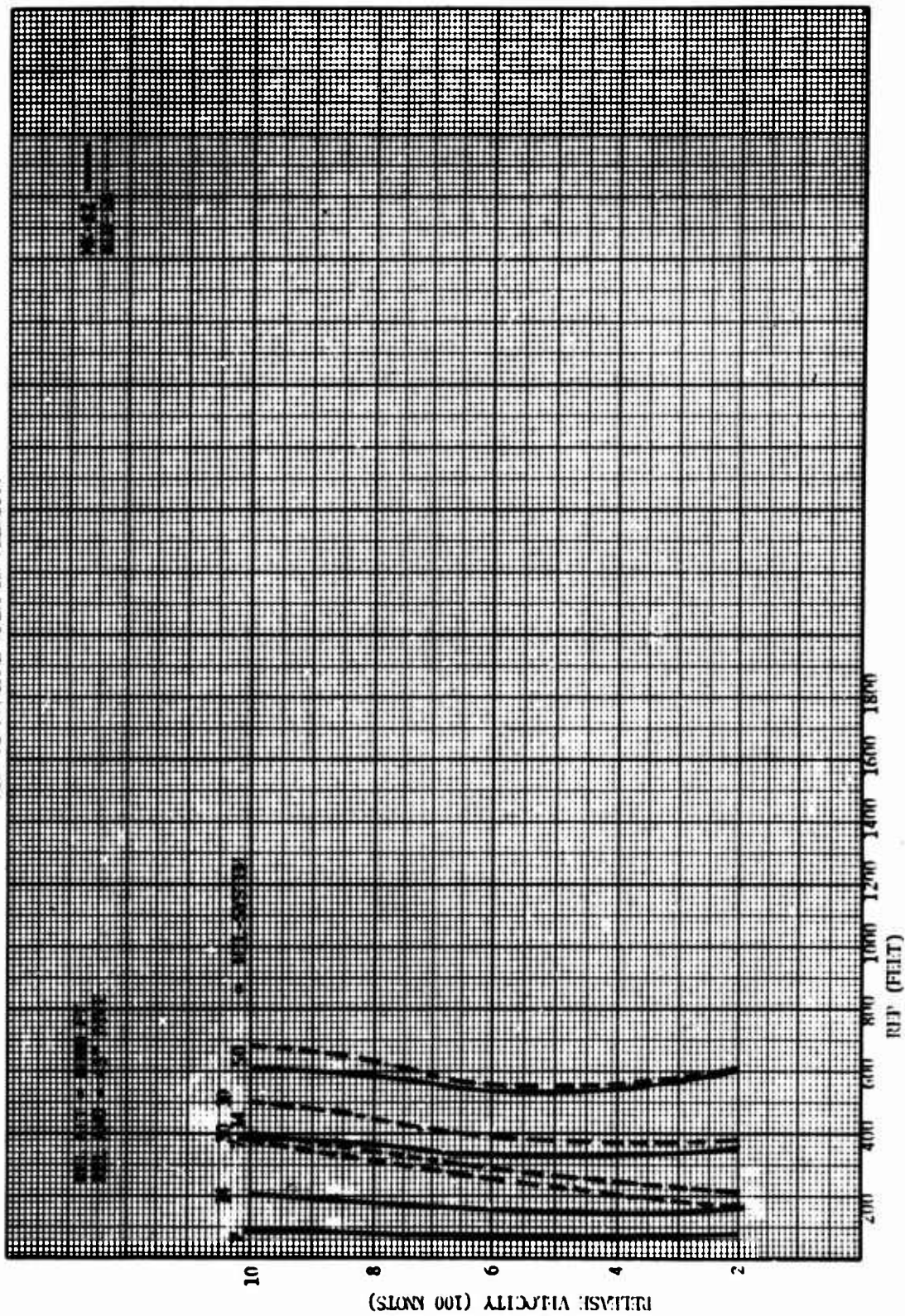

Figure 72. REP vs Nominal Release Velocity 8000 Ft Rel Alt, 45° Dive

REP VS NOMINAL RELEASE ANGLE

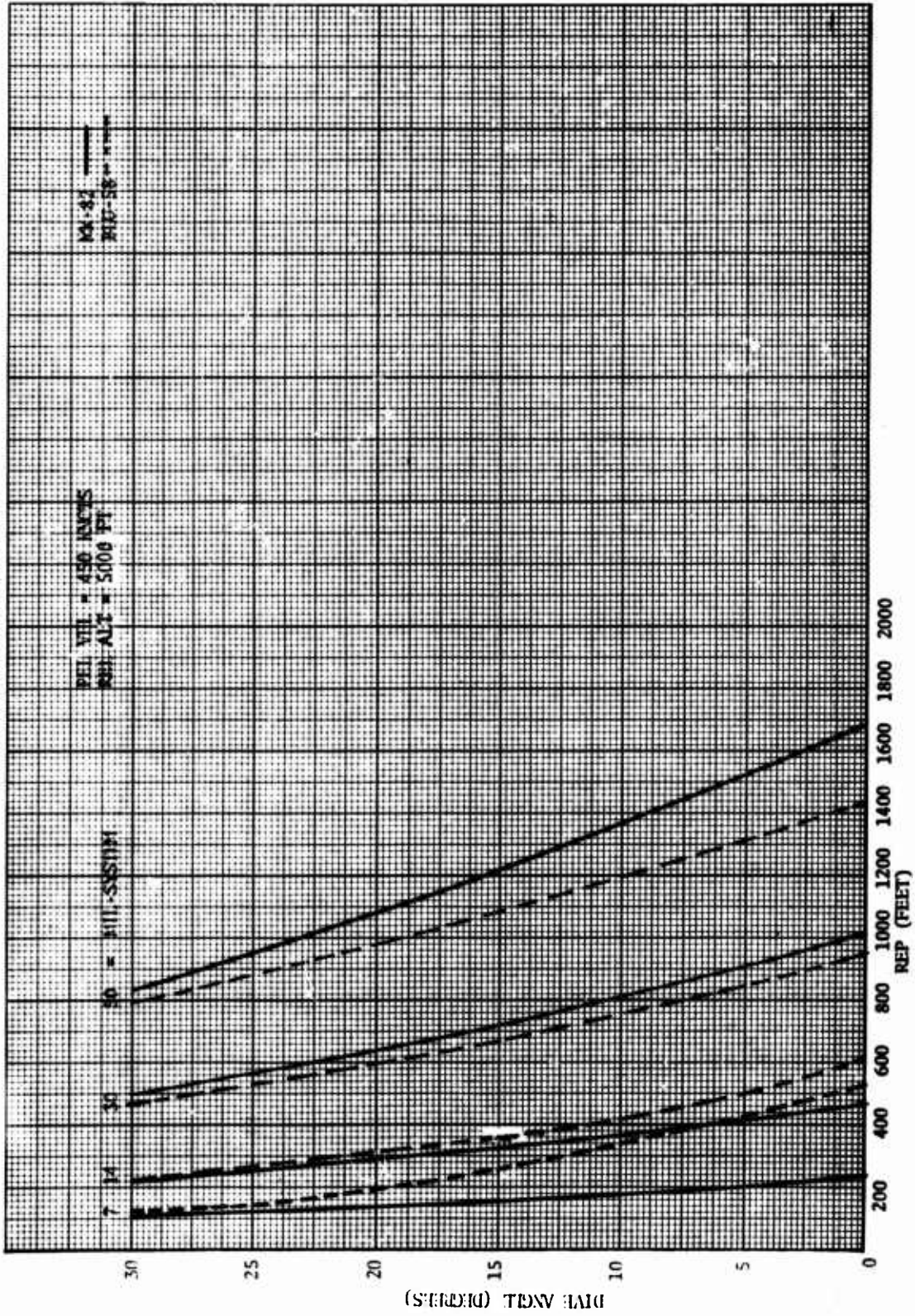

Figure 73. REP vs Nominal Release Velocity 450 Kts, 5000 Ft Rel Alt

REP VS NOMINAL RELEASE ANGLE

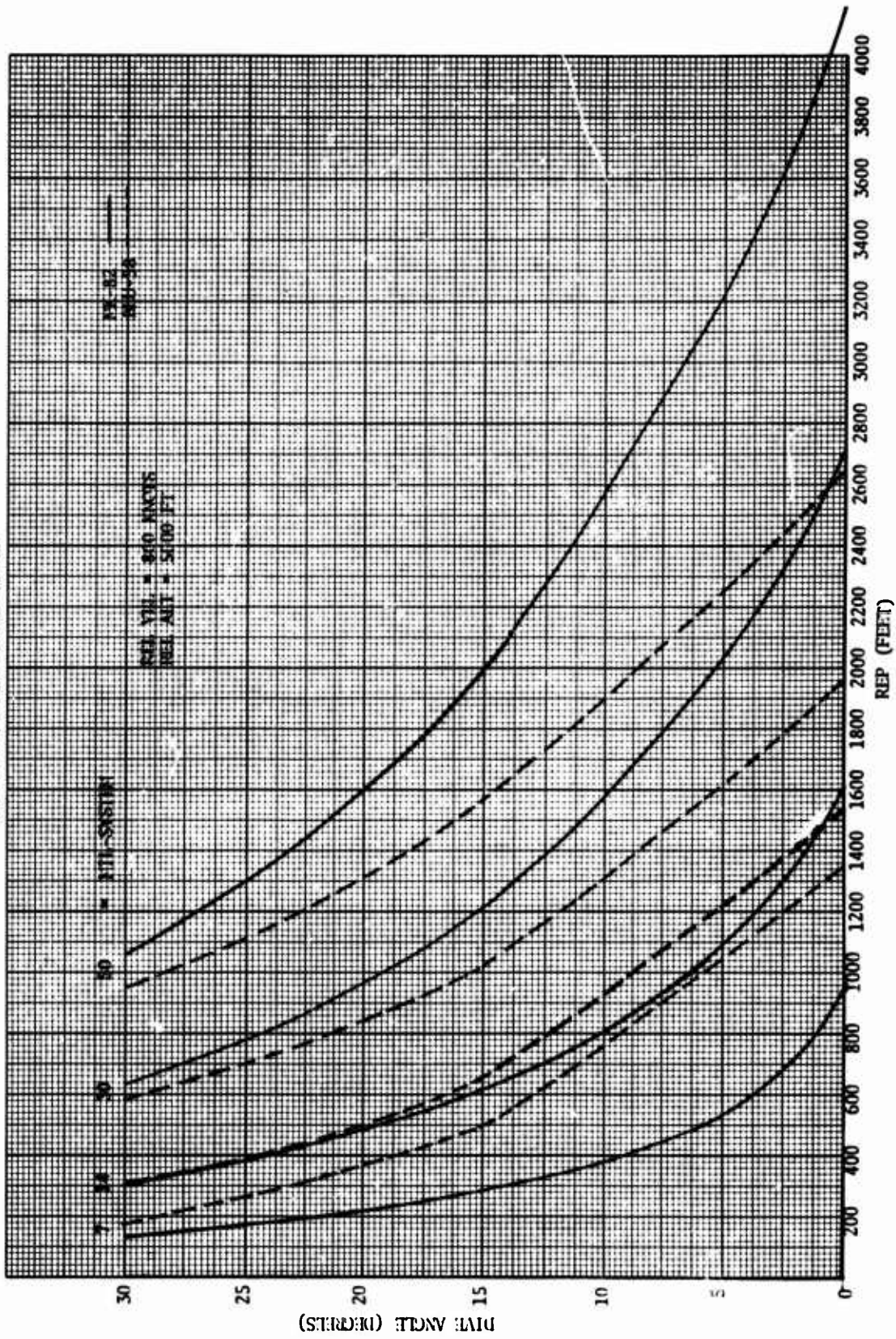

Figure 74. REP vs Nominal Release Velocity 860 Kts, 5000 Ft Rel Alt

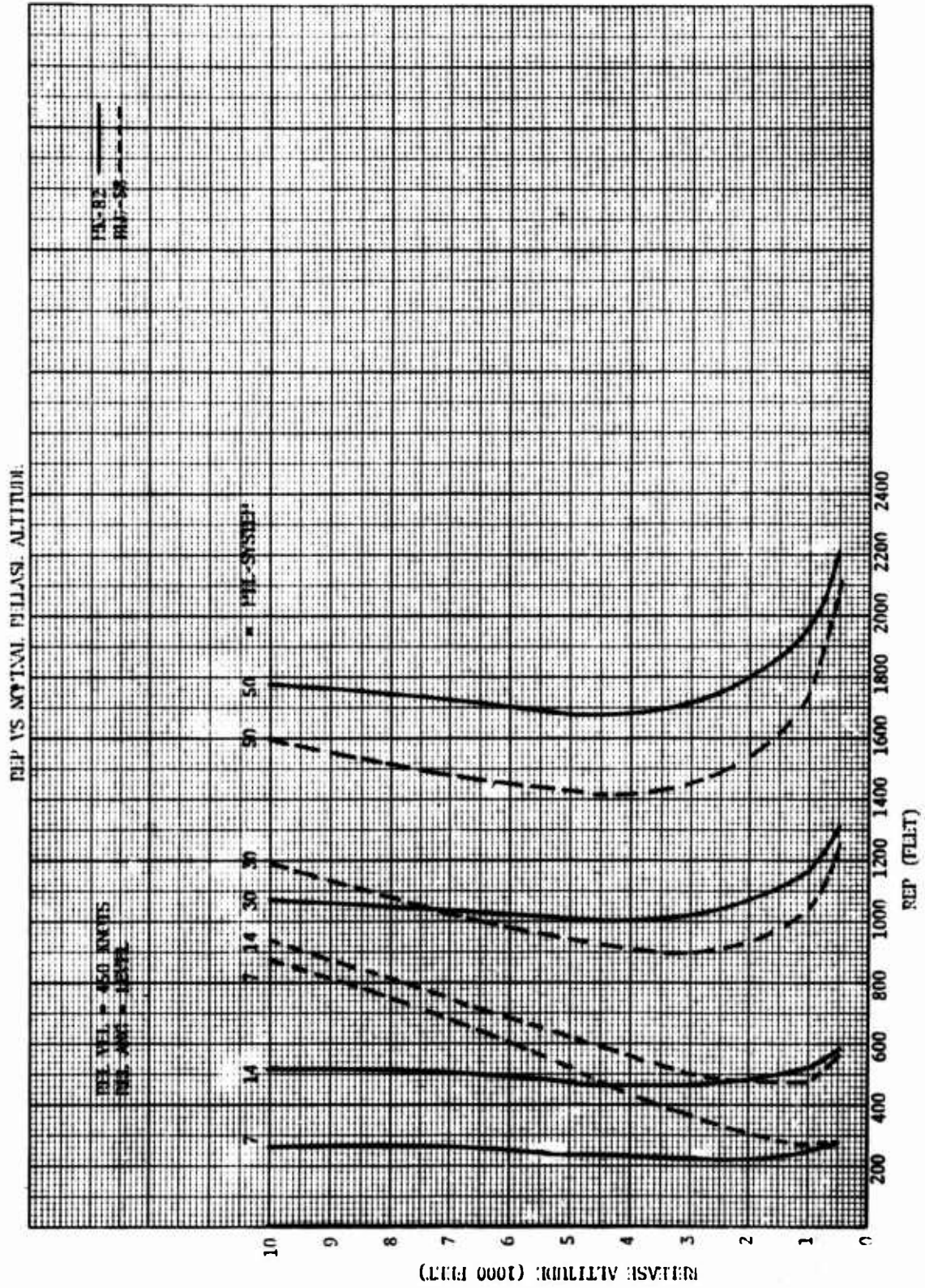

Figure 75. REP vs Nominal Release Altitude 450 Kts, Level

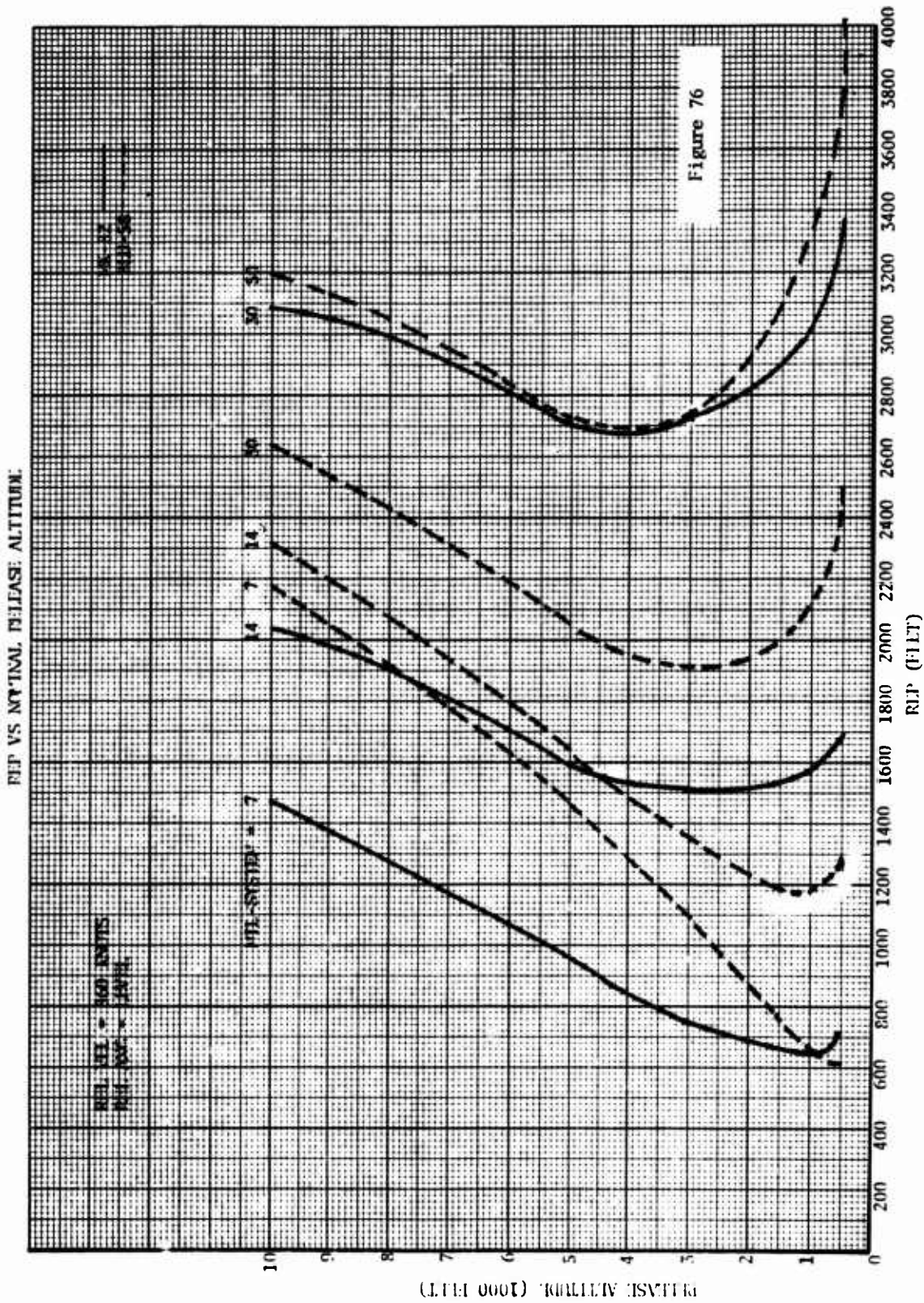

Figure 76. REP vs Nominal Release Altitude 860 Kts, Level

SECTION V

CONCLUSIONS

Quantitative Conclusions

The following table is presented to quantify the relative system accuracies for high-drag weapon deliveries versus low-drag weapon deliveries.

$$\text{PERCENT RATIO} = \frac{\text{HIGH-DRAG REP}}{\text{LOW-DRAG REP}}$$

1. 5,000-Foot Release Altitude, Level Release

MIL-SYSTEM	RELEASE SPEED				
	200 KNOTS	450 KNOTS	660 KNOTS	860 KNOTS	960 KNOTS
7	140%	222%	245%	155%	143%
14	103%	131%	129%	103%	97%
30	93%	93%	86%	76%	71%
50	91%	85%	74%	65%	60%

2. 8,000-Foot Release Altitude, 45-Degree Dive

MIL-SYSTEM	RELEASE SPEED				
	200 KNOTS	450 KNOTS	660 KNOTS	860 KNOTS	960 KNOTS
7	211%	300%	332%	351%	398%
14	134%	170%	178%	186%	199%
30	105%	116%	119%	126%	131%
50	99%	103%	103%	107%	109%

3. 5,000-Foot Release Altitude, 450-Knot Release Velocity

MIL-SYSTEM	RELEASE ANGLE		
	LEVEL RELEASE	15° DIVE	30° DIVE
7	222%	154%	118%
14	131%	108%	100%
30	93%	92%	95%
50	85%	89%	94%

4. 5,000-Foot Release Altitude, 860-Knot Release Velocity

MIL-SYSTEM	RELEASE ANGLE		
	LEVEL RELEASE	15° DIVE	30° DIVE
7	155%	176%	130%
14	103%	107%	100%
30	76%	84%	92%
50	65%	79%	90%

5. 450-Knot Release Velocity, Level Release

MIL-SYSTEM	RELEASE ALTITUDE					
	10,000 FT	8,000 FT	5,000 FT	3,000 FT	1,000 FT	500 FT
7	333%	278%	222%	162%	100%	97%
14	182%	161%	131%	107%	92%	96%
30	110%	103%	93%	88%	90%	95%
50	90%	87%	85%	84%	89%	95%

6. 860-Knot Release Velocity, Level Release

MIL-SYSTEM	RELEASE ALTITUDE					
	10,000 FT	8,000 FT	5,000 FT	3,000 FT	1,000 FT	500 FT
7	149%	151%	155%	146%	102%	85%
14	114%	109%	103%	90%	76%	76%
30	85%	81%	76%	70%	70%	74%
50	70%	68%	65%	64%	69%	73%

Qualitative Conclusions

The ratio table examined system accuracy (REP values) as a function of weapon drag. The following conclusions examine system accuracy as a function of release velocity, altitude, and dive angle. Although the system accuracy graphs contain vast amounts of information, these conclusions are only intended to point out some of the more important portions.

NOTE: The system accuracy graphs and conclusions based on these graphs are concerned with nominal release conditions while the sensitivity graphs are concerned with errors in these nominal conditions.

## 1. REP Versus Release Velocity

### a. Level Release (5,000-Foot Release Altitude)

(1) For the most accurate systems (7 mils), the low-drag weapon is better at all velocities. For the least accurate systems (30 and 50 mils), the high-drag weapon is better for all velocities. Probably the two weapons are about equally effective for a 20-mil-level-system.

(2) For the low-drag weapon, a change in velocity when in the transonic or supersonic region causes a greater change in REP than does a similar change in velocity in the subsonic region.

(3) For either weapon, supersonic velocity causes a significant increase in REP.

### b. 45-Degree Dive (8,000-Foot Release Altitude)

(1) For the most accurate systems, the low-drag weapon's accuracy is unaffected by the release velocity, and the high-drag weapon's accuracy is somewhat affected by changing from subsonic to supersonic velocity.

(2) For the least accurate systems, both weapons have increased accuracy with increased velocity up to the transonic region, and in the transonic to supersonic region both weapons have decreased accuracy with increased velocity.

(3) The accuracy of either weapon in a 45-degree dive is less sensitive to changes in release velocity than the accuracy of a level release.

## 2. REP Versus Release Altitude

### a. 450 Knots, Level Release

(1) Above two thousand feet, the accuracy of the low-drag weapon is relatively unaffected by changes in altitude.

(2) Above three thousand feet, the accuracy of the high-drag weapon decreases with increasing altitude (the more accurate the system, the higher the degradation for a given altitude change).

(3) Below one thousand feet, the accuracy of both weapons decreases with decreasing altitude (the small slant range angle causes large increases when projecting into the ground plane).



**b. 860 Knots, Level Release**

(1) There is an altitude (for each system) where either increasing or decreasing altitude causes decreased accuracy. For the least accurate systems, this optimum altitude is higher than for the more accurate systems.

(2) Above this optimum altitude, for the more accurate system, increased altitude causes greater decrease in accuracy in the high-drag weapon than in the low-drag weapon.

(3) In general, changing the release velocity from 450 knots to 860 knots is somewhat similar to degrading the mil-system by a factor of three (e.g., a 14-mil-level-system is about as accurate at 860 knots as a 50-mil-level-system at 450 knots).

**3. REP Versus Release Angle**

a. Increased dive angle causes increased accuracy (and increased doubt about the validity of the assumption that the release errors are independent of delivery conditions).

b. For supersonic delivery, a small dive angle can yield significant improvement in accuracy (e.g., a 15-degree dive yields more than a fifty percent improvement in accuracy when compared to a level release).

**NOTE:** The system accuracy numbers produced for a 45-degree dive cannot be used on these graphs since they were computed for an 8,000-foot release altitude.

The following sums up the system accuracy study in very broad terms:

a. For level releases, the greatest accuracy can be obtained by releasing a low-drag weapon at low velocities and low to medium altitudes (2,000 to 4,000 feet).

b. For 45-degree releases, the low-drag weapon is still more accurate but the release velocity is now relatively unimportant.

c. The steeper the dive angle, the more accurate the delivery.

These results are not surprising and are not in conflict with opinion and experience. However, it is believed that the major contribution this report will make toward solving the weapon delivery problem is to provide some quantitative estimate (in the absence of actual test data) for the degradation or improvement of system delivery accuracy for a variety of delivery conditions.

## APPENDIX I

### GENERAL EXPLANATION OF ERROR PROPAGATION

The purpose of this appendix is to enumerate those parameters which influence a weapon trajectory and to present a brief explanation of the mechanical relationships involved. The parameters are grouped into (a) aircraft associated parameters; (b) release mechanism associated parameters; and (c) weapon associated parameters. Some parameters are also included which do not appear on the sensitivity graphs.

#### 1. AIRCRAFT ASSOCIATED PARAMETERS

The initial position and velocity of the bomb at release depend to a large extent on the initial position and velocity of the aircraft at release.

##### a. Aircraft Position at Release

(1) Altitude - The effect of release altitude is easily seen. A weapon released at a lower altitude than planned has a shorter time of fall and, therefore, a shorter downrange travel. A weapon released at a higher altitude than planned has a longer time of fall and, therefore, a longer downrange travel.

(2) Downrange and Crossrange Position of Aircraft at Release - The effects of these variables are obvious. They are stated here for the sake of completeness.

##### b. Aircraft Velocity at Release

(1) Velocity Magnitude - A weapon released in a dive at a higher speed than intended would have both a greater horizontal and vertical velocity. The greater horizontal velocity tends to increase the downrange distance, but the greater vertical velocity tends to decrease the downrange travel by shortening the time of fall. An additional consideration is that the aerodynamic drag on the weapon is also increased, which tends to nullify the initially higher weapon velocity after a short period of time.

(2) Dive Angle - The effect of an error in dive angle is simply to increase the magnitude of one velocity component at the expense of decreasing the other.

(3) Heading - An error in heading means that the projection of the aircraft velocity vector in the ground plane does not pass through the target. In effect, this gives the weapon an initial crossrange velocity component which causes it to impact at some crossrange distance

from the target. Usually the decrease in downrange velocity component due to a heading error is negligible.

(4) Aircraft Roll Rate - In most cases, the weapon is located some physical distance from the aircraft centerline. Therefore, the effect of a roll velocity at release is to increase or decrease the effective ejection velocity of the weapon since both act perpendicular to the wing. Of course, the effect of this parameter depends upon weapon station location.

## 2. RELEASE MECHANISM ASSOCIATED PARAMETERS

This includes the carriage mechanism of the aircraft along with the associated ejection cartridge. The variables involved in these devices also affect the initial position and velocity of the weapon. In addition, the point of application of the ejection force is inseparably involved in determining any subsequent forces and moments acting on the bomb.

### a. Release Time Delay

The release time delay consists of that time interval from release signal (whether of human or computer origin) until the bomb is mechanically separated from the aircraft. This time interval is composed of three main parts:

- (1) Delay from closing of firing key to cartridge initiation.
- (2) Delay from cartridge initiation until first hook motion.
- (3) Delay from first hook motion until full hook opening.

### b. Ejection Force Magnitude and Time Duration

(1) Effect of Ejection Force on Ejection Velocity - The obvious effect here is that an increase in ejection force results in a higher weapon ejection velocity at the end of the ejection stroke.

(2) Effect of Time Duration on Ejection Velocity - The magnitude of the time interval during which the ejector stroke is in contact with the bomb is identical to the time interval that the ejection force is being applied. Of course, the longer this time interval the greater the ejection velocity at the end of the stroke.

(3) Effect of Ejection Velocity on Impact Point - In a level release, the effect of an ejection velocity is to impart a vertical velocity component to the weapon, thereby decreasing its time of fall and downrange travel. In the dive mode, one component of the ejection velocity

is in the vertical direction and another component in the (negative) horizontal direction, the effect of both being to decrease the horizontal range of the weapon.

c. Point of Ejector Force Application

The point of ejector force application determines the magnitude of the initial torque applied to the weapon. This initial torque will determine the angular displacements of the weapon, which in turn cause aerodynamic forces and moments to act on the weapon. Since the lift and drag forces acting on the weapon are strong functions of angle of attack, these initial oscillations can significantly alter the trajectory.

In order to adequately discuss the effects of this phenomenon, the "pitch-up" moment and the "pitch-down" moment should be considered as two separate cases.

(1) Assume that there are no initial aerodynamic moments acting on the weapon. If the ejector foot strikes the weapon in front of the CG, the resultant torque will cause the weapon to pitch down, resulting in a negative angle of attack. This negative AOA will cause (a) the aerodynamic drag to increase, which tends to shorten the downrange travel, and (b) a negative lift force, which also tends to shorten the trajectory. Therefore, during the first half oscillation (negative AOA), forces are generated which will clearly shorten the downrange travel.

(2) Now examine the case where the ejector foot strikes the weapon behind the CG location. The resulting torque will cause the bomb to pitch up, resulting in a positive AOA. This positive AOA will cause (a) the aerodynamic drag to increase, which tends to shorten the downrange travel, and (b) a positive lift force, which tends to lengthen the downrange travel. Therefore, during the first half oscillation (positive AOA), the net effect of this motion on downrange travel depends upon the relative magnitudes of the lift and drag forces.

Thus far the example has been restricted to only ejector-foot produced torques and initial half oscillations; however, the example may be generalized quite easily. Any aerodynamic torque initially present will be independent of the magnitude or direction of the ejector-foot torque. Therefore, the conclusions drawn for ejector-foot torque will apply equally well to a net torque resulting from a combination of ejection force and aerodynamic forces. The only additional requirement would be a knowledge of the magnitude and direction of the aerodynamic torque in order to correlate pitch-up/pitch-down motion with ejector-foot location.

With regard to applying the analysis to the complete oscillation phase of the weapon, all that is needed is to combine the aerodynamic

force effects of the positive versus the negative AOA cases. In doing so, care must be taken to remember that the maximum amplitude of each succeeding half oscillation is smaller than the amplitude of the preceding one. This is the familiar characteristic of underdamped harmonic motion.

### 3. WEAPON ASSOCIATED PARAMETERS

These are errors in the physical parameters of the weapon itself. Therefore, these errors remain constant throughout the trajectory and are introduced even before the weapon is loaded on the aircraft. All of these errors affect the forces and moments acting on the weapon throughout its trajectory.

a. **Weapon Mass** - The aerodynamic accelerations acting on the bomb are inversely proportional to the bomb mass. (Of course, the gravitational accelerations are independent of bomb mass.) Thus, an increase in down-range travel with an increase in bomb mass would be expected.

b. **Weapon Body Diameter** - The aerodynamic accelerations acting on the weapon are directly proportional to its maximum body diameter squared. Therefore, a decrease in horizontal travel for increases in body diameter would be expected.

c. **Weapon Transverse Moment of Inertia** - For the first time, deviations from nominal release conditions are necessary in order to study the effect of a weapon physical parameter. It is obvious that, if the weapon does not undergo any initial oscillations, the weapon trajectory is completely independent of moment of inertia. Therefore, it would be concluded that, for an undisturbed nominal release, errors in weapon moment of inertia have no effect upon weapon trajectory. However, if it is assumed that the bomb is given an initial angular velocity (which is almost invariably the case in reality), the oscillation sensitivity and the sensitivity of the impact point to errors in transverse moments of inertia can be examined. As the transverse moment of inertia (holding the initial angular velocity constant) is increased, the maximum pitch-down angle increases since the angular momentum is being increased without a corresponding increase in restoring and damping moments. Thus, the increase in pitch-down angle causes the decrease in horizontal travel.

d. **Atmospheric Air Density** - Increasing this variable has the same effect as increasing the axial force coefficient since the axial force is directly proportional to both. The air density also has an additional effect which is generally overlooked. A change in air density results in a change in the speed of sound, which means that the aerodynamic coefficients will change as a result of their functional relationship with Mach number.

e. **Weapon Aerodynamic Coefficients** - Before examination of each of the coefficients in some detail, a few general comments should be made. The trajectory is much more sensitive to errors in the axial force coefficient than in any of the others. This is true for two main reasons. First, the axial force coefficient is the only one affecting the entire trajectory. The effect of all other coefficients vanish once the initial oscillations damp out. Thus, it is logical to assume that the trajectory would be more sensitive to the ever-present axial drag rather than the ephemeral induced drag (as long as the induced drag is not several orders of magnitude greater).

Secondly, the nature of the weapon dynamics is such that errors in the other coefficients tend to be self-compensating. For example, consider the normal force coefficient,  $C_N$ . For an initial pitch-down bomb motion, the  $C_N$  coefficient is important in determining the amount of negative normal force generated. However, during the second half of this oscillation, the bomb pitches up almost as much as it pitches down. This means that the same coefficient  $C_N$  determines how much positive normal force is generated. If the two pitch angles were equal, then the effect of the net generated normal force on the overall trajectory would be negligible regardless of the magnitude of  $C_N$ . Thus, the net effect of an error in  $C_N$  only involves the difference in successive normal forces which are generated by successively decreasing pitch amplitudes. Another example could involve the restoring moment coefficient,  $C_M$ . Visualize a pitching bomb which has just passed through the zero angle of attack position in either direction. If the restoring moment coefficient (and thus, the restoring moment itself) is decreased, then the angular velocity at this point (and all subsequent points until maximum amplitude is reached) should be greater, causing the bomb to achieve a higher pitch amplitude. However, the restoring moment is not the only factor involved. The damping moment is proportional to the angular velocity, meaning that, in this case the damping moment will be increased. Thus, a decrease in  $C_M$  causes the restoring moment to decrease and indirectly causes the damping moment to increase. Since these moments act in the same direction, the net effect of the decreased  $C_M$  is somewhat lessened.

Now, examine the coefficients in more detail:

(1) **Axial Force Coefficient ( $C_A$ )** - Increasing this parameter has the same effect as increasing body reference area. Therefore, shorter downrange travel for increasing values of  $C_A$  would be expected.

(2) **Pitch Plane**

(a) Pitching Moment Coefficient ( $C_m$ ) - Increasing this coefficient results in a greater restoring moment which, in turn, causes smaller maximum pitch amplitudes and quicker dampening of the harmonic oscillations. Of course, this results in longer downrange travel due to less induced drag.

(b) Normal Force Coefficient ( $C_N$ ) - Increasing the normal force coefficient for an initial pitch-down weapon motion causes more negative lift, resulting in shorter downrange travel.

(c) Damping Moment Coefficient ( $C_{m\dot{\theta}}$ ) - Increasing this coefficient causes smaller pitch amplitudes, resulting in longer downrange travel due to less induced drag.

### (3) Yaw Plane

What the bomb does in the pitch plane affects only the downrange travel. However, what occurs in the yaw plane not only affects the crossrange displacement but also the horizontal weapon range. Therefore, both a crossrange and horizontal range sensitivity for these variables must be considered.

(a) Yawing Moment Coefficient ( $C_n$ ) - An increase in yawing moment coefficient would cause a decrease in yaw amplitude, resulting in less crossrange travel and greater downrange travel (due to less induced drag).

(b) Side Force Coefficient ( $C_Y$ ) - An increase in side force coefficient results in a greater normal force acting on the bomb. This normal force has a component in the crossrange direction and one in the (negative) downrange direction. Remembering that the original yaw amplitude is damped on each succeeding half-oscillation, this results in a greater crossrange error (for a positive initial yaw angle) and a shorter downrange travel.

(c) Damping Moment Coefficient ( $C_{m\dot{\psi}}$ ) - The crossrange travel is extremely insensitive to the damping moment in the yaw plane. This is largely due to the fact that the net side forces generated are not so much a function of the magnitude of the maximum yaw amplitudes as a function of the magnitude difference of succeeding half-oscillations. The damping coefficient affects the magnitude of the yaw angle but has little effect on the rate of maximum magnitude decrease on successive half oscillations. However, since the downrange travel is a function of the yaw angle magnitude, an increase in damping coefficient increases downrange travel by decreasing yaw angle amplitudes.

## APPENDIX II

### SAMPLE CONVERSION OF SYSTEM REP VALUES TO MILS

The purpose of this appendix is to convert some of the system REP values presented in Section IV to mils. Following the conversion table is a list of four observations which are presented as supporting evidence for the contention that mil error is a poor representation of system accuracy when different delivery conditions are being compared.

1. **Seven-Mil-Level-Systems (5,000-Foot Release Altitude, Level Release)**

<u>CONDITION (KNOTS)</u>	<u>REP (FEET)</u>	<u>MILS<sup>1</sup></u>
Low-Drag	200	113
	450	236
	660	409
	860	947
	960	1191
High-Drag	200	158
	450	523
	660	1001
	860	1464
	960	1700

2. **Seven-Mil-Dive-Systems (8,000-Foot Release Altitude, 45-Degree Angle)**

Low-Drag	200	81	10
	450	75	7
	660	79	7
	860	96	8
	960	91	7
High-Drag	200	171	20
	450	225	21
	660	262	23
	860	337	28
	960	362	30

---

1 The range error probable value is rotated from the ground plane into the plane perpendicular to the line-of-sight. The number is then changed from REP (fifty percent between two parallel lines) to CEP form (radius of a circle containing fifty percent). Finally, this CEP type number is changed to mils. (To convert the extrapolated REP values to mils, circular normality must be assumed. This assumption was not needed to compute the extrapolated REP values themselves.)



3. Fourteen-Mil-Level-Systems (5,000-Foot Release Altitude, Level Release)

<u>CONDITION (KNOTS)</u>	<u>REP (FEET)</u>	<u>MILS<sup>2</sup></u>
Low-Drag 200	234	23
450	472	14
660	868	13
860	1591	16
960	1939	16
High-Drag 200	242	25
450	617	22
660	1124	24
860	1641	28
960	1879	30

4. Fourteen-Mil-Dive-Systems (8,000-Foot Release Altitude, 45-Degree Angle)

Low-Drag 200	163	19
450	151	14
660	167	14
860	202	16
960	201	16
High-Drag 200	219	26
450	257	24
660	297	26
860	376	31
960	399	33

- 
- 2 The range error probable value is rotated from the ground plane into the plane perpendicular to the line-of-sight. The number is then changed from REP (fifty percent between two parallel lines) to CEP form (radius of a circle containing fifty percent). Finally, this CEP type number is changed to mils. (To convert the extrapolated REP values to mils, circular normality must be assumed. This assumption was not needed to compute the extrapolated REP values themselves.)

## OBSERVATIONS

1. Twenty-three mils equal 234 feet for level release, 200 knots, low-drag weapon (14-mil-level-system), and 16 mils equal 1,939 feet for level release, 960 knots, low-drag weapon (14-mil-level-system). That is, two-thirds as many mils represents nine times more error.
2. Seven mils equal 236 feet for 450 knots, low-drag weapon, level release, 5,000-foot release altitude, and 7-mils equal 75 feet for 450 knots, low-drag weapon, 45-degree dive, 8,000-foot release altitude.
3. Ten mils equal 1,191 feet for level release, 960 knots, low-drag weapon and 22 mils equal 1,001 feet for level release, 660 knots, high-drag weapon.
4. A 14-mil-level-system, when delivering a high-drag weapon at 960 knots, level release, has 30 mils error on the ground.

UNCLASSIFIED

Security Classification

DOCUMENT CONTROL DATA - R & D

(Security classification of title, body of abstract and indexing annotation must be entered when the overall report is classified)

1. ORIGINATING ACTIVITY (Corporate author) Analysis Division Air Force Armament Laboratory Eglin Air Force Base, Florida		2a. REPORT SECURITY CLASSIFICATION <b>UNCLASSIFIED</b>	
3. REPORT TITLE <b>THEORETICAL SENSITIVITY ANALYSIS AND SYSTEM DELIVERY ACCURACY COMPUTATIONS FOR HIGH AND LOW DRAG WEAPONS AT SEVERAL SUBSONIC AND SUPERSONIC DELVIERY CONDITIONS</b>		2b. GROUP	
4. DESCRIPTIVE NOTES (Type of report and inclusive dates) Final Report - April 1970 to October 1970			
5. AUTHOR(S) (First name, middle initial, last name) Jesse M. Gonzalez 1st Lt Arthur R. Denny			
6. REPORT DATE October 1970	7a. TOTAL NO. OF PAGES 148	7b. NO. OF REFS	
8a. CONTRACT OR GRANT NO.	8b. ORIGINATOR'S REPORT NUMBER(S) AFATL-TR-70-110		
8. PROJECT NO.	8c. OTHER REPORT NO(S) (Any other numbers that may be assigned this report)		
8. OTHER REPORT NO(S)			
10. DISTRIBUTION STATEMENT This document is subject to special export controls and each transmittal to foreign governments or foreign nationals may be made only with prior approval of the Air Force Armament Laboratory (DLYE), Eglin AFB, Florida 32542.			
11. SUPPLEMENTARY NOTES Available in DDC		12. SPONSORING MILITARY ACTIVITY Air Force Armament Laboratory Air Force Systems Command Eglin Air Force Base, Florida	
13. ABSTRACT The purpose of this report is threefold: (1) To examine the sensitivity of weapon impact position to errors in pertinent delivery parameters; (2) to examine the combined effect of these delivery errors on overall system accuracy for eight different mil-systems; and (3) to compare the relative accuracy of different delivery conditions (level versus dive, subsonic versus supersonic, high-drag weapon versus low-drag weapon) for each of the eight different mil-systems. This report not only extends the sensitivity analysis (purpose 1) presented in Air Force Armament Laboratory Armament Memorandum Report 69-20 to high-drag weapons and to a much larger range of release conditions, but also includes system accuracy data (purpose 2) and relative accuracy data for different delivery conditions (purpose 3), neither of which was considered in the previous report. Although many assumptions are necessitated by the severe lack of test data for determining errors in delivery parameters and correlation coefficients between pairs of these parameters, this is believed to be the best possible analysis which can be performed under the above restrictions to determine the delivery accuracy of conventional free-fall weapon delivery systems. Even though the assumptions at times seem fairly restrictive, all qualitative and most quantitative conclusions presented in this report are considered valid.			

**UNCLASSIFIED**

Security Classification

14. KEY WORDS	LINK A		LINK B		LINK C	
	ROLE	WT	ROLE	WT	ROLE	WT
Weapon Impact Position Delivery Parameters Delivery Errors Mil-Systems Level Delivery Dive Delivery Subsonic Supersonic High-Drag Weapon Low-Drag Weapon Sensitivity Analysis Correlation Coefficients						

**UNCLASSIFIED**

Security Classification