

UNCLASSIFIED

AD NUMBER
AD871980
NEW LIMITATION CHANGE
TO Approved for public release, distribution unlimited
FROM Distribution authorized to U.S. Gov't. agencies and their contractors; Critical Technology; 01 APR 1970. Other requests shall be referred to Army Missile Command, ATTN: AMSMI-RE, Redstone Arsenal, AL 35809.
AUTHORITY
USAMC ltr dtd 29 Nov 1972

THIS PAGE IS UNCLASSIFIED

AD No. AD871980

REF FILE COPY



AD 20

REPORT NO. RE-TR-70-7

AN ANALYTICAL MODEL FOR PREDICTING THE RADIATION FROM JET PLUMES IN THE MID-INFRARED SPECTRAL REGION

by

H. Tracy Jackson

April 1970

This document is subject to special export controls and each transmittal to foreign governments or foreign nationals may be made only with prior approval of this Command, ATTN: AMSMI-RE.

U.S. ARMY MISSILE COMMAND

Redstone Arsenal, Alabama 35809

AV DDC
RECEIVED
JUL 27 1970
REGULATED

1 April 1970

Report No. RE-TR-70-7

**AN ANALYTICAL MODEL
FOR PREDICTING THE RADIATION FROM JET PLUMES
IN THE MID-INFRARED SPECTRAL REGION**

by

H. Tracy Jackson

**DA Project No. IM2623xxA204
AMC Management Structure Code No. 522C.11.146**

*This document is subject to special export controls
and each transmittal to foreign governments or foreign
nationals may be made only with prior approval of this
Command, ATTN: AMSMI-RE.*

**Electro-Optical Branch
Advanced Sensors Laboratory
Research and Engineering Directorate
U. S. Army Missile Command
Redstone Arsenal, Alabama 35809**

**Best
Available
Copy**

ABSTRACT

This report describes an analytical model for predicting the emission of radiation from a jet plume in the mid-infrared spectral region. It is assumed that the dominant radiation arises for the CO₂ molecule. Results are therefore reported for the 4.3-micrometer band of gaseous carbon dioxide which is assumed to cover the spectral region 2050 to 2400 cm⁻¹ (4.17 - 4.88 micrometers). The temperature range that is considered varies from 300° to 2100°K. The objective of the reported program was to develop a computerized program for predicting radiant energy emissions which could be readily integrated into a flow field calculation. A description is given of both the radiation model and the flow field model. The described program provides both the spectral and spatial intensity distributions of the emitted radiation.

CONTENTS

	Page
Section I. INTRODUCTION	1
Section II. JET FUELS	3
Section III. FLOW FIELD	11
Section IV. RADIATION CALCULATIONS	18
Section V. RADIATION COMPUTER PROGRAM	28
REFERENCES	40
Appendix. FLOW FIELD PROGRAM	41

ILLUSTRATIONS

		Page
Table		
I	Jet Fuels	4
II	Atmospheric Composition	5
III	Radiation Computer Program	29
IV	Typical Set Input Data	34
V	Input Data Sequence	35
VI	Typical Output Data	36
A-I	Input Data Sequence	42
A-II	Typical Set of Input Data	47
A-III	Flow Field Computer Program	48
A-IV	Typical Output Data	58
Figure		
1	Approach Outline	2
2	Mole Percent of CO ₂ Contained in Exhaust Products as a Function of Carbon to Hydrogen Fuel Weight Ratio with Oxidizer to Fuel Ratio as a Parameter	10
3	Plume Model and Objective	11
4	Distinct Plume Features	12
5	Comparison of Plume Flow Field Analytical Model with Manufacturer's Data for a Particular Jet Engine	14

ILLUSTRATIONS (Concluded)

Figure		Page
6	Axial Decay of Temperature and CO ₂ Concentration	14
7	Ratio of Plume to Ambient Temperature Versus Radial Position with Downstream Position as a Parameter	15
8	Ratio of Plume to Ambient CO ₂ Concentration Versus Radial Position with Downstream Position as a Parameter	15
9	Isotherms for an Inflight Plume	16
10	Geometry for Radiation Calculations	19
11	Emission Model	22
12	Comparison of Homogeneous and Non-homogeneous Calculations	23
13	Typical Turbojet Plume Surface Emission at 90-Degree Aspect	24
14	Axial Decay of Plume Radiation for a Typical Turbojet	25
15	Comparison of Atmospheric Transmission Model with Measured Data	26
16	Remote Plume Spectral Signature	27
17	Comparison of Model with Experimental Data	27

Section I. INTRODUCTION

This report presents the results of the second phase of a program* which has been undertaken to predict analytically the spectral and spatial distribution of radiation emitted from an inhomogeneous, nonisothermal system of hot gases. Results are reported for the 4.3-micrometer band of gaseous carbon dioxide (CO_2) which is assumed to cover the spectral region 2050 to 2400 cm^{-1} (4.17 to 4.88 micrometers). The temperature range that is considered varies from 300° to 2100°K . It was pointed out in the first phase [1] of this study that the program was initiated because of current interest in being able to predict the radiant energy emitted by a particular system of hot gases in narrow bands of the infrared spectrum. The objective of the program was to develop a computerized computational scheme for predicting radiant energy emissions which could be readily integrated into a flow field calculation. Such a program readily provides both the spectral and spatial intensity distribution of the emitted radiation.

In particular, this report outlines the current status of the program with emphasis on modeling the radiation emitted from the hot gaseous combustion products of fixed wing jet aircraft in the mid-infrared portion of the spectrum. It is well established that one of the major sources of radiation emitted from a jet aircraft is the radiation emitted from the hot jet plume. This is particularly true when the aircraft is viewed from a direction such that the hot tail pipe is not seen. Since jet fuels are largely hydrocarbons, approximately 15 percent hydrogen and 85 percent carbon, which are burned in an excess of air or oxygen, then there is considerable CO_2 in the hot exhaust gases. The CO_2 molecule possesses a very strong radiating band centered around 4.3 micrometers. The radiation arising from this vibration-rotation band of CO_2 therefore represents the major source of plume emission in the mid-infrared spectral region.

The ultimate objective of the overall program is to be able to determine the radiant energy available to a remote sensor from a particular target or class of targets operating under a specified set of arbitrary conditions. This overall problem then readily divides into three distinct phases: (1) flow field description of the hot gaseous plume, (2) radiation model describing the emission characteristics of this gaseous environment, and (3) atmospheric modification to this radiated energy. The second and third phases have been previously reported [1-4] on and will not be considered here in any depth.

*The results of the initial phase of this work are reported in a previous work [1], which discusses the first phase of the study leading to the development of a general spectral emissivity model for carbon dioxide.

This discussion will be largely concerned with that portion of the program which describes the method of coupling the flow field description of the plume with the radiation model. In particular, the flow field description, which provides the temperature and concentration profiles for the radiating specie, simply serves as an input to the radiation model which in turn is capable of describing the spectral and spatial emission characteristics of the gaseous jet plume. An outline of the approach that has been taken is shown in Figure 1.

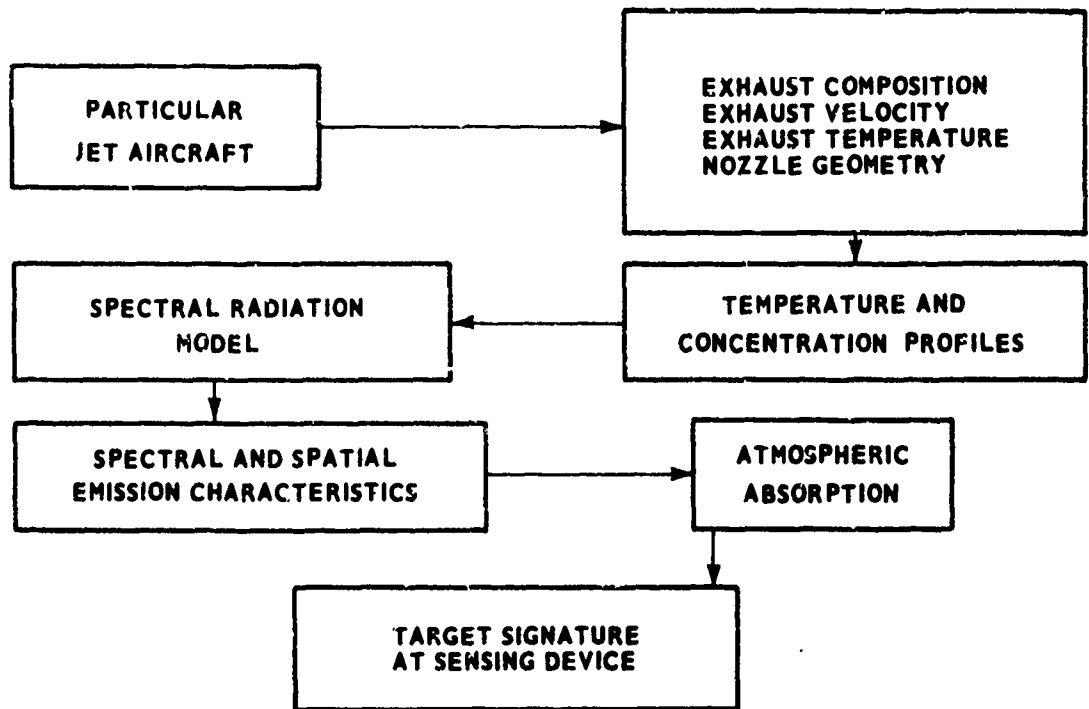

FIGURE 1. APPROACH OUTLINE

Section II. JET FUELS

Jet fuels consist primarily of hydrocarbons with only small amounts of other elements or compounds such as nitrogen, oxygen, sulphur and water. These non-hydrocarbons are generally controlled very carefully to rather exacting specifications for the various commercial types of jet propulsion fuels. The total amount of these non-hydrocarbons generally does not exceed 1 percent of the fuel composition. Thus, for any practical calculation involving jet fuels, it can be assumed that the fuels consist only of carbon and hydrogen. Both turbo-prop and turbojet engines use the same types of fuels. These propulsion fuels can be divided into three main types [5]:

- 1) Aviation kerosenes which have boiling temperatures in the range of 140° to 280°C. Such fuels with crystalline temperatures not higher than -60°C are considered excellent jet fuels. They possess high heats of combustion, low saturated vapor pressures, and good viscosity characteristics which ensure normal functioning of the jet engine under a rather wide range of operating conditions.
- 2) Wide range distillate fuels which include gasoline, kerosene, and ligroine fractions and have boiling temperatures in the range of 60° to 280°C. This type of fuel is highly volatile and generally possesses a high saturated vapor pressure. This causes high altitude operating difficulties because of vaporization and boiling.
- 3) Heavy petroleum fractions which have a low vapor pressure. This type of fuel is used principally for supersonic flight speeds, and in naval aircraft and training aircraft because of its very high flash point.

Table I lists the most common jet fuels used in civilian and military aircraft.

The C:H ratios listed in Table I were estimated from the empirical relationship⁵

$$H\% = 26 - 15\rho^{15} \quad , \quad (1a)$$

and

$$C\% = 100 - H\% \quad , \quad (1b)$$

where ρ^{15} is the density of the jet fuel at 15°C in g/cm³. The normalized compositions were then derived by assuming the total molecular weight to be

TABLE I. JET FUELS

Designation	Country	Type	Measured Density (g/cm ³)	Density Specification (g/cm ³)	Heat of Combustion (kcal/kg)	Normalized Composition C _x H _y		C:H Weight Ratio
						X	Y	
-1	U. S. S. R.	1	0.815*	0.800-0.850*	10,250	7.18	13.7	6.26
TS-1	U. S. S. R.	1	0.785*	> 0.775*	10,250	7.14	14.1	6.03
T-2	U. S. S. R.	2	0.760*	> 0.775*	10,250	7.11	14.5	5.85
JP-1B	U. K.	1	0.785*	0.785-0.825**	10,280	7.14	14.1	6.03
JP-4B	U. K.	2	0.751*	0.750-0.802**	10,280	7.10	14.6	5.78
JP-5B	U. K.	1	-	0.780-0.850**	10,300	-	-	-
JP-1	U. S. A.	1	0.804**	0.780-0.850**	10,300	7.17	13.8	6.17
JP-3	U. S. A.	2	0.792**	0.740-0.780**	10,270	7.15	14.0	6.08
JP-4	U. S. A.	2	0.764*	0.750-0.802**	10,400	7.12	14.4	5.88
JP-5	U. S. A.	3	0.831*	0.780-0.845**	10,253	7.20	13.4	6.39
Air-3405	France	1	-	Not standardized	10,150	-	-	-
Air-3407	France	2	-	0.740-0.825*	10,200	-	-	-

* 20°C

** 15.5°C

100 g/g-mole. In general, the C:H ratio increases somewhat with the heaviness of fractional composition and as the C:H ratio increases, the amount of air required for complete combustion decreases. The amount of air required for the complete combustion of a quantity of fuel is easily calculated, and for most jet fuels, the ratio varies from 14 to 15 units of air to one unit of fuel. This can be illustrated by computing the mass of air required for the complete combustion of a unit mass of fuel. One may consider a hydrocarbon of the form $C_x H_y$ and assume that air is composed only of nitrogen and oxygen. This is reasonable, since the atmosphere is composed of the following major constituents.

TABLE II. ATMOSPHERIC COMPOSITION

Specie	Mole Percent
Nitrogen	78.09
Oxygen	20.95
Argon	0.93
Carbon dioxide	0.03
Hydrogen	0.01

This shows that nitrogen and oxygen compose over 99 percent of the atmosphere by volume. It can therefore be assumed that the oxidizer is of the form $N_A O_B$. For the temperatures and pressures encountered in a typical jet engine, nitrogen acts only as an inert specie. Therefore, the following burning or combustion process may be considered:

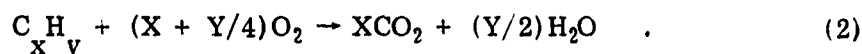

The mass of oxygen required for complete combustion of a unit mass of fuel is then given by

$$\frac{\text{Mass oxygen}}{\text{Mass fuel}} = \frac{(2X + Y/2)M_O}{XM_C + YM_H} \quad (3)$$

where M_i represents the molecular weight of the i^{th} specie. In order to compute the mass of air required, then it is only necessary to divide the above expression by the mass fraction of oxygen occurring in the atmosphere. This is readily obtained by multiplying the mole fraction listed in Table II by the ratio of the molecular weight of oxygen to the mean molecular weight of the

atmosphere. This gives 23.2 percent by weight for oxygen. Thus the mass of air required for complete combustion of a unit mass of fuel is given by

$$\frac{\text{Mass air}}{\text{Mass fuel}} = \frac{1}{0.232} \left\{ \frac{(2X + Y/2) M_O}{X M_C + Y M_H} \right\} \quad (4)$$

In general, for the jet engine type of problem being discussed, an excess air factor is used to limit the temperature of the gases entering the turbine. This factor is generally of the order 3.8 to 4.0. However, at this point, the oxidizer (air) to fuel ratio can be simply denoted as O/F, and this can be treated as a parameter. The composition of the combustion products can now be obtained by first computing the coefficients A and B for the atmospheric composition $N_A O_B$. As previously noted, the mass fraction of oxygen is 0.232 and can be computed from the composition $N_A O_B$ by the expression

$$f_O = 0.232 = \frac{B M_O}{B M_O + A M_N} \quad (5)$$

The term "B" is uniquely defined by assuming 100 as the denominator. A similar calculation for nitrogen gives the result

$$N_A O_B = N_{5.48} O_{1.45} \quad (6)$$

The composition of the product constituents can now be obtained from the reaction

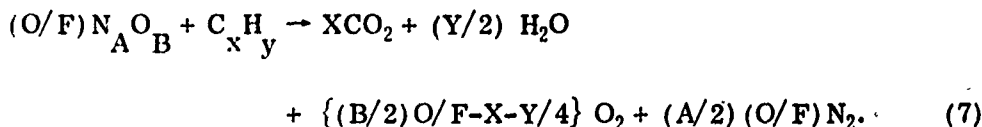

If it is now assumed that a unit mass of fuel is being consumed, then the mass of the exhaust products, W_1 , can be written from the above equation, i. e.,

$$W_{CO_2} = \frac{X(M_C + 2M_O)}{X M_C + Y M_H} \quad (8)$$

$$W_{H_2O} = \frac{Y(2M_H + M_O)}{2(X M_C + Y M_H)} \quad (9)$$

$$W_{O_2} = \left\{ \frac{B(O/F) - 2X - Y/2}{XM_C + YM_H} \right\} M_O \quad (10)$$

$$W_{N_2} = \frac{A(O/F)M_N}{XM_C + YM_H} \quad (11)$$

For unit mass of fuel, a mass of O/F units of air is assumed to be consumed so that a total of (1 + O/F) units is involved in the reaction. The mass fraction of each product specie, α_i , is then given by simply dividing the exhaust product constituent mass by the total mass. Thus

$$\alpha_i = \frac{W_i}{\sum W_i} = \frac{W_i}{1 + O/F} \quad (12)$$

so that the mass fraction of CO₂, for example, contained in the exhaust products after combustion is given by

$$\alpha_{CO_2} = \frac{X(M_C + 2M_O)}{(XM_C + YM_H)(1 + O/F)} \quad (13)$$

Since the mole fraction of the combustion products is also of concern, particularly if concentrations are expressed in partial pressures, then it will be useful to consider the relationship between mass fraction, α_i , and mole fraction, β_i . For an ideal gas mixture in thermal equilibrium, the total pressure can be written as $P_T \nu \eta_T$, where η_T is the total number of moles and understood to be the weight of the gas divided by the mean molecular weight. If the total pressure of the gaseous mixture is now taken to be the sum of the partial pressures present in the mixture, then for each constituent the partial pressure is $P_i \nu \eta_i$. Thus

$$P_i = P_T (\eta_i / \eta_T) = P_T \beta_i \quad (14)$$

or

$$P_i = P_T \left(\frac{W_i}{M_i} \frac{M_T}{W_T} \right) = P_T \alpha_i \frac{M_T}{M_i} \quad (15)$$

Equating these two equations yields the desired relationship, namely

$$\beta_i = \alpha_i \frac{M_T}{M_i} \quad , \quad (16)$$

where M_T is the average molecular weight of the gaseous mixture which is easily shown to be

$$M_T = \frac{1}{\sum \alpha_i / M_i} \quad , \quad (17)$$

where the sum extends over the number of gases present in the mixture. Thus for any specie within the mixture, the relation between the mass fraction and mole fraction is

$$\beta_i = \frac{\alpha_i}{M_i} \frac{1}{\sum \alpha_i / M_i} \quad . \quad (18)$$

Substitution of previously defined quantities into the above expression yields

$$\beta_{\text{CO}_2} = \frac{4X}{Y + 2(O/F)(A + B)} \quad , \quad (19)$$

$$\beta_{\text{H}_2\text{O}} = \frac{2Y}{Y + 2(O/F)(A + B)} \quad , \quad (20)$$

$$\beta_{\text{N}_2} = \frac{2A(O/F)}{Y + 2(O/F)(A + B)} \quad , \quad (21)$$

$$\beta_{\text{O}_2} = \frac{2B(O/F) - 4X - Y}{Y + 2(O/F)(A + B)} \quad . \quad (22)$$

The results of the preceding discussion can be illustrated by considering a specific example. The common hydrocarbon fuel CH_2 may be considered which has a C:H ratio of 5.96 and consists of 14.4 percent hydrogen and 85.6 percent carbon. Normalizing the molecular weight to a value of 100 gives a chemical formula of $\text{C}_{7.13}\text{H}_{14.3}$. The mass of oxygen required for complete combustion of a unit mass of fuel is given by equation (3),

$$\frac{\text{Mass oxygen}}{\text{Mass fuel}} = \left(\frac{14.26 + 7.15}{100} \right) 16.0 = 3.43 \quad .$$

The mass of air required for the combustion process is given by equation (4) and obtained by dividing the above number by 0.232:

$$\frac{\text{Mass air}}{\text{Mass fuel}} = \frac{3.43}{0.232} = 14.8 \quad .$$

Using an excess air factor of four then gives an oxidizer to fuel ratio of 59.2. Since this occurs as a parameter in determining the concentration of the product constituents, an O/F ratio of 60 will be used. The mass fraction of each of the product species is then given by equation (12). Substituting into this set of equations yields the following:

<u>Product</u>	<u>Mass Percent</u>
CO ₂	5.14
H ₂ O	2.11
O ₂	17.20
N ₂	75.51

Equation (17) can then be used to compute the average molecular weight of the product gas mixture. This yields $M_T = 28.85$. Equations (16) or (19) through (22) then give:

<u>Product</u>	<u>Mole Percent</u>
CO ₂	3.37
H ₂ O	3.38
O ₂	15.51
N ₂	77.74

Finally, it will be pointed out that the CO₂ concentration present in the exhaust products as computed above is approximately 100 times the normal atmospheric concentration of CO₂. The mole percent or percent by volume of the constituents, when expressed as a fraction, also gives the partial pressure of the specie when the total pressure of the gaseous mixture is one atmosphere [equation (14)]. Figure 2 shows the mole percent of CO₂ contained in the exhaust products as a function of C:H with air to fuel ratio expressed as a parameter.

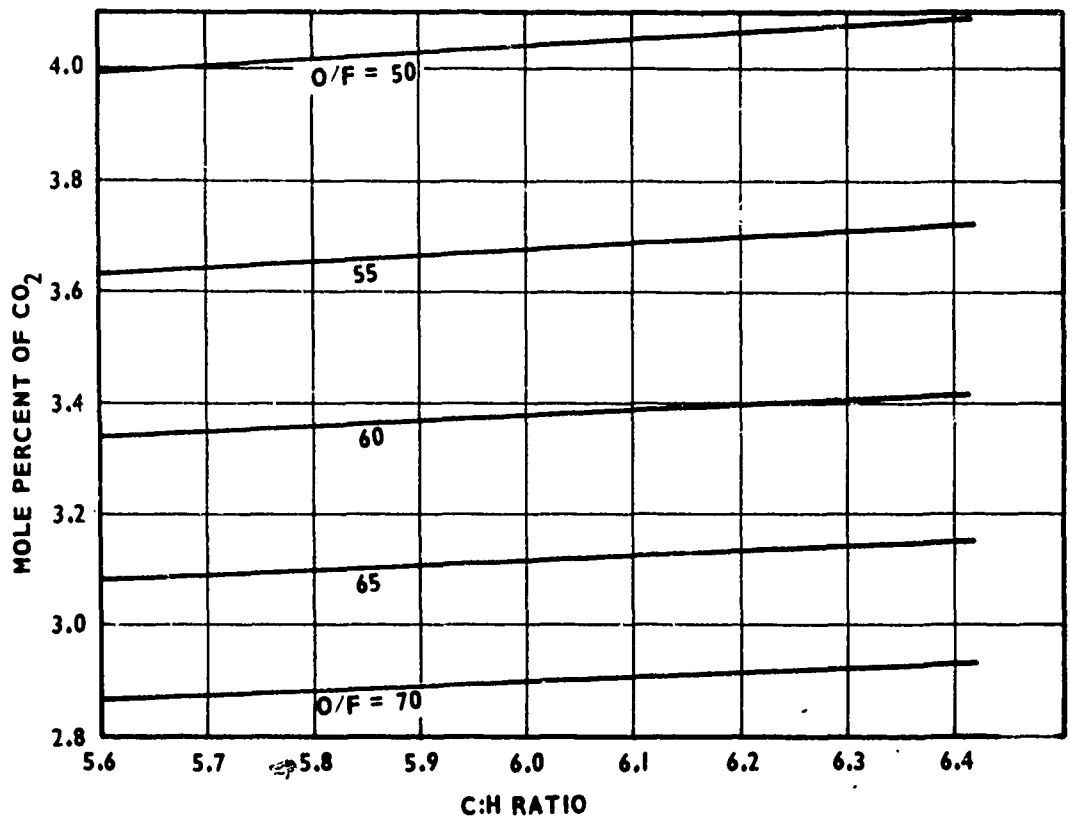

FIGURE 2. MOLE PERCENT OF CO₂ CONTAINED IN EXHAUST PRODUCTS AS A FUNCTION OF CARBON TO HYDROGEN FUEL WEIGHT RATIO WITH OXIDIZER TO FUEL RATIO AS A PARAMETER

Section III. FLOW FIELD

The flow field or plume model must be capable of generating the temperature and specie concentration within the exhaust plume as a function of the initial values at the tailpipe exit plane and the ambient conditions. Figure 3 depicts a typical jet plume along with the objective of the plume or flow field model. An axisymmetric coordinate system is used to define any point within the plume. The coordinate X measures the downstream position from the exit plane of the nozzle or tail pipe and the coordinate R measures the radial position or distance normal to the symmetry axis within the plume. The plume is divided into two regions called the core and developed or mixing regions. The core of the plume is a region of constant velocity and thermodynamic properties, whereas the developed portion of the plume is that region where the plume possesses property gradients in both the axial and radial directions. This model is a finite difference flow field program which takes the conditions at the exit nozzle; velocity, pressure, temperature, specie or constituent concentration, nozzle size, and ambient or free stream conditions, and then computes the temperature and specie concentration throughout the plume.

OBJECTIVE: TO DETERMINE THE PLUME SPREADING CHARACTERISTICS, IN PARTICULAR THE AXIAL AND RADIAL TEMPERATURE - COMPOSITION DECAY RELATIONSHIPS FROM A KNOWLEDGE OF THE GEOMETRY AND EXIT CONDITIONS OF THE NOZZLE.

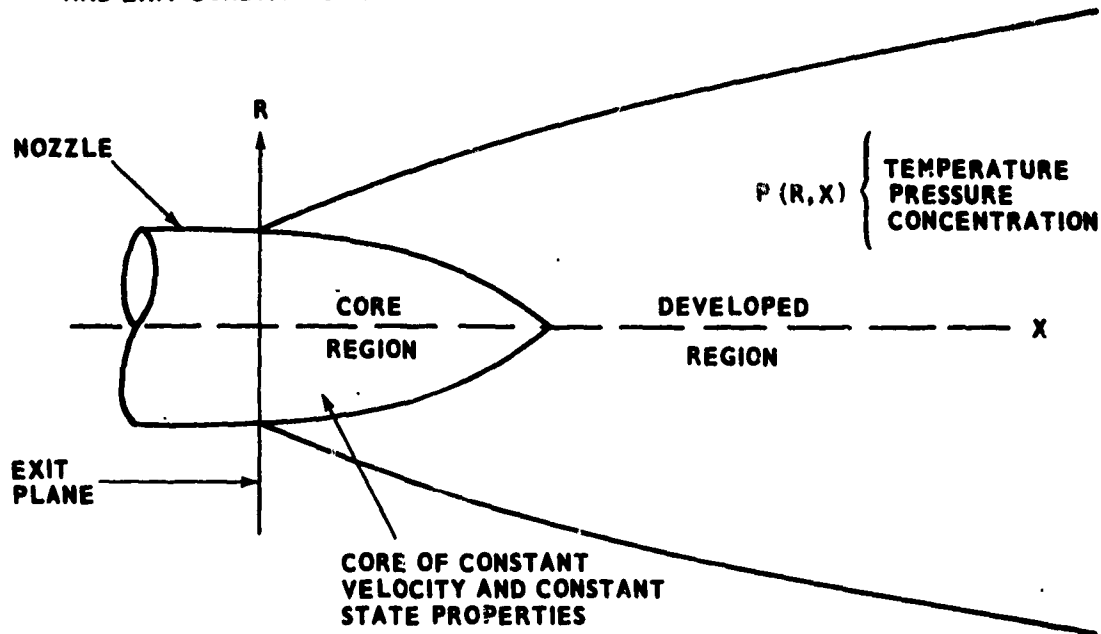

FIGURE 3. PLUME MODEL AND OBJECTIVE

The primary problem is to consider the mixing of two streams which are taken to be parallel but which possess different velocities, temperatures, and chemical compositions. Only the basic features of the physical problem will be mentioned in this limited discussion. These features can be outlined by considering a fully expanded axisymmetric jet exhausting into a uniform unbounded parallel stream. This is shown in Figure 4 where it is assumed that the pressures of the two streams are the same. The transport mechanisms that take place between the two streams include the transfer of momentum, the conduction of heat, and the diffusion of species causing the two streams to mix. In the region downstream of the jet exit plane, three distinct regions exist. In regions I and II, the two streams retain their original properties. Region III contains a mixture of the two streams resulting in nonuniform temperature, velocity, and specie concentration profiles. The mixing process tends to reduce the difference in the properties of the two streams. The flow itself can be either laminar or turbulent, and the analysis of either can be accomplished by considering only changes in the mathematical description of the expressions for the transport coefficients.

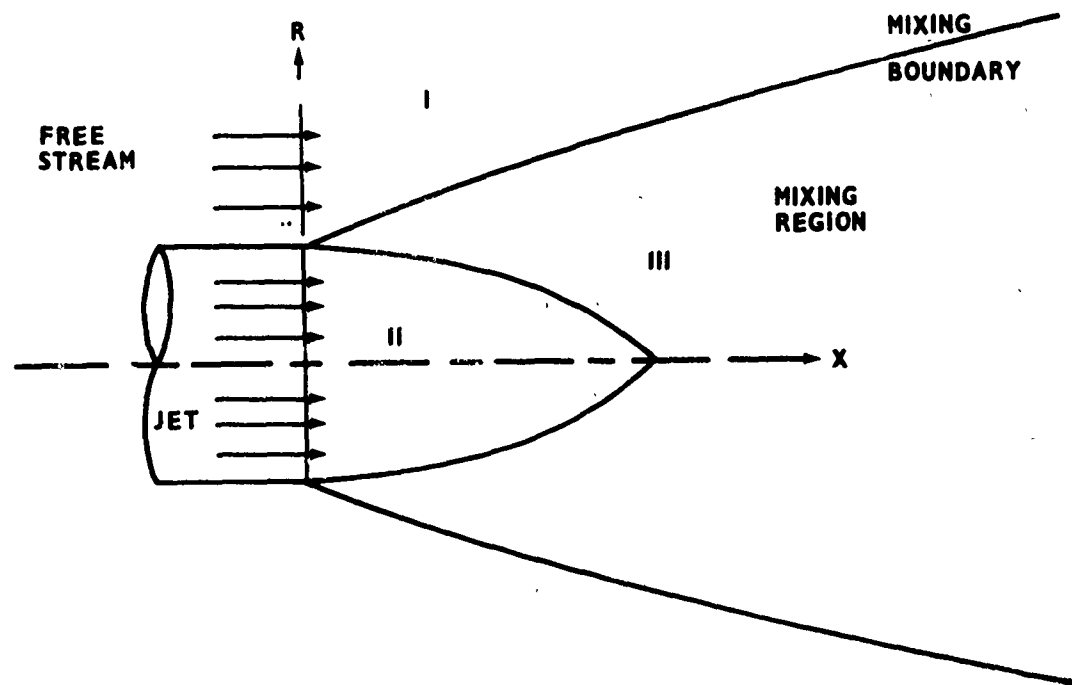

FIGURE 4. DISTINCT PLUME FEATURES

For the systems under consideration, both the pressure and temperature are relatively low. This results in the reaction time being much longer than

the flow time so that mixing occurs before any reaction takes place [6]. This frozen type flow can be analytically described by utilizing appropriate transport coefficients, an equation of state, expressions describing the temperature dependence of the species specific heat and enthalpy, and the conservation equations for continuity, energy, momentum and species. A lack of basic knowledge concerning the turbulent transport properties forces one to rely heavily on experimental data for the eddy viscosity, eddy conductivity (Prandtl number) and diffusion coefficient (Lewis number). The most difficult problem was the adoption of a satisfactory eddy viscosity model to use in the basic numerical program. A considerable amount of effort was expended to achieve a satisfactory viscosity model for incorporation into the flow program.*

Typical results from the program are shown in Figures 5 through 9. Figure 5 shows the axial values of the temperature and velocity decay for a particular jet engine compared with the manufacturer's data. This is for a compressible axially symmetric free turbulent jet exhausting into quiescent air at sea level conditions. Results for an inflight aircraft are shown in Figures 6 through 9. Figure 6 shows the decay of the temperature and CO₂ concentration along the symmetry axis. This aircraft has a turbojet engine and is assumed to be flying at sea level conditions with a speed of 280 meters per second. The top curve is a normalized plot of how the temperature varies with downstream distance along the symmetry axis. The ordinate is the ratio of the axial temperature to the temperature at the tailpipe exit. At a downstream distance of 35 feet the temperature has decayed by a factor of approximately 2.5. The dotted line shows the ambient temperature ratio and at 35 feet downstream the axial temperature is 25 to 30 percent above ambient temperature. The lower curve in Figure 6 shows a normalized plot of how the CO₂ concentration varies with downstream distance along the symmetry axis. The ordinate is the ratio of the CO₂ concentration along the symmetry axis to the concentration of the tailpipe exit. This represents a concentration which is 105 times the atmospheric CO₂ concentration (0.33 percent by volume). At a distance of 35 feet downstream the concentration has decayed to within 10 to 15 percent of the ambient value. Figures 7 and 8 show the radial distribution of the temperature and CO₂ concentration at selected axial positions. These clearly depict the diminishing core and appearance of the mixing region as a function of downstream distance. The ordinate in both plots is the ratio of the plume property to the free stream property. Figure 9 shows particular isotherms and the core region (shaded) for the same plume.

* This basic program was supplied to the author by Dr. A. Ferri and Dr. P. Baronti of Advanced Technology Laboratories, Inc., 400 Jericho Turnpike, Jericho, New York 11753.

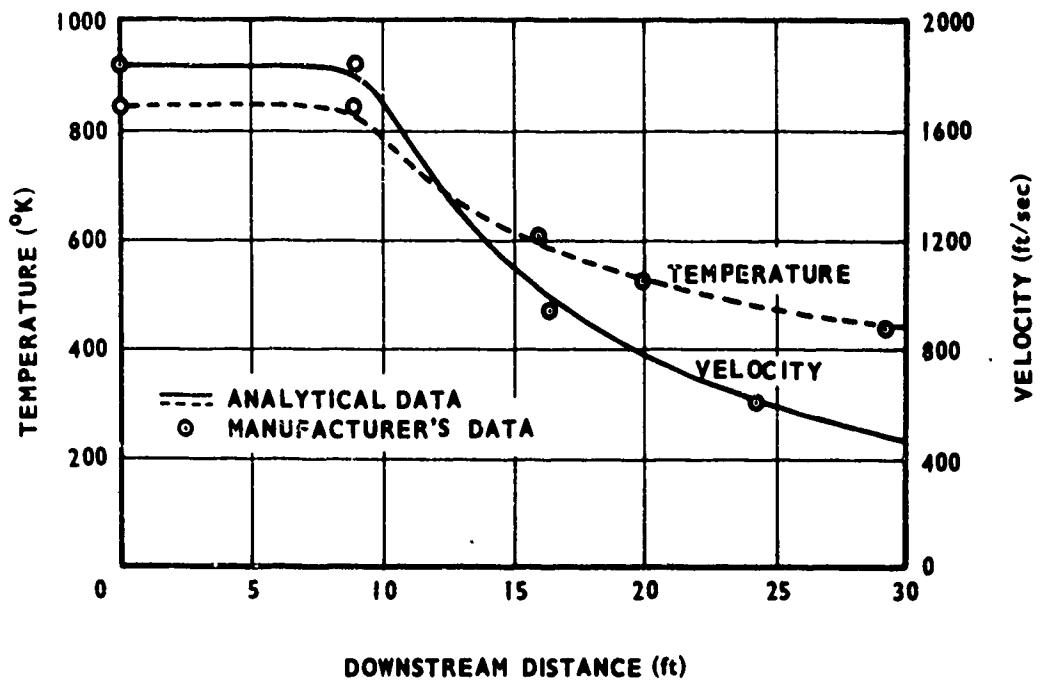

FIGURE 5. COMPARISON OF PLUME FLOW FIELD ANALYTICAL MODEL WITH MANUFACTURER'S DATA FOR A PARTICULAR JET ENGINE

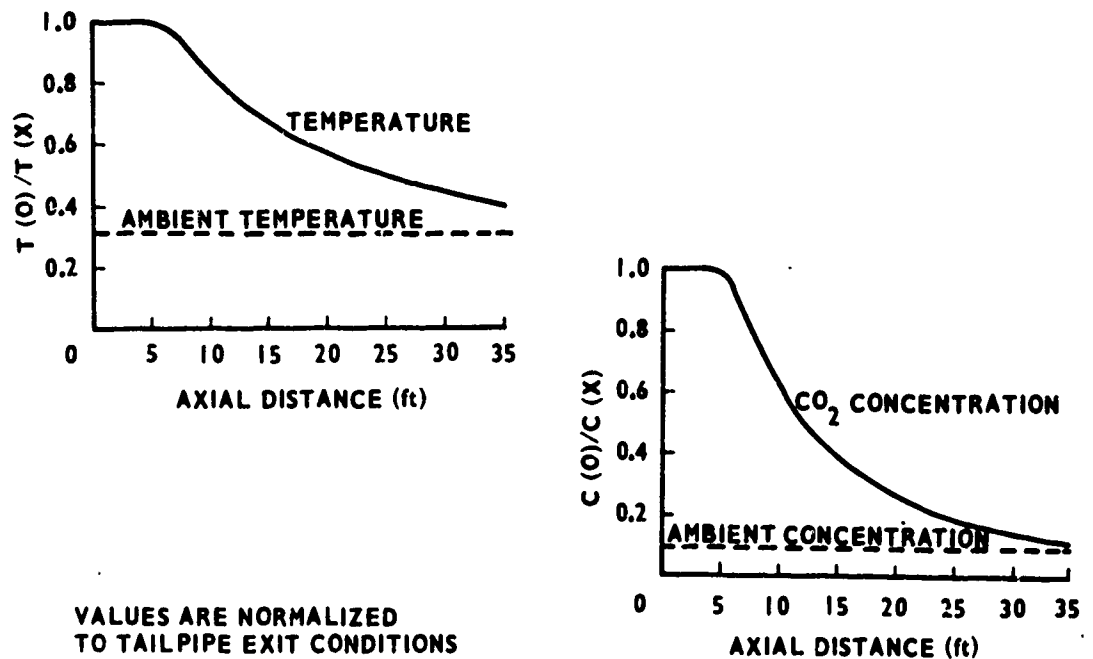

FIGURE 6. AXIAL DECAY OF TEMPERATURE AND CO₂ CONCENTRATION

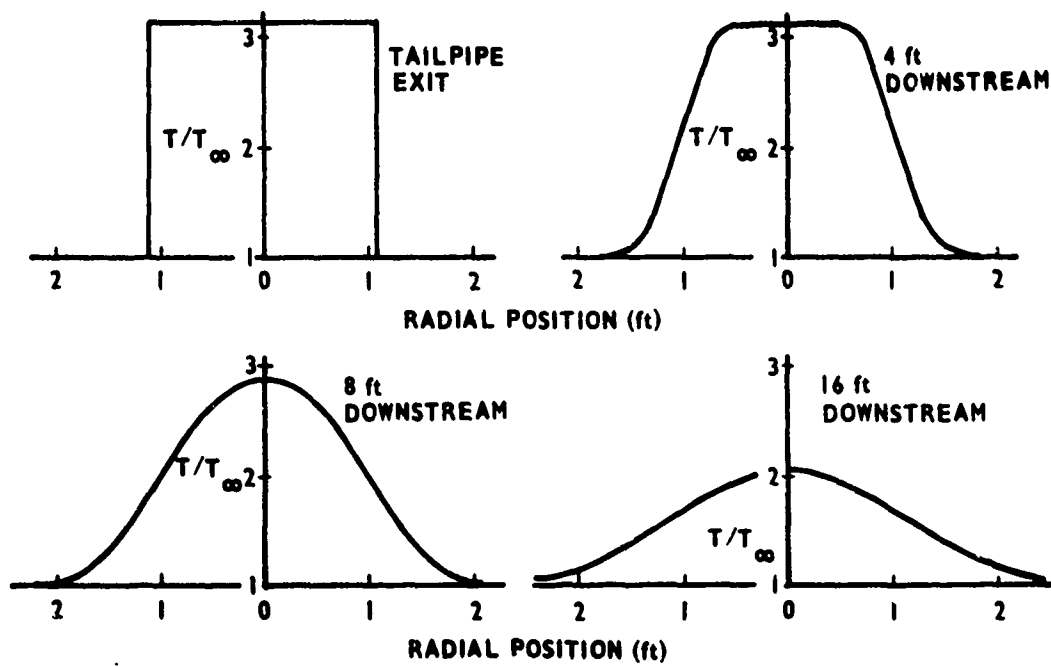

FIGURE 7. RATIO OF PLUME TO AMBIENT TEMPERATURE VERSUS RADIAL POSITION WITH DOWNSTREAM POSITION AS A PARAMETER

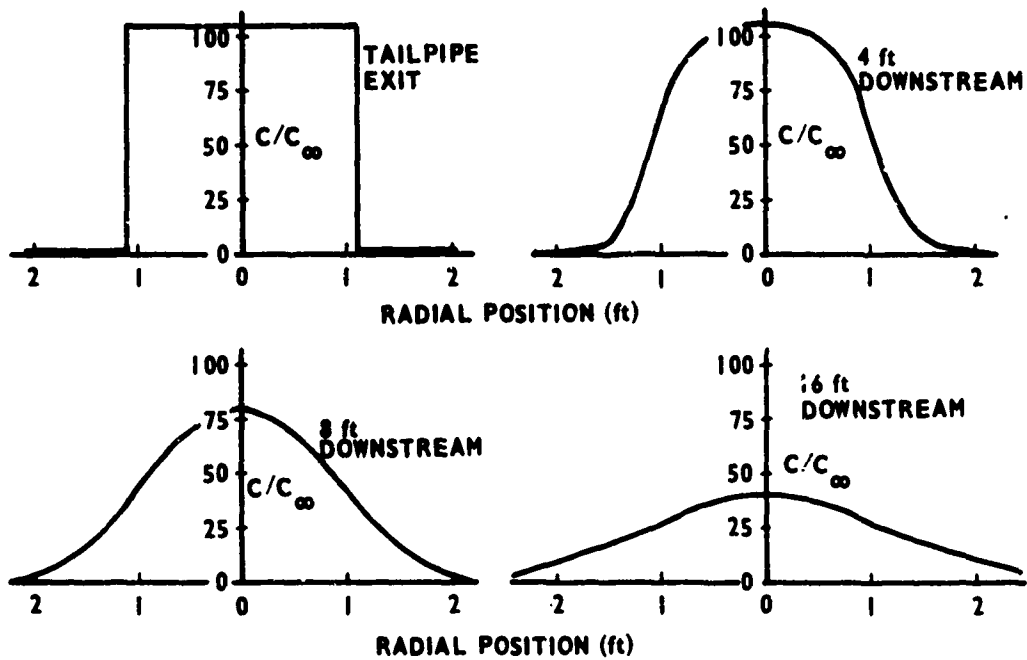

FIGURE 8. RATIO OF PLUME TO AMBIENT CO_2 CONCENTRATION VERSUS RADIAL POSITION WITH DOWNSTREAM POSITION AS A PARAMETER

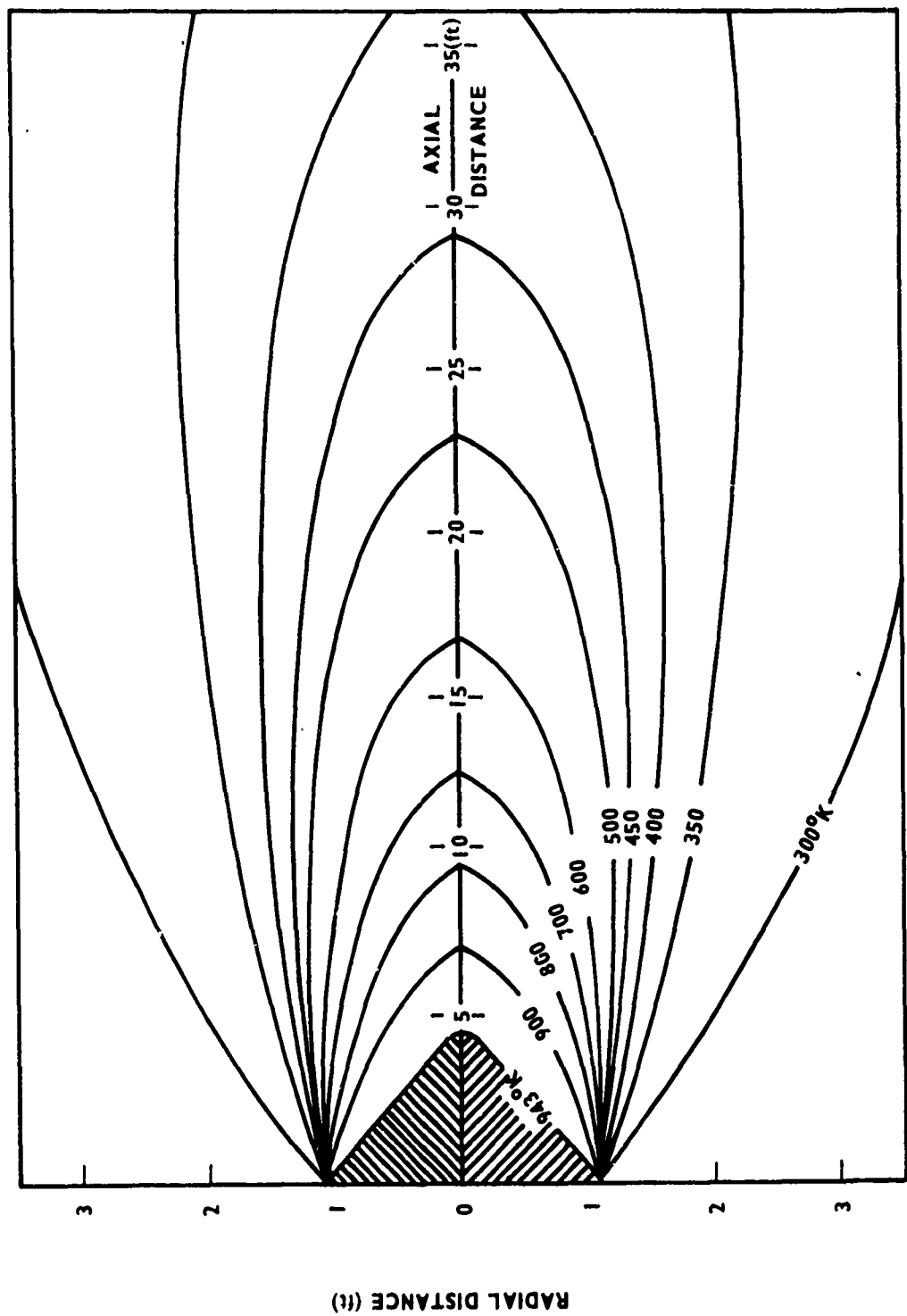

FIGURE 9. ISOTHERMS FOR AN INFLIGHT PLUME

The Advanced Technology Laboratories generalized frozen mixing program [6] is written in Fortran IV and can be used on any large scale computing system. The input instructions, a listing of the program, a typical set of input data and a sample of the subsequent output are included in the appendix.

Section IV. RADIATION CALCULATIONS

After the flow field calculations have been made for a particular aircraft, the radiation calculations may be started. The mathematical details and description of the radiation model have previously been reported on [1]. Figure 10 shows the geometry which is used for making the radiation calculations. The plume is depicted simply as a truncated ice cream cone. The outer edge of the plume is defined by the isotherm $T/T_{\infty} = 1.05$. This was found necessary, particularly for a jet exhausting into quiescent air, because of the slow exponential of the plume width in the radial direction.

A direction is then chosen in which it is desired to make the radiation calculations. This direction is indicated by α and called the aspect angle. A plane is then set up to cut the plume in this direction. The aspect angle is the angle between the symmetry axis and the direction that is chosen to make the radiation calculations. Zero degrees is the direction indicated by looking downstream along symmetry axis, 90 degrees is looking normal to the symmetry axis, and 180 degrees is looking upstream along the symmetry axis. Within this plane, various parallel lines of sight are constructed for actually making the radiation calculations. The coordinate Z_0 measures the distance of the line of sight above a line in the plane which intersects the symmetry axis. The distance measured along a particular line of sight is indicated as ℓ . The $\ell = 0$ point is where the line of sight first intersects the plume surface. The coordinate X_0 measures the downstream position where the calculation is being made and R_0 is the radius of the plume at this point.

Next the coordinates (X, R) are computed as a function of ℓ , Z_0 , α , X_0 and R_0 along the line of sight.

$$R = \left\{ Z_0^2 + \left[\ell \sin \alpha - \sqrt{R_0^2 - Z_0^2} \right]^2 \right\}^{1/2},$$
$$X = X_0 + \ell \cos \alpha.$$

The increment $\Delta\ell$ which divides the plume thickness into small segments is automatically calculated by the computer. The flow field data have been stored in the computer previous to calculating the coordinates (X, R) along the line of sight. A two-dimensional interpolation scheme is then used to calculate the plume properties along the line of sight. There is now a dimensional line segment, the length of which represents the plume thickness, with the temperature and concentration of the radiating specie specified along the line. The molecular band parameters are now computed at each specified point along the line segment. The emission calculations can now be made.

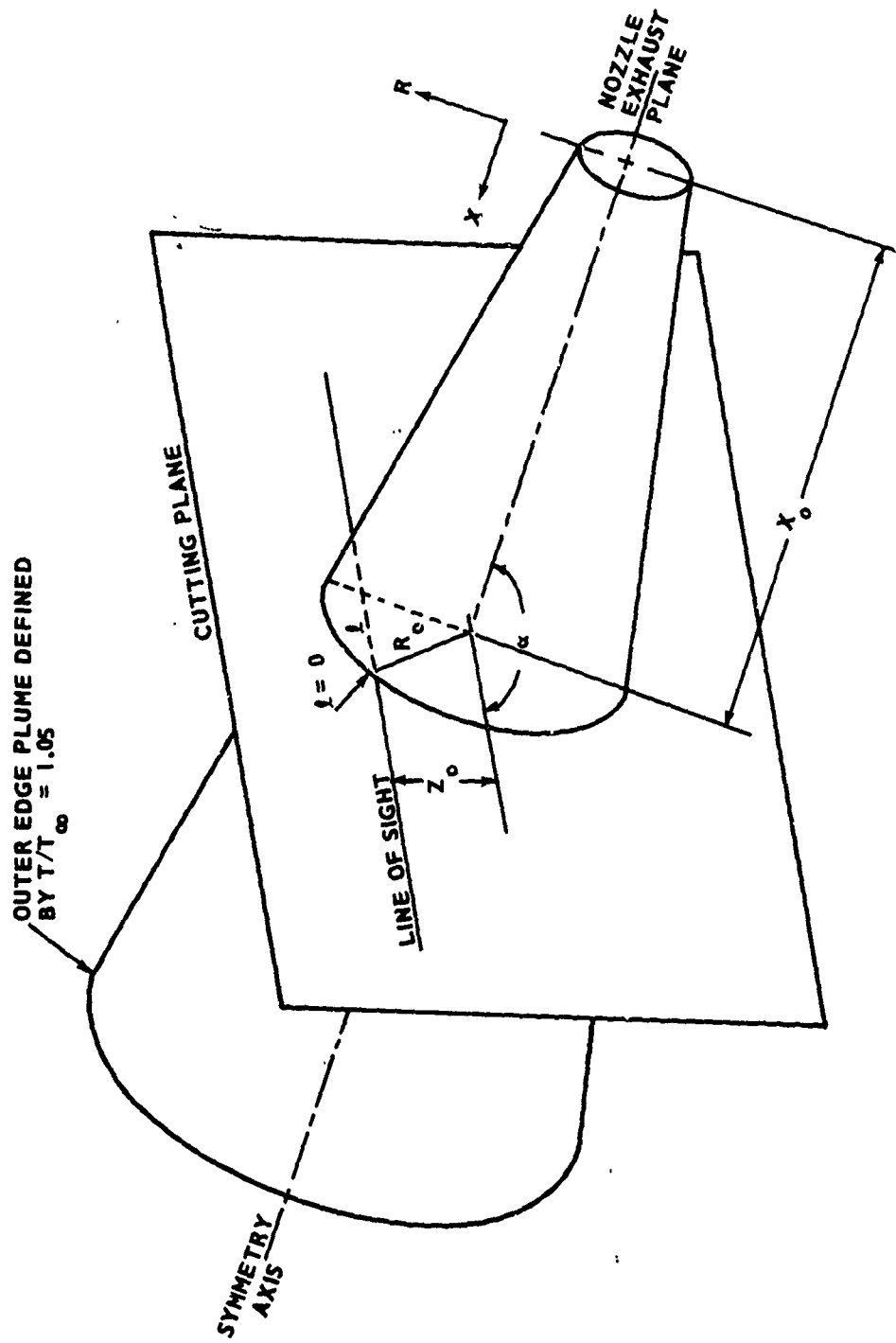

FIGURE 10. GEOMETRY FOR RADIATION CALCULATIONS

It is not an easy task to calculate accurately the radiation emitted from a homogeneous gas. The problem is obviously more complicated when dealing with an inhomogeneous gas. A modified form of the statistical band model has been chosen for making the emissivity calculations. For the inhomogeneous calculations this was further modified by using a method similar to the Curtis-Godson method. This method takes inhomogeneous gas which has a certain transmissivity and replaces it with a homogeneous gas which has the same transmissivity.

In this discussion only the results of the method will be outlined. The radiating band structure exhibited by the hot plume exhaust gases is actually composed of many closely spaced or overlapping spectral lines. In general, to calculate the emissivity or transmissivity of a gas, three parameters must be known for the absorbing or emitting molecule. The molecular band parameters are dependent on spectral location as well as the state of the gas. These three parameters are denoted as S , d , and γ where S is the average intensity of a spectral line, d is the spacing between lines, and γ is the line half-width. For the inhomogeneous calculations, these parameters are combined in a particular manner and an equivalent set of parameters is computed. These equivalent parameters are denoted by μ and ν and shown below.

$$\nu = \int_0^{Y(\ell)} \frac{S[\lambda, T(\ell)]}{d^2[\lambda, T(\ell)]} \gamma [P_e, T(\ell)] dY(\ell) \quad ,$$

$$\mu = \int_0^{Y(\ell)} \frac{S[\lambda, T(\ell)] dY(\ell)}{d[\lambda, T(\ell)]} \quad .$$

These parameters are computed in terms of the basic band parameters and a quantity denoted as Y which is referred to as the reduced optical path or equivalent gas thickness. The reduced optical path is defined as

$$Y(\ell) = \int_0^{\ell} \frac{P_{\text{CO}_2}}{P_e(\ell)} d\ell \quad ,$$

where ℓ represents the actual thickness of gas being considered, P_{CO_2} is the partial pressure of the absorbing gas, and P_e is the equivalent pressure.

The equivalent pressure is defined by the relationship

$$P_e = P_t + b P_{\text{CO}_2} \quad ,$$

where P_t is the total pressure of the gaseous system, and b is a spectral broadening coefficient which depends on the overall gaseous composition.

The transmission of the plume along the chosen line of sight can now be computed as a function of plume thickness and spectral location λ :

$$\tau(\lambda, \ell) = \exp \left\{ \frac{-2\nu}{\mu} \left(\sqrt{1 + \frac{\mu^2}{\nu}} - 1 \right) \right\} .$$

This calculation is necessary since the radiation emitted from the interior of the plume must be transmitted through a portion of the plume. At this point the computer has available at each spectral point of interest the transmission along the line of sight ℓ . The plume thickness is now divided into a number of small segments of thickness $\Delta \ell_i$ (Figure 11). Average plume properties are assigned to each segment so that each segment can be considered as a homogeneous gas. The spectral emissivity is calculated for each homogeneous segment. This is computed from the equation

$$\epsilon_i(\lambda, \Delta \ell_i) = 1 - \exp \left\{ \frac{-2\gamma(\bar{P}_e, \bar{T})}{d(\lambda, \bar{T})} \bar{P}_e \left[\sqrt{\frac{1 + S(\lambda, \bar{T}) P_{CO_2} \Delta \ell_i}{\gamma(\bar{P}_e, \bar{T}) \bar{P}_e}} - 1 \right] \right\} ,$$

where all the quantities on the right hand side of the equation have previously been defined. The radiation emitted from a particular segment is then obtained by multiplying the emissivity by Planck's black body spectral emission function. This is then multiplied by the transmission factor to obtain the radiation emitted from the surface of the plume by the segment $\Delta \ell_i$. The result is indicated by $I_i(\lambda, 0)$ and given by the relationship

$$I_i(\lambda, 0) = \frac{\epsilon_i C_1 \lambda^{-5} \tau_i}{\pi [\exp(C_2/\lambda T) - 1]} .$$

This is repeated for all segments along the line of sight, and the results are then summed to obtain the spectral radiation from this one point on the plume at the spectral point λ . This procedure is repeated for each spectral point to get the spectral distribution of radiation, again from this particular point on the plume, in the direction of α . The whole set of computations is now repeated for several points on the plume surface in order to obtain the spatial distribution or the total radiation emitted from the plume in the direction of the aspect angle α :

$$I(\lambda, \alpha, X_0, Z_0) = \sum_i I_i \left[W / (cm^2\text{-ster-}\mu m) \right]$$

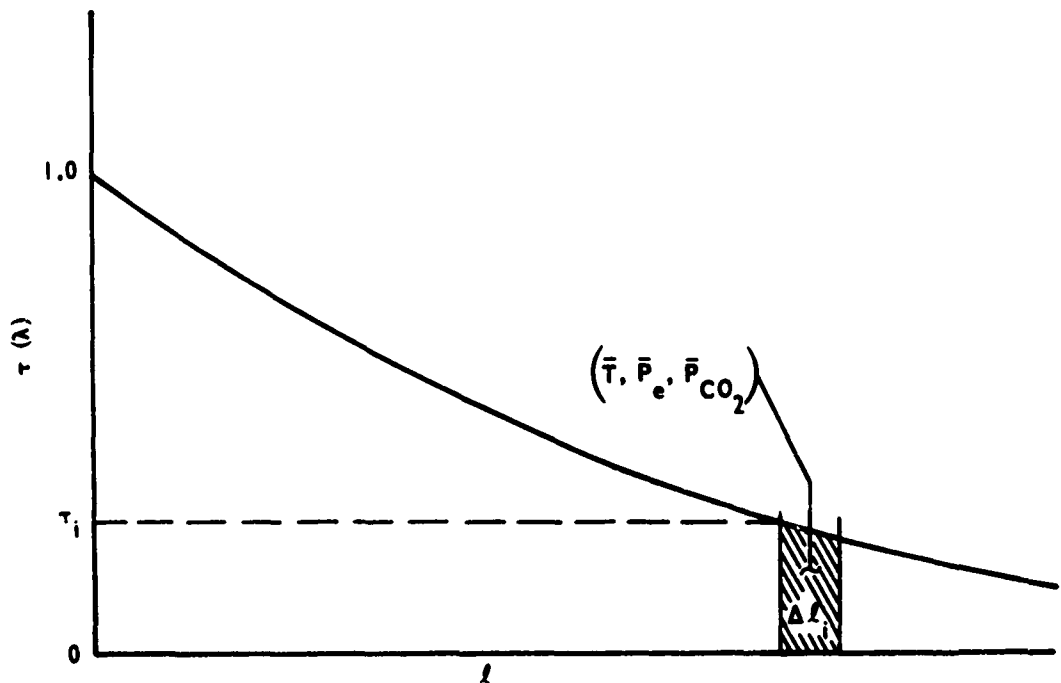

FIGURE 11. EMISSION MODEL

Figure 12 shows a comparison of the results of the homogeneous and non-homogeneous calculations for a particular homogeneous gas. This represents the spectral emissivity of a slice of gas taken at the exit plane of a typical exhaust nozzle.

Results from the program are shown in Figure 13. This is for an inflight aircraft and for the same aircraft operating in a tied-down or static position. Both curves are for sea level conditions and each is for a 90-degree aspect angle. Again this is for a typical jet aircraft. The emitted radiation has been integrated over the surface of the plume so each curve gives the spectral distribution of the plume emission.

It is interesting to note that the radiation emitted from the aircraft in a static position is larger than that emitted from the inflight aircraft. The 280-meter per second curve has a peak value of 1770 watts per steradian-micrometer whereas the static curve reaches a peak of 2300 watts per steradian-micrometer. This is apparently due to the free stream air which cools and reduces the size of the plume. This is also indicated by considering the area under each curve which represents the total emitted radiation. These values are indicated by Figure 13, where it can be seen that the static value is approximately 30 percent less than the inflight value.

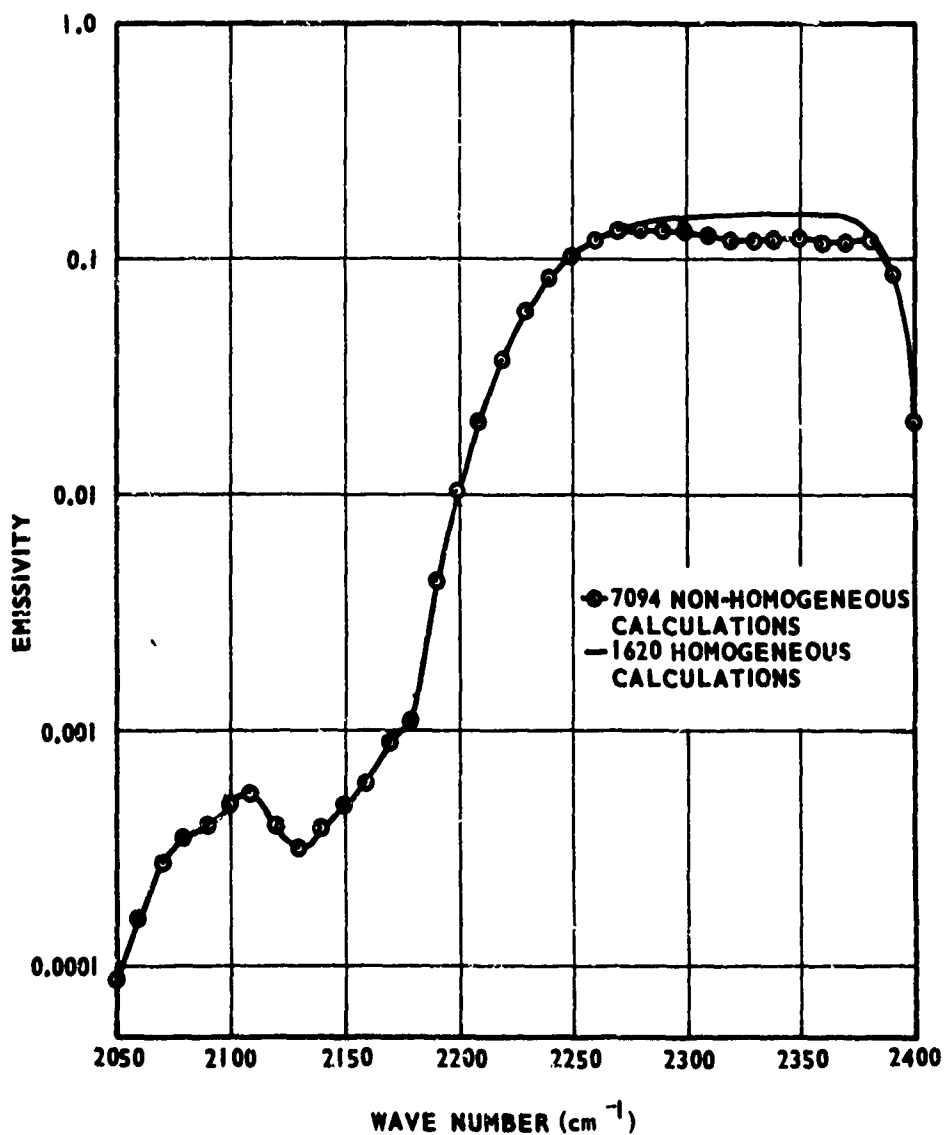

FIGURE 12. COMPARISON OF HOMOGENEOUS AND NON-HOMOGENEOUS CALCULATIONS

The absorption dips occurring in each curve are due to the cooler outer extremities of the plume absorbing the radiation from the hotter interior. This effect is more pronounced for the static curve since the plume is larger in size. The small peaks seen beyond 4.8 micrometers are due to a much weaker CO₂ band centered in this region.

Figure 14 shows data for the same inflight aircraft that was discussed in Figure 13. Again this is for a 90-degree aspect. The results are presented

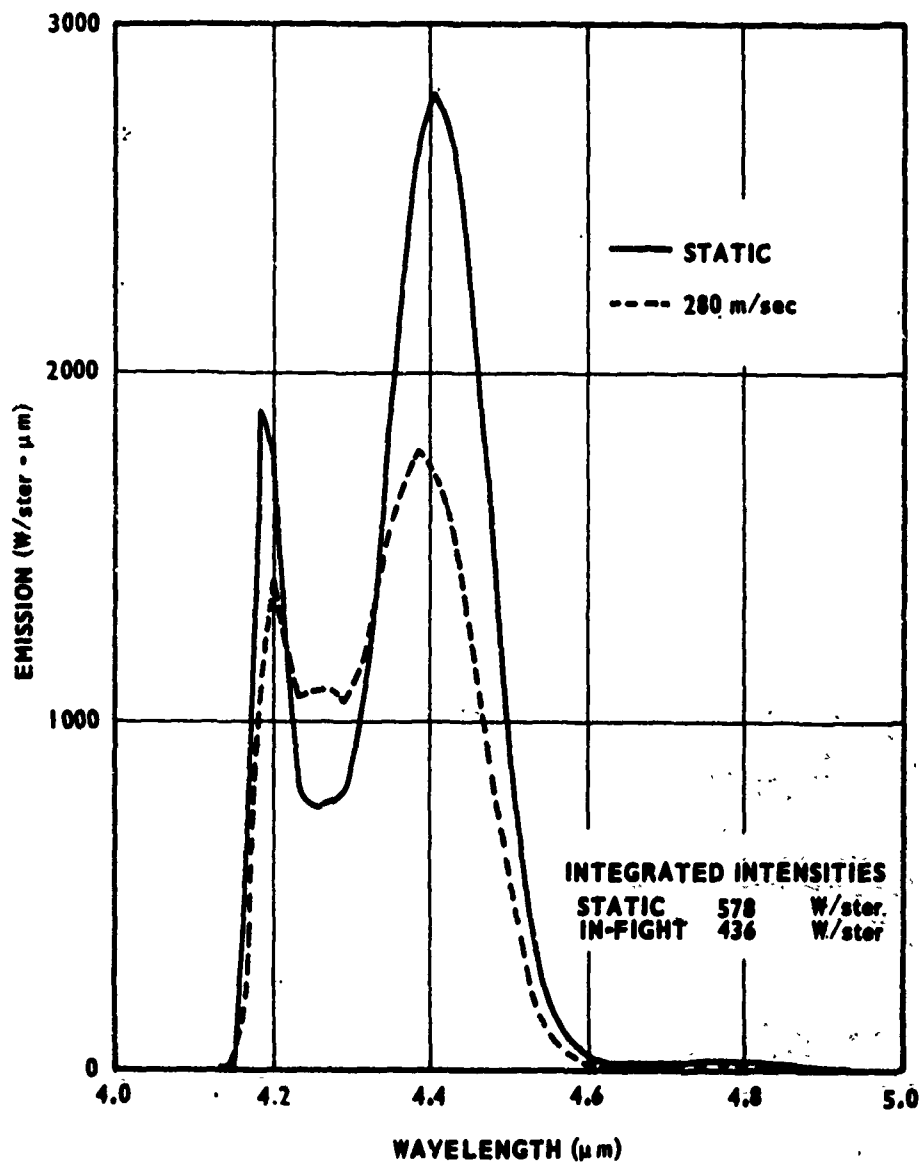

FIGURE 13. TYPICAL TURBOJET PLUME SURFACE EMISSION AT 90-DEGREE ASPECT

in a different manner, in that the spatial distribution was not integrated over the whole surface of the plume but only over the radial coordinate and then integrated over the spectral region. The result gives the axial decay of the radiation or the radiation per unit length of plume. This permits the radiation centroid to be calculated which is also shown in Figure 14. The plume geometrical centroid is about 7 feet aft of the tailpipe for this particular aircraft.

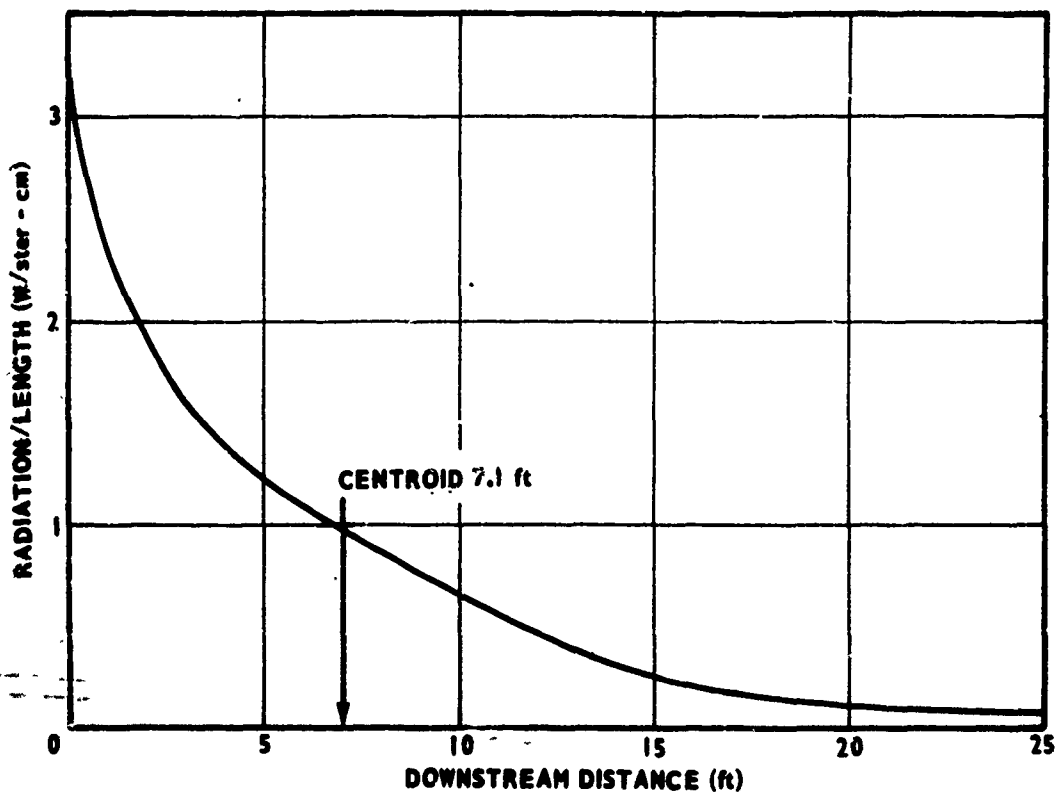

FIGURE 14. AXIAL DECAY OF PLUME RADIATION FOR A TYPICAL TURBOJET

One of the major objectives of this effort is to be able to predict the radiant energy that is emitted from a jet aircraft and is available to a remote sensor. This implies that the signature must be propagated through the atmosphere which, in reality, acts as an attenuation filter. Therefore an atmospheric transmission model [3] has also been developed in order to determine the atmospheric modification to the emitted energy. It is a two-component model that was derived from the well-known experimental data of Taylor and Yates. Molecular absorption of H_2O was considered along with other constituents of constant concentration such as CO_2 , N_2O , CH_4 and CO . The constituents of constant concentration were combined into a single species, XO_2 . The amount of XO_2 was chosen to be 32 atm cm/km, which is the average concentration of CO_2 . Figure 15 shows a comparison of the transmission model with a set of independent measured transmission data. It can be seen that the computer model matches the measured data quite nicely. The broad absorption dip between 4.2 and 4.45 micrometers is due to CO_2 absorption. The dip at 4.5 micrometers is due to N_2O , and the fine structure is due primarily to H_2O .

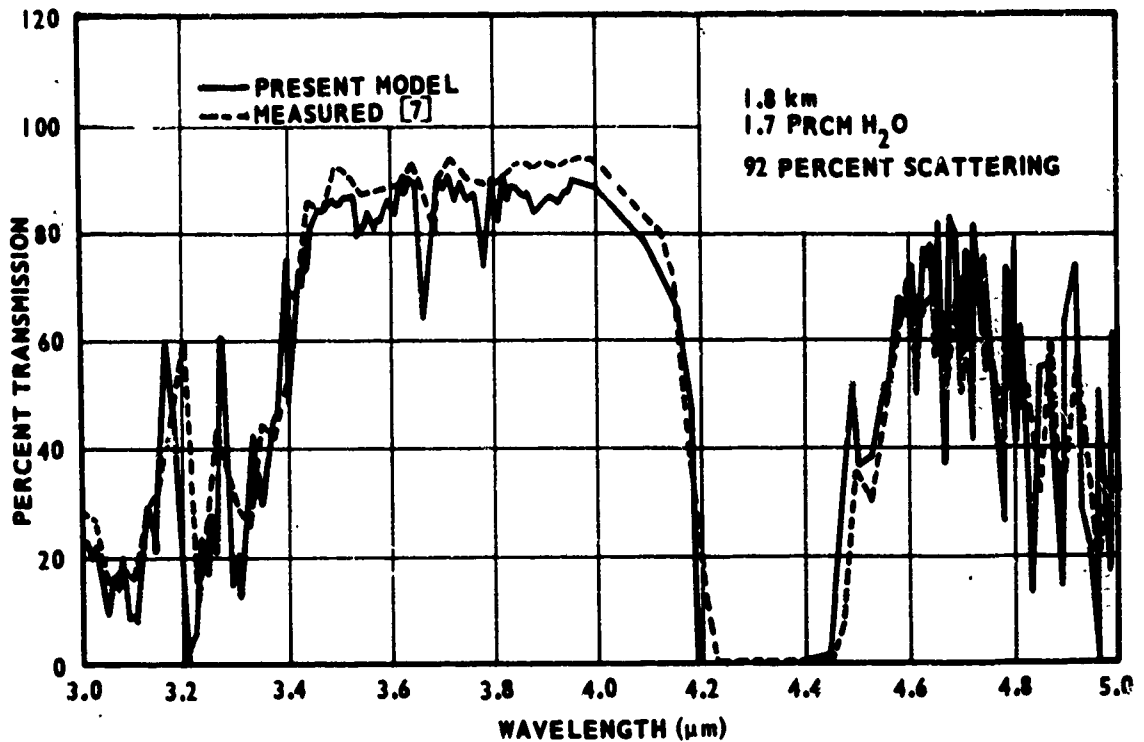

FIGURE 15. COMPARISON OF ATMOSPHERIC TRANSMISSION MODEL WITH MEASURED DATA

Figure 16 shows a typical plume signature put through 1, 7, and 15 kilometers of atmosphere by using the previously described transmission model. This shows the importance of the wings or skirts of the emission band since the center of the band gets completely absorbed in relatively short path lengths.

A comparison of the results of the present model with measured data is shown in Figure 17. This is for a particular jet aircraft operating in a static position at 100-percent power. The aspect angle is 10 degrees and the measured data were recorded at 1 mile from the aircraft. The theoretical results were put through the above described atmospheric transmission model to obtain the signature shown in Figure 17.

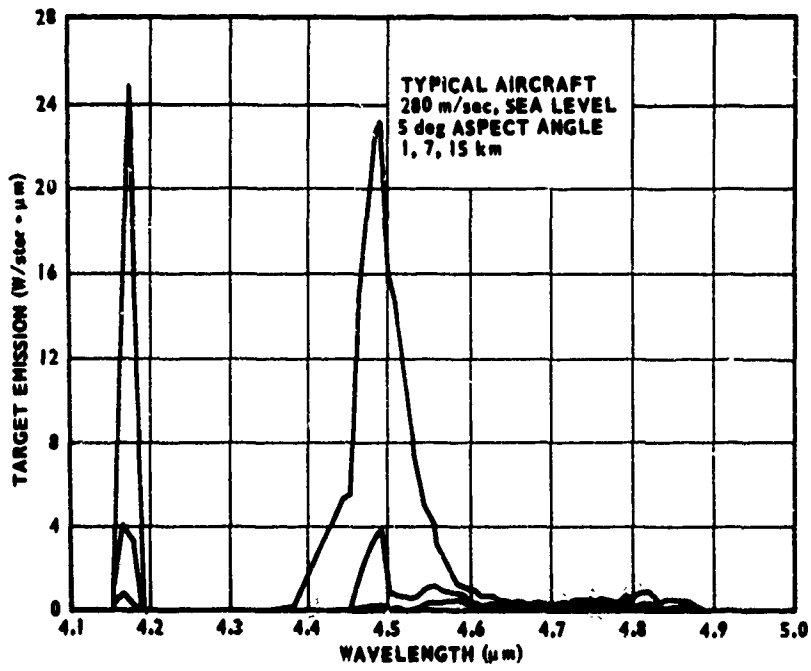

FIGURE 16. REMOTE PLUME SPECTRAL SIGNATURE

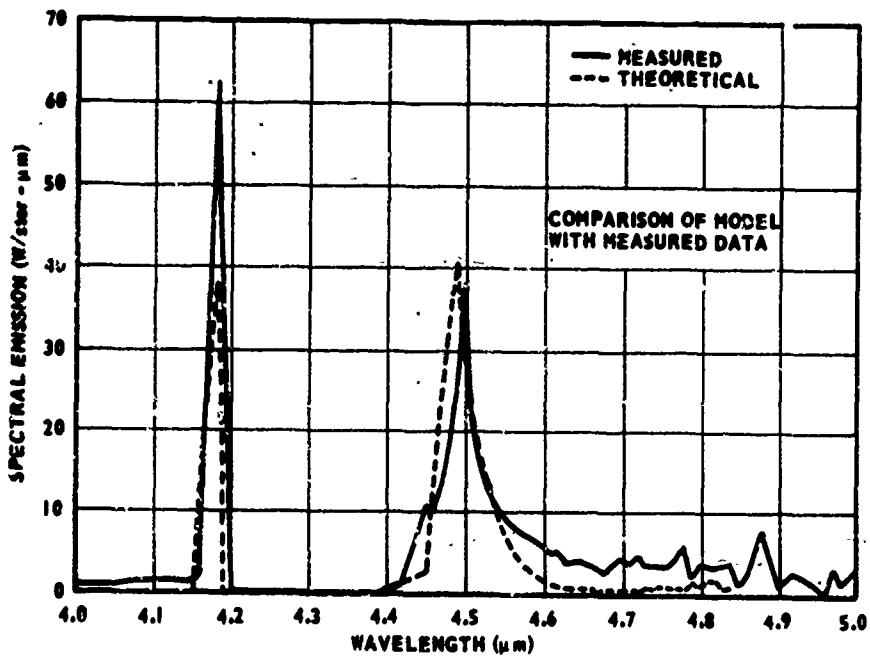

FIGURE 17. COMPARISON OF MODEL WITH EXPERIMENTAL DATA

Section V. RADIATION COMPUTER PROGRAM

A copy of the computer program is shown in Table III. A typical set of input data is shown in Table IV. The first 72 data cards are standard input for each run. These cards alternately list the molecular CO₂ band parameters S/d and $S^{1/2}/d$ as a function of wave number and temperature. The first data record on each card gives the wave number and the remaining seven records list the band parameter at the given wave number as a function of temperature in increments of 300°K (for second data record, $T = 300^\circ\text{K}$; for third, $T = 600^\circ\text{K}$; for eighth, $T = 2100^\circ\text{K}$).

The next two data cards are also standard input for each run and simply contain headings (RADIATION) for the output data headings.

The next two cards are used to document the date of the run and the description or title of the run. The first card contains the date (first 12 columns) and the second the title or name of the run (first 72 columns). The next card must contain two pieces of information according to the format (2I5). The first is the number of X-stations (NXS) that are desired in the calculations and the second is the number of radial or Z points (NZPEX) desired at each X station. (These numbers must be less than or equal to 60 and 8, respectively). The computer checks to insure that these limits are maintained. The coordinate X measures downstream position in centimeters, and Z is the coordinate normal to X, also measured in centimeters. The actual magnitude of these numbers and their spacing is determined by the flow field computation. Again NXS and NZPEX count only the number of the points at which calculations are made. The set of flow field data is next read into the computer. This is denoted between statements 172 and 110 of the program listing. An axisymmetric coordinate system is used so that any plume property is defined by the coordinates X and R. Data from the flow field calculations are written on tape at specific X or downstream locations. The number of radial points at each X position is denoted (NRP) and each radial point defined by R(I). At each downstream position where a radiation calculation is desired, the temperature $T(I, J)$ (I denotes the number of the downstream position, J denotes the number of the radial position) in degrees-Kelvin, the radial position $R(I, J)$ in centimeters, and the partial pressure of CO₂ (PCO_2) in atmosphere is written on tape. The number of radial points at any given X position must be less than or equal to 25. It is assumed that the total pressure anywhere in the plume is 1 atmosphere. These quantities are not written or read according to a format but rather in binary notation.

Finally a card is read which contains two quantities, ALPHA and ISTOP according to the format (F10.5, I5); ALPHA is the aspect angle in degrees and ISTOP is either 1, 2 or 3. A (1) will terminate the run after the calculations

TABLE III. RADIATION COMPUTER PROGRAM

TEST	- EFN	SOURCE STATEMENT - IFNIST -	03/11/70
C		TRACY JACKSON 7/24/68	
C		CO2 4.3 MICRON BAND PLUME SPECTRAL RADIATION PROGRAM	
		DIMENSION X(6C),R(60,25),I(60,25),PC2(60,25),SGC(36,7),SOD2(36,7)	
		DIMENSION WAVNC(36),WAVLH(36),TT(7),TSPRAD(36)	
C		READ BAND PARAMETERS FOR CO2 EMISSIVITY CALCULATIONS	
C		REWIND 10	1
		DO 100 I=1,36	
		READ(5,1000) WAVNO(I),(SCD(I,J),J=1,7)	4
		READ(5,1000) WAVNO(I),(SCD2(I,J),J=1,7)	10
100		WAVLH(I)=10000./WAVNO(I)	
1000		FORMAT(F7.1,7E5.2)	
		DO 101 J=1,7	
		TT(J)=300.*TJ	
		DO 101 I=1,36	
101		SOD2(I,J)=SOD2(I,J)*SGD2(I,J)	
		DIMENSION DATE(2),TITLE(12),HEACNC(18)	
		READ(5,1051)(HEADNG(J),J=1,18)	33
1051		FORMAT(12A6/6A6)	
		READ(5,1050) DATE(1),DATE(2),(TITLE(J),J=1,12)	40
1050		FORMAT(2A6/12A6)	
		WRITE(6,1100) DATE(1),DATE(2),(TITLE(I),I=1,12)	47
1100		FORMAT(1H1,4CX,52HC2 4.3 MICRON BAND PLUME SPECTRAL RADIATION PRO	
		GRAM/1HC,62X,2A6/1HC,3CX,12A6)	
		WRITE(6,1101)	54
1101		FORMAT(1HC,41HALL PLUME COORDINATES ARE MEASURED IN CM.)	
		WRITE(6,1102)	55
1102		FORMAT(1HC,17H WAVELENGTH-(1/CM))	
		WRITE(6,1103)	56
1103		FORMAT(1HC,20HWAVELENGTH-(MICRONS))	
		WRITE(6,1104)	57
1104		FORMAT(1HC,41HRADIATION-(WATTS/SG.CM.-MICRON-STERADIAN))	
C		NXS=NUMBER X STATIONS	
C		NZPEX=NUMBER Z POINTS AT EACH X STATION	
C		READ(5,1001) NXS,NZPEX	58
1001		FORMAT(2I5)	
		IF(NXS.GT.60) GO TO 170	
		IF(NZPEX.GT.8) GO TO 171	
		GO TO 172	
170		WRITE(6,1120)	68
1120		FORMAT(1H1,40H NUMBER OF X-STATIONS MUST BE 60 OR LESS)	
		STOP	
171		WRITE(6,1121)	69
1121		FORMAT(1H1,36H NUMBER OF Z-POINTS MUST BE 8 OR LESS)	
		STOP	
C		READ INPUT DATA TAPE FROM PLUME FLOW FIELD PROGRAM	
C		NRP=NUMBER OF RADIAL POINTS	
C		172 CONTINUE	
		READ(10) (TITLE(I),I=1,12)	70
		READ(10) NCRUN	77
		DO 102 I=1,NXS	
		READ(10) X(I),NRP	81
		READ(10)(T(I,J),R(I,J),PC2(I,J),J=1,NRP)	84
		IF(NRP.LT.25) GO TO 110	
		GO TO 102	
110		NRP1=NRP+1	
		GO 111 KK=NRP1,25	

TABLE III. RADIATION COMPUTER PROGRAM (Continued)

```

TEST      - EFN  SOURCE STATEMENT - IFA(S) -
-----
C          R(I,KK)=R(I,APP)
C          T(I,KK)=T(I,APP)
111 PC12(I,KK)=PC2(I,APP)
102 CONTINUE
C          IPAGE=G
C
C          ALPHA=ASPECT ANGLE IN DEGREES(O DEG=NCSE-ON)
C          ISTOP=1,WILL TERMINATE PROGRAM AFTER SINGLE ALPHA CALCULATION
C          ISTOP=2,RETURNS TO THIS POINT FOR ANOTHER ALPHA
C          ISTOP=3,RETURNS TO STMT 173 TO READ NEW SET FLOW FIELD DATA
C
103 READ(5,101C)ALPHA,ISTOP                                     110
1010 FORMAT(F10.5,15)
C          ALP=ALPHA/57.295780
C          CC=CGS(ALP)                                         112
C          SC=SIY(ALP)                                         113
C          PI=3.1415926
C          D1 163 L=1.36
160 TSPRAD(1)=0.
C          NXSM1=NXS-1
C          IF(ALPHA.EQ.0.C.OR.ALPHA.EQ.180.C) NXSM1=1
C          D1 166 L=1,NXSM1
C          IXC=1
C          R0=R(I,X0,25)
C          X0=X(I,X0)+.01
C          IF(ALPHA.EQ.180.C) X0=X(NXS)
C          ZPEX=N/ZPEX
C          DELZ=X0/ZPEX
C          D1 162 M=1,NZPEX
C          ZN=M
C          ZI=DELZ*(ZN-1.)
C          IF(ALPHA.EQ.0.C) RC=2.*R(1,25)+(ZN-1.)*(R(NXS,25)-2.*R(1,25))/ZPEX
C          IF(ALPHA.EQ.180.C) RC=(ZN-1.)*(R(NXS,25))/ZPEX
C
C *****
C          CALCULATE COORDINATES X,R ALONG LINE-OF-SIGHT AS FUNCTION OF ITS
C          LENGTH
C
C          DIMENSION CR(100),CX(100),CL(100)
C          DELL=1C.
C          IF(ALPHA.EQ.0.C.OR.ALPHA.EQ.180.C) DELL=X(NXS)/98.
200 XL=0.
C          D1 201 J=1,100
C          N=J
C          APR=XL*SC-SQRT(RC*RC-Z0*Z0)                               148
C          CP(N)=SQRT(Z0*Z0+APR*APR)                               149
C          CA(N)=XC+XL*CC
C          CL(N)=XL
C          IF(CX(N).LT.0.) GO TO 204
C          IF(CX(N).GT.X(NXS)) GO TO 204
C          IF(ALPHA.EQ.0.0.OR.ALPHA.EQ.180.C) GO TO 203
C          D1 201 K=1,NXS
C          KI=K
C          IF(CX(N).LE.X(K)) GO TO 202
201 CONTINUE
202 IF(CR(N).GT.R(KI,25)) GO TO 204
203 XL=XL+DELL
C
C          DELL TOO SMALL, INCREASE AS FOLLOWS
C
C          DELL=DELL+DELL/2.
C          GO TO 200
204 IF(N.LT.50) GO TO 205
C          GO TO 249

```

TABLE III. RADIATION COMPUTER PROGRAM (Continued)

```

TEST      - EFF. SOURCE STATEMENT - IFA(S) -
-----
C
C  BELL TO LARGE, DECREASE AS FOLLOWS.
C
205 BELL=CL(N)/75.
C
C  PLUME THICKNESS NEGLIGIBLE AT THIS POINT, MOVE ON TO NEXT POINT
C  AFTER SETTING ALL SPECTRAL RADIATION VALUES EQUAL TO ZERO
C
IF (BELL.LE.C.CC5) GO TO 510
GO TO 220
C
C *****
C  CALCULATE PRESSURE AND TEMPERATURE ALONG LINE-OF-SIGHT AT EACH X,R
C
DIMENSION CT(100),CP(100)
299 DO 302 J=1,N
DO 301 L=1,NXS
MM=L
IF (C.X(J).LE.X(L)) GO TO 302
301 CONTINUE
302 DO 303 L=1,25
MM=L
IF (C.R(J).LE.R(NN.L)) GO TO 304
303 CONTINUE
304 DR1=CR(J)-R(NN-1,MM-1)
DR2=R(NN-1,MM)-R(NN-1,MM-1)
DR3=CR(J)-R(NN,MM-1)
DR4=R(NN,MM)-R(NN,MM-1)
DX1=CX(J)-X(NN-1)
CX2=X(NN)-X(NN-1)
TX1=T(NN-1,MM-1)+(T(NN-1,MM)-T(NN-1,MM-1))*DR1/DR2
TX2=T(NN,MM-1)+(T(NN,MM)-T(NN,MM-1))*DR3/DR4
CT(J)=TX1+(TX2-TX1)*DX1/DX2
PX1=PCU2(NN-1,MM-1)+(PCC2(NN-1,MM)-PCC2(NN-1,MM-1))*DR1/DR2
PX2=PCU2(NN,MM-1)+(PCC2(NN,MM)-PCC2(NN,MM-1))*DR3/DR4
CP(J)=PX1+(PX2-PX1)*DX1/DX2
IF (CT(J).LT.300.) CT(J)=300.
300 IF (CP(J).LT.C.C0033) CP(J)=C.C0033
C
C *****
C  CALCULATE AT EACH SPECTRAL POINT (CONSIDERED THE BAND PARAMETERS
C  AT EACH X,R ALONG LINE-OF-SIGHT
C
DIMENSION CSOD(36,100),CSOD2(36,100)
DO 401 K=1,N
IR1=CT(K)/300.
IF (IR1.LT.1) IR1=1
ET1=(CT(K)-T(IR1))/300.
DO 401 L=1,36
CSOD(L,K)=SOD(L,IR1)+DT1*(SOD(L,IR1+1)-SOD(L,IR1))
401 CSOD2(L,K)=SOD2(L,IR1)+DT1*(SOD2(L,IR1+1)-SOD2(L,IR1))
C
C *****
C  CALCULATE TRANSMISSION AT EACH SPECTRAL POINT FROM EDGE OF PLUME
C  TO X,R ALONG LINE-OF-SIGHT
C
DIMENSION Y(100),TRANS(36,100)
Y(1)=0.
DO 501 K=2,N
501 Y(K)=Y(K-1)+0.5*(CL(K)-CL(K-1))*(CP(K)+CP(K-1))
DO 502 K=1,36
TRANS(K,1)=1.C
P=0.
C=C.

```

TABLE III. RADIATION COMPUTER PROGRAM (Continued)

```

TEST - CFM SOURCE STATEMENT - (FMS) - 03/11/70
-----
502 J=2,N
CY=).5*(Y(J)-Y(J-1))
PVT=C.5*(CT(J)+CT(J-1))
GAM=C.75*SQRT(3C)/PVT
P=P+CY*(CSO1(K,J-1)+CSCD(K,J))
Q=Q+CY*(AM*(CSO2(K,J-1)+CSCD2(K,J))
A+G=-2.*(Q/P)*(-1.+SQRT(1.+P*P/C))
502 TRANS(K,J)=EXP(A+G)
-----
C *****
C CALCULATE TOTAL SPECTRAL EMISSION/UNIT-AREA FROM THE POINT
C XL, YL, ZL IN THE DIRECTION OF ALPHA
C
C DIMENSION SPRAD(36,11),ZB(9),NSTEPS(9),DELTA(9)
C INDX=0
C GO TO 620
610 INDX=100
620 ZB(M)=ZL
IF (ALPHA.EQ.C.C.OR.ALPHA.EQ.180.C) ZB(M)=RC
NSTEPS(M)=N
DELTA(M)=DELL
MX=M
DO 600 K=1,36
600 SPRAD(K,M)=C.
IF (INDEX.GT.50) GO TO 602
M=M-1
DO 601 K=1,M+1
PV1=(CT(K)+CT(K+1))*0.5
XX=14386./PVT
DO 601 L=1,36
TSVTY=(TRANS(L,K)-TPAS(L,K+1))/TRANS(L,K)
P=L*WAVLH(L)
PLKAD=11906.+(PWL**(-5))/(EXP(XX/PWL)-1.)
SPRAD(L,M)=PLKAD*TSVTY*TRANS(L,K)+SPRAD(L,M)
601 CONTINUE
602 CONTINUE
-----
C *****
C PERFORM SPATIAL INTEGRATION OVER FLAME SURFACE TO OBTAIN THE TOTAL
C SPECTRAL EMISSION IN THE DIRECTION OF ALPHA, ALSO PERFORM AN
C INTEGRATION OVER THE SPECTRAL REGION TO OBTAIN THE TOTAL RADIATION
C THAT IS EMITTED FROM THE PLUME AT ASPECT ANGLE ALPHA
C
C MXPI=MX+1
C ZB(MX+1)=R(INC,25)
C DO 700 L=1,36
C SPRAD(L,MX+1)=C.
700 SPRAD(L,MX+1)=C.
IF (ALPHA.EQ.C.C.OR.ALPHA.EQ.180.C) ZB(MX+1)=R(NXS,25)
DO 701 L=1,36
C 701 M=2,MXPI
701 SPRAD(L,MX+1)=SPRAD(L,MX+1)+(ZB(M)-ZB(M-1))*(SPRAD(L,M-1)+SPRAD(L,
1M))
IF (ALPHA.EQ.C.C.OR.ALPHA.EQ.180.C) GO TO 705
IF (IX).EQ.1) GO TO 703
DO 702 L=1,36
702 TSPRAD(L)=TSPRAD(L)+(X(L)-X(L-1))*(SL/2.)*(SPRAD(L,MX+2)+SPRAD(L,M
1X+1))
703 DO 704 L=1,36
704 SPRAD(L,MX+1)=SPRAD(L,MX+1)
GO TO 707
705 DO 706 L=1,36
DO 706 M=2,MXPI
706 TSPRAD(L)=TSPRAD(L)+(ZB(M)*ZB(M)-ZB(M-1)*ZB(M-1))*PI*(SPRAD(L,M)+S

```

TABLE III. RADIATION COMPUTER PROGRAM (Concluded)

03/11/70

TEST	SOURCE STATEMENT	IFMS
	IPKAD(L,M=1)/2.	
	7C7 DO 7C9 L=1,36	
	7C8 SPRAD(L,MXP1)=SPRAD(L,MX+J)	
C	*****	
C	WRITE DESIRED OUTPUT	
	IPAGE=IPAGE+1	
	WRITE(6,1200) DATE(1),DATE(2),IPAGE	417
1200	FORMAT(1H1,62X,2A6,3CX,4HPAGE,L3)	
	WRITE(6,1201)(TITLE(J),J=1,12)	418
	WRITE(6,1205) ACRON	423
1205	FORMAT(1H0,60X,7HRCN NC=,I4)	
1201	FORMAT(1HC,3CX,12A6)	
	ABXX=NSTEPS(1)-1	
	ROT2=ABXX*DELTA(1)	
	WRITE(6,1202) ALPHA,XI,ROT2	424
1202	FORMAT(1H0,14H ASPECT ANGLE=,E1C,4,5X,2CHDCWNSTREAM POSITION=,E10,	
	14,5X,16HPLUME THICKNESS=,F10,4)	
	WRITE(6,1500)(NSTEPS(J),J=1,MX)	425
1500	FORMAT(1H0,7H STEPS=,6X,9I12)	
	WRITE(6,1501)(DELTA(J),J=1,MX)	430
1501	FORMAT(1H ,9H DELTA L=,7X,9E12,4)	
	WRITE(6,1203)(ZH(J),J=1,MX)	435
1203	FORMAT(1H ,17H RADIAL POSITION=,E11,4,8E12,4)	
	MX2=2*MXP1	
	WRITE(6,1204)(HEADING(J),J=1,MX2)	440
1204	FORMAT(1HC,17H WAVNMBR WAVLGH,2X,18A6)	
	DO 1205 J=1,36	
1205	WRITE(6,1206) WAVNC(J),WAVLH(J),(SPRAD(J,K),K=1,MXP1)	447
1206	FORMAT(1H ,F7,C,F9,3,9E12,4)	
	DIMENSION RUNITL(6C)	
	RUNITL(I)=0.	
	DO 1250 J=2,36	
1250	RUNITL(I)=RUNITL(I)+(WAVLH(J-1)-WAVLH(J))*0.5*(SPRAD(J-1,MXP1)+	
	SPRAD(J,MXP1))	
	WRITE(6,1251) RUNITL(I)	465
1251	FORMAT(1H0,46HRADIATION/UNIT LENGTH OF PLUME(WATTS/STER-CM)=,E11,4	
	I)	
	WRITE(6,1207)	467
1207	FORMAT(1H0,2CX,94HNOTE-THE LAST RADIATION COLUMN ABOVE GIVES THE S	
	PECTRAL RADIATION/UNIT LENGTH OF PLUME SURFACE)	
106	CONTINUE	
	IPAGE=IPAGE+1	
	WRITE(6,1200) DATE(1),DATE(2),IPAGE	471
	WRITE(6,1201)(TITLE(J),J=1,12)	472
	WRITE(6,1208) ALPHA	475
1208	FORMAT(1H0,14H ASPECT ANGLE=,F1C,4)	
	TOTRAD=0.	
	DO 7C9 L=2,36	
7C9	TOTRAD=TOTRAD+(WAVLH(L-1)-WAVLH(L))*(TSRAD(L-1)+(TSRAD(L)))	
	TOTRAD=TOTRAD/2.	
	WRITE(6,1209)	490
1209	FORMAT(1H0,37H WAVNMBR WAVLGH SPECTRAL RADIATION)	
	WRITE(6,1210)(WAVNC(J),WAVLH(J),TSRAD(J),J=1,36)	491
1210	FORMAT(1H ,F7,C,F9,3,4X,E12,4)	
	WRITE(6,1211) TOTRAD	500
	CENTR=C.	
	DO 1252 I=1,NXSM1	
1252	RUNITL(I)=RUNITL(I)*X(I)*SC*SC	
	DO 1253 I=2,NXSM1	
1253	CENTR=CENTR+(X(I)-X(I-1))*0.5*(RUNITL(I-1)+RUNITL(I))	
	CENTR=CENTR/TOTRAD	
	WRITE(6,1254) CENTR	520
1254	FORMAT(1H0,9HCENTROID=,E11,4)	
1211	FORMAT(1H0,24H TOTAL RADIATION EMITTED=,E10,4,11H WATTS/STER)	
	G) TO(107,103,172),ISTOP	
107	REWIND 10	522
	STOP	
	END	

TABLE IV. TYPICAL SET INPUT DATA

SDATA									
2050.	2.60E-03	4.80E-04	3.40E-04	4.10E-04	8.20E-04	5.70E-03	2.60E-02		
2050.	4.60E-02	6.80E-02	1.33E-01	3.35E-01	7.90E-01	2.90E+00	8.90E-00		
2060.	8.01E-03	1.03E-03	5.72E-04	6.37E-04	1.37E-03	9.08E-03	3.56E-02		
2060.	5.25E-02	7.50E-02	1.49E-01	1.76E-01	1.00E-00	3.60E-00	1.00E+01		
2070.	1.87E-02	1.89E-03	9.57E-04	1.06E-03	2.28E-03	1.42E-02	4.76E-02		
2070.	6.00E-02	8.42E-02	1.68E-01	4.10E-01	1.28E-00	4.40E-00	1.13E+01		
2080.	1.5E-02	1.94E-03	1.30E-03	1.66E-03	3.81E-03	2.13E-02	6.28E-02		
2080.	6.67E-02	9.25E-02	1.84E-01	4.56E-01	1.63E-00	5.23E-00	1.25E+01		
2090.	6.31E-03	1.63E-03	1.57E-03	2.54E-03	6.41E-03	3.08E-02	8.30E-02		
2090.	7.47E-02	1.15E-01	2.56E-01	5.09E-01	2.06E-00	6.10E-00	1.37E+01		
2100.	1.81E-03	1.47E-04	2.10E-03	2.65E-03	1.06E-02	4.28E-02	1.08E-01		
2100.	7.89E-02	1.67E-01	3.95E-01	6.00E-01	2.54E-00	7.00E-00	1.47E+01		
2110.	9.55E-04	1.26E-03	2.32E-03	1.59E-03	1.73E-02	5.86E-02	1.41E-01		
2110.	8.13E-02	2.01E-01	5.00E-01	7.60E-01	3.04E-00	7.90E-00	1.57E+01		
2120.	5.65E-04	8.82E-04	1.70E-03	2.46E-03	2.80E-02	8.05E-02	1.81E-01		
2120.	6.40E-02	2.14E-01	5.58E-01	9.73E-01	3.59E-00	8.76E-00	1.66E+01		
2130.	4.88E-04	6.96E-04	1.78E-03	4.98E-03	4.38E-02	1.15E-01	2.31E-01		
2130.	8.68E-02	2.35E-01	6.12E-01	1.24E-00	4.19E-00	9.60E-00	1.37E+01		
2140.	4.78E-04	7.30E-04	1.73E-03	5.55E-03	6.73E-02	1.63E-01	2.95E-01		
2140.	8.97E-02	2.50E-01	6.66E-01	1.00E-00	4.85E-00	1.04E+01	1.82E+01		
2150.	4.91E-04	7.81E-04	2.20E-03	1.92E-02	1.01E-01	2.25E-01	3.73E-01		
2150.	9.24E-02	2.66E-01	7.40E-01	2.01E-00	5.63E-00	1.12E+01	1.90E+01		
2160.	5.22E-04	8.56E-04	7.78E-03	3.44E-02	1.53E-01	3.06E-01	4.68E-01		
2160.	9.60E-02	2.95E-01	8.77E-01	2.51E-00	6.48E-00	1.20E+01	1.98E+01		
2170.	5.81E-04	1.01E-03	3.03E-03	8.16E-02	2.28E-01	4.07E-01	5.80E-01		
2170.	9.37E-02	3.55E-01	1.11E-00	3.15E-00	7.35E-00	1.36E+01	2.03E+01		
2180.	6.95E-04	1.46E-03	8.87E-03	1.09E-01	3.32E-01	5.36E-01	7.10E-01		
2180.	1.02E-01	4.22E-01	1.54E-00	3.91E-00	8.26E-00	1.39E+01	2.05E+01		
2190.	9.01E-04	2.63E-03	2.18E-02	1.88E-01	4.70E-01	7.00E-01	8.57E-01		
2190.	1.17E-01	4.90E-01	1.72E-00	4.81E-00	9.27E-00	1.47E+01	3.06E+01		
2200.	1.28E-03	6.27E-03	5.06E-02	3.15E-01	6.56E-01	8.03E-01	1.00E-00		
2200.	1.27E-01	5.81E-01	2.10E-00	4.81E-00	1.05E+01	1.56E+01	2.10E+01		
2210.	2.45E-03	1.65E-02	1.00E-01	4.92E-01	8.88E-01	1.11E-00	1.17E-00		
2210.	1.32E-01	6.97E-01	2.57E-00	6.90E-00	1.19E+01	1.64E+01	2.17E+01		
2220.	7.93E-03	4.54E-02	2.22E-01	7.28E-01	4.16E-00	1.35E-00	1.36E-00		
2220.	1.97E-01	8.44E-01	3.02E-00	8.02E-00	1.33E+01	1.72E+01	2.25E+01		
2230.	3.10E-04	1.22E-01	3.67E-01	1.04E-00	1.46E-00	1.61E-00	1.55E-00		
2230.	2.65E-02	1.48E-00	3.65E-00	9.12E-00	1.45E+01	1.81E+01	2.35E+01		
2240.	4.84E-03	2.66E-01	1.45E-01	1.46E-00	1.88E-00	1.86E-00	1.72E-00		
2240.	4.31E-01	1.48E-00	4.43E-00	1.01E+01	1.55E+01	1.87E+01	2.41E+01		
2250.	2.32E-01	1.86E-01	5.13E-01	1.98E-00	2.22E-00	2.11E-00	1.87E-00		
2250.	6.94E-01	2.04E+00	5.25E+00	1.71E+01	1.59E+01	1.69E+01	2.33E+01		
2260.	9.37E-03	7.93E-01	1.53E-00	2.60E-00	2.01E-00	2.32E-00	1.98E-00		
2260.	1.01E-00	2.65E-00	5.99E-00	1.18E+01	1.59E+01	1.63E+01	2.17E+01		
2270.	5.27E-01	1.26E-00	2.36E-00	3.27E-00	2.96E-00	3.49E-00	2.06E-00		
2270.	1.18E-00	3.20E-00	4.53E-00	1.24E+01	1.57E+01	1.78E+01	1.96E+01		
2280.	7.99E-01	2.60E-00	3.57E-00	3.94E-00	3.26E-00	2.61E-00	2.10E-00		
2280.	1.81E-00	3.75E-00	3.46E-00	1.27E+01	1.52E+01	1.57E+01	1.74E+01		
2290.	1.84E-00	4.43E-00	5.70E-00	4.53E-00	3.48E-00	2.69E-00	2.12E-00		
2290.	2.57E-00	4.37E-00	7.40E-00	4.23E+01	1.48E+01	1.58E+01	1.59E+01		
2300.	4.40E-00	7.42E-00	6.77E-00	4.95E-00	3.60E-00	2.71E-00	2.11E-00		
2300.	4.01E-00	5.38E-00	8.90E-00	1.23E+01	1.42E+01	1.47E+01	1.45E+01		
2310.	8.72E-00	1.12E+01	7.90E-00	5.14E-00	3.63E-00	2.69E-00	2.07E-00		
2310.	6.70E+00	7.29E+00	1.02E+01	7.23E+01	1.32E+01	1.34E+01	1.30E+01		
2320.	1.34E+01	1.46E+01	8.25E-00	5.14E-00	3.60E-00	2.65E-00	2.01E-00		
2320.	9.37E+00	1.60E+01	1.12E+01	1.16E+01	1.27E+01	1.21E+01	1.15E+01		
2330.	1.67E+01	1.43E+01	7.97E-00	5.08E-00	3.57E-00	2.61E-00	1.95E-00		
2330.	1.22E+01	1.14E+01	1.12E+01	1.08E+01	1.10E+01	1.07E+01	1.00E+01		
2340.	1.76E+01	1.11E+01	7.45E-00	5.10E-00	3.55E-00	2.53E-00	1.25E-00		
2340.	1.44E+01	1.10E+01	1.04E+01	4.55E-00	5.70E-00	9.22E-00	8.52E-00		
2340.	1.73E+01	1.15E+01	7.64E-00	3.27E-00	3.50E-00	2.40E-00	1.69E-00		
2350.	1.59E+01	1.08E+01	7.50E-00	8.91E-00	4.15E-00	7.61E-00	7.22E-00		
2360.	1.79E+01	1.06E+01	1.00E+01	5.33E-00	3.28E-00	2.12E-00	1.43E-00		
2360.	1.40E+01	1.01E+01	7.60E-00	6.57E-00	6.33E-00	5.77E-00	5.45E-00		
2370.	2.1E+01	1.80E+01	1.50E-00	4.90E-00	2.89E-00	1.67E-00	1.09E-00		
2370.	6.97E-00	4.44E-00	5.90E-00	2.30E-00	4.56E-00	4.12E-00	3.67E-00		
2380.	1.51E+01	7.20E-00	1.00E-00	3.07E-00	1.77E-00	1.05E-00	6.50E-01		
2380.	2.65E-00	3.07E-00	4.10E-00	2.80E-00	2.20E-00	1.90E-00	1.60E-00		
2390.	2.87E-01	9.07E-01	1.70E-00	1.20E-00	7.20E-01	4.80E-01	3.00E-01		
2400.	2.4E-01	1.44E-01	1.90E-00	1.47E-00	1.20E-00	1.00E-00	9.00E-01		
2400.	9.01E-02	7.5E-02	1.00E-01	1.50E-01	1.50E-01	1.30E-01	1.00E-01		
2400.	4.04E-01	2.10E-01	6.83E-01	4.00E-01	8.60E-01	8.10E-01	8.00E-01		

RADIATION RADIATION RADIATION RADIATION RADIATION RADIATION
 6 MAR 70
 TYPICAL TURBOJET AIRCRAFT - SE LEVEL CONDITIONS - 900 DEG EGT STATIC
 97.

are finished for a particular ALPHA, a (2) will return the program to accept a new ALPHA and ISTOP, and a (3) returns the program to read a new set of flow field data. The input data sequence is summarized in Table V.

TABLE V. INPUT DATA SEQUENCE

Card No.	Column No.	Description	Format
1-72	1-7	* Wavenumber	F7.1
1-72/odd	8-70	* $7-S/d$ values (300, 600, . . . , 2100 °K)	7E9.2
1-72/even	8-70	* $7-S^{1/2}/d$ values (300, 600, . . . , 2100 °K)	7E9.2
73-74	1-72	* Printout headings (RADIATION)	12A6/4A6
75	1-12	Date	2A6
76	1-72	Title	12A6
77	1-5	Number X Stations	I5
	6-10	Number Z points each X	I5
78	1-10	Aspect Angle	F10.5
	11-15	ISTOP	15

* Standard for all runs.

A typical set of output data from the program is shown in Table VI. The aspect angle is listed in degrees, the downstream position is given in centimeters, and the plume thickness at the downstream position (X) is also given in centimeters. At each downstream position, the thickness along the line of sight is divided in a number of segments to make the radiation calculations. The number of such segments or zones is denoted by STEPS and the size of each step is indicated by DELTAL in centimeters. These quantities are automatically calculated by the computer. The Z coordinate, previously described, gives the radial position at which the calculation is being made at a particular downstream location. This RADIAL POSITION is also given in centimeters.

The first two tabulated columns of data give the wave number (cm^{-1}) and wavelength (μ). Next N radiation columns are listed, of which the first N-1 gives the radiation emitted from the plume surface in the direction of at the downstream location (X) and radial position (Z). This is given in watts per steradian-micrometer- cm^2 . The last radiation column for which no radial position is indicated gives the spectral radiation per unit length of plume surface, i. e., the first N-1

TABLE VI. TYPICAL OUTPUT DATA

6 MAR 70

ALL PLUME CONCENTRATIONS ARE MEASURED IN CP.

WAVELENGTH (MICRONS)

RADIATION INTENSITY (STEP-CM)

TYPICAL TURBOJET AIRCRAFT - SEA LEVEL CONDITIONS - 900 DEG EGT STATIC

6 MAR 70

TYPICAL TURBOJET AIRCRAFT - SEA LEVEL CONDITIONS - 900 DEG EGT STATIC

RUN NO. 1

ASPECT ANGLE=0.9000E 02 DOWNSTREAM POSITION=0.1230E 03 PLUME THICKNESS=0.1440E 03

STEPS	DELTA L	73	74	75	76	77	78	79	80	81	82	83
RADIAL POSITION	C.2000E 01	C.2000E 01	C.2000E 01	C.2000E 01	C.2000E 01	C.2000E 01	C.2000E 01	C.2000E 01	C.2000E 01	C.2000E 01	C.2000E 01	C.2000E 01
2650.	4.378	0.1100E-03	0.1100E-03	0.1100E-03	0.1100E-03	0.1100E-03	0.1100E-03	0.1100E-03	0.1100E-03	0.1100E-03	0.1100E-03	0.1100E-03
2660.	4.454	0.2077E-03	0.1974E-03	0.1598E-03	0.1577E-03	0.1577E-03	0.1577E-03	0.1577E-03	0.1577E-03	0.1577E-03	0.1577E-03	0.1577E-03
2070.	4.481	0.2630E-03	0.3445E-03	0.2744E-03	0.1190E-03	0.1190E-03	0.1190E-03	0.1190E-03	0.1190E-03	0.1190E-03	0.1190E-03	0.1190E-03
2080.	4.408	0.4710E-03	0.4431E-03	0.3458E-03	0.1257E-03	0.1257E-03	0.1257E-03	0.1257E-03	0.1257E-03	0.1257E-03	0.1257E-03	0.1257E-03
2090.	4.785	0.5194E-03	0.5053E-03	0.3799E-03	0.1022E-03	0.1022E-03	0.1022E-03	0.1022E-03	0.1022E-03	0.1022E-03	0.1022E-03	0.1022E-03
2100.	4.767	0.7045E-03	0.6570E-03	0.4792E-03	0.1017E-03	0.1017E-03	0.1017E-03	0.1017E-03	0.1017E-03	0.1017E-03	0.1017E-03	0.1017E-03
2110.	4.719	0.7748E-03	0.7214E-03	0.5208E-03	0.8849E-04	0.8849E-04	0.8849E-04	0.8849E-04	0.8849E-04	0.8849E-04	0.8849E-04	0.8849E-04
2120.	4.717	0.5711E-03	0.5315E-03	0.3828E-03	0.7076E-04	0.7076E-04	0.7076E-04	0.7076E-04	0.7076E-04	0.7076E-04	0.7076E-04	0.7076E-04
2130.	4.695	0.4605E-03	0.4341E-03	0.3122E-03	0.5697E-04	0.5697E-04	0.5697E-04	0.5697E-04	0.5697E-04	0.5697E-04	0.5697E-04	0.5697E-04
2140.	4.673	0.5953E-03	0.5422E-03	0.3892E-03	0.4645E-04	0.4645E-04	0.4645E-04	0.4645E-04	0.4645E-04	0.4645E-04	0.4645E-04	0.4645E-04
2150.	4.651	0.4448E-03	0.4173E-03	0.2882E-03	0.3992E-04	0.3992E-04	0.3992E-04	0.3992E-04	0.3992E-04	0.3992E-04	0.3992E-04	0.3992E-04
2160.	4.629	0.3171E-02	0.1273E-02	0.6248E-03	0.1310E-03	0.1310E-03	0.1310E-03	0.1310E-03	0.1310E-03	0.1310E-03	0.1310E-03	0.1310E-03
2170.	4.587	0.3188E-02	0.1750E-02	0.8998E-03	0.2801E-03	0.2801E-03	0.2801E-03	0.2801E-03	0.2801E-03	0.2801E-03	0.2801E-03	0.2801E-03
2180.	4.565	0.1633E-01	0.1591E-01	0.1078E-02	0.1394E-03	0.1394E-03	0.1394E-03	0.1394E-03	0.1394E-03	0.1394E-03	0.1394E-03	0.1394E-03
2190.	4.525	0.3104E-01	0.2407E-01	0.2055E-01	0.2498E-02	0.2498E-02	0.2498E-02	0.2498E-02	0.2498E-02	0.2498E-02	0.2498E-02	0.2498E-02
2200.	4.505	0.5581E-01	0.5248E-01	0.3888E-01	0.4071E-02	0.4071E-02	0.4071E-02	0.4071E-02	0.4071E-02	0.4071E-02	0.4071E-02	0.4071E-02
2210.	4.484	0.4418E-01	0.7946E-01	0.6142E-01	0.1146E-01	0.1146E-01	0.1146E-01	0.1146E-01	0.1146E-01	0.1146E-01	0.1146E-01	0.1146E-01
2220.	4.464	0.1083E 00	0.1036E 00	0.8276E-01	0.1834E-01	0.1834E-01	0.1834E-01	0.1834E-01	0.1834E-01	0.1834E-01	0.1834E-01	0.1834E-01
2230.	4.444	0.1250E 00	0.1205E 00	0.9971E-01	0.2549E-01	0.2549E-01	0.2549E-01	0.2549E-01	0.2549E-01	0.2549E-01	0.2549E-01	0.2549E-01
2240.	4.424	0.1314E 00	0.1275E 00	0.1084E 00	0.3200E-01	0.3200E-01	0.3200E-01	0.3200E-01	0.3200E-01	0.3200E-01	0.3200E-01	0.3200E-01
2250.	4.405	0.1291E 00	0.1257E 00	0.1092E 00	0.3639E-01	0.3639E-01	0.3639E-01	0.3639E-01	0.3639E-01	0.3639E-01	0.3639E-01	0.3639E-01
2260.	4.386	0.1173E 00	0.1142E 00	0.1001E 00	0.3704E-01	0.3704E-01	0.3704E-01	0.3704E-01	0.3704E-01	0.3704E-01	0.3704E-01	0.3704E-01
2270.	4.367	0.4648E-01	0.4384E-01	0.3224E-01	0.2249E-01	0.2249E-01	0.2249E-01	0.2249E-01	0.2249E-01	0.2249E-01	0.2249E-01	0.2249E-01
2280.	4.348	0.7374E-01	0.7155E-01	0.4244E-01	0.2249E-01	0.2249E-01	0.2249E-01	0.2249E-01	0.2249E-01	0.2249E-01	0.2249E-01	0.2249E-01
2290.	4.329	0.4593E-01	0.4823E-01	0.3034E-01	0.1475E-01	0.1475E-01	0.1475E-01	0.1475E-01	0.1475E-01	0.1475E-01	0.1475E-01	0.1475E-01
2300.	4.310	0.3164E-01	0.3034E-01	0.2552E-01	0.1152E-01	0.1152E-01	0.1152E-01	0.1152E-01	0.1152E-01	0.1152E-01	0.1152E-01	0.1152E-01
2310.	4.292	0.2314E-01	0.2274E-01	0.1905E-01	0.8995E-02	0.8995E-02	0.8995E-02	0.8995E-02	0.8995E-02	0.8995E-02	0.8995E-02	0.8995E-02
2320.	4.274	0.2248E-01	0.2134E-01	0.1737E-01	0.7405E-02	0.7405E-02	0.7405E-02	0.7405E-02	0.7405E-02	0.7405E-02	0.7405E-02	0.7405E-02
2330.	4.255	0.2510E-01	0.2390E-01	0.1945E-01	0.7851E-02	0.7851E-02	0.7851E-02	0.7851E-02	0.7851E-02	0.7851E-02	0.7851E-02	0.7851E-02
2340.	4.237	0.4144E-01	0.3949E-01	0.3273E-01	0.1279E-01	0.1279E-01	0.1279E-01	0.1279E-01	0.1279E-01	0.1279E-01	0.1279E-01	0.1279E-01
2350.	4.219	0.7463E-01	0.7463E-01	0.6448E-01	0.2214E-01	0.2214E-01	0.2214E-01	0.2214E-01	0.2214E-01	0.2214E-01	0.2214E-01	0.2214E-01
2360.	4.202	0.7463E-01	0.7463E-01	0.6448E-01	0.2214E-01	0.2214E-01	0.2214E-01	0.2214E-01	0.2214E-01	0.2214E-01	0.2214E-01	0.2214E-01
2370.	4.184	0.5377E-01	0.9000E-01	0.7372E-01	0.2143E-01	0.2143E-01	0.2143E-01	0.2143E-01	0.2143E-01	0.2143E-01	0.2143E-01	0.2143E-01
2380.	4.167	0.2877E-01	0.2711E-01	0.2051E-01	0.4448E-02	0.4448E-02	0.4448E-02	0.4448E-02	0.4448E-02	0.4448E-02	0.4448E-02	0.4448E-02
2390.	4.147	0.2877E-01	0.2711E-01	0.2051E-01	0.4448E-02	0.4448E-02	0.4448E-02	0.4448E-02	0.4448E-02	0.4448E-02	0.4448E-02	0.4448E-02
2400.	4.127	0.2877E-01	0.2711E-01	0.2051E-01	0.4448E-02	0.4448E-02	0.4448E-02	0.4448E-02	0.4448E-02	0.4448E-02	0.4448E-02	0.4448E-02

RADIATION/UNIT LENGTH OF PLUMEWATTS/STEP-CM= 0.1358E 01

NOTE- THE LAST RADIATION COLUMN ABOVE GIVES THE SPECTRAL RADIATION/UNIT LENGTH OF PLUME SURFACE

TABLE VI. TYPICAL OUTPUT DATA (Continued)

6 MAR 70
TYPICAL TURBOJET AIRCRAFT - SEA LEVEL CONDITIONS - 900 DEG EGT STATIC

WAVELENGTH	ASPECT ANGLE=0.900CE 02		DC=INST=MAP POSITION=0.104CF 04		PLUME THICKNESS=0.750CE 03		RUN NO= 1	
	76	76	76	76	76	76	76	76
DELTA L	0.100E 02	0.100E 02	0.100E 02	0.100E 02	0.100E 02	0.100E 02	0.100E 02	0.100E 02
RADIAL POSITION=C	C.520VE C2	C.150SE C3	C.104ZE C3	C.104ZE C3	C.104ZE C3	C.104ZE C3	C.104ZE C3	C.104ZE C3
2040.	C.1012E-04	C.845E-04	C.1130E-04	C.4052E-04	C.2035E-05	C.1254E-05	C.1254E-05	C.1254E-05
2040.	C.1012E-04	C.845E-04	C.1130E-04	C.4052E-04	C.2035E-05	C.1254E-05	C.1254E-05	C.1254E-05
2070.	C.1578E-04	C.2241E-04	C.2166E-04	C.2166E-04	C.1120E-04	C.7001E-05	C.3430E-05	C.3430E-05
2080.	C.5482E-04	C.4042E-04	C.2021E-04	C.2021E-04	C.1046E-04	C.6471E-05	C.4404E-05	C.4404E-05
2090.	C.2625E-04	C.1908E-04	C.9270E-05	C.9270E-05	C.4654E-05	C.2800E-05	C.1856E-05	C.1856E-05
2100.	C.1025E-04	C.7004E-04	C.3074E-05	C.1784E-05	C.1446E-05	C.8434E-06	C.5453E-06	C.3744E-06
2110.	C.6234E-05	C.437E-05	C.1784E-05	C.1784E-05	C.7993E-06	C.4554E-06	C.2921E-06	C.1950E-06
2120.	C.4234E-05	C.2744E-05	C.1091E-05	C.1091E-05	C.4778E-06	C.2693E-06	C.1723E-06	C.1148E-06
2130.	C.3452E-05	C.2249E-05	C.9031E-06	C.9031E-06	C.1985E-06	C.2254E-06	C.1495E-06	C.9747E-07
2140.	C.3469E-05	C.2243E-05	C.8881E-06	C.8881E-06	C.3846E-06	C.2180E-06	C.1393E-06	C.5439E-07
2150.	C.3604E-05	C.2319E-05	C.9088E-06	C.9088E-06	C.3934E-06	C.2204E-06	C.1406E-06	C.9515E-07
2160.	C.3855E-05	C.2470E-05	C.9597E-06	C.9597E-06	C.4124E-06	C.2303E-06	C.1466E-06	C.9921E-07
2170.	C.4366E-05	C.2793E-05	C.1071E-05	C.1071E-05	C.4555E-06	C.2529E-06	C.1606E-06	C.1045E-06
2180.	C.5801E-05	C.3634E-05	C.1346E-05	C.1346E-05	C.5567E-06	C.3046E-06	C.1919E-06	C.1254E-06
2190.	C.6135E-05	C.3590E-05	C.1346E-05	C.1346E-05	C.4098E-06	C.2545E-06	C.1708E-06	C.1428E-06
2200.	C.5135E-04	C.1116E-04	C.1790E-05	C.1790E-05	C.1291E-05	C.4526E-06	C.2932E-06	C.2613E-06
2210.	C.4615E-04	C.2673E-04	C.8179E-05	C.8179E-05	C.2793E-05	C.1362E-05	C.8030E-06	C.5257E-06
2220.	C.1263E-03	C.7385E-04	C.2316E-04	C.2316E-04	C.4130E-05	C.4042E-05	C.2412E-05	C.1600E-05
2230.	C.3322E-03	C.2000E-03	C.6723E-04	C.6723E-04	C.2535E-04	C.1321E-04	C.8135E-05	C.5484E-05
2240.	C.6567E-03	C.4300E-03	C.1493E-03	C.1493E-03	C.6086E-04	C.3125E-04	C.2197E-04	C.1831E-04
2250.	C.9598E-03	C.8400E-03	C.2502E-03	C.2502E-03	C.1090E-03	C.6285E-04	C.4177E-04	C.2535E-04
2260.	C.1267E-02	C.9703E-03	C.3332E-03	C.3332E-03	C.1584E-03	C.8135E-04	C.5742E-04	C.3430E-04
2270.	C.1489E-02	C.1079E-03	C.4083E-03	C.4083E-03	C.1745E-03	C.9135E-04	C.6255E-04	C.3744E-04
2280.	C.1491E-02	C.1007E-03	C.4997E-03	C.4997E-03	C.2784E-03	C.1474E-03	C.1011E-03	C.7100E-04
2290.	C.1041E-02	C.6053E-03	C.6593E-03	C.6593E-03	C.2784E-03	C.1874E-03	C.1431E-03	C.1031E-03
2300.	C.6840E-03	C.5588E-03	C.3773E-03	C.3773E-03	C.2930E-03	C.2223E-03	C.1435E-03	C.1031E-03
2310.	C.4239E-03	C.347E-03	C.2488E-03	C.2488E-03	C.2520E-03	C.2266E-03	C.2107E-03	C.1953E-03
2320.	C.3150E-03	C.2928E-03	C.2568E-03	C.2568E-03	C.2320E-03	C.2169E-03	C.2069E-03	C.1962E-03
2330.	C.2763E-03	C.2620E-03	C.2383E-03	C.2383E-03	C.2210E-03	C.2097E-03	C.2020E-03	C.1957E-03
2340.	C.2590E-03	C.2469E-03	C.2282E-03	C.2282E-03	C.2138E-03	C.2040E-03	C.1972E-03	C.1910E-03
2350.	C.2761E-03	C.2586E-03	C.2307E-03	C.2307E-03	C.2138E-03	C.2040E-03	C.1972E-03	C.1910E-03
2360.	C.4667E-03	C.3912E-03	C.2845E-03	C.2845E-03	C.1998E-03	C.1998E-03	C.1920E-03	C.1876E-03
2370.	C.9275E-03	C.6737E-03	C.3574E-03	C.3574E-03	C.2267E-03	C.1987E-03	C.1822E-03	C.1707E-03
2380.	C.9092E-03	C.5893E-03	C.2315E-03	C.2315E-03	C.1635E-03	C.1635E-03	C.1347E-03	C.1167E-03
2390.	C.2226E-03	C.1396E-03	C.5173E-04	C.5173E-04	C.1007E-04	C.5813E-04	C.3871E-04	C.2744E-04
2400.	C.2226E-03	C.1396E-03	C.5173E-04	C.5173E-04	C.1007E-04	C.5813E-04	C.3871E-04	C.2744E-04

RADIATION/UNIT LENGTH OF PLUME(WATTS/STER-CPI)= 0.6334E-01
NOTE-THE LAST RADIATION COLUMN GIVES THE SPECTRAL RADIATION/UNIT LENGTH OF PLUME SURFACE

TABLE VI. TYPICAL OUTPUT DATA (Concluded)

6 MAR 70
TYPICAL TURBOJET AIRCRAFT - SEA LEVEL CONDITIONS - 900 DEG EGT STATIC

ASPECT ANGLE-0.90CCE C2	WAVENUM	WAVENUM	SPECTRAL RADIATION
	2050.	C.478	0.3897E 01
	2060.	6.654	0.4881E 01
	2070.	6.831	0.1698E 02
	2080.	6.908	0.1784E 02
	2090.	6.785	0.1396E 02
	2100.	6.762	0.1522E 02
	2110.	6.739	0.1337E 02
	2120.	6.717	0.9694E 01
	2130.	6.695	C.7864E 01
	2140.	6.674	C.9569E 01
	2150.	6.651	0.1187E 02
	2160.	6.630	0.1475E 02
	2170.	6.608	C.2051E 02
	2180.	6.587	0.44C2E 02
	2190.	6.566	0.1058E 03
	2200.	6.545	0.2381E 03
	2210.	6.525	0.4662E 03
	2220.	6.505	0.8753E 03
	2230.	6.484	0.1422E 04
	2240.	6.464	0.5973E 04
	2250.	6.444	0.2430E 04
	2260.	6.423	C.5705E 04
	2270.	6.403	0.2194E 04
	2280.	6.383	0.2308E 04
	2290.	6.364	0.1824E 04
	2300.	6.348	0.1317E 04
	2310.	6.330	0.9324E 03
	2320.	6.292	0.7772E 03
	2340.	6.274	C.7651E 03
	2350.	6.255	0.7421E 03
	2360.	6.237	C.7693E 03
	2370.	6.219	0.1049E 04
	2380.	6.202	0.1788E 04
	2390.	6.184	0.1892E 04
	2400.	6.167	0.5212E 03

TOTAL RADIATION EMITTED-C.5777E 03 WATTS/STER
CENTROID- 6.2151E 03

values of radiation have been integrated across the radial position coordinate. The last column therefore has units of watts per steradian-micrometer-cm. The next to the last line of printout gives the radiation per unit length of plume surface; i. e. , the last column has been integrated over the spectral regime. As indicated, this has units of watts per steradian-cm.

After the spectral and spatial distributions have been computed for each downstream location at a particular aspect angle, the results are then integrated over the whole surface of the plume. The last output page for a given aspect angle contains this information as a function of both wave number and wavelength. This is listed as SPECTRAL RADIATION and given in watts per steradian-micrometer. Next, a spectral integration is performed which gives the total radiation emitted in watts per steradian. Finally the centroid of radiation along the length of the plume is computed and listed in centimeters.

REFERENCES

1. Jackson, H. Tracy, Jr., A Model for the Spectral Emissivity of Carbon Dioxide in the 4.3 Micron Band, Report No. RE-TR-69-9, U. S. Army Missile Command, Redstone Arsenal, Alabama, April 1969.
2. Hyman, William D., and Dublin D. H., A Computer Program for Infrared System Analysis, Report No. RE-TM-68-5, U. S. Army Missile Command, Redstone Arsenal, Alabama, September 1968.
3. Hyman, William D., An Infrared Systems Analysis Program for the IBM 7094 Computer, Report No. RE-TR-69-4, U. S. Army Missile Command, Redstone Arsenal, Alabama, March 1969.
4. Loh, Edwin D., An Empirical Model for Atmospheric Transmission in the Mid-Infrared Spectral Region, RE-TR-70-4, U. S. Army Missile Command, Redstone Arsenal, Alabama, January 1970.
5. Ragozin, N. A., Jet Propulsion Fuels, translated from the Russian by William E. Jones, Pergamon Press, New York, 1961.
6. Baronti, Paolo, Method of Analysis of Mixing Processes with Combustion, Report No. ATL TR No. 106, Advanced Technology Laboratories, Inc., 400 Jericho Turnpike, Jericho, New York, November 1967.
7. Gebbie, H. A., Harding, W. R., Hilsum, C., Pryce, A. W., and Roberts, V., Proc. Royal Soc. (London), A 206, 87, 1951.

Appendix FLOW FIELD PROGRAM

This appendix outlines the flow field frozen mixing computer program which is used to provide the input data to the radiation program. A typical set of input-output data is shown, a description of the input data is given, and the computer program is listed. A brief description of the viscosity options is also included for completeness.

The viscosity option occurs on the second data card and is labelled ITURB by the computer, where ITURB = 0, 1, 2, 3, or 4. The statement ITURB = 0 indicates laminar flow and the viscosity is given by Sutherland's law. For ITURB = 1 or 2, the eddy viscosity is computed from the expressions

$$\mu = K_2 r_{1/2} \rho_0 U_0 \quad , \quad (\text{ITURB} = 1)$$

$$\mu = K_2 r_{1/2} \left| \rho_0 U_0 - \rho_\infty U_\infty \right| \quad , \quad (\text{ITURB} = 2)$$

where K_2 , the turbulent viscosity coefficient, is taken to be 0.0285. The subscripts refer to jet center line and ambient conditions, and $r_{1/2}$ is the value of R at $\rho U = \frac{1}{2}(\rho_\infty U_\infty - \rho_0 U_0)$. For ITURB = 3, $r_{1/2} = \left| r_{0.99} - r_{0.50} \right|$, where $r_{0.50}$ is the value of R at $U = \frac{1}{2}(U_\infty + U_0)$ and $r_{0.99}$ is the value of R at $U = (0.01U_\infty + 0.99U_0)$. The viscosity is then given by the expression

$$\mu = K_2 r_{1/2} \rho_0 U_0 \quad . \quad (\text{ITURB} = 3)$$

For the option ITURB = 4, the viscosity is computed from the expression

$$\mu = 10^{-4} + X(\rho_\infty U_\infty + \rho_0 U_0), \quad (\text{ITURB} = 4)$$

where X is the downstream position. The latter option is utilized for jet aircraft plumes in the core region with this region being defined by the condition $\left. \frac{d^2U}{dR^2} \right|_{R=0} = 0$. Outside the core model 3 is used for aircraft in flight and

model 1 for static conditions. The program automatically selects the mode outlined above when the input data specifies option 4. Table A-I describes the input data sequence for the program. The thermodynamic data are obtained from NASA document SP-3001, pages 308-326. A typical set of input data is shown in Table A-II followed by the program itself in Table A-III. Table A-IV then shows a few pages of selected printout or output generated by the input data described in Table A-I. The initial page specifies the input data; the remaining output gives the properties as a function of downstream and radial position.

The only programmed error message occurs if the summation of the initial specie mass fractions (indicated by SIGMA) differ by more than 1 percent from unity.

The actual output from this program that is used in the radiation model is written on magnetic tape. The program first expands the number of radial points to 25 by defining the plume width to be that radial point where $T/T_\infty = 1.05$. This width is then divided into 25 evenly spaced points and the properties determined at each point by interpolation. Dimensions are converted from feet to centimeters, mass fraction to mole fraction or partial pressure, and temperature ratio to absolute temperature. The resulting tape is then read as input to the radiation model.

TABLE A-I. INPUT DATA SEQUENCE

Card No.	Column No.	Description	Format
1	1-72	Title Card	72H
2	1-5	Month (Jan = 01,, Dec = 12)	15
	6-10	Day	15
	11-15	Year (Last Two Digits)	15
	16-20	Initial number of grid points (if the variable profile option is used) or initial number of points in jet (if the step input option is used).	15
	21-25	Number of species (21 maximum)	15
	26-30	Pressure option: 0 = Constant Pressure 1 = Polynomial Fit	15
	31-35	Viscosity option: 0 = Laminar (Sutherland's Law) 1 = $K_2 r_{1/2} \rho_0 U_0$ 2 = $K_2 r_{1/2} \rho_0 U_0 - \rho_c U_c $ 3 = $K_2 r_{1/2} \rho_0 U_0$ 4 = $10^{-4} + X(\rho_0 U_0 + \rho_c U_c)$	15
	36-40	Flow option: 0 = Axisymmetric 1 = Two Dimensional	15

TABLE A-I. INPUT DATA SEQUENCE (Continued)

Card No.	Column No.	Description	Format	
	41-45	Input profile option: 0 = Step Input 1 = Variable Profile	I 5	
3	1-10	First print increment (ft)	E10.8	
	11-20	Final X for first print increment (ft)	E10.8	
	21-30	Second print increment (ft)	E10.8	
	31-40	Final X for second print increment (ft)	E10.8	
	41-50	Third print increment (ft)	E10.8	
	51-60	Final X for third print increment (ft) and for terminating the case	E10.8	
	61-70	X initial (ft)	E10.8	
4	1-10	Lewis Number	E10.8	
	11-20	Prandtl Number	E10.8	
	21-30	The initial radius of the jet in feet if the step input option is used, otherwise $\Delta \Psi$, the radial spacing in streamline coordinates	E10.8	
	31-40	K_1 the coefficient of laminar viscosity	E10.8	
	41-50	K_2 the coefficient of turbulent viscosity	E10.8	
5	1-10	P_0 } Pressure fit coefficients: P_1 } If option 1 is used, P_0 is the pressure in lb/ft ² and P_1, P_2, P_3, P_4 are blank. If option 2 is used, P_1 is the coefficient in the pressure polynomial as follows: P_2 } P_3 } P_4 } $P \text{ (lb/ft}^2\text{)} = \sum_{i=0}^4 p_i X_i$	E10.8	
	11-20		P_1	E10.8
	21-30		P_2	E10.8 [†]
	31-40		P_3	E10.8
	41-50		P_4	E10.8
6	-	Thermodynamic data for the different species being considered. There are 3 cards for each specie as described below. The specie may be input in any arbitrary order.	-	
6a	1-6	Hollerith representation of the specie (e. g. H20)	A6	

TABLE A-I. INPUT DATA SEQUENCE (Continued)

Card No.	Column No.	Description	Format
	11-20	Molecular weight	E10.8
	21-30	T_{1L} lower temperature bound for fit 1	E10.8
	31-40	T_{1H} upper temperature bound for fit 1	E10.8
	41-50	T_{2L} lower temperature bound for fit 2	E10.8
	51-60	T_{2H} upper temperature bound for fit 2	E10.8
6b	1-10	a_1)	E10.8
	11-20	a_2)	E10.8
	21-30	a_3)	E10.8
	31-40	a_4)	E10.8
	41-50	a_5)	E10.8
	51-60	a_6)	E10.8
	61-70	a_7)	E10.8
		Coefficients for low temperature fits	
		See NASA SP3001	
6c	1-10	..)	E10.8
	11-20	..)	E10.8
	21-30	..)	E10.8
	31-40	..)	E10.8
	41-50	..)	E10.8
	51-60	..)	E10.8
	61-70	..)	E10.8
		Coefficients for high temperature fits	
		NASA SP3001	
IF THE VARIABLE INPUT OPTION IS USED:			
7	1-10	T_0)	E10.8
	11-20	T_1)	E10.8
	11-20	.	E10.8
	11-20	.	E10.8
	11-20	.	E10.8
	61-70	T_6)	E10.8
		Axis value of temperature (°K)	
		The values of the temperature at each of the inputted psi grid points are punched 7 to a card from the axial value and ending with the free stream values (°K)	
7'	1-10	T_7)	E10.8
		T_7)	E10.8

TABLE A-I. INPUT DATA SEQUENCE (Continued)

Card No.	Column No.	Description	Format
7"	61-70	T_7	E10.8
	1-10	T_{13}	
		T_{14}	E10.8
		T_{14}	E10.8
		T_e } Free stream value of temperature ($^{\circ}$ K)	E10.8
8	1-10	U_0	E10.8
	1-10	U_0	E10.8
8'	61-70	U_6	E10.8
	1-10	U_7	E10.8
	1-10		E10.8
	1-10		E10.8
8"	61-70	U_{13}	E10.8
	1-10	U_{14}	E10.8
		U_{14}	E10.8
		U_e	E10.8
IF THE STEP INPUT OPTION IS USED:			
9	1-10	α_1	E10.8
	11-20	α_2	E10.8
	21-30	α_3	E10.8
	31-40	α_4	E10.8
	41-50	α_5	E10.8
	51-60	α_6	E10.8
	61-70	α_7	E10.8
		} Axis values of species mass fractions.	
9'	1-10	α_1	E10.8
	11-20	α_2	E10.8
	21-30	α_3	E10.8
	31-40	α_4	E10.8
	41-50	α_5	E10.8
	51-60	α_6	E10.8
	61-70	α_7	E10.8
	61-70	α_7	E10.8
		} Values of species mass fractions at each inputted psi grid point are punched on one card per point beginning with the axial value and ending with the free stream. A maximum of 7 species per card. The order of the species must	

TABLE A-1. INPUT DATA SEQUENCE (Concluded)

Card No.	Column No.	Description		Format
	61-70 61-70	α_7 α_7	correspond to the order of the thermodynamic data (card type 6)	
9"	1-10 11-20 21-30 31-40 41-50 51-60 61-70	α_1 α_2 α_3 α_4 α_5 α_6 α_7	Free stream values	E10.8 E10.8 E10.8 E10.8 E10.8 E10.8 E10.8
IF THE STEP INPUT OPTION IS USED:				
7	1-10 11-20 21-30 31-40		Jet temperature (°K) Free stream temperature (°K) Jet velocity (ft/sec) Free stream velocity (ft/sec)	E10.8 E10.8 E10.8 E10.8
8	1-10 11-20 21-30 31-40 41-50 51-60 61-70	α_1 α_2 α_3 α_4 α_5 α_6 α_7	Specie mass fractions in the jet. A maximum of seven species per card. If there are more than seven species continue on another card in the same format. The order of the species must correspond to the order the thermodynamic data (card type 6) for each specie input.	E10.8 E10.8 E10.8 E10.8 E10.8 E10.8 E10.8
9	1-10 11-20 21-30 31-40 41-50 51-60 61-70	α_1 α_2 α_3 α_4 α_5 α_6 α_7	Specie mass fractions at the edge. Comments for card 8 are applicable.	E10.8 E10.8 E10.8 E10.8 E10.8 E10.8 E10.8
10	1-10 11-15		The initial radius of the jet (ft) Run number	E10.8 15

TABLE A-II. TYPICAL SET OF INPUT DATA

SDATA	03	06	70	10	4	0	4	0	0	0	2.0	50.0	0.0
TYPICAL TURBOJET AIRCRAFT - SEA LEVEL CONDITIONS - 900 DEG EGT STATIC													
0.25	10.0	1.0	20.0	2.0	50.0	0.0							
1.4	.71	1.000	0.0	.0285									
2117.													
O2	32.0	300.	1000.	1000.	5000.								
3.7189+00	-2.5167-03	8.5837-06	-8.2999-09	2.7082-12	-1.0576+03	3.9081+00							
3.5976+00	7.8146-04	-2.2387-07	4.2490-11	-3.3460-15	-1.1928+03	3.7493+00							
N2	28.014	300.	1000.	1000.	5000.								
3.6916+00	-1.3333-03	2.8503-06	-9.7688-10	-9.9772-14	-1.0628+03	2.2875+00							
2.8546+00	1.5976-03	-6.2566-07	1.1316-10	-7.6897-15	-8.9017+02	6.3903+00							
CO2	44.011	300.	1000.	1000.	5000.								
2.1701	1.03781-02	-1.0733-056	3.4591-09	-1.6280-12	-4.8352+04	1.06643+01							
4.41292+003	1.9228-03	-1.2978-062	4.1474-10	-1.6742-14	-4.8944+04	-7.2875-01							
H2O	18.016	300.	1000.	1000.	5000.								
4.15650+00	-1.7244-035	6.9823-06	-4.5930-091	4.2336-12	-3.0288+04	-6.8616-01							
2.67075+003	0.03171-03	-8.5351-071	1.7908-10	-6.1973-15	-2.9888+046	8.86383+00							
900.	300.	1800.	1.										
.17535	.75290	.05195	.01980										
.2318	.7677	.0005	0.0										
1.000	1												

TABLE A-III. FLOW FIELD COMPUTER PROGRAM

03/09/70

MAIN1 - FFN SOURCE STATEMENT - IFA(S)

```

C
  MAIN1
  COMMON P,X,DPDX,POUT,HE,PE,DPDUT,P,DELPSI,CX,XMUT,XMUL,DEL,XMUK1,X
  1MUK2,PRNT,PCNT,UF,RHCE,TE,XP3,RFALE
  COMMON IOUT,MPSI,MHALF,MINIT,IFINIS,APSI,IPAGE,IPRESS,ISTART,ITURB
  1,ITURA,IJET,NS,MDAY,MONTH,MYEAR,IAX2C,IVAR
  COMMON WTMOLE(21),COEFFP(5),ALPHA(21,59),HCUT(59),RCOTY(59),RT(59)
  1,T(59),H(21,59),RALPHA(21,59),PSI(59),RU(59),U(59),XLE(59),TITLE(1
  22),SUM(59),ETA(59),XMU(59),A(59),AWAIT(59),RMGOUT(59),UGUT(59),TOU
  3T(59),CP(21,59),HSTG(59),RMC(59),Y(59),XMAX(3),XFRT(3),CPBARI(59),S
  4IGMA(59),HBAR(59),AFITS(21,2,7),TFITS(21,4),SPECID(21)
  REWIND 10
  1 CALL INPUT
  CALL INIAL
  2 CALL FROZ1
  CALL COMPUT
  IF (IFINIS.GT.1) GO TO 1
  CALL EXPLIC
  IF (IFINIS.GT.1) GO TO 1
  GO TO 2
  ENC
  
```

FROZ2 - FFN SOURCE STATEMENT - IFN(S)

```

  FROZ2
  SUBROUTINE INPLT
  COMMON K,X,DPDX,POUT,HE,PE,CPOUT,P,DELPSI,CX,XMUT,XMUL,DEL,XMUK1,X
  1MUK2,PRNT,PCNT,UF,RHCE,TE,XP3,RFALE
  COMMON IOUT,MPSI,MHALF,MINIT,IFINIS,APSI,IPAGE,IPRESS,ISTART,ITURB
  1,ITURA,IJET,NS,MDAY,MONTH,MYEAR,IAX2C,IVAR
  COMMON WTMOLE(21),COEFFP(5),ALPHA(21,59),HCUT(59),RCOTY(59),RT(59)
  1,T(59),H(21,59),RALPHA(21,59),PSI(59),RU(59),U(59),XLE(59),TITLE(1
  22),SUM(59),ETA(59),XMU(59),A(59),AWAIT(59),RMGOUT(59),UGUT(59),TOU
  3T(59),CP(21,59),HSTG(59),RMC(59),Y(59),XMAX(3),XFRT(3),CPBARI(59),S
  4IGMA(59),HBAR(59),AFITS(21,2,7),TFITS(21,4),SPECID(21)
  DIM NS(21),YSJET(21),YSEGE(21)
  IF INIS=0
  IPAGE=0
  IOUT=0
  CX=0.0
  R=3.5752932
  READ(5,1) (TITLE(I),I=1,12)
  READ(5,100) MCNTH,MDAY,MYEAR,MPSI,NS,IPRESS,ITURB,IAX2C,IVAR
  MPSI=MPSI-1
  READ(5,1000) XPRT(1),XMAX(1),XPRT(2),XMAX(2),XPRT(3),XMAX(3),X
  READ(5,1000) XLE(1),SIGMA(1),YJET,XMLK1,XMLK2
  READ(5,1000) (COEFFP(I),I=1,5)
  DO 50 J=1,NS
  READ(5,2000) SPECID(J),WTMOLE(J), (TFITS(J,K),K=1,4)
  READ(5,1000) (AFITS(J,1,K),K=1,7)
  READ(5,1000) (AFITS(J,2,K),K=1,7)
  50 CONTINUE
  IF (IVAR.NE.C) GO TO 40
  READ(5,1000) IJET,TEGGE,UJET,UECCE
  READ(5,1000) (YSJET(J),J=1,NS)
  READ(5,1000) (YSEGE(J),J=1,NS)
  CUM=C.C
  P=COEFFP(1)
  DO 37 J=1,NS
  37 CUM=CUM+YSJET(J)/WTMOLE(J)
  RMUJ=P/49517.501/TJET/DUM
  IF (IAX2C.EQ.0) DELPSI=YJET*SQRT(RMUJ*UJET)/FLGAT(MPSI-1)
  IF (IAX2C.NE.0) DELPSI=YJET*RMUJ*LJET/FLGAT(MPSI-1)
  INJ=38 I=1,MPSI
  T(I)=TJET
  U(I)=UJET
  
```

TABLE A-III. FLOW FIELD COMPUTER PROGRAM (Continued)

CO 38 J=1,NS		
ALPHA(J,I)=YSJET(J)		
MPSI=MPSI+2		
NPSI=MPSI-1		060S0114
T(MPSI)=TEDGE		
T(NPSI)=TEDGE		
UT(MPSI)=UEDGE		
U(NPSI)=UEDGE		
CO 39 J=1,NS		
ALPHA(J,MPSI)=YSEEDGE(J)		
39 ALPHAT(J,NPSI)=YSEEDGE(J)		
GO TC 60		
40 DELPSI=YJET		
NPSI=MPSI-1		
03/09/70		
FROZ2	- EFN	SOURCE STATEMENT - TFA(S) -
READ(5,1000)(T(I),I=1,MPSI)		114
READ(5,1000)(U(I),I=1,MPSI)		121
DO 41 I=1,MPSI		
READ(5,1000)(ALPHA(J,I),J=1,NS)		130
41 CONTINUE		
60 RETURN		
1 FORMAT(12A6)		066S0646
100 FORMAT(14I5)		
1000 FORMAT(7E10,8)		066S0648
2000 FORMAT(A6,4X,5E10,8)		
ENG		066S0649
FROZ3	- EFN	SOURCE STATEMENT - TFA(S) -
SUBROUTINE FRCZ1		
COMMON R,X,DPCX,POUT,HE,PE,DPOUT,P,DELPSI,CX,XMUT,XMUL,DEL,XMUR1,X		
IMUK2,PRNT,PCNT,UE,RHOE,TE,XP3,HALF		
COMMON IOUT,MPSI,MHALF,MINIT,IFINIS,NPSI,IPAGE,IPRESS,ISTART,IYK8		
1,IYURA,IJET,NS,MOAY,MOATH,PYEAR,IXZC,IVAR		
COMMON WTMOLE(21),CDEFFP(5),ALPHA(21,59),HCUT(59),ROOTT(59),RT(59)		
1,T(59),H(21,59),RALPHA(21,59),PSI(59),RU(59),U(59),XLE(59),TITLE(1		
22),SUM(59),ETA(59),XNU(59),A(59),AWAIT(59),RHODUT(59),UDUT(59),YOU		
3T(59),CP(21,59),HSTG(59),RHO(59),Y(59),XMAX(3),XPRY(3),CPBAR(59),S		
4IGMA(59),HBAR(59),AFITS(21,2,7),TFITS(21,4),SPECTU(21)		
P=CDEFFP(1)+X*(CDEFFP(2)+X*(CDEFFP(3)+X*(CDEFFP(4)+X*(CDEFFP(5))))		
DPCX=CDEFFP(2)+X*(2.*CDEFFP(3)+X*(3.*CDEFFP(4)+X*(4.*CDEFFP(5))))		
DO 1 I=1,MPSI		
ROOTT(I)=SORT(T(I))		
AWAIT(I)=0.0		
DO 2 J=1,NS		
2 AWAIT(I)=AWAIT(I)+ALPHA(J,I)/WTMOLE(J)		
1 RHOT(I)=P/89517.501/T(I)/AWAIT(I)		
DO 20 I=1,MPSI		
DO 10 J=1,NS		
K=1		
IF(T(I),GT,TFITS(J,2)) K=2		
CP(J,I)=(AFITS(J,K,1)+T(I))*(AFITS(J,K,2)+T(I))*(AFITS(J,K,3)+T(I))*(
1AFITS(J,K,4)+T(I))*(AFITS(J,K,5))))*1.987*1.8/WTMOLE(J)		
H(J,I)=(AFITS(J,K,6)+T(I))*(AFITS(J,K,1)+T(I))*(AFITS(J,K,2)/2.+T(I)		
1*(AFITS(J,K,3)/3.+T(I))*(AFITS(J,K,4)/4.+T(I))*(AFITS(J,K,5)/5.))))		
2*1.987*1.8/WTMOLE(J)		
10 CONTINUE		
CPBAR(I)=0.0		
HBAR(I)=0.0		
DO 30 J=1,NS		
CPBAR(I)=CPBAR(I)+CP(J,I)*ALPHA(J,I)		
30 HBAR(I)=HBAR(I)+H(J,I)*ALPHA(J,I)		
20 CONTINUE		
Y(I)=0.0		
CO 25 I=2,MPSI		
IF(IAX20.EQ.0)		
066S1535		
060S0240		

TABLE A-III. FLOW FIELD COMPUTER PROGRAM (Continued)

```

1Y(I)=SQRT(Y(I-1)**2+DELPSI*(PSI(I)/RHO(I)/U(I)+PSI(I-1)/RHO(I-1)/U06S0241
2(I-1)))
** (IAX20,40,1)
88
1Y(I)=Y(I-1)+DELPSI*(1./RHO(I)/U(I)+1./RHO(I-1)/U(I-1))/2.
25 CONTINUE
I=ITURR.NE.C) GO TO 40
XMT=0
CO 23 I=1,MPSI
23 XMU(I)=XMUK1*(1)*RGCTT(I)/(I(I)+111.)+XMT 066S1549
XMLE=XMU(I)
GO TO 100 066S1556
40 GO TO(20,45,60,100),ITURA
45 DUM=.5*(RHO(I)*U(I)+RHO(MPSI)*U(MPSI)) 066S1558
L=42 J=1,MPSI 066S1559
I=MPSI-J+1 066S1560
IF(RHO(I)*U(I)-DUM) 51,51,52 066S1561
52 CONTINUE 066S1562
51 DEL=Y(I)-(Y(I)-Y(I+1))*(RHO(I)*L(I)-DUM)/(RHO(I)*U(I)-RHO(I+1)*U(I)066S1563
FRGZ3 - EFN SOURCE STATEMENT - IFN(S) -
1(I)) 066S1564
55 XMT=XMUK2*DEL*ABS(RHO(I)*U(I)-RHO(MPSI)*U(MPSI))
GO TO 100
1001 IF(ABS(U(I)-U(I2)),LT,.002*U(I)) GO TO 1004
IF(U(MPSI).GT.20.16) TC 1003
ITURR=1
ITURA=1
GO TO 26
1003 ITURR=3
ITURA=3
GO TO 60
1004 RUNT=RHO(I)*U(I)
RUNT=RHO(MPSI)*U(MPSI)
XMT=X*(RUNT+RLXT)/900.+1.E-04
CO 99 I=1,MPSI
99 XMU(I)=XMT
GO TO 100
26 CONTINUE
DUM=C.5*(RHO(I)*U(I)+RHO(MPSI)*U(MPSI))
CO 831 I=1,MPSI
I=I
IM=I-1
IF(RHO(I)*U(I).GT.DUM) I=MPSI-I+1
IF(RHO(I)*U(I).GT.DUM) IM=I-1
IF(RHO(I)*U(I)-DUM) 831,832,832
831 CONTINUE
832 RHALF=Y(I)-(Y(I)-Y(IM))*(RHO(I)*L(I)-DUM)/(RHO(I)*U(I)-RHO(IM)*U(I
IM))
GO TO 733
60 CONTINUE
DUM1=.5*(U(I)+U(MPSI))
DUM2=.99*U(I)+.01*U(MPSI)
CO 721 I=2,MPSI
IF((U(I-1)-DUM1)*(L(I)-DUM1).LE.C.0) I=I
IF((L(I-1)-DUM2)*(U(I)-DUM2).LE.C.C) I2=I
731 CONTINUE
RONE=Y(I1)-(Y(I1)-Y(I1-1))*(U(I1)-DUM1)/(U(I1)-U(I1-1))
RTWO=Y(I2)-(Y(I2)-Y(I2-1))*(L(I2)-DUM2)/(U(I2)-U(I2-1))
RHALF=ABS(RONE-RTWO)
733 CO 433 I=1,MPSI
433 XMU(I)=XMUK2*RHALF*RHO(I)*U(I)
IF(RHALF*(RHALF-Y(MPSI)).GT.C.0) CALL EXIT 231
XMT=XMU(I)
100 RETURN 066S1592
END 066S1603
FRGZ4 - EFN SOURCE STATEMENT - IFN(S) -
SUMRJTINE EXPLIC 066S1944
COMMON R,X,DPOX,P,ILT,HE,FF,DPOUT,F,DELPSI,CX,XMUT,XMUL,DEL,XMUK1,X

```

TABLE A-III. FLOW FIELD COMPUTER PROGRAM (Continued)

```

IMUK2,PHNT,PCNT,UE,RHCE,TE,XP3,R*ALF
COMMON IDUT,MPSI,MHALF,MINIT,IFINIS,MPSI,IPAGE,IPRESS,ISTART,ITURB
1. TURB,IJET,NS,MDAY,MONTH,MYEAR,IAX2D,IVAR
C MON WTMOLE(21),COEFFP(5),ALPHA(21,59),HCUT(59),RCLYT(59),RT(59)
1. (59),H(21,59),RALPHA(21,59),PSI(59),RU(59),U(59),XLE(59),TITLE(1
22.,SUM(59),ETA(59),XMU(59),A(59),AWAIT(59),RHQOUT(59),UOUT(59),TOU
3T(59),CP(21,59),HSTG(59),RHC(59),Y(59),XMAX(3),XFRT(3),CPBAR(59),
4IGMA(59),HBAR(59),AFITS(21,2,7),TFITS(21,4),SPECID(21)
IF(IAX2D.EQ.0) DX=DELPSI*DELPSI*SIGMA(1)/XMU(1)/XLE(1)/12.0
IF(IAX2D.EQ.1) DX=DELPSI**2*SIGMA(1)/XMU(1)/RHOT(1)/U(1)/6.0
DO 1C I=2,NPSI
CIVIS=A(I+1)+A(I-1)+A(I)+A(I)
DELX=DELPSI**2*SIGMA(1)/XLE(1)/CIVIS/1.5
IF(IAX2D.EQ.C) DELX=DELX+PSI(I)
10 CX=AMIN(1,DX,DELX)
DIFY = Y(2) - Y(1)
IF(DX-DIFY) 162,162,163
163 CX=DIFY/2.
162 CONTINUE
DO 100 I=2,NPSI
EX1=DELPSI**2/DX
IF(IAX2D.EQ.0) EX1=EX1*PSI(I)
EX11=.5*(A(I)+A(I+1))
EX12=.5*(A(I)+A(I-1))
RU(I)=iEX11*(L(I+1)-U(I))+EX12*(L(I-1)-U(I))/EX1+U(I)
EX4=0.0
DO 2C J=1,NS
20 EX4=EX4+CP(J,I)*(ALPHA(J,I+1)-ALPHA(J,I-1))
FX2=EX1*CPBAR(I)
EX5=XLE(I)*A(I)/SIGMA(I)
EX6=.5*(EX5+XLE(I+1)*A(I+1)/SIGMA(I+1))
EX7=.5*(EX5+XLE(I-1)*A(I-1)/SIGMA(I-1))
EX8=CPBAR(I)*A(I)/SIGMA(I)
EX9=.5*(EX8+CPBAR(I+1)*A(I+1)/SIGMA(I+1))
EX10=.5*(EX8+CPBAR(I-1)*A(I-1)/SIGMA(I-1))
EX13=EX1-EX6-EX7
EX14=EX4*FX5/4.
RT(I)=(U(I+1)-U(I-1))*2*A(I)/EX2/100151.23+(EX9+EX14)*T(I+1)+(EX
11J-EX14)*T(I-1)+(EX2-EX5-EX10)*T(I)/EX2
DO 40 J=1,NS
40 RALPHA(J,I)=(EX6+ALPHA(J,I+1)+EX13*ALPHA(J,I)+EX7*ALPHA(J,I-1))/EX
11
RT(I)=RT(I)+CX*DPDX/RHC(1)/CPBAR(1)/25037.807
RU(I)=RU(I)-CX*DPDX/RHO(1)/U(I)
100 CONTINUE
IF(IAX2D.EQ.C) EX16=4.0*XMU(1)*CX/DELPSI/DELPSI
IF(IAX2D.EQ.1) EX16=2.0*XMU(1)*CX*RHC(1)*U(1)/DELPSI**2
RU(I)=-DX*DPDX/RHO(1)/U(1)+EX16*(L(2)-U(1))+UT(I)
DO 200 J=1,NS
200 RALPHA(J,I)=EX16*XLE(I)*(ALPHA(J,2)-ALPHA(J,I))/SIGMA(I)+ALPHA(J,I
1)
RT(I)=DX*DPDX/RHC(1)/CPBAR(1)/25037.807+EX16*(T(2)-T(I))/SIGMA(I)+
1T(I)
FRQZ4 - EFN SOURCE STATEMENT = IFN(S) =
CFL=DX
IF(IFINIS)5C,1.5C
1 IFINIS=1
MINIT=MPSI
MHALF=MPSI+MPSI-1
50 CONTINUE
X=X+CX
DO 3C I=1,59
DO 5 J=1,NS
5 ALPHA(J,I)=RALPHA(J,I)
T(I)=RT(I)
3C U(I)=RU(I)
1000 IF(MPSI-MHALF)599,1500,1500
999 IF(ABS(U(NPSI)-U(MPSI))-.001*U(MPSI)) 1001,1004,1004
1001 IF(ABS(T(NPSI)-T(MPSI))-.001*T(MPSI))1002,1004,1004

```

TABLE A-III. FLOW FIELD COMPUTER PROGRAM (Continued)

```

1102 DO 1003 J=1,NS
      IF (ALPHA(J,MPSI)-1.0-30) 1003,1003,1222
1222 IS ABS(ALPHA(J,MPSI)-ALPHA(J,MPSI))-0.01*ALPHA(J,MPSI))1003,1003,1
      1004
1003 CONTINUE
      G. TO 2000
1004 MPSI=MPSI+1
      MPSI=MPSI-1
      G. TO 2000
1500 IF INIS=0
      CALL FROZ1
      CALL COMPUT
      IF (IFINIS.GT.1) RETURN
      DELPSI=DELPSI+DELPSI
      DO 1600 I=1,MINIT
      U(I)=U(2*I-1)
      DO 1650 J=1,NS
1650 ALPHA(J,I)=ALPHA(J,2*I-1)
1600 T(I)=T(2*I-1)
      MPSI=4*INIT
      MPSI=MPSI-1
      DO 1700 I=MINIT,59
      T(I)=T(MPSI)
      RT(I)=T(MPSI)
      DO 1750 J=1,NS
      ALPHA(J,I)=ALPHA(J,MPSI)
1750 R(ALPHA(J,I)=ALPHA(J,MPSI)
      RU(I)=L(MPSI)
1700 U(I)=U(MPSI)
      DO 1800 I=2,59
1800 PSI(I)=PSI(I-1)+DELPSI
2000 RETURN
      END

```

FROZ5 - CFN SOURCE STATEMENT - IFNIS) -

```

SUBROUTINE INITAL
COMMON K,X,UPCX,PULT,HE,PE,DP,OUT,F,DELPSI,CX,XMUT,XMUL,DEL,XMUK1,X
IMUK2,PRNT,PCNT,UE,RHCE,TE,XP3,KHALF
COMMON IUOUT,MPSI,MHALF,MINIT,IFINIS,NPSI,IFAGE,IFRESS,ISTART,ITURB
I,ITURA,IJET,NS,MDAY,MONTH,MYEAR,IX2C,IVAR
COMMON ATMULE(21),COEFFP(5),ALPHA(21,59),HCUT(59),ROCTY(59),RT(59)
L,T(59),H(21,59),RALPHA(21,59),PSI(59),RU(59),U(59),XLE(59),TITLE(1
22),SUM(59),ETA(59),XMU(59),A(59),AWAIT(59),RHODUT(59),UOUT(59),TCU
ITI(59),CPI(21,59),HSTG(59),RHG(59),Y(59),XMAX(3),XFRT(3),CPBAR(59),S
4IGMA(59),HBAR(59),AFITS(21,2,7),TFITS(21,4),SPEC(D(21)
XP=C.C
ITURA=ABS(ITLRA)
CFI=CX
IFLAG1=0
DO 220 I=1,MPSI
DUMA=0.0
DO 10 J=1,NS
10 DUMA=DUMA+ALPHA(J,I)
IF (DUMA.EQ.0.C)G TO 220
14 IF (ABS(DUMA-1.)-.01)13,13,100
100 WRITE(6,111)DUMA,I
IF LAC1=1
111 FORMAT(13H SIGMA ALPHA=1PE15.7,12H POINT NUMBER(5,6)IN PSI)
13 DO 15 J=1,NS
15 ALPHA(J,I)=ALPHA(J,I)/DUMA
220 CONTINUE
IF (IFLAG1.EQ.1) CALL EXIT
DO 228 I=2,59
XLE(I)=XLE(I)
SIGMA(I)=SIGMA(I)
228 PSI(I)=PSI(I-1)+DELPSI
CUMY=3.05E-8
29 P=C.C*COEFFP(1)+X*(COEFFP(2)+X*(COEFFP(3)+X*(COEFFP(4)+X*COEFFP(5))))

```

TABLE A-III. FLOW FIELD COMPUTER PROGRAM (Continued)

DO 9C I=MPSI,59	066S0754	
RT(I)=T(MPSI)	066S0755	
T(I)=T(MPSI)	066S0756	
DO 80 J=1,NS		
ALPHA(J,I)=ALPHA(J,MPSI)	066S0758	
80 ALPHA(J,I)=ALPHA(J,MPSI)	066S0759	
RU(I)=U(MPSI)	066S0762	
90 U(I)=U(MPSI)	066S0766	
WRITE(6,341)(TITLE(I),I=1,12)		63
IF(IAX2D.EQ.C) WRITE(6,616)		70
IF(IAX2D.EQ.1) WRITE(6,617)		72
WRITE(6,888) PCNTH,MDAY,MYEAR		73
WRITE(6,999)		74
WRITE(6,609)		75
WRITE(6,611)		76
WRITE(6,612)		77
WRITE(6,615)		78
WRITE(6,618)		79
IF(IPRESS-2) (C1,6C2,604		
601 WRITE(6,701)CCEFFP(I)		81
GO TO 804	066S0858	
602 WRITE(6,702)CCEFFP(I),I=1,5)		83
FROZ5 - EFN SOURCE STATEMENT - IFN(5) -		
804 CONTINUE		
WRITE(6,999)		90
WRITE(6,808)SIGMA(I),XLE(I)		91
WRITE(6,999)		92
WRITE(6,809) ITURA		93
WRITE(6,810)XMK1,XMK2		94
XMK1=XMK1*DUHMY	066S0866	
WRITE(6,999)		95
DO 171 I=1,3		
171 WRITE(6,812) XPR(I),XMAX(I)		99
WRITE(6,999)		103
WRITE(6,613) U(MPSI),T(MPSI)		104
RETURN		
341 FORMAT(1H1,24X,3HGENERALIZED FRCZEN MIXING PROGRAM/1H0,5X,12A6)		
808 FORMAT(1H0,34X,4HDATE13,1H/,12,1H/,12)		
609 FORMAT(1H8 VELOCITY-(FT/SEC),20X,17HENTHALPY-(BTU/LB))		
611 FORMAT(29H TEMPERATURE-(DEGREES KELVIN),9X,22HPST=(TSLD/SEC)**1/		
12)		
612 FORMAT(22H DENSITY-(SLGS/FT**3),16X,19HPRESSURE-(LB/FT**2))		
613 FORMAT(19H EDGE VELOCITY(U)=E11.4,15X,21HEDGE TEMPERATURE(TE)=E11		
1.4)		
615 FORMAT(29H VISCOSITY(MU)-(LB*SEC/FT**2),9X,12HRAII-(FEET))		
616 FORMAT(33X,17HAXISYMMETRIC FLOW)		
617 FORMAT(32X,20HTWO DIMENSIONAL FLOW)		
618 FORMAT(25H SPECIES-(MASS FRACTIONS))		
808 FORMAT(16H PRANDTL NUMBER=F5.2,24X,13HLEWIS NUMBER=F5.2)		
809 FORMAT(18H VISCOSITY OPTION=I2)		
810 FORMAT(31H LAMINAR VISCOSITY COEFFICIENT=F5.2,9X,32HTURBULENT VISC		
OSITY COEFFICIENT=F7.4)		
812 FORMAT(12H PRINT EVERYF7.3,5H FEET,21X,8HUNTIL X=F8.3,5H FEET)		
999 FORMAT(1H0)		
701 FORMAT(1H0,20X,23HCONSTANT PRESSURE P=E15.7)		
702 FORMAT(1H0,30X,63HPOLYNOMIAL PRESSURE FIT P=A+B*(X)+C*(X**2)+D	066S0960	
1(X**3)+E*(X**4)/15X,2HA=1PE15.7,3H B=1PE15.7,3H C=1PE15.7,3H D=1PE15.7,3H	066S0961	
215.7,3H E=1PE15.7)	066S0962	
END	066S1008	
FROZ6 - EFN SOURCE STATEMENT - IFN(6) -		
SUBROUTINE COMPUT		
DIMENSION R JACK(60,25),PJACK(60,25),TRATEM(60,25),XJACK(60)		
COMMON R,X,DPCX,POUT,HE,FE,DPOUT,P,DELPSI,CX,XMUT,XMUL,DEL,XMUK1,X		
IMUK2,PRNT,PCNTH,UE,RHOE,TE,XP3,RHALF		
COMMON IDUT,MPSI,MHALF,MINIT,IFINIS,NPSI,IPAGE,IPRESS,ISTART,ITURB		
I,ITURA,IJET,NS,MDAY,MONTH,MYEAR,IAX2D,IVAR		

TABLE A-III. FLOW FIELD COMPUTER PROGRAM (Continued)

```

COMMON WTMOLE(21),COEFFP(5),ALPHA(21,59),HOUT(59),ROOTT(59),RT(59)
1,T(59),H(21,59),RALPHA(21,59),PSI(59),RU(59),U(59),XCE(59),TTITLE(1
22),SUM(59),ETA(59),XMU(59),A(59),AWAIT(59),RHOOUT(59),UOUT(59),TOU
3T(59),CP(21,59),HSTG(59),RHC(59),Y(59),XMAX(3),XPRT(3),CPBAK(59),S
4IGMA(59),HBAR(59),AFITS(21,2,7),TFITS(21,4),SPECID(21)
IOUT=IOUT+1
IF(XP3.EQ.0.C) XP3=XPRT(1)
IF(IAX2D.EQ.0) GO TO 42
DO 41 I=1,MPSI
41 A(I)=XMU(I)*RHC(I)*U(I)
GO TO 43
42 A(1)=0.0
A(2)=DELPSI*XML(2)
DO 44 I=3,MPSI
44 A(I)=XMU(I)*RHC(I)*U(I)*Y(I)*Y(I)/PSI(I)
43 CONTINUE
RBAKCL=X
IF(IFINIS.EQ.C) GO TO 600
CO 500 I=1,3
IF(RBARDL.LT.XMAX(I))GO TO 501
500 CONTINUE
GO TO 888
501 PRNT=XPRT(I)
IF(RBARDL.LT.XP3) RETURN
DO 6699 I=1,3
IF(RBARDL.LT.XMAX(I)) GC TC 6688
6699 CONTINUE
888 IFINIS=2
GO TO 555
6688 XP3=XP3+XPRT(I)
600 CONTINUE
555 CONTINUE
572 FORMAT(E10.8,15)
IF(X.EQ.0.) READ(5,572) ROC,NORLA
IF(X.EQ.0.) IXP=C
IF(X.EQ.0.) GC TO 802
CHGX=X-PREX
CMPR=XPRT(1)-C.1
IF(CHGX.LT.CMPR) RETURN
802 PREX=X
IXP=IXP+1
IF(IXP.EQ.61) GO TC 999
TTEST=1.05*(MPSI)
XJACK(IXP)=X
DO 525 KUNK=1,25
RJACK(IXP,KUNK)=Y(KUNK)
SJACK=C.0
DO 530 KONK=1,NS
530 SJACK=SJACK+ALPHA(KUNK,KUNK)/WT*CLE(KUNK)
FRU26 - EFN SOURCE STATEMENT - IFN(S)
PJACK(IXP,KUNK)=ALPHA(3,KUNK)/WT*CLE(3)/SJACK
TRATEM(IXP,KUNK)=T(KUNK)
IF(TRATEM(IXP,KUNK).LE.TTEST) GC TC 540
525 CONTINUE
540 IF(T(KUNK).GT.T(MPSI)) GO TC 544
545 PJACK(IXP,KUNK)=C.0033
DYP=Y(KUNK-1) + Y(2)
GO TO 548
544 WTR1=ALOG(T(KUNK-1)/T(MPSI) - 1.)
WTR2=ALOG(T(KUNK)/T(MPSI) - 1.)
WTRP=ALOG(0.05)
YTR1=Y(KUNK-1)
YTR2=Y(KUNK)
YTRP=(YTR1*YTR1*(WTRP-WTR2)+YTR2*YTR2*(WTR1-WTRP))/(WTR1-WTR2)
DYP=SQRT(YTRP)
ZTR1=ALOG(PJACK(IXP,KUNK)-C.0033)
ZTR2=ALOG(PJACK(IXP,KUNK)-C.0033)
BTRA=(ZTR1-ZTR2)/(YTR2*YTR2-YTR1*YTR1)
CTRA=ZTR1+BTRA*YTR1*YTR1

```

TABLE A-III. FLOW FIELD COMPUTER PROGRAM (Continued)

```

PJACK(I X P , K U N K ) = 0 . 0 0 0 3 3 + E X P ( C T R A - B T R A * D Y P * D Y P )
548 RJACK(I X P , K U N K ) = D Y P
TRATEM(I X P , K U N K ) = T I E S T
IF(KUNK.EQ.25) GO TO 565
KUNKP1=KUNK+1
DO 564 IJK=KUNKP1,25
PJACK(I X P , I J K ) = P J A C K ( I X P , K U N K )
RJACK(I X P , I J K ) = R J A C K ( I X P , K U N K )
564 TRATEM(I X P , I J K ) = T I E S T
565 IF(I X P . N E . 5 0 ) G O T O 5 6 7
ATR=0.
CTR=0.
DO 566 IJK=20,60
TY=RJACK(IJK,25)-RGO
ATR=ATR+TY
566 CTR=CTR+XJACK(IJK)
CTR=ATR/CTR
DO 568 IJK=1,60
568 RJACK(IJK,25)=RUC+DTR*XJACK(IJK)
DO 573 NP=1,60
DO 573 IP=1,24
IF(TRATEM(NP,IP).EQ.TTEST) RJACK(NP,IP)=RJACK(NP,25)
573 CONTINUE
DO 574 NP=2,60
IF(RJACK(NP,25).LE.RJACK(NP-1,25)) RJACK(NP,25)=RJACK(NP-1,25)+0.1
574 CONTINUE
WRITE(6,9000)
9000 FORMAT(IH1)
9001 FORMAT(IH,4E12.5)
DO 576 NP=1,60
576 WRITE(6,9001) XJACK(NP),RJACK(NP,25),TRATEM(NP,25),PJACK(NP,25)
II=25
DO 577 NP=1,60
XJACK(NP)=XJACK(NP)*30.48
DO 578 KK=1,25
578 XJACK(NP, KK)=RJACK(NP, KK)*30.48
577 CONTINUE
FROZ6 - EFN SOURCE STATEMENT = IFN(T5)

DIMENSION CAT(25),RAT(25),PAT(25)
DO 750 NXP=1,60
DO 751 NRP=1,25
IF(TRATEM(NXP,NRP).EQ.TTEST) GO TO 752
751 CONTINUE
752 RAMAX=RJACK(NXP,NRP)
NATPL=NRP
DO 753 NN=1,NRP
IF(RJACK(NXP,NN).GT.RAMAX) GO TO 754
753 CONTINUE
GO TO 755
754 NRP=NN
RX=(RJACK(NXP,NRP-1)+RJACK(NXP,NRP+1))/2.
PT1=(TRATEM(NXP,NRP-1)-T(MPSI))/(TRATEM(NXP,NRP+1)-T(MPSI))
IF(PT1.LT.1.0) PT1=1.0
PT2=-ALOG(PT1)
PT3=RX*RX-RJACK(NXP,NRP-1)**2
PT4=RJACK(NXP,NRP+1)**2-RJACK(NXP,NRP-1)**2
PT5=(PT3/PT4)*PT2
PT6=TRATEM(NXP,NRP-1)-T(MPSI)
TRATEM(NXP,NRP)=T(MPSI)+PT6*EXP(PT5)
PT1=((PJACK(NXP,NRP-1)-0.00033)/(PJACK(NXP,NRP+1)-0.00033))
IF(PT1.LT.1.0) PT1=1.0
PT2=-ALOG(PT1)
PT5=(PT3/PT4)*PT2
PT6=PJACK(NXP,NRP-1)-0.00033
PJACK(NXP,NRP)=0.00033+PT6*EXP(PT5)
RJACK(NXP,NRP)=RX
755 CONTINUE
DELTA=RAMAX/24.
DO 756 NRP=2,25

```

131

195

195

254

263

270

272

55

TABLE A-III. FLOW FIELD COMPUTER PROGRAM (Continued)

	CNT=NRP-1	
	RAT(NRP)=CNT*DELTR	
	PI=3.00033	
	TI=T(MPSI)	
	DO 757 JJK=2,NATPL	
	IF(RAT(NRP).LT.RJACK(NXP,IJK)) GO TO 758	
757	CONTINUE	
758	R1=RJACK(NXP,IJK-1)	
	R2=RJACK(NXP,IJK)	
	RX=RAT(NRP)	
	T1=TRATEM(NXP,IJK-1)	
	T2=TRATEM(NXP,IJK)	
	P1=PJACK(NXP,IJK-1)	
	P2=PJACK(NXP,IJK)	
	PT1=(RX*RX-R1*R1)/(R2*R2-R1*R1)	
	PT2=(T1-T1)/(T2-T1)	
	IF(PT2.LT.1.0) PT2=1.0	
	PT2=-ALOG(PT2)*PT1	295
	CAT(NXP)=T1+(T1-T1)*EXP(PT2)	300
	PT2=(P1-P1)/(P2-P1)	
	IF(PT2.LT.1.0) PT2=1.0	
	PT2=-ALOG(PT2)*PT1	304
	PAT(NRP)=P1+(P1-P1)*EXP(PT2)	305
756	CONTINUE	
	DO 759 JK=2,25	
	FKU26 - EFN SOURCE STATEMENT - (FA(S) -	
	RJACK(NXP,JK)=RAT(JK)	
	PJACK(NXP,JK)=PAT(JK)	
759	TRATEM(NXP,JK)=CAT(JK)	
	WRITE(10)(TITLE(I),I=1,12)	318
	WRITE(10) NURLN	323
	DO 579 NP=1,60	
	WRITE(10) XJACK(NP),I1	325
	WRITE(10)(TRATEM(NP,JK),RJACK(NP,JK),PJACK(NP,JK),JJ=1,25)	327
579	CONTINUE	
	WRITE(6,786) XJACK(NXP)	335
	DO 780 JK=1,25	
780	WRITE(6,787)RJACK(NXP,JK),TRATEM(NXP,JK),PJACK(NXP,JK)	339
750	CONTINUE	
786	FORMAT(1H, 'E11.4')	
787	FORMAT(1H, 'E15.4')	
567	DO 75 I1=1,MPSI	
	I=MPSI+1-I1	06650051
	TOUT(I)=T(I)/T(MPSI)	
	UCLT(I)=U(I)/U(MPSI)	06650055
	R=CCLT(I)=KHG(I)/RHU(MPSI)	06650056
	HSTG(I)=HRAK(I)+U(I)*U(I)/50075.614	06650057
	HOUT(I)=HSTG(I)/HSTG(MPSI)	06650058
	SUM(I)=0.0	06650059
	DO 11 J=1,NS	
11	SUM(I)=SUM(I)+ALPHA(J,I)	06650061
25	CONTINUE	
	IPAGE=IPAGE+1	06650102
	WRITE(6,201)(TITLE(I),I=1,12),IPAGE	375
	WRITE(6,721) ACRUN	386
721	FORMAT(1H, 'ICRUN NUMBER,14')	
	WRITE(6,102) X,UX,IGUT	387
	WRITE(6,608)XMLL,XMUT,RHALF	388
	WRITE(6,609) F,DPDX	389
	WRITE(6,107)	390
	DO 10 I1=1,MPSI	
10	WRITE(6,207) I,COUT(I),TCLT(I),R=CCLT(I),HOUT(I),SUM(I),Y(I),PSI(I)	
	I,1	394
	K=MINO(7,NS)	
	WRITE(6,201)(TITLE(I),I=1,12),IPAGE	404
	WRITE(6,108) (SPECID(I),I=1,K)	411
	DO 20 I1=1,MPSI	
20	WRITE(6,208) I,(ALPHA(J,I),J=1,K)	
	IF(NS.LE.7) RETURN	421

TABLE A-III. FLOW FIELD COMPUTER PROGRAM (Concluded)

```

K=MINO(14,NS)
WRITE(6,201)(TITLE(I),I=1,12),1 PAGE          430
WRITE(6,108)(SPEC ID(I),I=8,K)                437
DO 34 I=1,MPSI
34 WRITE(6,208) I,(ALPHA(J,I),J=8,K)          447
IF(NS.EE.14) RETURN
K=MINO(21,NS)
WRITE(6,201)(TITLE(I),I=1,12),1 PAGE          456
WRITE(6,108)(SPEC ID(I),I=15,K)              463
DO 35 I=1,MPSI
35 WRITE(6,208) I,(ALPHA(J,I),J=15,K)        472
RETURN
999 IF INIS=2
FRUZ6 - EFN SOURCE STATEMENT - (FN(S) -
RETURN
208 FORMAT(13,7E11.3)
108 FORMAT(3HOPT,7(3X,A6,2X))
201 FORMAT(1H1,3X,12A6,2X,4HPAGE(3))
207 FORMAT(13,7E15.6,14)
107 FORMAT(3HOPT,6X,4HU/UE,11X,4HT/TE,9X,8HRHO/RHUE,9X,4HH/HE,10X,5MSI
IGMA,12X,1HY,13X,3HPSI,7X,2HPT)
608 FORMAT(6HUMU L=E13.5,7X,5HPU T=E13.5,13X,6HRRALF=E13.5)
609 FORMAT(3HOP=E11.3,10X,5HCPDX=E11.3)
102 FORMAT(3HOX=E13.5,10X,8HDELTA X=E13.5,10X,6HSTEPS=14)
END
36650478

```

TABLE A-IV. TYPICAL OUTPUT DATA

GENERALIZED FROZEN MIXING PROGRAM

TYPICAL TURBOJET AIRCRAFT - SEA LEVEL CONDITIONS - 900 DEG EGT STATIC
 AXISYMMETRIC FLOW

DATE 3/ 6/70

VELOCITY-(FT/SEC) ENTHALPY-(BTU/LB)
 TEMPERATURE-(DEGREES KELVIN) P*-(LBS/SG/SEC**1/2)
 DENSITY-(SLUGS/FT**3) PRESSURE-(LB/FT**2)
 VISCOSITY(MU)-(LB*SEC/FT**2) FACII-(FEET)
 SPECIES-(MASS FRACTIONS)

CONSTANT PRESSURE P= 0.2117000E 04

PRANDTL NUMBER= 0.71 LEWIS NUMBER= 1.40

VISCOSITY OPTION= 4 TURBULENT VISCOSITY COEFFICIENT= 0.0285
 LAMINAR VISCOSITY COEFFICIENT= 0.

PRINT EVERY 0.250 FEET UNTIL X= 10.000 FEET
 PRINT EVERY 1.000 FEET UNTIL X= 20.000 FEET
 PRINT EVERY 2.000 FEET UNTIL X= 50.000 FEET

EDGE VELOCITY(U)= 0.10000E 01 EDGE TEMPERATURE(T)= 0.3000E 03

TYPICAL TURBOJET AIRCRAFT - SEA LEVEL CONDITIONS - 900 DEG EGT STATIC PAGE 1

RUN NUMBER 1

X= C. DELTA X= 0. STEPS= 1

MU L= -0.00000E-19 MU Y= 0.10000E-03 RHALF= -0.00000E-19

P= 0.212F 04 DPDX= -0.

PT	U/LE	T/TE	H/C/WHCE	H/HE	SIGMA	Y	PSI
1	0.18000E 04	0.30000E 01	0.333567E 00	-0.280078E 02	0.100000E 01	0.	-0.00000E-19
2	0.180000E 04	0.300000E 01	0.333567E 00	-0.280078E 02	0.100000E 01	0.111711E 00	0.129844E 00
3	0.180000E 04	0.300000E 01	0.333567E 00	-0.280078E 02	0.100000E 01	0.222222E 00	0.259488E 00
4	0.180000E 04	0.300000E 01	0.333567E 00	-0.280078E 02	0.100000E 01	0.333333E 00	0.389332E 00
5	0.180000E 04	0.300000E 01	0.333567E 00	-0.280078E 02	0.100000E 01	0.444444E 00	0.519376E 00
6	0.180000E 04	0.300000E 01	0.333567E 00	-0.280078E 02	0.100000E 01	0.555556E 00	0.649220E 00
7	0.180000E 04	0.300000E 01	0.333567E 00	-0.280078E 02	0.100000E 01	0.666667E 00	0.779064E 00
8	0.180000E 04	0.300000E 01	0.333567E 00	-0.280078E 02	0.100000E 01	0.777778E 00	0.908908E 00
9	0.180000E 04	0.300000E 01	0.333567E 00	-0.280078E 02	0.100000E 01	0.888889E 00	0.103875E 01
10	0.180000E 04	0.300000E 01	0.333567E 00	-0.280078E 02	0.100000E 01	0.100000E 01	0.113866E 01
11	0.180000E 04	0.300000E 01	0.333567E 00	-0.280078E 02	0.100000E 01	0.100000E 01	0.129844E 01
12	0.180000E 04	0.300000E 01	0.333567E 00	-0.280078E 02	0.100000E 01	0.151955E 02	0.142828E 01

TABLE A-IV. TYPICAL OUTPUT DATA (Conclude*d*)

TYPICAL TURBOJET AIRCRAFT - SEA LEVEL CONDITIONS - 900 DEG EGT STATIC PAGE 1

PT	O2	N2	CO2	h2c
1	0.175E 0C	0.753E 00	0.520E-01	2.198E-01
2	0.175E 0C	0.753E 00	0.520E-01	0.158E-01
3	0.175E 0C	0.753E 00	0.520E-01	0.158E-01
4	0.175E 00	0.753E 00	0.520E-01	0.158E-01
5	0.175E 0C	0.753E 00	0.520E-01	0.158E-01
6	0.175E 0C	0.753E 00	0.520E-01	0.158E-01
7	0.175E 0C	0.753E 00	0.520E-01	0.158E-01
8	0.175E 0C	0.753E 00	0.520E-01	0.158E-01
9	0.175E 0C	0.753E 00	0.520E-01	0.158E-01
10	0.175E 0C	0.753E 00	0.520E-01	0.158E-01
11	0.232E 0C	0.758E 00	0.500E-03	C.
12	0.232E 00	0.760E 00	0.500E-03	C.

UNCLASSIFIED

Security Classification

DOCUMENT CONTROL DATA - R & D		
<i>(Security classification of title, body of abstract and indexing annotation must be entered when the overall report is classified)</i>		
1. ORIGINATING ACTIVITY (Corporate author) Advanced Sensors Laboratory Research and Engineering Directorate U. S. Army Missile Command Redstone Arsenal, Alabama 35809		2a. REPORT SECURITY CLASSIFICATION Unclassified
		2b. GROUP NA
3. REPORT TITLE AN ANALYTICAL MODEL FOR PREDICTING THE RADIATION FROM JET PLUMES IN THE MID-INFRARED SPECTRAL REGION		
4. DESCRIPTIVE NOTES (Type of report and inclusive dates) Technical Report		
5. AUTHOR(S) (First name, middle initial, last name) H. Tracy Jackson		
6. REPORT DATE 1 April 1970	7a. TOTAL NO. OF PAGES 66	7b. NO. OF REFS 7
8a. CONTRACT OR GRANT NO.	9a. ORIGINATOR'S REPORT NUMBER(S) RE-TR-70-7	
b. PROJECT NO. (DA) 1M2623xxA204 AMC Management Structure Code No. c. 522C. 11. 146 d.	9b. OTHER REPORT NO(S) (Any other numbers that may be assigned this report) AD	
10. DISTRIBUTION STATEMENT This document is subject to special export controls and each transmittal to foreign governments or foreign nationals may be made only with prior approval of this Command, ATTN: AMSMI-RE.		
11. SUPPLEMENTARY NOTES None	12. SPONSORING MILITARY ACTIVITY Same as No. 1	
13. ABSTRACT This report describes an analytical model for predicting the emission of radiation from a jet plume in the mid-infrared spectral region. It is assumed that the dominant radiation arises for the CO ₂ molecule. Results are therefore reported for the 4.3-micrometer band of gaseous carbon dioxide which is assumed to cover the spectral region 2050 to 2400/cm ⁻¹ (4.17 - 4.88 micrometers). The temperature range that is considered varies from 200° to 2100°K. The objective of the reported program was to develop a computerized program for predicting radiant energy emissions which could be readily integrated into a flow field calculation. A description is given of both the radiation model and the flow field model. The described program provides both the spectral and spatial intensity distributions of the emitted radiation.		

DD FORM 1473
1 NOV 66REPLACES DD FORM 1473, 1 JAN 64, WHICH IS
OBSOLETE FOR ARMY USE.

UNCLASSIFIED

Security Classification

63

UNCLASSIFIED

Security Classification

14.	KEY WORDS	LINK A		LINK B		LINK C	
		ROLE	WT	ROLE	WT	ROLE	WT
	Jet plume radiation Mid-infrared spectral region CO ₂ molecule Radiant energy emission Flow field model						

UNCLASSIFIED

Security Classification