

UNCLASSIFIED

AD NUMBER
AD860559
NEW LIMITATION CHANGE
TO Approved for public release, distribution unlimited
FROM Distribution authorized to U.S. Gov't. agencies and their contractors; Administrative/Operational Use; Aug 1968. Other requests shall be referred to U.S. Army Missile Command, Redstone Arsenal, AL.
AUTHORITY
USAMC ltr, 29 Nov 1972

THIS PAGE IS UNCLASSIFIED

AD

REPORT NO. RD-TR-68-10

**AN EXPERIMENTAL INVESTIGATION
OF THE INTERFERENCE EFFECTS DUE TO
A LATERAL JET ISSUING FROM A BODY
OF REVOLUTION OVER THE MACH NUMBER
RANGE OF 0.8 TO 4.5**

by

Donald J. Spring

August 1968

*This document is subject to special export controls
and each transmittal to foreign governments or foreign
nationals may be made only with prior approval of this
Command, ATTN: AMSM-RD.*

AD 860559



U.S. ARMY MISSILE COMMAND

Redstone Arsenal, Alabama

OCT 27 1968
RECEIVED
G

ACCESSION FOR		
CFSTI	WHITE SECTION	<input type="checkbox"/>
DCC	BUFF SECTION	<input checked="" type="checkbox"/>
UNANNOUNCED		
JUSTIFICATION		
BY		
DISTRIBUTION/AVAILABILITY CODES:		
DIST.	AVAIL.	and/or SPECIAL
2		

DISCLAIMER

The findings in this report are not to be construed as an official Department of the Army position unless so designated by other authorized documents.

DISPOSITION INSTRUCTIONS

**Destroy this report when it is no longer needed.
Do not return it to the originator.**

BLANK PAGE

20 August 1968

Report No. RD-TR-68-10

**AN EXPERIMENTAL INVESTIGATION
OF THE INTERFERENCE EFFECTS DUE TO
A LATERAL JET ISSUING FROM A BODY
OF REVOLUTION OVER THE MACH NUMBER
RANGE OF 0.8 TO 4.5**

by

Donald J. Spring

DA Project No. 1M262301A206
AMC Management Structure Code No. 5221.11.148

*This document is subject to special export controls
and each transmittal to foreign governments or foreign
nationals may be made only with prior approval of this
Command, ATTN: AMSMI-RD.*

Aerodynamics Branch
Advanced Systems Laboratory
Research and Development Directorate
U. S. Army Missile Command
Redstone Arsenal, Alabama 35809

ABSTRACT

A research study currently being conducted by the U. S. Army Missile Command is aimed at developing a technique for predicting the aerodynamic characteristics of missiles that use lateral or transverse jets as the control system. As a part of this study, an experimental test program was conducted with the use of a body of revolution with a lateral jet located at several body locations over the Mach number range from 0.8 to 4.5. The jet pressure ratio was varied between 0 and 100 in increments of 20, and both slots and circular nozzles were tested. The data are presented in plots and tabular form. In addition, short descriptions of two other approaches are also presented. These approaches are compared with the experimental data and show agreement with 10 to 16 percent.

CONTENTS

	Page
1. Introduction	1
2. Apparatus and Instrumentation	1
3. Results and Discussion	2
LITERATURE CITED	27
Appendix. TABULATED DATA	29

ILLUSTRATIONS

Figure		Page
1	Pertinent Model Dimensions	5
2	Pertinent Nozzle Details	6
3	Photograph of Model Noses, Circular Nozzles	7
4	Photograph of Model Noses, Slot Nozzles	8
5	Tunnel Installation	9
6	Schlieren Photographs, $M_\infty = 0.8$	10
7	Schlieren Photographs, $M_\infty = 2.0$, Circular Nozzles	11
8	Schlieren Photographs, $M_\infty = 2.0$, Slot Nozzles	12
9	Typical Variation of Normal-Force Coefficient Versus Angle of Attack for Several Jet Pressure Ratios	13
10	Typical Variation of Pitching-Moment Coefficient Versus Angle of Attack for Several Jet Pressure Ratios	15
11	Typical Variation of Incremental Normal-Force Coefficient with Jet Pressure Ratio	17
12	Typical Variation of Incremental Pitching-Moment Coefficient with Jet Pressure Ratio	18
13	Variation of Momentum Ratio with Jet Pressure Ratio	19
14	Variation of K_N and K_m as a Function of Momentum Ratio for a Circular Nozzle	20
15	Variation of K_N and K_m as a Function of Momentum Ratio for a Slot Nozzle	21
16	Variation of the Parameters K and N with Body Position	22

ILLUSTRATIONS (Concluded)

Figure		Page
17	Comparison of Experimental Data and Empirical Correlation Parameter	23
18	Model for Equivalent Body Analogy	24
19	Comparison of Incremental Force Data	25
20	Comparison of Incremental Moment Data	26

NOMENCLATURE

1. General

C_N	Normal force coefficient (normal force/ $q_\infty S$)
C_m	Pitching moment coefficient about model reference (pitching moment/ $q_\infty SD$)
D	Model reference diameter (ft)
$DCN, \Delta C_N$	Incremental normal force coefficient
$DCM, \Delta C_m$	Incremental pitching moment coefficient
F_{N1}	Interference normal force (lb)
F_T	Jet thrust (lb)
K	Constant, given by Equation (1)
K_m	Moment augmentation ratio $(1 + M_1/F_T X)$
K_N	Force augmentation ratio $(1 + F_{N1}/F_T)$
M, M_∞	Free stream Mach number
M_e	Jet exit Mach number
M_1	Interference pitching moment (ft-lb)
M_R	Momentum ratio $[(\rho V^2)_{jet}/(\rho V^2)_\infty]$
N	Constant, given by Equation (1)
P_{tj}, P_{oj}	Jet total pressure (psf)
P_∞, P_{INF}	Free stream static pressure (psf)
q_∞	Free stream dynamic pressure (psf)
S	Model cross-sectional area (ft ²)
V	Velocity (ft/sec)
X	Nozzle location (ft)
ρ	Density (slugs/ft ³)

2. Configuration

B Body

- C₁ Circular nozzle ($M_e = 1.0$)
C₂ Circular nozzle ($M_e = 2.94$)
F₁ Rectangular fins
S₁ Slot nozzle ($M_e = 1.0$)
X₁ Nozzle location (3.000 calibers aft of nose)
X₂ Nozzle location (4.364 calibers aft of nose)
X₃ Nozzle location (5.727 calibers aft of nose)
X₄ Nozzle location (2.000 calibers aft of nose)



JET INTERACTION FLOW FIELD

1. Introduction

A considerable amount of interest in the use and application of control devices that depend upon the generation of a reactive force for the control of missiles has been expressed by agencies of the Department of Defense. Inherent in the use of these devices is the interaction of the jet flow with the free stream flow which is an extremely complicated process, as shown by the frontispiece. A large amount of effort in the past has been expended toward an understanding of the interaction process, but unfortunately, these in general have been limited to the two-dimensional cases since they are more amenable to solution. In early 1966 the U. S. Army Missile Command decided to realign its efforts in the lateral jet area and to attempt to develop a technique that would permit direct application to proposed missiles in the preliminary design stage. Initially, a thorough literature survey along with an analysis of all existing methods was accomplished and reported.^{1,2}

To achieve the desired results, three approaches were selected:

- a) An experimental investigation
- b) An empirical approach using correlation of the experimental data
- c) A semi-empirical or analytical approach.

All of the approaches were to cover the Mach number range from 0 to 5, jet pressure ratios from 0 to 100 (weak to strong injection), small angles of attack, three-dimensional flow fields, and normal injection from a single jet at arbitrary body locations with the normal injection being in the pitch plane.

This report will primarily present the results from the experimental phase of the research project and will only give a short description of the other two approaches along with some comparisons with the experimental data.

2. Apparatus and Instrumentation

The model used for these tests was sting-mounted and consisted of a 4-caliber tangent-ogive nose and a 5-caliber cylindrical afterbody. The overall length was 12.375 inches, and the reference diameter was 1.375 inches. Interchangeable nose sections were used to vary the nozzle location and geometry. Both circular and slot type nozzles with a sonic exit Mach number were tested with body locations of $X/D = 3.0, 4.36, \text{ and } 5.73$ calibers. In addition, two

other circular nozzles, one sonic and one supersonic ($M_e = 2.94$), were tested at an X/D location of 2.0. For all tests, an artificial boundary layer trip was installed on the models. Pertinent dimensions are shown in Figure 1, and photographs of the noses and tunnel installations are shown in Figures 2 through 5. For all tests, the jet nozzle exit was oriented in the pitch plane at $\phi = 0^\circ$; fins were oriented at $\phi = 0^\circ, 90^\circ, 180^\circ, \text{ and } 270^\circ$ as shown in Figure 1.

The transonic part of the program was conducted in the Arnold Engineering Development Center's 1-foot transonic tunnel at Mach numbers between 0.8 and 1.5. A more detailed description of this test facility has been given previously.³

The supersonic portion was carried out in the U. S. Army Ballistic Research Laboratories tunnel No. 1 at Mach numbers between 1.75 and 4.5.⁴

The instrumentation used during the tests was a six-component internal strain-gage balance designed so that the injectant air passed through the center of the balance. This method results in changes in measured forces due to the pressurization of less than 1 percent. In addition, the jet chamber pressure and temperature were measured.

3. Results and Discussion

a. Experimental Program

Typical Schlieren photographs taken during the series of tests are shown in Figures 6 through 8. Figure 6 is for injection from a circular, sonic nozzle into a 0.8 Mach number free stream, while the other two figures are for sonic injection into a Mach number 2.0 free stream from a circular and a slot type nozzle, respectively. It is readily apparent from an examination of these figures that the classical schematic generally used to depict the lateral jet flow field does not adequately describe the case for injection into the high subsonic free stream. This area thus becomes one in which little analytical work has been done to date, but which will be pursued in more depth by the Army Missile Command.

The data taken during the tests were primarily the forces and moments in the pitch plane. Plots of the typical variation of these two parameters with angle of attack for several jet pressure ratios are shown in Figures 9 and 10 for a free stream Mach number range between 0.8 and 4.5. For the force data, most of the curves retain the same slope, at a constant Mach number over the $\pm 2^\circ$ angle of attack range, regardless of jet pressure ratio. This allows the data to be represented by the basic slopes plus the incremental force or moment at zero angle of attack.

The variations of the incremental force and moment, for one typical nozzle shape and location, are plotted as a function of jet pressure ratio for all free stream, test Mach numbers in Figures 11 and 12. The complete set of incremental data is presented in the appendix.

One parameter that was used in an early attempt to obtain a linear variation of the augmentation ratios was the momentum ratio, which varied with jet pressure ratio (Figure 13). The variation of K_N and K_m as a function of the momentum ratio is shown in Figures 14 and 15 for a circular and a slot nozzle, respectively. Note that, for all Mach numbers except 4.5, the indications are that the jet causes an interference such that a degradation in control force and moment occurs. Also, the slot type nozzle causes a larger amount of degradation than the circular nozzle, but this may be caused by the larger frontal area of the slot jet. In general, the data did not exhibit the linear variation desired with the use of momentum ratio as one parameter. Further efforts to obtain a satisfactory correlation of the data were carried out and are discussed in the following section.

b. Empirical Correlation

An empirical correlation technique was pursued concurrently and has been described fully.⁵ Basically, this technique was a curve-fitting routine of the experimental data (Figures 14 and 15). The parameters that were used are the momentum ratio (M_R) and the force augmentation ratio (K_N). The most consistent behavior in the variations of the data was obtained when the augmentation ratio was multiplied by the momentum ratio and then plotted versus the momentum ratio. This resulted in a set of linear curves that intersected the X-axis at different points and which had different slopes. By a shift of the curves to the zero origin and by a rotation of the curves to the common slope of 2.0, the following empirical relationship was derived which is the most satisfactory representation of the test data:

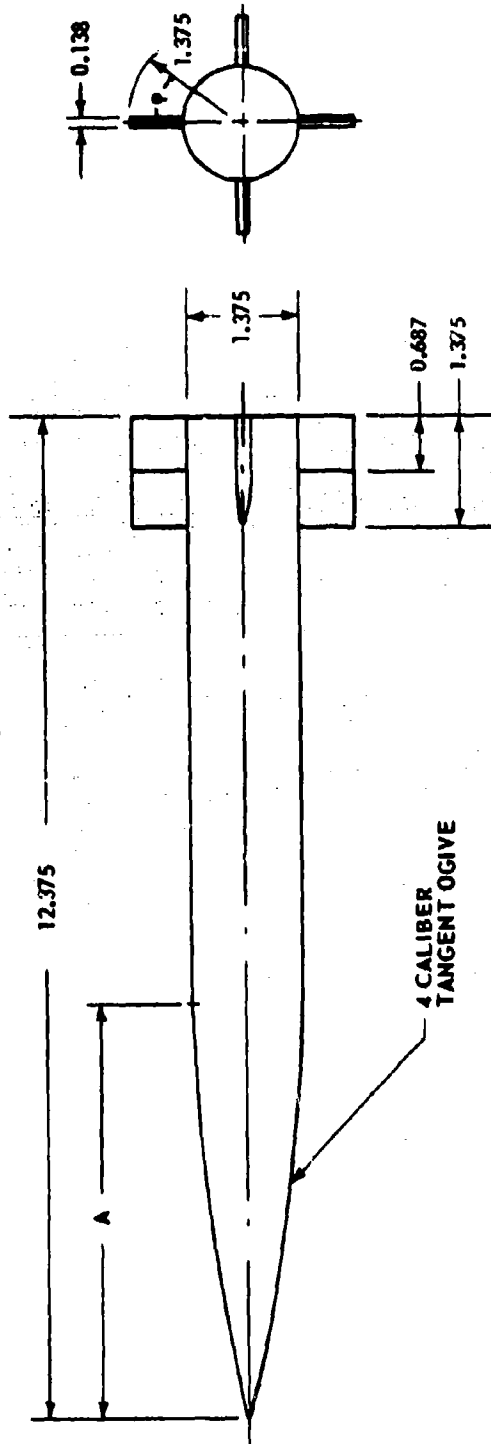
$$\frac{2.0 K_N M_R}{1 + K M_\infty} = M_R - N/e M_\infty \quad (1)$$

The variation of K and N is shown in Figure 16 for all the available test data. The values calculated by the empirical technique in Equation (1) are compared to the corresponding experimental data in Figure 17 and show an accuracy band of ± 10 percent.

c. Supersonic Analogy

An analogy has been developed based upon an equivalent body technique. Basically, a body diameter is determined based upon conservation of momentum principles such that the change in longitudinal component of momentum must be balanced by the drag acting upon the equivalent body. Once the equivalent body has been determined, a method of characteristics solution is obtained for the equivalent body which is then located on the jet center line at the equivalent body radius above the jet exit. The equivalent body, as shown in Figure 18, is a sphere-cylinder combination that replaces the lateral jet. The equivalent body characteristics net intersection with the missile body is solved and the resultant pressures are integrated to yield the interference forces and moments. Cassell et al.⁶ provide a more complete description of this technique.

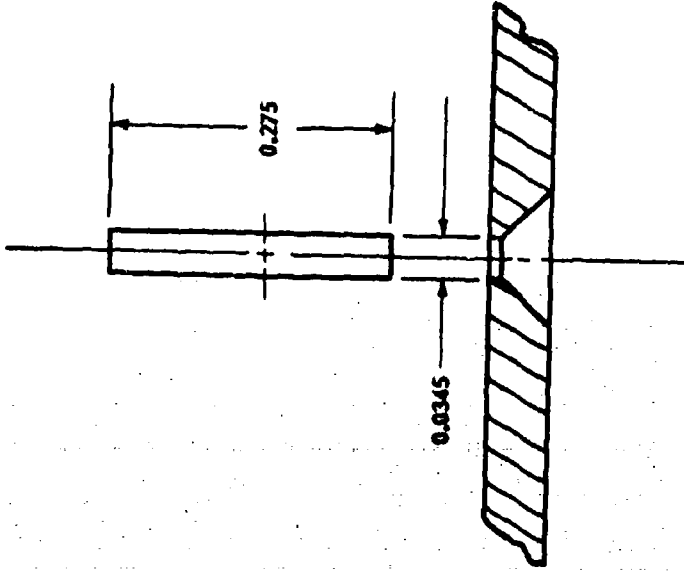
Figures 19 and 20 show a comparison of the results from this technique as compared to some of the experimental data. The general trends exhibited by the analogy appear to be correct while, at the same time, the magnitude appears to be in error by from 11 to 16 percent. Accuracies of this order are generally considered acceptable for the normal parametric studies during preliminary design programs. Further improvements are being investigated at the present time.



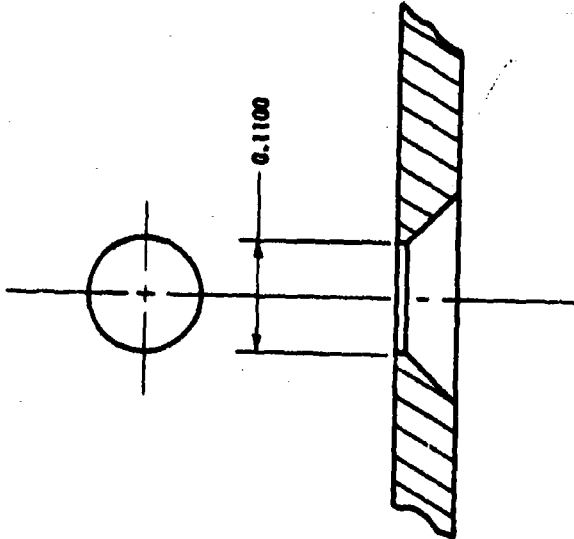
NOTE: AT ALL LOCATIONS THE JET IS ORIENTED
 IN THE PITCH PLANE AT $\phi = 0^\circ$ WITH THE
 FINS ORIENTED AT $\phi = 0^\circ, 90^\circ, 180^\circ$, AND
 270° .

JET LOCATION - A	
POSITION	X
1	4.125
2	6.000
3	7.875

FIGURE 1. PERTINENT MODEL DIMENSIONS



SLOT NOZZLE



CIRCULAR NOZZLE

NOT TO SCALE

FIGURE 2. PERTINENT NOZZLE DETAILS

BLANK PAGE



FIGURE 3. PHOTOGRAPH OF MODEL NOSES, CIRCULAR NOZZLES



FIGURE 4. PHOTOGRAPH OF MODEL NOSES, SLOT NOZZLES

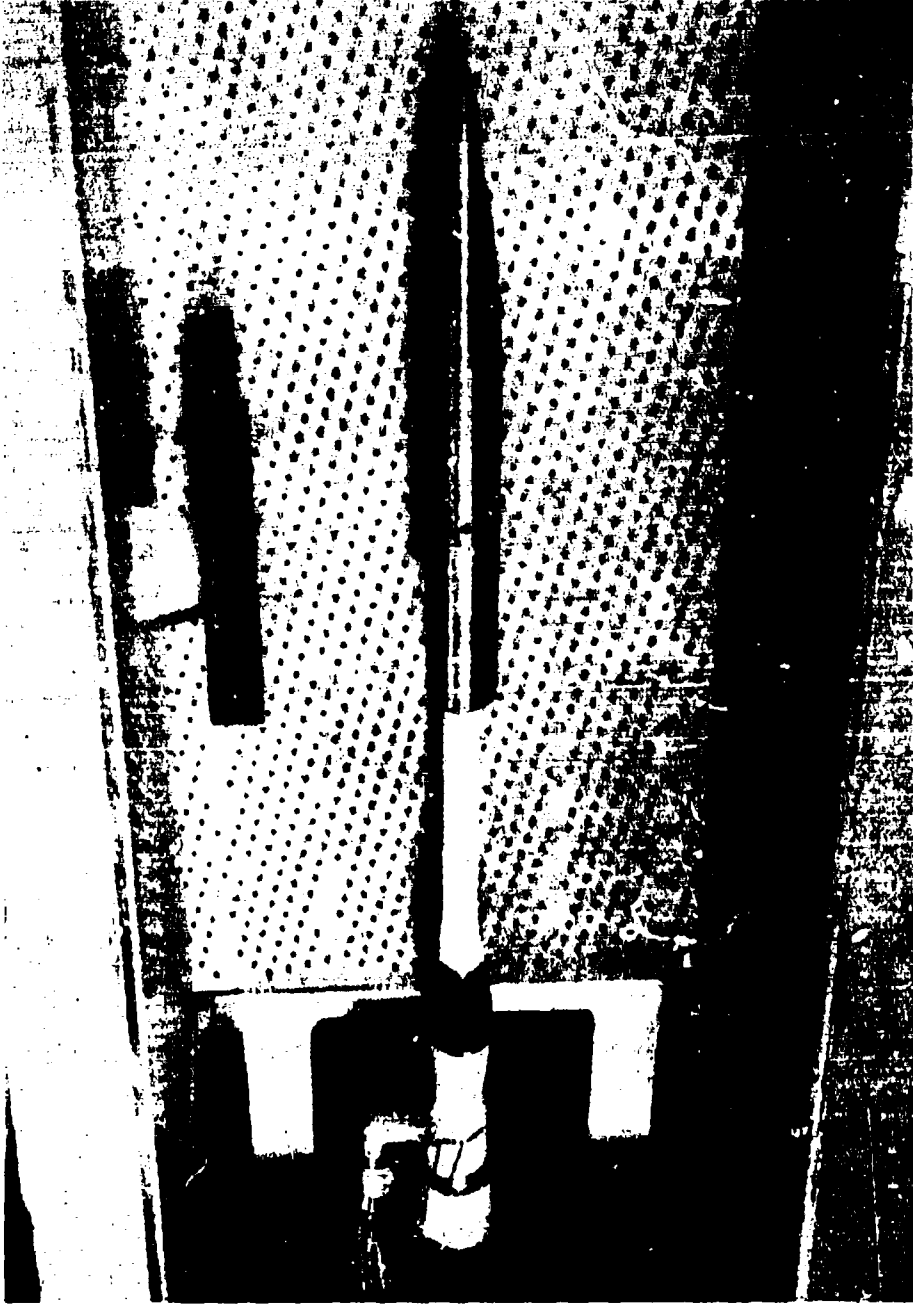
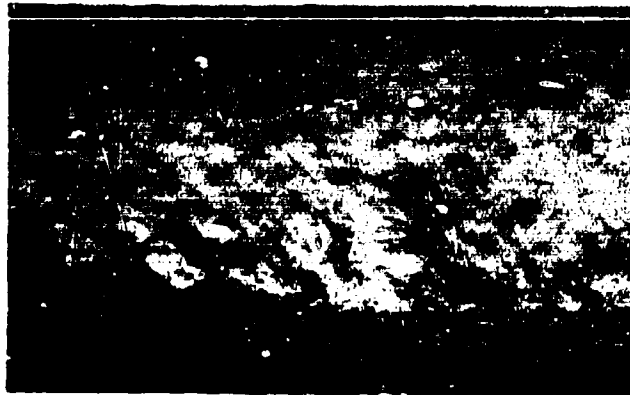
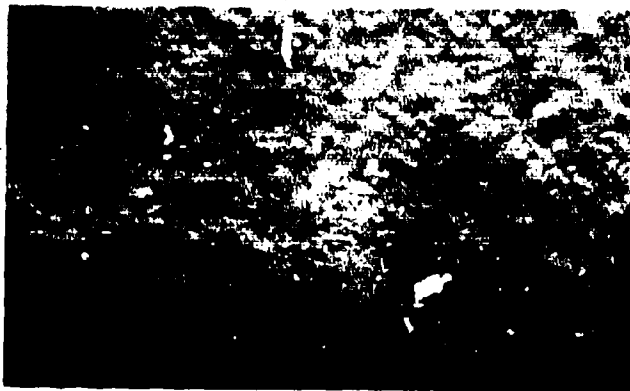


FIGURE 5. TUNNEL INSTALLATION



$P_1/P_\infty = 20$



$P_1/P_\infty = 40$



$P_1/P_\infty = 60$

FIGURE 6. SCHLIEREN PHOTOGRAPHS, $M_\infty = 0.8$



$$P_t/P_\infty = 40$$



$$P_t/P_\infty = 20$$



$$P_t/P_\infty = 0$$

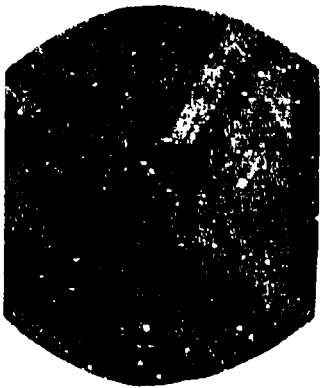


$$P_t/P_\infty = 100$$

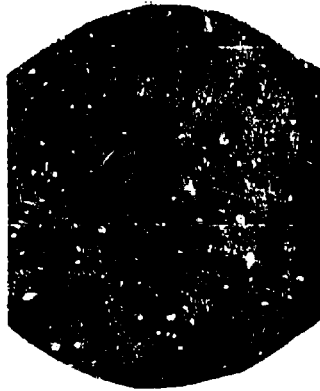


$$P_t/P_\infty = 60$$

FIGURE 7. SCHLIEREN PHOTOGRAPHS, $M_\infty = 2.0$, CIRCULAR NOZZLES



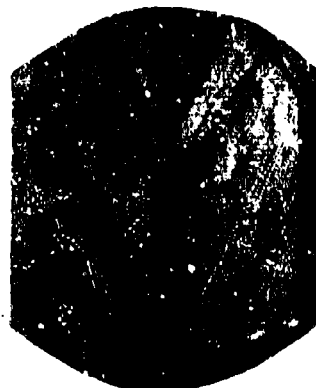
$P_t/P_\infty = 0$



$P_t/P_\infty = 20$



$P_t/P_\infty = 40$



$P_t/P_\infty = 60$



$P_t/P_\infty = 80$



$P_t/P_\infty = 100$

FIGURE 8. SCHLIEREN PHOTOGRAPHS, $M_\infty = 2.0$, SLOT NOZZLES

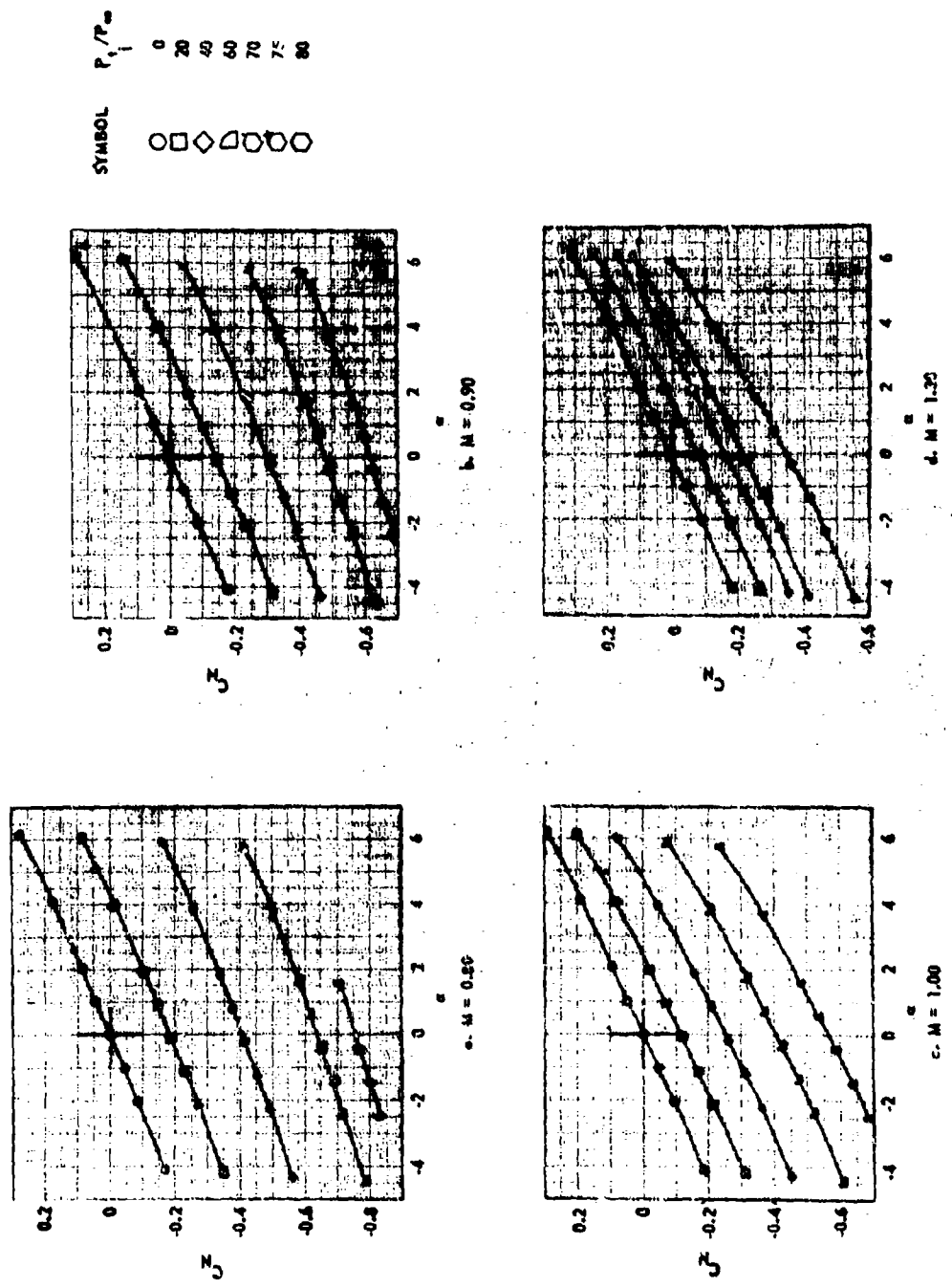


FIGURE 9. TYPICAL VARIATION OF NORMAL-FORCE COEFFICIENT VERSUS ANGLE OF ATTACK FOR SEVERAL JET PRESSURE RATIOS

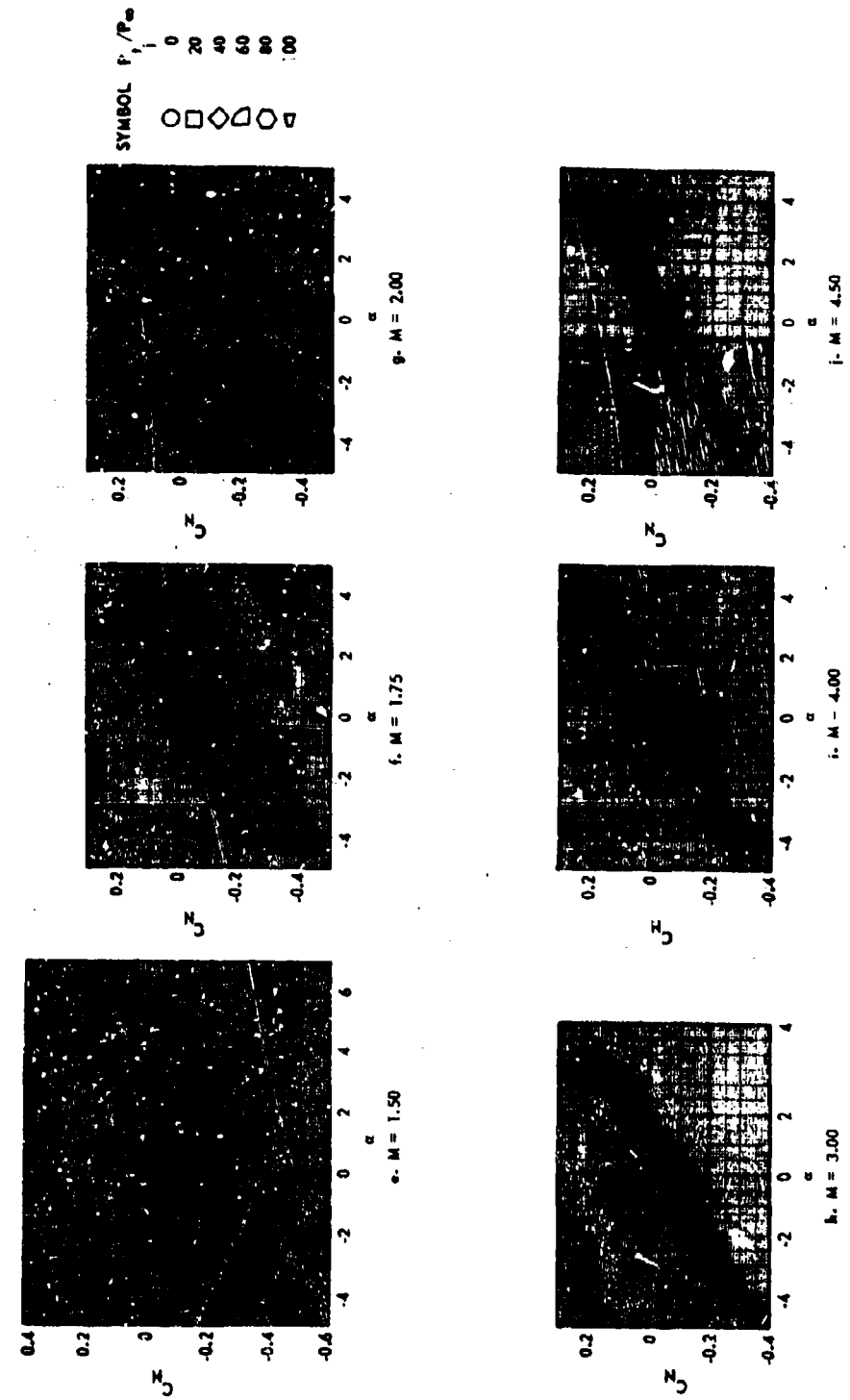


FIGURE 9. TYPICAL VARIATION OF NORMAL-FORCE COEFFICIENT VERSUS ANGLE OF ATTACK FOR SEVERAL JET PRESSURE RATIOS (Concluded)

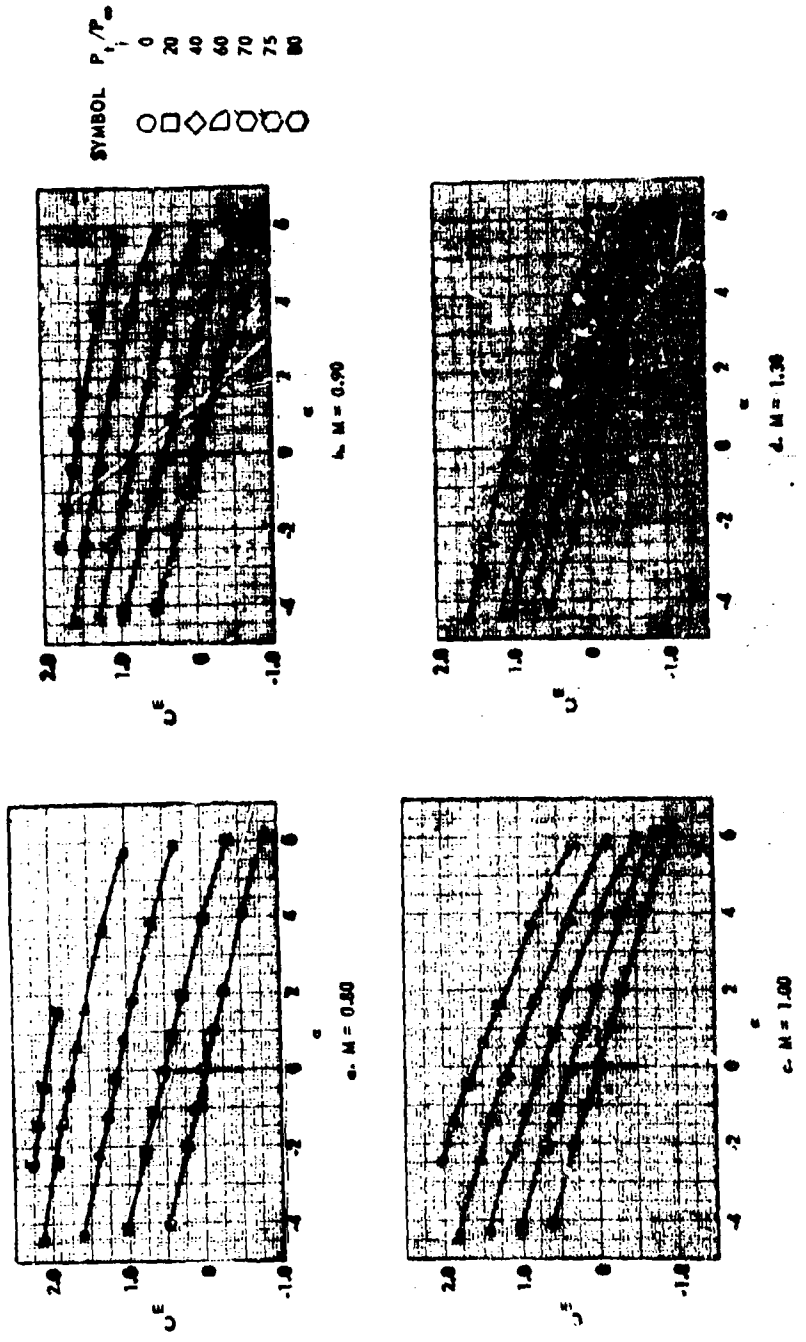


FIGURE 10. TYPICAL VARIATION OF PITCHING-MOMENT COEFFICIENT VERSUS
ANGLE OF ATTACK FOR SEVERAL JET PRESSURE RATIOS

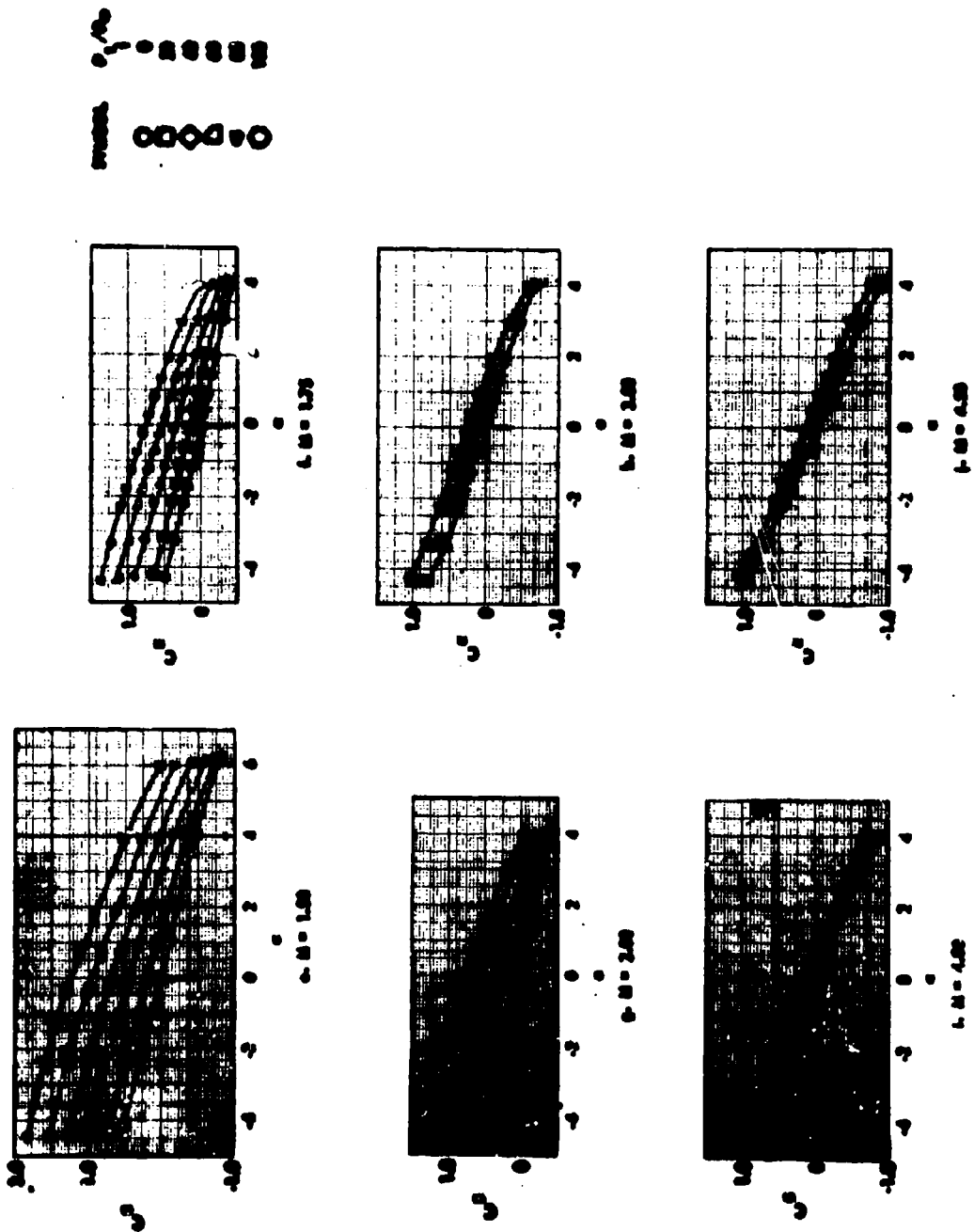


FIGURE 10. TYPICAL VARIATION OF PITCHING-MOMENT COEFFICIENT VERSUS ANGLE OF ATTACK FOR SEVERAL JET PRESSURE RATIOS (Concluded)

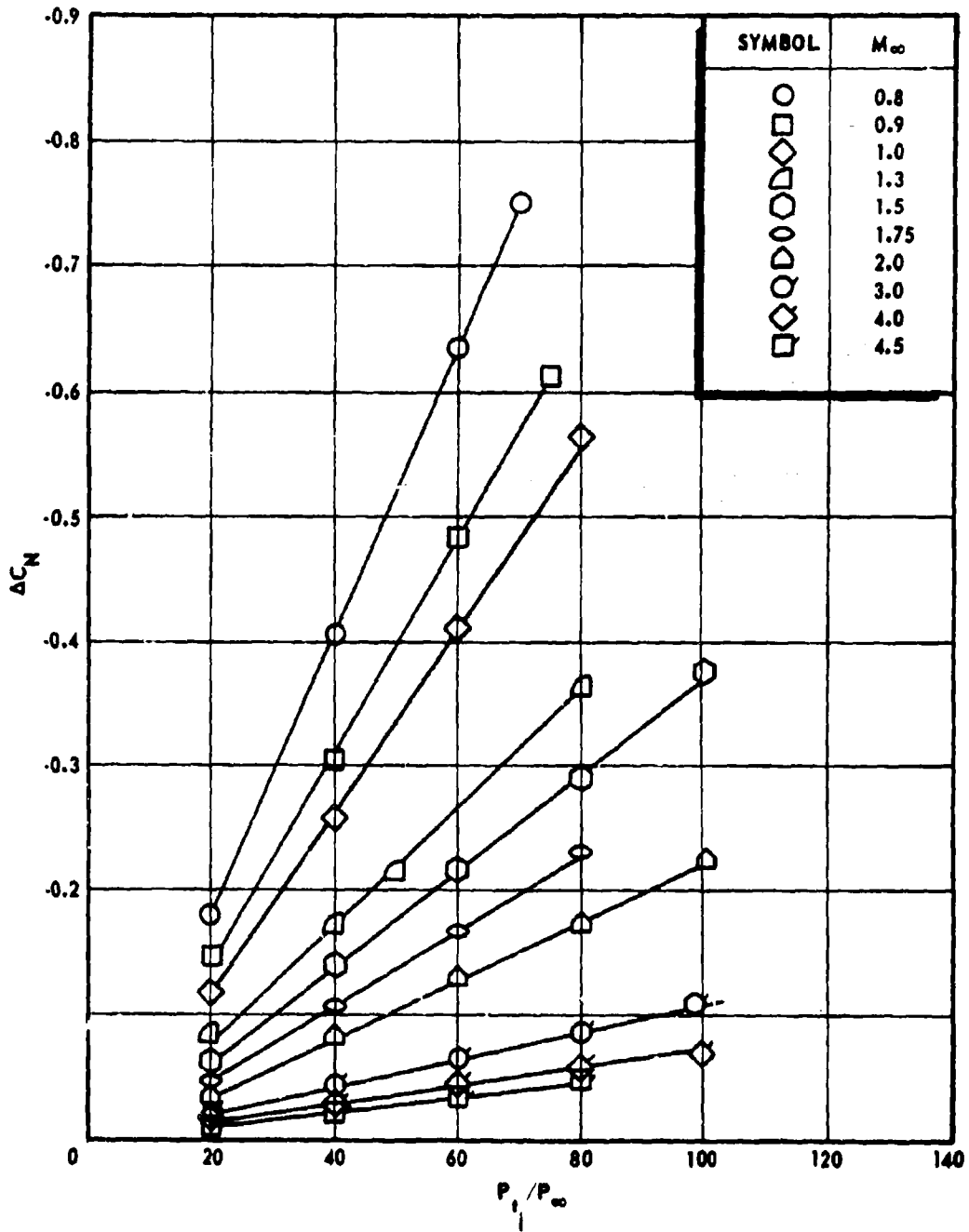


FIGURE 11. TYPICAL VARIATION OF INCREMENTAL NORMAL-FORCE COEFFICIENT WITH JET PRESSURE RATIO

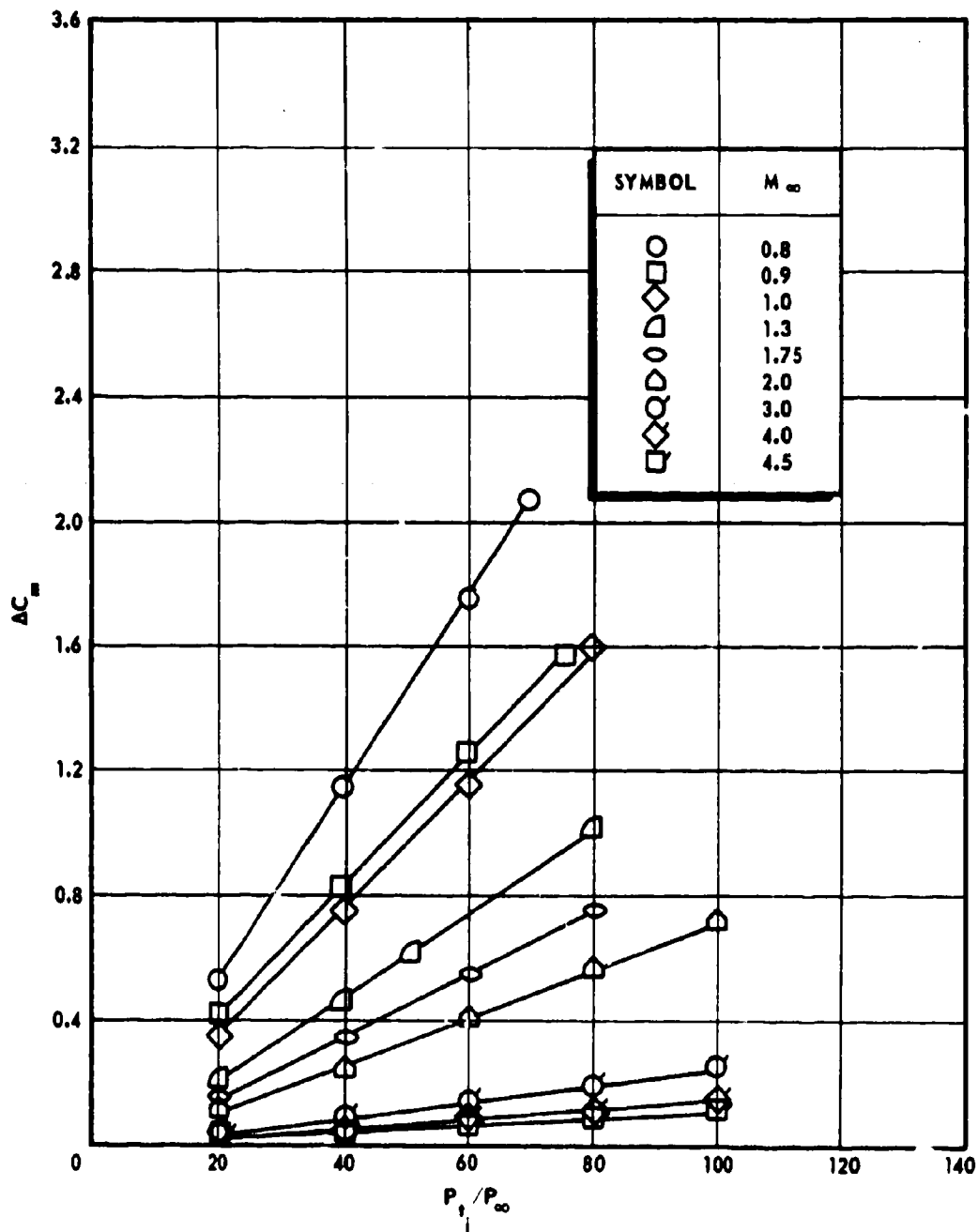


FIGURE 12. TYPICAL VARIATION OF INCREMENTAL PITCHING-MOMENT COEFFICIENT WITH JET PRESSURE RATIO

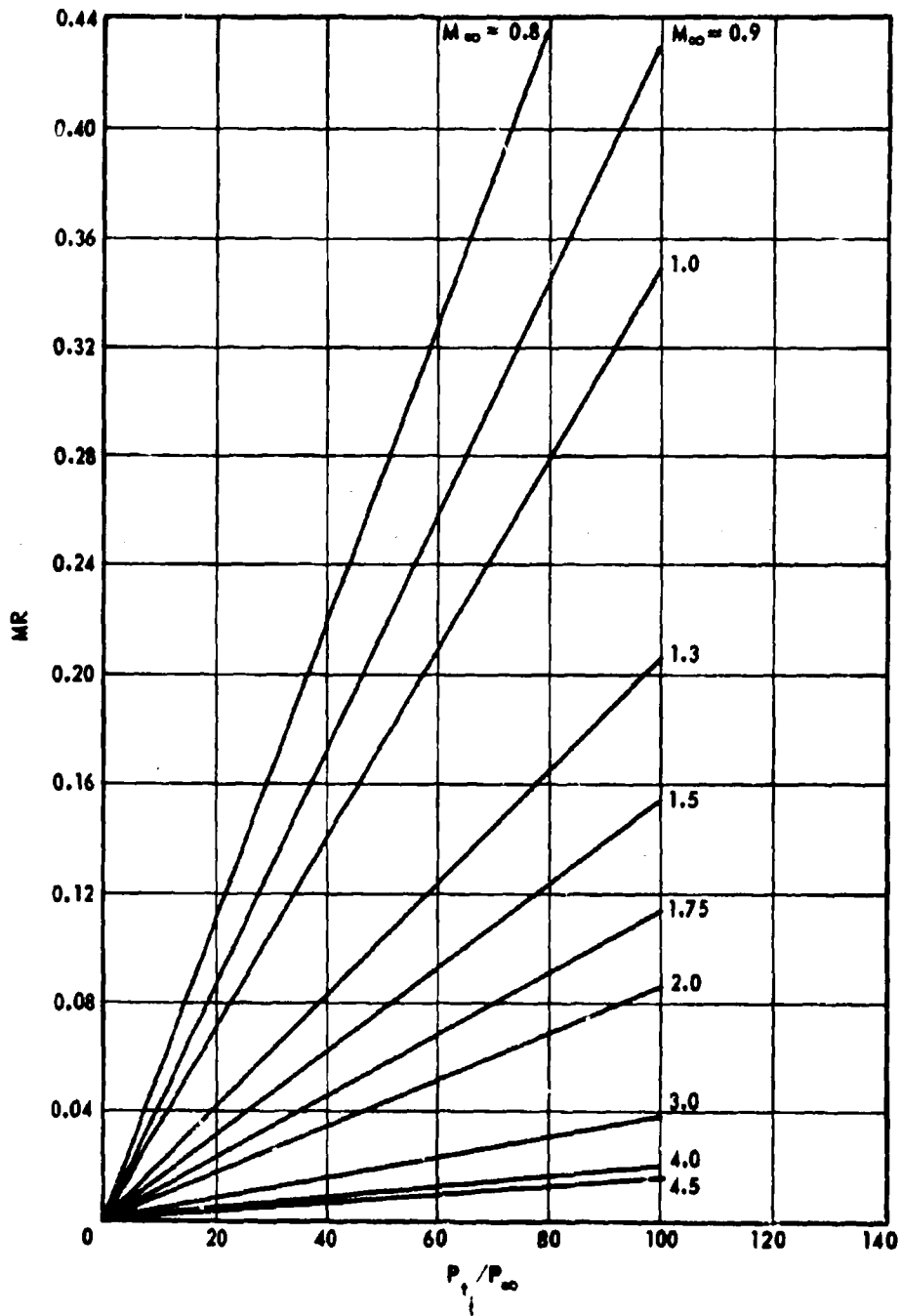


FIGURE 13. VARIATION OF MOMENTUM RATIO WITH JET PRESSURE RATIO

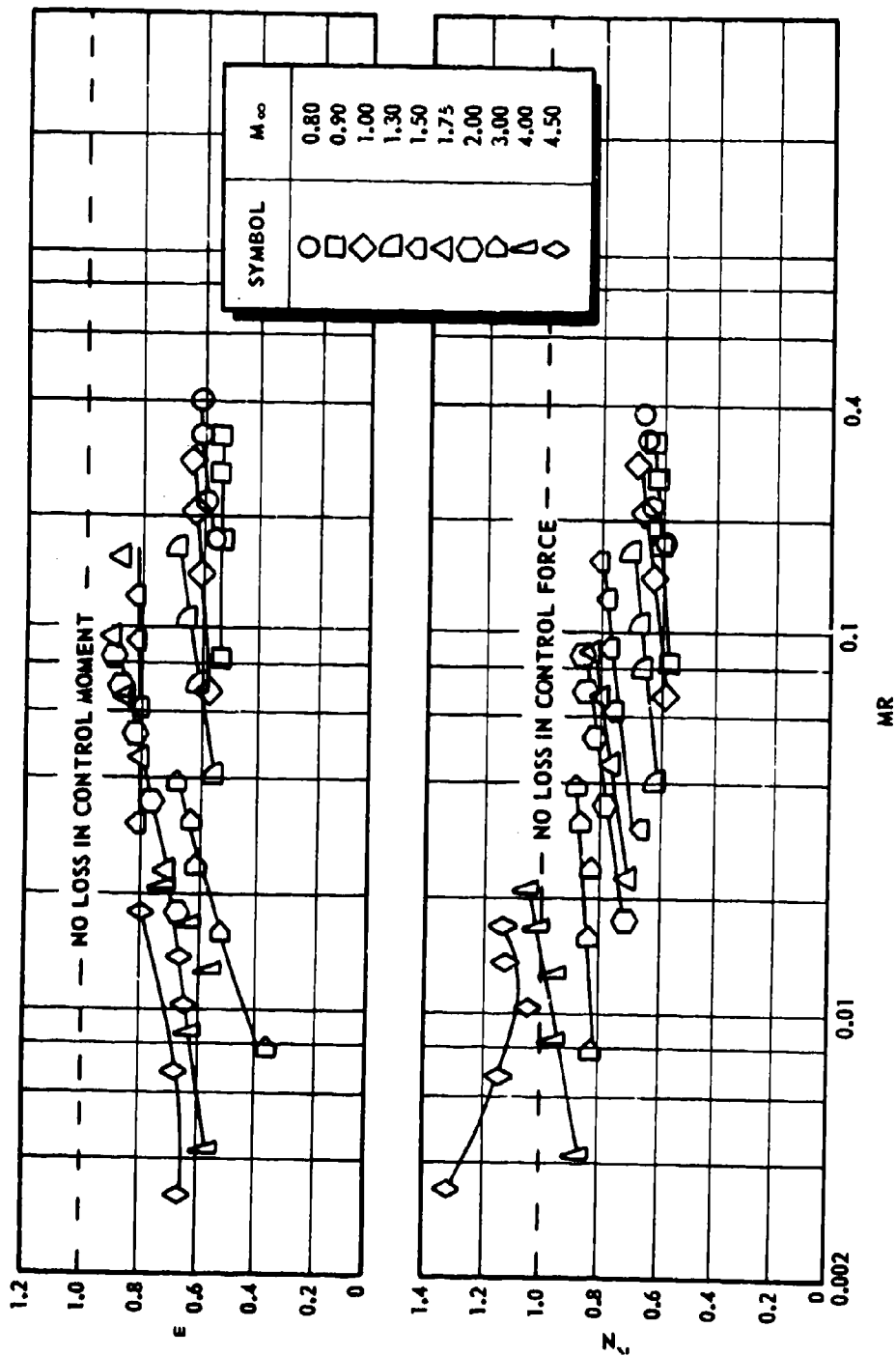


FIGURE 14. VARIATION OF K_N AND K_m AS A FUNCTION OF MOMENTUM RATIO FOR A CIRCULAR NOZZLE

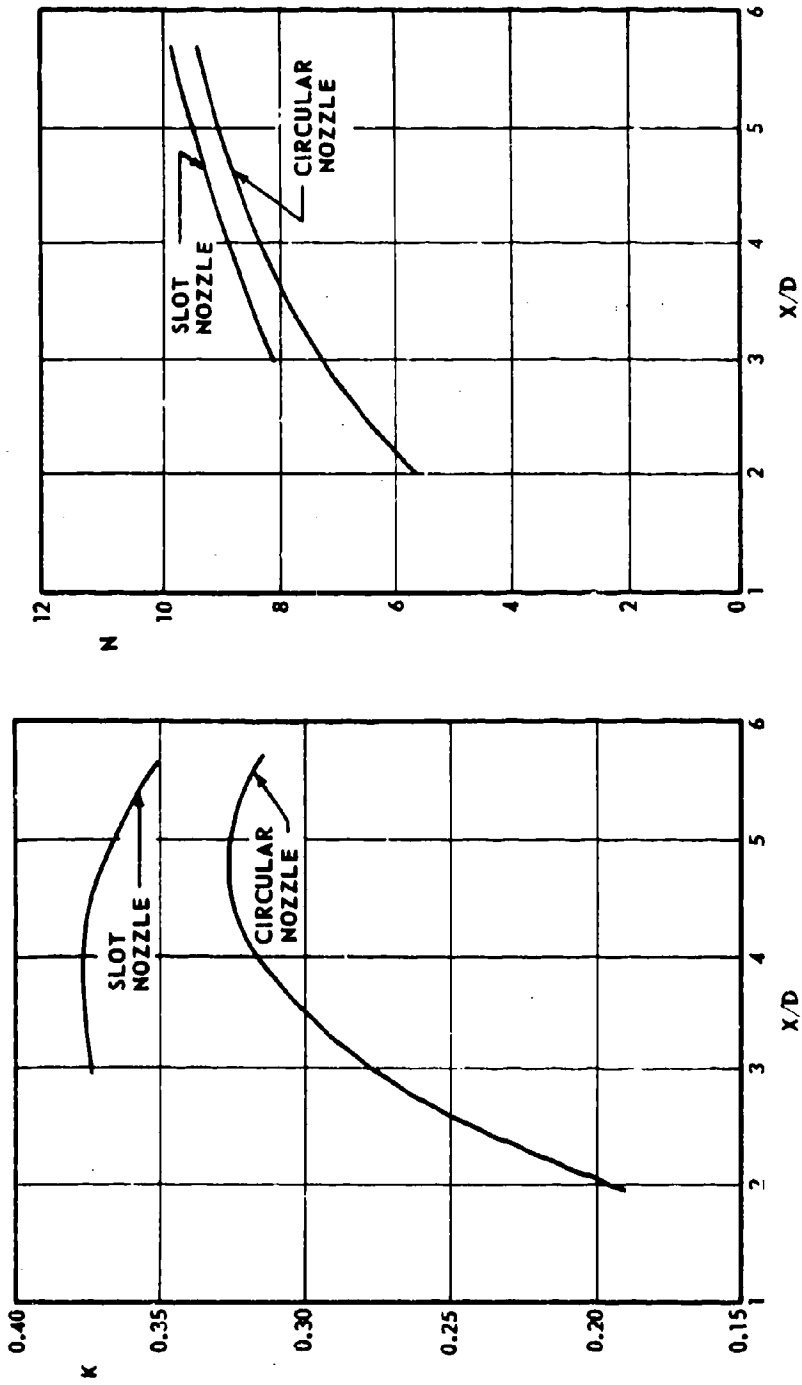
$M_e = 1.00$ 

FIGURE 16. VARIATION OF THE PARAMETERS K AND N WITH BODY POSITION

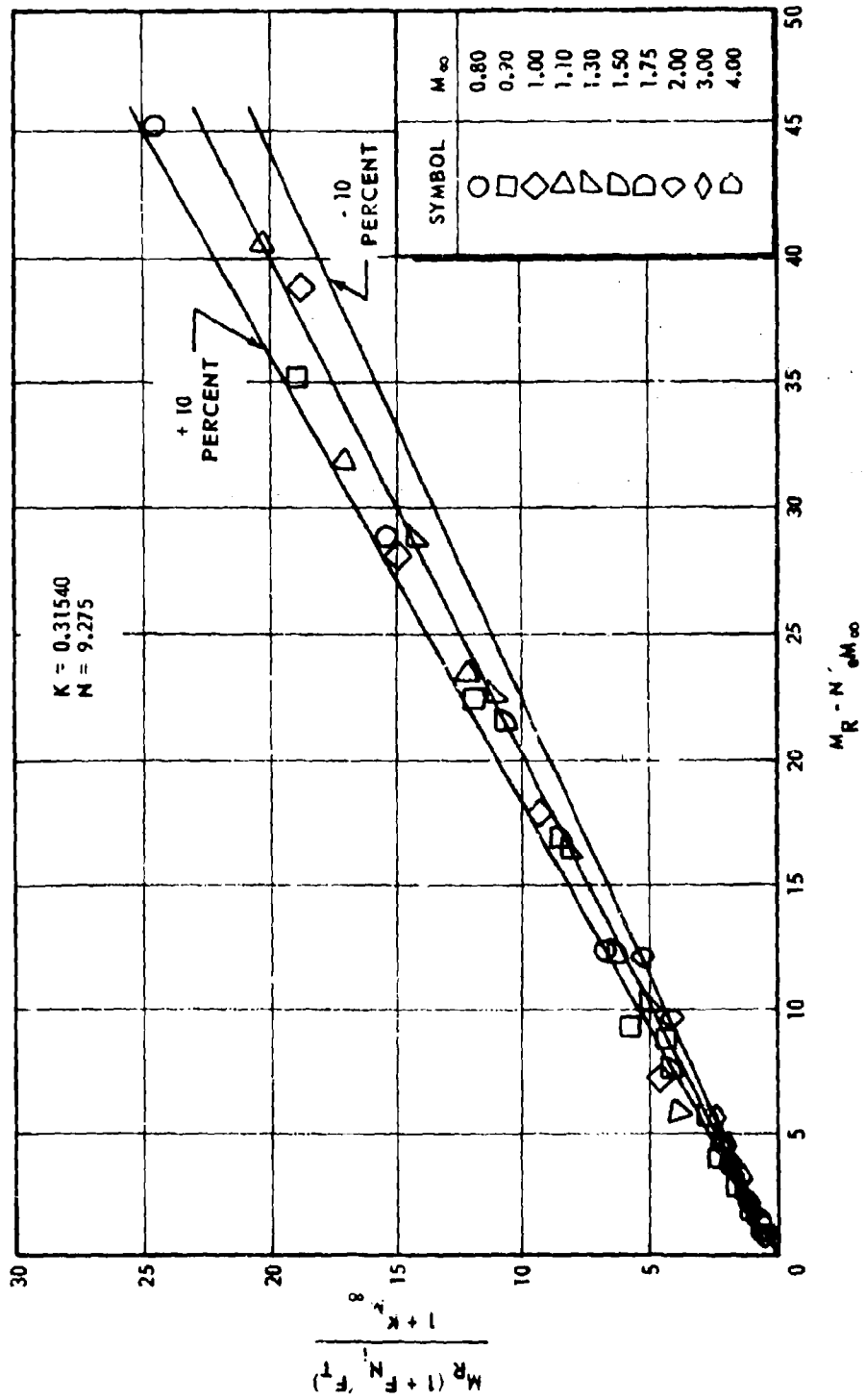


FIGURE 17. COMPARISON OF EXPERIMENTAL DATA AND EMPIRICAL CORRELATION PARAMETER

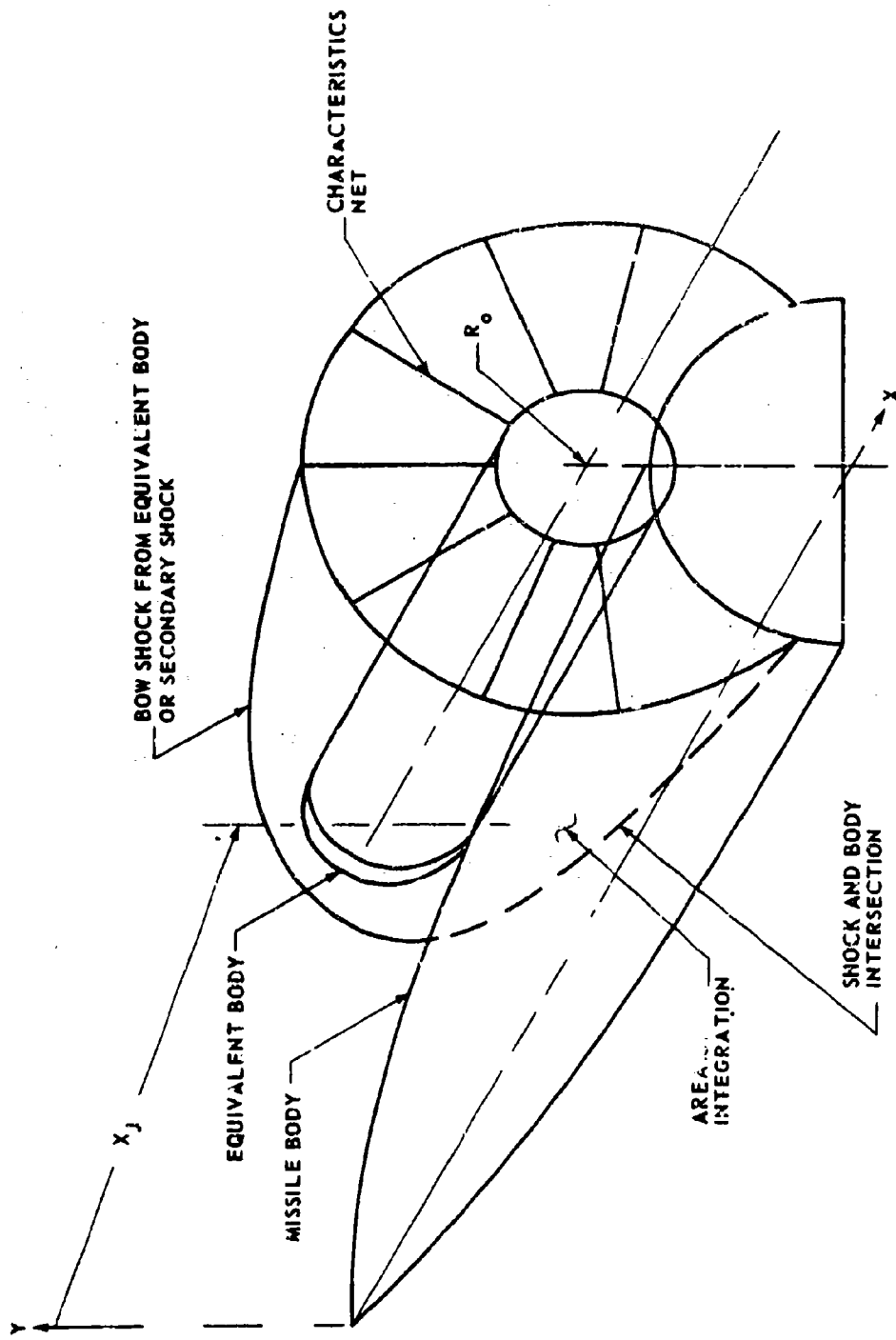


FIGURE 18. MODEL FOR EQUIVALENT BODY ANALOGY

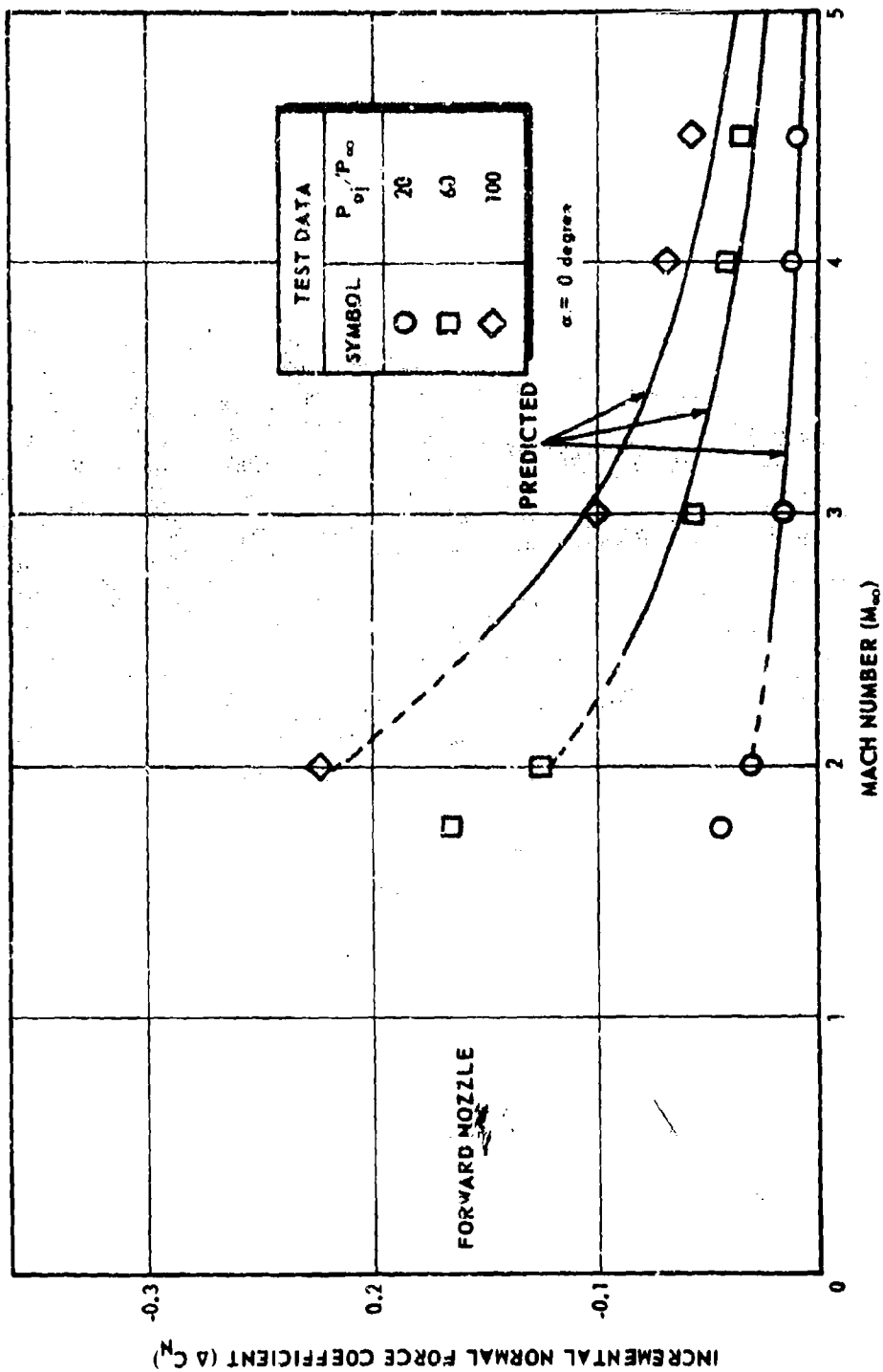


FIGURE 19. COMPARISON OF INCREMENTAL FORCE DATA

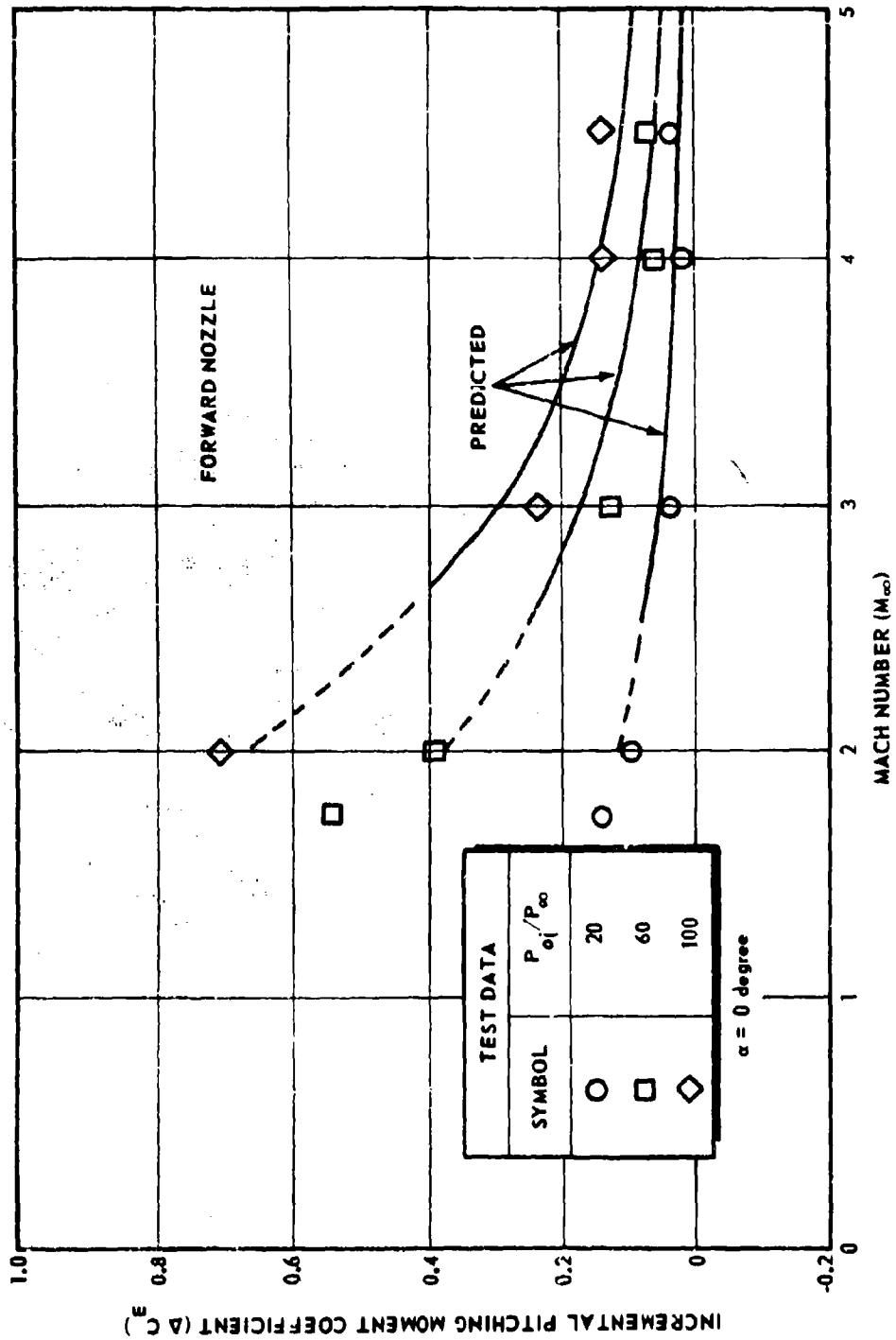


FIGURE 20. COMPARISON OF INCREMENTAL MOMENT DATA

LITERATURE CITED

1. U. S. Army Missile Command, Redstone Arsenal, Alabama, **Transverse Jet Experiments and Theories -- A Survey of the Literature** by D. J. Spring et al. , Report No. RD-TR-67-4, June 1967.
2. U. S. Army Missile Command, Redstone Arsenal, Alabama, **Transverse Jet Experiments and Theories -- A Survey of the Literature** by D. J. Spring et al. , Report No. RD-TR-67-5, September 1967 (Secret).
3. **Arnold Engineering Development Center, Tennessee, Test Facilities Handbook**, Seventh edition, July 1968.
4. **Ballistic Research Laboratories, Aberdeen Proving Ground, Maryland, Wind Tunnel Testing Facilities at the Ballistic Research Laboratories** by J. C. McMullen, Report No. BRL-1292, July 1960.
5. Lockheed Missiles and Space Company, Huntsville, Alabama, **Lateral Jet Missile Interference Data Correlation Study** by D. F. Coble, Report No. LMSC/HREC A791585, June 1968.
6. McDonnell-Douglas Astronautics Company, Santa Monica, California, **Lateral Jet Control Effectiveness Prediction for Axisymmetric Missile Configurations** by L. A. Cassell et al. , U. S. Army Missile Command Report No. RD-TR-68-5, June 1968.

BLANK PAGE

Appendix
TABULATED DATA

CONFIGURATION BC1X1

	POJ/PINF	DCN	DCM	KN	KM
.800	19.70	-.1819	.5200	.5780	.5508
.800	39.70	-.4056	1.1400	.6264	.5868
.800	60.00	-.6375	1.7500	.6470	.5920
.800	69.60	-.7574	2.0600	.6614	.5996
.900	19.70	-.1425	.4000	.5731	.5362
.900	39.70	-.3040	.8000	.5942	.5212
.900	59.60	-.4790	1.2500	.6194	.5388
.900	75.30	-.6184	1.5600	.6312	.5307
1.000	19.70	-.1157	.3500	.5744	.5792
1.000	39.60	-.2535	.7400	.6133	.5967
1.000	59.30	-.4061	1.1500	.6517	.6151
1.000	79.40	-.5673	1.5900	.6776	.6330
1.300	20.00	-.0728	.2000	.6013	.5506
1.300	39.70	-.1603	.4400	.6537	.5981
1.300	51.10	-.2116	.6100	.6674	.6413
1.300	79.20	-.3450	1.0000	.6982	.6745
1.500	20.00	-.0601	.2200	.6609	.6064
1.500	39.90	-.1396	.4500	.7540	.8102
1.500	59.80	-.2151	.6900	.7700	.8234
1.500	80.00	-.2933	.9300	.7822	.8268
1.500	100.00	-.3783	1.2400	.8055	.8801
1.750	20.00	-.0470	.1420	.7035	.7085
1.750	40.10	-.1046	.3300	.7651	.8046
1.750	60.10	-.1680	.5400	.8145	.8727
1.750	80.10	-.2304	.7420	.8353	.8967
2.000	20.00	-.0365	.1030	.7135	.6712
2.000	40.10	-.0813	.2420	.7767	.7707
2.000	60.10	-.1287	.3950	.8149	.8337
2.000	80.10	-.1784	.5500	.8448	.8682
2.000	100.00	-.2276	.7100	.8616	.8959
3.000	20.10	-.0190	.0250	.8314	.3646
3.000	40.00	-.0387	.0750	.8340	.5388
3.000	60.10	-.0593	.1280	.8449	.6079
3.000	80.10	-.0818	.1780	.8715	.6322
3.000	99.80	-.1038	.2400	.8859	.6828
4.000	20.00	-.0112	.0220	.8758	.5734
4.000	40.20	-.0255	.0500	.9720	.6353
4.000	60.20	-.0383	.0650	.9685	.5478
4.000	80.10	-.0546	.0980	1.0342	.6187
4.000	99.90	-.0696	.1420	1.0550	.7174
4.500	20.00	-.0134	.0200	1.3262	.6598
4.500	40.10	-.0238	.0420	1.1511	.6771
4.500	59.90	-.0327	.0600	1.0518	.6433
4.500	79.80	-.0468	.0820	1.1262	.6577
4.500	99.70	-.0595	.1250	1.1438	.8009

CONFIGURATION BC1X2

M	POJ/PINF	DCN	DCM	KN	KM
.800	19.90	-.1907	.8250	.5996	.5944
.800	39.70	-.4231	1.6700	.6534	.5910
.800	59.70	-.6650	2.6800	.6783	.6265
.800	79.70	-.9221	3.6900	.7022	.6439
.800	99.40	-1.1741	4.6500	.7155	.6494
.900	19.80	-.1412	.5500	.5648	.5042
.900	40.10	-.3155	1.2000	.6104	.5320
.900	59.90	-.5016	1.9200	.6453	.5661
.900	79.70	-.6940	2.6750	.6689	.5908
.900	99.30	-.9200	3.5600	.7103	.6298
1.000	20.00	-.1207	.4900	.5899	.5488
1.000	40.00	-.2689	1.0800	.6439	.5926
1.000	59.90	-.4296	1.7200	.6824	.6261
1.000	79.60	-.5932	2.3600	.7067	.6443
1.000	99.70	-.7625	3.0250	.7238	.6580
1.300	19.80	-.0668	.2700	.5575	.5164
1.300	40.00	-.1700	.7000	.6879	.6492
1.300	60.00	-.2650	1.1400	.7102	.7001
1.300	80.00	-.3650	1.5700	.7312	.7207
1.300	99.60	-.4659	1.9800	.7482	.7287
1.500	19.70	-.0784	.3400	.8758	.8704
1.500	40.00	-.1550	.6500	.8351	.8025
1.500	59.80	-.2303	.9700	.8245	.7958
1.500	79.90	-.3082	1.3000	.8230	.7956
1.500	100.10	-.3847	1.6100	.8183	.7849
1.750	20.00	-.0437	.2700	.6541	.9261
1.750	40.10	-.0999	.4190	.7307	.7023
1.750	60.10	-.1575	.6550	.7636	.7277
1.750	79.20	-.2156	.9050	.7906	.7605
2.000	20.00	-.0326	.1130	.6373	.5062
2.000	40.10	-.0742	.2750	.7089	.6021
2.000	60.10	-.1191	.4620	.7542	.6704
2.000	80.00	-.1658	.6600	.7861	.7171
2.000	99.90	-.2118	.8520	.8026	.7399
3.000	20.00	-.0195	.0250	.8577	.2520
3.000	40.10	-.0346	.0900	.7438	.4433
3.000	60.00	-.0543	.1550	.7749	.5069
3.000	80.00	-.0767	.2420	.8182	.5916
3.000	100.00	-.0961	.3150	.8185	.6148
3.000	243.00	-.2547	.9520	.8886	.7611
4.000	20.00	-.0190	.0550	1.4858	.9856
4.000	40.00	-.0289	.0850	1.1072	.7463
4.000	59.90	-.0403	.1280	1.0242	.7455
4.000	80.30	-.0550	.1800	1.0392	.7794
4.000	99.80	-.0750	.2420	1.1380	.8415
4.500	20.10	-.0136	.0380	1.3390	.8574
4.500	40.10	-.0237	.0780	1.1463	.8645
4.500	60.10	-.0350	.1080	1.1220	.7934
4.500	80.00	-.0486	.1680	1.1666	.9241
4.500	100.00	-.0589	.1980	1.1288	.8696

CONFIGURATION BC1X3

N	POJ/PIRF	DCN	DCM	KP	KH
.800	20.00	-.1768	1.0000	.5593	.5461
.800	40.10	-.4149	2.1800	.6342	.5818
.800	59.90	-.6631	3.4500	.6741	.6124
.800	80.00	-.9279	4.8300	.7039	.6398
.800	100.10	-1.2000	6.2100	.7261	.6561
.900	19.90	-.1521	.8000	.6053	.5258
.900	39.90	-.3278	1.6800	.6374	.5704
.900	59.60	-.5242	2.6800	.6779	.6051
.900	79.90	-.7419	3.8100	.7132	.6395
.900	99.30	-.9586	4.9400	.7401	.6659
1.000	19.80	-.1249	.6300	.6165	.5432
1.000	39.90	-.2691	1.4000	.6460	.5868
1.000	59.90	-.4298	2.2500	.6827	.6240
1.000	79.50	-.5355	2.7900	.6388	.5811
1.000	99.50	-.6914	3.6200	.6576	.6012
1.300	20.00	-.0700	.3500	.5782	.5047
1.300	40.00	-.1597	.8500	.6463	.6006
1.300	59.70	-.2469	1.3000	.6650	.6114
1.300	80.00	-.3403	1.7900	.6817	.6261
1.300	99.10	-.4356	2.3000	.7031	.6482
1.500	19.80	-.0567	.2900	.6301	.5627
1.500	40.10	-.1293	.6700	.6948	.6267
1.500	59.70	-.1993	1.0400	.7147	.6512
1.500	80.00	-.2717	1.4200	.7246	.6612
1.500	99.40	-.3434	1.8000	.7357	.6733
1.750	20.00	-.0418	.1950	.6256	.5096
1.750	40.20	-.0912	.4500	.6654	.5732
1.750	60.20	-.1458	.7350	.7057	.6211
1.750	80.30	-.2019	1.0280	.7301	.6491
2.000	20.00	-.0318	.1400	.6217	.4779
2.000	40.10	-.0683	.3180	.6525	.5304
2.000	60.20	-.1096	.5250	.6928	.5795
2.000	80.10	-.1518	.7330	.7188	.6110
2.000	100.00	-.1946	.9550	.7367	.6312
3.000	20.00	-.0161	.0650	.7082	.4992
3.000	39.90	-.0375	.1750	.8102	.6602
3.000	59.90	-.0582	.2700	.8320	.6739
3.000	79.90	-.0807	.3850	.8620	.7180
3.000	100.50	-.1008	.4900	.8543	.7251
4.000	19.90	-.0117	.0500	.9197	.6862
4.000	40.00	-.0235	.1030	.8927	.6890
4.000	60.00	-.0402	.1950	1.0199	.8638
4.000	80.30	-.0570	.2950	1.0770	.9732
4.000	100.00	-.0731	.3780	1.1069	.9994
4.500	20.00	-.0063	.0180	.6235	.3110
4.500	39.90	-.0175	.0700	.8507	.5941
4.500	60.10	-.0306	.1500	.9809	.8396
4.500	80.10	-.0460	.2300	1.1028	.9627
4.500	100.90	-.0599	.3080	1.1376	1.0214

CONFIGURATION BSIXI

M	POJ/PINF	DCN	DCM	KN	KM
.800	19.90	-.0985	.0900	.3097	.0943
.800	40.00	-.0974	-.4400	.1492	-.2247
.800	49.80	-.2116	-.2100	.2594	-.0858
.800	59.80	-.3373	.1100	.3434	.0373
.800	69.60	-.4663	.4300	.4072	.1251
.900	20.00	-.1090	.2400	.4315	.3167
.900	40.00	-.1638	.1200	.3177	.0775
.900	59.70	-.4139	.7700	.5343	.3313
.900	69.30	-.5378	1.1600	.5970	.4292
1.000	19.90	-.1104	.3500	.5424	.5732
1.000	40.00	-.2746	.8200	.6575	.6545
1.000	59.90	-.4468	1.3500	.7097	.7148
1.000	79.70	-.6285	1.8900	.7478	.7496
1.300	19.80	-.0610	.1600	.5091	.4451
1.300	39.70	-.1454	.3700	.5929	.5029
1.300	59.50	-.2495	.6700	.6743	.6036
1.300	79.30	-.3595	1.0200	.7266	.6872
1.300	99.50	-.4776	1.4100	.7677	.7555
1.500	20.00	-.0779	.1500	.8566	.5498
1.500	39.90	-.1567	.4000	.8464	.7202
1.500	59.80	-.2387	.6600	.8545	.7876
1.500	79.90	-.3238	.9500	.8647	.8456
1.500	99.90	-.4195	1.3000	.8942	.9237
1.750	20.00	-.0484	.1420	.7244	.7085
1.750	40.10	-.1078	.3350	.7885	.8168
1.750	60.10	-.1732	.5320	.8397	.8597
1.750	80.00	-.2359	.7500	.8563	.9015
2.000	19.90	-.0386	.1050	.7586	.6878
2.000	40.00	-.0854	.2450	.8180	.7822
2.000	60.10	-.1357	.4020	.8593	.8485
2.000	80.00	-.1857	.5650	.8805	.8930
2.000	100.00	-.2399	.7450	.9082	.9401
3.000	20.00	-.0240	.0500	1.0557	.7331
3.000	40.00	-.0437	.0880	.9418	.6321
3.000	59.90	-.0674	.1450	.9635	.6909
3.000	80.00	-.0915	.2140	.9761	.7610
3.000	99.90	-.1152	.2780	.9822	.7901
4.000	19.90	-.0206	.0400	1.6193	1.0481
4.000	40.00	-.0336	.0700	1.2873	.8940
4.000	59.90	-.0487	.0950	1.2377	.8048
4.000	79.90	-.0642	.1380	1.2191	.8735
4.000	99.80	-.0797	.1780	1.2093	.9003
4.500	19.40	-.0102	.0050	1.0420	.1702
4.500	38.80	-.0240	.0350	1.2005	.5836
4.500	59.90	-.0408	.0780	1.3124	.8363
4.500	79.80	-.0536	.1050	1.2899	.8422
4.500	100.00	-.0630	.1350	1.2074	.8624

CONFIGURATION 851X2

M	POJ/PINF	DCN	DCN	KH	KH
.800	19.80	-.1303	.4000	.4118	.2497
.800	39.50	-.1869	.2000	.2901	.0711
.800	59.40	-.4160	1.0400	.4265	.2443
.800	79.00	-.7020	2.2700	.5393	.3997
.800	97.40	-.9870	3.4500	.6139	.4917
.900	19.60	-.1249	.4300	.5049	.3984
.900	39.60	-.1957	.4000	.3835	.1796
.900	59.70	-.3752	1.0700	.4844	.3165
.900	79.50	-.6190	2.0600	.5981	.4561
.900	98.30	-.8745	3.2600	.6820	.5827
1.000	19.80	-.1904	.8300	.9403	.9394
1.000	39.60	-.3473	1.4500	.8402	.8039
1.000	59.50	-.5189	2.1400	.8298	.7843
1.000	78.60	-.6903	2.8600	.8330	.7909
1.000	98.80	-.8807	3.6400	.8437	.7991
1.300	20.00	-.0715	.3200	.5905	.6057
1.300	39.70	-.1691	.7600	.6896	.7102
1.300	59.50	-.2780	1.2700	.7513	.7866
1.300	79.30	-.3965	1.7900	.8014	.8291
1.300	99.20	-.4992	2.2100	.8049	.8166
1.500	20.10	-.0659	.2700	.7209	.5515
1.500	39.80	-.1514	.5300	.8199	.6577
1.500	59.60	-.2258	.8200	.8111	.6750
1.500	79.80	-.2361	1.1300	.6313	.6924
1.500	99.60	-.3958	1.5500	.8462	.7544
1.750	20.00	-.0449	.1650	.6720	.5659
1.750	40.00	-.1021	.4030	.7487	.6772
1.750	60.10	-.1628	.6700	.7893	.7444
1.750	80.00	-.2219	.9150	.8055	.7612
2.000	19.90	-.0353	.1190	.6937	.5359
2.000	40.00	-.0797	.2950	.7634	.6475
2.000	60.00	-.1253	.4830	.7948	.7021
2.000	79.90	-.1741	.6850	.8265	.7452
2.000	99.80	-.2196	.8750	.8330	.7606
3.000	20.00	-.0208	.0650	.9149	.6552
3.000	40.00	-.0398	.1150	.8577	.5674
3.000	60.00	-.0628	.2000	.8963	.6541
3.000	80.00	-.0875	.3020	.9335	.7383
3.000	99.90	-.1105	.3940	.9421	.7698
4.000	20.10	-.0162	.0450	1.2603	.8022
4.000	39.90	-.0280	.0820	1.0755	.7218
4.000	59.90	-.0411	.1380	1.0445	.8037
4.000	80.00	-.0573	.1800	1.0867	.7823
4.000	96.50	-.0722	.2520	1.1333	.9064
4.000	99.70	-.0752	.2630	1.1422	.9154
4.500	19.40	-.0130	.0400	1.3281	.9555
4.500	38.80	-.0236	.0680	1.1805	.7795
4.500	60.00	-.0367	.1150	1.1785	.8453
4.500	79.40	-.0468	.1500	1.1248	.8262
4.500	100.00	-.0597	.1920	1.1441	.8432

CONFIGURATION BS1X3

M	POJ/PINF	DCN	DCM	KN	KM
.800	20.00	-.1615	.7300	.5051	.3987
.800	39.90	-.2197	.7400	.3375	.1985
.800	59.60	-.4996	2.1600	.5105	.3853
.800	79.00	-.7829	3.7000	.6015	.4963
.800	94.70	-1.0019	4.9600	.6411	.5541
.900	19.90	-.1297	.6100	.5161	.4238
.900	40.00	-.1980	.6500	.3840	.2201
.900	60.00	-.3920	1.6200	.5035	.3633
.900	79.80	-.6118	2.7800	.5889	.4672
.900	99.70	-.8750	4.2400	.6728	.5692
1.000	19.80	-.1151	.6000	.5684	.5174
1.000	39.60	-.2788	1.4700	.6745	.6209
1.000	59.60	-.4482	2.3500	.7155	.6551
1.000	79.40	-.6218	3.2600	.7427	.6798
1.000	92.40	-.7408	3.8900	.7592	.6961
1.300	20.00	-.0634	.3100	.5236	.4670
1.300	39.90	-.1610	.8400	.6532	.5950
1.300	59.90	-.2615	1.3800	.7020	.6468
1.300	79.90	-.3670	1.9800	.7361	.6934
1.300	99.50	-.4708	2.5600	.7568	.7185
1.500	20.00	-.0739	.2700	.8126	.5184
1.500	39.60	-.1338	.6300	.7283	.5987
1.500	59.40	-.2245	1.0700	.8092	.6734
1.500	79.80	-.2980	1.4800	.7968	.6909
1.500	100.00	-.3928	1.9600	.8364	.7287
1.750	20.00	-.0415	.1900	.6211	.4965
1.750	40.00	-.0956	.4750	.7010	.6082
1.750	60.00	-.1525	.7750	.7406	.6571
1.750	79.90	-.2134	1.0950	.7756	.6949
2.000	20.00	-.0315	.1320	.6158	.4505
2.000	40.00	-.0756	.3520	.7241	.5887
2.000	60.00	-.1189	.5780	.7542	.6401
2.000	80.10	-.1655	.8920	.7837	.7375
2.000	99.90	-.2120	1.1400	.8033	.7543
3.000	20.00	-.0209	.0820	.9193	.6298
3.000	40.00	-.0412	.1790	.8879	.6735
3.000	60.00	-.0640	.2990	.9262	.7451
3.000	79.90	-.0904	.4420	.9656	.8243
3.000	99.80	-.1116	.5530	.9525	.8241
4.000	20.20	-.0107	.6400	.8281	.5405
4.000	39.90	-.0239	.1030	.9180	.6908
4.000	59.90	-.0401	.1880	1.0191	.8342
4.000	80.50	-.0588	.2920	1.1082	.9609
4.000	99.90	-.0774	.3450	1.1732	1.0454
4.500	28.60	-.0119	.0450	.8135	.5371
4.500	57.10	-.0286	.1300	.9657	.7664
4.500	86.10	-.0500	.2450	1.1144	.9534
4.500	115.00	-.0707	.3650	1.1770	1.0610
4.500	20.00	-.0092	.0350	.9105	.6048
4.500	40.20	-.0215	.0980	1.0372	.8255
4.500	59.90	-.0330	.1600	1.0615	.8985
4.500	79.90	-.0470	.2320	1.1296	.9736
4.500	100.00	-.0604	.3100	1.1575	1.0

CONFIGURATION BC1X4

M	POJ/PINF	DCN	DCM	KN	KM
.800	10.00	-.0987	.2300	.5786	.7502
.800	20.20	-.1882	.4400	.5826	.6810
.800	30.00	-.2927	.6300	.6021	.6480
.800	39.90	-.4011	.8500	.6162	.6530
.800	49.80	-.5112	1.0200	.6268	.6253
.900	20.10	-.1507	.3500	.5935	.6892
.900	30.00	-.2272	.5000	.5915	.5509
.900	40.00	-.3061	.6000	.5937	.5819
.900	50.00	-.3894	.7400	.5918	.5718
.900	60.00	-.4710	.8500	.6050	.5459
1.000	19.80	-.1214	.2700	.5996	.6667
1.000	40.00	-.2646	.5900	.6336	.7064
1.000	49.80	-.3395	.7400	.6504	.7088
1.000	59.80	-.4192	.8900	.6670	.7080
1.000	69.70	-.5049	1.0900	.6879	.7426
1.300	20.00	-.0581	.1000	.4799	.4130
1.300	40.00	-.1386	.2500	.5609	.5058
1.300	60.00	-.2226	.3800	.5965	.5092
1.300	79.90	-.3192	.6200	.6402	.6218
1.300	89.90	-.3604	.7200	.6417	.6410
1.500	20.10	-.0798	.2500	.8730	1.3675
1.500	39.60	-.1456	.4200	.7925	1.1431
1.500	79.50	-.2181	.5900	.7848	1.0615
1.500	.70	-.2900	.7400	.7764	.9906
1.500	99.80	-.3641	.8700	.7769	.9282
1.750	20.00	-.0430	.1020	.6436	.7633
1.750	39.90	-.0903	.1980	.6639	.7278
1.750	60.00	-.1475	.3380	.7163	.8207
1.750	80.10	-.2087	.4990	.7566	.9046
2.000	20.00	-.0349	.0800	.6823	.7820
2.000	40.20	-.0753	.1700	.7176	.8100
2.000	60.20	-.1200	.2750	.7586	.8692
2.000	80.30	-.1633	.3600	.7713	.8502
2.000	100.00	-.2095	.4750	.7931	.8991
3.000	20.00	-.0164	.0020	.7214	.0439
3.000	40.00	-.0366	.0400	.7888	.4310
3.000	59.90	-.0571	.0720	.8163	.5146
3.000	80.00	-.0782	.1120	.8342	.5974
3.000	100.00	-.0991	.1500	.8441	.6388
4.000	20.00	-.0112	-.0100	.8758	-.3910
4.000	39.90	-.0232	.0080	.8911	.1536
4.000	59.90	-.0369	.0220	.9378	.2795
4.000	79.80	-.0503	.0420	.9564	.3193
4.000	99.60	-.0637	.0700	.9685	.3521
4.500	20.00	-.0093	-.0120	.9205	-.5938
4.500	40.10	-.0184	-.0160	.8899	-.2918
4.500	60.40	-.0248	-.0380	.7910	-.6050
4.500	80.60	-.0364	-.0050	.8671	-.0595
4.500	100.00	-.0477	.0100	.9141	.0958

CONFIGURATION BC2X4

M	POJ/PINF	DCN	DCM	KN	KM
.600	19.60	-.0871	.2600	.2753	.4109
.800	39.90	-.1988	.5700	.3054	.4379
.800	59.70	-.3065	.8500	.3146	.4335
.800	64.40	-.3374	.5400	.3187	.4440
.800	99.40	-.5271	1.4300	.3212	.4357
.900	19.60	-.0649	.2000	.2624	.4043
.900	39.60	-.1523	.4400	.2969	.4289
.900	59.70	-.2342	.6500	.3023	.4195
.900	84.70	-.3414	.9400	.3094	.4260
.900	100.30	-.4090	1.1000	.3126	.4203
1.000	20.00	-.0513	.1400	.2507	.3421
1.000	40.00	-.1197	.3500	.2866	.4190
1.000	59.80	-.1898	.5200	.3020	.4137
1.000	79.80	-.2588	.7200	.3075	.4278
1.000	94.00	-.3082	.8600	.3104	.4331
1.100	19.70	-.0421	.1500	.2529	.4505
1.100	39.60	-.1001	.3400	.2930	.4976
1.100	59.60	-.1575	.5300	.3042	.4829
1.100	79.60	-.1769	.6700	.2950	.4829
1.100	99.80	-.2678	.8100	.3073	.4647
1.300	20.10	-.0209	.0500	.1717	.2054
1.300	39.90	-.0550	.1200	.2231	.2434
1.300	59.90	-.0956	.2200	.2566	.2953
1.300	79.90	-.1341	.3300	.2689	.3309
1.300	89.60	-.1550	.3700	.2769	.3305
1.500	19.90	-.0378	.1400	.4178	.7738
1.500	39.70	-.0684	.2200	.3713	.5972
1.500	59.70	-.1016	.3400	.3643	.6096
1.500	79.40	-.1314	.4400	.3531	.5912
1.500	99.30	-.1700	.5600	.3645	.6004
1.750	20.00	-.0137	.0400	.2050	.2993
1.750	40.10	-.0319	.0900	.2333	.3291
1.750	60.20	-.0527	.1500	.2550	.3630
1.750	80.20	-.0775	.2280	.2810	.4128
2.000	20.00	-.0098	.0180	.1915	.1759
2.000	40.20	-.0223	.0380	.2125	.1810
2.000	60.30	-.0385	.0980	.2429	.3092
2.000	80.20	-.0563	.1550	.2662	.3665
2.000	100.00	-.0760	.2100	.2877	.3975
3.000	20.00	-.0549	.0030	.2155	.0659
3.000	40.10	-.0097	.0100	.1977	.1074
3.000	60.00	-.0158	.0300	.2255	.2140
3.000	80.10	-.0226	.0400	.2408	.2131
3.000	100.00	-.0302	.0600	.2572	.2555
4.000	19.50	-.0057	.0060	.4576	.2408
4.000	40.00	-.0092	.0120	.3524	.2298
4.000	59.90	-.0111	.0180	.2821	.2287
4.000	80.00	-.0171	.0240	.3243	.2275
4.000	100.00	-.0197	.0300	.2983	.2271
4.500	18.30	-.0010	.0050	.1085	.2714
4.500	36.90	-.0036	.0100	.1895	.2632
4.500	55.40	-.0065	.0150	.2263	.2511
4.500	73.90	-.0111	.0200	.2886	.2600
4.500	92.70	-.0154	.0250	.3185	.2585

CONFIGURATION BCIXIP1

M	PUJ/PINF	DCN	DCM	KN	KPI
.800	19.90	-.1785	.3500	.5612	.3608
.800	39.70	-.3527	.7600	.5447	.3912
.800	59.40	-.5691	1.2900	.5835	.4408
.800	79.30	-.8095	1.8800	.6196	.4796
.900	19.80	-.1246	.2300	.4984	.3067
.900	39.90	-.2732	.5400	.5312	.3500
.900	49.80	-.3475	.6300	.5392	.3258
.900	59.80	-.4357	.8400	.5628	.3608
.900	69.80	-.5253	1.0400	.5789	.3820
1.000	70.30	-.1083	.2900	.5211	.4652
1.000	40.20	-.2395	.6400	.5706	.5082
1.000	59.80	-.3783	.9100	.6019	.4826
1.000	69.80	-.4530	1.0500	.6163	.4762
1.000	79.70	-.4996	1.2800	.5944	.5076
1.100	19.80	-.0806	.1500	.4816	.2988
1.100	39.60	-.1774	.3900	.5193	.3805
1.100	59.50	-.2785	.5500	.5389	.3547
1.100	79.40	-.3968	.8000	.5734	.3874
1.100	89.40	-.4643	.9600	.5953	.4103
1.300	19.90	-.0656	.1400	.5446	.3874
1.300	39.60	-.1321	.2600	.5401	.3543
1.300	59.70	-.2168	.5000	.5839	.4489
1.300	79.10	-.3063	.7000	.6206	.4728
1.300	99.20	-.4031	.9700	.6499	.5213
1.500	19.90	-.0820	.3500	.9064	1.2897
1.500	40.00	-.1528	.5300	.8232	.9518
1.500	60.10	-.2272	.7400	.8093	.8786
1.500	79.90	-.3016	.9600	.8054	.8545
1.500	100.00	-.3828	1.2200	.8151	.8659
1.750	19.90	-.0400	.0300	.6018	.1504
1.750	39.90	-.0940	.1900	.6911	.4656
1.750	59.80	-.1490	.3600	.7260	.5847
1.750	79.70	-.2090	.5520	.7616	.6705
2.000	19.90	-.0300	.0050	.5895	.0327
2.000	39.90	-.0720	.1400	.6914	.4481
2.000	68.10	-.1320	.3400	.7365	.6323
2.000	79.90	-.1590	.4150	.7548	.6567
2.000	99.80	-.2030	.5550	.7700	.7017
3.000	20.20	-.0150	-.0250	.6530	-.3627
3.000	40.20	-.0310	-.0200	.6647	-.1429
3.000	61.80	-.0530	.0300	.7341	.1385
3.000	80.20	-.0710	.0700	.7555	.2483
3.000	100.00	-.0910	.1250	.7751	.3549
4.000	20.10	-.0120	-.0050	.9335	-.1296
4.000	40.10	-.0200	.0300	.7643	.3821
4.000	60.00	-.0440	.0800	1.1164	.6765
4.000	80.00	-.0580	.0900	1.1000	.5689
4.000	99.90	-.0690	.1200	1.0459	.6063
4.500	20.20	-.0110	-.0900	1.0775	-2.9386
4.500	40.20	-.0190	-.0700	.9166	-1.1257
4.500	60.20	-.0310	-.0300	.9921	-.3200
4.500	80.20	-.0380	-.0200	.9098	-.1596
4.500	100.00	-.0500	-.0100	.9582	-.0638

CONFIGURATION AC1X2F1

M	PUJ/PINF	DCN	DCM	KN	KM
.800	19.90	-.1773	.6900	.5575	.4972
.800	39.70	-.3861	1.3000	.5952	.4601
.800	59.80	-.6043	2.0800	.6153	.4854
.800	79.70	-.8674	2.8900	.6605	.5043
.800	99.50	-1.0589	3.6800	.6446	.5134
.900	19.90	-.1355	.4100	.5392	.3739
.900	41.60	-.3065	.9800	.5712	.4185
.900	59.70	-.4586	1.5000	.5920	.4437
.900	79.00	-.6458	2.0500	.6280	.4568
.900	99.20	-.8083	2.6800	.6246	.4746
1.000	19.90	-.1179	.3900	.5547	.4391
1.000	39.80	-.2586	.9000	.6224	.4964
1.000	59.70	-.3932	1.4500	.6267	.5296
1.000	79.60	-.5357	1.9000	.6382	.5187
1.000	99.20	-.6957	2.4300	.6637	.5313
1.100	20.00	-.0956	.3100	.5653	.4201
1.100	39.60	-.1067	.7900	.3123	.5299
1.100	59.60	-.2874	1.1800	.5552	.5224
1.100	79.50	-.4469	1.5700	.6450	.5183
1.100	99.00	-.5648	2.0000	.6533	.5302
1.300	19.80	-.0583	.1600	.4866	.3060
1.300	39.60	-.1531	.4900	.6259	.4591
1.300	59.80	-.2512	.9600	.6755	.5916
1.300	79.50	-.3523	1.4400	.7102	.6653
1.300	99.30	-.4479	1.8500	.7215	.6829
1.500	19.80	-.0725	.3700	.8056	.9422
1.500	39.80	-.1354	.5300	.7332	.6577
1.500	60.30	-.2058	.7900	.7306	.6427
1.500	80.00	-.2739	1.0800	.7305	.6601
1.500	99.90	-.3435	1.3200	.7322	.6448
1.750	20.00	-.0470	.1010	.7035	.3464
1.750	32.90	-.0730	.2100	.6537	.4309
1.750	60.00	-.1380	.4300	.6702	.4785
1.750	80.00	-.1910	.6500	.6933	.5407
2.000	20.10	-.0210	-.0100	.4084	-.0445
2.000	40.00	-.0560	.1000	.5364	.2195
2.000	60.00	-.0950	.2200	.6026	.3198
2.000	79.90	-.1290	.3500	.6124	.3808
2.000	99.80	-.1700	.4900	.6448	.4259
3.000	20.20	-.0100	-.0800	.4353	-.7981
3.000	40.10	-.0280	-.0300	.6019	-.1477
3.000	60.10	-.0440	.0300	.6269	.0979
3.000	80.20	-.0660	.0850	.7023	.2072
3.000	100.00	-.0840	.1420	.7155	.2771
4.000	20.00	-.0100	-.0500	.7820	-.8960
4.000	40.00	-.0200	-.0160	.7662	-.1404
4.000	60.00	-.0300	.0100	.7611	.0581
4.000	80.00	-.0460	.0520	.8724	.2260
4.000	99.90	-.0580	.1200	.8791	.4168
4.500	19.90	-.0130	.0200	1.2934	.4560
4.500	40.20	-.0250	.0300	1.2061	.3316
4.500	59.90	-.0340	.0700	1.0936	.5160
4.500	79.90	-.0490	.1100	1.1777	.6058
4.500	100.00	-.0610	.1800	1.1690	.7905

CONFIGURATION HC1X3F1

M	PUJ/PINF	DCM	DCR	KA	KH
.800	20.60	-.1600	.7200	.4853	.3813
.800	40.40	-.3476	1.6400	.5273	.4344
.800	60.10	-.5569	2.6300	.5642	.4652
.800	80.20	-.7907	3.7600	.5983	.4968
.800	99.60	-1.0040	4.7900	.6106	.5086
.900	20.80	-.1176	.5800	.4469	.3848
.900	40.80	-.2595	1.0900	.4932	.3617
.900	60.50	-.4166	1.7800	.5306	.3958
.900	80.50	-.5852	2.5900	.5583	.4314
.900	100.30	-.7662	3.3700	.5856	.4697
1.000	19.80	-.1032	.5600	.5097	.4829
1.000	39.50	-.2282	1.0400	.5535	.4604
1.000	59.40	-.3650	1.6900	.5847	.4727
1.000	79.30	-.5047	2.4000	.6036	.5011
1.000	105.40	-.6863	3.1900	.6160	.4999
1.100	20.00	-.0867	.3900	.5127	.4027
1.100	39.70	-.1867	.8700	.5451	.4435
1.100	59.70	-.2996	1.4000	.5778	.4714
1.100	79.50	-.4306	2.1100	.6215	.5317
1.100	99.60	-.5575	2.7900	.6410	.5601
1.300	19.90	-.0693	.3000	.5754	.4349
1.300	39.80	-.1437	.6000	.5845	.4261
1.300	59.90	-.1877	.9100	.5038	.4265
1.300	79.70	-.2914	1.3200	.5859	.4634
1.300	99.40	-.3703	1.6900	.5958	.4748
1.500	19.90	-.0683	.2800	.7550	.5404
1.500	40.00	-.1188	.5500	.6600	.5174
1.500	59.80	-.1711	.7700	.6125	.4813
1.500	79.60	-.2245	.9900	.6018	.4633
1.500	99.80	-.2831	1.2300	.6040	.4582
1.750	20.10	-.0190	-.0650	-.2629	-.1689
1.750	40.20	-.0570	.0700	.4158	.0891
1.750	60.20	-.0910	.2100	.4404	.1774
1.750	80.10	-.1290	.3450	.4677	.2184
2.000	20.00	-.0120	-.0430	.2346	-.1467
2.000	40.00	-.0390	.0600	.3735	.1003
2.000	60.10	-.0670	.1500	.4742	.1658
2.000	80.10	-.0900	.2400	.4262	.1984
2.000	100.10	-.1230	.3800	.4651	.2509
3.000	20.40	-.0100	-.0600	.4309	-.4514
3.000	40.20	-.0260	.0050	.5575	.0187
3.000	61.80	-.0440	.1000	.6094	.2418
3.000	80.20	-.0620	.1700	.6597	.3158
3.000	100.00	-.0820	.2700	.6984	.4015
4.000	20.00	-.0140	.0050	1.0948	.0682
4.000	40.10	-.0300	.0800	1.1465	.5338
4.000	60.00	-.0480	.1850	1.2179	.8195
4.000	80.10	-.0640	.2650	1.2123	.8764
4.000	100.00	-.0800	.3700	1.2114	.9782
4.500	20.10	-.0080	-.1100	.7876	-1.8911
4.500	40.10	-.0200	-.0570	.9673	-.4813
4.500	60.10	-.0350	.0420	1.1220	.2350
4.500	79.90	-.0420	.0900	1.0094	.3776

UNCLASSIFIED

Security Classification

DOCUMENT CONTROL DATA - R & D

(Security classification of title, body of abstract and indexing annotation must be entered when the overall report is classified)

1. ORIGINATING ACTIVITY (Corporate author) Advanced Systems Laboratory Research and Development Directorate U. S. Army Missile Command Redstone Arsenal, Alabama 35809		2a. REPORT SECURITY CLASSIFICATION Unclassified	
		2b. GROUP N/A	
3. REPORT TITLE AN EXPERIMENTAL INVESTIGATION OF THE INTERFERENCE EFFECTS DUE TO A LATERAL JET ISSUING FROM A BODY OF REVOLUTION OVER THE MACH NUMBER RANGE OF 0.8 TO 4.5			
4. DESCRIPTIVE NOTES (Type of report and inclusive dates) None			
5. AUTHOR(S) (First name, middle initial, last name) Donald J. Spring			
6. REPORT DATE 20 August 1968	7a. TOTAL NO. OF PAGES 51	7b. NO. OF REFS 6	
8a. CONTRACT OR GRANT NO.	8b. ORIGINATOR'S REPORT NUMBER(S) RD-TR-68-10		
8c. PROJECT NO. (DA) 1M262301A206 AMC Management Structure Code No. 5221. 11. 148	8d. OTHER REPORT NO(S) (Any other numbers that may be assigned this report) AD		
10. DISTRIBUTION STATEMENT This document is subject to special export controls and each transmittal to foreign governments or foreign nationals may be made only with prior approval of this Command, ATTN: AMSMI-RD.			
11. SUPPLEMENTARY NOTES None		12. SPONSORING MILITARY ACTIVITY Same as No. 1.	
13. ABSTRACT A research study currently being conducted by the U. S. Army Missile Command is aimed at developing a technique for predicting the aerodynamic characteristics of missiles that use lateral or transverse jets as the control system. As a part of this study, an experimental test program was conducted with the use of a body of revolution with a lateral jet located at several body locations over the Mach number range from 0.8 to 4.5. The jet pressure ratio was varied between 0 and 100 in increments of 20, and both slots and circular nozzles were tested. The data are presented in plots and tabular form. In addition, short descriptions of two other approaches are also presented. These approaches are compared with the experimental data and show agreement with 10 to 16 percent.			

DD FORM 1473

REPLACES DD FORM 1473, 1 JAN 64, WHICH IS OBSOLETE FOR ARMY USE.

UNCLASSIFIED

Security Classification

14. KEY WORDS	LINK A		LINK B		LINK C	
	ROLE	WT	ROLE	WT	ROLE	WT
Missiles, aerodynamic characteristics Lateral jets Transverse jets Jet pressure ratio Slot nozzle Circular nozzle						