

UNCLASSIFIED

AD NUMBER
AD857807
NEW LIMITATION CHANGE
TO Approved for public release, distribution unlimited
FROM Distribution authorized to U.S. Gov't. agencies and their contractors; Critical Technology; JUN 1969. Other requests shall be referred to Air Force Materials Lab., Attn: MAAE, Wright-Patterson AFB, OH 45433.
AUTHORITY
Air Force Materials Lab/AFSC ltr dtd 2 Mar 1972

THIS PAGE IS UNCLASSIFIED

AFML-TR-69-161

~~odd-10~~

AD857807

DESIGN ALLOWABLES FOR  
TITANIUM ALLOYS

A. W. Sommer  
G. R. Martin

North American Rockwell Corporation

TECHNICAL REPORT AFML-TR-69-161

June 1969

D D C  
RECEIVED  
SEP 9 1969  
RECEIVED  
B

This document is subject to special export controls and each transmittal to foreign governments or foreign nationals may be made only with the prior approval of Air Force Materials Laboratory, MAAE Wright-Patterson Air Force Base, Ohio 45433.

Air Force Materials Laboratory  
Air Force Systems Command  
Wright-Patterson Air Force Base, Ohio

380

**Best  
Available  
Copy**

## NOTICES

When government drawings, specifications, or other data are used for any purpose other than in connection with a definitely related government procurement operation, the United States government thereby incurs no responsibility nor any obligation whatsoever; and the fact that the government may have formulated, furnished, or in any way supplied the said drawings, specifications, or other data, is not to be regarded by implication or otherwise as in any manner licensing the holder or any other person or corporation, or conveying any rights or permission to manufacture, use, or sell any patented invention that may in any way be related hereto.

This document is subject to special export controls and each transmittal to foreign governments or foreign nationals may be made only with prior approval of MAAE, Air Force Materials Laboratory.

Information in this report is embargoed under the Department of State ITIAR. This report may be released to foreign governments by department or agencies of the U.S. government subject to approval of Air Force Materials Laboratory, Materials Applications Division, or higher authority within the Air Force. Private individuals or firms require a Department of State export license.

ACCESSION FOR	
CFST	WRITE SECTION <input type="checkbox"/>
DDC	DIFF SECTION <input checked="" type="checkbox"/>
UNANNOUNCED	<input type="checkbox"/>
JUSTIFICATION	
BY	
DISTRIBUTION/AVAILABILITY CODES	
DIST.	AVAIL. AND/OR SPECIAL
2	

Copies of this report should not be returned unless return is required by security considerations, contractual obligations, or notice on a specific document.

AFML-TR-69-161

DESIGN ALLOWABLES FOR  
TITANIUM ALLOYS

A. W. Sommer  
G. R. Martin

North American Rockwell Corporation

TECHNICAL REPORT AFML-TR-69-161

June 1969

## FOREWORD

This report was prepared by North American Rockwell Corporation, Los Angeles Division, under USAF Contract No. AF 33(615)-3979. The contract was initiated under Project No. 7381, "Materials' Application". Task No. 738106, "Engineering and Design Data". The work was administered under the direction of the Air Force Materials Laboratory, Wright-Patterson Air Force, Ohio, by Mr. C. L. Harmsworth, Project Engineer.

Dr. A. W. Sommer of the NR/LAD Research and Engineering Division, Materials and Producibility Laboratory was the Program Manager. Mr. G. R. Martin was the Project Engineer. Others who cooperated in the research and in the preparation of the report were F. Wermuth, M. Harrigan, G. Keller, and R. Lorenz, Statistics.

This report covers work conducted from May 1969. The contractor's report number is NA 69-350.

The report was submitted by the author in May 1969.

This technical report has been reviewed and is approved.

*A Olevitch*

A. OLEVITCH  
Chief, Materials Engineering Branch  
Materials Support Division  
Air Force Materials Laboratory

## ABSTRACT

The purpose of this program was to develop design information on four titanium alloys for inclusion into Military Handbook-5. The alloys investigated were Ti-6Al-4V Condition STA, Ti-4Al-3Mo-1V Annealed Condition, Ti-13V-11Cr-3Al Annealed Condition, and Ti-6Al-6V-2Sn Annealed Condition and Condition STA.

The mechanical properties investigated were tensile, compression, shear, bearing, fracture toughness and fatigue. The general results obtained are presented in Section VII of this report and the data generated for Military Handbook-5 are presented in Section VIII.

This abstract has been approved for public release and sale; its distribution is unlimited.

## TABLE OF CONTENTS

Section		Page
I	INTRODUCTION	1
	1.1 Purpose of Program	1
	1.2 Background	1
II	TEST MATERIALS	2
	2.1 Discussion	3
	2.2 Material Certification	3
	2.2.1 Material, Ti 4Al-3Mo-1V Cond. A	4 - 10
	2.2.2 Material, Ti 13V-11Cr-3Al Cond. A	11 - 16
	2.2.3 Material, Ti 6Al-4V Cond. STA	17 - 25
	2.2.4 Material, Ti 6Al-6V-2Sn Cond. A and STA	26 - 41
	2.3 Thermal Processing of Material	42
	2.4 Microstructural Examination of Test Material	42
	2.4.1 Ti 4Al-3Mo-1V Cond. A	42 - 45
	2.4.2 Ti 13V-11Cr-3Al Cond. A	46 - 49
	2.4.3 Ti 6Al-4V Cond. STA	50 - 51
	2.4.4 Ti 6Al-6V-2Sn Cond. A and STA	55 - 70
	2.5 Mechanical Properties Determined	71
	2.6 Test Conditions	71 - 78
III	TEST SPECIMENS	79
	3.1 Specimen Identification Codes	80 - 81
	3.2 Specimen Sampling	82 - 83
	3.3 Specimen Configuration	84 - 95
	3.4 Specimen Preparation	96



## TABLE OF CONTENTS

Section		Page
IV	TEST EQUIPMENT	97
	4.1 Static Tests	98
	4.1.1 Load Apparatus	98
	4.1.2 Extensometers	98
	4.1.3 Furnaces	98 - 99
	4.2 Fatigue Tests	99
V	TEST PROCEDURES	100
	5.1 Tensile Tests	101
	5.2 Compression Tests	102
	5.3 Bearing Tests	103
	5.4 Shear Tests	104
	5.5 Fracture Toughness Tests	105
	5.6 Metallurgical Stability Tests	105 - 106
	5.7 Fatigue Tests	106
VI	SUMMARY AND ANALYSIS OF TEST RESULTS	113
	6.1 Statistical Analysis - R.T. Design Allowables	114 - 115
	6.2 Discussion of R.T. Design Allowables	116
	6.3 Data Presentation	116
	6.3.1 Effect of Temperature Curves	116
	6.3.2 Effect of Exposure Curves	117
	6.3.3 Stress-Strain Curves	117
	6.3.4 Constant Life Diagrams	117
	6.3.5 Fracture Toughness Tests	118
	6.3.6 Summary of Room Temperature Test Results	118
	6.4 Population Tables	119 - 126
	6.5 Tables of Summary of Room Temperature Test Results	127 - 134

## TABLE OF CONTENTS

Section		Page
VII	TEST RESULTS	135
7.1	Ti 4Al-3Mo-1V Cond. A	136
	7.1.1 Tensile Tests	137 - 138
	7.1.1.1 Tensile Stability Tests	139
	7.1.1.2 Tensile Modulus (Precision)	140 - 141
	7.1.2 Compression Tests	142 - 143
	7.1.3 Bearing Tests	144 - 145
	7.1.4 Shear Tests	146
	7.1.5 Fatigue Tests	147 - 152
7.2	Ti 13V-11Cr-3Al Cond. A (or ST)	153
	7.2.1 Tensile Tests	154 - 155
	7.2.1.1 Tensile Stability Tests	156
	7.2.1.2 Tensile Modulus (Precision)	157 - 158
	7.2.2 Compression Tests	159
	7.2.3 Bearing Tests	160 - 161
	7.2.4 Shear Tests	162
7.3	Ti 6Al-4V Cond. STA	163
	7.3.1 Tensile Tests	164 - 166
	7.3.1.1 Tensile Stability Tests	167 - 168
	7.3.1.2 Tensile Modulus (Precision)	169 - 170
	7.3.2 Compression Tests	171 - 173
	7.3.3 Bearing Tests	174 - 177
	7.3.4 Shear Tests	178 - 179
	7.3.5 Fracture Toughness	180

## TABLE OF CONTENTS

Section	Page
7.3.6 Fatigue Tests	181 - 185
7.4 Ti 6Al-6V-2Sn	186
7.4.1 Ti 6Al-6V-2Sn Cond. A	186
7.4.1.1 Tensile Tests	187 - 190
7.4.1.1.1 Tensile Stability Tests	191 - 192
7.4.1.1.2 Tensile Modulus (Precision)	193 - 194
7.4.1.2 Compression Tests	195 - 198
7.4.1.3 Bearing Tests	199 - 202
7.4.1.4 Shear Tests	203 - 204
7.4.1.5 Fracture Toughness Tests	205
7.4.1.6 Fatigue Tests	206 - 211
7.4.2 Ti 6Al-6V-2Sn Cond. STA	212
7.4.2.1 Tensile Tests	213 - 215
7.4.2.1.1 Tensile Stability Tests	216 - 217
7.4.2.1.2 Tensile Modulus (Precision)	218 - 219
7.4.2.2 Compression Tests	220 - 222
7.4.2.3 Bearing Tests	223 - 225
7.4.2.4 Shear Tests	226
7.4.2.5 Fracture Toughness Tests	227
7.4.2.6 Fatigue Tests	228 - 233
VIII MIL-HDBK-5 DATA PRESENTATION	234
8.1 Ti 4Al-3Mo-1V Cond A	235 - 241
8.2 Ti 13V-11Cr-3Al Cond A	242 - 248
8.3 Ti 6Al-4V Cond. STA	249 - 255
8.4 Ti 6Al-6V-2Sn Cond A	256 - 262
8.5 Ti 6Al-6V-2Sn Cond STA	263 - 267
IX REFERENCES	268 - 269

## APPENDIX

Section		Page
A.	WORKING CURVES	
1.1	Ti 4Al-3Mo-1V Cond. A	271 - 278
1.2	Ti 13V-11Cr-3Al Cond. A	279 - 283
1.3	Ti 6Al-4V Cond. STA	289 - 311
1.4	Ti 6Al-6V-2Sn Cond. A	312 - 334
1.5	Ti 6Al-6V-2Sn Cond. STA	335 - 350
B.	FATIGUE S-N CURVES	
2.1	Ti 4Al-3Mo-1V Cond. A	351 - 353
2.2	Ti 6Al-4V Cond. STA	354 - 356
2.3	Ti 6Al-6V-2Sn Cond. A	357 - 359
2.4	Ti 6Al-6V-2Sn Cond. STA	360 - 362

## LIST OF ILLUSTRATIONS

Section		Figure	Page
II	TEST MATERIALS		
2.4.1	Microstructures, Ti-4Al-3Mo-1V Cond. A	2-1	43
2.4.1	Microstructures, Ti-4Al-3Mo-1V Cond. A	2-2	44
2.4.1	Microstructures, Ti-4Al-3Mo-1V Cond. A	2-3	45
2.4.2	Microstructures, Ti-13V-11Cr-3Al Cond. A	2-4	47
2.4.2	Microstructures, Ti-13V-11Cr-3Al Cond. A	2-5	48
2.4.2	Microstructures, Ti-13V-11Cr-3Al Cond. A	2-6	49
2.4.3	Microstructures, Ti-6Al-4V Cond. STA	2-7	51
2.4.3	Microstructures, Ti-6Al-4V Cond. STA	2-8	52
2.4.3	Microstructures, Ti-6Al-4V Cond. STA	2-9	53
2.4.3	Microstructures, Ti-6Al-4V Cond. STA	2-10	54
2.4.4	Microstructures, Ti-6Al-6V-2Sn Cond. A	2-11	55
2.4.4	Microstructures, Ti-6Al-6V-2Sn Cond. A	2-12	56
2.4.4	Microstructures, Ti-6Al-6V-2Sn Cond. A	2-13	57
2.4.4	Microstructures, Ti-6Al-6V-2Sn Cond. A	2-14	58
2.4.4	Microstructures, Ti-6Al-6V-2Sn Cond. A	2-15	60
2.4.4	Microstructures, Ti-6Al-6V-2Sn Cond. A	2-16	61
2.4.4	Microstructures, Ti-6Al-6V-2Sn Cond. A	2-17	62
2.4.4	Microstructures, Ti-6Al-6V-2Sn Cond. A	2-18	63
2.4.4	Microstructures, Ti-6Al-6V-2Sn Cond. A	2-19	64
2.4.4	Microstructures, Ti-6Al-6V-2Sn Cond. STA	2-20	65
2.4.4	Microstructures, Ti-6Al-6V-2Sn Cond. STA	2-21	66
2.4.4	Microstructures, Ti-6Al-6V-2Sn Cond. STA	2-22	67
2.4.4	Microstructures, Ti-6Al-6V-2Sn Cond. STA	2-23	68
2.4.4	Microstructures, Ti-6Al-6V-2Sn Cond. STA	2-24	69
2.4.4	Microstructures, Ti-6Al-6V-2Sn Cond. STA	2-25	70
III	TEST SPECIMENS		
3.2	Typical Test Specimen Layout	3-1	83
3.3	Specimen, Tensile Test, Flat	3-2	85
3.3	Specimen, Tensile Test, Round	3-3	86
3.3	Specimen, Compression Test, Flat	3-4	87
3.3	Specimen, Compression Test, Round	3-5	88
3.3	Specimen, Bearing Tests	3-6	89
3.3	Specimen, Shear Tests	3-7	90
3.3	Specimen, Fatigue Tests Flat Smooth	3-8	91
3.3	Specimen, Fatigue Tests, Flat Notched	3-9	92
3.3	Specimen, Fatigue Tests, Round Smooth	3-10	93
3.3	Specimen, Fatigue Tests Round Notched	3-11	94
3.3	Specimen, Fracture Toughness	3-12	95
V	TEST PROCEDURES		
5.1	Room Temperature Tensile Test Setup	5-1	107
5.1	Elevated Temperature Tensile Test Setup	5-2	108
5.2	Elevated Temperature Compression Test Setup	5-3	109
5.3	Bearing Test Setup	5-4	110
5.4	Shear Test Setup	5-5	111
5.5	Fatigue Test Setup	5-6	112

LIST OF ILLUSTRATIONS

Section		Figure	Page
<b>VII</b>	<b>TEST RESULTS</b>		
7.1.1	Typical Tensile Stress-Strain Curve (full range) for Annealed Ti-4Al-3Mo-1V Alloy Sheet at Room Temperature	7-1	141
7.1.5	Constant Life Diagram, Ti-4Al-3Mo-1V Cond. A., $K_t = 1.0$	7-2	151
7.1.5	Constant Life Diagram, Ti-4Al-3Mo-1V Cond. A., $K_t = 3.0$	7-3	152
7.2.1	Typical Tensile Stress-Strain Curve (full-range) for Annealed Ti-13V-11Cr-3Al Alloy Sheet at Room Temperature	7-4	153
7.3.1	Typical Tensile Stress-Strain Curve (full-range) for Solution Treated and Aged Ti-6Al-4V Alloy Sheet	7-5	170
7.3.6	Constant Life Diagram, Ti-6Al-4V Cond. STA, $K_t = 1.0$	7-6	184
7.3.6	Constant Life Diagram, Ti-6Al-4V Cond. STA, $K_t = 3.0$	7-7	185
7.4.1.1	Typical Tensile Stress-Strain Curve (full-range) for Annealed Ti-6Al-6V-2Sn Alloy Plate at Room Temperature	7-8	194
7.4.1.6	Constant Life Diagram, Ti-6Al-6V-2Sn Cond. A, $K_t = 1.0$	7-9	210
7.4.1.6	Constant Life Diagram, Ti-6Al-6V-2Sn Cond. A, $K_t = 1.0$	7-10	211
7.4.2.1	Typical Tensile Stress-Strain Curve (full range) for Solution Treated and Aged Ti-6Al-6V-2Sn Alloy Plate at Room Temperature	7-11	219
7.4.2.6	Constant Life Diagram, Ti-6Al-6V-2Sn Cond. STA, $K_t = 1.0$	7-12	232
7.4.2.6	Constant Life Diagram, Ti-6Al-6V-2Sn Cond. STA, $K_t = 3.0$	7-13	233
<b>VIII</b>	<b>DESIGN MECHANICAL AND PHYSICAL PROPERTIES OF Ti-4Al-3Mo-1V</b>		
8.1	Effect of Temperature on the Ultimate Tensile Strength ( $F_{tu}$ ) of Annealed Ti-4Al-3Mo-1V	8.1.1	236
8.1	Effect of Temperature on the Tensile Yield Strength ( $F_{ty}$ ) of Annealed Ti-4Al-3Mo-1V Alloy Sheet	8.1.2	236
8.1	Effect of Exposure at Elevated Temperature on The Room Temperature Ultimate Tensile Strength ( $F_{tu}$ ) of Annealed Ti-4Al-3Mo-1V Alloy Sheet	8.1.3	237
8.1	Effect of Exposure at Elevated Temperature on the Room Temperature Tensile Yield Strength ( $F_{ty}$ ) of Annealed Ti-4Al-3Mo-1V Alloy Sheet	8.1.4	237
8.1	Effect of Temperature on the Compressive Yield Strength ( $F_{cy}$ ) of Annealed Ti-4Al-3Mo-1V Alloy Sheet	8.1.5	238

## LIST OF ILLUSTRATIONS

Section		Figure	Page
8.1	Effect of Temperature on Ultimate Shear Strength ( $F_{su}$ ) of Annealed Ti-4Al-3Mo-1V Alloy Sheet	8.1.6	238
8.1	Effect of Temperature on Ultimate Bearing Strength ( $F_{bru}$ ) of Annealed Ti-4Al-3Mo-1V Alloy Sheet	8.1.7	239
8.1	Effect of Temperature on Bearing Yield Strength ( $F_{bry}$ ) of Annealed Ti-4Al-3Mo-1V Alloy Sheet	8.1.8	239
8.1	Typical Tensile Stress-strain curve for Annealed Ti-4Al-3Mo-1V Alloy Sheet at Room-temperature	8.1.9	240
8.1	Typical Compressive Stress-strain Curves for Annealed Ti-4Al-3Mo-1V Alloy Sheet at Room-temperature	8.1.10	240
8.1	Effect of Temperature on the Elongation ( $e$ ) of Annealed Ti-4Al-3Mo-1V Alloy Sheet	8.1.11	241
8.1	Typical Tensile Stress-strain Curves for Annealed Ti-4Al-3Mo-1V Alloy Sheet at Room and Elevated Temperatures	8.1.12	241
8.2	Effect of Temperature on the Ultimate Tensile Strength ( $F_{tu}$ ) of Annealed Ti-13V-11Cr-3Al Alloy Sheet	8.2.1	243
8.2	Effect of Temperature on the Tensile Yield Strength ( $F_{ty}$ ) of Annealed Ti-13V-11Cr-3Al Alloy Sheet	8.2.2	243
8.2	Effect of Exposure at Elevated Temperature on the Room-temperature Ultimate Tensile Strength ( $F_{tu}$ ) of Annealed Ti-13V-11Cr-3Al Alloy Sheet.	8.2.3	244
8.2	Effect of Exposure at Elevated Temperature on the Tensile Yield Strength ( $F_{ty}$ ) of Annealed Ti-13V-11Cr-3Al Alloy Sheet.	8.2.4	244
8.2	Effect of Temperature on the Compressive Yield Strength ( $F_{cy}$ ) of Annealed Ti-13V-11Cr-3Al Alloy Sheet.	8.2.5	245
8.2	Effect of Temperature on the Ultimate Shear Strength ( $F_{su}$ ) of Annealed Ti-13V-11Cr-3Al Alloy Sheet.	8.2.6	245
8.2	Effect of Temperature on the Ultimate Bearing Strength ( $F_{bru}$ ) of Annealed Ti-13V-11Cr-3Al Alloy Sheet	8.2.7	246
8.2	Effect of Temperature on the Bearing Yield Strength ( $F_{bry}$ ) of Annealed Ti-13V-11Cr-3Al Alloy Sheet	8.2.8	246
8.2	Effect of Temperature on the Elongation ( $e$ ) of Annealed Ti-13V-11Cr-3Al Alloy Sheet.	8.2.9	247
8.2	Typical Tensile Stress-strain Curves for Annealed Ti-13V-11Cr-3Al Alloy Sheet at Room and Elevated Temperatures.	8.2.10	247
8.2	Typical Tensile Stress-strain Curve for Annealed Ti-13V-11Cr-3Al Alloy Sheet at Room Temperature	8.2.11	249
8.2	Typical Compressive Stress-strain Curve for Annealed Ti-13V-11Cr-3Al Alloy Sheet at Room Temperature	8.2.12	249

## LIST OF ILLUSTRATIONS

Section		Figure	Page
8.3	Effect of Temperature on the Ultimate Tensile Strength ( $F_{tu}$ ) of Solution Treated and Aged Ti-6Al-4V Alloy Plate.	8.3.1	250
8.3	Effect of Temperature on the Tensile Yield Strength ( $F_{ty}$ ) of Solution Treated and Aged Ti-6Al-4V Alloy Plate.	8.3.2	250
8.3	Effect of Exposure at Elevated Temperature on the Room Temperature Ultimate Tensile Strength ( $F_{tu}$ ) of Annealed Ti-6Al-4V Alloy Plate.	8.3.3	251
8.3	Effect of Exposure at Elevated Temperature on the Room-temperature Tensile Yield Strength ( $F_{ty}$ ) of Annealed Ti-6Al-4V Alloy Plate	8.3.4	251
8.3	Effect of Temperature on the Compressive Yield Strength ( $F_{cy}$ ) of Solution Treated and Aged Ti-6Al-4V Alloy Plate.	8.3.5	252
8.3	Effect of Temperature on the Ultimate Shear Strength ( $F_{su}$ ) of Solution Treated and Aged Ti-6Al-4V Alloy Plate.	8.3.6	252
8.3	Effect of Temperature on the Ultimate Bearing Strength ( $F_{bru}$ ) of Solution Treated and Aged Ti-6Al-4V Alloy Plate.	8.3.7	253
8.3	Effect of Temperature on the Bearing Yield Strength ( $F_{bry}$ ) of Solution Treated and Aged Ti-6Al-4V Alloy Plate.	8.3.8	253
8.3	Effect of Temperature on the Elongation ( $e$ ) of Ti-6Al-4V Alloy Plate.	8.3.9	254
8.3	Typical Tensile Stress-strain Curves for Annealed Ti-6Al-4V Alloy Plate at Room and Elevated Temperatures.	8.3.10	254
8.3	Typical Compressive Stress-strain Curve for Annealed Ti-6Al-4V Alloy Plate at Room Temperature	8.3.11	255
8.4	Effect of Temperature on the Ultimate Tensile Strength ( $F_{tu}$ ) of Annealed Ti-6Al-6V-2Sn Alloy Plate.	8.4.1	257
8.4	Effect of Temperature on the Tensile Yield Strength ( $F_{ty}$ ) of Annealed Ti-6Al-6V-2Sn Alloy Plate	8.4.2	257
8.4	Effect of Exposure at Elevated Temperature on the Room-temperature Ultimate Tensile Strength ( $F_{tu}$ ) of Annealed Ti-6Al-6V-2Sn Alloy Plate.	8.4.3	258
8.4	Effect of Exposure at Elevated Temperature on the Room-temperature Tensile Yield Strength ( $F_{ty}$ ) of Annealed Ti-6Al-6V-2Sn Alloy Plate.	8.4.4	258
8.4	Effect of Temperature on the Compressive Yield Strength ( $F_{cy}$ ) of Annealed Ti-6Al-6V-2Sn Alloy Plate		



## LIST OF ILLUSTRATIONS

Section		Figure	Page
8.4	Effect of Temperature on the Compressive Yield Strength ( $F_{cy}$ ) of Annealed Ti-6Al-6V-2Sn Alloy Plate.	8.4.5	257
8.4	Effect of Temperature on the Ultimate Shear Strength ( $F_{su}$ ) of Annealed Ti-6Al-6V-2Sn Alloy Plate.	8.4.6	259
8.4	Effect of Temperature on the Ultimate Bearing Strength ( $F_{bru}$ ) of Annealed Ti-6Al-6V-2Sn Alloy Plate.	8.4.7	260
8.4	Effect of Temperature on the Bearing Yield Strength ( $F_{bry}$ ) of Annealed Ti-6Al-6V-2Sn Alloy Plate.	8.4.8	260
8.4	Typical Tensile Stress-strain Curve for Annealed Ti-6Al-6V-2Sn Alloy Plate at Room Temperature	8.4.9	261
8.4	Typical Compressive Stress-strain Curves for Annealed Ti-6Al-6V-2Sn Alloy Plate at Room-temperature	8.4.10	261
8.4	Effect of Temperature on the Elongation ( $e$ ) of Annealed Ti-6Al-6V-2Sn Alloy Plate.	8.4.11	262
8.4	Typical Tensile Stress-strain Curves for Annealed Ti-6Al-6V-2Sn Alloy Plate at Room and Elevated Temperatures.	8.4.12	262

## LIST OF TABLES

Section		Table	Page
<b>II TEST MATERIALS</b>			
2.6	Tension Tests, Number of Tests Per Temperature	II-1	73
2.6	Compression Tests, Number of Tests Per Temperature	II-2	74
2.6	Bearing Tests, Number of Tests Per Temperature	II-3	75
2.6	Shear Tests, Number of Tests Per Temperature	II-4	76
2.6	Fracture Toughness Tests, Number of Tests	II-5	77
2.6	Fatigue Tests, Number of Tests	II-6	73
<b>VI SUMMARY AND ANALYSIS OF TEST RESULTS</b>			
6.2	Populations Used to Obtain Allowables, Ti-4Al-3Mo-1V Cond. A	VI-1	119
6.2	Populations Used to Obtain Allowables, Ti-13V-11Cr-3Al Cond. A	VI-2	120
6.2	Populations Used to Obtain Allowables, Ti-6Al-4V Cond. STA	VI-3	121-122
6.2	Populations Used to Obtain Allowables, Ti-6Al-6V-2Sn Cond. A	VI-4	123-124
6.2	Populations Used to Obtain Allowables, Ti-6Al-6V-2Sn Cond. STA	VI-5	125-126
6.3.6	Summary of Room Temperature Test Results, Ti-4Al-3Mo-1V Cond. A	VI-6	127
6.3.6	Summary of Room Temperature Test Results, Ti-13V-11Cr-3Al Cond. A	VI-7	128
6.3.6	Summary of Room Temperature Test Results, Ti-6Al-4V Cond. STA	VI-8	129-130
6.3.6	Summary of Room Temperature Test Results, Ti-6Al-6V-2Sn Cond. A	VI-9	131-132
6.3.6	Summary of Room Temperature Test Results, Ti-6Al-6V-2Sn Cond. STA	VI-10	133-134
<b>VIII MIL-HDBK-5 DATA PRESENTATION</b>			
8.1	Design Mechanical and Physical Properties of Ti-4Al-3Mo-1V	VIII-1	235
8.2	Design Mechanical and Physical Properties of Ti-13V-11Cr-3Al	VIII-2	242
8.3	Design Mechanical and Physical Properties of Ti-6Al-4V	VIII-3	249
8.4	Design Mechanical and Physical Properties of Ti-6Al-6V-2Sn	VIII-4	256

SECTION I  
INTRODUCTION

1.1 PURPOSE OF THE PROGRAM

The program objective was to support the development of MIL-HDBK-5 data on titanium alloys by conducting a mechanical property design data program for four selected titanium alloys. The alloys evaluated are:

1. Ti-4Al-3Mo-1V Cond. A - Sheet
2. Ti-13V-11Cr-3Al Cond. A - Sheet
3. Ti-6Al-4V Cond. STA - Plate
4. Ti-6Al-6V-2Sn Cond. A and STA - Plate

The mechanical property tests performed were tension, compression, bearing, shear, and thermal stability at temperatures from ambient to 800F in conjunction with fracture toughness and fatigue tests at room temperature. The data generated was compared with data obtained by means of a literature search.

1.2 BACKGROUND

MIL-HDBK-5 has long been accepted by the DOD and the FAA as the appropriate source of design allowables on structural materials. In order to establish and maintain an acceptable level of confidence in the handbook the MIL-HDBK-5 Supervisory Committee has imposed certain reliability criteria on the data and their analysis. These include a general requirement for at least ten heats or lots of each material condition from three or more (if possible) producers. A minimum total of 100 tests should go into the establishment of each allowable value. Consequently, the only properties that are genuinely established as "A" and "B" value (statistically reliable allowables) are  $F_{tu}$  and  $F_{ty}$  at room temperature. The remaining properties such as compression, bearing, and shear, if they are included, are usually derived using ratioing techniques. Elevated temperature properties may also be derived. It is the purpose of this program to obtain these data on several titanium alloys using information from producers, users, data information centers and a test program. The alloys were selected as a result of a review of gaps in MIL Hdbk-5 data and based on requests for data received by the Department of Defense Information Centers.

## Section II

### TEST MATERIALS

Contained within this section are; (1) material procurement specification requirements, (2) vendor certifications (3) thermal processing history, (4) metallography (5) mechanical properties to be determined, and (6) test conditions for all the materials utilized in this investigation.

	Page
Test Materials; Specification Requirements and Certification	3 - 41
Thermal Processing	42
Microstructures	42 - 70
Mechanical Properties Determined	71
Test Conditions	71 - 76

## 2.1 Discussion:

The material data contained herein, identifies the source and provides the chemistry, heat treat condition, and material thickness for all the material used in the subject program. Each material is listed with the applicable vendor heat number, chemical composition, and the results of the supplier's tensile tests as obtained from the vendor certifications. All material utilized under this program sponsorship was procured to MIL-T-9046 requirements with all thermal processing adhering to the requirements of MIL-H-81200.

A brief summary of the materials, source and number of heats is listed below:

<u>Material</u>	<u>Source</u>	<u>Number of Heats</u>
Ti-4Al-3Mo-1V Cond. A	TMCA	5
	RMI	1
Ti-13V-11Cr-3Al Cond. ST	TMCA	5
Ti-6Al-4V Cond. STA	TMCA	5
	RMI	3
Ti-6Al-6V-2Sn Cond. A and STA	TMCA	15

In addition to the data obtained from the test program, data has also been incorporated from North American's Engineering and Quality Control Laboratories and test reports from the following vendors and users:

Titanium Metals Corporation of America  
NASA - Langley  
DMIC Data Sheets (Battelle Memorial Institute)  
The Boeing Company  
Reactive Metals, Incorporated

## 2.2 Material Certification

The following pages present the test material procurement specification requirements along with the vendor certifications sent with the test material. One heat of Ti 4Al-3Mo-1V Condition A was received without an attached certification. Efforts to obtain this certification proved unsuccessful.

2.21 Material: Ti 4Al-3Mo-1V Cond A (Specification requirements)

Specification MIL-T-9046 Sheet, Strip and Plate  
Type III

SPECIFICATION MINIMUM PROPERTIES (KSI)	
Tensile Strength	125
Yield Strength 0.2% Offset	115
Elongation %	10

SPECIFICATION CHEMICAL LIMITS													
C (Max.)	Fe (Max)	N	Al	V	Cr	Mo	H	Zr	Sn	Mn	O <sub>2</sub> (Max)	Ti	Total Other Elements (Max.)
0.08	0.30	0.05	5.5 6.75	3.5 4.5	—	—	0.015	—	—	—	0.20	Bal	0.40

2.2.1 (continued)

MATERIAL: Ti 4Al-3Mo-1V Cond. A

VENDOR HEAT NUMBER: G-1595 (TMCA)

NR/LAD IDENTIFICATION: Heat 1

CHEMICAL COMPOSITION:

CARBON	0.023	VANADIUM	1.1
IRON	0.09	MOLYBDENUM	3.3
NITROGEN	0.008	HYDROGEN	0.012
ALUMINUM	4.6	OXYGEN	0.10

HEAT TREAT CONDITION: Annealed Per MIL-H-81200

Vendor Test No.	Test Temp.	Mat'l. Cond.	Nom. Gage	Spec. Direct.	Ult. Tensile Strength Ksi	0.2% Yield Strength Ksi	$\frac{1}{2}$ Elong.
F-8649	Room	Annealed	0.034	Long.	134.7	123.5	12.5
				Trans.	139.8	128.3	12.0

2.2.1 (continued)

MATERIAL: Ti-4AL-3Mo-1V Cond. A

VENDOR HEAT NUMBER: G-895 (TMCA)

NR/LAD IDENTIFICATION: Heat 2

CHEMICAL COMPOSITION:

CARBON	0.023	VANADIUM	1.1
IRON	0.09	MOLYBDENUM	3.2
NITROGEN	0.014	HYDROGEN	0.008
ALUMINUM	4.5	OXYGEN	0.11

HEAT TREAT CONDITION: Annealed Per MIL-H-81200

Vendor Test No.	Test Temp.	Mat'l. Cond.	Nom. Gage	Spec. Direct.	Ult. Tensile Strength Ksi	0.2% Yield Strength Ksi	% Elong.
J-0679	Room	Annealed	0.055	Long.	133.0	124.1	14.0
				Trans.	137.3	131.8	10.5



2.2.1 (continued)

MATERIAL: T1-4Al-3Mo-1V Cond. A

VENDOR HEAT NUMBER: G-2446

NR/LAD IDENTIFICATION: Heat 3

CHEMICAL COMPOSITION:

CARBON	0.022	VANADIUM	1.1
IRON	0.06	MOLYBDENUM	3.2
NITROGEN	0.007	HYDROGEN	0.009
ALUMINUM	4.3	OXYGEN	0.10

HEAT TREAT CONDITION: Annealed Per MIL-H-81200

Vendor Test No.	Test Temp.	Mat'l. Cond.	Non. Gage	Spec. Direct.	Ult. Tensile Strength Ksi	0.2% Yield Strength Ksi	% Elong.
J-0678	Room	Annealed	0.063	Long.	131.9	123.8	15.5
				Trans.	136.5	130.8	12.0

2.2.1 (continued)

MATERIAL: Ti-4Al-3Mo-1V Cond. A

VENDOR HEAT NUMBER: G-1523 (TMCA)

Heat 4

NR/LAD IDENTIFICATION:

CHEMICAL COMPOSITION:

CARBON	0.025	VANADIUM	1.0
IRON	0.09	MOLYBDENUM	3.3
NITROGEN	0.010	HYDROGEN	0.012
ALUMINUM	4.4	OXYGEN	0.12

HEAT TREAT CONDITION: Annealed Per MIL-H-81200

Vendor Test No.	Test Temp.	Mat'l. Cond.	Nom. Gage	Spec. Direct.	Ult. Tensile Strength Ksi	0.2% Yield Strength Ksi	% Elong.
F-7737	Room	Annealed	0.051	Long.	134.8	118.0	13.5
				Trans.	136.2	122.6	14.0

2.2.1 (continued)

MATERIAL: Ti-4Al-3Mo-1V Cond. A

VENDOR HEAT NUMBER: C-1401 (TMCA)

NR/LAD IDENTIFICATION: Heat 5

CHEMICAL COMPOSITION:

CARBON	0.025	VANADIUM	1.2
IRON	0.09	MOLYBDENUM	3.3
NITROGEN	0.011	HYDROGEN	0.005
ALUMINUM	4.3	OXYGEN	0.12

HEAT TREAT CONDITION: Annealed Per MIL-H-81200

Vendor Test No.	Test Temp.	Mat'l. Cond.	Nom. Gage	Spec. Direct.	Ult. Tensile Strength Ksi	0.2% Yield Strength Ksi	% Elong.
F-7786	Room	Annealed	0.067	L	131.0	121.8	11.5
				T	140.4	136.0	13.5

2.2.1 (continued)

MATERIAL: T1-4A1-3Mo-1V Cond. A

VENDOR HEAT NUMBER: 321055 (FMI)

NR/LAD IDENTIFICATION: Heat 6

CHEMICAL COMPOSITION:

CARBON	0.015	VANADIUM	0.91
IRON	0.19	MOLYBDENUM	3.27
NITROGEN	0.004	HYDROGEN	62 PPM
ALUMINUM	3.80	OXYGEN	0.091

HEAT TREAT CONDITION: Annealed Per MIL-H-81200

Vendor Test No.	Test Temp.	Mat'l. Cond.	Nom. Gage	Spec. Direct.	Ult. Tensile Strength Ksi	0.2% Yield Strength Ksi	% Elong.
-	RT	A	0.110	L	131.5	124.8	13.0
				T	138.8	136.0	14.0

Note: Above tests performed by North American Rockwell, Los Angeles Division

2.2.2 Material: Ti 13V-11Cr-3Al Cond A or ST (Specification Requirements)

Specification MIL-T-9046  
Type IV

Sheet, Strip and Plate

SPECIFICATION MINIMUM PROPERTIES (KSI)		
	0.050 Gage	Other 0.050 Gage
Tensile Strength	132	125
Yield Strength 0.2% Offset	126	120 (Min)
Elongation %	8.0	10.

SPECIFICATION CHEMICAL LIMITS													Total Other Elements (Max.)
C (Max)	Fe (Max)	N	Al	V	Cr	Mo	H	Zr	Sn	Mn	O <sub>2</sub> (Max)	Ti	
0.05	0.15	0.05	2.5	12.5	10	—	0.025	—	—	—	0.20	Bal.	0.40
	0.30		3.5	14.5	12								

2.2.2 (continued)

MATERIAL: T1-13V-11Cr-3Al

VENDOR HEAT NUMBER: D-7855 (TMCA)

NR/LAD IDENTIFICATION: Heat 1

CHEMICAL COMPOSITION:

CARBON	0.017	VANADIUM	13.7
IRON	0.15	CHROMIUM	10.9
NITROGEN	0.030	HYDROGEN	0.010
ALUMINUM	3.1	OXYGEN	0.13

HEAT TREAT CONDITION: Solution Treated

Vendor Test No.	Test Temp.	Mat'l. Cond.	Non. Case	Spec. Direct.	Ult. Tensile Strength Ksi	0.2% Yield Strength Ksi	% Elong.
F-2102	Room	ST	0.040	Long.	136.8	128.4	18.0
				Trans	141.7	132.7	9.5
	Room	STA(1)	Long.	194.1	176.3	7.0	
			Trans	208.5	192.7	4.5	

Lab Aged 24 Hours at 900°F

2.2.2 (continued)

MATERIAL: Ti-13V-11Cr-3Al  
 VENDOR HEAT NUMBER: D-7770 (TMCA)  
 NR/LAD IDENTIFICATION: Heat 2

CHEMICAL COMPOSITION:

CARBON	0.017	VANADIUM	13.6
IRON	0.16	CHROMIUM	10.8
NITROGEN	0.028	HYDROGEN	0.023
ALUMINUM	3.1	OXYGEN	0.12

HEAT TREAT CONDITION: Solution Treated

Vendor Test No.	Test TEMP.	Mat'l. Cond.	Nom. Gage	Spec. Direct.	Ult. Tensile Strength Ksi	0.2% Yield Strength Ksi	% Elong.
F-1951	Room	ST	0.038	Long.	134.4	129.0	18.5
				Trans.	140.9	136.8	14.0
	Room	ST(1)		Long.	193.5	175.2	6.0
				Trans.	205.0	188.9	5.0

(1) Lab Aged 24 Hrs. at 900°F

2.2.2 (continued)

MATERIAL: Ti-13V-11Cr-3Al  
VENDOR HEAT NUMBER: D-7107 (TMCA)  
NR/LAD IDENTIFICATION: Heat 3

CHEMICAL COMPOSITION:

CARBON	0.028	VANADIUM	13.5
IRON	0.16	CHROMIUM	10.8
NITROGEN	.022	HYDROGEN	0.004
ALUMINUM	3.0	OXYGEN	0.14

HEAT TREAT CONDITION: Solution Treated

Vendor Test No.	Test Temp.	Mat'l. Cond.	Nom. Case	Spec. Direct.	Ult. Tensile Strength Ksi	0.2% Yield Strength Ksi	% Elong.
T-0342	Room	ST	0.035	Long.	136.9	133.7	21.0
				Trans.	140.3	135.7	17.0
		STA(1)		Long.	193.2	175.9	9.5
				Trans.	200.1	184.1	7.0

(1) Lab Aged 24 Hrs. at 900°F



2.2.2 (continued)

MATERIAL: Ti-13V-11Cr-3Al  
 VENDOR HEAT NUMBER: D-7639 (TMCA)  
 NR/LAD IDENTIFICATION: Heat 4

CHEMICAL COMPOSITION:

CARBON	0.023	VANADIUM	13.7
IRON	0.17	CHROMIUM	10.6
NITROGEN	0.025	HYDROGEN	0.015
ALUMINUM	3.1	OXYGEN	0.12

HEAT TREAT CONDITION: Solution Treated

Vendor Test No.	Test Temp.	Mat'l. Cond.	Nom. Gage	Spec. Direct.	Ult. Tensile Strength Ksi	0.2% Yield Strength Ksi	% Elong.
C-9887	Room	ST	0.038	Long.	139.7	135.1	16.0
				Trans.	144.6	139.2	13.0
		STA(1)		Long.	197.9	179.1	7.5
				Trans.	208.9	191.4	5.5

(1) Lab Aged 24 Hrs. at 900°F

2.2.2 (continued)

MATERIAL: Ti-13V-11Cr-3Al

VENDOR HEAT NUMBER: D-7110 (TMCA)

NR/LAD IDENTIFICATION: Heat 5

CHEMICAL COMPOSITION:

CARBON	0.027	VANADIUM	13.7
IRON	0.16	CHROMIUM	10.8
NITROGEN	0.026	HYDROGEN	0.003
ALUMINUM	3.0	OXYGEN	0.12

HEAT TREAT CONDITION: Solution Treated

Vendor Test No.	Test Temp.	Mat'l. Cond.	Nom. Gage	Spec. Direct.	Ult. Tensile Strength Ksi	0.2% Yield Strength Ksi	% Elong.
T-0294	Room	ST	0.037	Long.	133.6	130.7	22.5
				Trans.	138.1	135.9	17.5
		STA <sup>(1)</sup>		Long.	180.1	164.1	9.0
				Trans.	179.8	165.7	6.5

(1) Lab Aged 24 Hrs. at 900°F

2.2.3 Material: Ti 6Al-4V Cond STA (Specification Requirements)

Specification MIL-T-9046 Sheet, Strip, and Plate  
Type III Comp C

SPECIFICATION MINIMUM PROPERTIES (KSI)				
	≥ 1/4" to 1/2"	≥ 1/2" to 3/4"	3/4" to 1"	1" to 1-1/2"
Tensile Strength (Min)	160	160	150	145
Yield Strength (Min) 0.2% Offset	145	145	140	135
Elongation %	8	8	6	6

SPECIFICATION CHEMICAL LIMITS													
C (Max)	Fe (Max)	N	Al	V	Cr	Mo	H	Zr	Sn	Mn	O <sub>2</sub> (Max)	Ti	Total Other Elements (Max)
0.08	0.30	0.05	5.5 6.75	3.5 4.5	—	—	0.015	—	—	—	0.20	Bal.	0.40

2.2.3 (continued)

MATERIAL: TI-6Al-4V  
 VENDOR HEAT NUMBER: HT G 4956 (TMCA)  
 NR/LAD IDENTIFICATION: Heat 1

CHEMICAL COMPOSITION:

CARBON	0.025	VANADIUM	4.1
IRON	0.10	HYDROGEN	0.009
NITROGEN	0.010	OXYGEN	0.10
ALUMINUM	6.0		

HEAT TREAT CONDITION: Solution Treated and Aged to MIL-T-9046E  
 Type 3 Comp C

Vendor Test No.	Test Temp.	Mat'l. Cond.	Nom. Gage	Spec. Direct.	Ult. Tensile Strength Ksi	0.2% Yield Strength Ksi	% Elong.
J-3183	RT	STA	0.250	L	166.6	153.0	8.5
				T	183.2	171.8	8.0

2.2.3 (continued)

MATERIAL: TI-6Al-4V  
 VENDOR HEAT NUMBER: HT G-4796 (TMCA)  
 NR/LAD IDENTIFICATION: Heat 2

CHEMICAL COMPOSITION:

CARBON	0.026	VANADIUM	4.2
IRON	0.15	HYDROGEN	0.005
NITROGEN	0.015	OXYGEN	0.14
ALUMINUM	6.4		

HEAT TREAT CONDITION: Solution Treated and Aged to MIL-T-9046E  
 Type 3 Comp C 1700°F 1/4 Hr - W.Q.  
 Aged 4 hours - 1000°F A.C.

Vendor Test No.	Test Temp.	Mat'l. Cond.	Nom. Gage	Spec. Direct.	Ult. Tensile Strength Ksi	0.2% Yield Strength Ksi	% Elong.
J-4376	RT	STA	0.250	I	176.0	164.0	9.0
				T	180.2	174.3	10.5

2.2.3 (continued)

MATERIAL: T1-6AL-4V  
 VENDOR HEAT NUMBER: HT X-53788 (RMI)  
 NR/LAD IDENTIFICATION: Heat 6

CHEMICAL COMPOSITION:

CARBON	0.03	VANADIUM	4.2
IRON	0.16	HYDROGEN	72 ppm
NITROGEN	0.011	OXYGEN	0.107
ALUMINUM	6.1		

HEAT TREAT CONDITION: Prod. Solution Treated 1725°F for 10 minutes  
 W. Q. Aged 1000°F for 4 Hrs. and Air Cooled

Vendor Test No.	Test Temp.	Mat'l. Cond.	Nom. Gage	Spec. Direct.	Ult. Tensile Strength Ksi	0.2% Yield Strength Ksi	% Elong.
	RT	STA	0.250	L	168.0	156.0	8.0
				T	168.0	151.0	8.0

2.2.3 (continued)

MATERIAL: T1-6A1-4V  
 VENDOR HEAT NUMBER HT G-6539 (TMCA)  
 NR/LAD IDENTIFICATION: Heat 1

CHEMICAL COMPOSITION:

CARBON	0.024	VANADIUM	4.2
IRON	0.16	HYDROGEN	0.005
NITROGEN	0.008	OXYGEN	0.19
ALUMINUM	6.2		

HEAT TREAT CONDITION: Solution Treated and Aged to MIL-T-9046E  
 Type 3 Comp C

Vendor Test No.	Test Temp.	Mat'l. Cond.	Nom. Gage	Spec. Direct.	Ult. Tensile Strength Ksi	0.2% Yield Strength Ksi	% Elong.	% Red. Area
J-3855	RT	STA	0.500	L	171.1	158.1	19.0	41.2
				T	168.1	155.2	16.5	42.6

2.2.3 (continued)

MATERIAL: Ti- 6Al-4V  
 VENDOR HEAT NUMBER HT G-7278 (TMCA)  
 MR/LAD IDENTIFICATION: Heat: 2

CHEMICAL COMPOSITION:

CARBON	0.025	VANADIUM	4.2
IRON	0.17	HYDROGEN	0.005
NITROGEN	0.009	OXYGEN	0.20
ALUMINUM	6.4		

HEAT TREAT CONDITION: Solution Treated and Aged to MIL-T-9046E  
 Type 3 Comp C

Vendor Test No.	Test Temp.	Mat'l. Cond.	Nom. Gage	Spec. Direct.	Ult. Tensile Strength Ksi	0.2% Yield Strength Ksi	% Elong.	% Red. Area
J-5801	RT	STA	0.500	L	175.5	163.3	15.0	39.5
				T	182.2	172.4	14.0	35.8



2.2.3 (continued)

MATERIAL: T1-6Al-4V  
 VENDOR HEAT NUMBER HT 302634 (RMI)  
 NR/LAD IDENTIFICATION: Heat 7

CHEMICAL COMPOSITION:

CARBON	0.02	VANADIUM	4.3
IRON	0.12	HYDROGEN	42 ppm
NITROGEN	0.013	OXYGEN	0.168
ALUMINUM	6.4		

HEAT TREAT CONDITION: Prod. Solution Treated 1725°F for 10 minutes  
 W.Q. Lab Aged 1000°F for 4 Hours Air Cooled.

Vendor Test No.	Test Temp.	Mat'l. Cond.	Nom. Gage	Spec. Direct.	Ult. Tensile Strength Ksi	0.2% Yield Strength Ksi	% Elong.
	RT	STA	0.475	L	170.0	153.0	7.0
				T	173.0	162.0	9.0

2.2.3 (continued)

**MATERIAL:** T1-6Al-4V  
**VENDOR HEAT NUMBER:** HT G-7021 (TMCA)  
**WR/LAD IDENTIFICATION:** Heat 2

**CHEMICAL COMPOSITION:**

<b>CARBON</b>	0.022	<b>VANADIUM</b>	4.2
<b>IRON</b>	0.18	<b>HYDROGEN</b>	0.004
<b>NITROGEN</b>	0.12	<b>OXYGEN</b>	0.17
<b>ALUMINUM</b>	6.3		

**HEAT TREAT CONDITION:** Solution Treated and Aged to MIL-T-9046E  
 Type 3 Comp C 1675°F, 15 Min. - W.Q. Age  
 4 Hours 1000°F A.C.

Vendor Test No.	Test Temp.	Mat'l. Cond.	Nom. Gage	Spec. Direct.	Ult. Tensile Strength Ksi	0.2% Yield Strength Ksi	% Elong.
J-4821	RT	STA	1.000	L.	168.5	155.0	14.5
				T	176.8	165.9	17.0

2.2.3 (continued)

MATERIAL: TI-6Al-4V  
 VENDOR HEAT NUMBER HT 293504 (RMI)  
 NR/LAD IDENTIFICATION: Heat 6

CHEMICAL COMPOSITION:

CARBON	0.03	VANADIUM	4.4
IRON	0.08	HYDROGEN	30 ppm
NITROGEN	0.010	OXYGEN	0.160
ALUMINUM	6.4		

HEAT TREAT CONDITION:

Vendor Test No.	Test Temp.	Mat'l. Cond.	Nom. Gage	Spec. Direct.	Ult. Tensile Strength Ksi	0.2% Yield Strength Ksi	% Elong.
	RT	STA	1.025	L	150.0/ 161.0	143.0/ 148.0	12.0/ 14.0
				T	145.0/ 161.0	143.0/ 148.0	11.0/ 15.0

2.2.4 Material: Ti 6Al-6V-2Sn Cond A and STA (Specification Requirements)

Specification MIL-T-9046

Sheet, Strip and Plate

Type III Comp E

SPECIFICATION MINIMUM PROPERTIES (KSI)			
	Annealed	STA	
		To 1-1/2" Thick	1-1/2" to 2" Thick
Tensile Strength (Min)	155	170	160
Yield Strength (Min) 0.2% Offset	145	160	150
Elongation %	(Long) 10 (Trans) 8	8	6

SPECIFICATION CHEMICAL LIMITS													
C (Max)	Fe (Max)	N	Al	V	Cr	Mo	H	Zr	Sn	Mn	O <sub>2</sub> (Max)	Ti	Total Other Elements (Max)
0.05	0.35	0.05	5.0	5.0	—	—	0.015	—	1.5	—	0.20	Bal	0.30
	1.00		6.0	6.0					2.5				

2.2.4 (continued)

MATERIAL: T1- 6Al-6V-2Sn  
 VENDOR HEAT NUMBER: HT G-3104 (TMCA)  
 NR/LAD IDENTIFICATION: Heat 1

CHEMICAL COMPOSITION:

CARBON	0.011	HYDROGEN	0.006
IRON	0.73	TIN	2.1
NITROGEN	0.016	COPPER	0.61
ALUMINUM	5.6	OXYGEN	0.16
VANADIUM	5.7		

HEAT TREAT CONDITION: Annealed - Anneal Temp.  
 1300F P/M 25F

Vendor Test No.	Test Temp.	Mat'l. Cond.	Nom. Gage	Spec. Direct.	Ult. Tensile Strength Ksi	0.2 % Yield Strength Ksi	% Elong.
J-0411	Room	Annealed	0.340	L	155.0	148.4	15.0
				T	166.8	161.5	18.0

2.2.4 (continued)

MATERIAL: Ti-6Al-6V-2Sn  
 VENDOR HEAT NUMBER: HT G-3212 (TMCA)  
 NR/LAD IDENTIFICATION: Heat 2

CHEMICAL COMPOSITION:

CARBON	0.024	HYDROGEN	0.007
IRON	0.70	TIN	2.0
NITROGEN	0.014	COPPER	0.66
ALUMINUM	5.4	OXYGEN	0.13
VANADIUM	5.4		

HEAT TREAT CONDITION: Annealed - Anneal Temp.  
 1300F P/M 25F

Vendor Test No.	Test Temp.	Mat'l. Cond.	Nom. Gage	Spec. Direct.	Ult. Tensile Strength Ksi	0.2 % Yield Strength Ksi	% Elong.
J-0414	Room	Annealed	0.320	L	156.1	151.1	15.0
				T	160.3	156.3	16.5

2.2.4 (continued)

MATERIAL: T1-6Al-6V-2Sn  
 VENDOR HEAT NUMBER: FT 4-3211 (TMCA)  
 NR/LAD IDENTIFICATION: Heat 3

CHEMICAL COMPOSITION:

CARBON	0.023	HYDROGEN	0.006
IRON	0.71	TIN	2.0
NITROGEN	0.010	COPPER	0.67
ALUMINUM	5.6	OXYGEN	0.15
VANADIUM	5.5		

HEAT TREAT CONDITION: Annealed - Anneal Temp.  
 1300F P/M 25F

Vendor Test No.	Test Temp.	Mat'l. Cond.	Nom. (gage)	Spec. Direct.	Ult. Tensile Strength Ksi	0.2 % Yield Strength Ksi	% Elong.
J-0413	Room	Annealed	0.310	L	157.6	152.7	15.5
				T	155.7	149.9	15.0

2.2.4 (continued)

MATERIAL: Ti-6Al-6V-2Sn

VENDOR HEAT NUMBER: HT G-881 (TMCA)

NR/LAD IDENTIFICATION: Heat 4

CHEMICAL COMPOSITION:

CARBON	0.025	HYDROGEN	0.004
IRON	0.66	TIN	2.0
NITROGEN	0.012	COPPER	0.69
ALUMINUM	5.5	OXYGEN	0.16
VANADIUM	5.5		

HEAT TREAT CONDITION: Annealed - Anneal Temp.  
1300F P/M 25F

Vendor Test No.	Test Temp.	Mat'l. Cond.	Nom. Gage	Spec. Direct.	Ult. Tensile Strength Ksi	0.2 % Yield Strength Ksi	% Elong.
J-0412	Room	Annealed	0.315	L	157.4	151.3	15.0
				T	160.5	155.4	18.0



2.2.4 (continued)

MATERIAL: Ti-6Al-6V-2Sn  
 VENDOR HEAT NUMBER: HT G 1537 (TMCA)  
 NR/LAD IDENTIFICATION: Heat 5

CHEMICAL COMPOSITION:

CARBON	0.025	HYDROGEN	0.004
IRON	0.74	TIN	2.0
NITROGEN	0.013	COPPER	0.76
ALUMINUM	5.5	OXYGEN	0.17
VANADIUM	5.6		

HEAT TREAT CONDITION: Annealed - Anneal Temp.  
 1300F P/M 25F

Vendor Test No.	Test Temp.	Mat'l. Cond.	Nom. Gage	Spec. Direct.	Ult. Tensile Strength Ksi	0.2 % Yield Strength Ksi	% Elong.
J-0415	Room	Annealed	0.310	L	159.8	154.7	14.0
				T	163.1	158.1	15.3

2.2.4 (continued)

MATERIAL: Ti-6Al-6V-2Sn

VENDOR HEAT NUMBER: HT G-393 (TMCA)

NR/LAD IDENTIFICATION: Heat 1

CHEMICAL COMPOSITION:

CARBON	0.022	HYDROGEN	0.004
IRON	0.75	TIN	1.9
NITROGEN	0.009	COPPER	0.64
ALUMINUM	5.5	OXYGEN	0.12
VANADIUM	5.3		

HEAT TREAT CONDITION: Annealed - Anneal Temp.

1300F P/M 25F

Vendor Test No.	Test Temp.	Mat'l. Cond.	Nom. Gage	Spec. Direct.	Ult. Tensile Strength Ksi	0.2 % Yield Strength Ksi	% Elong.	% Red. Area
J-0416	Room	Annealed	0.630	L	155.6	150.0	18.0	38.2
				T	155.4	151.4	16.5	35.7

2.2.4 (continued)

MATERIAL: Ti-6Al-6V-2Sn

VENDOR HEAT NUMBER: HT G-2443 (TMCA)

NR/LAD IDENTIFICATION: Heat 2

CHEMICAL COMPOSITION:

CARBON	0.023	HYDROGEN	0.004
IRON	0.67	TIN	2.1
NITROGEN	0.013	COPPER	0.66
ALUMINUM	5.3	OXYGEN	0.16
VANADIUM	5.7		

HEAT TREAT CONDITION: Annealed - Anneal Temp.

1300F P/M 25F

Vendor Test No.	Test Temp.	Mat'l. Cond.	Nom. Gage	Spec. Direct.	Ult. Tensile Strength Ksi	0.2 % Yield Strength Ksi	% Elong.
J-0420	Room	Annealed	0.610	L	159.6	156.9	16.0
				T	162.0	158.4	18.0

2.2.4 (continued)

MATERIAL: Ti-6Al-6V-2Sn

VENDOR HEAT NUMBER: HT G-1971 (TMCA)

NR/LAD IDENTIFICATION: Heat 3

CHEMICAL COMPOSITION:

CARBON	0.023	HYDROGEN	0.006
IRON	0.68	TIN	2.1
NITROGEN	0.012	COPPER	0.70
ALUMINUM	5.3	OXYGEN	0.17
VANADIUM	5.4		

HEAT TREAT CONDITION: Annealed - Anneal Temp.

1300F P/M 25F

Vendor Test No.	Test Temp.	Mat'l. Cond.	Nom. Gage	Spec. Direct.	Ult. Tensile Strength Ksi	0.2 % Yield Strength Ksi	% Elong.
J-417	Room	Annealed	0.610	L	161.0	158.2	17.0
				T	162.4	157.4	17.0

2.2.4 (continued)

MATERIAL: T1-6Al-6V-2Sn  
 VENDOR HEAT NUMBER: HT G-2504  
 NR/LAD IDENTIFICATION: Heat 4

CHEMICAL COMPOSITION:

CARBON	0.023	HYDROGEN	0.004
IRON	0.66	TIN	2.1
NITROGEN	0.011	COPPER	0.66
ALUMINUM	5.6	OXYGEN	0.16
VANADIUM	5.4		

HEAT TREAT CONDITION: Annealed - Anneal Temp.  
 1300F P/M 25F

Vendor Test No.	Test Temp.	Mat'l. Cond.	Nom. Gage	Spec. Direct.	Ult. Tensile Strength Ksi	0.2 % Yield Strength Ksi	% Elong.
J-0418	Room	Annealed	0.610	L	162.1	158.9	16.5
				T	161.1	160.1	19.5

2.2.4 (continued)

MATERIAL: T1-6Al-6V-2Sn  
 VENDOR HEAT NUMBER: HT G-3106 (TMCA)  
 NR/LAD IDENTIFICATION: Heat 5

CHEMICAL COMPOSITION:

CARBON	0.016	HYDROGEN	0.005
IRON	0.77	TIN	2.0
NITROGEN	0.019	COPPER	0.59
ALUMINUM	5.6	OXYGEN	0.15
VANADIUM	5.8		

HEAT TREAT CONDITION: Annealed - Anneal Temp.  
 1300F P/M 25F

Vendor Test No.	Test Temp.	Mat'l. Cond.	Nom. Gage	Spec. Direct.	Ult. Tensile Strength Ksi	0.2 % Yield Strength Ksi	% Elong.
J-0419	Room	Annealed	0.615	L	159.0	155.6	17.0
				T	158.8	156.3	18.0

2.2.4 (continued)

MATERIAL: T1-6A1-6V-2S1  
 VENDOR HEAT NUMBER: HT G-3023 (TMCA)  
 NR/LAD IDENTIFICATION: Heat 1

CHEMICAL COMPOSITION:

CARBON	0.023	HYDROGEN	0.004
IRON	0.67	TIN	2.0
NITROGEN	0.012	COPPER	0.63
ALUMINUM	5.5	OXYGEN	0.15
VANADIUM	5.6		

HEAT TREAT CONDITION: Annealed - Anneal Temp.  
 1300F P/M 25F

Vendor Test No.	Test Temp.	Mat'l. Cond.	Nom. Gage	Spec. Direct.	Ult. Tensile Strength Ksi	0.2 % Yield Strength Ksi	% Elong.
J-0430	Room	Annealed	1.570	L	155.9	145.5	20.0
				T	155.4	145.3	18.5

2.2.4 (continued)

MATERIAL: T1-6Al-6V-2Sn

VENDOR HEAT NUMBER: HT G-3214

NR/LAD IDENTIFICATION: Heat 2

CHEMICAL COMPOSITION:

CARBON	0.023	HYDROGEN	0.004
IRON	0.69	TIN	2.0
NITROGEN	0.011	COPPER	0.65
ALUMINUM	5.4	OXYGEN	0.17
VANADIUM	5.5		

HEAT TREAT CONDITION: Annealed - Anneal Temp.  
1300F P/M 25F

Vendor Test No.	Test Temp.	Mat'l. Cond.	Nom. Gage	Spec. Direct.	Ult. Tensile Strength Ksi	0.2 % Yield Strength Ksi	% Elong.
J-0428	Room	Annealed	1.510	L	155.4	149.4	18.0
				T	156.0	149.8	17.5



2.2.4 (continued)

MATERIAL: T1-6Al-6V-2Sn

VENDOR HEAT NUMBER: HT G-2070

NR/LAD IDENTIFICATION: Heat 3

CHEMICAL COMPOSITION:

CARBON	0.023	HYDROGEN	0.007
IRON	0.73	TIN	2.0
NITROGEN	0.009	COPPER	0.73
ALUMINUM	5.6	OXYGEN	0.15
VANADIUM	5.6		

HEAT TREAT CONDITION: Annealed - Anneal Temp.

1300F P/M 25F

Vendor Test No.	Test Temp.	Mat'l. Cond.	Nom. Gage	Spec. Direct.	Ult. Tensile Strength Ksi	0.2 % Yield Strength Ksi	% Elong.
J-0427	Room	Annealed	1.570	L	155.4	149.2	19.0
				T	161.5	151.8	18.5

2.2.4 (continued)

MATERIAL: Ti-6Al-6V-2Sn  
 VENDOR HEAT NUMBER: HT G-1971 (TMCA)  
 NR/LAD IDENTIFICATION: Heat 4

CHEMICAL COMPOSITION:

CARBON	0.023	HYDROGEN	0.004
IRON	0.68	TIN	2.1
NITROGEN	0.012	COPPER	0.70
ALUMINUM	5.3	OXYGEN	0.17
VANADIUM	5.4		

HEAT TREAT CONDITION: Annealed - Anneal Temp.  
 1300F P/M 25F

Vendor Test No.	Test Temp.	Mat'l. Cond.	Nom. Gage	Spec. Direct.	Ult. Tensile Strength Ksi	0.2 % Yield Strength Ksi	% Elong.
J-0431	Room	Annealed	1.50	L	155.2	149.6	15.5
				T	155.6	147.7	18.5

2.2.4 (continued)

MATERIAL: T1-6Al-6V-2Sn  
 VENDOR HEAT NUMBER: HT G-3024 (TMCA)  
 NR/LAD IDENTIFICATION: Heat 5

CHEMICAL COMPOSITION:

CARBON	0.023	HYDROGEN	0.004
IRON	0.69	TIN	2.0
NITROGEN	0.015	COPPER	0.62
ALUMINUM	5.6	OXYGEN	0.15
VANADIUM	5.6		

HEAT TREAT CONDITION: Annealed - Anneal Temp.

1300F P/M 25F

Vendor Test No.	Test Temp.	Mat'l. Cond.	Nom. Gage	Spec. Direct.	Ult. Tensile Strength Ksi	0.2 % Yield Strength Ksi	% Elong.
J-0429	Room	Annealed	1.60	L	156.4	151.0	17.5
				T	160.1	153.4	18.5

### 2.3 THERMAL PROCESSING OF MATERIALS

All test materials with the exception of the Ti-6Al-6V-2Sn condition STA, had all the required thermal processing done by the mill prior to receipt by NR/LAD. The Ti-6Al-6V-2Sn material which was received in the annealed condition was heat treated to the STA condition by NR/LAD. The thermal processing of all test material both at the mill or at NR/LAD conformed to the requirements of MIL-H-81200.

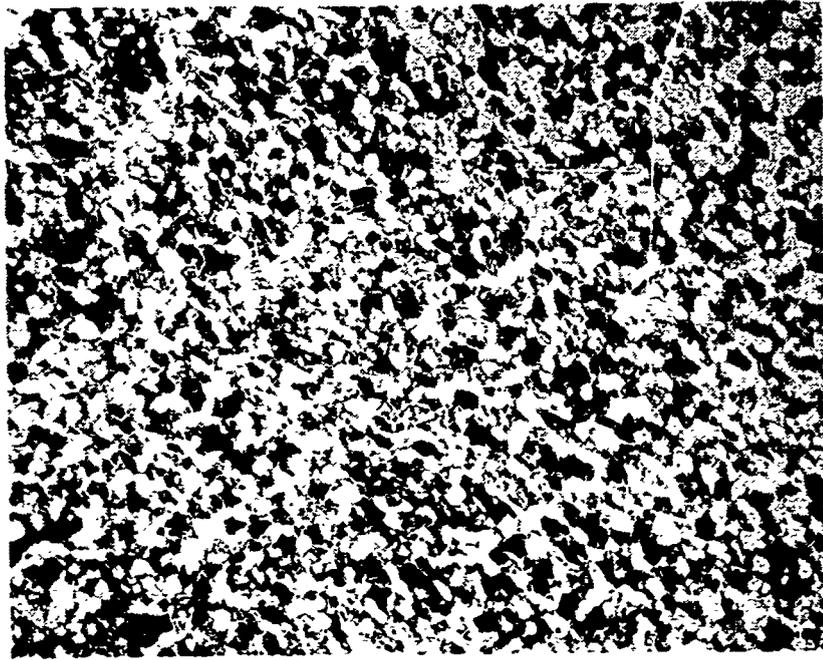
### 2.4 MICROSTRUCTURAL EXAMINATION OF TEST MATERIALS

A microstructural examination of all test material was performed by NR/LAD. The photomicrographs in conjunction with a brief analysis of the structures observed and their relationship to the resulting mechanical properties are presented in the following section.

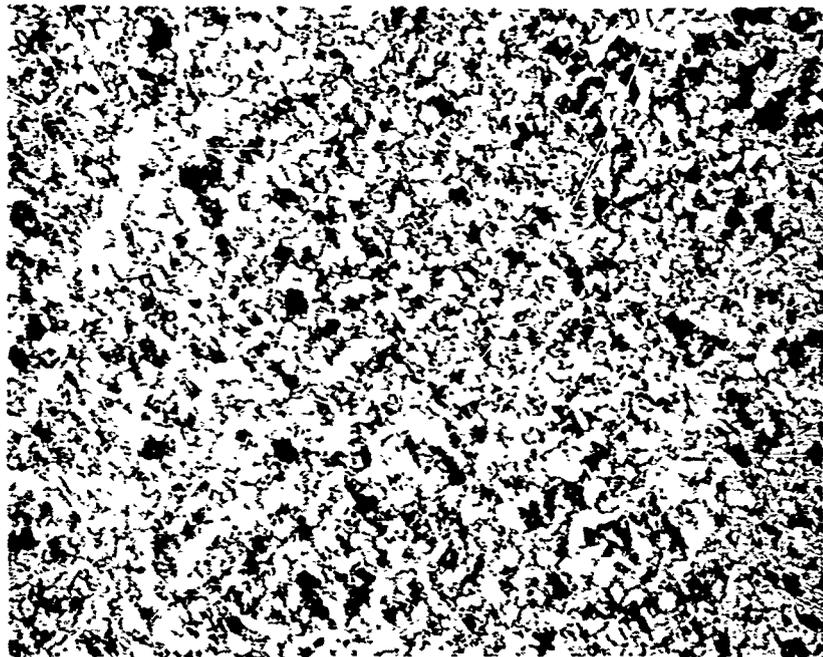
- 2.4.1 Ti-4Al-3Mo-1V, Cond. A: Photomicrographs typical of microstructures of six heats of Ti-4Al-3Mo-1V, Cond. A, program sheet material ranging in gages from 0.034" to 0.110" are shown in Figures 2-1 through 2-3. NR heat numbers 1 through 5 depict uniform, equi-axed microstructures consisting of islands of primary alpha phase surrounded by a matrix of transformed and retained beta. NR heat #3 shows some slight banding of the alpha phase which is not expected to have any unusual effect in terms of mechanical properties. NR heat #6, Figure 2-3 supplied by a different producer, exhibits a finer, more directional grain structure indicating the probability of a lower final rolling temperature in this instance. This particular photomicrograph displays a very faint trace of a prior beta grain boundary suggesting total rolling reduction may have been less than desired; however, mechanical properties tests indicate comparable mechanical properties with tensile ductility at room temperature perhaps slightly better than the other heats of Ti-4Al-3Mo-1V. In general, the microstructures of all six heats are quite uniform, the above mentioned differences being subtle, and, as would be expected, mechanical properties tests substantiate this microstructural uniformity.

FIG. 2-1

Ti 4Al-3Mo-1V Cond A



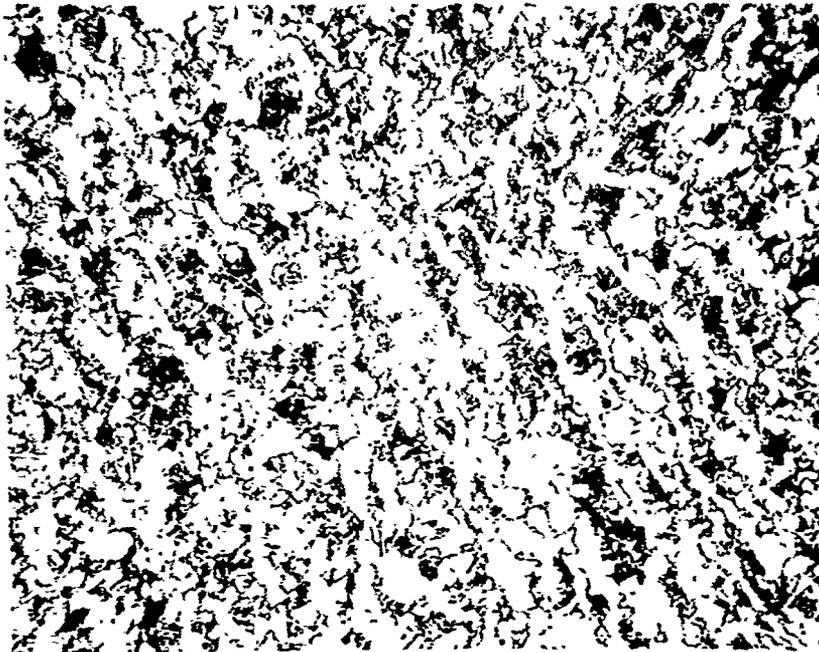
Heat G 1596 Nom Gage 0.034" NR Heat #1



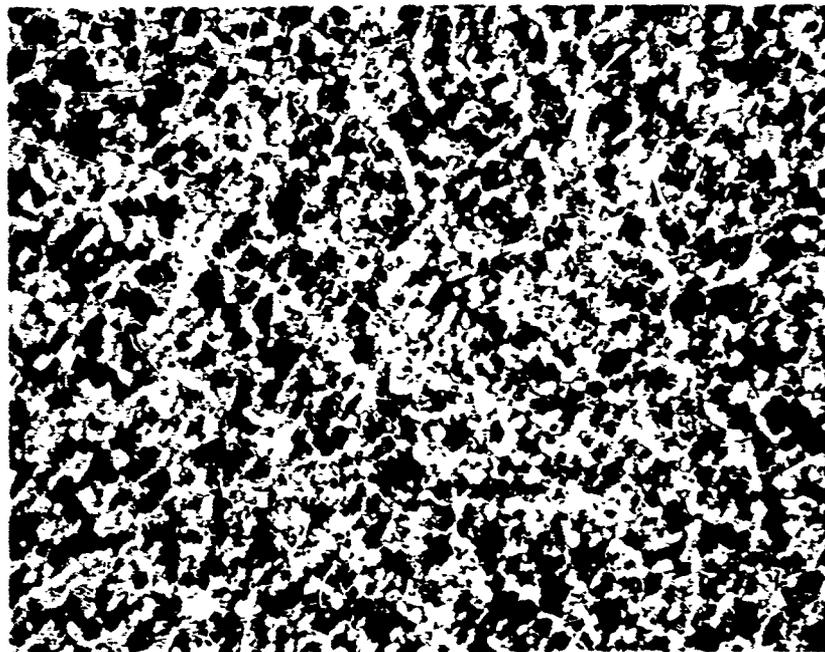
Heat G 895 Nom Gage 0.055" NR Heat #2  
500X

FIG. 2-2

TH 4Al-3Mo-1V Cond A



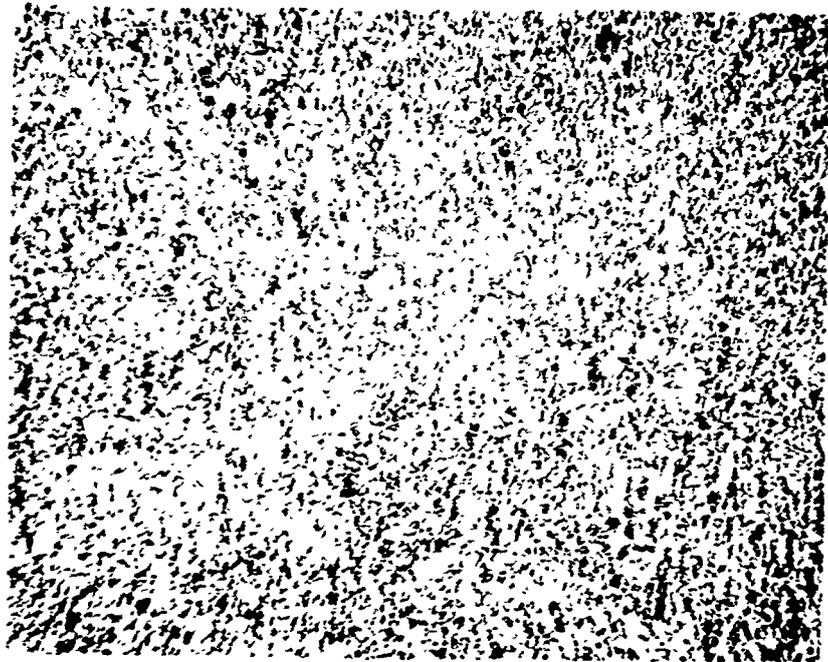
Heat G 2446 Nom Gage 0.063" NR Heat #3



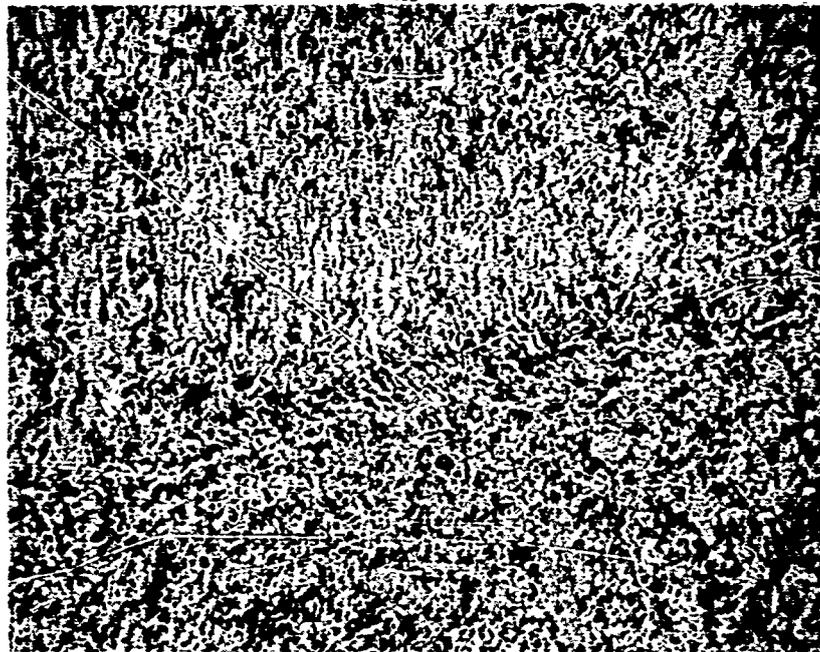
Heat G 1523 Nom Gage 0.051" NR Heat #4  
500X

FIG.2-3

T1 4Al-3Mo-IV Cond A



Heat G 1401 Nom Gage 0.067 NR Heat #5  
250X



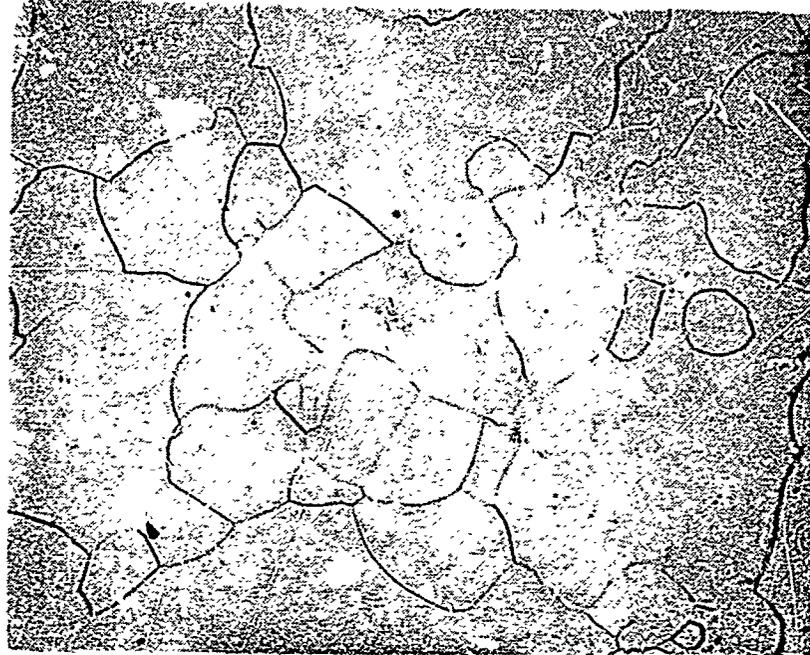
Heat 321055 Nom Gage 0.110" NR Heat #6  
500X

24.2 Ti-13V-11Cr-3Al, Cond. A (ST): Typical microstructures from five heats of alloy Ti-13V-11Cr-3Al sheet in the annealed or solution treated condition are shown in Figures 2-4 through 2-6. The photomicrographs depict structures considered normal for the material and illustrate the essentially single-phase, beta microstructure characteristic of the alloy as solution treated. Microstructural variations among the five heats are slight, NR heat numbers 3 and 5 exhibiting somewhat smaller grain size than the others. Mechanical properties of the heats are uniform and similar with NR heat numbers 3 and 5 tending to exhibit properties slightly higher than the average. This is not considered extremely significant since NR heat #4 with comparatively large grain size also exhibits higher than the average properties. Again, microstructural and properties variations are subtle.

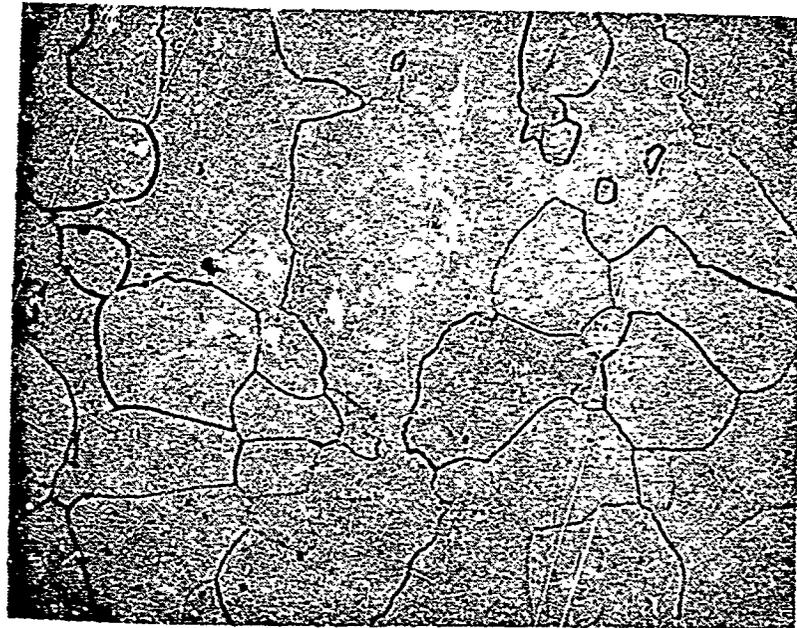


FIG. 2-4

Ti 13V-11Cr-3Al Cond A or ST



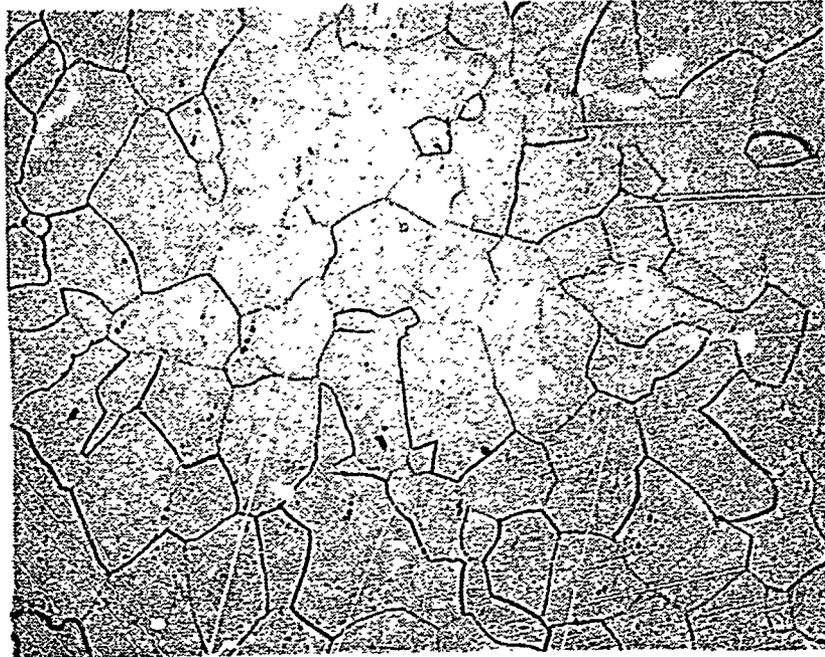
Heat D-7855 Nom Gage 0.040" NR Heat #1



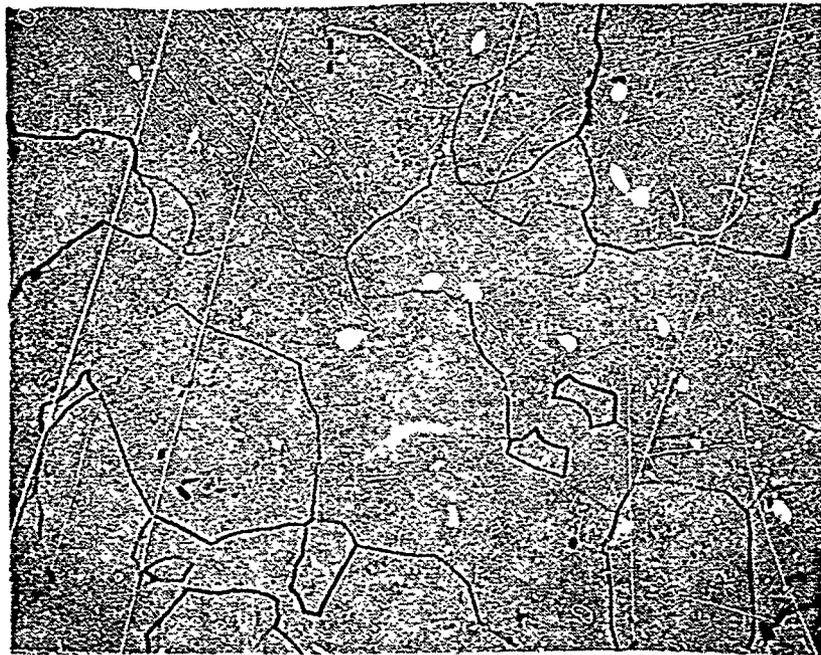
Heat D-7770 Nom Gage 0.038" NR Heat #2  
275X

FIG. 2-5

Ti 13V-11Cr-3Al Cond A or ST



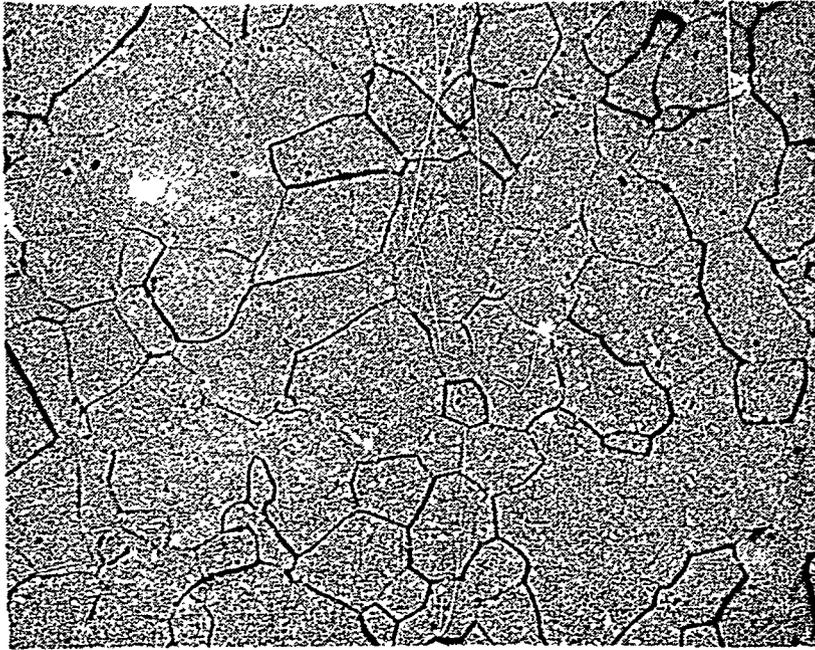
Heat D 7107 Nom Gage 0.035 NR Heat #3



Heat D 7639 Nom Gage 0.038" 275X NR Heat #4

FIG. 2-6

Ti 13V-11Cr-3Al Cond A or ST



Heat D 7110 Nom Gage 0.037 NR Heat #5

275 X

243 Ti-6Al-4V, Cond. STA: Microstructures representing eight heats of Ti-6Al-4V, Cond. STA plate are shown in Figures 2-7 through 2-10. In contrast to the other program materials, a wide variation in microstructures from heat to heat was obtained and considerable variation in mechanical properties as a function of gage, supplier, heat, and testing direction also noted.

With respect to the nominal 0.250-inch gage material, three different microstructures were obtained from the three heats of material represented. The first, G4956, Figure 2-7, shows a transus-type structure, i.e., free from primary alpha with acicular alpha, and possible alpha prime, resulting from quenching from high in the alpha-beta field. Some banding is also noted and mechanical properties are considered satisfactory for heat-treated material. The second, heat G4796, represents material though stated to be heat treated is, to the contrary, believed to be annealed. It is suggested the material was thoroughly worked during rolling at relatively low final rolling temperatures resulting in a mixture of equiaxed alpha and intergranular beta. It might be argued that the photomicrograph represents material quenched from low in the alpha-beta phase, approximately 1500°F or lower; however, properties obtained show a spread between ultimate and yield strength much more indicative of annealed material than that associated with quenched and aged retained beta. In addition, the level of mechanical properties obtained would be quite low for material at 0.15% oxygen, solution treated at 1700°F and aged at 1000°F. The third, heat X53788, represents material finished from above the beta transus temperature and quenched from high in the alpha beta field. The microstructure is uniform, fine-grained and exhibits good strength, lower tensile ductility, and relatively good fracture toughness associated with such structures.

Material in the nominal 0.500-inch gage again displays a variation in microstructure. Heats G6539 and G7278, are similar and more nearly typify structures normally associated with heat treated and aged thin-sectioned Ti-6Al-4V products. Both show a mixture of primary alpha plus aged alpha prime with the latter heat showing some gross rolling deformation. Properties too reflect typical strength levels and tensile ductilities for such material in both cases, the latter indicating greater anisotropy, as might be expected. Material from heat 302634, Figure 2-9 again illustrates material finish rolled from above the beta transus, quenched from high in the alpha-beta field and aged. Microstructure is similar to that of 0.250-inch gage heat X53788 with somewhat higher strength, probably due to higher oxygen content.

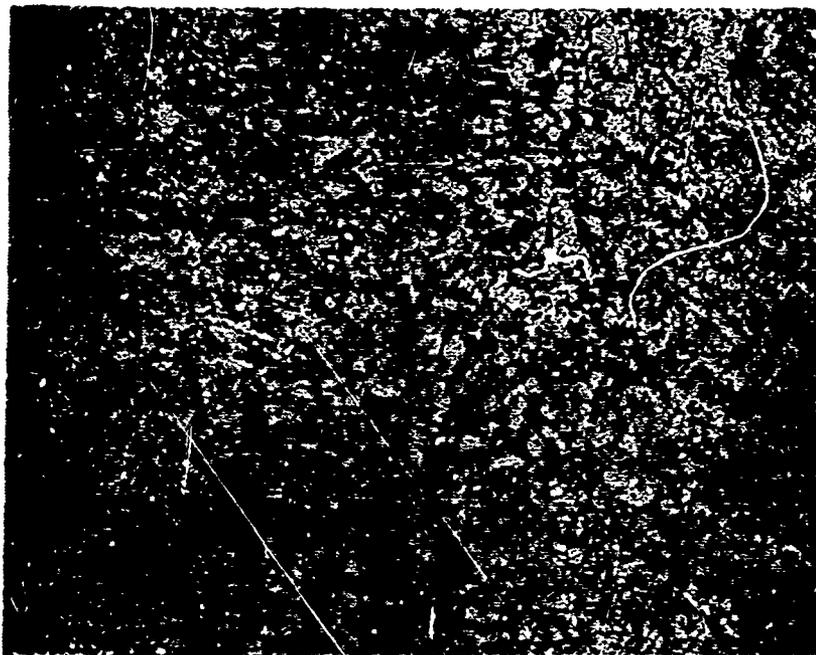
In the nominal 1.00-inch plate gage somewhat different microstructures were obtained for the two heats of material displayed, Figure 2-10, representing somewhat different working histories. Both display material rolled and heat treated in the alpha-beta field; however, with properties expected of material so processed.

FIG.2-7

T1 6A1-4V Cond STA



Heat G 4956 Nom Gage 0.250" NR Heat #1



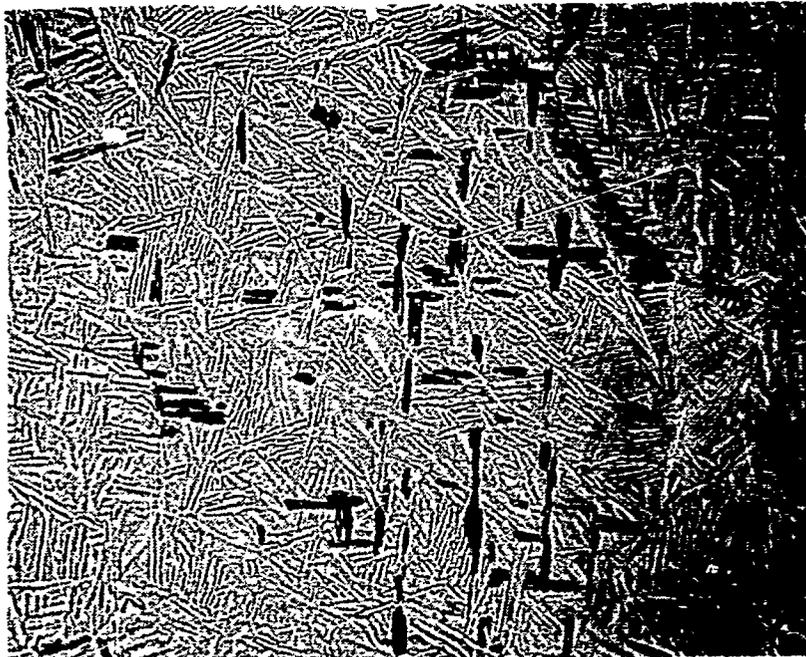
Heat G 4796 Nom Gage 0.250" NR Heat #2

250 X

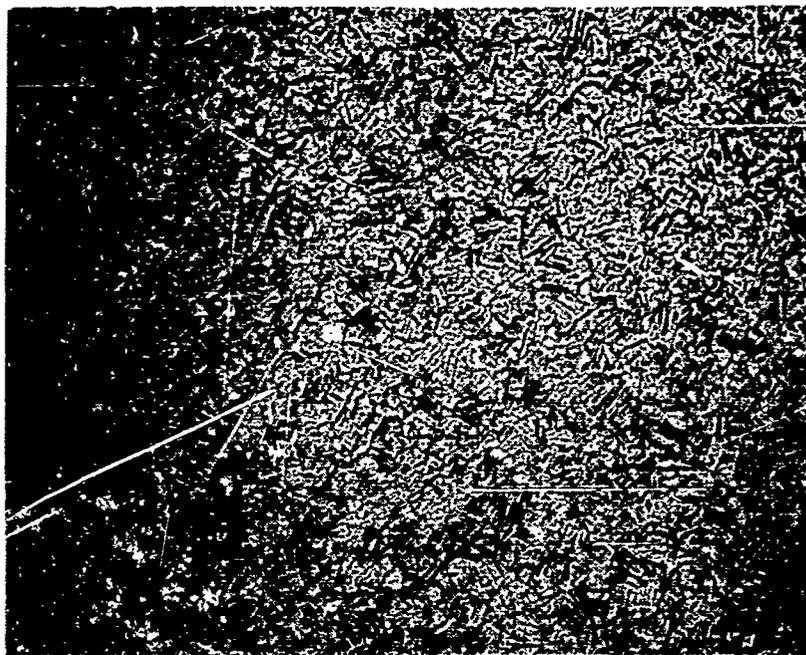
FIG. 2-8

Ti 6Al-4V

Cond STA



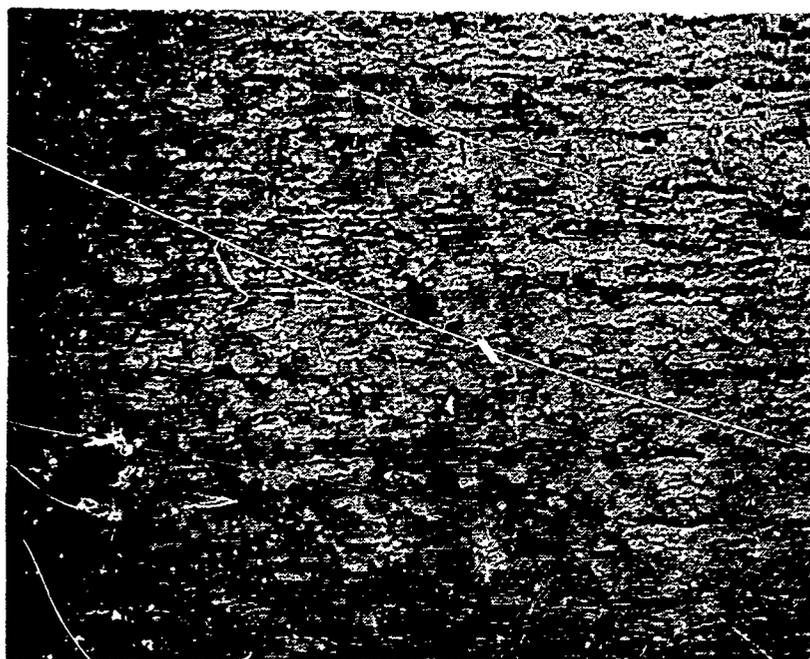
Heat X 53788      Nom Gage 0.250"      NR Heat #6



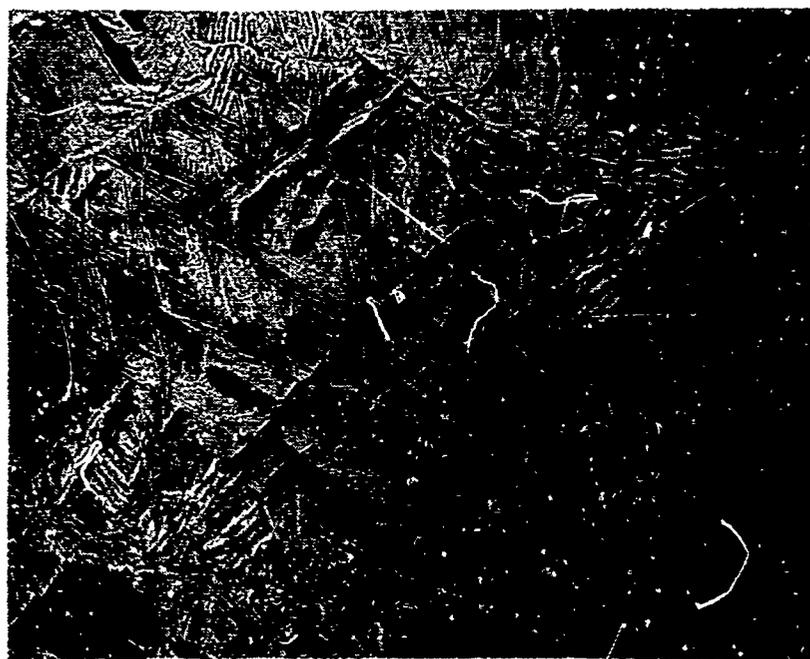
Heat G 6539      Nom Gage 0.500"      NR Heat #1

FIG. 2-9

Ti 6Al-4V Cond STA



Heat G 7278 Nom Gage 0.500" NR Heat #2



Heat 302634 Nom Gage 0.475" NR Heat #7

250 X

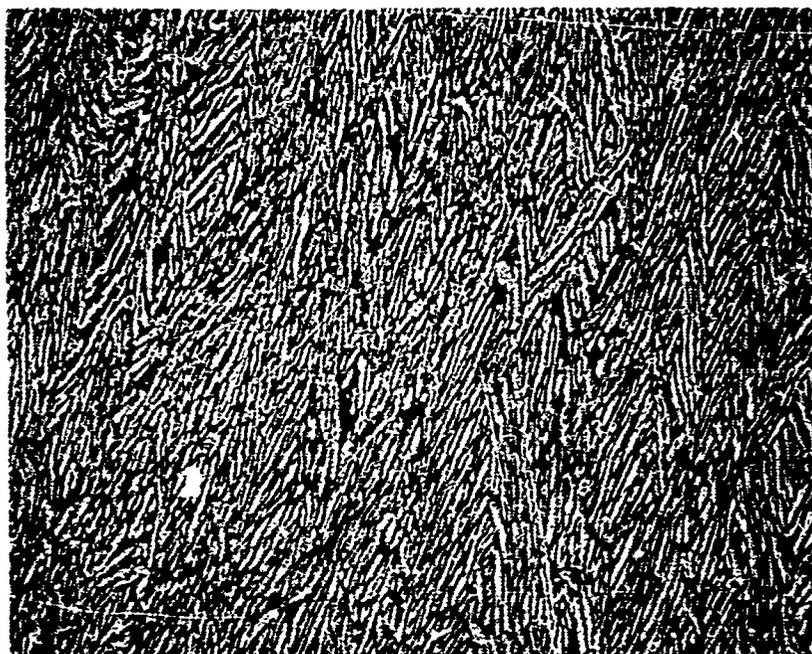
FIG. 2-10

Ti 6Al-4V

Cond STA



Heat G 7021 Nom Gage 1.025" NR Heat #2



Heat 293504 Nom Gage 1.025" NR Heat #6

250 X



2.4.4 Ti-6Al-6V-2Sn, Cond. A and STA: Typical microstructures of 14 heats of alloy Ti-6Al-6V-2Sn plate both annealed and fully heat treated are shown in Figures 2-11 through 2-25. Photomicrographs for annealed plate of the nominal 0.250 inch gage (0.310 to 0.340-inch), Figures 2-11 through 2-13 depict thoroughly worked microstructures of primary alpha phase in a retained beta phase matrix. Phase delineation is not distinct in any of the five, the microstructures all showing evidence of considerable grain deformation from working at low, final rolling temperatures, and of course fine grain size. Variations among the five heats are extremely small metallographically and, as expected, properties are also uniformly high.

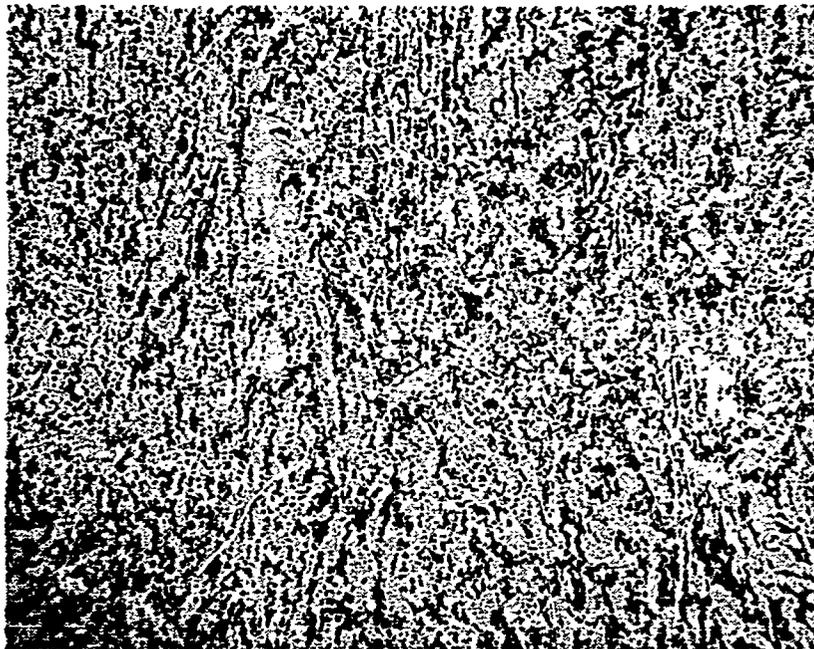
As gages are increased, variation in rolling practice becomes evident. The five heats of the nominal 0.500-inch gage (0.610 to 0.630-inch) plate shown in Figures 2-14 through 2-16, both annealed and heat treated, continue to illustrate a fine-grained, thoroughly-worked microstructure. Phase demarkation is somewhat greater; however, even in the annealed material suggesting higher finish rolling temperatures. This is a matter of small degree, nevertheless, since annealed properties remain quite high for the annealed 0.500-inch material in comparison to the 0.250-inch. The effects of heat treatment to Cond. STA are quite clearly illustrated showing an increase in the beta phase at the expense of alpha due to quenching from high in the alpha-beta field.

With increase in gage of plate to 1.50-inch nominal gage (1.50 to 1.60-inch), the higher finish rolling temperature required becomes evident, particularly in the microstructures of annealed material, Figures 2-17 through 2-19. The alpha phase is seen to be present, in all five heats, in the form of moderately coarse platelet form, fairly well distributed throughout the microstructure with little evidence of prior beta grain boundaries. Properties are correspondingly lower than the annealed thinner gage material, as would be expected. Again uniformity of properties among the five heats is evident both annealed and heat treated, in spite of the localized aberrations noted in two of the microstructures of Cond. STA material. Some rather pronounced coarseness of the primary alpha plates with the suggestion of prior beta grain boundary alpha formation is seen in NR heat #8, Figure 2-24, and in contrast, a localized enrichment of beta phase material is evident in the microstructure of NR heat #10, Figure 2-25, due probably to chemical segregation of beta-stabilizer element(s) in the ingot. Neither of these conditions appears to be general throughout the material to the extent that mechanical properties test results show no effect.

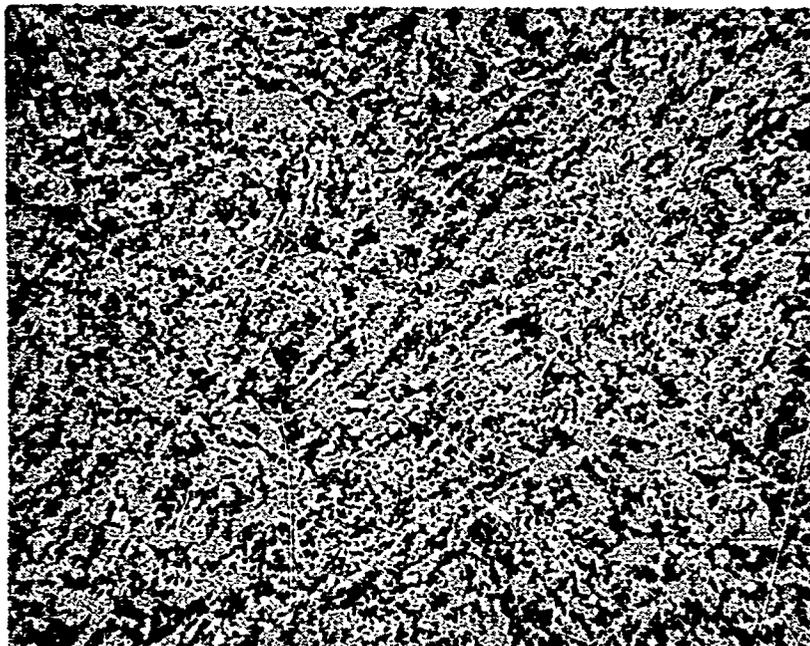
FIG. 2-11

Ti 6Al-6V-2Sn

Cond A



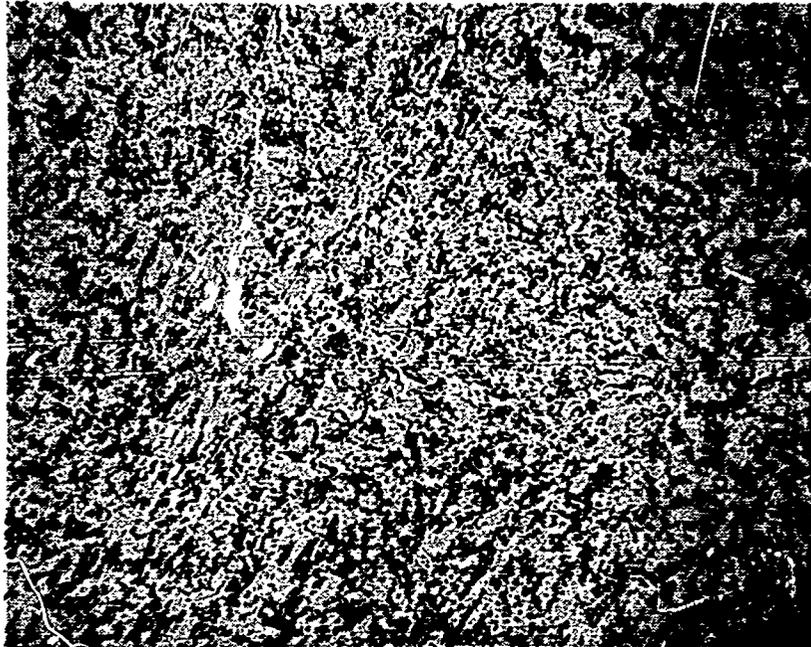
Heat G 3105 Nom Gage 0.340" NR Heat #1



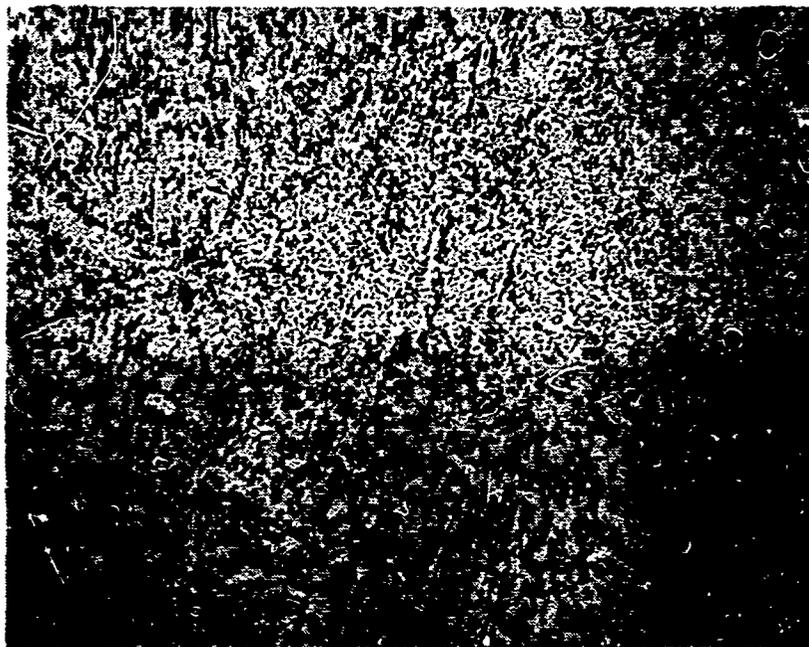
Heat G 3212 Nom Gage 0.330 NR Heat #2  
275X

FIG. 2-12

TH 6Al-6V-2Sn Cond A



Heat G 3211 Nom Gage 0.320 NR Heat #3

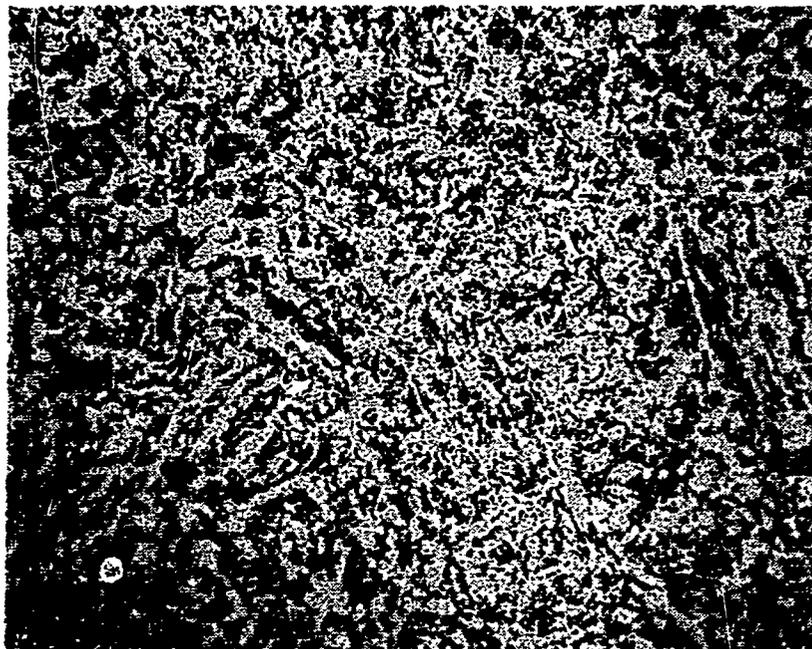


Heat G 881 Nom Gage 0.315 NR Heat #4  
275X

FIG. 2-13

Ti 6Al-6V-2Sn

Cond A



Heat G 1537

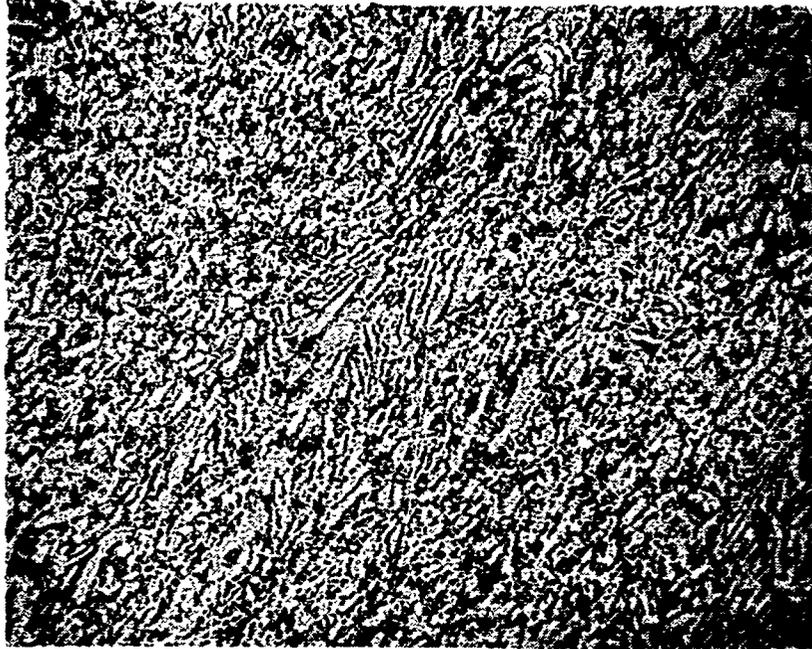
Nom Gage 0.310

NR Heat #5

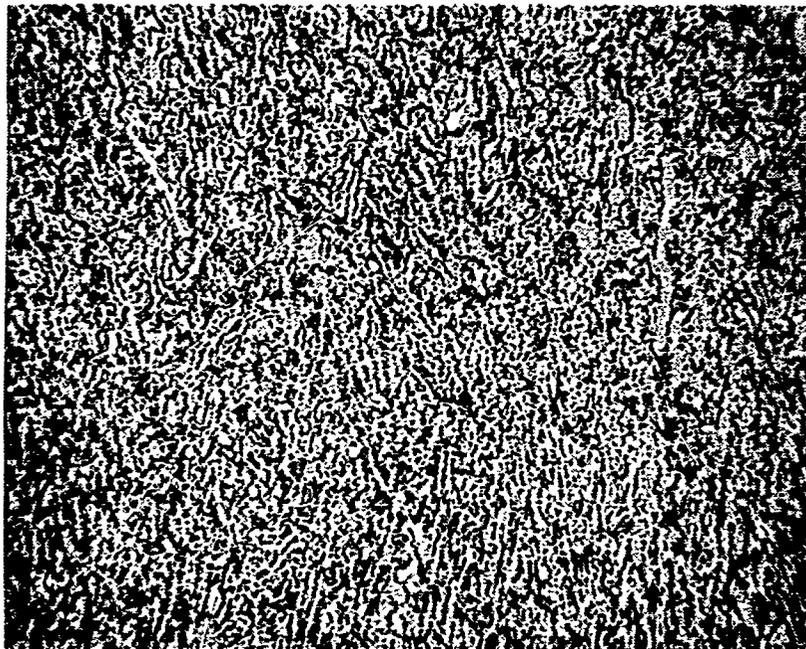
275X

FIG. 2-14

Ti 6Al-6V-2Sn



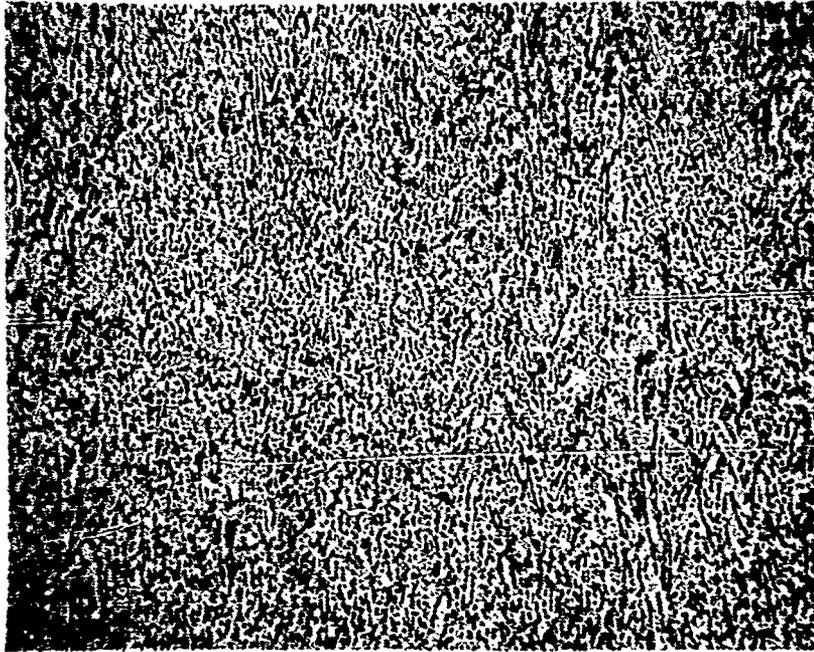
Heat G 393 Nom Gage 0.630" NR Heat #1



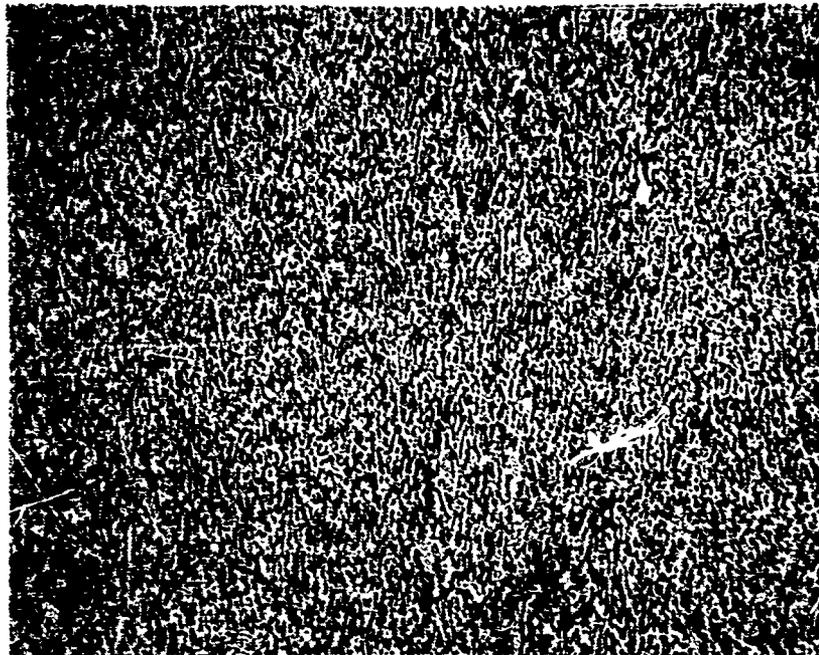
Heat G 2443 Nom Gage 0.610" NR Heat #2  
275X

FIG. 2-15

Ti 6Al-6V-2Sn Cond A



Heat G 1971 Nom Gage 0.610" NR Heat #3

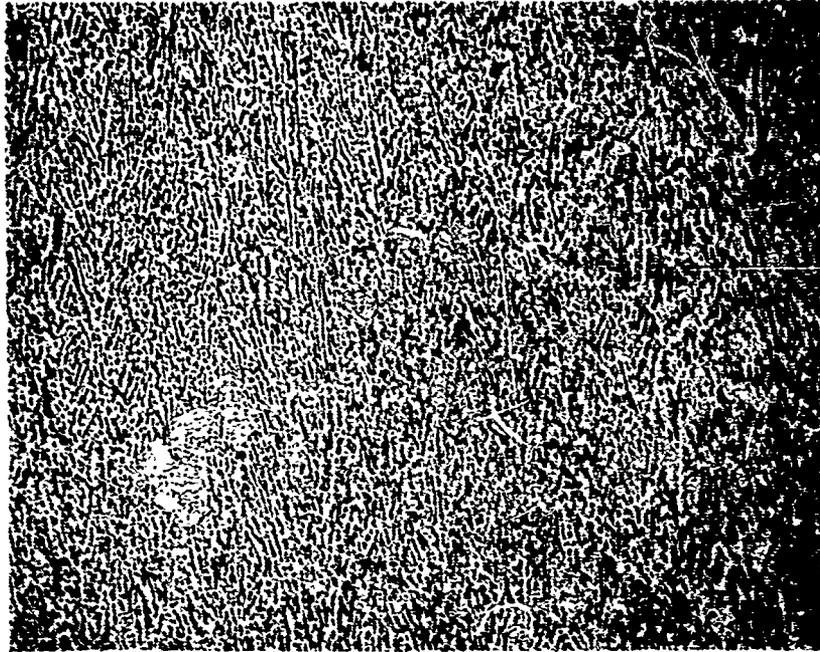


Heat G 2504 Nom Gage 0.610" NR Heat #4

275X

FIG. 2-16

Ti 6Al-6V-2Sn Cond A

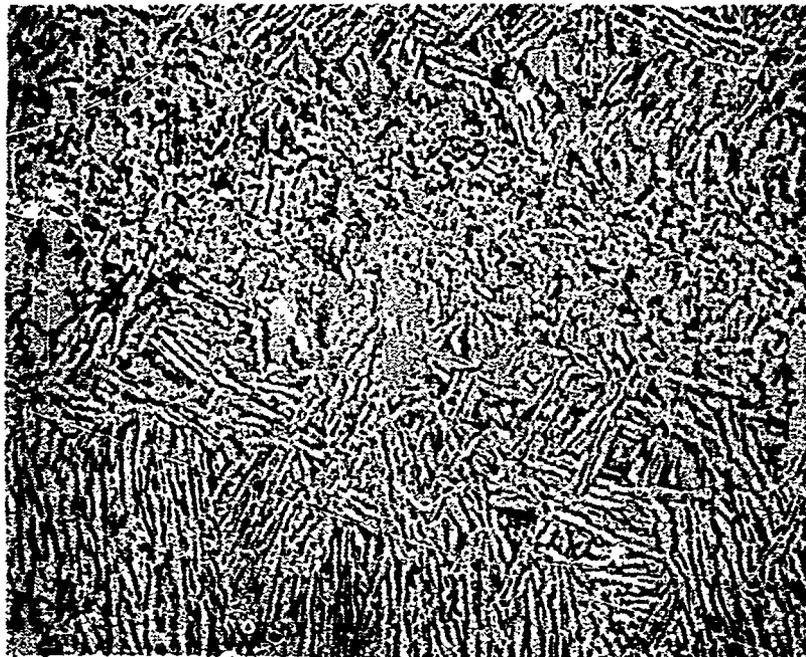


Heat G 3106 Nom Gage 0.615 NR Heat #5

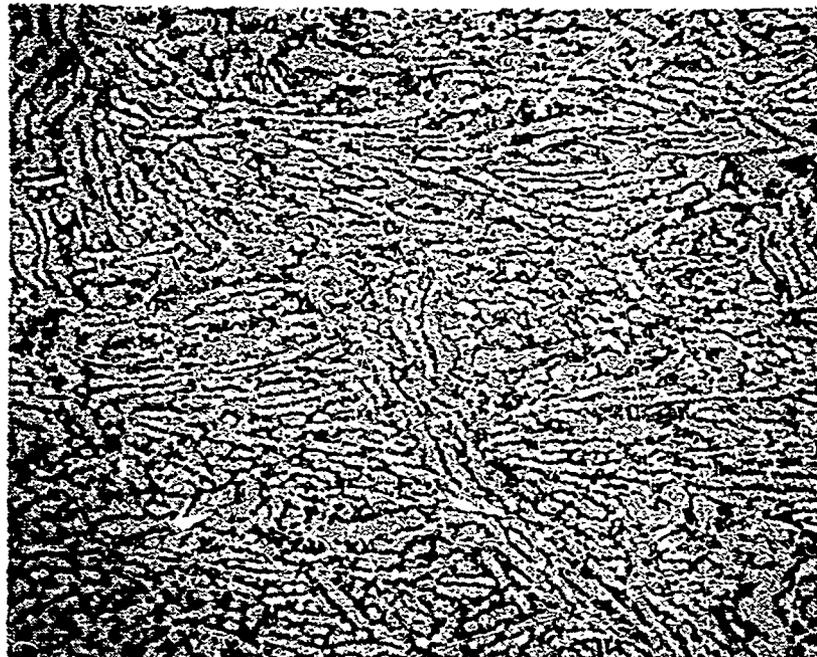
275X

FIG. 2-17

Ti 6Al-6V-2Sn Cond A



Heat G 3023 Nom Gage 1.570" NR Heat #1

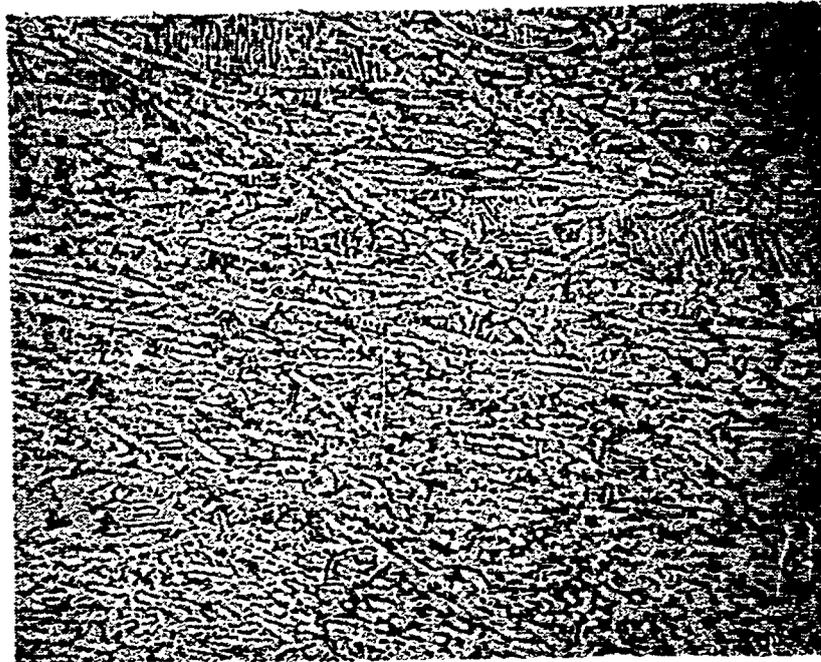


Heat G 3214 Nom Gage 1.570  
275X NR Heat #2



FIG. 2-18

Ti 6Al-6V-2Sn Cond A



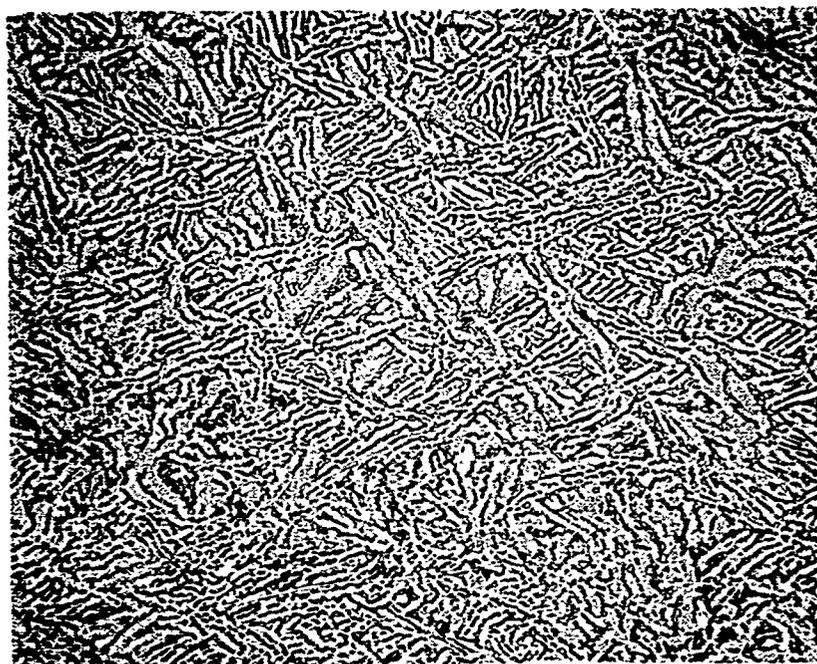
Heat G 2070 Nom Gage 1.570 NR Heat #3



Heat G 1971 Nom Gage 1.50 NR Heat #4  
275X

FIG. 2-19

Ti 6Al-6V-2Sn      Cond A

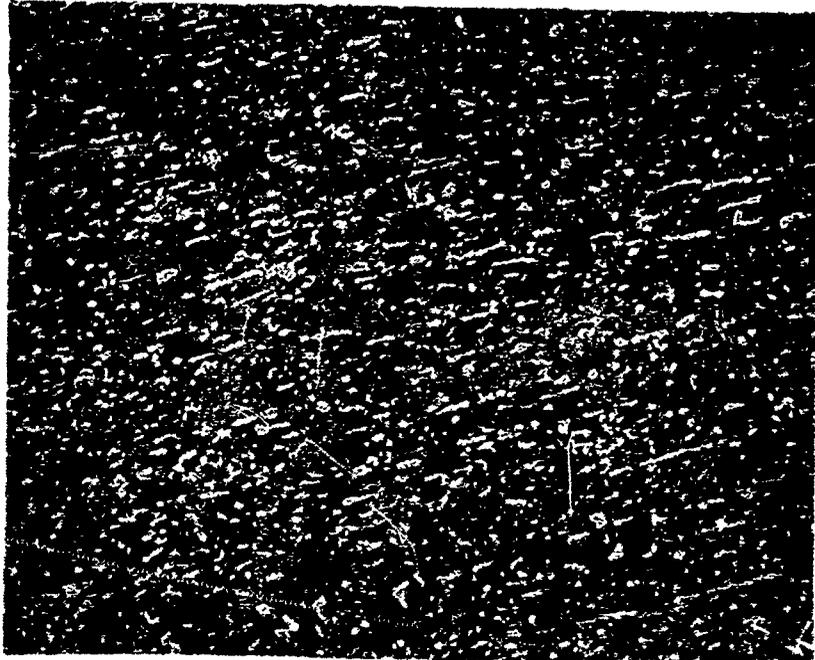


Heat G 3024      Nom Gage 1.60"      NR Heat 5

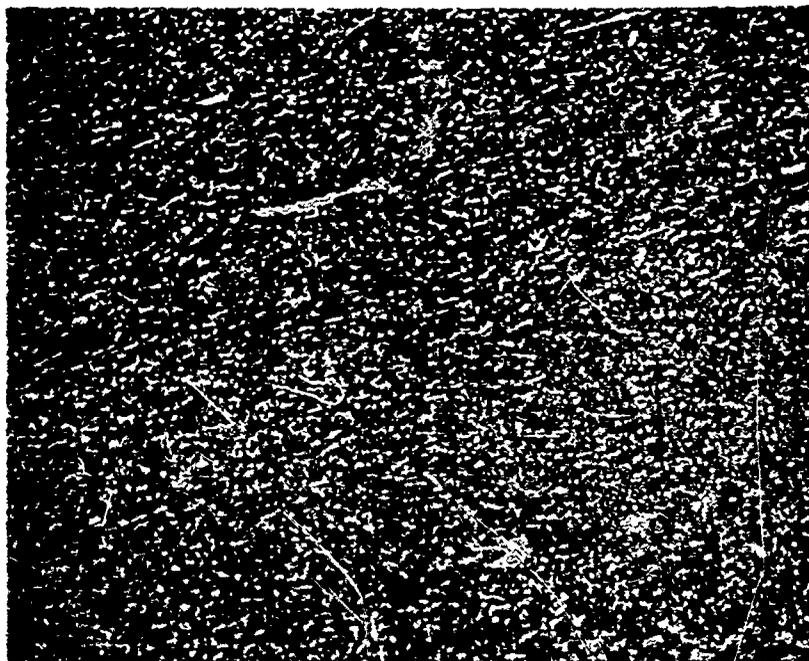
275X

FIG. 2-20

Ti 6Al-6V-2Sn Cond STA



Heat G 393 Nom Gage 0.630" NR Heat #6

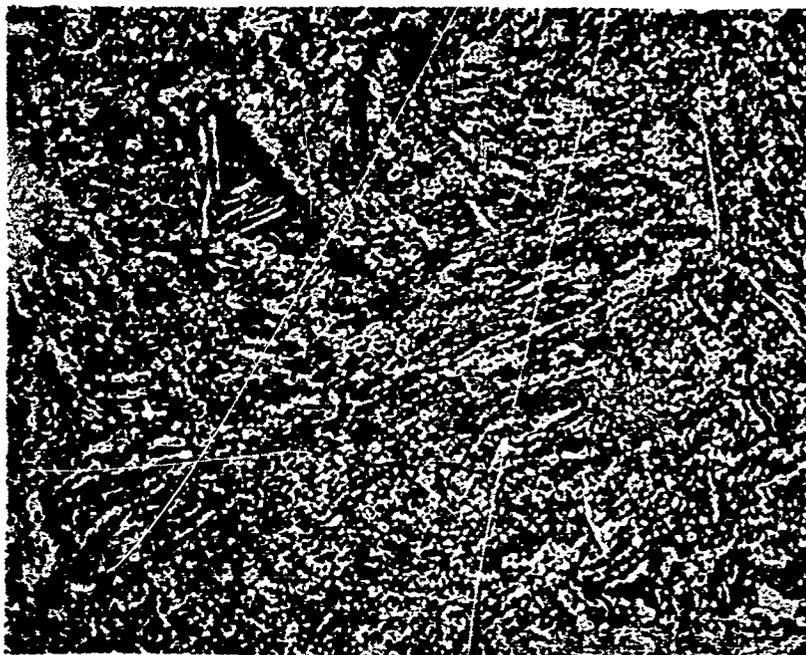


Heat G 2443 Nom Gage 0.610" NR Heat #7  
250X

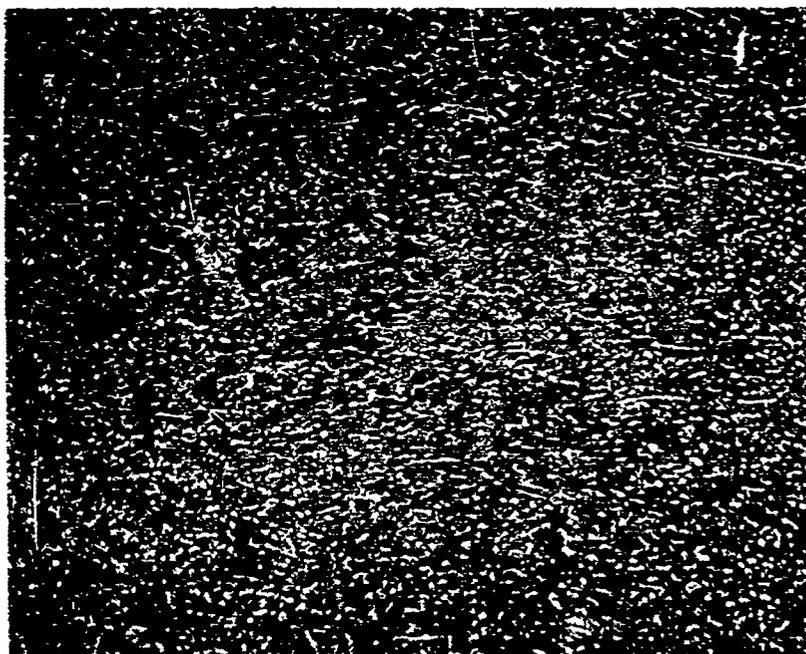
NOT REPRODUCIBLE

FIG. 2-21

Ti 6Al-6V-2Sn Cond STA



Heat G 1971 Nom Gage 0.610" NR Heat #8



Heat G 2504 Nom Gage 0.610" NR Heat #9  
250X

FIG. 2-22

T1 6Al-6V-2Sn Cond STA

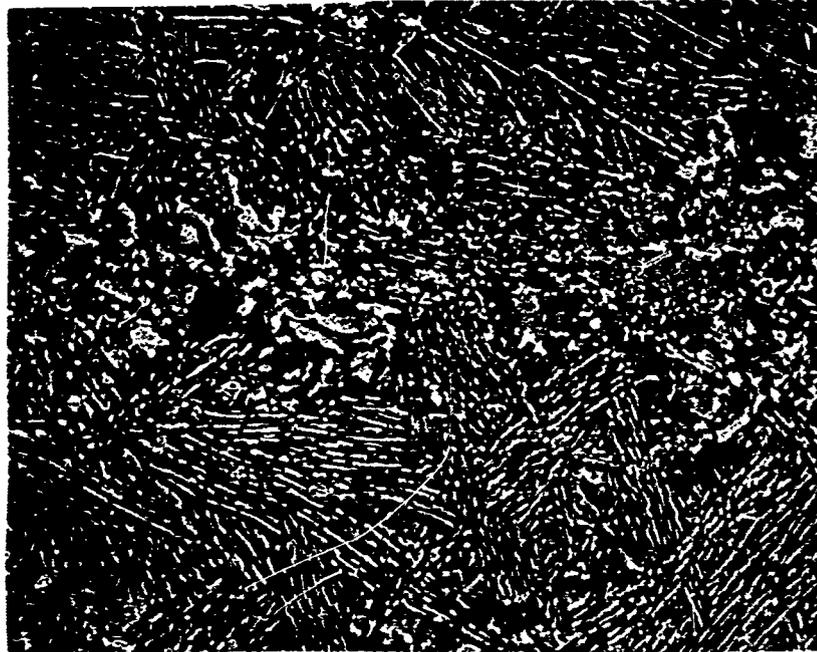


neat G 3106 Nom Gage 0.615 HR Heat #10

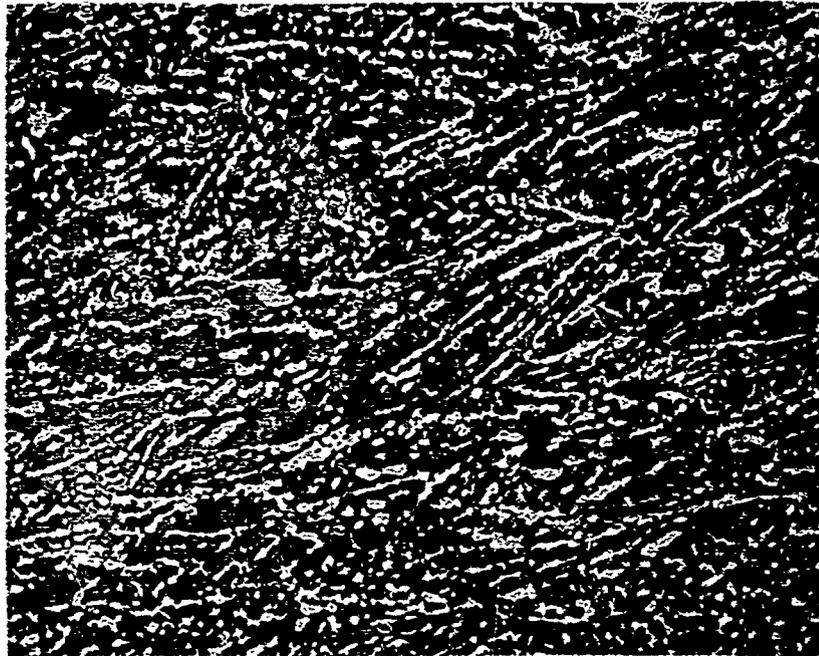
250 X

FIG. 2-23

Ti 6Al-6V-2Sn Cond STA



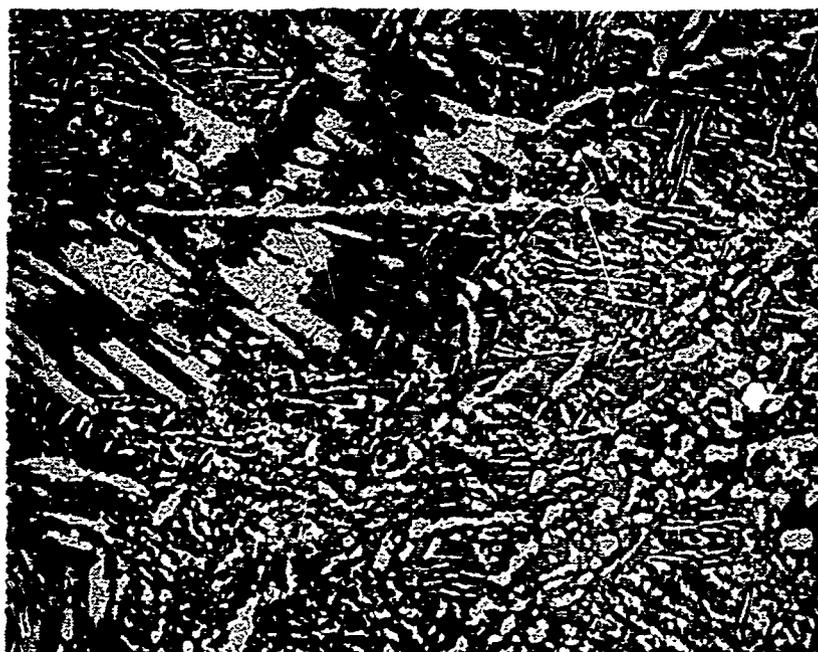
Heat G 3023 Nom Gage 1.570" NR Heat #6



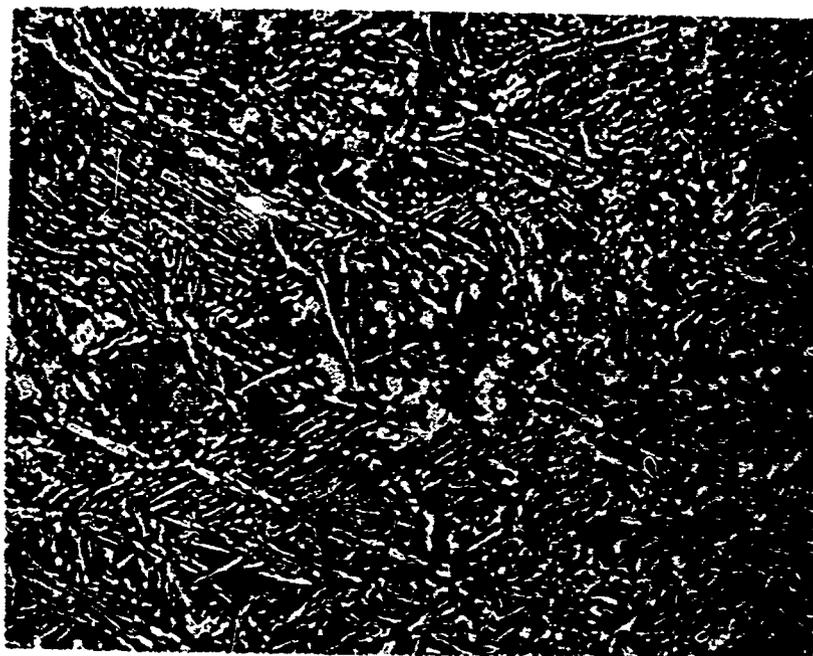
Heat G 3214 Nom Gage 1.570" NR Heat #7  
250X

FIG. 2-24

TI 6Al-6V-2Sn Cond STA



Heat G 2070 Nom Gage 1.570 NR Heat #8

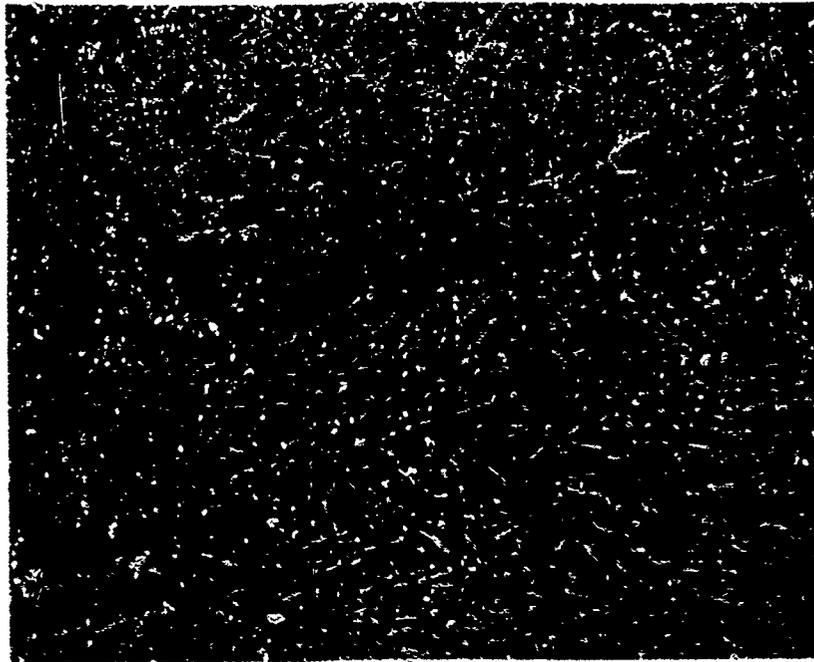


Heat G 1971 Nom Gage 1.50 NR Heat #9

250 X

FIG. 2-25

Ti 6Al-6V-2Sn Cond STA



Heat G 3024 Nom Gage 1.60 NR Heat #10

250 X

70



### Mechanical Properties Determined

2.5 The various mechanical properties determined from each type of test performed are as follows:

1. Tensile Tests - Sheet and Plate
  - (a) Ultimate Tensile Strength
  - (b) 0.2% Offset Tensile Yield Strength
  - (c) Percent Elongation
  - (d) Percent Reduction of Area
  - (e) Precision Elastic Tension Modulus (Selected Sample)
2. Compression Tests - Sheet and Plate
  - (a) 0.2% Offset Compression Yield Strength
3. Bearing Tests - Sheet and Plate  
 $e/D = 1.5$  and  $e/D = 2.0$ 
  - (a) Ultimate Bearing Strength
  - (b) 2% Offset Bearing Yield Strength
4. Shear Tests - Sheet and Plate
  - (a) Ultimate Shear Strength
5. Fracture Toughness Tests - Plate
  - (a) Plane Strain Fracture Toughness Value (K<sub>1c</sub>)
6. Thermal Stability Tests - Sheet and Plate
  - (a) Ultimate Tensile Strength, 0.2% Offset Yield Strength, % Elongation, % Reduction in Area for test specimens at room temperature and elevated temperature after exposure to elevated temperature for prolonged periods of time.
7. Fatigue Tests - Sheet and Plate
  - (a) Stress versus number of cycles to failure, as a function of specimen geometry (smooth and notched) as well as stress-ratio.

### 2.6 Test Conditions

Room and elevated temperature, tension, compression, bearing, and shear mechanical property tests for the longitudinal and transverse direction as well as limited test in the short transverse direction for the four materials were performed in an air atmosphere. The range of elevated test temperatures included 400F, 600F, and 800F. The thermal stability tests which determined the effects of exposure

in air temperatures of 400F, 600F, and 800F for times of 10, 100, and 1000 hours, were compiled from tests at exposure temperature and at room temperature after exposure.

Fracture toughness test data were obtained at room temperature in air. In addition, fracture toughness tests were made on specimens at room temperature which had been exposed at 400F, 600F, and 800F for periods of 10, 100, and 1000 hours.

Axial fatigue tests were performed on three of the materials in the longitudinal direction using smooth test specimen configurations ( $K_t = 1.0$ ) and notched test specimen configurations ( $K_t = 3.0$ ). The tests were run at room temperature at stress ratios of  $R = 1.0, -0.3, 0$  and  $+0.3$  where:

$$R = \frac{\text{Minimum Stress}}{\text{Maximum Stress}}$$

Test conditions for the complete program are shown in Tables II-1 through II-6.

Table 11-1

TENSION TESTS

NUMBER OF TESTS PER TEMPERATURE

Material	Thickness (inches)	WT	400 °F	600 °F	800 °F	Thermal Stability									
						Tested at 400 °F		Tested at 600 °F		Tested at 800 °F		Tested at Elevated Temp.			
						400 °F	600 °F	400 °F	600 °F	400 °F	600 °F	400 °F	600 °F		
T1 4AL-3Mo-1V (Cond. A)	≤ 0.110	12	8	8	8	3	3	3	3	3	3	3	3	3	3
T1 13V-11Cr-3Al (Cond. A)	≤ 0.110	10	6	6	6	3	3	3	3	3	3	3	3	3	3
T1 6AL-4V (STA)	0.250-0.300	6	5	5	5	3	3	3	3	3	3	3	3	3	3
T1 6AL-4V (STA)	0.500-0.650	6	2	2	2	3	3	3	3	3	3	3	3	3	3
T1 6AL-4V (STA)	≥ 1.000	6	3	3	3	3	3	3	3	3	3	3	3	3	3
T1 6AL-6V-2Sn (Cond. A)	0.250-0.300	10	5	5	5	3	3	3	3	3	3	3	3	3	3
T1 6AL-6V-2Sn (Cond. A)	0.500-0.650	10	2	2	2	3	3	3	3	3	3	3	3	3	3
T1 6AL-6V-2Sn (Cond. A)	≥ 1.000	15	3	3	3	3	3	3	3	3	3	3	3	3	3
T1 6AL-6V-2Sn (STA)	0.250-0.300	2	1	1	1	3	3	3	3	3	3	3	3	3	3
T1 6AL-6V-2Sn (STA)	0.500-0.650	14	2	2	2	3	3	3	3	3	3	3	3	3	3
T1 6AL-6V-2Sn (STA)	≥ 1.000	20	3	3	3	3	3	3	3	3	3	3	3	3	3

Table 11-2

## COMPRESSION TESTS

## NUMBER OF TESTS PER TEMPERATURE

Material	Thickness (inches)	RT	400°F	600°F	800°F
TI 4AL-3Mo-1V (Cond. A)	≤0.110	12	4	4	4
TI 13V-11CR-3Al (Cond. A)	≤0.110	10	2	2	2
TI 6AL-4V (STA)	0.250-0.300	6	4	4	4
TI 6AL-4V (STA)	0.500-0.650	6	2	2	2
TI 6AL-4V (STA)	≥1.000	6	3	3	3
TI 6AL-6V-2Sn (Cond. A)	0.250-0.300	10	2	2	2
TI 6AL-6V-2Sn (Cond. A)	0.500-0.650	10	2	2	2
TI 6AL-6V-25n (Cond. A)	≥1.000	15	3	3	3
TI 6AL-6V-2Sn (STA)	0.250-0.300	2	-	-	-
TI 6AL-6V-2Sn (STA)	0.500-0.650	10	2	2	2
TI 6AL-6V-2Sn (STA)	≥1.000	15	3	3	3

Table 11-3

BEARING TESTS

NUMBER OF TESTS PER TEMPERATURE

Material	Thickness (inches)	ø/D = 1.5				ø/D = 2.0			
		RT	400 F	600 F	800 F	RT	400 F	600 F	800 F
		TH 4AL-3Mo-1V (Cond. A)	8	4	4	4	4	4	4
TH 13V-11CR-3AL (Cond. A)	6	2	2	2	2	2	2	2	
TH 6AL-4V (STA)	5	4	4	4	4	4	4	4	
TH 6AL-4V (STA)	4	1	1	1	1	1	1	1	
TH 6AL-4V (STA)	5	1	1	1	1	1	1	1	
TH 6AL-6V-2Sn (Cond. A)	6	2	2	2	2	2	2	2	
TH 6AL-6V-2Sn (Cond. A)	6	1	1	1	1	1	1	1	
TH 6AL-6V-2Sn (Cond. A)	8	1	1	1	1	1	1	1	
TH 6AL-6V-2Sn (STA)	1	-	-	-	-	-	-	-	
TH 6AL-6V-2Sn (STA)	6	1	1	1	1	1	1	1	
TH 6AL-6V-2Sn (STA)	8	1	1	1	1	1	1	1	

Table 11-4

SHEAR TESTS

NUMBER OF TESTS PER TEMPERATURE

Material	Thickness (inches)	RT	400°F	600°F	800°F
TH 6AL-3Mo-1V (Cond. A)	≤ 0.110	8	4	4	4
TH 13V-11CR-3AL (Cond. A)	≤ 0.110	6	2	2	2
TH 6AL-4V (STA)	0.250-0.310	5	4	4	4
TH 6AL-4V (STA)	0.500-0.630	4	1	1	1
TH 6AL-4V (STA)	≥ 1.00	3	1	1	2
TH 6AL-6V-2Sn (Cond. A)	0.250-0.310	6	2	1	1
TH 6AL-6V-2Sn (Cond. A)	0.500-0.630	6	1	1	1
TH 6AL-6V-2Sn (Cond. A)	≥ 1.00	6	1	1	1
TH 6AL-6V-2Sn (STA)	0.250-0.310	1	-	-	-
TH 6AL-6V-2Sn (STA)	0.500-0.630	6	1	1	1
TH 6AL-6V-2Sn (STA)	≥ 1.00	6	1	1	1

Table 11-5  
**FRACTURE TOUGHNESS TESTS**  
**NUMBER OF TESTS**

Material	Material Thickness	RT	Thermal Stability - Tested at R.T.		
			400°F	600°F	800°F
TI 6AL-4 (STA)	0.250 to 0.300	5	3	3	3
TI 6AL-6V-25Ti (Cond. A)	0.250 to 0.300	6	3	3	3
TI 6AL-6V-25Ti	0.250 to 0.300	1	-	-	-

Table II-6

TENSION-TENSION FATIGUE TESTS

NUMBER OF TESTS

Material	Material Thickness	RT	
		Smooth K <sub>t</sub> 1.0	Notched K <sub>t</sub> 3.0
TI 4AL-3Mo-1V (Cond. A)	≤ 0.110"	32	32
TI 6AL-4V (STA)	- 1.000"	24	24
TI 6AL-6V-2Sn (Cond. A)	≥ 1.000"	32	32
TI 6AL-6V-2Sn (STA)	≥ 1.000"	32	32



### Section III

#### TEST SPECIMENS

Contained within this section are the; (1) test specimen identification codes, (2) test specimen sampling, (3) test specimen configurations and (4) test specimen preparation procedures.

	Page
Test Specimen Identification Codes	80 - 81
Test Specimen Sampling	82
Test Specimen Configurations	84 - 95
Test Specimen Preparation	96

SECTION III  
TEST SPECIMENS

3.1 SPECIMEN IDENTIFICATION CODES

A typical test specimen identification would be as follows: TVIZLTRL. In general, test specimen code numbers will have the above form with each letter or number having a specific meaning as indicated below:

The letter "T" or "R" indicates the producer which are Titanium Metals Corp. and Reactive Metals, Inc.

The next letter in the coding system indicates the alloy:

- A - Ti-6Al-4V (Cond. STA)
- V - Ti-6Al-6V-2Sn (Cond. A and STA)
- C - Ti-13V-11Cr-3Sn (Cond. A or ST)
- M - Ti-4Al-3Mo-1V (Cond. A)

The following number in the coding sequence identifies the heat number for the particular alloy. There can be as many as 10 heats.

The next letter in the coding sequence relates to the gage of material being tested. In this regard these letters have been utilized in the following manner:

- X - Gages of Material  $< 0.250$  In.
- Y - Gages of Material  $\leq 0.630$  In.
- Z - Gages of Material  $\geq 1.000$  In.

The above applies to both sheet and plate stock gages with all sheet specimens using the X designation.

The next letter indicates test specimen orientation in relation to the rolling direction marked on the raw stock. The directions test specimens were taken are as follows:

- L - Longitudinal (parallel to the rolling direction)
- T - Transverse (perpendicular to the rolling direction)
- S - Short transverse (through the thickness of the heavy gage plate)
- LE - Refers to bearing specimens only, with the test specimen being taken on edge parallel to the direction of rolling
- TE - Refers to bearing specimens only, with the test specimens being taken on edge perpendicular to the direction of rolling

The next letter refers to the type of test which is to be performed. The following indicates the types of tests:

- T - Tension
- C - Compression
- S - Shear
- B1 - Bearing  $e/D = 1.5$
- B2 - Bearing  $e/D = 2.0$
- F - Fracture Toughness
- V - Fatigue
- W - Room Temperature Stability
- X - Elevated Temperature Stability

Where a stability test is indicated, the type of stability test is identified, i.e., (X) with the type of test specimen following, i.e., (T) tensile.

The next to last letter or number in the coding sequence refers to the test temperature or the exposure temperature:

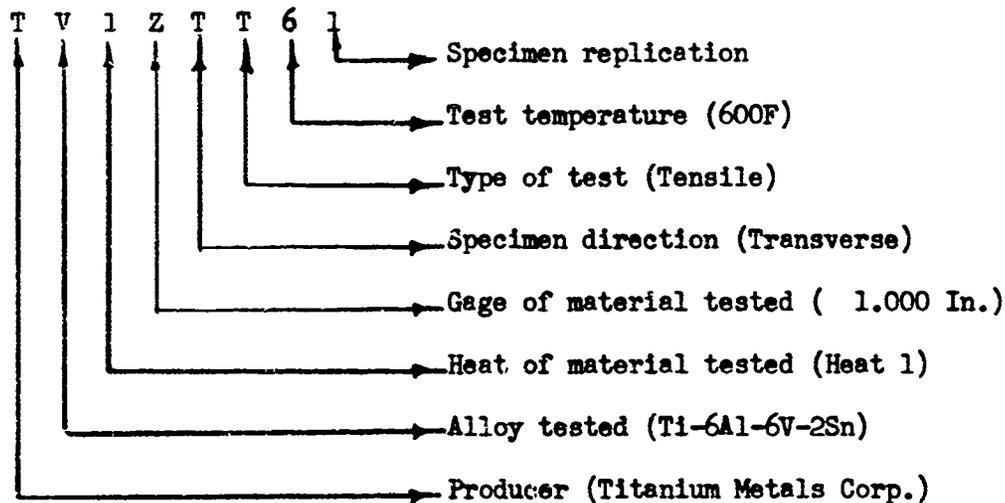
- R - Room Temperature
- 4 - 400F
- 6 - 600F
- 8 - 800F

The last number in the sequence reflects individual specimen replication (i.e., 1, 2 and 3).

Miscellaneous notations and exceptions to the coding system: The last number in the coding sequence of the thermal stability test specimen refers to the exposure time rather than specimen replication. In this regard:

- 1 - 10 hours exposure
- 2 - 100 hours exposure
- 3 - 1000 hours exposure

An example of the coding system is shown in the diagram below:



### 3.2 SPECIMEN SAMPLING

Due to the fact that most of the test material was received from the two suppliers as bits and pieces, the layout of test coupons was necessarily dictated by the size of the piece of material. A typical test specimen layout for one of the sheet gage heats is shown in Figure 3-1. As can be seen, removal of committed test coupons resulted in a minimum of surplus material.



### 3.3 SPECIMEN CONFIGURATION

Typical test specimen configurations used on this program are shown in Figures 3-2 through 3-12. The configurations selected were tailored to material sizes available. The use of sub size specimens were avoided with the exception of those test specimens taken in the short transverse direction (through the thickness) of the heavy gage plate stock and the round bar fatigue tests. All test specimens conform, where applicable, to ASTM Standards.

REV	DATE	REVISIONS
0		ISSUED
1		REWORKED
2		REWORKED
3		REWORKED
4		REWORKED
5		REWORKED

SYMBOL	DESCRIPTION
1	MAY BE REWORKED
2	CANNOT BE REWORKED
3	REWORKED
4	REWORKED
5	REWORKED

DATE	BY	DESCRIPTION
1-15-53		
1-21-53		
1-28-53		
2-4-53		
2-11-53		
2-18-53		
2-25-53		
3-4-53		
3-11-53		
3-18-53		
3-25-53		
4-1-53		
4-8-53		
4-15-53		
4-22-53		
4-29-53		
5-6-53		
5-13-53		
5-20-53		
5-27-53		
6-3-53		
6-10-53		
6-17-53		
6-24-53		
7-1-53		
7-8-53		
7-15-53		
7-22-53		
7-29-53		
8-5-53		
8-12-53		
8-19-53		
8-26-53		
9-2-53		
9-9-53		
9-16-53		
9-23-53		
9-30-53		
10-7-53		
10-14-53		
10-21-53		
10-28-53		
11-4-53		
11-11-53		
11-18-53		
11-25-53		
12-2-53		
12-9-53		
12-16-53		
12-23-53		
12-30-53		

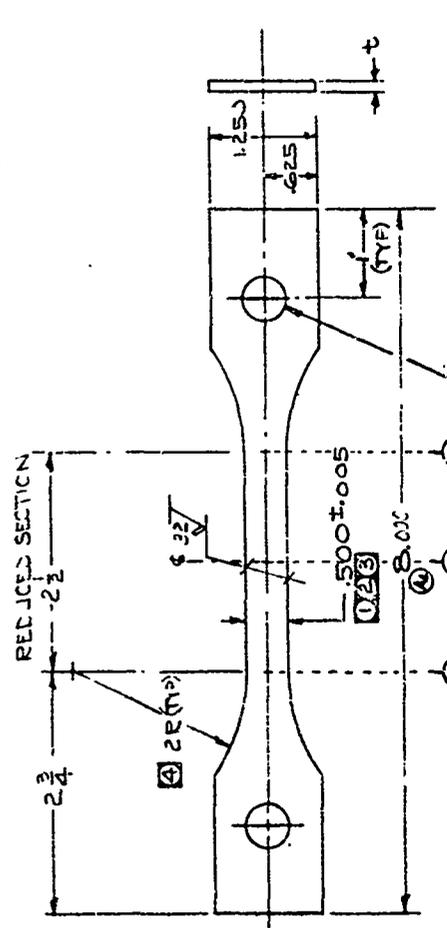
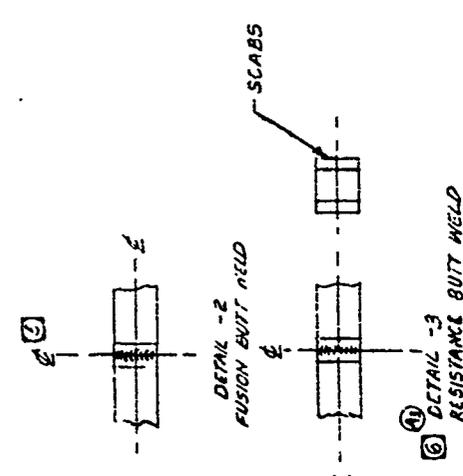


FIG. 3-2  
A TT-15139

- M. WIDTH AT (A) AND/OR (C) TO EXCEED WIDTH AT (B) BY 0.0005 TO 0.003 INCHES
- (C) 13. SPECIMENS SHOULD BE CUT FROM THE AREAS MARKED ON THE PANELS
- (C) 12. SCABS SHOULD BE REMOVED FROM SIDES



- 11. MAX THICKNESS OF SPAC. WHEN .125
- 10. WHEN NOTED ON ATTACHED INSTRUCTION SHEET TO HAVE WELD BEAD ATTACHED PLAINLY, MINIMUM AMOUNT TO REMOVE WELD BEAD UP DOWN 20% UNDERST. AND DEFECTS FROM AREAS NOT EMPHAS. SUBJECT OF BRIDGE SPECIMEN TO BE MACHINED TO ORIGINAL THICKNESS ± .001. FINISH MACHINING THICKNESS TO BE NO LESS THAN 25% OF ORIGINAL AVERAGE METAL THICKNESS. 10% OF AVERAGE METAL THICKNESS IS MINIMUM AMOUNT TO BE MACHINED FROM AVE. SURFACE
- 9. CENTER OF REDUCED SECTION MUST BE ON CENTERLINE IF WELD BEAD ROOT (DETAIL -2 ONLY)
- 8. RETURN TO TEST ENGINEER FOR LIGHT ETCH IF WELD BEAD IS NOT VISIBLE (DETAIL -2 ONLY)
- 7. BLANK WIDTH 3/16 GREATER FOR .062 UNDER STOCK, 1/8 GREATER FOR .062 OVER STOCK
- 6. IDENTIFY PER NAA SPEC LA0104-003
- 5. RADIUS MUST NOT UNDERCUT THE REDUCED SECTION
- 4. SIDES OF REDUCED SECTION MUST BE PARALLEL TO EACH OTHER & TO THE CENTERLINE WITHIN .001 T.I.R.
- 3. HOLES TO BE ON CENTERLINE OF REDUCED SECTION WITHIN ± .003
- 2. EDGES OF REDUCED SECTION TO BE LEFT SHARP
- 1. MACHINE PER NAA SPEC LA0103-024

NOTES: UNLESS OTHERWISE NOTED:

REVISION	DATE	DESCRIPTION
1		
2		
3		
4		
5		

REVISION	DATE	DESCRIPTION
1		
2		
3		
4		
5		

REVISION	DATE	DESCRIPTION
1		
2		
3		
4		
5		

REVISION	DATE	DESCRIPTION
1		
2		
3		
4		
5		

REVISION	DATE	DESCRIPTION
1		
2		
3		
4		
5		

REVISION	DATE	DESCRIPTION
1		
2		
3		
4		
5		

REVISION	DATE	DESCRIPTION
1		
2		
3		
4		
5		

REVISION	DATE	DESCRIPTION
1		
2		
3		
4		
5		

REVISION	DATE	DESCRIPTION
1		
2		
3		
4		
5		

REVISION	DATE	DESCRIPTION
1		
2		
3		
4		
5		

REVISION	DATE	DESCRIPTION
1		
2		
3		
4		
5		

REVISION	DATE	DESCRIPTION
1		
2		
3		
4		
5		

REVISION	DATE	DESCRIPTION
1		
2		
3		
4		
5		

REVISION	DATE	DESCRIPTION
1		
2		
3		
4		
5		

REVISION	DATE	DESCRIPTION
1		
2		
3		
4		
5		

REVISION	DATE	DESCRIPTION
1		
2		
3		
4		
5		

REVISION	DATE	DESCRIPTION
1		
2		
3		
4		
5		

REVISION	DATE	DESCRIPTION
1		
2		
3		
4		
5		

REVISION	DATE	DESCRIPTION
1		
2		
3		
4		
5		

REVISION	DATE	DESCRIPTION
1		
2		
3		
4		
5		

REVISION	DATE	DESCRIPTION
1		
2		
3		
4		
5		

REVISION	DATE	DESCRIPTION
1		
2		
3		
4		
5		

REVISION	DATE	DESCRIPTION
1		
2		
3		
4		
5		

REVISION	DATE	DESCRIPTION
1		
2		
3		
4		
5		

REVISION	DATE	DESCRIPTION
1		
2		
3		
4		
5		

REVISION	DATE	DESCRIPTION
1		
2		
3		
4		
5		

REVISION	DATE	DESCRIPTION
1		
2		
3		
4		
5		

REVISION	DATE	DESCRIPTION
1		
2		
3		
4		
5		

REVISION	DATE	DESCRIPTION
1		
2		
3		
4		
5		

REVISION	DATE	DESCRIPTION
1		
2		
3		
4		
5		

REVISION	DATE	DESCRIPTION
1		
2		
3		
4		
5		

REVISION	DATE	DESCRIPTION
1		
2		
3		
4		
5		

REVISION	DATE	DESCRIPTION
1		
2		
3		
4		
5		

REVISION	DATE	DESCRIPTION
1		
2		
3		
4		
5		

REVISION	DATE	DESCRIPTION
1		
2		
3		
4		
5		

REVISION	DATE	DESCRIPTION
1		
2		
3		
4		
5		

REVISION	DATE	DESCRIPTION
1		
2		
3		
4		
5		

REVISION	DATE	DESCRIPTION
1		
2		
3		
4		
5		

REVISION	DATE	DESCRIPTION
1		
2		
3		
4		
5		

REVISION	DATE	DESCRIPTION
1		
2		
3		
4		
5		

REVISION	DATE	DESCRIPTION
1		
2		
3		
4		
5		

REVISION	DATE	DESCRIPTION
1		
2		
3		
4		
5		

REVISION	DATE	DESCRIPTION
1		
2		
3		
4		
5		

REVISION	DATE	DESCRIPTION
1		
2		
3		
4		
5		

REVISION	DATE	DESCRIPTION
1		
2		
3		
4		
5		

REVISION	DATE	DESCRIPTION
1		
2		
3		
4		
5		

REVISION	DATE	DESCRIPTION
1		
2		
3		
4		
5		

REVISION	DATE	DESCRIPTION
1		
2		
3		
4		
5		

REVISION	DATE	DESCRIPTION
1		
2		
3		
4		
5		

REVISION	DATE	DESCRIPTION
1		
2		
3		
4		
5		

REVISION	DATE	DESCRIPTION
1		
2		
3		
4		
5		

REVISION	DATE	DESCRIPTION
1		
2		
3		
4		
5		

REVISION	DATE	DESCRIPTION
1		
2		
3		
4		
5		

REVISION	DATE	DESCRIPTION
1		
2		
3		
4		



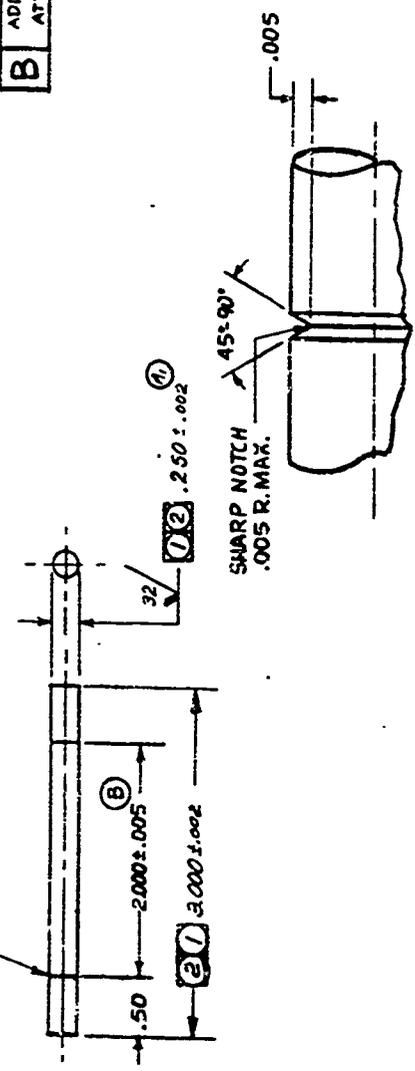




REVISIONS		DATE	SIGNATURE
1	MAY BE REWORKED		
2	CANNOT BE REWORKED		
3	RECORD CHANGE		
4	HOW SHOW PRACTICE		
5	PARTS N.A.-X OK		
A	1. REDRAWN TO SCALE 2. ADDED "ROUND TO TITLE"	10/16/58	M. HARRIS
B	ADDED DETAIL "A" STRAIN GAGE ATTACHMENT NOTCH		

TT-14780

DETAIL "A", TYPICAL 2 PLACES. (B)



DETAIL "A" (B)  
STRAIN GAGE ATTACHMENT NOTCH  
SCALE: NONE

FIG. 3-5

REC'D	PH	UH	RECD	PART NO	DESC	MATERIAL	SIZE	ZONE	MATL SPEC	QTY PER END ITEM	USED ON	NEXT ASSY	APPLICATION
						1116-1959							NORTH AMERICAN AVIATION, INC.
<p>TOLEANCES EXCEPT AS NOTED</p> <p>ANGLES FRACTIONS DECIMALS ±1/2° ±1/32 ±.010</p> <p>✓ SURFACE ROUGHNESS PER MIL-STD-10 (FA6-219)</p> <p>HEAT TREAT</p> <p>FINISH</p>													
<p>DRILLED HOLE TOLERANCES</p> <p>.040 TO .1285: +.002, -.001</p> <p>.134 TO .228: +.003, -.001</p> <p>.234 TO 1/2: +.004, -.001</p> <p>3/4 TO 1: +.005, -.001</p> <p>1 1/4 TO 2: +.010, -.001</p>													
<p>DATE 11-16-1959</p> <p>DR BY W. VERGEELES</p> <p>CHK BY</p> <p>APPD BY</p> <p>APPD BY</p>													
<p>SPECIMEN - ROUND, COMPRESSION TEST, GENERAL USE</p>													
												DWG SIZE	TT-14780
												SCALE	FULL
												WT	

4. HEAT TREAT PART PRIOR TO FINISH MACHINING

3. IDENTIFY PARTS BY DECAL OR RUBBER STAMPING

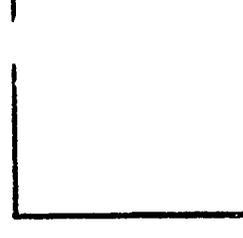
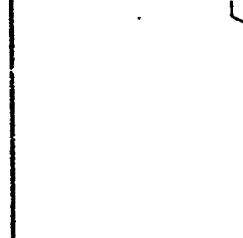
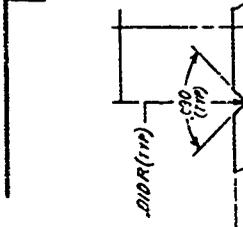
2. ENDS & SIDES TO BE SQUARE: WITHIN 15'

1. PARALLEL WITHIN .0005 T.I.R

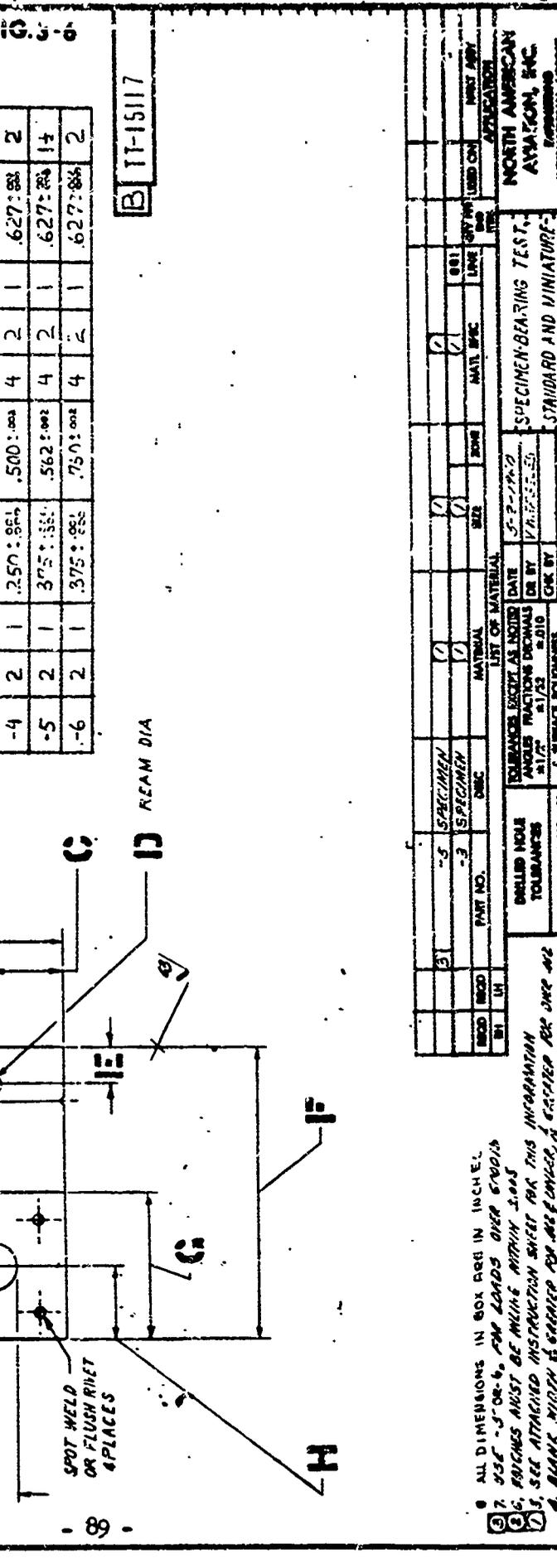
NOTES: ULESS OTHERWISE NOTED

REV. NO.	DATE	REVISIONS
1	11-15-17	INITIALS
2		
3		
4		
5		
6		
7		

SYM	DESCRIPTION
A	MAY BE REVOKED
B	RECORD CHANGE
C	CANNOT BE REVOKED
D	HOW WORK PRACTICE
E	POINTS MADE OK
F	ADDRESSES (BY CONTRACTOR)
G	INITIALS
H	ADDITIONAL COMMENTS
I	NOTE B ACOLD
J	UN-GRADDED TO NOTE 7



PART NO.	B	C	D	E	F	G	H	J	% RATIO
-1	1	1	0.125 ± .001	0.1875 ± .001	2	1	1	1	0.250 ± .001
-2	1	1	0.125 ± .001	0.250 ± .001	2	1	1	1	0.250 ± .001
-3	2	1	0.250 ± .001	0.375 ± .001	4	2	1	1	0.627 ± .001
-4	2	1	0.250 ± .001	0.500 ± .001	4	2	1	1	0.627 ± .001
-5	2	1	0.375 ± .001	0.562 ± .001	4	2	1	1	0.627 ± .001
-6	2	1	0.375 ± .001	0.750 ± .001	4	2	1	1	0.627 ± .001

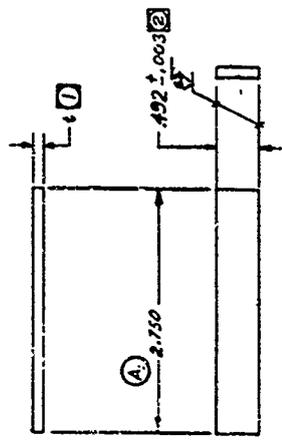


REV. NO.	DATE	REVISIONS
1	11-15-17	INITIALS
2		
3		
4		
5		
6		
7		

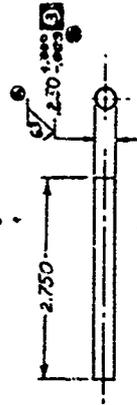
1. ALL DIMENSIONS IN BOX ARE IN INCHES.  
 2. USE .5 OR .6 FOR LOADS OVER 500 LB.  
 3. BRIGES MUST BE MADE WITHIN 3.003  
 4. SEE ATTACHED INSTRUCTION SHEET FOR THIS INFORMATION  
 5. BLANK WITHIN IS GRABBER FOR MEASUREMENT, A GRABBER FOR MEASUREMENT, A GRABBER FOR MEASUREMENT  
 6. HOLES TO BE ON E WITHIN 3.003  
 7. ALL FINISHED SURFACES  
 8. IDENTIFY PER LADDER-003  
 9. NOTES: UNLESS OTHERWISE NOTED

NORTH AMERICAN AVIATION, INC.  
 STANDARD AND MINIATURE ROOM AND ELEVATED TEMPERATURE  
 SPECIMEN BEARING TEST  
 SCALE FULL  
 WT  
 11-1517  
 C

SYN	DESCRIPTION	DATE	SIGNATURE
A	1. 2.750 IN. L <sup>6</sup> 2. ADDED -3 SPECIMEN 3. REVISED NOTES 1, 4 & ADDED NOTE 5		
B	1. 2.750 IN. L <sup>6</sup> 2. ADDED 4 <sup>6</sup> NOTL 6		
C	1. 492 WAS .495		
D	1. DOUBLE WAS SINGLE		



(A) -1 SPECIMEN  
SHEET MAT'L ONLY



(A) -1 SPECIMEN  
ROUND BAR MAT'L ONLY

FIG. 3-7

D TT-12584

- (2) 1. HEAT TREATMENT TO BE PERFORMED PRIOR TO FINISH MACHINING.
- (3) 2. LONG MACHINED SURFACES TO BE PARALLEL WITHIN .002
- (4) 3. 1- BLANK WIDTH TO BE 3/4 FOR GAGES UP TO .003 AND 1/2 FOR THICKER MATERIAL.
- (5) 4. EDGES TO BE LEFT SQUARE ON ALL FLAT SURFACES.
- (6) 5. IDENTIFY PER SPEC. FA 6-54
- (7) 6. SEE ATTACHED INSTRUCTION SHEET FOR THIS INFORMATION.

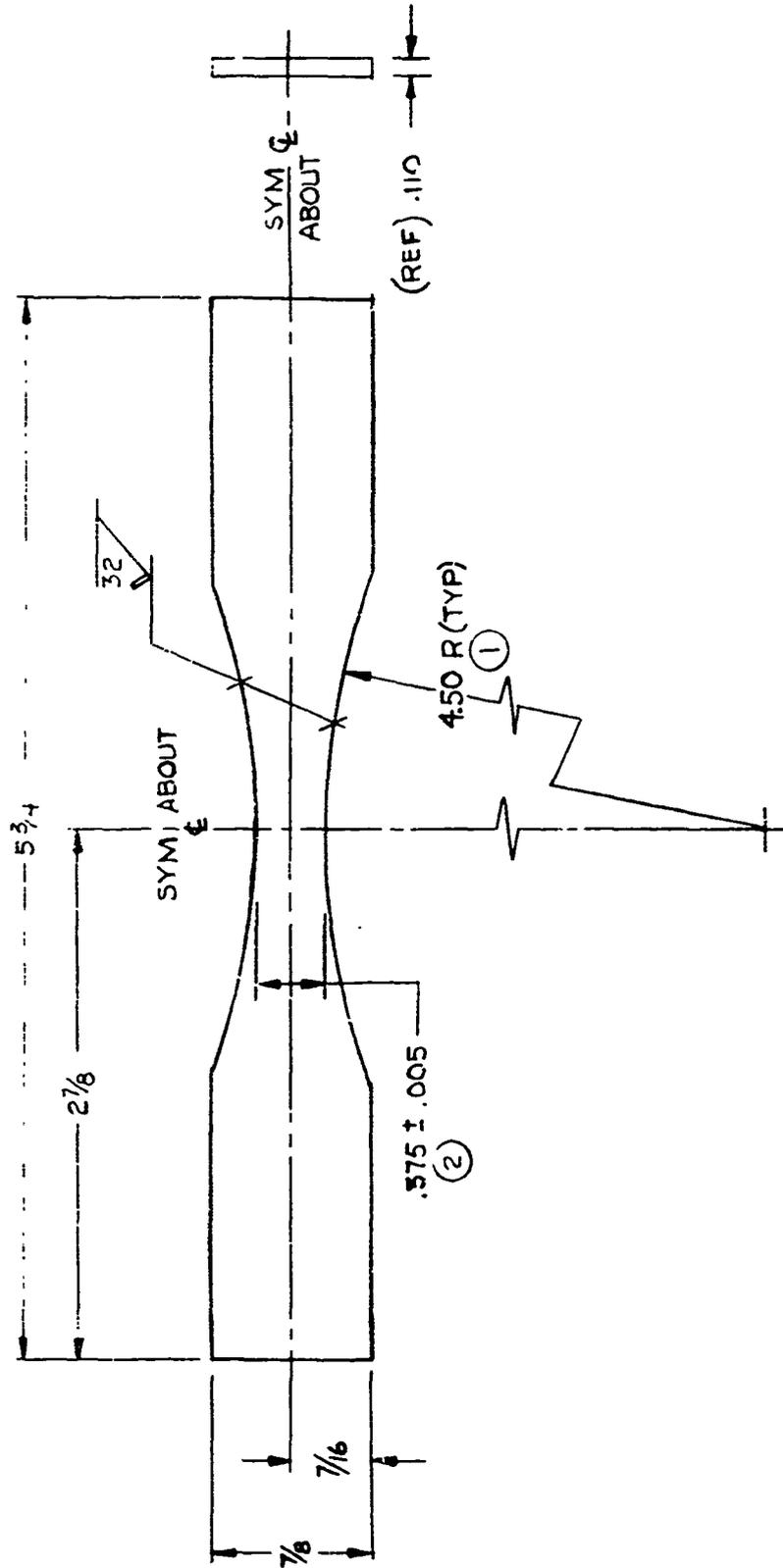
NOTES: UNLESS OTHERWISE NOTED

PAGE NO.	PART NO.	DESC.	MATERIAL	SIZE	QTY.	DATE	DR BY	CHK BY	APPD BY
1									
TOLERANCES EXCEPT AS NOTED: ANGLES FRACTIONS DECIMALS ± 0.10 SURFACE ROUGHNESS PER MIL. STD. 10 (FA 6-319) HEAT TREAT FINISH									
LIST OF MATERIAL: DATE DR BY CHK BY APPD BY									
SPECIMEN - DOUBLE SHEAR TEST									
NORTH AMERICAN AVIATION, INC. INTERNATIONAL AIRPORT LOS ANGELES 47, CALIF.									
SCALE: FULL MT									
DTT-12584									

FIG. 3-8

SPECIMEN --  
FATIGUE TEST,  
SMOOTH

SCALE : FULL



- 4. ✓ SURFACE ROUGHNESS PER MIL - STD - 10 (FA6-219)
- ② 3. RADIUS MUST NOT UNERCUT THE REDUCED SECTION
- ① 2. EDGES OF REDUCED SECTION TO BE LEFT SHARP
- 1. TOLERANCES: FRACTIONS ± 1/32 , DECIMALS ± .010

NOTES: UNLESS OTHERWISE NOTED

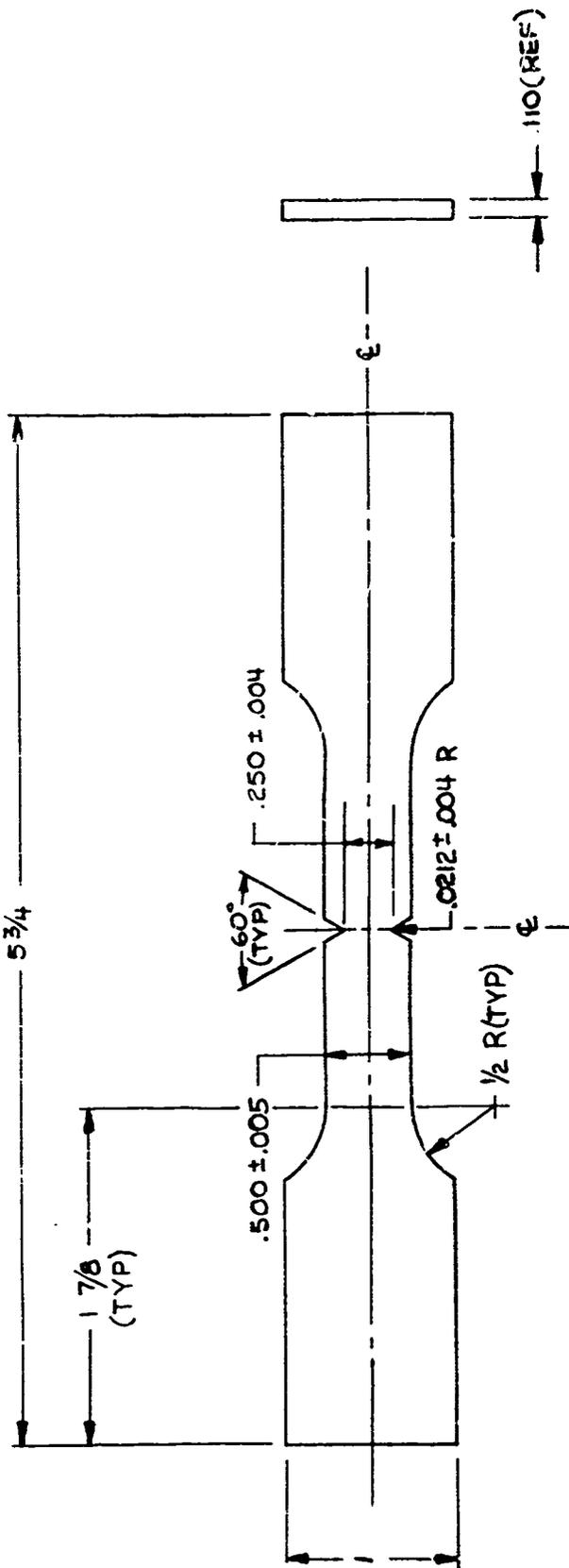


FIG. 3-9

SPECIMEN --  
FATIGUE TEST,  
NOTCHED

SCALE: FULL

8. NOTCH AND REDUCED SECTION TO BE SYMMETRICAL ABOUT  $\phi \pm .002$ .
7. CENTERLINE OF NOTCHES TO BE LESS THAN .005 APART.
6. MACHINE NOTCH SURFACE  $\sqrt{R}$
5. TOOL CHATTER, METAL TEARING, OR OTHER TOOL MARKS IN NOTCH WILL BE CAUSE FOR REJECTION. DO NOT BUFF.
4. NOTCHES TO BE MADE WITH LIGHT FINISHING CUTS OR LIGHT GRINDING & MUST HAVE CONTOUR SHOWN.
3. MACHINE SURFACES  $\sqrt{R}$
2.  $\sqrt{}$  SURFACE ROUGHNESS PER MIL-STD-10 (FA6-219).
  - i. TOLERANCES: ANGLES  $\pm 1/2^\circ$ , FRACTIONS  $\pm 1/32$ .

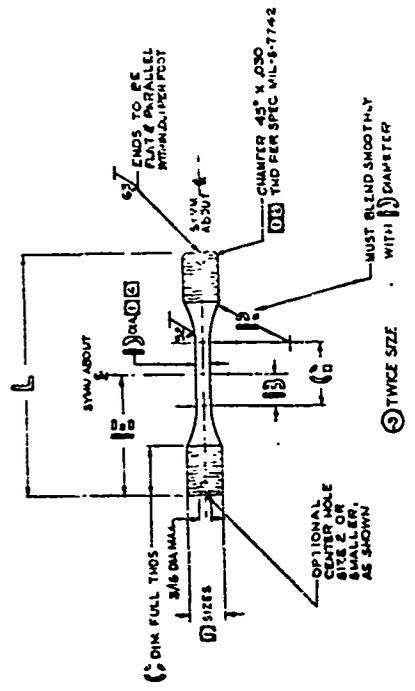
NOTES: UNLESS OTHERWISE NOTED

FIG. 3-10

TT-15618

DATE OF REVISION	BY	REASON
10/15/58	...	...

TT-15558



ART NO	1	2	3	4	5	6	7	8	9	10	11	12	13	14	15	16	17	18	19	20	21	22	23	24	25	26	27	28	29	30	31	32	33	34	35	36	37	38	39	40	41	42	43	44	45	46	47	48	49	50																																																																																																																																																																																																																																																																																																																																																																				
IN.	1/4	3/8	1/2	5/8	3/4	7/8	1	1 1/8	1 1/4	1 3/8	1 1/2	1 5/8	1 3/4	1 7/8	2	2 1/8	2 1/4	2 3/8	2 1/2	2 5/8	2 3/4	2 7/8	3	3 1/8	3 1/4	3 3/8	3 1/2	3 5/8	3 3/4	3 7/8	4	4 1/8	4 1/4	4 3/8	4 1/2	4 5/8	4 3/4	4 7/8	5	5 1/8	5 1/4	5 3/8	5 1/2	5 5/8	5 3/4	5 7/8	6	6 1/8	6 1/4	6 3/8	6 1/2	6 5/8	6 3/4	6 7/8	7	7 1/8	7 1/4	7 3/8	7 1/2	7 5/8	7 3/4	7 7/8	8	8 1/8	8 1/4	8 3/8	8 1/2	8 5/8	8 3/4	8 7/8	9	9 1/8	9 1/4	9 3/8	9 1/2	9 5/8	9 3/4	9 7/8	10	10 1/8	10 1/4	10 3/8	10 1/2	10 5/8	10 3/4	10 7/8	11	11 1/8	11 1/4	11 3/8	11 1/2	11 5/8	11 3/4	11 7/8	12	12 1/8	12 1/4	12 3/8	12 1/2	12 5/8	12 3/4	12 7/8	13	13 1/8	13 1/4	13 3/8	13 1/2	13 5/8	13 3/4	13 7/8	14	14 1/8	14 1/4	14 3/8	14 1/2	14 5/8	14 3/4	14 7/8	15	15 1/8	15 1/4	15 3/8	15 1/2	15 5/8	15 3/4	15 7/8	16	16 1/8	16 1/4	16 3/8	16 1/2	16 5/8	16 3/4	16 7/8	17	17 1/8	17 1/4	17 3/8	17 1/2	17 5/8	17 3/4	17 7/8	18	18 1/8	18 1/4	18 3/8	18 1/2	18 5/8	18 3/4	18 7/8	19	19 1/8	19 1/4	19 3/8	19 1/2	19 5/8	19 3/4	19 7/8	20	20 1/8	20 1/4	20 3/8	20 1/2	20 5/8	20 3/4	20 7/8	21	21 1/8	21 1/4	21 3/8	21 1/2	21 5/8	21 3/4	21 7/8	22	22 1/8	22 1/4	22 3/8	22 1/2	22 5/8	22 3/4	22 7/8	23	23 1/8	23 1/4	23 3/8	23 1/2	23 5/8	23 3/4	23 7/8	24	24 1/8	24 1/4	24 3/8	24 1/2	24 5/8	24 3/4	24 7/8	25	25 1/8	25 1/4	25 3/8	25 1/2	25 5/8	25 3/4	25 7/8	26	26 1/8	26 1/4	26 3/8	26 1/2	26 5/8	26 3/4	26 7/8	27	27 1/8	27 1/4	27 3/8	27 1/2	27 5/8	27 3/4	27 7/8	28	28 1/8	28 1/4	28 3/8	28 1/2	28 5/8	28 3/4	28 7/8	29	29 1/8	29 1/4	29 3/8	29 1/2	29 5/8	29 3/4	29 7/8	30	30 1/8	30 1/4	30 3/8	30 1/2	30 5/8	30 3/4	30 7/8	31	31 1/8	31 1/4	31 3/8	31 1/2	31 5/8	31 3/4	31 7/8	32	32 1/8	32 1/4	32 3/8	32 1/2	32 5/8	32 3/4	32 7/8	33	33 1/8	33 1/4	33 3/8	33 1/2	33 5/8	33 3/4	33 7/8	34	34 1/8	34 1/4	34 3/8	34 1/2	34 5/8	34 3/4	34 7/8	35	35 1/8	35 1/4	35 3/8	35 1/2	35 5/8	35 3/4	35 7/8	36	36 1/8	36 1/4	36 3/8	36 1/2	36 5/8	36 3/4	36 7/8	37	37 1/8	37 1/4	37 3/8	37 1/2	37 5/8	37 3/4	37 7/8	38	38 1/8	38 1/4	38 3/8	38 1/2	38 5/8	38 3/4	38 7/8	39	39 1/8	39 1/4	39 3/8	39 1/2	39 5/8	39 3/4	39 7/8	40	40 1/8	40 1/4	40 3/8	40 1/2	40 5/8	40 3/4	40 7/8	41	41 1/8	41 1/4	41 3/8	41 1/2	41 5/8	41 3/4	41 7/8	42	42 1/8	42 1/4	42 3/8	42 1/2	42 5/8	42 3/4	42 7/8	43	43 1/8	43 1/4	43 3/8	43 1/2	43 5/8	43 3/4	43 7/8	44	44 1/8	44 1/4	44 3/8	44 1/2	44 5/8	44 3/4	44 7/8	45	45 1/8	45 1/4	45 3/8	45 1/2	45 5/8	45 3/4	45 7/8	46	46 1/8	46 1/4	46 3/8	46 1/2	46 5/8	46 3/4	46 7/8	47	47 1/8	47 1/4	47 3/8	47 1/2	47 5/8	47 3/4	47 7/8	48	48 1/8	48 1/4	48 3/8	48 1/2	48 5/8	48 3/4	48 7/8	49	49 1/8	49 1/4	49 3/8	49 1/2	49 5/8	49 3/4	49 7/8	50	50 1/8	50 1/4	50 3/8	50 1/2	50 5/8	50 3/4	50 7/8



- 1. AFTER LIGHT FINISH MACHINING POLISH THE TEST PORTION OF THE SPECIMEN WITH FINE EMERY PAPER. USE NO. 000, FOLLOWED BY A FINAL LONGITUDINAL POLISH WITH NO. 000 EMERY PAPER, COARSE BUFF OR BRIND.
- 2. NO UNDERCUTTING OF D DIA. RADIUS.
- 3. HEAT TREATMENT TO BE PERFORMED PRIOR TO FINISH MACHINING & THREADING.
- 4. SEE ATTACHED INSTRUCTION SHEET FOR THIS INFORMATION.
- 5. REDUCED SECTION MUST BE PARALLEL WITHIN .001 T.I.R.
- 6. MACHINE PER MIL SPEC LAD-05-004.
- 7. CONCENTRIC WITHIN .001 T. I. R.

NOTES: UNLESS OTHERWISE NOTED.

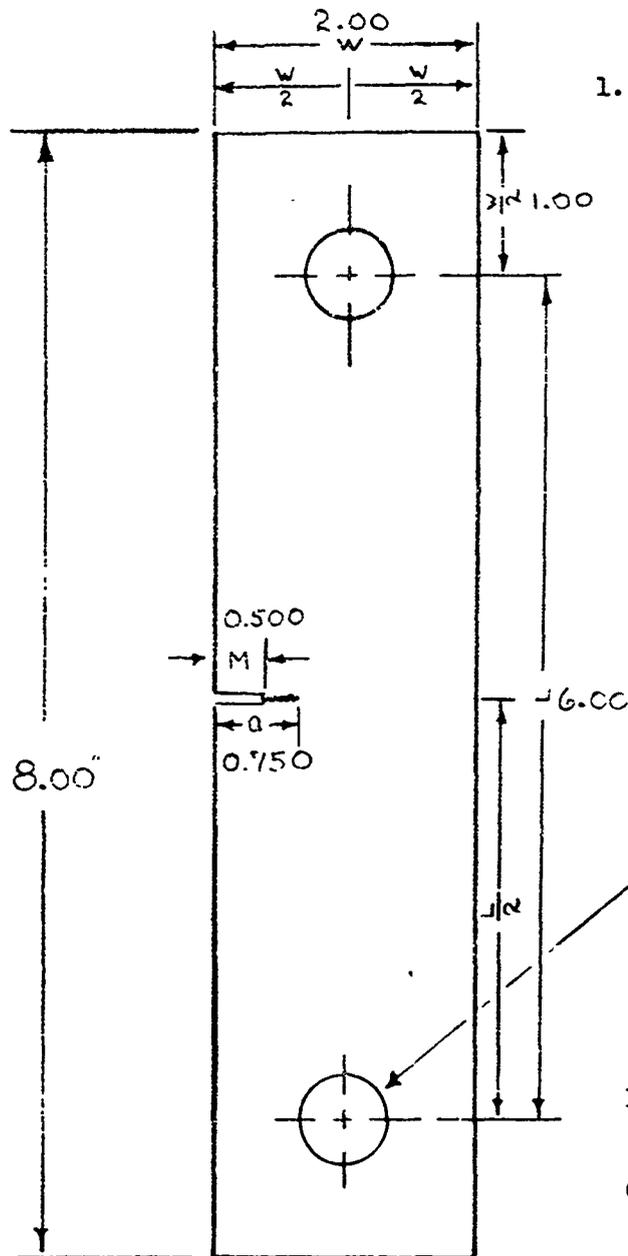
DATE OF REVISION	BY	REASON
11/15/58	...	...

ART NO	1	2	3	4	5	6	7	8	9	10	11	12	13	14	15	16	17	18	19	20	21	22	23	24	25	26	27	28	29	30	31	32	33	34	35	36	37	38	39	40	41	42	43	44	45	46	47	48	49	50																																																																																																																																																																																																																																																																																				
IN.	1/4	3/8	1/2	5/8	3/4	7/8	1	1 1/8	1 1/4	1 3/8	1 1/2	1 5/8	1 3/4	1 7/8	2	2 1/8	2 1/4	2 3/8	2 1/2	2 5/8	2 3/4	2 7/8	3	3 1/8	3 1/4	3 3/8	3 1/2	3 5/8	3 3/4	3 7/8	4	4 1/8	4 1/4	4 3/8	4 1/2	4 5/8	4 3/4	4 7/8	5	5 1/8	5 1/4	5 3/8	5 1/2	5 5/8	5 3/4	5 7/8	6	6 1/8	6 1/4	6 3/8	6 1/2	6 5/8	6 3/4	6 7/8	7	7 1/8	7 1/4	7 3/8	7 1/2	7 5/8	7 3/4	7 7/8	8	8 1/8	8 1/4	8 3/8	8 1/2	8 5/8	8 3/4	8 7/8	9	9 1/8	9 1/4	9 3/8	9 1/2	9 5/8	9 3/4	9 7/8	10	10 1/8	10 1/4	10 3/8	10 1/2	10 5/8	10 3/4	10 7/8	11	11 1/8	11 1/4	11 3/8	11 1/2	11 5/8	11 3/4	11 7/8	12	12 1/8	12 1/4	12 3/8	12 1/2	12 5/8	12 3/4	12 7/8	13	13 1/8	13 1/4	13 3/8	13 1/2	13 5/8	13 3/4	13 7/8	14	14 1/8	14 1/4	14 3/8	14 1/2	14 5/8	14 3/4	14 7/8	15	15 1/8	15 1/4	15 3/8	15 1/2	15 5/8	15 3/4	15 7/8	16	16 1/8	16 1/4	16 3/8	16 1/2	16 5/8	16 3/4	16 7/8	17	17 1/8	17 1/4	17 3/8	17 1/2	17 5/8	17 3/4	17 7/8	18	18 1/8	18 1/4	18 3/8	18 1/2	18 5/8	18 3/4	18 7/8	19	19 1/8	19 1/4	19 3/8	19 1/2	19 5/8	19 3/4	19 7/8	20	20 1/8	20 1/4	20 3/8	20 1/2	20 5/8	20 3/4	20 7/8	21	21 1/8	21 1/4	21 3/8	21 1/2	21 5/8	21 3/4	21 7/8	22	22 1/8	22 1/4	22 3/8	22 1/2	22 5/8	22 3/4	22 7/8	23	23 1/8	23 1/4	23 3/8	23 1/2	23 5/8	23 3/4	23 7/8	24	24 1/8	24 1/4	24 3/8	24 1/2	24 5/8	24 3/4	24 7/8	25	25 1/8	25 1/4	25 3/8	25 1/2	25 5/8	25 3/4	25 7/8	26	26 1/8	26 1/4	26 3/8	26 1/2	26 5/8	26 3/4	26 7/8	27	27 1/8	27 1/4	27 3/8	27 1/2	27 5/8	27 3/4	27 7/8	28	28 1/8	28 1/4	28 3/8	28 1/2	28 5/8	28 3/4	28 7/8	29	29 1/8	29 1/4	29 3/8	29 1/2	29 5/8	29 3/4	29 7/8	30	30 1/8	30 1/4	30 3/8	30 1/2	30 5/8	30 3/4	30 7/8	31	31 1/8	31 1/4	31 3/8	31 1/2	31 5/8	31 3/4	31 7/8	32	32 1/8	32 1/4	32 3/8	32 1/2	32 5/8	32 3/4	32 7/8	33	33 1/8	33 1/4	33 3/8	33 1/2	33 5/8	33 3/4	33 7/8	34	34 1/8	34 1/4	34 3/8	34 1/2	34 5/8	34 3/4	34 7/8	35	35 1/8	35 1/4	35 3/8	35 1/2	35 5/8	35 3/4	35 7/8	36	36 1/8	36 1/4	36 3/8	36 1/2	36 5/8	36 3/4	36 7/8	37	37 1/8	37 1/4	37 3/8	37 1/2	37 5/8	37 3/4	37 7/8	38	38 1/8	38 1/4	38 3/8	38 1/2	38 5/8	38 3/4	38 7/8	39	39 1/8	39 1/4	39 3/8	39 1/2	39 5/8	39 3/4	39 7/8	40	40 1/8	40 1/4	40 3/8	40 1/2	40 5/8	40 3/4	40 7/8





FIG. 3-12



NOTES:

1. Coupons are nominally 0.25 in. thick. In order to meet the specimen thickness callout an equal amount of material shall be removed from both surfaces of the coupon

B = 0.230 ± .001 (see Note 1)

B = Specimen Thickness

D = Pin Hole Diameter

Clearance drill and ream for 0.625 Dia. Pin 2 holes as shown

$$\frac{M}{a} = < 0.75$$

$$L/W > 3$$

$$2 < W/B < 12$$

$$0.20 < a/W < 0.40$$

$$K_{IC}^2 = \left[ \frac{1}{1-\nu^2} \right] \left( \frac{P}{B} \right)^2 \frac{1}{W} \left[ 759 \frac{a}{W} - 32 \left( \frac{a}{W} \right)^2 + 117 \left( \frac{a}{W} \right)^3 \right]$$

$$a = a_0 + \frac{K_{IC}^2}{6\pi\sigma_{YS}^2} \quad \text{In All Cases}$$

Figure 2 Recommended Single-Edge-Notch Tensile Specimen Geometry

### 3.4 SPECIMEN PREPARATION

Every effort was made to insure that the variations in test results would be due to material properties, by requiring and holding close test specimen machining tolerances. The conditions for machining were carefully chosen to provide a minimum of distortion and surface defects which might influence the resulting test data. Additionally, care was exercised to insure that the material was not overheated during any of the cutting or machining operations.

## Section IV

### TEST EQUIPMENT

Contained within this section are the various pieces of test equipment used in this investigation.

	Page
Static Tests	98 - 99
Fatigue Tests	99

SECTION IV  
TEST EQUIPMENT

4.1 STATIC TESTS

4.1.1 Loading Apparatus

The loading apparatus used in the performance of tension, compression, bearing, shear, fracture toughness, and stability tests, are as follows:

- One Instron Universal Testing Machine - 10,000 capacity
- One Instron Universal Testing Machine - 20,000 capacity
- One Baldwin-Lima-Hamilton Universal Testing Machine - 50,000 capacity
- One Baldwin-Lima-Hamilton Universal Testing Machine - 120,000 capacity
- One Richle Universal Testing Machine - 120,000 capacity

All of the above mentioned machines are equipped with strain-rate pacers and autographic recorders.

4.1.2 Extensometers

- Weideman Dual Range Extensometer, Model TSMD
- Weideman Dual Range Extensometer, Model KSMD
- Weideman Averaging Type Extensometer, Model PS-SM
- Weideman Averaging Type Extensometer, Model PS-3MH
- Instron Strain Gage Extensometer, Model G-51-12
- Instron Strain Gage Extensometer, Model G-51-11
- Baldwin Strain Beams, Model SB1E
- Aminco-Tuckerman Optical Strain Gage System

With the exception of the Tuckerman optical strain gage system, the above listed extensometers and strain gage extensometers were used with autographic recording equipment which are built in to the various Universal testing machines to measure load versus deformation.

4.1.3 Furnaces

The furnaces used for achieving the static elevated test temperatures are as follows:

- (1) Pacific Scientific Forced Air Furnace - 1400F capability  
Honeywell-Brown "Elektronik" recorder controller
- (2) Hevi-Duty Split Tube Radiant Furnace - 2000F capability  
Wheelco pyrometer controllers
- (3) Messimers Circulating Air Chamber - 1000F capability  
Brown proportional controller
- (4) NR/LAD built Split Tube Radiant Furnaces - 2000F capability  
wheelco pyrometer controllers

The furnaces used for thermal stability exposure work were:

- (1) Pacific Scientific Forced Air Furnaces - 1400F capability  
Honeywell-brown Fry-O-Vane controllers
- (2) Arcweld Radiant Tube "Dial-O-Matic" Furnace - 2000F capability  
Honeywell-Brown controllers

The furnaces used for heat treating the Ti-6Al-6V-2Sn material to Cond. STA are as follows:

- (1) Hevi-Duty Radiant Furnace - 2100F capability  
Leeds and Northrup controllers
- (2) Pacific Scientific Forced Air Furnaces - 1400F capability  
Honeywell-Brown controllers

#### 4.2 FATIGUE TESTS

The fatigue test machines used to construct the Goodman Diagrams included:

- (1) Amsler Vibraphone Fatigue Machine - 22,000 Lb. capacity,  
60 - 300 CPS
- (2) Baldwin-Sonntag Fatigue Machine - 10,000 Lb. capacity (has a  
5:1 load multiplier 50,000 Lb.),  
30 CPS
- (3) Krcuse Direct Stress Fatigue Machine - 5000Lb. capacity (has a  
2:1 load multiplier, 10,000 Lb.)

NOTE: The fracture toughness tests were pre-cracked using the above listed Krcuse Direct Stress Fatigue Machine

## Section V

### TEST PROCEDURES

Contained within this section are the procedures utilized for the various mechanical property tests performed in this investigation

	Page
Tensile Tests	101
Compression Tests	102
Bearing Tests	103
Shear Tests	104
Fracture Toughness Tests	105
Metallurgical Stability Tests	105
Fatigue Tests	106

## SECTION V

### TEST PROCEDURES

#### 5.1 TENSILE TESTS

Tensile tests on the subject program were performed using a Riehle, Baldwin-Lima-Hamilton, and Instron Universal test machines which are fully equipped with autographic recorders and automatic strain pacers. These machines are calibrated at least once each year to the appropriate ASTM Standard to ensure loading accuracy.

Tensile specimens tested at the indicated elevated temperatures were heated by means of a Pacific Scientific forced air furnace that has a capability of 1400F and tube radiant-type furnaces that have a temperature capability of 200F. All furnaces are capable of maintaining  $\pm 5F$  over a 2-inch gage length.

Specimen temperature measurements were made by means of 20 A.W.G diameter chromel-alumel thermocouples attached to the center of the test specimen and calibrated potentiometers for obtaining emf readings.

All measurements of individual specimens for area determinations were made using a calibrated micrometer capable of measuring  $\pm 0.0001$  inch of the nominal specimen dimension. A minimum of five width and thickness measurements were taken over the individual specimens' gage length for the cross-sectional area determination.

Determination of the tensile yield strength and the elastic modulus of each individual specimen tested were performed by attaching a Baldwin-Lima-Hamilton or an Instron strain gage extensometer to the gage length of the test specimen.

An automatic strain pacer was used to monitor the induced strain to the tensile yield strength. A strain rate of 0.005 in./in./min. was maintained up to the yield strength. After yielding occurred, the loading rate was increased so as to produce failure of the specimen in approximately one minute.

In addition to the autographically recorded load-elongation graphs, a limited number of stress-strain plots were made, using Tuckerman optical strain gages. This instrument conforms to ASTM E83-57T, Class A, requirements which limit the maximum error of indicated strain to 0.00001 or 10 times as limiting as the requirements specified for Class B-1 extensometers. Data generated using this instrument serves as a base line for comparing subsequent test data obtained using the conventional autographic extensometers.

Typical full range stress-strain curves for each of the materials tested in conjunction with the precision elastic modulus obtained for the various materials are reported in Section VII of this report.

Typical room temperature and elevated temperature tensile setups are shown in Figures 5-1 and 5-2, respectively.

## 5.2 COMPRESSION TESTS

Compression testing of the four materials was accomplished by employing a compression subpress in conjunction with a Universal-type testing machine. One of the compression subpresses used was designed and built at NR/LAD, and employs a rigid frame containing a lower carbide loading anvil which is parallel to the bed of the testing machine. Within the frame, a sliding plunger is contained which accommodates the upper carbide loading anvil. The plunger is rigidly aligned within the support frame by the use of low-friction graphite plugs.

Specimen side support is provided by a plate assembly made up of small carbide balls backed up by a carbide plate with the balls protruding through a front retaining plate in which the holes for the balls are large enough to allow rotation and translation of each ball while, at the same time, retaining the ball within the plate. This method of support provides nearly frictionless contact even at high temperatures.

A special fixture is used to make gage mark indentations on each side of the specimen into which the hardened points of the extensometer arms fit. The extensometer arms pass through an access hole in the bottom of the subpress frame and, in turn, are connected to a common lineal differential transducer located in an ambient temperature zone. The extensometer system used meets ASTM Standard E83-57T, Class B-1, requirements.

The NR/LAD built compression subpress has proven to yield exceptionally reliable and highly reproducible compressive yield strengths as well as elastic moduli on a variety of materials tested in it from room temperature to 1300F. Materials with known moduli have been tested and the results obtained from the subpress agree remarkably well with the known values. The reproducibility of the subpress has been demonstrated time and again on large NR test programs where replication of test effort has been necessary.

Elevated temperature compression testing is provided for by a specially constructed resistance wound furnace, which is designed so that the elements are in close proximity to the subpress body. Temperature uniformity is measured by three thermocouples inserted in the side support plates adjacent to the specimen. The test machine employed temperature measurement and specimen measurement techniques, as well as strain pacing, paralleling those described for the tensile. All compression tests were conducted in accordance with ASTM E 209-63T. Figure 5-3 shows the NR/LAD built compression subpress.



### 5.3 BEARING TESTS

Bearing tests on the program were performed using a Universal-type testing machine and a bearing fixture. One of the fixtures used, Figure 5.4, accommodates the bearing test specimen and is basically an adjustable clevis that contains the loading pin as well as providing for appropriate deformation measurements.

When the specimen is in place within the test fixture, the extension arms employing point contacts, locate on the sides of the bearing test specimen. When a load (tension) is applied, the relative displacement occurring between the pin, which is an integral part of the test fixture, and the pickup arms located on the sides of the test specimen is transferred to a linear differential transducer. The obtained signal is, in turn, fed into the test machine's autographic recorder, providing the necessary load-deformation plots necessary to obtain the 2 percent bearing yield strength.

The bearing fixture itself is made from Haynes 25 and contains carbide bushings that accommodate the loading pin. The loading pins themselves are fabricated from hot work die steels, heat-treated to the 280 - 300 Ksi range to resist brinelling during test.

Temperature measurements were made by attaching a thermocouple to the test specimen in the area of the pin.

Elevated test temperatures were achieved using a tube furnace previously described in the Tensile Test section.

All bearing tests were performed in accordance with ASTM E 234-64T.

## 5.4 SHEAR TESTS

Shear tests on the subject program were accomplished using an NR/LAD-built double shear subpress, shown in Figure 5-5. A Universal-type testing machine previously described provided the necessary loading requirements.

The shear subpress is basically a rigid frame containing the necessary load bearing edges which are carbide, and provides the required lateral restraint of the sheet shear specimen during test. Contained within the frame is a plunger which, in turn, is placed within the frame. By applying a compressive load, the subpress imparts a double-shear load condition to the restrained specimen. When the shear subpress is properly adjusted, the respective carbide load bearing edges, contained within the plunger and frame, pass within 1/100 of an inch of each other during tests. It has been NR/LAD experience that this subpress provides highly reproducible and reliable shear test data.

NR/LAD has tried a variety of shear test specimens and fixtures in an effort to obtain consistent and reliable shear property data. Methods tried and discarded after proving unsatisfactory have included the conventional single-shear tension sheet specimen as well as fixtures which test specimens in single shear. The double-shear subpress described has proved superior to the various other methods explored so far as producing both reliable and reproducible shear test data.

Elevated test temperatures were achieved using a specially constructed resistance-wound furnace designed for use with the shear subpress. Temperature measurements were made from a thermocouple which is inserted into the subpress in very close proximity to the test specimen.

Since only ultimate load was determined, no deformation measurements were made.

Specimen measurement techniques paralleled those described for the tensile tests.

The single-shear ultimate strength was derived from the double shear load by merely taking half the failing load and dividing it by the cross-sectional area of the specimen.

The shear tests performed were in accordance with ARTC 13-S-1 detail requirements.

## 5.5 FRACTURE TOUGHNESS TESTS

The fracture toughness test used to obtain plane strain ( $K_{Ic}$ ) values for the four titanium alloys employed the single-edge-notch tension-type specimen. Selection of this configuration was based on several considerations: First, and most important, specimens conforming to this configuration yield correct and consistent  $K_{Ic}$  values, References 1 and 2. Secondly, while this configuration provided the necessary plane strain test data for the program, it also has the advantage of substantial material economy.

Precracking of the individual test specimens to the desired predetermined depth was accomplished using a fatigue machine. The total depth of the sawed crack, plus that induced by fatigue (natural crack), will equal approximately one third of the specimen width, with the sawed crack depth being equal to or less than 0.75 of the total crack depth. Crack growth induced by fatiguing was carefully monitored by means of a binocular microscope.

Tension testing of the precracked fracture toughness test specimens was performed using a Universal-type testing machine. Load deflection curves were obtained for each specimen tested using a Class B-1 extensometer applied to the edge of the specimen across the crack zone as a compliance gage. A cross-head speed of .05 In./Min. was used for the fracture toughness tests. Upon completion of testing, the load versus deflection plots were analyzed for "pop-in" load.  $K_{Ic}$  values were then determined by means of the following relationship:

$$K_{Ic} = \left[ \frac{1}{1-\nu^2} \right] \left( \frac{P}{B} \right)^2 \frac{1}{W} \left[ 7.59 \frac{a}{W} - 32 \left( \frac{a}{W} \right)^2 + 117 \left( \frac{a}{W} \right)^3 \right]$$

where:

- B = specimen thickness
- a = crack length at "pop-in" (in)
- w = specimen width (in)
- $\nu$  = Poisson's ratio

All of the fracture toughness testing was conducted at room temperature and was limited to the 1/4-inch thick materials.

## 5.6 METALLURGICAL STABILITY TESTS

The effect of exposure to selected elevated temperatures for prolonged periods of time was determined for the four selected alloys using tensile and fracture toughness tests as the measuring criteria.

Tensile test specimens of the appropriate configuration were exposed to elevated temperatures of 400F, 600F, and 800F for time durations of 10, 100, and 1000 hours. After exposure, some of the test specimens were tested at room temperature with the remaining being tested at the elevated temperatures at which they were exposed.

Fracture toughness test specimens were exposed at 400F, 600F and 800F for 10, 100, and 1000 hours, and tested at room temperature after elevated temperature exposure.

Test equipment, fixtures and procedures for each type of test are described in the preceding text.

### 5.7 FATIGUE TEST

Fatigue tests were performed on the subject program using the equipment described in Section IV. All tests were at room temperature, employing both smooth and notched ( $K_t = 3.0$ ) fatigue test specimen configurations. Four minimum-to-maximum stress ratios (R factors) were used. These were  $R = -1.0$ ,  $R = -0.3$ ,  $R = 0$  and  $R = +0.3$ . The stress levels were varied within a group of specimens so that S-N curves could be constructed. From the various S-N curves generated for the four R factors for a given alloy and  $K_t$ , constant life diagrams were then constructed. A photograph of one of the fatigue test machines employed in this investigation is shown in Figure 5-6.

Fig 5-1

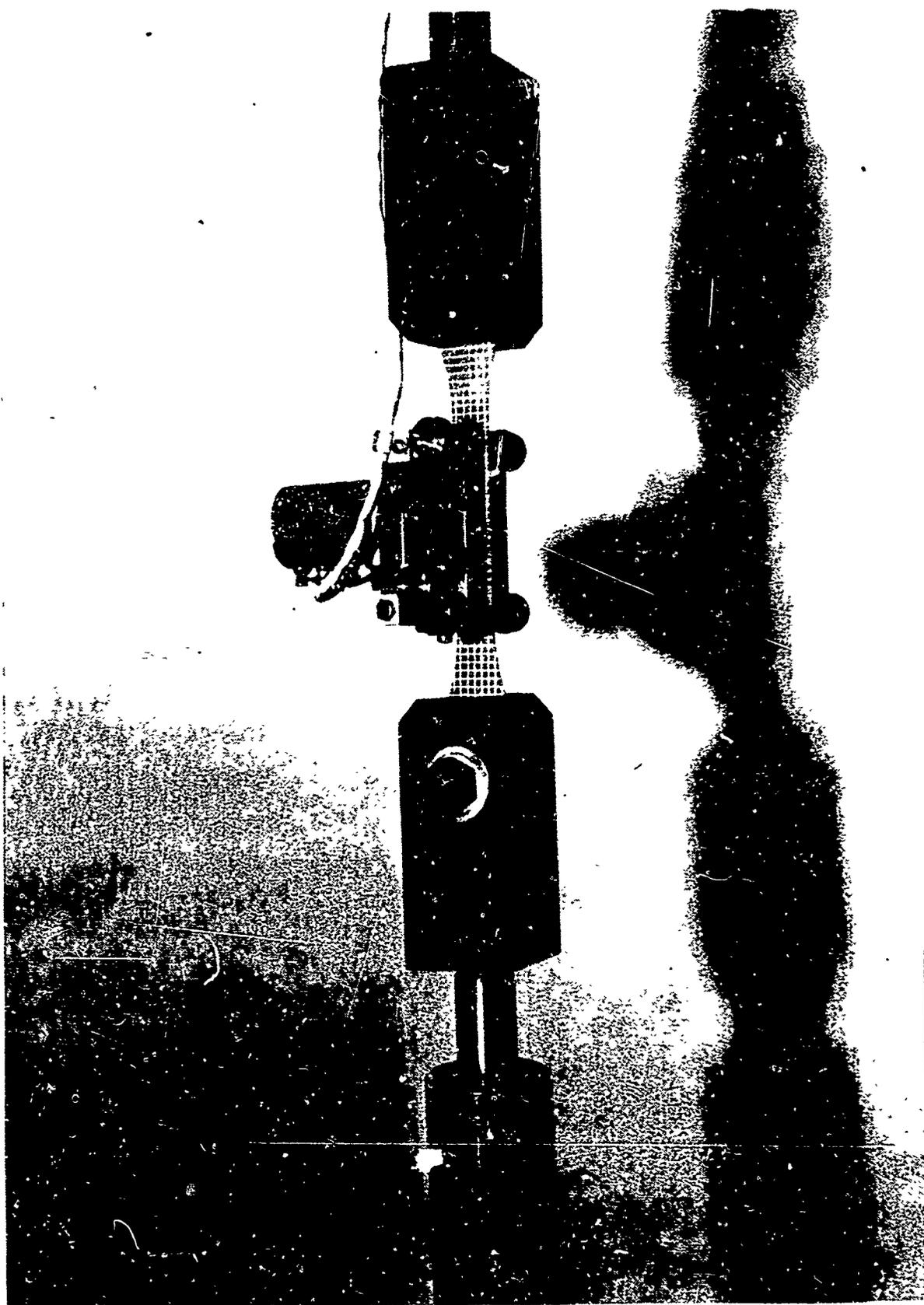


Fig 5-2

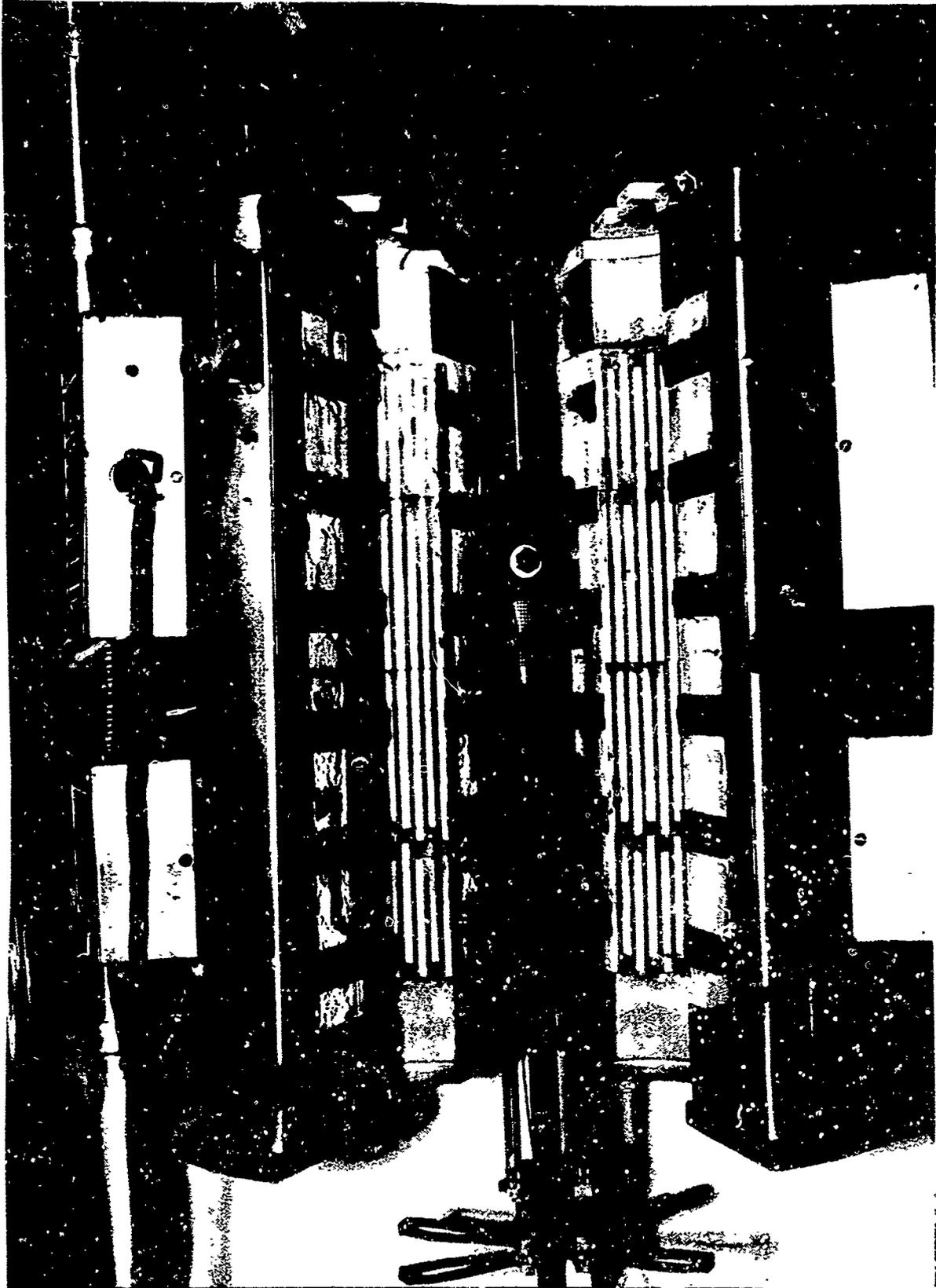


Fig 5-3

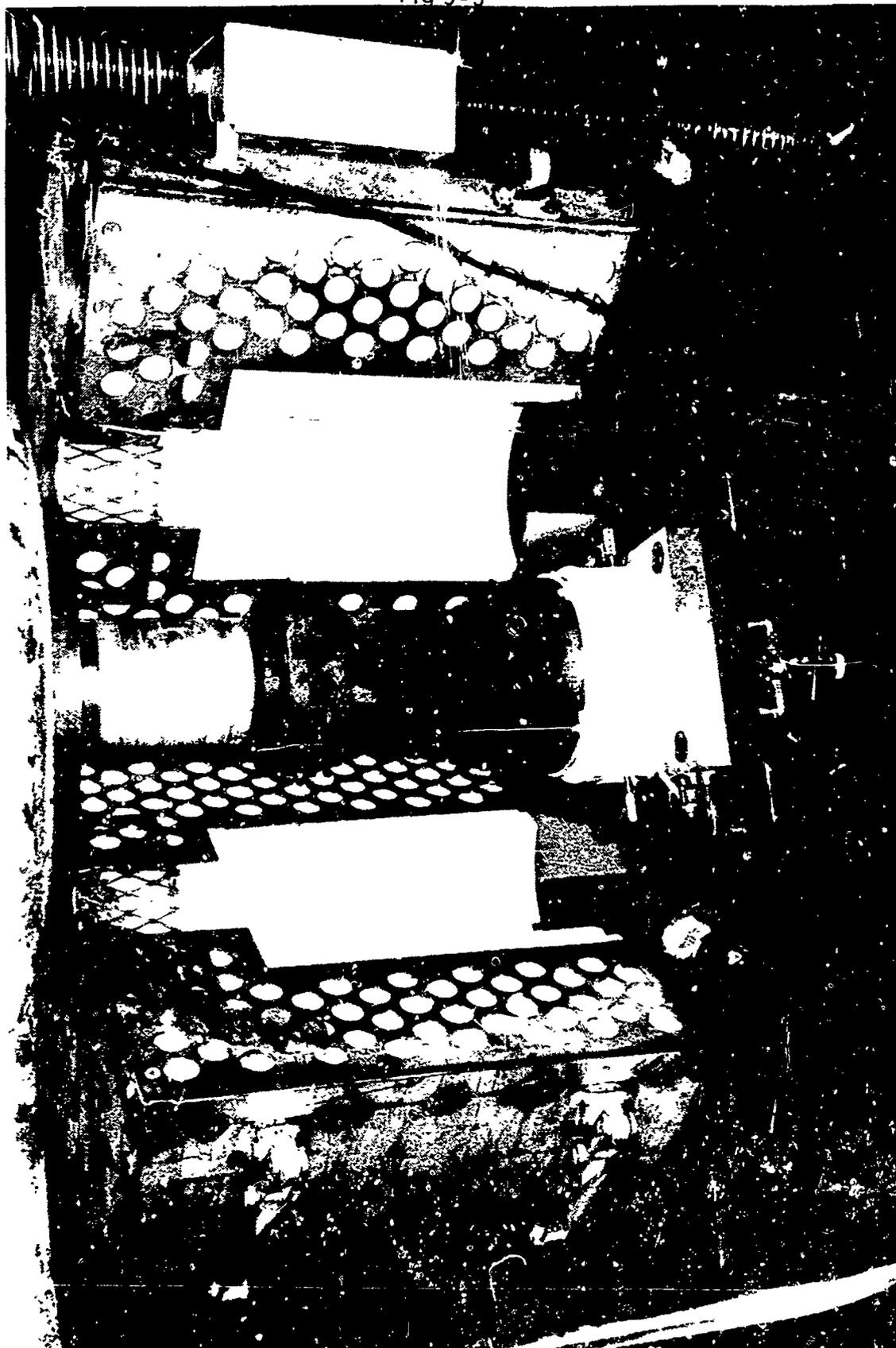


Fig 5-4

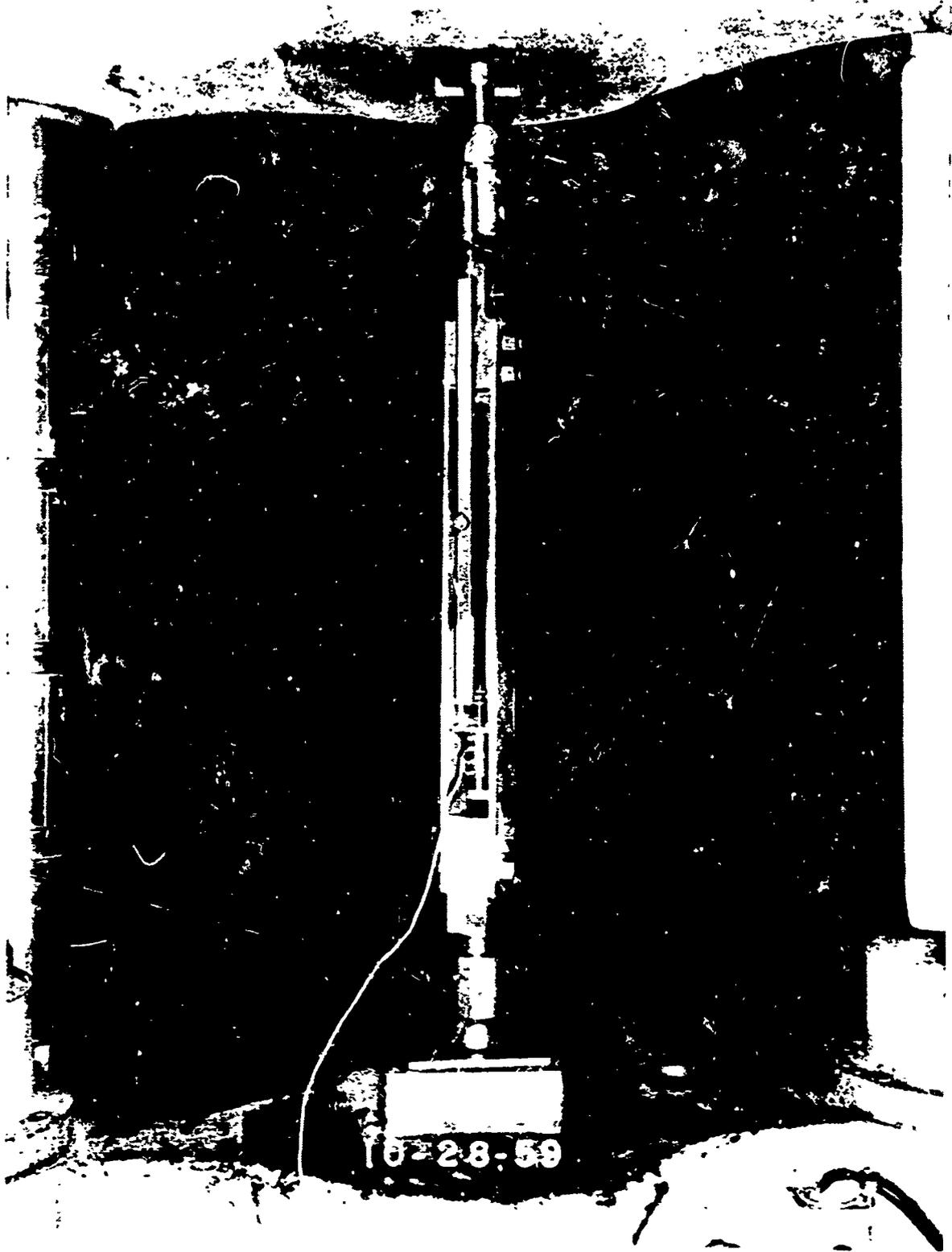




Fig 5-5

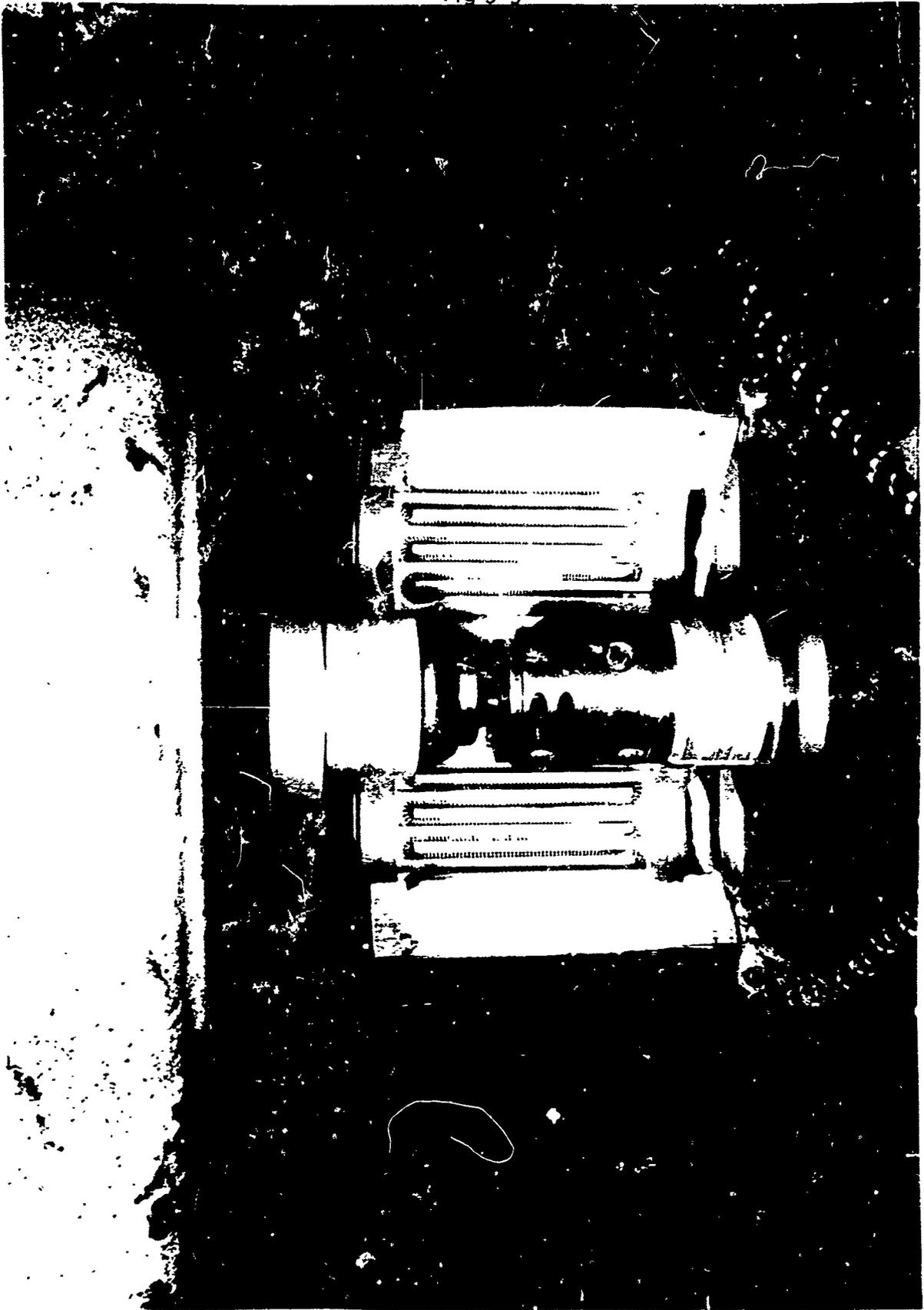
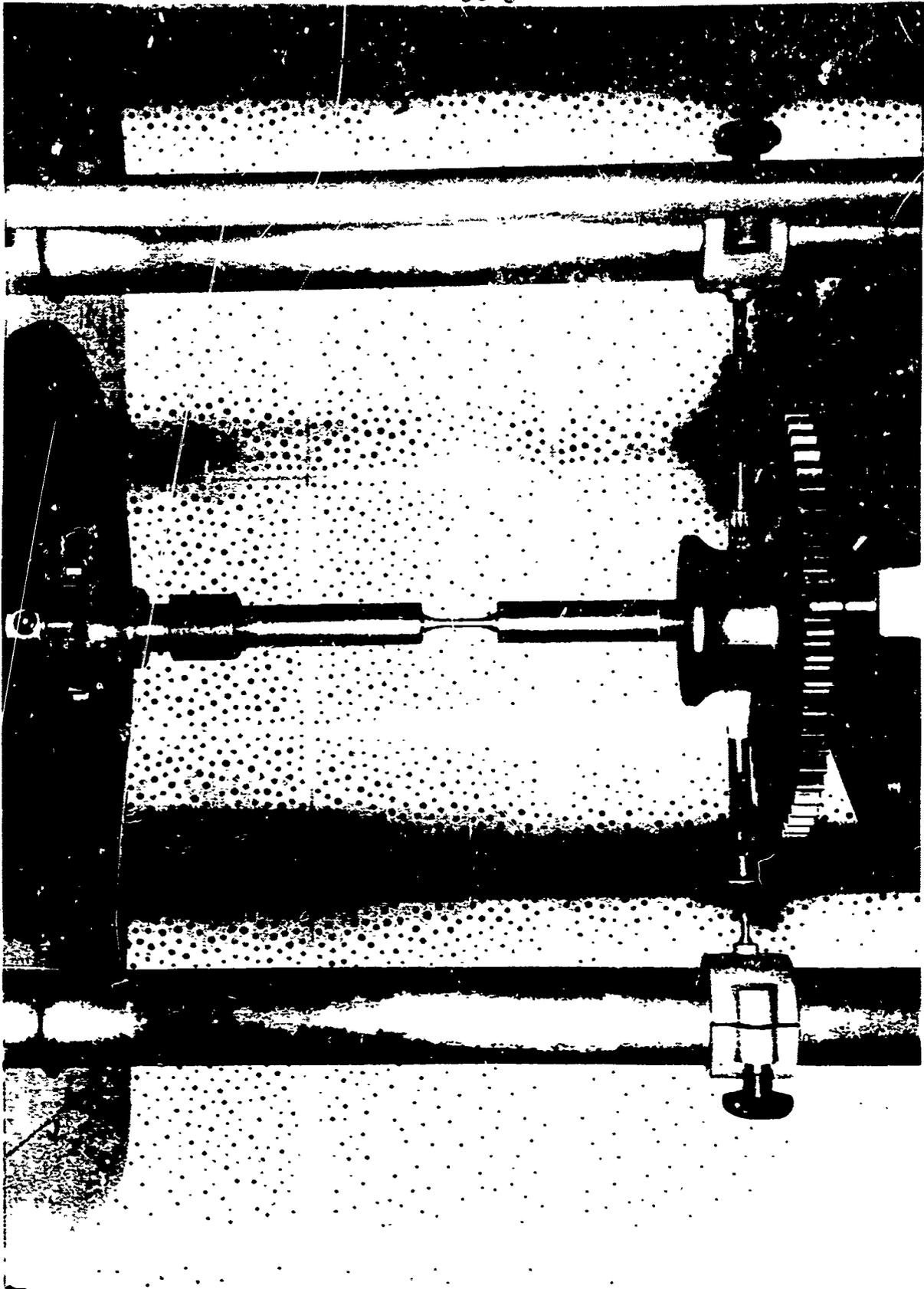


Fig 5-6



## Section VI

### SUMMARY AND ANALYSIS OF TEST RESULTS

Contained within this section are the statistical analysis procedures used to obtain the "A" and "B" Design Allowables, in addition to summary tables of the test results obtained in this investigation.

	Page
Methods of Statistical Analysis - R.T. Design Allowables	114 - 115
Discussion of R.T. Design Allowables	116
Data Presentation	116 - 118
Populations Used to Obtain Allowables	119 - 124
Summary of Room Temperature Test Results	125 - 132

## 6.1 METHODS OF STATISTICAL ANALYSIS - R.T. DESIGN ALLOWABLES

This analysis was accomplished in accordance with "MIL-HDBK-5 Guidelines for the Presentation of Data", AFML TR-66-386 Battelle Memorial Institute.

The mechanical properties presented here are identified by a letter (i.e., A or B) to indicate the basis upon which they were established. An "A" value is the property above which 99 percent of the population is expected to fail with a confidence of 95 percent. A "B" value is the property above which 90 percent of the population is expected to fail with a confidence of 95 percent.

There are two methods of obtaining these values and they are:

1. Directly Calculated Values - The directly calculated "A" values are obtained as follows:

$$\text{"A" value} = \bar{x} - KS_x$$

$$\text{Where } \bar{x} = \frac{\sum x}{n}$$

$$S_x = \sqrt{\frac{(x - \bar{x})^2}{(n - 1)}}$$

where  $\bar{x}$  is the average value of individual measurements,  $S_x$  standard deviation of individual measurements,  $n$  the number of individual measurements and  $K$ , the one-sided tolerance factor for normal distribution and specified probability, confidence, and population (i.e., for "A",  $K = K_{.99, .95, n}$ ).

The "B" values are calculated as follows:

$$\text{"B" value} = \bar{x} - KS_x$$

$$\text{Where } K = K_{.90, .95, n}$$

The values of  $K$  were obtained from the table "One-Sided Tolerance Factors for the Normal Distribution and a Confidence of .95", in Tables of Normal Probability Functions in above referenced document.

An additional requirement is that the population,  $n$ , must consist of at least 100 points from a minimum of ten different heats of material. Because of the scarcity of available data, this requirement usually can be satisfied for room temperature tensile ultimate and yield only.

2. Derived Values - These values are established through their relationship to directly calculated "A" or "B" values of  $F_{tu}$  or  $F_{ty}$  as obtained in the foregoing section. This method consists of pairing individual ultimate strength values (i.e.,  $F_{tu}$ ,  $F_{su}$ ,  $F_{bru}$ ) with individual tensile ultimate strength values, or individual yield strength values (i.e.,  $F_{ty}$ ,  $F_{bry}$ ) with individual tensile yield strength values, determining the mean ratio of these pairs with a probability of 95 percent and multiplying the directly calculated "A" or "B" values of  $F_{tu}$  or  $F_{ty}$  by this factor. Derived values are therefore equal to:

$$(\bar{r} - t_{.05} S_{\bar{r}}) F_{tu} \text{ (A or B)}$$

or 
$$(\bar{r} - t_{.05} S_{\bar{r}}) F_{ty} \text{ (A or B)}$$

where 
$$\bar{r} = \frac{\sum r}{n}$$

$$S_{\bar{r}} = \sqrt{\frac{\sum (r - \bar{r})^2}{n(n-1)}}$$

and  $t_{.05}$  is the two-sided tolerance factor for the "t" distribution, a probability of 95 percent and the population,  $n$ , involved. The values of  $t_{.05}$  were obtained from a table in the referenced document. The derived values of the mechanical properties have the same validity (A or B) as the values of  $F_{tu}$  or  $F_{ty}$  used in equations (4) and (5). Ten pairs of measurements ( $n = 10$ ) are the minimum for establishing a derived allowable.

#### LIST OF STATISTICAL SYMBOLS

A	"A" basis for mechanical property values
B	"B" basis for mechanical property values
K	One-sided tolerance factor for the normal distribution and the specified probability, confidence and population
n	The number of individual measurements or paired measurements - population
r	Ratio of two paired measurements
$\bar{r}$	ratio of two paired measurements
$S_{\bar{r}}$	Standard error of paired measurement ratios
$S_x$	Standard deviation of individual measurements
t	Two-sided tolerance factor for the "t" distribution and the specified probability and population
x	Value of an individual measurement
$\bar{x}$	The average value of individual measurements
$\Sigma$	The summation of

## 6.2 DISCUSSION OF ROOM TEMPERATURE ALLOWABLES

The values of all the mechanical properties for the Ti-4Al-3Mo-2V Cond. A sheet, Ti-6Al-4V Cond. STA plate, and Ti-6Al-6V-2Sn Cond. A and STA plate are presented as "S" values. This was a result of insufficient quantities of producers and users test data being supplied to NR/LAD during the solicitation of data phase of the subject contract. It should be noted that NR/LAD solicited the industry for test data applicable for the alloy covered in the scope of this contract. Much of the data obtained as a result of solicitation could not be used because of it not being the proper gage range, wrong condition, or inadequately identified to confidently be used.

The desired property values (i.e., all properties except  $F_{tu}$ ,  $F_{ty}$  and  $e$ ) for all alloys are limited because only five ratios were used to obtain each value, while a minimum of ten ratios is required by the MIL-HDBK-5 Guidelines.

The  $F_{tu}$ ,  $F_{ty}$  and  $e$  values for the Ti-13V-11Cr-3Al sheet alloy are valid "A" and "B" values to the extent that sufficient number of test data were available to establish valid statistical values; however, all test data reflect one producer only. Additionally, much of the applicable data was obtained in summary form which did not show the distribution. Therefore, a test for normality could not be made.

Table VI-1 to VI-4 indicate the populations and other pertinent information used in calculation of the allowables.

## 6.3 DATA PRESENTATION

### 6.3.1 Effect of Temperature Curves

These curves are presented as Per Cent Strength at Room Temperature vs Test Temperature. The procedure used to obtain these curves is as follows:

- a. Plot the individual values for the property at each temperature.
- b. Indicate the average value at each temperature.
- c. Draw the curve passing through the average at room temperature and either the average or 5 percent above minimum value, whichever is lowest, at each elevated temperature.
- d. Obtain the curve value at each temperature as a percentage of the curve value at room temperature.
- e. Plot the per cent values and fit the curve.

To obtain in a smooth curve in step (e), engineering judgment was used and the curves do not necessarily pass through the stated values at each temperature.

### 6.3.2 Effect of Exposure Curves

These curves are presented in "Per Cent Strength at Room Temperature vs Exposure Temperature"; they show the effect on the properties of specimens tested at room temperature after exposure to elevated temperature. These curves are drawn using the same technique described above.

The working curves (steps (a), (b), and (c)) can be found in the Appendix. Where aging has occurred and strength has increased with either temperature or exposure time, as in the case of Ti-13V-11Cr-3Al, a dashed line indicates this phenomena. In accordance with the MIL-HDBK-5 Guidelines, the working curve is drawn so that strength is not shown to increase with either temperature or exposure time.

### 6.3.3 Stress-Strain Curves

The method used to obtain these curves is as follows:

- a. For each alloy and at each temperature, select several well defined typical curves.
- b. Measure the plastic strains at different percentages of the yield strength and compute the average plastic strain at each percentage.
- c. Select the modulus values to be used: at room temperature use the value obtained by precision modulus measurements made in this program; at elevated temperatures obtain a value from data contained in MIL-HDBK-5, where available, or from data generated in this program.
- d. Use the average value for the yield strength at room temperature; find the elevated temperature average yield strengths using the appropriate "Effect of Temperature" curve and the room temperature value.
- e. Draw the straight line portion of the curve using the selected modulus; add the plastic strain and the elastic strain at the percentages of the yield strength chosen in step (b) to obtain the remainder of the curve.

### 6.3.4 Constant Life Diagrams

The fatigue constant life diagrams presented in Section VII for the test materials were constructed from the S-N curves contained within the Appendix. Engineering judgement was exercised in the construction of constant life diagram to smooth out some of the humps.

### 6.3.5 Fracture Toughness Tests

The fracture toughness test results are presented in Section VII in tabular form. As there is no standardized treatment of these test data listed within the "Guidelines" for inclusion into MIL-HDEK-5, pertinent detail test data is included along with the computed fracture toughness values. No attempt was made to summarize either the fatigue or fracture toughness test data.

### 6.3.6 Summary of Room Temperature Test Results

A summary of room temperature test results for the various materials tested are presented in Table VI-5 to VI-9. The summary presents averaged test values for the various mechanical property tests performed with the exception of the fatigue tests and plane strain fracture toughness tests.



6.4 POPULATIONS USED TO OBTAIN ALLOWABLES

Table VI - 1

Ti 4Al-3Mo-1V Condition A

Material Form and Property	Direction	Values * Obtained	** Method	Pairs	Heats	Vendors	Specimens
Sheet F <sub>tu</sub>	L	S	Direct		9	3	19
	LT	S	Direct		8	3	17
F <sub>ty</sub>	L	S	Direct		9	3	19
	LT	S	Direct		8	3	17
F <sub>cy</sub>	L	S	Derived	6	6	2	6
	LT	S	Derived	6	6	2	6
F <sub>su</sub>	L	S	Derived	6	6	2	6
	LT				2	2	2
F <sub>bru</sub> (e/D=1.5)	L	S	Derived	6	6	2	6
	LT				2	2	2
(e/D=2.0)	L	S	Derived	6	6	2	6
	LT				2	2	2
F <sub>bry</sub> (e/D=1.5)	L	S	Derived	6	6	2	6
	LT				2	2	2
e		S	Direct		9	3	36

\* See 6.2 for discussion of the validity of these values.

\*\* Direct "S" values were taken from MIL-T-9046.

## 6.4 (continued)

Table VI - 2

Ti 13V-11Cr-3Al Condition A

Material Form and Property	Direction	Values* Obtained	Method	Pairs	Heats	Vendors	Specimens
Sheet $F_{tu}$	L	A & B	Direct		Unknown	1	4385
	LT	A & B	Direct		Unknown	1	2929
$F_{ty}$	L	A & B	Direct		Unknown	1	4385
	LT	A & B	Direct		Unknown	1	2929
$F_{cy}$	L	A & B	Derived	4	4	1	4
	LT	A & B	Derived	5	5	1	5
$F_{su}$	L	A & B	Derived	5	5	1	5
	LT				1	1	1
$F_{bru}$ (e/D=1.5)	L	A & B	Derived	5	5	1	5
	LT				1	1	1
(e/D=2.0)	L	A & B	Derived	5	5	1	5
	LT				1	1	1
$F_{bry}$ (e/D=1.5)	L	A & B	Derived	5	5	1	5
	LT				1	1	1
(e/D=2.0)	L	A & B	Derived	5	5	1	5
	LT				1	1	1
e	L	A	Direct		Unknown	1	2828
	LT	A	Direct		Unknown	1	2962

\* See 6.2 for discussion of the validity of these values.

## 6.4 (cont'd)

Table VI - 3

T1 6Al-4V Condition STA

Material Form and Property	Direction	Values Obtained	** Method	Heats	Vendors	Specimens
Plate .250 to .300						
F <sub>tu</sub>	L	S	Direct	15	2	33
	LT	S	Direct	13	2	29
F <sub>ty</sub>	L	S	Direct	15	2	33
	LT	S	Direct	13	2	29
F <sub>cy</sub>	L			3	2	3
	LT			3	2	3
F <sub>su</sub>	L			3	2	3
	LT			2	2	3
F <sub>bru</sub> (e/D=1.5)	L			3	2	3
	LT			2	2	2
(e/D=2.0)	L			3	2	3
	LT			2	2	2
F <sub>bry</sub> (e/D=1.5)	L			3	2	3
	LT			2	2	2
(e/D=2.0)	L			3	2	3
	LT			2	2	2
e		S	Direct	15	2	62
Plate .500 to .630						
F <sub>tu</sub>	L	S	Direct	20	2	35
	LT	S	Direct	11	2	21
F <sub>ty</sub>	L	S	Direct	20	2	35
	LT	S	Direct	11	2	21
F <sub>cy</sub>	L			3	2	3
	LT			3	2	3
F <sub>su</sub>	L			3	2	3
	LT			1	1	1
F <sub>bru</sub> (e/D=1.5)	L			3	2	3
	LT			1	1	1

\*\* Direct "S" values were taken from MIL-T-9046.

6.4 (cont'd)

Table VI-3 (Cont'd)

T1 6A1-4V Condition STA

Material Form and Property	Direction	Values Obtained	** Method	Heets	Vendors	Specimens
(e/D=2.0)	L			3	2	3
	LT			1	1	1
F <sub>bry</sub> (e/D=1.5)	L			3	2	3
	LT			1	1	1
(e/D=2.0)	L			3	2	3
	LT			1	1	1
e		S	Direct	20	2	56
Plate . <u>.750 to 1.000</u>						
F <sub>tu</sub>	L	S	Direct	5	2	27
	LT	S	Direct	5	2	27
F <sub>ty</sub>	L	S	Direct	5	2	27
	LT	S	Direct	5	2	27
F <sub>cy</sub>	L			2	2	2
	LT			2	2	2
F <sub>su</sub>	L			2	2	2
	LT			1	1	1
F <sub>bru</sub> (e/D=1.5)	L			2	2	2
	LT			1	1	1
(e/D=2.0)	L			2	2	2
	LT			1	1	1
F <sub>bry</sub> (e/D=1.5)	L			2	2	2
	LT			1	1	1
(e/D=2.0)	L			2	2	2
	LT			1	1	1
e		S	Direct	5	2	54
Plate <u>1.200 to 1.500</u>						
F <sub>tu</sub>	L	S	Direct	9	2	16
	LT	S	Direct	9	2	16
F <sub>ty</sub>	L	S	Direct	9	2	16
	LT	S	Direct	9	2	16
e		S	Direct	9	2	32

\* Direct "S" values were taken from - 122 -  
MIL-T-9046.

## 6.4 (cont'd)

Table VI - 4

Ti 6Al-6V-2Sn Condition A

Material Form and Property	Direction	Values * Obtained	** Method	Pairs	Heats	Vendors	Specimens
<u>Plate .250 to .300</u>							
F <sub>tu</sub>	L	S	Direct		7	1	15
	LT	S	Direct		7	1	15
F <sub>ty</sub>	L	S	Direct		7	1	15
	LT	S	Direct		7	1	14
F <sub>cy</sub>	L	S	Derived	5	5	1	5
	LT	S	Derived	5	5	1	5
F <sub>su</sub>	L	S	Derived	5	5	1	5
	LT				1	1	1
F <sub>bru</sub> (e/D=1.5)	L	S	Derived	5	5	1	5
	LT				1	1	1
(e/D=2.0)	L	S	Derived	5	5	1	5
	LT				1	1	1
F <sub>bry</sub> (e/D=1.5)	L	S	Derived	5	5	1	5
	LT				1	1	1
(e/D=2.0)	L	S	Derived	5	5	1	5
	LT				1	1	1
e		S	Direct		7	1	30
<u>Plate .500 to .630</u>							
F <sub>tu</sub>	L	S	Direct		6	1	12
	LT	S	Direct		6	1	12
F <sub>ty</sub>	L	S	Direct		6	1	12
	LT	S	Direct		6	1	12
F <sub>cy</sub>	L	S	Derived	5	5	1	5
	LT	S	Derived	5	5	1	5
F <sub>su</sub>	L	S	Derived	5	5	1	5
	LT				1	1	1

\* See 6.2 for discussion of the validity of these values

\*\* Direct "S" values were taken from MJL-T-9046.

## 6.4 (cont'd)

Table VI - 4 (cont'd)

T1 6Al-6V-2Sn Condition A

Material Form and Property	Direction	Values * Obtained	** Method	Pairs	Heats	Vendors	Specimens
<u>Plate</u> <u>.500 to .630</u>							
F <sub>bru</sub> (e/D=1.5)	L	S	Derived	5	5	1	5
	LT				1	1	1
(e/D=2.0)	L	S	Derived	5	5	1	5
	LT				1	1	1
F <sub>bry</sub> (e/D=1.5)	L	S	Derived	5	5	1	5
	LT				1	1	1
(e/D=2.0)	L	S	Derived	5	5	1	5
	LT				1	1	1
e		S	Direct		6	1	24
<u>Plate</u> <u>≥1.50</u>							
F <sub>tu</sub>	L	S	Direct		5	1	10
	LT	S	Direct		5	1	10
F <sub>ty</sub>	L	S	Direct		5	1	10
	LT	S	Direct		5	1	10
F <sub>cy</sub>	L	S	Derived	5	5	1	5
	LT	S	Derived	5	5	1	5
F <sub>su</sub>	L	S	Derived	5	5	1	5
	LT				1	1	1
F <sub>bru</sub> (e/D=1.5)	L	S	Derived	5	5	1	5
	LT				1	1	1
(e/D=2.0)	L	S	Derived	4	4	1	4
	LT				1	1	1
F <sub>bry</sub> (e/D=1.5)	L	S	Derived	5	5	1	5
	LT				1	1	1
(e/D=2.0)	L	S	Derived	5	5	1	5
	LT				1	1	1
e		S	Direct		5	1	20

\*\* Direct "S" values were taken from MIL-T-9046

\* See 6.2 for discussion of the validity of these values

Table VI - 5

Ti-6Al-6V-2Sn Condition STA

Material Form and Property	Direction	Values * Obtained	** Method	Pairs	Heats	Vendors	Specimens
Plate .500 to .630							
F <sub>tu</sub>	L	S	Direct		5	1	5
	LT	S	Direct		5	1	5
F <sub>ty</sub>	L	S	Direct		5	1	5
	LT	S	Direct		5	1	5
F <sub>cy</sub>	L	S	Derived	5	5	1	5
	LT	S	Derived	5	5	1	5
F <sub>su</sub>	L	S	Derived	5	5	1	5
	LT				1	1	1
F <sub>bru</sub> (e/D=1.5)	L	S	Derived	5	5	1	5
	LT				1	1	1
(e/D=2.0)	L	S	Derived	5	5	1	5
	LT				1	1	1
F <sub>bry</sub> (e/D=1.5)	L	S	Derived	5	5	1	5
	LT				1	1	1
(e/D=2.0)	L	S	Derived	5	5	1	5
	LT				1	1	1
e		S	Direct		5	1	10
<u>≥ 1.50</u>							
F <sub>tu</sub>	L	S	Direct	1	5	1	5
	LT	S	Direct		5	1	5
F <sub>ty</sub>	L	S	Direct		5	1	5
	LT	S	Direct		5	1	5
F <sub>cy</sub>	L	S	Derived	5	5	1	5
	LT	S	Derived	5	5	1	5
F <sub>su</sub>	L	S	Derived	5	5	1	5
	LT				1	1	1

\* See 6.2 for discussion of the validity of these values.

\*\* Direct "S" values were taken from MIL-T-9046.

Table VI - 5 (continued)

Ti 6Al-6V-2Sn Condition STA

Material Form and Property	Direction	Values * Obtained	** Method	Pairs	Heats	Vendors	Specimens
F <sub>bru</sub> (e/D=1.5)	L	S	Derived	5	5	1	5
	LT				1	1	1
(e/D=2.0)	L	S	Derived	5	5	1	5
	LT				1	1	1
F <sub>bry</sub> (e/D=1.5)	L	S	Derived	5	5	1	5
	LT				1	1	1
(e/D=2.0)	L	S	Derived	5	5	1	5
	LT				1	1	1
e		S	Direct		5	1	10

\* See 6.2 for discussion of the validity of these values.

\*\* Direct "S" values were taken from MIL-T-9046.



Table VI-6

## SUMMARY OF ROOM TEMPERATURE TEST RESULTS

Ti 4Al-3Mo-1V      Annealed Condition

Property	Thickness	Direction	No. of Tests	Property Value *
Tensile Ultimate Strength (KSI)	≤ .110	L	6	131.1
		LT	6	136.7
Tensile Yield Strength (KSI)	≤ .110	L	6	124.2
		LT	6	132.8
Compressive Yield Strength (KSI)	≤ .110	L	6	127.6
		LT	6	136.3
Bearing Ultimate Strength (KSI) e/D = 1.5	≤ .110	L	6	210.8
		LT	2	219.7
Bearing Ultimate Strength (KSI) e/D = 2.0	≤ .110	L	6	277.3
		LT	2	283.9
Bearing Yield Strength (KSI) e/D = 1.5	≤ .110	L	6	171.4
		LT	2	177.9
Bearing Yield Strength (KSI) e/D = 2.0	≤ .110	L	6	202.9
		LT	2	218.6
Shear Ultimate Strength (KSI)	≤ .110	L	6	82.8
		LT	2	84.2

\* Average value for more than 1 test.

Table VI -7

## SUMMARY OF ROOM TEMPERATURE TEST RESULTS

Ti 13V-11Cr-3Al Annealed Condition

Property	Thickness	Direction	No. of Tests	Property Value *
Tensile Ultimate Strength (KSI)	≤ .110	L	5	135.3
		LT	5	137.8
Tensile Yield Strength (KSI)	≤ .110	L	5	134.6
		LT	5	136.9
Compressive Yield Strength (KSI)	≤ .110	L	4	132.3
		LT	5	137.2
Bearing Ultimate Strength (KSI) e/D = 1.5	≤ .110	L	5	221.5
		LT	1	224.0
Bearing Ultimate Strength (KSI) e/D = 2.0	≤ .110	L	5	303.4
		LT	1	311.0
Bearing Yield Strength (KSI) e/D = 1.5	≤ .110	L	5	173.0
		LT	1	176.9
Bearing Yield Strength (KSI) e/D = 2.0	≤ .110	L	5	192.0
		LT	1	205.0
Shear Ultimate Strength (KSI)	≤ .110	L	5	96.8
		LT	1	98.2

\* Average value for more than 1 test.

Table VI-8

## SUMMARY OF ROOM TEMPERATURE TEST RESULTS

Ti 6Al-4V STA Condition

Property	Thickness	Direction	No. of Tests	Property Value *
Tensile Ultimate Strength (KSI)	.250 to .300	L	3	161.4
		LT	3	167.1
	.500 to .630	L	3	175.9
		LT	3	178.2
	≥ 1.00	L	2	152.9
		LT	2	159.0
ST	2	152.9		
Tensile Yield Strength (KSI)	.250 to .300	L	3	149.7
		LT	3	155.5
	.500 to .630	L	3	161.7
		LT	3	164.5
	≥ 1.00	L	2	146.2
		LT	2	151.4
ST	2	145.0		
Compressive Yield Strength (KSI)	.250 to .300	L	3	157.1
		LT	3	176.5
	.500 to .630	L	3	171.6
		LT	3	166.9
	≥ 1.00	L	2	156.8
		LT	2	158.7
ST	2	153.2		
Bearing Ultimate Strength (KSI) e/D = 1.5	.250 to .300	L	3	262.9
		LT	2	268.8
	.500 to .630	L	3	274.1
		LT	1	274.1
	≥ 1.00	L	2	250.9
		LT	1	267.3
LE		1	233.8	
TE	1	224.0		
Bearing Ultimate Strength (KSI) e/D = 2.0	.250 to .300	L	3	317.9
		LT	2	330.8
	.500 to .630	L	3	339.2
		LT	1	331.2
	≥ 1.00	L	2	315.7
		LT	1	334.3
LE		1	310.8	
TE	1	299.4		
Bearing Yield Strength (KSI) e/D = 1.5	.250 to .300	L	3	222.8
		LT	2	232.9
	.500 to .630	L	3	240.2
		LT	1	240.9
	≥ 1.00	L	2	215.9
		LT	1	217.8
LE		1	214.0	
TE	1	207.7		

\* Average value for more than 1 test.

Table VI 8 (cont'd)

## SUMMARY OF ROOM TEMPERATURE TEST RESULTS

Ti 6Al-4V STA Condition

Property	Thickness	Direction	No. of Tests	Property Value *
Bearing Yield Strength (KSI) e/D = 2.0	.250 to .300	L	3	256.0
		LT	2	279.3
	.500 to .630	L	3	283.8
		LT	1	271.7
	≥ 1.00	L	2	251.1
		LT	1	264.2
		LE	1	265.8
		TE	1	257.3
Shear Ultimate Strength (KSI)	.250 to .300	L	3	98.7
		LT	2	105.4
	.500 to .630	L	3	103.6
		LT	1	98.3
	≥ 1.00	L	2	95.2
		LT	1	102.0

\* Average value for more than 1 test.

Table VI - 9

## SUMMARY OF ROOM TEMPERATURE TEST RESULTS

Ti 6Al-6V-2Sn Annealed Condition

Property	Thickness	Direction	No. of Tests	Property Value *
Tensile Ultimate Strength (KSI)	.250 to .300	L	5	161.2
		LT	5	171.2
	.500 to .630	L	5	160.9
		LT	5	163.5
	1.00	L	5	154.6
		LT	5	154.1
ST	5	154.8		
Tensile Yield Strength (KSI)	.250 to .300	L	5	158.8
		LT	5	166.6
	.500 to .630	L	5	158.3
		LT	5	160.2
	1.00	L	5	148.5
		LT	5	149.1
ST	5	143.1		
Compressive Yield Strength (KSI)	.250 to .300	L	5	162.6
		LT	5	184.3
	.500 to .630	L	5	170.6
		LT	5	173.2
	1.00	L	5	161.4
		LT	5	157.5
ST	5	153.6		
Bearing Ultimate Strength (KSI) e/D = 1.5	.250 to .300	L	5	261.8
		LT	1	274.6
	.500 to .630	L	5	275.5
		LT	1	264.4
	1.00	L	5	264.1
		LT	1	256.4
LE		1	244.9	
TE	1	212.9		
Bearing Ultimate Strength (KSI) e/D = 2.0	.250 to .300	L	5	330.8
		LT	1	354.3
	.500 to .630	L	5	344.7
		LT	1	392.9
	1.00	L	4	337.6
		LT	1	327.4
		LE	1	317.4
		TE	1	294.5

\* Average value for more than 1 test.

Table VI-9 (cont'd)

## SUMMARY OF ROOM TEMPERATURE TEST RESULTS

Ti 6Al-6V-2Sn Annealed Condition

Property	Thickness	Direction	No. of Tests	Property Value *	
Bearing Yield Strength (KSI) $e/D = 1.5$	.250 to .300	L	5	224.5	
		LT	1	212.2	
	.500 to .630	L	5	230.2	
		LT	1	222.5	
	1.00	L	5	218.4	
		LT	1	217.3	
		LE	1	215.6	
		TE	1	200.6	
	Bearing Yield Strength (KSI) $e/D = 2.0$	.250 to .300	L	5	252.5
			LT	1	286.1
.500 to .630		L	5	271.6	
		LT	1	307.1	
1.00		L	5	264.0	
		LT	1	253.4	
		LE	1	267.7	
		TE	1	256.4	
Shear Ultimate Strength (KSI)	.250 to .300	L	5	99.6	
		LT	1	108.7	
	.500 to .630	L	5	106.0	
		LT	1	108.2	
	1.00	L	5	102.0	
		LT	1	105.3	

\* Average value for more than 1 test.

Table VI - 10

## SUMMARY OF ROOM TEMPERATURE TEST RESULTS

Ti 6Al-6V-2Sn STA Condition

Property	Thickness	Direction	No. of Tests	Property Value *	
Tensile Ultimate Strength (KSI)	.250 to .300	L	1	184.6	
		LT	1	191.2	
	.500 to .630	L	5	183.1	
		LT	5	183.5	
	≥ 1.00	L	5	187.4	
		LT	5	188.3	
		ST	5	182.3	
	Tensile Yield Strength (KSI)	.250 to .300	L	1	176.5
			LT	1	186.0
.500 to .630		L	5	177.1	
		LT	5	176.5	
≥ 1.00		L	5	176.2	
		LT	5	179.0	
		ST	5	167.6	
Compressive Yield Strength (KSI)		.250 to .300	L	1	184.1
			LT	1	206.0
	.500 to .630	L	5	188.8	
		LT	5	188.3	
	≥ 1.00	L	5	195.4	
		LT	5	191.4	
Bearing Ultimate Strength (KSI) e/D = 1.5	.250 to .300	L	1	298.6	
	.500 to .630	L	5	291.5	
		LT	1	287.4	
	≥ 1.00	L	5	295.4	
		LT	1	289.0	
		LE	1	261.1	
		TE	1	251.7	
Bearing Ultimate Strength (KSI) e/D = 2.0	.250 to .300	L	1	360.4	
	.500 to .630	L	5	365.2	
		LT	1	350.2	
	≥ 1.00	L	5	360.6	
		LT	1	343.7	
		LE	1	350.3	
		TE	1	342.5	

\* Average value for more than 1 test.

Table VI- 10 (cont'd)

## SUMMARY OF ROOM TEMPERATURE TEST RESULTS

Ti 6Al-6V-2Sn STA Condition

Property	Thickness	Direction	No. of Tests	Property Value *
Bearing Yield Strength (KSI) e/D = 1.5	.250 to .300	L	1	277.7
	.500 to .630	L	5	263.5
		LT	1	265.1
	≥ 1.00	L	5	270.9
		LT	1	266.5
		LE	1	240.0
		TE	1	242.5
Bearing Yield Strength (KSI) e/D = 2.0	.250 to .300	L	1	296.7
	.500 to .630	L	5	298.3
		LT	1	298.1
	≥ 1.00	L	5	304.9
		LT	1	283.3
		LE	1	289.4
		TE	1	312.0
Shear Ultimate Strength (KSI)	.250 to .300	L	1	107.0
	.500 to .630	L	5	111.8
		LT	1	118.0
	≥ 1.00	L	5	114.6
		LT	1	111.0

\* Average value for more than 1 test.



## Section VII

### TEST RESULTS

Contained within this section are the results of the various mechanical property tests performed in this investigation.

	Page
Ti-4Al-3Mo-1V Cond. A	135 - 149
Ti-13V-11Cr-3Al Cond. A	150 - 158
Ti-6Al-4V Cond. STA	159 - 180
Ti-6Al-6V-2Sn Cond. A	181 - 205
Ti-6Al-6V-2Sn Cond. STA	206 - 226

7.1 Ti 4Al-3Mo-1V Cond A

7.1.1 Tensile Tests

Ti 4Al-3Mo-1V ANNEALED CONDITION

Thickness (Inches)	Manufacturer and Heat No.	Specimen Number	Test Direction	Test Temperature (°F)	F <sub>ty</sub> (Ksi)	F <sub>tu</sub> (Ksi)	% Elongation	% Reduction Area		
≤ .110	Timet G 1596	TM1XLT81	L	RT	126.2	133.6	12.0	-		
		TM1XLT41	L	400	89.4	103.8	10.0	-		
		TM1XLT61	L	600	81.9	96.9	7.5	-		
		TM1XLT81	L	800	71.2	86.5	7.5	-		
		TM1XTTR1	T	RT	125.2	134.7	11.0	-		
		TM1XTT41	T	400	94.1	107.6	10.0	-		
		TM1XTT61	T	600	81.8	97.6	7.0	-		
		TM1XTT81	T	800	78.7	90.6	7.0	-		
	Timet G 895	TM2XLT81	L	RT	128.7	133.2	12.5	-		
		TM2SLT41	L	400	100.4	106.4	12.5	-		
		TM2XLT61	L	600	85.7	96.4	8.0	-		
		TM2XLT81	L	800	75.0	87.1	7.5	-		
		TM2XTTR1	T	RT	132.8	135.4	11.5	-		
		TM3XLT81	L	RT	123.4	130.0	12.0	-		
		TM3XLT41	L	400	93.8	102.2	12.5	-		
		TM3XLT61	L	600	81.6	92.2	8.5	-		
	Timet G 2446	TM3XLT81	L	800	74.1	85.6	9.5	-		
		TM3XLT81	T	RT	135.9	136.5	12.0	-		
		TM4XLT81	L	RT	120.9	128.1	12.0	-		
		TM4XLT41	L	400	88.5	102.3	12.5	-		
		TM4XLT61	L	600	79.2	96.4	9.5	-		
		TM4XLT81	L	800	71.2	88.4	8.5	-		
		TM4XTTF1	T	RT	127.2	132.3	13.5	-		
			Timet G 1523	TM5XLT81	L	RT	121.2	130.4	12.0	-
TM5XLT41	L			400	90.9	100.7	13.0	-		
TM5XLT61	L			600	79.4	90.8	9.0	-		
TM5XLT81	L			800	73.5	85.2	9.0	-		
TM5XTTR1	T			RT	139.4	142.2	12.0	-		
≤ .110	Timet G 1401			TM5XLT81	L	RT	121.2	130.4	12.0	-
				TM5XLT41	L	400	90.9	100.7	13.0	-
				TM5XLT61	L	600	79.4	90.8	9.0	-
		TM5XLT81	L	800	73.5	85.2	9.0	-		
		TM5XTTR1	T	RT	139.4	142.2	12.0	-		

7.1.1 Tensile Tests (continued)

TI 4A1-3Mo-1V ANNEALED CONDITION

Thickness (Inches)	Manufacturer and Heat No.	Specimen Number	Test Direction	Test Temperature (°F)	F <sub>ty</sub> (Ksi)	F <sub>tu</sub> (Ksi)	% Elongation	% Reduction Area
.110 ↕ .110	RMI 321055 ↕ RMI 321055	RM6XLTRL	L	RT	124.8	131.5	13.0	-
		RM6XLTT41	L	400	88.7	99.3	16.0	-
		RM6XLTT61	L	600	78.4	89.4	14.0	-
		RM6XLTT81	L	800	70.5	81.9	15.0	-
		RM6XTTRL	T	RT	136.0	133.8	14.0	-
		RM6XTTT41	T	400	100.1	106.0	15.0	-
		RM6XTTT61	T	600	87.3	95.4	15.0	-
		RM6XTTT81	T	800	77.9	87.4	12.0	-

7.1.1 Tensile Stability Tests

Ti 4Al-3Mo-IV ANNEALED CONDITION

Thickness (Inches)	Manufacturer and Heat No.	Specimen Number	Test Direction	Exposure		Test Temperature (°F)	F <sub>ty</sub> (Ksi)	F <sub>tu</sub> (Ksi)	Percent Elongation	% Reduction Area
				Temperature (°F)	Time (Hrs.)					
S .110	Timet G 1596	TMLXLTW41	L	400	10	RT	122.6	133.7	13.0	-
		TMLXLTW42	L	400	100	RT	122.8	132.5	12.0	-
		TMLXLTW43	L	400	1000	RT	121.8	130.0	13.5	-
		TMLXLTW61	L	600	10	RT	121.0	131.7	13.0	-
		TMLXLTW62	L	600	100	RT	121.0	132.5	12.0	-
		TMLXLTW63	L	600	1000	RT	122.6	134.4	13.0	-
		TMLXLTW81	L	800	10	RT	120.4	131.1	12.0	-
		TMLXLTW82	L	800	100	RT	120.2	131.5	13.0	-
		TMLXLTW83	L	800	1000	RT	123.5	131.8	12.5	-
		S .110	Timet G 1596	TMLXLTW41	L	400	10	400	89.5	104.2
TMLXLTW42	L			400	100	400	90.6	105.1	13*	-
TMLXLTW43	L			400	1000	400	89.3	104.2	14	-
TMLXLTW61	L			600	10	600	78.2	94.9	8	-
TMLXLTW62	L			600	100	600	79.9	95.1	8	-
TMLXLTW63	L			600	1000	600	75.7	92.9	15	-
TMLXLTW81	L			800	10	800	71.8	87.6	8*	-
TMLXLTW82	L			800	100	800	72.7	89.1	8	-
TMLXLTW83	L			800	1000	800	73.2	89.1	8*	-

\*Ductile through guage mark or within specimen width of guage marks.

TM-4A1-3Mo-IV COND. A

7.1.1.2 Tensile Tests - Precision Elastic Modulus (Thickness)

Thickness (inches)	Manufacturer and Heat No.	Specimen Number	Test Direction	Test Temperature	Precision "E" x 10 <sup>6</sup>
-.110	Timet G 1596	TMXLTR1	L	RT	16.2

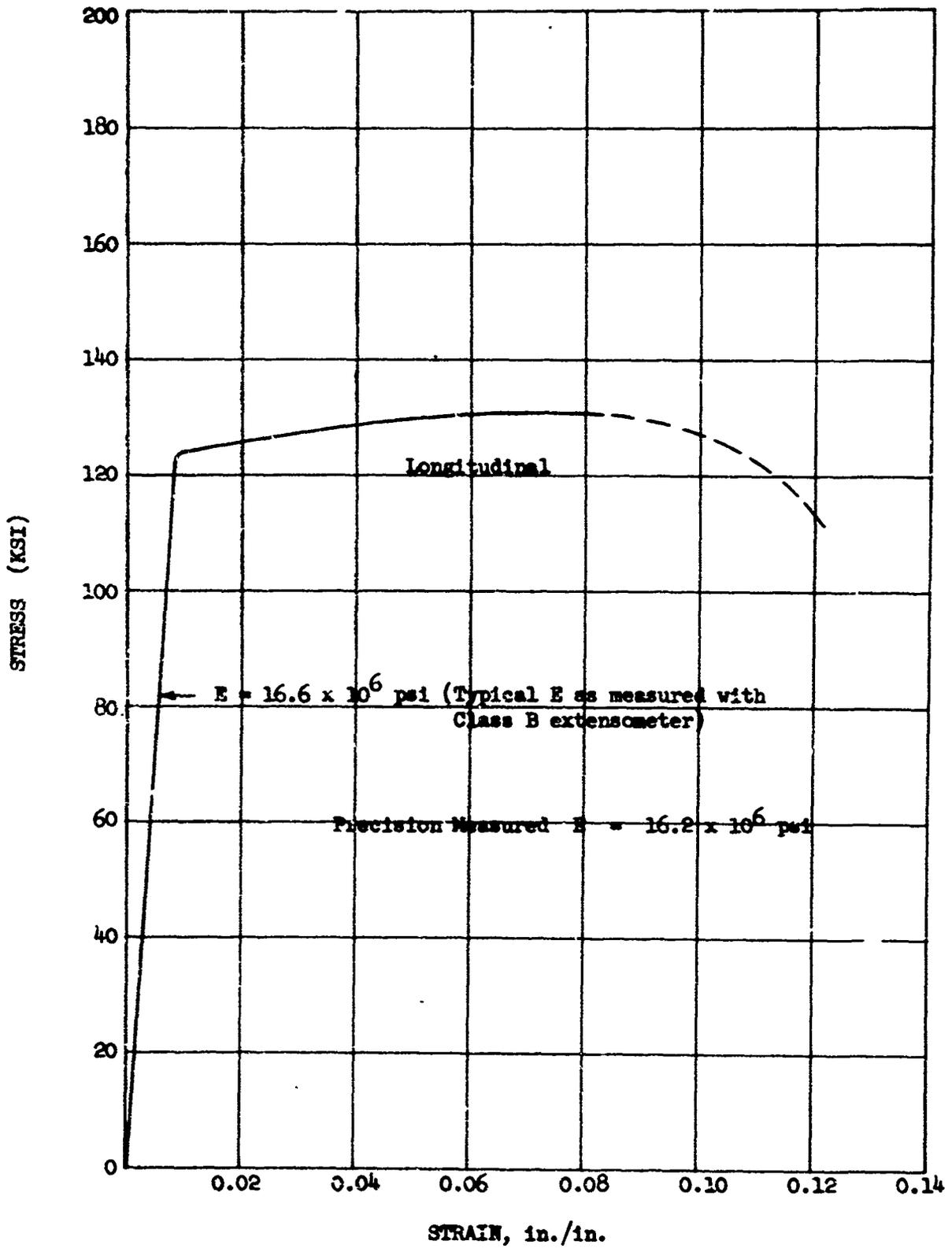


Figure 7-1 Typical Tensile Stress-Strain Curve (full-range) for Annealed Ti-4Al-3Mo-1V Alloy Sheet at Room Temperature

7.1.2 Compression Tests TH 4Al-3Mo-1V ANNEALED CONDITION

Thickness (Inches)	Manufacturer and Heat No.	Specimen Number	Test Direction	Test Temperature (°F)	F <sub>cy</sub> (Ks1)	
S .110	Timet G 1596	TM1XLCR1	L	RT	125.9	
		TM1XLC41	L	400	91.5	
		TM1XLC61	L	600	81.1	
		TM1XLC81	L	800	72.7	
		TM1XLCR1	T	RT	122.6	
		TM1XTC41	T	400	90.6	
		TM1XTC61	T	600	81.2	
		TM1XTC81	T	800	72.9	
	S .110	Timet G 895	TM2XLCR1	L	RT	131.2
			TM2XLCR1	T	RT	131.5
Timet G 2446		TM3XLCR1	L	RT	127.5	
		TM3XTCR1	T	RT	133.3	
		TM4XLCR1	L	RT	124.7	
TM4XTCR1	T	RT	129.6			
S .110	Timet G 1401	TM5XLCR1	L	RT	126.0	
		TM5XTCR1	T	RT	155.3	



4Al-3Mo-1V Annealed Condition

7.1.2 Compression Tests (continued)

Thickness (Inches)	Manufacturer and Heat No.	Specimen Number	Test Direction	Test Temperature (°F)	F <sub>cy</sub> (Ksi)
≤ .110	RMI 321055	RM6XLCR1	L	RT	129.1
		RM6XLC41	L	400	93.5
≤ .110	RMI 321055	RM6XLC61	L	600	82.1
		RM6XLC81	L	800	75.7
		RM6XTCR1	T	RT	145.7
		RM6XTC41	T	400	104.2
		RM6XTC61	T	600	91.9
		RM6XTC81	T	800	86.2

Ti 4Al-3Mo-1V ANNEALED CONDITION

7.1.3 Bearing Tests

Thickness (Inches)	Manufacturer and Heat No.	Specimen Number	Test Direction	e/D	Test Temperature (°F)	F <sub>max</sub> (Ksi) (2% Offset)	F <sub>max</sub> (Ksi)	
≤ .110	Timet G1596	TM1XLB1R1	L	1.5	RT	162.4	201	
		TM1XLB1L1	L	1.5	400	135.3	162.4	
		TM1XLB161	L	1.5	600	154.1	154.1	
		TM1XLB181	L	1.5	800	124.7	144.7	
		TM1XTB1R1	T	1.5	RT	159.4	206	
		TM1XTB1L1	T	1.5	400	133.0	161.4	
		TM1XTB161	T	1.5	600	134.1	155.3	
		TM1XTB18	T	1.5	800	125.9	142.4	
	≤ .110	Timet G1596	TM1XLB2R1	L	2.0	RT	198.8	279
			TM1XLB2L1	L	2.0	400	147.1	202.4
TM1XLB261			L	2.0	600	143.5	191.8	
TM1XLB281			L	2.0	800	140.0	183.5	
TM1XTB2R1			T	2.0	RT	197.6	263	
TM1XTB2L1			T	2.0	400	163.5	204.7	
TM1XTB261			T	2.0	600	151.8	195.3	
TM1XTB281			T	2.0	800	149.4	187.1	
Timet G 895		TM2XLB1R1	L	1.5	RT	170.0	208	
		TM2XLB2R1	L	2.0	RT	190.7	279	
Timet G 2446	TM3XLB2R1	L	1.5	RT	167.7	207		
	TM3XLB2R1	L	2.0	RT	208.9	280		
Timet G 1523	TM4XLB1R1	L	1.5	RT	168.0	206		
	TM4XLB2R1	L	2.0	RT	189.1	276		
Timet G 1401	TM5XLB1R1	L	1.5	RT	178.5	214.2		
	TM5XLB2R1	L	2.0	RT	215.2	274.5		

Ti 4Al-3Mo-1V ANNEALED CONDITION

7.1.3 Bearing Tests (continued)

Thickness (Inches)	Manufacturer and Heat No.	Specimen Number	Test Direction	o/D	Test Temperature (oF)	$P_{MT}$ (Ksi) (2% Offset)	$P_{max}$ (Ksi)
S .110	RMI 321055	RM6XLB1R1	L	1.5	RT	181.9	228.8
		RM6XLB141	L	1.5	400	136.9	173.8
		RM6XLB161	L	1.5	600	132.6	159.2
		RM6XLB18	L	1.5	800	115.3	134.9
		RM6XTB1R1	T	1.5	RT	186.3	233.3
		RM6XTB141	T	1.5	400	140.9	183.7
		RM6XTB161	T	1.5	600	131.8	162.4
		RM6XTB181	T	1.5	800	121.1	146.5
	RMI 321055	RM6XLB2R1	L	2.0	RT	214.7	275.0
		RM6XLB241	L	2.0	400	159.3	233.5
RM6XLB261		L	2.0	600	150.5	205.7	
RM6XLB281		L	2.0	800	139.5	186.8	
RMI 321055	RM6XTB2R1	T	2.0	RT	239.6	304.7	
	RM6XTB241	T	2.0	400	166.2	242.1	
	RM6XTB261	T	2.0	600	159.8	213.8	
	RM6XTB281	T	2.0	800	150.9	196.5	

Ti 4Al-3Mo-1V ANNEALED CONDITION

7.1.4 Shear Tests

Thickness (Inches)	Manufacturer and Heat No.	Specimen Number	Test Direction	Test Temperature (°F)	Fey (Ksi)
≤ .110	Timet G 1596	TM1XLSR-	L	RT	83.8
		TM1XLS41	L	400	65.0
	Timet G 1596	TM1XLS01	L	600	56.8
		TM1XLS81	L	800	51.5
		TM1XTSR1	L	RT	78.8
		TM1XTS41	T	400	63.4
		TM1XTS61	T	600	56.9
		TM1XTS81	T	800	51.9
	Timet G 895	TM2XLSR1	L	RT	82.2
		Timet G 2446	TM3XLSR1	L	RT
TM4XLSR1			L	RT	82.7
Timet G 1401		TM5XLSR1	L	RT	83.6
FMI 321065		FMI 321065	FM6XLSR1	L	RT
	FM6XLS41		L	400	68.5
	FMI 321065	FM6XLS61	L	600	62.1
		FM6XLS81	L	800	58.4
		FM6XTSR1	T	RT	89.6
		FM6XTS41	T	400	74.0
		FM6XTS61	T	600	66.7
		FM6XTS81	T	800	61.6

Ti 4Al-3Mo-1V ANNEALED CONDITION

7.1.5 Fatigue Test  $F_{tu}$  - 131.5 Avg.

Thickness (Inches)	Manufacturer and Heat No.	Specimen Number	Test Direction	$K_t$	R	Max. (Ksi)	% $F_{tu}$	N (Cycles to Failure)
.110	RMI 321055	RM6XLVR25	L	1.0	-1.0	78,000	59.	51,000
		RM6XLVR26	L	1.0	-1.0	91,000	69.	20,000
		RM6XLVR27	L	1.0	-1.0	65,000	50	10,000,000
		RM6XLVR28	L	1.0	-1.0	72,800	55.	50,000
		RM6XLVR29	L	1.0	-1.0	70,200	53.	83,000
		RM6XLVR30	L	1.0	-1.0	67,000	51.	146,000
		RM6XLVR31	L	1.0	-1.0	66,000	50.	114,000
		RM6XLVR32	L	1.0	-1.0	65,500	50.	11,260,000
		RM6XLVR9	L	1.0	-0.3	97,500	74.	114,000
		RM6XLVR10	L	1.0	-0.3	91,000	69.	68,000
		RM6XLVR11	L	1.0	-0.3	84,500	64.	91,000
		RM6XLVR12	L	1.0	-0.3	104,000	79.	24,000
		RM6XLVR13	L	1.0	-0.3	78,000	59.	116,000
		RM6XLVR14	L	1.0	-0.3	65,000	50	10,000,000
		RM6XLVR15	L	1.0	-0.3	75,400	75.	14,307,000
		RM6XLVR16	L	1.0	-0.3	110,500	84.	23,000

(1) Specimen over stressed  
 → No Failure

7.1.5 Fatigue Tests  
 TH 4AL-3Mo-1V ANNEALED CONDITION  
 $F_{tu} = 131.5$

7.1.5 Fatigue Tests

Thickness (Inches)	Manufacturer and Heat No.	Specimen Number	Test Direction	$K_t$	R	Max. (Ksi)	% $F_{tu}$	N (Cycles to Failure)
5.110	RMI 321055	RM6XLVR 1	L	1.0	0	91,000	69.	293,000(1)
		RM6XLVR 2	L	1.0	0	104,000	79.	65,000
		RM6XLVR 3	L	1.0	0	91,000	69.	11,163,000
		RM6XLVR 4	L	1.0	0	97,500	74	93,000
		RM6XLVR 5	L	1.0	0	110,500	84	53,000
		RM6XLVR 6	L	1.0	0	94,900	72	15,600,000
		RM6XLVR 7	L	1.0	0	120,900	92	17,000
		RM6XLVR 8	L	1.0	0	96,200	73	164,000
4.110	RMI 321055	RM6XLVR17	L	1.0	+0.3	117,000	89	73,000
		RM6XLVR18	L	1.0	+0.3	104,000	79	24,400,000
		RM6XLVR19	L	1.0	+0.3	122,200	93	39,000
		RM6XLVR20	L	1.0	+0.3	114,400	87	212,000
		RM6XLVR21	L	1.0	+0.3	113,100	86	133,000
		RM6XLVR22	L	1.0	+0.3	110,500	84	10,000,000
		RM6XLVR23	L	1.0	+0.3	112,450	86	58,000
		RM6XLVR24	L	1.0	+0.3	126,750	97	46,000

(1) Grip Failure  
 —→ No Failure

Ti 4Al-3Mo-1V ANNEALED CONDITION

$F_{tu} = 131.5$

7.1.5 Fatigue Tests

Thickness (Inches)	Manufacturer and Heat No.	Specimen Number	Test Direction	$K_t$	R	Max. (Ksi)	% $F_{tu}$	N (Cycles to Failure)
.110	RMI 321055	RM6XLVR41	L	3.0	-1.0	52,000	40	7,000
		RM6XLVR42	L	3.0	-1.0	39,000	30	52,000
		RM6XLVR43	L	3.0	-1.0	32,500	25	94,000
		RM6XLVR44	L	3.0	-1.0	26,000	20	10,337,000
		RM6XLVR45	L	3.0	-1.0	29,900	23	12,940,000
		RM6XLVR46	L	3.0	-1.0	35,000	27	136,500
		RM6XLVR47	L	3.0	-1.0	32,000	24	5,441,000
		RM6XLVR48	L	3.0	-1.0	33,000	25	103,000
.110	RMI 321055	RM6XLVR57	L	3.0	-0.3	65,000	49	7,000
		RM6XLVR58	L	3.0	-0.3	52,000	40	36,000
		RM6XLVR59	L	3.0	-0.3	45,500	34	68,000
		RM6XLVR60	L	3.0	-0.3	39,000	30	14,700,000
		RM6XLVR61	L	3.0	-0.3	58,500	45	18,000
		RM6XLVR63	L	3.0	-0.3	42,900	33	101,000
		RM6XLVR64	L	3.0	-0.3	40,500	31	2,699,000
		No Failure						

7.1.5 Fatigue Tests

Ti 4Al-3Mo-1V ANNEALED CONDITION

$F_{tu} = 131.5$

Thickness (Inches)	Manufacturer and Heat No.	Specimen Number	Test Direction	$K_t$	R	Max. (Ksi)	% $F_{tu}$	N (Cycles to Failure)
≤ .110	RMI 321055	RM6XLVR33	L	3.0	0	10,000	79	2,000
		RM6XLVR34	L	3.0	0	91,000	69	4,000
		RM6XLVR35	L	3.0	0	65,000	50	13,000
		RM6XLVR36	L	3.0	0	52,000	40	2,106,000
		RM6XLVR37	L	3.0	0	62,400	48	15,000
		RM6XLVR38	L	3.0	0	57,200	44	35,000
		RM6XLVR39	L	3.0	0	49,400	38	2,593,000
		RM6XLVR40	L	3.0	0	46,800	36	2,554,000
		RM6XLVR64	L	3.0	0	42,900	33	6,063,000
		≤ .110	RMI 322055	RM6XLVR49	L	3.0	+0.3	65,000
RM6XLVR50	L			3.0	+0.3	78,000	59	16,000
RM6XLVR51	L			3.0	+0.3	58,500	45	99,000
RM6XLVR52	L			3.0	+0.3	52,000	40	114,000
RM6XLVR53	L			3.0	+0.3	45,500	35	10,210,000
RM6XLVR54	L			3.0	+0.3	49,000	38	10,312,000
No Failure	No Failure	RM6XLVR55	L	3.0	+0.3	50,700	39	10,000,000
		RM6XLVR56	L	3.0	+0.3	85,000	65	11,000



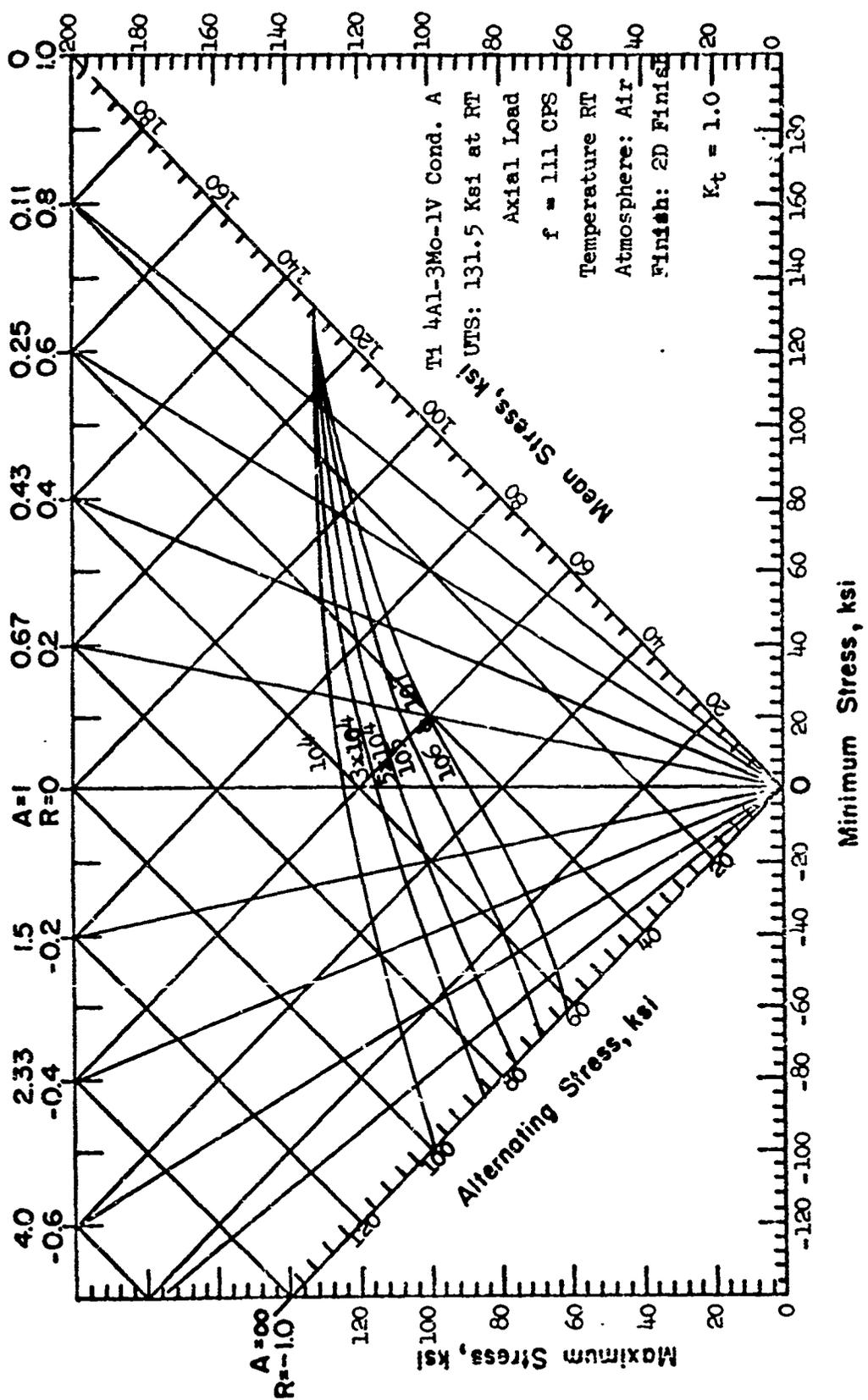
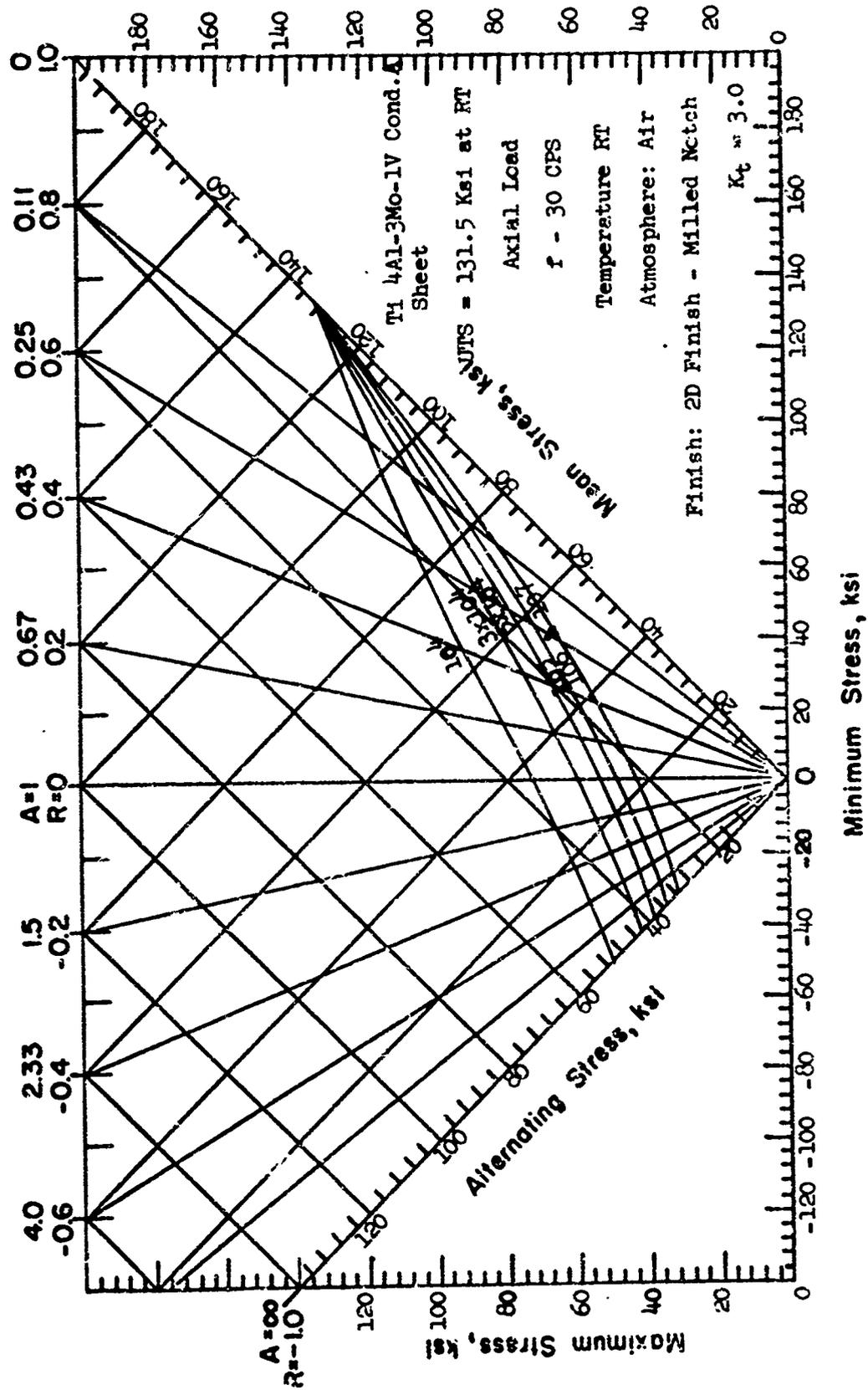


Figure 7-2

Figure 7-3



7.2 T1 13V-11Cr-3A1 Cond. A(or ST)

7.2.1 Tensile Tests

TI 13V-11Cr-3Al ANNEALED

Thickness (Inches)	Manufacturer and Heat No.	Specimen Number	Test Direction	Test Temperature (°F)	F <sub>ty</sub> (Ksi)	F <sub>tu</sub> (Ksi)	% Elongation	% Reduction Area		
≤ .110	Timet D 7855	TC1XLT81	L	RT	131.8	133.6	12	-		
		TC1XLT41	L	400	100.8	110.3	22.5	-		
		TC1XLT61	L	600	96.2	108.1	22.5	-		
		TC1XLT81	L	800	95.2	112.4	16.5	-		
		TC1XTTR1	T	RT	141.0	143.7	13.0	-		
		TC1XTT41	T	400	108.0	113.9	19.5	-		
		TC1XTT61	T	600	105.5	113.6	16.5	-		
		TC1XTT81	T	800	100.0	115.9	14.0	-		
		≤ .110	Timet D 7770	TC2XLT81	L	RT	135.8	135.8	22.5	-
				TC2XLT41	L	400	103.4	114.7	22.0	-
TC2XLT61	L			600	101.1	113.7	22.5	-		
TC2XLT81	L			800	93.4	115.8	15.0	-		
TC2XTTR1	T			RT	134.7	135.0	16.0	-		
≤ .110	Timet D 7107			TC3XLT81	L	RT	137.1	137.1	22.5	-
				TC3XLT41	L	400	101.1	111.9	27.0	-
				TC3XLT61	L	600	98.9	111.1	25.0	-
				TC3XLT81	L	800	92.8	111.7	18.0	-
				TC3XTTR1	T	RT	132.4	132.8	17.0	-

7.2.1 Tensile Tests

TI 13V-11Cr-3Al ANNEALED

Thickness (Inches)	Manufacturer and Heat No.	Specimen Number	Test Direction	Test Temperature (°F)	F <sub>ty</sub> (Ksi)	F <sub>tu</sub> (Ksi)	% Elongation	% Reduction Area
≤ .110	Timet D 7639	TC4XLTR1	L	RT	137.4	137.4	20.0	-
		TC4XLT41	L	400	103.4	117.1	16.0	-
		TC4XLT61	L	600	103.7	115.3	22.5	-
		TC4XLT81	L	800	101.6	116.3	16.5	-
		TC4XTTR1	T	RT	139.1	140.0	19.0	-
≤ .110	Timet D 7110	TC5XLTR1	L	RT	131.1	131.1	24.0	-
		TC5XLT41	L	400	104.5	113.4	28.0	-
		TC5XLT61	L	600	100.0	113.2	26.5	-
		TC5XLT81	L	800	48.9	116.3	18.0	-
		TC5XTTR1	T	RT	137.4	137.4	20.5	-

7.2.1.1 Tensile Stability Tests

TI 13V-11Cr-3Al ANNEAL ED

Thickness (Inches)	Manufacturer and Heat No.	Specimen Number	Test Direction	Exposure		Test Temperature (°F)	F <sub>ty</sub> (Ksi)	F <sub>tu</sub> (Ksi)	Percent Elongation	% Reduction Area
				Temperature (°F)	Time (Hrs.)					
≤.110	Timet D 7855	TC1XLTW41	L	400	10	RT	129.0	132.4	18.0	-
		TC1XLTW42	L	400	100	RT	132.5	134.0	15.0	-
		TC1XLTW43	L	400	1000	RT	132.4	132.9	22.0	-
		TC1XLTW61	L	600	10	RT	132.4	137.7	14.0	-
		TC1XLTW62	L	600	100	RT	137.1	138.1	17.0	-
		TC1XLTW63	L	600	1000	RT	184.8	202.9	4.0	-
		TC1XLTW81	L	800	10	RT	142.4	148.1	15.5	-
		TC1XLTW82	L	800	100	RT	210.1	226.7	5.0	-
		TC1XLTW83	L	800	1000	RT	232.9	241.9	0.5	-
		≤.110	Timet D 7855	TC1XLTX41	L	400	10	400	102	111
TC1XLTX42	L			400	100	400	104	114	28	-
TC1XLTX43	L			400	1000	400	104	112	23	-
TC1XLTX61	L			600	10	600	101	111	22	-
TC1XLTX62	L			600	100	600	104.1	114.5	20.5	-
TC1XLTX63	L			600	1000	600	148.4	177.7	7.0	-
TC1XLTX81	L			800	10	800	106.4	125.0	12.5	-
TC1XLTX82	L			800	100	800	160.5	187.3	5.0	-
TC1XLTX83	L			800	1000	800	173.6	197.7	2.5	-

TH 13V-11CR-3AL COND. A

7.2.1.2 Tensile Tests - Precision Elastic Modulus (Tuckerman)

Thickness (inches)	Manufacturer and Heat No.	Specimen Number	Test Direction	Test Temperature	Precision "E" x 10 <sup>6</sup>
0.110	Timet D 7855	TCLX179L	L	RT	14.6

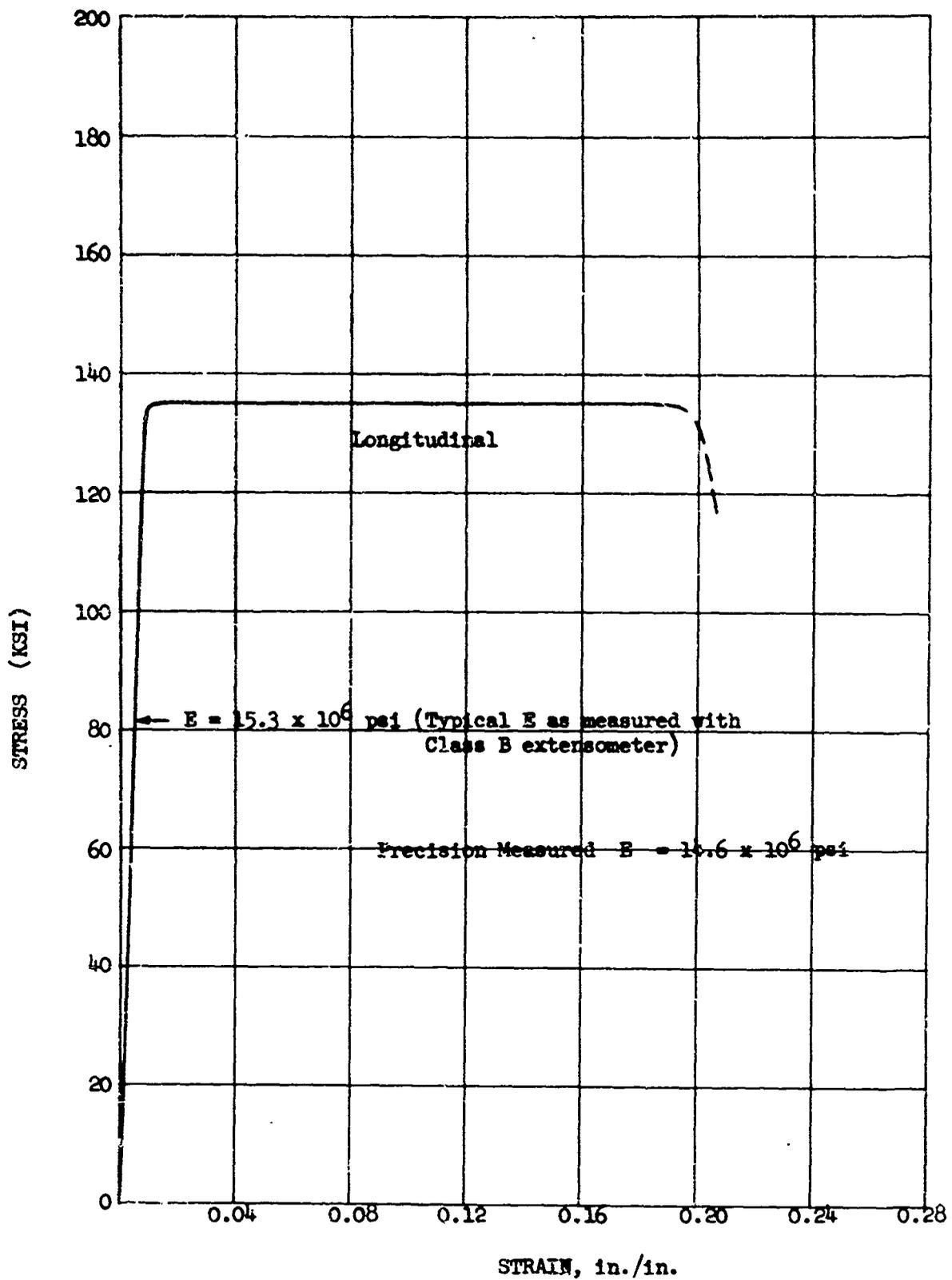


Figure 7-4 Typical Tensile Stress-Strain Curve (full-range) for Annealed Ti-13V-11Cr-3Al Alloy Sheet at Room Temperature



7.2.2 Compression Tests

TI 13V-11Cr-3Al ANNEALED

Thickness (Inches)	Manufacturer and Heat No.	Specimen Number	Test Direction	Test Temperature (°F)	F <sub>y</sub> (Ksi)
̄.110 ↕ ̄.110	Timet D 7855	TC1XLCR1	L	RT	132.1
	Timet D 7855	TC1XLC41	L	400	105.8
	Timet D 7855	TC1XLC61	L	600	97.2
	Timet D 7855	TC1XLC81	L	800	99.9
	Timet D 7855	TC1XTCR1	T	RT	134.9
	Timet D 7855	TC1XTC41	T	400	113.9
	Timet D 7855	TC1XTC61	T	600	107.4
	Timet D 7855	TC1XTC81	T	800	105.7
	Timet D 7770	TC2XLCR1	L	RT	134.2
	Timet D 7770	TC2XTCR1	T	RT	140.0
	Timet D 7107	TC3XLCR1	L	RT	131.4
	Timet D 7107	TC3XTCR1	T	RT	141.7
	Timet D 7639	TC4XLCR1	L	RT	131.5
	Timet D 7634	TC4XTCR1	T	RT	133.6
	Timet D 7110	TC5XLCR1	L	RT	116.1 (1)
	Timet D 7110	TC5XTCR1	T	RT	135.7
(1) Stress - Strain Curve Erratic -	Specimen Probably not seated			Test invalid	

This document contains technical information which is the property of the U.S. Government and is loaned to your organization; it and its contents are not to be distributed outside your organization.

## 7.2.3 Bearing Tests

Ti 13V-11Cr-3Al ANNEALED

Thickness (Inches)	Manufacturer and Heat No.	Specimen Number	Test Direction	e/D	Test Temperature (°F)	F <sub>max</sub> (Ksi) (2% Offset)	F <sub>max</sub> (Ksi)	
≤ .110	Timet D 7855	TC1XLB1R1	L	1.5	RT	172.2	221	
	Timet D 7855	TC1XLB141	L	1.5	400	149.1	198.2	
	Timet D 7855	TC1XLB161	L	1.5	600	153.7	200.0	
	Timet D 7855	TC1XLB181	L	1.5	800	155.5	200.0	
	Timet D 7855	TC1XTB1R1	T	1.5	RT	176.9	224	
	Timet D 7855	TC1XTB141	T	1.5	400	142.6	200.9	
	Timet D 7855	TC1XTB161	T	1.5	600	150.9	195.4	
	Timet D 7855	TC1XTB181	T	1.5	800	170.4	205.6	
	≤ .110	Timet D 7855	TC1XLB2R1	L	2.0	RT	191.7	300
		Timet D 7855	TC1XLB241	L	2.0	400	179.6	265.7
		Timet D 7855	TC1XLB261	L	2.0	600	176.4	263.6
		Timet D 7855	TC1XLB281	L	2.0	800	188.2	258.2
		Timet D 7855	TC1XTB2R1	T	2.0	RT	205	311
		Timet D 7855	TC1XTB241	T	2.0	400	165.0	262.1
		Timet D 7855	TC1XTB261	T	2.0	600	182.0	263.0
		Timet D 7855	TC1XTB281	T	2.0	800	200.0	266.0

7.2.3 Bearing Tests

Ti 13V-11Cr-3Al ANNEALED

Thickness (Inches)	Manufacturer and Heat No.	Specimen Number	Test Direction	e/d	Test Temperature (OF)	F <sub>max</sub> (Ksi) (2% Offset)	F <sub>max</sub> (Ksi)
≤ .110	Timet D 7770	TC2XLB1R1	L	1.5	RT	176.0	215.6
	Timet D 7770	TC2XLB2R1	L	2.0	RT	188.8	300
	Timet D 7107	TC3XLB1R1	L	1.5	RT	172.7	224
	Timet D 7107	TC3XLB2R1	L	2.0	RT	192.0	303
	Timet D 7639	TC4XLB1R1	L	1.5	RT	169.4	221
	Timet D 7639	TC4XLB2R1	L	2.0	RT	193.9	306
≤ .110	Timet D 7110	TC5XLB1R1	L	1.5	RT	174.7	226
	Timet D 7110	TC5XLB2R1	L	2.0	RT	193.7	308

## 7.2.4 Shear Tests

Ti 13V-11Cr-3Al ANNEALED

Thickness (Inches)	Manufacturer and Heat No.	Specimen Number	Test Direction	Test Temperature (°F)	F <sub>0.2</sub> (ksi)
.110	Timet D 7855	TC1XLSR1	L	RT	96.1
		TC1XLS41	L	400	81.9
		TC1XLS61	L	600	82.8
		TC1XLS81	L	800	76.7
		TC1XTSR1	T	RT	98.2
		TC1XTS41	T	400	84.0
		TC1XTS61	T	600	82.1
		TC1XTS81	T	800	78.2
.110	Timet D 7770 Timet D 7107 Timet D 7639 Timet D 7110	TC2XLSR1	L	RT	99.4
		TC3XLSR1	L	RT	94.4
		TC4XLSR1	L	RT	95.8
		TC5XLSR1	L	RT	98.2

7.3 TH 6A1-4V COND. STA

7.3.1 Tensile Tests

Thickness (Inches)	Manufacturer and Heat No.	Specimen Number	Test Direction	Test Temperature (°F)	F <sub>ty</sub> (Ksi)	F <sub>tu</sub> (Ksi)	% Elongation	% Reduction Area
.250 to .300	Timet G 4956	TALXLT81	L	RT	155.6	170.2	9	-
		TALXLT41	L	400	115.7	135.1	10	-
		TALXLT61	L	600	105.0	127.2	10	-
		TALXLT81	L	800	87.5	109.1	12	-
		TALXTT81	T	RT	169.0	182.5	8	-
		TALXTT41	T	400	135.6	153.2	12	-
		TALXTT61	T	600	126.0	143.8	10	-
		TALXTT81	T	800	118.4	138.1	10	-
	Timet G 4796	TA2XLT81	L	RT	140.0	146.9	13	-
		TA2XLT41	L	400	100.9	116.8	18	-
		TA2XLT61	L	600	86.0	105.6	17	-
		TA2XLT81	L	800	80.8	98.6	17	-
Timet G 4796	TA2XTT81	T	RT	146.0	152.1	14	-	
	RMI X 53788	RA6XLT81	L	RT	153.6	167.2	7	-
		RA6XLT41	L	400	112.5	133.7	13*	-
		RA6XLT61	L	600	95.4	124.0	12	-
		RA6XLT81	L	800	108.5	133.1	11	-
		RA6XTT81	T	RT	151.4	166.7	7	-
		RA6XTT41	T	400	106.9	132.3	12**	-
		RA6XTT61	T	600	92.8	121.7	11	-
RA6XTT81		T	800	87.1	111.4	13	-	
.250 to .300	*Broke through guage mark or within spec. width of guage mark							
	**Broke through Extensometer placement							

## 7.3.1 Tensile Tests

Thickness (Inches)	Manufacturer and Heat No.	Specimen Number	Test Direction	Test Temperature (°F)	F <sub>ty</sub> (Ksi)	F <sub>tu</sub> (Ksi)	% Elongation	% Reduction Area
.500 to .630	Timet G 6539	TALYLTR1	L	RT	164.9	178.7	12	36
		TALYLT41	L	400	125.5	146.4	17	52
		TALYLT61	T	600	107.8	134.3	5	51
		TALYLT81	L	800	101.0	123.5	15	57
		TALYTTTR1	T	RT	158.4	173.8	11	28
		TALYTT41	T	400	120.3	142.7	15	44
		TALYTT61	T	600	97.8	126.9	13	43
		TALYTT81	T	800	97.4	122.3	16	55
.500 to .630	Timet G 7278	TA2YLTR1	L	RT	164.7	177.0	10	32
		TA2YTTTR1	T	RT	178.0	188.5	11	33
≥ 1.00	RMI 302634	RA7YLTR1	L	RT	155.6	172.0	7	16
		RA7YTTTR1	T	RT	157.2	172.4	7	14
	Timet G 7021	TA2ZLTR1	L	RT	142.3	152.0	12	22
		TA2ZTTTR1	T	RT	157.6	166.7	12	25
		TA2ZSTR1	ST	RT	141.9	147.6	10	25

7.3.1 Tensile Tests

TH 6A1-4V Cond. STA

Thickness (Inches)	Manufacturer and Heat No.	Specimen Number	Test Direction	Test Temperature (°F)	F <sub>ty</sub> (Ksi)	F <sub>tu</sub> (Ksi)	% Elongation	% Reduction Area
≥ 1.00	RMI 293504	RAZLTL1	L	RT	150.1	153.7	13	40
		RA6ZLT41	L	400	104.6	116.4	18	54
		RA6ZLT61	L	600	91.0	104.7	17	57
		RA6ZLT81	L	800	84.2	97.0	17	57
		RA6ZTTL1	T	RT	145.2	151.2	13	37
		RA6ZTT41	T	400	107.0	118.6	17	49
		RA6ZTT61	T	600	93.2	105.8	15	53
		RA6ZTT81	T	800	85.7	99.4	16	50
		RA6ZST1	ST	RT	148.1	158.2	11	21
		RA6ZST41	ST	400	112.8	123.4	13	28
≥ 1.00	RMI 293504	RA6ZST61	ST	600	96.3	112.4	16	34
		RA6ZST81	ST	800	89.2	102.3	13	42



## 7.3.1.1 Tensile Stability Tests

TH 6AL-4V Cond. STA

Thickness (Inches)	Manufacturer and Heat No.	Specimen Number	Test Direction	Exposure		Test Temperature (°F)	Y <sub>T</sub> (Ksi)	F <sub>TU</sub> (Ksi)	Percent Elongation	% Reduction Area
				Temperature (°F)	Time (Hrs.)					
.250 to .300	Timet G 4956	TALXLTW41	L	400	10	RT	157.0	170.7	8	-
		TALXLTW42	L	400	100	RT	157.0	170.6	6	-
		TALXLTW43	L	400	1000	RT	156.7	171.0	8	-
		TALXLTW61	L	600	10	RT	155.7	170.8	7	-
		TALXLTW62	L	600	100	RT	157.7	170.9	6	-
		TALXLTW63	L	600	1000	RT	158.0	171.6	8	-
		TALXLTW81	L	800	10	RT	158.2	171.4	7	-
		TALXLTW82	L	800	100	RT	159.8	172.2	8	-
		TALXLTW83	L	800	1000	RT	161.0	174.5	7	-
		TALXLTX41	L	400	10	400	115.6	137.0	9	-
		TALXLTX42	L	400	100	400	118.2	136.8	10	-
		TALXLTX43	L	400	1000	400	117.2	136.6	10	-
		TALXLTX61	L	600	10	600	105.9	128.0	9*	-
		TALXLTX62	L	600	100	600	104.4	127.2	8	-
TALXLTX63	L	600	1000	600	105.6	126.1	9	-		
TALXLTX81	L	800	10	800	100.2	121.0	8	-		
TALXLTX82	L	800	100	800	100.3	121.8	5*	-		
TALXLTX83	L	800	1000	800	99.0	122.2	9	-		

\*Indicates broke through gage mark or within specimen width of gage marks.

7.3.1.1 Tensile Stability Tests

T1 6A1-4V Cond. STA

Thickness (Inches)	Manufacturer and Heat No.	Specimen Number	Test Direction	Exposure		Test Temperature (°F)	F <sub>cy</sub> (Ksi)	F <sub>tu</sub> (Ksi)	Percent Elongation	% Reduction Area
				Temperature (°F)	Time (Hrs.)					
.500 to .630	Timet G 6539	TALYLTW41	L	400	10	RT	164.7	175.5	12	25
		TALYLTW42	L	400	100	RT	160.5	177.4	11	31
		TALYLTW43	L	400	1000	RT	162.1	174.1	13	30
		TALYLTW61	L	600	10	RT	160.9	172.3	12	31
		TALYLTW52	L	600	100	RT	160.5	172.6	12	32
		TALYLTW63	L	600	1000	RT	167.0	177.6	12	38
		TALYLTW81	L	800	10	RT	161.5	173.6	12	28
		TALYLTW82	L	800	100	RT	162.6	172.5	12	30
		TALYLTW83	L	800	1000	RT	163.1	175.9	13	33
.500 to .630	Timet G 6539									

TI-6AL-4V COND. STA

7.3.1.1.2 Tensile Tests - Precision Elastic Modulus (Tuckerman)

Thickness (inches)	Manufacturer and Heat No.	Specimen Number	Test Direction	Test Temperature	Precision "E" x 10 <sup>6</sup>
.250-.300	Timet G 4956	TALXLRU	L	RT	16.2

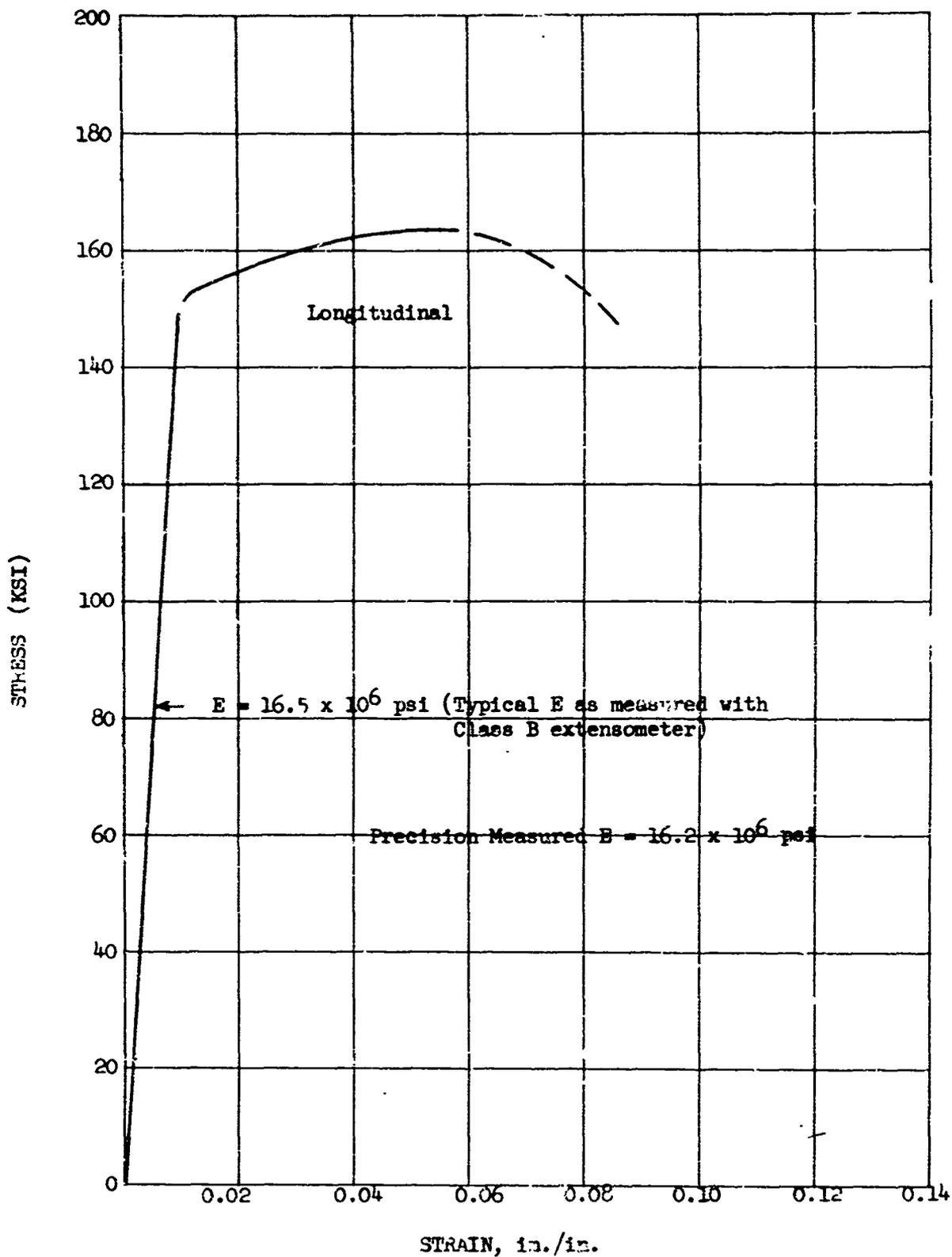


Figure 7-5 Typical tensile stress-strain curve (full-range) for solution treated and aged Ti-6Al-4V alloy sheet at room temperature.

7.3.2 Compression Tests

T1 6A1-4V COND. STA

Thickness (Inches)	Manufacturer and Heat No.	Specimen Number	Test Direction	Test Temperature (°F)	Fcy (Ksi)	
.250 to .300	Timet G 4956	TALXLCR1	L	RT	154.2	
		TALXLC41	L	400	118.7	
		TALXLC61	L	600	113.0	
		TALXLC81	L	800	99.8	
		TALXTCR1	T	RT	186.9	
		TALXTC41	T	400	150.2	
		TALXTC61	T	600	143.2	
		TALXTC81	T	800	132.0	
	Timet G 4796	TA2XLCR1	L	RT	150.8	
		TA2XLCR1	T	RT	187.2	
		RMI X 53788	RA6XLCR1	L	RT	166.4
			RA6XLC41	L	400	117.3
.250 to .300	RMI X 53788	RA6XLC61	L	600	103.4	
		RA6XLC81	L	800	102.7	
		RA6XTCR1	T	RT	155.3	
		RA6XTC41	T	400	115.8	
	RMI X 53788	RA6XTC61	T	600	99.9	
		RA6XTC81	T	800	93.1	

T1 6A1-4V Cond. STA

7.3.2 Compression Tests

Thickness (Inches)	Manufacturer and Heat No.	Specimen Number	Test Direction	Test Temperature (°F)	Fcy (Ksi)	
.500 to .630	Timet G 6539	TALYLCR1	L	RT	173.5	
		TALYLC41	L	400	127.7	
		TALYLC61	L	600	114.6	
		TALYLC81	L	800	102.0	
		TALYTCR1	T	RT	165.7	
		TALYTC41	T	400	125.4	
		TALYTC61	T	600	108.4	
		TALYTC81	T	800	107.8	
	.500 to .630	Timet G 7278	TA2YLCR1	L	RT	177.2
			TA2YTCR1	T	RT	163.8
RMI 302634		RATYLCR1	L	RT	164.1	
		RATYTCR1	T	RT	171.3	
Timet G 7021		TA2ZLCR1	L	RT	156.0	
		TA2ZTCR1	T	RT	157.6	
≥ 1.00	Timet G 7021	TA2ZSCR1	ST	RT	148.7	

T1 6A1-4V Cond. STA

7.3.2 Compression Tests

Thickness (Inches)	Manufacturer and Heat No.	Specimen Number	Test Direction	Test Temperature (°F)	F <sub>cy</sub> (Ksi)
≥ 1.00	RMI 293504	RA6ZLCR1	L	RT	157.5
		RA6ZLC41	L	400	114.4
		RA6ZLC61	L	600	96.4
		RA6ZLC81	L	800	95.4
		RA6ZTCR1	T	RT	159.7
		RA6ZTC41	T	400	117.1
		RA6ZTC61	T	600	101.5
		RA6ZTC81	T	800	98.7
		RA6ZSCR1	ST	RT	157.7
		RA6ZSC41	ST	400	112.0
		RA6ZSC61	ST	600	96.1
≥ 1.00	RMI 293504	RA6ZSC81	ST	800	89.1

## 7.3.3 Peeling Tests

T1 6AL-4V Cond. STA

Thickness (Inches)	Manufacturer and Heat No.	Specimen Number	Test Direction	e/D	Test Temperature (°F)	Yield (Ksi) (2% Offset)	Tensile (Ksi)
.250 to .300	Timet 3 4956	TALXLB1R1	L	1.5	RT	241.2	256.8
		TALXLB141	L	1.5	400	197.6	214.1
		TALXLB161	L	1.5	600	190.5	196.8
		TALXLB181	L	1.5	800	176.7	185.6
		TALXTB1R1	T	1.5	RT	237.5	278.1
		TALXTB141	T	1.5	400	196.4	229.4
		TALXTB161	T	1.5	600	183.9	213.0
		TALXTB181	T	1.5	800	173.5	198.1
	Timet G 4956	TALXLB2R1	L	2.0	RT	265.2	324.5
		TALXLB241	L	2.0	400	219.2	251.9
		TALXLB261	L	2.0	600	215.7	231.5
		TALXLB281	L	2.0	800	206.4	234.8
		TALXTB2R1	T	2.0	RT	289.3	344.0*
		TALXTB241	T	2.0	400	240.3	263.7
.250 to .300	Timet G 4796	TA2XLB1R1	L	1.5	RT	199.7	242.6
		TA2XLB2R1	L	2.0	RT	225.6	294.9
*Pin broke - specimen retested							



## 7.3.3 Bearing Tests

T1 6A1-4V Cond. STA

Thickness (Inches)	Manufacturer and Heat No.	Specimen Number	Test Direction	e/D	Test Temperature (°F)	$P_{max}$ (Ksi) (2% Offset)	$P_{max}$ (Ksi)
.250 to .300	RMT X53788	RA6XLB1R1	L	1.5	RT	227.4	269.2
		RA6XLB141	L	1.5	400	179.0	216.8
		RA6XLB161	L	1.5	600	165.7	200.6
		RA6XLB181	L	1.5	800	155.8	186.2
		RA6XTB1R1	T	1.5	RT	228.3	259.4
		RA6XTB141	T	1.5	400	179.0	212.9
		RA6XTB161	T	1.5	600	165.6	198.7
		RA6XTB181	T	1.5	800	158.5	184.1
.250 to .300	RMI X 53788	RA6XLB2R1	L	2.0	RT	277.1	334.3
		RA6XLB241	L	2.0	400	208.9	274.9
		RA6XLB261	L	2.0	600	195.2	251.5
		RA6XLB281	L	2.0	800	194.6	243.2
		RA6XTB2R1	T	2.0	RT	269.3	317.6
		RA6XTB241	T	2.0	400	215.2	264.5
		RA6XTB261	T	2.0	600	189.0	238.7
		RA6XTB281	T	2.0	800	177.3	228.6
.500 to .630	Timet G 6539	TALYLB1R1	L	1.5	RT	240.9	278.6
		TALYLB141	L	1.5	400	192.0	236.8
		TALYLB161	L	1.5	600	175.0	214.0
		TALYLB181	L	1.5	800	177.7	206.7
		TALYTB1R1	T	1.5	RT	240.9	274.1
.500 to .630	Timet G 6539	TALYLB1R1	L	1.5	RT	240.9	278.6
		TALYTB1R1	T	1.5	RT	240.9	274.1

T1 6A1-4V Cond. STA

7.3.3 Bearing Tests

Thickness (Inches)	Manufacturer and Heat No.	Specimen Number	Test Direction	e/D	Test Temperature (°F)	F <sub>max</sub> (Ksi) (2% Offset)	F <sub>max</sub> (Ksi)
.500 to .630	Timet G 6539	TALYLB2R1	L	2.0	RT	293.2	351.0
		TALYLB241	L	2.0	400	228.4	276.7
		TALYLB261	L	2.0	600	209.7	266.0
		TALYLB281	L	2.0	800	208.2	239.0
		TALYTB2R1	T	2.0	RT	271.7	331.2
.500 to .630	Timet G 7278	TA2YLB1R1	L	1.5	RT	238.6	281.3
		TA24LB2R1	L	2.0	RT	276.0	336.4
.500 to .630	RMI 302634	RA7YLB1R1	L	1.5	RT	241.2	262.5
		RA7YLB2R1	L	2.0	RT	275.1	330.1
≥ 1.00	Timet G 7021	TA2ZLR1R1	L	1.5	RT	212.2	247.8
		TA2ZLB2R1	L	2.0	RT	247.0	306.7
≥ 1.00	RMI 293504	RA6ZLB1R1	L	1.5	RT	219.5	253.9
		RA6ZLE141	L	1.5	400	168.8	209.6
		RA6ZLE161	L	1.5	600	156.8	189.7
		RA6ZLE181	L	1.5	800	150.4	177.9
		RA6ZTB1R1	T	1.5	RT	217.8	267.3
≥ 1.00	RMI 293504	RA6ZLEB1R1	LE	1.5	RT	214.0	233.8
		RA6ZTBB1R1	TE	1.5	RT	207.7	224.0

7.3.3 Bearing Tests

TH 6A1-4V Cond. STA

Thickness (Inches)	Manufacturer and Heat No.	Specimen Number	Test Direction	e/D	Test Temperature (°F)	P <sub>MAX</sub> (Ksi) (2% Offset)	P <sub>SMO</sub> (Ksi)
≥ 1.00	RMI 293504	RA6ZLB2R1	L	2.0	RT	255.1	324.6
		RA6ZLB241	L	2.0	400	213.4	258.6
		RA6ZLB261	L	2.0	2.0	179.9	234.0
		RA6ZLB281	L	2.0	2.0	166.2	219.5
		RA6ZTB2R1	T	2.0	2.0	264.2	334.3
		RA6ZLFB2R1	LE	2.0	2.0	265.8	310.8
≥ 1.00	RMI 293504	RA6ZTEB2R1	TE	2.0	RT	257.3	299.4

T1-6A1-4V Cond. STA

7.3.4 Shear Tests

Thickness (Inches)	Manufacturer and Heat No.	Specimen Number	Test Direction	Test Temperature (°F)	F <sub>su</sub> (Ksi)
.250 to .300	Timet G 4956	TALXLSR1	L	RT	101.0
		TALXLS41	L	400	86.0
		TALXLS61	L	600	74.8
		TALXLS81	L	800	64.1
	Timet G 4956	TALXTSR1	T	RT	113.0
		TALXTS41	T	400	89.7
		TALXTS61	T	600	85.3
		TALXTS81	T	800	79.2
	Timet G 4796	TA2XLSR1	L	RT	93.2
		RMI X53788	RA6XLSR1	L	RT
RA6XLS41	L		400	87.3	
RA6XLS61	L		600	71.6	
RA6XLS81	L		800	73.2	
RA6XTSR1	T		RT	47.7	
RA6XTS41	T		400	84.0	
RA6XTS61	T		600	76.8	
RA6XTS81	T		800	72.0	
.250 to .300	RMI X53788	TALYLSR1	L	RT	96.3
		TALYLS41	L	400	88.3
		TALYLS61	L	600	74.7
		TALYLS81	L	800	77.4
		TALYTSR1	T	RT	98.3
.500 to .630	Timet G 6539	TALYLSR1	L	RT	96.3
			L	400	88.3
.500 to .630	Timet G 6539	TALYLSR1	L	600	74.7
			L	800	77.4
.500 to .630	Timet G 6539	TALYTSR1	T	RT	98.3

TH 6A1-4V Cond. STA

7.3.4 Shear Tests

Thickness (Inches)	Manufacturer and Heat No.	Specimen Number	Test Direction	Test Temperature (°F)	F <sub>ca</sub> (Kst)
.500 to .630	Timet G 7278	TA2YLSR1	L	RT	106.0
.500 to .630	RMI 302634	TA7YLSR1	L	RT	108.0
≥ 1.00	Timet G 7021	TA2ZLSR1	L	RT	88.3
≥ 1.00	RMI 293504	RA6ZLSR1	L	RT	102.0
		RA6ZLS41	L	400	77.6
		RA6ZLS61	L	600	70.0
		RA6ZLS81	L	800	73.5
≥ 1.00	RMI 293504	RA6ZTSR1	T	RT	102.0

TI-6Al-4V Cond. STA

7.3.5 Fracture Toughness Tests

Thickness (inches)	Manufacturer and Heat No.	Specimen Number	Test Direc- tion	Exposure		Load Pop-in (lbs)	Crack Depth	K Factor	K <sub>IC</sub> Ksi√in	Net Fracture Strength, #in	Load at Failure (lbs)		
				Temp. (°F)	Time (Hrs.)								
.250 - .300	Timet G 4956	TALXLF01	L	-	-	6400	.800	6.96	44.5	31.7	7530		
		TALXLF04	L	400	10	6850	.760	6.48	44.4	44.4	8330		
		TALXLF02	L	400	100	5480	.600	4.79	26.2	17.5	5680		
		TALXLF03	L	400	1000	6400	.790	6.84	43.7	35.4	7520		
		TALXLF05	L	600	10	6500	.790	6.84	46.5	37.1	7420		
		TALXLF06	L	600	100	6500	.800	6.96	45.7	35.6	7570		
		TALXLF07	L	600	1000	5500	.820	7.20	39.6	38.2	7160		
		TALXLF08	L	800	10	4500	.820	7.20	32.4	45.5	7980		
		TALXLF09	L	800	100	5600	.800	6.96	39.0	34.2	6840		
		TALXLF10	L	800	1000	4950	.880	7.96	39.4	26.6	5730		
		250-.300	FMI X53788	TALXTF01	T	-	-	5000	.740	8.32	40.0	44.3	8160
				TA2XLF01	L	-	-	7200	.700	7.416	53.4	38.8	8030
				RA6XLF01	L	-	-	10200	.760	6.48	66.0	48.5	10960
RA6XTF01	T			-	-	9300	.770	6.604	61.5	47.1	11780		

$F_{tu} = 153.7$

7.3.6 Fatigue Tests

Thickness (Inches)	Manufacturer and Heat No.	Specimen Number	Test Direction	$K_t$	R	Max. (Ksi)	% $F_{tu}$	N (Cycles to Failure)		
≥ 1.00	RMI 293504	RA6ZLVR19	L	1.0	-1.0	120,000	78	13,000		
		RA6ZLVR20	L	1.0	-1.0	100,000	65	81,000		
		RA6ZLVR21	L	1.0	-1.0	90,000	59	72,000		
		RA6ZLVR22	L	1.0	-1.0	80,000	52	608,000		
≥ 1.00	RMI 293504	RA6ZLVR23	L	1.0	-1.0	65,000	42	5,768,000		
		RA6ZLVR24	L	1.0	-1.0	62,000	40	10,000,000 →		
		RA6ZLVR13	L	1.0	-0.3	130,000	84	20,000		
		RA6ZLVR14	L	1.0	-0.3	110,000	73	16,000		
		RA6ZLVR15	L	1.0	-0.3	90,000	58	2,716,000		
		RA6ZLVR16	L	1.0	-0.3	100,000	65	955,000		
		RA6ZLVR17	L	1.0	-0.3	85,000	55	1,699,000		
		RA6ZLVR18	L	1.0	-0.3	78,000	54	1,362,000		
		≥ 1.00	RMI 293504	RA6ZLVR 7	L	1.0	0	130,000	84	343,000
				RA6ZLVR 8	L	1.0	0	145,000	94	8,000
RA6ZLVR 9	L			1.0	0	125,000	81	198,000		
RA6ZLVR10	L			1.0	0	118,000	77	362,000		
RA6ZLVR11	L			1.0	0	110,000	73	522,000		
RA6ZLVR12	L			1.0	0	95,000	62	1,429,000		
	→ No Failure									

7.3.6 Fatigue Tests

TI 6Al-4V Cond. STA

$F_{tu} = 153.7$

Thickness (Inches)	Manufacturer and Heat No.	Specimen Number	Test Direction	$K_t$	R	Max. (Ksi)	% $F_{tu}$	N (Cycles to Failure)
≥ 1.00	RMI 293504	RA6ZLVR-1	L	1.0	+ 0.3	120.0	78	459,000
		RA6ZLVR-2	L	1.0	+ 0.3	130.0	85	487,000
		RA6ZLVR-3	L	1.0	+ 0.3	110.0	73	1,101,000
		RA6ZLVR-4	L	1.0	+ 0.3	140.0	91	205,000
		RA6ZLVR-5	L	1.0	+ 0.3	100.0	65	2,237,000
		RA6ZLVR-6	L	1.0	+ 0.3	90.0	59	4,186,000
≥ 1.00	RMI 293504	RA6ZLVR-6A	L	1.0	+ 0.3	80.0	52	9,274,000
		RA6ZLVR-43	L	3.0	- 1.0	60.0	39	10,000
		RA6ZLVR-44	L	3.0	- 1.0	45.0	29	40,000
		RA6ZLVR-45	L	3.0	- 1.0	30.0	19	210,000
		RA6ZLVR-46	L	3.0	- 1.0	15.0	10	15,700,000 →
		RA6ZLVR-47	L	3.0	- 1.0	24.0	16	838,000
		RA6ZLVR-48	L	3.0	- 1.0	37.5	24	53,000
		RA6ZLVR-37	L	3.0	- 0.3	60.0	39	15,000
		RA6ZLVR-38	L	3.0	- 0.3	37.5	24	10,000,000 →
		RA6ZLVR-39	L	3.0	- 0.3	52.5	34	20,000
		RA6ZLVR-40	L	3.0	- 0.3	45.0	29	39,000
		RA6ZLVR-41	L	3.0	- 0.3	42.0	27	37,000
RA6ZLVR-42	L	3.0	- 0.3	39.0	25	146,000		
	No Failure							



Ti 6Al-4V Cond. STA

F<sub>tu</sub> = 173.7

7.3.6 Fatigue Tests

Thickness (Inches)	Manufacturer and Heat No.	Specimen Number	Test Direction	K <sub>t</sub>	R	Max. (Ksi)	% F <sub>tu</sub>	N (Cycles to Failure)	
≥ 1.00	RMI 293504	RA6ZLVR25	L	3.0	0	60.0	39	77,000	
		RA6ZLVR26	L	3.0	0	75.0	49	27,000	
		RA6ZLVR27	L	3.0	0	90.0	58	10,000	
		RA6ZLVR28	L	3.0	0	45.0	29	102,000	
		RA6ZLVR29	L	3.0	0	35.0	23	2,074,000	
		RA6ZLVR30	L	3.0	0	30.0	19	4,407,000	
	≥ 1.00	RMI 293504	RA6ZLVR31	L	3.0	+ 0.3	45.0	29	1,109,000
			RA6ZLVR32	L	3.0	+ 0.3	90.0	58	18,000
			RA6ZLVR33	L	3.0	+ 0.3	75.0	49	32,000
			RA6ZLVR34	L	3.0	+ 0.3	60.0	39	74,000
RA6ZLVR35			L	3.0	+ 0.3	39.0	25	9,800,000	
RA6ZLVR36			L	3.0	+ 0.3	52.5	34	377,000	
	No Failure								

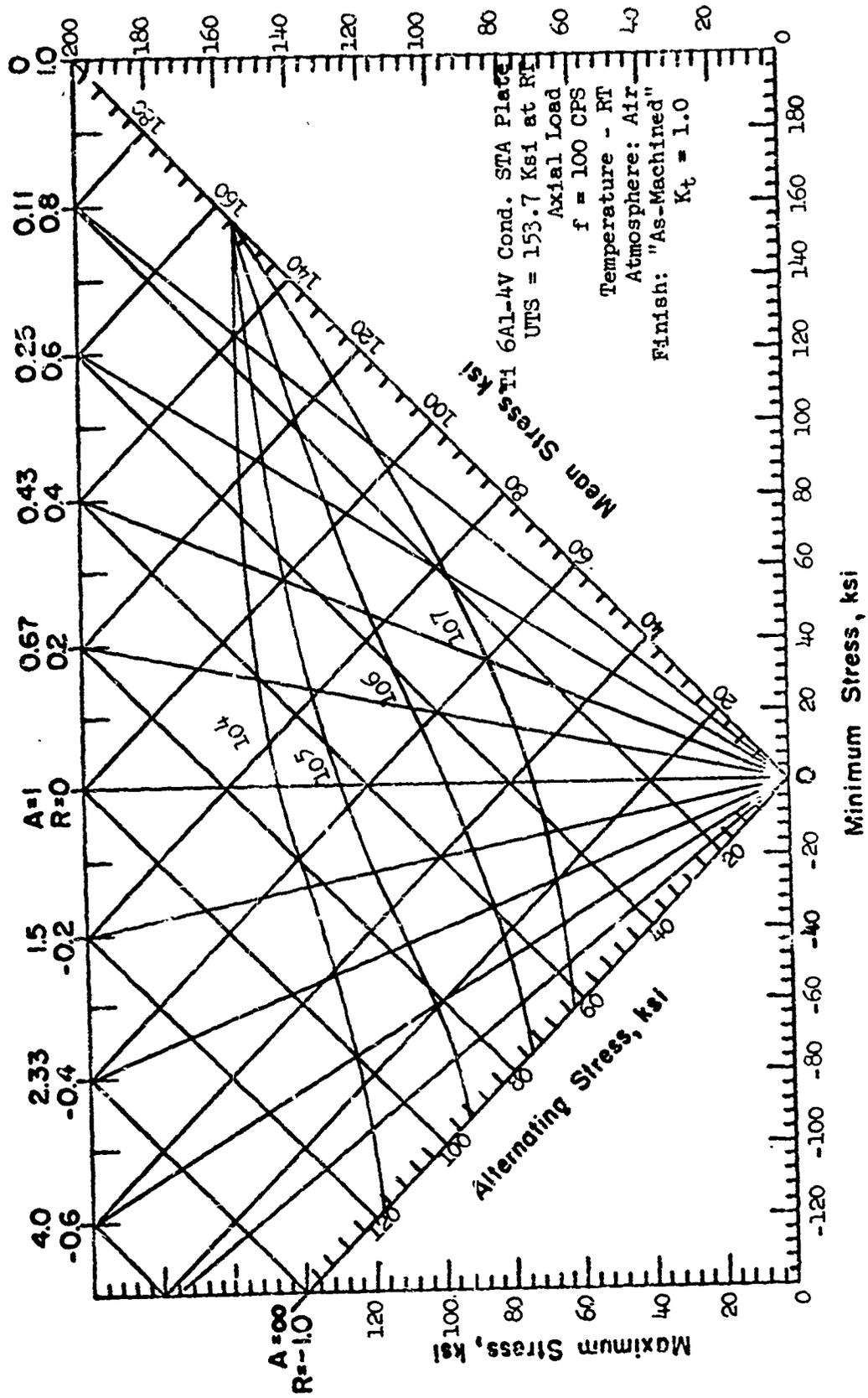


Figure 7-6

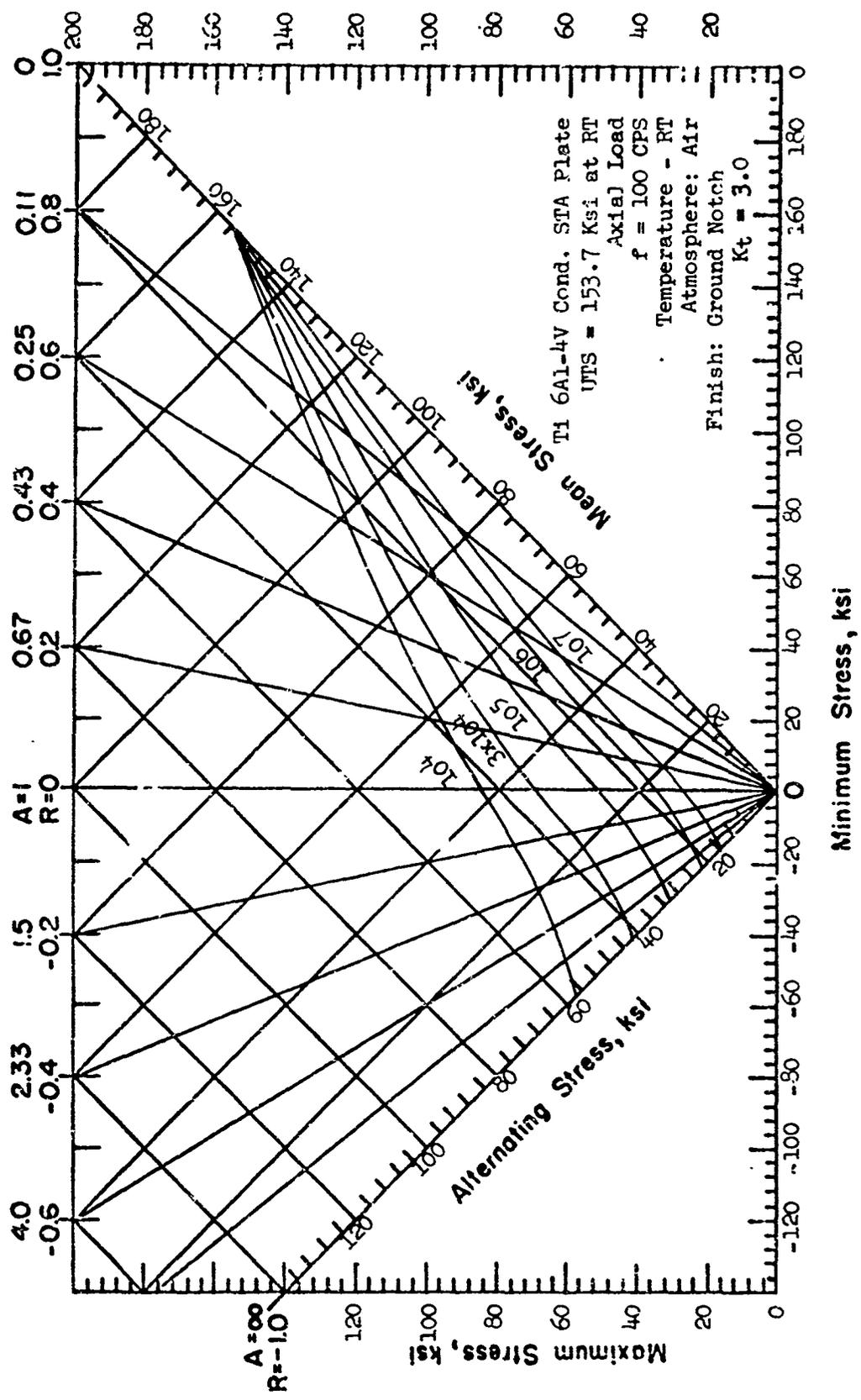


Figure 7-7

7.4 Ti-6Al-6V-2Sn

7.4.1 Ti-6Al-6V-2Sn Cond. A

7.4.1 Annealed  
7.4.1.1 Tensile Test

Ti-6Al-6V-2Sn Cond. A

Thickness (Inches)	Manufacturer and Heat No.	Specimen Number	Test Direction	Test Temperature (°F)	F <sub>ty</sub> (Ksi)	F <sub>tu</sub> (Ksi)	% Elongation	% Reduction Area
.250 to .300	Timet G3105	TV1XLTR1	L	RT	157.3	159.1	9.0	-
		TV1XLT41	L	400	118.9	131.0	12.5	-
		TV1XLT61	L	600	107.9	122.2	10.0	-
		TV1XLT81	L	800	97.3	109.9	13.0	-
		TV1XTTR1	T	RT	171.0	176.9	16.5	-
		TV1XT41	T	400	134.6	150.7	12.0	-
		TV1XT61	T	600	131.7	145.4	9.0	-
		TV1XTT81	T	800	116.0	127.0	14.0	-
.250 to .300	Timet G3212	TV2XLTR1	L	RT	162.1	164.6	8.5	-
		TV2XLT41	L	400	123.4	134.7	12.5	-
		TV2XLT61	L	600	109.6	126.3	11.0	-
		TV2XLT81	L	800	99.8	111.6	13.0	-
		TV2XTTR1	T	RT	164.2	167.2	12.0	-
		TV3XLTR1	L	RT	159.0	161.4	13.0	-
		TV3XLT41	L	400	126.4	139.0	11.0	-
		TV3XLT61	L	600	112.0	127.3	13.5	-
		TV3XLT81	L	800	102.9	116.3	11.0	-
		TV3XTTR1	T	RT	164.5	167.1	16.0	-

7.4.1.1 Annealed - Tensile Tests

Ti-6Al-6V-2Sn Cond. A

Thickness (Inches)	Manufacturer and Heat No.	Specimen Number	Test Direction	Test Temperature (°F)	F <sub>ty</sub> (Ksi)	F <sub>tu</sub> (Ksi)	% Elongation	% Reduction Area
.250 to .300	Timet C 881	TV4XLTR1	L	RT	158.3	161.1	11.0	-
		TV4XLTP41	L	400	124.8	136.8	12.0	-
		TV4XLTP61	L	600	108.4	124.1	11.0	-
		TV4XLTP81	L	800	99.5	112.0	13.0	-
		TV4XTTR1	T	RT	164.3	169.5	15.0	-
.250 to .300	Timet G 1537	TV5XLTR1	L	RT	158.6	160.5	12.0	-
		TV5XLTP41	L	400	127.1	139.5	10.0	-
		TV5XLTP61	L	600	114.7	130.2	10.5	-
		TV5XLTP81	L	800	107.2	121.2	13.0	-
		TV5XTTR1	T	RT	169.0	175.1	15.0	-
.500 to .630	Timet G 393	TV1VLTTR1	L	RT	154.1	156.4	17.5	40.1
		TV1VLTTP41	L	400	123.9	136.0	18.5	50.6
		TV1VLTTP61	L	600	112.4	127.9	17.0	50.9
		TV1VLTTP81	L	800	102.5	115.1	20.5	56.9
		TV1VTTTR1	T	RT	153.8	159.9	17.5	34.4
.500 to .630	Timet G 393	TV1VTTTP41	T	400	123.5	136.8	18.0	43.1
		TV1VTTTP61	T	600	111.3	127.5	18.5	40.7
		TV1VTTTP81	T	800	103.1	117.1	19.0	47.5

7.4.1.1 Annealed Tensile Tests

Thickness (Inches)	Manufacturer and Heat No.	Specimen Number	Test Direction	Test Temperature (°F)	F <sub>ty</sub> (Ksi)	F <sub>tu</sub> (Ksi)	% Elongation	% Reduction Area	
.500 to .630	Timet G 2443	TV2YLTR1	L	RT	157.2	158.6	17.5	40.4	
		TV2YTR1	T	RT	159.0	161.6	17.0	32.9	
	Timet G 1971	TV3YLTR1	L	RT	159.2	162.2	16.5	34.9	
		TV3YTR1	T	RT	160.4	162.6	16.0	33.1	
	Timet G 2504	TV4YLTR1	L	RT	161.8	165.1	17.5	35.7	
		TV4YTR1	T	RT	163.7	166.9	16.5	37.4	
	Timet G 3106	TV5YLTR1	L	RT	159.2	161.9	17.0	35.4	
		TV5YTR1	T	RT	164.3	165.7	17.5	37.4	
	≥ 1.00	Timet G 3023	TVLZLTR1	L	RT	149.0	158.0	17.0	31.6
			TVLZLT41	L	400	117.0	132.8	18.5	49.2
Timet G 3023		TVLZLT61	L	600	100.8	118.6	19.0	45.8	
		TVLZLT81	L	800	86.6	105.7	19.0	54.7	
Timet G 3023		TVLZTTR1	T	RT	140.0	158.0	17.0	31.6	
		TVLZTT41	T	400	109.3	126.3	19.0	45.7	
Timet G 3023		TVLZTT61	T	600	96.5	114.7	19.0	41.2	
		TVLZTT81	T	800	86.9	104.3	21.0	49.2	
Timet G 3023		Timet G 3023	TVLZSTR1	ST	RT	138.2	156.7	10.0	27.8
			TVLZST41	ST	400	111.6	132.1	15.0	27.0
≥ 1.00	Timet G 3023	TVLZST61	ST	600	93.6	117.9	15.0	41.9	
		TVLZST81	ST	800	84.5	107.9	20.0	41.6	

TH 6Al-6V-2Sn Cond. A

7.4.1.1 Annealed Tensile Tests

Thickness (Inches)	Manufacturer and Heat No.	Specimen Number	Test Direction	Test Temperature (°F)	F <sub>ty</sub> (Ksi)	F <sub>tu</sub> (Ksi)	% Elongation	% Reduction Area
≥ 1.00	Timet G 3214	TV2ZLTRL	L	RT	151.6	158.8	17.5	31.7
		TV2ZTTRL	T	RT	153.4	156.2	17.0	36.8
		TV2ZSTRL	ST	RT	145.7	157.8	2.5 (*)	11.5
	Timet G 2070	TV3ZLTRL	L	RT	147.4	152.0	16.0	36.8
		TV3ZTTRL	T	RT	155.1	160.1	14.5	24.9
		TV3ZSTRL	ST	RT	143.6	152.9	7.5	34.0
	Timet G 1971	TV4ZLTRL	L	RT	147.2	151.8	20.0	29.1
		TV4ZTTRL	T	RT	151.0	154.3	14.0	32.6
		TV4ZSTRL	ST	RT	144.8	154.8	15.0	35.6
Timet G 3024	TV5ZLTRL	L	RT	147.2	152.6	16.0	32.3	
	TV5ZTTRL	T	RT	149.8	154.0	18.0	35.4	
	TV5ZSTRL	ST	RT	143.2	151.8	2.5	0.97	

(\*) Failed in Gage Mark



T1-6Al-6V-2Sn Cond. A

7.4.1.1.1 Annealed Tensile Stability Tests

Thickness (Inches)	Manufacturer and Heat No.	Specimen Number	Test Direction	Exposure		Test Temperature (°F)	F <sub>ty</sub> (Ksi)	F <sub>tu</sub> (Ksi)	Percent Elongation	% Reduction Area		
				Temperature (°F)	Time (Hrs.)							
.250 to .300	Timet G 3105	TVLXLW41	L	400	10	RT	157	160	11	---		
		TVLXLW42	L	400	100	RT	158	162	6*	---		
		TVLXLW43	L	400	1000	RT	154	158	11	---		
		TVLXLW61	L	600	10	RT	153	157	13	---		
		TVLXLW62	L	600	100	RT	153	157	12	---		
		TVLXLW63	L	600	1000	RT	155	158	11	---		
		TVLXLW81	L	800	10	RT	153	156	12	---		
		TVLXLW82	L	800	100	RT	154	158	11	---		
		TVLXLW83	L	800	1000	RT	162	163	5**	---		
		.250 to .300	Timet G 3105	TVLXLW41	L	400	10	400	123.8	133.3	14	---
				TVLXLW42	L	400	100	400	121.3	131.4	13	---
				TVLXLW43	L	400	1000	400	120.3	131.4	12*	---
TVLXLW61	L			600	10	600	107.6	122.4	11	---		
TVLXLW62	L			600	100	600	108.3	122.9	12	---		
TVLXLW63	L			600	1000	600	107.9	122.8	11*	---		
TVLXLW81	L			800	10	800	95.1	108.1	16	---		
TVLXLW82	L			800	100	800	99.4	113.9	13	---		
TVLXLW83	L			800	1000	800	105.9	120.3	11	---		

\* Broke through gage mark.

\*\* Retested after pin hole failure w/reduced width.

TI-6Al-6V-2Sn Condi. A

7.4.1.1.1 Annealed Tensile Stability

Thickness (Inches)	Manufacturer and Heat No.	Specimen Number	Test Direction	Exposure		Test Temperature (°F)	F <sub>ty</sub> (Ksi)	F <sub>tu</sub> (Ksi)	Percent Elongation	% Reduction Area
				Temperature (°F)	Time (Hrs.)					
.500 to .630	Timet G 393	TV1YLTW41	L	400	10	RT	144	150	17	40
		TV1YLTW42	L	400	100	RT	156	160	17	37
		TV1YLTW43	L	400	1000	RT	152	157	17	40
		TV1YLTW61	L	600	10	RT	154	158	18	41
		TV1YLTW62	L	600	100	RT	154	158	17	37
		TV1YLTW63	L	600	1000	RT	154	158	18	40
		TV1YLTW81	L	800	10	RT	157	162	17	39
		TV1YLTW82	L	800	100	RT	158	165	16	33
.500 to .630	Timet G 393	TV1YLTW83	L	800	1000	RT	162	165	11	17
		TV1ZLTW41	L	400	10	RT	145	152	18	34
		TV1ZLTW42	L	400	100	RT	146	152	17	33
≥ 1.00	Timet G 3023	TV1ZLTW43	L	400	1000	RT	145	151	16	32
		TV1ZLTW61	L	600	10	RT	147	153	17	31
		TV1ZLTW62	L	600	100	RT	145	151	17	33
		TV1ZLTW63	L	600	1000	RT	147	154	16	29
		TV1ZLTW81	L	800	10	RT	148	154	16	28
		TV1ZLTW82	L	800	100	RT	149	156	15	27
≥ 1.00	Timet G 3023	TV1ZLTW83	L	800	1000	RT	152	156	8	14

TI-6AL-6V-2Sn COND A

7.4.1.1.2 Tensile Tests - Precision Elastic Modulus (Tuckerman)

Thickness (inches)	Manufacturer and Heat No.	Specimen Number	Test Direction	Test Temperature	Precision "E" $\times 10^6$
.250-.300	Timet G 3105	TVLXLTRI	L	RT	15.6

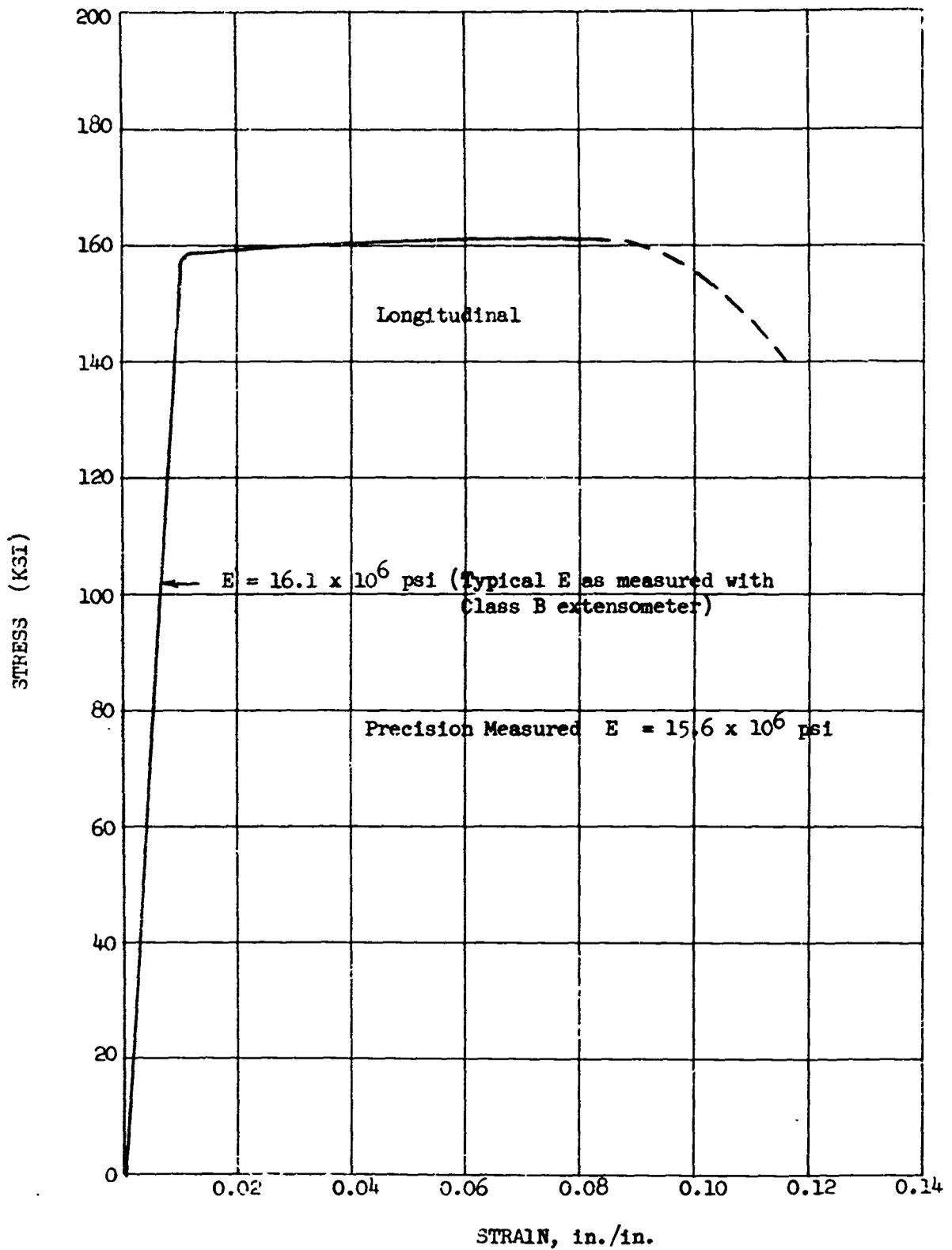


Figure 7-9 Typical Tensile Stress-Strain Curve (full-range) for Annealed Ti-6Al-6V-2Sn Alloy Plate at Room Temperature.

Ti-6Al-6V-2Sn Cond. A

7.4.1.2 Annealed Compression Tests

Thickness (Inches)	Manufacturer and Heat No.	Specimen Number	Test Direction	Test Temperature (°F)	Fcy (Ksi)
.250 to .300	Timet G 3105	TV1XLCR1	L	RT	157.1
		TV1XLC41	L	400	120.9
		TV1XLC61	L	600	105.3
		TV1XLC81	L	800	97.2
	Timet G 3105	TV1XTCR1	T	RT	195.3
		TV1XTC41	T	400	149.7
		TV1XTC61	T	600	135.2
		TV1XTC81	T	800	129.2
	Timet G 3212	TV2XLCR1	L	RT	163.5
		TV2XTCR1	T	RT	177.5
	Timet G 3211	TV3XLCR1	L	RT	163.8
		TV3XTCR1	T	RT	179.9
Timet G 881	TV4XLCR1	L	RT	163.9	
	TV4XTCR1	T	RT	183.4	
.250 to .300	Timet G 1537	TV5XLCR1	L	RT	164.9
	Timet G 1537	TV5XTCR1	T	RT	185.4

TI-6Al-6V-2Sn Cond. A

7.4.1.2 Annealed Compressor Tests

Thickness (Inches)	Manufacturer and Heat No.	Specimen Number	Test Direction	Test Temperature (°F)	F <sub>cy</sub> (Ksi)
.500 to .630	Timet G 393	TV1YLCR1	L	RT	167.4
	Timet G 393	TV1YLC41	L	400	125.1
	Timet G 393	TV1hLC61	L	600	118.2
	Timet G 393	TV1YLC81	L	800	106.1
	Timet G 393	TV1YTCR1	T	RT	167.2
	Timet G 393	TV1YTC41	T	400	127.9
	Timet G 393	TV1YTC61	T	600	117.7
	Timet G 393	TV1YTC81	T	800	105.3
	Timet G 2443	TV2YLCR1	L	RT	170.4
	Timet G 2443	TV2YTCR1	T	RT	173.7
	Timet G 1971	TV3YLCR1	L	RT	171.0
	Timet G 1971	TV3YTCR1	T	RT	174.3
.500 to .630	Timet G 2504	TV4YLCR1	L	RT	172.3
	Timet G 2504	TV4YTCR1	T	RT	180.2
	Timet G 3106	TV5YLCR1	L	RT	172.0
	Timet G 3106	TV5YTCR1	T	RT	170.8

T1-6Al-6V-2Sn Cond. A

7.4.1.2 Annealed Compression Tests

Thickness (Inches)	Manufacturer and Heat No.	Specimen Number	Test Direction	Test Temperature (°F)	Poy (ksi)	
$\geq 1.00$	Timet G 3023	TV1ZLCR1	L	RT	148.9	
	Timet G 3023	TV1ZLC41	L	400	120.2	
	Timet G 3023	TV1ZLC61	L	600	105.5	
	Timet G 3023	TV1ZLC81	L	800	96.7	
	Timet G 3023	TV1ZTCR1	T	RT	150.5	
	Timet G 3023	TV1ZTC41	T	400	115.3	
	Timet G 3023	TV1ZTC61	T	600	103.4	
	Timet G 3023	TV1ZTC81	T	800	93.4	
	Timet G 3023	TV1ZSCR1	ST	RT	153.0	
	Timet G 3023	TV1ZSC41	ST	400	116.2	
	Timet G 3023	TV1ZSC61	ST	600	99.4	
	Timet G 3023	TV1ZSC81	ST	800	90.9	
	$\geq .100$	Timet G 3214	TV2ZLCR1	L	RT	162.4
		Timet G 3214	TV2ZTCR1	T	RT	167.1
Timet G 3214		TV2ZSCR1	ST	RT	156.7	
Timet G 2070		TV3ZLCR1	L	RT	162.4	
Timet G 2070		TV3ZTCR1	T	RT	157.5	
Timet G 2070		TV3ZSCR1	ST	RT	156.3	

TI-6Al-6V-6Sn Cond. A

7.4.1.2 Annealed Compression Tests

Thickness (Inches)	Manufacturer and Heat No.	Specimen Number	Test Direction	Test Temperature (°F)	$F_{su}$ (Ksi)
$\geq 1.00$  $\geq 1.00$	Timet G 1971	TV4ZLCRL	L	RT	168.2
	Timet G 1971	TV4ZTCRL	T	TR	155.4
	Timet G 1971	TV4ZSCRL	ST	RT	157.7
	Timet G 3024	TV5ZLCRL	L	RT	166.3
	Timet G 3024	TV5ZTCRL	T	RT	157.0
	Timet G 3024	TV5ZSCRL	ST	RT	144.5



T1-6A1-6V-2Sn Cond. A

7.4.1.3 Annealed Bearing Tests

Thickness (Inches)	Manufacturer and Heat No.	Specimen Number	Test Direction	e/d	Test Temperature (°F)	F <sub>max</sub> (ksi) (2% Offset)	F <sub>max</sub> (ksi)
.250 to .300	Timet G 3105	TV1XLB1R1	L	1.5	RT	224.0	252.5
	Timet G 3105	TV1XLB1L1	L	1.5	400	186.4	213.2
	Timet G 3105	TV1XLB161	L	1.5	600	169.3	187.3
	Timet G 3105	TV1XLB181	L	1.5	800	148.0	180.0
	Timet G 3105	TV1XTB1R1	T	1.5	RT	212.2	274.6
	Timet G 3105	TV1XTB1L1	T	1.5	400	184.1	231.3
	Timet G 3105	TV1XTB161	T	1.5	600	177.4	218.7
	Timet G 3105	TV1XTB181	T	1.5	800	150.0	193.3
	Timet G 3105	TV1XLB2R1	L	2.0	RT	247.2	314.1
	Timet G 3105	TV1XLB2L1	L	2.0	400	217.6	276.9
	Timet G 3105	TV1XP261	L	2.0	600	202.8	237.2
	Timet G 3105	TV1XLB281	L	2.0	800	168.4	232.6
	Timet G 3105	TV1XTB2R1	T	2.0	RT	286.1	354.3
	Timet G 3105	TV1XTB2L1	T	2.0	400	238.3	297.1
	Timet G 3105	TV1XTB261	T	2.0	600	215.4	267.3
Timet G 3105	TV1XTB281	T	2.0	800	198.5	253.8	
.250 to .300	Timet G 3212	TV2XLB1R1	L	1.5	RT	228.0	273.7
	Timet G 3212	TV2XLB2R1	L	2.0	RT	249.2	329.6
	Timet G 3211	TV3XLB1R1	L	1.5	RT	222.2	266.0
	Timet G 3211	TV3XLB2R1	L	2.0	RT	244.7	331.6

7.4.1.3 Annealed Bearing Tests

TI-6Al-6V-2Sn Cond. A

Thickness (Inches)	Manufacturer and Heat No.	Specimen Number	Test Direction	e/d	Test Temperature (°F)	F <sub>MAX</sub> (Ksi) (2% Offset)	F <sub>YIELD</sub> (Ksi)
.250 to .300	Timet G 881	TV4XLB1R1	L	1.5	RT	221.7	250.0
	Timet G 861	TV3XLB2R1	L	2.0	RT	255.7	323.9
.250 to .300	Timet G 1537	TV5XLB1R1	L	1.5	RT	226.4	266.8
	Timet G 1537	TV5XLB2R1	L	2.0	RT	267.3	354.7
.500 to .630	Timet G 393	TV1YLB1R1	L	1.5	RT	221.6	267.8
	Timet G 393	TV1YLB141	L	1.5	400	193.7	238.1
	Timet G 393	TV1YLB161	L	1.5	600	176.9	212.3
	Timet G 393	TV1YLB181	L	1.5	800	160.0	200.4
	Timet G 393	TV1YTB1R1	T	1.5	RT	222.5	264.4
	Timet G 393	TV1YLB2R1	L	2.0	RT	259.1	330.1
	Timet G 393	TV1YLB241	L	2.0	400	229.6	288.1
	Timet G 393	TV1YLB261	L	2.0	600	202.9	255.5
	Timet G 393	TV1YLB281	L	2.0	800	176.4	235.0
	Timet G 393	TV1YTB2R1	T	2.0	RT	307.1	392.9
.500 to .630	Timet G 2443	TV2YLB1R1	L	1.5	RT	230.4	277.9
	Timet G 2443	TV2YLB2R1	L	2.0	RT	252.2	318.9
.500 to .630	Timet G 1971	TV3YLB1R1	L	1.5	RT	234.3	274.5
	Timet G 1971	TV3YLB2R1	L	2.0	RT	296.2	376.2

TM-6A1-6V-2Sn Cond. A

7.4.1.3 Annealed Bearing Tests

Thickness (Inches)	Manufacturer and Part No.	Specimen Number	Test Direction	e/D	Test Temperature (°F)	F <sub>MAX</sub> (Ksi) (2% Offset)	F <sub>MAX</sub> (Ksi)
.500 to .630	Timet G 2504	TV4YLB1R1	L	1.5	RT	235.1	276.2
	Timet G 2504	TV4YLB2R1	L	2.0	RT	284.0	356.0
.500 to .630	Timet G 3106	TV3YLB1R1	L	1.5	RT	229.7	281.1
	Timet G 3106	TV5YLB2R1	L	2.0	RT	266.4	342.1
≥ 1.00	Timet G 3023	TV1ZLB1R1	L	1.5	RT	224.9	265.4
	Timet G 3023	TV1ZLB1L1	L	1.5	400	182.1	225.0
≥ 1.00	Timet G 3023	TV1ZLB161	L	1.5	600	163.2	202.5
	Timet G 3023	TV1ZLB181	L	1.5	800	154.3	185.9
≥ 1.00	Timet G 3023	TV1ZTB1R1	T	1.5	RT	217.3	256.4
	Timet G 3023	TV1ZLEB1R1	LE	1.5	RT	215.6	244.9
≥ 1.00	Timet G 3023	TV1ZTEB1R1	TE	1.5	RT	200.6	212.9
	Timet G 3023	TV1ZLB2R1	L	2.0	RT	277.5	340.0
≥ 1.00	Timet G 3023	TV1ZLB2L1	L	2.0	400	209.1	280.1
	Timet G 3023	TV1ZLB261	L	2.0	600	199.5	252.0
≥ 1.00	Timet G 3023	TV1ZLB281	L	2.0	800	178.0	231.6
	Timet G 3023	TV1ZTB2R1	T	2.0	RT	253.4	327.4
≥ 1.00	Timet G 3023	TV1ZLEB2R1	LE	2.0	RT	267.7	317.4
	Timet G 3023	TV1ZTEB2R1	TE	2.0	RT	256.4	294.5

T1-6A1-6V-25n Cond. A

7.4.1.3 Annealed Bearing Tests

Thickness (Inches)	Manufacturer and Heat No.	Specimen Number	Test Direction	e/D	Test Temperature (°F)	F <sub>MAX</sub> (Ksi) (2% Offset)	F <sub>MIN</sub> (Ksi)
≥ 1.00	Timet G 3214	TV2ZLB1R1	L	1.5	RT	211.8	263.9
	Timet G 3214	TV2ZLB2R1	L	2.0	RT	275.0	(1)
	Timet G 2070	TV3ZLB1R1	L	1.5	RT	220.0	265.5
	Timet G 2070	TV3ZLB2R1	L	2.0	RT	264.1	338.0
≥ 1.00	Timet G 1471	TV4ZLB1R1	L	1.5	RT	214.8	259.0
	Timet G 1471	TV4ZLB2R1	L	2.0	RT	247.7	320.7
	Timet G 3023	TV5ZLB1R1	L	1.5	RT	220.7	266.7
	Timet G 3024	TV5ZLB2R1	L	2.0	RT	255.5	350.8
(1) Pin Failure							

Ti-6Al-6V-2Sn Cond. A

7.4.1.4 Annealed Shear Tests

Thickness (Inches)	Manufacturer and Heat No.	Specimen Number	Test Direction	Test Temperature (°F)	F <sub>su</sub> (Ksi)
.250 to .300	Timet G 3105	TV1XLSR1	L	RT	95.5
		TV1XLS41	L	400	80.0
		TV1XLS61	L	600	72.5
		TV1XLS81	L	800	68.8
	Timet G 3105	TV1XTSR1	T	RT	108.7
		TV1XTS41	T	400	92.3
		TV1XTS61	T	600	85.7
		TV1XTS81	T	800	80.7
.250 to .300	Timet G 3212	TV2XLSR1	L	RT	100.0
		TV3XLSR1	L	RT	102.4
	Timet G 1537	TV4XL3R1	L	RT	101.1
		TV3XLSR1	L	RT	98.8
.500 to .630	Timet G 393	TV1YLSR1	L	RT	105.7
		TV1YLS41	L	400	92.5
		TV1YLS61	L	600	74.8
		TV1YLS81	L	800	78.5
	Timet G 2443	TV1YTSR1	T	RT	110.7
		TV2YLSR1	L	RT	100.7
		TV3YLSR1	L	RT	113.0
		TV4YLSR1	L	RT	99.8
.500 to .630	Timet G 3106	TV5YLSR1	L	RT	99.8

Ti-6Al-6V-2Sn Cond. A

7.4.1.4 Annealed Shear Tests.

Thickness (Inches)	Manufacturer and Heat No.	Specimen Number	Test Direction	Test Temperature (°F)	F <sub>su</sub> (Ksi)
≥ 1.00 	Timet G 3023	TV1ZLSR1	L	RT	104.2
		TV1ZLS41	L	400	86.3
		TV1ZLS61	L	600	77.8
		TV1ZLS81	L	800	72.9
		TV1ZTSR1	T	RT	
≥ 1.00 	Timet G 3214	TV2XLSR1	L	RT	100.6
	Timet G 2070	TV3ZLSR1	L	RT	102.3
	Timet G 1971	TV4ZLSR1	L	RT	102.7
	Timet G 3024	TV5ZLSR1	L	RT	100.0

T1-6A1-6V-2Sn Cond. A

7.4.1.5 Fracture Toughness Tests

Thickness (inches)	Manufacturer and Heat No.	Specimen Number	Test Direc- tion	Exposure		Test Temp. (lbs)	Load Pop-in (lbs)	Crack Depth a	K Factor	K <sub>Ic</sub> Ksi $\sqrt{in}$	Net Fracture Strength, $\sigma_n$ (Ksi)	Load at Failure (lbs)
				Temp. (°F)	Time (Hrs.)							
.250 - .300	Timet G 3105	TV1XLF41	L	-	-	RT	5300	.800	6.96	36.8	55.0	13720
		TV1XLF42 (1)	L	400	10	RT	5900	.730	6.132	36.0	51.0	9580
		TV1XLF43	L	400	1000	RT	1070	.330	32.506	35.0	59.0	2010
		TV1XLF61	L	600	10	RT	5600	.770	6.604	37.0	70.6	14100
		TV1XLF62 (1)	L	600	100	RT	5200	.770	6.604	34.4	76.0	14250
		TV1XLF63	L	600	1000	RT	1640	.270	24.509	40.0	71.0	2710
		TV1XLF81	L	800	10	RT	5100	.760	6.48	33.0	53.8	13420
		TV1XLF82	L	800	100	RT	5000	.780	6.72	33.6	58.0	11660
		TV1XLF83	L	800	1000	RT	1140	.350	35.457	40.0	62.0	1870
								RT	5800	.760	6.48	37.4
.250 - .300	Timet G 3105	TV1XFR1	T	-	-	RT	4400	.830	7.31	32.0	58.2	13100
		TV2XFR1	L	-	-	RT	5350	.780	6.72	36.0	48.5	9700
		TV3XFR1	L	-	-	RT	4620	.750	6.34	29.4	38.5	8520
		TV4XFR1	L	-	-	RT	4900	.770	6.604	32.2	41.6	8350
		TV5XFR1	L	-	-	RT	6400	.800	6.96	40.0	32.0	8100
		(1)	Subsize Specimen									

$F_{tu} = 158.0$

TI 6Al-6V-2Sn Cond. A

7.4.1.6 Annealed Fatigue Tests

Thickness (Inches)	Manufacturer and Heat No.	Specimen Number	Test Direction	$K_t$	R	Max. (Ksi)	% $F_{tu}$	N (Cycles to Failure)		
≥ 1.00	Timet G 3023	TV1ZLVR49	L	3.0	-1	70.0	44	5,000		
		TV1ZLVR50	L	3.0	-1	52.5	33	11,000		
		TV1ZLVR51	L	3.0	-1	35.0	22	104,000		
		TV1ZLVR52	L	3.0	-1	26.25	17.	225,000		
		TV1ZLVR53	L	3.0	-1	17.5	11	10,000,000		
		TV1ZLVR54	L	3.0	-1	43.75	28	21,000		
		TV1ZLVR55	L	3.0	-1	22.750	14	1,982,000		
		TV1ZLVR56	L	3.0	-1	38.0	24	38,000		
		≥ 1.00	Timet G 3023	TV1ZLVR57	L	3.0	-0.3	35.0	22	288,000
				TV1ZLVR58	L	3.0	-0.3	61.25	39	20,000
TV1ZLVR59	L			3.0	-0.3	52.5	33	24,000		
TV1ZLVR60	L			3.0	-0.3	43.75	28	16,000		
TV1ZLVR61	L			3.0	-0.3	31.5	20	1,361,000		
TV1ZLVR62	L			3.0	-0.3	28.0	18	9,700,000		
TV1ZLVR63	L			3.0	-0.3	78.75	50	6,000		
TV1ZLVR64	L			3.0	-0.3	45.5	29	126,000		
	No Failure									



Ti 6Al-6V-2Sn Cond. A

F<sub>tu</sub> = 158.0

7.4.1.5 Annealed Fatigue Tests

Thickness (Inches)	Manufacturer and Heat No.	Specimen Number	Test Direction	K <sub>t</sub>	R	Max. (Ksi)	% F <sub>tu</sub>	N (Cycles to Failure)		
≥ 1.00	Timet G 3023	TVLXLVR33	L	3.0	0	87.5	55	7,000		
		TVLXLVR34	L	3.0	0	70.0	44	14,000		
		TVLXLVR35	L	3.0	0	52.5	33	68,000		
		TVLXLVR36	L	3.0	0	35.0	22	3,706,000		
		TVLXLVR37	L	3.0	0	31.5	20	1,883,000		
		TVLXLVR38	L	3.0	0	28.0	18	4,841,000		
		TVLXLVR39	L	3.0	0	21.0	13	7,850,000 →		
		TVLXLVR40	L	3.0	0	45.5	29	112,000		
		TVLZLVR41	L	3.0	+0.3	96.25	61	13,000		
		TVLZLVR42	L	3.0	+0.3	78.75	50	8,000		
≥ 1.00	Timet G 3023	TVLZLVR43	L	3.0	+0.3	70.0	44	42,000		
		TVLZLVR44	L	3.0	+0.3	52.5	33	144,000		
		TVLZLVR45	L	3.0	+0.3	43.75	28	393,000		
		TVLZLVR46	L	3.0	+0.3	35.0	22	9,600,000 →		
		TVLZLVR47	L	3.0	+0.3	87.5	55	18,000		
		TVLZLVR48	L	3.0	+0.3	113.75	72	4,000		
		No Failure	No Failure							

7.4.1.6

Annealed Fatigue Tests

TH-6A1-6V-2Sn Cond. A

F<sub>tu</sub> = 158.0

Thickness (Inches)	Manufacturer and Heat No.	Specimen Number	Test Direction	K <sub>t</sub>	R	Max. (Ksi)	% F <sub>tu</sub>	N (Cycles to Failure)		
≥1.00	Timet G 3023	TV1ZLVR17	L	1.0	-1	130.	82	5,000		
		TV1ZLVR18	L	1.0	-1	100.	64	51,000		
		TV1ZLVR19	L	1.0	-1	85.	58	97,000		
		TV1ZLVR20	L	1.0	-1	78.75	50	374,000		
		TV1ZLVR21	L	1.0	-1	70.	44	260,000		
		TV1ZLVR22	L	1.0	-1	122.5	78	12,000		
		TV1ZLVR23	L	1.0	-1	113.75	76	15,000		
		TV1ZLVR24	L	1.0	-1	60.	38	10,000,000 →		
		≥1.00	Timet G 3023	TV1ZLVR25	L	1.0	-0.3	120.	76	161,000
				TV1ZLVR26	L	1.0	-0.3	55.	35	11,200,000 →
				TV1ZLVR27	L	1.0	-0.3	100.	63	143,000
				TV1ZLVR28	L	1.0	-0.3	70.	44	3,351,000
TV1ZLVR29	L			1.0	-0.3	100.	63	245,000		
TV1ZLVR30	L			1.0	-0.3	140.	89	47,000		
TV1ZLVR31	L			1.0	-0.3	155.	98	6,000		
TV1ZLVR32	L			1.0	-0.3	80.	51	3,232,000		
	→ No Failure									

Ti 6Al-6V-2Sn Cond. A

F<sub>tu</sub> = 158.0

7.4.1.6 Annealed Fatigue Tests

Thickness (Inches)	Manufacturer and Heat No.	Specimen Number	Test Direction	K <sub>t</sub>	R	Max. (Ksi)	% F <sub>tu</sub>	N (Cycles to Failure)
≥ 1.00	Timet G 3023	TV1ZLVR-1	L	1.0	0	160,000	101	8,000
		TV1ZLVR-2	L	1.0	0	145,000	92	17,000
		TV1ZLVR-3	L	1.0	0	130,000	82	194,000
		TV1ZLVR-4	L	1.0	0	135,000	35	70,000
		TV1ZLVR-5	L	1.0	0	125,000	79	268,000
		TV1ZLVR-6	L	1.0	0	115,000	73	339,000
		TV1ZLVR-7	L	1.0	0	105,000	66	583,000
		TV1ZLVR-8	L	1.0	0	80,000	51	1,164,000
≥ 1.00	Timet G 3023	<b>TV1ZLVR-71</b>	<b>L</b>	<b>1.0</b>	<b>0</b>	<b>60,000</b>	<b>38</b>	<b>31,706,000</b> →
		TV1ZLVR-9	L	1.0	+0.3	155,000	98	29,000
		TV1ZLVR-10	L	1.0	+0.3	145,000	72	178,000
		TV1ZLVR-11	L	1.0	+0.3	140,000	89	59,000
		TV1ZLVR-12	L	1.0	+0.3	135,000	85	207,000
		TV1ZLVR-13	L	1.0	+0.3	125,000	79	619,000
		TV1ZLVR-14	L	1.0	+0.3	120,000	75	384,000
		TV1ZLVR-15	L	1.0	+0.3	110,000	69	585,000
		TV1ZLVR-16	L	1.0	+0.3	95,000	60	738,000

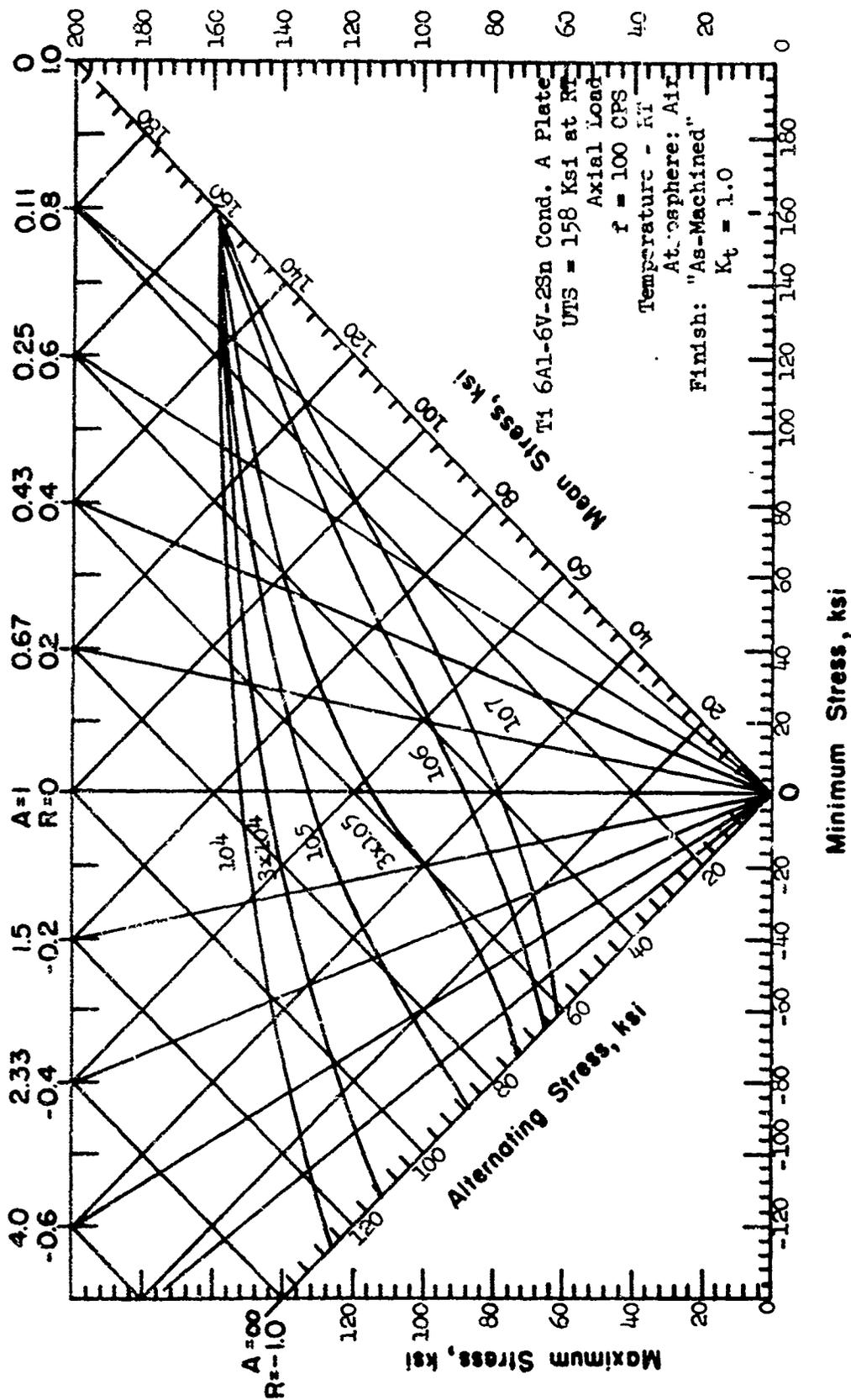


Figure 7-9

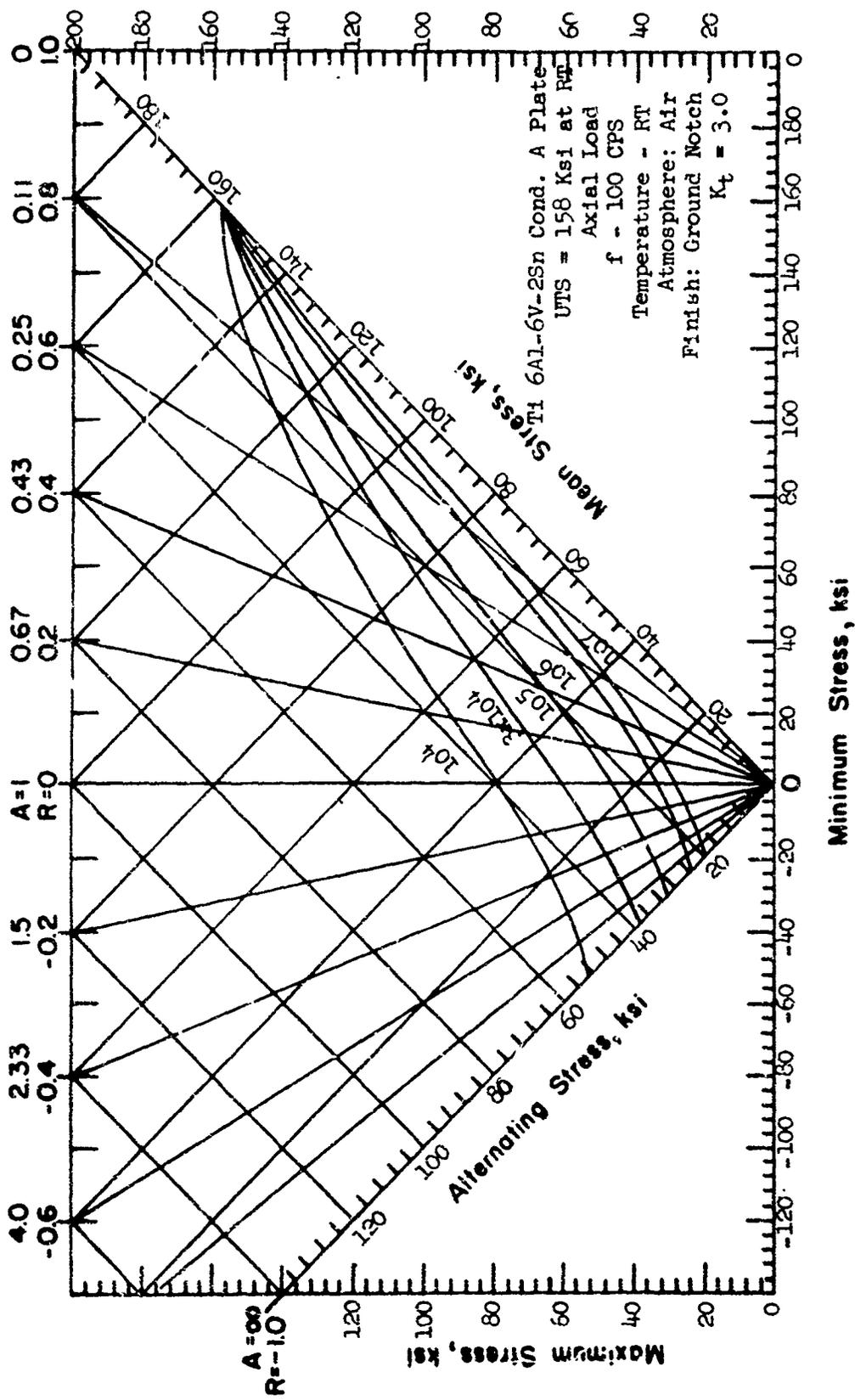


Figure 7-10

7.4.2 T1 6Al-6V-2Sn Cond. STA

## 7.4.2.1 STA Tensile Tests

Ti 6Al-6V-2Sn Cond. STA

Thickness (Inches)	Manufacturer and Heat No.	Specimen Number	Test Direction	Test Temperature (°F)	F <sub>ty</sub> (Ksi)	F <sub>tu</sub> (Ksi)	% Elongation	% Reduction Area
.250 to .300	Timet G 3105	TV7XLTR1	L	RT	176.5	184.0	8	-
		TV7XLTF41	L	400	139.7	153.8	9	-
		TV7XLTF61	L	600	123.6	142.6	9	-
		TV7XLTF81	L	800	117.9	133.1	12	-
		TV7XTTR1	T	RT	186.0	191.2	10	-
.500 to .630	Timet G 393	TV6XLTR1	L	RT	174.0	181.0	10	28
		TV6XLTF41	L	400	143.5	158.6	12	36
		TV6XLTF61	L	600	133.0	148.8	12	42
		TV6XLTF81	L	800	123.3	141.6	17	63
		TV6YTPR1	T	RT	174.3	182.6	7	20
		TV6YTF41	T	400	145.6	160.3	12	39
		TV6YTF61	T	600	133.0	149.6	11	31
		TV6YTF81	T	800	122.9	140.8	12	45
.500 to .630	Timet G 2443	TV7YLTR2	L	RT	178.0	181.0	9	32
		TV7YLTR1	L	RT	178.2	183.8	8	20
		TV76TPR1	T	RT	182.6	188.0	8	19
		TV8YLTR1	L	RT	178.0	183.0	9	24
		TV8YLTR1	L	RT	175.9	184.0	11	30
		TV8YTPR1	T	RT	174.0	180.8	12	34
		TV9YLTR2	L	RT	183.0	188.0	8	26
		TV9YLTR1	L	RT	176.8	188.5	10	24
		TV9YTPR1	T	RT	180.8	187.7	10	31

7.4.2.1 STA Tensile

Ti 6Al-6V-2Sn Cond. STA

Thickness (Inches)	Manufacturer and Heat No.	Specimen Number	Test Direction	Test Temperature (°F)	F <sub>y</sub> (Ksi)	F <sub>tu</sub> (Ksi)	% Elongation	% Reduction Area
.500 to .630	Timet G 3106	TV10YLTR2	L	RT	175.0	182.0	12	26
		TV10YLTRL	L	RT	170.8	178.2	12	39
		TV10YTTRL	T	RT	170.8	178.6	13	41
≥ 1.00	Timet G 3023	TV6ZLTR1	L	RT	175.3	186.4	10	32
		TV6ZLTR2	L	RT	182.0	190.0	7	19
		TV6ZLTR41	L	400	138.5	153.1	15	54
		TV6ZLTR61	L	600	125.3	145.6	15	59
		TV6ZLTR81	L	800	120.1	137.9	17	70
		TV6ZTRR1	T	RT	178.6	187.8	10	29
	Timet G 3023	TV6ZTRR41	T	400	138.3	155.2	12	42
		TV6ZTRR61	T	600	124.1	144.8	13	45
		TV6ZTRR81	T	800	113.0	131.3	14	59
		TV6ZSTR1	ST	RT	159.6	173.7	8	33
		TV6ZST41	ST	400	132.5	146.5	10	46
		TV6ZST61	ST	600	114.3	133.9	12	49
≥ 1.00	Timet G 3214	TV7ZLTR1	L	RT	181.0	191.0	8	23
		TV7ZLTR2	L	RT	181.0	191.0	9	25
	Timet G 3214	TV7ZTRR1	T	RT	179.9	188.8	8	37
		TV7ZSTR1	ST	RT	171.1	186.6	10	33



7.4.2.1 STA Tensile

Ti 6Al-6V-2Sn Cond. STA

Thickness (Inches)	Manufacturer and Heat No.	Specimen Number	Test Direction	Test Temperature (°F)	F <sub>ty</sub> (Ksi)	F <sub>tu</sub> (Ksi)	% Elongation	% Reduction Area
≥ 1.00	Timet G 2070	TV8ZLTR1	L	RT	180.0	191.3	8	18
		TV8ZLTR2	L	RT	181.0	192.0	7	23
		TV8ZTTR1	T	RT	179.0	187.0	7	17
		TV8ZSTR1	ST	RT	165.3	180.5	7	26
≥ 1.00	Timet G 1971	TV9ZLTR1	L	RT	174.8	185.6	10	32
		TV9ZLTR2	L	RT	182.0	190.0	11	41
		TV9ZTTR1	T	RT	175.8	186.7	10	31
		TV9ZSTR1	ST	RT	173.8	186.3	8	18
≥ 1.00	Timet G 3024	TV10ZLTR1	L	RT	180.0	192.1	7	22
		TV10ZLTR2	L	RT	180.0	194.0	6	22
		TV10ZTTR1	T	RT	181.5	191.2	10	30
		TV10ZSTR1	ST	RT	168.0	184.6	4	9

7.4.2.1.1 STA Tensile Stability Tests

T1 6A1-6V-2Sn Cond. STA

Thickness (Inches)	Manufacturer and Heat No.	Specimen Number	Test Direction	Exposure		Test Temperature (°F)	F <sub>ty</sub> (Ksi)	F <sub>tu</sub> (Ksi)	Percent Elongation	% Reduction Area
				Temperature (°F)	Time (Hrs.)					
.500 to .630	Timet G 393	TV6YLTW41	L	400	10	RT	174.7	179.8	8	29
		TV6YLTW42	L	400	100	RT	169.2	180.4	8	20
		TV6ULTW43	L	400	1000	RT	174.4	182.5	8	23
		TV6YLTW51	L	600	10	RT	175.3	181.6	9	27
		TV6YLTW62	L	600	100	RT	172.0	180.0	9	25
		TV6YLTW63	L	600	1000	RT	175.6	181.3	9	27
		TV6YLTW81	L	800	10	RT	177.8	184.7	8	25
		TV6YLTW82	L	800	100	RT	183.8	189.0	7	15
.500 to .630	Timet G 393	TV6YLTW83	L	800	1000	RT	183.8	192.2	8	22

7.4.2.1.1 STA Tensile Stability Tests

Ti 6Al-6V-2Sn Coll. STA

Thickness (Inches)	Manufacturer and Heat No.	Specimen Number	Test Direction	Exposure		Test Temperature (°F)	F <sub>ty</sub> (Ksi)	F <sub>tu</sub> (Ksi)	Percent Elongation	% Reduction Area
				Temperature (°F)	Time (Hrs.)					
≥ 1.00	Timet G 3023	TV6ZLTW41	L	400	10	RT	175.6	182.8	8	21
		TV6ZLTW42	L	400	100	RT	175.0	185.9	7	20
≥ 1.00	Timet G 3023	TV6ZLTW43	L	400	1000	RT	181.0	188.8	8	28
		TV6ZLTW61	L	600	10	RT	176.2	183.0	9	25
		TV6ZLTW62	L	600	100	RT	174.7	180.8	9	24
		TV6ZLTW63	L	600	1000	RT	176.4	186.0	10	31
		TV6ZLTW81	L	800	10	RT	181.2	187.0	8	19
		TV6ZLTW82	L	800	100	RT	181.5	192.8	9	29
		TV6ZLTW83	L	800	1000	RT	185.1	192.2	8	21

TH-6AL-6V-2SP COND. STA

7.4.2.1.2 Tensile Tests - Precision Elastic Modulus (Tuckeyman)

Thickness (inches)	Manufacturer and Heat No.	Specimen Number	Test Direction	Test Temperature	Precision "g" x 10 <sup>6</sup>
.250-.300	Timet G 3105	TWVXLTR1	L	RT	16.1

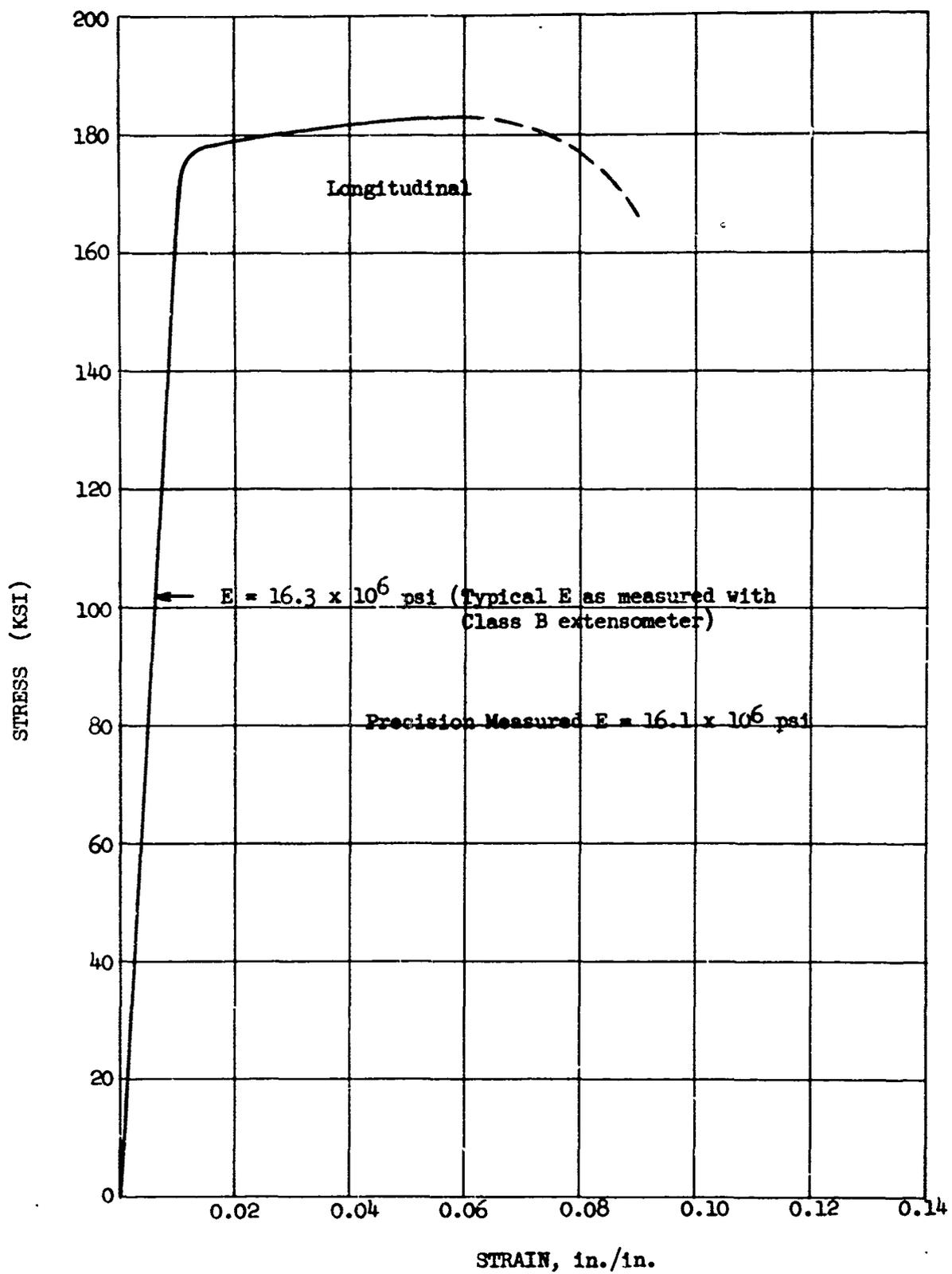


Figure 7-11 Typical Tensile Stress-Strain Curve (full-range) for Solution Treated and Aged Ti-6Al-6V-2Sn Alloy Plate at Room Temperature

Ti 6Al-6V-2Sn Cond. STA

7.4.2.2 STA Compression Tests

Thickness (Inches)	Manufacturer and Heat No.	Specimen Number	Test Direction	Test Temperature (°F)	F <sub>0.2</sub> (Ksi)
.250 to .300	Timet G 3105	TV7XLCR1	L	RT	184.1
	Timet G 3105	TV7XTCR1	T	RT	206.0
.500 to .630	Timet G 393	TV6YLCR1	L	RT	182.3
		TV6YLC41	L	400	149.2
	Timet G 393	TV6YLC61	L	600	141.0
		TV6YLC81	L	800	125.7
	Timet G 393	TV6YTCR1	T	RT	187.0
		TV6YTC41	T	400	154.0
		TV6YTC61	T	600	139.4
		TV6YTC81	T	800	126.3
		TV7YLCR1	L	RT	188.3
		TV7YTCR1	T	RT	194.6
.500 to .630	Timet G 1971	TV8YLCR1	L	RT	190.7
		TV8YTCR1	T	RT	187.8
.500 to .630	Timet G 2504	TV9YLCR1	L	RT	195.5
		TV9YTCR1	T	RT	191.0
.500 to .630	Timet G 3106	TV10YLCR1	L	RT	187.0
		TV10YTCR1	T	RT	183.3

Ti 6Al-6V-2Sn Cond. STA

7.4.2.2 STA Compression Tests

Thickness (Inches)	Manufacturer and Heat No.	Specimen Number	Test Direction	Test Temperature (°F)	F <sub>cy</sub> (Ksi)
≥ 1.00	Timet G 3023	TV6ZLCR1	L	RT	208.2
		TV6ZLC41	L	400	153.3
		TV6ZLC61	L	600	133.6
		TV6ZLC81	L	800	121.9
		TV6ZTCR1	T	RT	194.2
		TV6ZTC41	T	400	150.7
		TV6ZTC61	T	600	134.6
		TV6ZTC81	T	800	119.7
		TV6ZSCR1	ST	RT	182.7
		TV6ZSC41	ST	400	140.3
		TV6ZSC61	ST	600	131.2
		TV6ZSC81	ST	800	126.5
≥ 1.00	Timet G 3023	TV7ZLCR1	L	RT	191.5
		TV7ZTCR1	T	RT	191.2
		TV7ZSCR1	ST	RT	193.1
		TV8ZLCR1	L	RT	195.7
		TV8ZTCR1	T	RT	185.0
		TV8ZSCR1	ST	RT	190.3

7.4.2.2 STA Compression Tests

T1 GAl-6V-2Sn Cond. STA

Thickness (Inches)	Manufacturer and Heat No.	Specimen Number	Test Direction	Test Temperature (°F)	F <sub>cy</sub> (Ksi)
≥ 1.00 ↕ ≥ 1.00	Timet G 1971	TV9ZLCR1	L	RT	183.3
	↕	TV9ZTCR1	T	RT	192.0
	Timet G 1971	TV9ZSCR1	ST	RT	200.5
	↕	TV10ZLCR1	L	RT	198.2
	Timet G 3024	TV10ZTCR1	T	RT	194.5
	↕	TV10ZSCR1	ST	RT	205.3



7.4.2.3 STA Bearing Tests

Thickness (Inches)	Manufacturer and Heat No.	Specimen Number	Test Direction	e/d	Test Temperature (oF)	F <sub>MAX</sub> (Ksi) (2% Offset)	F <sub>MAX</sub> (Ksi)
.250 to .300	Timet G 3105	TV7XLB1R1	L	1.5	RT	277.7	298.6
	Timet G 3105	TV7XLB2R1	L	2.0	RT	296.7	360.4
.500 to .630	Timet G 393	TV6YLB1R1	L	1.5	RT	252.5	276.7
		TV6YLB1L1	L	1.5	400	218.4	250.8
		TV6YLB161	L	1.5	600	222.2	238.1
		TV6YLB181	L	1.5	800	187.9	213.3
		TV6YTB1R1	T	1.5	RT	265.1	287.4
		TV6YLB2R1	L	2.0	RT	298.8	343.3
.500 to .630	Timet G 393	TV6YLB241	L	2.0	400	254.5	300.3
		TV6YLB261	L	2.0	600	254.2	296.5
		TV6YLB281	L	2.0	800	242.9	292.0
		TV6YTB2R1	T	2.0	RT	298.1	350.2
		TV7YLB1R1	L	1.5	RT	268.1	293.6
		TV7YLB2R1	L	2.0	RT	302.4	366.3
.500 to .630	Timet G 2070	TV8YLB1R1	L	1.5	RT	261.0	302.5
		TV8YLB2R1	L	2.0	RT	295.0	371.8
.500 to .630	Timet G 1971	TV9YLB1R1	L	1.5	RT	277.5	293.0
		TV9YLB2R1	L	2.0	RT	299.3	373.4

T4 6AI-6V-2Sn Cond. STA

7.4.2.3 STA Bearing Tests

Thickness (Inches)	Manufacturer and Heat No.	Specimen Number	Test Direction	e/d	Test Temperature (°F)	F <sub>50%</sub> (Ksi) (2% Offset)	F <sub>max</sub> (Ksi)
.500 to .630	Timet G 3106	TV10YLB1R1	L	1.5	RT	255.4	291.6
		TV10YLB2R1	L	2.0	RT	295.8	371.4
≥ 1.00	Timet G 3023	TV6ZLB1R1	L	1.5	RT	258.0	288.6
		TV6ZLB1L1	L	1.5	400	226.9	256.1
		TV6ZLB161	L	1.5	600	201.4	227.1
		TV6ZLB181	L	1.5	800	200.0	228.5
		TV6ZTB1R1	T	1.5	RT	266.5	289.0
		TV6ZLEB1R1	LE	1.5	RT	240.0	261.1
		TV6ZTEB1R1	TE	1.5	RT	242.5	251.7
		TV6ZLB2R1	L	2.0	RT	299.0	353.2
		TV6ZLB2L1	L	2.0	400	253.3	306.9
		TV6ZLB261	L	2.0	600	234.4	282.2
≥ 1.00	Timet G 3023	TV6ZLB281	L	2.0	800	226.5	285.2
		TV6ZTB2R1	T	2.0	RT	283.3	343.7
		TV6ZLEB2R1	LE	2.0	RT	289.4	350.3
		TV6ZTEB2R1	TE	2.0	RT	312.0	342.5
		TV7ZLB1R1	L	1.5	RT	272.5	295.0
		TV77LB2R1	L	2.0	RT	325.4	372.1

Ti 6Al-6V-2Sn Cond. STA

7.4.2.3 STA Bearing Tests

Thickness (Inches)	Manufacturer and Heat No.	Specimen Number	Test Direction	e/D	Test Temperature (°F)	F <sub>MAX</sub> (Ksi) (2% Offset)	F <sub>END</sub> (Ksi)
≥ 1.00	Timet G 2070	TV8ZLB1R1	L	1.5	RT	267.9	291.3
	Timet G 2070	TV8ZLB2R1	L	2.0	RT	284.0	347.7
≥ 1.00	Timet G 1971	TV9ZLB1R1	L	1.5	RT	277.2	303.9
	Timet G 1971	TV9ZTB1R1	L	2.0	RT	304.3	361.4
≥ 1.00	Timet G 3024	TV10ZLB1R1	L	1.5	RT	279.0	298.2
	Timet G 3024	TV10ZLB2R1	L	2.0	RT	312.0	369.6

7.4.2.4 STA Shear Tests

TI 6A1-6V-2Sn Cond. STA

Thickness (Inches)	Manufacturer and Heat No.	Specimen Number	Test Direction	Test Temperature (°F)	Fcy (Ksi)
.250 to .300	Timet G 3105	TV7XLSR1	L	RT	107.0
.500 to .630	Timet G 393	TV6YLSR1	L	RT	108.0
		TV6YLS41	L	400	93.7
		TV6YLS61	L	600	89.8
		TV6YLS81	L	800	83.6
		TV6YTSR1	T	RT	118.0
.500 to .630	Timet G 2443	TV7YLSR1	L	RT	106.0
		TV8YLSR1	L	RT	115.0
		TV9YLSR1	L	RT	115.0
		TV10YLSR1	L	RT	115.0
≥ 1.00	Timet G 3023	TV6ZLSR1	L	RT	111.0
		TV6ZLS41	L	400	96.3
		TV6ZLS61	L	600	89.7
		TV6ZLS81	L	800	87.3
		TV6ZTSR1	T	RT	111.0
≥ 1.00	Timet G 3024	TV7ZLSR1	L	RT	116.0
		TV8ZLSR1	L	RT	114.0
		TV9ZLSR1	L	RT	116.0
		TV10ZLSR1	L	RT	116.0

T1-6A1-6V-2Sn Cond. STA

7.4.2.5 Fracture Toughness Tests

Thickness (inches)	Manufacturer and Heat No.	Specimen Number	Test Direc- tion	Exposure		Test Temp. (lbs)	Load Pop-in (lbs)	a Crack Depth	K Factor	K <sub>Ic</sub> Ksi $\sqrt{\text{in}}$	Net Fracture Strength, $\sigma_n$ (Ksi)	Load at Failure (lbs)
				Temp. (*F)	Time (Hrs.)							
.250 - .300	Timet G 3105	TV7XLFR1	L	-	-	RT	4900	.750	6.34	31.0	34.3	6860

TH 6A1-6V-23n Cond. STA

$F_{tu} = 186.4$

7.4.2.6 STA Fatigue Tests

Thickness (Inches)	Manufacturer and Heat No.	Specimen Number	Test Direction	$K_t$	R	Max. (Ksi)	% $F_{tu}$	N (Cycles to Failure)
≥ 1.00	Timet G 3023	TV6ZLVR25	L	1.0	-1	152.0	81.	10,000
		TV6ZLVR26	L	1.0	-1	142.5	76	21,000
		TV6ZLVR27	L	1.0	-1	133.0	71	26,000
		TV6ZLVR28	L	1.0	-1	114.0	61	68,000
		TV6ZLVR29	L	1.0	-1	95.0	51	9,224,000
		TV6ZLVR30	L	1.0	-1	108.3	58	108,000
		TV6ZLVR31	L	1.0	-1	102.6	55	3,105,000
		TV6ZLVR32	L	1.0	-1	161.5	87	7,000
		TV6ZLVR17	L	1.0	-0.3	152.0	82	141,000
		TV6ZLVR18	L	1.0	-0.3	161.5	87	66,000
		TV6ZLVR19	L	1.0	-0.3	142.5	76	430,000
		TV6ZLVR20	L	1.0	-0.3	171.1	92	8,000
≥ 1.00	Timet G 3023	TV6ZLVR21	L	1.0	-0.3	123.5	66	1,041,000
		TV6ZLVR22	L	1.0	-0.3	104.5 (1)	56	591,000
		TV6ZLVR23	L	1.0	-0.3	104.5 (1)	56	327,000
		TV6ZLVR24	L	1.0	-0.3	104.5 (1)	56	1,066,000
		TV6ZLVR24A	L	1.0	-0.3	100.0	54	997,000

(1) Grip Failure

TH 6A1-6V-2Sn Cond. STA

F<sub>cu</sub> = 186.4

7.4.2.6 STA Fatigue Tests

Thickness (Inches)	Manufacturer and Heat No.	Specimen Number	Test Direction	K <sub>t</sub>	R	Max. (ksi)	% F <sub>cu</sub>	N (Cycles to Failure)
≥ 1.00	Timet G 3023	TV6ZLVR1	L	1.0	0	161.5	87	310,000
		TV6ZLVR2	L	1.0	0	171.0	92	21,000
		TV6ZLVR3	L	1.0	0	152.0	81	36,000
		TV6ZLVR4	L	1.0	0	133.0	71	1,041,000
		TV6ZLVR5	L	1.0	0	114.0	61	4,723,000
		TV6ZLVR6	L	1.0	0	142.5	76	405,000
		TV6ZLVR7	L	1.0	0	104.5	56	15,050,000
		TV6ZLVR8	L	1.0	0	152.0	81	99,000 (1)
≥ 1.00	Timet G 3023	TV6ZLVR9	L	1.0	+0.3	180.5	97	17,000
		TV6ZLVR10	L	1.0	+0.3	161.5	87	370,000
		TV6ZLVR11	L	1.0	+0.3	171.0	92	23,000
		TV6ZLVR12	L	1.0	+0.3	152.0	81	693,000
		TV6ZLVR13	L	1.0	+0.3	142.5	76	949,000
		TV6ZLVR14	L	1.0	+0.3	122.5	66	5,820,000
		TV6ZLVR15	L	1.0	+0.3	161.2	90	622,000
		TV6ZLVR16	L	1.0	+0.3	184.3	99	13,000

(1) Grip Failure

F<sub>tu</sub> = 186.4

T1 6A1-6V-2Sn Cond. STA

7.4.2.6 STA Fatigue Tests

Thickness (Inches)	Manufacturer and Heat No.	Specimen Number	Test Direction	K <sub>t</sub>	R	Max. (ksi)	% F <sub>tu</sub>	N (Cycles to Failure)
≥ 1.00	Timet G 3023	TV6ZLVR49	L	3.0	-1	57.0	30	4,000
		TV6ZLVR50	L	3.0	-1	47.5	25	20,000
		TV6ZLVR51	L	3.0	-1	38.0	20	81,000
		TV6ZLVR52	L	3.0	-1	28.5	15	154,000
		TV6ZLVR53	L	3.0	-1	19.0	10	10,000,000
		TV6ZLVR54	L	3.0	-1	24.7	13	175,000
		TV6ZLVR55	L	3.0	-1	41.8	22	14,000
		TV6ZLVR56	L	3.0	-1	53.2	28	15,000
		TV6ZLVR57	L	3.0	-0.3	57.54	31	20,000
		TV6ZLVR58	L	3.0	-0.3	47.5	25	40,000
		TV6ZLVR59	L	3.0	-0.3	38.0	20	46,000
		TV6ZLVR60	L	3.0	-0.3	28.5	15	10,000,000
		TV6ZLVR61	L	3.0	-0.3	34.2	18	10,000,000
		TV6ZLVR62	L	3.0	-0.3	76.0	41	7,000
		TV6ZLVR63	L	3.0	-0.3	38.0	20	112,000
		TV6ZLVR64	L	3.0	-0.3	66.5	35	10,000
≥ 1.00	No Failure							



T4 6A1-6V-23n Cond. STA

$F_{tu} = 186.4$

7.4.2.6 STA Fatigue Tests

Thickness (Inches)	Manufacturer and Heat No.	Specimen Number	Test Direction	$K_t$	R	Max. (Ksi)	$F_{tu}$	N (Cycles to Failure)		
$\geq 1.00$	Timet G 3023	TV6ZLVR33	L	3.0	0	76 *	44	4,000		
		TV6ZLVR34	L	3.0	0	83.0	31	24,000		
		TV6ZLVR35	L	3.0	0	57.0	25	114,000		
		TV6ZLVR36	L	3.0	0	47.5	15	25,000,000		
		TV6ZLVR37	L	3.0	0	28.5	28	28,000		
		TV6ZLVR38	L	3.0	0	53.2	36	27,000		
		TV6ZLVR39	L	3.0	0	56.5	23	7,213,000		
		TV6ZLVR40	L	3.0	0	43.7				
		TV6ZLVR41	L	3.0	+0.3	76.0	41	24,000		
		TV6ZLVR42	L	3.0	+0.3	57.0	31	223,000		
$\geq 1.00$	Timet G 3023	TV6ZLVR43	L	3.0	+0.3	66.5	36	11,000		
		TV6ZLVR44	L	3.0	+0.3	47.5	25	140,000		
		TV6ZLVR45	L	3.0	+0.3	34.2	18	10,000,000		
		TV6ZLVR46	L	3.0	+0.3	95.0	51	14,000		
		TV6ZLVR47	L	3.0	+0.3	104.5	36	3,000		
		TV6ZLVR48	L	3.0	+0.3	41.8	22	10,000,000		
		<p>→ No Failure</p> <p>* Overstressed</p>								

This document is the property of the U.S. Government and is loaned to your organization; it and its contents are not to be distributed outside your organization.

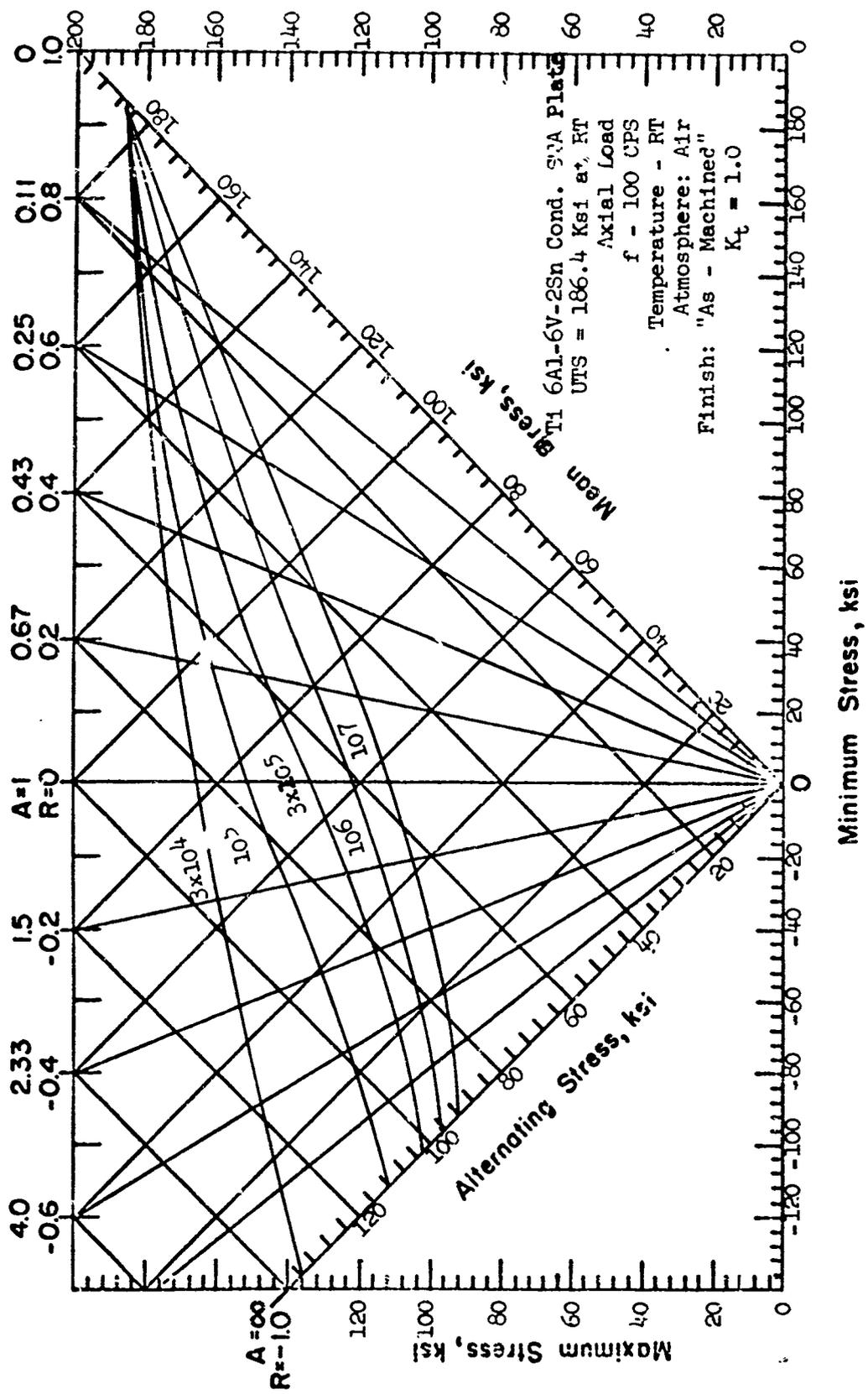


Figure 7-12

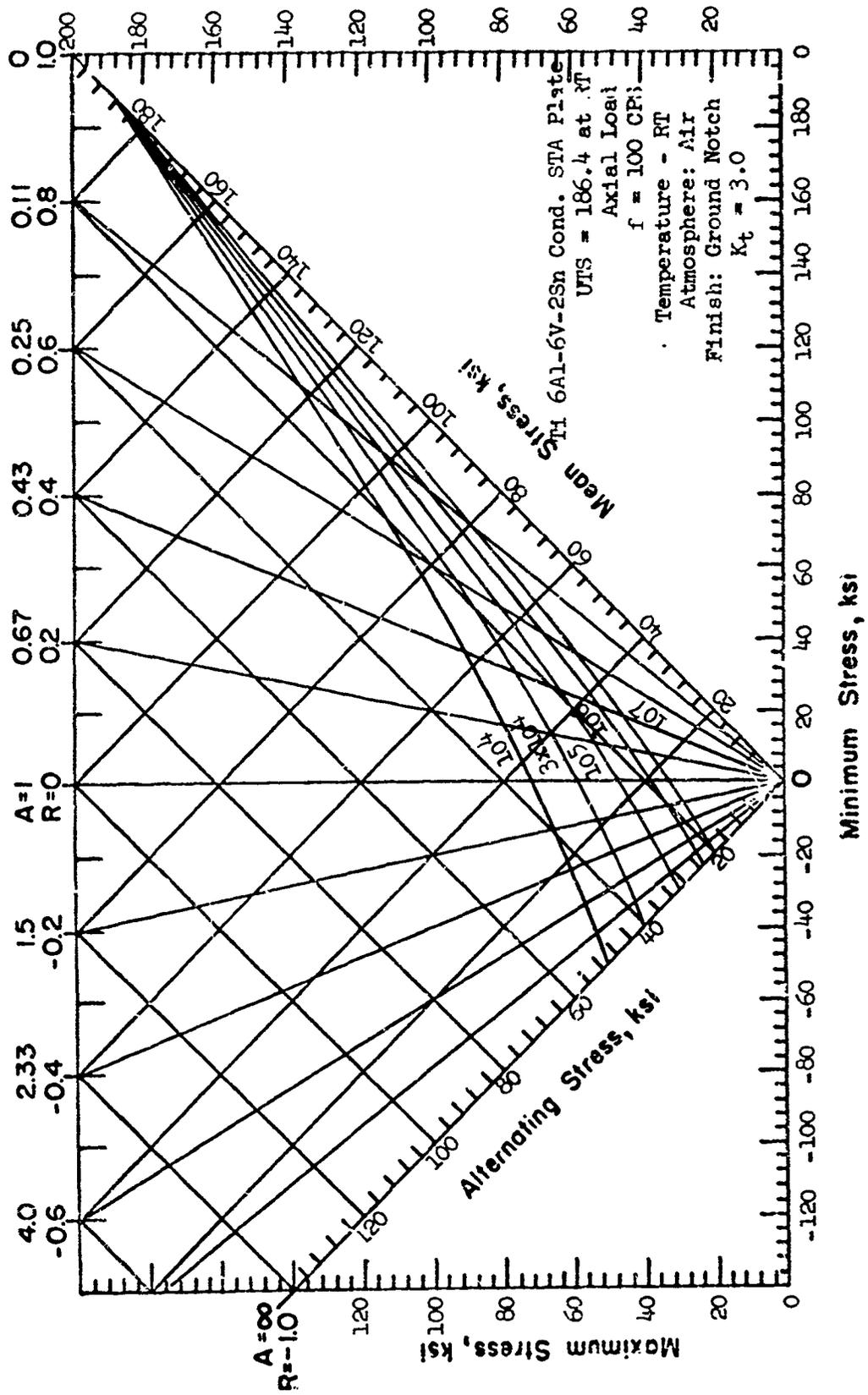


Figure 7-13

## SECTION VIII

### MIL-HDBK-5 DATA PRESENTATION

Contained in this section are the room temperature design allowables, effect of temperature curves, and stress-strain curves, for Ti-4Al-3Mo-1V Cond. A, Ti-13V-11Cr-3Al Cond. A, Ti-6Al-4V Cond. STA, and Ti-6Al-6V-2Sn Cond. A and Ti-6Al-6V-2Sn Cond. STA. Refer to Section VI for a discussion of the limitations of the allowables contained herein.

	Page
8.1 Design Allowables, Ti-4Al-3Mo-1V Cond. A	235 - 241
8.2 Design Allowables, Ti-13V-11Cr-3Al Cond. A	242 - 248
8.3 Design Allowables, Ti-6Al-4V Cond. STA	249 - 255
8.4 Design Allowables, Ti-6Al-6V-2Sn Cond. A	256 - 262
8.5 Design Allowables, Ti-6Al-6V-2Sn Cond STA	263 - 267

Table VIII-1

## 8.1 Design Mechanical and Physical Properties of Ti-4Al-3Mo-1V

Alloy	MIL-T-4046 Type III Comp. B
Form	Sheet and Strip
Condition	Annealed
Thickness or diameter, in.	$\leq .110$
Basis	S
Mechanical properties:	
F <sub>tu</sub> , ksi	125
L	
LT	
F <sub>ty</sub> , ksi	115
L	
LT	
F <sub>cy</sub> , ksi	112
L	
LT	
F <sub>su</sub> , ksi	77
F <sub>bru</sub> , ksi	
(e/D = 1.5)	191
(e/D = 2.0)	260
F <sub>bry</sub> , ksi:	
(e/D = 1.5)	150
(e/D = 2.0)	175
e, per cent:	
In 2 in.	10
In 4 D	
E, 10 <sup>6</sup> psi	16.2
E <sub>c</sub> , 10 <sup>6</sup> psi	
G, 10 <sup>6</sup> psi	
Physical properties:	
, lb/in. <sup>3</sup>	
C, Btu/(lb)(F)	
K, Btu/ (hr)(ft <sup>2</sup> )(F)/ft	
, 10 <sup>-6</sup> in./in./F	

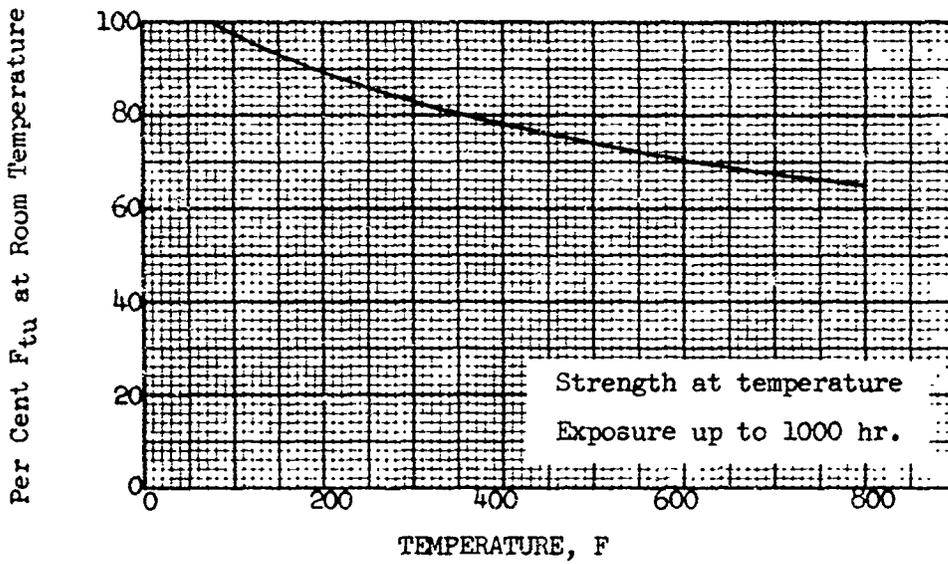


Figure 8.1.1 Effect of Temperature on the ultimate tensile strength ( $F_{tu}$ ) of annealed Ti-4Al-3Mo-1V alloy sheet.

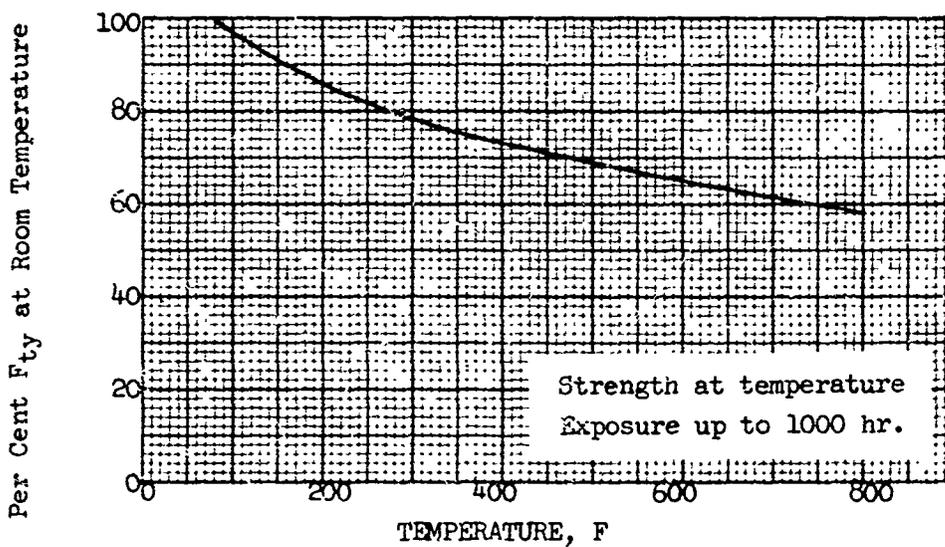


Figure 8.1.2 Effect of Temperature on the tensile yield strength ( $F_{ty}$ ) of annealed Ti-4Al-3Mo-1V alloy sheet.

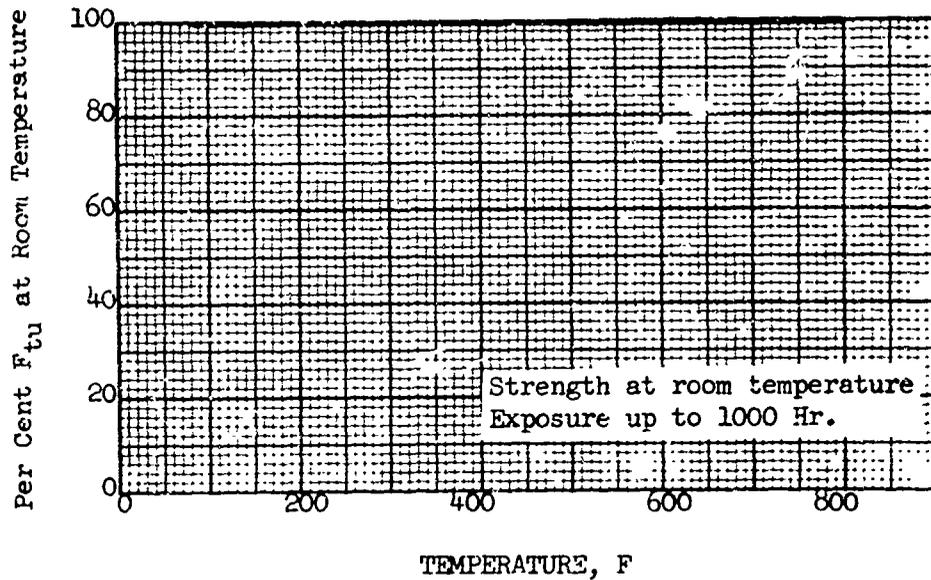


Figure 8.1.3 Effect of Exposure at elevated temperature on the room-temperature ultimate tensile strength ( $F_{tu}$ ) of annealed Ti-4Al-3Mo-1V alloy sheet.

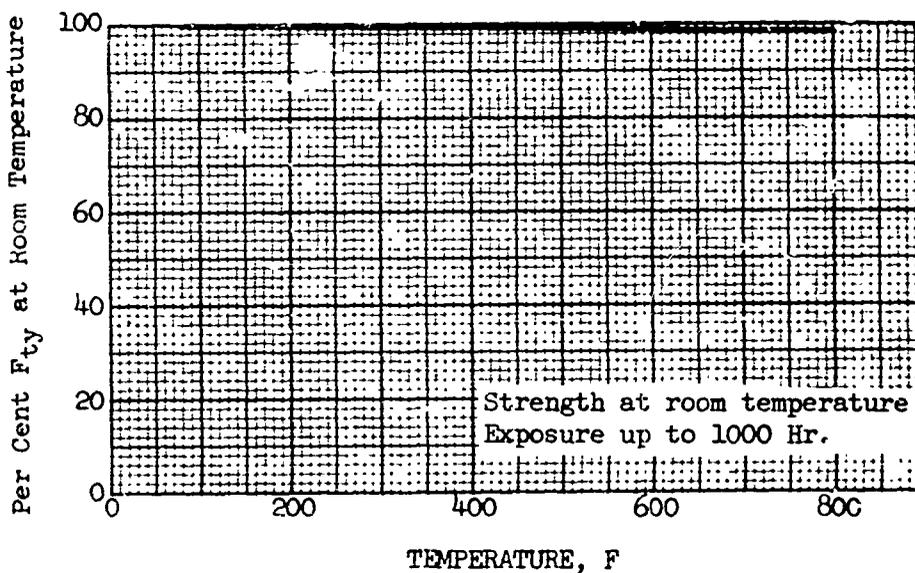


Figure 8.1.4 Effect of exposure at elevated temperature on the room-temperature tensile yield strength ( $F_{ty}$ ) of annealed Ti-4Al-3Mo-1V alloy sheet.

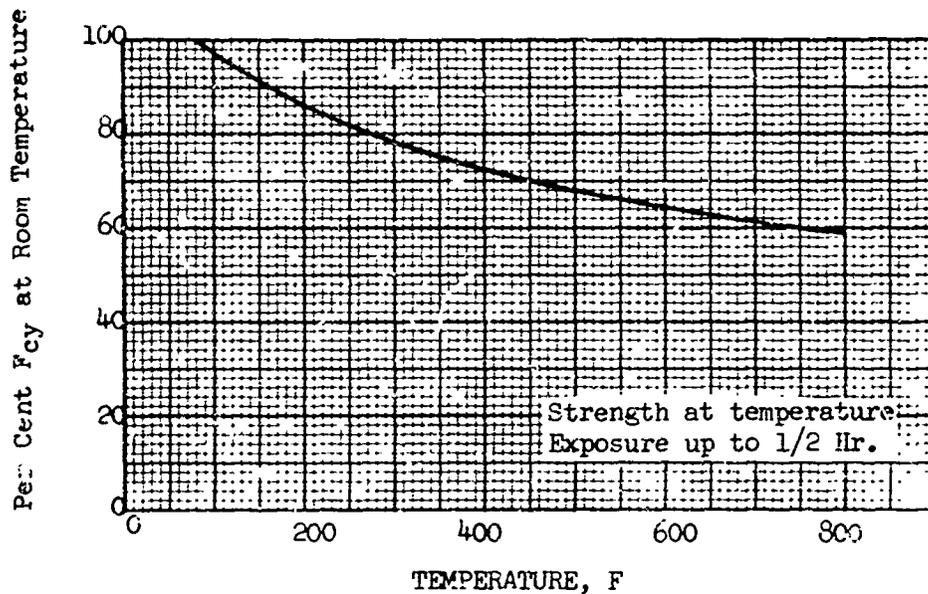


Figure 8.1.5 Effect of temperature on the compressive yield strength ( $F_{cy}$ ) of annealed Ti-4Al-3Mo-1V alloy sheet.

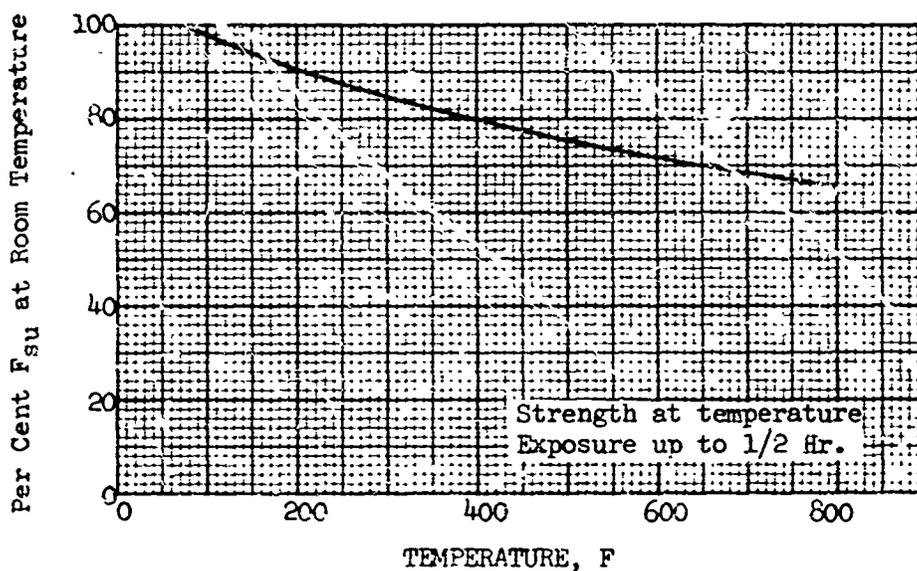


Figure 8.1.6 Effect of temperature on ultimate shear strength ( $F_{su}$ ) of annealed Ti-4Al-3Mo-1V alloy sheet.



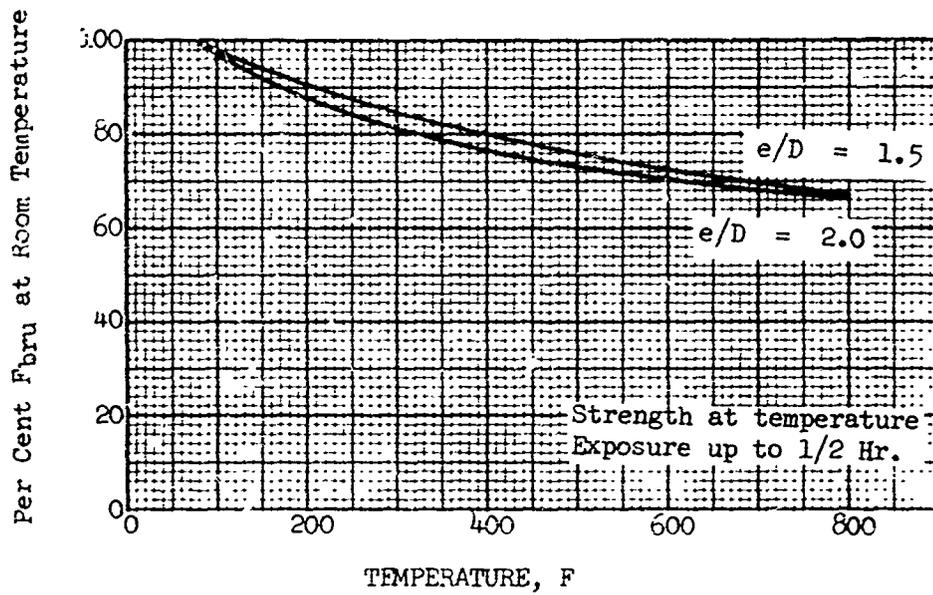


Figure 8.1.7 Effect of Temperature on ultimate bearing strength ( $F_{bru}$ ) of annealed Ti-4Al-3Mo-1V alloy sheet.

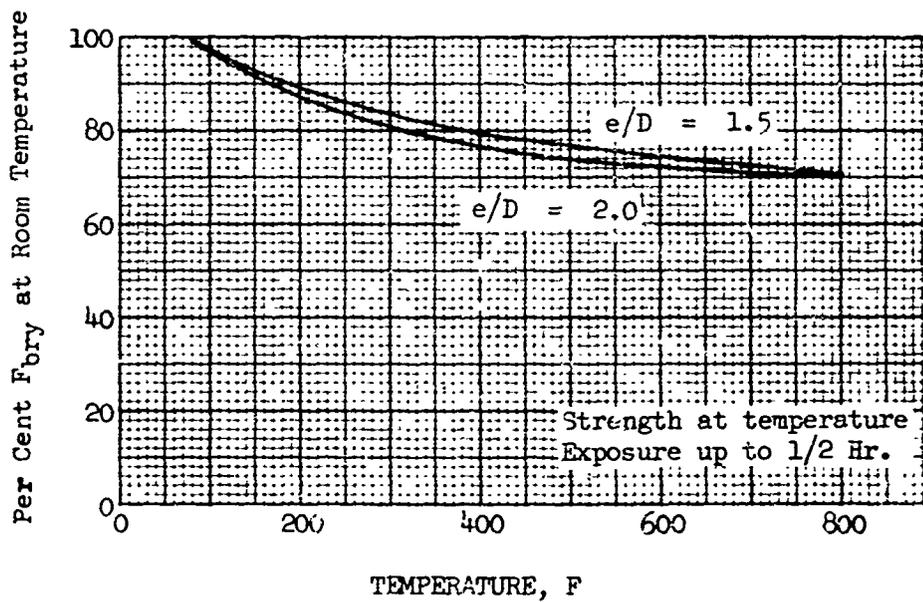


Figure 8.1.8 Effect of Temperature on bearing yield strength ( $F_{bry}$ ) of annealed Ti-4Al-3Mo-1V alloy sheet.

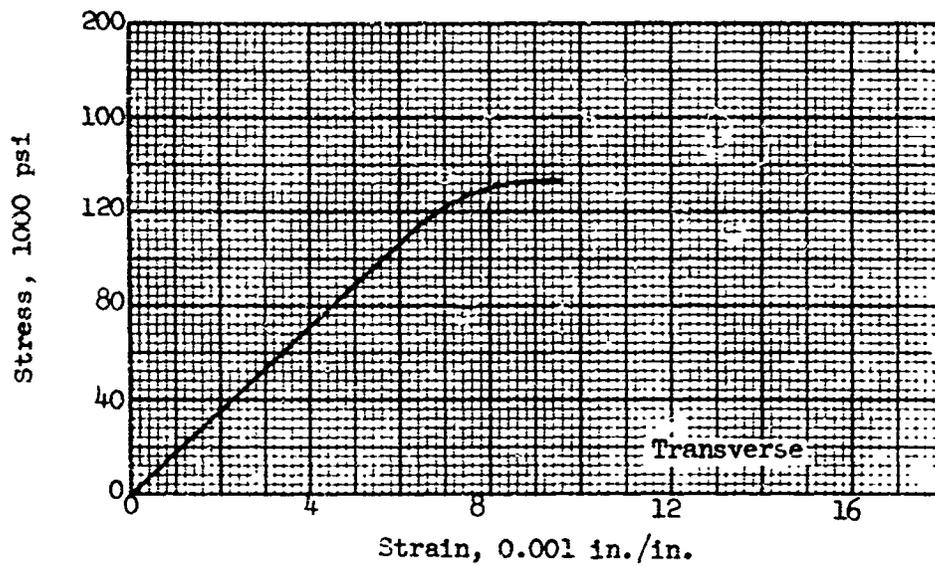


Figure 8.1.9 Typical tensile stress-strain curve for annealed Ti-4Al-3Mo-1V alloy sheet at room temperature.

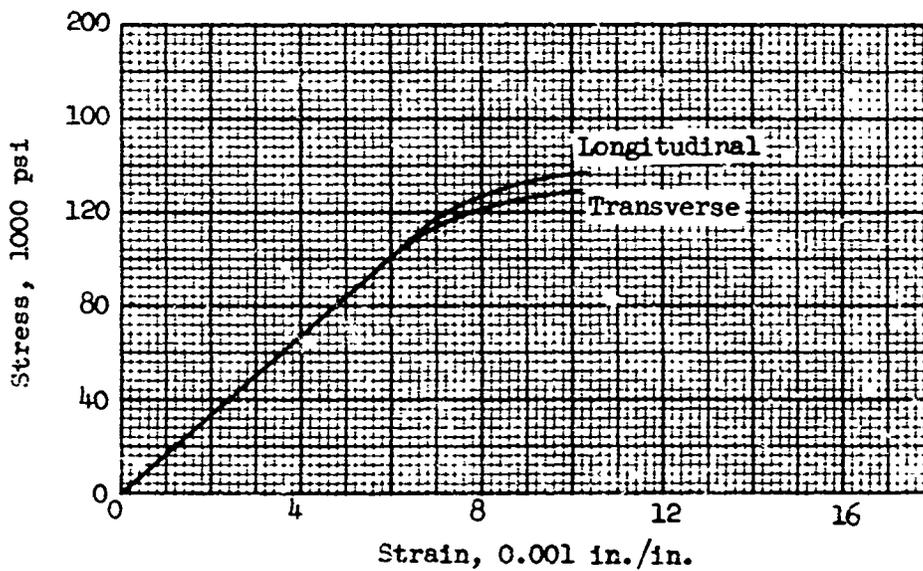


Figure 8.1.10 Typical compressive stress-strain curves for annealed Ti-4Al-3Mo-1V alloy sheet at room temperature.

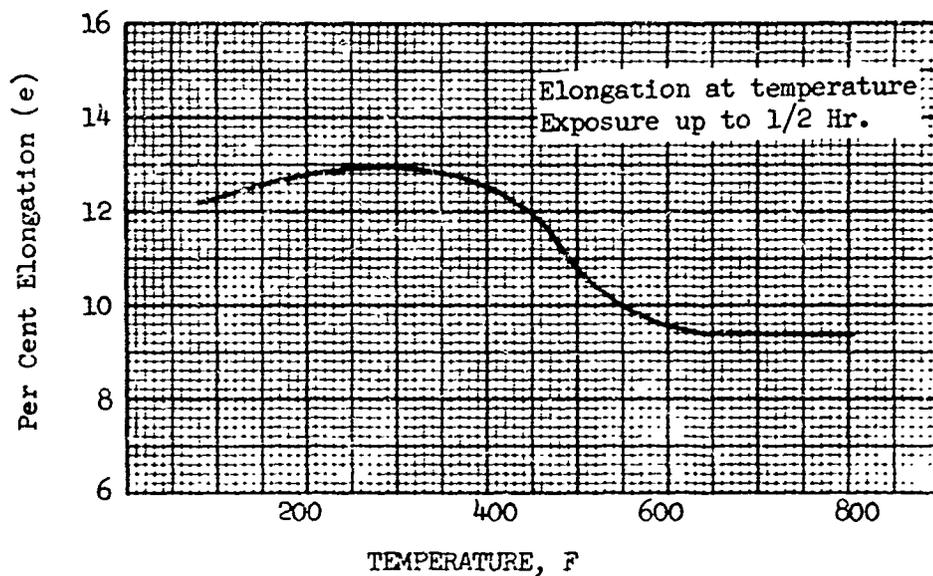


Figure 8.1.11 Effect of temperature on the elongation (e) of annealed Ti-4Al-3Mo-1V alloy sheet.

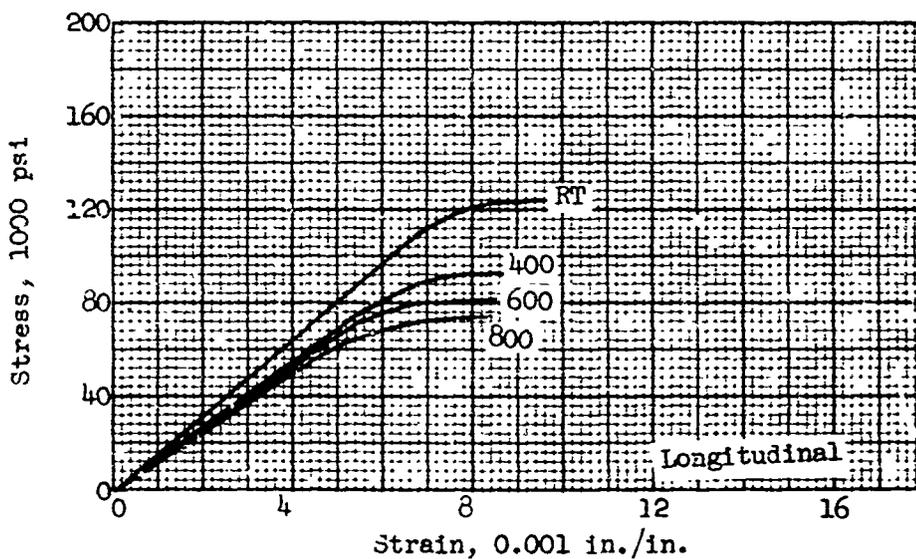


Figure 8.1.12 Typical tensile stress-strain curves for annealed Ti-4Al-3Mo-1V alloy sheet at room and elevated temperatures.

Table VIII-2

8.2 Design Mechanical and Physical Properties of T1 13V-11Cr-3Al

Alloy	MIL-T-9046 Type IV Comp. A			
	Sheet and Strip			
	Annealed			
	≤ .110			
Thickness or diameter, in.	Tentative			
Basis	A	B	A	B
Mechanical properties:				
F <sub>tu</sub> , ksi				
L	132	134		
LT	136	139		
F <sub>ty</sub> , ksi				
L	126	129		
LT	131	134		
F <sub>cy</sub> , ksi				
L			119	122
LT			123	126
F <sub>su</sub> , ksi			90	92
F <sub>bru</sub> , ksi				
(e/D = 1.5)			207	212
(e/D = 2.0)			286	292
F <sub>by</sub> , ksi:				
(e/D = 1.5)			156	160
(e/D = 2.0)			174	178
e, per cent:				
In 2 in. L	11			
LT	7			
E, 10 <sup>6</sup> psi	14.6			
E <sub>c</sub> , 10 <sup>6</sup> psi	14.6			
G, 10 <sup>6</sup> psi	14.6			
Physical properties:				
, lb/in. <sup>3</sup>				
C, Btu/(lb)(F)				
K, Btu/ (hr)(ft <sup>2</sup> )(F)/ft				
, 10 <sup>-6</sup> in./in./F				

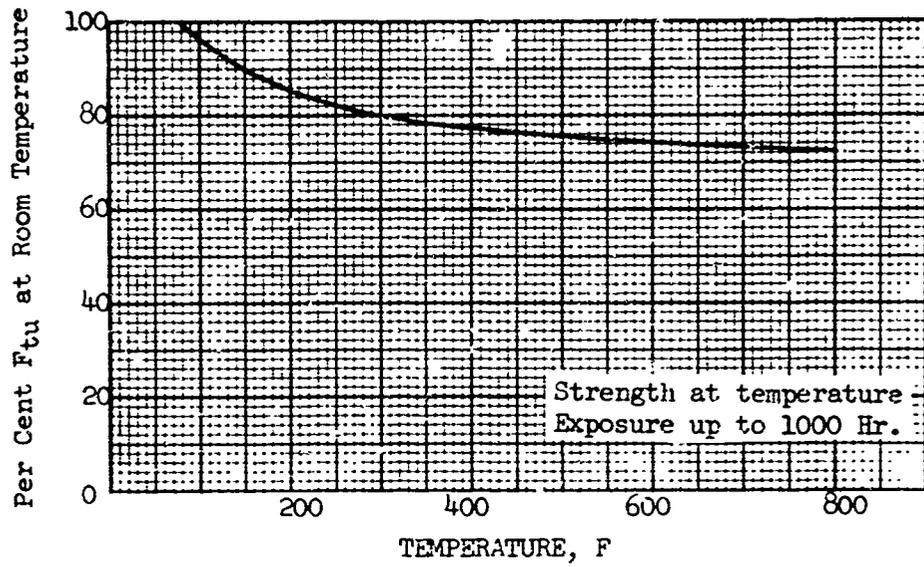


Figure 8.2.1 Effect of temperature on the ultimate tensile strength ( $F_{tu}$ ) of annealed Ti-13V-11Cr-3Al alloy sheet.

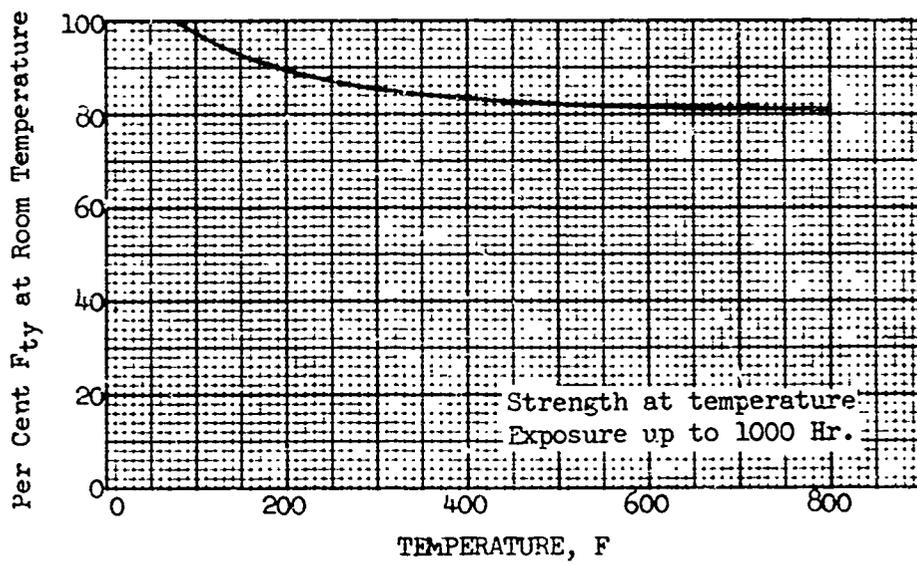


Figure 8.2.2 Effect of temperature on the tensile yield strength ( $F_{ty}$ ) of annealed Ti-13V-11Cr-3Al alloy sheet.

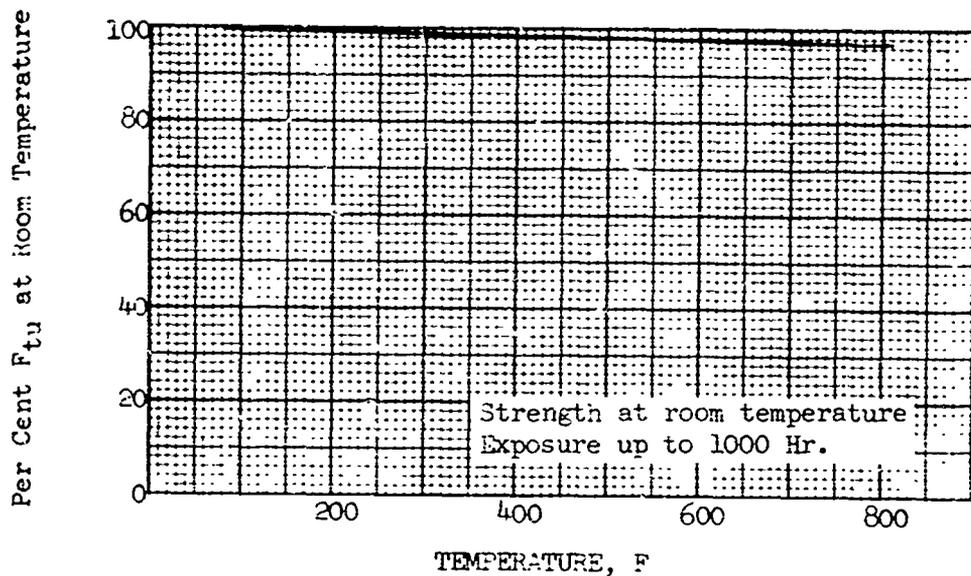


Figure 8.2.3 Effect of exposure at elevated temperature on the room-temperature ultimate tensile strength ( $F_{tu}$ ) of annealed Ti-13V-11Cr-3Al alloy sheet.

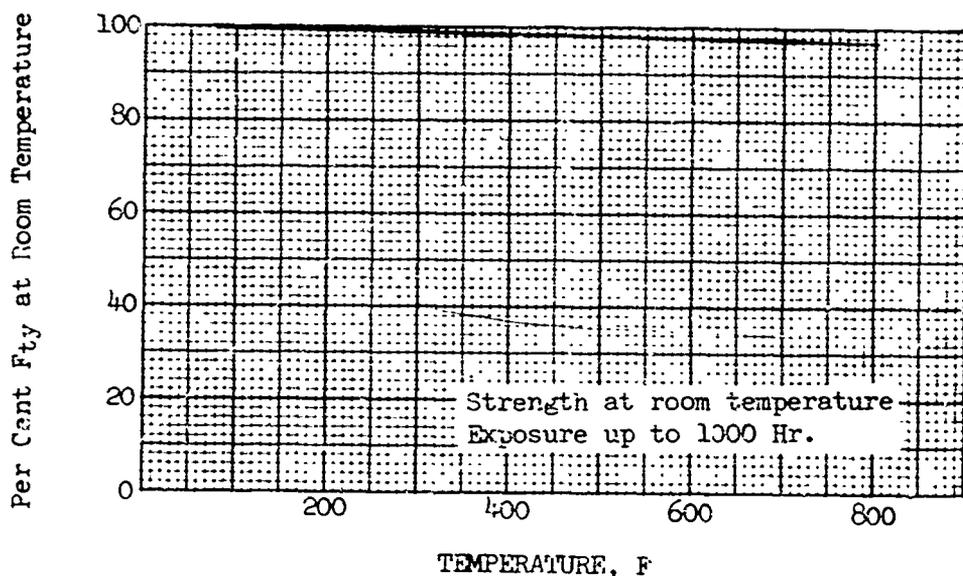


Figure 8.2.4 Effect of exposure at elevated temperature on the tensile yield strength ( $F_{ty}$ ) of annealed Ti-13V-11Cr-3Al alloy sheet.

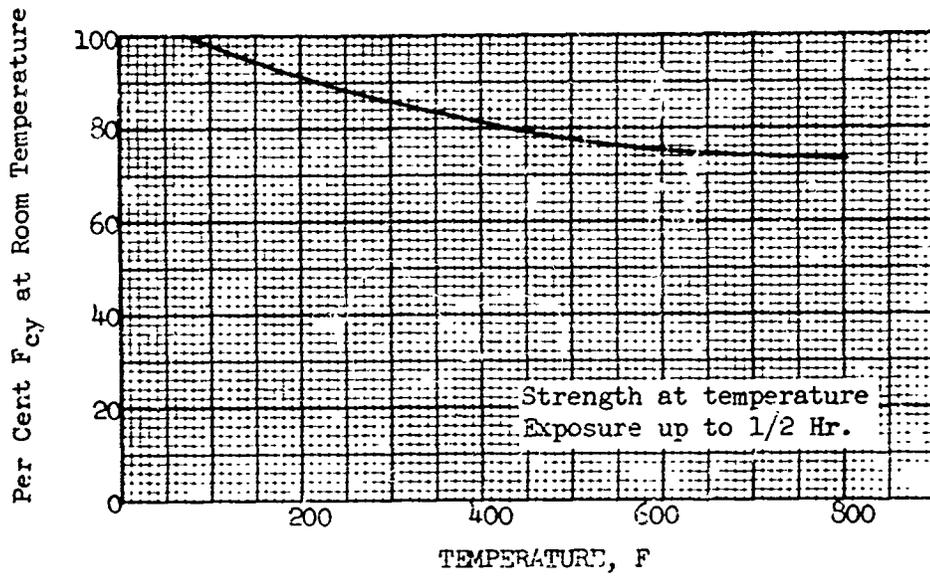


Figure 8.2.5 Effect of temperature on the compressive yield strength ( $F_{cy}$ ) of annealed Ti-13V-11Cr-3Al alloy sheet.

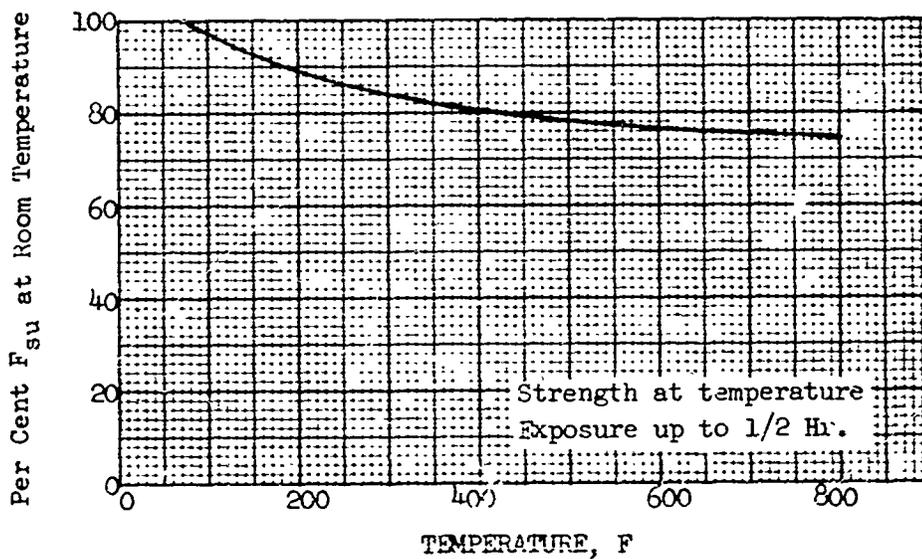


Figure 8.2.6 Effect of temperature on the ultimate shear strength ( $F_{su}$ ) of annealed Ti-13V-11Cr-3Al alloy sheet.

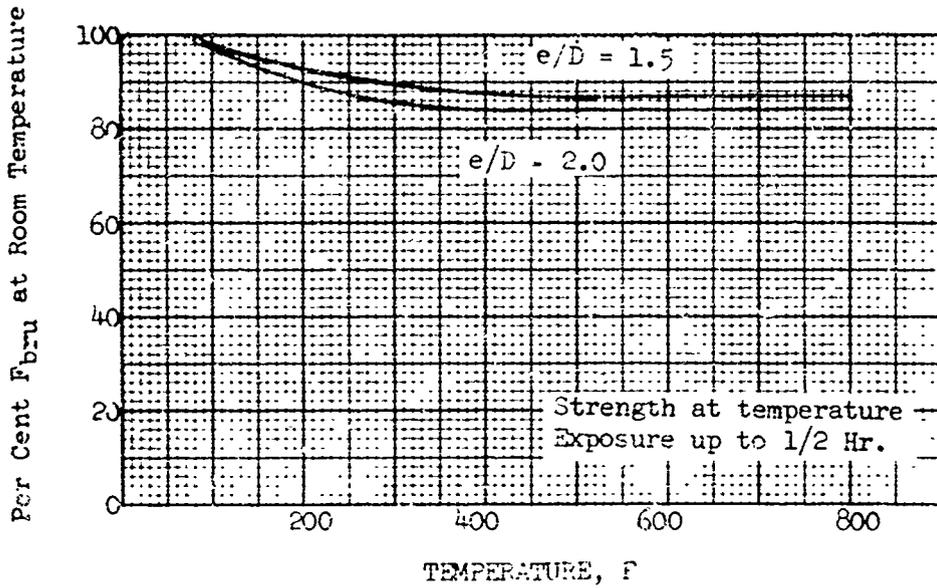


Figure 8.2.7 effect of temperature on the ultimate bearing strength ( $F_{bru}$ ) of annealed Ti-13V-11Cr-3Al alloy sheet

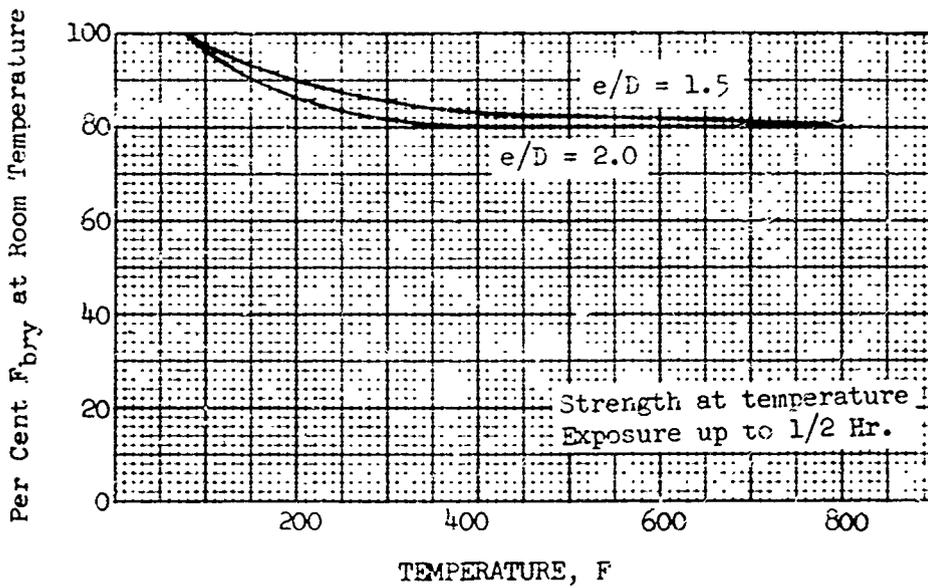


Figure 8.2.8 Effect of temperature on the bearing yield strength ( $F_{bry}$ ) of annealed Ti-13V-11Cr-3Al alloy sheet.



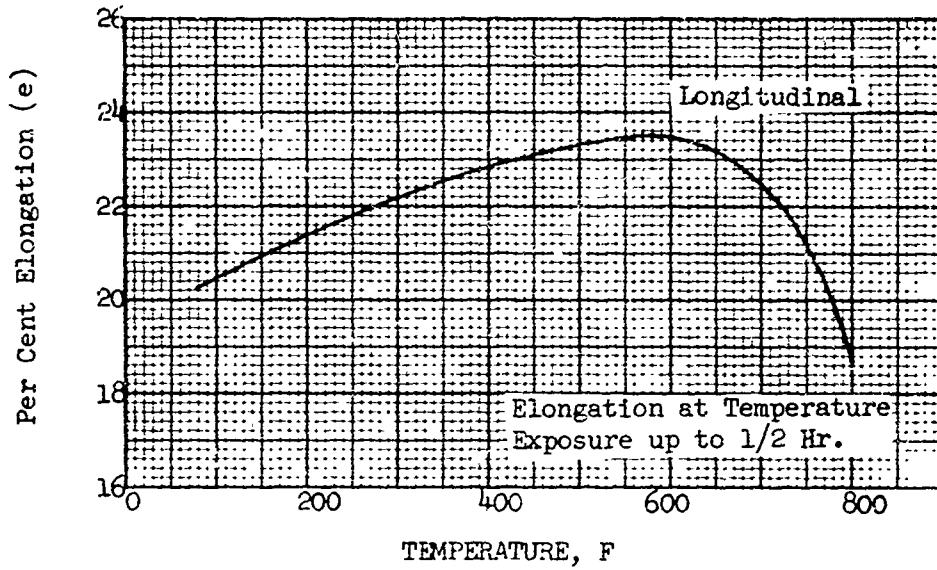


Figure 8.2.9 Effect of temperature on the elongation (e) of annealed Ti-13V-11Cr-3Al alloy sheet.

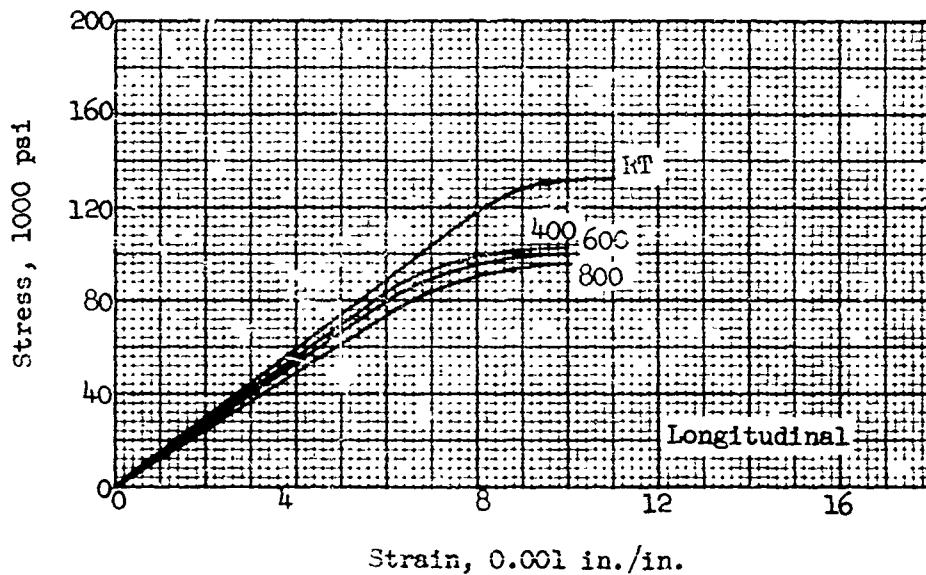


Figure 8.2.10 Typical tensile stress-strain curves for annealed Ti-13V-11Cr-3Al alloy sheet at room and elevated temperatures.

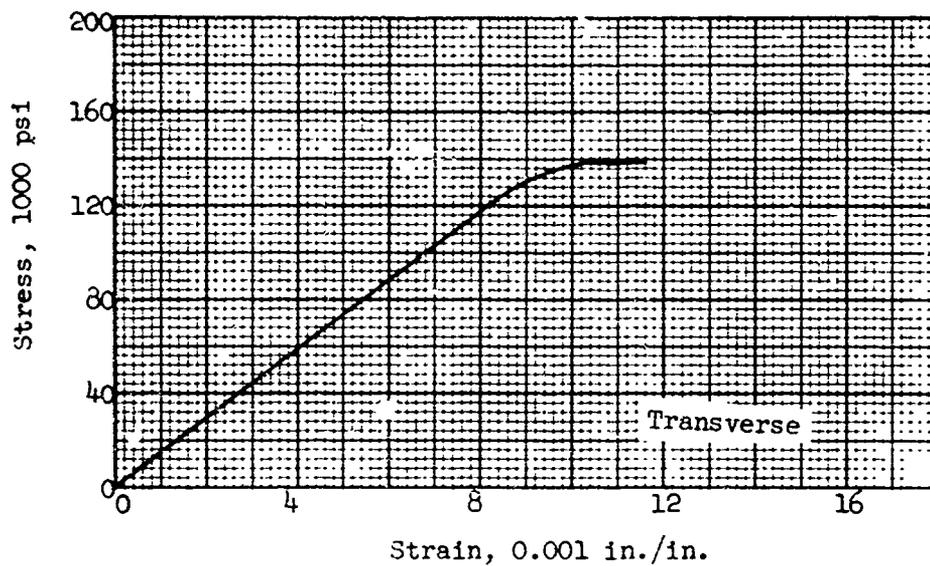


Figure 8.2.11 Typical tensile stress-strain curve for annealed Ti-13V-11Cr-3Al alloy sheet at room temperature.

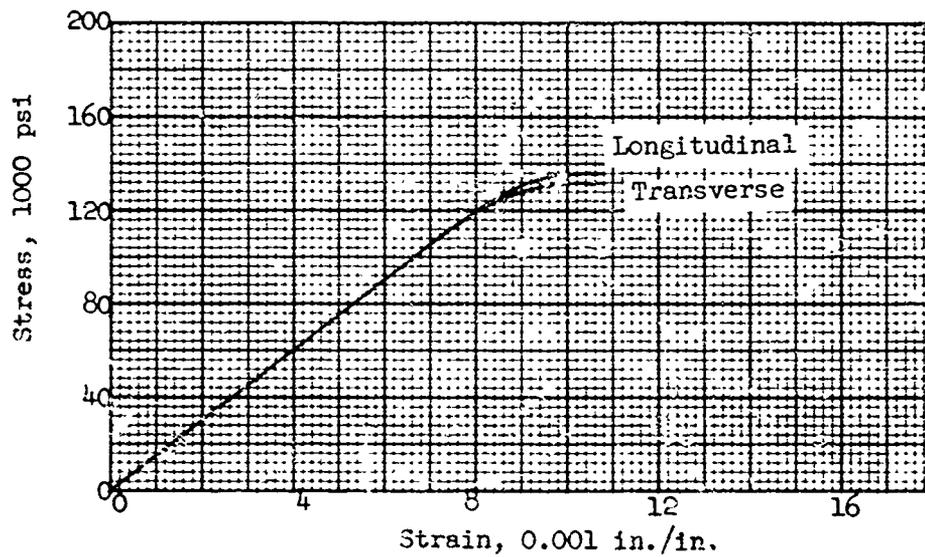


Figure 8.2.12 Typical compressive stress-strain curve for annealed Ti-13V-11Cr-3Al alloy sheet at room temperature.

Table VIII-3

## 8.3 Design Mechanical and Physical Properties of T1-6Al-4V

Alloy	MIL-T-9046 Type III Comp. C	
Form	Plate	
Condition	Solution Treated and Aged	
Thickness or diameter, in.	.188 to .750	.751 to 1.000
Basis	S	S
<b>Mechanical properties:</b>		
$F_{tu}$ , ksi	160	150
L		
LT		
$F_{ty}$ , ksi	145	140
L		
LT		
$F_{cy}$ , ksi		
L		
LT		
$F_{su}$ , ksi		
$F_{bru}$ , ksi		
( $e/D = 1.5$ )		
( $e/D = 2.0$ )		
$F_{by}$ , ksi:		
( $e/D = 1.5$ )		
( $e/D = 2.0$ )		
$e$ , per cent:		
In 2 in.		
In 4 D	8	6
$E$ , $10^6$ psi	16.2	
$E_c$ , $10^6$ psi		
$G$ , $10^6$ psi		
<b>Physical properties:</b>		
, lb/in. <sup>3</sup>		
$C$ , Btu/(lb)(F)		
$K$ , Btu/(hr)(ft <sup>2</sup> )(F)/ft		
, $10^{-6}$ in./in./F		

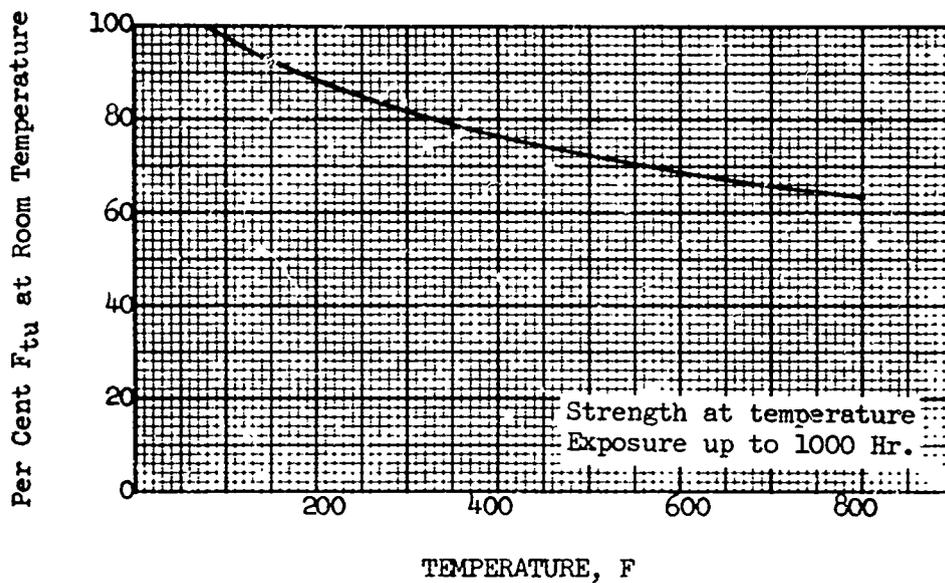


Figure 8.3.1 Effect of temperature on the ultimate tensile strength ( $F_{tu}$ ) of solution treated and aged Ti-6Al-4V alloy plate.

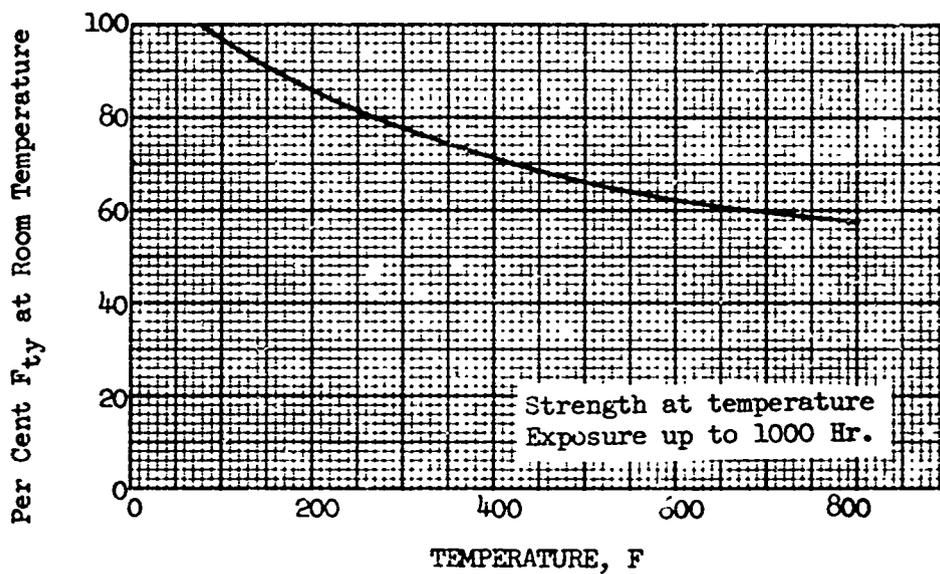


Figure 8.3.2 Effect of temperature on the tensile yield strength ( $F_{ty}$ ) of solution treated and aged Ti-6Al-4V alloy plate.

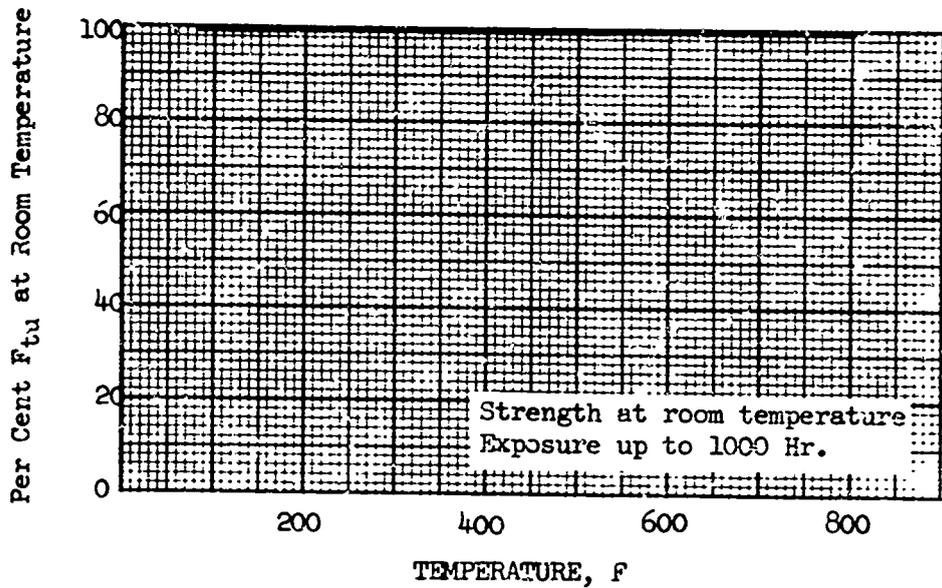


Figure 8.3.3 Effect of exposure at elevated temperature on the room temperature ultimate tensile strength ( $F_{tu}$ ) of solution treated and aged Ti-6Al-4V alloy plate.

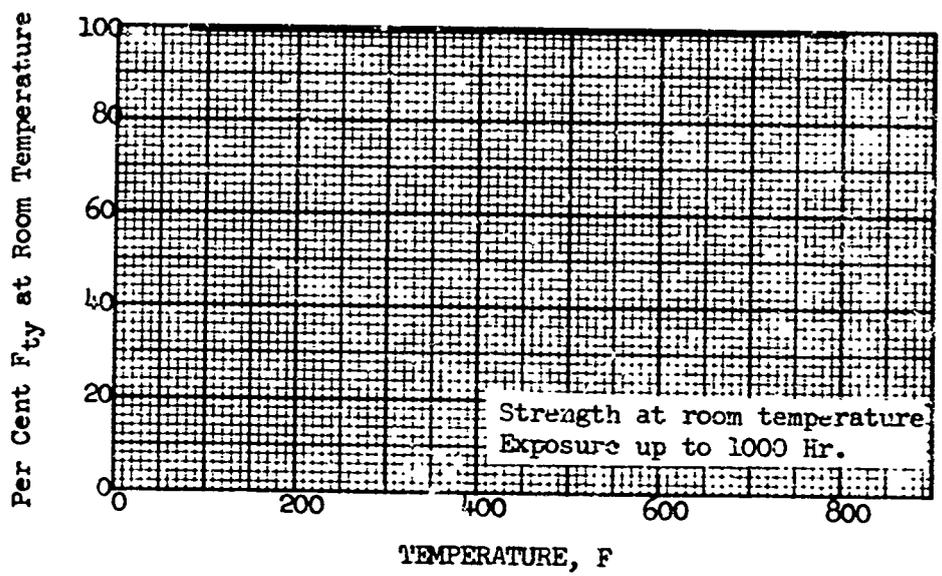


Figure 8.3.4 Effect of exposure at elevated temperature on the room temperature tensile yield strength ( $F_{ty}$ ) of solution treated and aged Ti-6Al-4V alloy plate.

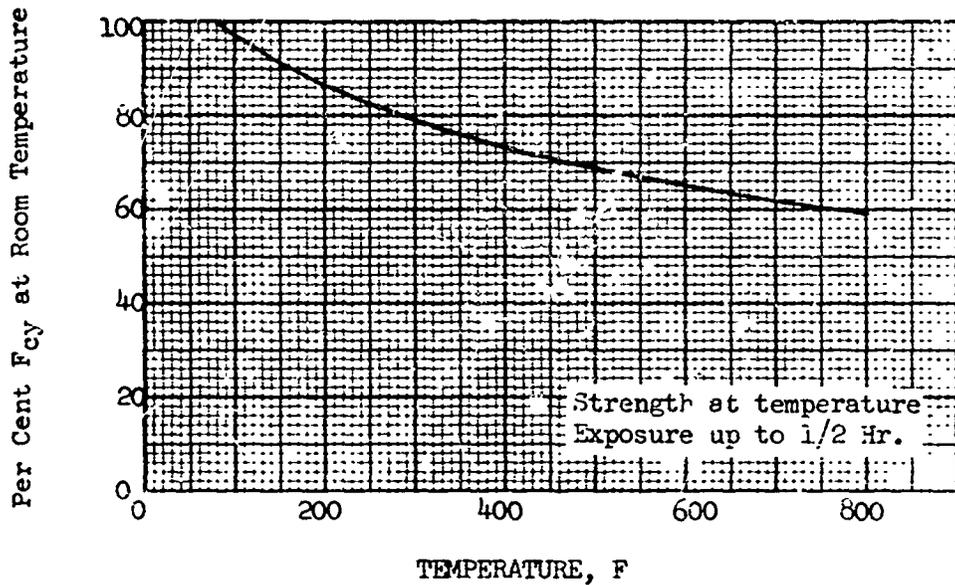


Figure 8.3.5 Effect of temperature on the compressive yield strength ( $F_{cy}$ ) of solution treated and aged Ti-6Al-4V alloy plate.

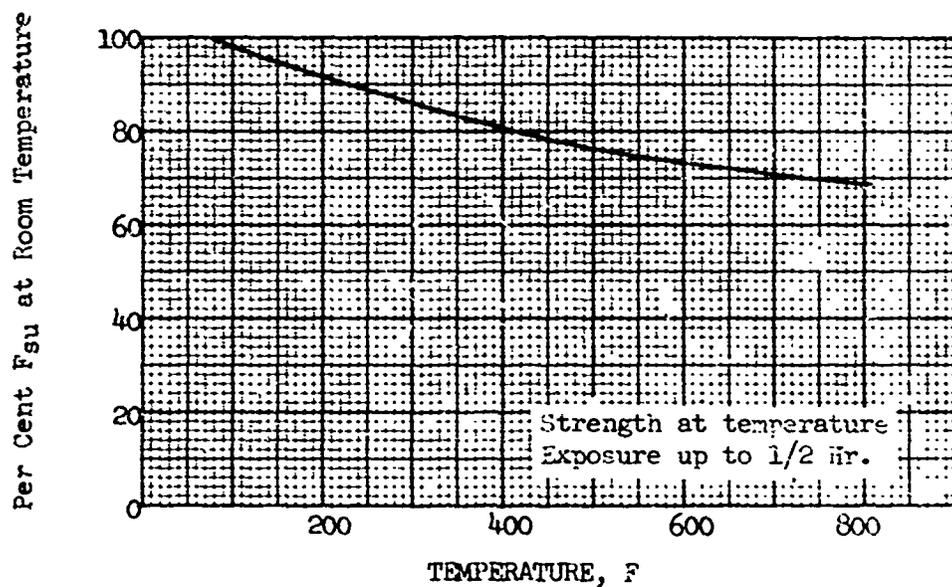


Figure 8.3.6 Effect of temperature on the ultimate shear strength ( $F_{su}$ ) of solution treated and aged Ti-6Al-4V alloy plate.

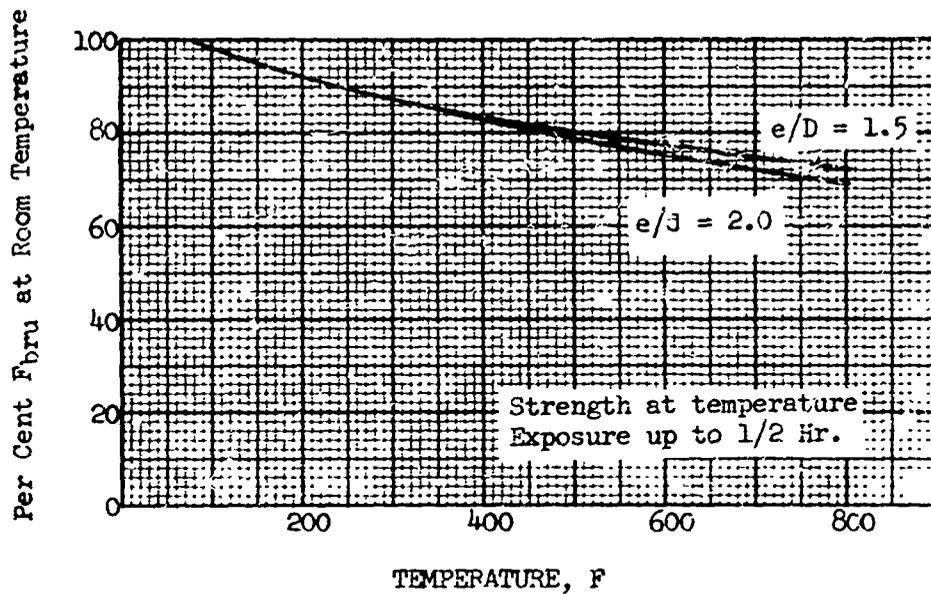


Figure 8.3.7 Effect of temperature on the ultimate bearing strength ( $F_{bru}$ ) of solution treated and aged Ti-6Al-4V alloy plate.

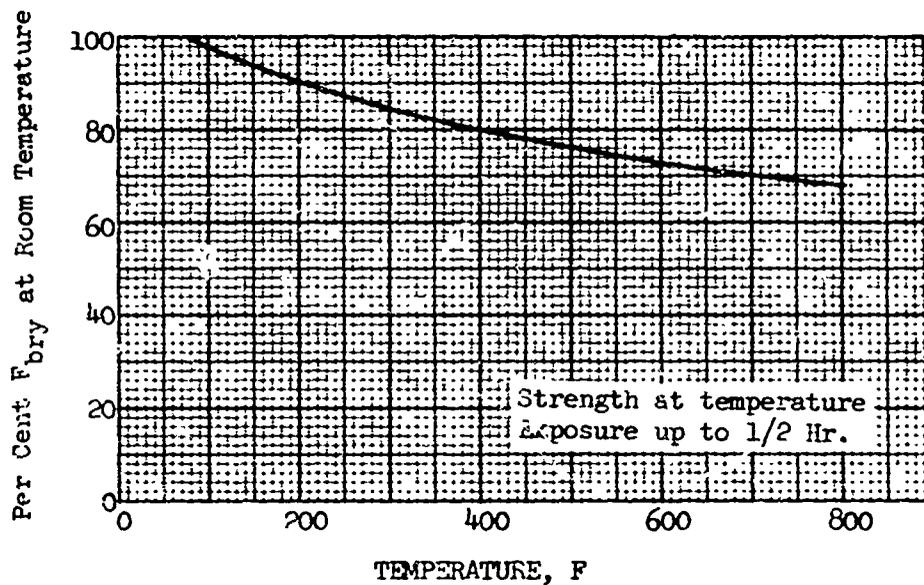


Figure 8.3.8 Effect of temperature on the bearing yield strength ( $F_{bry}$ ) of solution treated and aged Ti-6Al-4V alloy plate.

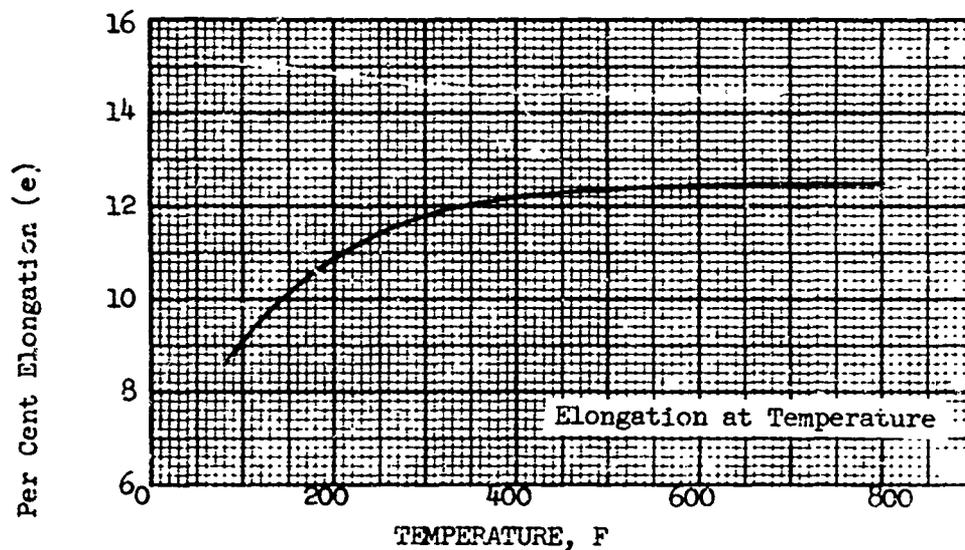


Figure 8.3.9 Effect of temperature on the elongation (e) of solution treated and aged Ti-6Al-4V alloy plate

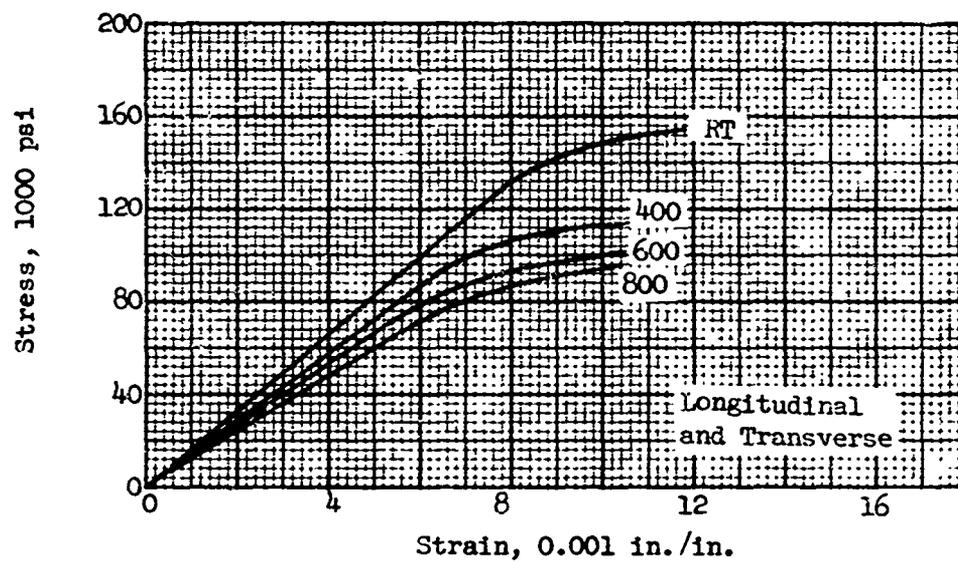


Figure 8.3.10 Typical tensile stress-strain curves for solution treated and aged Ti-6Al-4V alloy plate at room and elevated temperatures



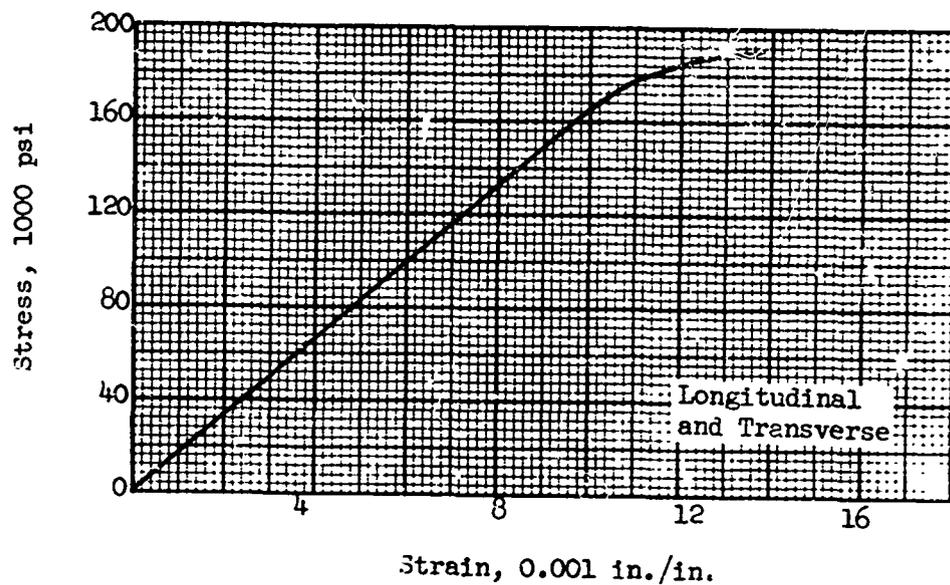


Figure 8.3.11 Typical compressive stress-strain curve for solution treated and aged Ti-6Al-4V alloy plate at room temperature.

Table VIII-4

## 8.4 Design Mechanical and Physical Properties of Ti-6Al-6V-2Sn

Alloy	MIL-T-9046 Type III Comp. E		
	Plate		
	Annealed		
	.250 to .300	.500 to .630	1.50
Form			
Condition			
Thickness or diameter, in.			
Basis	S	S	S
Mechanical properties:			
$F_{tu}$ , ksi	150	150	150
L			
LT			
$F_{ty}$ , ksi	140	140	140
L			
LT			
$F_{cy}$ , ksi	141	147	142
L			
LT			
$F_{su}$ , ksi	90	92	95
$F_{bru}$ , ksi			
( $e/D = 1.5$ )	234	251	249
( $e/D = 2.0$ )	275	301	310
$F_{by}$ , ksi:			
( $e/D = 1.5$ )	195	201	198
( $e/D = 2.0$ )	212	223	237
e, per cent:			
In 2 in.	10		
In 4 D		10	10
E, $10^6$ psi	15.6		
$E_c$ , $10^6$ psi			
G, $10^6$ psi			
Physical properties:			
, lb/in. <sup>3</sup>			
C, Btu/(lb)(F)			
K, Btu/(hr)(ft <sup>2</sup> )(F)/ft			
, $10^{-6}$ in./in./F			

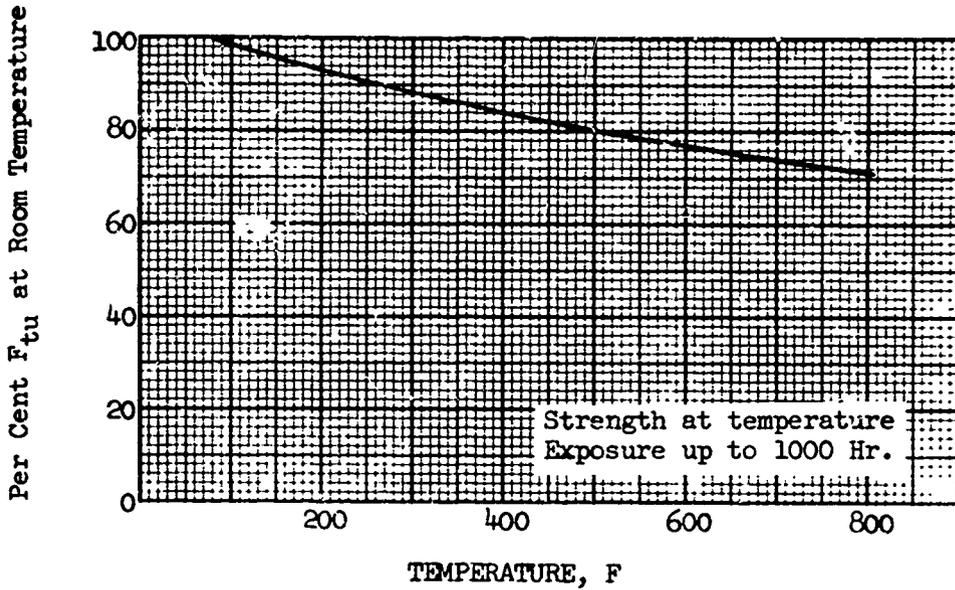


Figure 8.4.1 Effect of temperature on the ultimate tensile strength ( $F_{tu}$ ) of annealed Ti-6Al-6V-2Sn alloy plate.

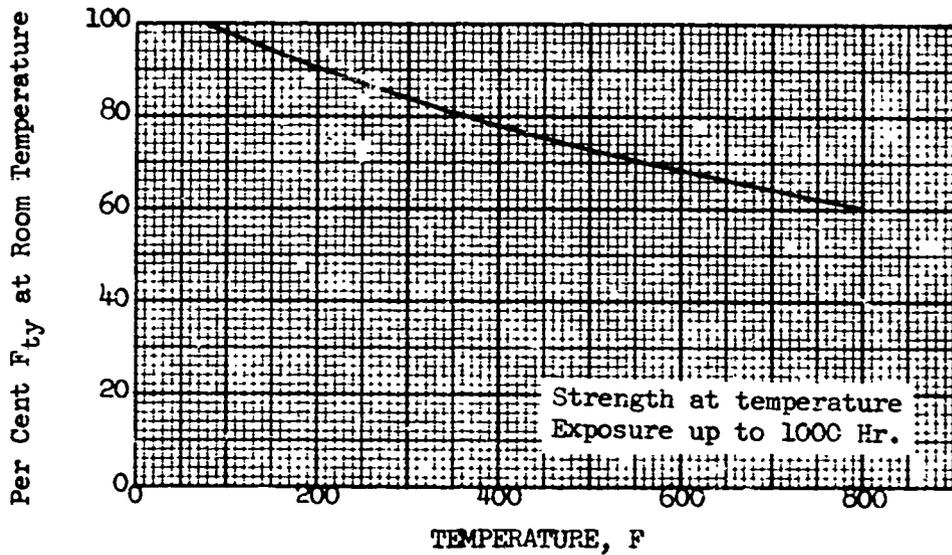


Figure 8.4.2 Effect of temperature on the tensile yield strength ( $F_{ty}$ ) of annealed Ti-6Al-6V-2Sn alloy plate.

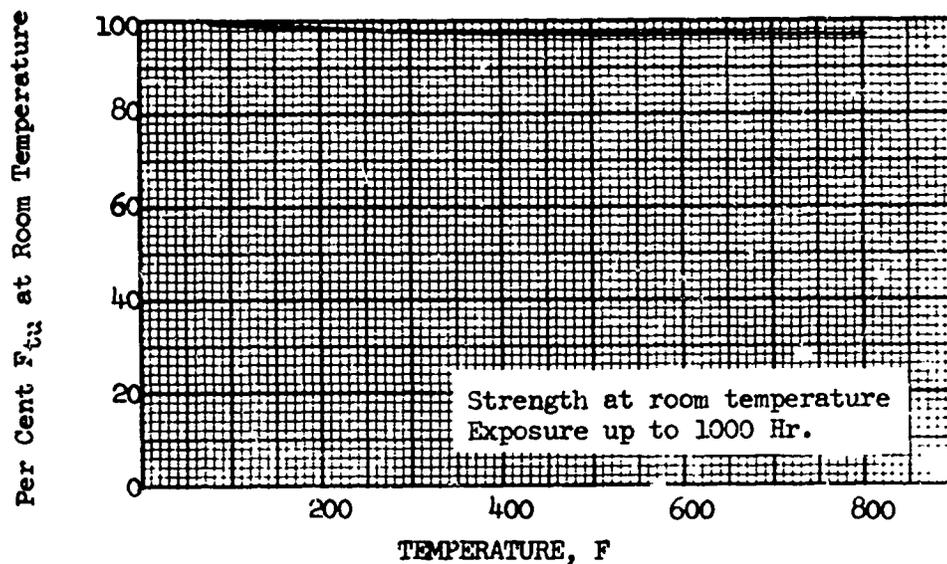


Figure 8.4.3 Effect of exposure at elevated temperature on the room-temperature ultimate tensile strength ( $F_{tu}$ ) of annealed Ti-6Al-6V-2Sn alloy plate.

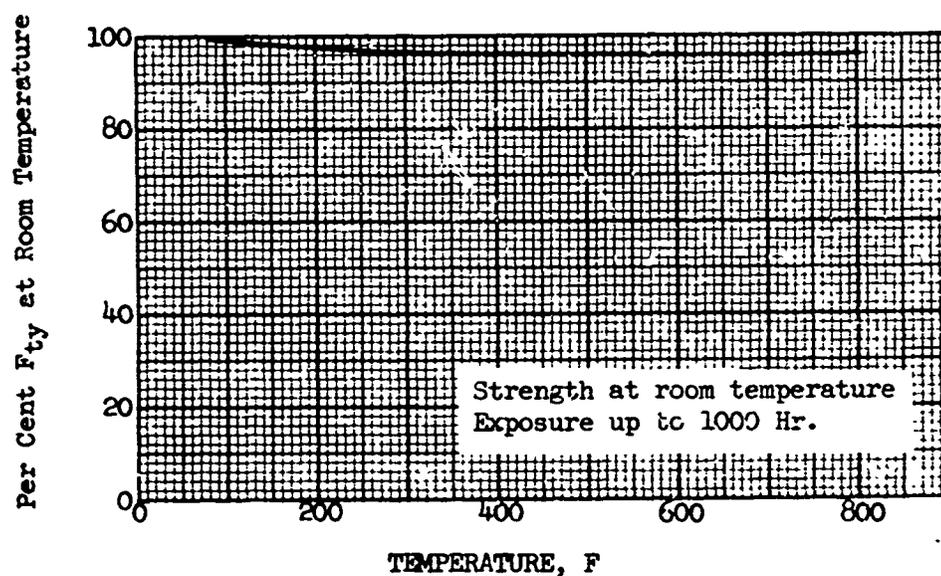


Figure 8.4.4 Effect of exposure at elevated temperature on the room temperature tensile yield strength ( $F_{ty}$ ) of annealed Ti-6Al-6V-2Sn alloy plate.

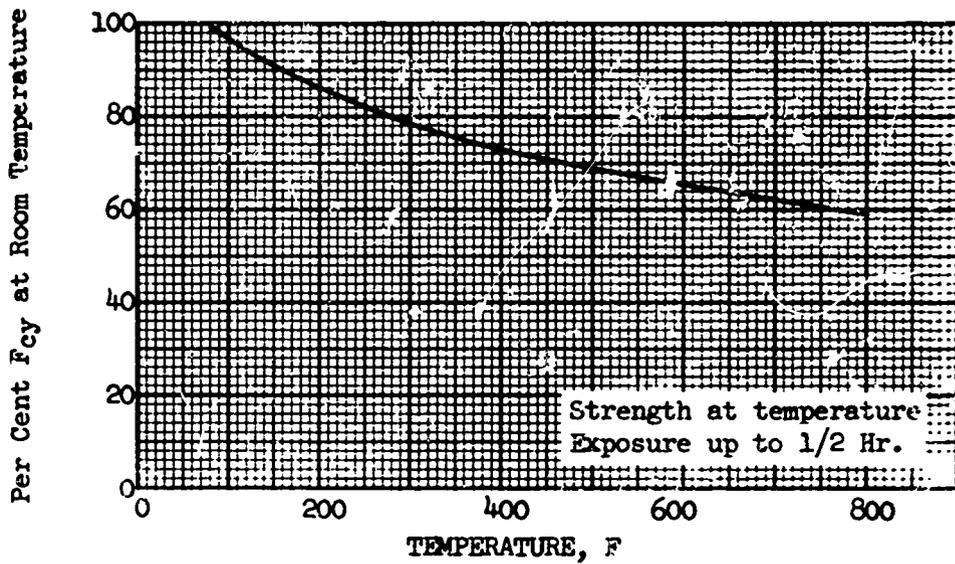


Figure 8.4.5 Effect of temperature on the compressive yield strength ( $F_{cy}$ ) of annealed Ti-6Al-6V-2Sn alloy plate.

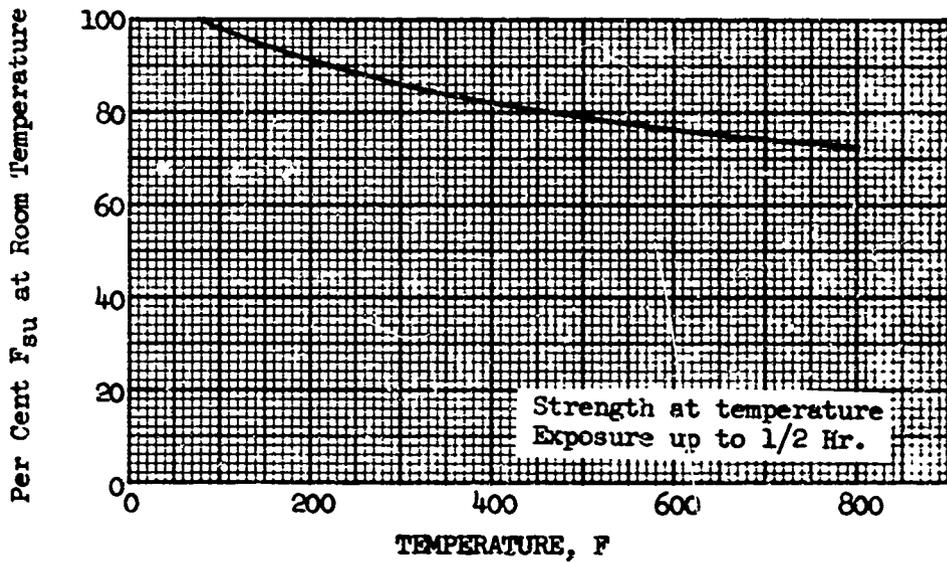


Figure 8.4.6 Effect of temperature on the ultimate shear strength ( $F_{su}$ ) of annealed Ti-6Al-6V-2Sn alloy plate.

Per Cent  $F_{bru}$  at Room Temperature

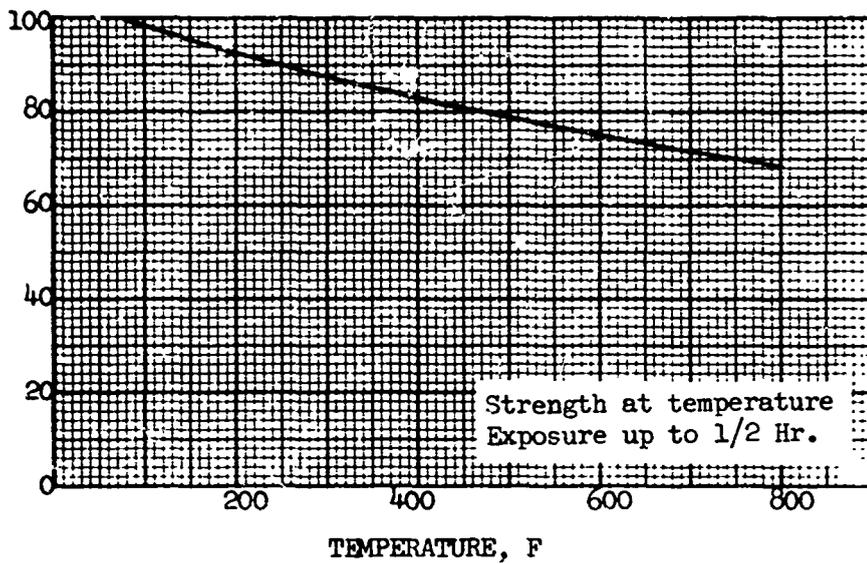


Figure 8.4.7 Effect of temperature on the ultimate bearing strength ( $F_{bru}$ ) of annealed Ti-6Al-6V-2Sn alloy plate.

Per Cent  $F_{bry}$  at Room Temperature

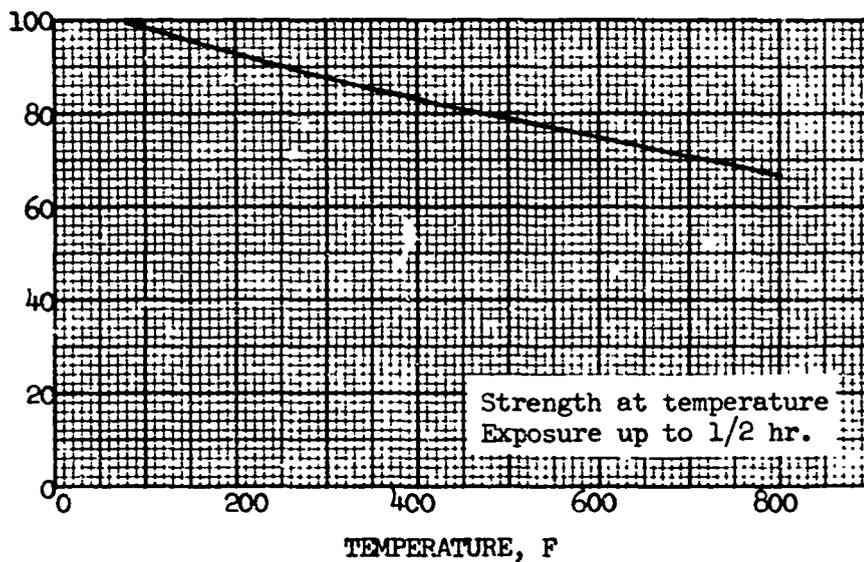


Figure 8.4.8 Effect of temperature on the bearing yield strength ( $F_{bry}$ ) of annealed Ti-6Al-6V-2Sn alloy plate.

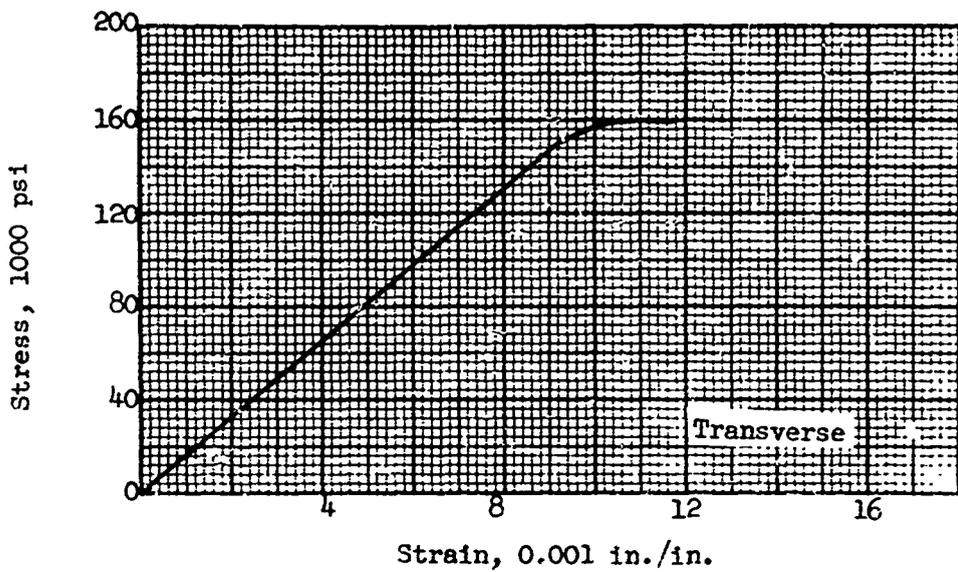


Figure 8.4.9 Typical tensile stress-strain curve for annealed Ti-6Al-6V-2Sn alloy plate at room temperature.

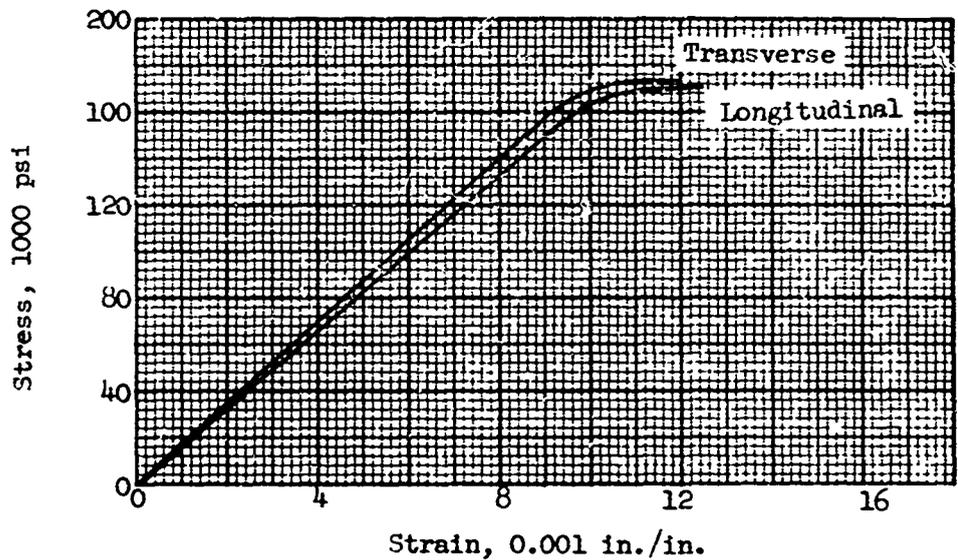


Figure 8.4.10 Typical compressive stress-strain curves for annealed Ti-6Al-6V-2Sn alloy plate at room temperature.

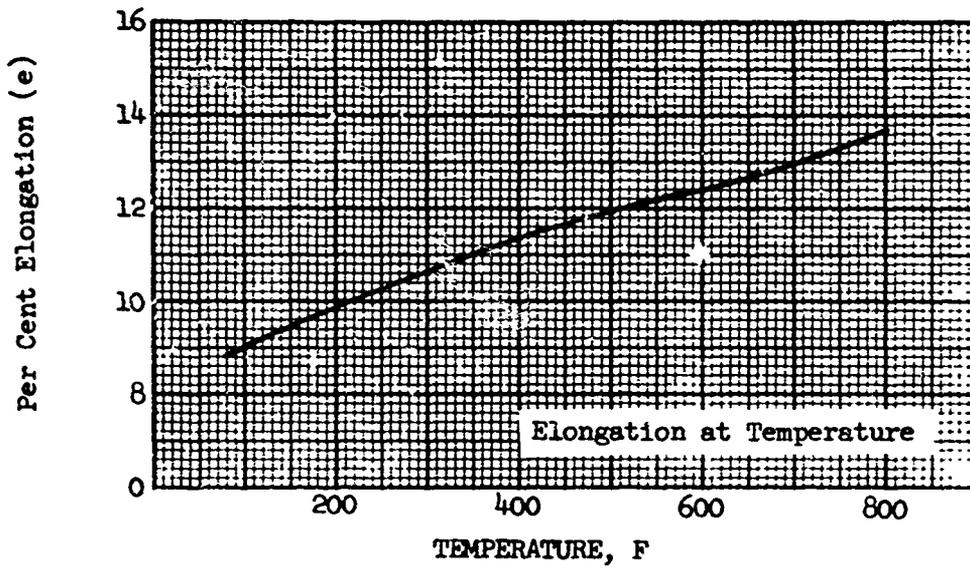


Figure 8.4.11 Effect of temperature on the elongation (e) of annealed Ti-6Al-6V-2Sn alloy plate.

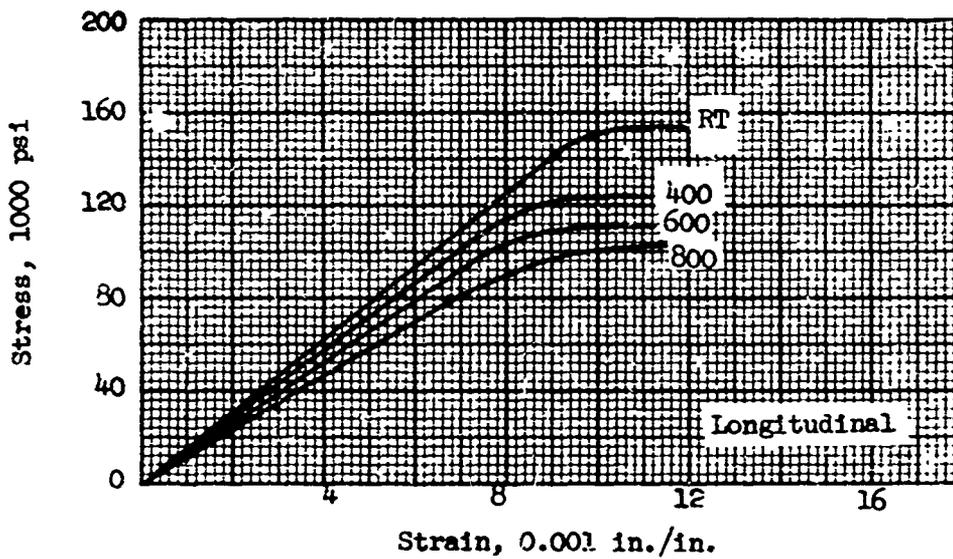


Figure 8.4.12 Typical tensile stress-strain curves for annealed Ti-6Al-6V-2Sn alloy plate at room and elevated temperatures.



8.5

## Design Mechanical and Physical Properties of Ti-6Al-6V-2Sn

Alloy	MIL-T-9046 Type III Comp. E	
	Plate	
Form	Solution Treated and Aged	
Condition	Solution Treated and Aged	
Thickness or diameter, in.	.500 to .630	1.50
Basis	S	S
<b>Mechanical properties:</b>		
F <sub>tu</sub> , ksi	170	160
L		
LT		
F <sub>ty</sub> , ksi	160	150
L		
LT		
F <sub>cy</sub> , ksi	167	156
L		
LT		
F <sub>su</sub> , ksi	98	94
F <sub>bru</sub> , ksi		
(e/D = 1.5)	260	242
(e/D = 2.0)	325	290
F <sub>bry</sub> , ksi:		
(e/D = 1.5)	232	220
(e/D = 2.0)	258	238
e, per cent:		
In 2 in.		
In 4 D	8	6
E, 10 <sup>6</sup> psi	16.1	
E <sub>c</sub> , 10 <sup>6</sup> psi		
G, 10 <sup>6</sup> psi		
<b>Physical properties:</b>		
, lb/in. <sup>3</sup>		
C, Btu/(lb)(F)		
K, Btu/ (hr)(ft <sup>2</sup> )(F)/ft		
, 10 <sup>-6</sup> in./in./F		

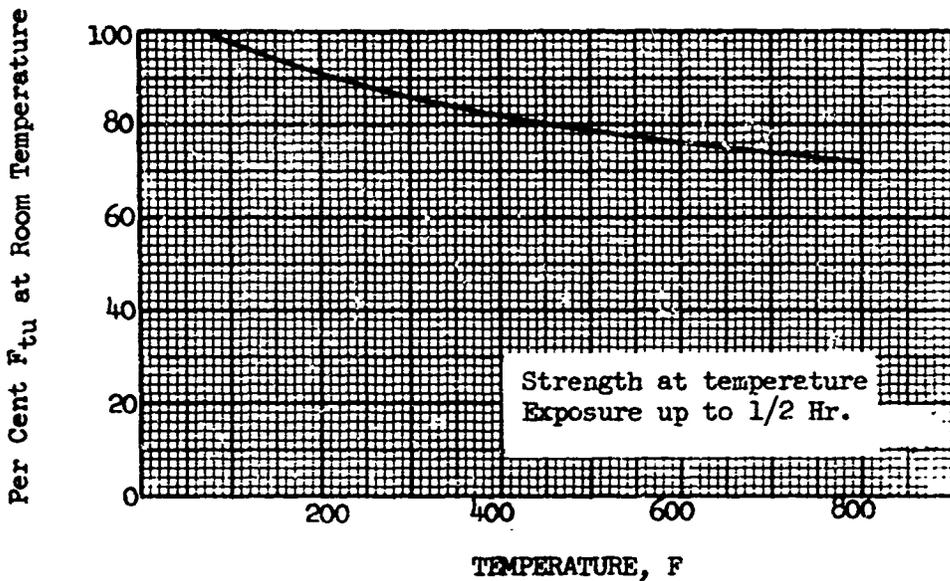


Figure 8.5.1 Effect of temperature on the ultimate tensile strength ( $F_{tu}$ ) of solution treated and aged Ti-6Al-6V-2Sn alloy plate.

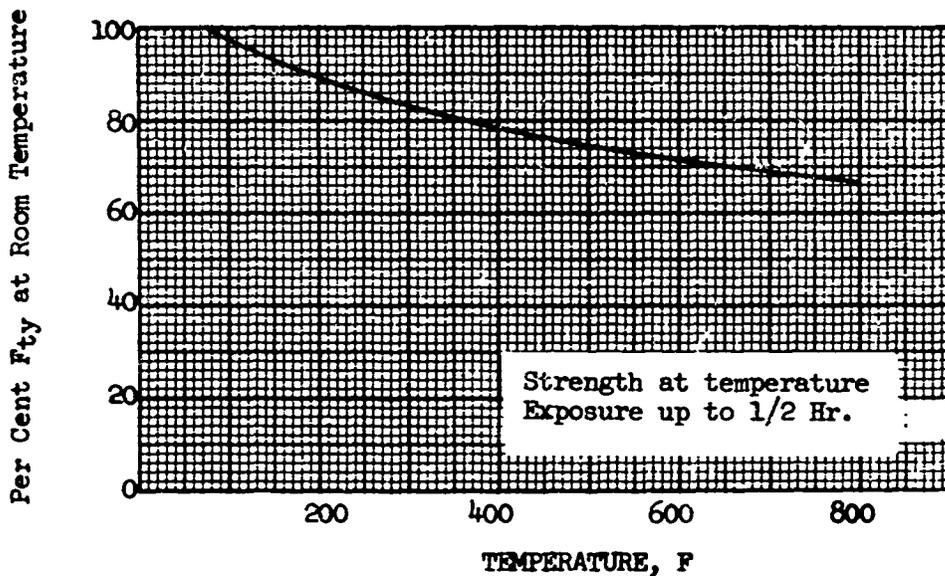


Figure 8.5.2 Effect of temperature on the tensile yield strength ( $F_{ty}$ ) of solution treated and aged Ti-6Al-6V-2Sn alloy plate.

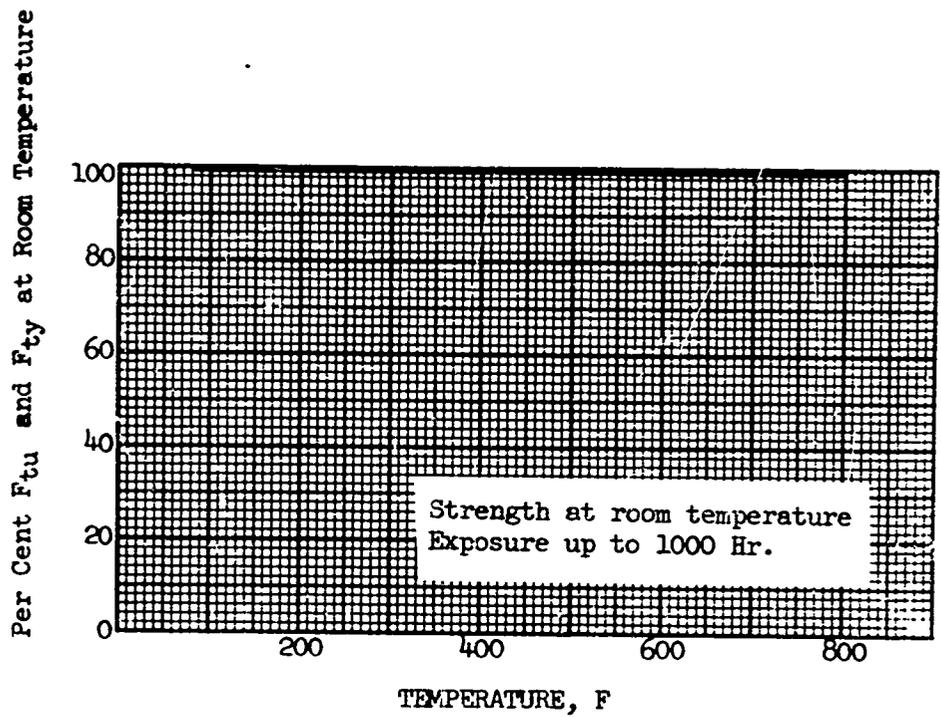


Figure 8.5.3 Effect of exposure at elevated temperature on the room temperature tensile yield and ultimate strength ( $F_{ty}$  and  $F_{tu}$ ) of solution treated and aged Ti-6Al-6V-2Sn alloy plate.

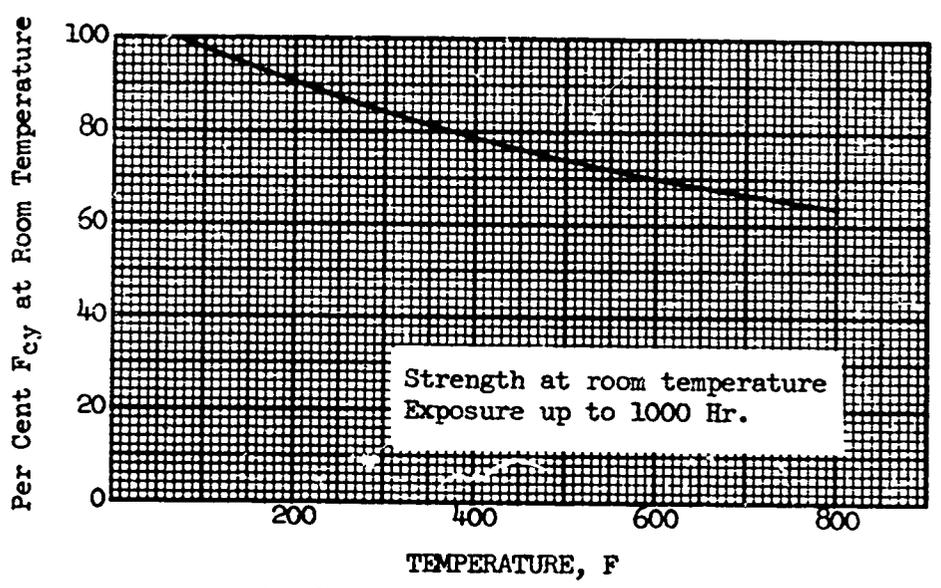


Figure 8.5.4 Effect of temperature on the compressive yield strength ( $F_{cy}$ ) of solution treated and aged Ti-6Al-6V-2Sn alloy plate.

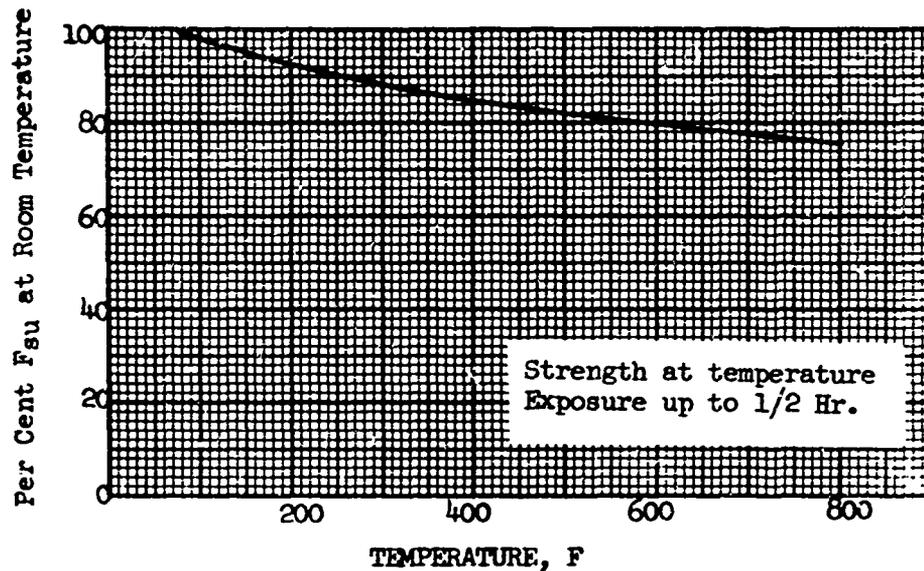


Figure 8.5.5 Effect of temperature on the ultimate shear strength ( $F_{su}$ ) of solution treated and aged Ti-6Al-6V-2Sn

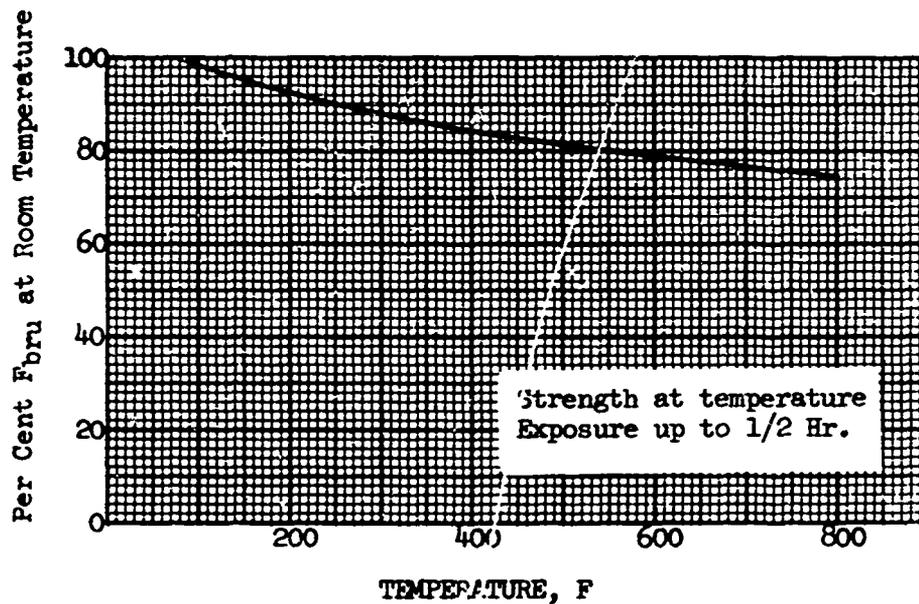


Figure 8.5.6 Effect of temperature on the ultimate bearing strength ( $F_{bru}$ ) of solution treated and aged Ti-6Al-6V-2Sn alloy plate.

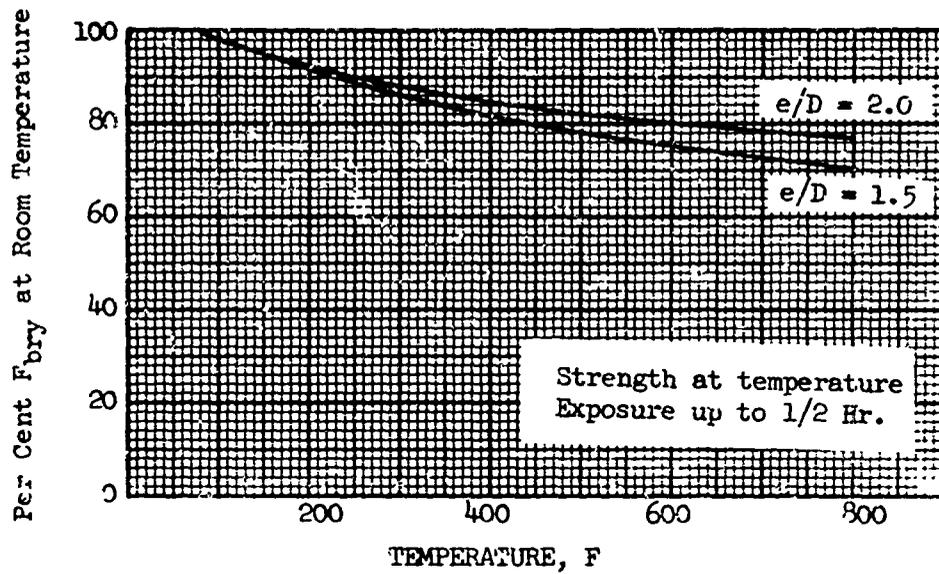


Figure 8.5.7 Effect of temperature on the bearing yield strength ( $F_{bry}$ ) of solution treated and aged Ti-6Al-6V-2Sn alloy plate.

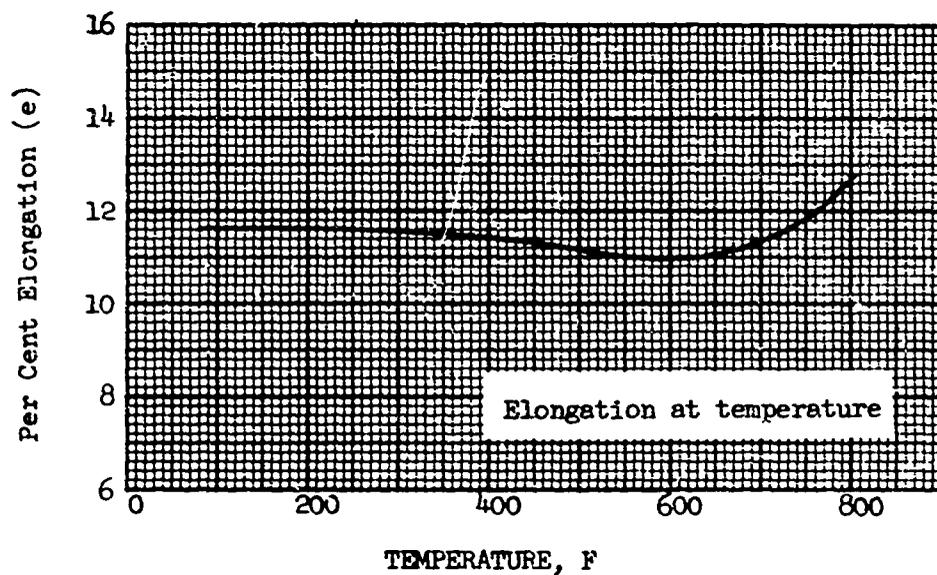


Figure 8.5.8 Effect of temperature on the elongation (e) of solution treated and aged Ti-6Al-6V-2Sn alloy plate.

SECTION IX - REFERENCES

1. AFML-TR-65-213, "Development of Standardized Test Methods to Determine Plane Strain Fracture Toughness", G. L. Hanna and E. A. Steigerwald.
2. ASTM STP 410, "Plane Strain Crack Toughness Testing of High Strength Metallic Materials", W. F. Brown Jr., and J. E. Srawley.

## APPENDIX

Contained within this Appendix are the; (1) Mechanical property working curves, and, (2) Fatigue S-N curves.

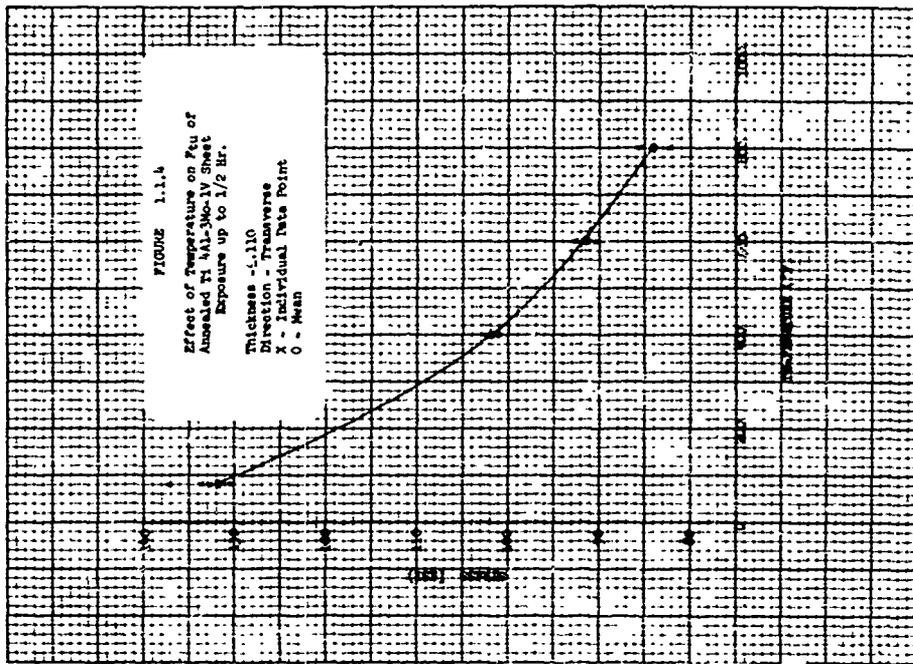
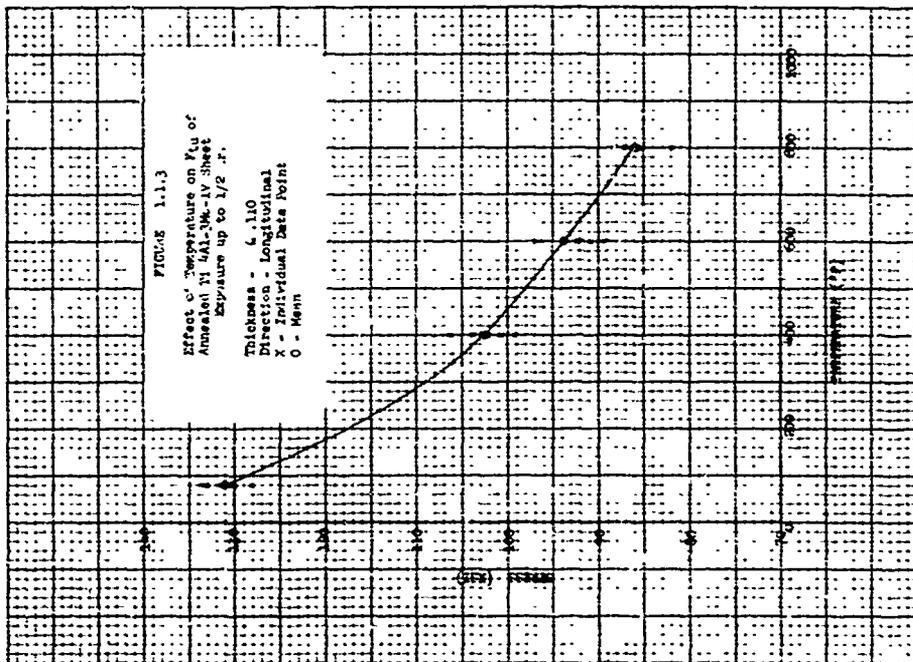
Section	Page
A. MECHANICAL PROPERTY WORKING CURVES	271-350
B. FATIGUE S-N CURVES	351-362

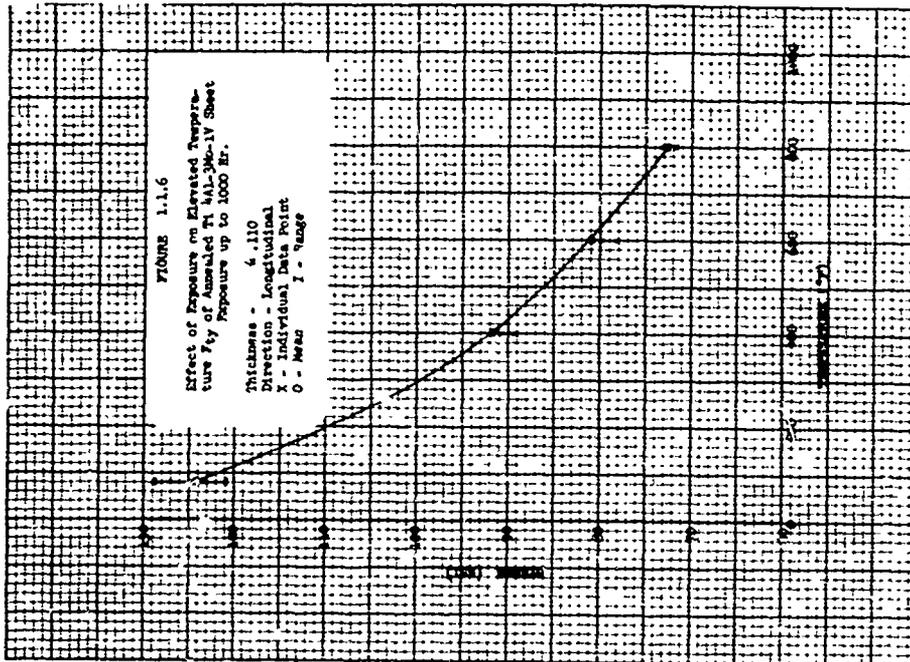
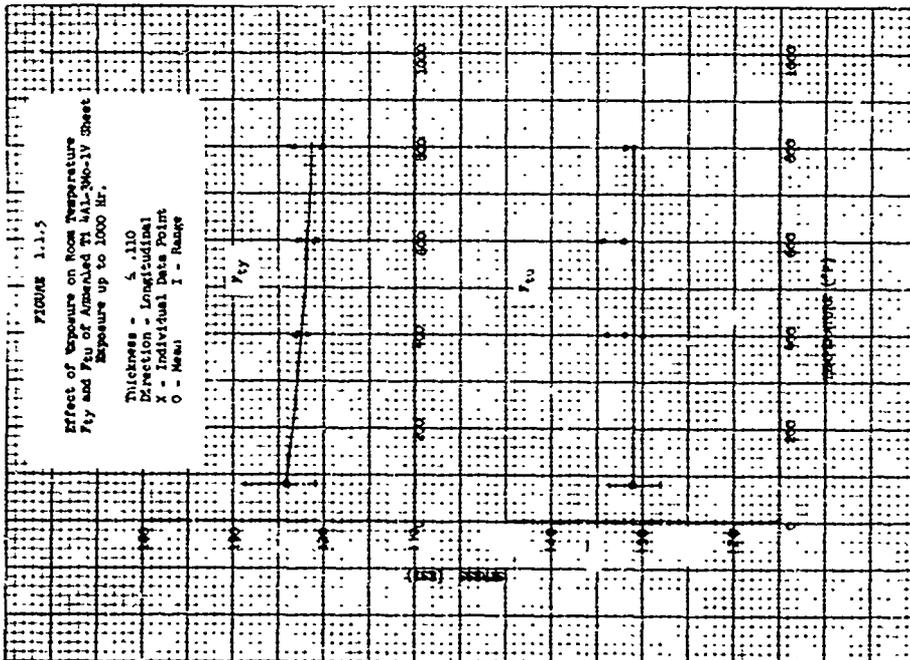


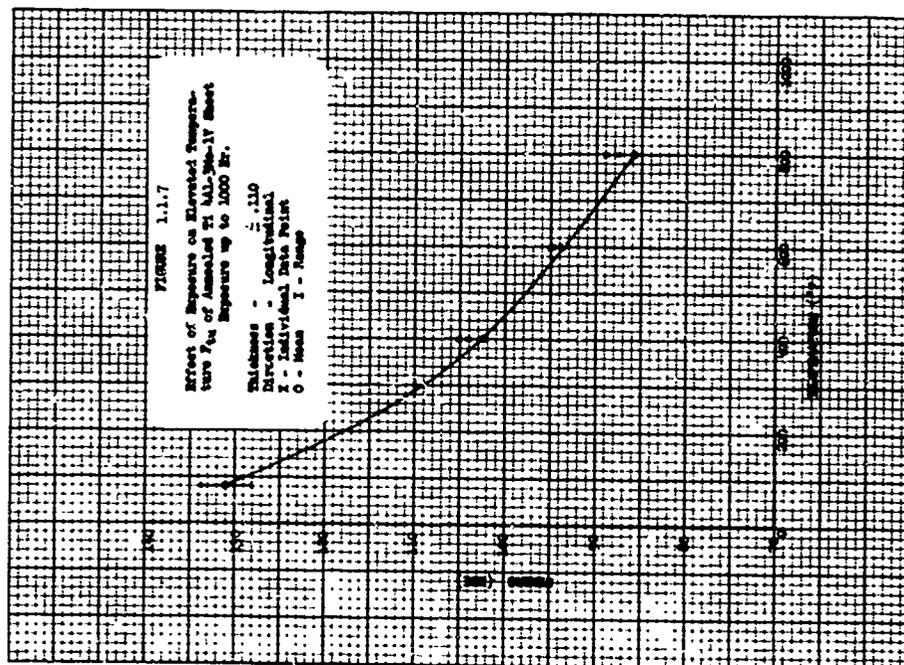
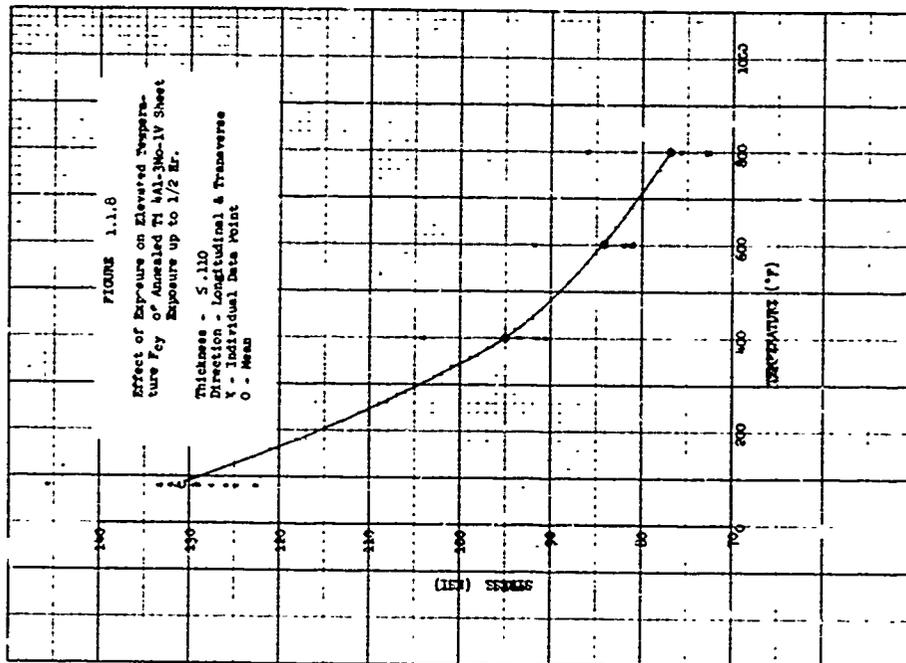
A. WORKING CURVES

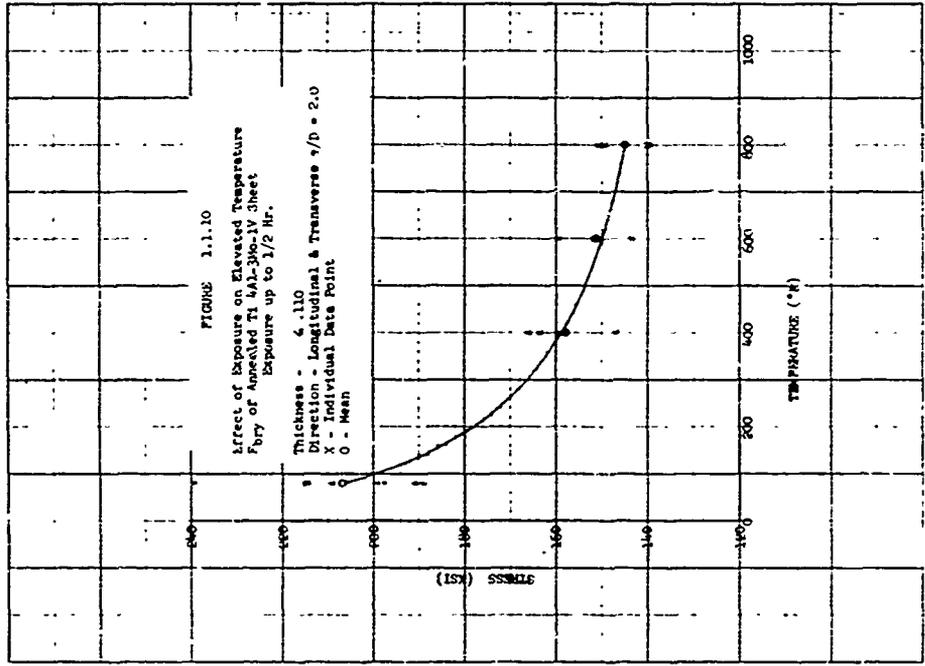
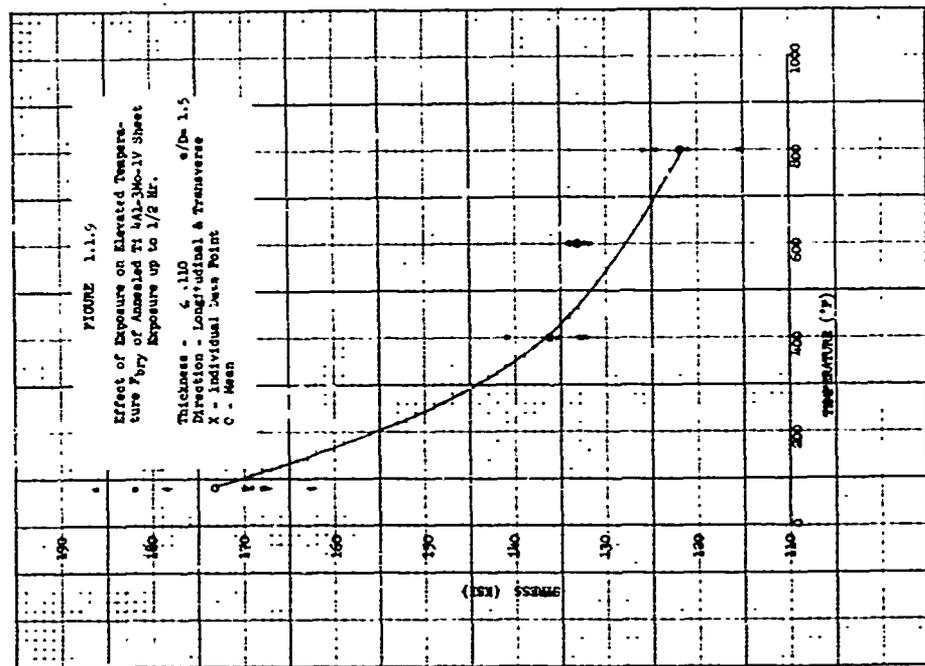
1.1 Ti-4Al-3Mo-1V Cond. A Figures 1.1.1 to 1.1.13

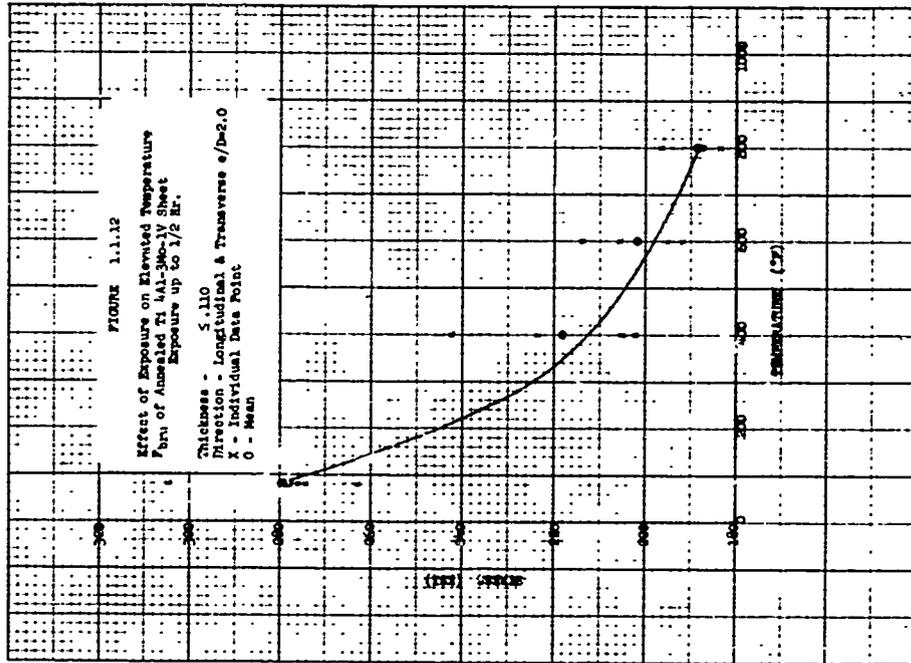
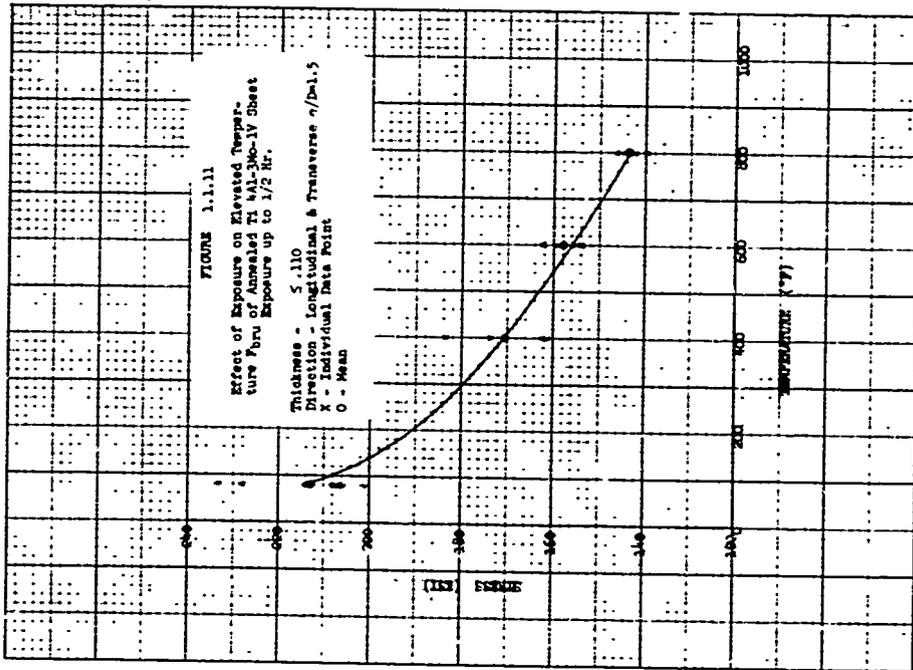


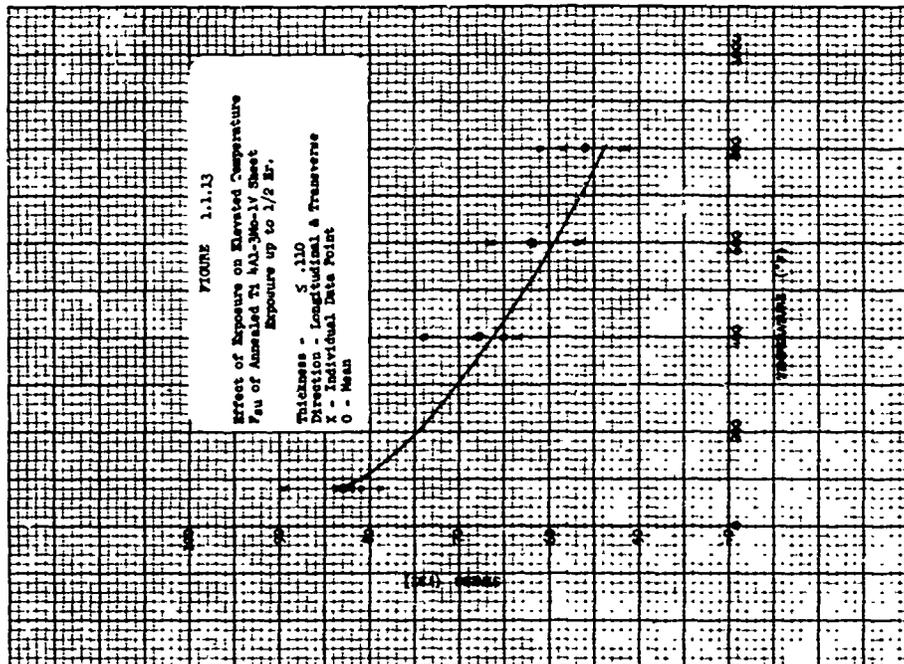










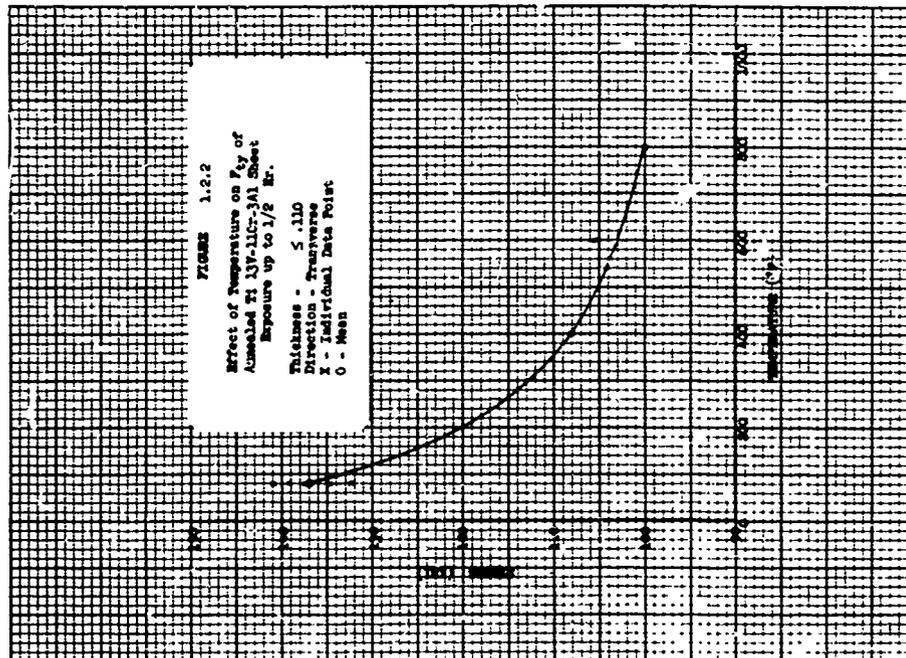
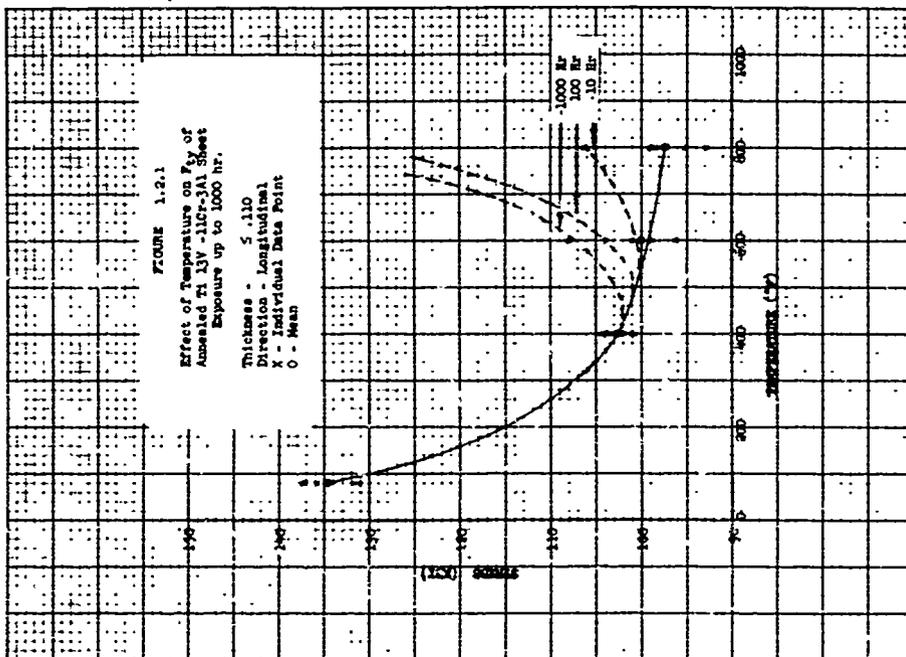


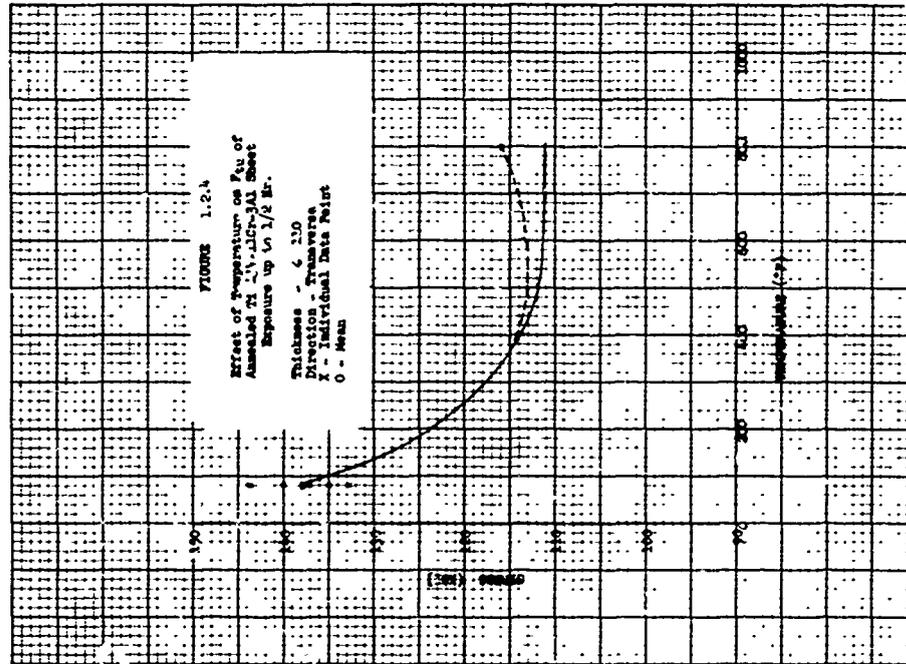
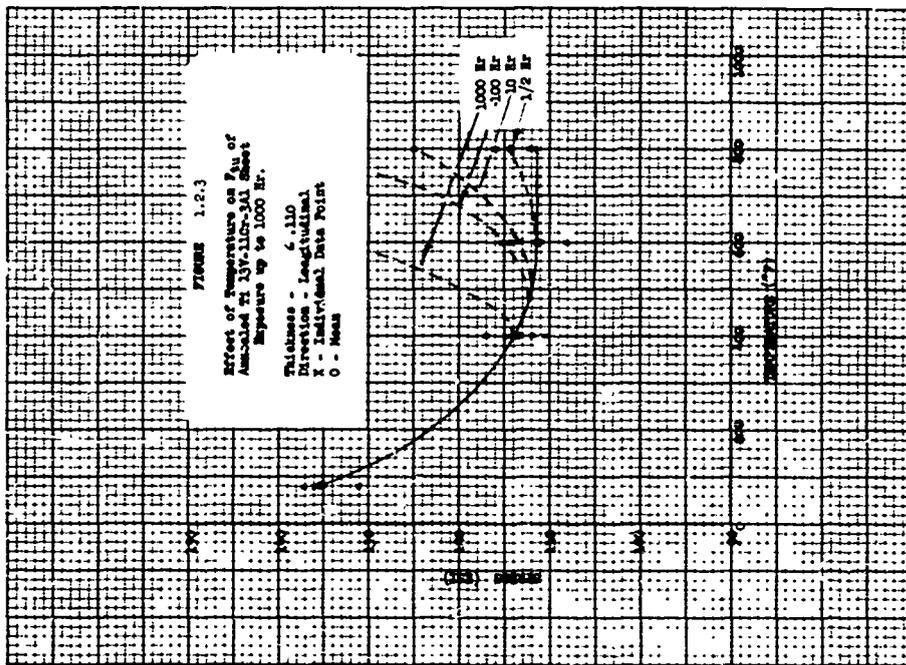


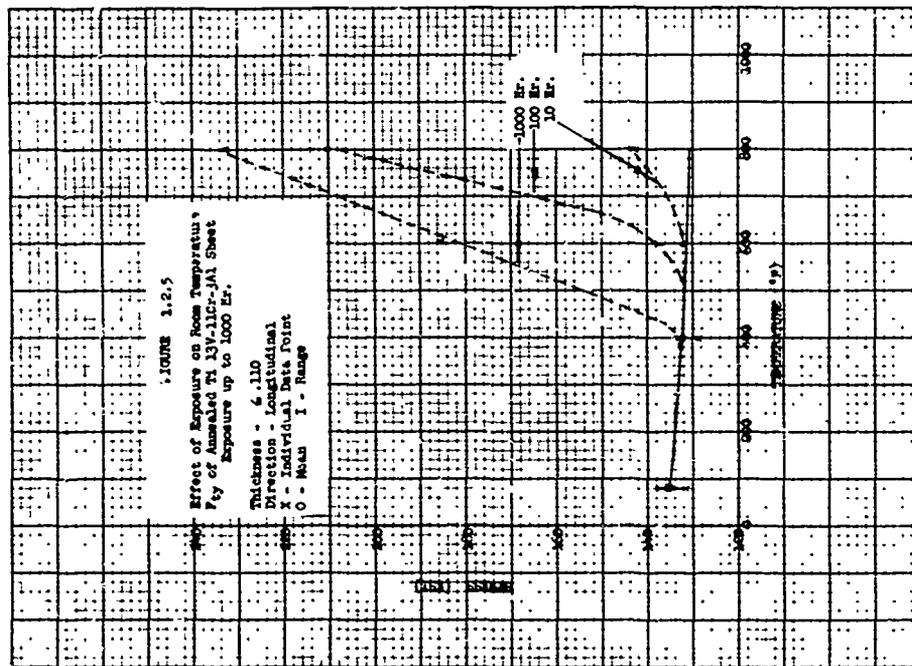
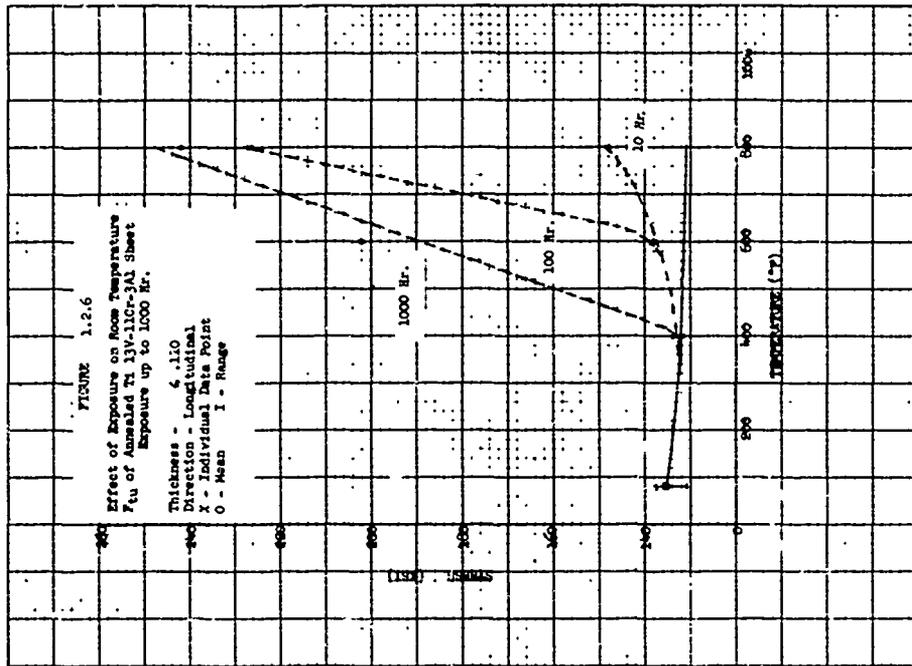
A. WORKING CURVES (Continued)

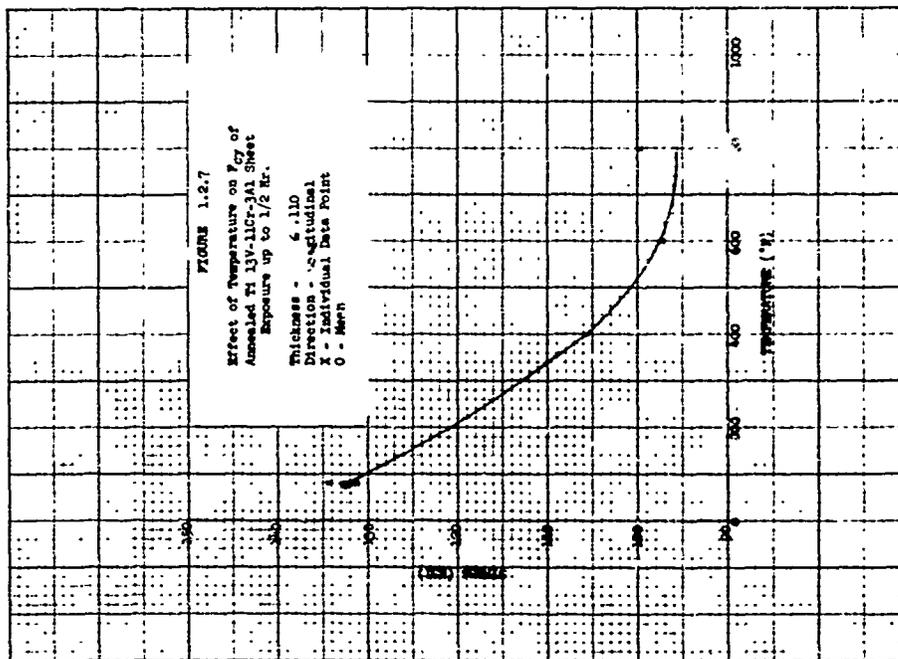
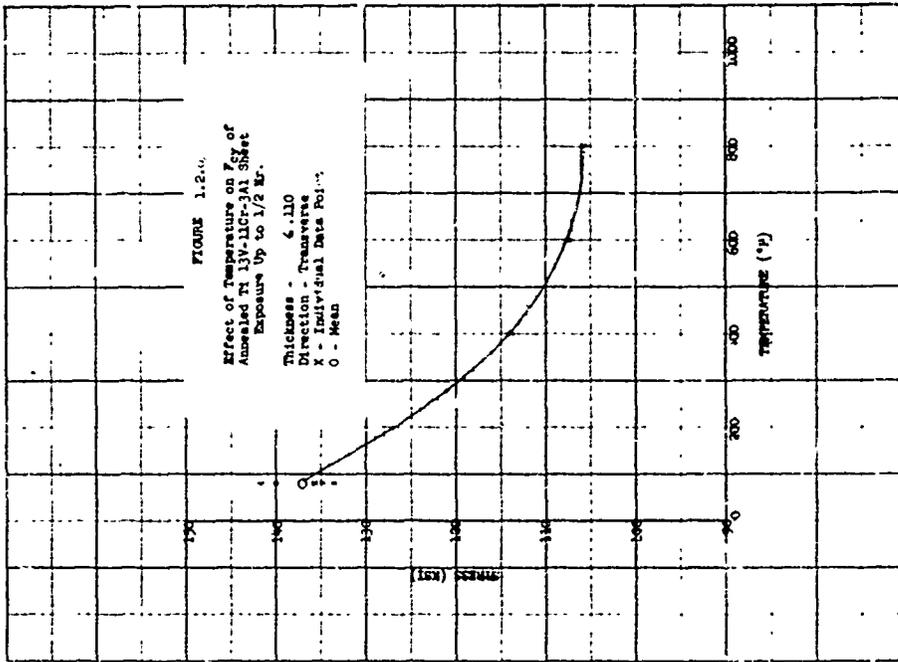
1.2 Ti-13V-11Cr-3Al Cond. A

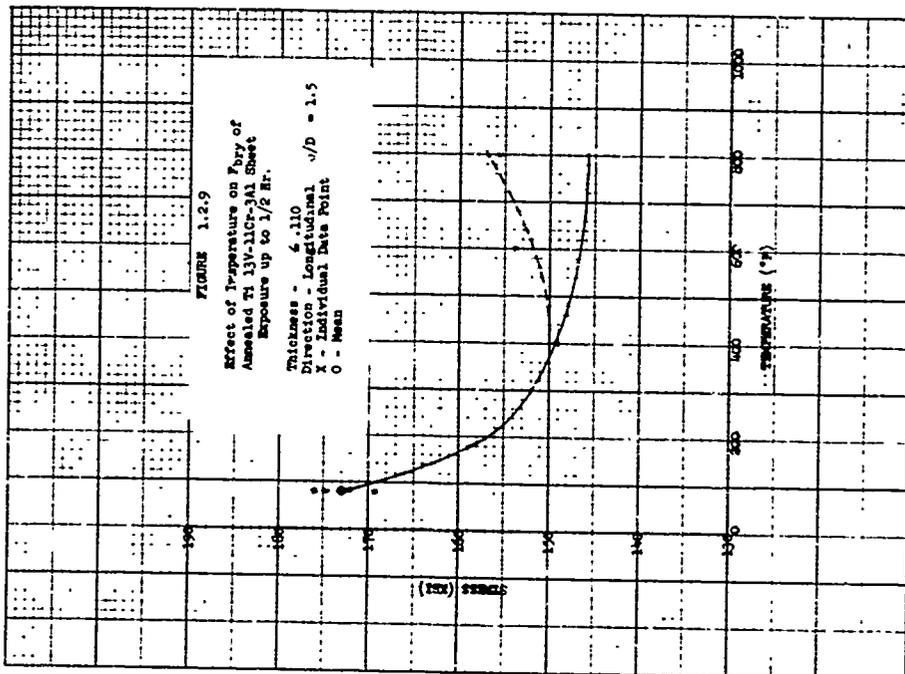
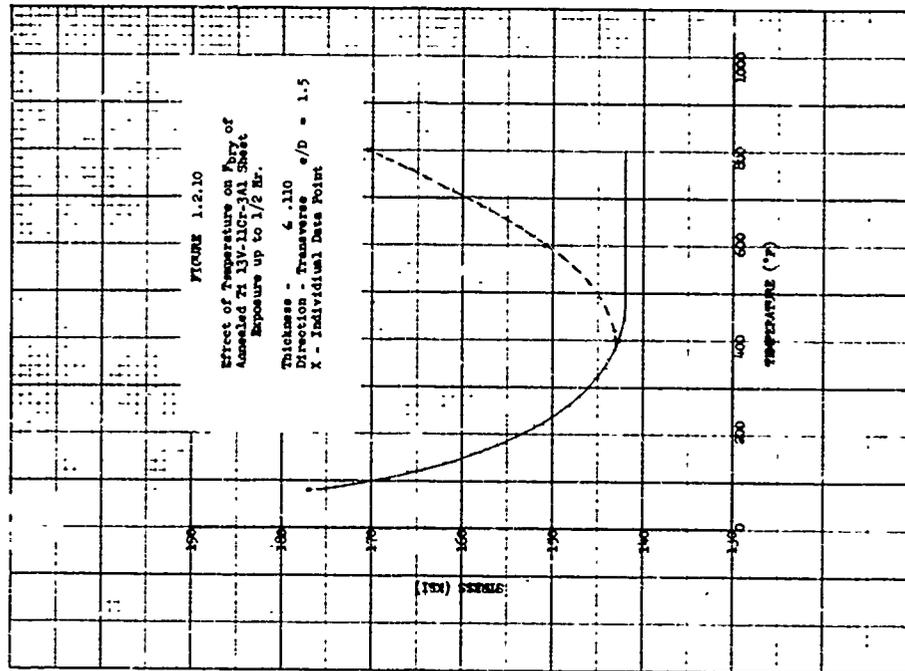
Figures 1.2.1 to 1.2.18

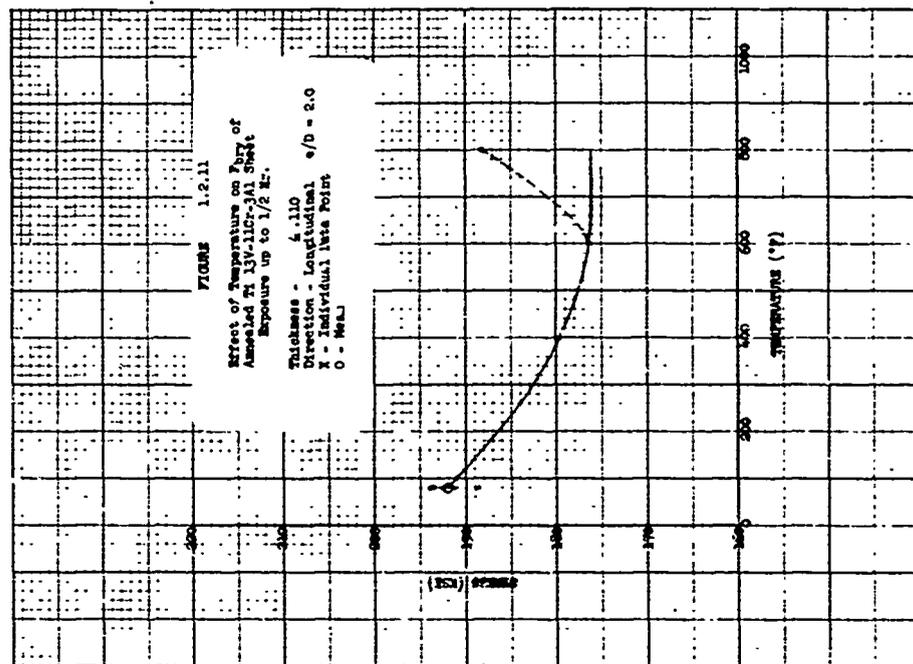
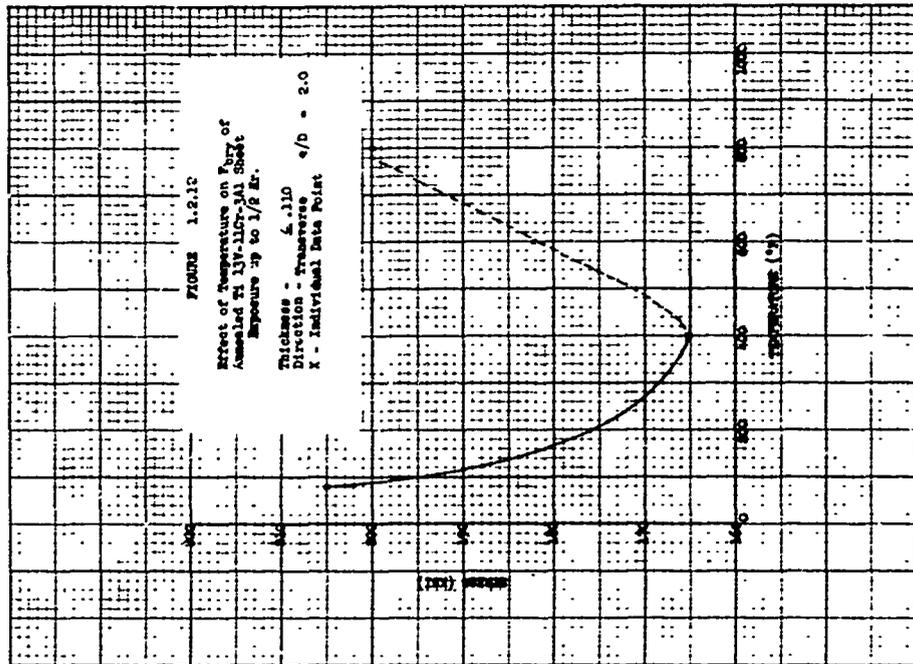


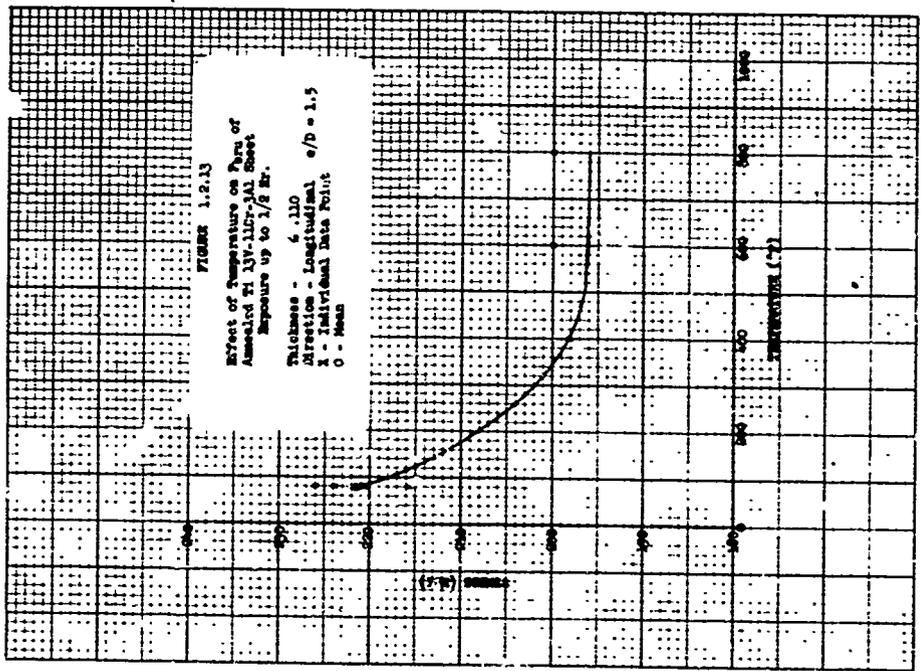
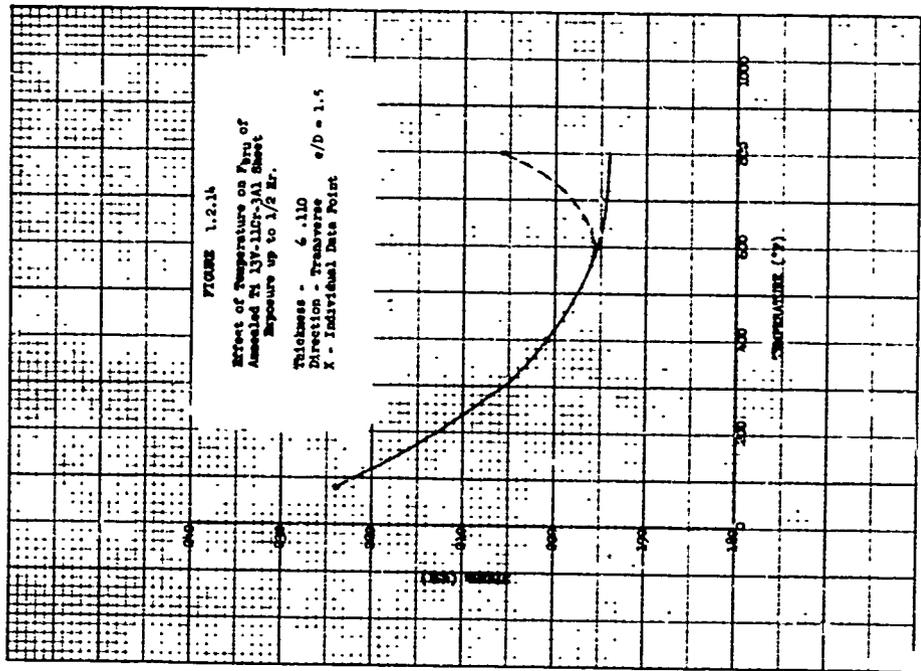




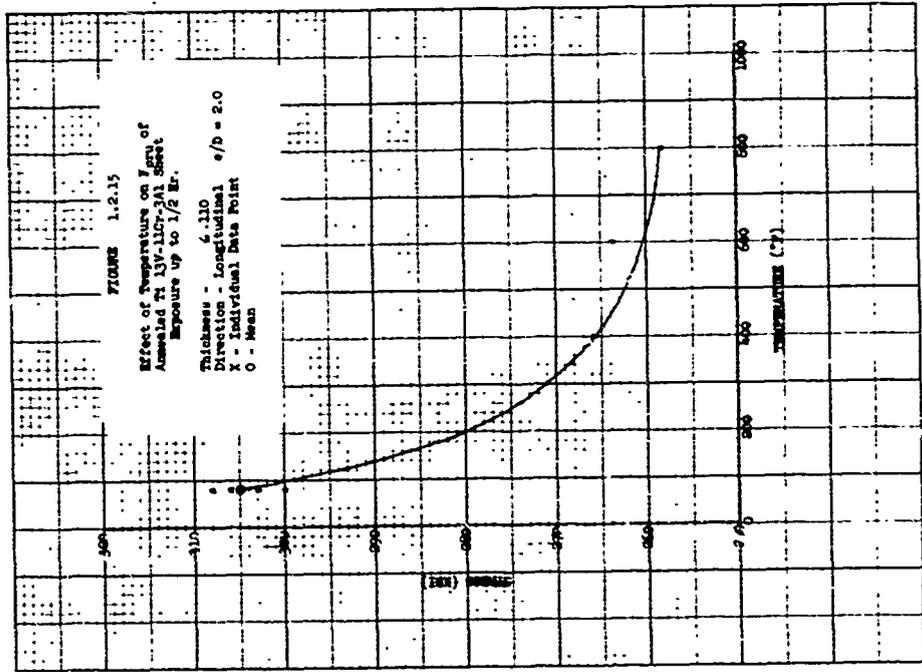
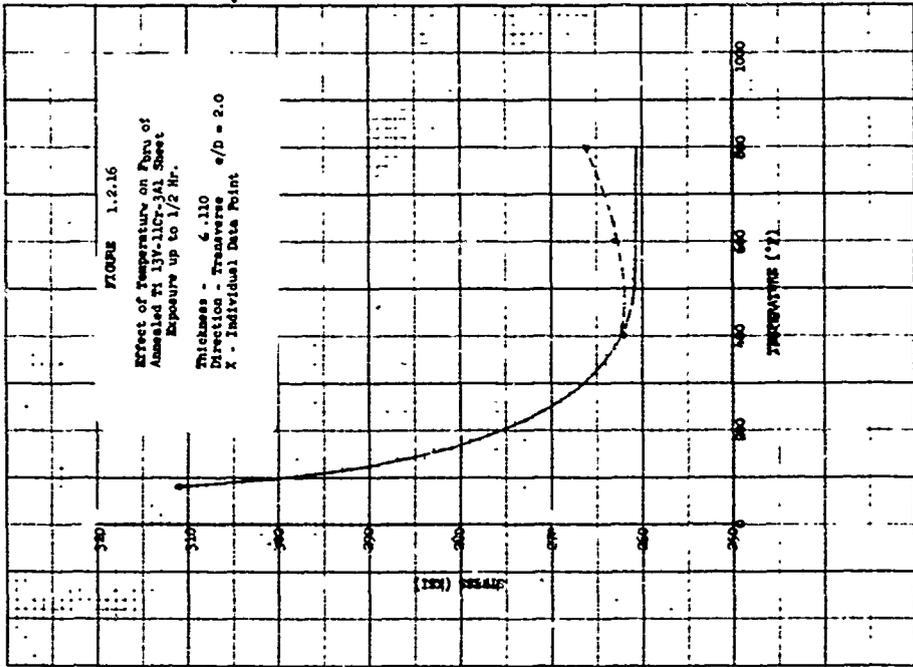


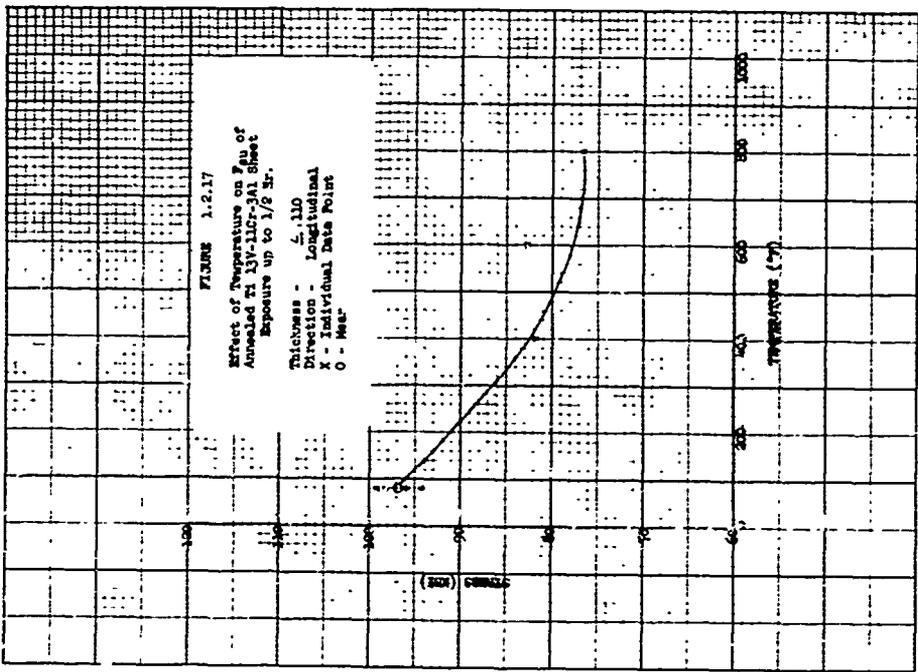
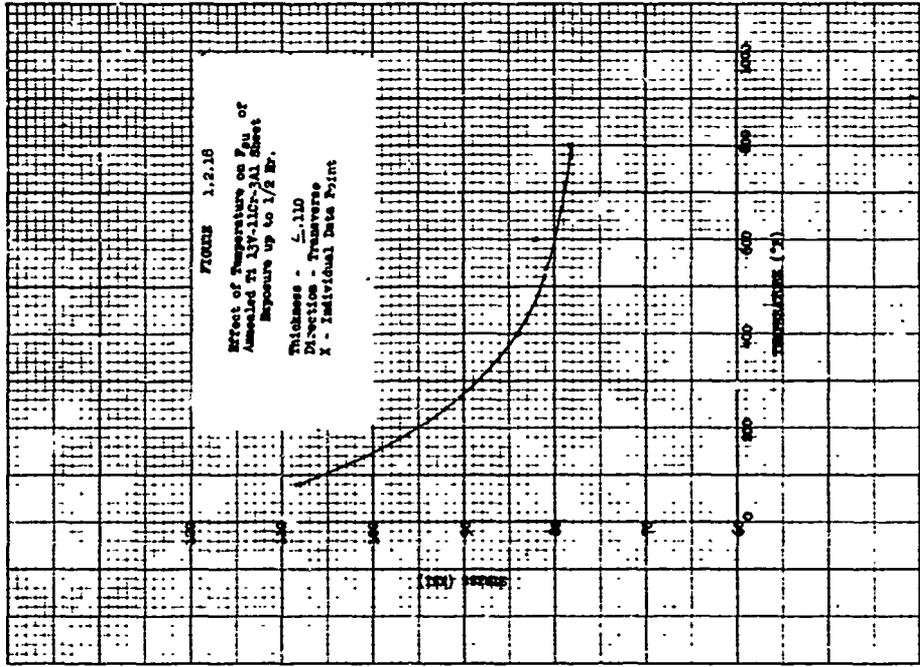






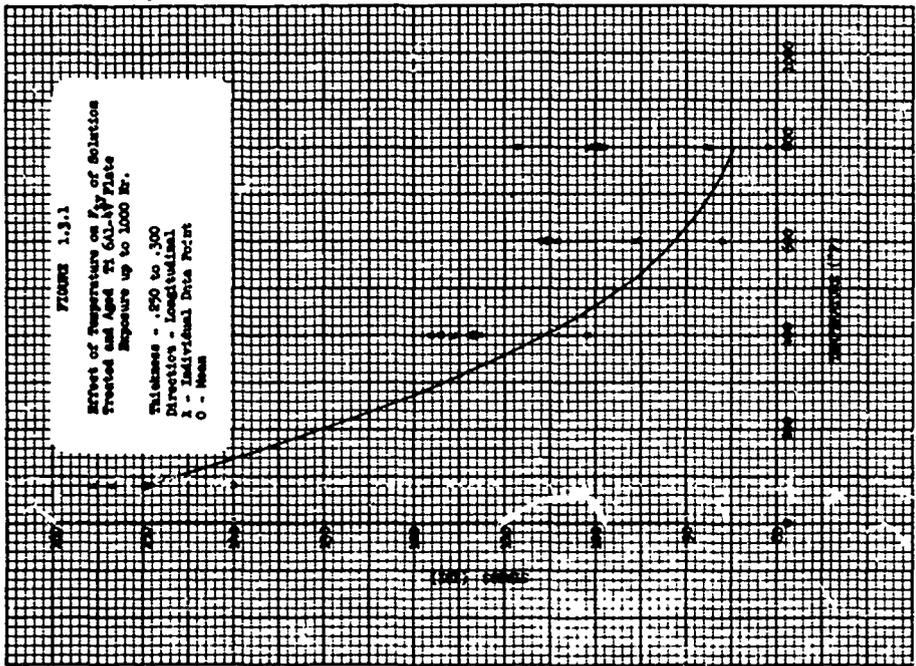
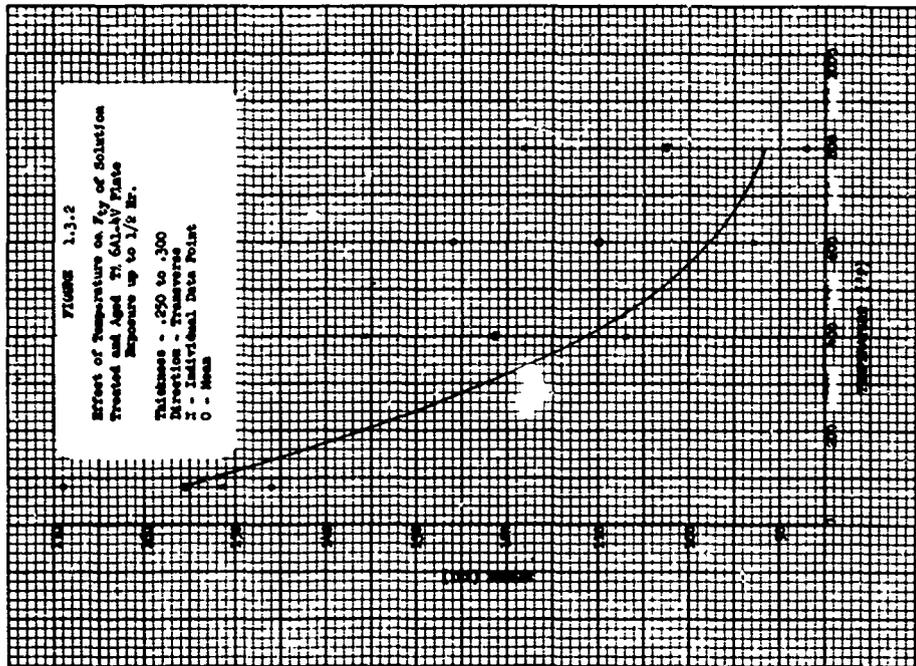


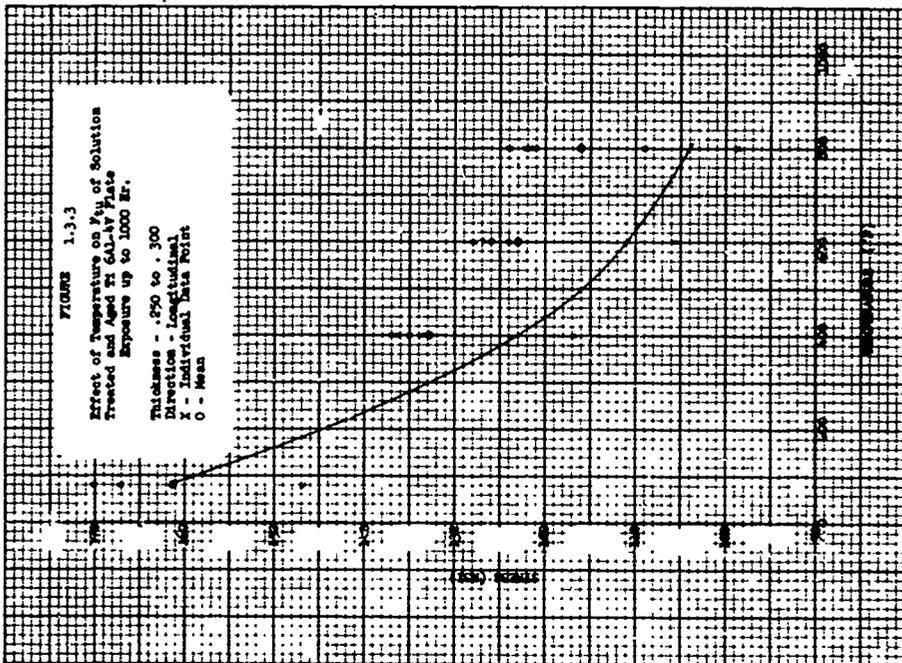
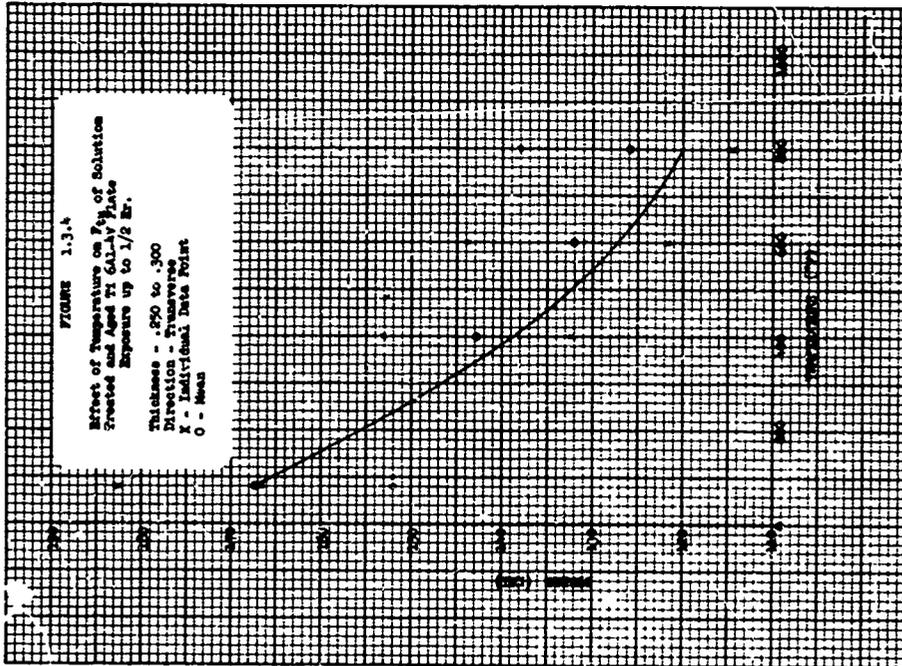


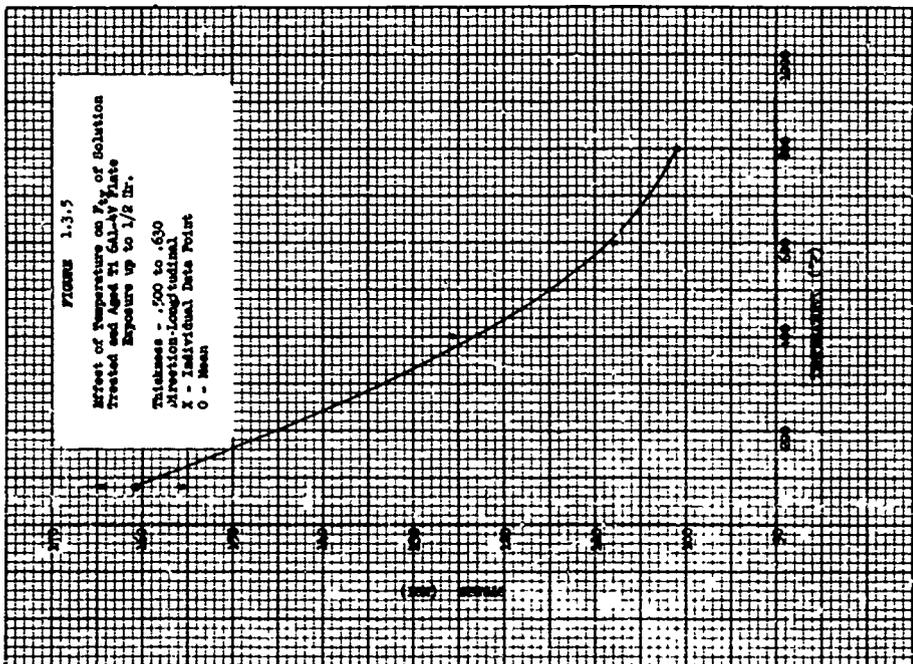
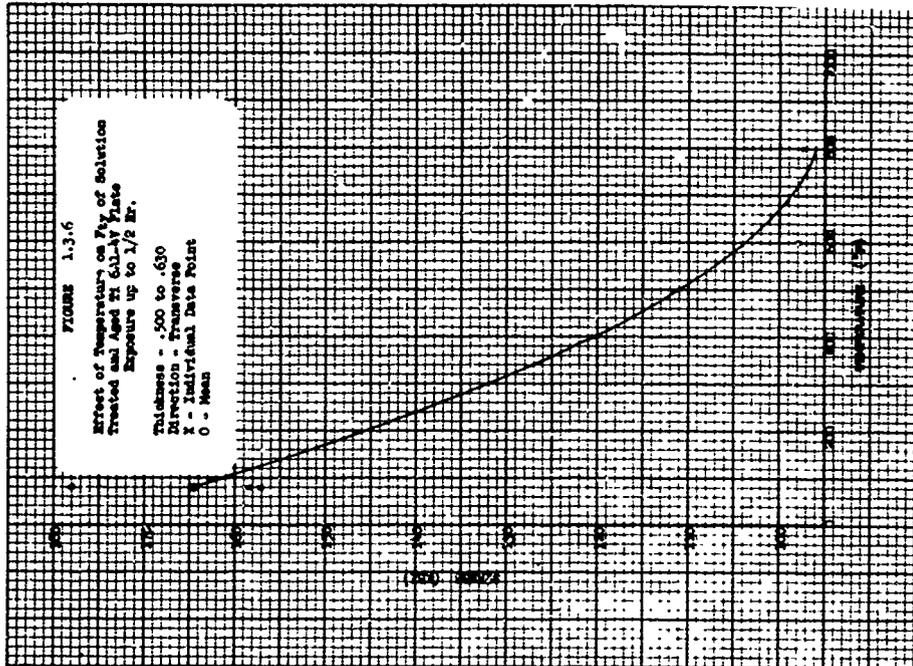


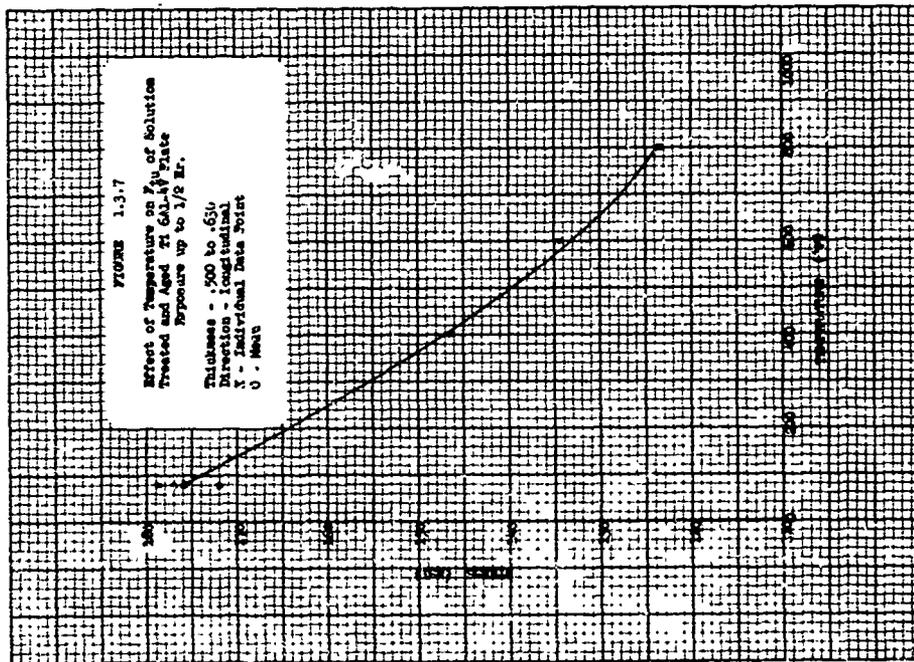
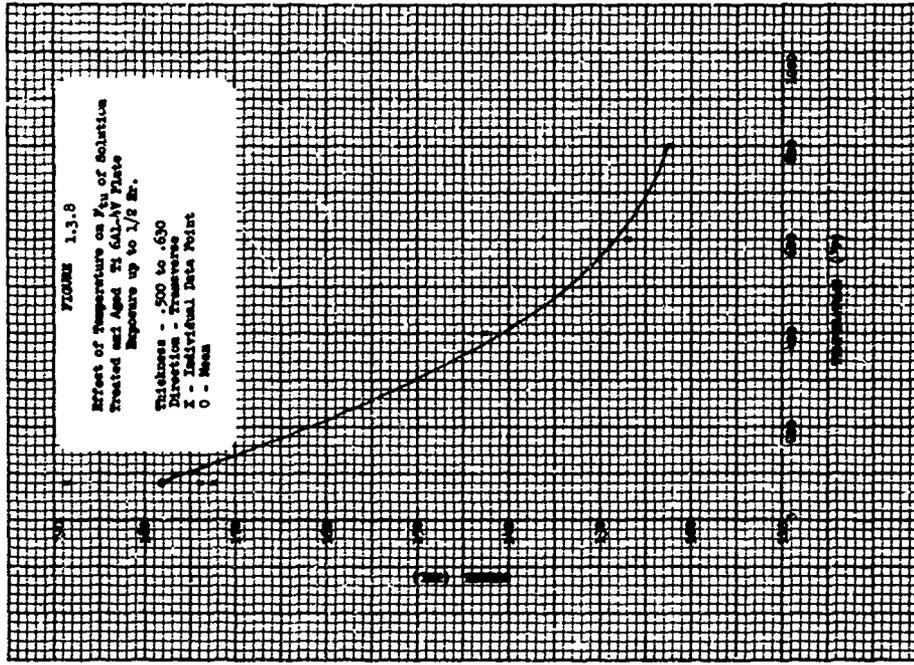
A. WORKING CURVES (continued)

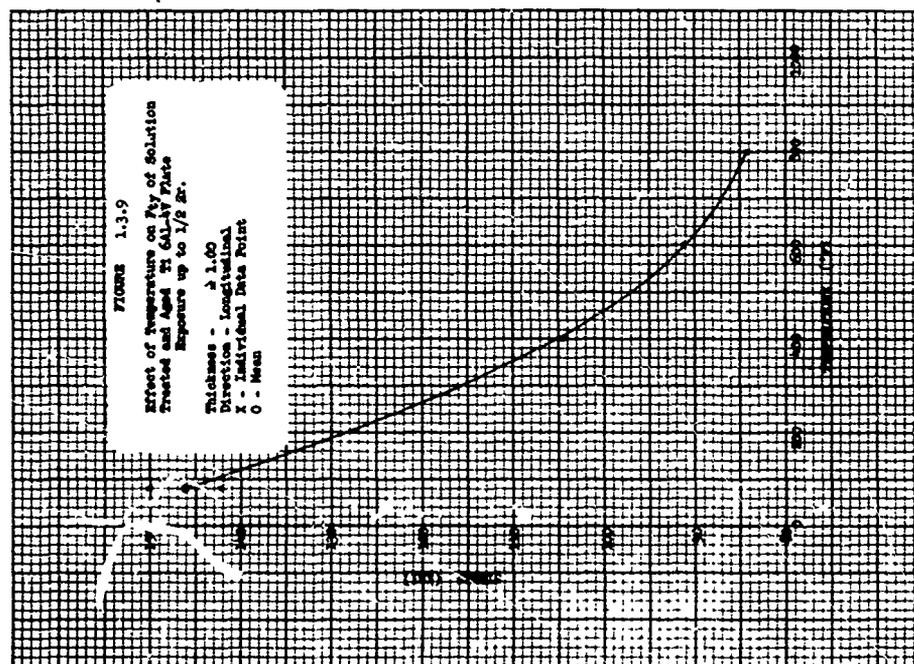
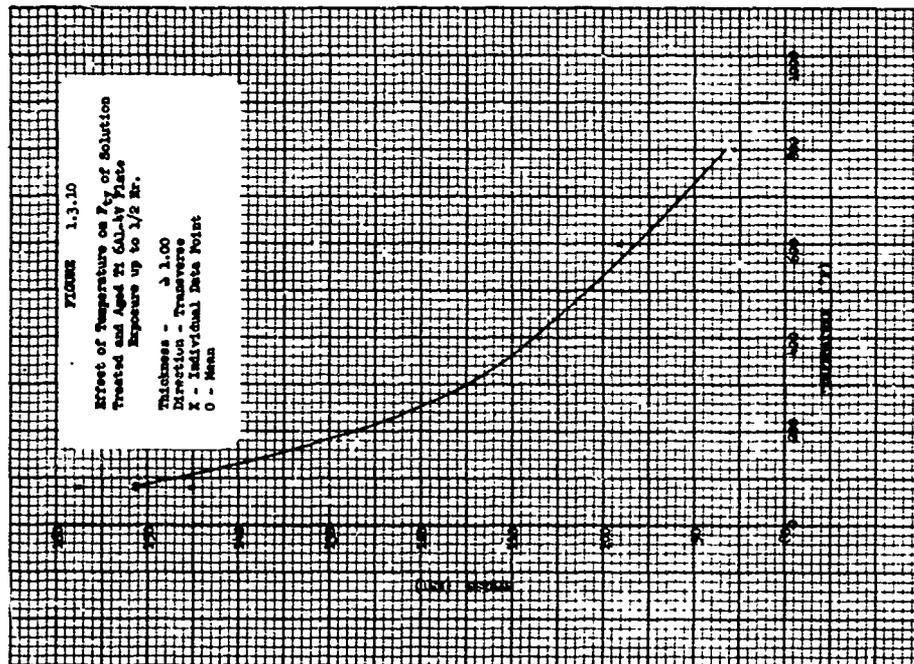
1.3 Ti-6Al-4V Cond. STA Figures 1.3.1 to 1.3.43



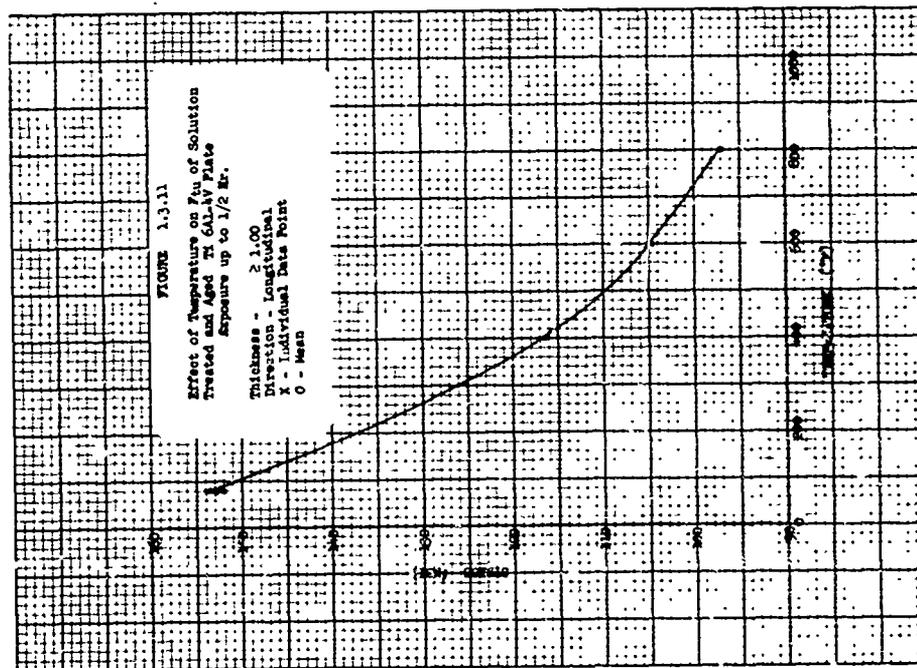
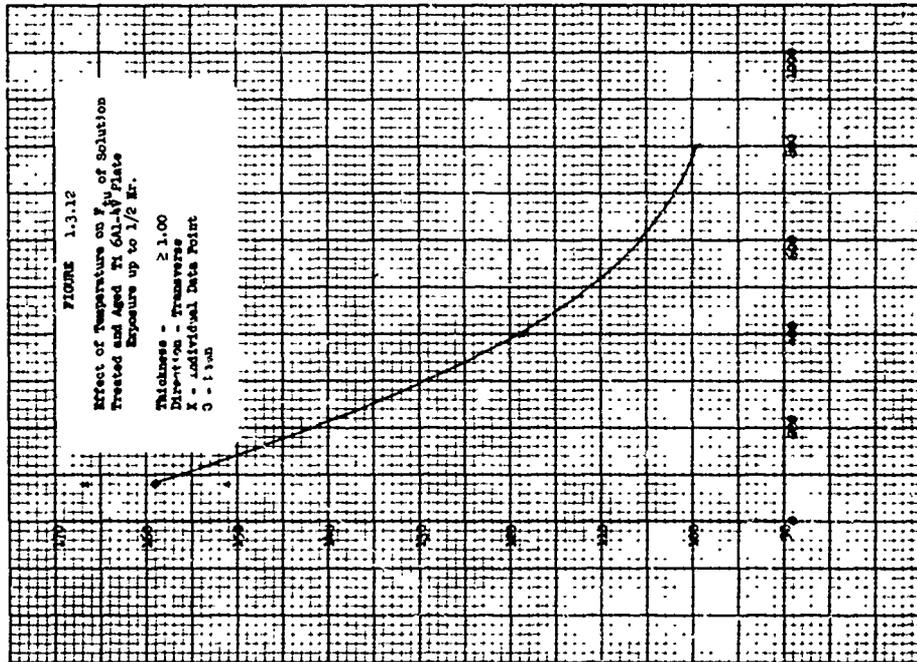


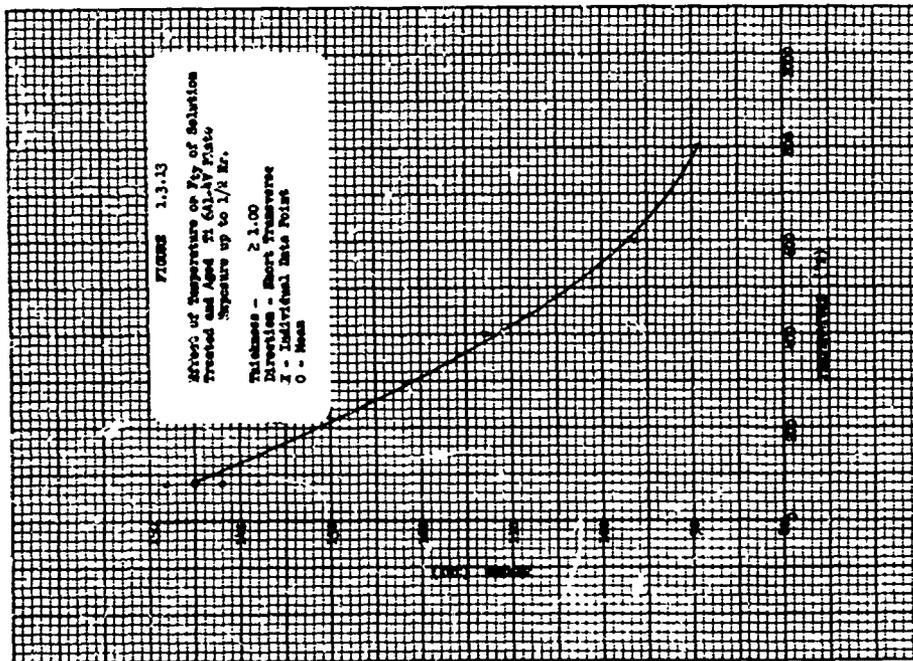
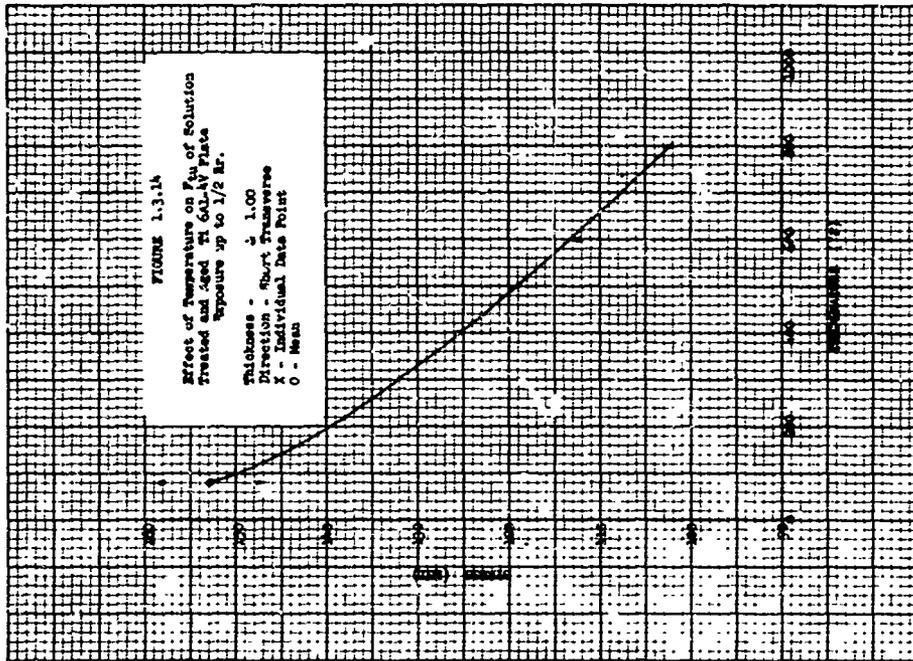


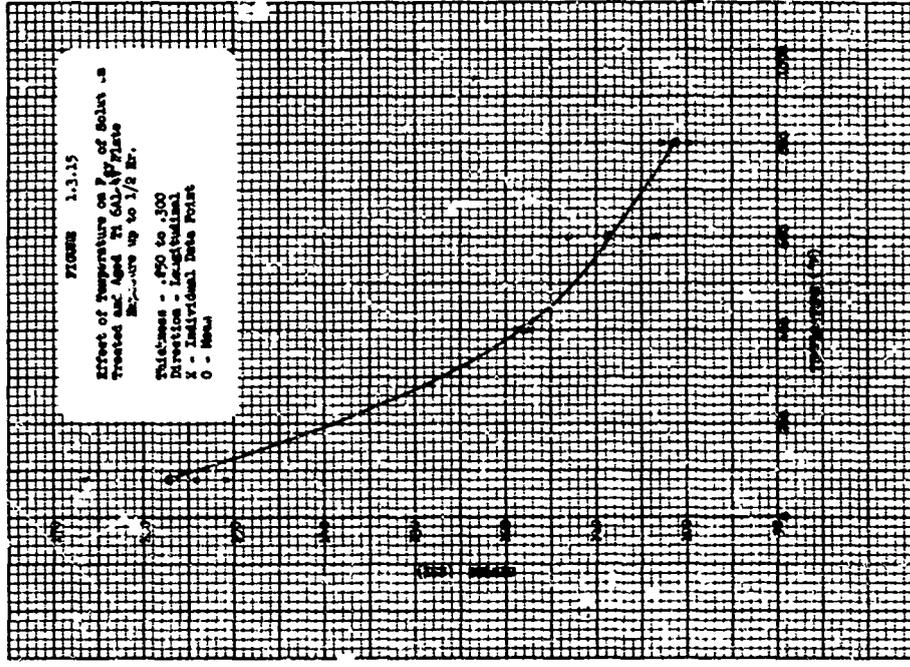
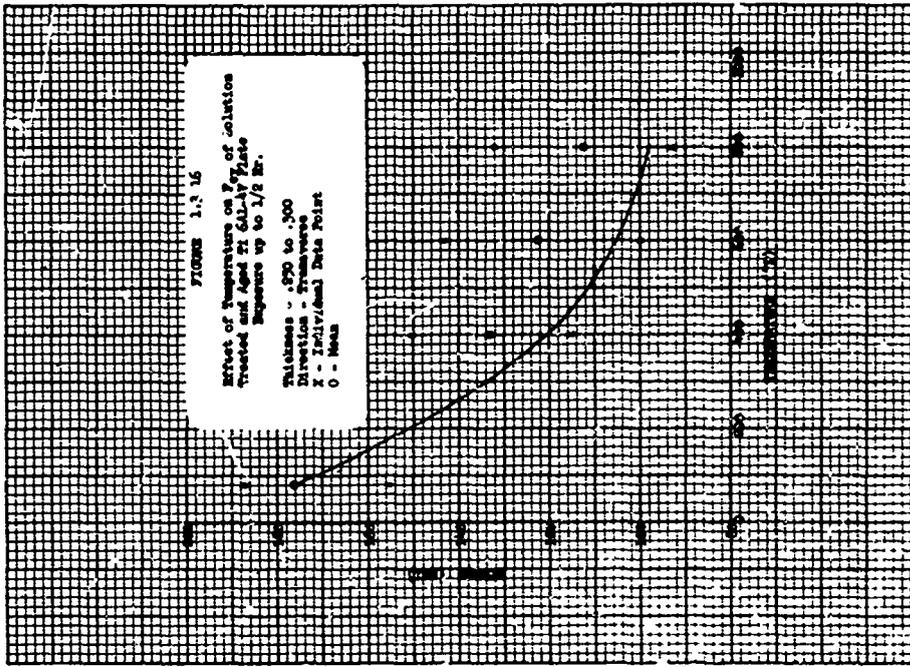


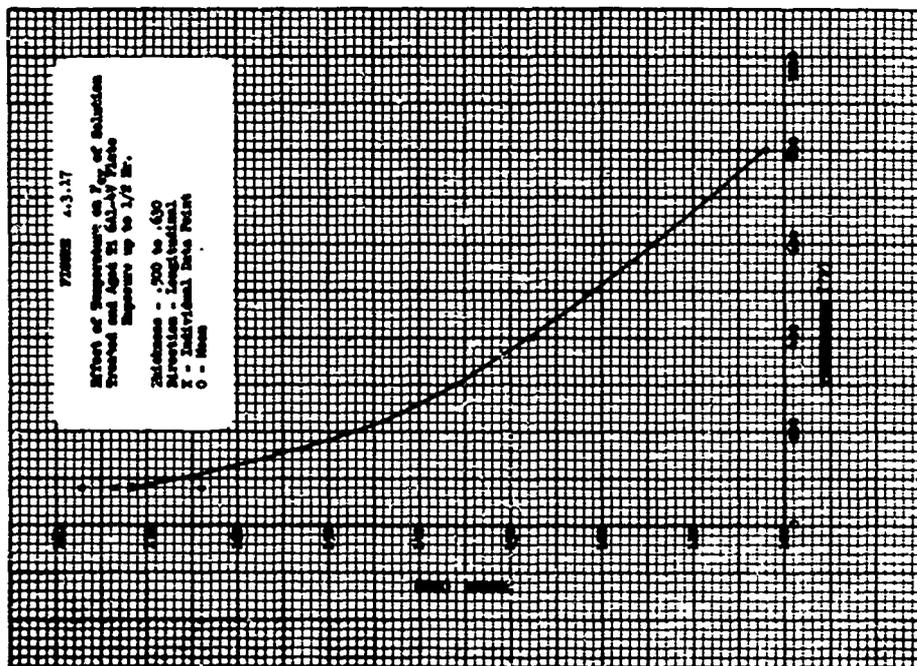
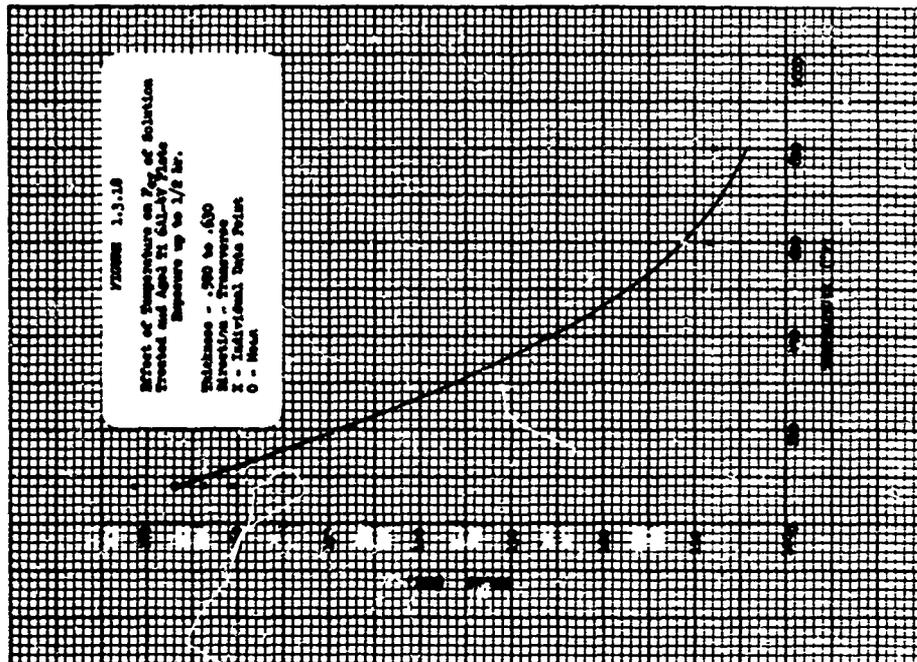


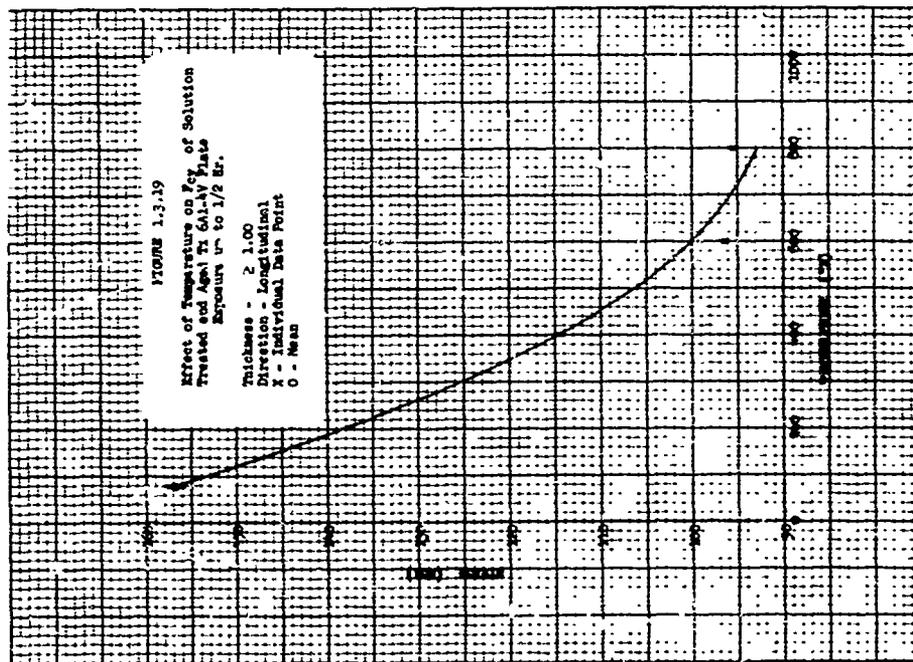
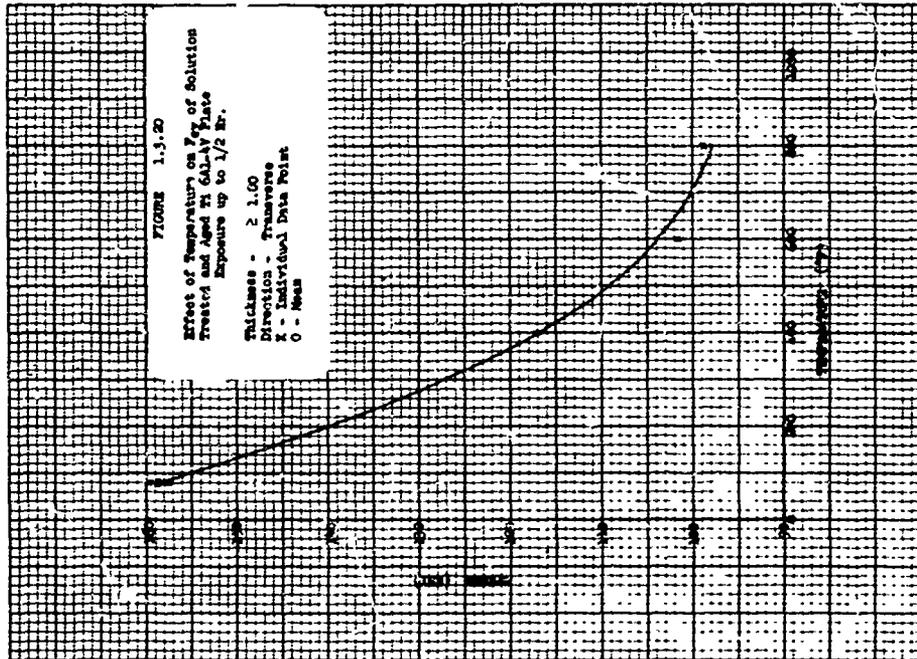


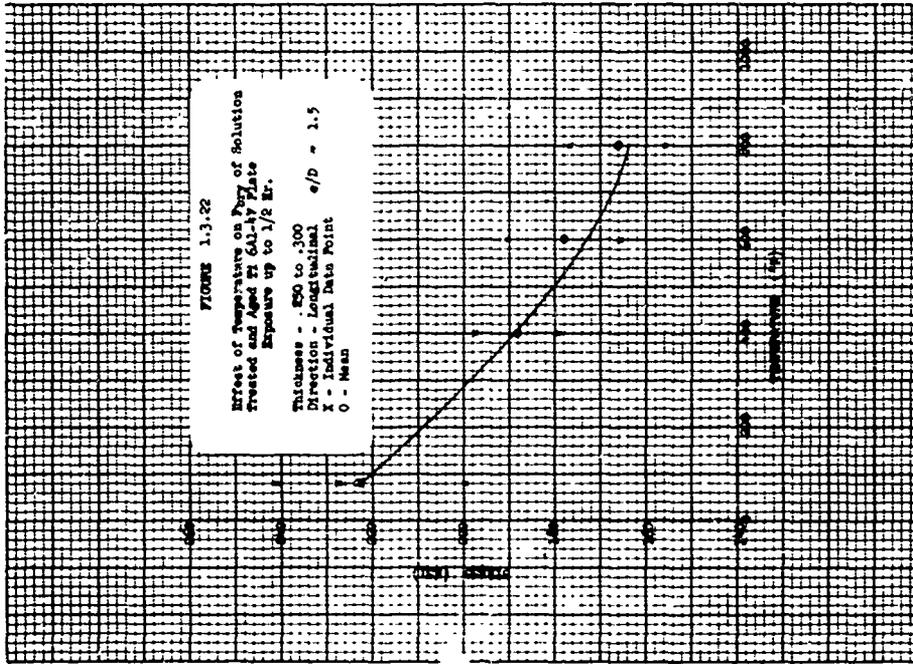
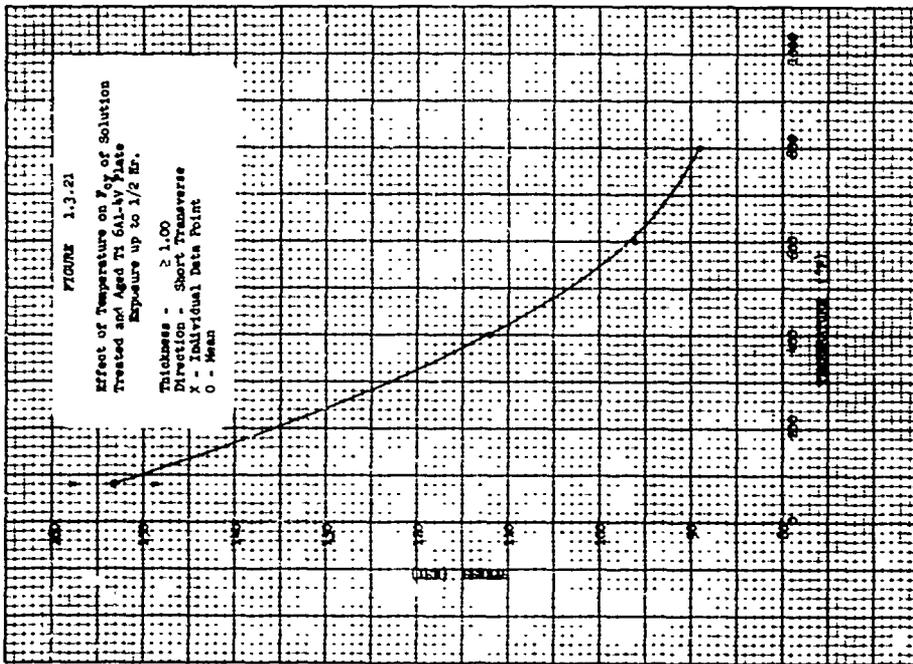




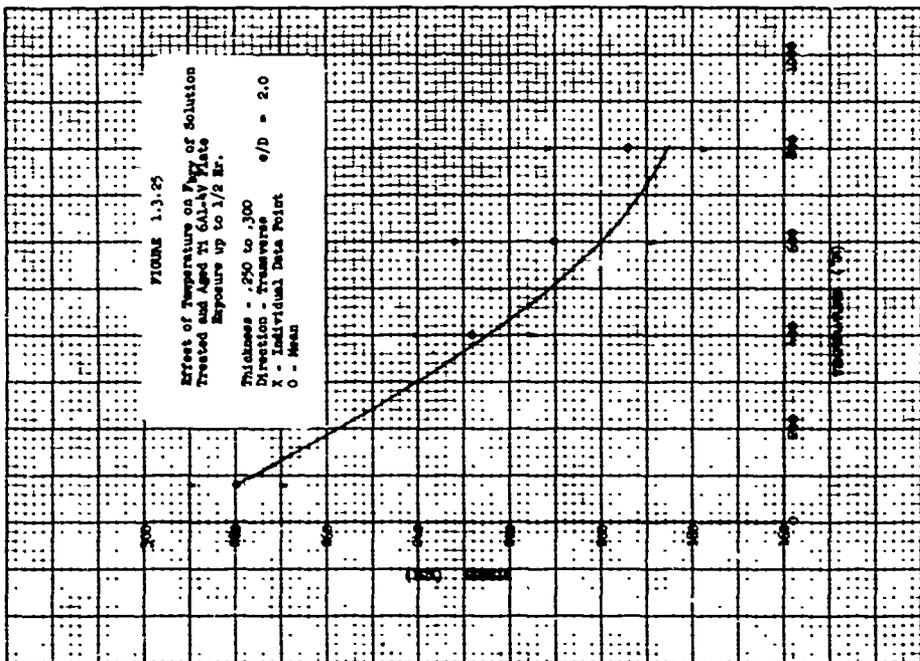
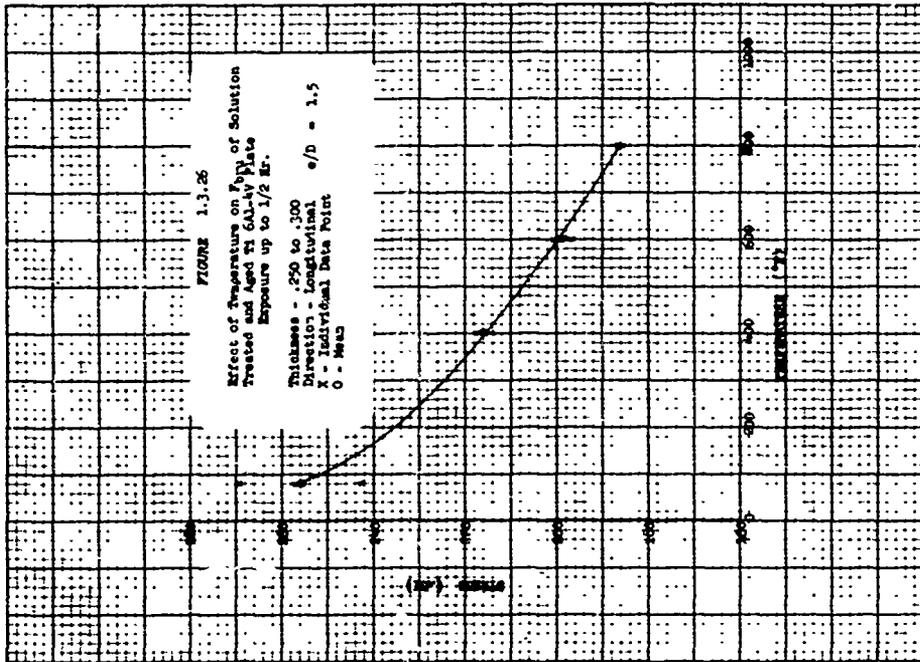




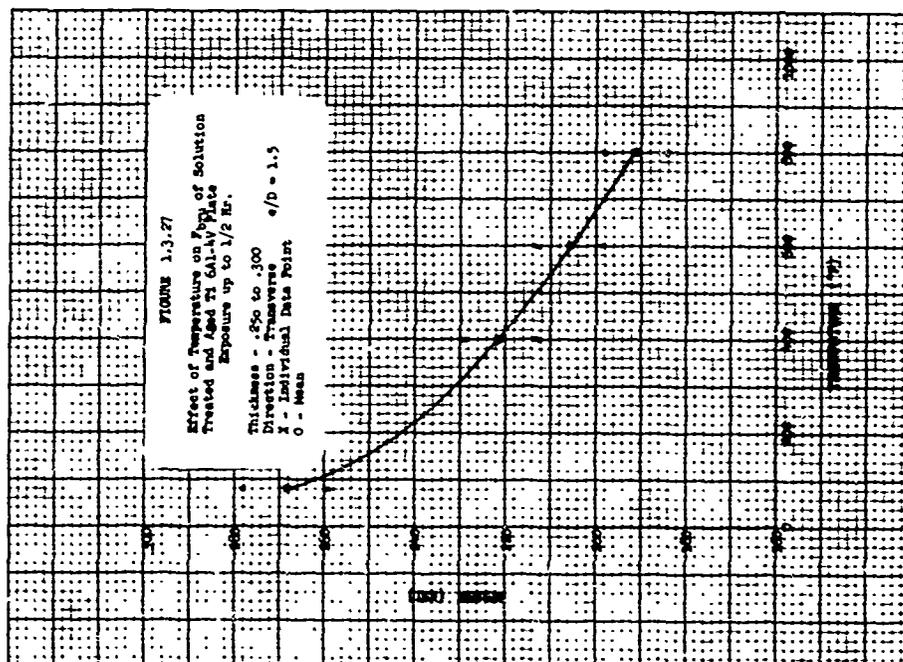
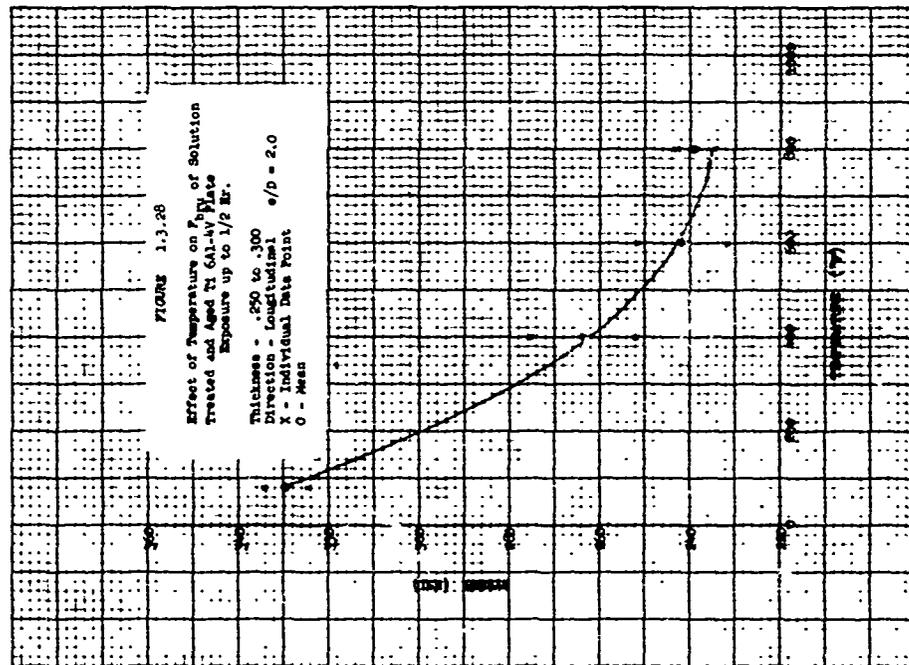


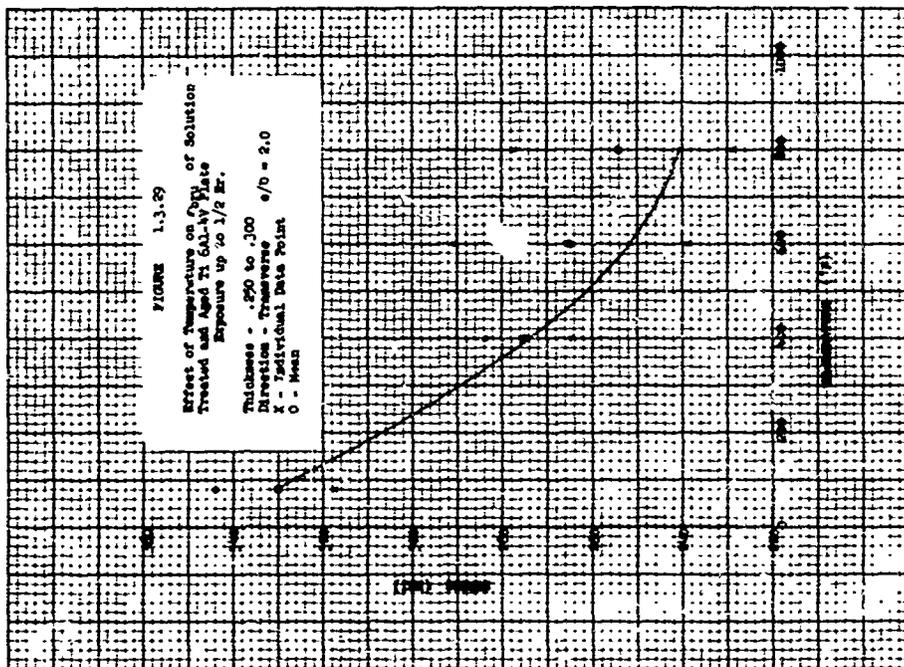
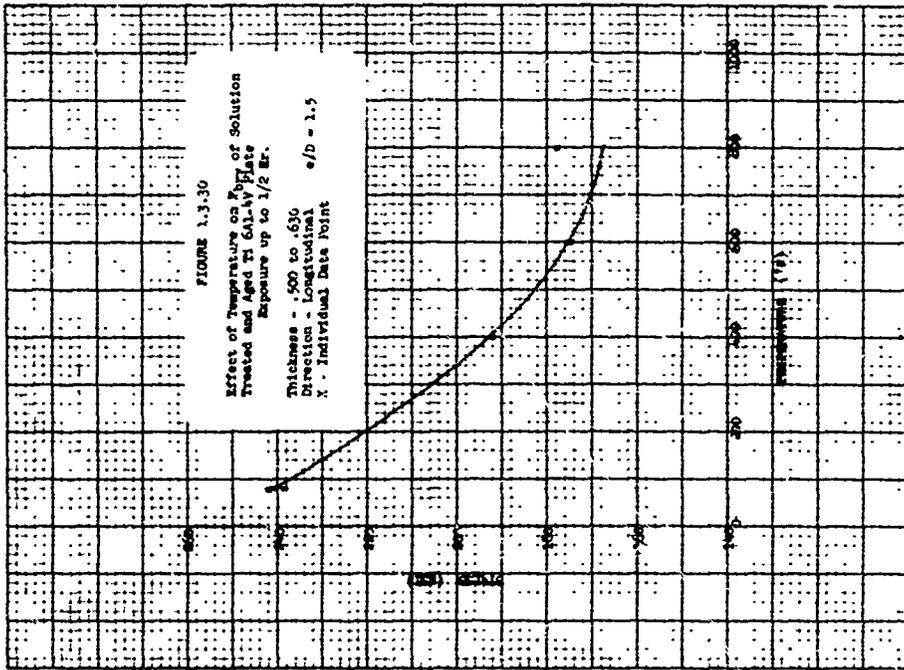


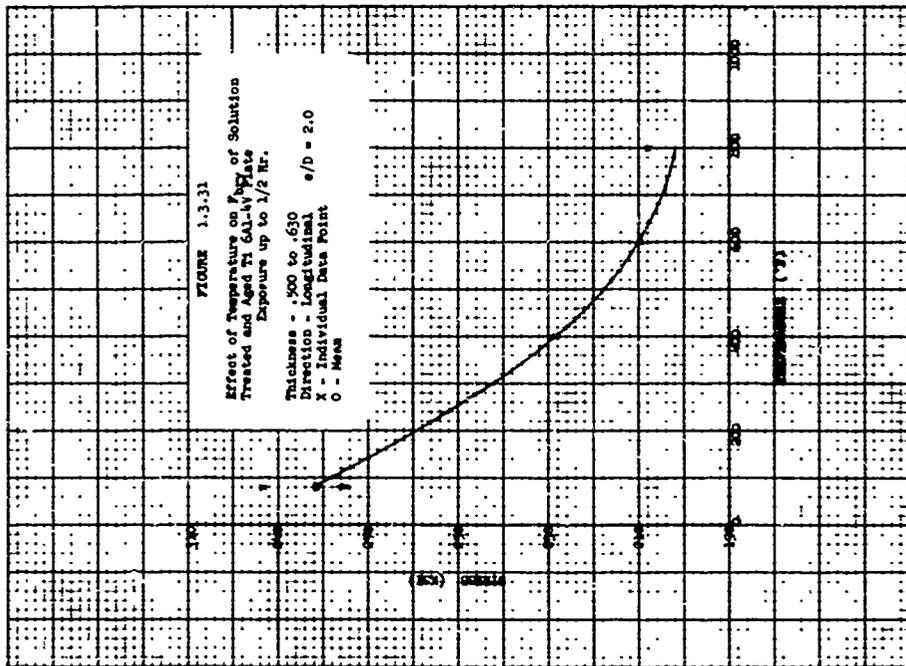
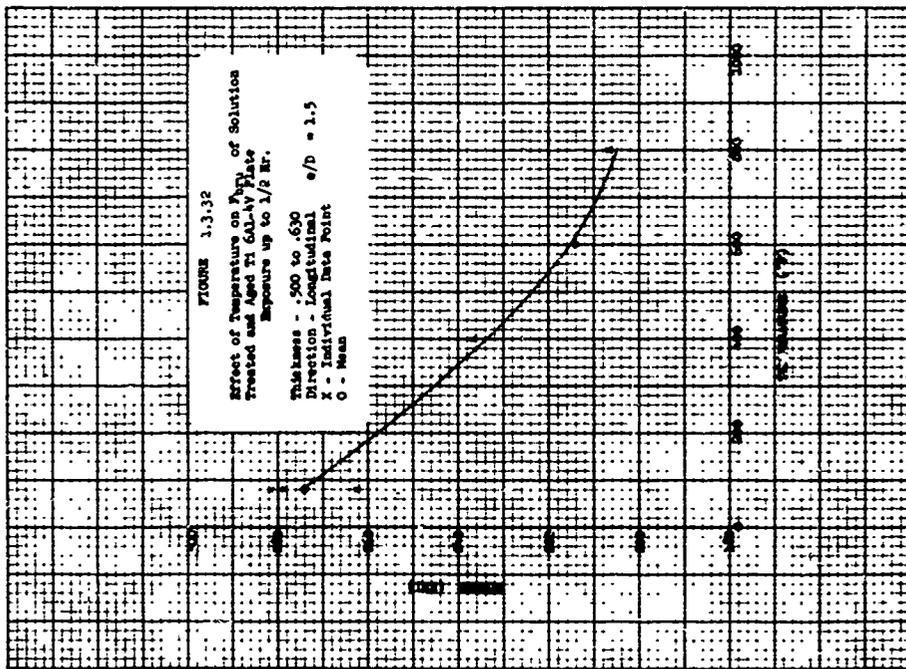


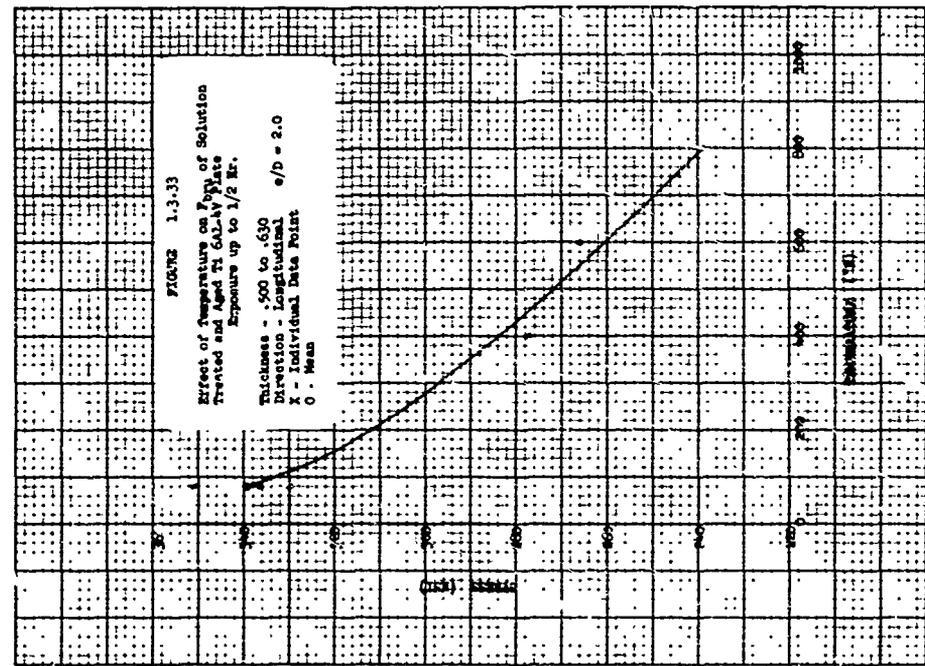
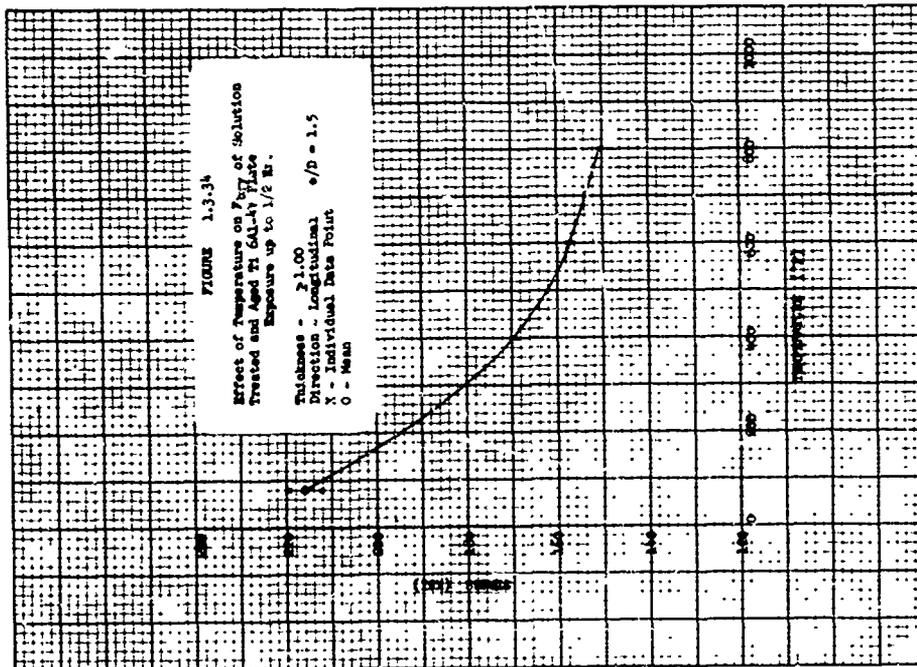


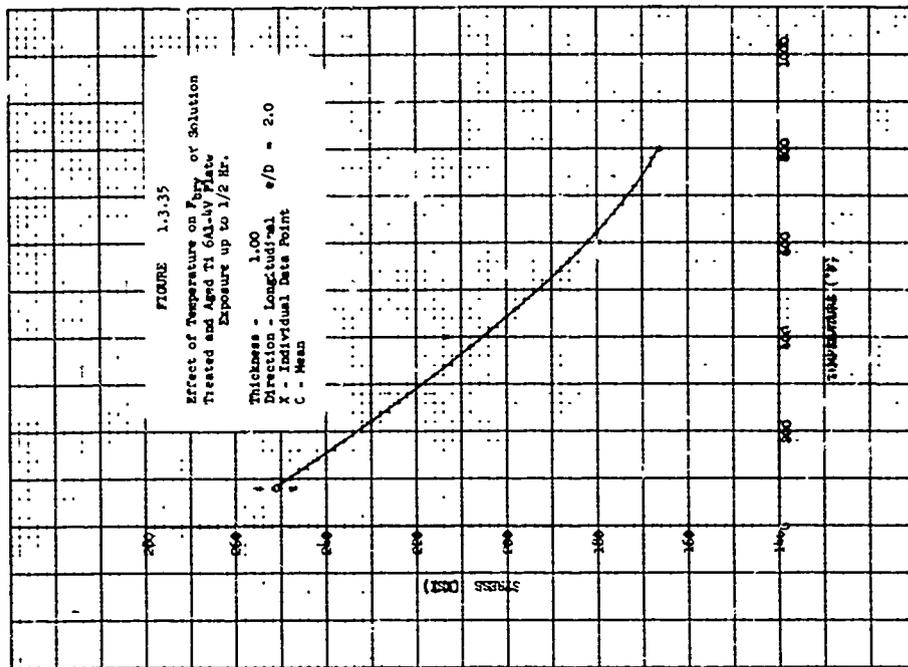
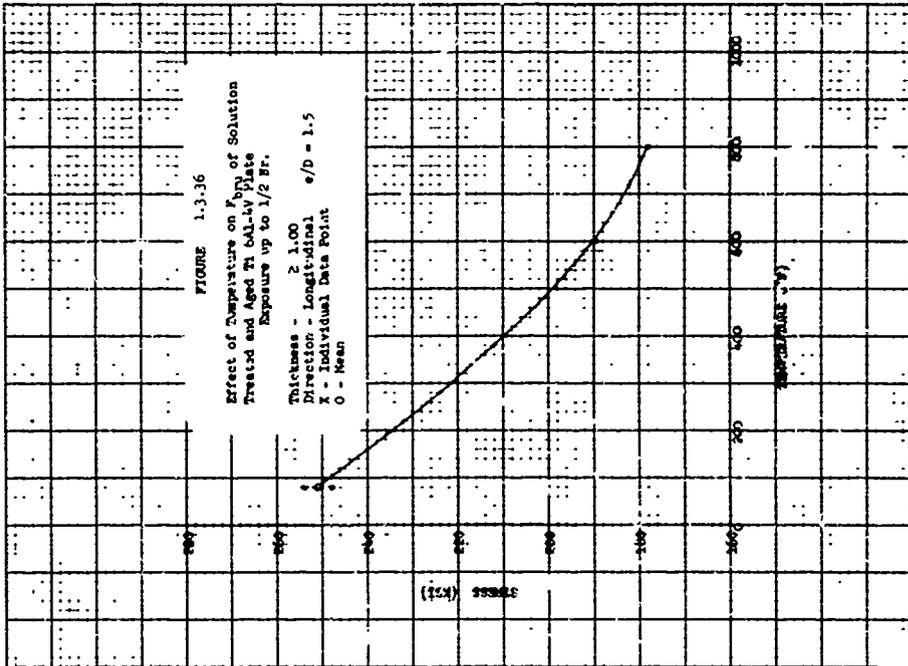


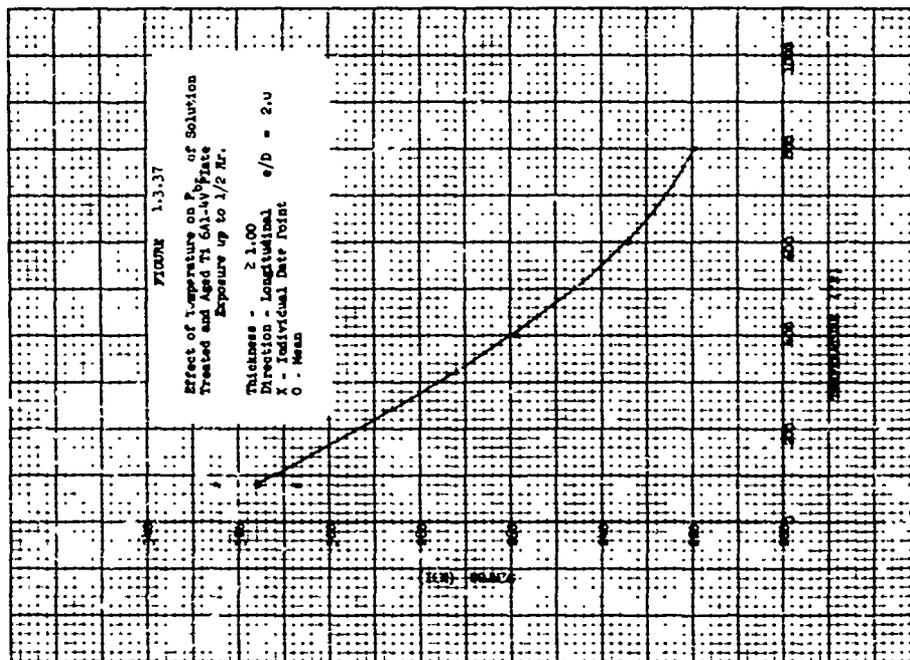
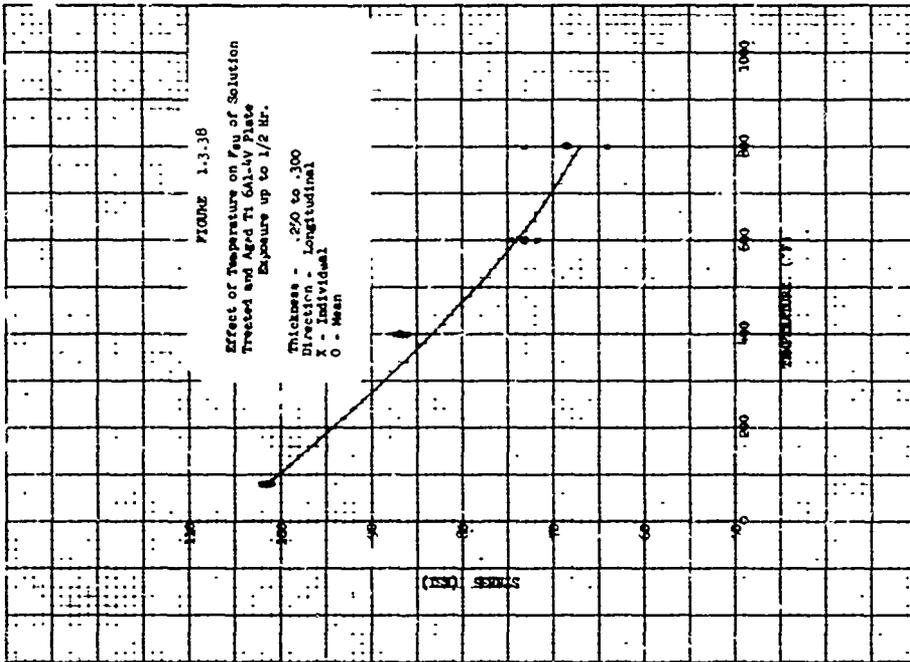


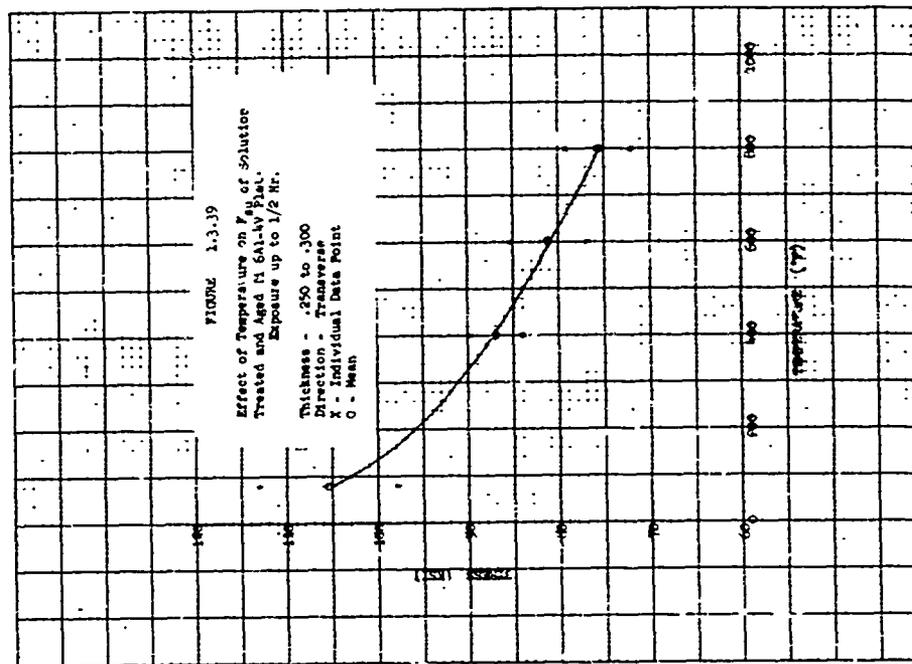
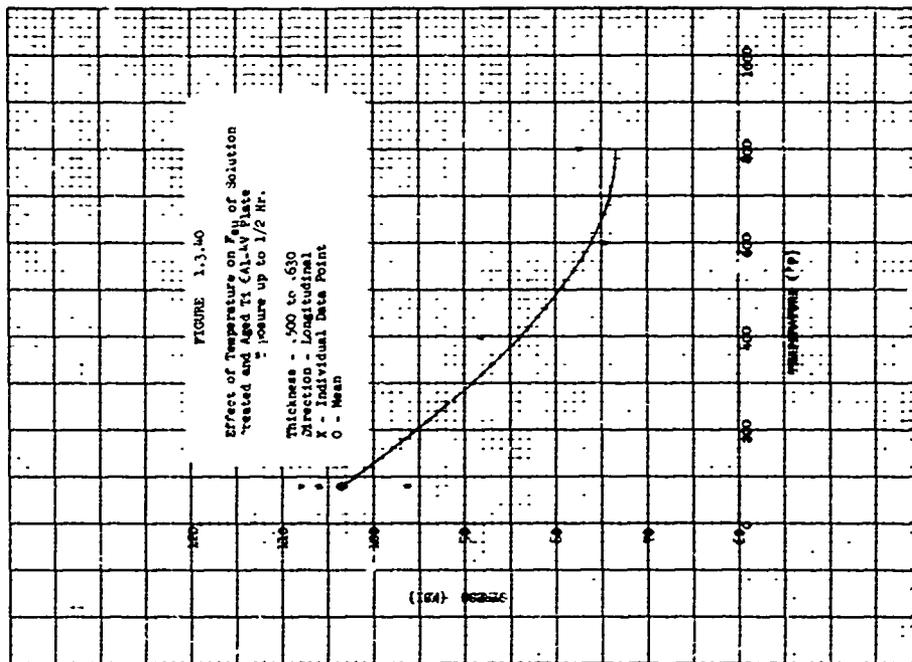


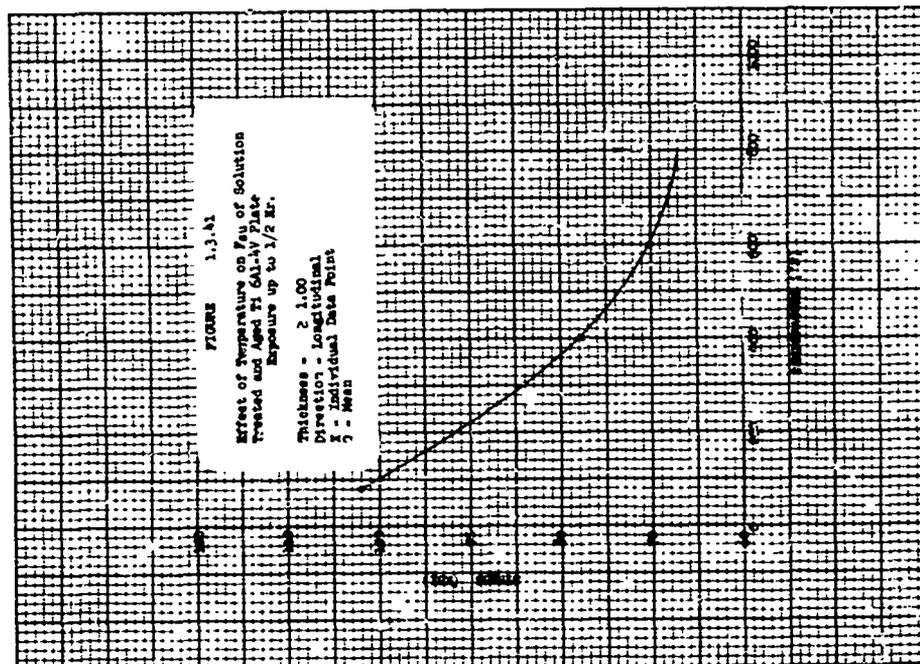
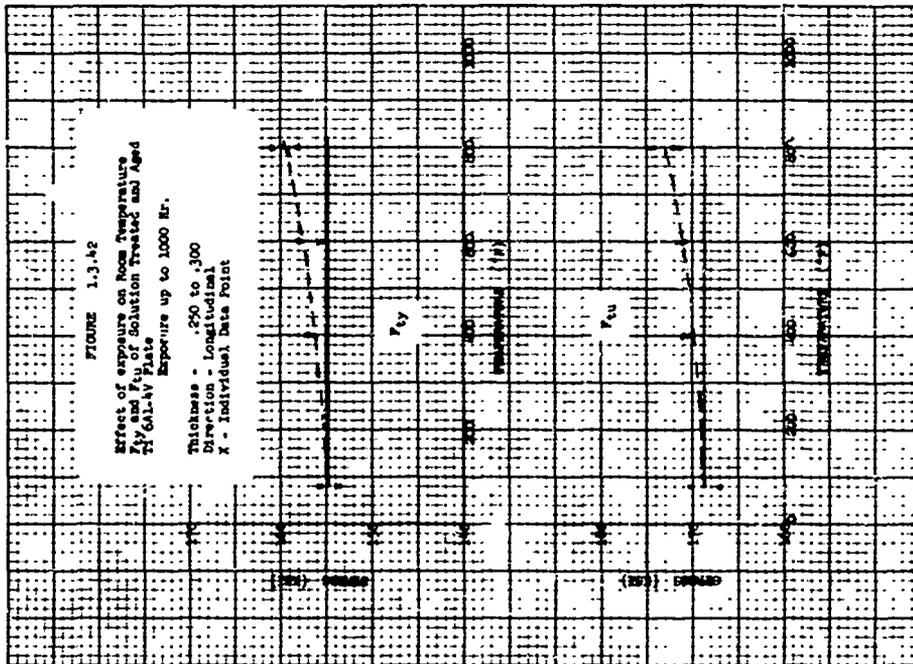




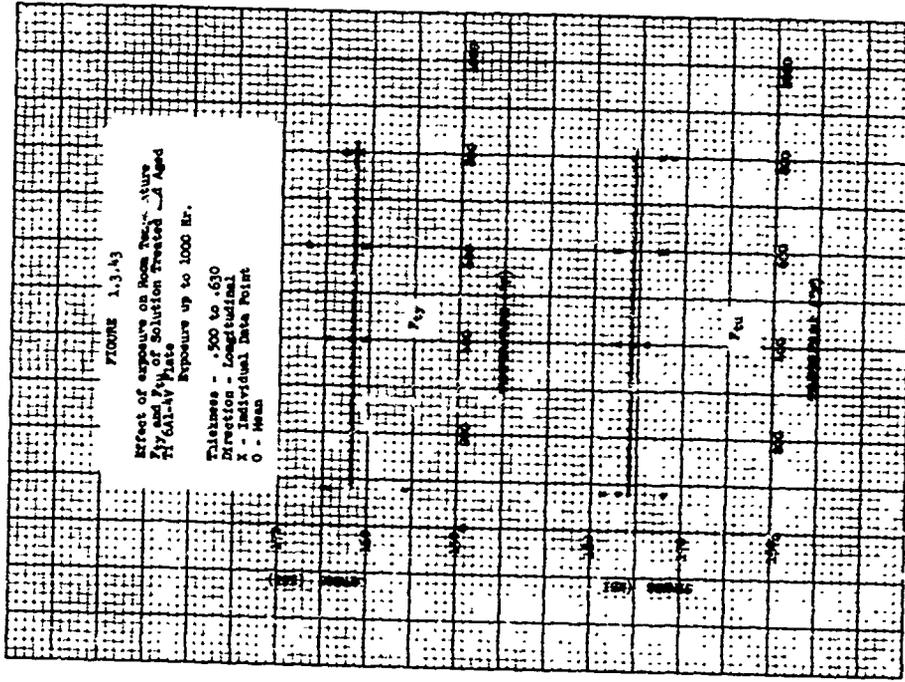








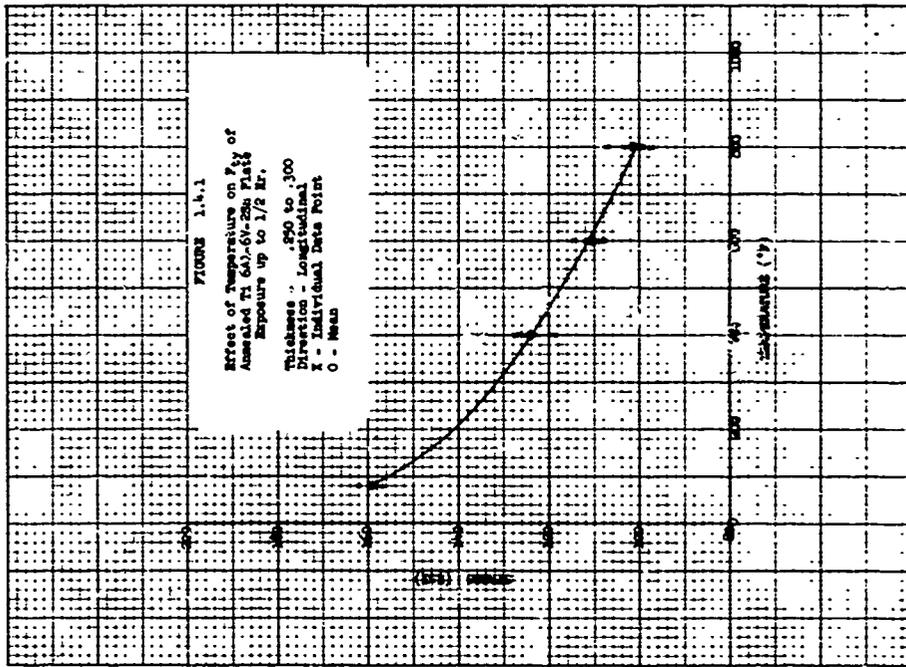
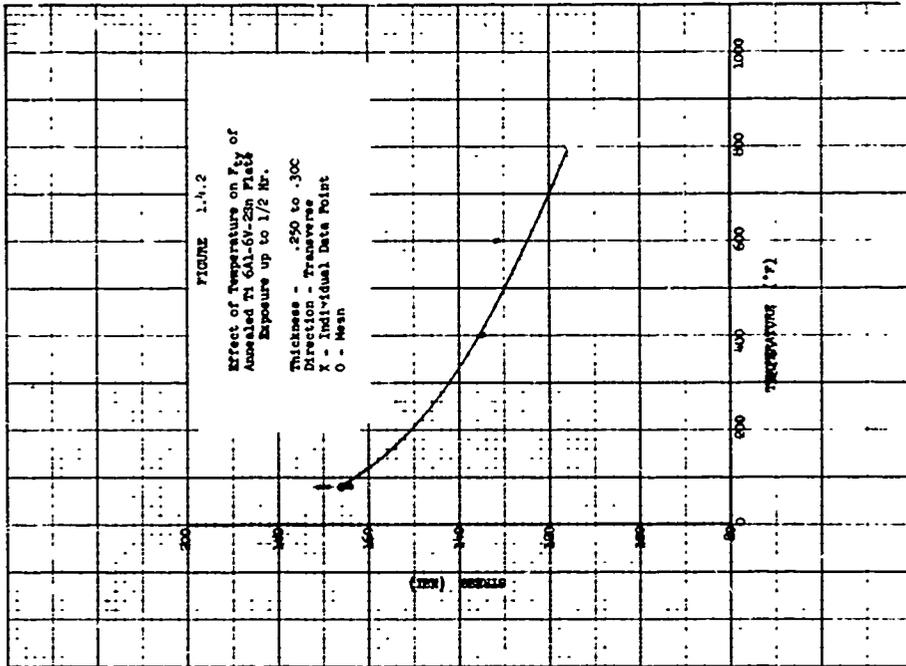


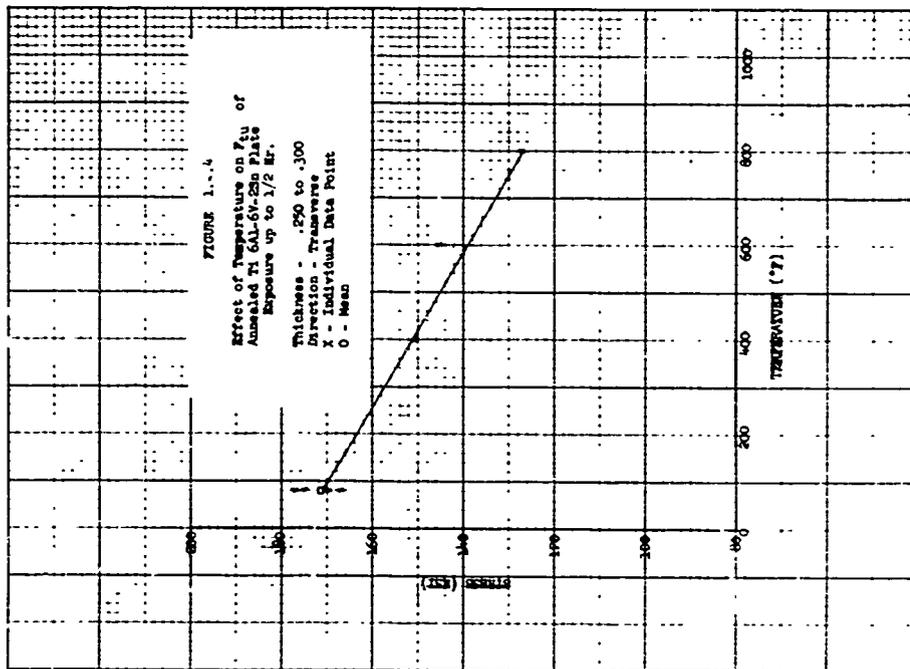
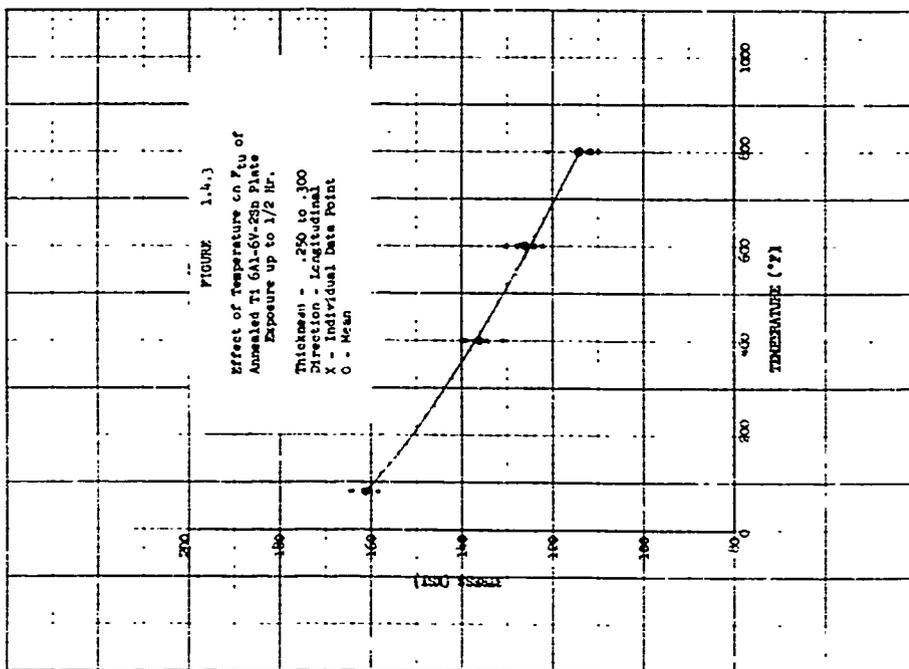


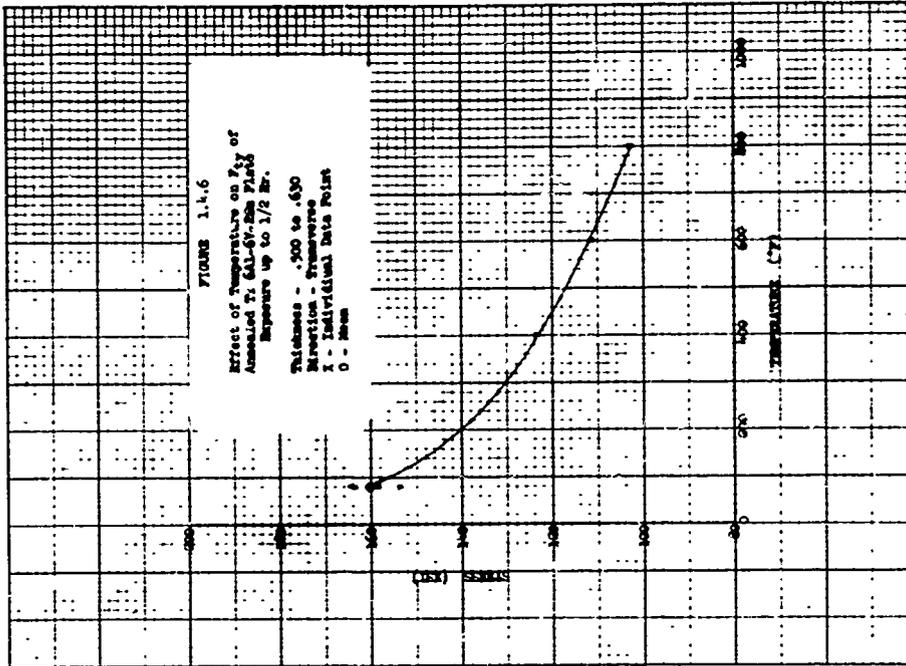
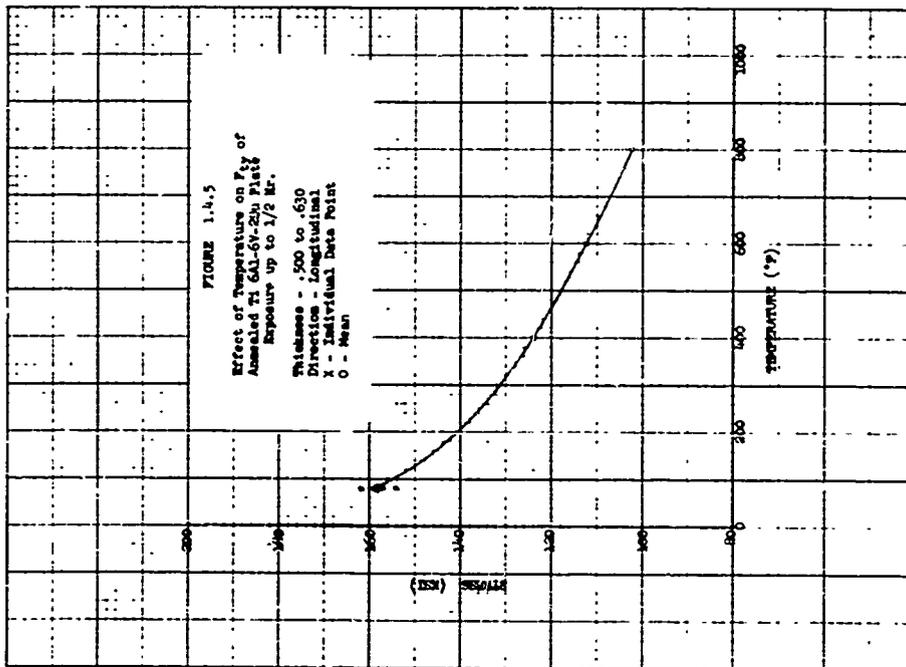
A WORKING CURVES (continued)

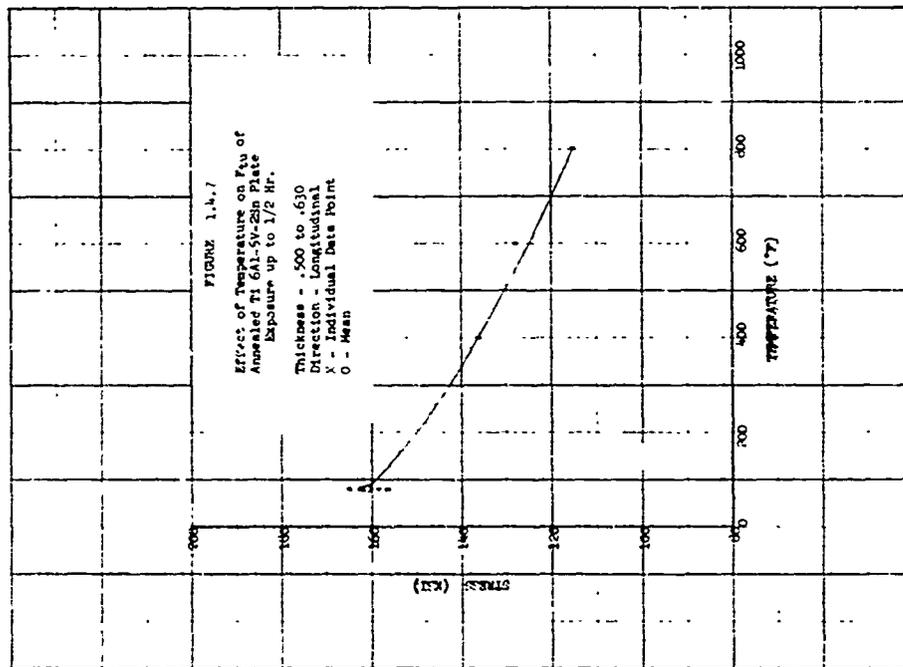
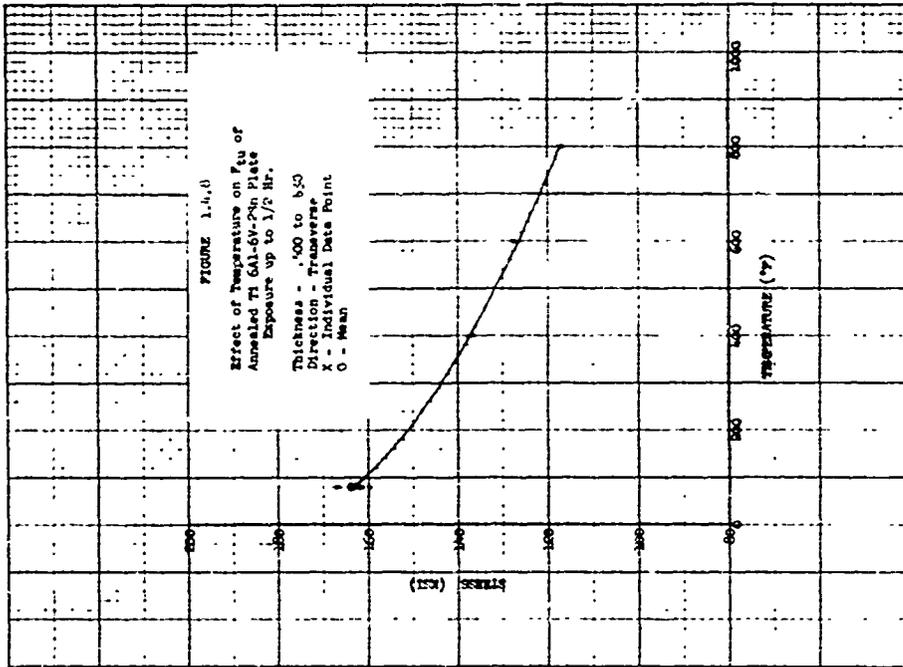
1.4 Ti-6Al-6V-2Sn Cond. A

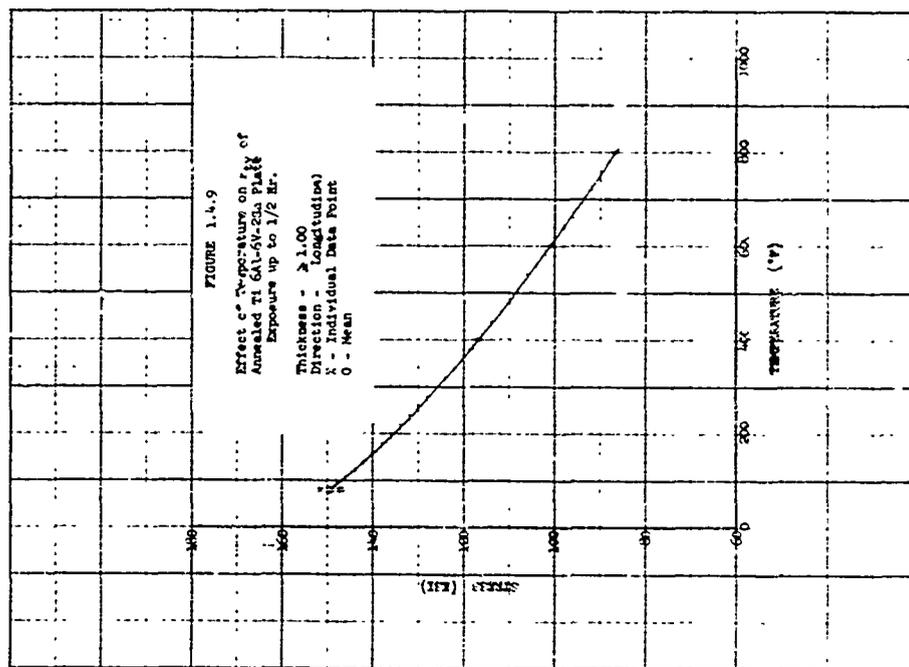
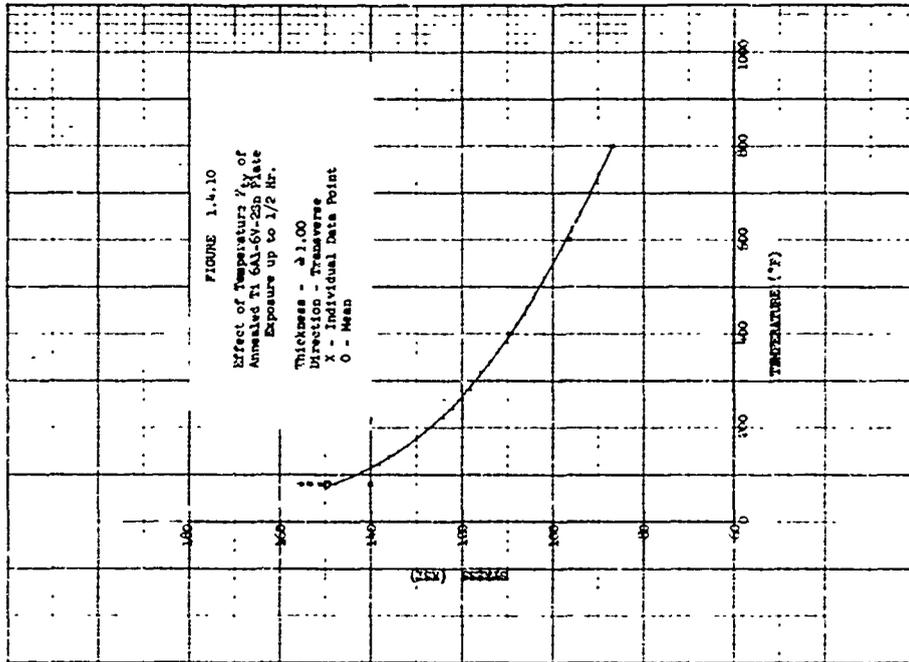
Figures 1.4.1 to 1.4.44

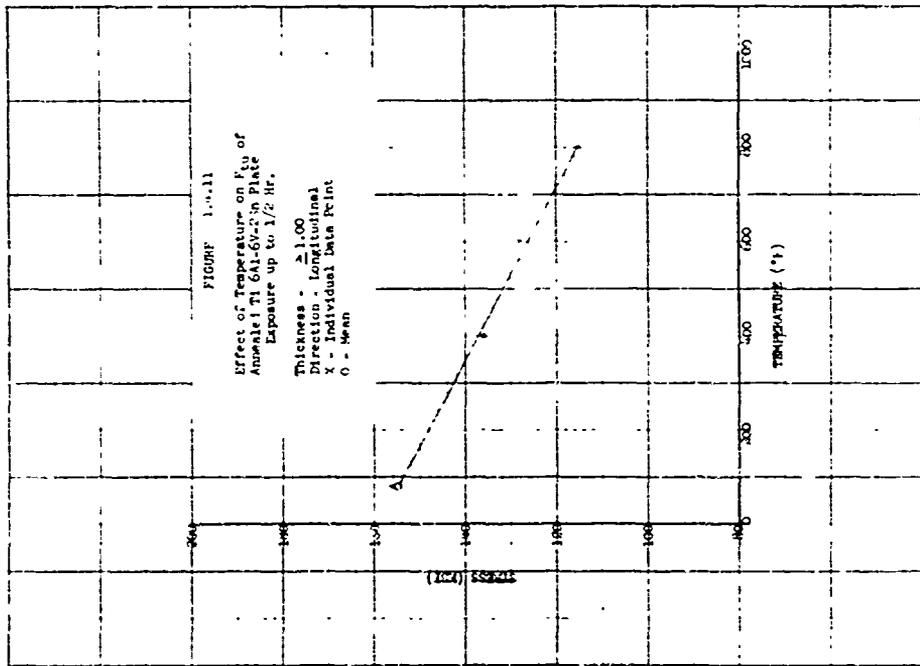
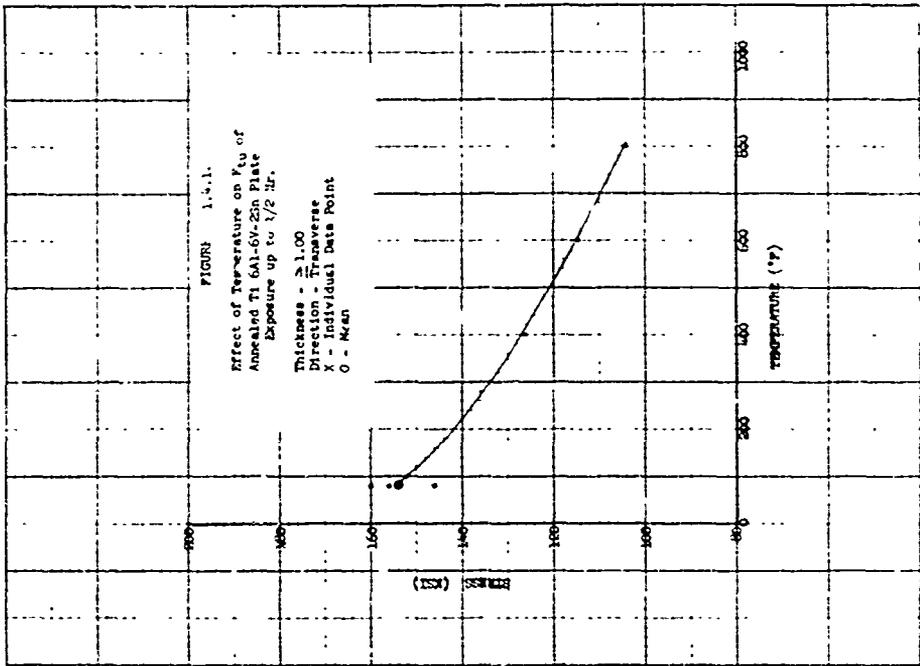




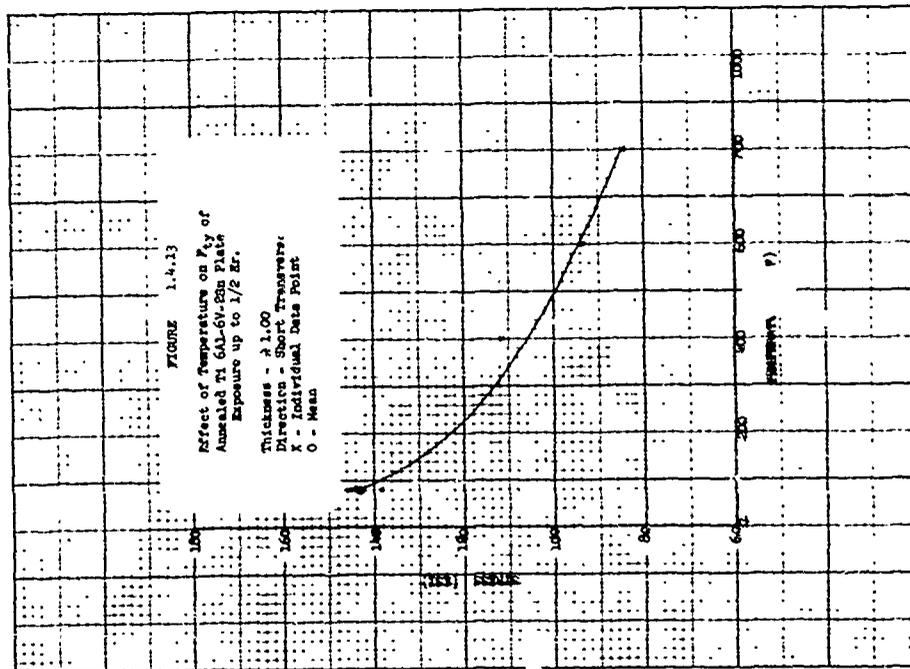
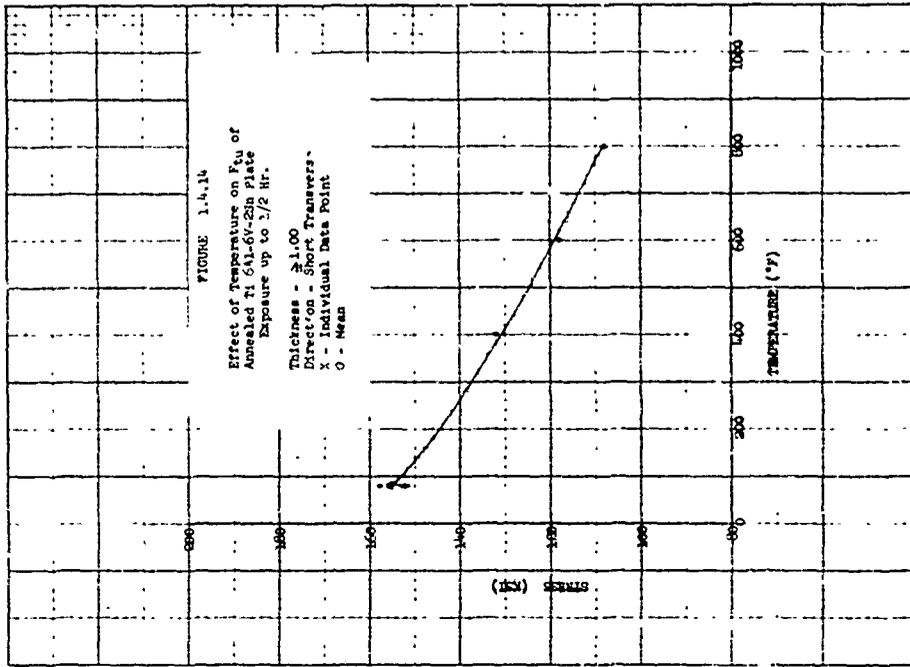


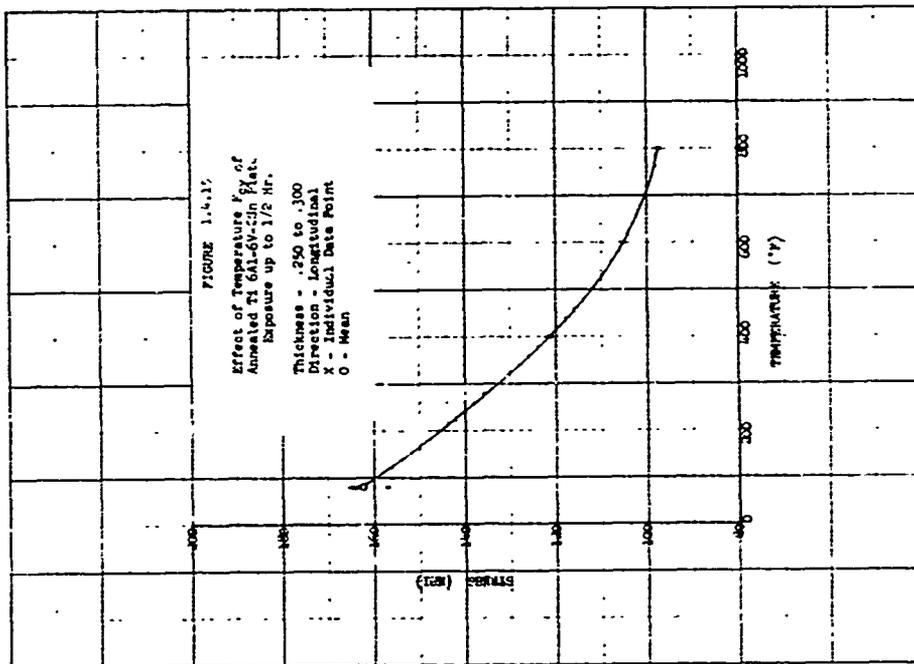
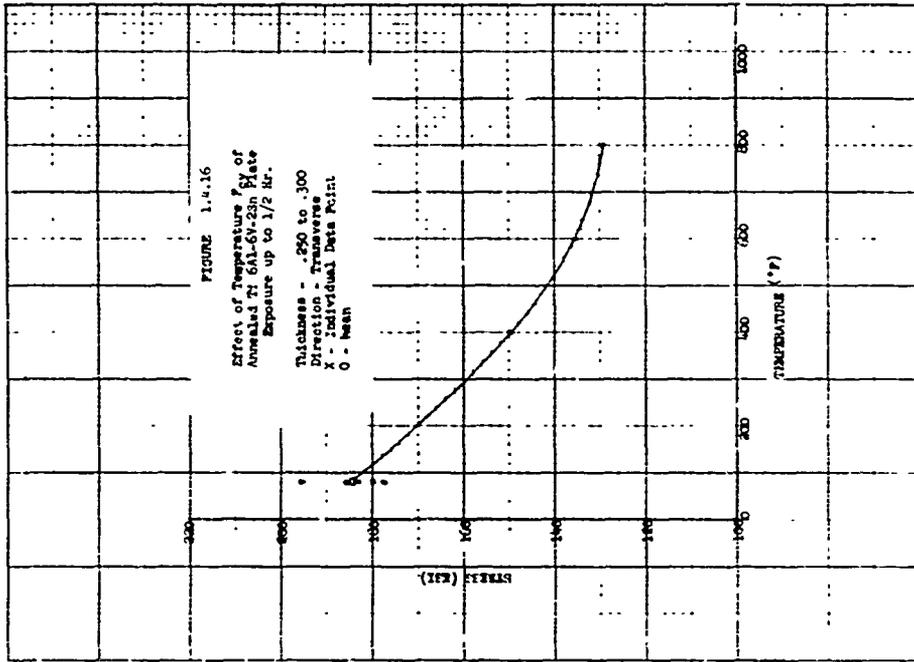


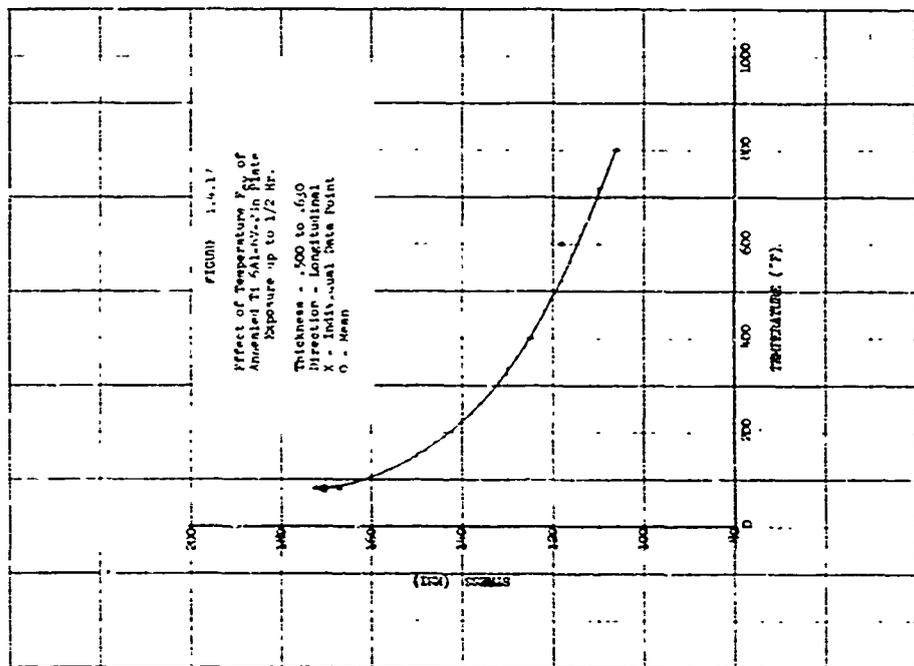
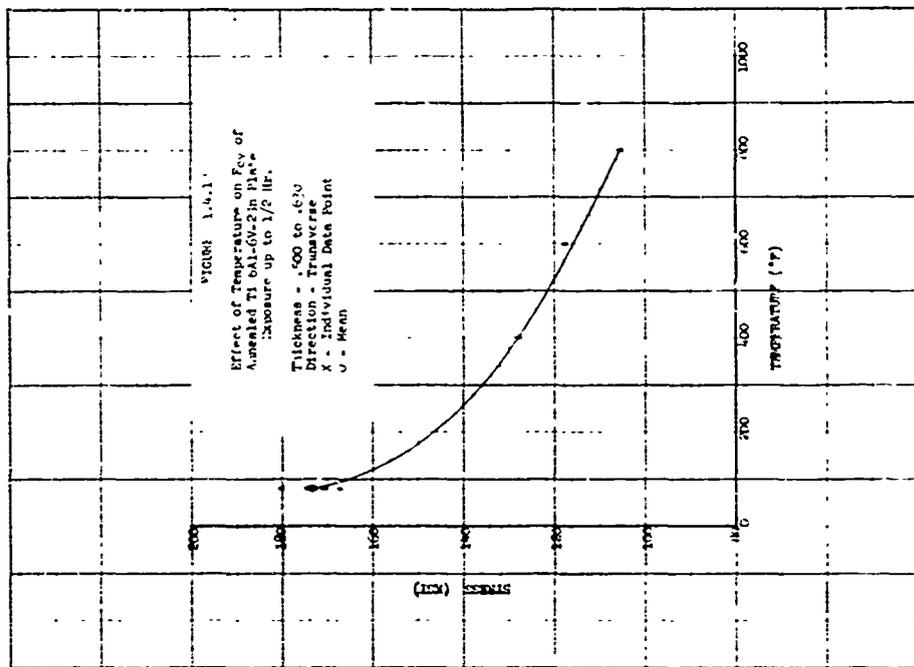




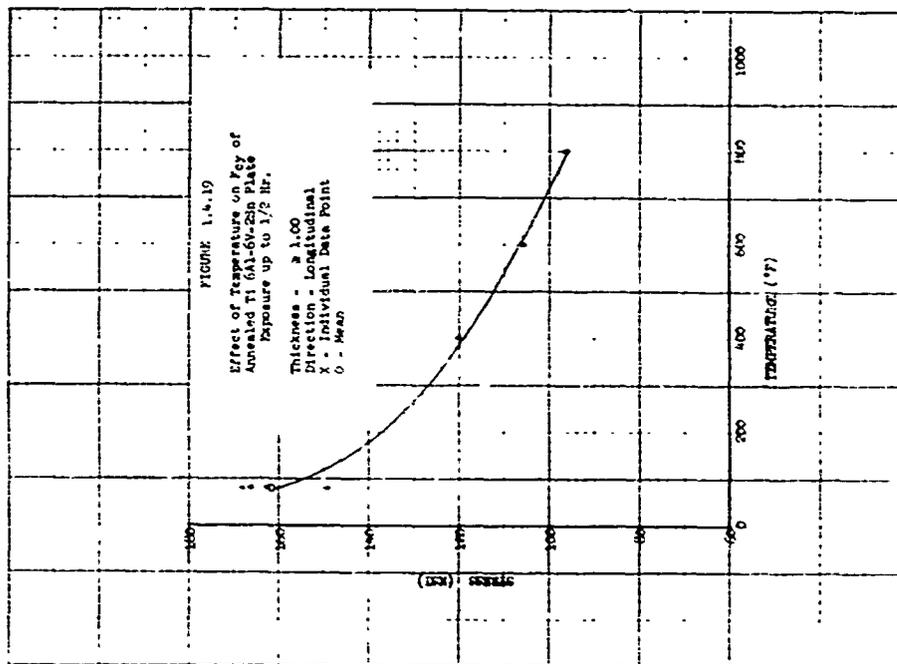
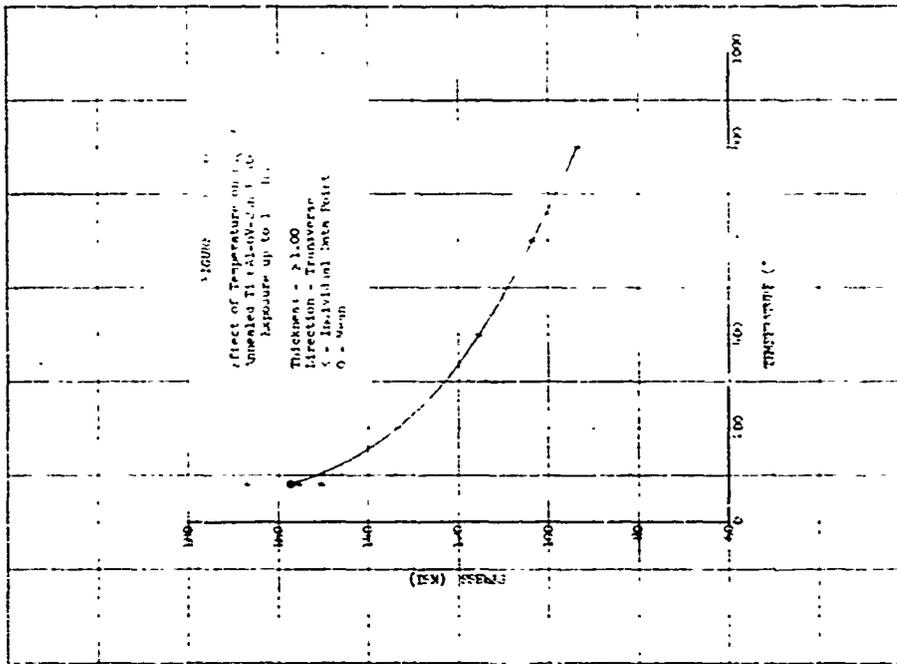


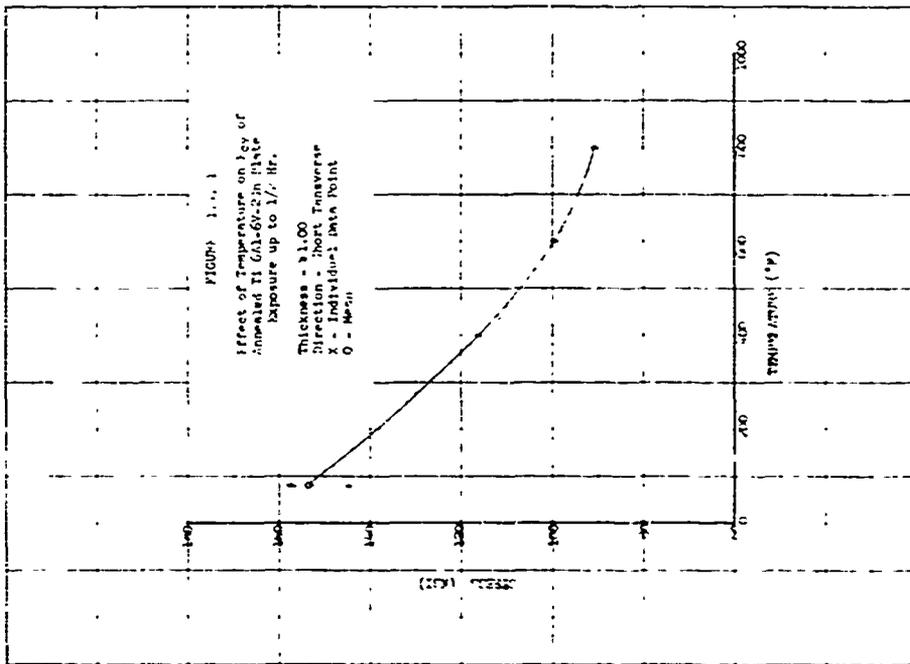
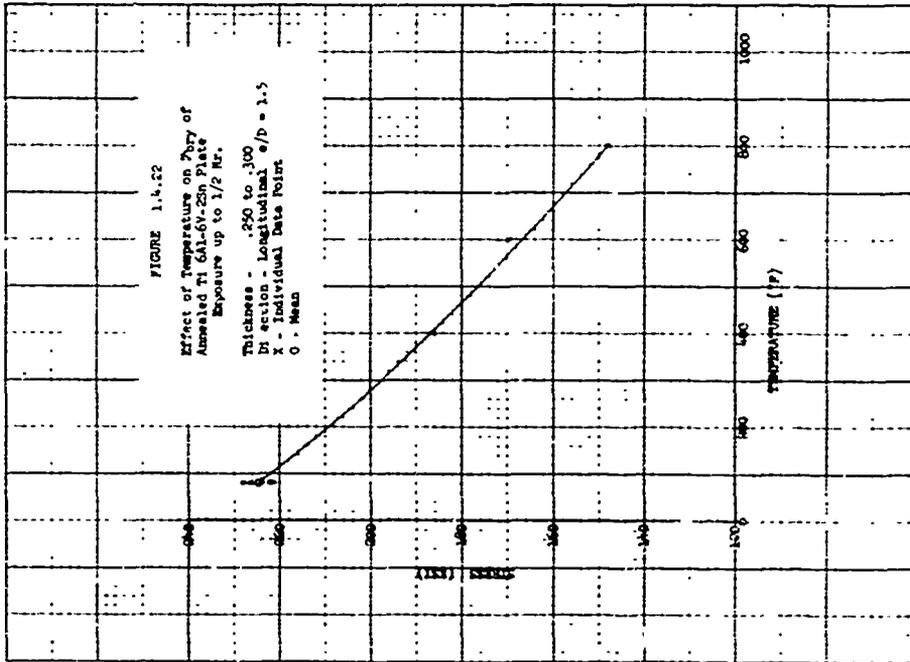


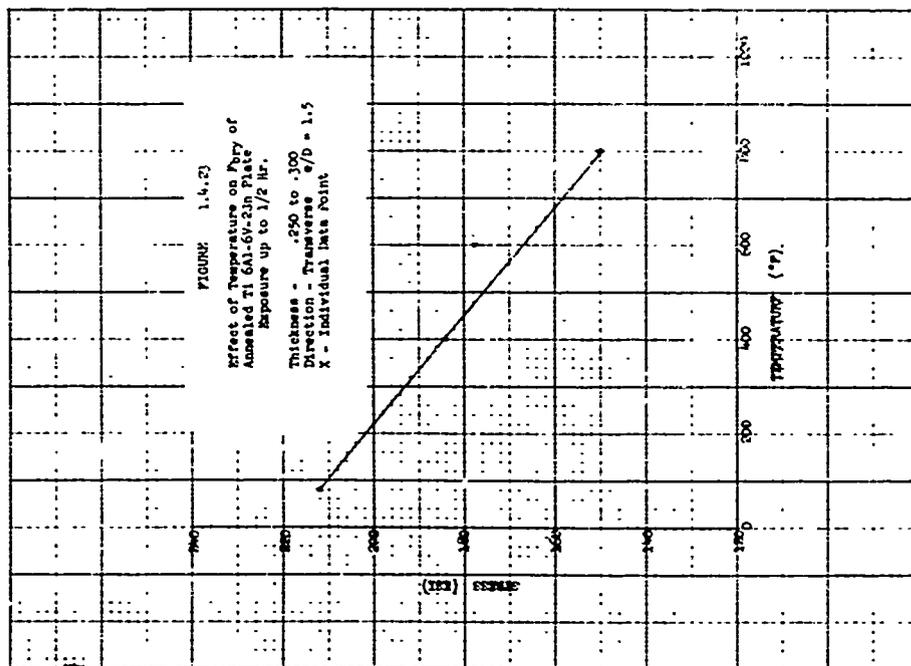
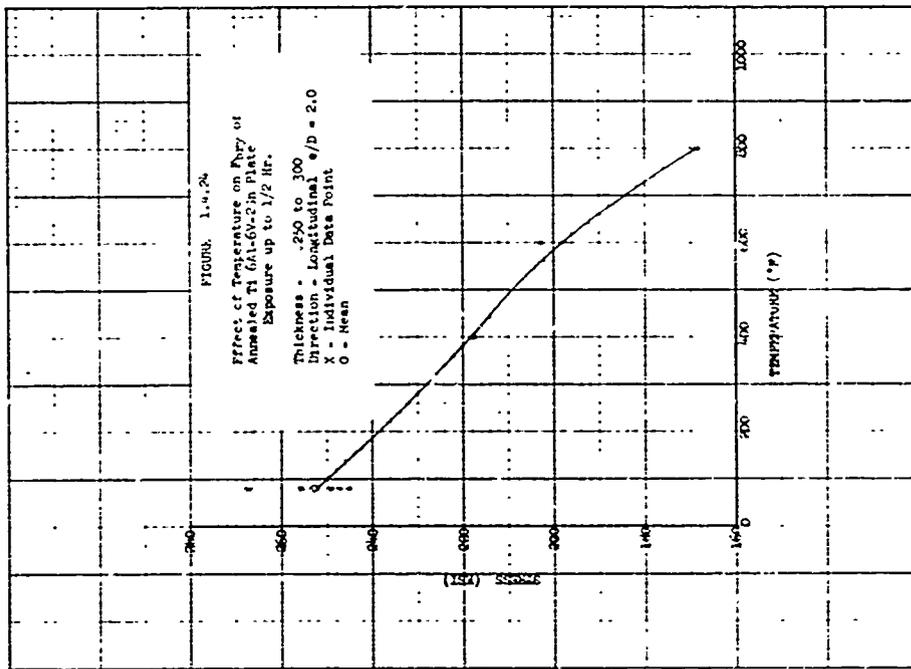


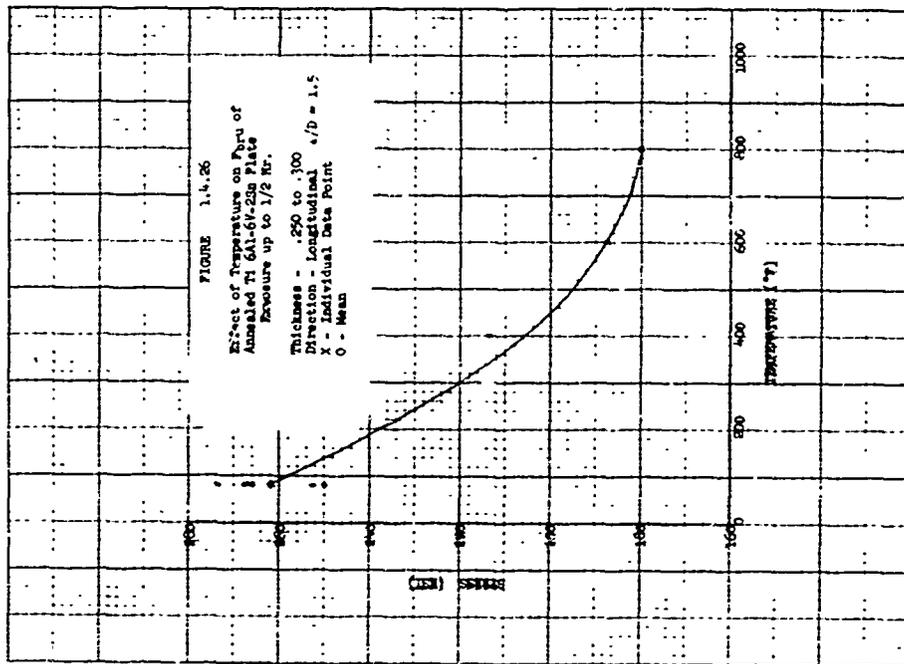
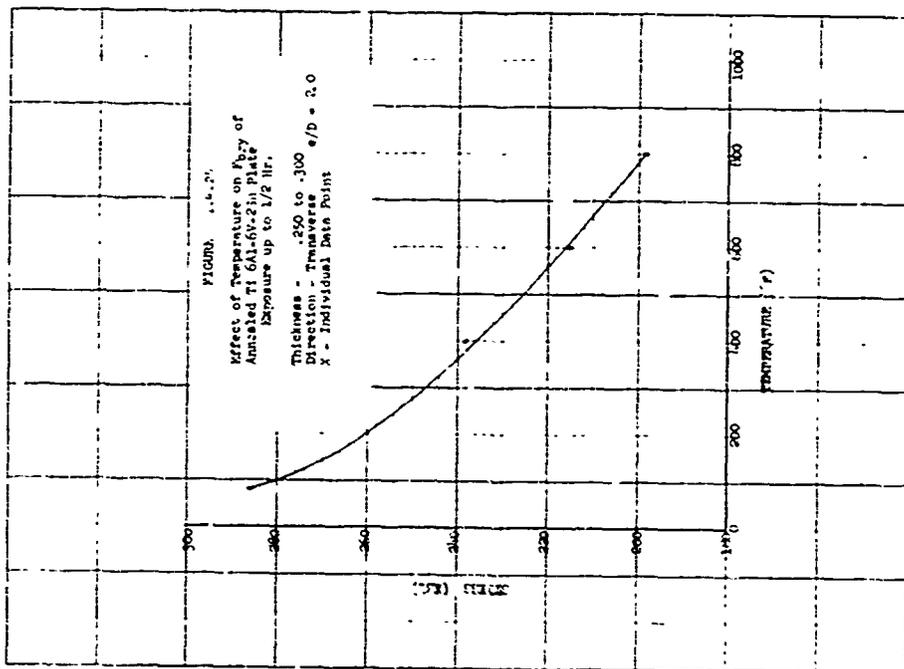


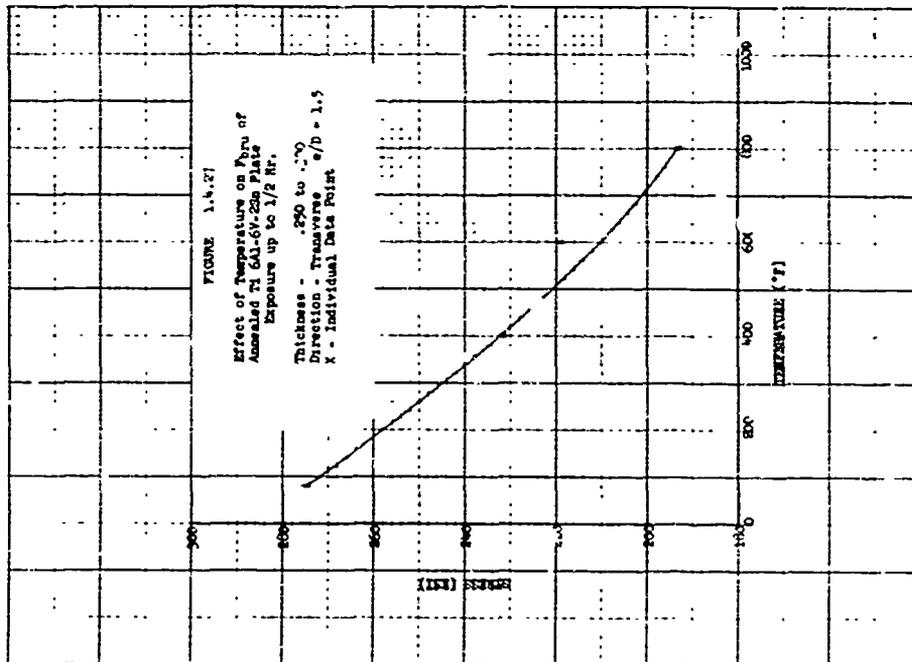
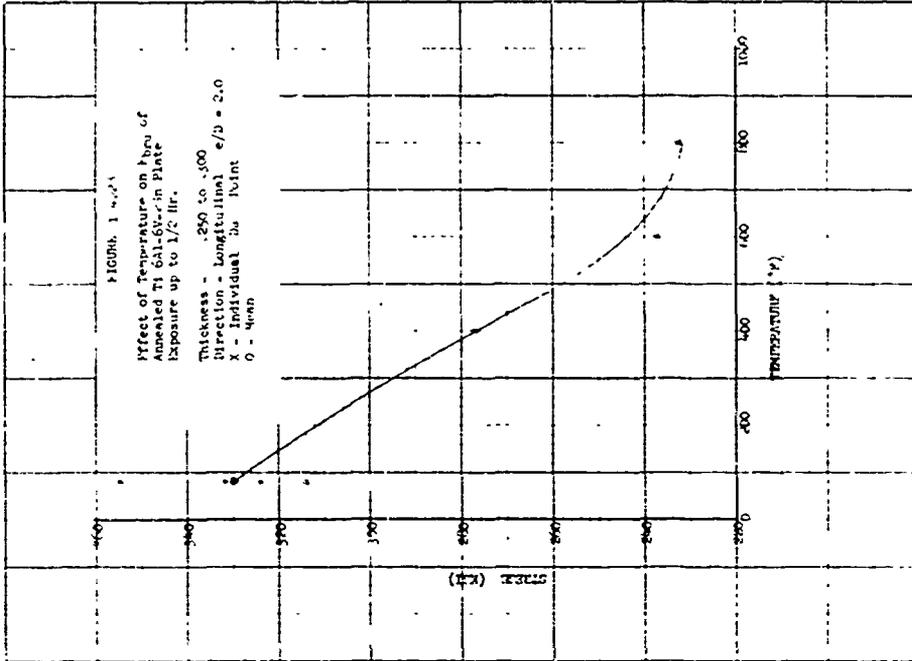
# NOT REPRODUCIBLE



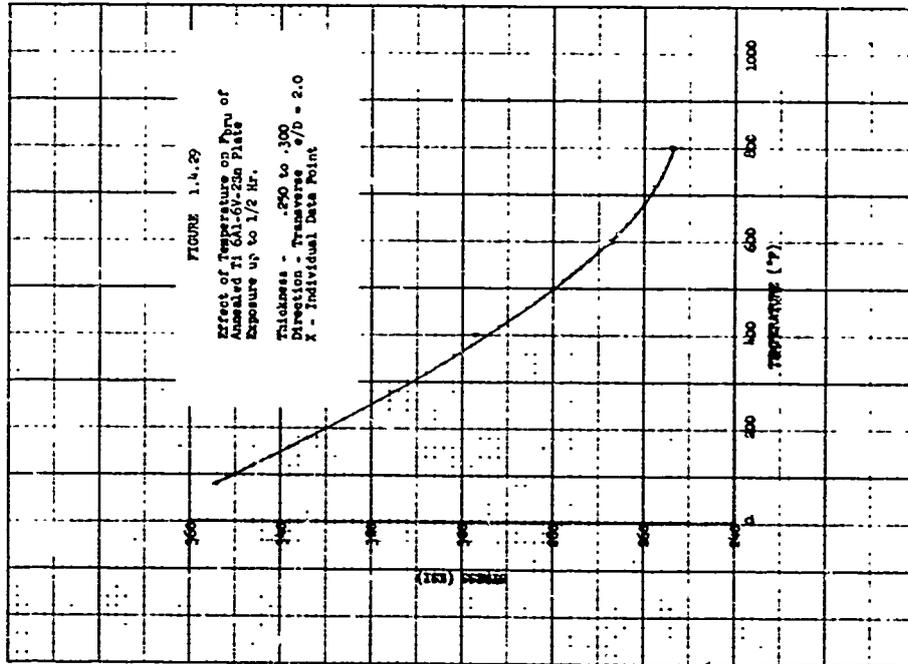
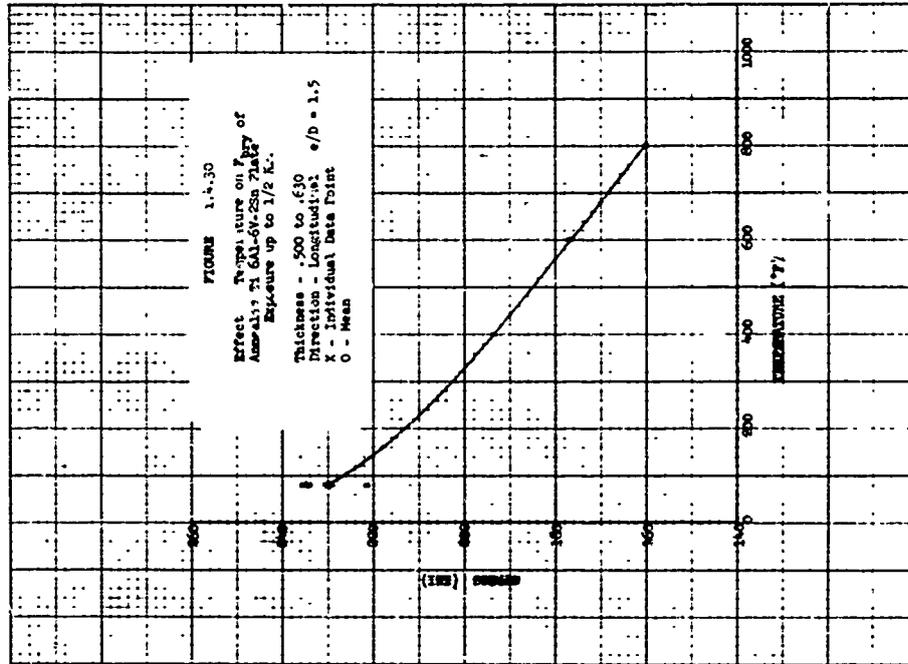


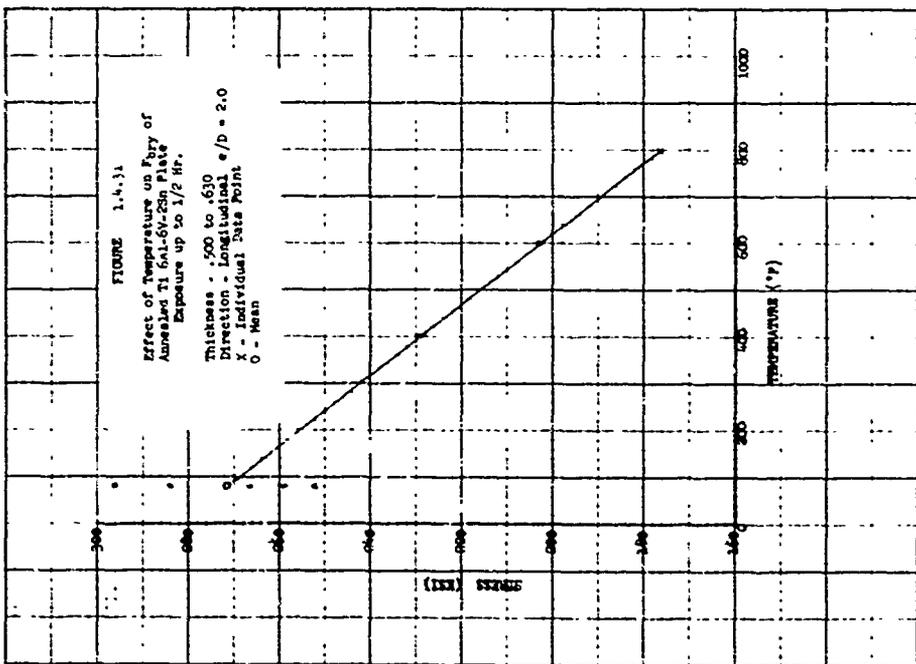
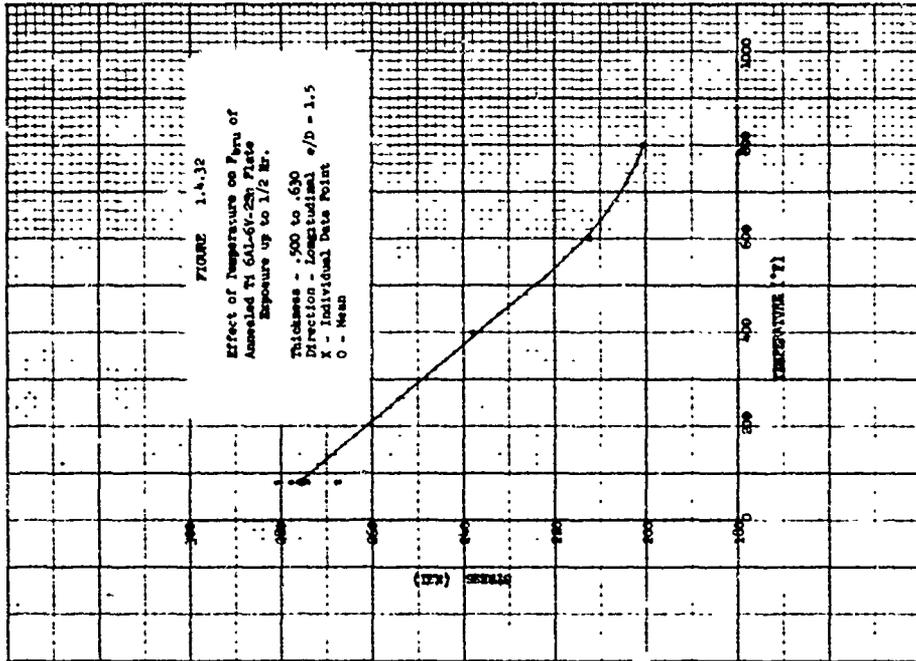


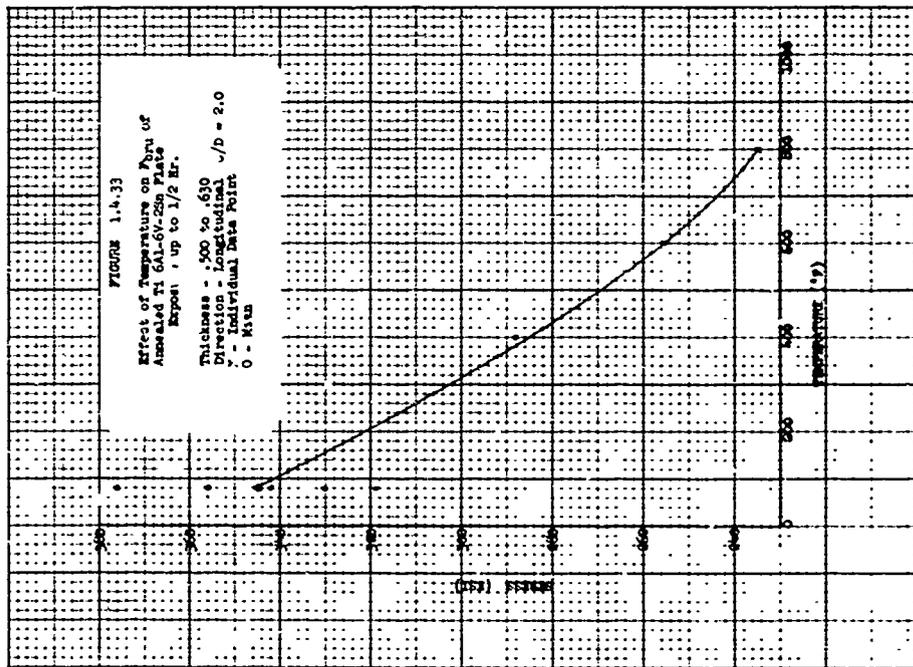
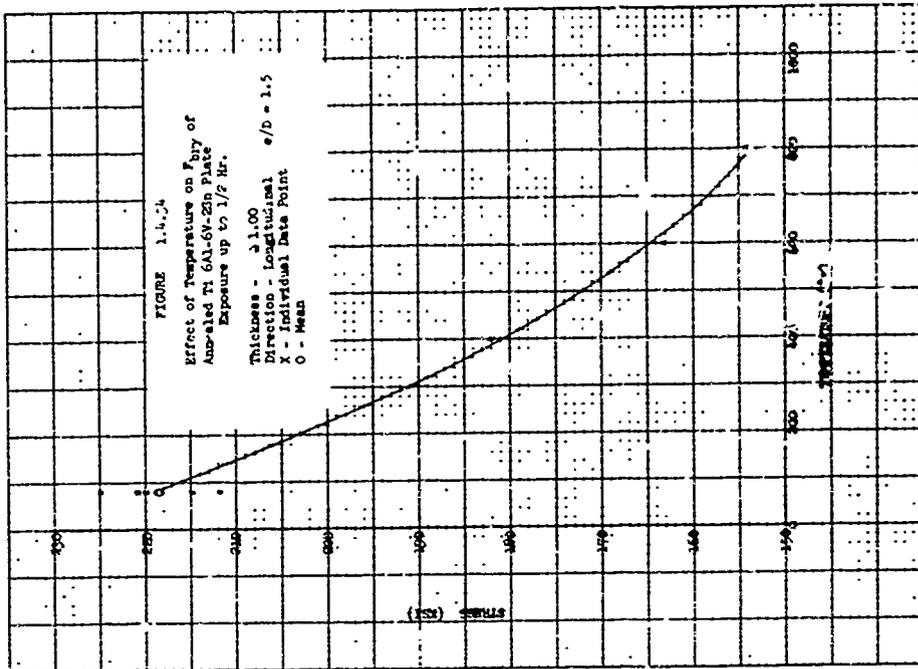


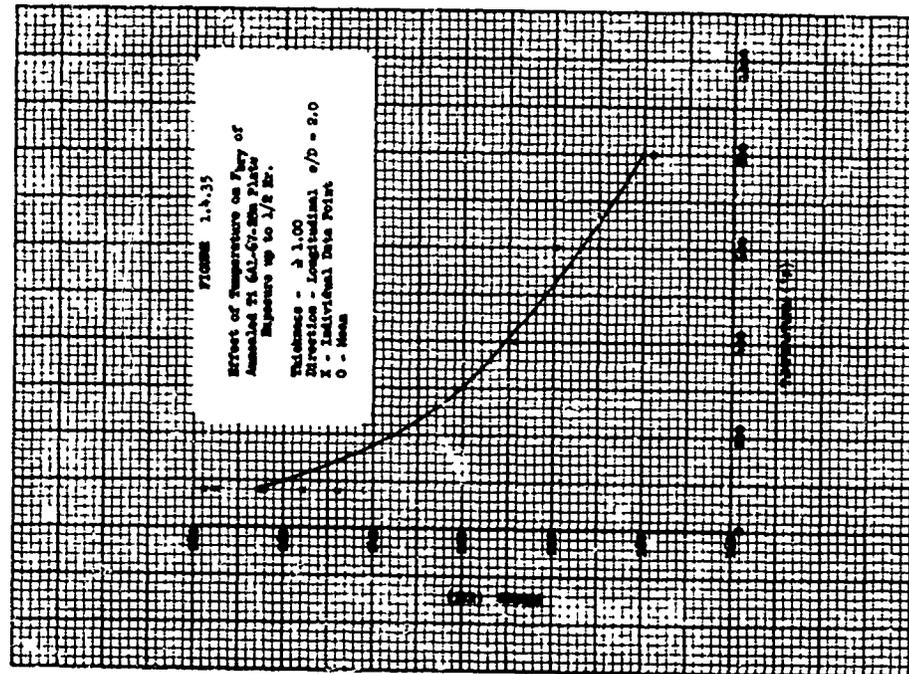
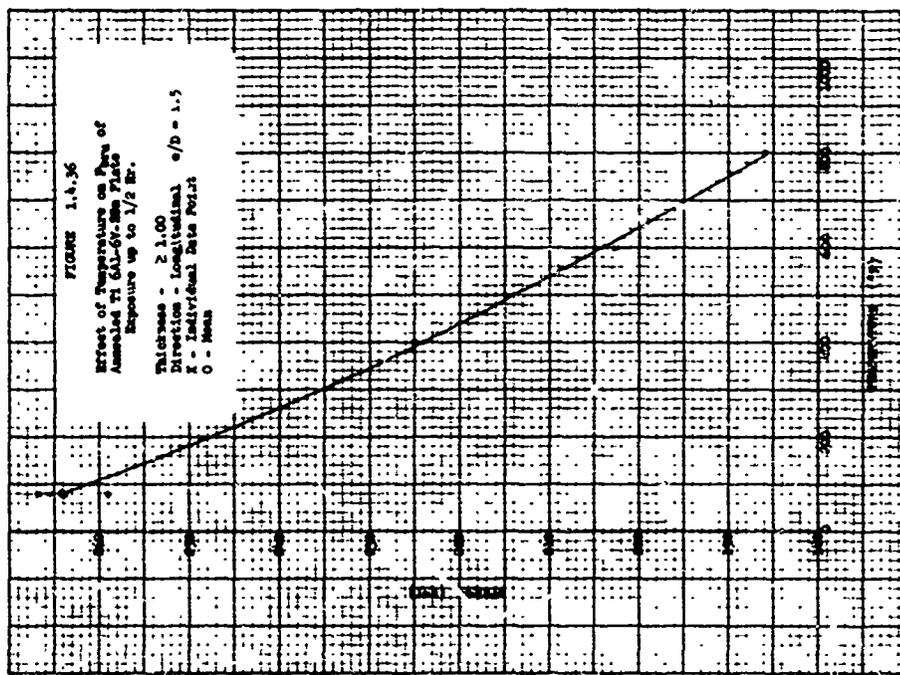


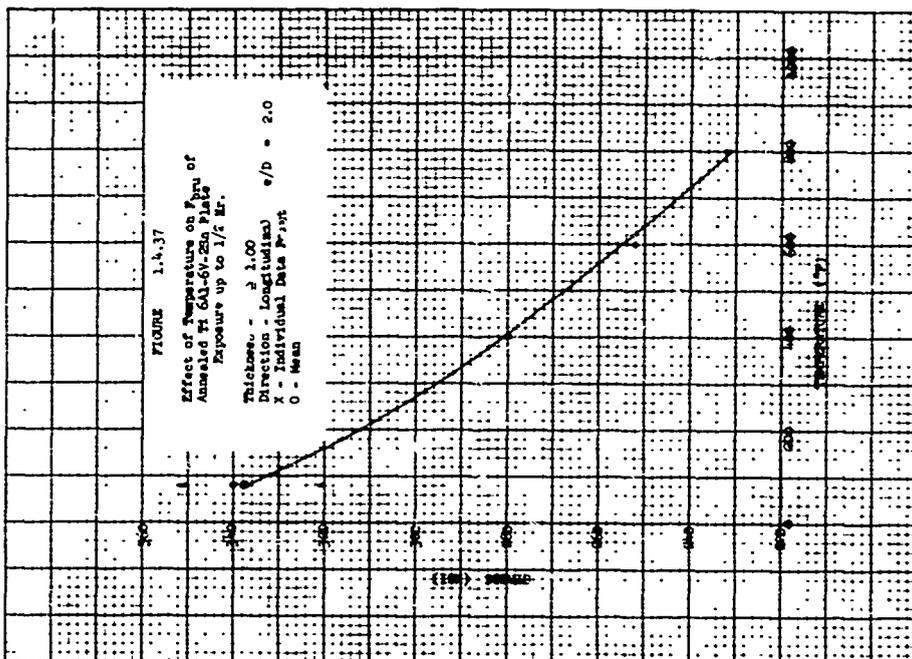
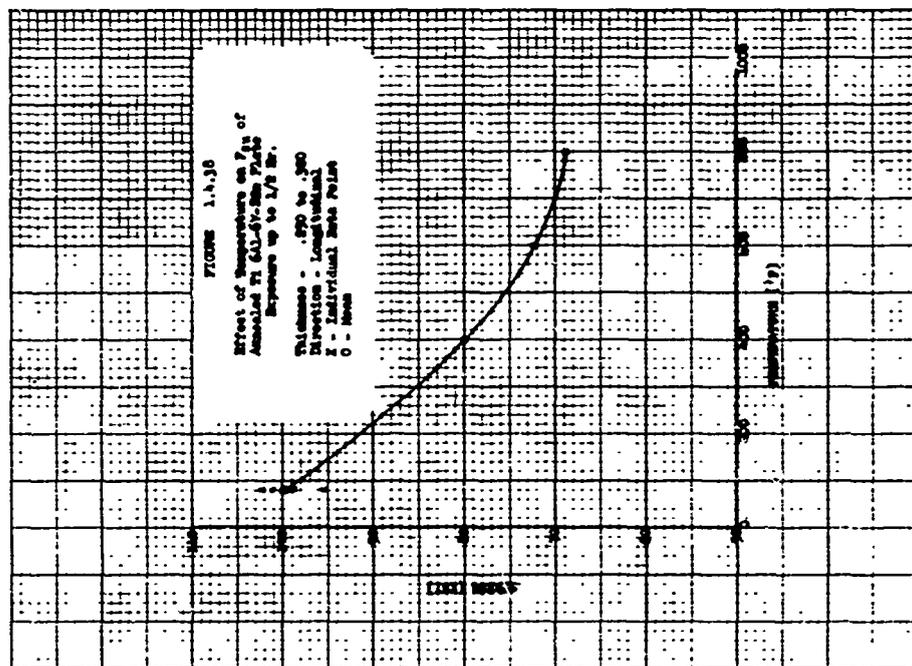




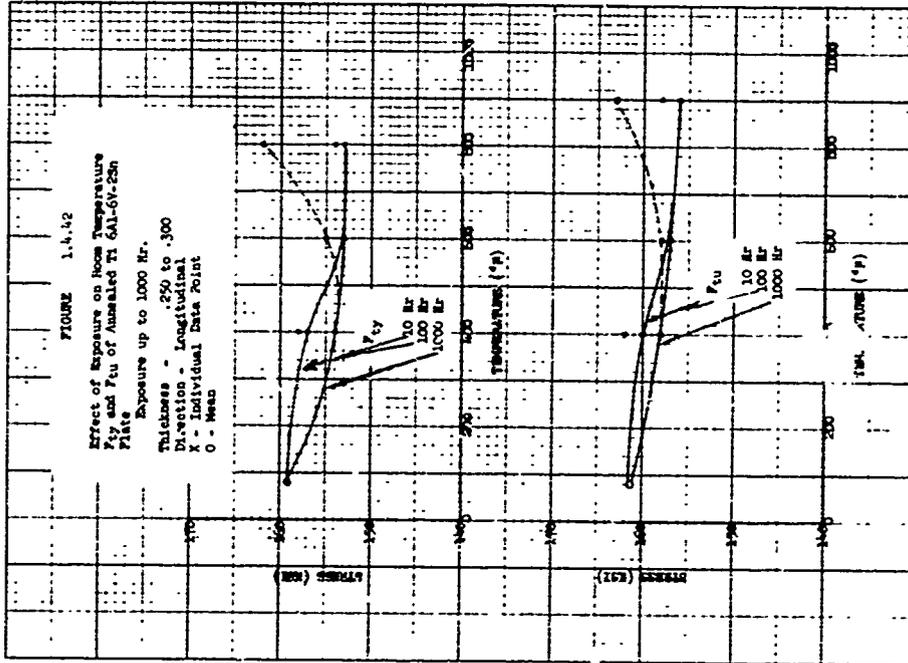
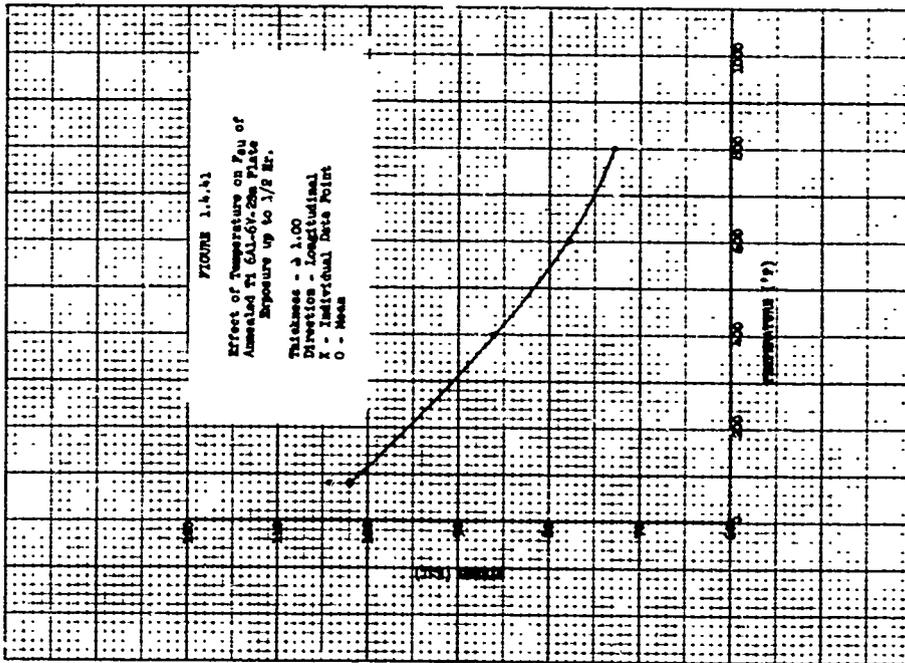


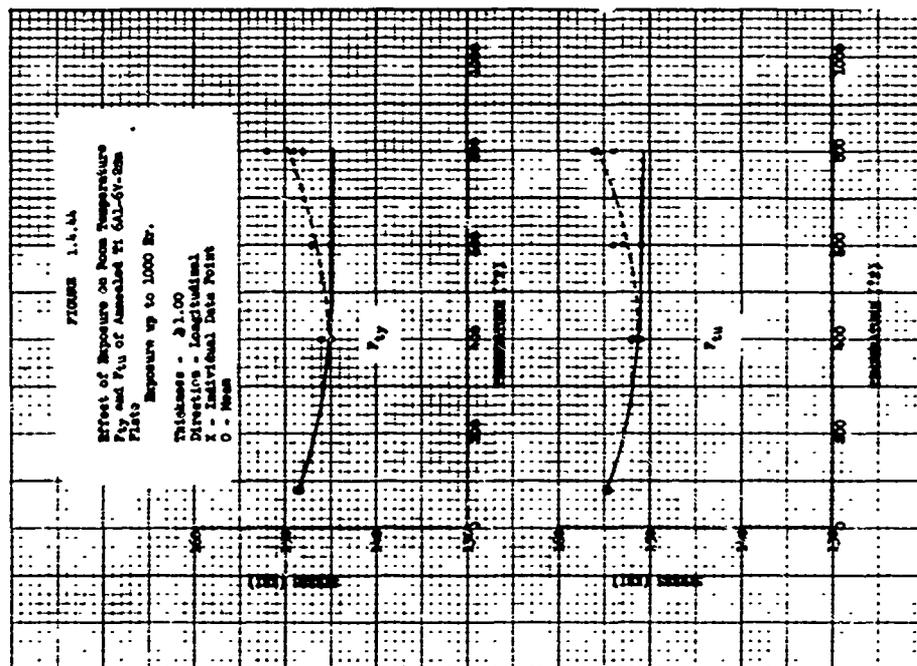
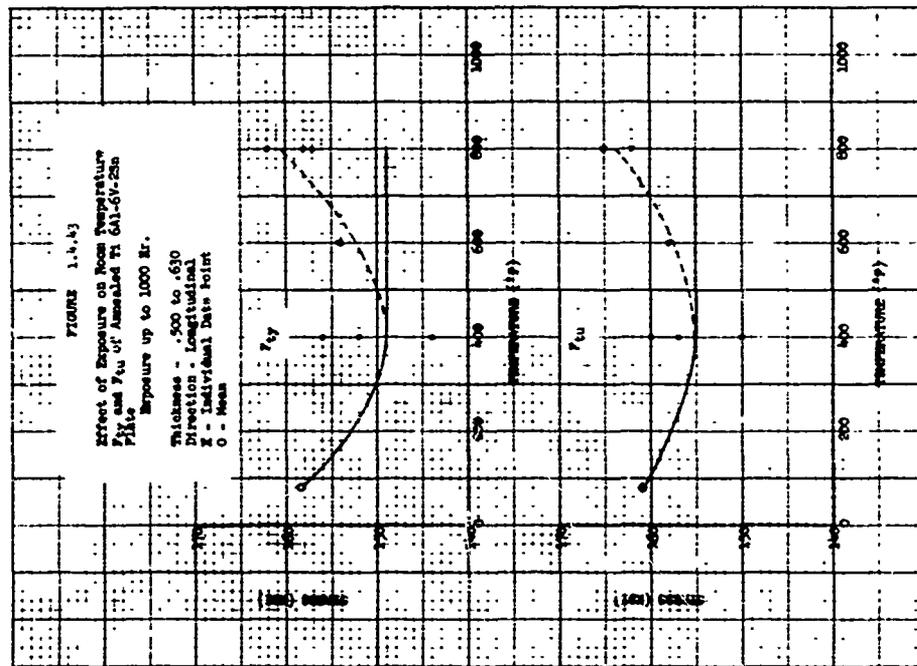










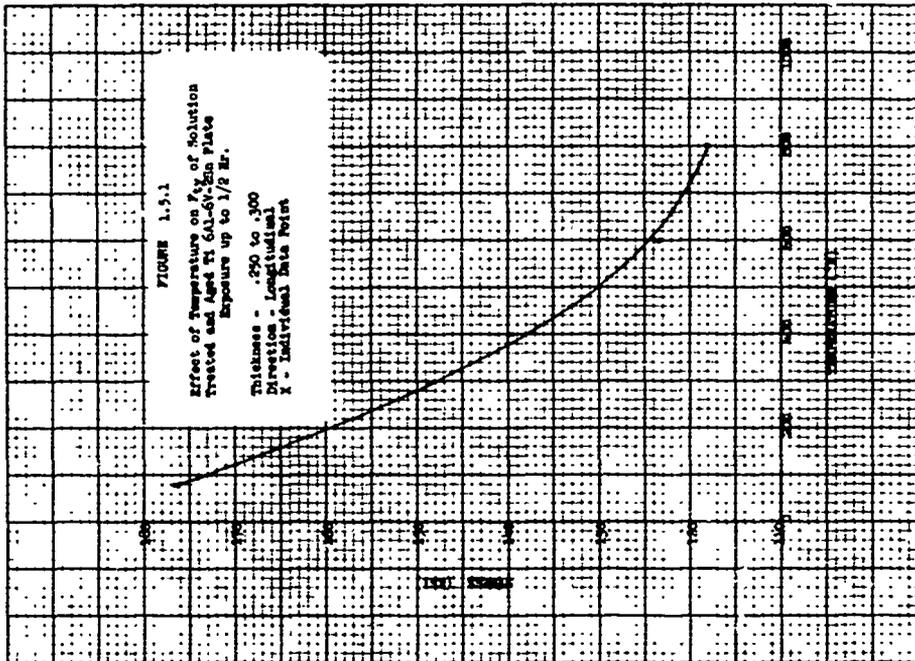
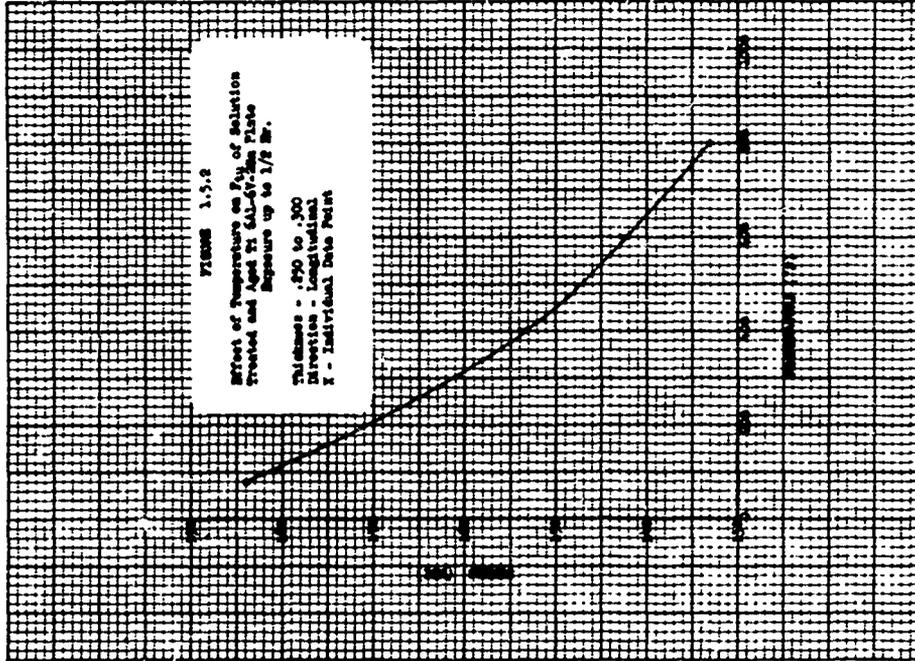


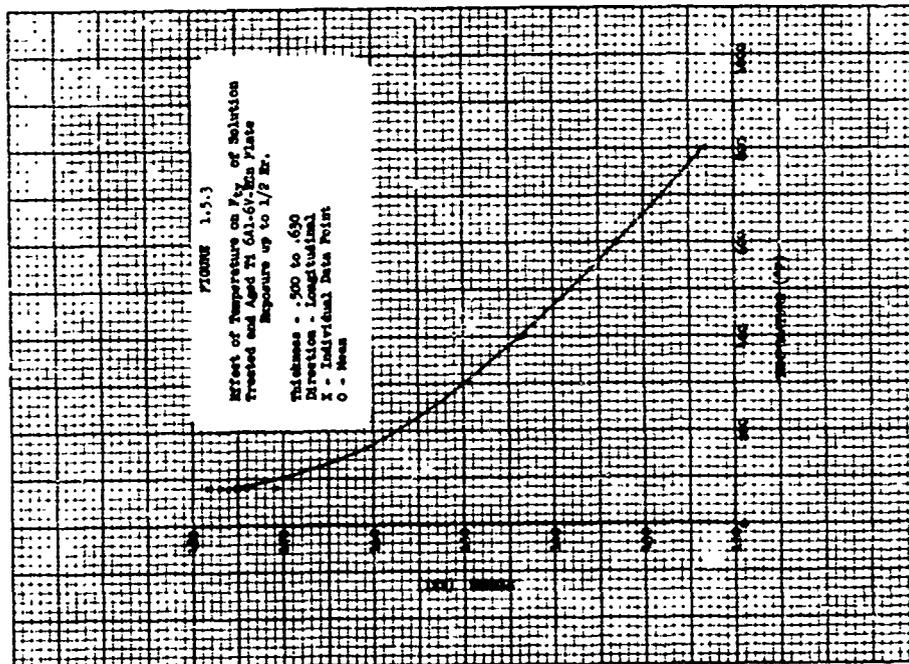
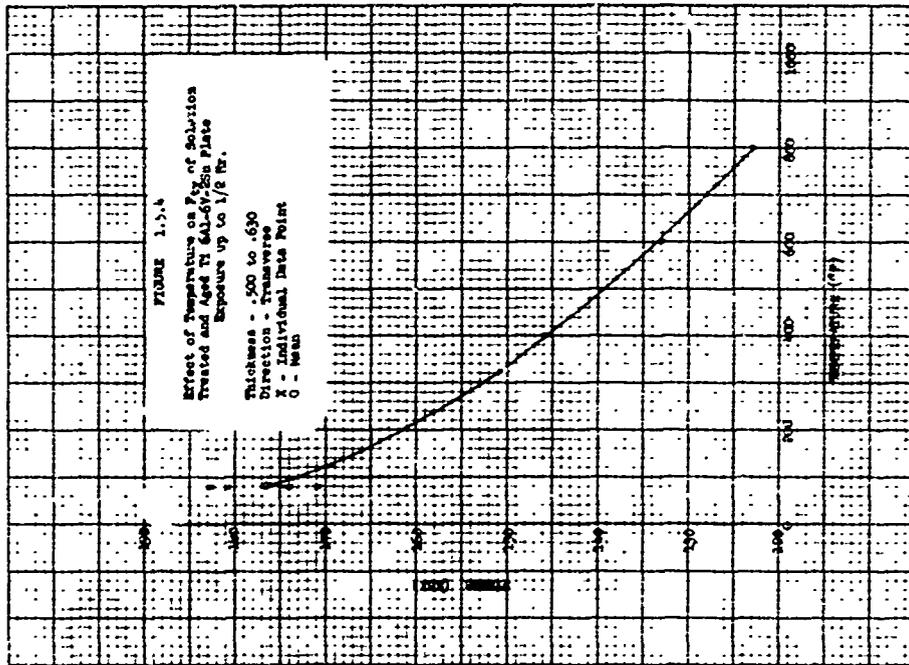


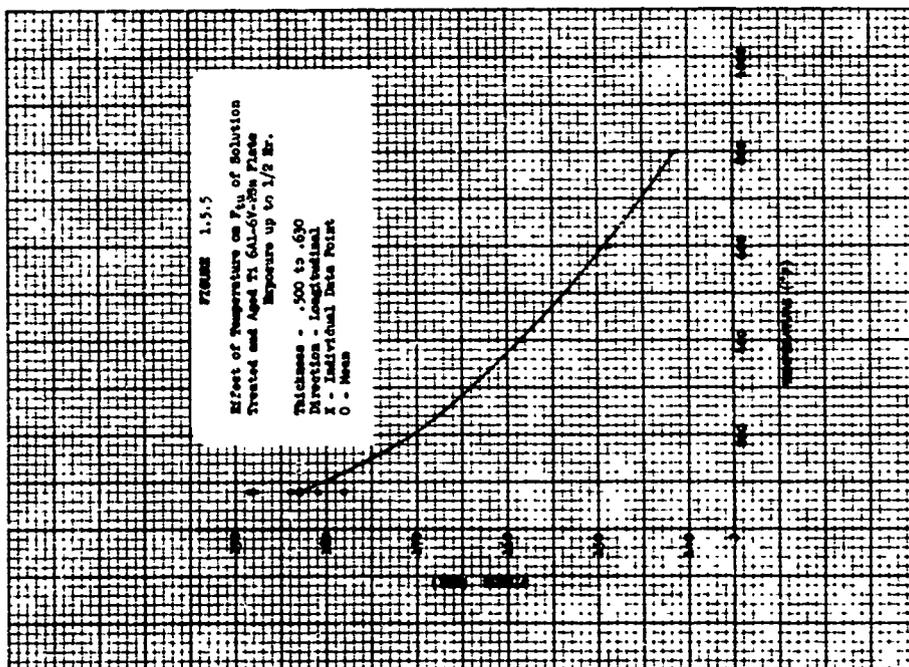
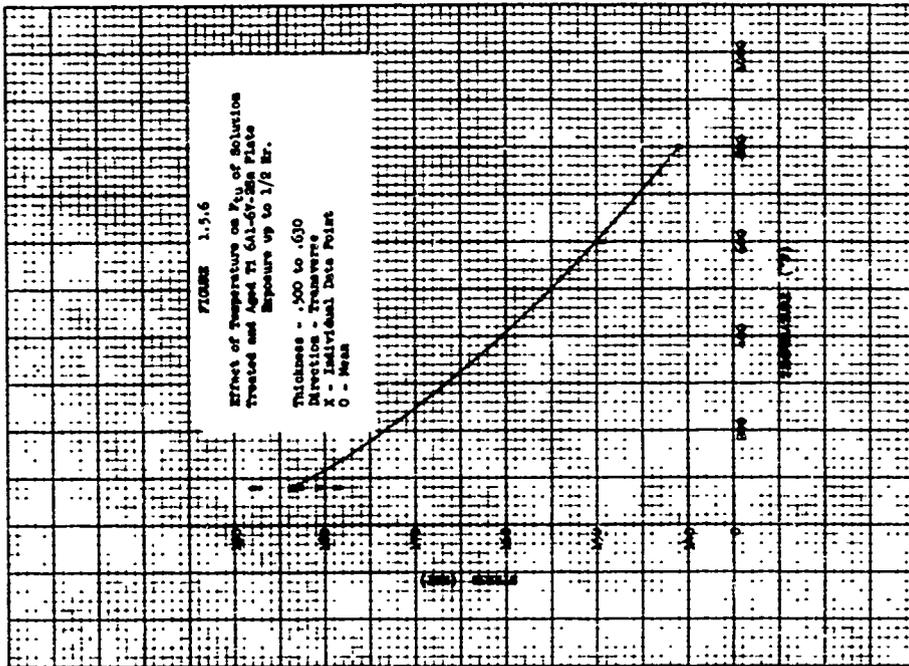
B. WORKING CURVES

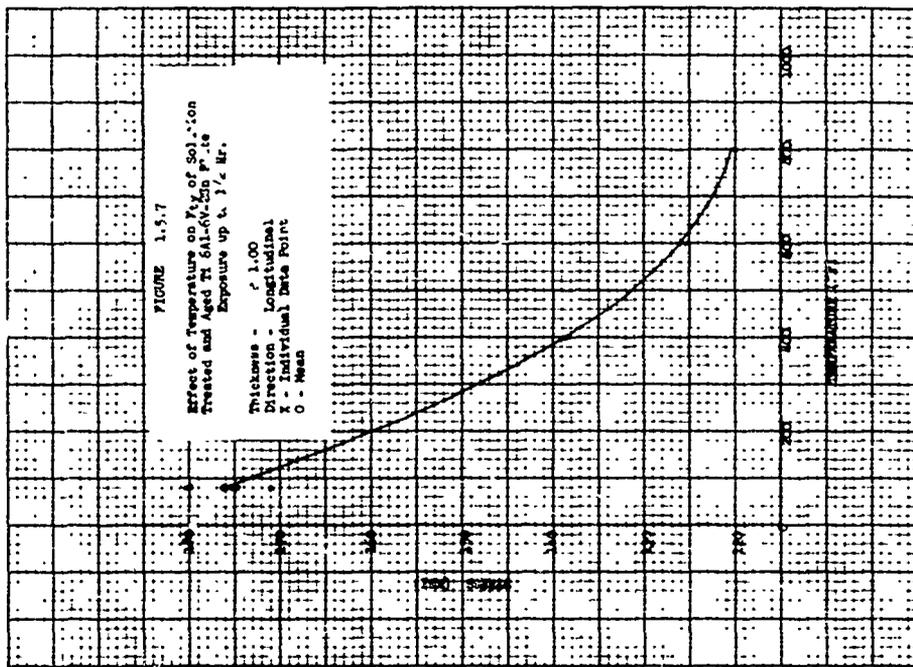
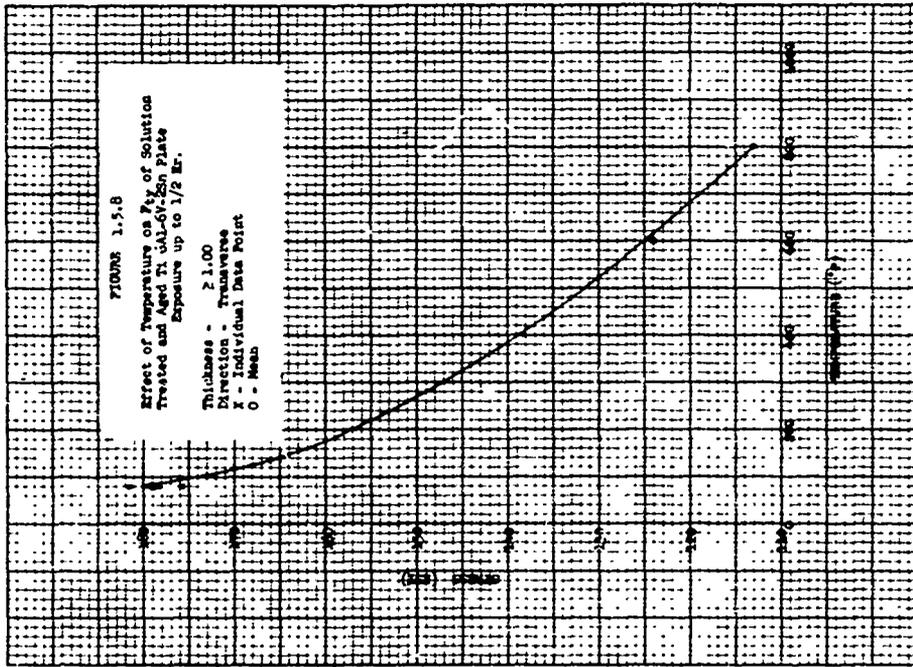
1.4 Tl 6Al-6V-2Sn Cond. STA

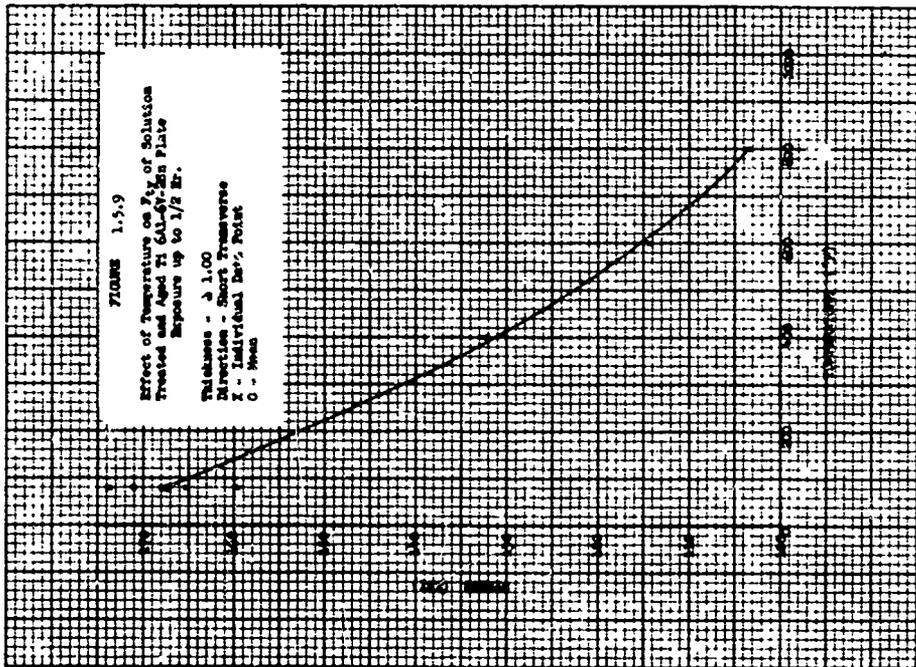
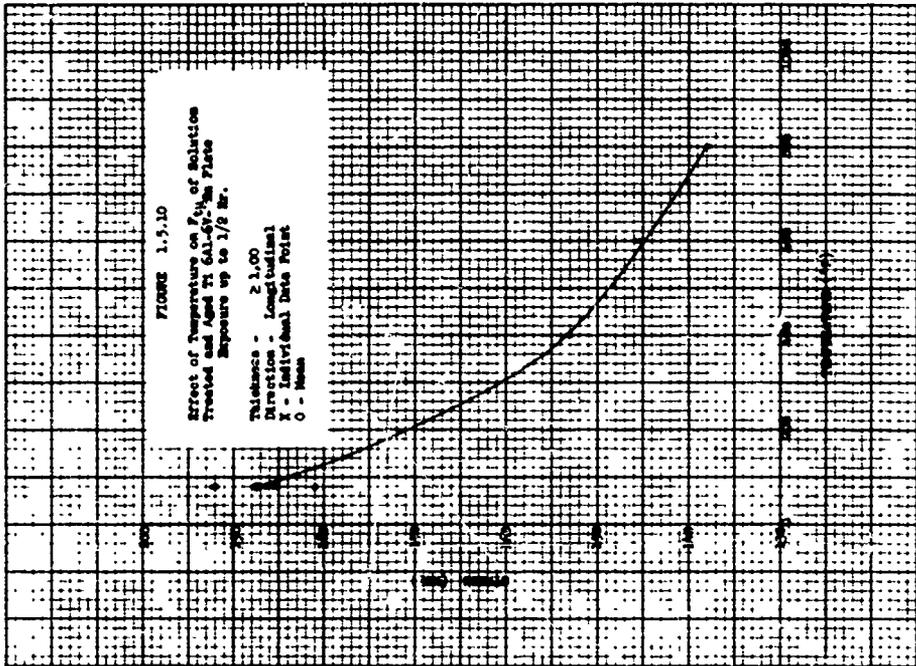
Figures 1.5.1 to 1.5.29

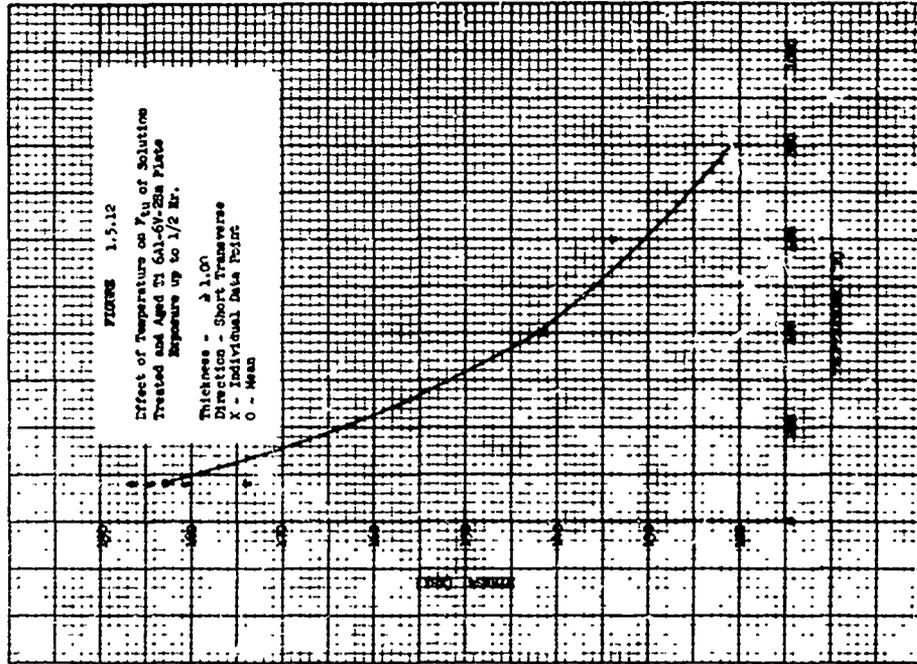
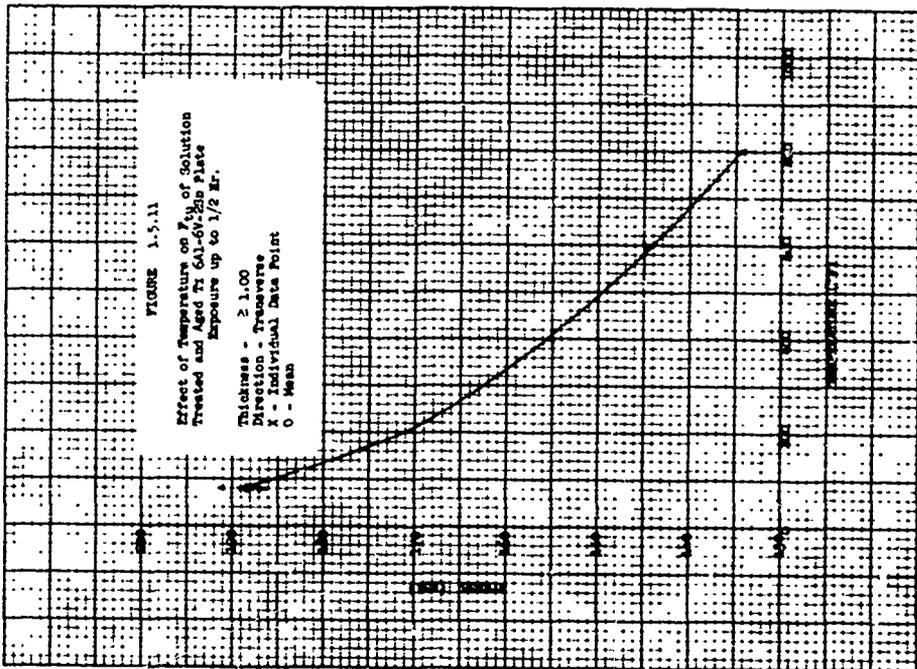


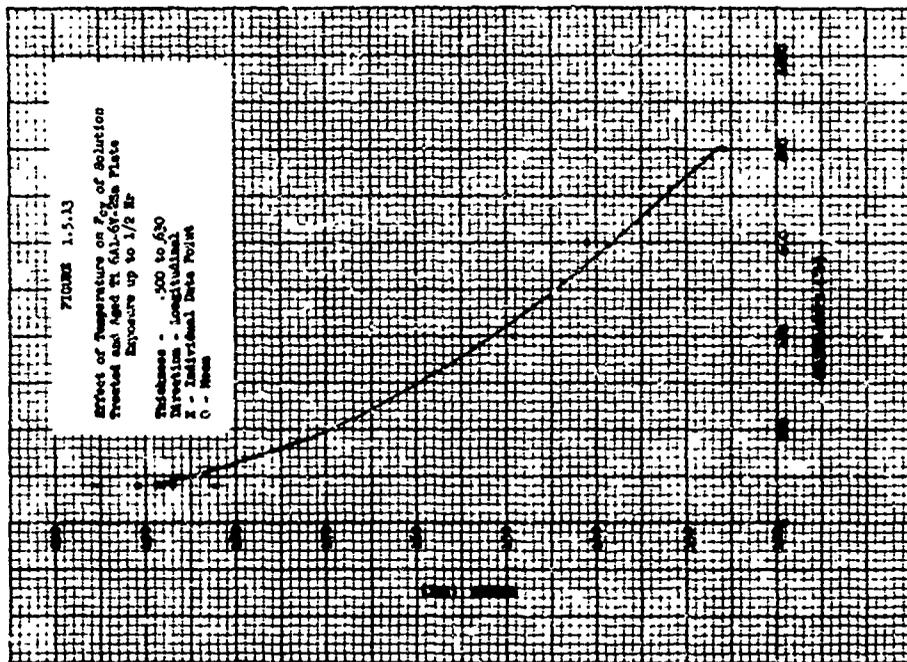
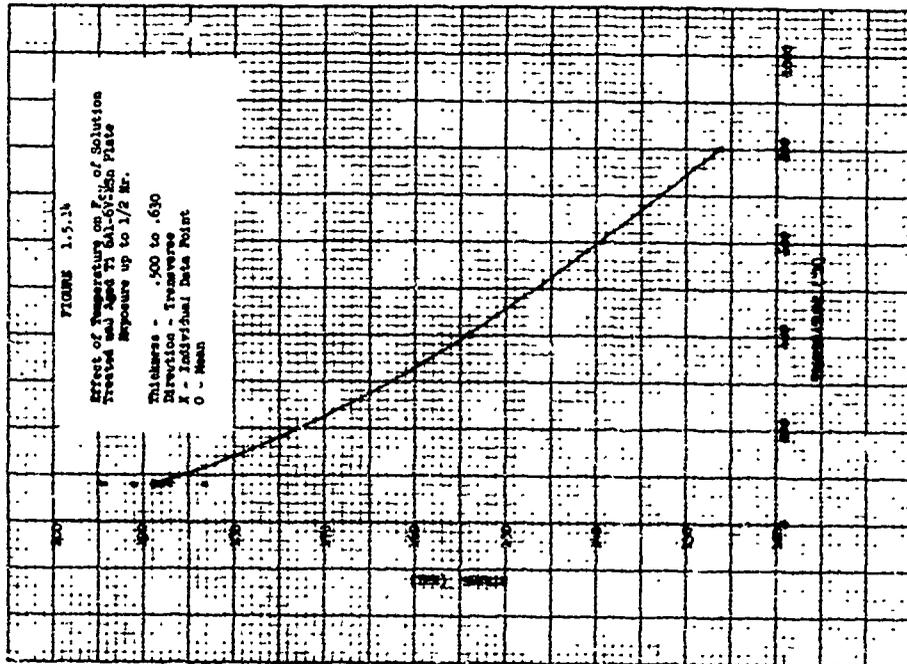




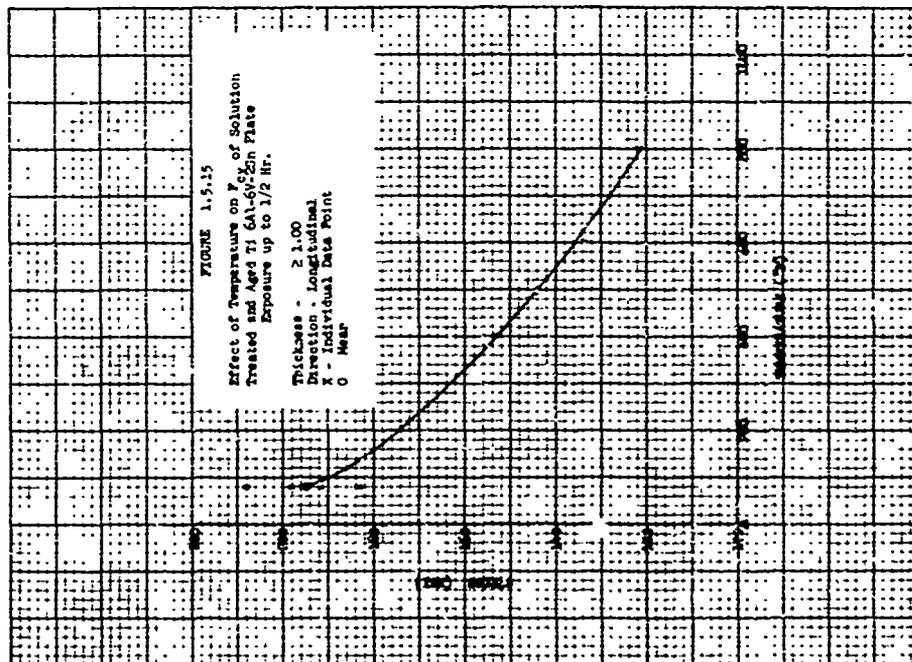
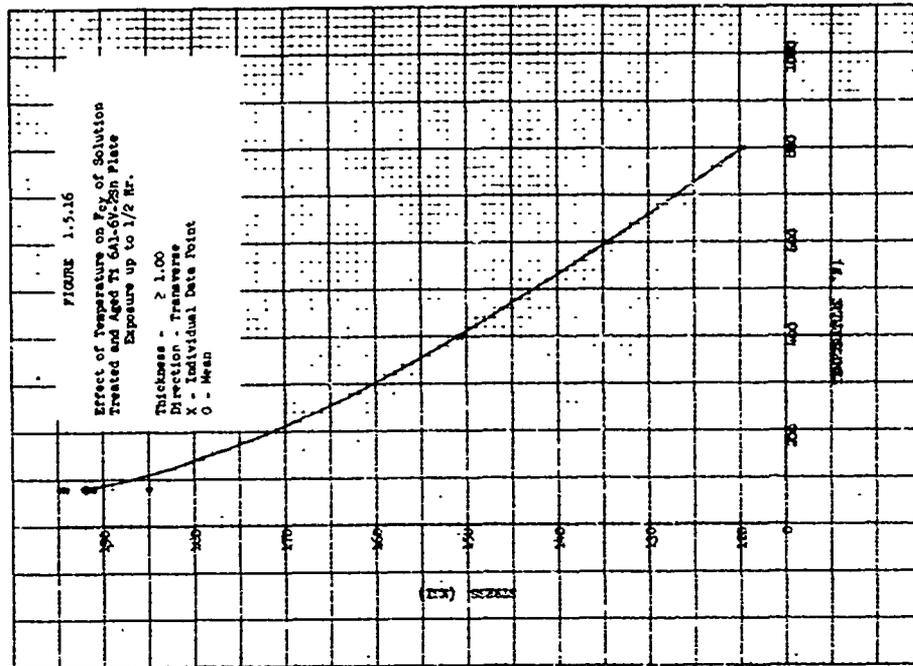


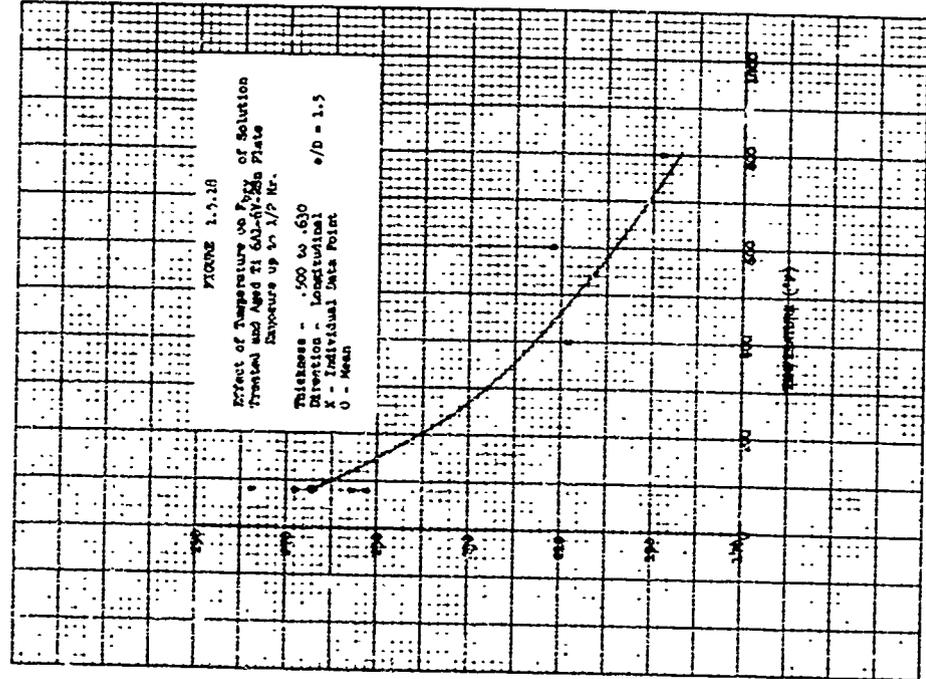
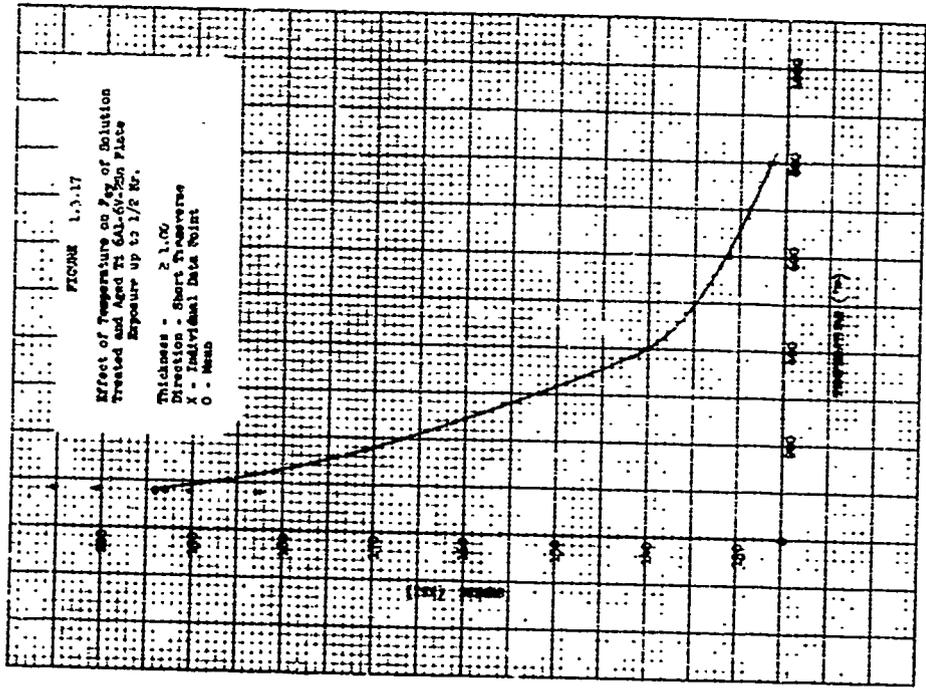


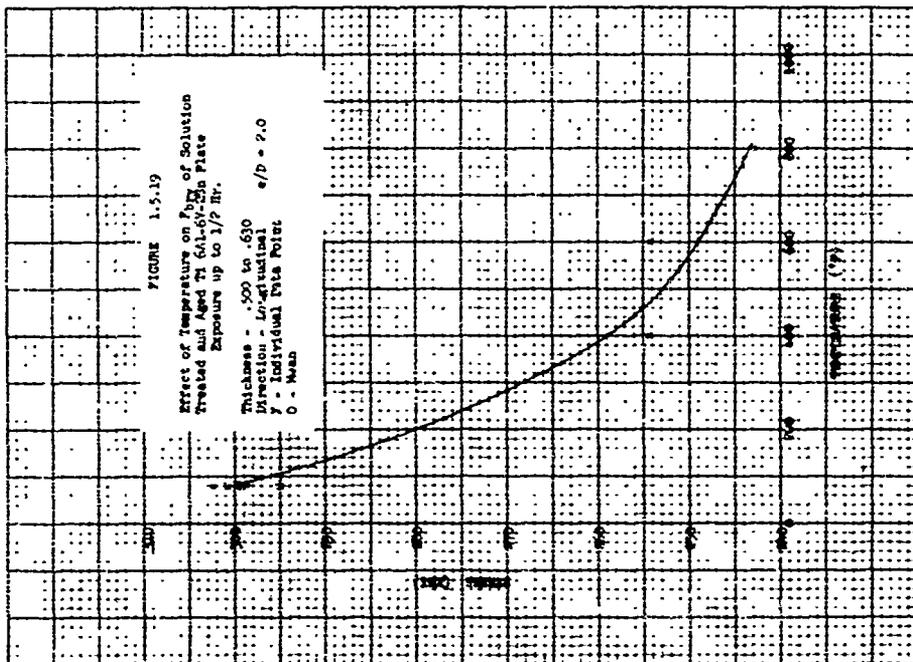
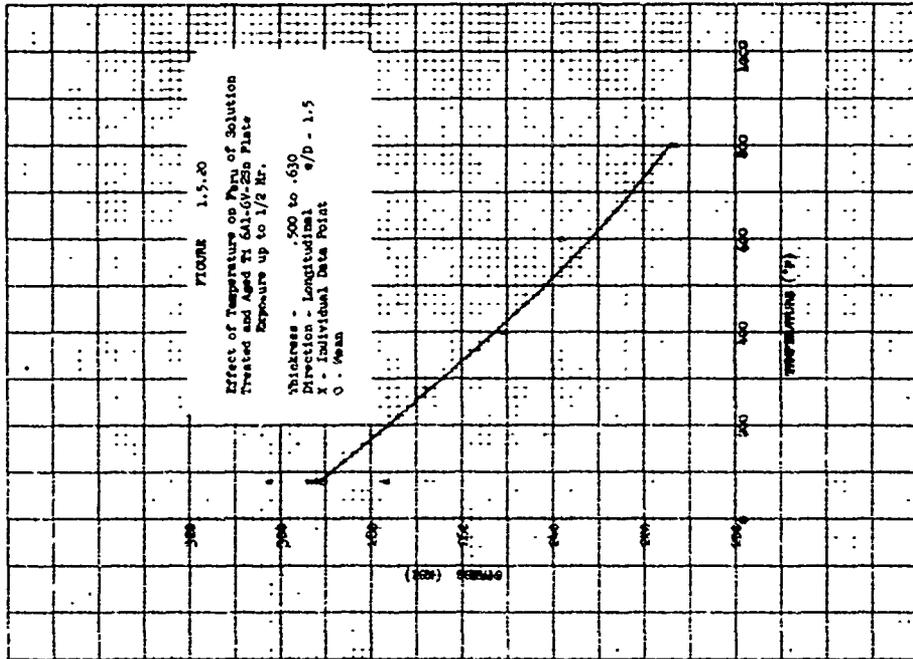


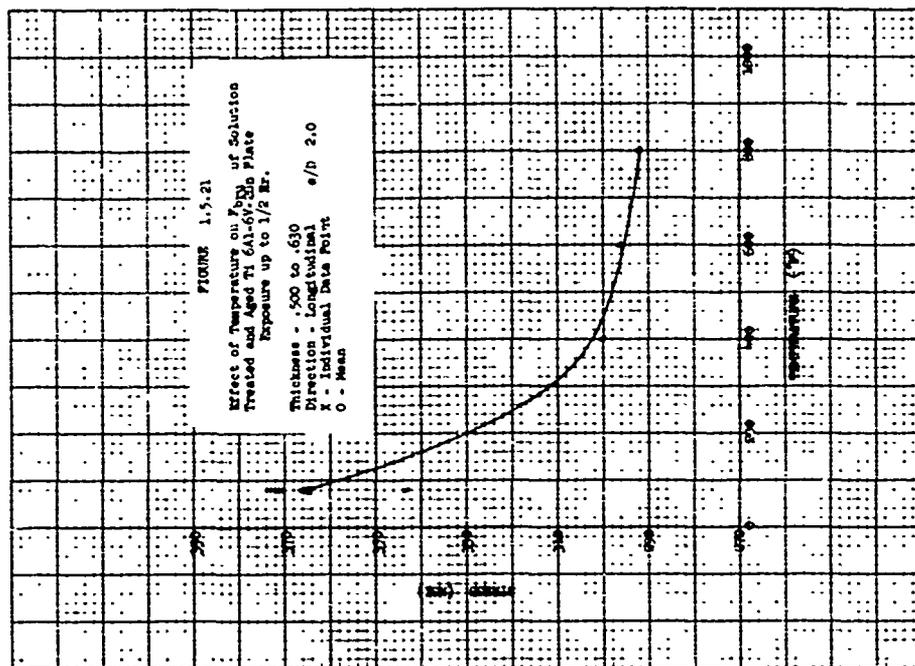
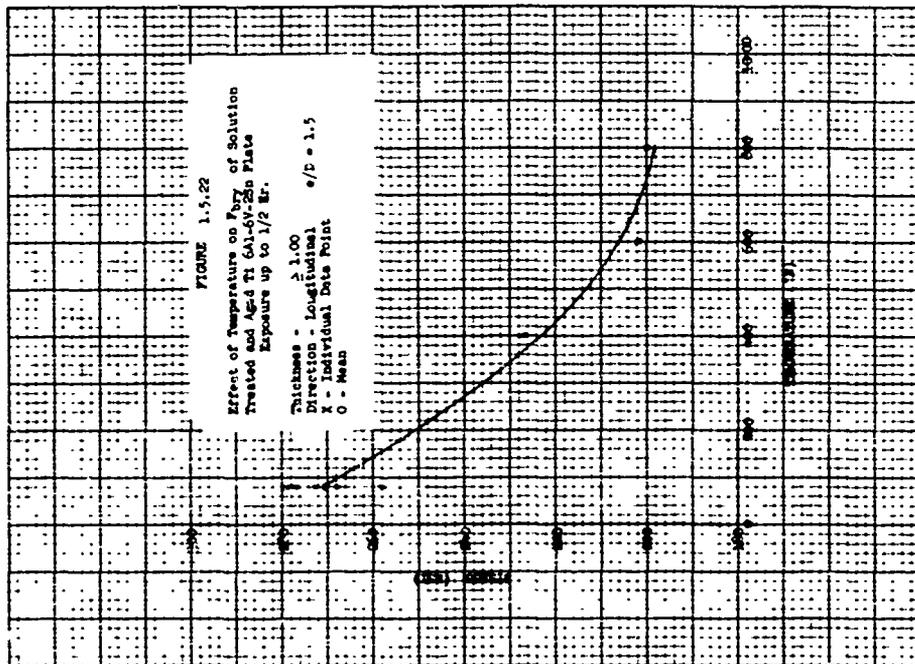


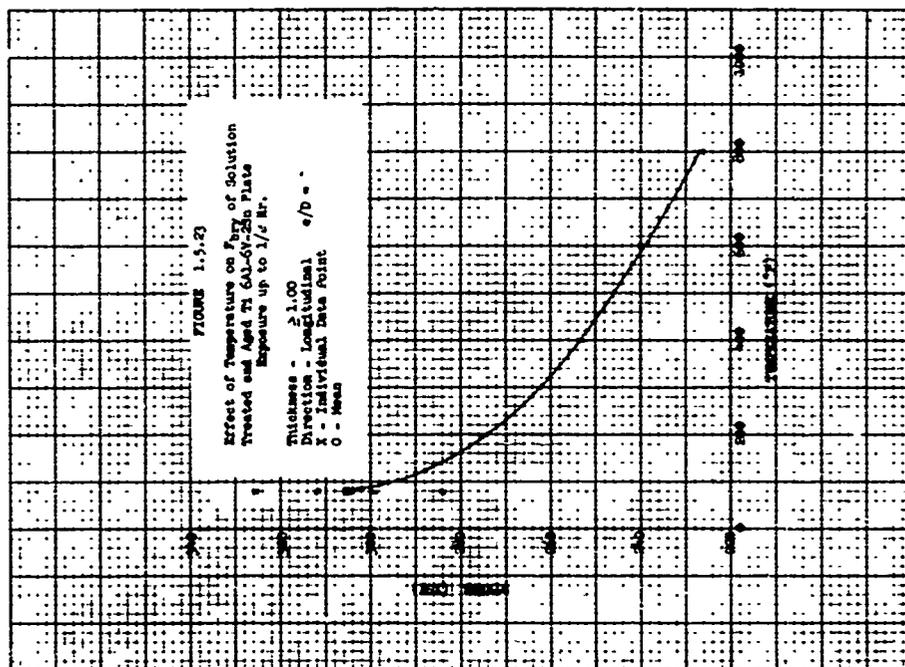
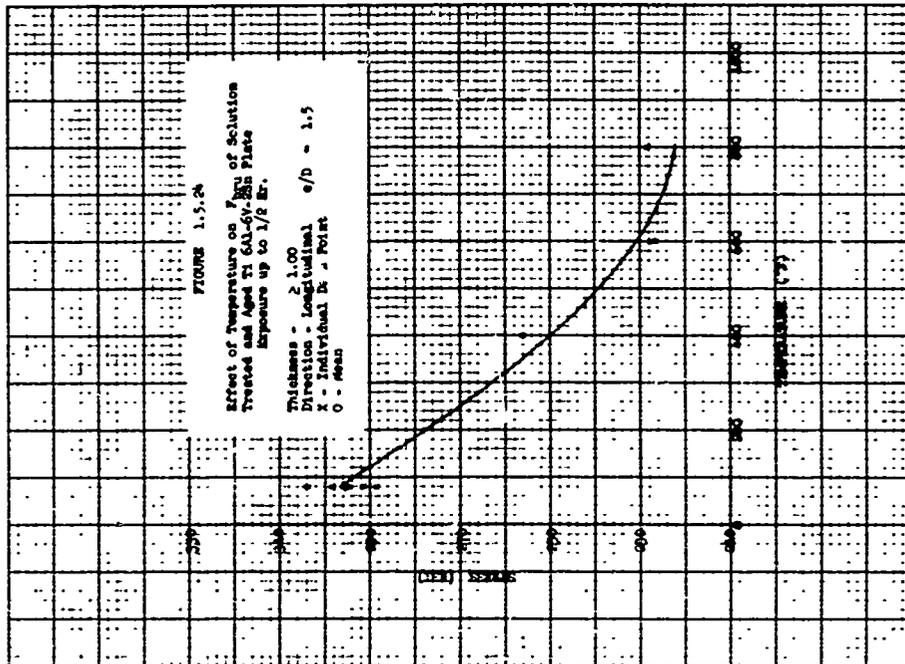


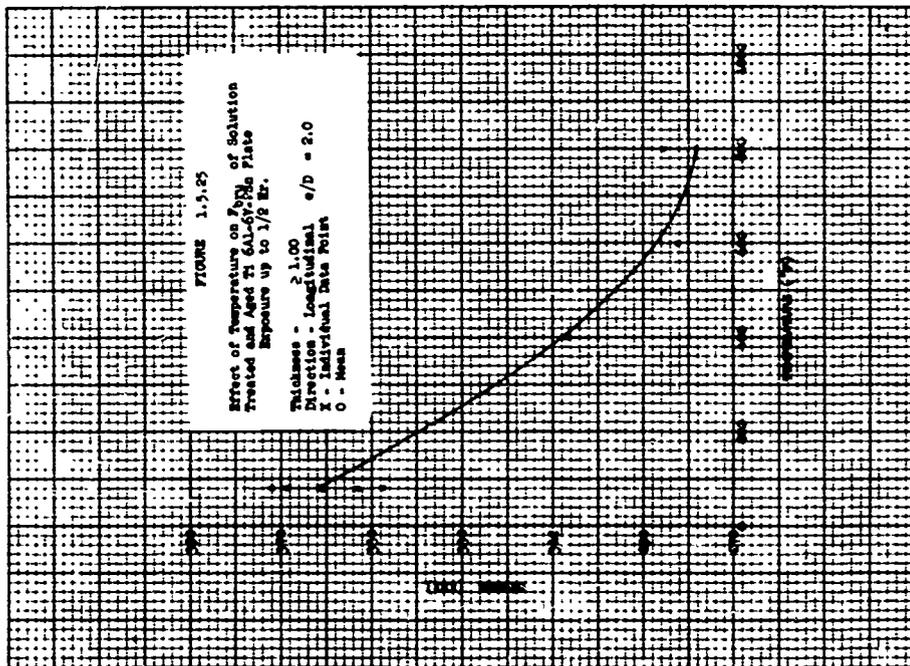
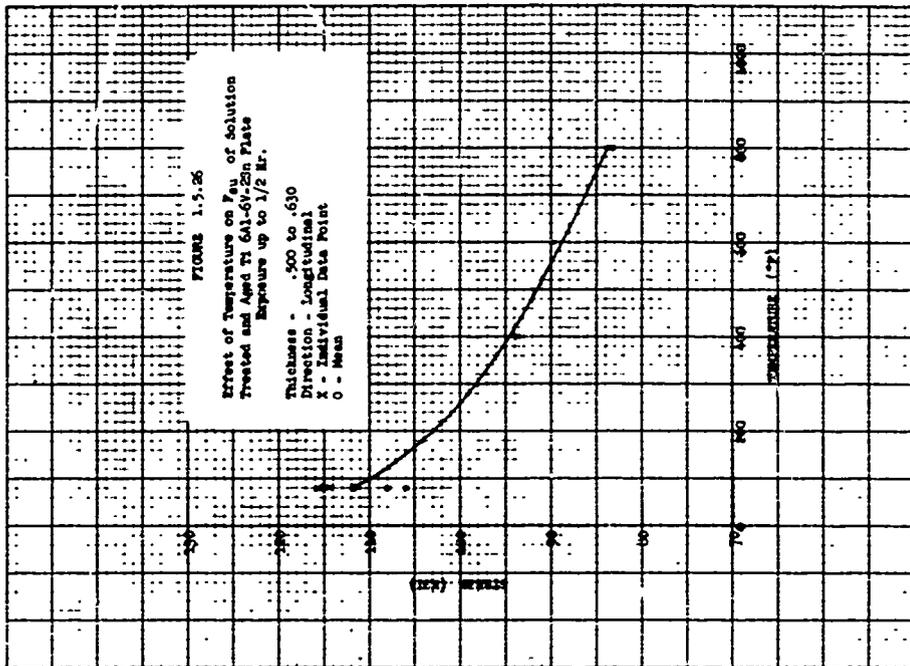


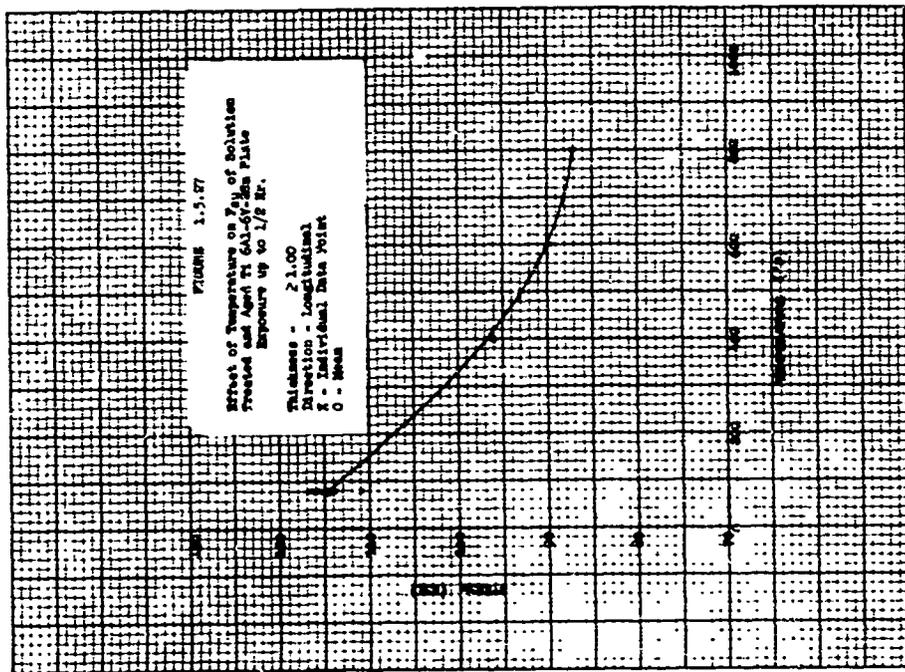
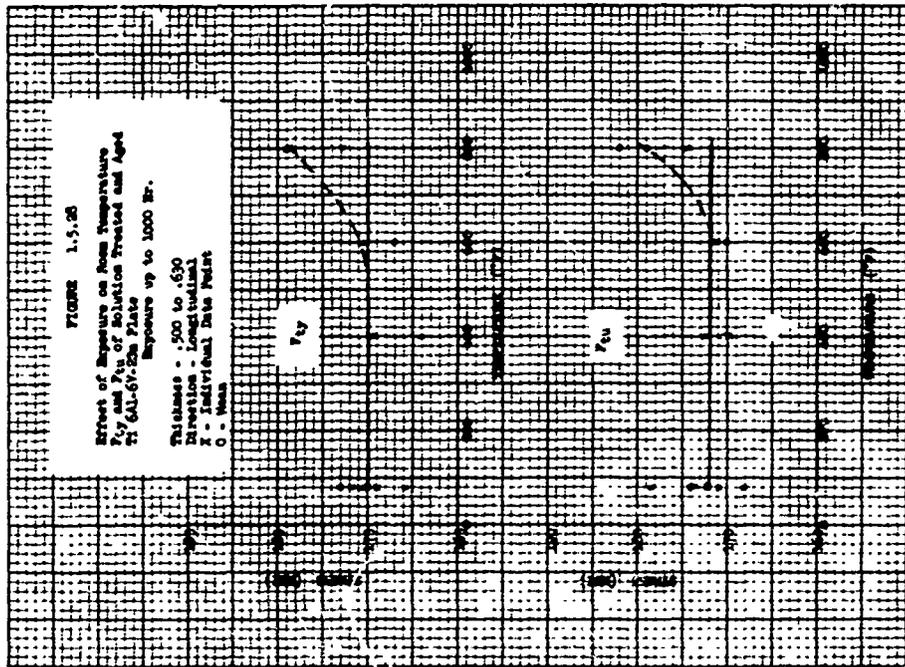


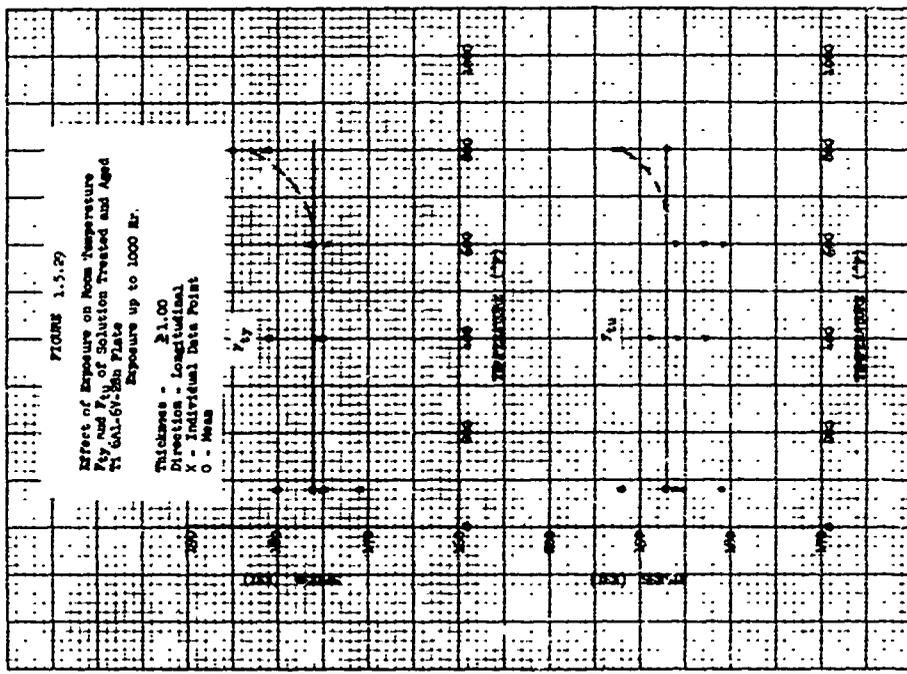










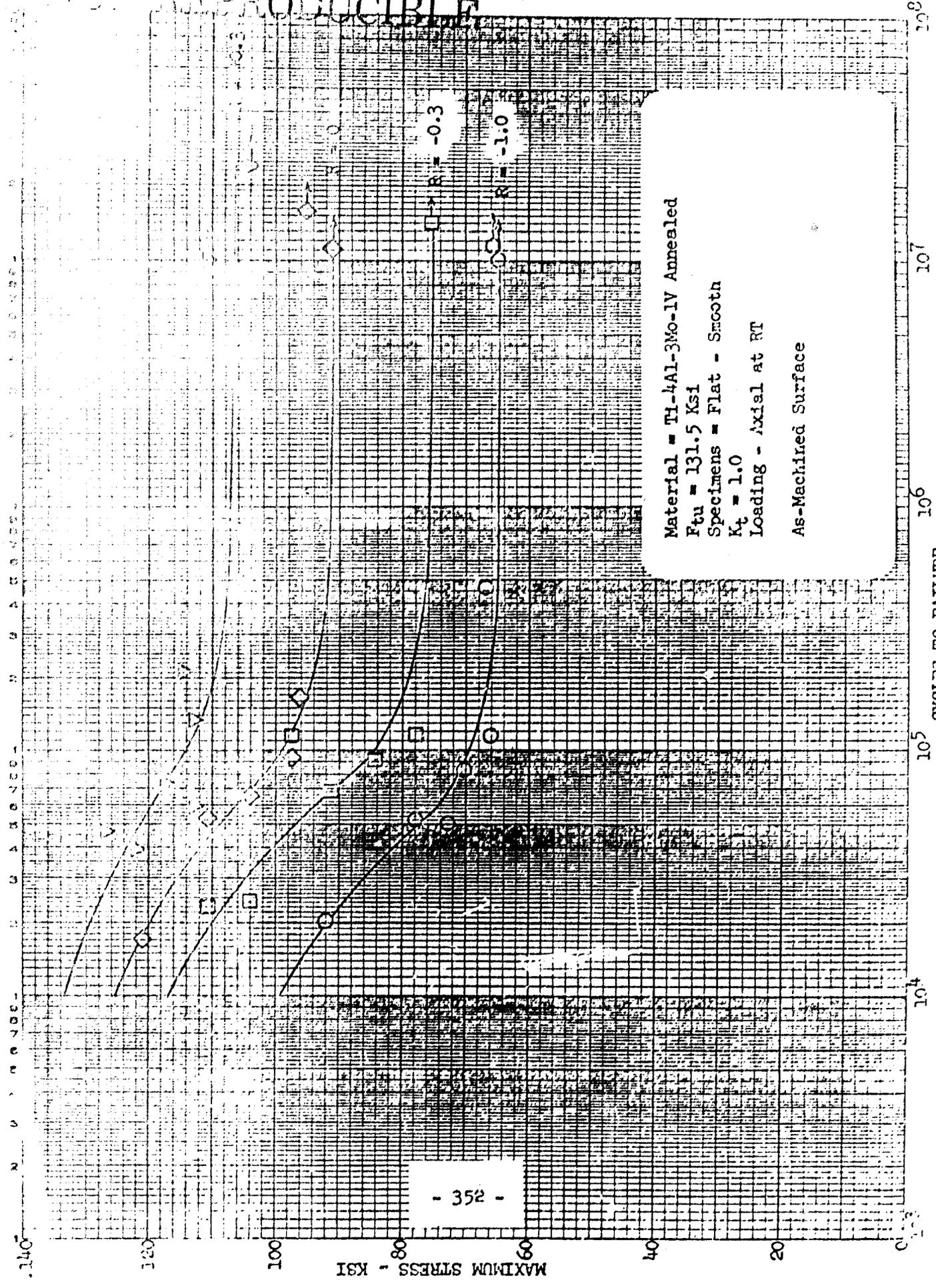




B. FATIGUE S-N CURVES

2.1 Ti-4Al-3Mo-1V Cond. A Figures 2.1.1 to 2.1.2

REPRODUCIBLE

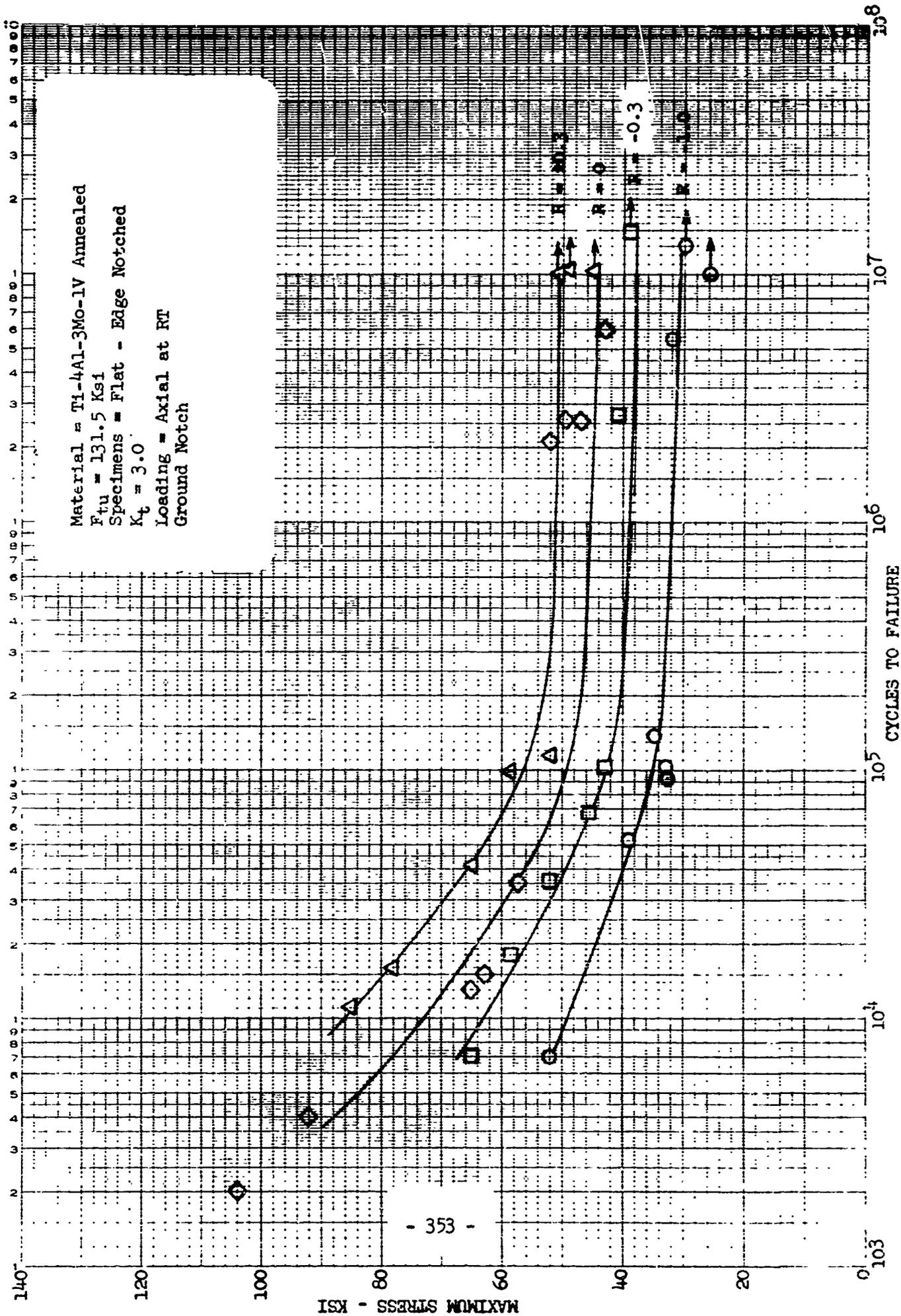


Material = Ti-4Al-3Mo-1V Annealed  
 F<sub>tu</sub> = 131.5 KSI  
 Specimens = Flat - Smooth  
 K<sub>t</sub> = 1.0  
 Loading = Axial at RT  
 As-Machined Surface

- 352 -

Best Available Copy

Figure 2.1.2

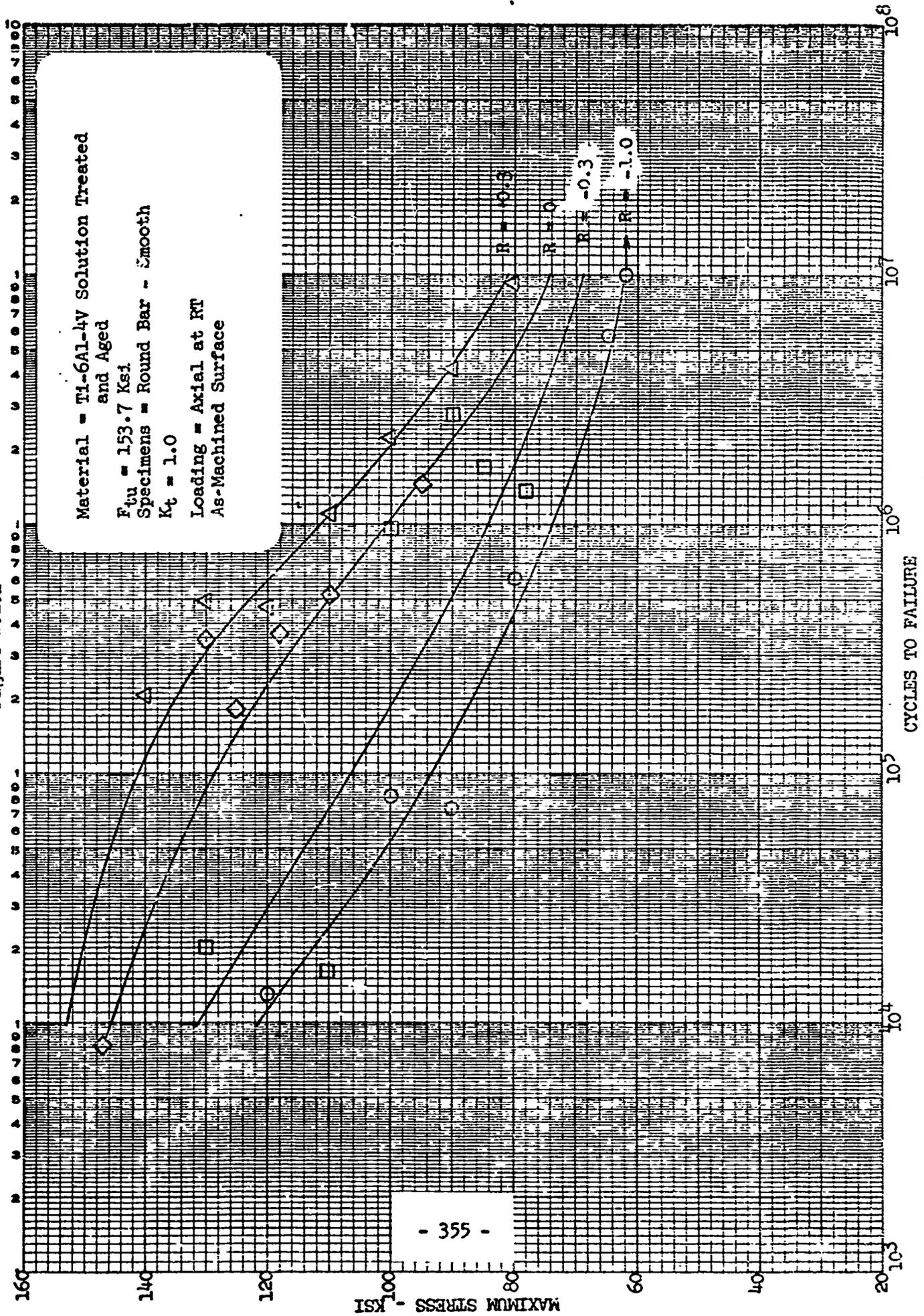


B. FATIGUE S-N CURVES

2.2 Ti-6Al-4V Cond. STA

Figures 2.2.1 to 2.2.2

Figure 2.2.1



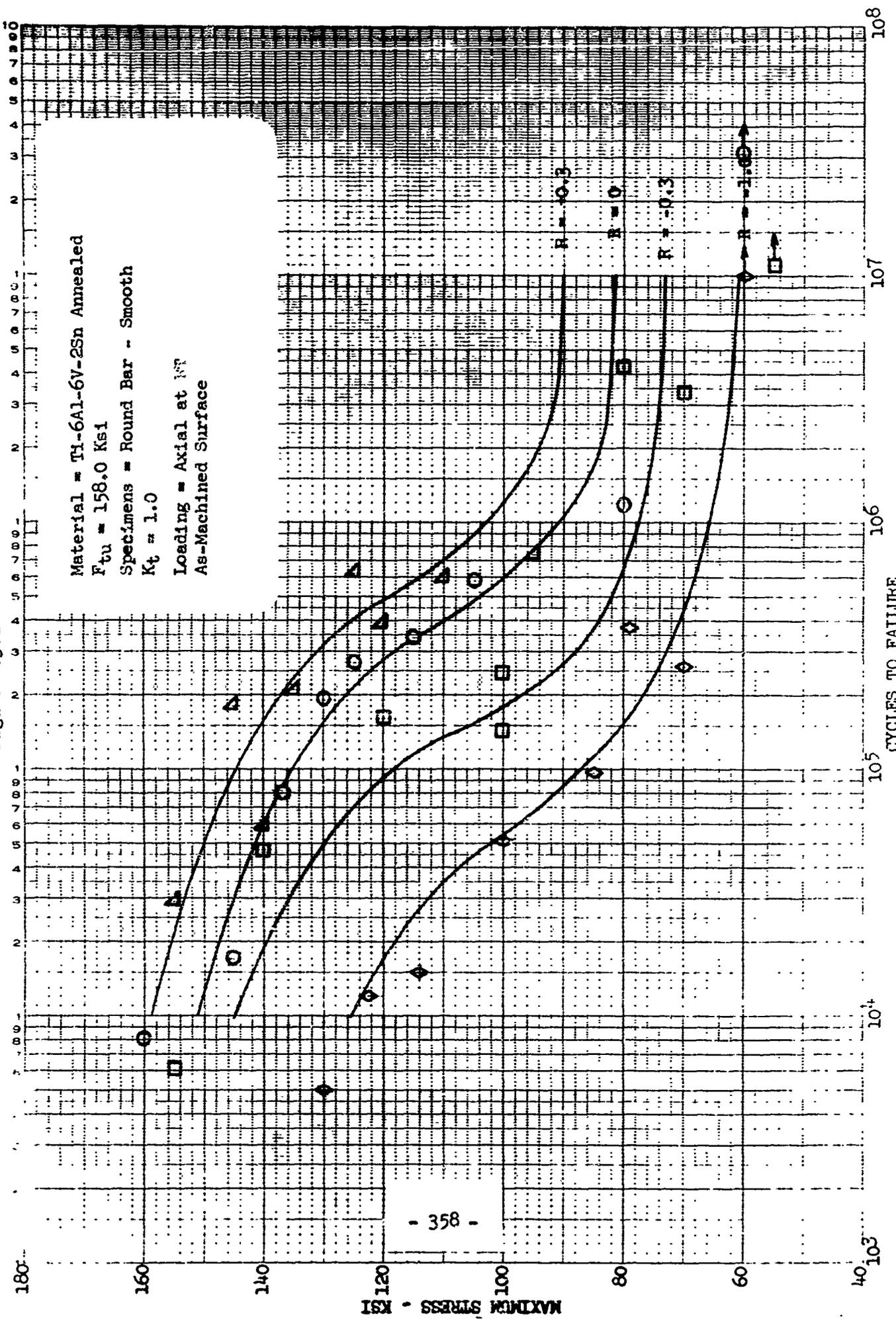


B FATIGUE S-N CURVES

2.3 Ti-6Al-6V-2Sn Cond. A Figures 2.3.1 to 2.3.2

Figure 2.3.1

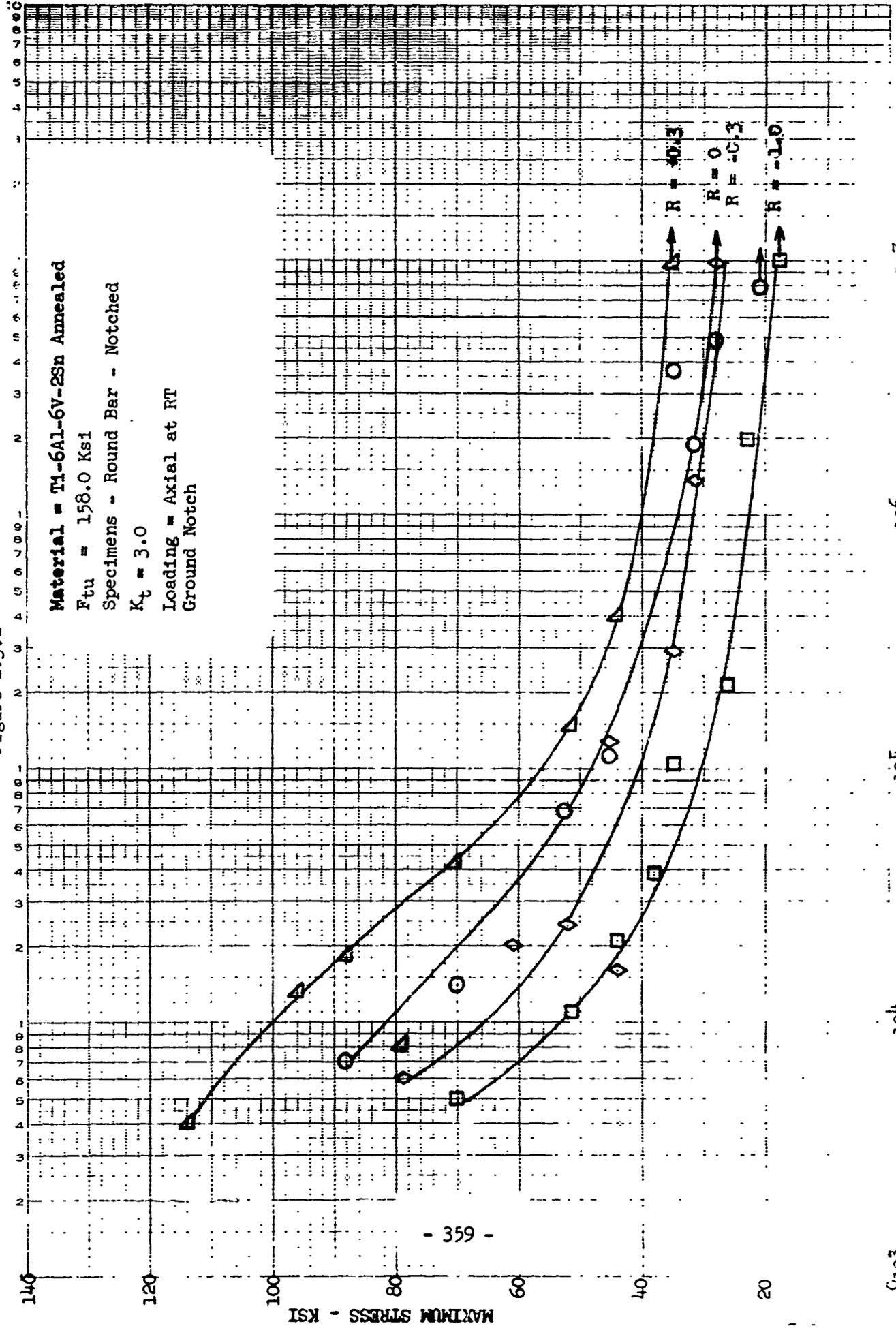
Material = Ti-6Al-6V-2Sn Annealed  
 $F_{tu} = 158.0$  Ksi  
 Specimens = Round Bar - Smooth  
 $K_t = 1.0$   
 Loading = Axial at  $10^7$   
 As-Machined Surface



- 358 -



Figure 2.3.2



B. FATIGUE S-N CURVES

2.4 Ti-6Al-5V-2Sn Cond. STA

Figures 2.4.1 to 2.4.2

Figure 2.4.1

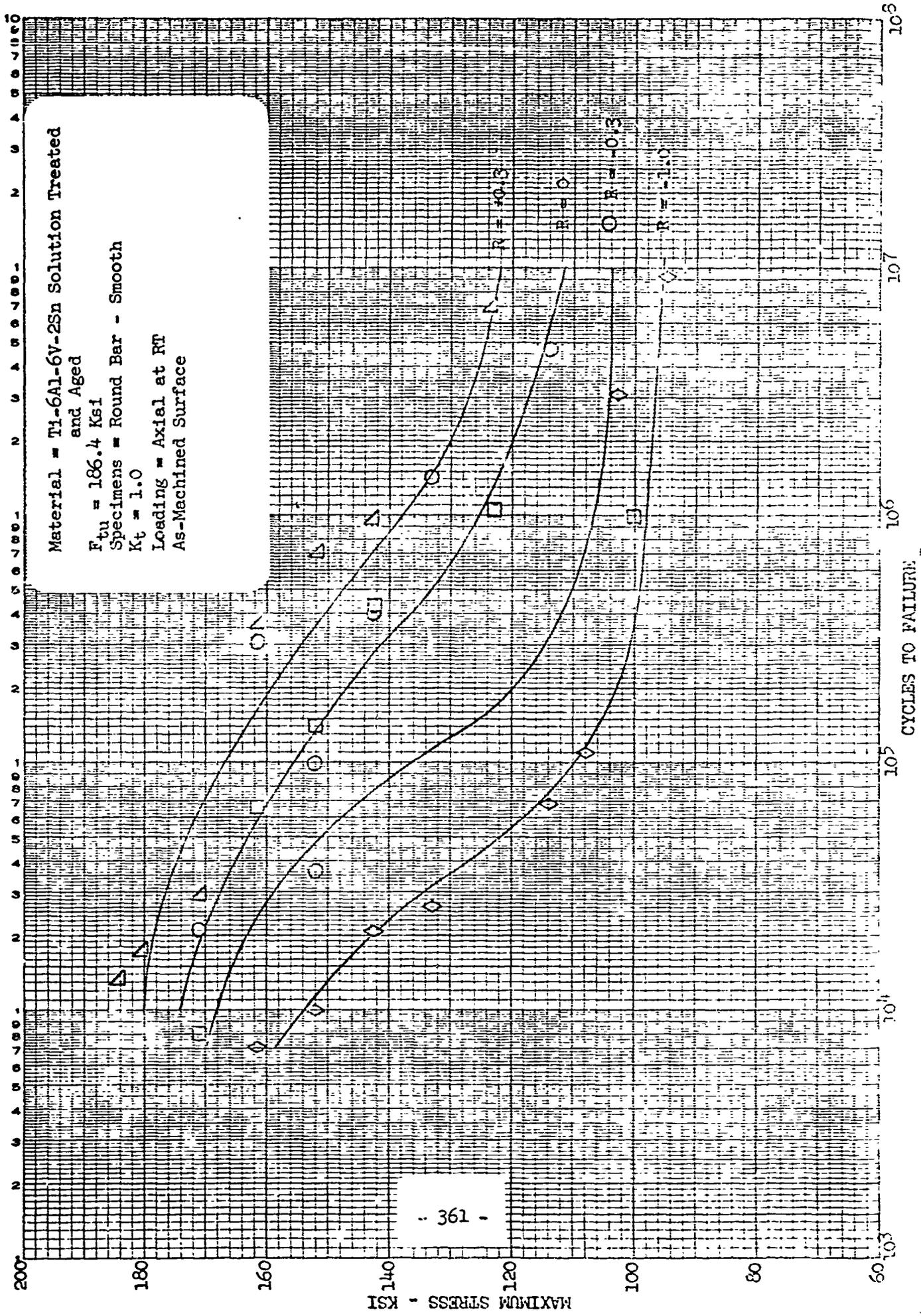
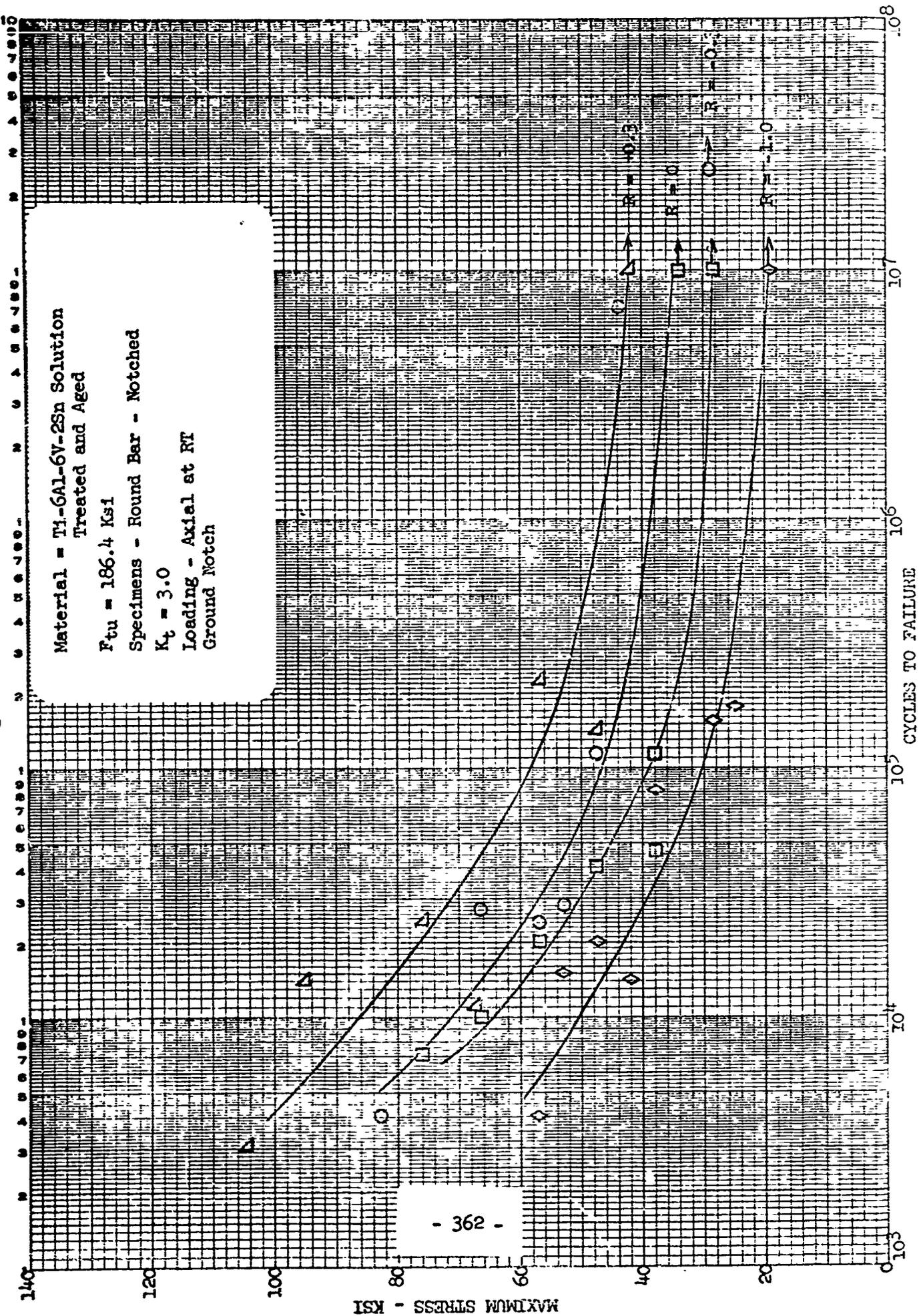


Figure 2.4.2

Material = Ti-6Al-6V-2Sn Solution  
Treated and Aged  
F<sub>tu</sub> = 186.4 Ksi  
Specimens - Round Bar - Notched  
K<sub>t</sub> = 3.0  
Loading - Axial at RT  
Ground Notch



Security Classification

DOCUMENT CONTROL DATA - R & D

(Security classification of title, body of abstract and indexing annotation must be entered when the overall report is classified)

1. ORIGINATING ACTIVITY (Corporate author) North American Rockwell Corporation, Los Angeles Division, International Airport, Los Angeles, California 90009		2a. REPORT SECURITY CLASSIFICATION Unclassified	
		2b. GROUP N/A	
3. REPORT TITLE  DESIGN ALLOWABLES FOR TITANIUM ALLOYS			
4. DESCRIPTIVE NOTES (Type of report and inclusive dates) Final Technical Report - May 1966 to May 1969			
5. AUTHOR(S) (First name, middle initial, last name) Alfred W. Sommer Gardner R. Martin			
6. REPORT DATE June 1969		7a. TOTAL NO OF PAGES 372 plus XIV	7b. NO OF REFS 2
8a. CONTRACT OR GRANT NO AF 33(615)-3979		9a. ORIGINATOR'S REPORT NUMBER(S) AFML-TR-69-161	
b. PROJECT NO 7381			
c. Task No. 738106		9b. OTHER REPORT NO(S) (Any other numbers that may be assigned this report) NA-69-350	
10. DISTRIBUTION STATEMENT This document is subject to special export controls and each transmittal to foreign governments or foreign nationals may be made only with prior approval of MAAE, Air Force Materials Laboratory			
11. SUPPLEMENTARY NOTES		12. SPONSORING MILITARY ACTIVITY Air Force Materials Laboratory, MAAE Air Force System Command Wright-Patterson AFB, Ohio	
13. ABSTRACT The purpose of this program was to develop design information on four titanium alloys for inclusion into Military Handbook-5. The alloys investigated were Ti-6Al-4V Condition STA, Ti-4Al-3Mo-1V Annealed Condition, Ti-13V-11Cr-3Al Annealed Condition, and Ti-6Al-6V-2Sn Annealed Condition and Condition STA. The mechanical properties investigated were tensile, compression, shear, bearing, fracture toughness and fatigue.  This document is subject to special export controls and each transmittal to foreign governments or foreign nationals may be made only with prior approval of MAAE, Air Force Materials Laboratory.			

DD FORM 1 NOV 55 1473

Unclassified

Security Classification

Unclassified

Security Classification

14. KEY WORDS	LINK A		LINK B		LINK C	
	ROLE	WT	ROLE	WT	ROLE	WT
Design Allowables						
Titanium Alloy Ti-6Al-4V Condition STA						
Titanium Alloy Ti-4Al-3Mo-1V Condition A						
Titanium Alloy Ti-13V-11Cr-3Al Condition A						
Titanium Alloy Ti-6Al-6V-2Sn Condition A and STA						
Tensile Tests						
Compression Tests						
Shear Tests						
Bearing Tests						
Fracture Toughness Tests						
Fatigue Tests						

Unclassified

Security Classification