

UNCLASSIFIED

AD NUMBER
AD857462
NEW LIMITATION CHANGE
TO Approved for public release, distribution unlimited
FROM Distribution authorized to U.S. Gov't. agencies and their contractors; Administrative/Operational Use; MAR 1969. Other requests shall be referred to Army Aviation Materiel Labs., Fort Eustis, VA.
AUTHORITY
USAAMRDL ltr dtd 18 Jun 1971

THIS PAGE IS UNCLASSIFIED

AD

AD 857462

**USAAVLABS TECHNICAL REPORT 69-13
REVIEW AND PRELIMINARY EVALUATION
OF LIFTING HORIZONTAL-AXIS
ROTATING-WING AERONAUTICAL SYSTEMS
(HARWAS)**

By
W. F. Foshag
G. D. Boshler

March 1969

**U. S. ARMY AVIATION MATERIEL LABORATORIES
FORT EUSTIS, VIRGINIA**

**CONTRACT DAAJ02-67-C-0046
AEROPHYSICS COMPANY
WASHINGTON, DC**

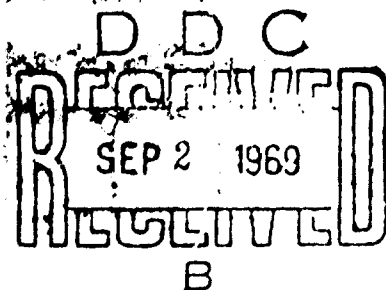

Best Available Copy

420

DEPARTMENT OF THE ARMY
U. S. ARMY AVIATION MATERIEL LABORATORIES
Fort Eustis, Virginia 23604

ERRATUM

USAAVLABS Technical Report 69-13

TITLE: Review and Preliminary Evaluation of Lifting Horizontal-Axis
Rotating-Wing Aeronautical Systems (HARWAS)

Delete the statement on cover, title page, and block 10 of DD Form 1473
which reads:

"This document has been approved for public release and sale;
its distribution is unlimited. "

and replace with the following statement:

"This document is subject to special export controls, and each
transmittal to foreign governments or foreign nationals may be
made only with prior approval of US Army Aviation Materiel
Laboratories, Fort Eustis, Virginia 23604. "



DEPARTMENT OF THE ARMY
U. S. ARMY AVIATION MATERIEL LABORATORIES
FORT EUSTIS, VIRGINIA 23604

This report, which is essentially a literature search, summarizes the horizontal axis lifting device technology from its inception to the present. The work was undertaken to permit evaluation, in the light of current mission requirements, material, and propulsion technology, of various mechanisms proposed over the years.

Frequently, in the solution of immediate problems, techniques are inadvertently reinvented at considerable expenditure of time and money. If this report can prevent such duplication of effort or repetition of prior mistakes, it will have served its purpose.

It is published to permit dissemination of information which might otherwise be unavailable and for the stimulation of ideas.

Task 1F 162204A14231
Contract DAAJ02-67-C-0046
USAAVLABS Technical Report 69-13
March 1969

REVIEW AND PRELIMINARY EVALUATION
OF LIFTING HORIZONTAL-AXIS
ROTATING-WING AERONAUTICAL SYSTEMS
(HARWAS)

By

W. F. Foshag
G. D. Boehler

Prepared by

Aerophysics Company
Washington, D. C.

~~SECRET~~ #2 UNCLASSIFIED

This document is subject to special export controls and each transmittal to foreign governments or foreign nationals may be made only with prior approval of _____

U. S. ARMY AVIATION MATERIEL LABORATORIES
FORT EUSTIS, VIRGINIA

This document has been approved
for public release and its
distribution is unlimited.

SUMMARY

The results of a Review and Preliminary Evaluation of Lifting Horizontal-Axis Rotating-Wing Aeronautical Systems (HARWAS) are presented.

Among the purely aeronautical applications, near-horizontal axis as well as horizontal axis devices are considered. The former cover the radial-lift propeller or "self-propelling" wing; the latter cover Magnus effect and related systems; cyclogiro systems and horizontal-axis propeller systems with cyclic pitch. A limited investigation of non-aeronautical applications of HARWAS is also made, which covers wing-rotor type windmills, cyclogiro windmill turbines, Magnus effect ship propulsion and cycloidal ship propulsion.

Approximately 1200 references are listed. A series of cross-index tables is also included to provide a quick means for the reader to determine the content and availability of the references.

An analysis of the various lift systems pertinent to the HARWAS field is made with a view to potential air vehicle applications. Over 20 original aeronautical applications are identified and evaluated in the light of recent advances in power plants, transmissions and lightweight structural techniques. This analysis points out the extraordinary variety of HARWAS and identifies promising new aeronautical systems, especially wing rotor aerial delivery devices, the rotating airfoil flap STOL airplane, and the cyclogiro VTOL or STOL airplane.

A preliminary performance and design study of two promising HARWAS concepts is also reported. The two concepts are the STOL logistics aircraft using a rotating airfoil flap and the amplified high-pitch cyclogiro for application to the composite aircraft mission.

FOREWORD

This report is the final report prepared by the Aerophysics Company in the performance of Contract DAAJ02-67-C-0046 (Task 1F 162204A14231) for the U. S. Army Aviation Materiel Laboratories (USAAVLABS). It describes a comprehensive review and evaluation of all known horizontal-axis rotating-wing aeronautical systems (HARWAS).

The research program was performed during the period from March 1967 to September 1968. Technical monitoring of the project for USAAVLABS was by W. E. Sickles.

The report is presented in three parts corresponding to the three phases of the program.

The first part discusses the bibliographical search; the bibliography itself is shown in Appendixes I and II. The second part presents an analysis of the material discovered during the search. The third part shows the results of the preliminary performance and design study of two promising concepts which were identified in the second part: the rotating flap STOL aircraft and the V/STOL cyclogiro transport.

In the conclusion, the various aeronautical systems that were identified are classified in the order of potential interest.

The authors would like to acknowledge the considerable assistance that they have received during the compilation of this report from the Stack and Reader Division, Library of Congress, and the staff of the National Air Museum. Special thanks are generally extended to all of those interested persons who acknowledged the general inquiry letter. This form letter, which was given wide distribution, was a useful tool in unearthing background information which would not necessarily have been found in the literature search. Further thanks are due F. Eastman, H. Focke, H. Platt, and I. Laskowitz for their detailed contributions to the report background.

The authors gratefully acknowledge the following sources for the photographs appearing in this report:

Figure

- 1 From Poggendorff's "Annalen der Physik und Chemie", v. 88, n. 1, 1853.
- 2 From Reference 9A.
- 5 National Archives.
- 6 National Archives.
- 7 By Douglas Rolfe for Air Progress.
- 8 By Douglas Rolfe for Air Progress.

Figure

- 9 Musée de l'Air.
- 10 Courtesy W. Foshag.
- 11 Courtesy B. Hortenke.
- 25 Courtesy Shell Aviation News.
- 32 NASA Photograph.
- 34 NASA Photograph.
- 38 NASA Photograph.
- 39 Courtesy "Aircraft Engineering".
- 46 National Air and Space Museum, C. G. B. Stuart Collection.
- 50 USAF Photographs.
- 60 From "Mechanics Magazine".
- 61 Musée de l'Air.
- 62 Library of Congress.
- 63 Library of Congress.
- 64 Musée de l'Air.
- 65 Courtesy H. Platt.
- 66 National Air and Space Museum.
- 68 Copyright "The Illustrated London News".
- 69 Copyright "The Illustrated London News".
- 71 Courtesy "Popular Science Monthly".
- 72 Musée de l'Air.
- 73 NASA Photograph.
- 74 University of Washington.
- 75 Courtesy F. Eastman.
- 76 Courtesy F. Eastman.
- 77 Courtesy F. Eastman.
- 80 Courtesy D. Cook.
- 82 Ursinus Collection - Library of Congress.
- 109 National Air and Space Museum.
- 110 Courtesy C. Richard.
- 112 Courtesy C. Richard.
- 121 Courtesy "Vertical World" Magazine.

Figure

- 122 Courtesy Curtiss-Wright Corporation.
- 123 Courtesy Curtiss-Wright Corporation.
- 124 From Reference 6K.
- 128 Courtesy "Popular Science Monthly".
- 129 Courtesy ASME - "Mechanical Engineering".
- 133 Courtesy DeHavilland Aircraft of Canada.

TABLE OF CONTENTS

	<u>Page</u>
SUMMARY	iii
FOREWORD	v
LIST OF ILLUSTRATIONS	xii
LIST OF TABLES	xxiv
INTRODUCTION	1
HARWAS BIBLIOGRAPHY	2
ANALYSIS	13
I. Horizontal-Axis Lifting Devices	
A. Magnus Effect and Related Systems	
1. Wing Rotor (Rotating Airfoil) Decelerators ..	13
a. Introduction	13
b. Pictorial Review	14
c. Aerodynamic and Dynamics of Wing Rotors	24
d. Application of Wing Rotors to Aerial Precision Delivery Missions	35
e. Gliding Performance of a Wing Rotor ...	35
2. Rotating Airfoil Convertible to Fixed Wing (RACW)	40
3. Rotating High-Lift Devices on Wings	43
a. Rotating Cylinder Leading-Edge Slat (RCLE)	45
b. Rotating Cylinder in Wing (RCIW)	46
c. Rotating Cylinder at the Trailing Edge (RCTE)	48
d. Rotating Cylinder in Flap (RCIF)	48
e. Rotating Airfoil in Wing (RAW)	59
f. Rotating Airfoil Slat (RAS)	59
g. Rotating Airfoil Flap (RAF)	59
h. Rotating Airfoil in Flap Leading Edge (RAIF)	70
i. Rotating Flap Systems in Ground Effect.	70
j. Rotating Flaps for Lateral Control	73
4. Orbiting Flap and Undulating Propeller	74
5. Cross-Flow or Transverse-Flow Fan and Flap	78

	<u>Page</u>
B. Cyclogiro Systems	
1. General Description	80
2. Pictorial Review	83
3. Configuration	98
4. Kinematic Discussion of Cycloidal and Trochoidal Motion	105
5. Analysis of Cyclogiro Blade-Rocking Motion	113
6. Classification and Further Discussion of Cyclogiro Systems	122
7. Full-Feathering Universal Pitch Systems	128
8. Aerodynamic Analysis of Cyclogiro Rotors	131
9. The Wright Field World War II Cyclogiro Project	144
10. Cyclogiro Test Data	152
11. Helicopter With Auxiliary Cycloidal Rotor Propulsion and Control	166
12. Evaluation of Cyclogiro Aircraft Potential ...	169
C. Horizontal-Axis Propellers With Cyclic Pitch: The Richard Helicoplane	
1. General Description	169
2. Principle of the Helicoplane	172
3. Wind Tunnel Test Results on the Helico- plane Principle	174
4. Potential of the Helicoplane Concept	182
II. Near-Horizontal Axis "Radial-Lift" Concepts	
A. Radial-Lift Propeller or Self-Propelling Wing	
1. Principle of the Radial-Lift Propeller or Self-Propelling Wing	184
2. VFW Wind Tunnel Tests	185
3. Characteristics of the VFW VC. 400 VTOL Aircraft	185
4. Curtiss-V/rtight X-100 and X-19 VTOL Aircraft	189
B. The Helicoplane With Inclined Propeller Axis	191
C. Potential of the Radial-Lift Concepts	191
III. Non-Aeronautical Applications of Harwas	
A. Wing Rotor-Type Windmills	194
B. Cyclogiro Windmill Turbine	199
C. Magnus Effect Ship Propulsion	201
D. Cycloidal Ship Propulsion	204

	<u>Page</u>
SUMMARY OF ANALYSIS	209
PRELIMINARY PERFORMANCE AND DESIGN STUDY OF TWO HARWAS CONCEPTS	
I Rotating Airfoil Flap (RAF) STOL Aircraft	212
II VTOL Cyclogiro Transport for the Composite Aircraft Mission	227
CONCLUSIONS	242
APPENDIXES	
I BIBLIOGRAPHICAL LISTING	243
II CROSS-INDEX TABLES	348
DISTRIBUTION	395

ILLUSTRATIONS

<u>Figure</u>		<u>Page</u>
1	The Original Autorotating Wing Rotor Device With Useful Payload Found in Nature: The Common Locust Tree (<i>robinia pseudoacacia</i>) Seed Pod	14
2	The Original Experimental Arrangement by Magnus in Determining the Side Thrust on a Rotating Cylinder in an Airstream	15
3	First Wing Rotor Performance Measurement and Theory by Ahlborn in 1897. Autorotating Metal Plate Released From Tower as Shown	16
4	Early (1903) Wing Rotor Glider Project Demonstrated by Koppen as Model	18
5	Navy-Assisted Magnus Effect Aircraft by Ames (1910) Mounted Atop Fast Steam Launch	18
6	Further Autorotating and Powered Wing Rotor Systems by Ames	19
7	Zaparka Magnus Rotor Aircraft. Possibly Flown Full Size Briefly in 1930	20
8	Guest and Popper Full-Size Magnus Rotor Aircraft. Main Engine 85 HP. Serrated and "Pocketed" Rotor Surface to Enhance Circulation	20
9	The Chappedelaine-Desgrandechamps-Caudron "Aérogyre" Being Rigged and Shown in Three Views. Several Flights in 1934. Lower Wings Rotate and Lock for STOL Conversion	21
10	Recent (1966) Adaptation of Autorotating Wing Rotors to Trailing-Edge Flap Systems To Turn the Flow Over Flap	22
11	Eight-Foot Wing Rotor Sailplane (1947) Demonstrating Good Flight Performance and Stability About All Axes	23
12	Successful Powered Wing Rotor Model by Horstenke. The Larger Model Is Controlled By Radio Command	23

<u>Figure</u>		<u>Page</u>
13	Aerodynamic Performance of a Collection of Powered Cylindrical Magnus Rotors at Several Aspect Ratios, With and Without Tip Plates	26
14	Aerodynamic Performance of a Collection of Powered Cylindrical Magnus Rotors at Several Aspect Ratios, With and Without Tip Plates	27
15	Aerodynamic Performance of a Collection of Noncircular Powered Rotor Shapes With Various Tip Plates, Aspect Ratios, and Profiles	28
16	Aerodynamic Performance of a Collection of Noncircular Powered Magnus Rotor Shapes, With and Without Tip Plates, at Several Aspect Ratios and With Various Profiles	29
17	Aerodynamic Performance of a Collection of Autorotating Wing Rotors With and Without Tip Plates, at Several Aspect Ratios and With Various Profiles	30
18	Aerodynamic Performance of a Collection of Autorotating Wing Rotors With and Without Tip Plates, at Several Aspect Ratios and With Various Profiles	31
19	Wing Rotor Aerial Delivery Precision Glider Carried Externally by the OV-10A COIN Airplane	36
20	Pilotless Convertible Glider Cruising as a Fixed Wing and Landing as a Wing Rotor	37
21	Aerial Cargo Delivery Autorotating Wing Rotor System, Carried Inside C-119 Aircraft	38
22	Remotely Controlled, Helicopter-Towed Wing Rotor Aerial Delivery System With Underslung Payload	39
23	Wing Rotor Sinking Speeds at Various Loadings as a Function of Hypothetical Maximum Lift Coefficients and Lift-Drag Ratios	41
24	Relative Glide Range and "Drop Cones" for Five Systems of Aerial Delivery	42

<u>Figure</u>		<u>Page</u>
25	Modern, Complex Wing-Flap System With Multiple Flaps Partially Extended, Deflected; Spoilers Up, Slat Open	44
26	Measured Lift Coefficients Plotted Against Angles of Attack for a Collection of Combination Fixed-Wing and Rotating Cylinder Slat System. Cylinder in the Leading Edge	47
27	Various Leading-Edge Rotating Slat Systems as Applied to Tilt-Wing V/STOL. Also Shown as Cross Shaft Interconnecting Power System	49
28	Typical Rotating Cylinder in Wing (RCIW) Arrangement by Thompson	49
29	Measured Lift Coefficient Plotted Against Rotor Spin Ratio for a Collection of Combination Fixed-Wing and Rotating Cylinder Flap Systems. Cylinder At or Near Trailing Edge. May be Used in Conjunction With a Nonrotating Fixed Flap	50
30	Theoretical and Measured Lift Coefficients Plotted Against Angles of Attack for a Collection of Combination Fixed-Wing and Rotating Cylinder Flap Systems. Cylinder At or Near Trailing Edge	51
31	Retraction System for Rotating Cylinder in Trailing Edge (RCTE) by Tino	53
32	NASA/Ames Rotating Cylinder Flap	53
33	Lift Performance Summary of NASA/Ames RCIF - Various Geometries	54
34	Full-Size Wind Tunnel Model of NASA/Ames RCIF Aircraft	54
35	Cylinder Speed and Horsepower Requirements for the NASA/Ames Rotating Cylinder Flap	55
36	Lift-Drag Polars for the NASA/Ames Rotating Cylinder Flap	55
37	Comparative Performance of RCIF With Mechanical Flap	56
38	Deflected-Slipstream V/STOL Full-Size Model in Ames Wind Tunnel	58

<u>Figure</u>		<u>Page</u>
39	Proposed Application of Alvarez-Calderon's Rotating Cylinder Flap (RCIF) to a VTOL Airplane	60
40	Lippisch Patent Describing Rotating Airfoil Slat (RAS) Device and Boundary Layer Energizer	60
41	Measured Lift Coefficient Against Angle of Attack for a Collection of Combination of Fixed-Wing and Rotating Noncircular Airfoil Rotating Flap Systems; Rotating Flap at or Near the Trailing Edge	61
42	Early Experiments by Riabouchinski To Determine the Performance of the Trailing-Edge Rotating Airfoil Flap	62
43	Wind Tunnel Results and Optimization of Rotating Airfoil Flap Position With Respect to Fixed Airfoil ...	64
44	Autorotation of a Trailing-Edge Airfoil Flap at Various Positions and for Different Free-Stream Velocities	65
45	Lift and Drag Polars of a Fixed Wing With Trailing-Edge Rotating Airfoil Flap. Flap in Powered Rotation, Autorotation, and in Braked (Spoiler) Rotation	65
46	Boeing XL-15 Liaison Aircraft With Full-Span External Airfoil Flaps (1949).	66
47	Rotating Airfoil Flap in Leading-Edge High-Lift RAS System by Henter and Kaser	71
48	Powered Rotating Airfoil in Conjunction With Multiple Flap by Lake	71
49	Influence of the Ground on a General Tilt-Wing V/STOL	72
50	Effect of Ground Height (h/c) on the Aerodynamic Characteristic of the NASA/Ames RCF Aircraft. $\delta = 70^\circ$ $\delta = 18^\circ$, Slats and End Plate On, Hinge 1	72
51	Attractive Force of Various Wing Rotor and Cylinder Devices Rotating in Proximity to a Ground Board	75

<u>Figure</u>		<u>Page</u>
52	Basic Arrangement of Orbiting Flap Undulator and Deundulator	75
53	Schematic Arrangements of Orbiting Flap. Lower Drawing Indicates Various Geometries Possible by Varying Angles, Spacing, and Rotation	76
54	Wind Tunnel Results by Schmidt on Air Vehicle of Fig. 55. Curves Are Aerodynamic Polars With Undulator in Rotation and Stopped. Note Thrust at $U/V = 2.75$, $\alpha = 0^\circ$	77
55	Aerodynamic Body of Orbiting Flap Test. Note Main Body Airfoil Ahead of Undulator and Deundulator	79
56	Suggestion by Schmidt for Aircraft Drag Reduction or Auxiliary Propulsion	79
57	Basic Cross-Flow Fan by Mortier, 1891 (U. S. Patent, No. 507445)	79
58	One of Many Patents by Laing for the Adaptation of the Cross-Flow Fan to STOL and VTOL Aircraft. Shown Are Two Means of Maintaining Pitch Trim With Such a System	81
59	U. S. Army Air Forces, Wright Field Fighter Cyclogiro Project (1943-1945). Wt., 3900 Lbs.; LOA, 25 Ft.; Rotor Dia., 5 Ft.; HP Instal., 490	82
60	First Concept of the Cyclogiro by Sir William Congreve, 1828. The Feathering System Is That of the Valved Pusher Arrangement, Class 6 Type	84
61	Antique Cyclogiro System by Herard in the 1880's. This Feathering Arrangement Is Typical of Class 6 Type	85
62	Unidentified Full-Size Cyclogiro of the 1920's. Note Rotary Engine and Direct Chain Drive	86
63	McWorter "Autoplane" Quarter-Scale Model Cyclogiro, Evaluated by the U. S. Army Air Service, McCook Field, 1919. Blade-Feathering Scheme That of Class 2 Type	87

<u>Figure</u>		<u>Page</u>
64	Moineau Low-Pitch Cyclogiro Project of the 1920's in Which Direction of Flight Is Along Axis of Rotation. 1/10th-Size Model Test in Wind Tunnel	88
65	Platt Cyclogiro Wind Tunnel Model (1929-1930) Tested at The Daniel Guggenheim School of Aeronautics, New York University	89
66	Laskowitz Three-Blade Low-Pitch Cyclogiro Rotor in the New York University Wind Tunnel. Rotor Dia., 3 Ft.; Span, 2 Ft.	90
67	Rohrbach Project "B" Cyclogiro, Three Views (1934)	90
68	Comprehensive View of the 1934 Rohrbach Cyclogiro. Although Extensively Studied, Outcome of This Project Is not Known	91
69	Control and Performance Characteristics of the Rohrbach Cyclogiro Project	92
70	Two Views of the Strandgren Project (1932) Showing Method of Generating Lightweight Spoked Rotor Wheel System	93
71	Artist's Impression of the Strandgren Low-Pitch Cyclogiro in Flight	94
72	Full-Size 19.6-Ft. -Dia. Strandgren Low-Pitch Cyclogiro Wheel on Test Stand at Lioré et Olivier Co. (1933). Functional and Static Lift Test	94
73	NACA (1934) Low-Pitch Cyclogiro Model in the Langley 20-Foot Wind Tunnel. 8-Foot Diameter, 8-Foot Span	95
74	15-Foot-Diameter Kirsten-University of Washington Pi-Pitch Cyclogiro Wheel. Designed and Constructed During 1922. Number of Blades Variable up to 24 . . .	96
75	Kirsten-University of Washington Pi-Pitch Cyclogiro Model in Wind Tunnel. Built Before 1934 and Tested in a Variety of Configurations With and Without Tail Rotor	97
76	University of Washington Amplified High-Pitch Cyclogiro Wind Tunnel Rotor. Dia. = 3 Ft.	99

<u>Figure</u>		<u>Page</u>
77	University of Washington Amplified High-Pitch Cyclogiro Wind Tunnel Rotor Blade	99
78	Hypothetical Full-Feathering Cyclogiro and Pitch Change Mechanism. Rotor System as Shown Tested in University of Washington Wind Tunnel	100
79	Wiessler Patent (1950) for a Convertible and Compound Cyclogiro in Which the Rotor May Be Stopped in Flight. Patent Further Describes Conversion of Turbine Means To Produce Shaft Power or Jet Thrust	101
80	Cook "Cyclodyne" Project (1958-1968) Pictorial Presentation and Vibration Test Arrangement of Three-Bladed Wind Tunnel Model. Rotor Dia., 4 Ft.; Span, 4 Ft.	102
81	Cook "Cyclodyne" Project (1958-1968). Three Views. Weight Breakdown and Estimated Performance	103
82	Cyclogiro With Conical Rotor	104
83	Conical Rotor Cyclogiro Reflecting Compactness	104
84	Cyclogiro Rotor Torque Compensation Methods	106
85	Kinematic Representation of Cycloidal and Trochoidal Motion. Numbers Show Angle Through Which Generating Circle Has Rotated	108
86	Geometrical Representation of Curtate Trochoidal Motion for a Cycloidal Propeller With Thrust and No Lift	108
87	Cyclogiro Blade Angle Diagram and Resolution of Blade Forces	110
88	Ideal Path Trajectories of Cyclogiro Rotor Blade for a Full Range of Pitch Ratio Systems, for a Thrusting Propeller	112
89	Orbital Variations of the Slope of the Blade Path With Variations in the Rotor Advance Ratio. Auxiliary Curves Indicate Blade Effectiveness	115

<u>Figure</u>		<u>Page</u>
90	Angular Velocity and Acceleration of the Cyclogiro Blade About Its Own Feathering Axis Throughout the Rotor Orbit With Variations in the Blade Rocking Parameter	118
91	Cyclogiro Rotor Blade Angularity With and Without Amplification ($K \neq 1$ and $K = 1$ Respectively) and Variations in the Ideal Rocking Motion (m)	121
92	Classification of Cyclogiro Feathering Systems by Blade Motion and Position Relative to Rotor Axis of Rotation. Note That Only Blade Settings Are Shown for Hovering or Vertical Flight	123
93	Schematic Demonstrating Cyclogiro Blade Feathering Means and Similarity in the Low-Pitch (Left) and High-Pitch Regimes. Note Opposite Orientation of Slider Arm at $\psi = 180^\circ$	125
94	Schematic of Cyclogiro Blade-Feathering Mechanism To Introduce Pitch Amplification Into Basic Blade Motion	125
95	Simplicity of Obtaining Fixed, Ideal Pi-Pitch Blade-Feathering Motion by Gearing (Left) or Chain and Sprockets (Right)	127
96	Modification of Fig. 89 To Demonstrate Changeover From Low- to High-Pitch Regime Through Pitch Amplification	130
97	Theoretical Performance and Power Requirements of the Wright Field WW II Cyclogiro Project	147
98	Comparative Static Lift Power Loading of Two Low-Pitch Cyclogiro Systems, With Variation in β and at Several Tip Speeds. Blades Alone	153
99	Hovering Figure of Merit vs. Thrust Coefficient/Solidity for Four Cyclogiro Systems and One Helicopter	155
100	Theoretical and Measured Lift Per Horsepower at Forward Speed for a Low-Pitch Cyclogiro	156
101	Theoretical and Measured Autorotation Gliding Polar Curve for a Low-Pitch Cyclogiro	157

<u>Figure</u>		<u>Page</u>
102	Wind Tunnel Arrangement of Three Comprehensive Cyclogiro Studies Covering All Pitch Feathering Types in Forward Flight	159
103	Experimental and Theoretical Lift-Thrust Polars for the Pi-Pitch Cyclogiro Model With Variations in the Number of Blades Per Rotor	161
104	Experimental and Theoretical Lift-Thrust Polars for the High-Pitch Cyclogiro With Three Variations in the Rotor Blade Rocking Amplitude Angle	162
105	Experimental Values and Theoretical Variations of $dC_L/d\alpha$ and C_T at Zero Lift for Three Full Ranges of Pitch Ratios	163
106	Experimental and Theoretical Values of dC_{De}/dC_L^2	164
107	Experimental and Theoretical Values of Equivalent Propulsive Efficiency and of No-Load Power Coefficient for Three Full Ranges of Pitch Ratios	165
108	Pemberton Billing Helicopter Project With Tip Rotor Cycloidal Propeller Blades for Azimuthal Thrust	167
109	Application of The Cycloidal Rotor for Helicopter Torque Control and Main Rotor Tilt. The Bulk and Drag of The Single Cycloidal Rotor in The Upper Picture is Reduced by The Use of Double Rotors as Shown in The Lower Picture. Design Suggestion by Pullin	168
110	Vought XF5U-1 Aircraft With Potential Performance Range From 0 to 450 Knots. Yawed Propellers Were Subject to Large Vertical Radial-Lift Forces in Forward Flight	170
111	Helicoplane Richard Test Propeller in Chalais-Meudon Wind Tunnel (1948)	171
112	Comparison Between the Operation of the Conventional Propeller (A), Helicoplane (B), and the Propeller With Axis Inclined to the Direction of Flight (C)	173
113	Richard Helicoplane Rotor Blade, French O. N. E. R. A. 1948 Wind Tunnel Tests	175

<u>Figure</u>		<u>Page</u>
114	Matrix of Runs Performed, Richard Helicoplane O. N. E. R. A. 1948 Wind Tunnel Tests	176
115	Static Thrust of Horizontal-Axis Richard Helicoplane, O. N. E. R. A. 1948 Tests	178
116	Static Performance, Horizontal-Axis Richard Helicoplane, O. N. E. R. A. 1948 Tests, $\Theta_0 = 59^\circ$	179
117	Forward Flight Polar, Horizontal-Axis Richard Helicoplane O. N. E. R. A. 1948 Tests	180
118	Forward Flight Performance, Horizontal and Inclined-Axis Richard Helicoplane, $I = -10^\circ, -5^\circ,$ $0^\circ, +5^\circ, +10^\circ$, O. N. E. R. A. 1948 Tests	181
119	Schematic Representation of Bird Flight After von Holst and Focke	186
120	Forces Acting on a Slowly Rotating Inclined-Axis Self-Propelling Wing. Wing ① Is Descending, ③ Ascending	186
121	Wind Tunnel Results of the Self-Propelling Wing of Focke and Vereinigte Flugtechnische Werke (VFW) 1959-1960	187
122	Vereinigte Flugtechnische Werke (VFW) VC. 400 Tilt-Wing VTOL Transport, Shown in Vertical and Horizontal Flight Arrangements	188
123	Curtiss-Wright X-100 VTOL Airplane Employing the Radial-Lift Concept	190
124	Curtiss-Wright X-19 VTOL Airplane Employing the Radial-Lift Concept	192
125	Vertical-Axis Double Savonius Windmill-Type F-13 of the Soviet Wind Energy Institute	195
126	Aerodynamic Performance of a Collection of Basic and Modified Savonius Wing Rotors Through Power Extracting (Braked) U/V Range up to U/V Max. in Free Autorotation	196

<u>Figure</u>		<u>Page</u>
127	Aerodynamic Performance of a Collection of Basic and Modified Savonius Wing Rotors Through Power Extracting (Braked) U/V Range up to U/V Max. in Free Autorotation. (Rotors: VI, VIa, VIc, IVb) Note: Small Arrows Directed at Rotor Profile Indicate Position of Static Zero or Null Starting Torque	197
128	Performance Summary of 11 Types of Windmills	198
129	Horizontal Windmill of the Cyclogiro Type by Donaldson. Essentially an Autorotating Low-Pitch Cyclogiro Delivering Power Through a Vertical Shaft	200
130	Savonius Autorotating Rotor Sailboat (1925). Semi-cylindrical Rotor Halves May Be Reversed To Come About on an Opposite Tack	202
131	Powered Cylindrical Flettner Rotor on 37-Ft. Racing Yacht Hull (1925). Rotor Must Be Stopped and Reversed for Coming About. Dia., 3.5 Ft.; H, 19.1 Ft.	203
132	Performance Comparison of a Barkentine Sail and Flettner Rotor. Ship's Hull and Rigging Included	205
133	Comparative Performance of Three Types of Marine Vertical-Axis Cycloidal Propellers With a Forward and Backward Driving Controllable Pitch Axial Propeller	207
134	DeHavilland DHC-5 "Buffalo" STOL Transport Aircraft With Double-Slotted Flaps Extended in Flight ...	213
135	Lift and Drag Polars for Rotating Airfoil Flap and Other Related High-Lift Flap Devices	218
136	Power Requirements for Rotating an Isolated Lenticular Wing Rotor and RCIF Cylinder Flap	218
137	Modification of DeHavilland DHC-5 "Buffalo" Incorporating Full-Span Rotating Airfoil Flaps (RAF) and Aileron (Flaperon) System. Gross Weight and Total Wing Area are Identical	220
138	Schematic Representation of the Hydraulic and Mechanical RAF Drive and Control System as Might Apply to Twin-Engine Aircraft	221

<u>Figure</u>		<u>Page</u>
139	General Characteristics and Horsepower Required To Achieve C_{Lmax} (V_{stall}) With RAF as Applied to DHC-5 STOL-Type Aircraft	223
140	Deflected Slipstream V/STOL Aircraft Utilizing Rotating Airfoil Flap (RAF) for Slipstream and Lateral Control	226
141	High-Speed Amplified High-Pitch VTOL Cyclogiro Project	229
142	University of Washington Amplified High-Pitch Cyclogiro Wind Tunnel Results in the Area of Design Interest. Vertical Lift (C_L) Is Plotted Against the Corresponding Available Thrust ($-C_D$) at Three Advance Ratios	231
143	University of Washington Amplified High-Pitch Cyclogiro Wind Tunnel Results in the Area of Design Interest. Vertical Lift (C_L) Is Plotted Against the Power Required (C_P) at Three Advance Ratios	232
144	Comparative VTOL Aircraft Concept Characteristics and Forward-Flight Performance	234
145	Schematic Diagrams Explaining Geometrically the Blade Rocking Motion for a High-Pitch Cyclogiro Rotor	235
146	Schematic Diagrams Explaining Geometrically the Blade Rocking Motion for an Amplified High-Pitch Cyclogiro Rotor	236
147	Lightweight Amplified High-Pitch Cyclogiro Mechanism From University of Washington Wind Tunnel Tests. Three Radial Torque Arms Drive Blades and Feathering Mechanism About Rotor Orbit	239

<u>Figure</u>		<u>Page</u>
127	Aerodynamic Performance of a Collection of Basic and Modified Savonius Wing Rotors Through Power Extracting (Braked) U/V Range up to U/V Max. in Free Autorotation. (Rotors: VI, VIa, VIc, IVb) Note: Small Arrows Directed at Rotor Profile Indicate Position of Static Zero or Null Starting Torque	197
128	Performance Summary of 11 Types of Windmills	198
129	Horizontal Windmill of the Cyclogiro Type by Donaldson. Essentially an Autorotating Low-Pitch Cyclogiro Delivering Power Through a Vertical Shaft	200
130	Savonius Autorotating Rotor Sailboat (1925). Semi-cylindrical Rotor Halves May Be Reversed To Come About on an Opposite Tack	202
131	Powered Cylindrical Flettner Rotor on 37-Ft. Racing Yacht Hull (1925). Rotor Must Be Stopped and Reversed for Coming About. Dia., 3.5 Ft.; H, 19.1 Ft.	203
132	Performance Comparison of a Barkentine Sail and Flettner Rotor. Ship's Hull and Rigging Included	205
133	Comparative Performance of Three Types of Marine Vertical-Axis Cycloidal Propellers With a Forward and Backward Driving Controllable Pitch Axial Propeller	207
134	DeHavilland DHC-5 "Buffalo" STOL Transport Aircraft With Double-Slotted Flaps Extended in Flight ...	213
135	Lift and Drag Polars for Rotating Airfoil Flap and Other Related High-Lift Flap Devices	218
136	Power Requirements for Rotating an Isolated Lenticular Wing Rotor and RCIF Cylinder Flap	218
137	Modification of DeHavilland DHC-5 "Buffalo" Incorporating Full-Span Rotating Airfoil Flaps (RAF) and Aileron (Flaperon) System. Gross Weight and Total Wing Area are Identical	220
138	Schematic Representation of the Hydraulic and Mechanical RAF Drive and Control System as Might Apply to Twin-Engine Aircraft	221

<u>Figure</u>		<u>Page</u>
139	General Characteristics and Horsepower Required To Achieve $C_{L_{max}}$ (V_{stall}) With RAF as Applied to DHC-5 STOL-Type Aircraft	223
140	Deflected Slipstream V/STOL Aircraft Utilizing Rotating Airfoil Flap (RAF) for Slipstream and Lateral Control	226
141	High-Speed Amplified High-Pitch VTOL Cyclogiro Project	229
142	University of Washington Amplified High-Pitch Cyclogiro Wind Tunnel Results in the Area of Design Interest. Vertical Lift (C_L) Is Plotted Against the Corresponding Available Thrust ($-C_D$) at Three Advance Ratios	231
143	University of Washington Amplified High-Pitch Cyclogiro Wind Tunnel Results in the Area of Design Interest. Vertical Lift (C_L) Is Plotted Against the Power Required (C_P) at Three Advance Ratios	232
144	Comparative VTOL Aircraft Concept Characteristics and Forward-Flight Performance	234
145	Schematic Diagrams Explaining Geometrically the Blade Rocking Motion for a High-Pitch Cyclogiro Rotor	235
146	Schematic Diagrams Explaining Geometrically the Blade Rocking Motion for an Amplified High-Pitch Cyclogiro Rotor	236
147	Lightweight Amplified High-Pitch Cyclogiro Mechanism From University of Washington Wind Tunnel Tests. Three Radial Torque Arms Drive Blades and Feathering Mechanism About Rotor Orbit	239

LIST OF TABLES

<u>Table</u>		<u>Page</u>
I	Key to Figures 13 and 14. Powered Magnus Cylinder Rotor Tests - Performance	32
II	Key to Figures 15 and 16. Powered Non-circular Rotor Tests - Performance	32
III	Key to Figures 17 and 18. Autorotating Wing Rotor Performance	33
IV	Coefficient of Equations on Pages 135 and 136	137
V	Weight Estimate, Wright Field Cyclogiro Fighter	146
VI	Comparative Characteristics of Three Cyclogiro Wind Tunnel Models	158
VII	Summary and Evaluation Chart for Horizontal-Axis Rotating-Wing Aeronautical Systems (HARWAS)	211
VIII	Hypothetical Rotating Airfoil Flap Function and Flight Program Adapted to DHC-5 "Buffalo"-Type STOL Aircraft	222

INTRODUCTION

In the growth of aircraft technology, lifting devices that rotate around a horizontal axis have been proposed and studied on many occasions, only to be discarded in favor of fixed-wing aircraft or of the helicopter rotor. It is the intention of this study to make a preliminary review and classification of all such devices and to evaluate them in the light of current structural and aerodynamic technology against requirements for higher performance rotating wing and composite aircraft. As far as is known, such a review has never been done before.

The project is divided into three phases:

- Phase I - Bibliographical Search
- Phase II - Analysis
- Phase III - Preliminary Performance and Design
of Two Promising Concepts

The report is also divided into three parts corresponding to the three phases. The references and the cross-index tables are presented as appendixes.

The investigation uncovered a larger amount of material than was anticipated. It was not possible, therefore, to go into as much detail for each topic as would be desirable. No attempt was made to use a consistent and completely defined set of symbols.

Because of the exceptionally large number of picture credits, these are listed separately in the Foreword.

All devices discussed in this report are referred to as: Lifting Horizontal-Axis Rotating-Wing Aeronautical Systems (HARWAS).

HARWAS BIBLIOGRAPHY

Scope of the Search and Survey

The bibliography search consisted of a detailed review of periodicals, journals, reports, newspapers, films, patents, and books, as well as interviews with technical researchers in the field of horizontal-axis rotating-wing aircraft systems. It has resulted in the bibliographical collection presented here. The broad and general nature of this collection is reflected by the inclusion of material not directly of an aeronautical nature. It is obvious that this additional material strongly complements the aeronautical background of the other references. For example, the theoretical treatment of the cycloidal propeller and its mechanical arrangement is of direct application to similar aeronautical problems. Another example of this double utility is the case of the wing rotor systems where the enhancement of horizontal-axis windmill performance indicates a means of also improving the wing rotor as an aircraft lifting system. Other examples of the complementary usefulness of these allied technical areas may be sensed by an examination of the cross-index tables.

The search began by looking up the citations in a number of accumulated references. This process was repeated several times, with the number of references involved growing to several hundred. It rapidly became obvious that a more efficient type of search would be necessary if the search was to be continued. This technique of looking up the citations in each reference generally went backward in time in the same problem area.

The content of the material varies from the complicated theoretical to the fascinating antique. In a review of this order, it is felt to be pertinent to include some of the more noteworthy older works. In the general spectrum of aeronautical development, the present knowledge on HARWAS might be considered at that evolutionary level the fixed-wing aircraft was at, say, in 1910. One point that this review may reveal to engineers and innovators of "advanced" aeronautical systems-- in the words of Mademoiselle Bertin, milliner to Marie Antoinette--is that:

"There is nothing new except what is forgotten."

Naturally, other existing broad-area bibliographical collections were carefully examined. These would be generally:

Technical Abstract Bulletin (TAB/DDC) Indexes
and Abstracts

Government-Wide Index to Federal Research and
Development Reports (GWI/CFST)

Scientific and Technical Aerospace Reports (STAR/
NASA)

International Aerospace Abstracts (IAS/AIAA)

The collection of the Defense Documentation Center was examined by means of various bibliographical requests and machine searches.

Secondary and specific bibliographies (for example, References 46B and 47B) were examined for further background. Nearly all of the books, periodical serial publications, and pre-1950 report material was examined directly in the stacks of the Library of Congress. This search has been generally through the engineering technology area and specifically, in the very extensive aeronautics collection.

Besides search by the means of cross-checking other author references, a very effective means of uncovering fresh references, lost material, and obscure publications was the mass search by hand, piece by piece, through pertinent journals and publications. Although such a task could not be completed altogether, the time spent was rewarded with many sources of unusual interest.

The earlier material published before 1920 may be of limited technical value, especially the innumerable patents. Some of this background information is, however, cited in those instances where the descriptions or disclosures show a definite understanding of the problem at hand, an awareness of the aerodynamic forces at play, and the description of realistic structures and workable mechanisms. Often, some of the earlier material is included which demonstrates an intriguing mechanical solution or mechanism which might suggest an evolution of ideas toward a more modern solution.

The patent literature is a special case of the technical background and is all too often neglected in surveys such as this. Admittedly, the patent description is essentially a technico-legal document and nearly always avoids or purposely overlooks the use of formulas and those mathematics so essential to the enquiring engineer. Nonetheless, if one learns the style of reading out the technical essence of a patent description, the results are often useful. This is particularly so to the design engineer.

Some general comments on the patent material are in order here to help toward a better understanding of, and a guide to, their technical usefulness:

1. One of the main purposes of the patent search was to intercept, classify, and retrieve any of the earlier material that demonstrated any applicable realistic technical worth. With this review of thousands of aeronautical patents, it became very difficult, with the very few moments which could be spent scanning an individual patent, to make a positive technical assessment of the value of an inventor's idea or device. One had to be able to literally, at a glance, accept or reject the patent on the spot.

2. One must have a general knowledge of the inventor's intent with his patent and must not be misled by the patent's drawing presentation (often no more than a technical cartoon) or the technico-legal language of the body of the patent proper. The often exaggerated proportions of the material pictured in patent description drawings must always be considered as a means of calling attention to certain novel portions or functions of the patent. There was always the temptation to dismiss a perfectly sound technical invention because of its odd presentation in the drawing. Literal engineering or shop drawings hardly ever make acceptable (to the examiner, for example) patent presentations.

3. Most often the inventor's intent was described in the preamble of the description or occasionally in the central explanation of detailed functioning. The patent claims were seldom of direct technical interest. Often a series of patent descriptions and patented devices would appear to be repetitive in their invention. This was often quite exasperating when one was attempting to make quick "go/no-go" decisions whether to accept or to reject a particular patent. A closer examination of the description in this case would nearly always reveal subtle and often very clever improvements over prior patent art.

4. One is often at a loss as to how to handle patent material of the 19th and early 20th centuries (up to about 1910), especially in matters of the cyclogiro or paddle wheel concepts. There was such a bulk of it! This search indicated that the horizontal-axis paddle wheel system is probably the most frequently used concept for aeronautical propulsion and sustenance--possibly even by number, in excess of the screw or propeller system. A moment's reflection shows why this is true. If one reconsiders the background of naval propulsion of this time--the stern and side wheelers--it was only natural to extend this thinking to yet unproven aircraft systems. Today, this material may be considered to be only a technical curiosity. Although the basic mechanical arrangements are often sound, the aerodynamic performance, with a very few outstanding exceptions (to be described), would appear to be about nil. A total review of this material would have been of benefit only to a patent examiner where a search of all prior art is required as standard patent procedure.

5. There is no question that a patent search of this magnitude was the perfect complement to the search of technical publications, periodicals, and reports. A researcher would often not disclose in an open journal that which he would (since he then has protection) in a patent. The patent, therefore, often supports the other technical publications. A patent, on the other hand, is

a very prejudiced document and is useful only for a qualitative understanding of the function of a particular device.

The search of the patent literature at this level can be shown to be a very useful tool. It demonstrates the abundance and availability of ideas, most of which are in the public domain. One of the continual temptations of the practicing engineer is to reinvent old ideas and, with enough incentive, to expand upon them. One feature that is unmistakably shown in a review such as this is the repeated occurrence of discovery and rediscovery of identical ideas by investigators who are completely unaware of the former results of identical or similar ideas, theories, or tests. It is in this case that a review such as this can serve as a strong tool to prevent such duplication and can serve, in its stead, as a means of cross-fertilizing older ideas to produce new advancing ideas. All in all, the review may well furnish that heuristic background from which come the technological breakthroughs and state-of-the-art advances.

The patents collected herein, although fairly complete, should not be regarded as a substitute for a final or professional patent search.

Another source of background information was sought from direct interviews with some of the authors or inventors. Initial contact with these interested persons was made through the use of a general inquiry form letter which was mailed widely to persons and institutions throughout the world. Response to this letter was moderately favorable, as it revealed unpublished material and otherwise obscure references. Some findings from the personal interviews resulting from this letter have been incorporated in the previous background discussion.

As an aid to the reader, several similar bibliographies have been included which cover adjacent fields of interest and application. The cited AGARD VTOL/STOL Bibliographies (Reference 6A and its supplements) may be used for comparative systems evaluation. The extensive FitzPatrick bibliography (Reference 15F) on natural flight covers the older references on unsteady aerodynamic problems as possibly encountered in most instances with horizontal-axis rotating-wing aircraft systems, as well as most citations on insect flight aerodynamics. This latter area is of interest to the problem of the cyclogiro.

At the writing of this report, most of the nearly 1200 listings have been verified with the exception of those specifically "not searched" in the index table. The actual reference, a copy thereof, or a microfilm version has been actually examined.

It is pertinent to mention at this point that the bibliographies appearing at the end of reports and articles contain too high a percentage of errors. This makes the locating of references extremely difficult. Often the error is repeated through a series of publications, which indicates either that the bibliographies are copied from other reports or that very little proofreading or checking of bibliographies is done by authors.

The reader will make note of the fact that no classified reports are listed in the bibliography.

Presentation of Results

Each reference citation is assigned a number to establish its order and to identify it in the cross-index tables. The references are generally listed in alphabetical order according to the author's last name. In very many instances, especially in the periodical literature, articles of interest have been presented without the credit of a specific author. More likely than not, this material will discuss a particular project or the work of a specific inventor or engineer. This material is thus entered into the body of the bibliography under the inventor's name, placed in parentheses, and arranged in an approximate alphabetical manner. Many reports were found which did not specify a particular author, and these too have been entered alphabetically by corporate issuing agency name or title.

Some of the references, especially those of a report nature, could be cited as published from more than one publication source. Thus, for example, a thesis may appear as a laboratory report, a journal article, or a meeting preprint. In such instances of multiple publication, the most readily available retrieval source is cited, and the alternate sources are briefly noted.

In the instance of the translation of foreign material into English text, the English reference source is given as the primary citation, with the original foreign language reference noted.

Patents are cited in alphabetical order by the inventor's last name. Inventors will often patent the same invention in one or more countries. In cases where this has happened, the United States or British English language patent is considered to be the primary citation, and the alternate foreign patents are noted.

The slant mark used with some British numbers is preceded by the last two numbers of the official A. D. (anno Domini) date. Until about 1913, British patent numbers were repeated annually. In general, six-digit numbers on British patents do not need the A. D. date for complete identification. Several of the cited British patents are not to be found in the collection of patent specifications and drawings but only in the British patent abstracts. These omitted patents were never formally issued. In some instances, foreign patents are issued in the name of a firm, and this name is used because the inventor remains anonymous.

Explanation and Key to the Index Tables

A series of cross-index tables is included to provide a skeleton form of reference abstracts and to provide a quick means to determine the content and availability of references. With these tables it becomes possible to search out a combination of subject or interests to a number of specific sources. By scanning the appropriate columns of descriptors, the scope of a particular reference may be quickly determined.

For the fullest understanding and use of the cross-index tables, the following key to some of the descriptors will serve to broadly explain their coverage:

1. Cyclogiro or Cycloidal Propulsion. This category includes and broadly covers aeronautical or marine lift and propulsion devices in which a multibladed feathering rotor system is rotated about a specific axis. In aircraft, this axis is usually horizontal; in marine applications, vertical. This group may also include devices which also extract energy from a moving fluid medium (mills or pumps).

2. Wing Rotor. This category includes winged systems in which a fixed-geometry foil or blade rotates about an axis to produce thrust and, in the case of mills, torque. Thrust or lift is produced on these vaned devices by Magnus effect. Most of these devices autorotate in an air stream, and power may be extracted from the axis shaft. Lift may be enhanced in the wing rotor system by driving the system above its natural autorotating condition by an exterior power source. The wing rotor must be impressed in a moving current to produce thrust or resultant forces.

3. Magnus Cylinder. This group includes a cylindrical rotor device operating much like the wing rotor to produce thrust or lift by Magnus effect. Unlike the wing rotor, it must be rotated by power, and, as a cylinder, it cannot absorb power in itself from a moving current. Like the wing rotor, it also must be impressed in a moving current to produce lift or thrust.

4. Cross-Flow Fan. This group includes a multibladed fan or pump device not too unlike certain cyclogiro systems but with a fixed geometry. Like the cyclogiro system, the cross-flow fan will produce static thrust when its shaft is power driven. As there is a large general description of this fan system in the engineering literature, the reader is referred to References 3E and 4E for a review in this area. The cross-flow fan, or tangential blower as it is sometimes called, may have a rotor with blades shaped somewhat like those of a forward curved centrifugal fan impeller. Unlike the common squirrel-cage fan rotor, both ends of the rotor or impeller are sealed, and the rotor is fitted into a casing or shroud in which the air enters at the periphery on one side, passes through the rotor, and leaves on the peripheral face at the other side. References included here describe this fan as applied to V/STOL aircraft only.

5. Other. This group includes various other systems which have been suggested, tested, or built in which a winged

or rotor system rotates about a horizontal axis. Among these, for example, is the Thrust Wing (German), Helicopter (French), or Radial-Lift Concept (Curtiss-Wright), in which an especially designed VTOL propeller blade and feathering mechanism may be arranged to directly furnish a substantial vertical component of lift while the propeller axis of rotation is nearly horizontal. Also, miscellaneous devices of interest are loosely classified in this category.

6. **Theoretical Exposition.** This category includes references in which an analysis is presented toward the understanding of a phenomenon or toward the answer to a specific problem. The text may be merely a hypothetical discussion or may be supported by detailed mathematical and graphical formulations. For a more comprehensive means of determining the content and method of approach of the fully theoretical references, it is suggested that the reader first review related summaries in the interpretative review and cross-index tables those items called out in: 12 - Review.

7. **Performance.** This group includes a qualitative and/or quantitative discussion of performance, range, etc., especially that of the complete system.

8. **Stability.** This group includes a qualitative and/or quantitative discussion of stability of a complete flight system and its criteria.

9. **Control and Maneuverability.** This category discusses in a qualitative and/or quantitative manner, controllability, control means, and mechanisms. Maneuverability is discussed primarily with reference to marine systems.

11. **Phenomenon Demonstration.** Discussion and demonstration of basic HARWAS fundamental flight mechanics such as in the deflection of spinning missiles in flight, the autorotation of free-falling cards and shapes, the curved flight of baseballs, the tumbling of aircraft, and the like are discussed under this heading.

12. **Review.** A category in which the reference covers an interpretative, comprehensive background review and evaluation.

13. **Comment of Interest.** A usually brief statement or clipping often accompanied by a photograph or drawing describing a matter of some technical importance. Usually the content of the statement does not warrant the full attention of a report or article, yet it is not altogether trivial for its background.

14. **Aircraft Sustentation.** This category pertains to an aeronautical system which is concerned primarily with the production of lift.

15. **Aircraft Propulsion.** This category pertains to an aeronautical system which is concerned primarily with the production of thrust.

When both items 14 and 15 are checked, the system may usually be considered to be that of a fully controllable cyclogiro device.

16. **Marine Propulsion.** This category pertains to a nautical system concerned solely as a thrust-producing device. Below the waterline, this may be a cycloidal propeller; above, it may be a sailing Magnus or wing rotor.

17. **Complete Aircraft.** The system as applied to a complete flying article as opposed to a test component will be discussed under this heading.

18. **Complete Ship.** This group discusses the complete marine system, including problems of hull hydrodynamics, interference, and overall performance.

19. **Rotating Flap or Slat.** This category pertains to an autorotating or powered wing rotor or Magnus cylinder used in conjunction with a fixed aircraft to enhance lift circulation and/or to energize the boundary layer. Such systems are to be considered as auxiliary to the main lifting wing. They may be located at or near the trailing edge (flap), in or near the leading edge (slat), or above or below the main wing surface. They may, at times, be retracted or faired into the structure of the fixed wing.

20. **Convertible Rotor to Wing.** These are systems in which the rotor (wing rotor or cyclogiro) may be stopped and/or started in flight are discussed under this heading. The blade of the stopped rotor is then considered to be a fixed lifting wing of the converted aircraft.

21. **Rotor-Rotor.** This is a system peculiar to the wing rotor or Magnus cylinder in which the horizontally rotating rotor system is corotated about a vertical axis or shaft. In essence, the rotor then may be considered to be a replacement for fixed blades (say, for example, in the case of thrust propeller). This group may also apply to decelerators, windmills, etc.

22. **Device Other Than Aircraft or Marine System.** As indicated by the following key letters, HARWAS may be applied to the following devices:

- B - Bomblet
- C - Control Device
- D - Decelerator
- F - Fluid Motor or Meter
- K - Kite
- W - Windmill

23. Feathering Pitch System. Refer to Figure 92 for key. This category classifies cyclogiro feathering systems by blade motion relative to rotor axis of rotation.

24. Rotor Systems per Installation. A rotor system is considered to be that independent collection of cyclogiro rotor blades or wing rotor vanes that, together, function as a singular lifting or thrusting system. Thus, the arrangement for Figure 64 is considered to have one rotor, that of Figure 68 is considered to have two, and that of Figure 59 is considered to have four rotor systems.

25. Number of Blades per Rotor. Rotor systems may have one or more blades as numbered in index. M stands for multiple, more than eight. Savonius wing rotor systems are considered to have two blades per rotor.

26. Blade or Rotor Profile. This category discusses profile or cross section of rotors, a prominent parameter in wing rotor studies. Subindexed in the following manner, they are:

- A - Conventional
- C - Cylinder
- D - Driving or Auxiliary Vanes System
- E - Ellipse
- F - Flat Plate
- G - Regular Geometric Shape
- I - Irregular Geometric Figure
- L - Lenticular
- P - Powered, Driven by External Source
- R - Rectangular, May Have Rounded Edges
- S - Semicircular Halves, Savonius
- X - Cruciform, Three or Four Points

27. Tip Path Other Than Circular. In cycloidal propulsion rotors, the blades usually sweep out the surface of

a cylinder, but, in some (mainly aeronautical) arrangements, they may describe a cone or other irregular truncated developments (in an attempt to simulate insect wing motions).

28. **Auxiliary to Fixed Wing.** Rotor systems are used to increase lift or drag. They may stop, start, convert, retract, or otherwise supplement aircraft control or performance.

30. **Flight or Drop Test.** The test in which horizontal-axis rotating-wing aircraft systems are flight-tested or dropped in wind tunnels (both horizontal or vertical), from aircraft, balloons, or towers is discussed under this heading.

58. **Presentation.**

B - Book
P - Patent Description
R - Report
S - Serial Publication
T - Thesis

59. **Classified.** References under this broad classification may be considered to have limited distribution to one degree or another. They may be generally considered to be Secret, Confidential, Restricted, Limited, Controlled Access, or not available for foreign circulation. This material is to be found in a supplementary report.

60. **Company Proprietary.** Material which is limited in its distribution and availability, in that it is usually generated for a particular organization for in-house knowledge or business falls under this heading. These references may consist of proposals, laboratory reports, etc.

61. **Not Generally Available.** This category refers to references which are not available to the general public at the time of this writing for a variety of reasons. Also see Index Items Nos. 59 and 60.

64. **Not Searched.** This category is cited where the references were not examined by the authors because of their immediate unavailability and the lack of time required to search for them. The reader may therefore only know of their existence, sense the content from the title, and hope to have better access to sources.

Status and Retrieval of References

Nearly all of the books, journals, serial publications, newspapers, general publications, and reports issued before 1950 are to be found in

the collection of the Library of Congress, Washington, D. C. This material is readily available for examination at that library. A limited amount of this material (that is, that material which is not specifically copyrighted) may be copied by the photoduplication service of that library. Much of this material may also be obtained outside of Washington, D. C., on a library loan basis.

An alternate source for some of this earlier material, and for much of it that has been published since then, is the Technical Information Service, American Institute of Aeronautics and Astronautics (AIAA).

Those German World War II aeronautical publications that formerly were part of the Defense Documentation Center collection are to be found in the microfilm collection of the National Air Museum, Washington, D. C. Those German documents with Department of Commerce Publication Board (PB) numbers may also be purchased through the regular Clearinghouse for Federal Scientific and Technical Information (CFSTI).

Those individuals or organizations within the Government or working on Government contracts, if presenting the proper field of interest register and other requirements, can obtain most of the Government-sponsored reports issued since 1950 from the Defense Documentation Center (DDC). All of the NACA/NASA reports, memorandums, notes, etc., are available, in a similar manner, from the NASA Scientific and Technical Information Facility.

Domestic and foreign patents may be directly examined in the search rooms of the U. S. Patent Office, Washington, D. C. Domestic patents may be purchased by mail, for cash (\$.50) or special coupons, from the U. S. Patent Office, Washington, D. C. Only the patent number is required to identify the order. Foreign patents are also kept in the Patent Office library in bound volumes by number or classification. Xerox copies may be made for \$.50 per page only at the main Patent Office. Domestic patents may be examined in one of the 22 patent copy libraries around the country. In order to examine patent material outside Washington, D. C., refer to: "How to Obtain Information From U. S. Patents", U. S. Department of Commerce, Patent Office, Washington, D. C. (for sale by the U. S. G. P. O., Washington, D. C., \$.20). Foreign patents may best be obtained by writing directly to the foreign patent office in question. The current addresses of these offices and their patent costs are described in the front portion of each issue of Chemical Abstracts.

ANALYSIS

I. HORIZONTAL-AXIS LIFTING DEVICES

A. MAGNUS EFFECT AND RELATED SYSTEMS

1. Wing Rotor (Rotating Airfoil) Decelerators

a. Introduction

Some aerodynamic properties of autorotating or forcibly rotated cylinders and airfoils were investigated even prior to the beginning of aviation. It was Maxwell who wrote the earliest (1853) known paper on the subject (Reference 41M). That entirely nonmathematical paper tried to explain the curious behavior of an oblong card which, left to fall freely in the air, started immediately to rotate about its longitudinal axis while deviating from the vertical in the horizontal direction perpendicular to the axis of rotation. Steady "terminal" conditions are soon reached, in which speed, rate of rotation, and path angle are all constant. This simple experiment revealed at once two important properties of an "aerofoil of large aspect ratio": (1) ability to autorotate; (2) ability, when rotating in an airstream, to create an asymmetrical pressure distribution, resulting in a force normal to both axis of rotation and mainstream velocity. About the same time, the famous "Magnus effect" on rotating circular cylinders was discovered, but it was not until the Kutta-Joukowski theory of aerodynamic lift appeared some 50 years later that a more general understanding of the "lift through circulation" principle became possible.

Very little has been done to exploit the use of airfoils rotating about a horizontal and transverse axis for generating lift in aircraft. The basic reason is that a rotating airfoil as the main lifting surface of an aircraft can generate high lift, but this is accompanied by a correspondingly high drag, so that it will have a lower lift-to-drag ratio than the corresponding fixed-wing configuration. The configuration is not competitive for standard aircraft applications.

Such rotating wings have been proposed in recent years for other aeronautical uses, particularly as "aerodynamic decelerators", for the air-to-ground precision delivery of cargo payloads. Such applications will be discussed in detail later in this section. The main features of the aerodynamics of rotating airfoils will first be reviewed. Aerophysics Company suggested in 1964 that devices embodying the use of single airfoils rotating about a horizontal and transverse axis be called "wing rotors". This name will be used extensively in the discussion that follows.

b. Pictorial Review

Magnus' original experimental apparatus, by means of which he established the existence of a side thrust on a rotating cylinder in an airstream, is shown in Figure 1 (Reference 13M). Thus, in Figure 2A, a stream of air is continuously discharged from the radial blower F as long as the crank-wheel E is kept in rotation. This air impinges upon the rotating cylinder and the deflection of the airstream will be indicated by the weather-vaning of the pivoted surfaces a and b. In Figure 2B, the radial blower discharges air onto the heavy brass cylinder mounted between bearings a and b. This Magnus cylinder is set into prolonged rotation by means of the small pulley e and a quickly pulled and unwinding starter string. The Magnus effect on the system will now cause the spinning cylinder, along with its supporting beam y - z, to slowly rotate in a horizontal plane about the vertical axis c - w. The lower board B - A, which also carries the blower F, is so arranged with the vertical pivot, that it will tend to rotate and lag behind the moving Magnus cylinder, thus demonstrating the continuous side or Magnus force produced by the rotating cylinder.

The original autorotating wing rotor device with a useful payload, found in nature, the locust tree seed pod (*Robinia pseudoacacia*), is shown in Figure 1.

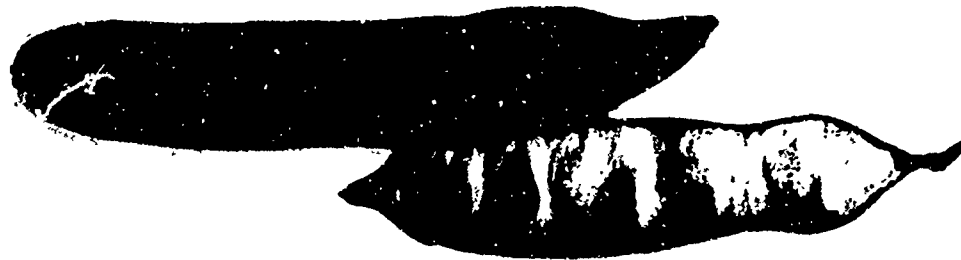

Figure 1. The Original Autorotating Wing Rotor Device With Useful Payload Found in Nature: The Common Locust Tree (*Robinia pseudoacacia*) Seed Pod.

The first measurements and primitive theory on wing rotors were made by Ahlborn in 1897; his apparatus and typical trajectories are shown in Figure 3.

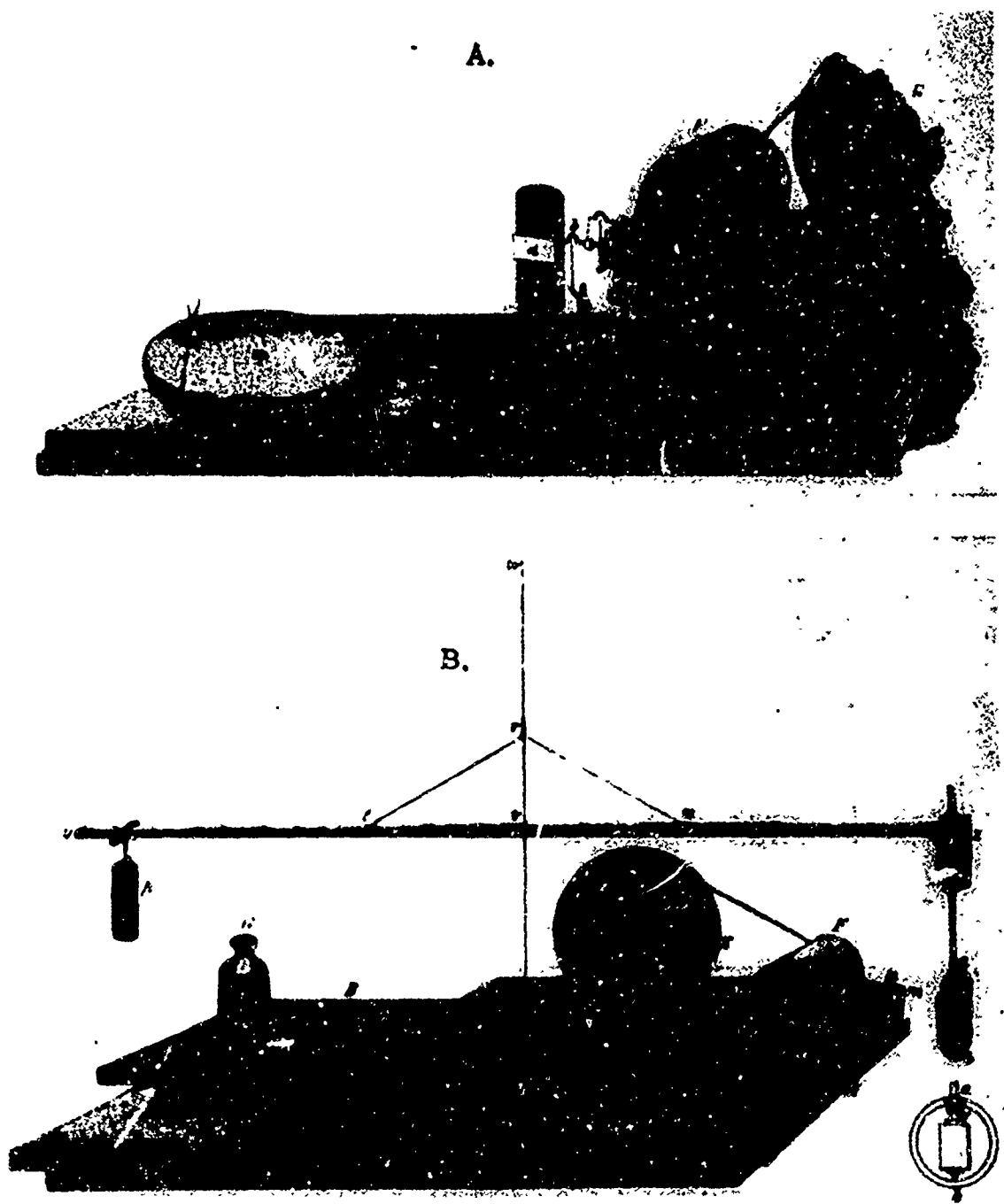

Figure 2. The Original Experimental Arrangement by Magnus in Determining the Side Thrust on a Rotating Cylinder in an Airstream.

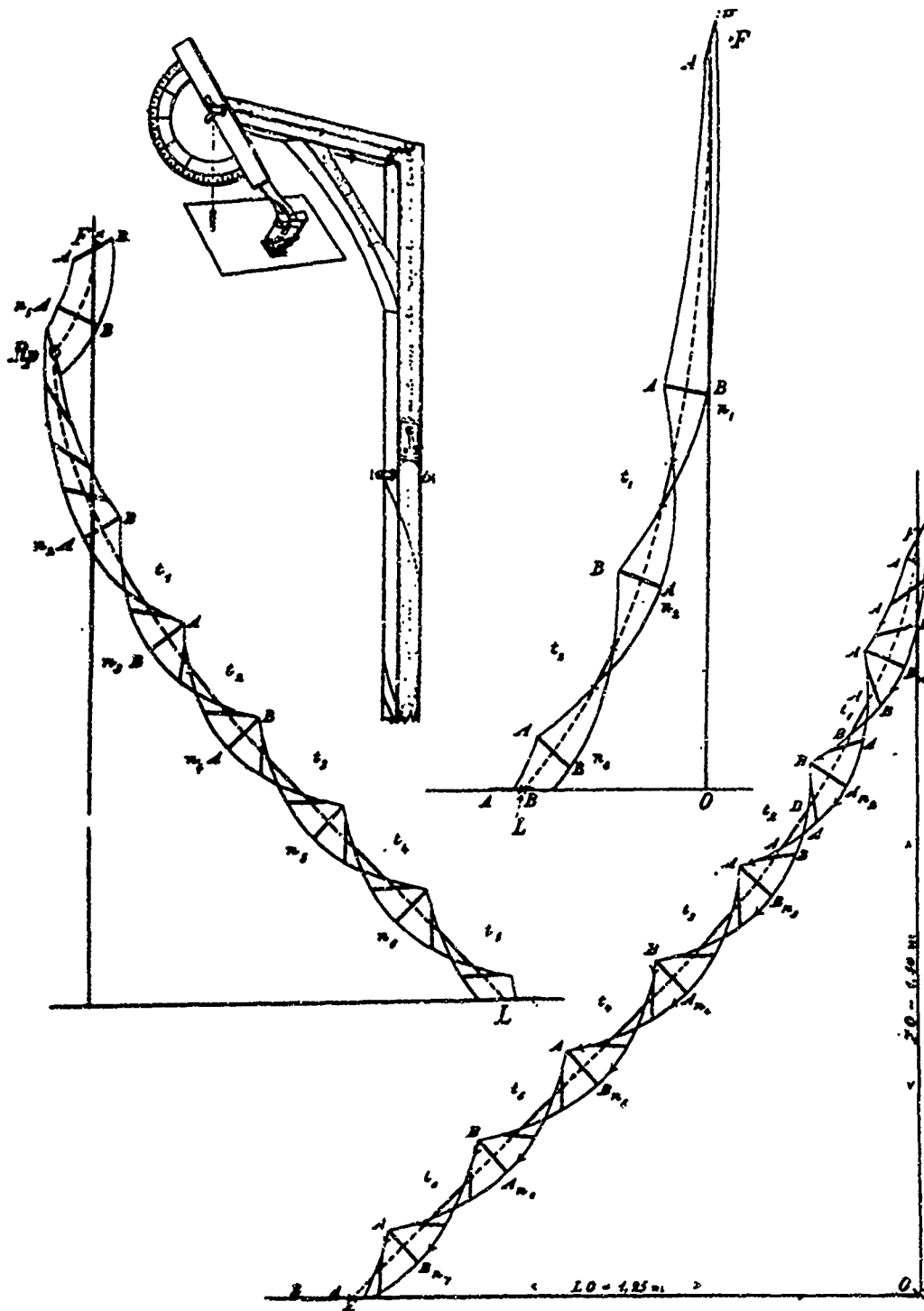

Figure 3. First Wing Rotor Performance Measurement and Theory by Ahlborn in 1897 (Ref. 9A). Autorotating Metal Plate Released From Tower as Shown.

Koppen's wing rotor glider (1903), of which models were built, is shown in Figure 4.

Another early wing rotor system, devised by Ames, is shown in Figures 5 and 6.

Several airplanes using Magnus cylinder lift for their main sustentation have been proposed at various times. Two such odd configurations are shown in Figures 7 and 8.

Wing rotors have often been used as toy kites.

A serious attempt was made in the thirties in France by Chappedelaine to develop an airplane with a main wing rotating about a horizontal axis. The "Aérogyre", shown in Figure 9, was built and flown. However, it crashed, and the project was abandoned. Performance of the aircraft is shown in the performance curves of Figures 15 and 16 (References 16C through 26C).

This project, though unsuccessful, is worth more than a passing mention, because the aircraft was basically sound. The reason that Chappedelaine used a rotating wing was that he knew he could obtain a higher lift out of a rotating wing, either autorotating or self-powered, than out of the same wing operating as a fixed wing. He intended to use this feature for takeoff and landing only, and to lock the wing for cruise flight. The "Aérogyre" type aircraft thus would have been a short takeoff and landing (STOL) airplane with the high cruise efficiency of the fixed-wing airplane and the additional safety of the autorotational landing.

Modern versions of the "Aérogyre" type aircraft have been proposed in the United States (Foshag, 1947; see Figure 11) and, very recently, in Germany (Horstenke, one of whose models is shown in Figure 12).

As a result of work done in Germany at the end of World War II, recent interest has been expressed in using rotating airfoils, not as main lift units but as auxiliary high-lift devices on aircraft wings. Crabtree, in 1957, reviewed the state of the art (Reference 52C). Following work done by Alvarez-Calderon since that time (References 18A through 24A), NASA/Ames is currently testing a rotating cylinder flap on a COIN-type aircraft (Reference 31A). Noncylindrical rotating devices can also be considered; two such configurations are shown in Figure 10.

Most research and development work currently performed in the United States on Magnus rotors and wing rotors is related to the dynamics and aerodynamics of bomblets. This

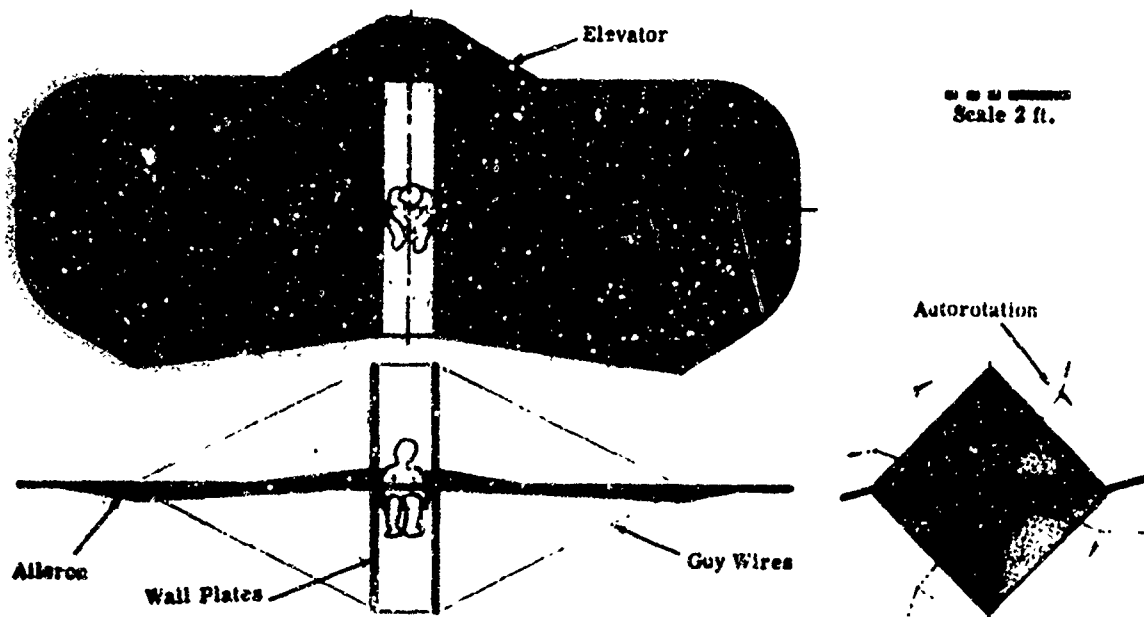

Figure 4. Early (1903) Wing Rotor Glider Project Demonstrated by Koppen as Model (Ref. 52M).

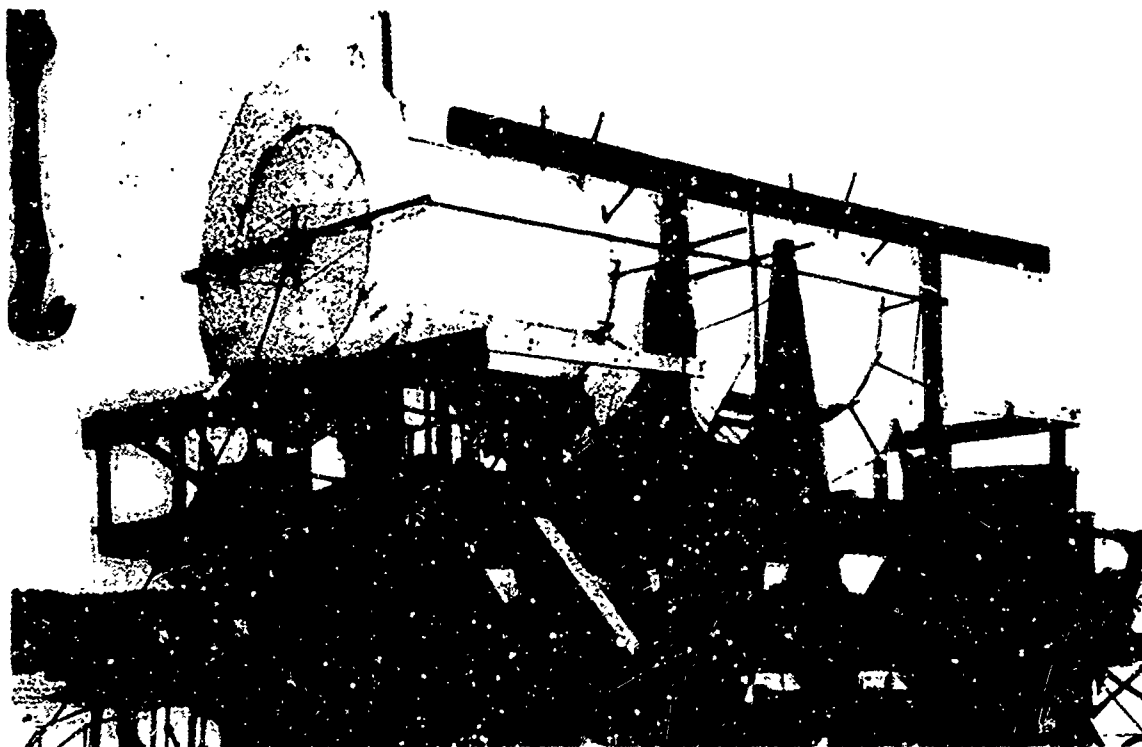

Figure 5. Navy-Assisted Magnus Effect Aircraft by Ames (1910) Mounted Atop Fast Steam Launch (Ref. 26A).

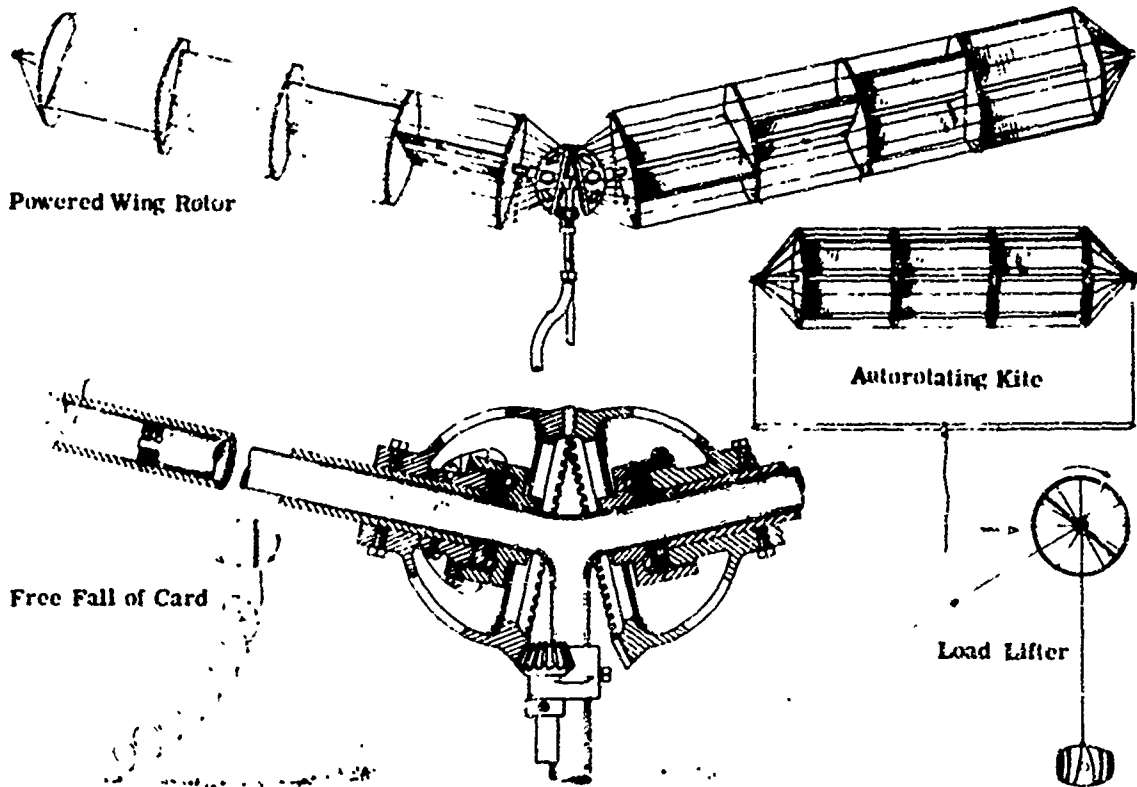
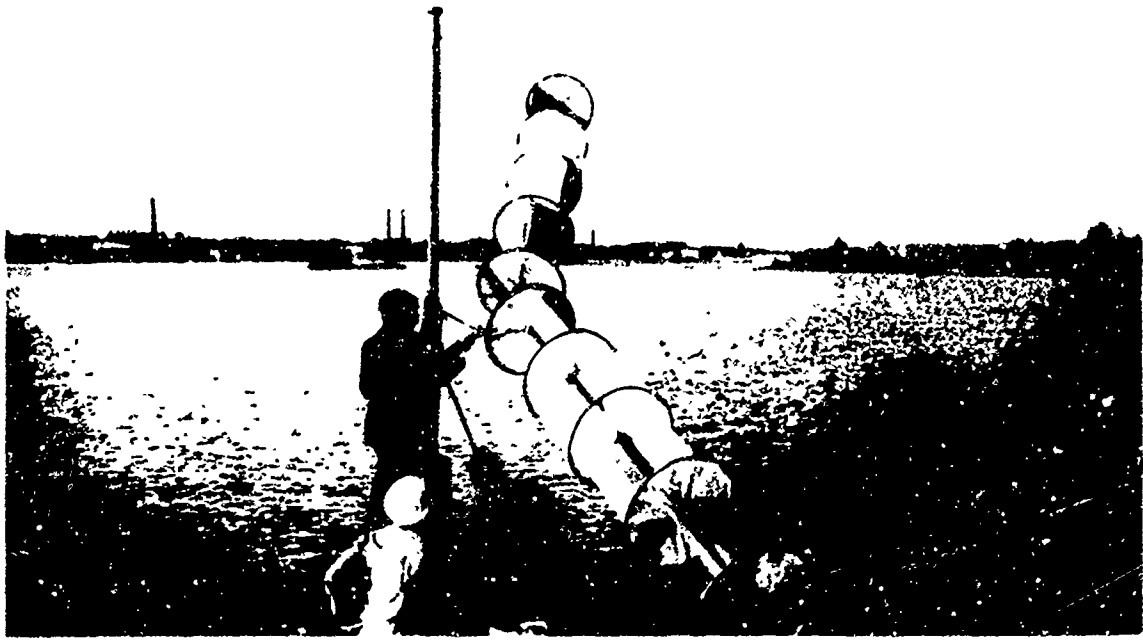

Figure 6. Further Autorotating and Powered Wing Rotor Systems by Ames (Ref. 25A).

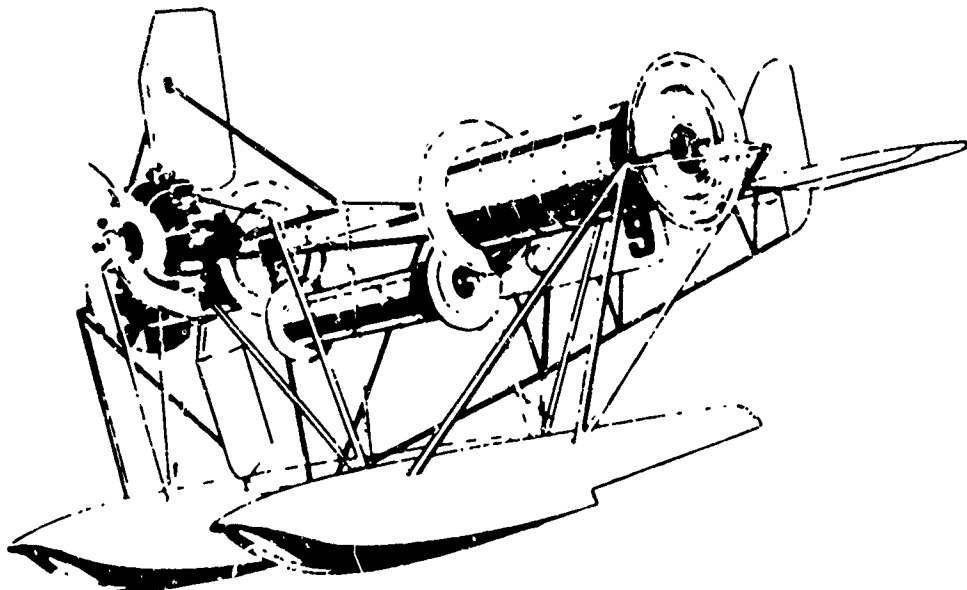

Figure 7. Zaparka Magnus Rotor Aircraft. Possibly Flown Full Size Briefly in 1930 (Refs. 2Z Through 12Z).

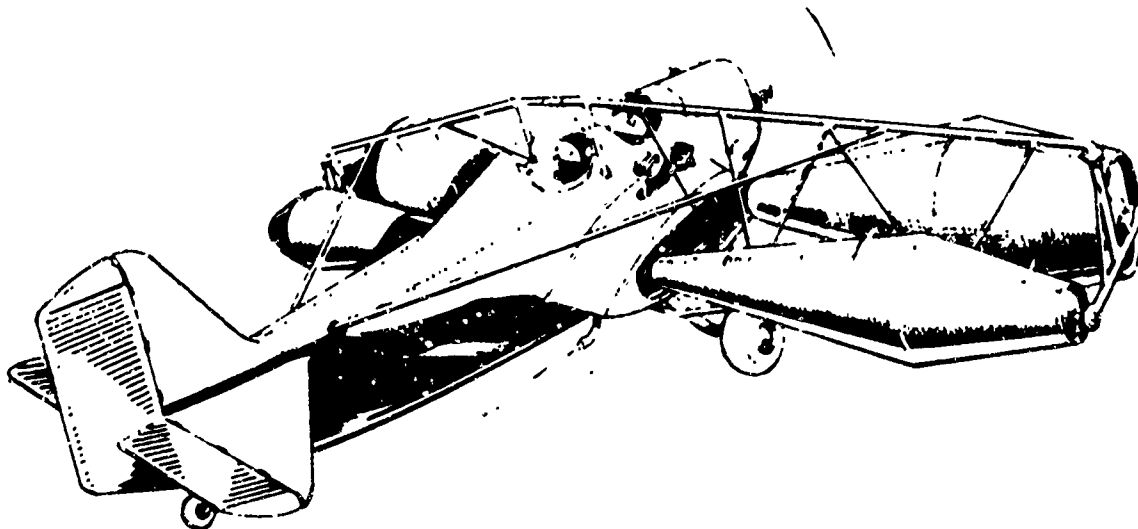

Figure 8. Guest and Popper Full-Size Magnus Rotor Aircraft. Main Engine 85 HP. Serrated and "Pocketed" Rotor Surface to Enhance Circulation (Refs. 53G Through 58G).

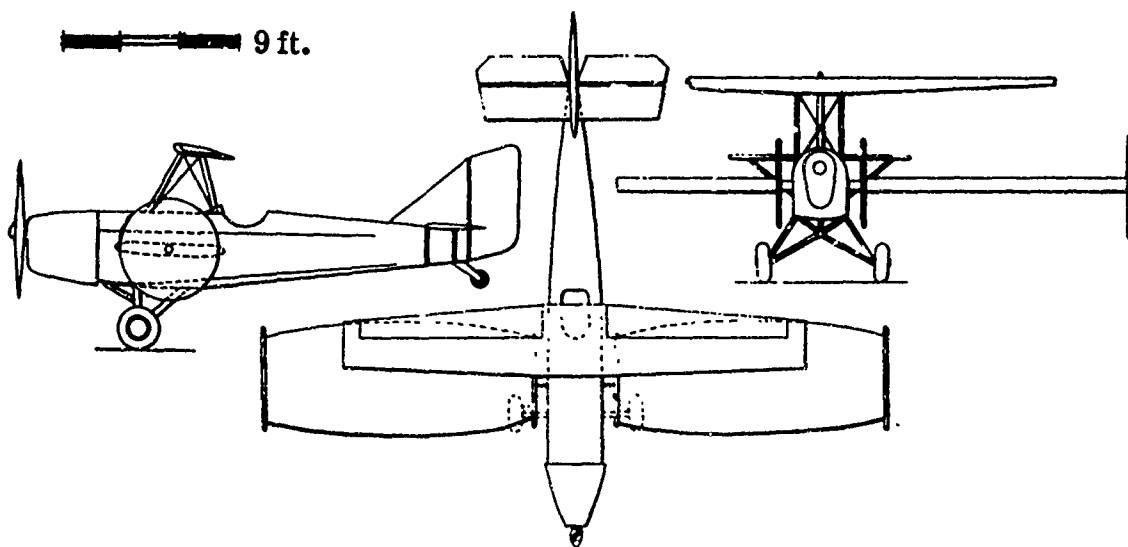
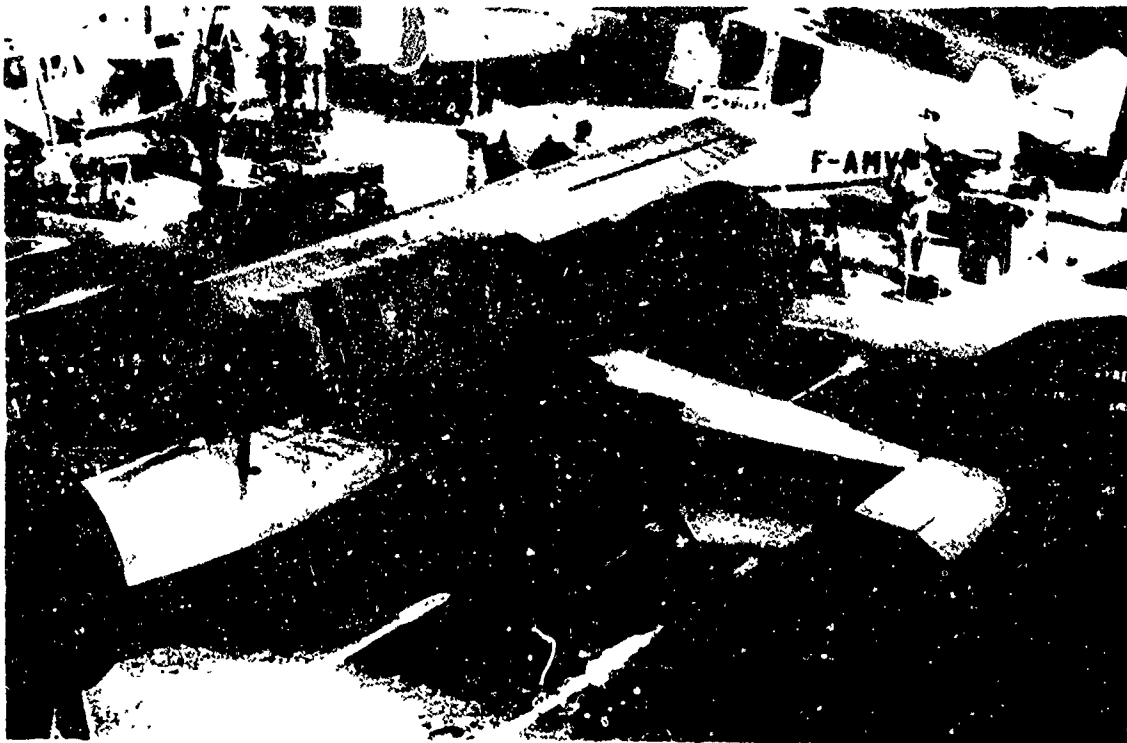

Figure 9. The Chappedelaine-Desgrandechamps-Caudron "Aérogyre" Being Rigged and Shown in Three Views. Several Flights in 1934. Lower Wings Rotate and Lock for STOL Conversion. (Refs. 16C through 26C).

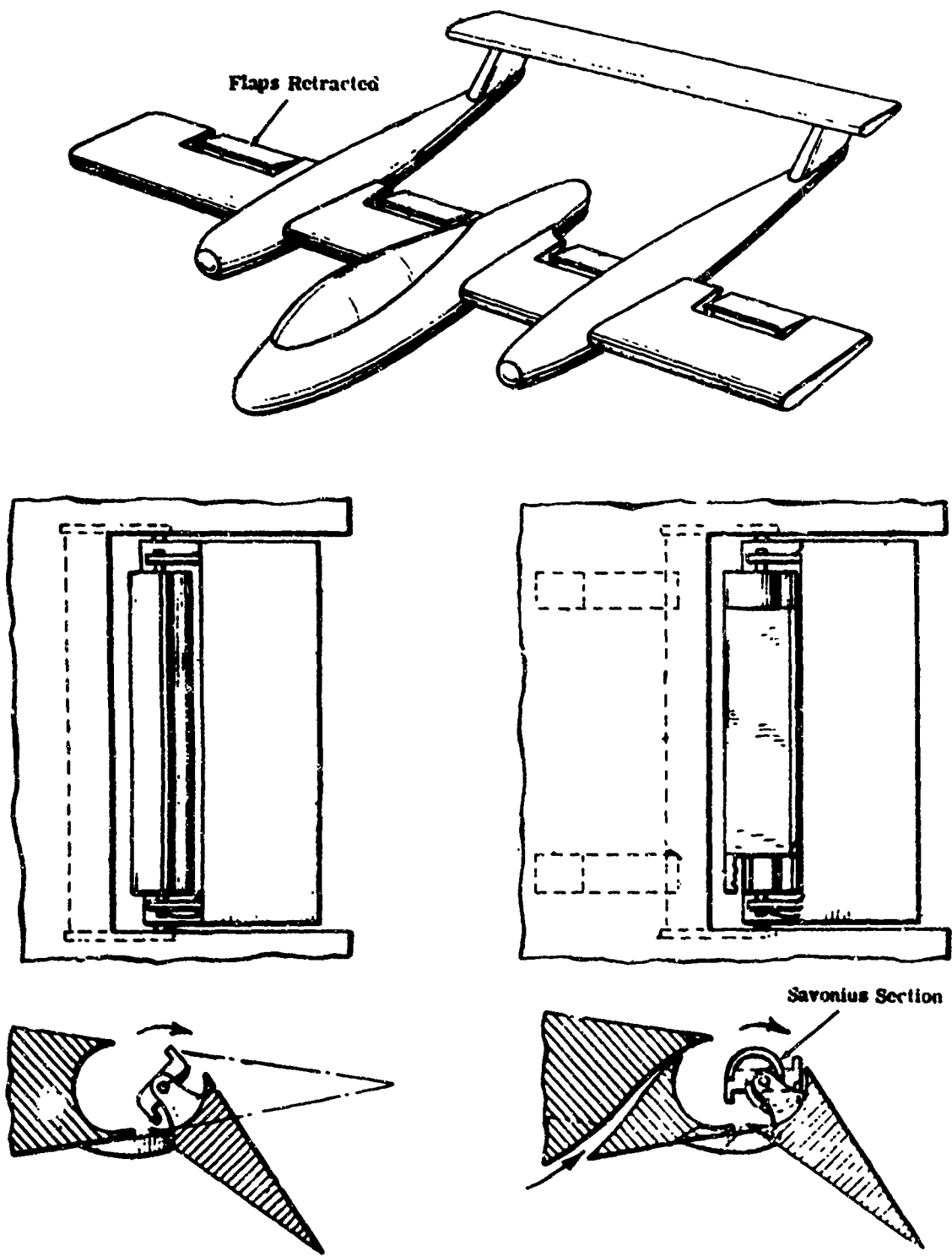

Figure 10. Recent (1966) Adaptation of Autorotating Wing Rotors to Trailing-Edge Flap Systems To Turn the Flow Over Flap. (From Brunk, Refs. 84B and 86B.)



Figure 11. Eight-Foot Wing Rotor Sailplane (1947) Demonstrating Good Flight Performance and Stability About All Axes. (Ref. 65F).

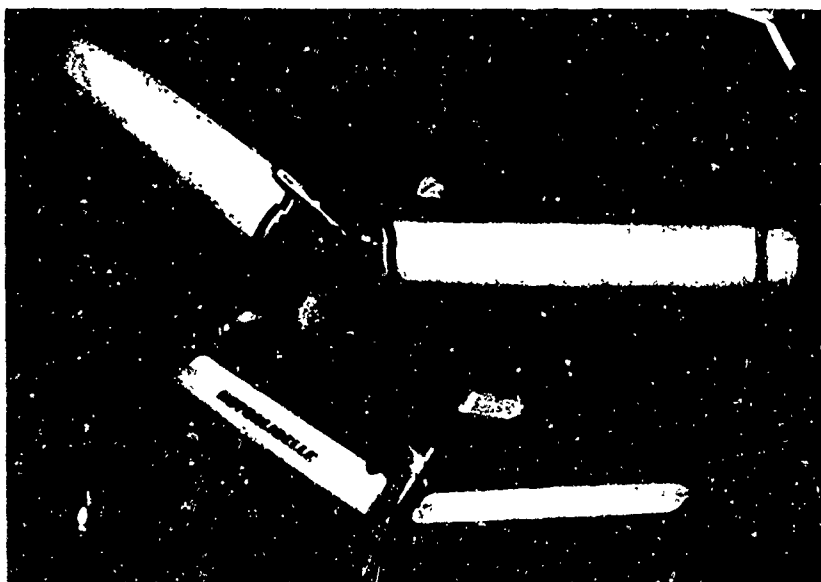

Figure 12. Successful Powered Wing Rotor Model by Horstenke (Refs. 52H Through 59H). The Larger Model Is Controlled by Radio Command.

work is concentrated at the Edgewood and Detrick facilities, as far as the Army is concerned, and at the Air Force Armament Laboratory, Eglin Air Force Base, as far as the Air Force is concerned. This work is mostly of a classified nature and will not be discussed further here. It is summarized in the Proceedings of the Conference on Dynamics and Aerodynamics of Bomblets, which took place at Eglin Air Force Base, Florida, September 26-28, 1967.

c. Aerodynamics and Dynamics of Wing Rotors

A conventional airfoil or wing placed in an airstream will not usually autorotate if its center of pressure and its chordwise center of gravity approximately coincide. One can, however, create a strong pitching moment and cause autorotation of any airfoil by moving its center of gravity backward, sufficiently far from the center of pressure. Similarly, a flat plate, a modified rectangular shape, or a cylinder with driving vanes will autorotate; the Magnus smooth cylinder is about the only one that will not. Actually, there are considerable differences between the wing rotor and the Magnus cylinder. The circular cylinder enforces circulation through viscosity alone and must be driven to overcome the resisting frictional torque; the circulatory motion of the air exhibits a complete axial symmetry and, thus, in steady conditions, should not differ much from an idealized "linear vortex", so that the usual formula $L = \rho V \Gamma$ (L is the lift, ρ the density, V the translational velocity, and Γ the circulation) should apply, at least approximately. In the case of a wing rotor, the velocity field is more or less unsteady and much more complicated, involving some significant radial out-and-in flow. In the presence of a mainstream, the mean aerodynamic torque will be positive (driving) at low rotational speeds and negative (resisting) at higher rates of rotation, so that the airfoil without an external drive will autorotate at some intermediate rate. A significant lift appears in such conditions, but it may be increased several times if the airfoil is driven by external power so as to acquire much higher rotational speeds than the autorotational one. At such speeds, the velocity field outside the cylindrical volume swept by the airfoil becomes more steady and may approach the form of a linear vortex field.

The theory of fluid motion associated with a rotating airfoil presents enormous difficulties. No successful analytical attempt has been made thus far to determine the aerodynamic characteristics of the rotating airfoil. An extremely crude estimate of lift for the two-dimensional case has been suggested, based on the concept of an idealized linear vortex whose circulation is assumed to be $\Gamma = 2\pi U$.

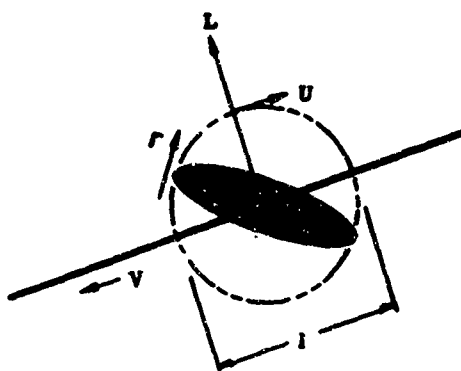

where l is the airfoil chord and U is the peripheral velocity. The lift per unit span is thus:

$$L = \rho v \Gamma = \pi \rho l U V$$

whence,

$$C_L = \frac{2 \Gamma}{V} = 2 \pi \frac{U}{V}$$

This formula leads to large values of C_L . The maximum theoretical value of the lift coefficient, for the cylinder, would correspond to the situation in which the two stagnation streamlines, obtained by superimposing the potential flow about a cylinder to the flow with circular streamlines to obtain a flow with circulation, coincide. This happens when $U/V = 2$.

Hence,

$$C_{Lmax} = 4 \pi = 12.56$$

A compilation of the state of the art of the aerodynamics of Magnus cylinders and wing rotors is shown in Figures 13 through 18. To avoid burdening the figures, three tables were prepared.

Table I lists the references pertinent to the performance of powered Magnus cylinders and the physical characteristics of each model. Performance is plotted, in Figures 13 and 14, in the form of C_{Lmax} versus U/V and C_{Lmax} versus C_D . C_D is the drag coefficient.

Table II correspondingly lists the same information for powered noncircular rotors. It is used in conjunction with Figures 15 and 16.

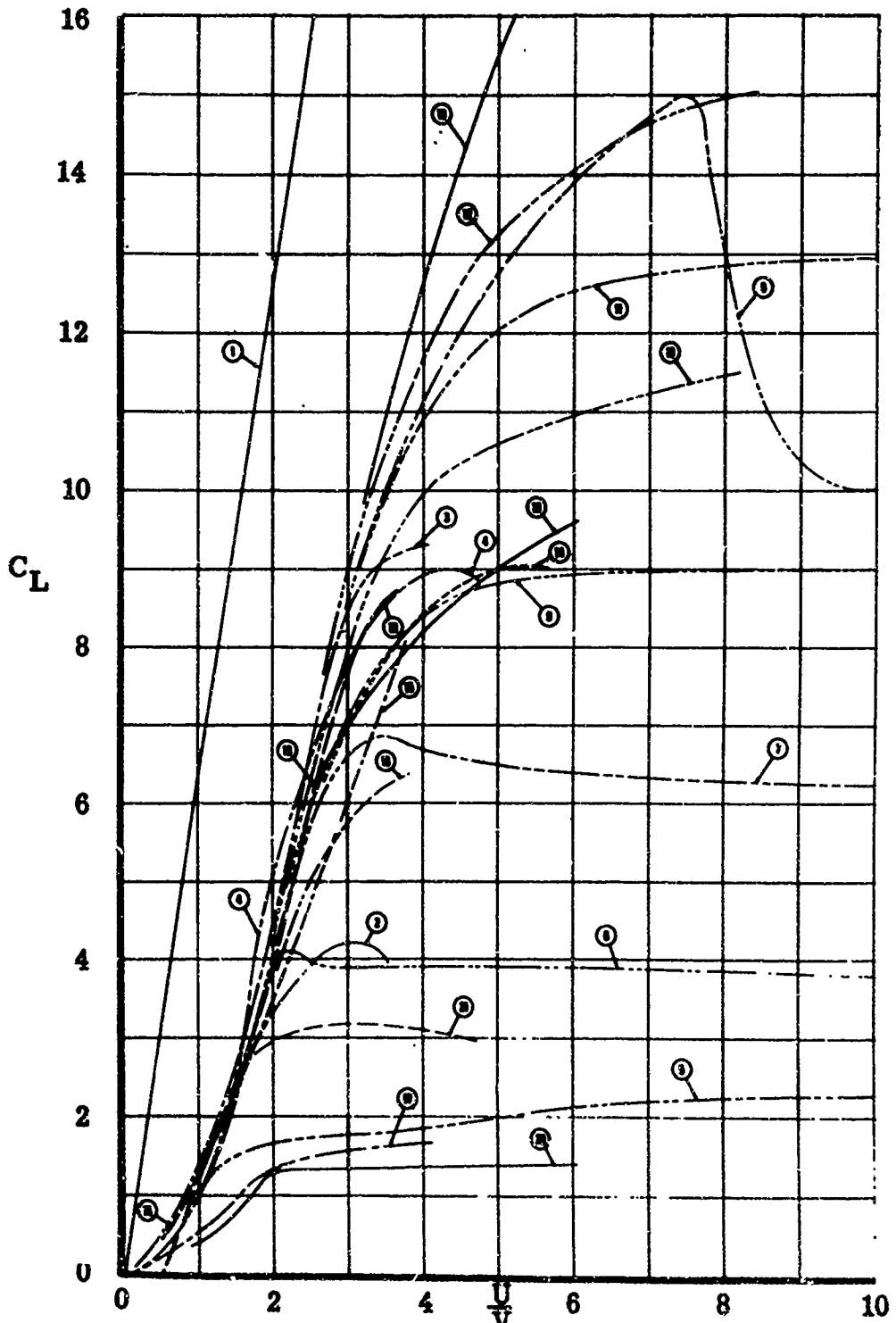

Figure 13. Aerodynamic Performance of a Collection of Powered Cylindrical Magnus Rotors at Several Aspect Ratios, With and Without Tip Plates. See Table I for Identification of Indicated Magnus Rotor Points.

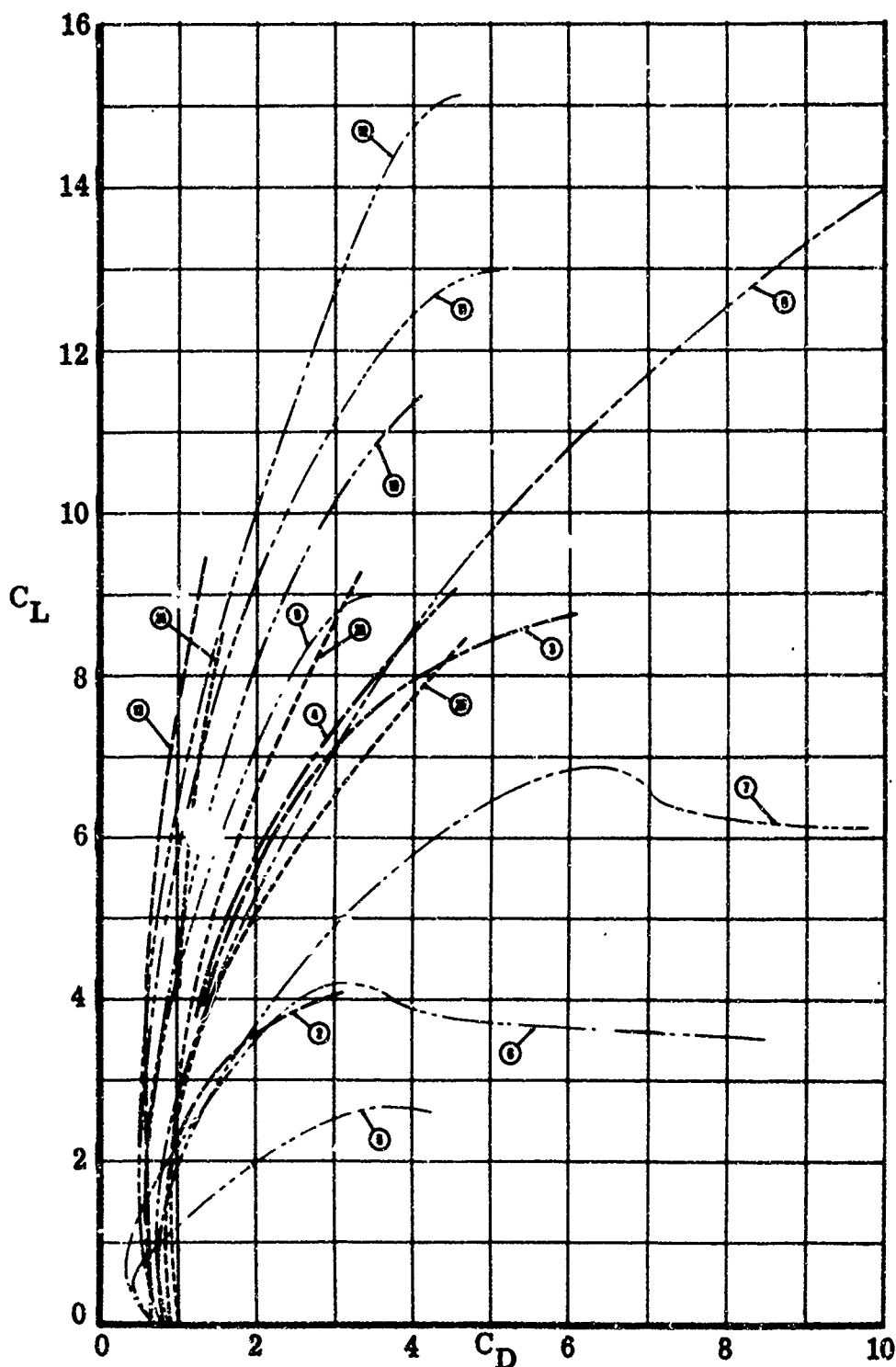

Figure 14. Aerodynamic Performance of a Collection of Powered Cylindrical Magnus Rotors at Several Aspect Ratios, With and Without Tip Plates. See Table I for Identification of Indicated Magnus Rotor Points.

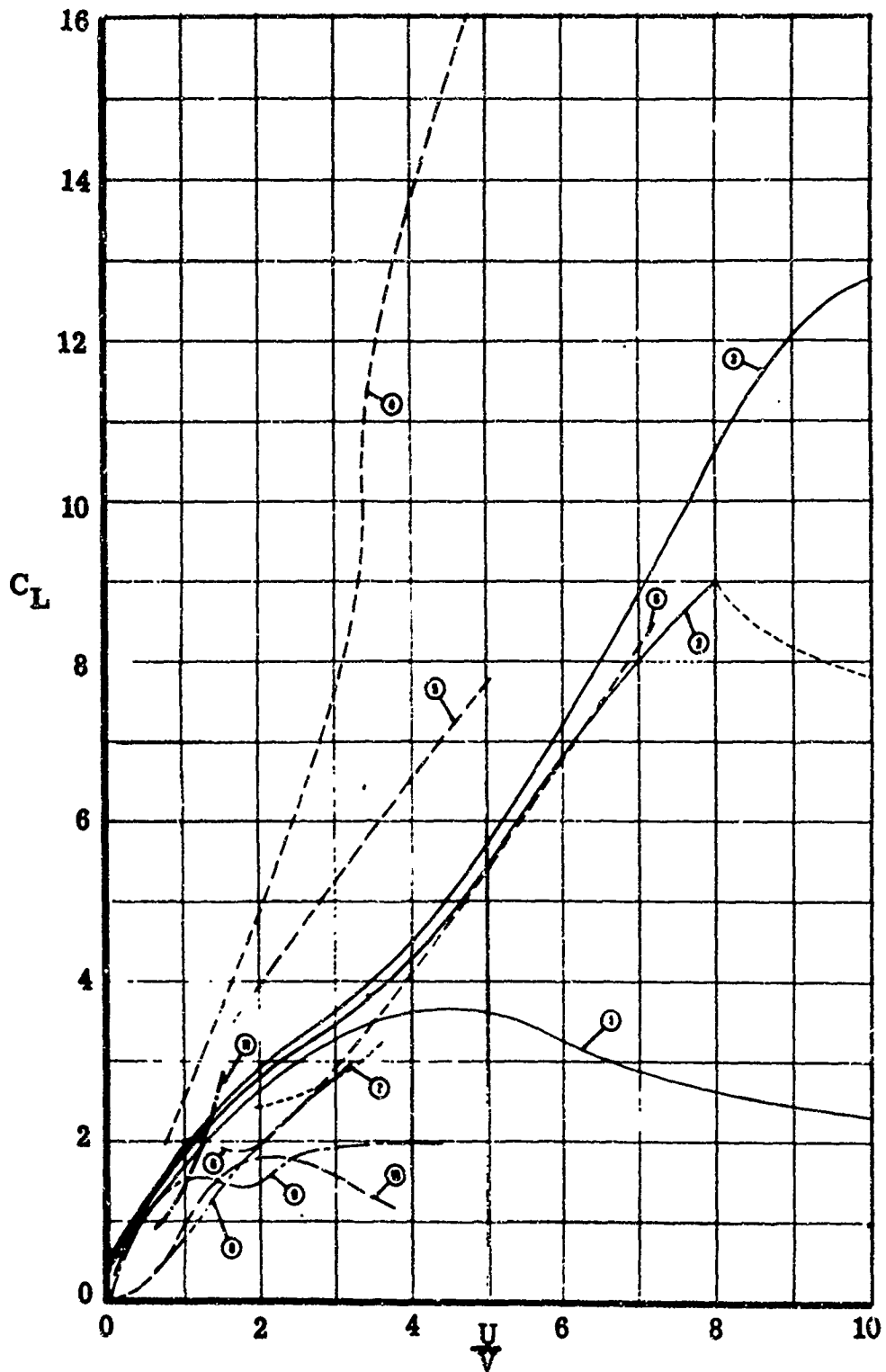

Figure 15. Aerodynamic Performance of a Collection of Noncircular Powered Rotor Shapes With Various Tip Plates, Aspect Ratios, and Profiles. See Table II for Identification of Curves.

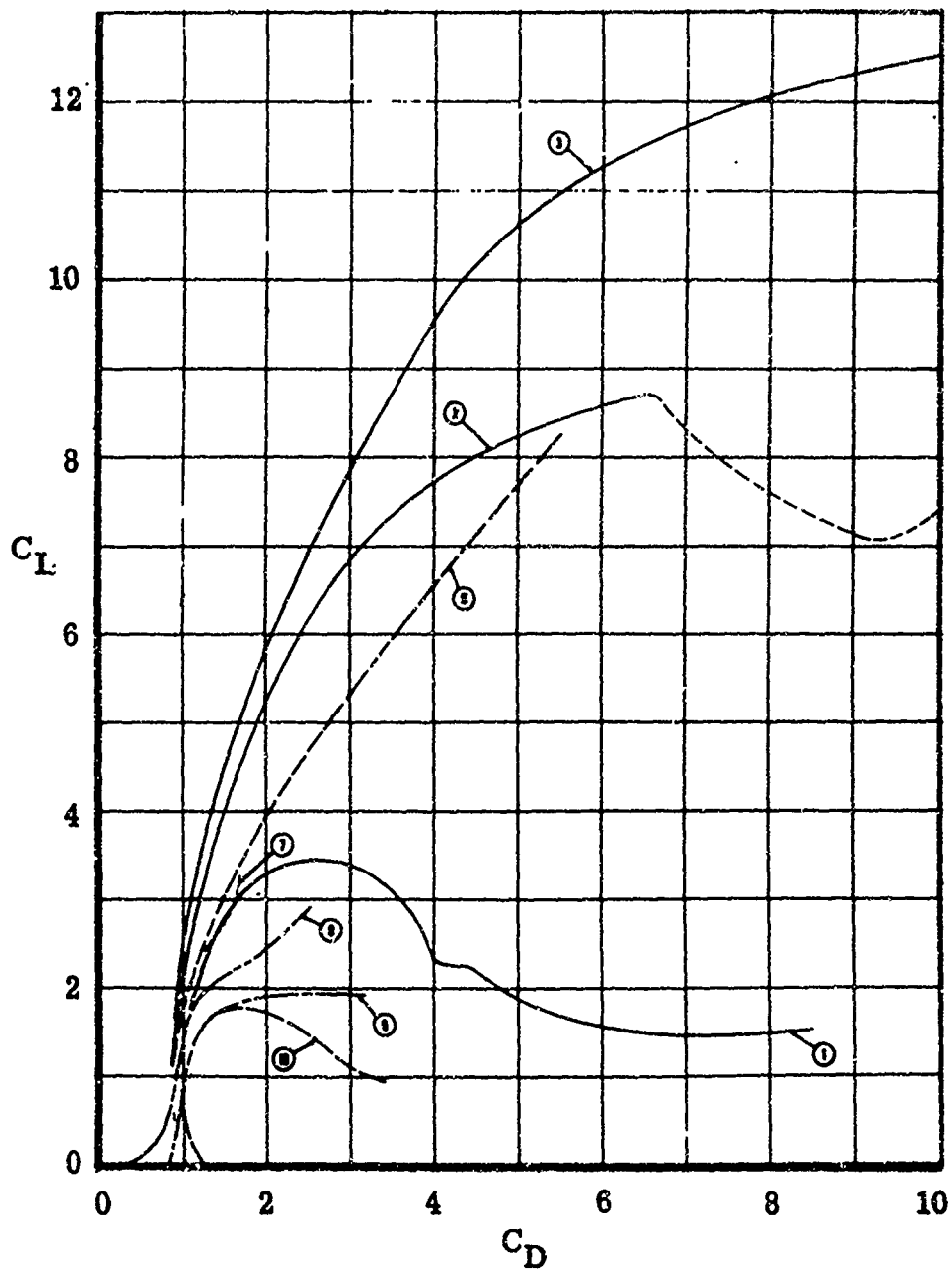

Figure 16. Aerodynamic Performance of a Collection of Non-circular Powered Magnus Rotor Shapes, With and Without Tip Plates, at Several Aspect Ratios and With Various Profiles. See Table II for Identification of Indicated Rotor Points (C_L vs. C_D).

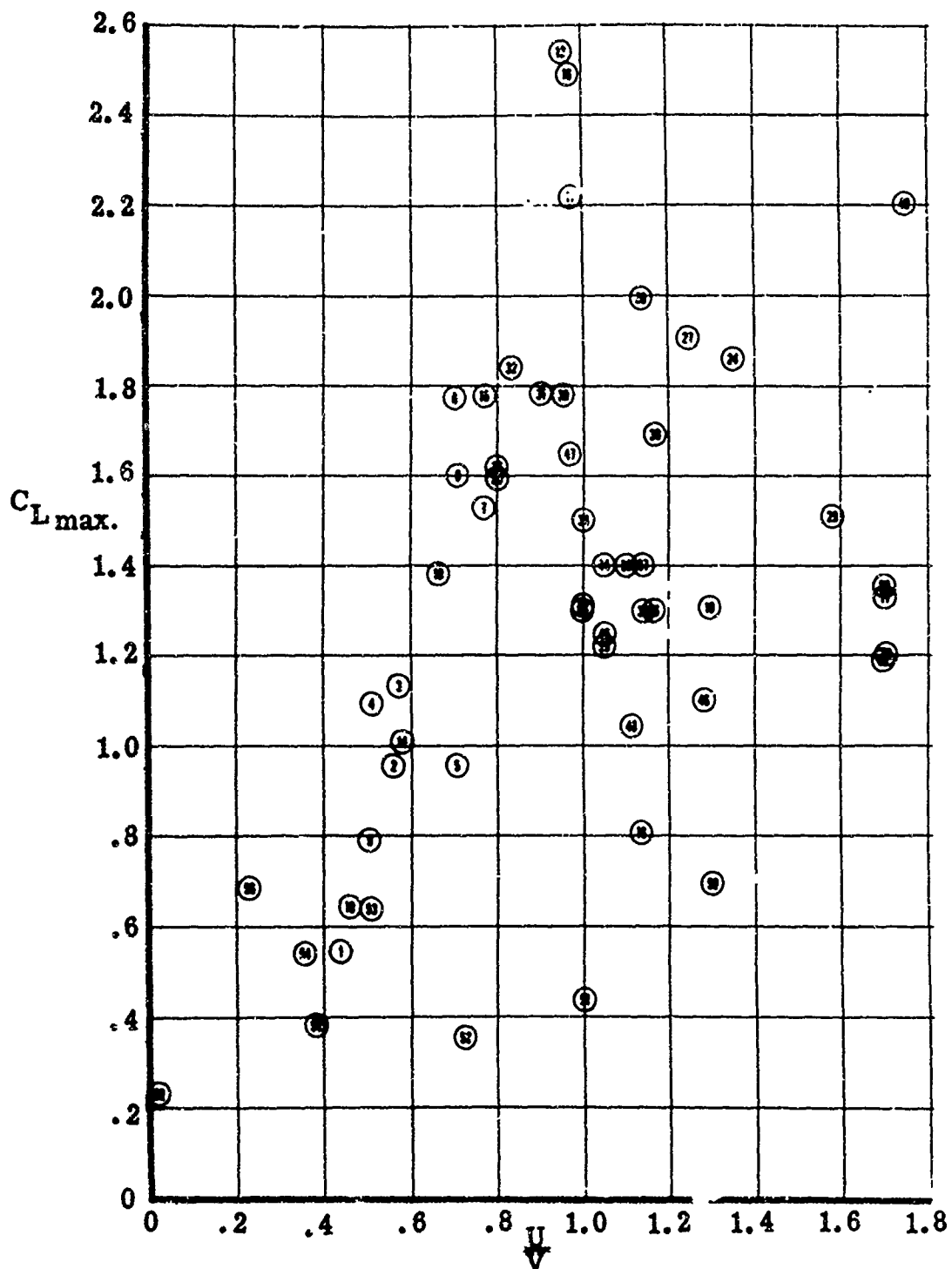

Figure 17. Aerodynamic Performance of a Collection of Autorotating Wing Rotors With and Without Tip Plates, at Several Aspect Ratios and With Various Profiles. See Table III for Identification of the Indicated Wing Rotor Points.

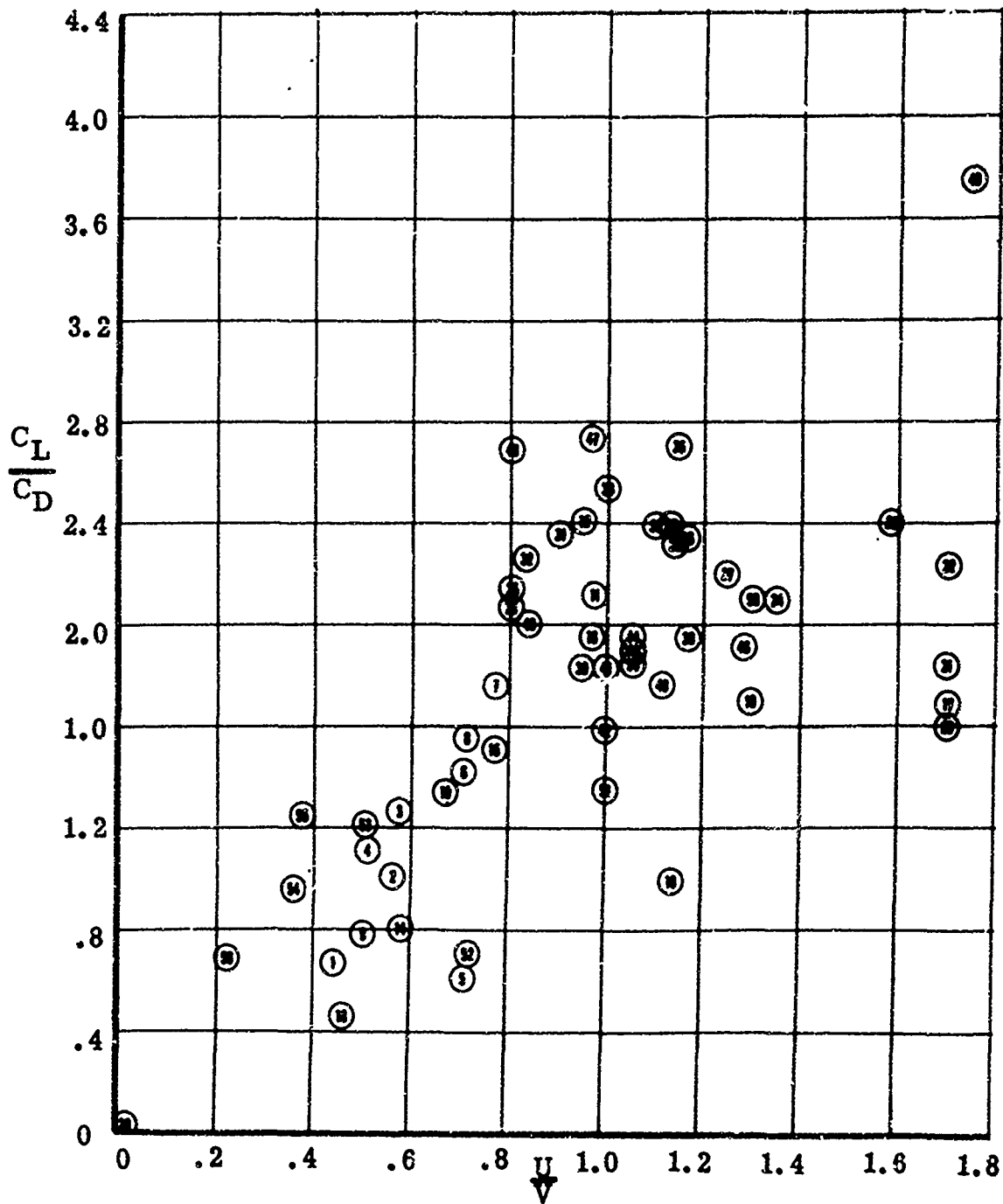

Figure 18. Aerodynamic Performance of a Collection of Autorotating Wing Rotors With and Without Tip Plates, at Several Aspect Ratios and With Various Profiles. See Table III for Identification of the Indicated Wing Rotor Points.

TABLE I. KEY TO FIGURES 13 and 14. POWERED MAGNUS CYLINDER ROTOR TESTS - PERFORMANCE

Curve Bubble No.	INVESTIGATOR	Reference Number	AR Aspect Ratio	h/c Tip Plate Ratio	t/c Thickness Ratio	REMARKS
1	Ideal Fluid		∞		Circular	
2	Ackeret	4A-43P	4.7	1	↑	Test for Rotor Ship
3	Flettner	4A-43P	4.7	1.72		Test for Rotor Ship
4	Goettingen	4A-43P	4.7	2.00		Test for Rotor Ship
5	Busemann	83B	1.7	1		
6	Goettingen	↑	1.7	1.5		
7	↑	↑	1.7	2		
8	↑	↑	1.7	3		
9	↓	↓	12	1		
10	↓	↓	12	1.5		
11	↓	↓	12	2		
12	Busemann	83B	12	3		
13	Thom	24T	12.5 / 26	3		
14	↑	19T	8	1		
15	↓	23T	5.7			Rough "Sanded" Surface
16	↓	23T	5.7			Smooth Surface
17	Thom	19T	4.4			Ends Fair into Hemi-Ellipsoids
18	Reid - NACA	12R	13.3			Across Tunnel Wall
19	Swanson	143S	∞	1		
20	Swanson	143S	2	1		
21	Schwartzberg	143S	4.5			
22	Mattoli	38M				Plain Cylinder
23	Mattoli	38M			↓	Cylinder with Fixed Coaxial Shield
24	Mattoli	38M			Circular	Cylinder with Fixed Coaxial Shield

TABLE II. KEY TO FIGURES 15 and 16. POWERED NONCIRCULAR ROTOR TESTS - PERFORMANCE

Curve Bubble No.	INVESTIGATOR	Reference Number	AR Aspect Ratio	h/c Tip Plate Ratio	t/c Thickness Ratio	REMARKS
1	Kuechemann	52C-52K	5	0	.167	
2	Kuechemann	52C-52K	5	(1)	.167	Elliptical Tip Plate - 1/1.83
3	Kuechemann	52C-52K	5	2.5	.167	
4	Holst	48H	5.3	2.5		Tested in Water
5	Holst	48H	5.3	0		Tested in Water
6	Holst	48H	3	1.5		Tested in Water
7	Chappedelaine	21C	6	≈ 1	.100	Convertible to Fixed Airfoil-3X
8	Riabouchinsky	19R	(8)	0		Flat Plate Rotating About L. E.
9	Riabouchinsky	19R	4	0		Flat Plate Rotating About Mid-Chord
10	Riabouchinsky	19R	4	0		Cruciform
11	Reid-NACA	12R	13.3			Cruciform Across Tunnel Wall

TABLE III. KEY TO FIGURES 17 and 18. AUTOROTATING WING ROTOR PERFORMANCE

Curve Bubble No.	INVESTIGATOR	Reference Number	AR Aspect Ratio	h/c Tip Plate Ratio	t/c Thickness Ratio	REMARKS
1	Joukovski	23J	1.5	0	-	Flat Plate
2	↑	23J	3.0	↑	-	↑
3	↑	23J	6.0	↑	-	↑
4	Joukovski	23J	12	↑	-	↑
5	Dupleich	35D	2	↑	.01	↑
6	↑	↑	4	↑	.01	↑
7	↑	↑	5	↑	.01	↑
8	↑	↑	6	↑	.01	Flat Plate
9	↑	↑	1.5	↑	.134	Rectangular Prism in Water
10	↑	↑	3	↑	.134	↑
11	↑	↑	6	↑	.134	↑
12	↑	↑	8.57	↑	.134	↑
13	↑	↑	1.42	↑	.333	↑
14	↑	↑	2.85	↑	.333	↑
15	↑	↑	5.71	↑	.333	↑
16	Dupleich	35D	8.57	↑	.333	Rectangular Prism in Water
17	Bach	3B	2	0	-	Rotor Profile II
18	↑	↑	↑	1.18	-	IIIa
19	↑	↑	↑	↑	-	IIIb
20	↑	↑	↑	↑	-	IV
21	↑	↑	↑	↑	-	V
22	↑	↑	↑	↑	-	VI
23	↑	↑	↑	↑	-	VIa
24	↑	↑	↑	↑	-	VIb
25	↑	↑	↑	↑	-	VIc
26	Bach	3B	2	1.18	-	Rotor Profile VIc
27	Chappedelaine	21C	6	1	.125	Shallow "S" Profile-1X
28	Chappe delaine	21C	6	1	.100	Symmetrical Airfoil-3X
29	Stone	118S	8	0	-	Tailless Aircraft Tumbling-Model 13
30	DeLeo - Huerta	10D	2	1.50	.28	Profile No. 1
31	↑	↑	↑	1.75	↑	1
32	↑	↑	↑	2.00	↑	1
33	DeLeo - Huerta	10D	↑	Rectangle	↑	1 Tip Plate No. 10
34	Kuklewicz-Tissue	37S	↑	↑	↑	A 75
35	↑	↑	↑	↑	↑	A 74
36	↑	↑	↑	↑	↑	A 71
37	↑	↑	↑	↑	↑	A 72
38	↑	↑	↑	↑	↑	A 73
39	↑	↑	↑	↑	↑	B 71
40	↑	↑	↑	↑	↑	C 71
41	↑	↑	↑	↑	↑	D 74
42	↑	↑	↑	↑	↑	D 75
43	↑	↑	↑	↑	↑	D 71
44	↑	↑	↑	↑	↑	D 72
45	↑	↑	↑	↑	↑	D 73
46	↑	↑	↑	↑	↑	E 71
47	Kuklewicz-Tissue	37S	2	Rectangle	.28	Profile No. P Tip Plate No. 51
48	Brunk	86B	8.0	↑	↑	Mod. Rectangle with Driving Vanes
49	Brunk	86B	4.0	↑	↑	Mod. Rectangle
50	Yelmgren	3Y	5.0	1.5	↑	Mod. Rectangle
51	Yelmgren	3Y	5.0	1.5	↑	Triangle
52	Yelmgren	3Y	5.0	1.5	↑	Cylinder with Driving Vanes
53	Iverson	131	2.0	↑	↑	Diamond - Double Wedge
54	↑	131	1.0	↑	↑	↑
55	↑	131	1.0	↑	↑	↑
56	Iverson	131	0.5	↑	↑	Diamond - Double Wedge

Table III lists the characteristics of all unclassified data relating to autorotating wing rotors. Performance is plotted in Figures 17 and 18.

Figure 17 shows that the maximum theoretical performance of an autorotating wing rotor, $C_{Lmax} = 12.56$ at $U/V = 2$, is far from being found in practice. The best C_{Lmax} is found (case 12) for $U/V = 0.95$ and is $C_L = 2.5$. The maximum U/V found in tests is $U/V = 1.75$, and the corresponding C_{Lmax} is 2.2. As can be seen from Figures 17 and 18, a systematic correlation of test data for wing rotors in autorotation is not possible at the present time. One has a feeling that higher C_{Lmax} than have been actually measured are possible with new shapes.

It was first noticed by Trancon in 1909 (Reference 39T) that the addition of large circular tip plates to a flat plate airfoil model would greatly enhance glide performance. All models of Figures 17 and 18 have tip plates. It would seem that a rotating airfoil without end plates acts as a curious sort of centrifugal pump which sucks secondary air in at the tips and ejects it radially in the midspan region. The process may be efficiently checked by the end plates.

It may also be noted that shapes with considerable thickness ratios, from the standpoint of fixed-wing airfoils, can have very good aerodynamic characteristics (maximum lift coefficient or lift-drag ratio) when used as rotating airfoils. They can thus be used as aerial delivery containers, the payload being contained within the shape.

It has been known since Maxwell (Reference 41M) that wing rotors are dynamically stable; i. e., Maxwell's oblong card would always stabilize in steady autorotation about an axis parallel to the longest dimension. However, only in the last four years have the dynamic equations of a special type of wing rotor, the "bomblet", been written and solved. Recent developments in this area were reported at the Conference on Dynamics and Aerodynamics of Bomblets, held at the Air Force Armament Laboratory, Eglin Air Force Base, Florida, on 26-28 September 1967. Significant work was done by Zipfel at Fort Detrick, Stilley at Honeywell, Brunk at Alpha Research, and Nicolaidis at Notre Dame University. Their work is either classified or contains distribution restrictions and therefore is not discussed in detail here. Suffice it to say that the dynamics of wing rotors are understood analytically and that criteria for dynamic stability of specific configurations are available.

Boehler and Foshag demonstrated in 1964, by means of flight tests of models, that wing rotors could be made to be

controllable. Means of controlling wing rotors are summarized in Reference 52B.

The properties of wing rotors can thus be summarized by saying that, as free gliding bodies, they are lifting devices that possess a high maximum lift coefficient ($C_L \approx 3$), high lift-drag ratio ($L/D \approx 4$), good dynamic stability, and good controllability.

d. Application of Wing Rotors to Aerial Precision Delivery Missions

The previously cited characteristics of isolated wing rotor devices (high lifting and glide performance, good stability, and good controllability) make them natural candidates for aerial delivery missions, for example, as precision drop gliders. Some typical applications are as follows:

- Long Range - delivery of personnel rescue kit; for example, in a package carried externally by the OV-10A COIN aircraft, as shown in Figure 19
- pilotless convertible glider cruising as a fixed wing and landing as a wing rotor, as shown in Figure 20
- delivery of cargo in remote areas, the rotor being stacked in the cargo hold of an aircraft, such as the C-130 Hercules. A design study shows that the C-130 cargo hold could contain 17,820 pounds of wing-rotor-deliverable fuel. The concept is shown applied to the C-119 aircraft in Figure 21
- Short Range - delivery of supplies over the battlefield or to counterguerillas, using the cargo hold of the C-130 aircraft as above
- underslung delivery of supplies with wing rotor towed behind a helicopter. The concept is illustrated in Figure 22
- ordnance applications: delivery of clustered bomblets autorotating in shallow glide for maximum dispersion

e. Gliding Performance of a Wing Rotor

The gliding performance of a wing rotor depends upon three parameters: the lift-drag ratio, L/D ; the maximum lift

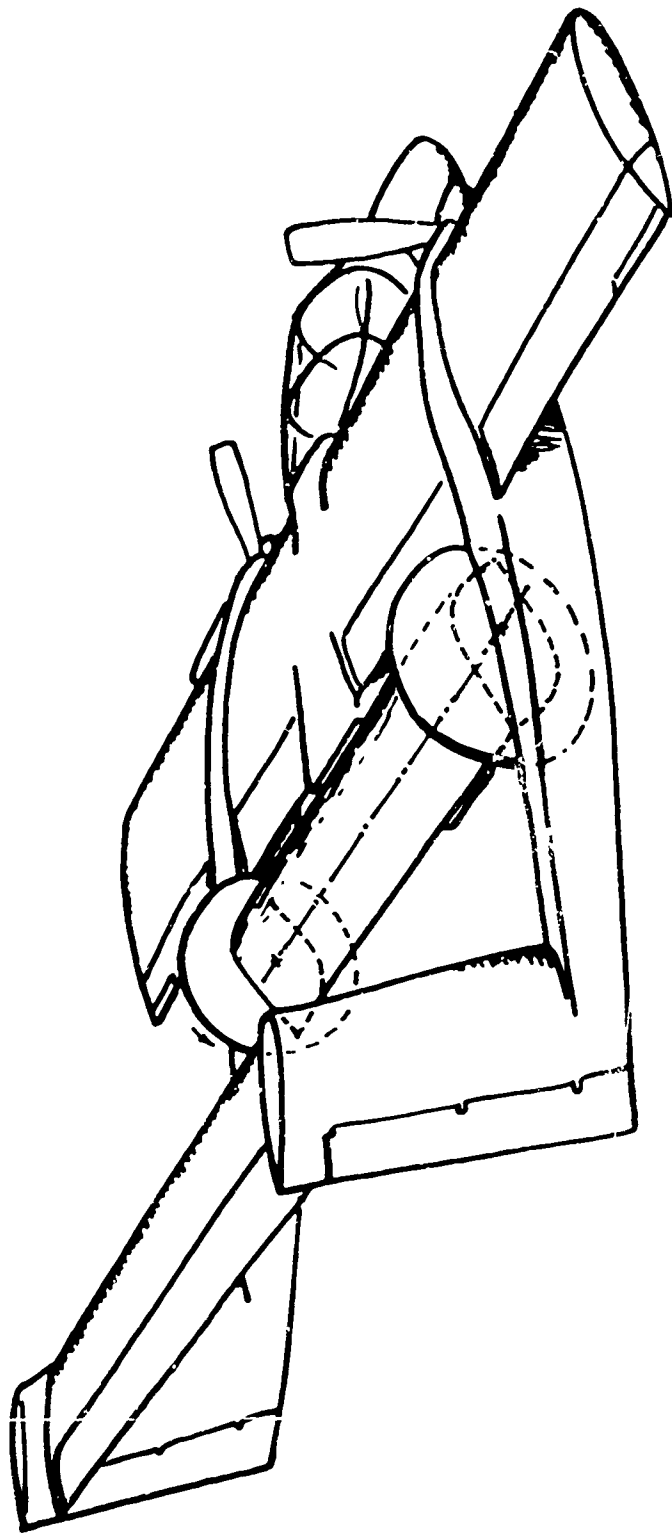

Figure 19. Wing Rotor Aerial Delivery Precision Glider
Carried Externally by the OV-10A COIN Airplane.



Figure 20. Pilotless Convertible Glider Cruising as a
Fixed Wing and Landing as a Wing Rotor.

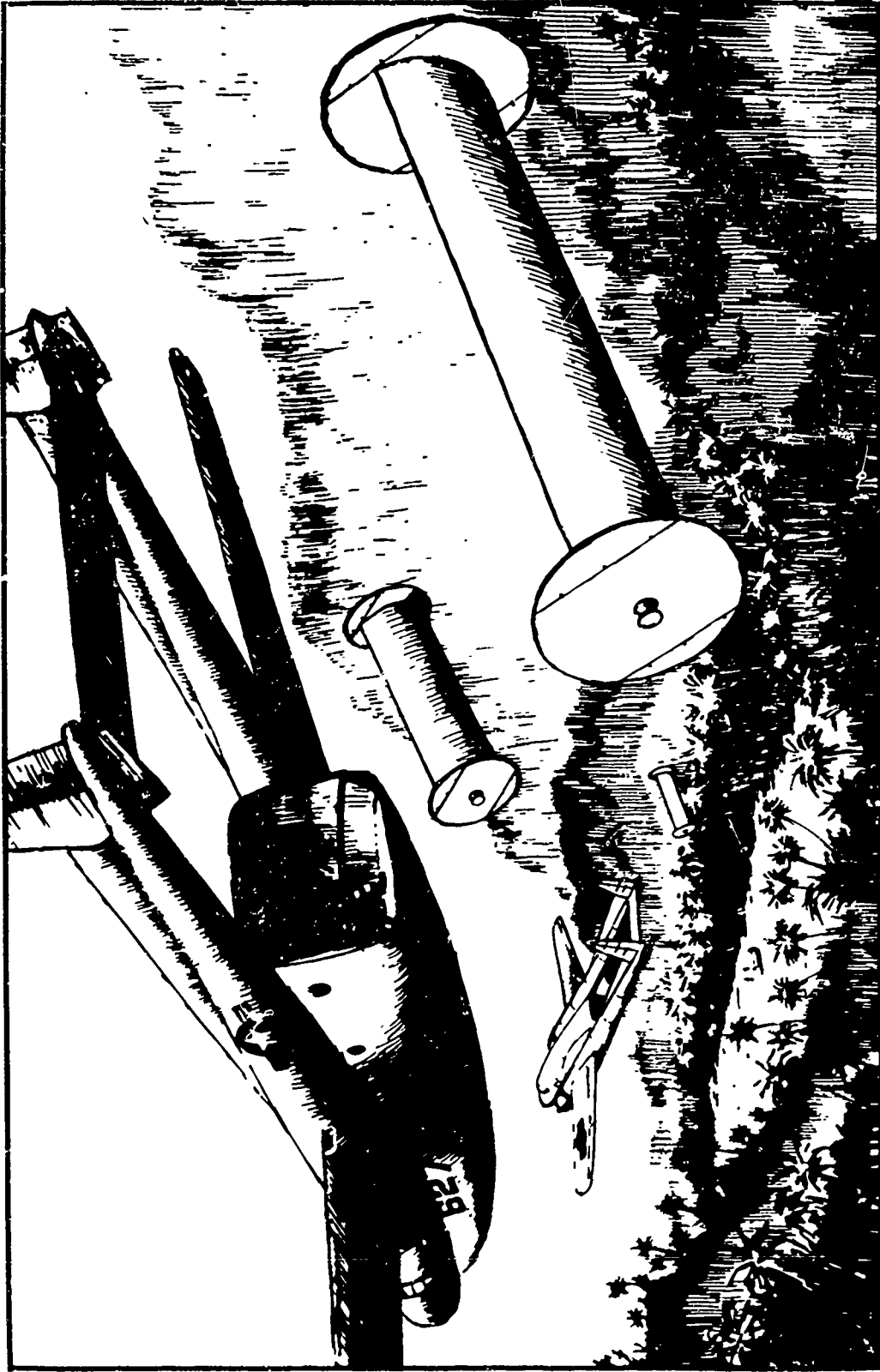

Figure 21. Aerial Cargo Delivery Autorotating Wing Rotor System, Carried Inside C-119 Aircraft.

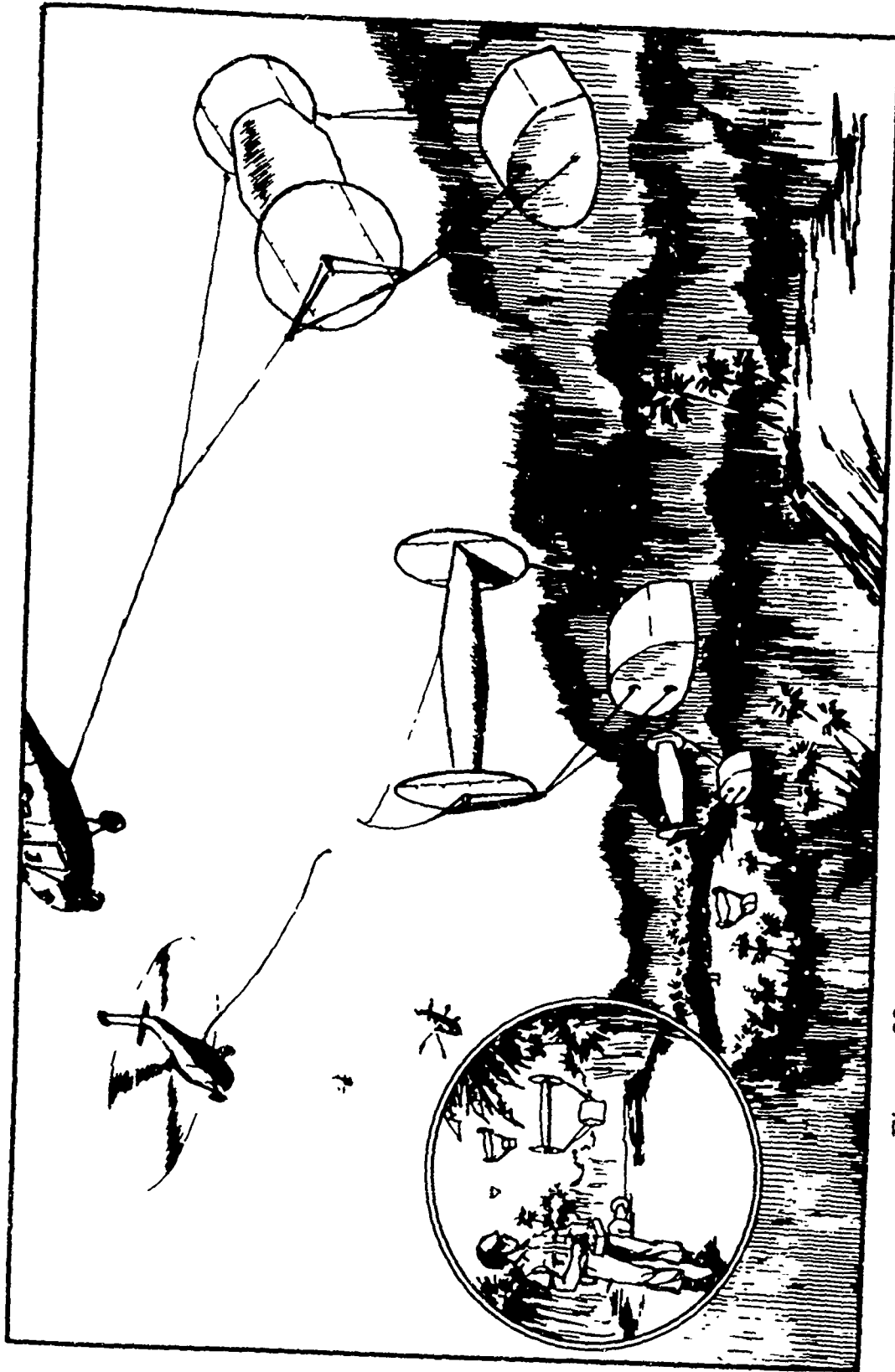

Figure 22. Remotely Controlled, Helicopter-Towed Wing Rotor Aerial Delivery System With Underslung Payload.

coefficient, C_{Lmax} ; and the wing loading, W/S . The gliding equations are well known, as follows (W is the gross weight, Θ the glide angle, and V_z the vertical sink velocity):

$$\begin{aligned} L &= W \cos \Theta \\ D &= W \sin \Theta \\ L/D &= \cotan \Theta \end{aligned} \qquad V_z = V \sin \Theta$$

$$V_{mph} = \sqrt{\frac{W/S}{0.00256 C_{Lmax} \left(\cos \Theta + \frac{\sin \Theta}{L/D} \right)}}$$

This performance is plotted in Figure 23 as V_z versus L/D for various values of W/S and various values of C_L .

With the values of C_{Lmax} and L/D known to be feasible today, it can be seen that acceptable values of V_z , for example, $V_z = 20$ ft/sec, can be achieved with wing loadings of 15 to 20 pounds per square foot, resulting in acceptable payloads. One problem with the internally contained payload is the dissipation of the angular momentum of the payload following impact. This may be minimized by using the proper flare-out technique.

A comparison of the glide performance of a typical wing rotor with that of competitive systems is illustrated in Figure 24. It can be seen that the wing rotor compares favorably with such systems.

2. Rotating Airfoil Convertible to Fixed Wing (RACW)

The idea of allowing a fixed-wing airfoil to autorotate or to be power driven about its midchord spanwise axis has intrigued innumerable inventors and engineers alike for a long time. The flight of aircraft with the continually autorotating wing rotors is possible if one is willing to pay the price of the high resulting drag. The drag penalty in cruise is removed in the concept in which the wing is fully rotated in Magnus effect fashion during takeoff and landing and braked to a fixed-wing position for cruise flight.

The previously mentioned Chappedelaine "Aérogyre" (Figure 9) has been the only full-size RACW convertible aircraft built. The characteristics of this unique project are described here:

Powerplant:	Renault 90 HP (100 HP Max.)
Transmission:	The wings could be driven through a clutch engagement of the powerplant.
Wings (Rotors):	Two rotors (or one wing) Total area - 129 Sq. Ft.

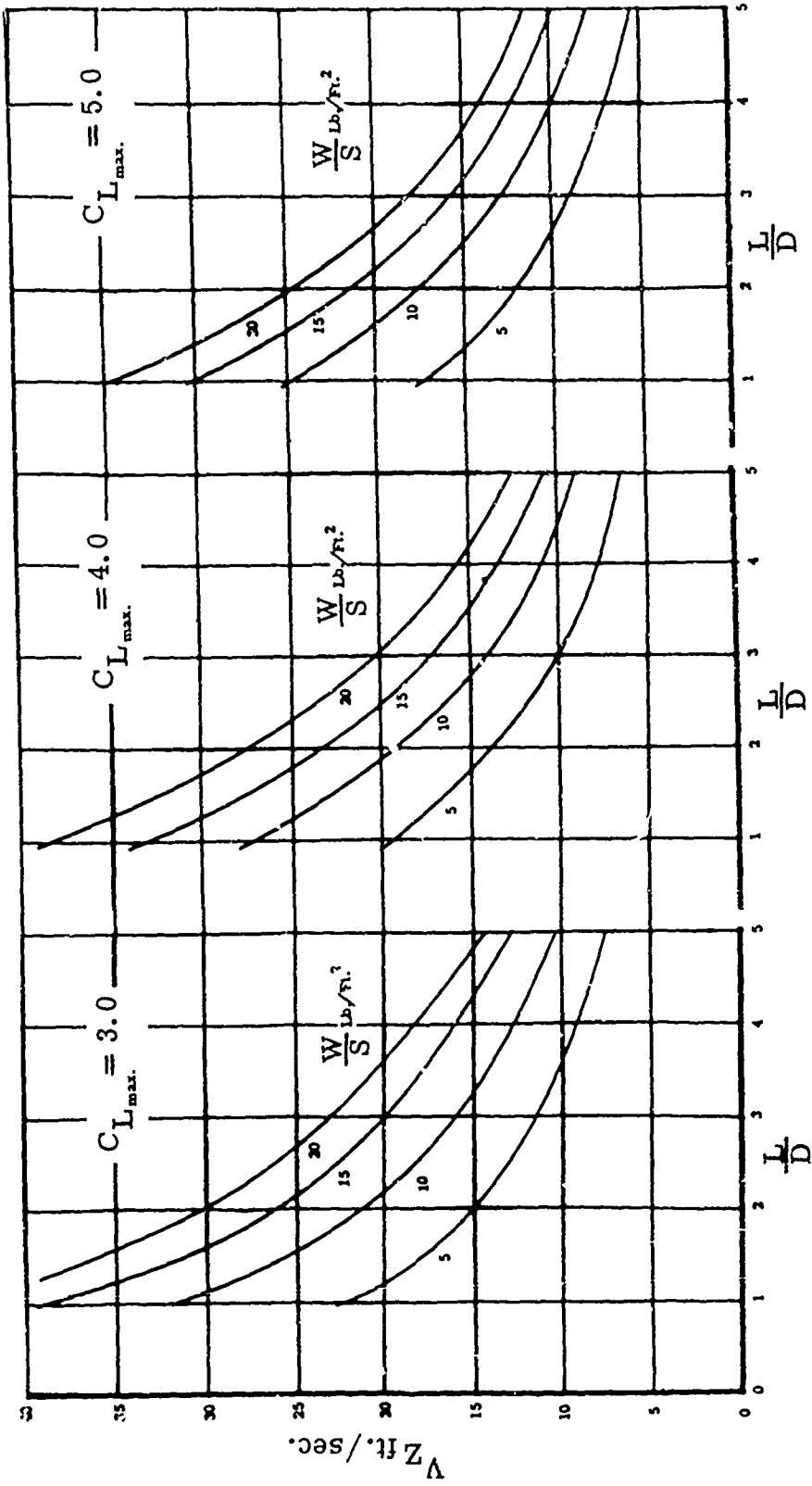

Figure 23. Wing Rotor Sinking Speeds at Various Loading as a Function of Hypothetical Maximum Lift Coefficients and Lift-Drag Ratios.

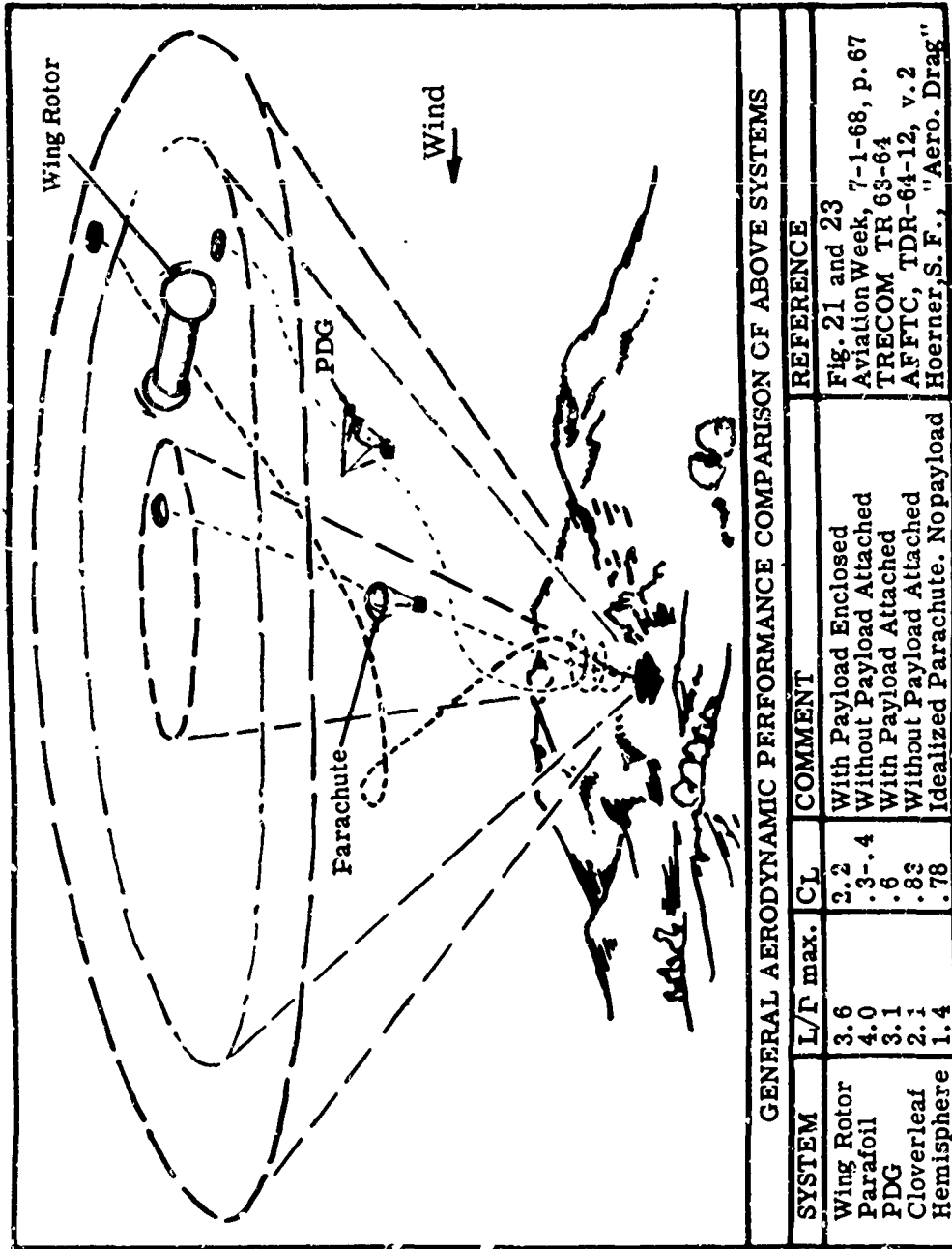

Figure 24. Relative Glide Range and "Drop Cones" for Five Systems of Aerial Delivery.

	Span - 13.1 Ft. (each panel)
	Max. chord - 5.25 Ft.
	End plate diameter - 4.9 Ft.
	Wing spread - 29.8 Ft.
Wing (Fixed:	Area - 64.5 Sq. Ft.
Fuselage:	Originally from a Caudron airplane
	Overall - 25. Ft.
Weight:	Gross - 1540 Lbs.

Performance based on model wind tunnel tests were estimated to be:

<u>Item</u>	<u>Aerogyre (Fixed Wing)</u>	<u>(Autorotating Wing)</u>	<u>(Powered Wing)</u>
Cruising Speed (MPH)	87		
Landing Speed (MPH)	40.3	21.7	17.4
Landing Run (Ft.)	490	148	162

Structural failure of this craft in flight brought the project to an end. Other than the following comments (Reference 50L), the flight tests were inconclusive:

- The mechanical device for disengaging the wings was imperfect, and consideration should have been given to the deflections produced in flight.
- The rotor RPM was too low, inducing vibrations in the structure. These vibrations did not show up in wind tunnel tests because the RPM was seven times greater than in full-scale tests.
- The means for increasing the RPM consists of increasing the aspect ratio of wings and then using several wings adequately located.

The RACW concept is only a STOL vehicle. There is insufficient evidence for a complete evaluation, but the complexity of rotating the wing hardly seems worth the STOL performance advantage.

3. Rotating High-Lift Devices on Wings

The demands of flight speed range flexibility of modern aircraft would appear to have taxed the flap designer's resources to the limit. It has become not too far from the usual to incorporate on a single craft tracked and mechanically complex flap installations with multiple slots, spoilers, tabs, and vortex generators. Figure 25 shows one such example. While nothing but praise is due the designers of such an arrangement, the question may be well asked if there is not a simpler way. To this end we will examine here



Figure 25. Modern, Complex Wing-Flap System With Multiple Flaps Partially Extended, Deflected; Spoilers Up, Slats Open.

several proposals and some background material on alternate flap systems of a possibly simpler design.

The rotating flap and slat devices to be described are basically STOL high-lift systems. These devices may be considered to be part of a VTOL arrangement only when they are used in a deflected slipstream system in conjunction with a thrust propeller slipstream. The rotating and activating elements may be located in or at the fixed wing's leading edge, aft, either in the wing or externally near the upper surface, or in or near the trailing edge. Certain arrangements place the rotating element in the leading edge of a deflected flap. These elements may be either cylindrical or airfoil-shaped, and they function to energize the boundary layer of the wing's upper surface and/or to act as a means of mechanically enhancing the wing's natural circulation. All of the cylindrical rotor elements naturally require external power, but the airfoil systems may or may not be powered. In some proposed applications, airfoil or vaned rotors arranged in conjunction with the main fixed wing may be driven as impellers in a manner to cause an energized transverse flow of air over the wing or flap. Other near-rotating flap devices are the cross-flow fan flap and the Schmidt orbiting flap. These will be discussed briefly. It may be mentioned that proposals and patents continue to describe the full chord airfoil endless circulating belt system (References 44H, 1N, etc.).

The use of the rotating cylinder as a boundary-layer energizer has been suggested for several non-aeronautical uses. Two of these arrangements would be the use of the cylinders at the entry of a very wide divergent angle diffuser and at the trailing edge of high-speed bluff bodies (vehicles).

The following discussion is organized following a classification of the flap by its type and its location with respect to the wing. Note that the main objective of the rotating flap and slat system is generally to produce high C_L 's. Other arrangements are described for glide path control (negative C_L 's and/or large C_D 's) and low-speed flight lateral control.

a. Rotating Cylinder Leading-Edge Slat (RCLE)

With the announcement of Flettner's rotor ship and the popularization of the Magnus effect in the 1920's (Reference 31F), the technical community and innumerable inventors initially proposed the use of the full rotating cylinder for aircraft sustentation (Reference 22F). The published three-dimensional Flettner rotor (Curve 3 on Figure 14) indicated the high drag penalty associated with the high C_L 's of the rotating cylinder. The first step taken to reduce the drag, with the hope of still keeping the high lift coefficients, was to fair in the trailing area aft of the cylinder. The first test in this direction was by Reid at

NACA (Reference 12R). The results, shown in Figure 26, yield maximum lift coefficients in excess of 2.

The final and most conclusive tests of this era were carried out at the N. V. Instituut Voor Aero en Hydro-Dynamiek of Amsterdam through a series of four reports (Reference 49W through 52W) by Wolff. Results of these tests are summarized in part in Figure 26. Again, these tests were conducted at low Reynolds numbers and are useful only on a comparative basis. The curves of Figure 26 show this rotating flap system with the cylinder stopped and in rotation for two profiles. The effect of rotation is roughly to triple the lift coefficient.

More recently (1963), a study was made of incorporating rotating cylinders of various surface textures in the leading and trailing edges of a hydrofoil. Results of these tests (Reference 66B) by Brooks are also shown in Figure 26. The resulting hydrofoil system was intended for an undersea vehicle control device. The poor performance may be due to the test aspect ratio (< 1). With an expenditure of about 1/10 HP to rotate the leading cylinder, only slightly more than 1 pound of lift was developed at 35 F.P.S. forward speed. This is equivalent to the lift developed by the hydrofoil without a rotating cylinder when placed at less than $1/2^\circ$ angle of attack. Two-dimensional tests were conducted at NASA/Ames of a NACA 23018 airfoil incorporating both leading-edge and rotating-cylinder flaps (Reference 18A).

A renewed interest in the leading-edge systems was shown by Alvarez-Calderon (Reference 20A); his proposed configurations are described in Figure 27. Several ingenious means are shown for uncovering the leading-edge rotating cylinder for V/STOL application. Note that the leading-edge cylinder may double as the cross shafting for the interconnected multipropeller V/STOL airplane.

One must come to the conclusion that until more systematic and higher Reynolds number tests are made, the rotating cylinder leading-edge slat system does not evidence significant performance potential for STOL application, in comparison with other arrangements discussed later.

b. Rotating Cylinder in Wing (RCIW)

Several investigators have studied the arrangement of locating the cylindrical rotor element in the thicker section of the wing profile, thus providing a stationary airfoil entry to the rotor. Wind tunnel tests were carried out to this end by Frey (Reference 59F), but these may be considered to be inconclusive due to the very low Reynolds numbers and general irregularities. Wolff and Koning (Reference 51W) also

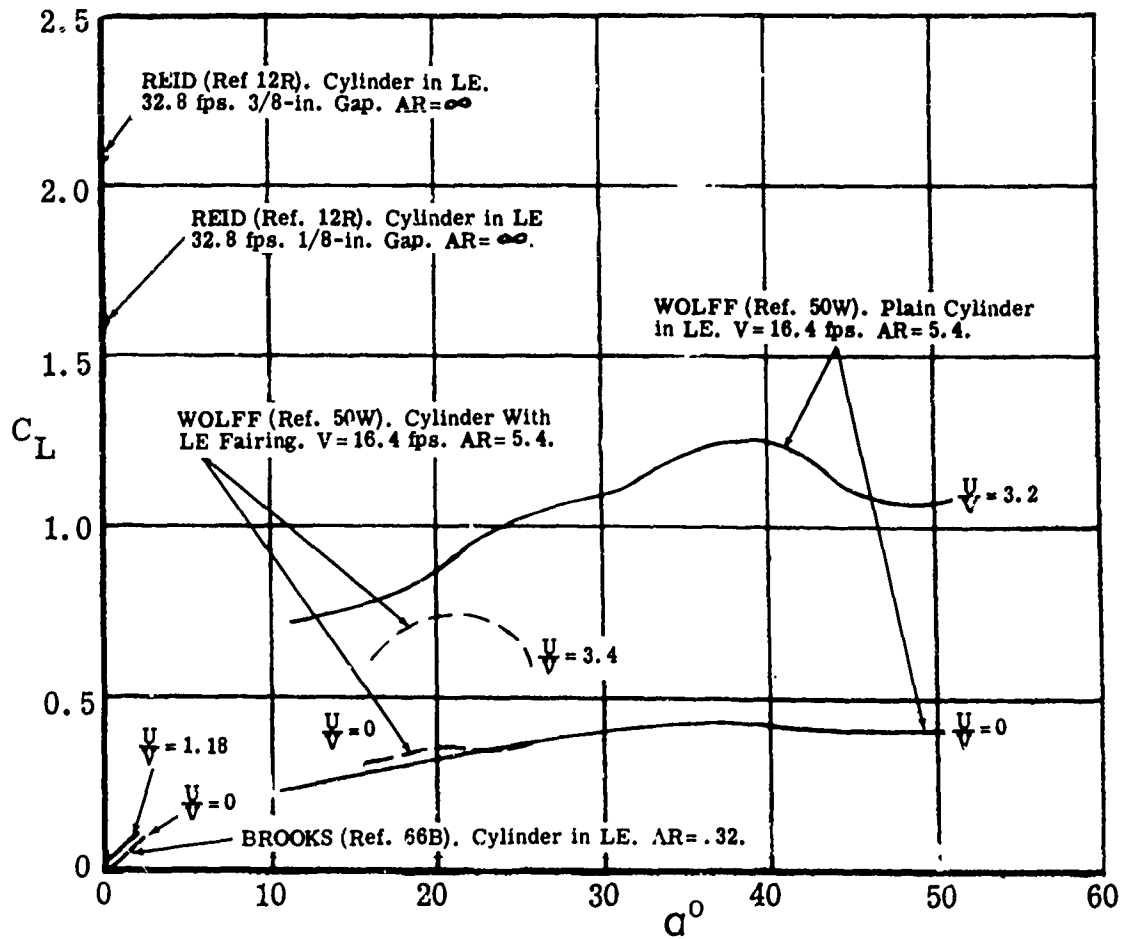

Figure 26. Measured Lift Coefficients Plotted Against Angles of Attack for a Collection of Combination Fixed Wing and Rotating Cylinder Slat System. Cylinder in the Leading Edge.

wind-tunnel-tested such a system with a fixed leading-edge fairing (Figure 26). R. Thompson built an electric-powered model capable of tethered STOL (kite) flight (Figure 28 and References 50L and 29T). Such systems do not appear to have merit as STOL devices.

c. Rotating Cylinder at the Trailing Edge (RCTE)

The rotating cylinder system located at the trailing edge may be considered to act as a circulation-augmenting device. Tests have been conducted by Longo (Reference 19J) and, more systematically, by Regenscheit (Reference 10R). Although both tests were run at low Reynolds numbers, their performance with and without a rotor is comparatively interesting because of the use of a reference-fixed airfoil. Partial results of the tests are shown in Figures 29 and 30. It is interesting to note that the Longo trailing-edge cylinder was rotated by an integral and auxiliary lenticular-shaped auto-rotating driving rotor. The Regenscheit tests were carried out with a broader range of rotor test positions. More recent, and also shown in Figure 29, is the Brooks rotating cylinder hydrofoil. Its performance, though quite superior to the similar arrangement in the leading edge, does not compare well with the other referenced RCTE arrangements.

Except when used as a control device, in which case the trailing-edge rotor would continually rotate, the adaptation of the cylinder to the trailing edge would require it to be retracted in some manner during cruise flight. Such an arrangement is suggested by the Tino patent (Reference 33T) and is shown in Figure 31.

The optimistic results of an analytical treatment for the rotating cylinder at a wing's trailing edge by Schmidt and Reichstein are shown in Figure 30 (Reference 42S). This simple theory may serve as an approximate method for locating the rotor axis with respect to the fixed wing.

Figure 29 also includes a comparison of the trailing-edge cylinder airfoil with that of one configuration of the NASA/Ames rotating airfoil flap (Reference 8D).

d. Rotating Cylinder in Flap (RCIF)

The RCIF is uniquely the invention of Alvarez-Calderon, whose patent coverage (References 19A, 20A, 21A, 23A, and 24A) on this system is quite comprehensive. Basically, the rotating cylinder is located in the flap's leading edge and is uncovered and put into rotation upon the flap's deflection. The RCIF is fundamentally a boundary-layer energizing system;

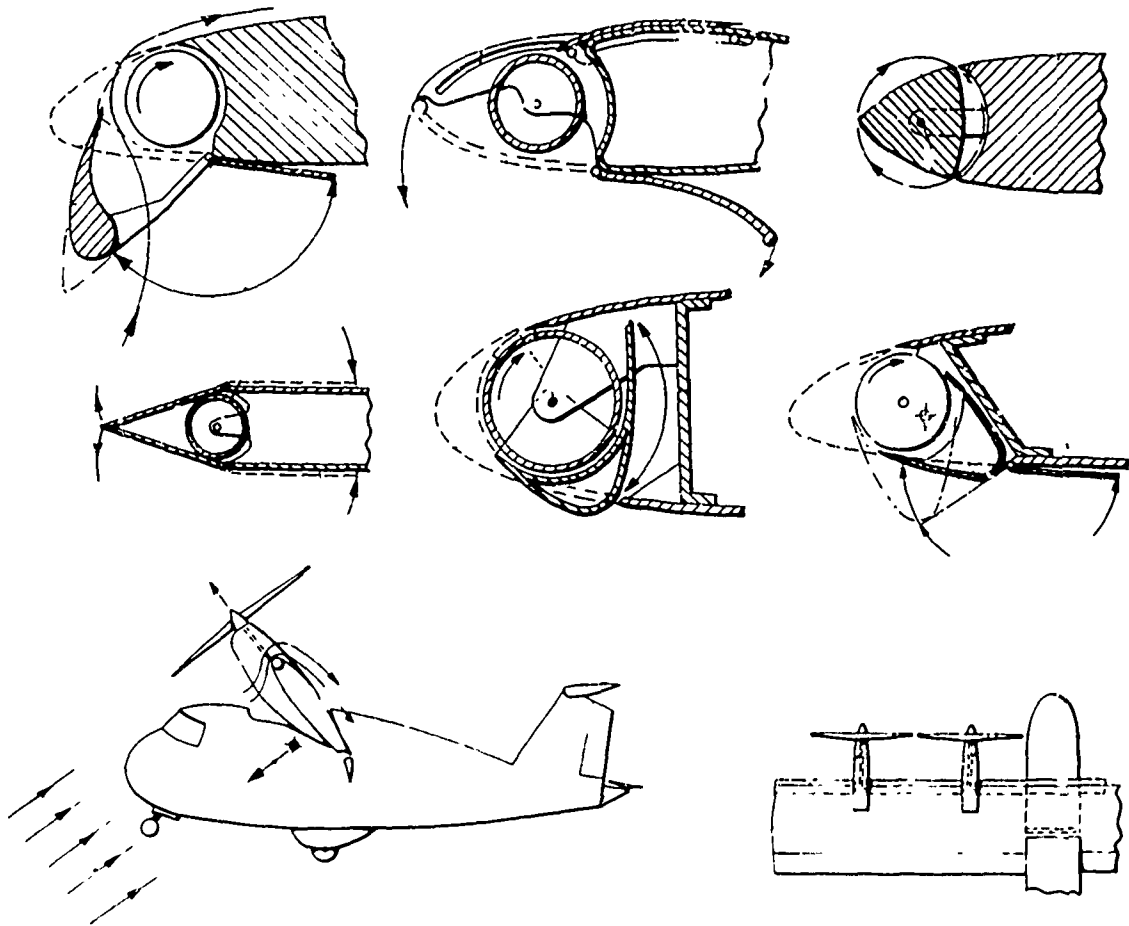

Figure 27. Various Leading-Edge Rotating Slat Systems as Applied to Tilt-Wing V/STOL. Also Shown as Cross Shaft Interconnecting Power System (Ref. 20A).

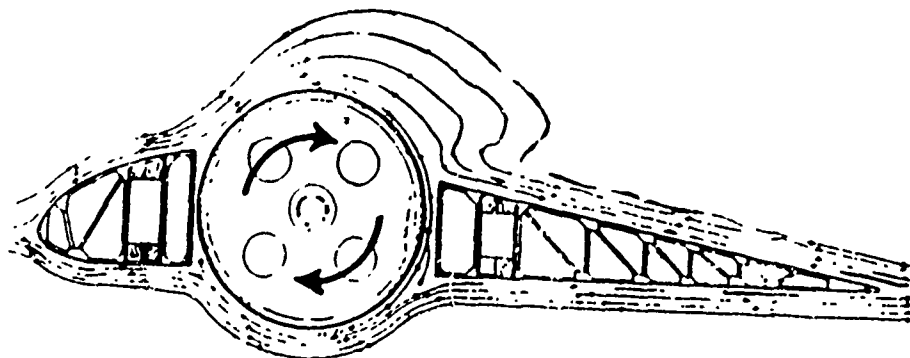

Figure 28. Typical Rotating Cylinder In Wing (RCIW) Arrangement by Thompson (Ref. 29 T).

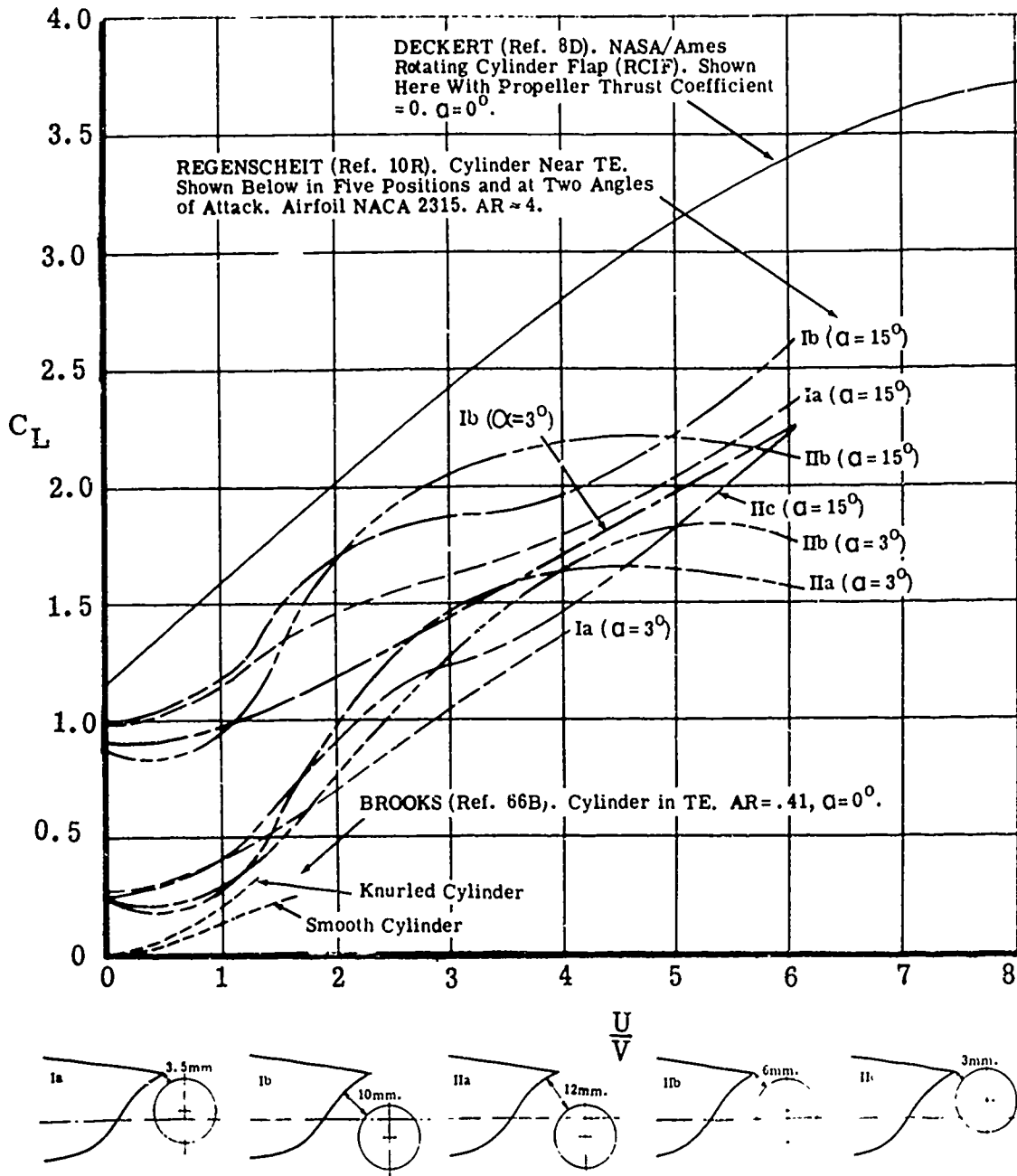

Figure 29. Measured Lift Coefficient Plotted Against Rotor Spin Ratio for a Collection of Combination Fixed-Wing and Rotating Cylinder Flap Systems. Cylinder at or Near Trailing Edge. May be Used in Conjunction With a Nonrotating Fixed Flap.

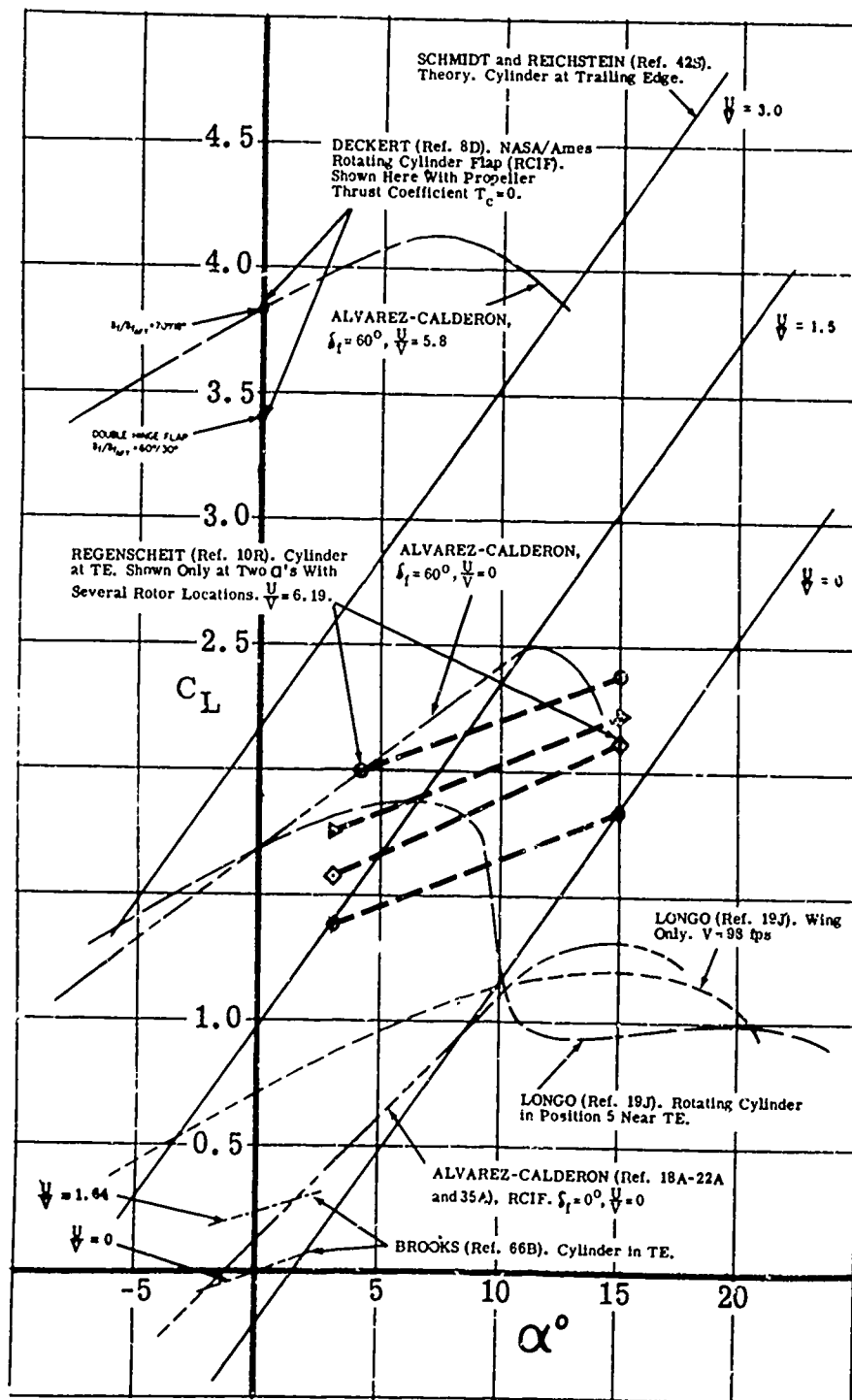

Figure 30. Theoretical and Measured Lift Coefficients Plotted Against Angles of Attack for a Collection of Combination Fixed-Wing and Rotating Cylinder Flap Systems. Cylinder at or Near Trailing Edge.

i. e., the rotor is to be considered as providing the means of energizing the boundary layer at the flap "knee" to insure the negotiation of curvature and the penetration against adverse pressure gradients existing for the flow at the deflected flap. As such, the RCIF may keep the wing's upper surface flow effectively attached when the flap is positioned through angles greater than 60° from the horizontal (Figure 32). Such an arrangement suggests an ideal system for the deflected-slipstream V/STOL application. To this end, semifree flight model and wind tunnel tests were made by Alvarez-Calderon at Stanford University (Reference 22A) to determine the potential and performance of the RCIF.

The results of these initial tests led to the prototype installation of an RCIF in a small aircraft (Reference 22A) and to studies of the adaptability of the system to the Ryan VZ-3RY and Fairchild M-224I flying deflected-slipstream test-beds. More significantly, large-scale two- and three-dimensional tests have recently been performed in the NASA/Ames wind tunnel, at Reynolds numbers of 2.1 to 2.9 million. These tests provide realistic information for deflected-slipstream VTOL and STOL aircraft (Figures 33, 34, 35, and 36).

It was initially suggested (Reference 18A) that it might be possible to aerodynamically balance the RCIF over a wide range of flap deflections and to transmit all flap loads through its hinge axis located at the aircraft center of gravity. It was felt that flap forces, regardless of magnitude or direction, could thus be eliminated. In a deflected-slipstream configuration, such an arrangement would be very attractive in minimizing the usual large pitch-down moment. Though this has not worked out exactly in practice, this approach has shown a significant reduction in pitching moment. Figure 37 shows such a change taking place, especially for flap hinge axis position 2, and also a reduction when compared to the fixed deflection flap.

Powering and driving the RCIF rotor present some points for further discussion. The power required may be treated as a part of the overall drag picture and is not included, as such, in any of the published data. It is interesting to discover that the torque reaction of the rotor-driving source would be resolved as a part of a pitch-down moment either on a free-flying model rig or on the NASA/Ames wind tunnel balance. It should be noted that this driving torque is included as a very small component of the overall pitching moment of the NASA/Ames tests.

A summary of some results of the NASA/Ames full-scale tests is presented in Figure 33. These tests are described as follows:

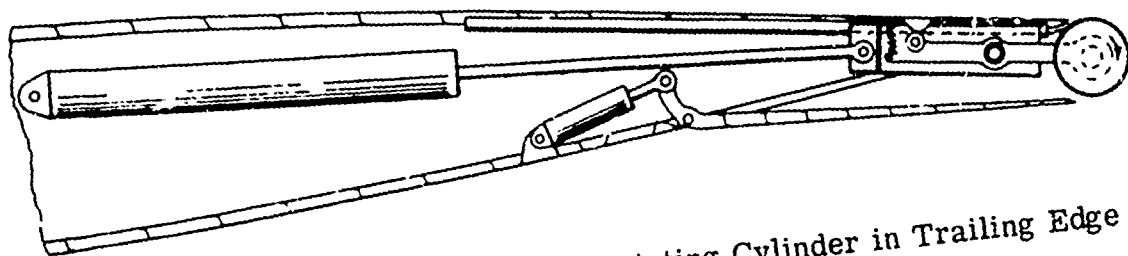

Figure 31. Retraction System for Rotating Cylinder in Trailing Edge (RCTE) by Tino (Ref. 33T).

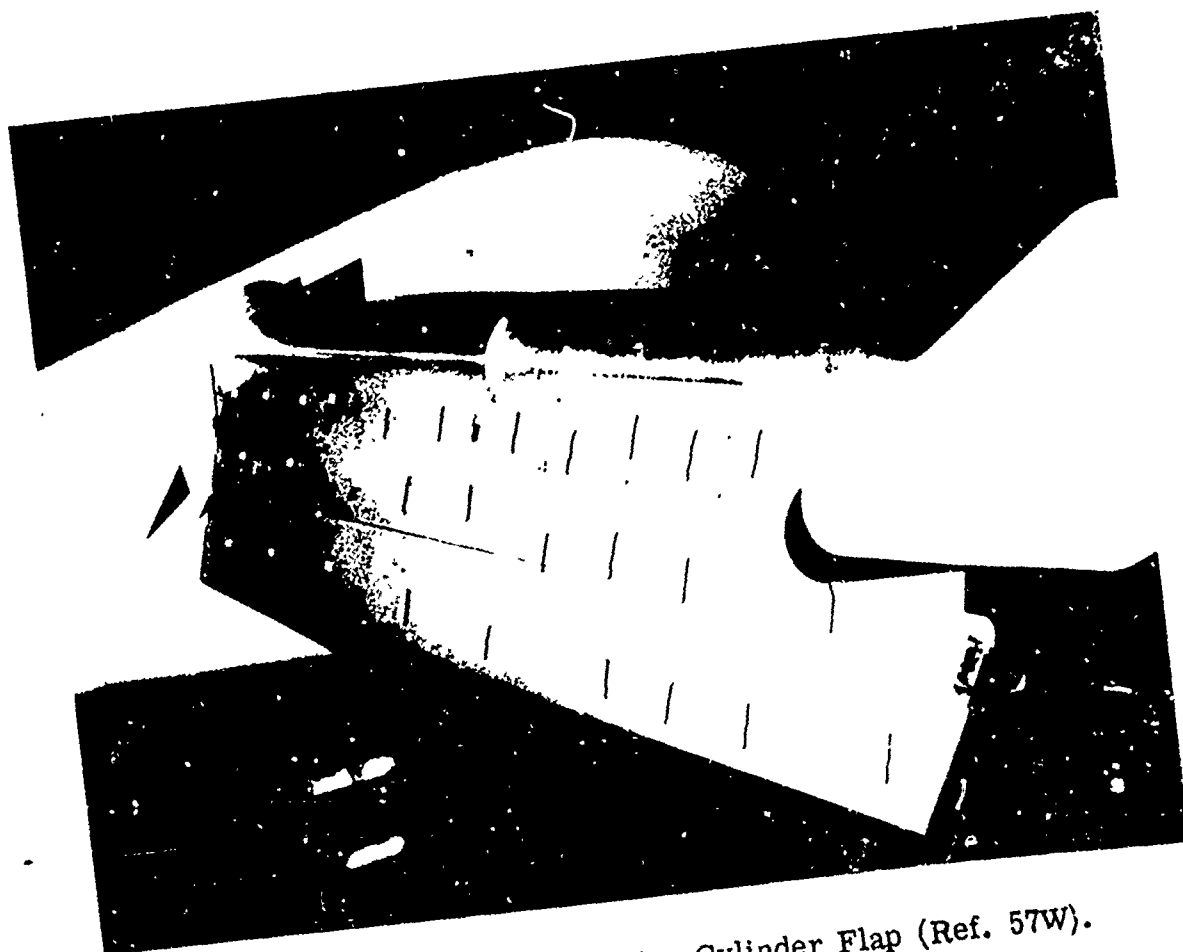

Figure 32. NASA/Ames Rotating Cylinder Flap (Ref. 57W).

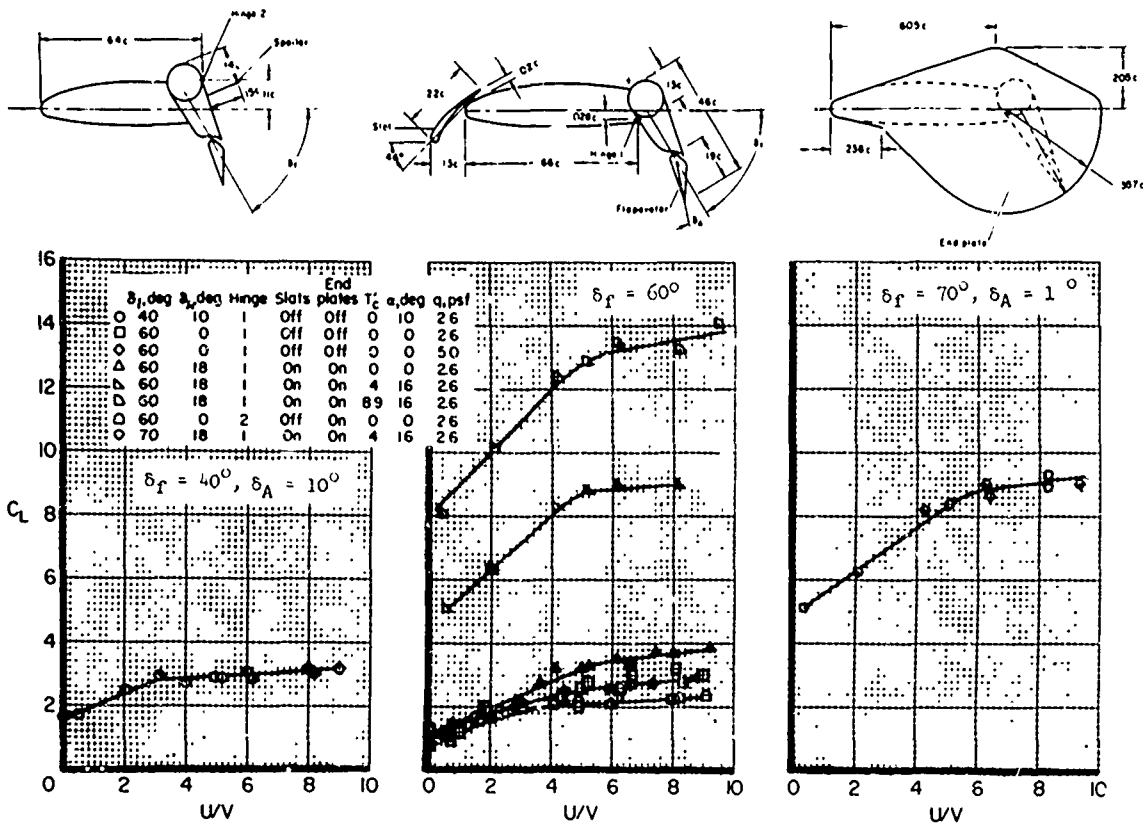

Figure 33. Lift Performance Summary of NASA/Ames RCIF-Various Geometries.



Figure 34. Full-Size Wind Tunnel Model of NASA/Ames RCIF Aircraft.

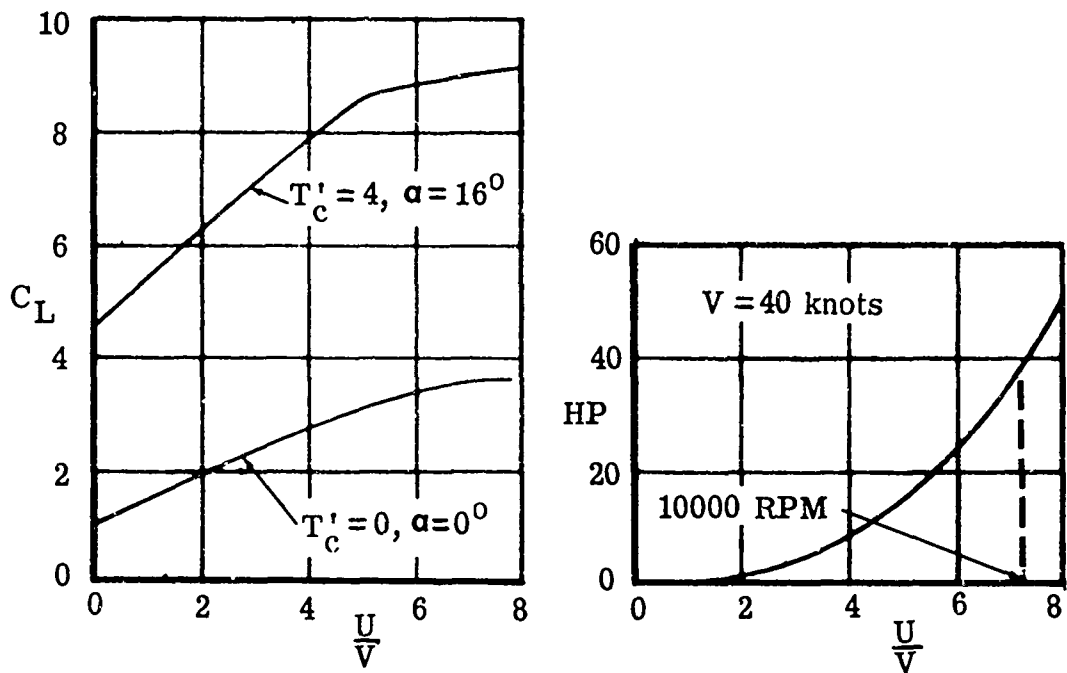

Figure 35. Cylinder Speed and Horsepower Requirements for the NASA/Ames (Ref. 8D) Rotating Cylinder Flap

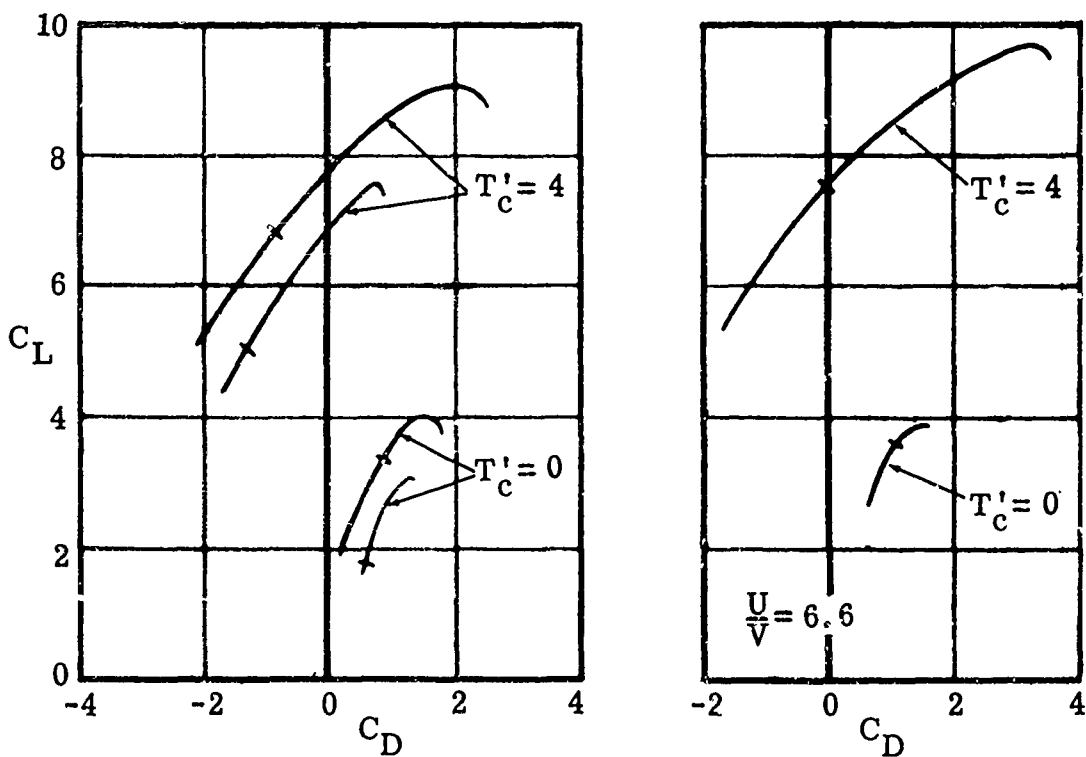

Figure 36. Lift-Drag Polars for the NASA/Ames (Ref. 8D) Rotating Cylinder Flap.

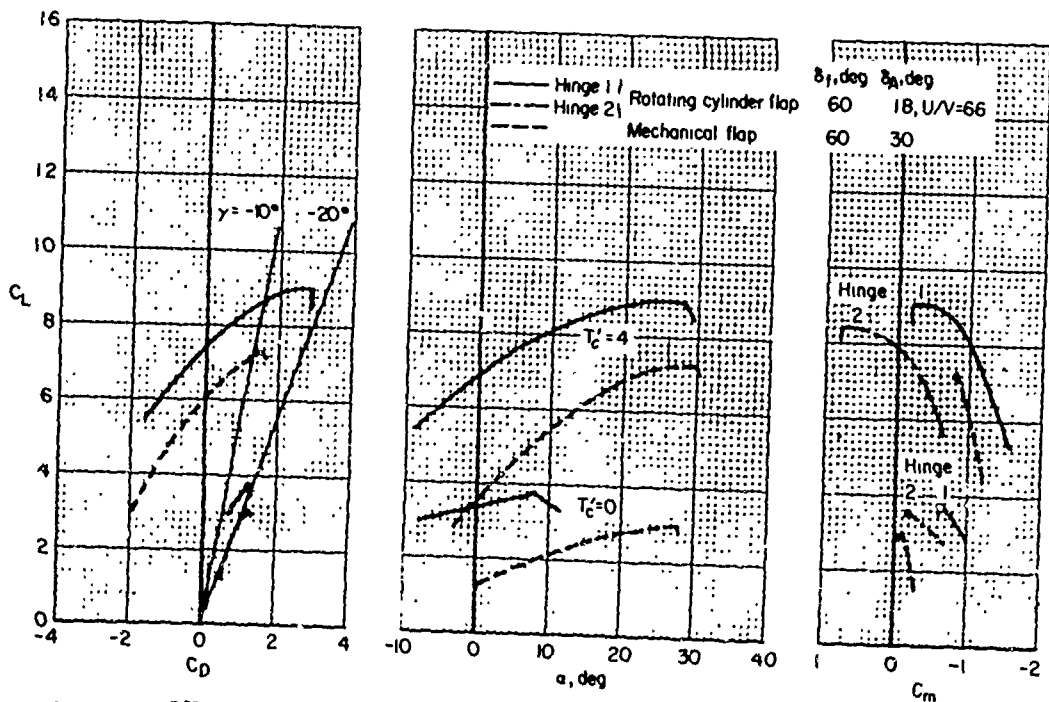
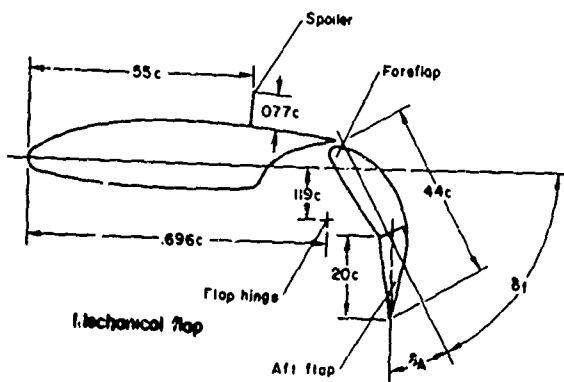
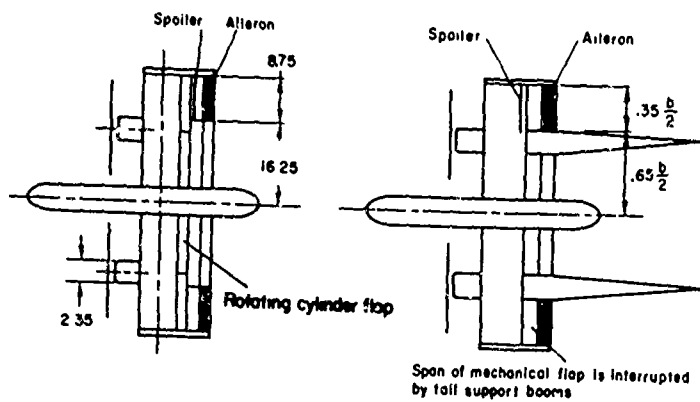

Figure 37. Comparative Performance of RCIF With Mechanical Flap (Ref. 57W).

"Wind-tunnel tests were made of a model of a twin turbo-propeller airplane with rotating cylinder flaps. The model had a straight untapered wing of aspect ratio 3.57 equipped with end plates. Cylinder rotation provided a lift coefficient increment of 2.0 and a maximum lift coefficient of 4.0 with 60° flap deflection and zero propeller thrust. A maximum lift coefficient of 9.1 was obtained with a thrust coefficient of 4. The cylinder rotational speed required for the test was varied with flap deflection and was independent of angle of attack and slipstream velocity. For a flap deflection of 60° and a free-stream velocity of 40 knots, the cylinder power required was approximately 0.7 horsepower per foot of cylinder length."

Some conclusions drawn from this particular configuration have been:

"This study has shown that the rotating cylinder flap can be an effective and efficient high lift device in the operating regions investigated. Cylinder rotational speed required is a direct function of airspeed and an inverse function of airfoil thickness (cylinder diameter limitation). The power required is proportional to the cube of the velocity; therefore, the mechanical requirements for rotating cylinder flaps will rapidly become more stringent if airspeed is increased, and detailed design efforts will be required to establish the feasibility of the device when used on aircraft with high approach speeds. However, the power requirements are less than for a comparable blowing flap BLC system. Proper choice of hinge line about which the rotating cylinder flap pivots can result in substantially lower pitching moments and flap hinge moments than those for a conventional mechanical flap."

Full-size four-propeller deflected-slipstream model tests continue at this time (Figure 38). Provisional results have indicated a greater lift performance enhancement due to the comparatively larger ratio of flap chord to propeller diameter.

In conclusion, the RCIF high-lift device appears to be extremely promising.

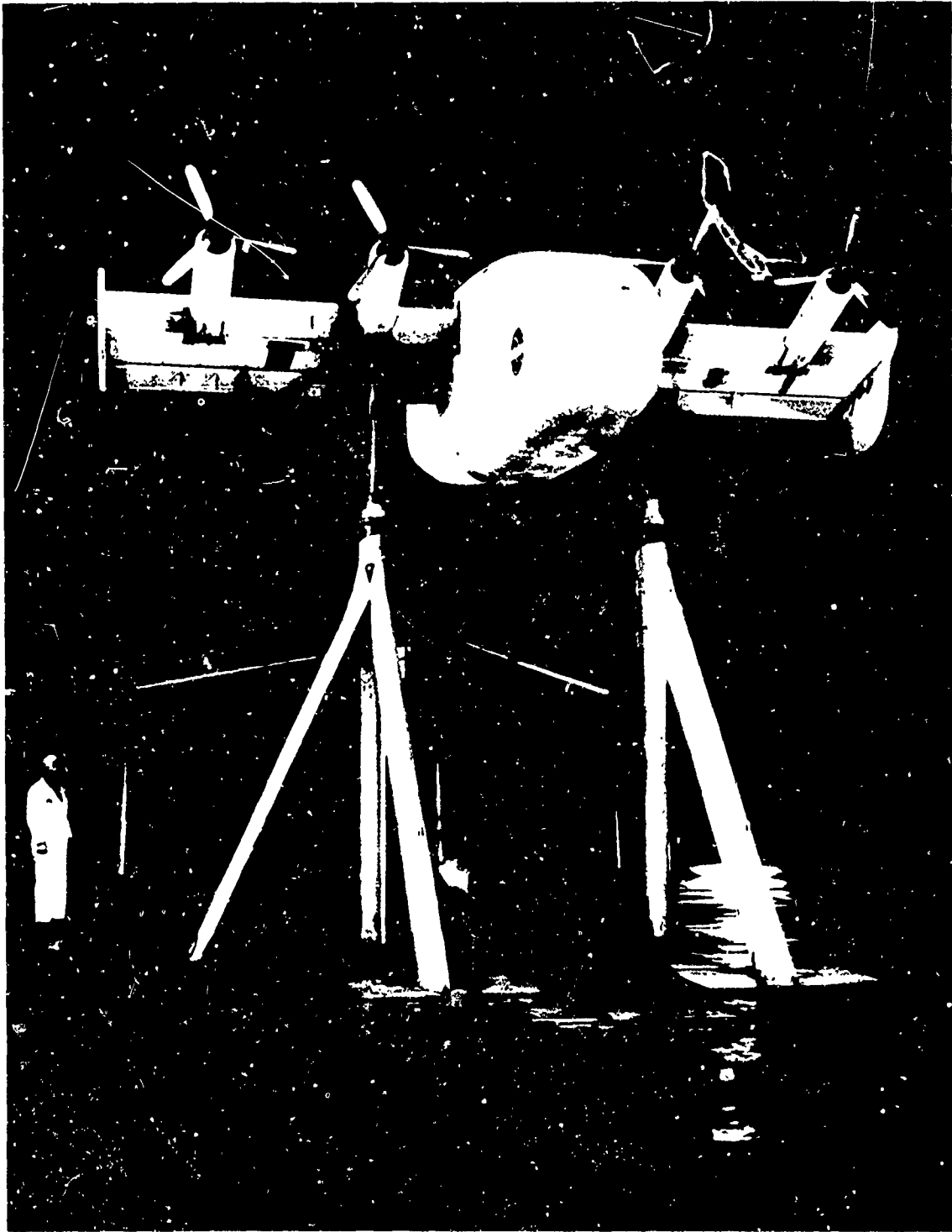

Figure 38. Deflected-Slipstream V/STOL Full-Size Model in Ames Wind Tunnel.

A typical application to a VTOL aircraft is shown in Figure 39.

e. Rotating Airfoil in Wing (RAW)

Various proposals have described the use of a rotating airfoil device, fairing or retracting into the upper surface of a fixed airfoil. It may be shown in a very preliminary fashion that the location of the rotating element in this area of the wing is far from being the optimum position for a circulation-enhancing device, but it could have some beneficial effect on energizing a weak boundary layer.

f. Rotating Airfoil Slat (RAS)

Auxiliary rotor devices of an airfoil, cruciform, or multivaned shape, located immediately in the leading edge of a fixed airfoil, are considered in this category (Figure 40). Such a rotor may be considered to be of the boundary-layer energizing type. Although such arrangements continue to be suggested from time to time, no practical tests have even been reported. It is interesting to note that a patent filed by F. W. T. Taylor (Reference 12T) as early as 1909 clearly shows an understanding of the installation of an autorotating leading-edge airfoil system for lift "enhancement" and longitudinal control. Like some subsequent arrangements, an installed vaned rotor may be driven over the full wing semispan in the manner of a transverse-flow fan (Reference 35M) and thus perform a means of direct blowing for a BLC system.

g. Rotating Airfoil Flap (RAF)

Encouraging analyses and tests have demonstrated that an auxiliary airfoil rotating near or at the trailing edge of a fixed main airfoil is a definite and attractive means of obtaining high lift coefficients and dramatic lateral and glide path aircraft control.

Fortunately, several investigators have tested this flap system (Figure 41). Initially, the phenomenon of a driven flat plate rotating behind a fixed surface was investigated in the wind tunnel by Riabouchinski in 1909 (Figure 42); it was subsequently tested in 1926 and reported in 1940 (References 27R and 28R). The arrangement of these experiments is shown in Figure 42, and the meager results are shown in Figure 41. The Brothers Longo in Italy extensively patented a convertible RAF system as early as 1925 (Reference 60L), and the results of their comparative wind tunnel results were published by Jona (Reference 19J). These tests were conducted with one basic 23% thick fixed wing, utilizing several lenticular-shaped,

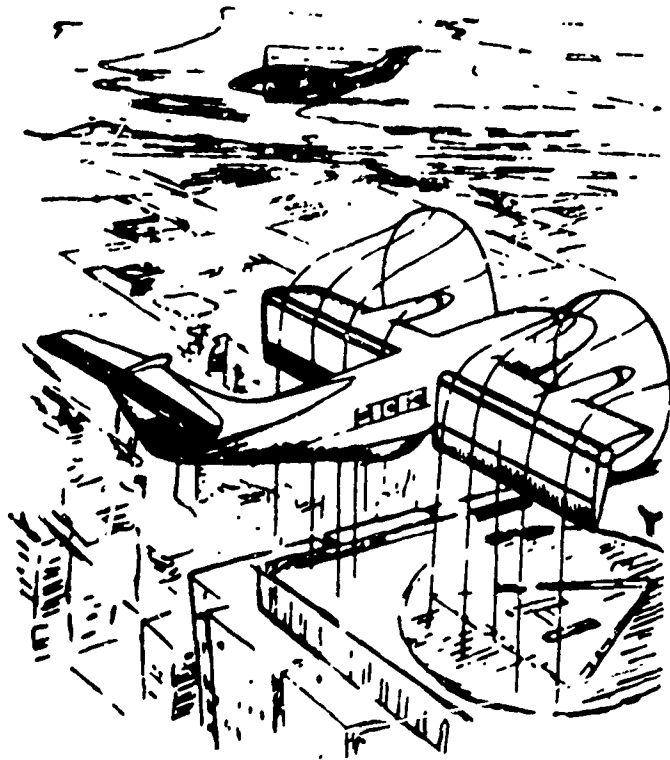

Figure 39. Proposed Application of Alvarez-Calderon's Rotating Cylinder Flap (RCIF) to a VTOL Airplane.

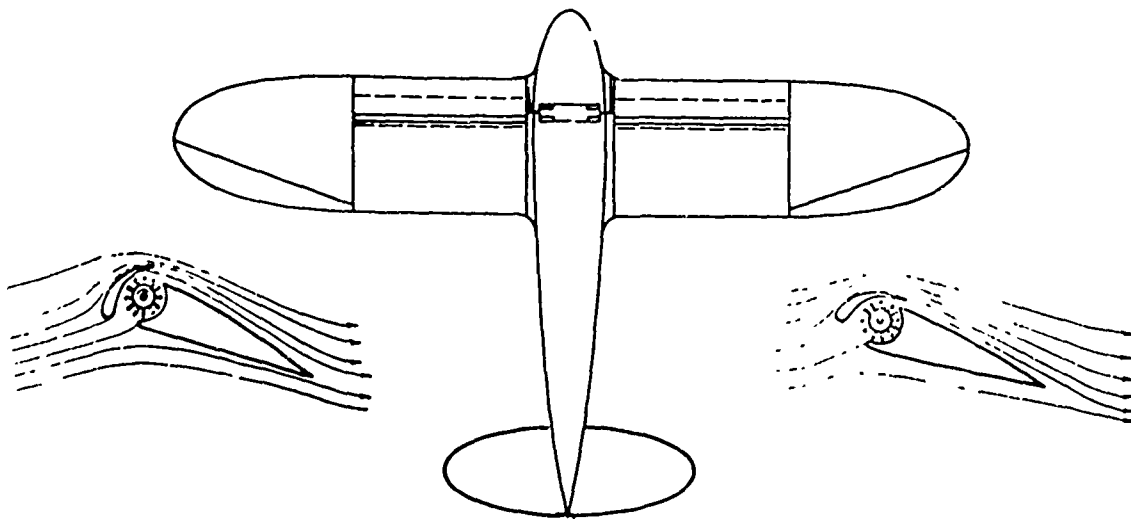

Figure 40. Lippisch Patent (Ref. 56L) Describing Rotating Airfoil Slat (RAS) Device and Boundary Layer Energizer.

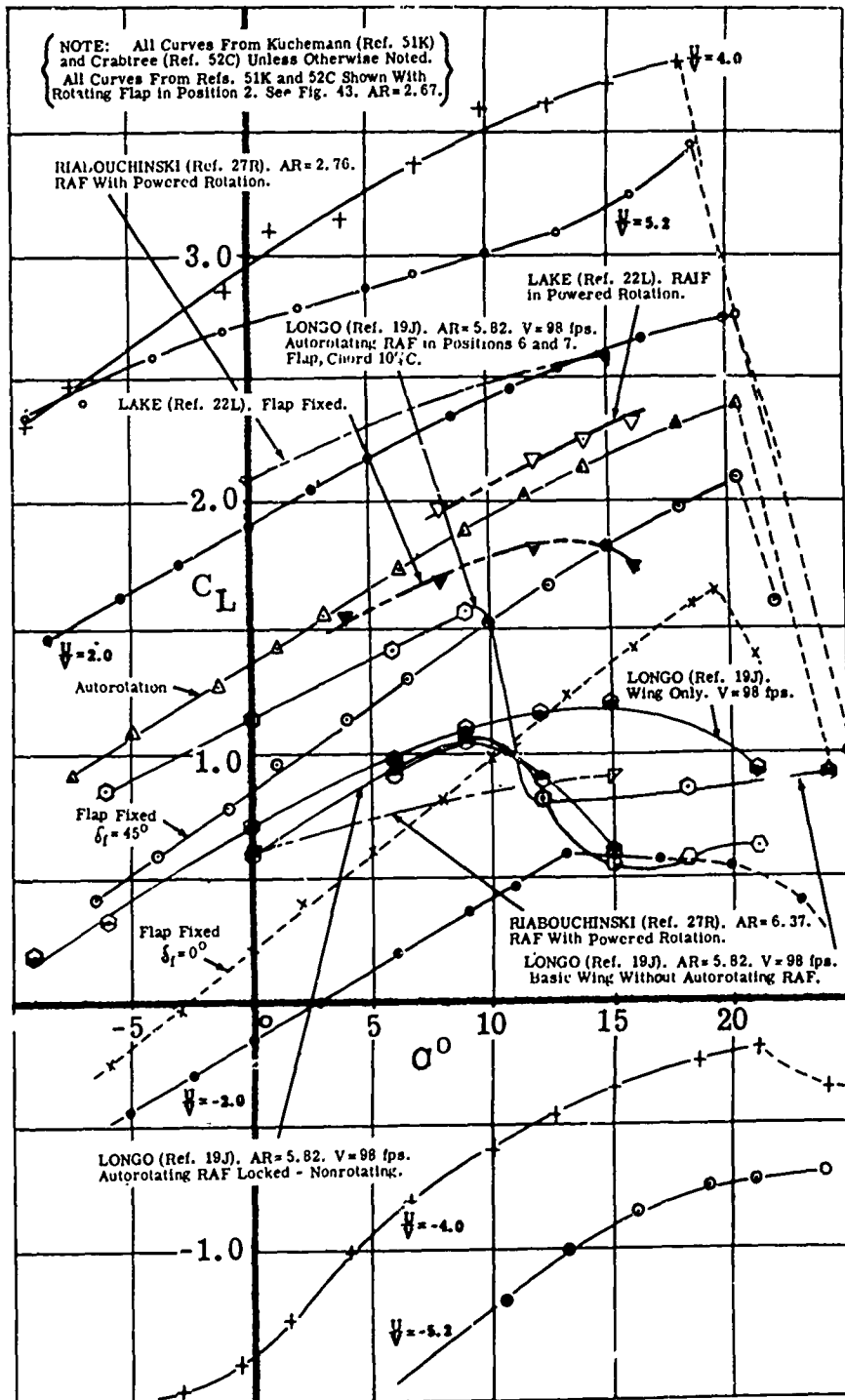

Figure 41. Measured Lift Coefficient Against Angle of Attack for a Collection of Combination of Fixed-Wing and Rotating Noncircular Airfoil Rotating Flap Systems; Rotating Flap at or Near the Trailing Edge.

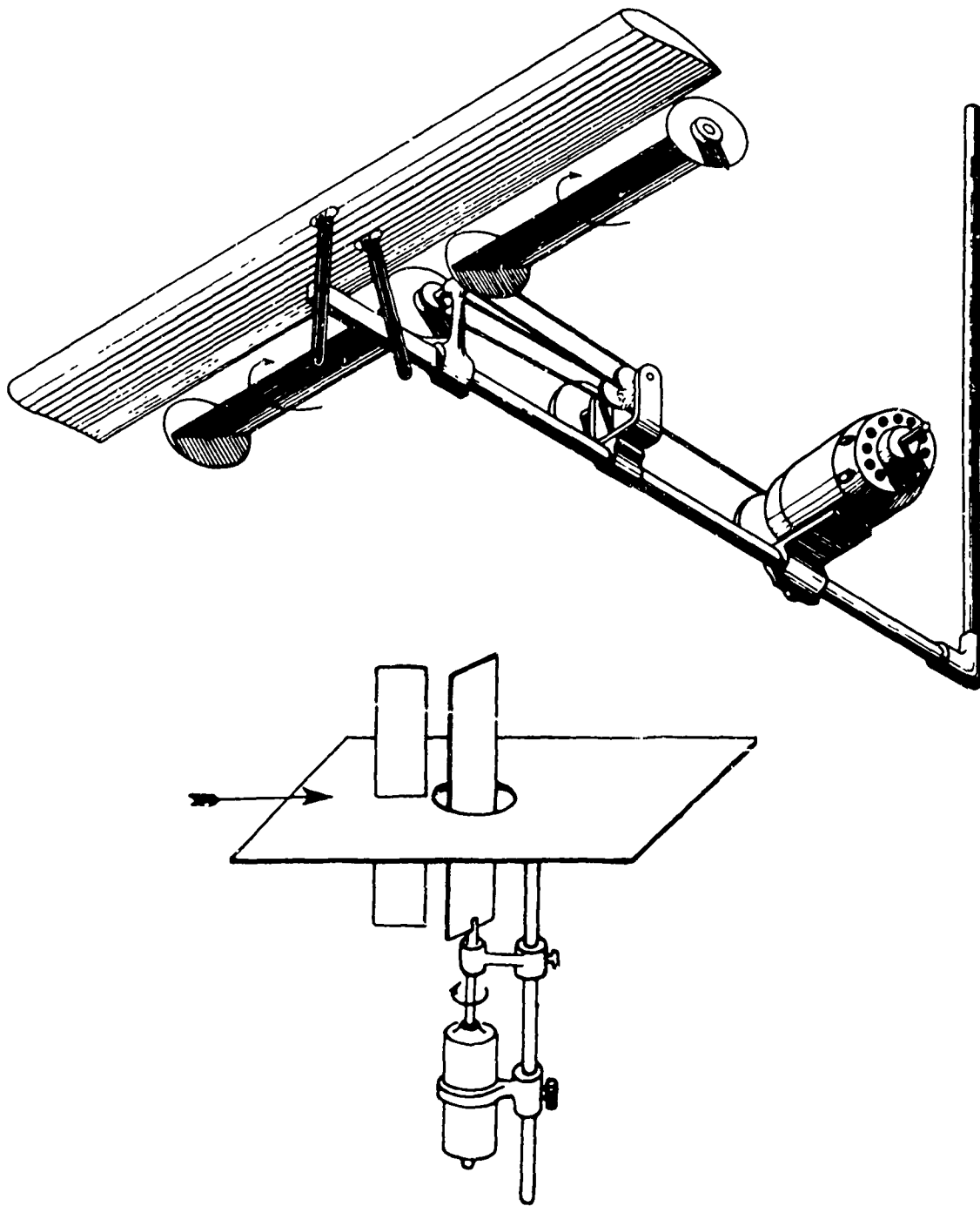

Figure 42. Early Experiments by Riabouchinski To Determine the Performance of the Trailing-Edge Rotating Airfoil Flap. (Ref. 19R).

trailing, fixed, and autorotating flaps and several wind-rotated cylinders--at various angles of attack and at several tunnel speeds. The selection of that test airfoil is inappropriate for modern applications.

The most useful background information for the application of the RAF was generated during World War II by Holst (Reference 48H) and Küchemann (Reference 51K) and later reviewed by Crabtree (Reference 52C) and Neumark (Reference 20N). The wind tunnel tests by Küchemann are relatively comprehensive and were carried out in a Reynolds number range from 60×10^6 (flap in autorotation) down to $.14 \times 10^6$ (flap operating at $U/V = 4$).

These tests were carried out on a 30- x 80-cm fixed wing located between two large stationary elliptical tip plates. The rotating flap was an airfoil with a chord 25% of the fixed-wing chord, with a profile not too unlike that of the main wing. Two smaller circular tip plates were rotated with the flap element. The axis of the flap was tested in three positions, below and in the vicinity of the fixed-wing trailing edge. Parameters varied in these tests were: rotating flap position, angle of incidence, tunnel speed, peripheral speed of RAF (autorotation, powered and stopped), direction of rotation. Lift, drag, and moment coefficients were determined. Some of these results are presented in Figures 41, 43, 44, and 45.

The arrangement of the RAF in these tests suggests adaptation of the flap in an external manner, as was often done in a wide variety of aircraft types by Junkers. If this is done, it is well to review the past experience of NACA/Langley in the wind tunnel and full-size flight tests of this external adjustable flap (NACA Reports 541, 573, 679; NACA TN 524, 604).

It would now become possible to combine these two separate devices, the RAF and the external flap, and to put them to practical use. Such a study, using the existing DeHavilland DHC-4 "Caribou" STOL aircraft, is later described on page 219. If one considers the installation simplicity of such a flap arrangement, as is shown, for example, on the Boeing XL-15 aircraft (Figure 46), then this adaptation to an existing design may not present too many problems.

It is suggested that the main fixed wing should be constructed continuously and that the external flaps also be rigged to serve as ailerons. The external flap would be supported to the trailing edge of the fixed wing through a series of hangers extending to the 50% chord or spin axis of the airfoil flap. These hangers would partially contain the

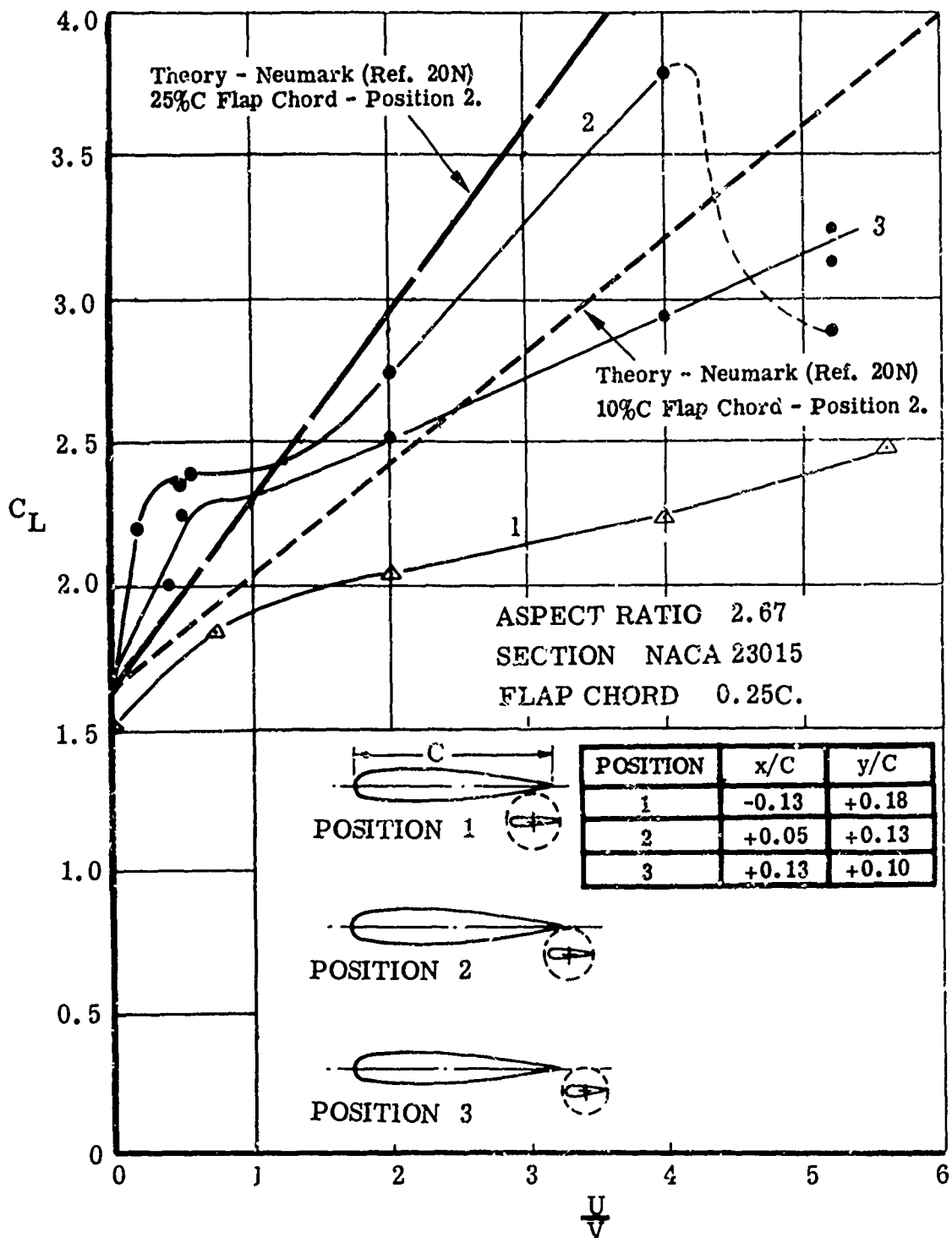

Figure 43. Wind Tunnel Results and Optimization of Rotating Airfoil Flap Position With Respect to Fixed Airfoil. From Küchemann (Ref. 51K) and Crabtree (Ref. 52C).

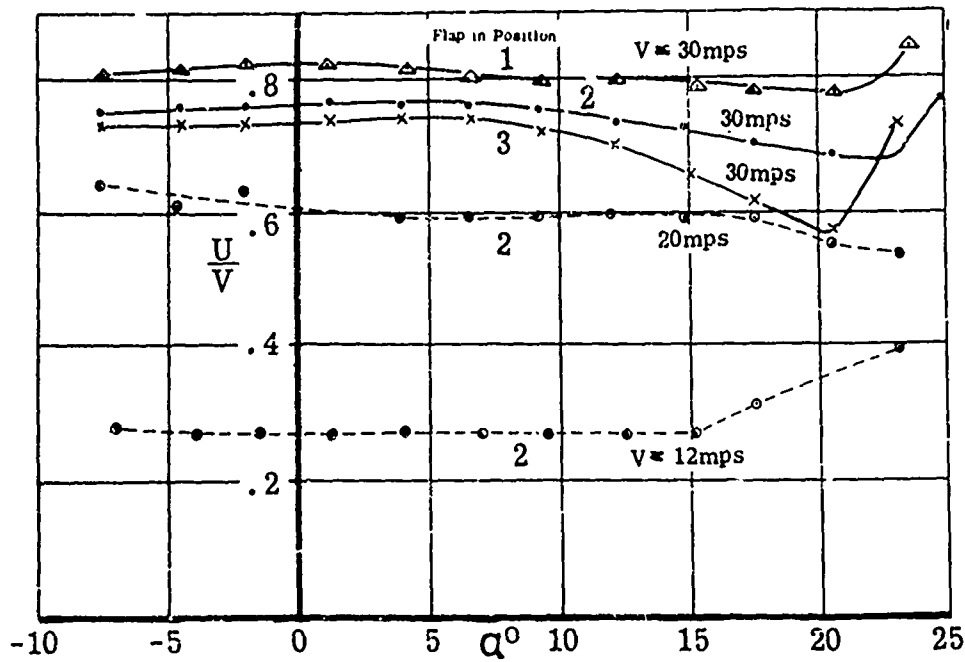

Figure 44. Autorotation of a Trailing Edge Airfoil Flap at Various Positions (See Fig. 18) and for Different Free-Stream Velocities. From Crabtree (Ref. 52C) and Küchemann (Ref. 51K).

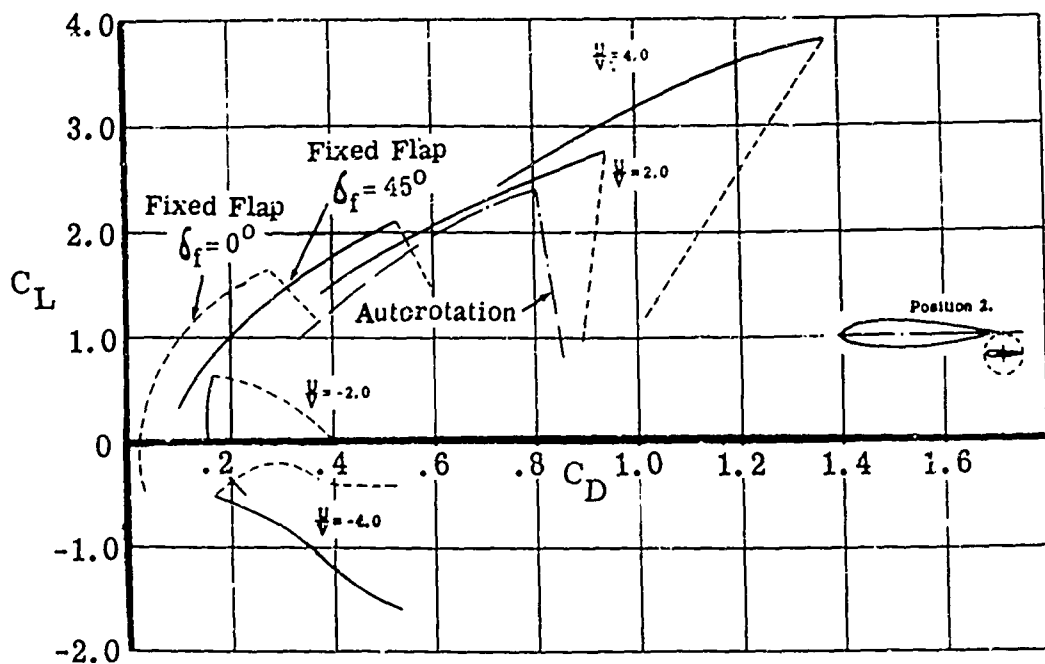

Figure 45. Lift and Drag Polars of a Fixed Wing with Trailing-Edge Rotating Airfoil Flap. Flap in Powered Rotation, Autorotation, and in Braked (Spoiler) Rotation. From Crabtree (Ref. 52C) and Küchemann (Ref. 51K).

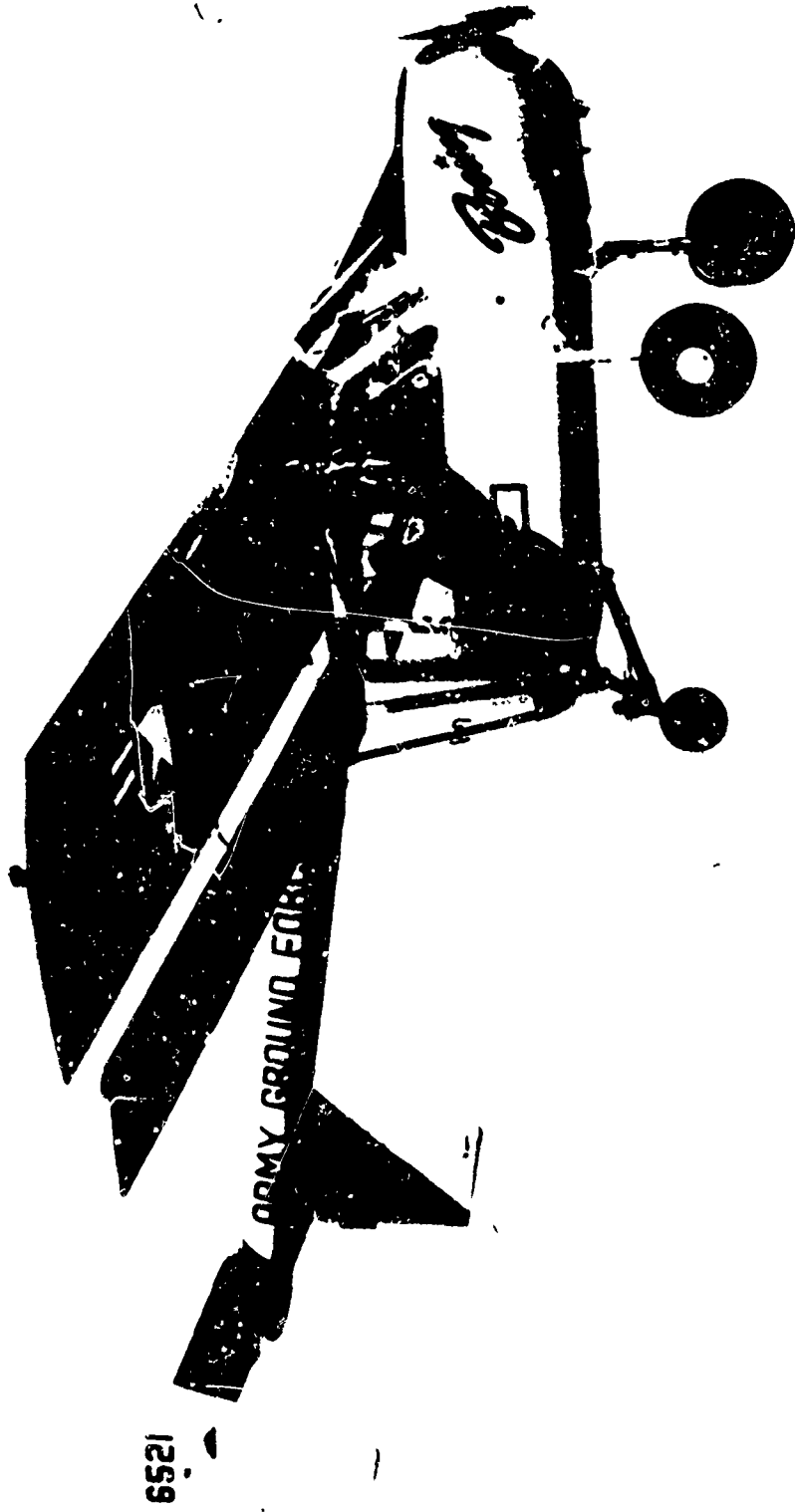

Figure 46. Boeing XL-15 Liaison Aircraft With Full-Span External Airfoil Flaps (1949).

drive shaft, axle housing, angle gearing, clutching, and flap angle locking mechanisms.

With a suitable flap thus installed, the following flight regimes and corresponding flap operations may be considered:

1. As a fixed wing - cruise. Airfoil flap is locked at its best cruise position. Flap area may be considered to be a part of the total fixed-wing area (Figure 41).
2. Flap deflected at various angles - operating as an external fixed flap for trim flight control or as a safety power-off backup system (Figure 41).
3. Flap rotated 90° to airstream and fixed as a (dive) brake or glide path control device.
4. Airfoil flap unlocked in free autorotation about its axle. Lift and drag now in excess of that of the fixed airfoil (Figure 41). As a safety backup, no shaft power required.
5. Airfoil flap unlocked and in powered rotation. Power may be practically applied to the flap axle at its junction in the support hangers, or the axle may be conveniently extended directly into the side of the fuselage. Lift and drag can be modulated by increases in power and peripheral speed of the airfoil flap. Note that the torque reaction required to drive the powered RAF appears, in part, as a component of the pitch-down moment on the aircraft.
6. Figure 41 shows that reverse rotation of the RAF produces negative lift coefficients. Thus, by rotating the flap backward, one may produce a negative lift. This may be employed as a glide path control system.
7. The RAF should be capable of being uniformly braked from the rotational state to the fixed-flap condition.

The flexibility of the RAF arranged in this manner is attractive. Before exploring the effects of flap in rotation, let us review the characteristics which have been determined for the fixed external flap.

Consideration of the external airfoil flap as a high-lift device indicates that it may be generally applied to improve

V/STOL aircraft performance. Previous investigations by NACA/Langley have shown that this device is capable of developing high lift coefficients and that it gives lower drag at these coefficients than ordinary flaps. Thus, it may be more favorable to such items of performance as takeoff and landing. At low lift coefficients, the external flap gives very nearly as low values of profile drag as a good plain airfoil of comparable thickness. Stability problems associated with large negative pitching moments occurring at high lift coefficients may be slightly greater than in the case of ordinary and split flaps. If the maximum lift coefficient of the wing with the external airfoil flap is referenced to the chord of the fixed wing, as is customary for other types of flaps, the resulting values would be about the same as those for single-slotted flaps. Generally, the full-span external flap has not been used extensively in this country. Some question arises as to the icing hazard between the flap and the wing.

Returning to the Küchemann RAF data of Figures 41, 43, 44, and 45, initial testing sought to determine the optimum position of the RAF to obtain C_{Lmax} (Figure 43). It is interesting to note that the determined optimum position 2 also satisfies the simple theories of Küchemann and Neumark and is also within the "optimum" position of the fixed external flap. The collapse of the lift curve of position 2 beyond $U/V = 4$ may be due to the fact that the test Reynolds number ($.14 \times 10^6$) at this U/V is causing an early transition to turbulence. Note that in these tests the Reynolds number varied from each U/V value as the flap peripheral speed (U) was held constant while the tunnel speed (V) was varied. It would be of interest to repeat a similar experiment in which the test Reynolds number could be raised to that of full-size aircraft landing and takeoff velocity and the U/V parameter could be held constant by varying the RPM of the rotating flap.

Several preliminary analytical attempts have been made to establish the theory of a wing with rotating flap (References 42S, 52C, 19N, and 20N). The theoretical attempts have been to represent a two-dimensional flat plate together with a straight line vortex at the axis of rotation of the flap. Thin airfoil theory can be developed for this ideal case, permitting solution by the potential flow method of conformal transformation. It may be noted that this is not too unlike the case of the two-dimensional jet flap airfoil, where the jet may be represented by a continuous distribution of vorticity in contrast with the axially concentrated vortex of the RAF theory.

A practical conclusion of Neumark's paper (Reference 20N) indicates a way to determine the contribution of the airfoil flap lift to the fixed-wing lift in the form of an incremental lift coefficient:

$$C_{L_1 S \Gamma} \approx \sqrt{\frac{L^2}{C^2} + \frac{2L}{C(1+\epsilon)}} \cdot \cos \frac{\beta}{2} \frac{U}{V}$$

where

$C_{L_1 S \Gamma}$ = incremental lift coefficient
(referenced to fixed-wing chord)

ϵ = gap parameter, in which

$$d_2 = 1/2 L (1 + \epsilon)$$

L = chord of airfoil flap

C = chord of fixed wing

β = angle between horizontal (x) and
reference line passing through
wing trailing edge and flap axis

U = peripheral velocity of flap

V = free-stream velocity

As a practical check, assume a wing chord to flap chord ratio (L/C) = 1/4 and the axis location angle $\beta = 52^\circ$. This corresponds roughly to the "optimum" theoretical locus of Neumark (Reference 20N, Figure 6). The incremental lift coefficient is determined for a range of values and added to the measured data of Küchemann (Reference 51K), and the resulting theoretically adjusted curve is shown in Figure 43 for the "optimum" position 2. The agreement between the measured and the adjusted curves of flap position 2 is surprisingly good.

It would be of further interest to determine the influence of slipstream effects and combined propeller thrust coefficients on enhancing the lift potential of the RAF.

Recent technological advances in the operational use of lightweight, high-speed drives and shafting supported over long lengths would be useful for adaptation of the rotating flap system to aircraft. Further, extensive operational experience by Junkers with the external flap is useful in understanding the problems of support structure, icing, etc. Some questions not yet answered might be the effect of the gyroscope couple of rotation flaps on structure and flight control and wake and buffeting problems created by the trailing-edge rotating airfoil flap.

h. Rotating Airfoil in Flap Leading Edge (RAIF)

The arrangement of a rotating airfoil in the leading edge of an adjustable fixed flap, as in the RCIF, is not a new suggestion. The patents of Henter and Kaser (Figure 47), filed in Germany in 1929, clearly indicate the application of a deflected slipstream over an RAF (Reference 28H) or a rotating airfoil ahead of, and adjacent to, a fixed flap (Reference 29H). The patent by Lake (Reference 22L) describes various adaptations of the RAIF to aircraft (Figure 48). This patent is of interest because it clearly suggests means of airfoil flap installation, drive, collective and differential control, and electromagnetic braking. The patent is also unusual in that it provides brief data on the power required to rotate the RAIF and the lift developed (Figure 41). The use of intermediate folding, rotating, flap tip plates is also suggested to prevent spanwise flow of air. The flap is also capable of autorotation. A more recent patent by Brunk (Reference 84B) describes a similar RAIF system in which, as the fixed flap is deflected, it uncovers fully autorotating airfoils in its leading edge. Like the RCIF, the arrangements are to be considered to be boundary-layer energizers to encourage flow attachment over a sharply deflected fixed flap. The Brunk system (Figure 10) suggests the use of two of the better bomblet or windmill sections. It should be noted that this system could benefit from improvements and adaptation in past and current bomblet profile studies. Note again that the autorotation system is self-contained, requiring no shaft power. Like the RAF system, the only preliminary flap power estimates that are available are those determined by Wiese (Reference 56W), and these are applicable only for an isolated lenticular rotor. The RAIF holds interest in that the retraction and stowage of the flap rotor could be more compact and simpler than that required for a comparable cylinder rotor. The RAIF should be capable of power-off autorotation.

i. Rotating Flap Systems in Ground Effect

The effect of the ground on general V/STOL performance is indicated in Figure 49, which shows the power required for a tilt-wing airplane, in and out of ground effect, as a function of takeoff speed. This shows that the airplane requires considerably more speed to produce a given lift with a given power in ground effect than out of ground effect. This indicates a greater takeoff speed and distance required within ground effect than outside it. For the deflected-slipstream RCIF NASA/Ames aircraft (Reference 57W), test data show the deterioration of lift performance in ground effect (Figure 50). This adverse ground effect is probably due to a collection of difficulties arising when the high-velocity deflected slipstream flows forward upon striking the ground circulation. The power-on characteristics ($T_c' = 4$) are most affected by the ground.

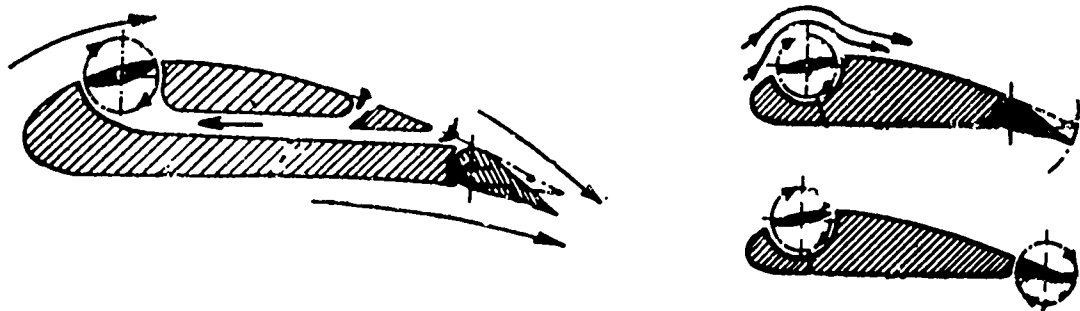

Figure 47. Rotating Airfoil Flap in Leading-Edge High-Lift RAS System by Henter and Kaser (Refs. 28H and 29H).

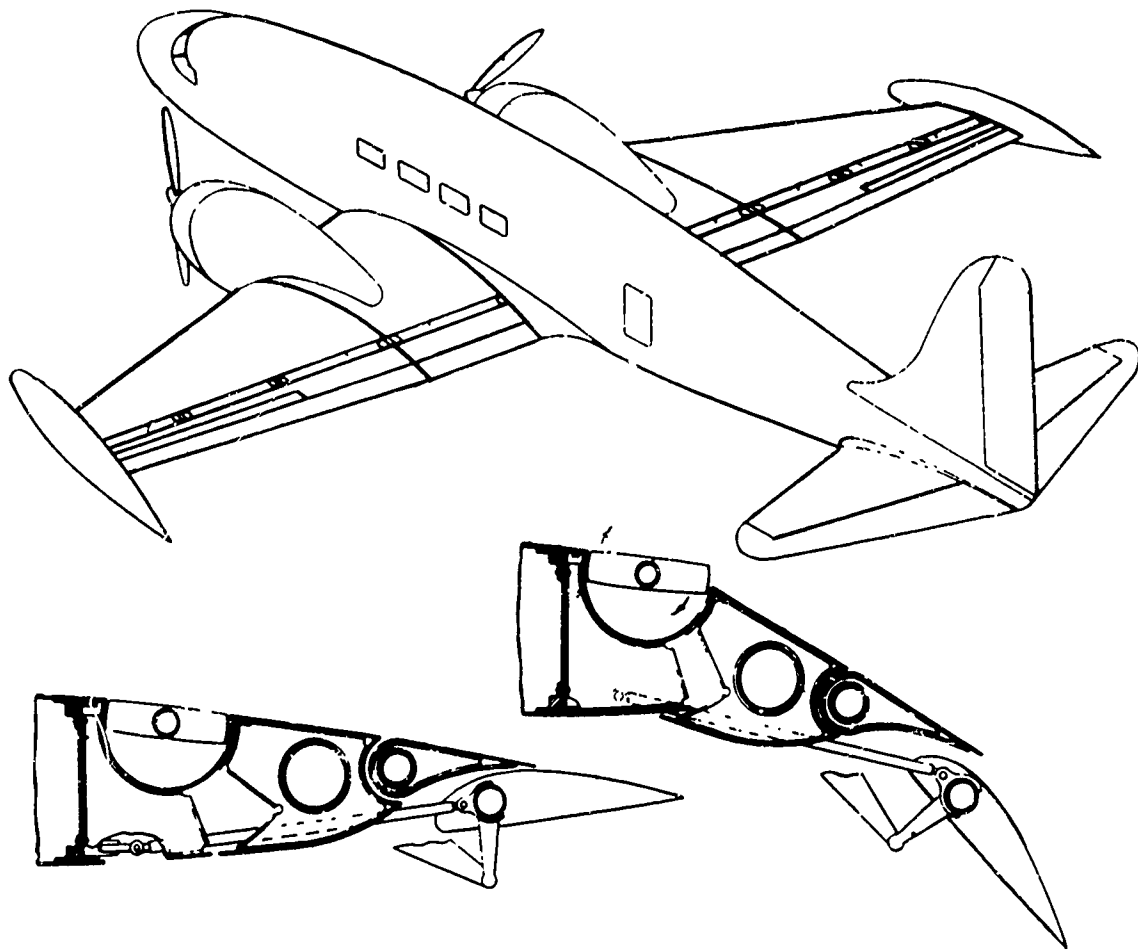

Figure 48. Powered Rotating Airfoil in Conjunction With Multiple Flap by Lake (Ref. 22 L).

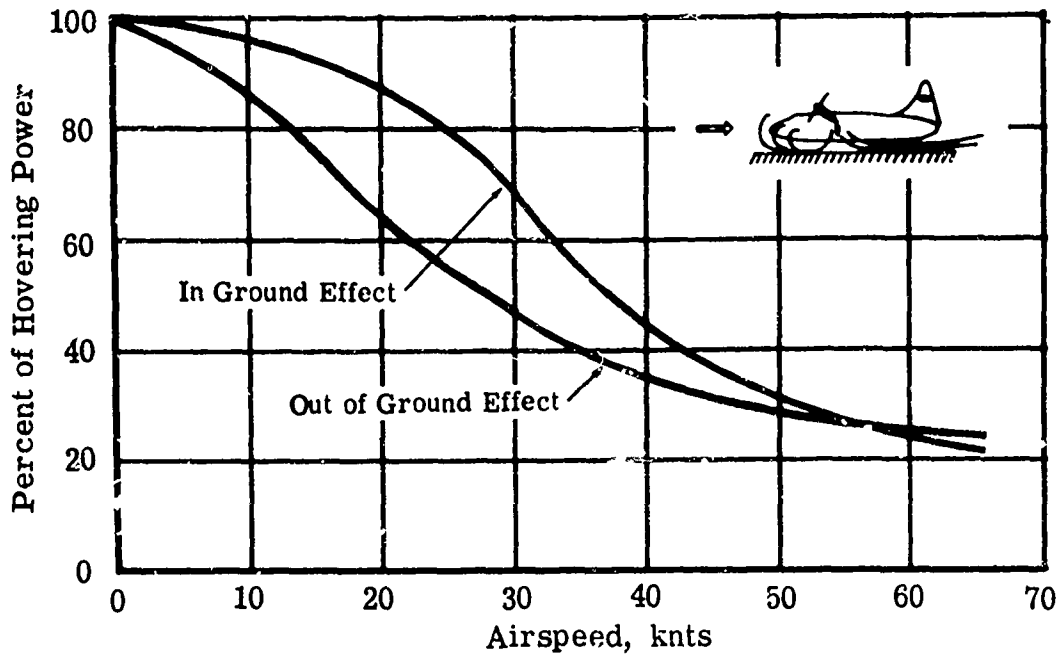

Figure 49. Influence of the Ground on a General Tilt Wing V/STOL.

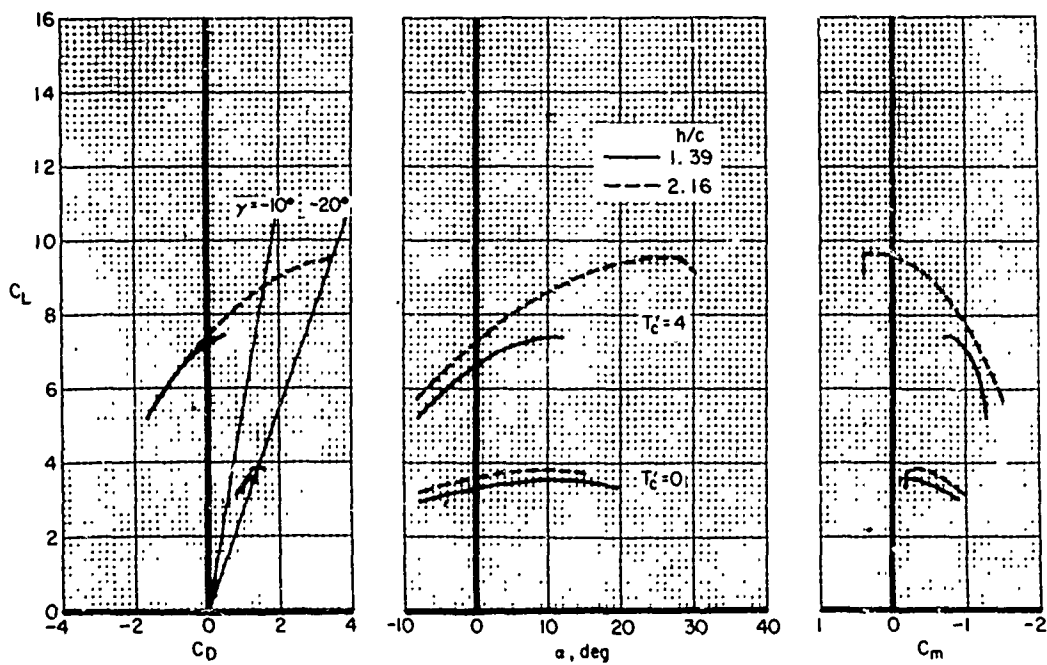

Figure 50. Effect of Ground Height (h/c) on the Aerodynamic Characteristic of the NASA/Ames RCIF Aircraft. $\delta_i = 70^\circ$ $\delta_A = 18^\circ$, Slats and End Plate on, Hinge 1 (See Fig. 75 and Ref. 57W).

No direct data exist on the influence of the ground on the Magnus effect or the circulation enhancement of the RAF arrangement. Experimental and analytical studies have been made on the attraction of flow with circulation toward a boundary or the ground (Reference 72R). This attraction or loss of lift, called the Raimondi effect, does not necessarily need forward speed to become effective. Data are shown here (Figure 51) for the attraction force between a rotating cylinder or between a rotating flap plate, and a ground board. This phenomenon may be expected to cause a decay in lift of Magnus effect systems when operating in ground effect. Further applicable analytical techniques are available for the study of the influence of ground effect on wing performance. These techniques have been cataloged and summarized in David Taylor Model Basin Report 2179, March 1966.

j. Rotating Flaps for Lateral Control

Taylor, Holst, and Neumark have suggested the use of small auxiliary wing rotors or rotating flaps as a means to obtain aircraft longitudinal or lateral control.

The results of the 1967 NASA full-size wind tunnel and flight test of the external flap system (Figure 37) indicate that when the full-span external flap is used also as an aileron, the rolling action is good; but the resulting adverse yaw is undesirable, and the stick forces (without boost) required to operate them increase too rapidly with speed.

It is suggested that, in a practical application of the RAF, the flap be split into an outboard and an inboard section. The inboard RAF would be driven at its highest and/or optimum RPM, while the powered rotation of the outboard portion (now considered as ailerons) would be driven through a differential and variable RPM system. Modulation of these outboard rotation aileron systems might be trimmed to provide very large and controllable low-speed roll forces. Here the problem is to program the control system of the outboard rotation ailerons to provide the proper roll characteristics without introducing the adverse yaw forces that were found in the full-span arrangement of the NASA flight tests.

The rotating cylinder and airfoil slat suggestions are not without interest as roll-producing or quasi-aileron devices. In the use of very thin high-speed wings, it is desirable to minimize elastic wing deflections originating from the trailing-edge aileron. In a thin wing, these deflections tend to act in a direction opposite to that of the desired roll motion and may produce undesirable aeroelastic problems. It is suggested that a controlled RCS or RAS in the wing leading edge may

produce the desired roll couple and also deflect the elastic wing in the desired direction.

4. Orbiting Flap and Undulating Propeller

Schmidt (References 41S, 43S, and 54S) has evolved a unique trailing-edge rotating flap which capitalized, in part, on the Knoller-Betz or Katzmayer effect. Essentially, it is a system of thrust augmentation, drag reduction, or thrust production, depending upon the configuration of the orbiting airfoil and/or fixed airfoil(s). The basic arrangement is shown in Figure 52, in which a leading airfoil or "undulator" is orbited ahead of an aft stationary airfoil or "deundulator". The combined system experiences an overall thrust as a result of the undulator's rotation.

Further, if the undulator and deundulator are submersed in the airstream of a propeller or jet, the effect on the system is an overall drag reduction or, effectively, a thrust augmentation (Figure 54). Figure 53 also indicates how further variations in the geometry and mechanical motion can be made to obtain not only thrust augmentation but also lift. The number of parameters needed to be manipulated to seek an optimum performance are innumerable. Schmidt has carried out many tests on several special configurations; the results of one arrangement are presented as a lift and drag polar in Figure 54. Note that:

α = angle of attack of main forward body
(note range from 0° to 25°)

ϵ = angle of incidence (constant) of undulator in orbit with respect to main body reference

β = angle of incidence of deundulator with respect to main body reference

U = peripheral speed of undulator

V = wind speed

n = RPM of undulator

The results, as explained in Reference 54S, are the wind tunnel results on an air and land vehicle (Figure 55). Note the very thick forward stationary airfoil body, the trailing and orbiting undulator, and the final stationary elevator-like deundulator.

Other innumerable adaptations of the orbiting airfoil flap have been suggested. One system proposed by Schmidt is the adaptation of the undulator airfoil as a thrust device and conventional flap.

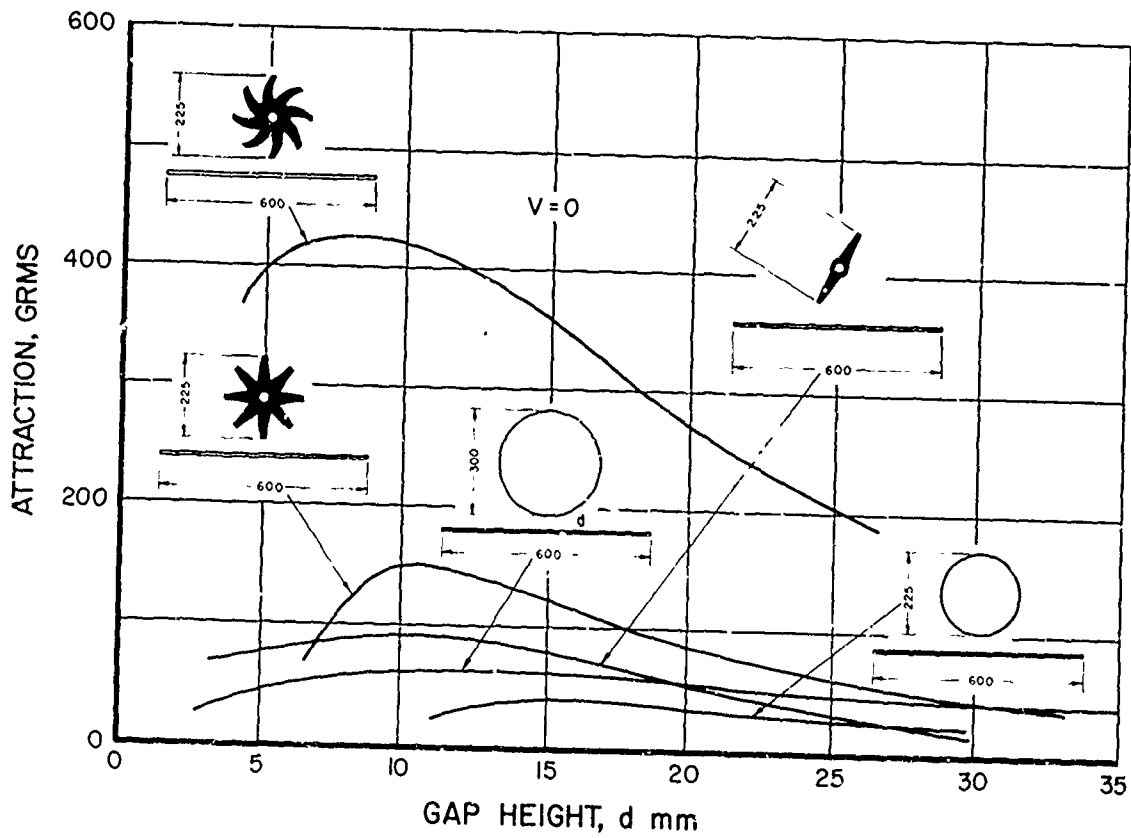

Figure 51. Attractive Force of Various Wing Rotor and Cylinder Devices Rotating in Proximity to a Ground Board (Ref. 72R).

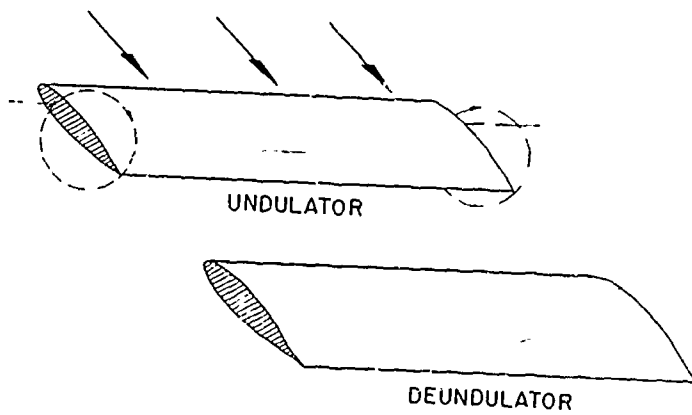

Figure 52. Basic Arrangement of Orbiting Flap Undulator and Deundulator.

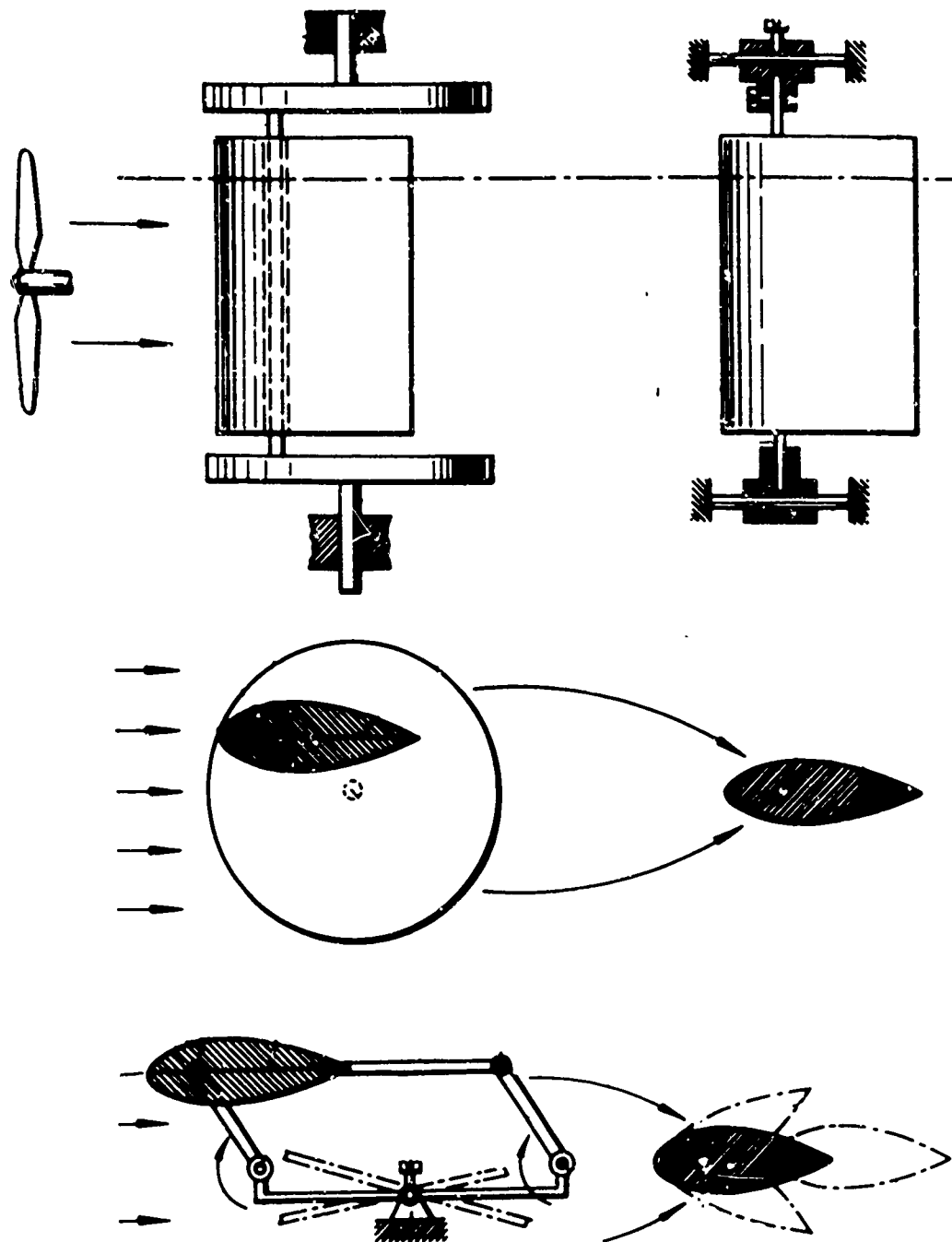

Figure 53. Schematic Arrangement of Orbiting Flap. Lower Drawing Indicates Various Geometries Possible by Varying Angles, Spacing, and Rotation.

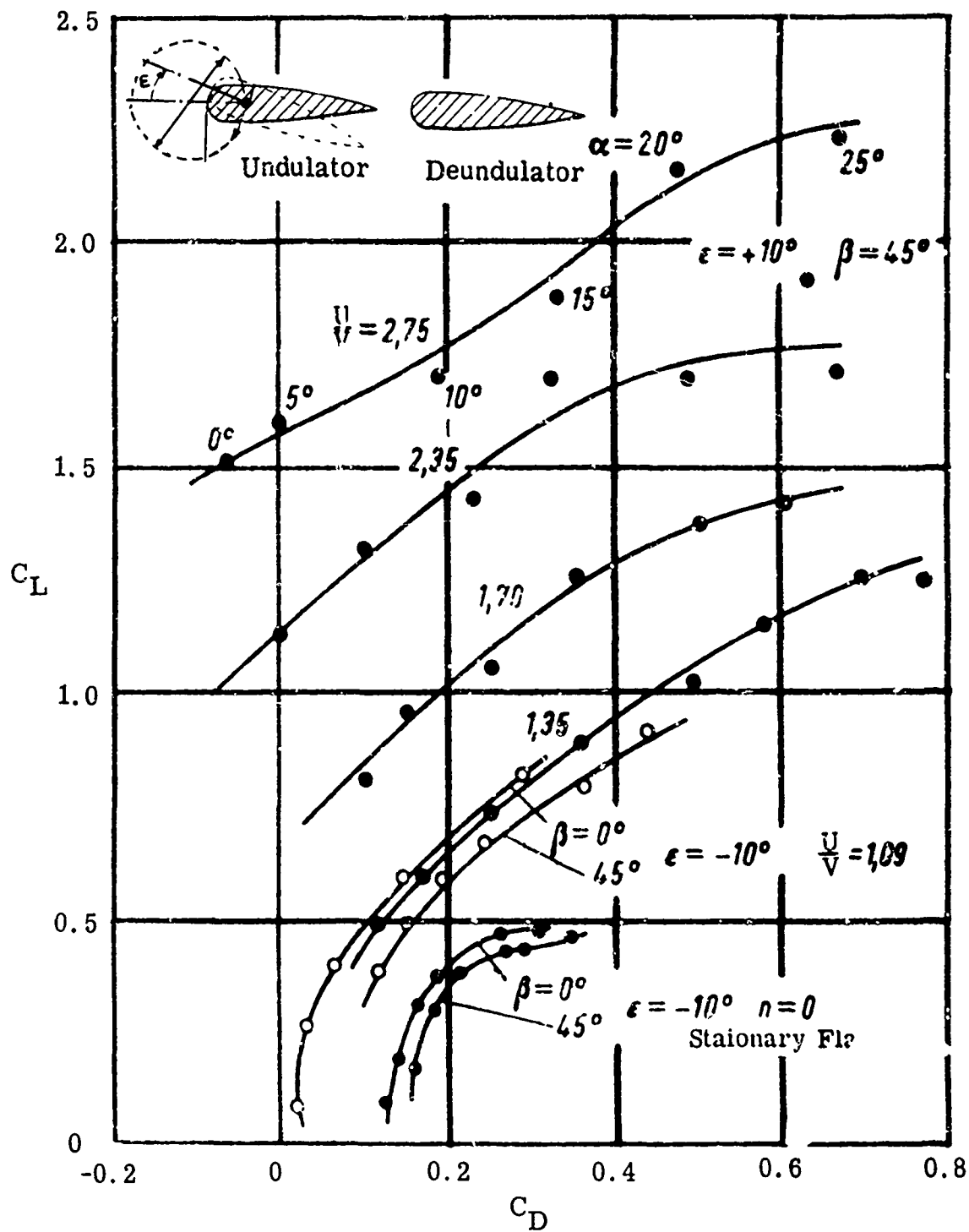

Figure 54. Wind Tunnel Results by Schmidt on Air Vehicle of Figure 55. Curves Are Aerodynamic Polars With Undulator in Rotation and Stopped. Note Thrust at $U/V = 2.75$, $\alpha = 0^\circ$ (Ref. 54S).

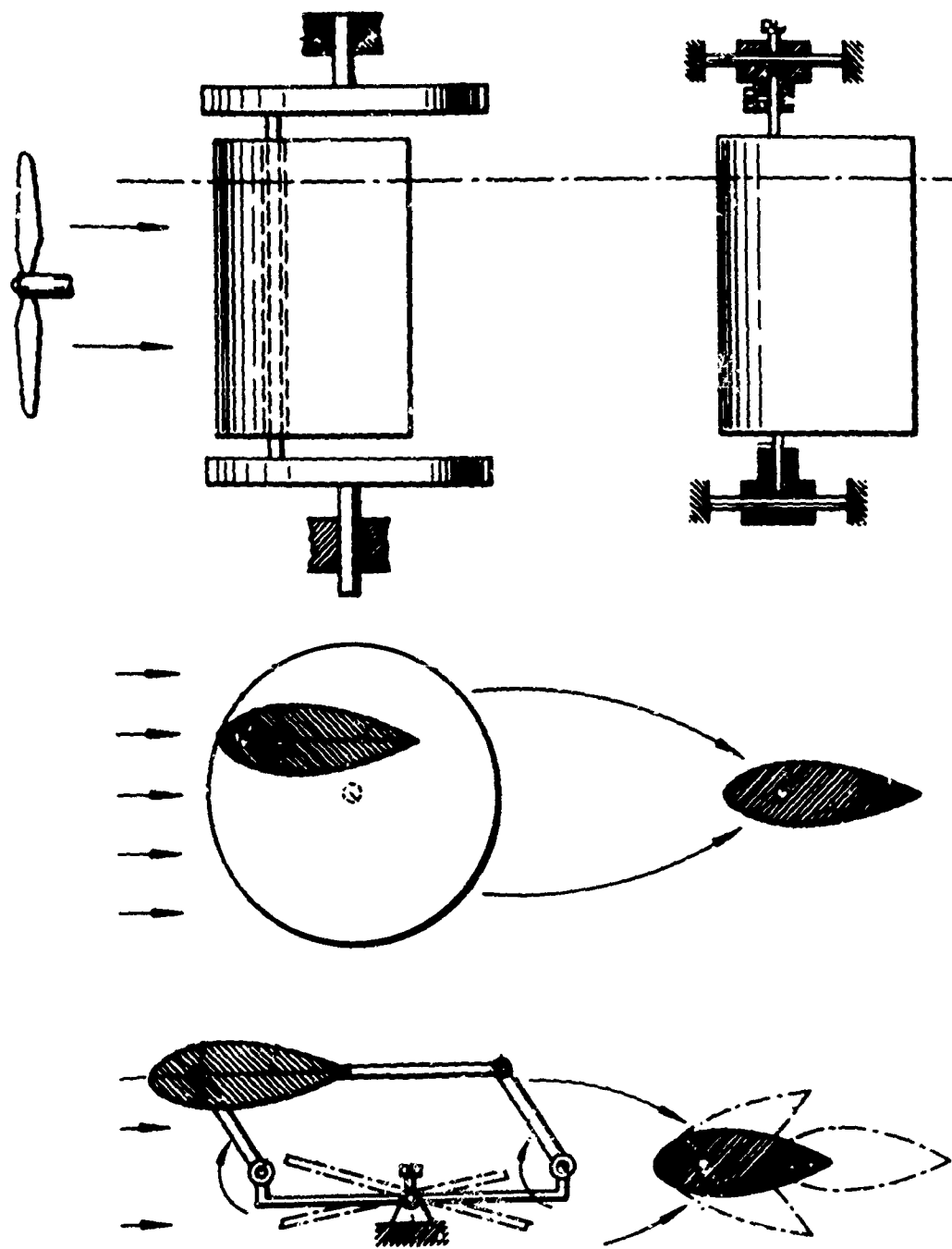

Figure 53. Schematic Arrangement of Orbiting Flap. Lower Drawing Indicates Various Geometries Possible by Varying Angles, Spacing, and Rotation.

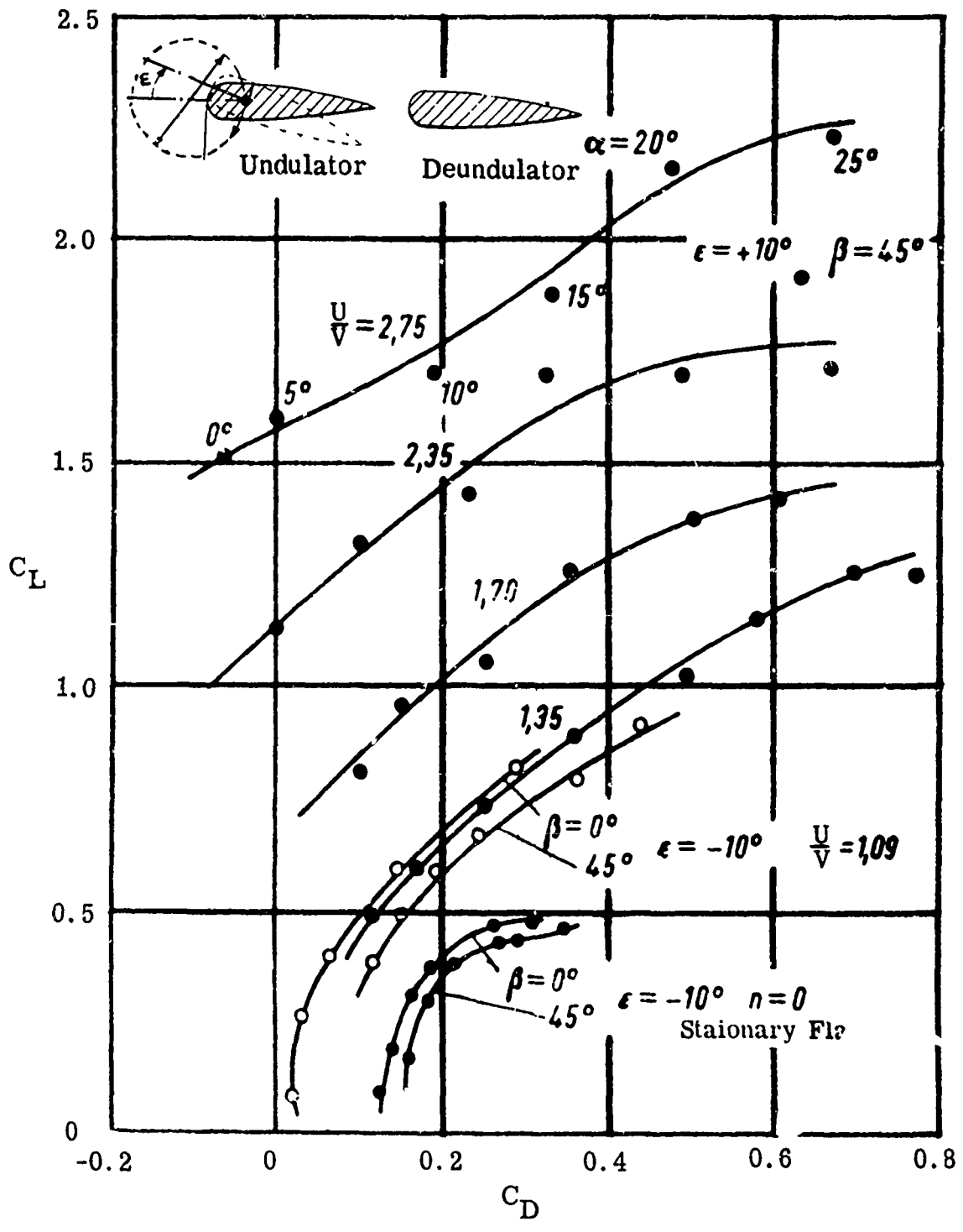

Figure 54. Wind Tunnel Results by Schmidt on Air Vehicle of Figure 55. Curves Are Aerodynamic Polars With Undulator in Rotation and Stopped. Note Thrust at $U/V = 2.75$, $C_L = 0^\circ$ (Ref. 54S).

This arrangement, as applied to a sailplane (Figure 56), for example, strongly resembles the RAF. Schmidt suggests the use of the tailplane as a possible undulator for this system. This, of course, must take into account tail buffeting problems and the like. This would further suggest an intriguing mechanical combination of the external, rotating, and orbiting flap for flight control and propulsion augmentation.

The background for the orbiting flap is summarized from Reference 54S:

"The Knoller-Betz effect has given rise to investigations of a flapping wing with rear-wing. Already in the 1940's, the efficiency of a flapping wing at higher frequencies could be proved to be doubled by the presence of a rigid wing behind it. Model experiments in air and water confirmed this theoretical knowledge. Because of the unavoidable movement to and fro of masses in the case of a flapping wing, considerably restricting the frequency of flapping, a rotating "undulator" has been developed which, in conjunction with the rigid rear wing, constitutes the novel "undulating propeller". This new propulsion mechanism is proved by experiments on the rotating arm and by experiments with the model of a ship also to produce a static thrust. Wind tunnel experiments have rendered good efficiencies. They especially have shown that the undulating propeller is able to produce good thrust, and to increase the lift considerably, even in the case of operation behind a thick wing, and have given the first polar diagrams [Figure 54] for it. The undulating propeller prevents separation of flow, even at very high angles of incidence. Finally, examples of application for the undulating propeller are given. As this propeller rendered most favourable values of lift also behind a very thick wing, the chord of which was twice its span, there is some hope that the "flying car" will be realized."

5. Cross-Flow or Transverse-Flow Fan and Flap

In 1891, Mortier patented in France a type of fan which entrains and discharges air along its entire axial length. Referring to Figure 57, taken from the original U.S. Patent (No. 507445), air enters the inlet at L, passes through the inlet face and the blading of the fan at a-b, crosses the center portion and axis area, is pressurized through the outlet blading c-d, and is diffused to its service at K. The intriguing fact of this fan is that the volume flow that it can handle is limited only by practical considerations of the rotor length. The flow inlet and exhaust are usually rectangular. Although patent coverage is extensive, the technical and analytical evolution of the

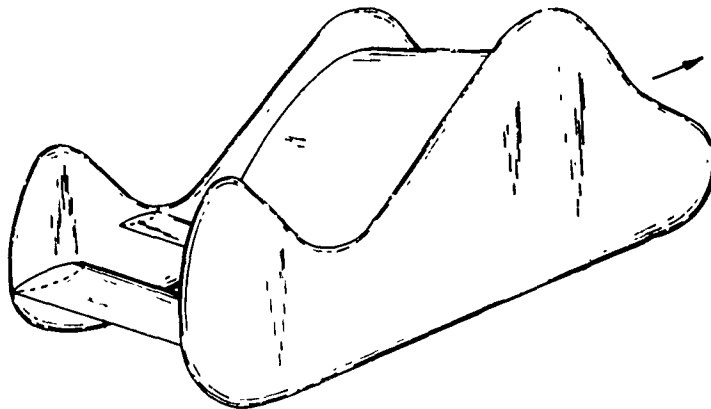

Figure 55. Aerodynamic Body of Orbiting Flap Test. Note Main Body Airfoil Ahead of Undulator and Deundulator.

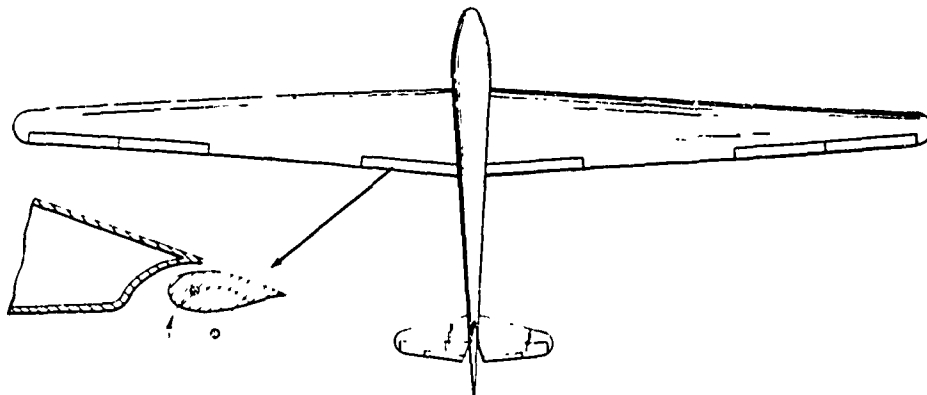

Figure 56. Suggestion by Schmidt (Ref. 53S) for Aircraft Drag Reduction or Auxiliary Propulsion.

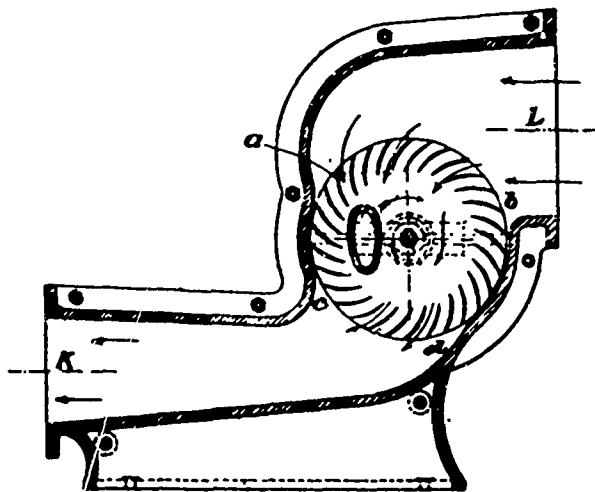

Figure 57. Basic Cross-Flow Fan by Mortier, 1891 (U.S. Patent, No. 507445).

transverse fan is just beginning to be understood. A survey of this particular system has been published by Eck (Reference 4E). Many parameters affect the performance of this fan system. The geometry of the outside stationary housing is found to be critical. Slight changes in the shaping of this shroud can give a very wide variety of pressure, flow, efficiency, and power selections.

The adaptation of crude linear cross fans to aircraft has been patented from time to time (References 35M, 36M, etc.). The fan is usually located spanwise in conjunction with a fixed wing and directs its exhaust over the wing surface in some manner to increase or control wing performance.

Only very recently has an intelligent attempt been made to combine the cross-flow fan with various arrangements of BLC, jet flap, and propulsive-wing aircraft systems. The combination of fan and aircraft systems has been given recent exhaustive patent coverage by Laing (References 12L through 21L). Two examples of this are presented here. Figure 58 shows a STOL propulsive-wing system which features a jet flap arrangement. In the cruise and thrust mode, the spanwise fans are deflecting flow essentially aftward and are also helping to maintain an attached boundary layer by the upper wing surface inlet suction area. In the STOL mode, the fan deflects considerable flow downward with the use of direct blowing and aft flap inlet suction. The wing is displaced upward and forward in such a manner as to help alleviate the pitch-down movement usually associated with the jet flap when operating in this manner. Going one step further, Laing also proposed to use the shrouded full-span cross-flow fan as a pure VTOL, as seen in Figure 58. Although it is believed that wind tunnel tests are being carried out to determine the feasibility of these basic ideas, no data have been published to date. At first glance, the cross-flow fan may offer certain attractive features, as it would eliminate the blower and the duct losses in a jet flap arrangement. Question has arisen as to the ability to make the fan rotors structurally sound, lightweight, and aerodynamically efficient.

B. CYCLOGIRO SYSTEMS

1. General Description

The cyclogiro aircraft which will be discussed in this section result from the application of the cycloidal propulsion principle to wings rotating in air about a horizontal axis while absorbing power. Another important application of the cycloidal propulsion principle is the cycloidal propeller, which is used for the propulsion and steering of ships; in the latter case, the blades operate in water and usually revolve around a vertical axis. The latter case will be discussed on pages 204 to 208.

A typical cyclogiro aircraft rotating-wing system is shown in Figure 59. The rotor consists of several blades rotating uniformly

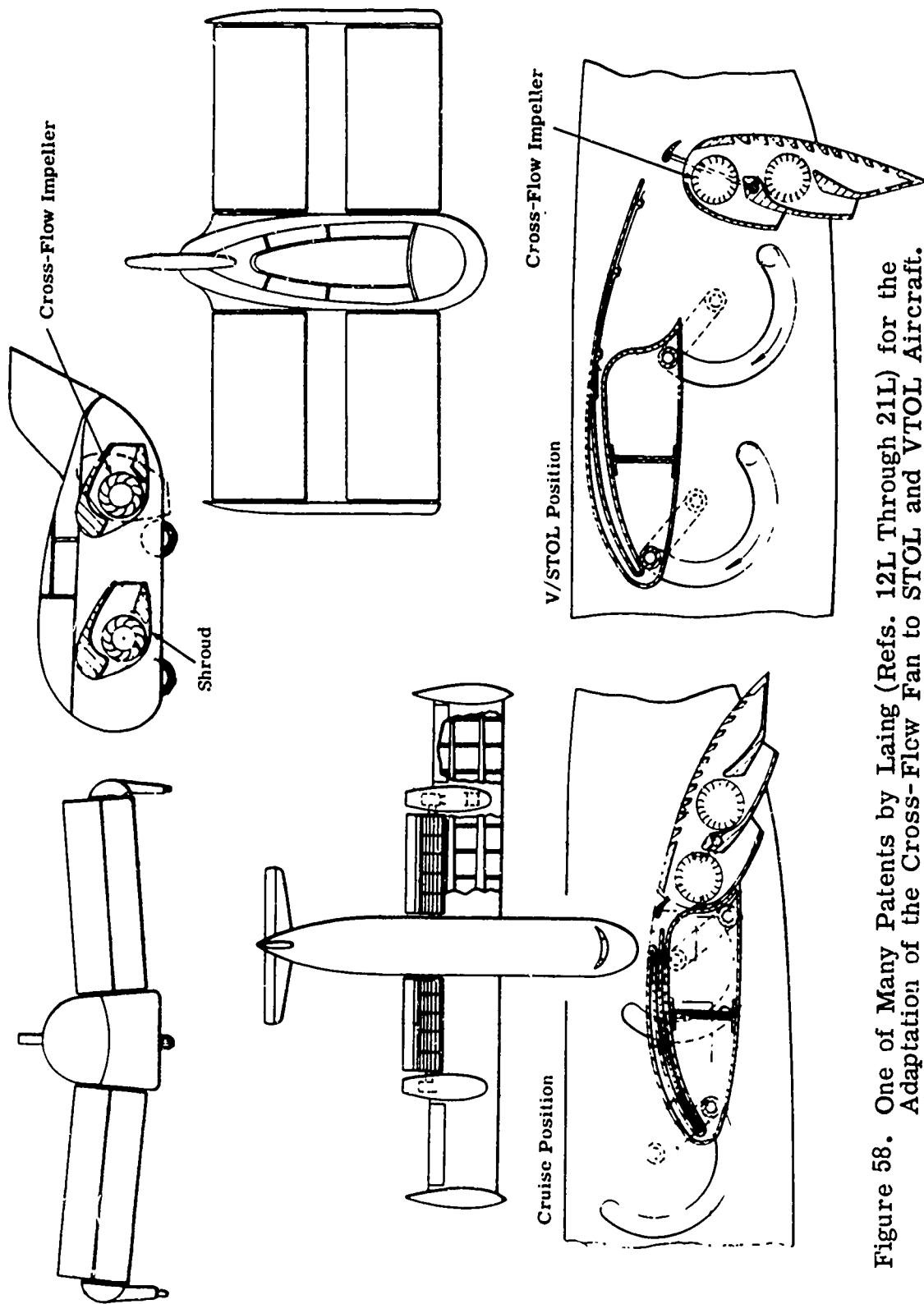

Figure 58. One of Many Patents by Laing (Refs. 12L Through 21L) for the Adaptation of the Cross-Flow Fan to STOL and VTOL Aircraft. Shown are Two Means of Maintaining Pitch Trim With Such a System.

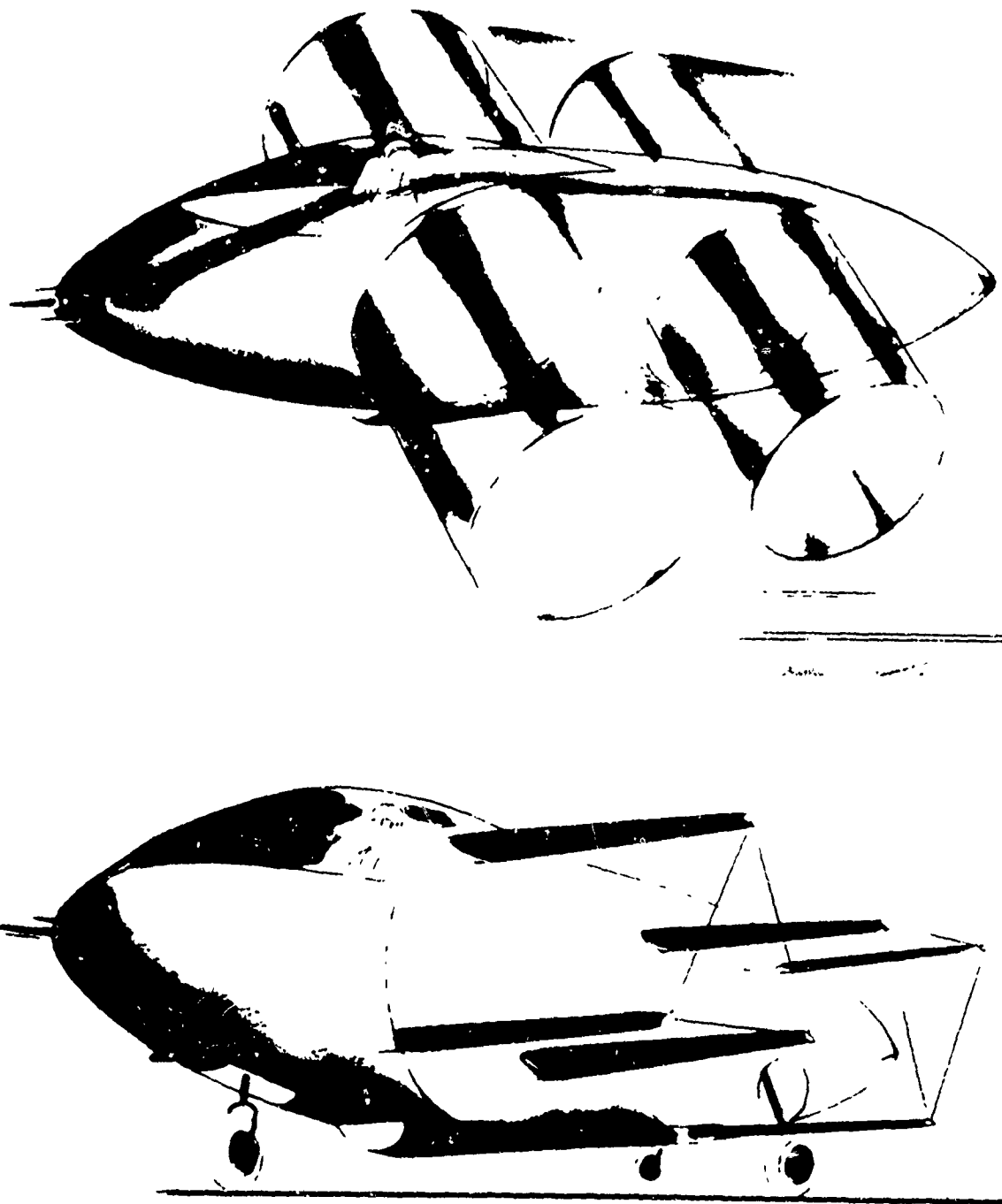

Figure 59. U.S. Army Air Forces, Wright Field Fighter Cyclogiro Project (1943-1945). Wt., 3900 Lbs.; LOA, 25 Ft.; Rotor Dia., 5 Ft.; HP Instal., 490. See Refs. 3CH and 31H.

about a horizontal axis usually perpendicular to the direction of flight. The angle of the individual blades to the tangent of the circle of the blade's path is varied by a double-cam arrangement, so designed that the periodic oscillation of the blades about their span axis may be changed both in amplitude and in phase angles. The net force on the rotor may thus be varied in magnitude and direction by movements of the cam. In particular, cyclogiro aircraft are capable of hovering flight. In forward flight, lift and propulsion are integrated.

2. Pictorial Review

The original "Aerial Carriage" man-powered cyclogiro was proposed by William Congreve in 1828 and is shown in Figure 60.

Another antique cyclogiro aircraft, proposed by Herard in the 1880's, is shown in Figure 61.

In the 1920's, still in the pioneering age of aviation, many efforts at building cyclogiros were started: Nemeth (the machine shown in Figure 62 is believed to be his design; moving pictures of that machine do exist); McWorter (Figure 63); in France, Pichou and Moineau (Figure 64).

Dr. Klemin, at New York University, became interested in cyclogiros and tested both Platt's (Figure 65) and Laskowitz's designs (Figure 66).

In Europe, in the 1930's, two engineers attracted major attention: Rohrbach in Germany (Figures 67 through 69) and Strandgren in France (Figures 70 through 72). Strandgren's basic paper was translated as NACA TM 727 (Reference 130S).

At the same time, NACA started investigating at Langley Field, Virginia, the fundamental claims of the cyclogiro as a VTOL or a STOL. This work was done by the same Wheatley who was responsible for the fundamental investigations of the autogiro and of the helicopter. Wheatley was responsible both for wind tunnel tests (Figure 73 and Reference 28W) and for a theoretical approach (Reference 25W). His work was not continued at NACA after the outbreak of World War II.

The towering figure in cycloidal propulsion and cyclogiros in the United States was Professor F. K. Kirsten of the University of Washington (Reference 28K). Kirsten (References 17K through 31K) became interested in cycloidal propulsion in the 1920's (Figure 74), built the wind tunnel model shown in Figure 75 in the early 1930's, and was responsible for a school of thought to develop at the University of Washington which resulted in the work done during World War II for the U. S. Army Air Forces. Kirsten's

AERIAL CARRIAGE.

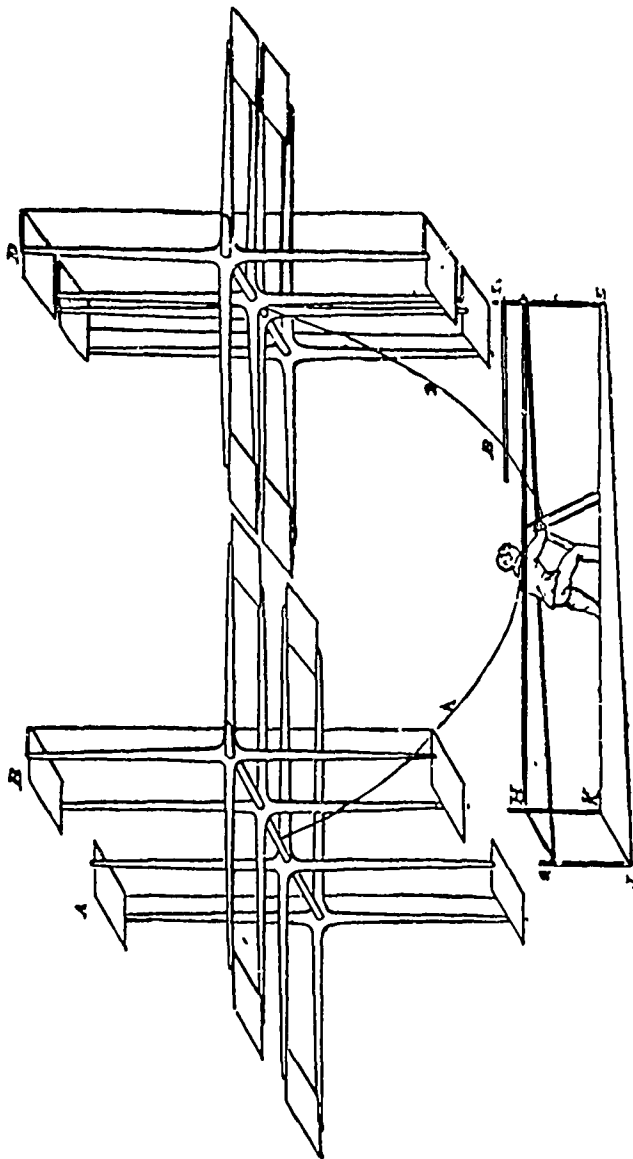

VOL. IX.

Figure 60. First Concept of the Cyclogiro by Sir William Congreve, 1828 (Ref. 44C). The Feathering System Is That of the Valved Pusher Arrangement.

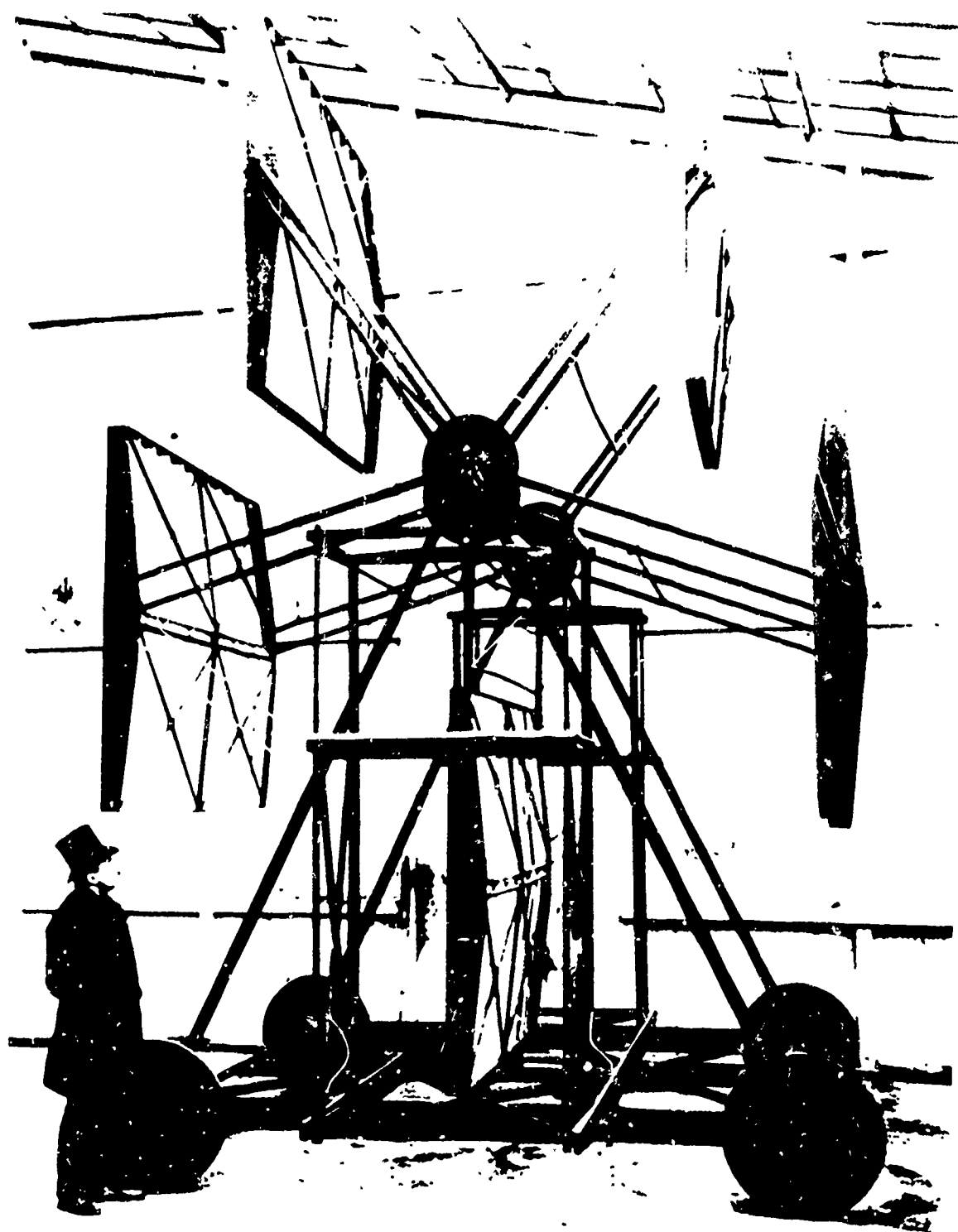

Figure 61. Antique Cyclogiro System by Herard in the 1830's. This Feathering Arrangement is Typical of Class 6 Type (Fig. 92).



Figure 62. Unidentified (Nemeth, Ref. 12N) Full-Size Cyclogiro of the 1920's. Note Rotary Engine and Direct Chain Drive.



Figure 63. McWorter "Autoplane" Quarter-Scale Model Cyclogiro, Evaluated by the U.S. Army Air Service, McCook Field, 1919. Blade Feathering Scheme That of Class 2 Type (Fig. 92). Item 24). Refs. 13Mc Through 16Mc.

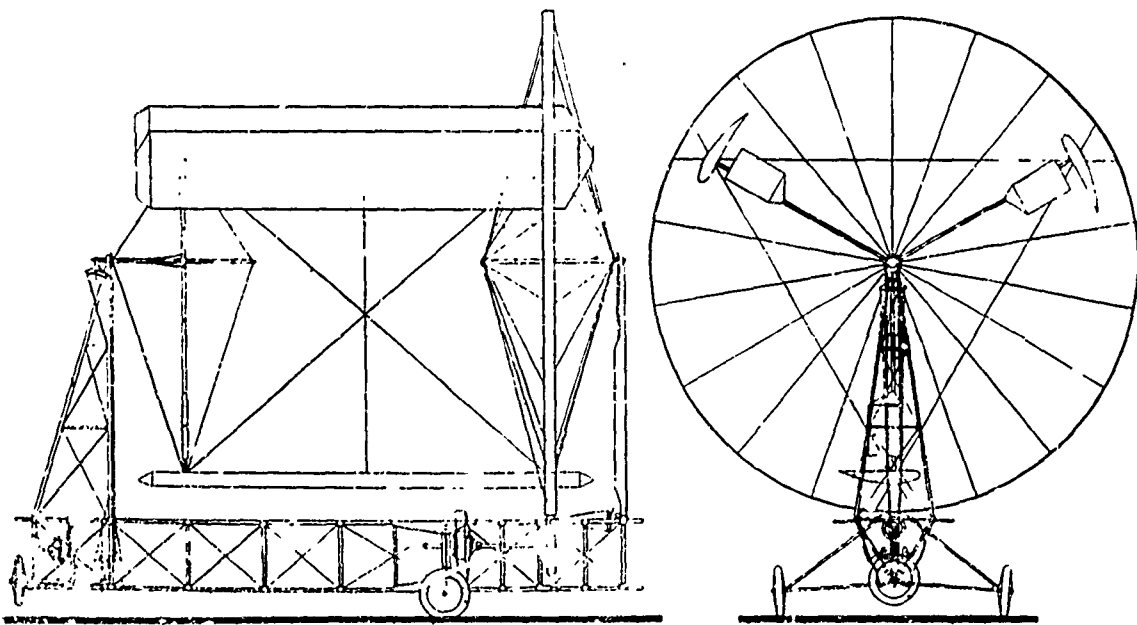
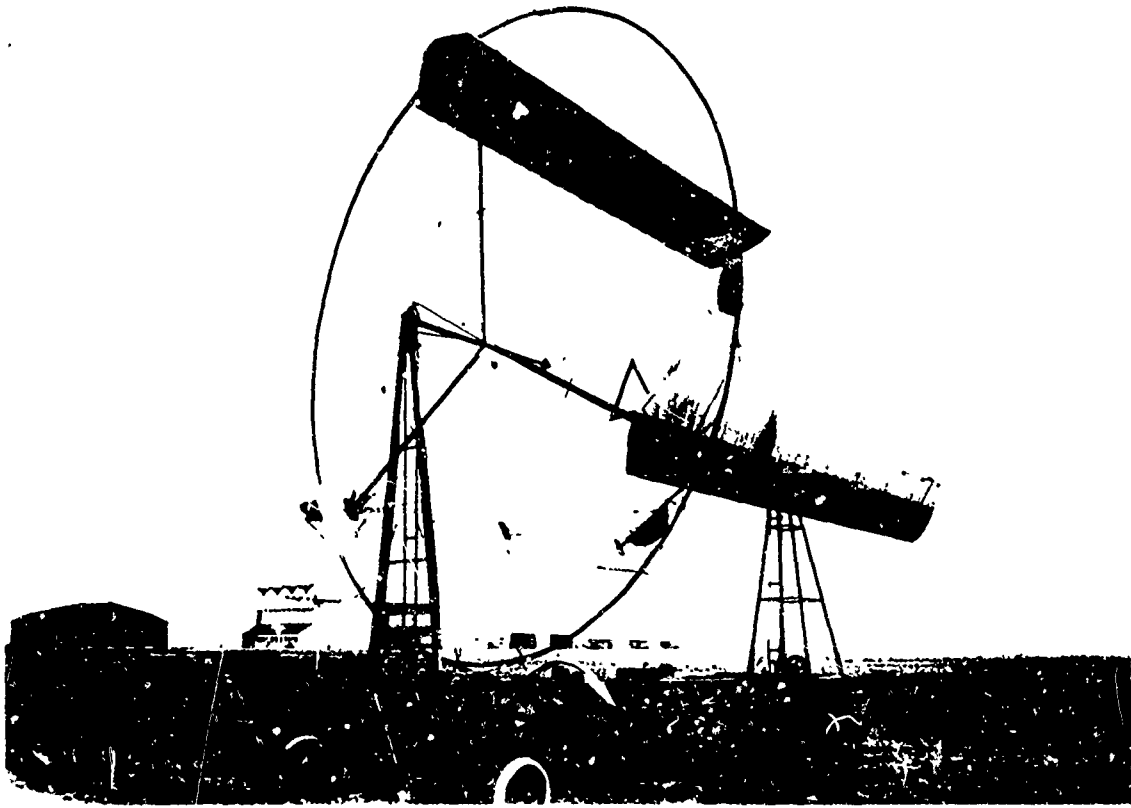

Figure 64. Moineau Low Pitch Cyclogiro Project of the 1920's in Which Direction of Flight Is Along Axis of Rotation. 1/10th-Size Model Test in Wind Tunnel. See Refs. 54M Through 57M.

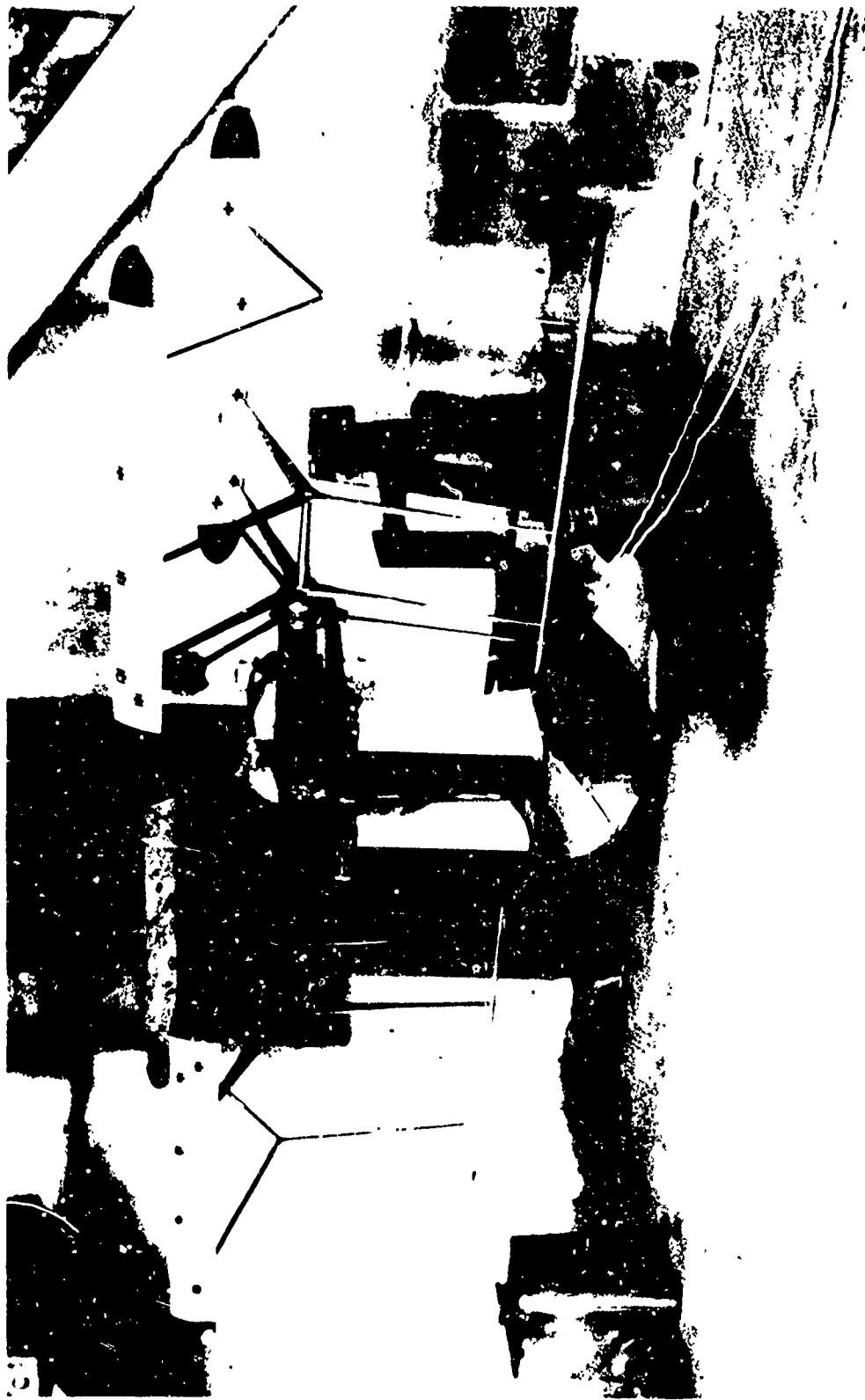

Figure 65. Platt Cyclogiro Wind Tunnel Model (1929-1930) Tested at The Daniel Guggenheim School of Aeronautics, New York University. See Refs. 24P Through 28P.

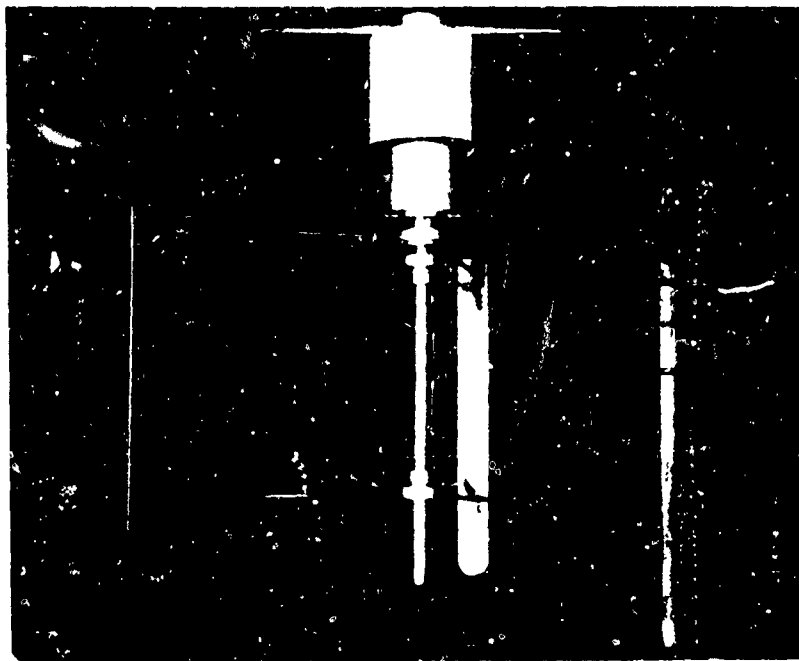

Figure 66. Laskowitz Three-Blade Low-Pitch Cyclogiro Rotor in the New York University Wind Tunnel. Rotor Dia. 3 Ft., Span 2 Ft. See Ref. 32L.

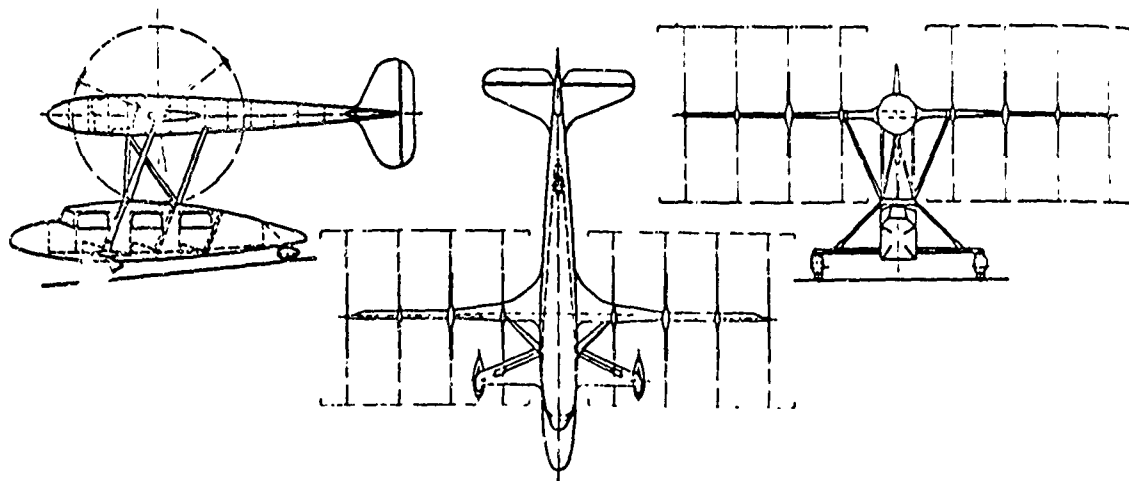

Figure 67. Rohrbach Project "B" Cyclogiro, Three Views (1934).

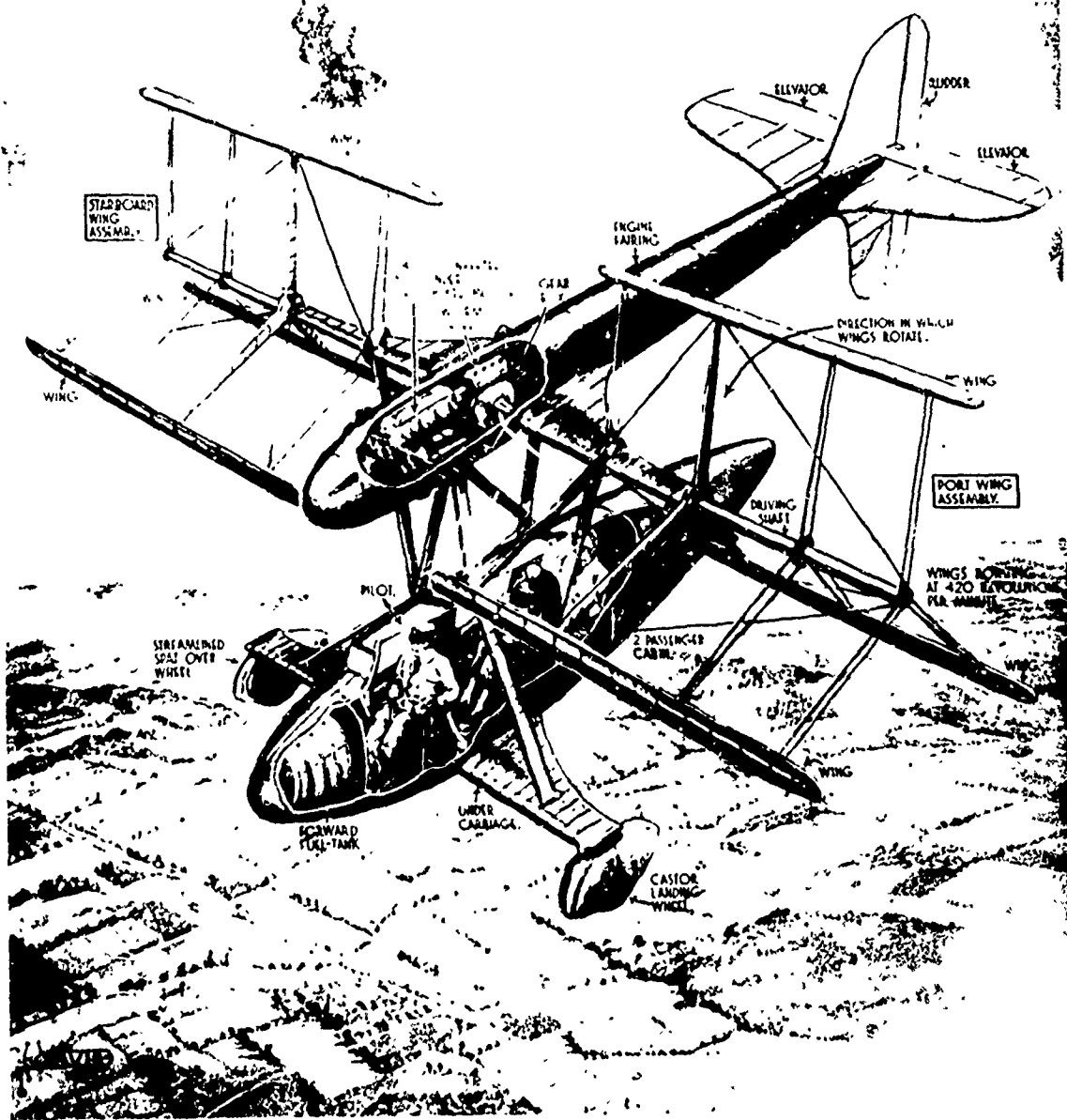

Figure 68. Comprehensive View of the 1934 Rohrbach Cyclogiro. Although Extensively Studied, Outcome of This Project Is Not Known. See Refs. 58R, 59R, and 79S. From Ref. 55R.

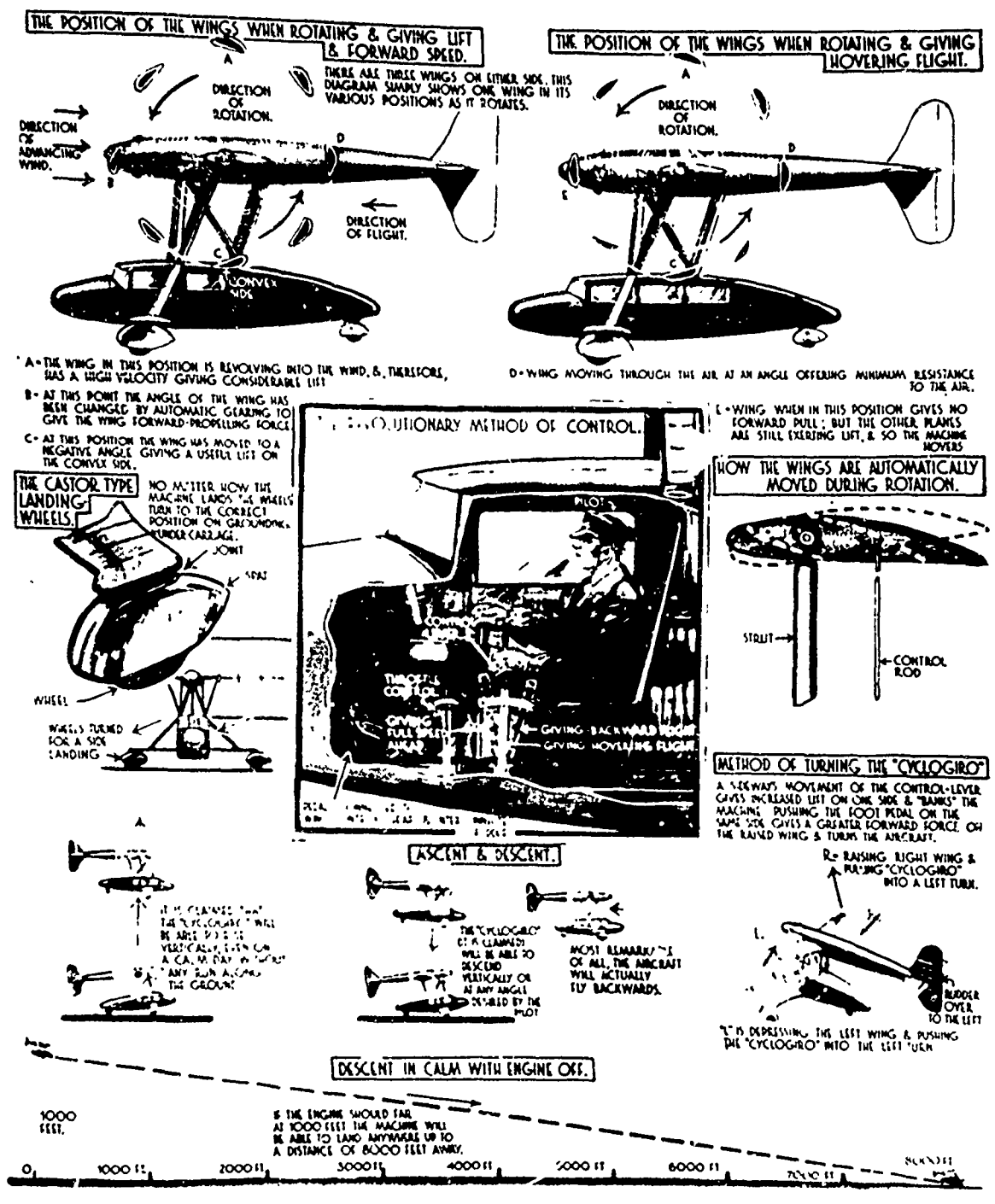

Figure 69. Control and Performance Characteristics of the Rohrbach Cyclogiro Project. From Ref. 55R.

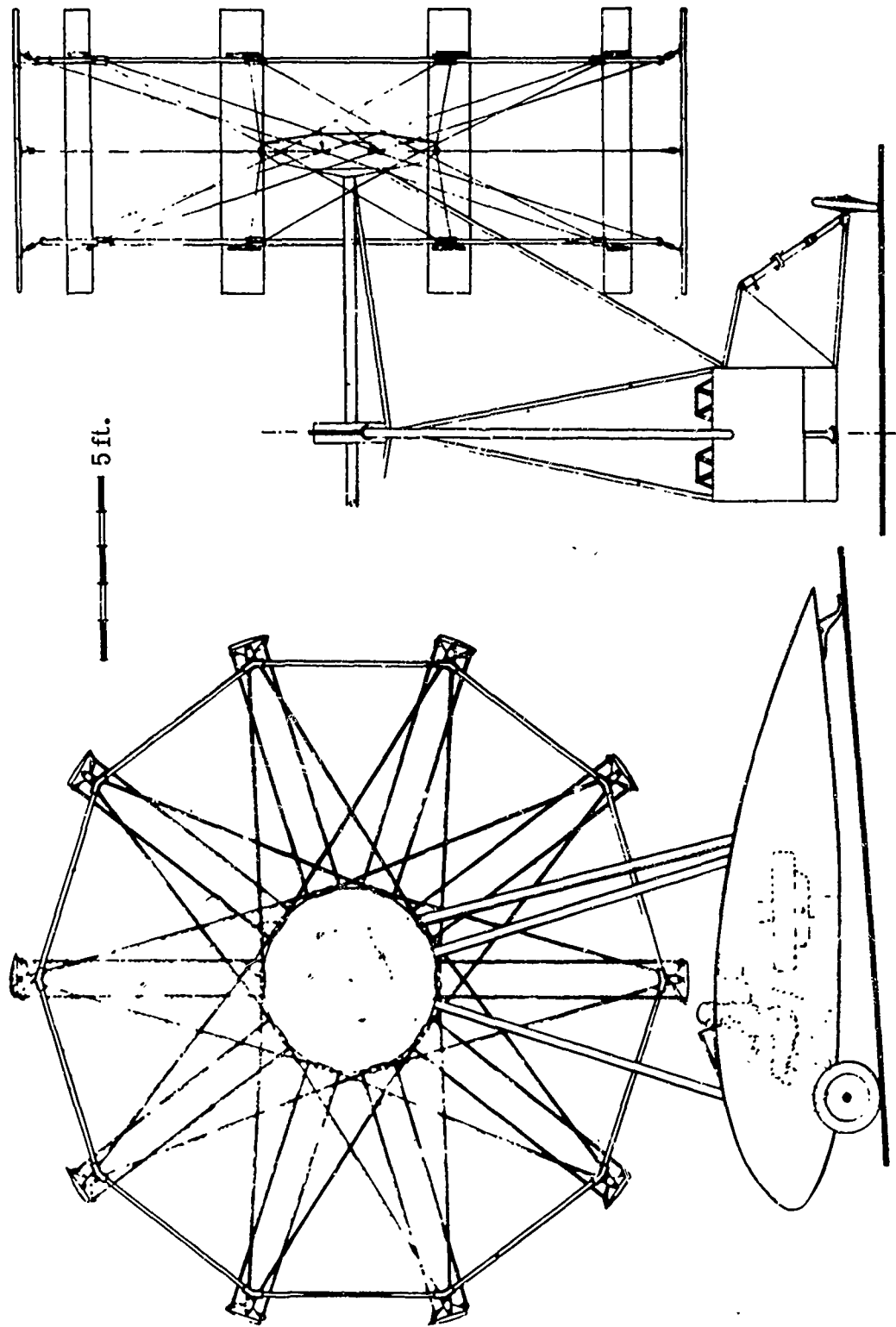
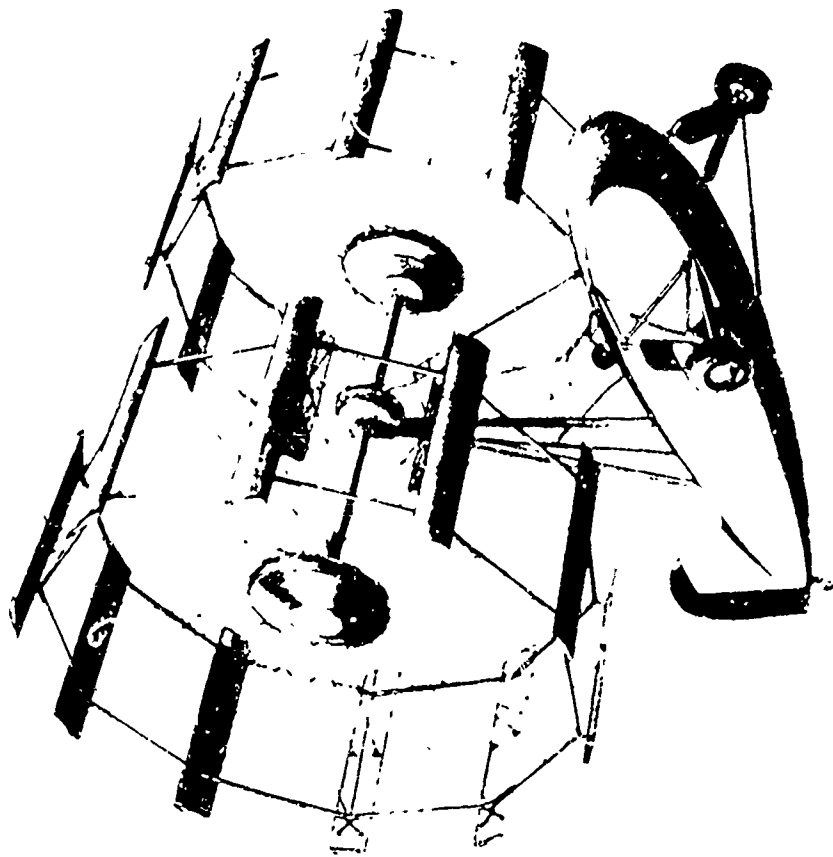

Figure 70. Two Views of the Strandgren Project (1932) Showing Method of Generating Lightweight Spoked Rotor Wheel System. See Ref. 122S.



72. Full-Size 19.6-Ft.-Dia. Strandgren Low-Pitch Cyclogiro Wheel on Test Stand at Lioré et Olivier Co. (1933). Functional and Static Lift Test. See Refs. 119S Through 135S.



71. Artist's Impression of the Strandgren Low-Pitch Cyclogiro in Flight.



Figure 73. NACA (1934) Low-Pitch Cyclogiro Model in the Langley 20-Foot Wind Tunnel. 8-Foot Diameter, 8-Foot Span. See Ref. 28W.

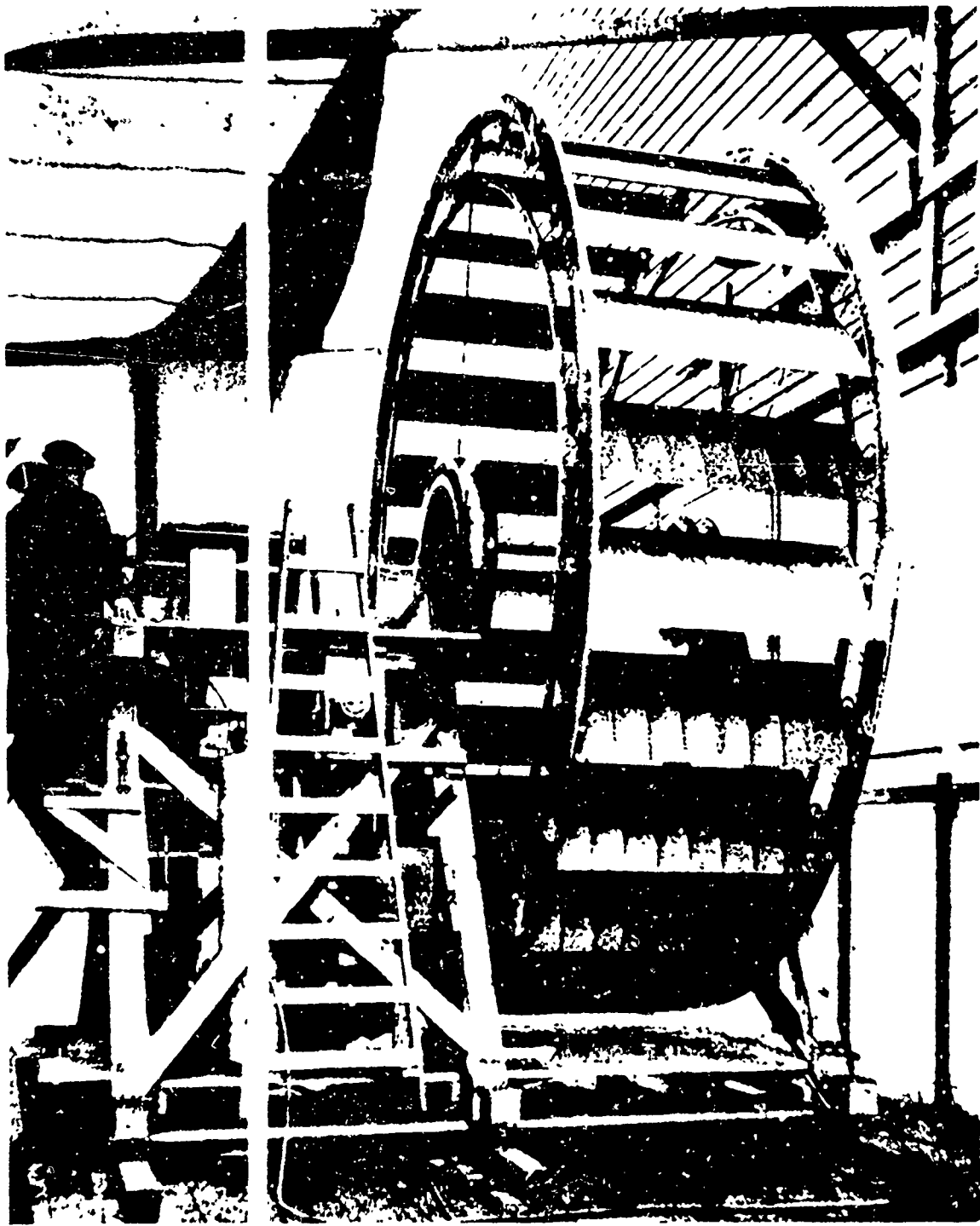

Figure 74. 15-Foot-Diameter Kirsten-University of Washington
Pi-Pitch Cyclogiro Wheel. Designed and Constructed
During 1922. Number of Blades Variable up to 24.
See Ref. 24K.

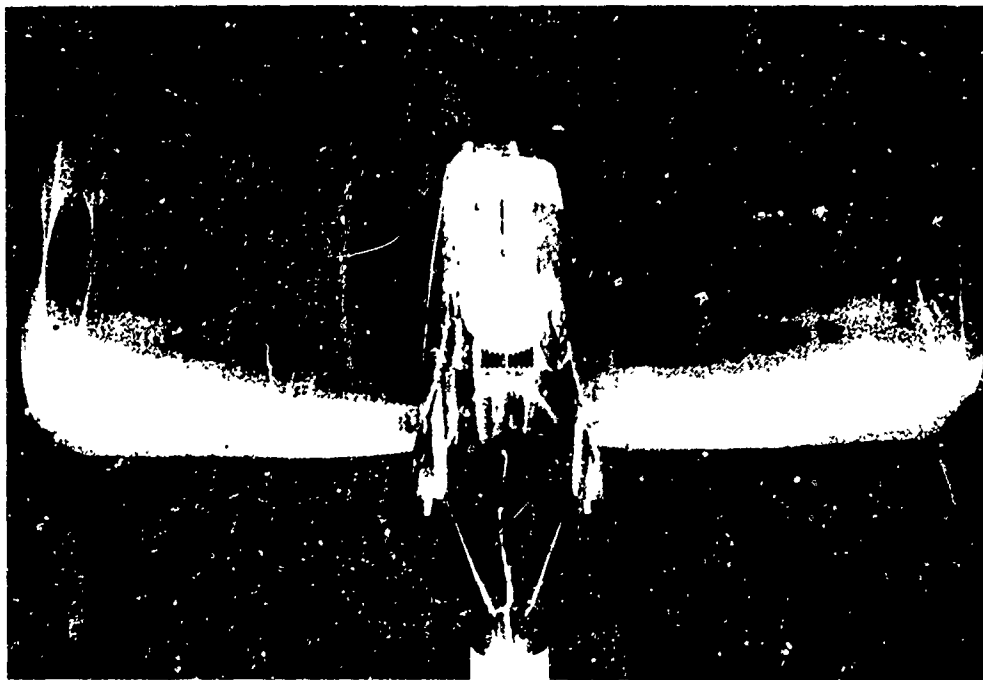
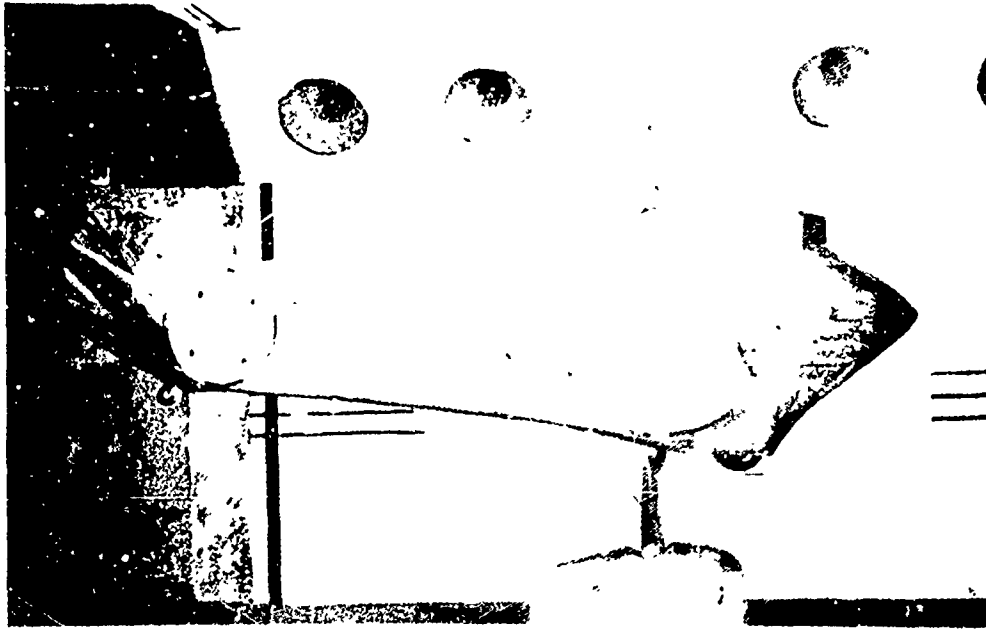

Figure 75. Kirsten-University of Washington Pi-Pitch Cyclogiro Model in Wind Tunnel. Built Before 1934 and Tested in a Variety of Configurations With and Without Tail Rotor. See Fig. 102 for Comparative Tunnel Installations. Also See Ref. 27K.

high-pitch cyclogiro wind tunnel model rotor is shown in Figures 76 and 77. The corresponding overall design is shown in Figure 78.

The U. S. Army Air Forces, during World War II, recognized the potential advantages of the cyclogiro aircraft (Reference 4H, for example) and supported work with Kirsten and Eastman. The result was a proposed fighter, shown in Figure 59.

Several investigators have recognized the advantages of the cyclogiro in low-speed flight and the corresponding disadvantage of a relatively high drag at high speed, and they have proposed to stop the rotors in high speed; this approach is shown in Figure 79, in a Wiessler 1950 patent. This is not necessarily the best approach, as Kirsten claimed on his high-pitch model that it was not desirable to stop the rotor at high speed, but only to slow it down.

In the 1960's, there has been no known active effort on cyclogiros, except for one inventor: Dave Cook. Cook was able to do limited static testing at Boeing-Wichita around 1959 (Figure 80). His latest proposed design is shown in Figure 81. Like Moineau (Figure 64), Cook chooses to have the axis of the rotor in the direction of flight.

3. Configuration

The cyclogiro rotor applied to an aircraft rotates about a horizontal axis. Despite the recurrent patent and proposal suggestions to the contrary, the arrangement of the rotor axis perpendicular to the fuselage in a spanwise direction appears to be the most adaptable and natural geometry. Those cyclogiro rotor arrangements with the rotor and blade axis parallel to the fuselage and general direction of flight introduce the very large aerodynamic problem of an additional spanwise airflow component due to forward-flight speed, and the problem of providing an independent forward propulsion. The only obvious advantage to such an arrangement would possibly be structural; that is, the rotor could be supported at both its root and its tip as suggested by Moineau (Figure 64). The discussions that follow will consider only the spanwise orientation of the cyclogiro rotor axis.

The rotor blades will also be considered to be revolving in a parallel manner about the rotor axis, and thus the longitudinal axes of the blades sweep out the surface of a right cylinder in hover. There are many suggestions for configurations in which the blade describes a conical surface, the vertex of the cone being located at the fuselage and the inboard end of the rotor system. Such an arrangement, as suggested by Richard (References 30R, 32R, 33R) and by Piskorsch (Figure 82, References 16P through 19P), would allow the rotor blade roots, feathering system, and transmission to be collected and unified at the focus of the rotor cone (Figure 83). The conical rotor system is not without aerodynamic interest, and

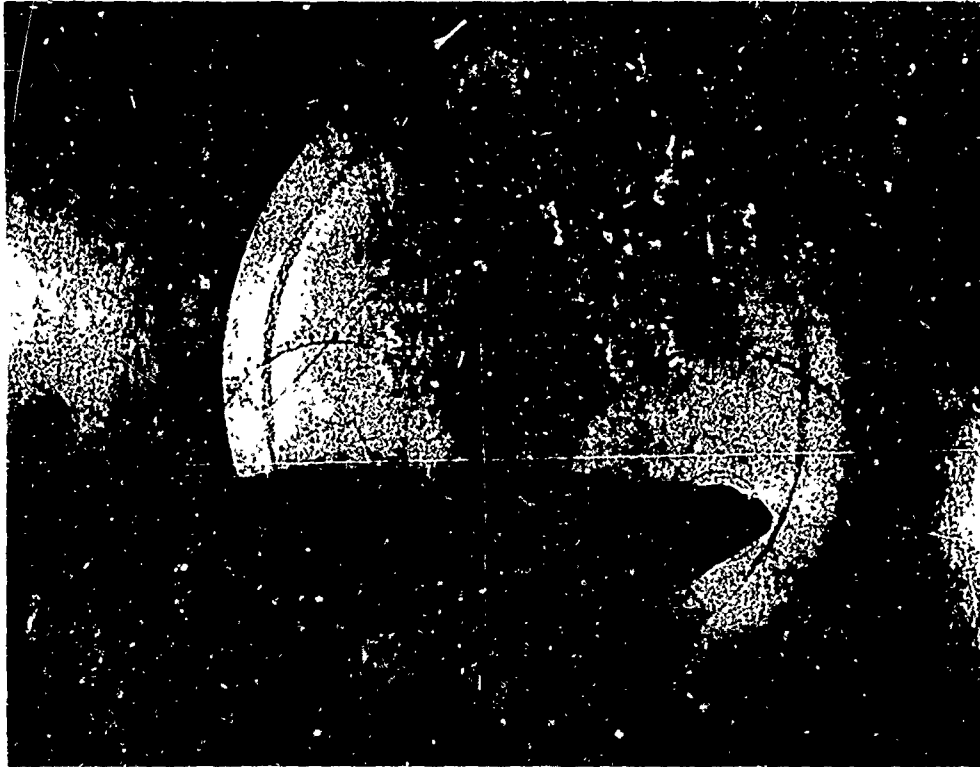
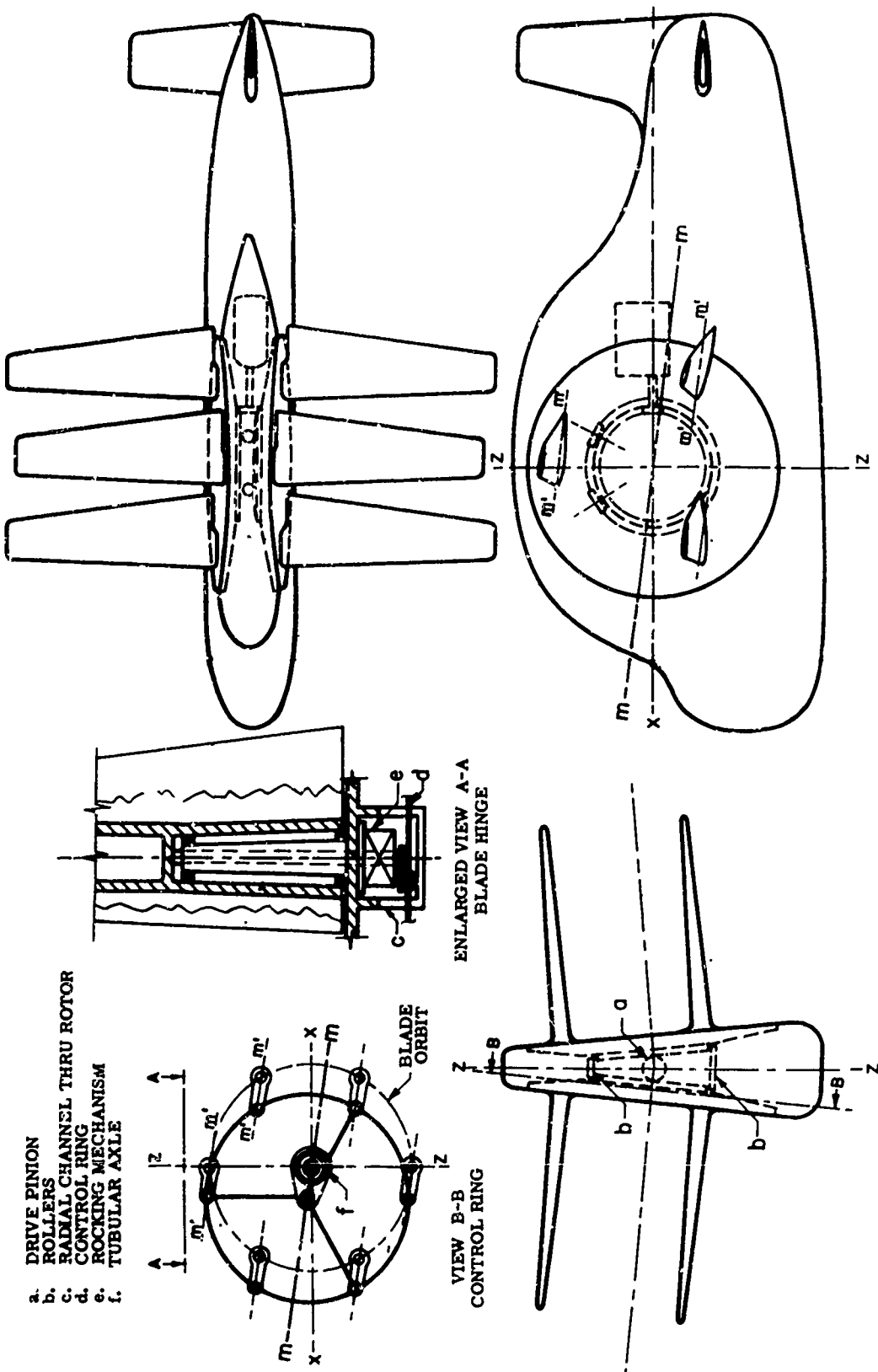

Figure 76. University of Washington Amplified High-Pitch Cyclogiro Wind Tunnel Rotor. Dia. = 3 Ft.



Figure 77. University of Washington Amplified High-Pitch Cyclogiro Wind Tunnel Rotor Blade. See Ref. 8B.



- a. DRIVE PINION
- b. ROLLERS
- c. RADIAL CHANNEL THRU ROTOR
- d. CONTROL RING
- e. ROCKING MECHANISM
- f. TUBULAR AXLE

Figure 78. Hypothetical Full-Feathering Cyclogiro and Pitch Change Mechanism. Rotor System as Shown Tested in University of Washington Wind Tunnel. See Eastman, Ref. 2E.

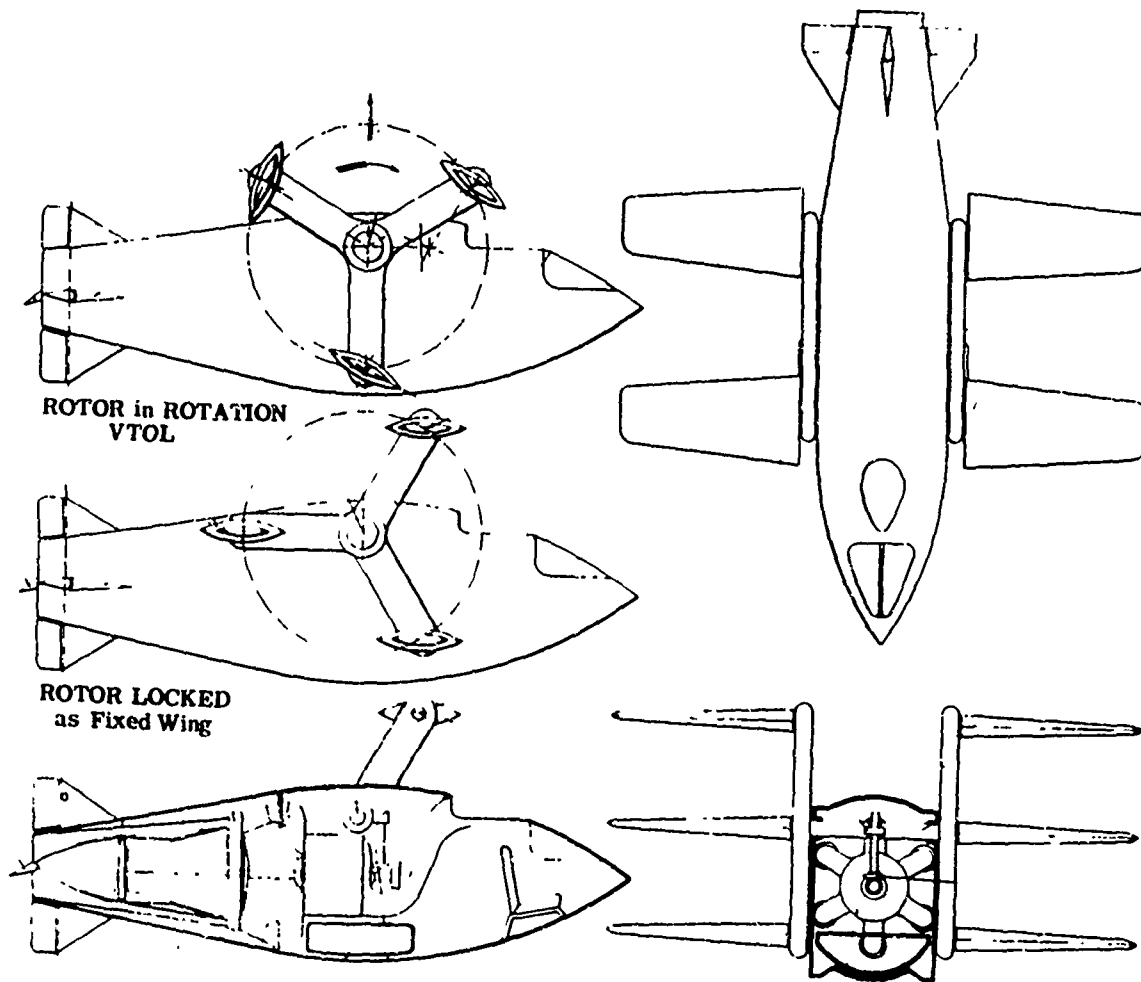

Figure 79. Wiessler Patent (1950) for a Convertible and Compound Cyclogiro in Which the Rotor May Be Stopped in Flight. Patent Further Describes Conversion of Turbine Means To Produce Shaft Power or Jet Thrust. See Ref. 31W.

CYCLODYNE VTOL
HIGH SPEED SYSTEM

Typical Small Military
Close Support, Counter
Insurgency Utility
Cyclodyne

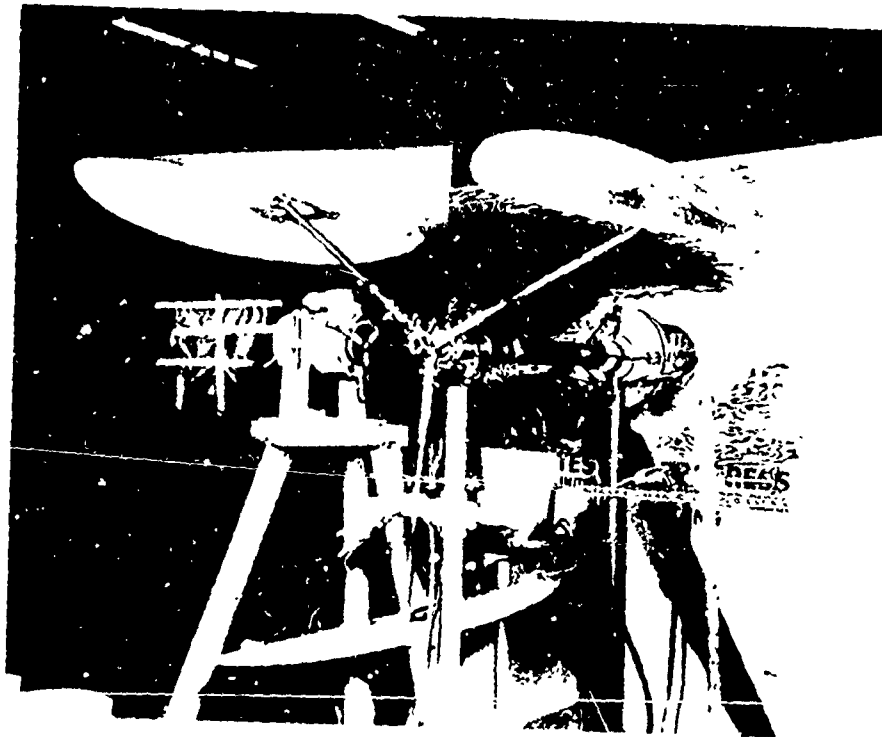
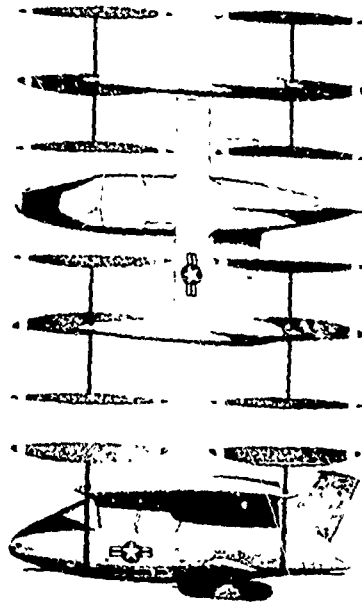
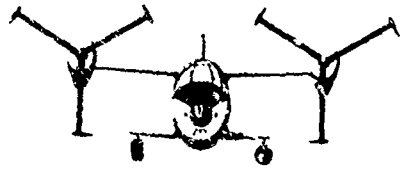

Figure 80. Cook "Cyclodyne" Project (1958-1968) Pictorial Presentation and Vibration Test Arrangement of Three-Bladed Wind Tunnel Model. Rotor Dia. 4 Ft., Span 4 Ft.

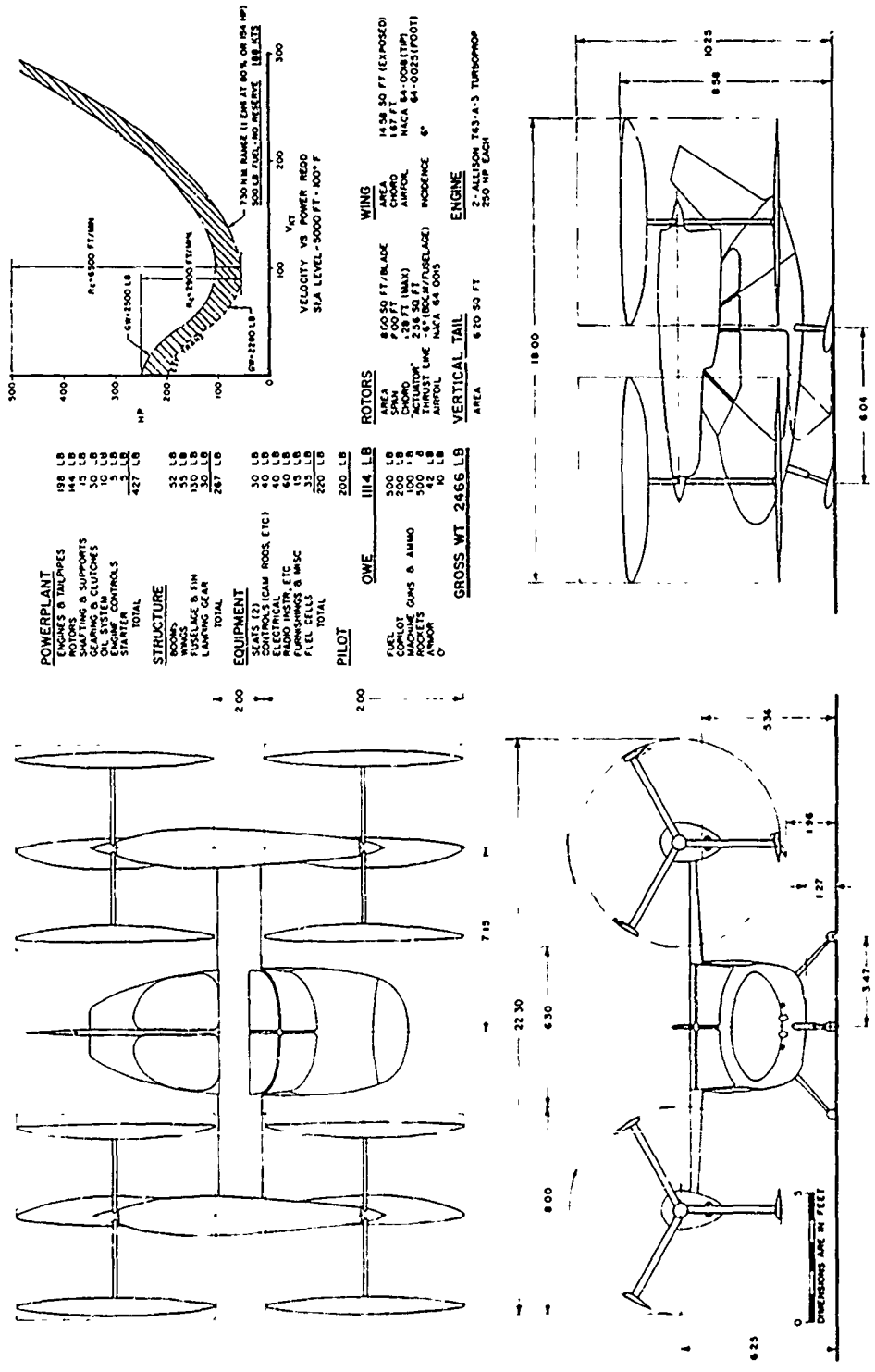

Figure 81. Cook "Cyclodyne" Project (1958-1968). Three Views. Weight Breakdown and Estimated Performance.



Figure 82. Cyclogiro With Conical Rotor. See Ref. 19P.

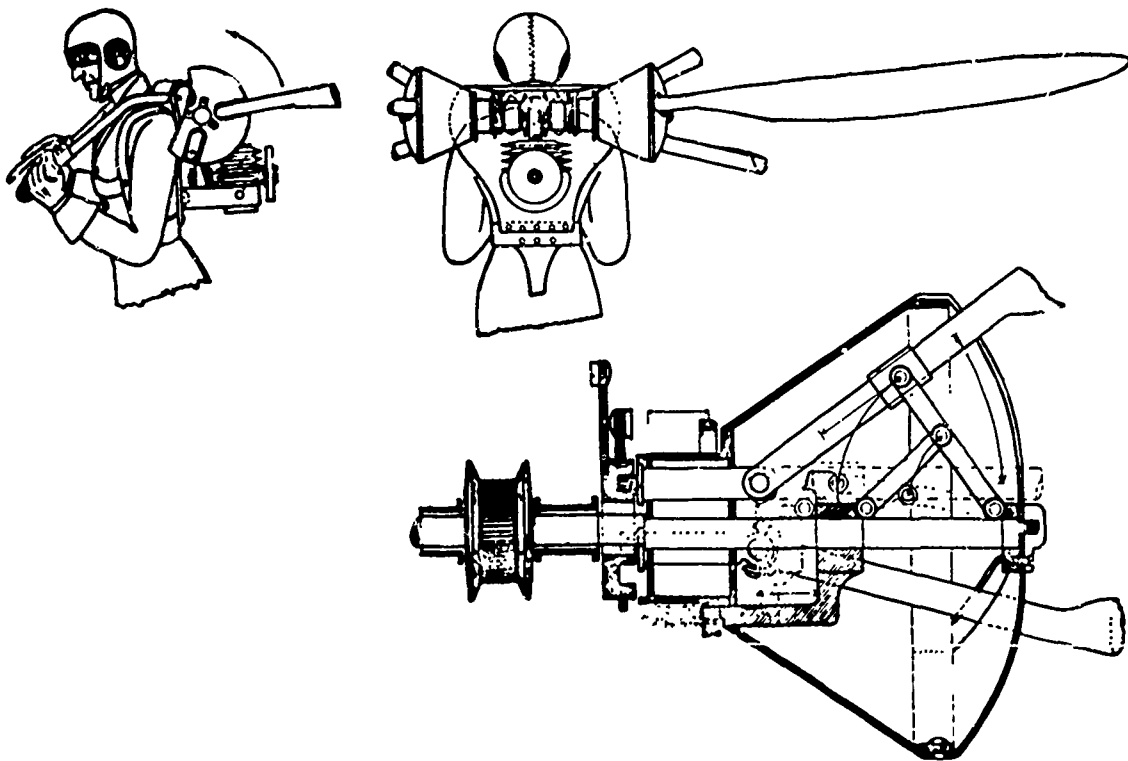

Figure 83. Conical Rotor Cyclogiro Reflecting Compactness See Ref. 15B.

it would be premature to discount its merits, especially when one considers the evolutionary flight excellence of insects, which do quite well with exactly this form of cyclogiro geometry.

The number of rotor systems per aircraft installation is dependent upon several considerations. Rotor torque compensation, though not as serious a problem as in the helicopter, must be reckoned with. The method suggested most often for torque compensation is to place the aircraft center of gravity sufficiently below the rotor axis so that the reaction couple between the rotor lift and aircraft weight (Figure 84) will cause the craft to seek an offset equilibrium trim position. The trim will pitch the aircraft either nosedown or -up depending upon the direction of rotation of the rotor. At first glance, it seems that the nosedown arrangement (A) would be desirable, as this also directs the rotor rotation in a suitable "Magnus effect" direction. Stability considerations might favor scheme (B), as the advancing blade of the rotor at forward speed would be passing over and through the upper rotor quadrant. Other aerodynamic drag forces on the rotor, upper structure, and fuselage, as well as trim forces originating in a horizontal stabilizer, may modify this general discussion.

Other means of torque balance have been tested by having the opposite concentric pair of rotor systems rotate in opposite directions; that is, the port rotor would rotate counter to the starboard rotor. Such is the case of the University of Washington cyclogiro of Figure 78. Such an arrangement allows the rotor system to be made more integral with the fuselage.

A third suggested means of absorbing the rotor torque is in the use of a fore and aft pair of rotors rotating in opposite directions (Figure 84C). This configuration is analogous to the tandem helicopter. This arrangement also offers the advantage of increasing the overall total rotor disc (cylinder) area by keeping the rotor span short and distributing the area over four rotors. There is a suggestion from marine cycloidal propeller practice that the gap area between the fore and aft rotors may partially contribute to the overall momentum "disc" area (see page 138 and Reference 30K).

4. Kinematic Discussion of Cycloidal and Trochoidal Motion

In forward flight, the path followed by the longitudinal axis of any single cyclogiro rotor blade closely approximates a cycloid or a trochoid. It is therefore useful to review first the kinematics of cycloidal and trochoidal motion.

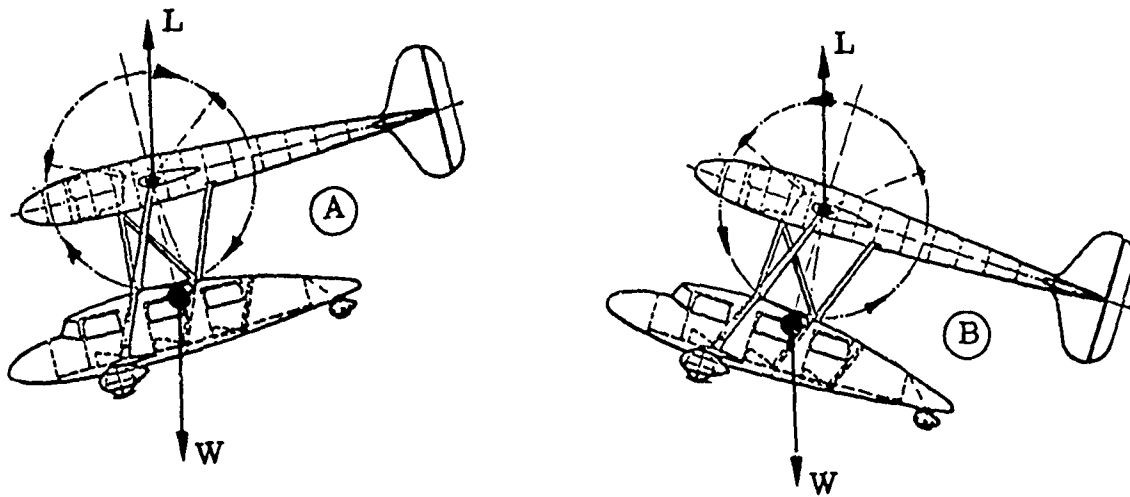

A and B - Single Rotor, Concurrent Rotation.

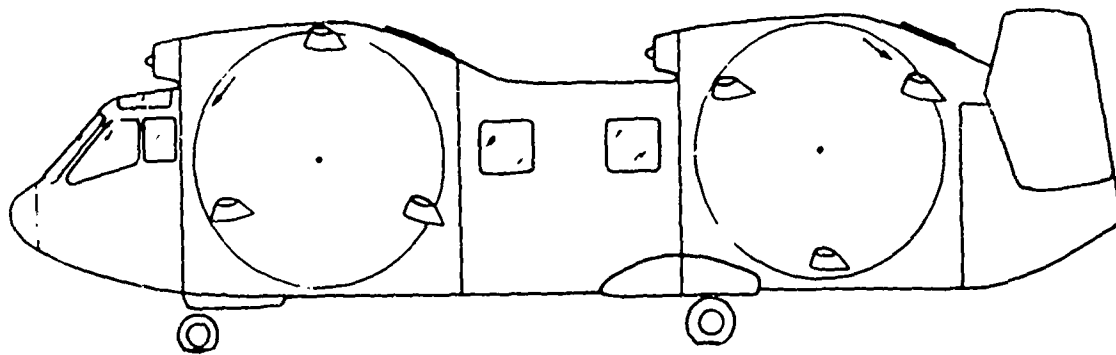

C - Tandem Fore and Aft Rotors, Opposite Rotation.

Figure 84. Cyclogiro Rotor Torque Compensation Methods.

Consider (Figure 85) a circle of radius b rolling without slipping along a straight line. Any point P on the circumference of the circle describes a cycloid. Any point on a radius of the rolling circle, at a distance e from the center, describes a trochoid. If $e > b$, it is a curtate trochoid, also sometimes incorrectly referred to as a "curtate cycloid"; if $e < b$, it is a prolate trochoid, also labelled a "prolate cycloid". When $e = 0$, this corresponds to the center of the rolling circle, the trajectory of which is obviously a straight line.

The equation of the trochoid may be established in a straightforward manner and is given, for example, in Marks' Handbook. Taking the origin of coordinates, as shown in Figure 85, at the upper point on the trochoid, defining a system of rectangular coordinates Ox, Oy as shown, and calling ψ the angle by which the generating circle has turned from the initial position, the parametric representation of the trochoid is

$$\begin{aligned}x &= b \psi + e \sin \psi \\y &= b + e \cos \psi\end{aligned}$$

Values of ψ are shown on the trajectories of Figure 85. The tangent at any point is given by

$$\frac{dy}{dx} = - \frac{e \sin \psi}{b + e \cos \psi} = - \frac{\sin \psi}{b/e + \cos \psi}$$

To understand the passage from the geometrical problem of the trochoid to the aerodynamic problem of the cyclogiro rotor, consider the sketch of Figure 86. Though it represents the special case of a cycloidal propeller with thrust in the x direction only, it will suffice for the time being. The general case in which both thrust and lift (in the y direction) are considered will be presented later.

The same point P , shown in Figure 85, revolves in Figure 86 in a circular orbit having a radius e and a center at O . This corresponds to the relative motion of the cyclogiro rotor with respect to the aircraft's fuselage. The coordinate system is shown in the same direction as in Figure 85 (Ox positive to the left). The orbit of P moves through a fluid with a velocity V directed in the negative direction along the x axis, i. e., toward the right. The velocity V corresponds to that of the rolling circle of Figure 85. Thus, the trajectory of point P in space is a cycloid or a trochoid. The case shown in Figure 86 corresponds to a curtate trochoid.

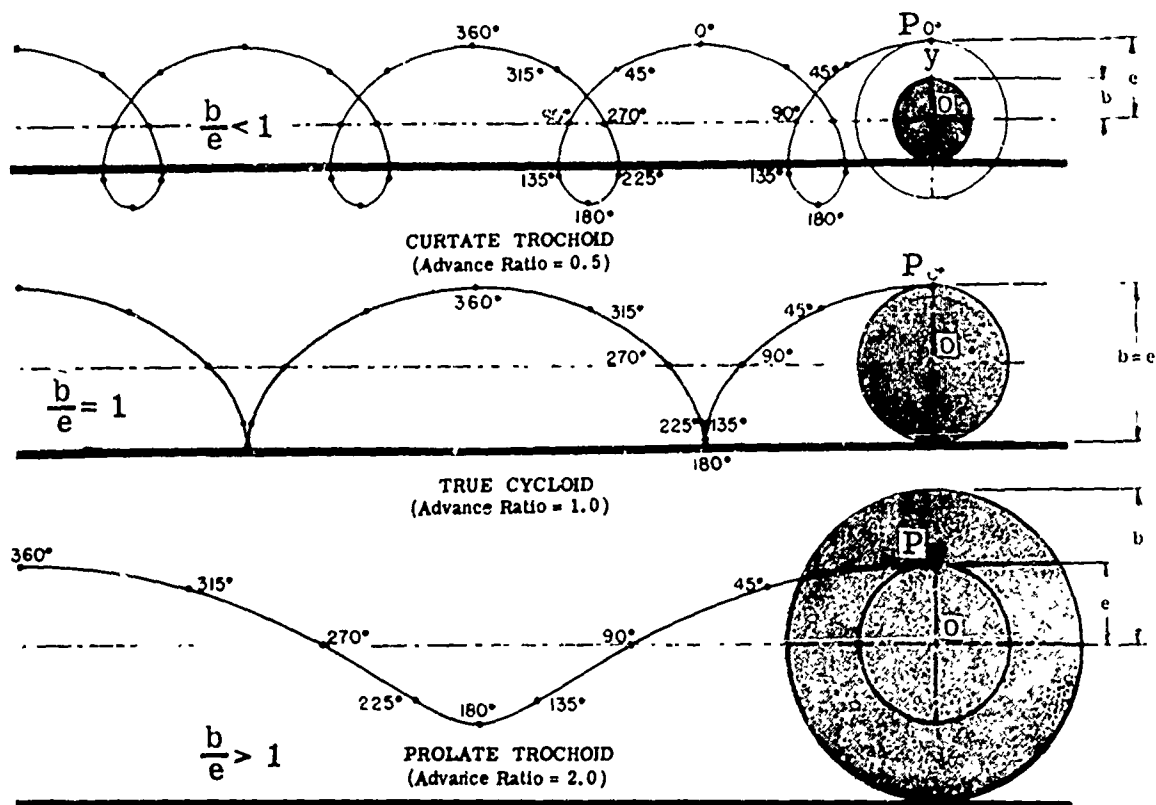

Figure 85. Kinematic Representation of Cycloidal and Trochoidal Motion. Numbers Show Angle thru which Generating Circle has Rotated.

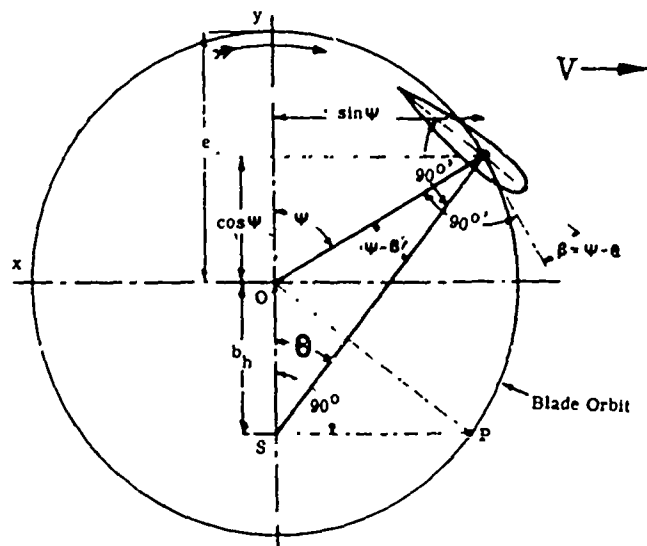

Figure 86. Geometrical Representation of Curtate Trochoidal Motion for a Cycloidal Propeller With Thrust and No Lift.

For a conventional axial propeller, pitch is defined as the linear advance along the axis of rotation in one revolution, and pitch ratio is defined as the ratio of the pitch to the propeller diameter. This definition is extended to the cycloidal propeller or rotor. The pitch ratio is thus defined as the ratio of the advance per revolution (of point P) at zero slip to the diameter $2e$ of the orbit. Calling the pitch ratio p , one has

$$p = \pi \frac{b}{e}$$

For a curtate trochoidal trajectory, $p < \pi$. This is called low-pitch motion. For a cycloidal trajectory, $p = \pi$. This is called pi-pitch motion. For a prolate trochoidal trajectory, $p > \pi$. This is called high-pitch motion.

The definition of the advance ratio (j) of a cyclogiro rotor is also similar to the corresponding definition for an axial propeller. It is the ratio of the speed of advance V of the orbit to the circumferential speed of point P. The velocity V should be based on local air; therefore, it may not be exactly equal to the forward velocity of the aircraft. A slipstream correction factor may be required. However, for normal flight conditions, the velocity V is assumed to be steady and uniform throughout the rotor cylinder.

If n is the speed of rotation of the rotor, in revolutions per second, the circumferential speed of point P is πnD , where $D = 2e$.

Hence,

$$j = \frac{V}{\pi nD}$$

When a cyclogiro blade such as that shown in Figure 86 rotates about O in a circular orbit which itself translates with a velocity V , aerodynamic forces originate on the blade, and these forces have a resultant which usually is not zero. Two special cases are when the resultant is horizontal, in which case the rotor acts as a thrusting device, and when the resultant is vertical, in which case the rotor is a lifting device. In the general case, the cyclogiro rotor has both a lifting and a thrusting component, the magnitude of which depends upon the prescribed rocking motion of the blade about its feathering axis P.

Figure 86 exemplifies low-pitch curtate trochoidal motion for a purely thrusting rotor. The general case, in which both lift and thrust resultant forces exist, is shown in Figure 87. Note that, in Figure 87, the orbital motion is counterclockwise, while it was chosen clockwise for Figure 86, to agree with the direction of rotation of Figure 85. Both Figures 86 and 87 will be used to explain rocking motion.

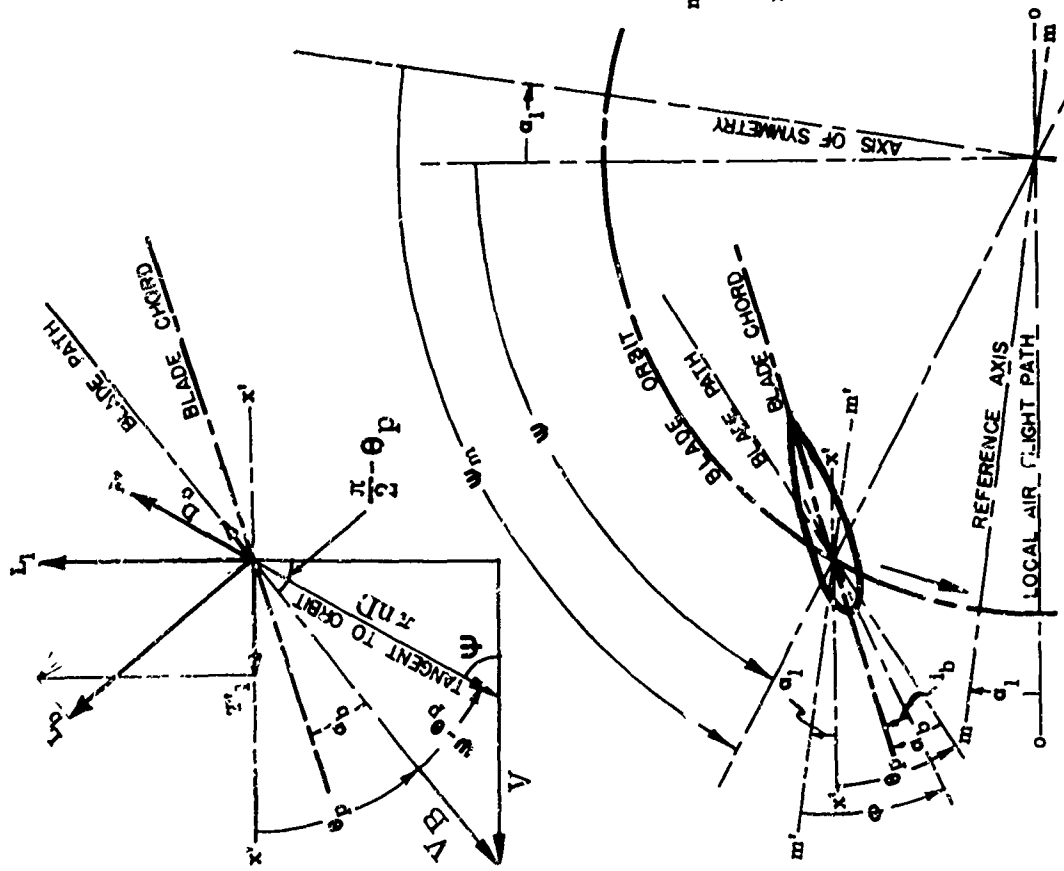

Where:

- D_0 = Blade Drag Parallel to Blade Path.
- F = Blade Force Tangent to Orbit.
- L_b = Blade Lift Perpendicular to Blade Path.
- L_1 = Mean Lift Perpendicular to Local Air Flight Path.
- T_1 = Mean Thrust Parallel to Local Air Flight Path.
- i_b = Incidence Angle Determined by Orientation on Control Shaft.
- o_b = Rotor Blade Angle of Attack in Local Air.
- o_1 = Rotor Angle of Attack Relative to Local Air.
- θ_p = Inclination of Blade Path to the Local Air Flight Path.
- ϕ = Blade Angle as Introduced by the Rocking Mechanism.
- ψ = Orbit or Phase Angle for θ_p .
- ψ_m = Orbit or Phase Angle for ϕ .

Axes:

- $m - m$ = Reference Axis Through Rotor Center.
- $m' - m'$ = Reference Axis Parallel to $m - m$.
- $o - o$ = Local Air Flight Path.
- $x' - x'$ = Local Air Flight Path other than Passing through Rotor Center.

Figure 87. Cyclogiro Blade Angle Diagram and Resolution of Blade Forces.

If only a thrust force is desired, the blade orientation is easy to determine, as shown in Figure 88. The upper sketch corresponds to the curtate cycloidal propeller blade setting. Six positions of the blade are shown, both as seen from the fuselage or as seen in their spatial motion. All lines normal to the blade chord at the rotational axis of the blades meet in a common point within the orbit, a distance b from the propeller center. The blades in this configuration oscillate but do not rotate about their axes. However, with respect to the vehicle to which the propeller is attached, the blades make a full revolution, though at variable speed, while the propeller makes one revolution at constant speed. By tracing a blade on its path through a cycle, it is observed that the leading edge always remains the leading edge. By moving the point of convergence of the normals to the blade chords along the vertical axis of symmetry inside the orbit circle, the propeller can operate along any curtate cycloidal path.

The middle sketch of Figure 88 shows that, for pure cycloidal motion of a thrusting propeller, the blade chord must always be normal to a line passing through point 4 and the rotative axis of the blade. The leading edge of the blade becomes the trailing edge every other propeller revolution. The condition of tangency of the blade is easily achieved by giving the blade a rotation about its center axis of one-half the rotational speed of the blade orbit.

The lower sketch of Figure 88 shows the blade settings for prolate cycloidal propellers. All lines normal to the blade chords converge in a point on the axis of symmetry outside the blade orbit of radius e , at a distance b from its center. It can be noted that the blades make one full revolution, though at variable speed, while the propeller makes one revolution at constant speed. However, the blades oscillate only with respect to the vehicle to which the propeller is attached.

A cyclogiro rotor, of which the cycloidal propeller discussed above is a special case, may thus be defined as a mechanism, the blade chords of which are tangent to a cycloidal or trochoidal curve at zero slip in all positions of their orbital travel.

Cyclogiro rotor usefulness would be greatly enhanced if the rotors could be designed so that a complete pitch-ratio variation of from 0 to ∞ could be obtained by a simple mechanism, or by any mechanism at all. It has been shown that low pitch or pi-pitch is desirable for hover and low-speed flight and that high pitch is essential for high-speed aircraft flight. As will be seen later, Eastman and Heuver have proposed mechanisms that cover certain ranges of both low pitch and high pitch and that can convert from one to the other in flight. However, there are two factors that militate against the universal pitch system: (1) for the pure cycloid, a blade profile with leading and trailing edge symmetrical about the 50-percent station, is an absolute requirement, whereas for the curtate and prolate cycloid, a streamlined blade seems to be

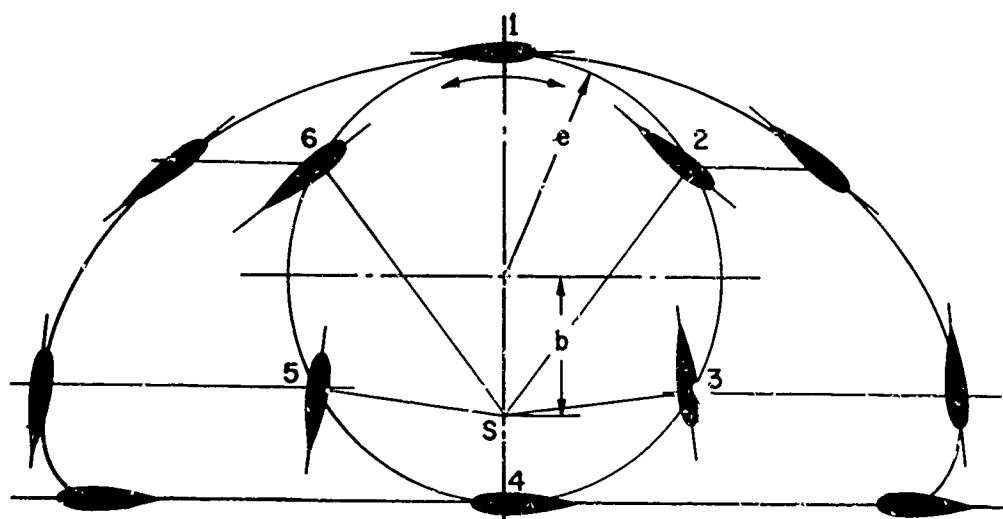

CURTATE CYCLOID
(Low-Pitch System)

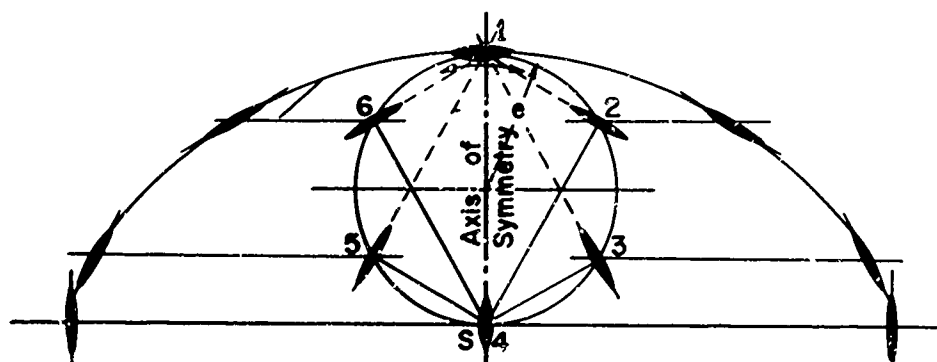

BASIC CYCLOID
(Pi-PITCH System)

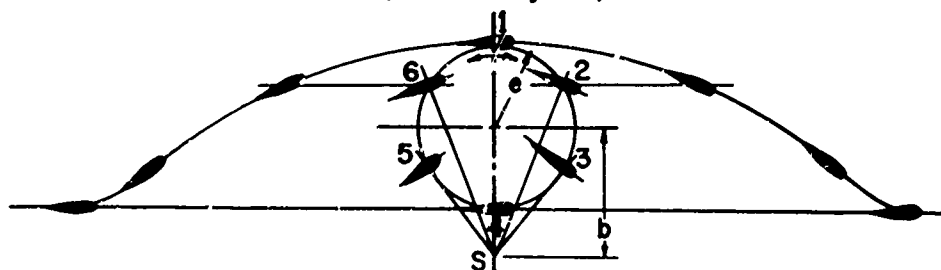

PROLATE CYCLOID
(High-Pitch System)

Figure 88. Ideal Path Trajectories of Cyclogiro Rotor Blade for a Full Range of Pitch Ratio Systems, for a Thrusting Propeller.

desirable for good efficiency; (2) the high acceleration forces required for both the curtate and prolate ranges in the close proximity where b/e approaches unity prevent a close approach to the pure cycloid. Only the ranges of pitch ratios from 0 to 0.8π and from 1.2π to ∞ can be covered by safe mechanical means.

From an observation of Figures 86 and 88, it is concluded that thrust control of a cyclogiro rotor is achieved by blade pitch changes, obtained themselves by moving, by the proper mechanical linkage, point S of Figures 86 and 88 up and down.

It is interesting to compare the pitch-change mechanisms for the conventional propeller and for the cycloidal propeller. The pitch changes in cycloidal propellers are brought about by mechanically varying the eccentricity of the blade control mechanisms. The entire cycloidal blade--from its tip to the base--is thereby realigned to follow a new cycloidal path. The mechanisms of variable-pitch screws also turn the entire blade--from tip to base--so that each blade element receives the same amount of angular displacement. However, since every blade element of the screw follows a different helix, the angular displacement of each blade element should be different for every pitch adjustment and should vary from zero at the propeller center to a maximum at the tip. Such a variation of angle would be possible if the blade could be mechanically distorted by twisting, but not by turning it about its base. The mechanical difficulties of creating a blade twist are quite apparent. If the variable-pitch screw is designed for a certain fixed pitch and this pitch is increased by turning the blade in its socket, the blade loading shifts toward the blade tip for low-pitch screws and a small angular turn of the blades. For high-pitch propellers and large angles of blade turn, the converse is true; namely, the blade loading shifts toward the propeller center. Hence, the accommodation of the variable-pitch screw from normal pitch to a different pitch setting is accomplished at the expense of efficiency. The problem is particularly severe for a convertible aircraft of the tilt-rotor type, as is well known. Here, the cyclogiro rotor presents an enormous conceptual advantage.

5. Analysis of Cyclogiro Blade-Rocking Motion

The purpose of the rocking motion is to keep the blades properly aligned with the airstream throughout their wave-shaped paths. The type of rocking motion that permits the blade to maintain constant angle of attack along a chosen path is called ideal motion. For practical reasons, i. e., to reduce blade accelerations in the critical portions of the orbit, it may be expedient to digress from ideal motion into what is referred to as "amplified motion". Both ideal and amplified motion will be discussed here.

Consider the blade angle diagram of Figure 87. However, the diagram of Figure 86, though covering a more restrictive

case, is equivalent and could be used.

The angle of inclination of the blade path, Θ_p , can be calculated from the velocity triangle, in the upper left corner of Figure 87:

$$\tan\left(\frac{\pi}{2} - \Theta_p\right) = \frac{V + \pi nD \cos \psi}{\pi nD \sin \psi}$$

or

$$\tan \Theta_p = \frac{\sin \psi}{j + \cos \psi}$$

$$\Theta_p = \tan^{-1} \frac{\sin \psi}{j + \cos \psi}$$

The variation of Θ_p with ψ (ideal motion), for various values of the advance ratio j , is plotted as the solid lines of Figure 89.

When $j > 1$ (shown as $1/j < 1$ on Figure 89), the curves oscillate about the zero axis; but when $j < 1$, they oscillate about a 45-degree axis. The type of oscillation is identical in the two cases, since Θ_p determined for a given value of $1/j$ is equal to $\psi - \Theta_p$ determined for the same value of j (this is proved by Kirsten in Reference 30K). In other words, a line tangent to the blade path rocks about the rotor path if $j > 1$, but it rocks in an identical manner about the rotor structure of $j < 1$. The sudden transition from one type of rocking motion to the other leads to the sharp distinction between a high-pitch cyclogiro and a low-pitch cyclogiro. It also follows from the geometrical definition of the trochoid, in Figure 85. The high-pitch machine is suitable for high advance ratios because its blades rock relative to the fuselage, but the low-pitch machine is limited to low advance ratios because its blades rock relative to the rotor structure, as seen previously.

A study of Figure 89 shows that, as j decreases from infinity and approaches the transition value, $j = 1$, the maximum value of Θ_p becomes larger and occurs later in the cycle. In the limit, the maximum is 90 degrees, and it occurs when $\psi = 180^\circ$. At this point, Θ_p suddenly changes 180 degrees in either the positive or the negative direction, depending upon whether or not the transition is made. Since to turn the blades 180 degrees instantly is impossible, ideal motion becomes impossible as the transition is approached. Nevertheless, as stated before, the pi-pitch propeller meets the requirement of ideal motion when $j = 1$.

Apparently, ideal motion is impossible when j is slightly less or slightly greater than one. However, since blade "effectiveness",

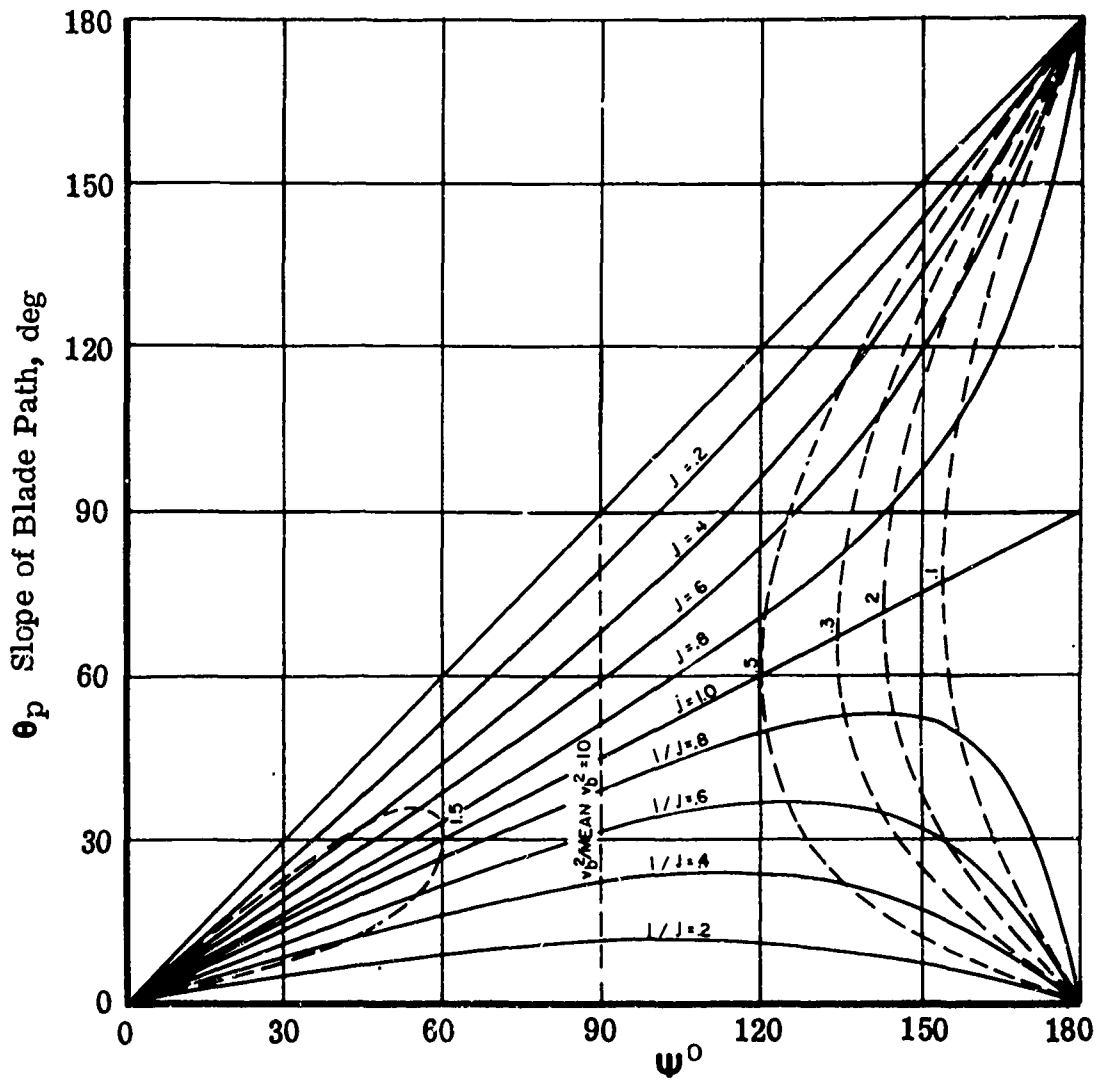

Figure 89. Orbital Variations of the Slope of the Blade Path With Variations in the Rotor Advance Ratio. Auxiliary Curves Indicate Blade Effectiveness.

i. e., the lifting ability of the blade, approaches zero at the same time that the angular acceleration becomes excessive, a distorted ideal or "amplified" motion can be substituted without appreciably affecting rotor characteristics. The reduction in effectiveness arises from the variation of the blade resultant velocity v_b throughout the orbit. Blade lift is proportional to v_b^2 , and therefore $v_b^2/\text{mean } v_b^2$ can be taken as a measure of blade effectiveness. Eastman, in Reference 2E, shows that the effectiveness is given by the equation

$$\frac{v_b^2}{\text{mean } (v_b^2)} = \frac{1 + 2j \cos \psi}{1 + j^2}$$

The dashed curves in Figure 89 are drawn through points of equal $v_b^2/\text{mean } (v_b^2)$, and the number on each curve indicates the value of the effectiveness ratio, between 0.1 and 1.5. It can be seen that greatest blade effectiveness occurs at small values of ψ and becomes very small around $\psi = 180^\circ$. With this information, a blade motion may be selected which conforms closely with the blade path throughout the effective part of the orbit, but which is distorted to reduce angular acceleration throughout the part where even a stalled blade will have little influence.

Blade angular velocity and angular acceleration can be plotted also as a function of ψ and j . However, their values will depend upon the type of blade-rocking motion.

Kirsten, in Reference 30K, calculates both for the configuration of Figure 86, i. e., the pure thrusting propeller. Eastman, in Reference 2E, notes that a simple swinging block linkage, in common use for quick-return mechanisms, will produce ideal motion. It consists of a block sliding in a slotted bar as it is moved by a crank of radius e . The axis of the crank is displaced a distance b

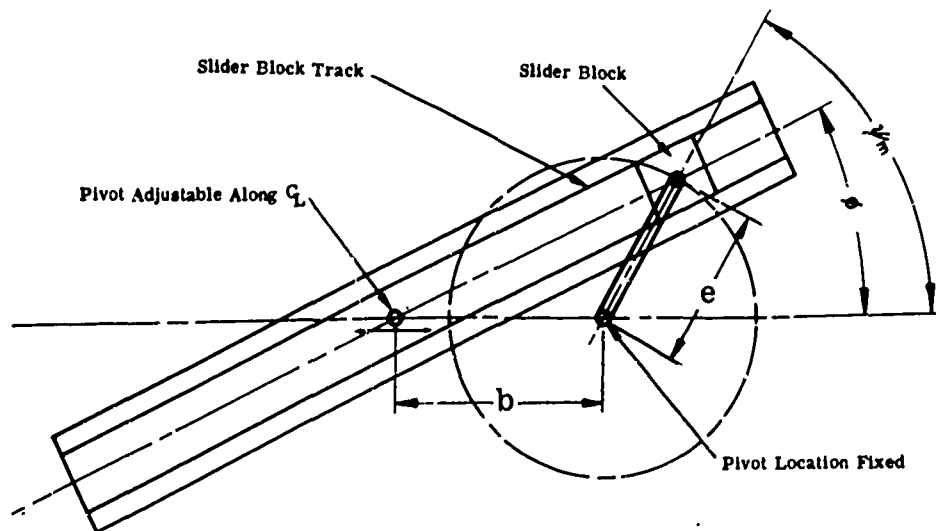

from the axis of the slotted bar. For this mechanism, one can define an ideal blade-rocking motion parameter, such as $m = b/e$. When $b > e$, the slotted bar oscillates exactly as required for ideal high-pitch motion. Similarly, $b < e$ corresponds to ideal low-pitch motion. For $b = e$, the mechanism is inoperative.

The rocking motion, being an ideal motion, is described by

$$\Phi = \tan^{-1} \frac{\sin \psi_m}{m + \cos \psi_m}$$

The angle Φ is shown in Figure 87.

The angular velocity and acceleration of the blade corresponding to the above motion are given by Kirsten and Eastman as

$$\frac{d\Phi}{dt} = 2\pi n \frac{1 + m \cos \psi_m}{1 + 2m \cos \psi_m + m^2}$$

$$\frac{d^2\Phi}{dt^2} = (2\pi n)^2 \frac{r(1-m^2) \sin \psi_m}{(1 + 2m \cos \psi_m + m^2)^2}$$

These equations are obtained by straightforward differentiation of the equation for Φ .

Angular velocity and acceleration are plotted in Figure 90. Consider first the angular velocity curves. The parameter against which they are plotted is the rocking motion parameter. This parameter replaces the advance ratio of Figure 89. As in Figure 89, there is a correspondence between a value of m corresponding to low-pitch motion and the corresponding value $1/m$ that gives high-pitch motion. Actually, the two curves are symmetrical with respect to the line $d\Phi/dt = 0.5$. From the earlier definition of the pitch ratio, it is equal to π times the rocking parameter.

An examination of the angular velocity and acceleration curves (Figure 90) reveals the large magnitude of the accelerations, for ideal motion, for m near 1, and for large values of ψ . These curves, plus the effectiveness curves of Figure 89, serve as a guide to the design of amplified-pitch mechanisms.

The limitation imposed by angular acceleration is best illustrated by comparing the maximum acceleration for ideal motion with that for harmonic motion having the same amplitude. The equations show that the maximum for ideal motion is essentially the same as for harmonic motion when m is either very small or very large, but that the acceleration increases more and more rapidly as m approaches unity. The acceleration is nearly four

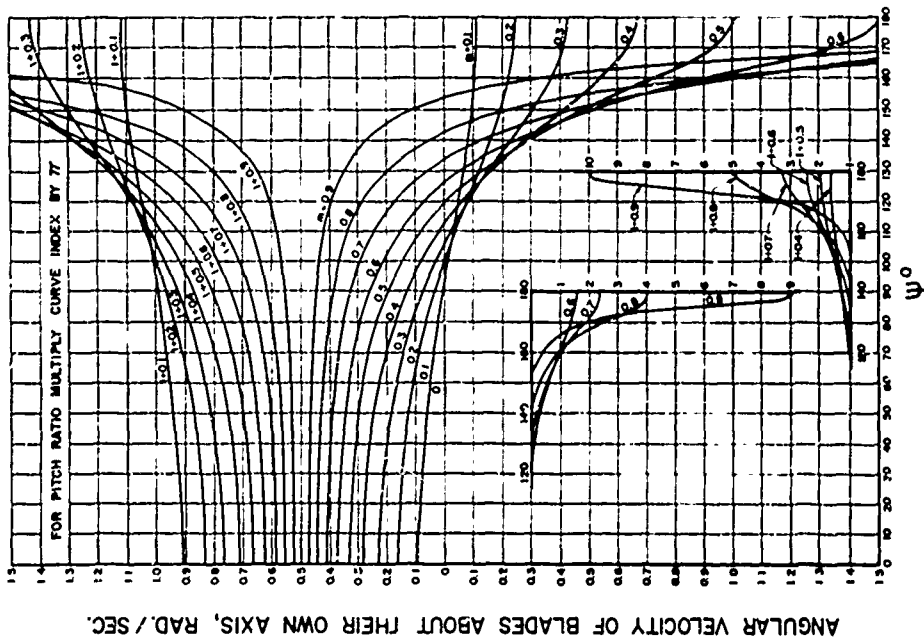
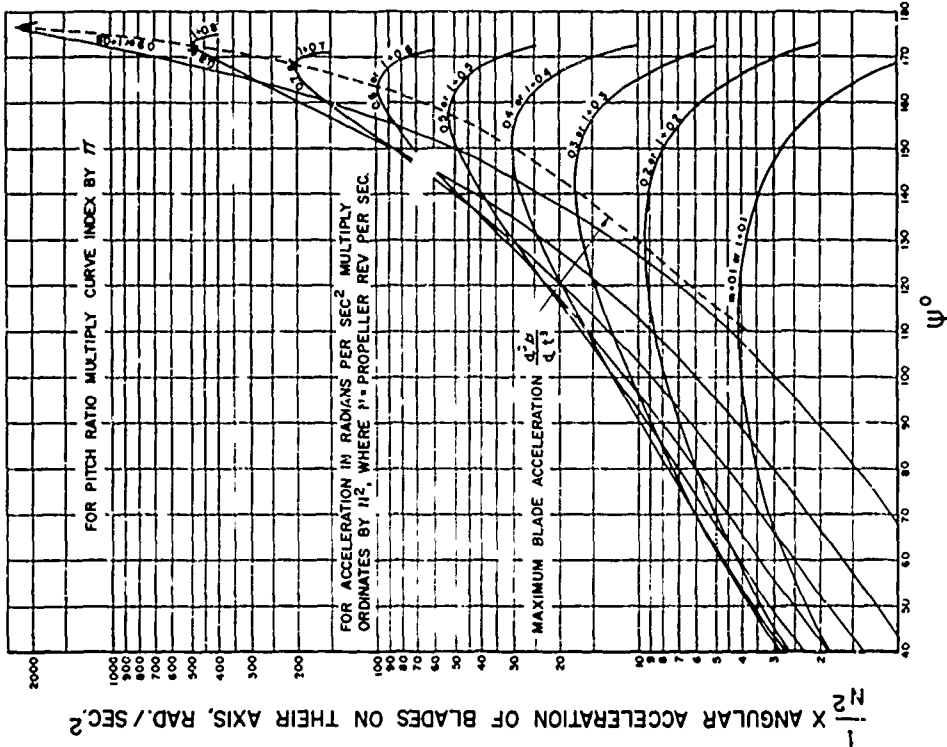

Figure 90. Angular Velocity and Acceleration of the Cyclogiro Blade About its own Feathering Axis Throughout the Rotor Orbit With Variations in the Blade Rocking Parameter.

times that for harmonic motion when m or $1/m$ becomes 0.8. This acceleration is considered to be a practical maximum value for m or $1/m$. Eastman (Reference 2E) suggests a maximum value of 0.6.

The transition from low-pitch to high-pitch motion cannot be made by changing at once from $m = 0.6$ to $1/m = 0.6$, because this would require an instantaneous change in the angular velocity of the blades. However, a distorted ideal motion can conform to the blade path for $j = 1$ throughout the effective part of the orbit without introducing excessive angular acceleration in the ineffective part. Since the blade angle for high-pitch motion will be identical to that for the low-pitch motion throughout the effective part of the orbit, transition is possible. Such a mechanism is shown schematically in Figure 78. This subject will be brought up again later.

Distortion of ideal blade motion introduces an orbital variation in pitch which corresponds in a sense to the radial variation defining the pitch distribution of a screw propeller. Following screw-propeller terminology, a reference blade angle, β , will be used. It is the angle through which the blade turns relative to the rotor structure, while ψ_m increases from 0 to 90 degrees. As for the screw, $\tan \beta$ is the advance ratio at which the blade angle of attack becomes zero at the reference position. For pure harmonic rocking motion, β is the amplitude in the low-pitch range for which the rocking is relative to the rotor structure, but it is 90 degrees minus the amplitude in the high-pitch range for which the rocking is relative to the reference axis. For ideal motion, $\beta = \tan^{-1} m$.

Preferred rocking motion will approach ideal motion throughout the effective part of the orbit, but to relieve inertia stresses it will approach constant angular acceleration throughout the ineffective part. Amplified ideal motion is a step in this direction, and it is easily obtained with gears or other means. Wind tunnel tests using this motion were made by Baker (Reference 8B). Using Φ_b for the rocking angle of the blade and using k for the amplification factor, amplified high-pitch motion is described by

$$\Phi_b = k\Phi, \quad \frac{d\Phi_b}{dt} = k \frac{d\Phi}{dt}, \quad \frac{d^2\Phi_b}{dt^2} = k \frac{d^2\Phi}{dt^2}$$

and

$$\beta = 90^\circ - k \tan^{-1} \frac{1}{m}$$

Since the mechanism must rock the blades, but not turn them through a complete revolution, m must be greater than unity.

Amplified low-pitch blade motion can be obtained by applying the same rocking motion relative to the rotor structure. In this case,

$$\Phi_b = \psi_m - k\Phi, \quad \frac{d\Phi_b}{dt} = 2\pi n - \frac{k d\Phi}{dt}, \quad \frac{d^2\Phi_b}{dt^2} = -k \frac{d^2\Phi}{dt^2}$$

and

$$\beta = k \tan^{-1} \frac{1}{m}$$

Again, m must be greater than unity.

For smooth transition, the two motions must have the same angular velocity as well as the same angular positions. This will be satisfied at $\psi_m = 0$, for $k = 1.33$. Therefore, smooth transition is possible at this point in the orbit.

The amplified motion defined by Φ_b can be approximated with the ideal motion mechanism by using an "equivalent" value of m , say, m' . Then,

$$\Phi_b = \tan^{-1} \frac{\sin \Phi_m}{m' + \cos \Phi_m}$$

Obviously, there will be a different value of m' for every position of the rotor. However, a value of m' , where $\psi_m = 90^\circ$, gives a close approximation to the actual motion. For this condition,

$$\tan^{-1} \frac{1}{m'} = K \tan^{-1} 1/m$$

Letting $\Phi' = K \tan^{-1} 1/m$, then

$$m' = \cot \Phi'$$

With $K = 1.5$ and $m = 4$, one finds $m' = 2.6$.

The curves in Figure 91 illustrate the amount of discrepancy for two different values of m when the amplification factor is 1.5. The difference is quite pronounced when the equivalent m becomes less than unity. However, the wide variation occurs in the most ineffective part of the orbit. By computing the equivalent m at a larger rotor angle, better agreement could be obtained at the larger rotor angles but the curves (of $K = 1.5$) would show much less coincidence at the smaller rotor angles in the most effective region.

The total rotor force is unsteady, owing to orbital variations in blade velocity and in angle of attack. If it is assumed that there are three blades per rotor, that ideal motion is used, and that the velocity through the rotor is uniform, the computed pulsation in lift reaches

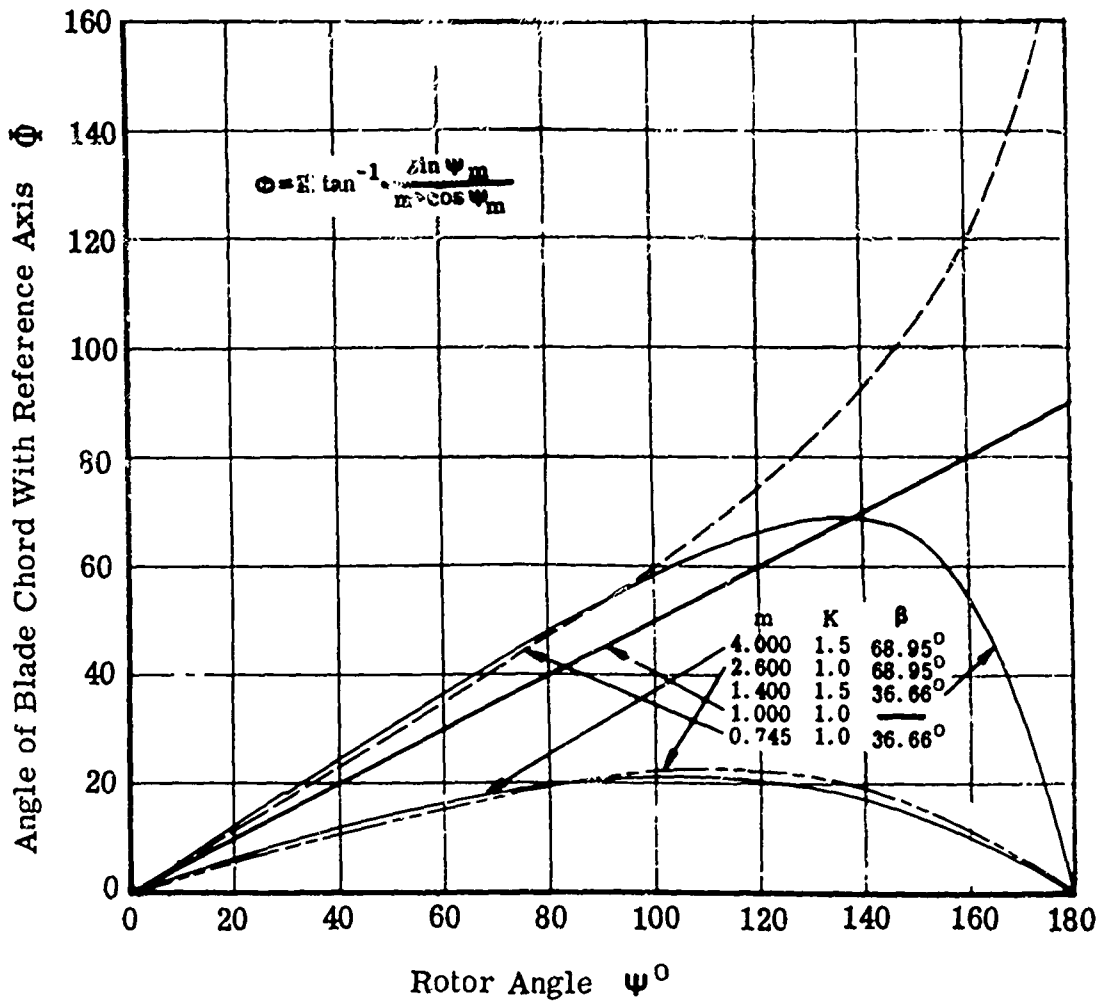

Figure 91. Cyclogiro Rotor Blade Angularity With and Without Amplification ($K \neq 1$ and $K = 1$ Respectively) and Variations in the Ideal Rocking Motion (m) (Ref. 8B).

a maximum of about 5 percent at low advance ratios and decreases to zero as the advance ratio approaches infinity. Actually, the maximum will not be attained, because low advance ratios will be employed only for near-hovering flight in which the pulsation will be subdued by prominent induced velocity. Nevertheless, Black has shown (Reference 39B) that the pulsation can be reduced or eliminated by proper choice of the blade-rocking motion. This may lead to a slightly modified ideal motion which will produce steady lift under normal flying conditions.

Preferred blade motion may be outlined as follows: Between cruising and maximum forward speed, high advance ratios will be used, and the only advantageous modification of ideal motion is that which will produce steady lift. Any other modifications will produce objectionable variations in blade load, and increased power losses. At near-hovering speed, on the other hand, low advance ratios will be used, and the blade velocity will be so low that aerodynamic loads cannot become excessive. In addition, a moderate increase in parasite power will be inconsequential, compared with the high slipstream loss, which is unavoidable at low speed. In this range, therefore, preferred rocking motion will be determined as much by the merits of the mechanism as by the slope of the blade path. The latter will be influenced by the nonuniform flow through the rotor. Nevertheless, even at low advance ratios, ideal motion establishes the pattern which should serve as a guide toward establishing the ultimate blade motion.

6. Classification and Further Discussion of Cyclogiro Systems

A complete classification of cyclogiro systems into eight classes was prepared in connection with the cross-index tables of Appendix II and is shown in Figure 92. The classification rests upon a distinction between the various types of blade-rocking motion. There are eight classes; each cyclogiro reference of the bibliography of Appendix I is identified with one of the eight classes, as shown in item 23 of the cross-index table. No attempt is made to fully describe, in Figure 92, the feathering motion corresponding to each rotor class. Rather, additional discussion of these classes will be given below using additional figures.

It will be noted first that the blade feathering motions discussed in the previous paragraph, e. g., low pitch, pi-pitch, and high-pitch systems, cover only the first three classes. Actually, most of the early proposed cyclogiro systems (before 1920) belong to classes 4 through 8 and use "pusher" feathering systems. It is anticipated that any future cyclogiro aircraft would utilize the "full-feathering" system; i. e., one in which the pitch ratio of the rotor blades can be changed at will as a function of the flight condition. Because of its importance, this system will be discussed separately on pages 128 to 131.

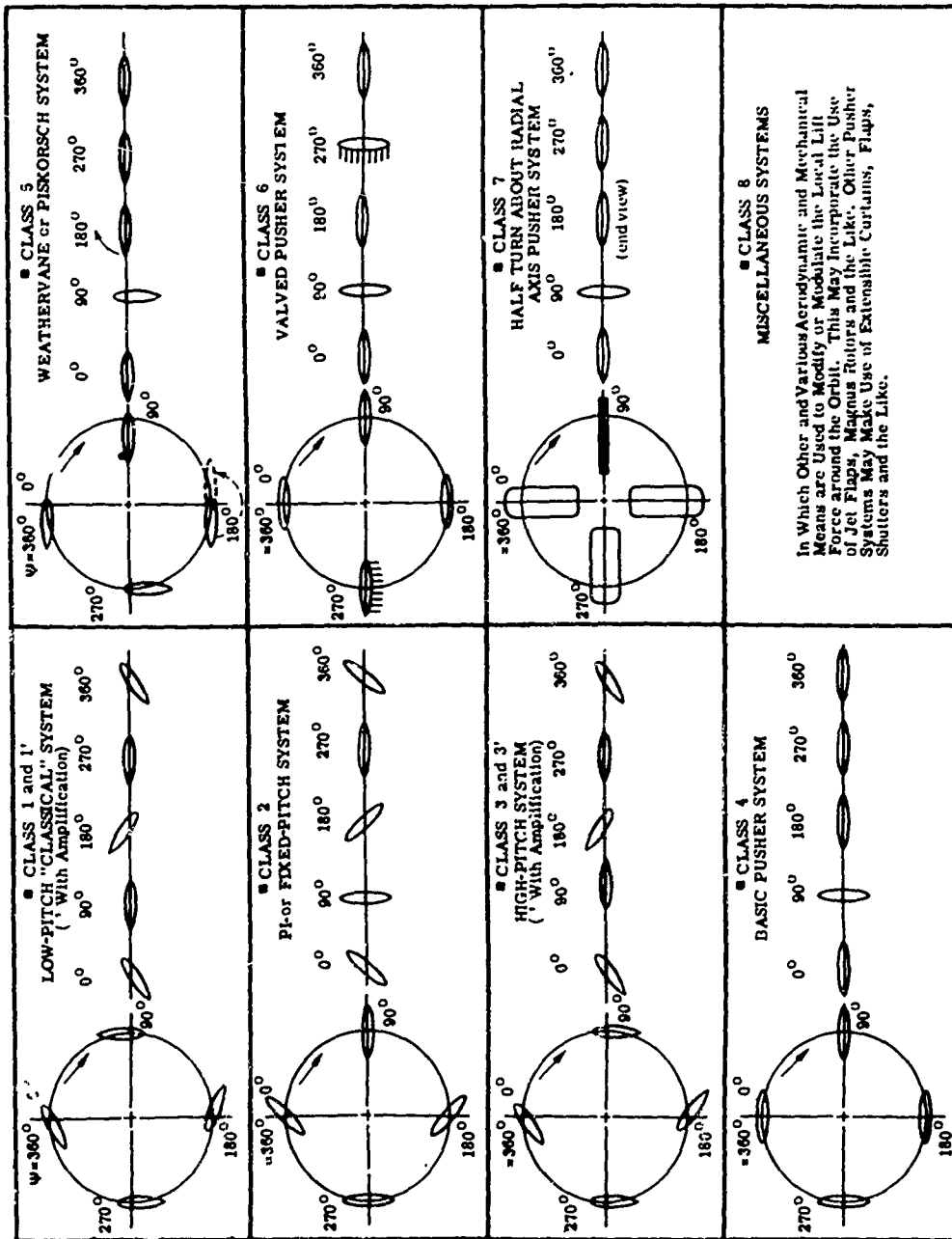

Figure 92. Classification of Cyclogiro Feathering Systems by Blade Motion and Position Relative to Rotor Axis of Rotation. Note That Only Blade Settings Are Shown for Hovering or Vertical Flight. Also See Item 23 of the Cross-Index Table of Appendix II.

Some additional details on the mechanical arrangements of the rotors of the different classes are given below:

Class 1: Low-pitch and amplified low-pitch systems

This has been the most exhaustively studied arrangement, witnessed by the number of references in the bibliography. Blade-feathering motion is invariably sought from a simple offset crank or excentric relative to the rotor axis, which feathers the blade through radial push rods. Such was the arrangement of the early NACA tests (Figure 73 and Reference 28W). The use of these linkages produces a blade motion which conforms closely with the ideal low-pitch motion when the amplitude is small, but which becomes progressively less satisfactory when the amplitude is increased to accommodate larger advance ratios. In addition, as shown in the previous paragraph (Figures 89 and 90), as the pitch ratio and advance ratios increase, blade accelerations can become excessive.

In 1935, Wheatley concluded from the NACA cyclogiro tests done on a low-pitch system (Reference 28W) that "the probable performance of the cyclogiro is very poor for normal power loadings". His indictment of the cyclogiro was really that of the low-pitch system at high advance ratios. These limitations of the low-pitch system were first recognized by Rohrbach in 1938 (Reference 58R). It is recognized today, as a result of the work done at the University of Washington, that the low-pitch system is well suited--actually is the best--at hover and low advance ratios.

A schematic demonstration of the operation of a typical low-pitch system is shown on the left side of Figure 93. (It was conceptually shown in Figures 86 and 88.)

The rationale for the amplified low-pitch system was given in a previous paragraph. A practical way to achieve amplified low pitch, according to Kirsten, is shown in Figure 94.

Class 2: Pi-pitch systems

The pi-pitch system was defined in a previous paragraph. It was shown that, by using a doubly symmetric airfoil profile, the need to rotate the airfoil instantaneously by 180° at $\psi = 180^\circ$ was alleviated. A schematic diagram of a pi-pitch mechanism is shown

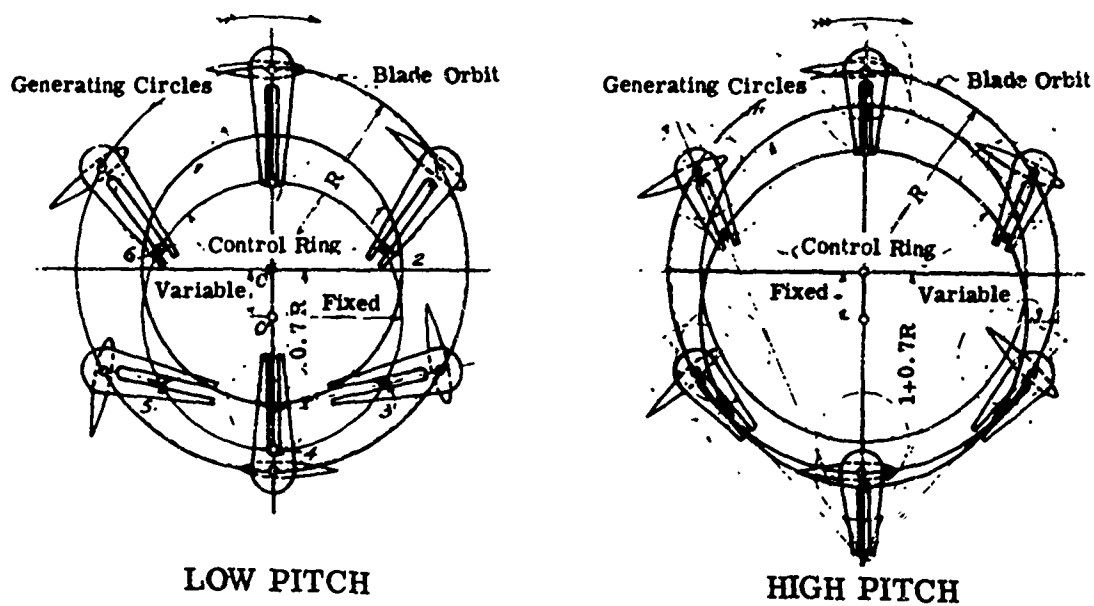

Figure 93. Schematic Demonstrating Cyclogiro Blade-Feathering Means and Similarity in the Low-Pitch (Left) and High-Pitch Regimes. Note Opposite Orientation of Slider Arm at $\psi = 180^\circ$.

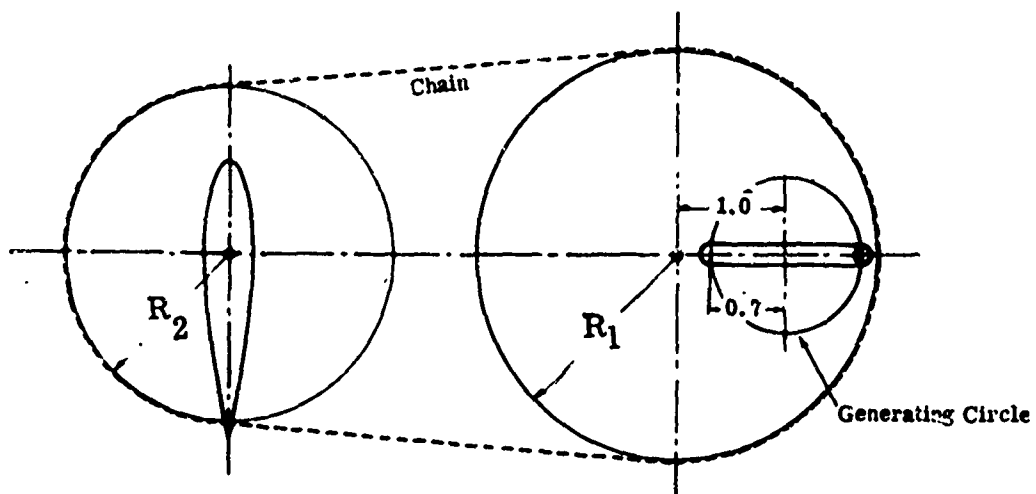

Figure 94. Schematic of Cyclogiro Blade-Feathering Mechanism To Introduce Pitch Amplification Into Basic Blade Motion (Ref. 30K).

in Figure 95. The relative simplicity of this arrangement makes it attractive. However, the doubly symmetric airfoil has fewer good aerodynamic characteristics than the cambered airfoil which is best adapted to low- or high-pitch systems. Also, the pi-pitch system has a good aerodynamic efficiency only at moderate advance ratios. Altogether, the pi-pitch system does not adapt well to aeronautical applications.

Class 3: High-pitch systems

A schematic demonstrating the operation of a typical high-pitch system is shown on the right side of Figure 93 (it was conceptually shown in Figure 88). In the limit, when the pitch ratio becomes infinity, the high-pitch cyclogiro rotor takes on a fixed-wing configuration. It stands to reason, therefore, that the high-pitch system is well suited for high-speed aircraft configurations. The advantage of the high-pitch cyclogiro over the fixed-wing airplane, independent of the VTOL argument, comes from the fact that in the cyclogiro, lift and thrust functions are integrated.

The rationale for the amplified high-pitch system was also discussed previously. Amplified high pitch is useless for operation of an aircraft at high speeds, but it may be useful for low-speed operation. An amplified high-pitch system makes possible a broader speed range than the pure high-speed system, which has a very poor aerodynamic efficiency at low speeds or in hover.

Classes 4 Through 7: Pusher feathering systems

The basic idea is a variation of the familiar paddle wheel: in the hover situation, for example, the descending blade ($\psi = 90^\circ$) adjusts its position so as to create a maximum resistance or "push" ($C_D \geq 1$), while the opposite ascending blade ($\psi = 270^\circ$) is set at the angle of minimum resistance (C_{Dmin}). The net effect is an acceleration of the system in a direction opposite to that of the "push". The blades travelling in the remaining quadrants of the orbit ($\psi = 0^\circ$ and 180°) usually remain in the position corresponding to C_{Dmin} . Horizontal thrust is obtained by inclining the lift vector by varying the feathering mechanism. Lift and thrust magnitudes were also changed in these older configurations by changing the rotor RPM.

Although such systems may be mechanically simple and are capable of producing lift as demonstrated

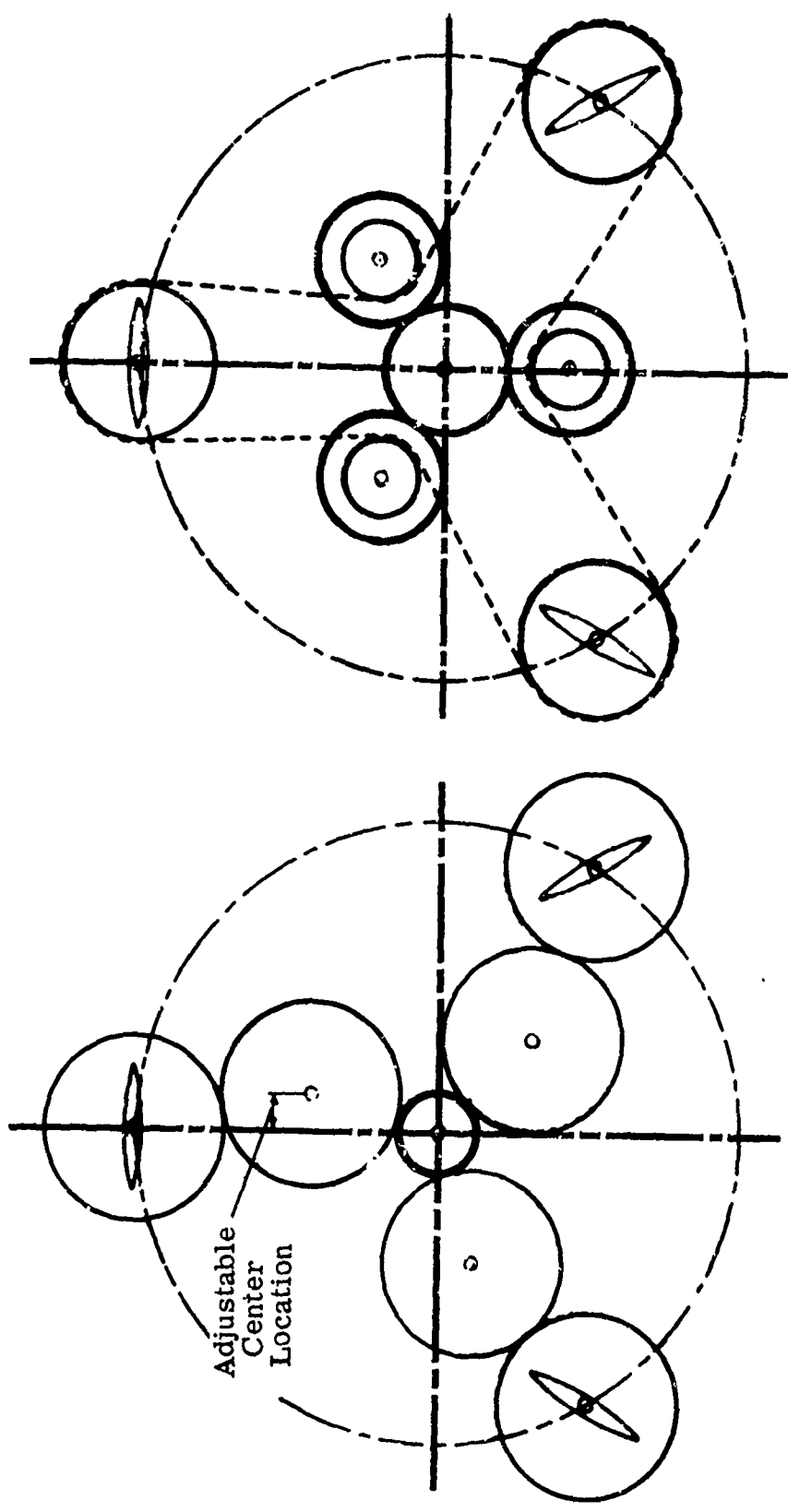

Figure 95. Simplicity of Obtaining Fixed, Ideal Pi-Pitch Blade-Feathering Motion by Gearing (Left) or Chain and Sprockets (Right).

by Pichou (Reference 13P), the fact that the effective blade is influencing only the local air and not the air through the entire swept cylinder demonstrates the lack of aerodynamic refinement. A corollary is excessive power requirements. Such systems can be defended for hovering flight, but their highspeed potential is nonexistent.

There may be an exception to this generalization in the form of a convertible "pusher" to fixed-wing cyclogiro arrangements. A patent by Wilcox (Reference 33W) shows a very straightforward system for changing from a hovering "pusher" cyclogiro to a multiplane fixed-wing high-speed aircraft. The simplicity of such an arrangement may offset the limitation on the aircraft's hovering capability.

Class 8: Miscellaneous systems

An unusual system was proposed by Hill and Nicholas (Reference 36H), the "jet flap cyclogiro". They proposed that the cyclogiro wheel be rotated by a reaction jet at the trailing edge of the blades and that the lift of the blades, assumed fixed (nonfeathering), be modulated by "jet flap" action. This in turn suggests rotor control by fluidics rather than by mechanical means. This particular proposal compounds the difficulties inherent to the jet flap phenomenon to those proper to the cyclogiro. Other indescribable cyclogiro systems are also to be found in this category.

7. Full-Feathering Universal Pitch Systems

It has been shown in the preceding discussions that each cyclogiro pitch regime operates efficiently only within a specific and related rotor advance ratio range; that is, the low-pitch system is very effective at low forward speeds and at hover, while, conversely, the high-pitch system excels at high forward speeds but suffers in the near-hover condition. Thus, in order to evolve a completely efficient full-flight-range high-speed cyclogiro, a system must be determined that will allow the rotor blade feathering motion to operate at its best efficiency regardless of its advance or pitch ratio. The full-feathering VTOL cyclogiro thus will be able to operate at nearly any pitch ratio between zero and infinity. The background, kinematics, aerodynamics, and mechanism required to obtain this system will be briefly discussed here.

The initial "discovery" of the need for a full-feathering universal pitch cyclogiro mechanism was explained and detailed by Rohrbach in a remarkable patent first filed in Germany in 1932 (Reference 58R). Although often described to the contrary, The Rohrbach Project "B"

cyclogiro (Figures 67 through 69) was probably intended to make use of the full-feathering system as reflected in the patent (Reference 58R). The yet-to-be-understood mechanical requirements for a full-feathering mechanism, the political difficulties of the time (1932-1935), and the reorganization of the Rohrbach Company (Reference 48R) probably were responsible for lack of completion of this advanced "TOL system. In his patent, Rohrbach discusses the simple and inadequate feathering mechanisms proposed for the low-pitch cyclogiros of his and previous times.

He then demonstrates the need for the efficient universal pitch feathering arrangement and describes a mechanism and control to obtain such a system. What is of further interest is that the patent anticipates the need for the blades to translate through the regime of low-pitch high blade accelerations to pi-pitch and thence through the area of high-pitch blade accelerations. The patent also anticipates the need for a means to relieve the blade accelerations in the vicinity of pi-pitch. The means was later to be called by Eastman "pitch amplification".

The patent describes pitch amplification in this manner:

"With a ratio of $U/V = 1$ (pi-pitch), the wing (blade) has to perform a sudden turn in the lower apex of the circle of revolution (orbit angle $\psi = 180^\circ$). Because of the smallness of the aerodynamical forces which are occurring in the lower portion of the circle of revolution, with a ratio of $U/V =$ nearly one, this 180° turn of the revolving wings could be performed much more gradually (lower and constant blade accelerations about its feathering axis) while a good deal of the lower part of the circle of revolution is transversed without noticeable aerodynamical loss."

The critical problem of the full-feathering system is to obtain the smooth passage of the rotor blade across the pi-pitch area. Eastman (Reference 2E) was able to demonstrate the quasi-mechanical and structural means to perform this transition and to insure efficient aerodynamic performance at the same time.

To understand kinematically how this is done, consider Figure 96. It is, in effect, a repetition of Figure 89, in which the x-x axis has been given the slope of $1/2$ in order to place the curve of $p = \pi$ (a straight line) at right angles to the y-y axis. Thus, the Θ_p vs. ψ curves for the low- and high-pitch systems become geometrically symmetrical about the $p = \pi$ line. This fact will become significant in the design of the full-feathering cyclogiro control mechanism.

In Figure 96, the dot-dash curves show amplified low- and high-pitch blade motions for the pitch ratios of $\pi \times .7$ and $\pi / .7$,

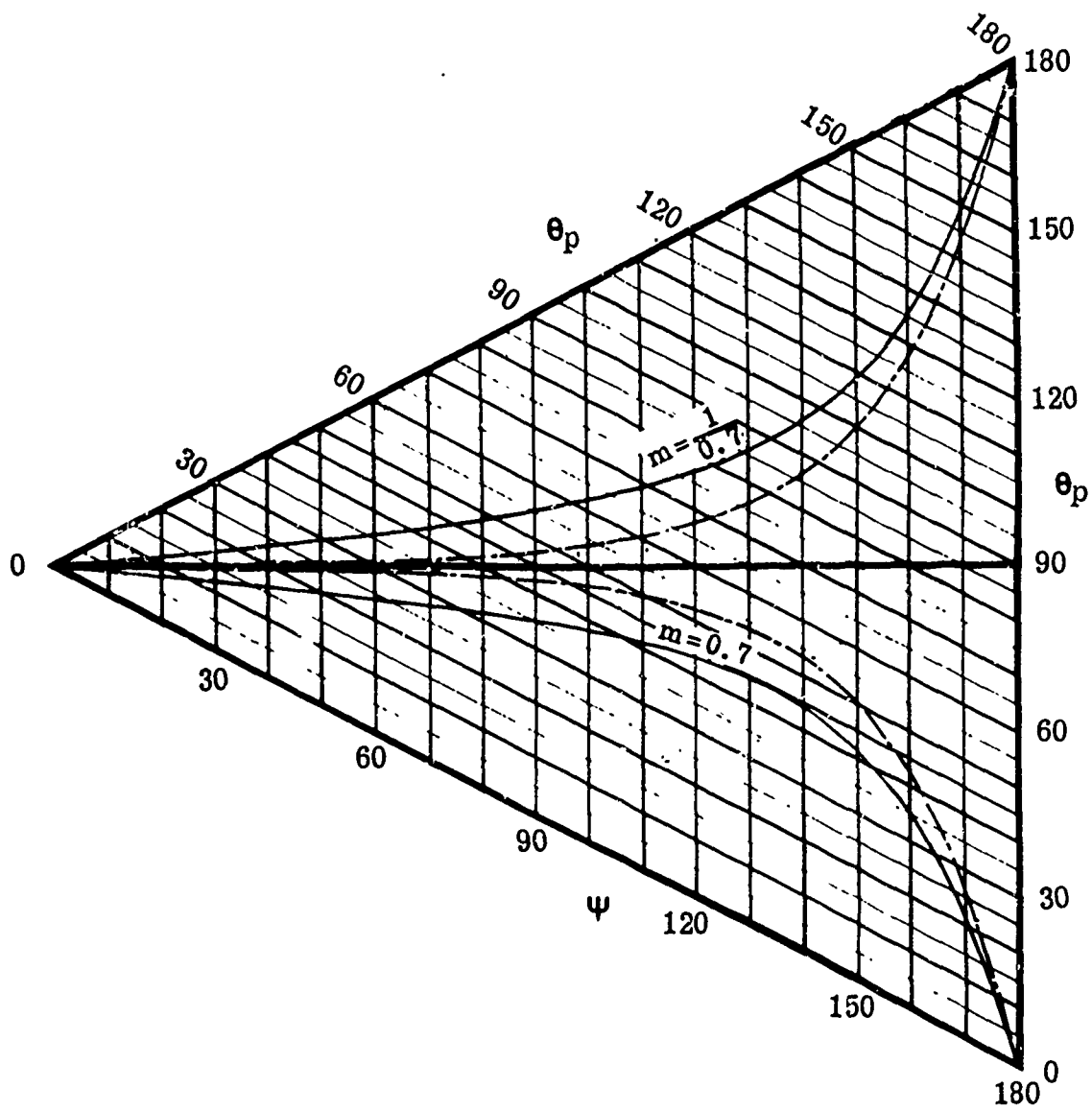

Figure 96. Modification of Figure 89 to Demonstrate Change-Over From Low- to High-Pitch Regime Through Pitch Amplification.

respectively. The appropriate blade motions are obtained by multiplying all ordinates by a constant of such a magnitude that the resultant curves are tangent to the $p = \pi$ line at the point where $\Theta = 0$ or at the top of the rotor orbit. Thus, the angular velocity $d\beta/dt$ when $\Theta = 0$ is exactly the same for $p = .7$ and for $p = 1/.7$. Consequently, if a mechanism can be designed to switch the pitch ratio from $.7\pi$ (low pitch) to $\pi/.7$ (high pitch) at the exact moment when the blade passes through the $\Theta = 0$ top position, no shock would result upon the rotor blade or mechanism. Thus, for a multiblade rotor system, the blade could be switched successively from the low-pitch to the high-pitch range. By this means, a smoothly progressive aerodynamic performance is produced which would be the equivalent of the performance of the pi-pitch system when half of the number of blades are operating in the low-pitch range and the other half in the high-pitch range. It may be shown (Reference 30K) by this arrangement that the critical blade accelerations may be less than those developed by the isolated amplified-pitch system.

A full-feathering rotor system is described in some detail by Kirsten (Reference 30K). This system involves a system of clutches and differentials at each rotor blade root plus several eccentric devices required to obtain the desired pitch motion. In the schematic of the full-feathering cyclogiro (Figure 78), Kirsten indicates the "rocking mechanism" only in the schematic of the universal pitch mechanism (view A-A, item "e"), and it is in this specific area of the rocking mechanism that the full-feathering system is open to criticism.

Although the aerodynamic performance potential of the full-feathering cyclogiro is unquestionable, a simpler and less delicate mechanism must be evolved which will safely produce universal pitch feathering. Such a system remains to be developed.

8. Aerodynamic Analysis of Cyclogiro Rotors

Background

Simplified aerodynamic analyses of cyclogiro rotors are straightforward enough that they appeared in the early 1930's. Analyses by Strandgren (Reference 130S) and Wheatley (Reference 25W) appeared simultaneously in 1933. Heuver and Hage presented a more refined analysis in Reference 30H (1943). The most recent analysis available today is that of Eastman (Reference 2E), last revised in 1951. Actually, the Heuver and Eastman analyses are quite similar and serve as a basis for the discussion which follows. These analyses are not by far as rigorous as they might be since unsteady effects are ignored, uniformity of the induced velocity components is assumed, and two-dimensional airfoil characteristics are used, with no really adequate provisions for stall. Much work

thus remains to be done to produce a satisfactory aerodynamic analysis of the cyclogiro rotor.

Aerodynamic Characteristics Based on Local Air, for Forward Flight

The angular relationships and velocity triangle for a blade element are shown in Figure 87, which shows a blade element section by a vertical plane parallel to the direction of flight. Conditions are assumed to be uniform in the spanwise direction. The velocity V is not the aircraft forward speed, but it is the local velocity at the rotor cylinder, assumed to be uniform throughout the cylinder. V will be related to the forward velocity in the developments that follow.

From Figure 87, local rotor blade angle of attack α_b is given by

$$\alpha_b = \alpha_1 + \theta_p - (\Phi - i_b)$$

where

α_1 = the rotor angle of attack based on local air. The magnitude of α_1 determines the amount of lift (in the vertical direction of the rotor). Thus, α_1 is also the angle between the local air flight path and the rotor axis of symmetry. If $\alpha_1 = 0$, the cyclogiro has no lift; it has only thrust. α_1 is controlled by the pilot.

θ_p = the inclination of the blade path to the local-air flight path. Its expression was given on page 114 as

$$\tan \theta_p = \frac{\sin \psi}{j + \cos \psi}$$

j = the advance ratio, $j = \frac{V}{\pi n D}$ where V is the local, not the forward-flight velocity.

Φ = the blade angle introduced by the rocking mechanism.

i_b = the incidence angle determined by the orientation of the blade on the control shaft.

Φ_b = $\Phi - i_b$ defines the amplitude of the rocking motion. This angle is determined graphically or analytically from the pitch-change mechanism characteristics. A typical graphical plot is given in Reference 30H. A typical analytical determination is given in Reference 30H. For the mechanism shown on page 116, one has

$$\tan \Phi = \frac{\sin(\psi + \alpha_1)}{m + \cos(\psi + \alpha_1)}$$

When both α_1 and i_b are zero, the rotor has no lift and exerts pure thrust. One has then

$$\alpha_{bt} = \tan^{-1} \frac{\sin \psi}{j + \cos \psi} - \tan^{-1} \frac{\sin \psi}{m + \cos \psi}$$

$$\alpha_{bt} = \tan^{-1} \frac{(m-j) \sin \psi}{1 + mj + (m+j) \cos \psi}$$

This periodic variation governs the thrust, as α_1 governs lift. It can be measured by the thrust angle of attack, obtained by letting $\psi = 90^\circ$ in the above equation.

$$\alpha_T = \tan^{-1} \frac{m-j}{1+mj} \approx \frac{m-j}{1+mj}$$

To obtain any desired thrust action, the pilot controls the blade-rocking motion, which is defined by m . This in turn controls the value of α_T .

When $m > j$, α_T is positive and the rotor exerts thrust.

When $m < j$, α_T is negative, and the rotor generates power by windmill action. In either case, the action can be visualized by observing the direction of the blade-lift vector at $\psi = 90^\circ$ and $\psi = 270^\circ$ on one of the paths in Figure 85. When α_T is positive, both vectors have a forward component, and their vertical components produce a retarding torque. When α_T is negative, however, both vectors have a rearward component and they produce a driving torque.

In general, rotor forces may be computed by resolution of the blade loads into three components, as shown in the upper left-hand corner of Figure 87. The three forces-- L' , normal to the local-air flight path; T' , parallel to the path; and F' , tangential to the orbit--are instantaneous values of the desired rotor forces and must be averaged over one complete cycle to provide mean values. Actually, the blade angle of attack α_b is calculated at twelve points equally spaced around the orbit, and the corresponding instantaneous values of the three rotor coefficients are computed.

Symbols and coefficients are used as follows:

Blade Lift Normal to Blade Path: $L_b = C_{L_b} S 1/2 \rho v_b^2$

thus remains to be done to produce a satisfactory aerodynamic analysis of the cyclogiro rotor.

Aerodynamic Characteristics Based on Local Air, for Forward Flight

The angular relationships and velocity triangle for a blade element are shown in Figure 87, which shows a blade element section by a vertical plane parallel to the direction of flight. Conditions are assumed to be uniform in the spanwise direction. The velocity V is not the aircraft forward speed, but it is the local velocity at the rotor cylinder, assumed to be uniform throughout the cylinder. V will be related to the forward velocity in the developments that follow.

From Figure 87, local rotor blade angle of attack α_b is given by

$$\alpha_b = \alpha_1 + \theta_p - (\Phi - i_b)$$

where

α_1 = the rotor angle of attack based on local air. The magnitude of α_1 determines the amount of lift (in the vertical direction of the rotor). Thus, α_1 is also the angle between the local air flight path and the rotor axis of symmetry. If $\alpha_1 = 0$, the cyclogiro has no lift; it has only thrust. α_1 is controlled by the pilot.

θ_p = the inclination of the blade path to the local-air flight path. Its expression was given on page 114 as

$$\tan \theta_p = \frac{\sin \psi}{j + \cos \psi}$$

j = the advance ratio, $j = \frac{V}{\pi n D}$ where V is the local, not the forward-flight velocity.

Φ = the blade angle introduced by the rocking mechanism.

i_b = the incidence angle determined by the orientation of the blade on the control shaft.

Φ_b = $\Phi - i_b$ defines the amplitude of the rocking motion. This angle is determined graphically or analytically from the pitch-change mechanism characteristics. A typical graphical plot is given in Reference 30H. A typical analytical determination is given in Reference 30H. For the mechanism shown on page 116, one has

$$\tan \Phi = \frac{\sin(\psi + \alpha_1)}{m + \cos(\psi + \alpha_1)}$$

When both α_1 and i_b are zero, the rotor has no lift and exerts pure thrust. One has then

$$\alpha_{bt} = \tan^{-1} \frac{\sin \psi}{j + \cos \psi} - \tan^{-1} \frac{\sin \psi}{m + \cos \psi}$$

$$\alpha_{bt} = \tan^{-1} \frac{(m-j) \sin \psi}{1 + mj + (m+j) \cos \psi}$$

This periodic variation governs the thrust, as α_1 governs lift. It can be measured by the thrust angle of attack, obtained by letting $\psi = 90^\circ$ in the above equation.

$$\alpha_T = \tan^{-1} \frac{m-j}{1+mj} \approx \frac{m-j}{1+mj}$$

To obtain any desired thrust action, the pilot controls the blade-rocking motion, which is defined by m . This in turn controls the value of α_T .

When $m > j$, α_T is positive and the rotor exerts thrust.

When $m < j$, α_T is negative, and the rotor generates power by windmill action. In either case, the action can be visualized by observing the direction of the blade-lift vector at $\psi = 90^\circ$ and $\psi = 270^\circ$ on one of the paths in Figure 85. When α_T is positive, both vectors have a forward component, and their vertical components produce a retarding torque. When α_T is negative, however, both vectors have a rearward component and they produce a driving torque.

In general, rotor forces may be computed by resolution of the blade loads into three components, as shown in the upper left-hand corner of Figure 87. The three forces-- L' , normal to the local-air flight path; T' , parallel to the path; and F' , tangential to the orbit--are instantaneous values of the desired rotor forces and must be averaged over one complete cycle to provide mean values. Actually, the blade angle of attack α_p is calculated at twelve points equally spaced around the orbit, and the corresponding instantaneous values of the three rotor coefficients are computed.

Symbols and coefficients are used as follows:

Blade Lift Normal to Blade Path: $L_b = C_{L_b} \frac{1}{2} \rho v_b^2$

Blade Drag Parallel to Blade Path: $D_b = C_{D_b} S \frac{1}{2} \rho V_b^2$

Mean Lift Normal to Local-Air Flight Path: $L_1 = C_{T_1} S \frac{1}{2} \rho V^2$

Main Tangential Force: $F = C_F S \frac{1}{2} \rho V^2$

Power Input: $F V/j$ $P = (C_{F/j}) S \frac{1}{2} \rho V^3$

Effective Power: $T_1 V = C_{T_1} S \frac{1}{2} \rho V^3$

Parasite Power, $P - T_1 V$, $P_p = (C_{F/j} - C_{T_1}) S \frac{1}{2} \rho V^3$

S is the total blade area.

The instantaneous values are defined as follows:

$$L' = C_L' S \frac{1}{2} \rho V^2 = L_b \cos \theta_p + D_b \sin \theta_p$$

$$C_L' = C_{L_b} (V_b/V)^2 \cos \theta_p + C_{D_b} (V_b/V)^2 \sin \theta_p$$

$$T' = C_{T'} S \frac{1}{2} \rho V^2 = L_b \sin \theta_p - D_b \cos \theta_p$$

$$C_{T'} = C_{L_b} (V_b/V)^2 \sin \theta_p - C_{D_b} (V_b/V)^2 \cos \theta_p$$

$$F' = C_{F'} S \frac{1}{2} \rho V^2 = L_b \sin (\psi - \theta_p) + D_b \cos (\psi - \theta_p)$$

$$C_{F'} = C_{L_b} (V_b/V)^2 \sin (\psi - \theta_p) + C_{D_b} (V_b/V)^2 \cos (\psi - \theta_p)$$

Blade interference is disregarded. Blade coefficients are those for any chosen airfoil, for a chosen aspect ratio; for example, 6 (as in Reference 30H) or 10 (as in Reference 2E). The ratio $(V_b/V)^2$ is calculated from the equation

$$\left(\frac{V_b}{V}\right)^2 = \frac{1}{j^2} (1 + 2j \cos \psi + j^2)$$

The rotor coefficients C_L and C_T are the arithmetic averages of the instantaneous values calculated as described above.

The aerodynamic performance of the rotor can be presented in the form of lift-thrust polars (C_L against C_T curves), which are comparable with constant RPM polars for a conventional wing-and-powered-nacelle combination. It is of interest to note the very large thrust which can be obtained without rocking the blades;

i. e., with $m = \infty$. In this case, the propelling action is essentially the same as for a flapping and oscillating airfoil, analyzed by Garrick in NACA TR No. 567.

Figure 107 shows a good efficiency of the cyclogiro rotor, when used as a propeller exerting thrust, but not lift. An additional advantage of the cyclogiro over the equivalent screw-propelled wing must be noted. Screw-propeller efficiency is based on a useful thrust which includes that required to overcome wing drag. In contrast, the efficiency shown for the cyclogiro rotor is based on net thrust, so that the power to overcome the drag of the lifting surfaces contributes to the propulsion losses instead of being recognized as useful thrust action. If blade drag is added to the net thrust, according to the 12-point average, the maximum efficiency will be at least 98 percent. In keeping with this figure, Garrick has shown in NACA TR No. 567 that for an infinite wing in pure flapping motion, the efficiency approaches 100 percent.

The approach to 100 percent propulsive efficiency can be explained as follows. In horizontal flight, propulsion results from the gliding action of the descending blade. The torque applied to the rotor simply shifts some of the weight from the ascending to the descending blade. Consequently, the only power loss attributable to propulsion results from a slight increase in overall blade drag. The increase, caused by higher blade velocity as compared with forward velocity, vanishes as j approaches infinity, but that due to concentration of lift on the descending blade remains.

Forward-Flight Theory Based on the "4-Point Average"

Eastman, in Reference 2E, after developing the "12-point average" theory, remarks that one gets a clearer physical picture by not attempting to follow the blades through 12 positions, but by looking at things globally and assuming that the effect of blade action is to uniformly deflect and accelerate the air passing through the rotor. He found that rotor coefficients, based on the local velocity V , can be expressed mathematically and with reasonable accuracy by averaging the four instantaneous coefficients existing at the quarter-turn points.

Expressions for rotor lift, thrust, and tangential force coefficients are obtained by adding the expressions for their instantaneous values at the quarter-turn points and dividing by four. At the position $\psi = 180^\circ$, the blade velocity reverses when $j < 1$. As a result, the coefficients below may have different expressions for low and for high pitch. These expressions are given below, together with the equations of Table IV.

$$C_{Ll} = \frac{dC_{L_b}}{d\alpha_b} \left[G i_b + M \alpha_1 \right]$$

$$C_{T1} = \frac{dC_{L_b}}{d\alpha_b} \frac{\sqrt{1+j^2}}{2j^2} \alpha_T - G C_{D_{b_0}} - \frac{dC_{db}}{d\alpha_b^2} \left[\frac{\sqrt{1+j^2}}{2j} \alpha_T^2 + H \alpha_1^2 \right]$$

$$C_F = \frac{dC_{L_b}}{d\alpha_b} \frac{\sqrt{1+j^2}}{2j} \alpha_T + Q C_{D_{b_0}} + \frac{dC_{db}}{d\alpha_b^2} \left[\frac{\sqrt{1+j^2}}{2j^2} \alpha_T^2 + R \alpha_1^2 \right]$$

where

$$C_{L_b} = (dC_{L_b}/d\alpha_b) \alpha_b$$

$$C_{D_b} = C_{D_{b_0}} + (dC_{D_b}/d\alpha_b^2) \alpha_b^2$$

The parasite power coefficient is given by

$$C_{F/j} - C_{T1} = E C_{D_{b_0}} + \frac{dC_{D_b}}{d\alpha_b^2} \left[\frac{(1+j^2)}{2j^3} \alpha_T^2 + (H + R/j) \alpha_1^2 \right]$$

$dC_{D_b}/d\alpha_b^2$ represents only the variation in blade profile drag, the relationship of induced drag effect being considered separately.

This is usually so small that the second turn on the right-hand side of the above equation can usually be disregarded. Eastman shows that, should greater accuracy be required, one can use

$$C_{F/j} - C_{T1} = K_p C_{D_{b_0}},$$

where

$$K_p = E + \frac{1}{C_{D_{b_0}}} \frac{dC_{D_b}}{d\alpha_b^2} \left[2j \sqrt{1+j^2} (C_{T1} + G C_{D_{b_0}})^2 + B C_{L_1}^2 \right]$$

Eastman compared, in Reference 2E, the results of the "12-point average" and of the "4-point average" methods. He found fairly good agreement, except when the coefficients were large. The discrepancy was due to blade stalling, which is accounted for in the 12-point method and not in the 4-point method.

Induced Velocity Effects

In the foregoing study, the assumed uniform flow through

TABLE IV. COEFFICIENT OF EQUATIONS ON PAGES 135 AND 136

	$j > 1$	$j = 1$	$j < 1$
B	$\frac{2\sqrt{1+j^2}}{j^2+1+j^2}$	Use Either \longrightarrow	$\frac{2\sqrt{1+j^2}}{j^2+1+j^2}$
E	$\frac{1}{2} + \frac{3j+(1+j^2)^{3/2}}{2j^3}$	Use Either \longrightarrow	$\frac{1+3j^2+(1+j^2)^{3/2}}{2j}$
G	$\frac{1+j^2+j\sqrt{1+j^2}}{2j^3}$	Use Either \longrightarrow	$\frac{2+\sqrt{1+j^2}}{2j}$
M	$\frac{m}{2} \left[\frac{m(1+j^2)-2j}{j^2(m^2-1)} + \frac{\sqrt{1+j^2}}{1+mj} \right]$	$\frac{m}{2} \left[\frac{(1+j)^2}{2j^2(1+m)} + \frac{\sqrt{1+j^2}}{1+mj} \right]$	$\frac{m}{2} \left[\frac{1+j^2-2mj}{j^2(1-m^2)} + \frac{\sqrt{1+j^2}}{1+mj} \right]$
H	$\frac{m^2}{4j^2} \left[\left(\frac{1+j}{1+m} \right)^2 + \left(\frac{1-j}{1-m} \right)^2 + \frac{2j^3\sqrt{1+j^2}}{(1+mj)^2} \right]$	$\frac{m^2}{4j^2} \left[\left(\frac{1+j}{1+m} \right)^2 + \frac{2j^3\sqrt{1+j^2}}{(1+mj)^2} \right]$	$\frac{m^2}{4j^2} \left[\left(\frac{1+j}{1+m} \right)^2 - \left(\frac{1-j}{1-m} \right)^2 + \frac{2j^3\sqrt{1+j^2}}{(1+mj)^2} \right]$
Q	$\frac{2j+\sqrt{1+j^2}}{2j^2}$	Use Either \longrightarrow	$\frac{1+j^2+\sqrt{1+j^2}}{2j^2}$
R	$\frac{m^2}{4j^2} \left[\left(\frac{1+j}{1+m} \right)^2 - \left(\frac{1-j}{1-m} \right)^2 + \frac{2j^3\sqrt{1+j^2}}{(1+mj)^2} \right]$	$\frac{m^2}{4j^2} \left[\left(\frac{1+j}{1+m} \right)^2 + \frac{2j^3\sqrt{1+j^2}}{(1+mj)^2} \right]$	$\frac{m^2}{4j^2} \left[\left(\frac{1+j}{1+m} \right)^2 + \left(\frac{1-j}{1-m} \right)^2 + \frac{2j^3\sqrt{1+j^2}}{(1+mj)^2} \right]$

the rotor cylinder provided the reference velocity V . Both the direction and the magnitude of this local velocity must be determined before the theory can be applied to an actual cyclogiro.

When the rotor is producing lift without thrust, it acts like a multiplane. This suggests that the area of the equivalent airstream, which is assumed to be deflected by lift action, may be that shown in the sketch below. This assumption was used by Wheatley (Reference 25W), and it is justified by tests of the high-pitch models.

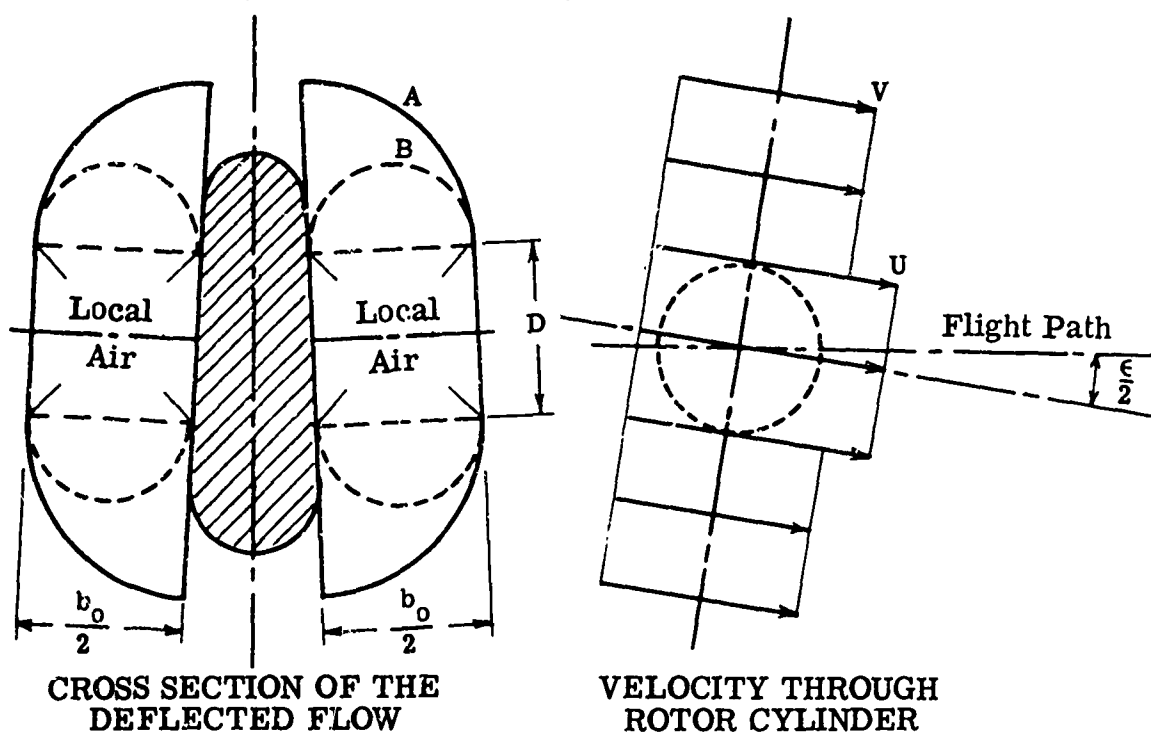

On the other hand, pi-pitch model tests seem to indicate that the area becomes smaller when the advance ratio approaches unity. There are also indications that the fuselage width may add to the equivalent span. Thus,

$$\pi b_0^2/4 < A_L < b_0 D + \pi b_0^2/4$$

The area of the equivalent uniform flow, which is accelerated by thrust action, is much larger than that for an equivalent screw-propelled wing. Wheatley (Reference 25W) used the projected area of the rotor cylinder, and experimental evidence seems to justify this assumption. Thus,

$$A_T = b_0 D$$

The combined equivalent flow pattern may be described as follows. An air stream having an area A_L and a velocity U is deflected by the force L_1 through an angle ϵ . Following accepted wing theory, the air is assumed to be deflected through half of this angle when it reaches the rotor. Therefore, $\epsilon/2$ determines the direction of the local air. If δ is the rotor angle of attack measured to the reference axis (angle between $m - m$ and $x - x$ in Figure 78), α is related to α_1 (page 110), rotor angle of attack relative to local air, by

$$\alpha = \alpha_1 + \epsilon/2$$

Superimposed upon the deflected flow is a region of area A_T , which is accelerated by the force T_1 . Following accepted propeller theory, the assumed total change in velocity is $2aU$, half of which is attained when the air reaches the rotor. Therefore,

$$V = U(1 + a)$$

In the sketch below, the forces T and L are the true thrust and lift, acting parallel and perpendicular to the flight path $0 - 0$. D_p is the residual drag. The forces T_1 and L_1 act parallel and perpendicular, respectively, to the local-air flight path $x - x$. They will be expressed in terms of new coefficients, C_x and C_N , which are based on the true forward velocity U .

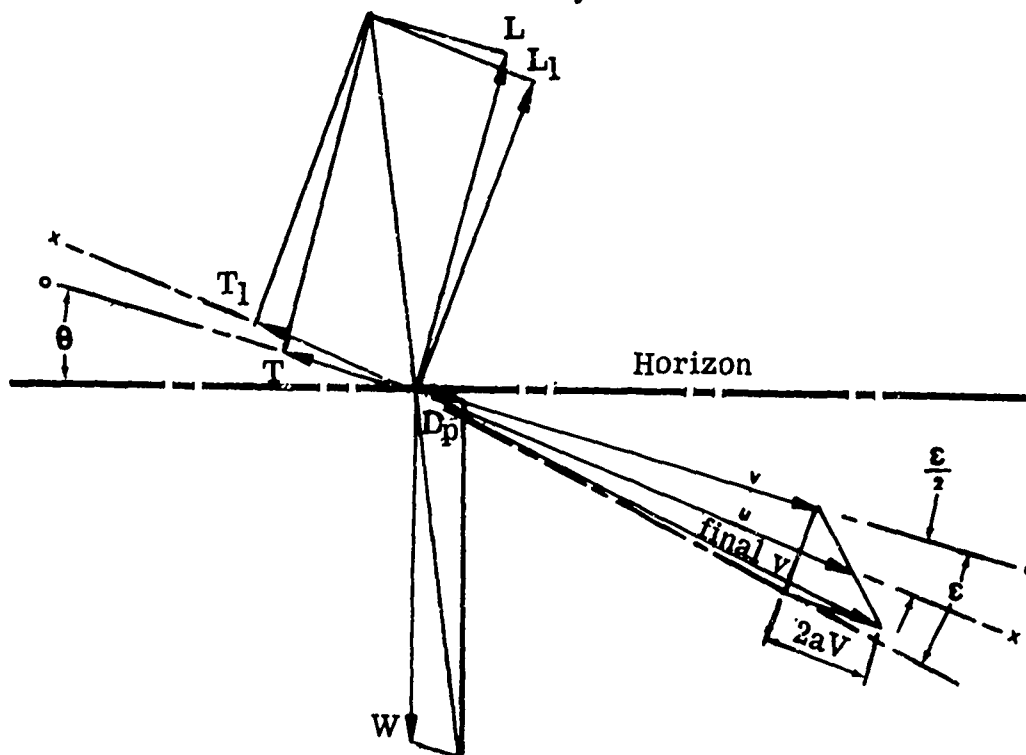

The momentum theory for lift gives the relation between C_N and $\sin(\epsilon/2)$; that for thrust gives the relation between C_X and the slip-stream factor, a .

$$L_1 = (\rho A_L U) 2U \sin \epsilon/2$$

$$C_N = \frac{L_1}{S 1/2 \rho U^2} = \frac{4A_L}{S} \sin \frac{\epsilon}{2}$$

$$T_1 = \rho A_T U (1 + a) (2a U)$$

$$C_X = \frac{T_1}{S 1/2 \rho U^2} = \frac{A_T}{S} (a + a^2)$$

$$a = 1/2 \left(-1 + \sqrt{1 + \frac{C_X S}{A_T}} \right)$$

From the sketch above

$$C_N = C_L \cos \frac{\epsilon}{2} - C_T \sin \frac{\epsilon}{2}$$

$$C_X = C_T \cos \frac{\epsilon}{2} + C_L \sin \frac{\epsilon}{2}$$

Hence, by straightforward substitution

$$C_N = \frac{C_L (4 A_L/S)}{\sqrt{C_L^2 + (C_T + 4 A_L/S)^2}}$$

$$C_X = \frac{C_L^2 + C_T (C_T + 4 A_L/S)}{\sqrt{C_L^2 + (C_T + 4 A_L/S)^2}}$$

The effective power, $T_1 V$, may be expressed in terms of C_X , since

$$T_1 = C_X S 1/2 \rho U^2 \quad \text{and} \quad V = U (1 + a)$$

$$T_1 V = 1/2 C_x (\sqrt{1 + C_x S/A_T}) S 1/2 \rho U^3$$

The equations for C_N , C_x , and $T_1 V$ establish the relation among lift, thrust, and effective power. The relation is important, because it determines cyclogiro performance when induced velocity effects predominate, as in near-hovering flight.

The gliding condition may be approximated by letting $C_x = 0$, because this means that only rotor parasite power will be supplied by the engine. In this case,

$$C_L^2 + C_T^2 + 4 A_L/S C_T = 0$$

The slope of the flight path is obtained from

$$\tan \Theta = C_T/C_L$$

The procedure for the complete cyclogiro performance calculations is as follows. For assumed values of j , Q_1 , and m , one calculates first local-air lift, thrust, and parasite power coefficients. Then the conversion to free-stream coefficients C_N , C_x , and C_{pp} (C_{pp} is the parasite power coefficient: $C_{pp} = P_p/SqU$) may be made after the velocity ratio, V/U , is known. This ratio, equal to $1+a$, is obtained by substituting

$$C_x = C_{T_1} (1+a)^2$$

into the equation

$$C_x = \frac{4 A_T}{S} (a + a^2)$$

Hence,

$$1 + a = \frac{1}{1 - S/4 A_T C_{T_1}}$$

For convenience, the other relations used to complete the analysis are listed below:

$$C_x = C_{T_1} (1+a)^2$$

$$C_N = C_{L_1} (1+a)^2$$

$$C_{pp} = K_p C_{D_{b_0}} (1+a)^3$$

$$C_p = C_{pp} + C_{T_1} (1 + a)^3$$

$$\epsilon/2 = \sin^{-1} (C_N S/4 A_L)$$

$$C_T = C_x \cos \frac{\epsilon}{2} - C_N \sin \frac{\epsilon}{2}$$

$$C_L = C_x \sin \frac{\epsilon}{2} + C_N \cos \frac{\epsilon}{2}$$

$$C_{Di} = C_p - C_T$$

$$\alpha = \alpha_1 + \frac{\epsilon}{2}$$

$$V/\pi nD = j/(1+a)$$

The coefficient C_{De} is called the extended-drag coefficient, because it represents a drag which, when multiplied by U , gives the entire power which does not contribute to the net thrust. In addition to parasite drag and induced drag, it includes an equivalent drag which accounts for propulsion losses. Its components may be separated as follows:

$$C_{De} = C_{pp} + C_{T_1} (1 + a)^3 - C_T = C_{pp} + C_x (1+a) - C_T$$

or

$$C_{De} = K_p C_{D_{b_0}} (1 + a)^3 + (C_x - C_T) + a C_x$$

The first term accounts for parasite power. The second term accounts for induced drag, and, when ϵ is small, it may be approximated by the familiar expression $SC_L^2/4A_L$. The last term accounts for slipstream power. Parasite power may be separated into three parts, by observing the components of the K_p equation

$$K_p = E + \frac{1}{C_{D_{b_0}}} \frac{dC_{D_b}}{dC_{L_b}} \left[2j \sqrt{1+j^2} (C_{T_1} + G C_{D_{b_0}})^2 + B C_{L_1}^2 \right]$$

The first term, E , accounts for the effect of minimum blade profile drag. The second term accounts for the increase in profile drag with C_{L_b} and is in two parts: that due to thrust action and that due to lift action.

When the rotor is autorotating with the torque equal to zero, C_{DC} is truly comparable with wing drag. Neglecting the slight

retarding influence of blade profile drag, $a = 0$ and $C_{T1} + GC_{Dbo} = 0$. As a result, the drag coefficient of a cyclogiro rotor is expressed, in the above equation, in the conventional manner. The first two terms are profile drag; the last term is induced drag and must be replaced by $C_x - C_T$ when ϵ is large.

$$C_D = E C_{Dbo} + B C_L^2 \frac{dC_{Db}}{dC_{Lo}^2} + C_L^2 S/4 A_L$$

The efficiency of a cyclogiro rotor used for propulsion alone is $\frac{TU}{p}$ or simply C_T/C_p . Therefore,

$$e = \frac{C_T}{C_x + K_p C_{Dbo} (1+a)^3 + a C_x}$$

As has been pointed out, the propulsive efficiency of a cyclogiro must include blade drag as part of the useful thrust, if it is to be compared with the propulsive efficiency of a screw-propeller airplane. The 12-point average method indicated that this efficiency might be as high as 98 percent. Now it is possible to be more specific. The additional useful thrust is that which would be required to overcome the drag of the blades if they were used in the conventional manner, thereby providing lift but not thrust. This is the drag which exists when $m = \infty$ and $j = \infty$. Therefore,

$$\text{Equivalent efficiency} = \frac{C_T + C_{Dbo} + C_L^2 \frac{dC_{Db}}{dC_{lb}^2} + (C_x - C_T)}{C_p}$$

This efficiency increases as the lift action increases, but its conservative zero lift value will be used for simplicity.

$$\eta = \frac{C_T + C_{Dbo}}{C_p} = e \frac{(C_T + C_{Dbo})}{C_T}$$

Representative values of η are as follows. Let $S/A_T = 1$, $m = \infty$, and $C_T = 0.04$. Then $\eta \approx 0.97$. Representing a steep climb by using $m = 2$ and $C_T = 0.2$ gives $\eta \approx 0.92$.

Aerodynamic Characteristics in Hover

In the hovering condition, rotor force coefficients become infinite,

and a separate use of the momentum theory determines the value of V , C_{T1} , and P .

The momentum area being assumed to be $A_T = b_o D$, one has

$$W = \rho A_T V (2V)$$

Hence,

$$V = \sqrt{\frac{W}{2\rho A_T}}$$

Also,

$$C_{T1} = \frac{W}{S \frac{1}{2} \rho V^2} = 4 A_T / S$$

and

$$P = P_p + WV$$

$$P = \frac{K_p C_{Dbo} S}{4\sqrt{2p}} \left(\frac{W}{A_T}\right)^{3/2} + W \frac{1}{2p} \left(\frac{W}{A_T}\right)^{1/2}$$

9. The Wright Field World War II Cyclogiro Project

It would seem that Heaver, who had been associated with Dr. Kirsten at the University of Washington in the 1930's, promoted interest in the cyclogiro at Wright Field at the beginning of World War II. As a result, analyses and preliminary design studies were performed and wind tunnel tests sponsored at the University of Washington. This effort was stopped, like many others, following the end of World War II.

The culmination of the Wright Field effort was the design of a fighter aircraft, designed on the same basis as the Bell XP-77. An artist conception of the cyclogiro aircraft is shown in Figure 59. Its general characteristics (taken from Reference 30H) are as follows:

Rotor

- High-Pitch System
- Range 1.25-20 Pi Pitch
- 3 Blades per Rotor
- Tandem Sets of Rotor
- Counterrotation of Fore and Aft Rotor Systems
- Total Blade Area = 90 ft.²
- Area of One Blade = 7.5 ft.²
- Span of One Blade = 6 ft.

Rotor Span = 15.5 ft.
 Blade Taper = 7.3
 Blade Section: NACA 0012 Series

Fuselage

Length - 25 ft.
 Width - 3.5 ft.
 Height - 6 ft.

Engine

Type W770-9
 Normal - 465 HP @ 12,000 ft.
 Military - 450 HP @ 27,000 ft.
 515 HP @ 12,000 ft.
 500 HP @ 27,000 ft.

A weight estimate is shown in Table V.

Estimated performance, calculated in accordance with the 12-point average method, discussed in the previous paragraph, is shown in Figure 97.

A performance comparison (estimated) with the Bell XP-77 airplane is as follows:

	<u>XP-77</u>	<u>Cyclogiro</u>
High Speed at Sea Level	327 MPH	340 MPH
High Speed at 27,000 Feet	420 MPH	428 MPH
Max. Rate of Climb, Sea Level	3,050 ft/min	2,900 ft/min
Max. Rate of Climb, 27,000 Feet	2,020 ft/min	2,000 ft/min
Speed Range (V max/V min)	4.5	8.5
Gross Weight	3,700 lbs	3,900 lbs

The cyclogiro and the XP-77 have the same engine, same armament, and approximately the same gross weight.

It will be noted that the above cyclogiro was not designed for hovering flight. However, its speed range is substantially in excess of that of the fixed-wing fighter.

The Wright Field conclusions (Reference 30H, 1943) were as follows:

1. The aerodynamic efficiency of the cycloidal propeller (rotor propulsion-lift device) appears to be superior to that of the conventional screw propeller and wing system.

TABLE V. WEIGHT ESTIMATE, WRIGHT FIELD CYCLOGIRO
FIGHTER (Reference 30H)

Design Gross Weight		3,900 lbs
Weight Empty		<u>2,686</u>
Rotor Group		
12 Blades	282	
12 Spindles	92	
2 Rotor Structures	258	
2 Rotor Mechanisms	140	
Body Group		275
Alighting Gear		
Main Landing Gear	202	
Auxiliary Landing Gear	90	
Powerplant Group (Less Propeller)		994
Engine (As Installed)	835	
Engine Accessories	47	
Powerplant Controls	5	
Starting System	22	
Lubricating System	10	
Fuel System	75	
Fixed-Equipment Group (Less Surface Controls)		523
Instruments	39	
Electrical	105	
Communicating	144	
Armament Provisions	183	
Furnishings	37	
Service Pickup	15	
Useful Load		<u>1,014</u>
One Crewman Plus Chute		180
56 Gallons Gasoline		336
4.6 Gallons Oil		35
Two 50-Caliber Guns		135
50 Caliber - 400 Rounds Ammunition		125
One 20-mm. Camera		135
20-mm. Ammunition (100 Rounds)		62
Gun Sights (N-7)		3
Gun Camera (ANN-4)		3

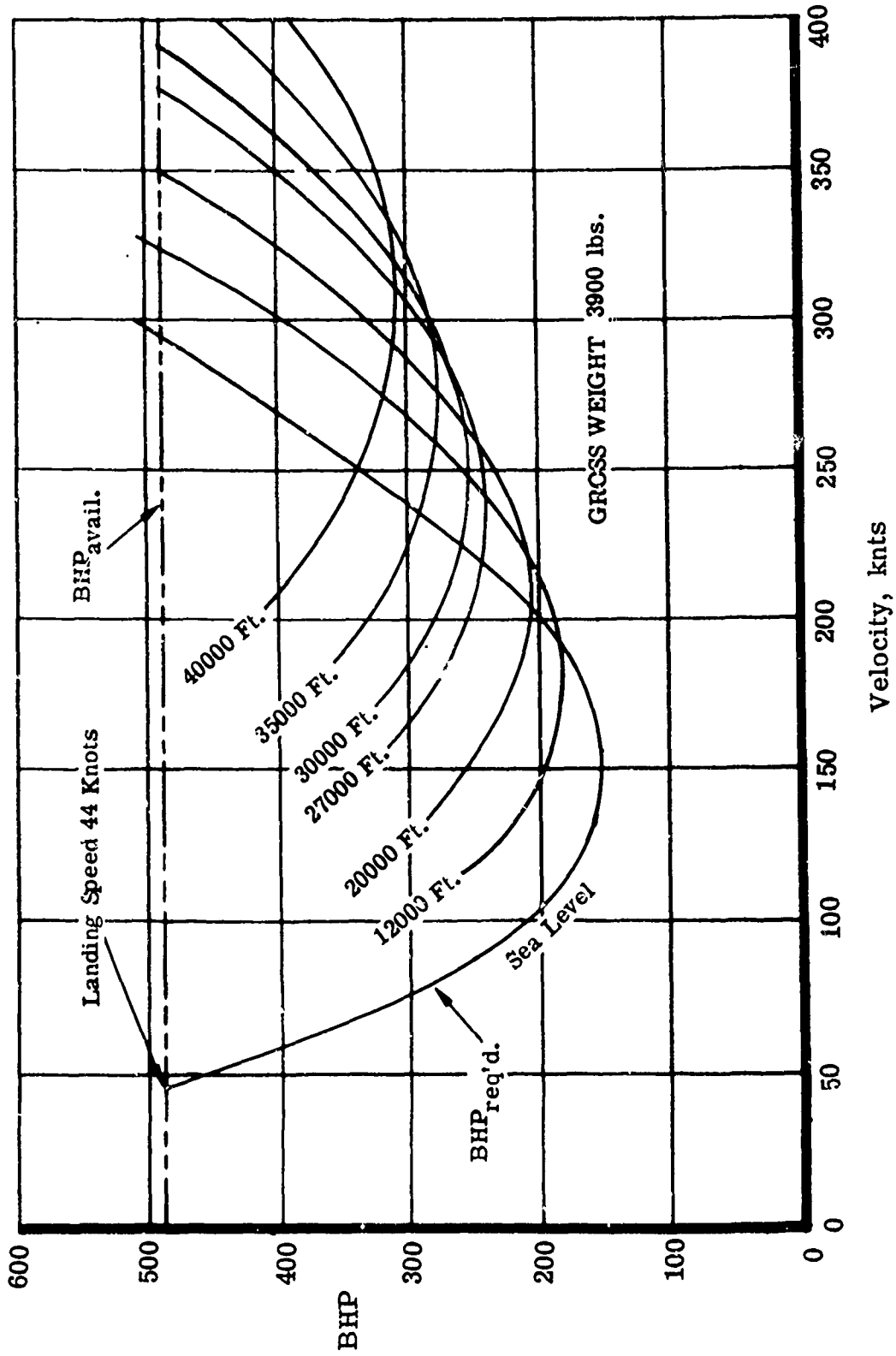

Figure 97. Theoretical Performance and Power Requirements of The Wright Field WW II Cyclogiro Project (Ref. 30H).

2. For conventional fighter power loadings, hovering flight can be attained only at low wing loadings, due to the limitations of the pitch-change mechanism.

3. The following advantages and disadvantages as compared with conventional fighters of the same power and useful load can be identified:

a. Advantages

- (1) possibility of greater speed range
- (2) possibility of high rate of roll and lower radius of turn
- (3) somewhat improved visibility from the cockpit
- (4) appears to be conveniently adaptable to nose armament installation
- (5) lower external noise level due to cycloidal propellers instead of screw type

b. Disadvantages

- (1) increased structural problems
- (2) increased flutter and vibration problems
- (3) possibility of stability and control difficulties
- (4) increased mechanical problems

4. In the design studied, due to the inherent size of the fuselage, it appears to be feasible to use more power than that shown in the preceding analysis with little increase in airplane drag. Hence, increased performance should be attained, giving higher speeds, higher rates of climb, and possible hovering flight.

Further analyses of the cyclogiro fighter design by the Wright Field Propeller Laboratory were reported in July 1944 (Reference 39B). The report noted the following:

1. It appears that large oscillatory aerodynamic forces and torques are present in the rotor system discussed above.
2. Oscillatory forces and torques can be eliminated by revision of blade angle changing mechanisms or by entire redesign so that blade angles will conform to those required by the theoretical analysis.
3. Experimentally determined rotor efficiencies that compare favorably with values for conventional

airplane propeller and wing systems have been obtained in recent tests.

4. The stresses, as calculated for maximum applied load factor pullout from a terminal velocity dive in a fighter aircraft, are approximately twice the allowable stresses for the assumed type of construction (1943-1945 hollow steel type of construction of propellers).

5. Mechanical and vibrational difficulties and stress considerations appear to indicate that this type of aircraft would not have been suitable for use as a fighter. It is believed, however, that this type of aircraft would be feasible for use where flight velocity and load factors were not so great.

6. This type of aircraft is capable of hovering flight.

7. Further tests of existing rotor mechanisms are necessary to ascertain the degree of oscillatory forces and torques and the magnitude of the stresses encountered.

As a result of the conclusions of Reference 39B, additional work was performed by Eastman at the University of Washington under the auspices of the Army Air Forces. This work was concentrated on the solution of the problems noted above; i. e., the development of more satisfactory cyclogiro control mechanisms and the correlation of theoretical analyses with test results (results of wind tunnel tests were the only ones available). Much of the earlier discussion of this chapter was borrowed from Reference 39B. Eastman made his own preliminary design, which is shown in Figure 78. Calculated performance (not reproduced in this report) confirmed the Wright Field results; i. e., higher maximum speed, higher rate of climb, and higher speed range for the cyclogiro than for either the airplane of similar characteristics or the helicopter.

Eastman's conclusions (from Reference 39B) regarding the major features of the cyclogiro are still essentially valid at this time. These conclusions are reproduced here:

"Although the theory is somewhat inaccurate when the rotor force is extremely large, model tests covering three different ranges of blade-rocking motion verify the theoretical trends. As a result, the theory predicts the general characteristics of a full-feathering cyclogiro rotor with certainty, and makes reasonably reliable quantitative predictions for specific applications.

"A freely autorotating cyclogiro rotor acts like a multiplane. When its blade rocking motion is adjusted

so that it autorotates slowly at high forward speeds, the advance ratio becomes so high that its characteristics will be essentially the same as those of a multiplane using the same blades and the same blade spacing. The autorotating speed will be fully controllable if a full-feathering mechanism can be perfected. The resulting effect upon rotor characteristics can be compared with that of an unlimited and fully controllable anti-stall device on a wing. If the slight retarding influence of mechanical friction is disregarded, the only apparent limitation on lift coefficient arises from the limitation on downwash angle. The stall is avoided by increasing the autorotating speed. As a result, rotor profile drag becomes larger, but it can be reduced to that of the equivalent multiplane, when high lift coefficient is no longer needed.

"If power is applied gradually so that rotor rpm is steadily increased beyond the autorotating speed, the drag will diminish gradually until it becomes zero. Thereafter, thrust is exerted, which will increase as long as power input is increased. If propulsive efficiency is important, the rocking motion should be changed gradually to avoid blade stalling.

"When the thrust required is negligible, so that the propelling action is used primarily to overcome the drag of the lifting surfaces, a very high advance ratio can be used, and the equivalent propulsive efficiency can exceed 98 per cent. In practice this figure will be reduced slightly by mechanical friction.

"The efficiency based on net thrust, as for example when the rotor replaces a screw propeller on a lighter-than-air craft or on a marine vessel, can be higher than that of a screw. In such applications, however, a more prominent reduction in power required will result from the use of rotor lift action to replace an existing control surface for steering or maneuvering, or for auxiliary sustentation.

"When rotor rpm is gradually reduced below that for autorotation, the drag increases and power is generated by windmill action. Neither the drag nor the power will increase indefinitely. The drag reaches a maximum when the air passing through the rotor is retarded to about half of its original speed; the power reaches a maximum when the air is retarded to about two-thirds of its original speed. To obtain these maximums, the stall is avoided by the use of low advance ratios, and the blade-rocking motion must be adjusted accordingly.

"Within the limits of power available, any combination of lift and thrust can be obtained by adjustment in inclination of the reference axis and in amplitude of the blade-rocking motion. In every case, the optimum rotor rpm, as determined by minimum parasite losses, is only slightly higher than that necessary to avoid blade stalling. When stalling does occur, it starts at one or more points on the orbit and its gradual progress prevents any sudden change in rotor force.

"A full-feathering cyclogiro offers distinct aerodynamic advantages over the screw-propelled airplane. Its span probably will be shorter than that of the airplane, for structural reasons. Nevertheless, its greater slipstream area and the ability to use its lifting surfaces for propulsion should result in higher rate of climb and higher maximum speed with the same power loading. In addition, it should be able to hover, and it should be extremely maneuverable regardless of the flight attitude. Its control will be positive and instantaneous, and since it is provided by the rotor mechanism, no need exists for additional control devices.

"According to the theory, full-feathering motion requires a transition from high-pitch motion, which rocks the blades relative to the reference axis, to low-pitch motion, which turns the blades through a complete revolution for every revolution of the rotor. This introduces a difficult amplified high-pitch motion. The use of this substitute motion will have little influence on the performance of the cyclogiro when it is climbing or when it is in level flight. It may be a handicap, however, in power-off maneuvers at very low forward speed.

"The structural problem is not as serious as might be expected, because rotor rpm will be low when forward speed is high. The problem can be further relieved by reducing the number of blades per rotor, so that a smaller blade aspect ratio will result for the same span. The theoretical blade-rocking motion will give reasonably steady lift if three blades are used per rotor, but the use of two blades per rotor may require a special rocking motion to avoid objectionable pulsations. The advantage arising from the use of fewer blades leads to conjecture regarding the employment of only one blade per rotor. Certainly this final step can be taken in gliding flight, for which rotor rpm normally will be zero, and for which a slow rotation will serve to reduce the gliding angle. In powered flight, it may be possible to compensate for the pulsations in the lift of a

single moving wing. A study of this possibility should be made, recognizing that the use of a conical, rather than a cylindrical swept surface, may lead to a machine having the advantages of a cyclogiro without sacrificing any of those of the airplane."

10. Cyclogiro Test Data

Hover

Test data show incontrovertible evidence that cyclogiro rotors are capable of hover flight. They further indicate that conventional screw momentum theory is applicable, if one uses as the area of the accelerated flow the projected area of the rotor cylinder A_T defined previously. A comparison of cyclogiro and helicopter shows that the momentum area of the cyclogiro in hover is likely to be significantly lower than that of the corresponding helicopter (two to three times). This means a higher power loading in hover for the cyclogiro than for the helicopter. For a composite aircraft application (VTOL with maximum speed greater than 300 knots), a high power loading is required for the high-speed condition; therefore, a high power loading in hover is not likely to be detrimental from the standpoint of installed power. From the standpoint of environmental effects (downwash velocity), this is another matter. The cyclogiro is not likely to be competitive for a "disc" loading of 10 lbs/ft²; a disc loading around 30 lbs/ft² seems to be more appropriate.

The static thrust of several old low-pitch cyclogiros is plotted in Figure 98 in the form of C_T against C_P , where

$$C_T = \frac{T}{\rho \omega^2 R^3 b}$$

$$C_P = \frac{P}{\rho \omega^3 R^4 b}$$

T = cyclogiro rotor thrust

ρ = air density

ω = cyclogiro rotor angular velocity

R = cyclogiro blade axis distance to center of rotation

b = cyclogiro rotal span

P = power required

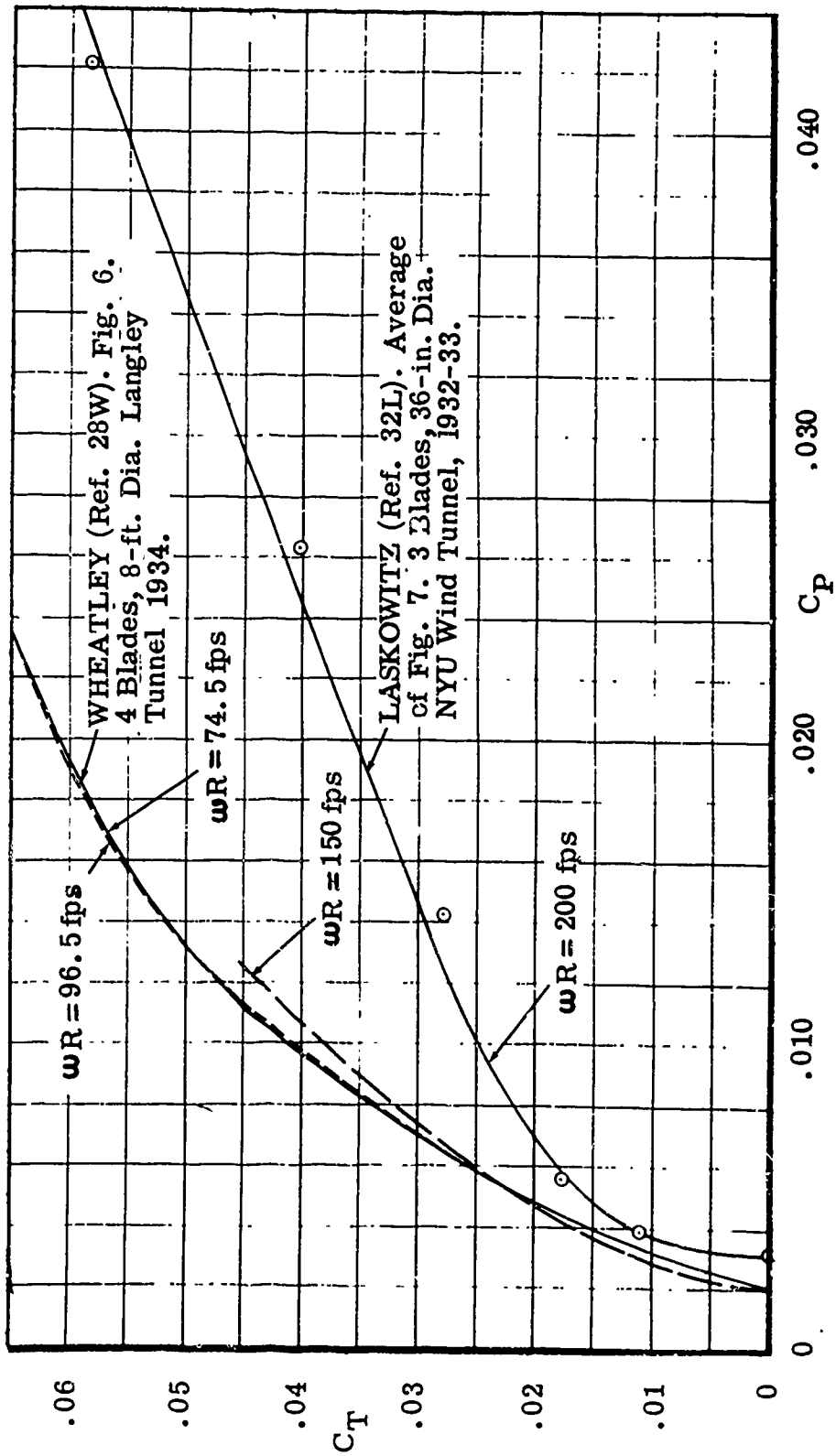

Figure 98. Comparative Static Lift Power Loading of Two Low-Pitch Cyclogiro Systems, With Variation in β and at Several Tip Speeds. Blades Alone.

The data of Figure 98 are replotted in Figure 99 in the familiar form of the figure of merit M versus the mean lift coefficient C_T/σ . C_T/σ for a cyclogiro may not have much meaning, but it is a convenient parameter σ , for a cyclogiro is defined (following Wheatley) as the ratio of the total blade chord to the peripheral length of the rotor cylinder.

$$\sigma = \frac{bc}{2\pi R}$$

where

b = the number of blades

c = the blade chord

The figure of merit is defined as usual as

$$M = .707 \frac{C_T^{3/2}}{C_Q}$$

All available test points are plotted and compared with typical helicopter results. It can be seen that most cyclogiros have performed in hover with a very poor efficiency. The exception is Moineau, with a figure of merit of 0.83. This definitely indicates that the hover potential of the cyclogiro is there, but the proper blade pitch mechanism is required for its exploitation.

A comparison made of calculated and measured lift per horsepower by Wheatley (References 25W and 28W) is shown in Figure 100. It reveals that the measured data fall very short of the theoretical predictions, especially in hover and at high speed. Again, this indicates the use by Wheatley of a poor feathering system (see Reference 58R).

Autorotation

The ability of a cyclogiro to autorotate is also beyond question. A typical comparison of calculated and measured data is shown in Figure 101.

Forward Flight

Three series of wind tunnel tests form the basis for our experimental knowledge of cyclogiro performance in forward flight. These data were analyzed thoroughly by Eastman in Reference 2E. The significant dimensional, theoretical, and measured characteristics of these models are shown in Table VI, and the general test arrangement is indicated in Figure 102.

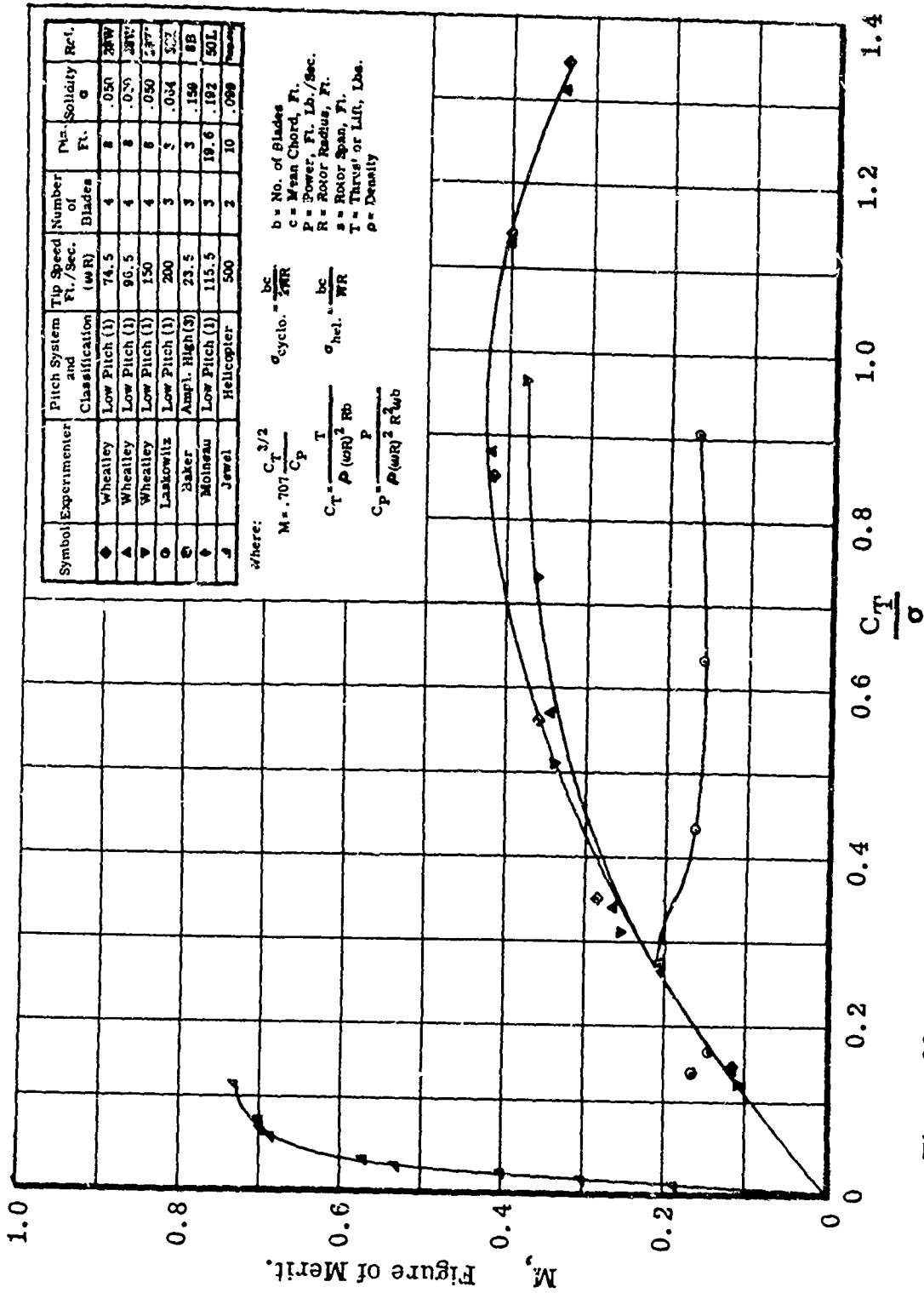

Figure 99. Hovering Figure of Merit vs. Thrust Coefficient / Solidity for Four Cyclogiro Systems and One Helicopter.

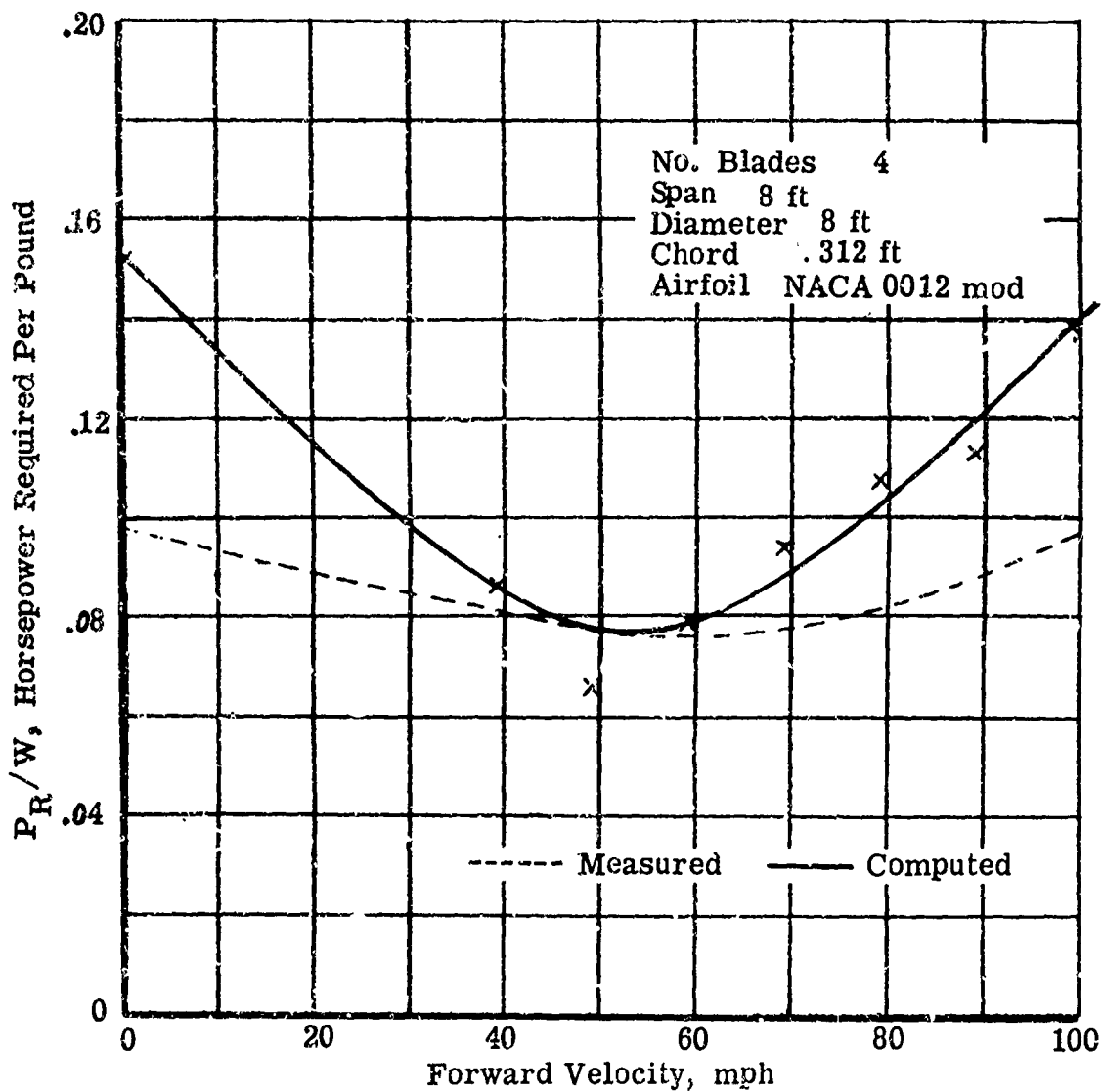

Figure 10J. Theoretical and Measured Lift Per Horsepower at Forward Speed for a Low-Pitch Cyclogiro. Wheatley NACA, Refs. 25W and 28W.

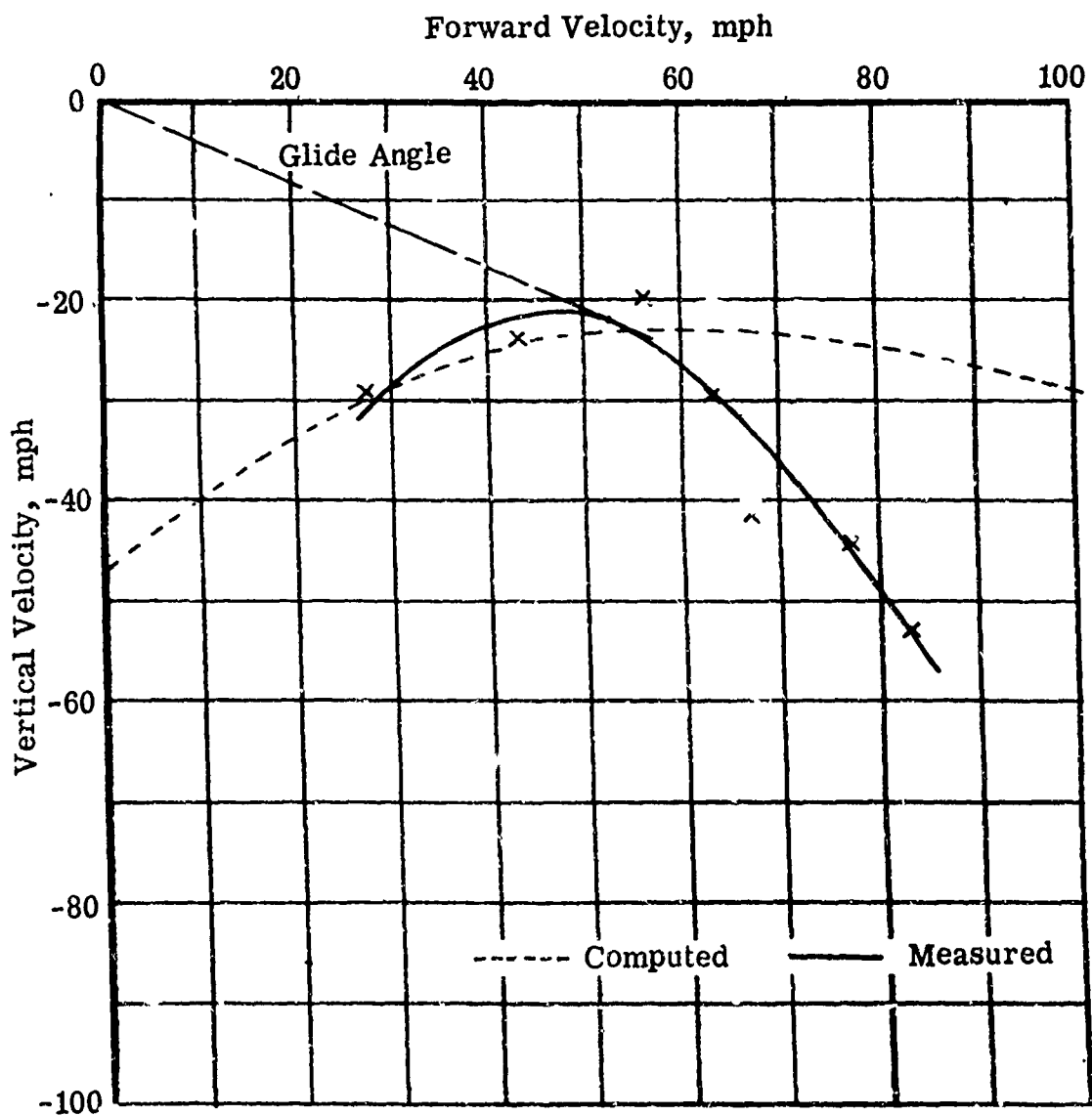
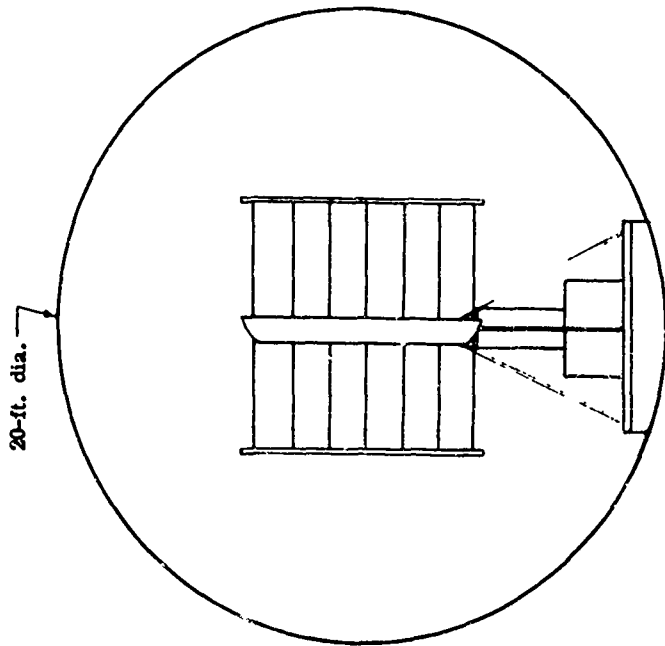

Figure 101. Theoretical and Measured Autorotation Gliding Polar Curve for a Low-Pitch Cyclogiro. Wheatley NACA, Refs. 25W and 28W.

TABLE VI. COMPARATIVE CHARACTERISTICS OF THREE CYCLOGIRO WIND-TUNNEL MODELS. See Also Figure 102.

	HIGH-PITCH MODEL	PI-PITCH MODEL	LOW-PITCH MODEL
Rotor arrangement	Two, counter-rotating	Two, with fuselage	One, both ends open
Blade rocking motion	Distorted Harmonic	Ideal, $m = 1$	Harmonic, relative to rotor
External bracing	None	Ties between blade tips	28 arms radiate from shaft
Root blade section	NACA 0025	Circular arcs	NACA 0012 (cambered to conform with mean blade path)
Tip blade section	NACA 0009	Circular arcs	NACA 0012 (cambered to conform with scan blade path)
Hinge position, c	1/4	1/2	1/4
Orbit diameter, ft	3	1.667 (1.5 at root, 1.833 at tip)	8
Overall span, b, ft	- - -	5.17	8
Blade span, b_0 , ft	6	4.33	8
Blade chord, ft	0.5 (0.667 at root, 0.333 at tip)	0.354 (0.312 at root, 0.396 at tip)	0.3125, no taper
Blades per rotor	3	2	4
Total blade area, S	9	3.07	10
Blade angle, β°	90	45	Variable
Air speed, v, ft/sec	99	33	Varied while $\pi n D = 150$
C_{Tmax} , measured (and for theory)	0.78	0.75	0.75
C_{p50} , measured (equiv. for theory)	0.017	0.039	0.038
	"	0.04	0.039
dC_{Tb}/dC^2_{lb} , for theory	0.01	0.0336	0.0336
$dC_{Tb}/d\alpha$ b : for theory	5	5	5
Reference No.	8B, 1E, 2E, 30H	20K, 24K, 30K	25W, 28W



LOW-PITCH MODEL

OPEN JET
 NACA - Langley
 Ref. 28W

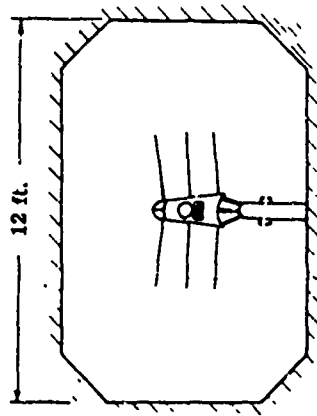

PI-PITCH MODEL

ENCLOSED JET
 University of Washington
 Refs. 20K and 24K

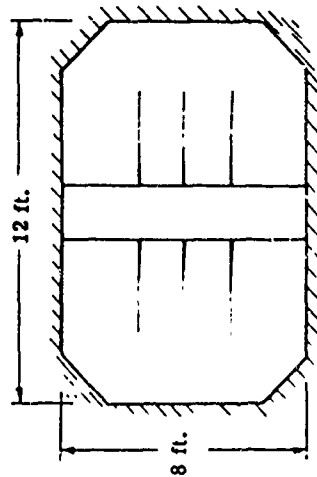

HIGH-PITCH MODEL

ENCLOSED JET
 University of Washington
 Refs. 8B, 1E, and 2E

Figure 102. Wind Tunnel Arrangement of Three Comprehensive Cyclogiro Studies Covering All Pitch Feathering Types in Forward Flight. See Table IV for Details of Test Models. From Refs. 2E.

The low-pitch model consisted of the single-rotor NACA arrangement of Figure 73. It had four high-aspect-ratio blades, each attached to a central axle by means of seven radial arms. All of the arms and axles were exposed to the airstream. After the uncertain influence of this bracing is allowed for, some doubt remains regarding the true rotor characteristics. As previously mentioned, the low-pitch feathering mechanism used here became progressively less satisfactory when operating at other than small advance ratios.

The comparative pi-pitch model (Figure 75) with fuselage and three cantilevered rotor blades turns two rotor systems with the top blade advancing and moving down. The driving torque in this instance adds a positive pitching moment about the spanwise axis (Figure 84). The double-edged blades are hinged at their midchord, because the leading edge must become the trailing edge on alternate revolutions. The blades are tapered so that their chord increases while their thickness decreases toward the tips. There was also a slight increase in orbit diameter toward the tips of the blades which would result in a spanwise variation in the advance ratio, which aggravated the unfavorable influence of the blade planform on spanwise lift distribution. The lack of root fillets of the blade was considered to have a definite detrimental effect on the overall effective span of the rotor system.

Several high-pitch and amplified high-pitch models were tested at the University of Washington. A typical configuration that corresponds to Baker's amplified high-pitch configuration (Reference 8B) is shown in Figures 76 and 77. The model consisted of two rotors, with a common horizontal axis, mounted on opposite sides of a central wind tunnel fairing and turning in opposite directions (for torque compensation). Blade-rocking amplitude was adjustable by changes of a quick-throw linkage. When the amplitude of the motion was small, ideal blade motion was closely approximated; for large amplitudes, however, serious discrepancies were introduced. In addition, the lack of good blade root fillets lessened the effective rotor span.

Eastman (Reference 2E) attempted to reduce and unify the test data, in an effort to support a full-feathering cyclogiro theory. As a whole, he was remarkably successful. Some of his typical results are shown in Figures 103 through 107, which must be viewed together with the results of the earlier discussion on cyclogiro aerodynamics, since theoretical and test results are presented simultaneously. Notations of Figures 103 through 107 are the same as those used for the earlier theoretical discussion.

Figure 103 shows the cyclogiro polar curve for a pi-pitch configuration. Figure 104 shows the same curve for a

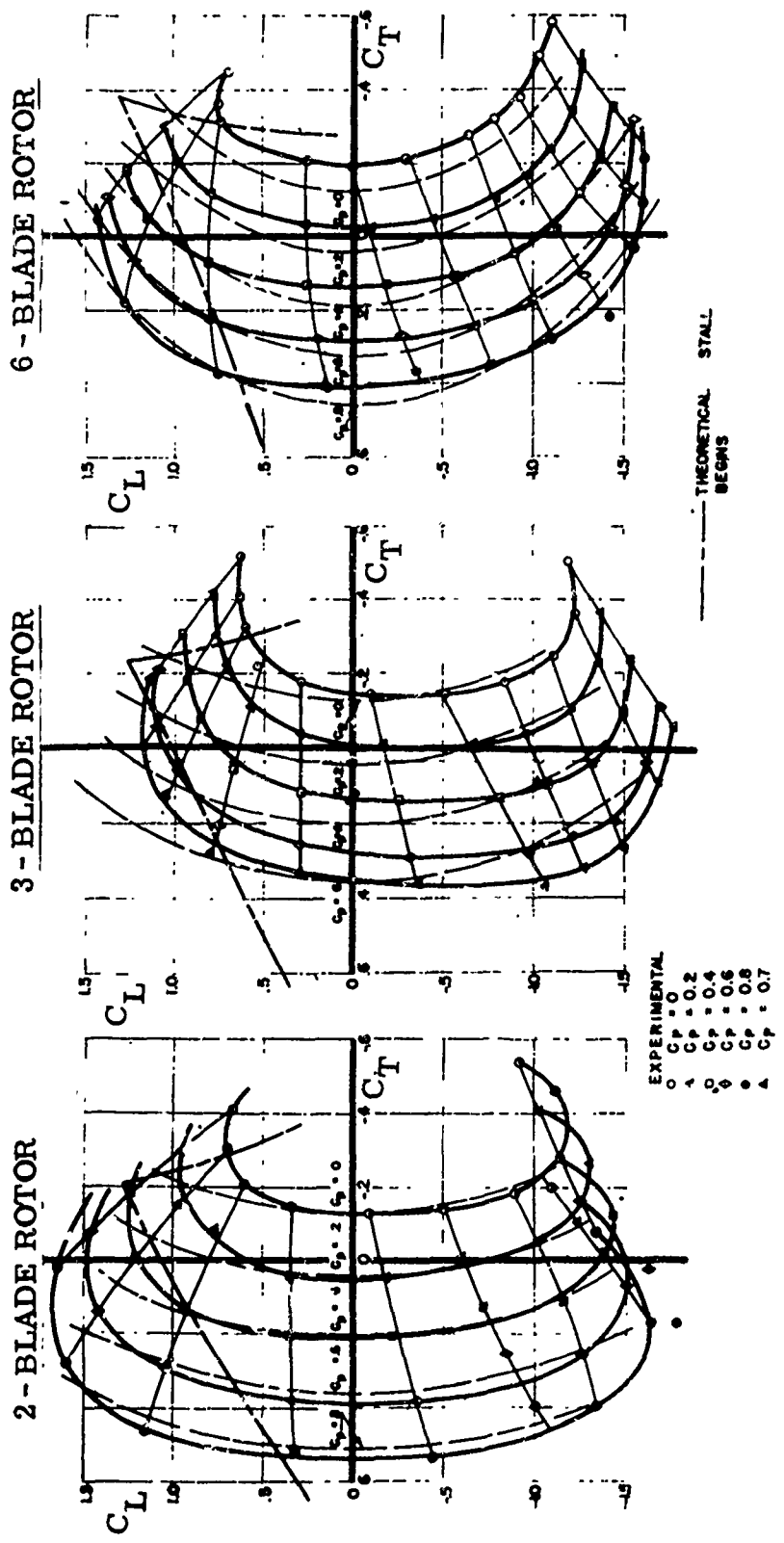

Figure 103. Experimental and Theoretical Lift-Thrust Polars for the Pi-Pitch Cyclogiro Model With Variations in the Number of Blades per Rotor. (Ref. 2E).

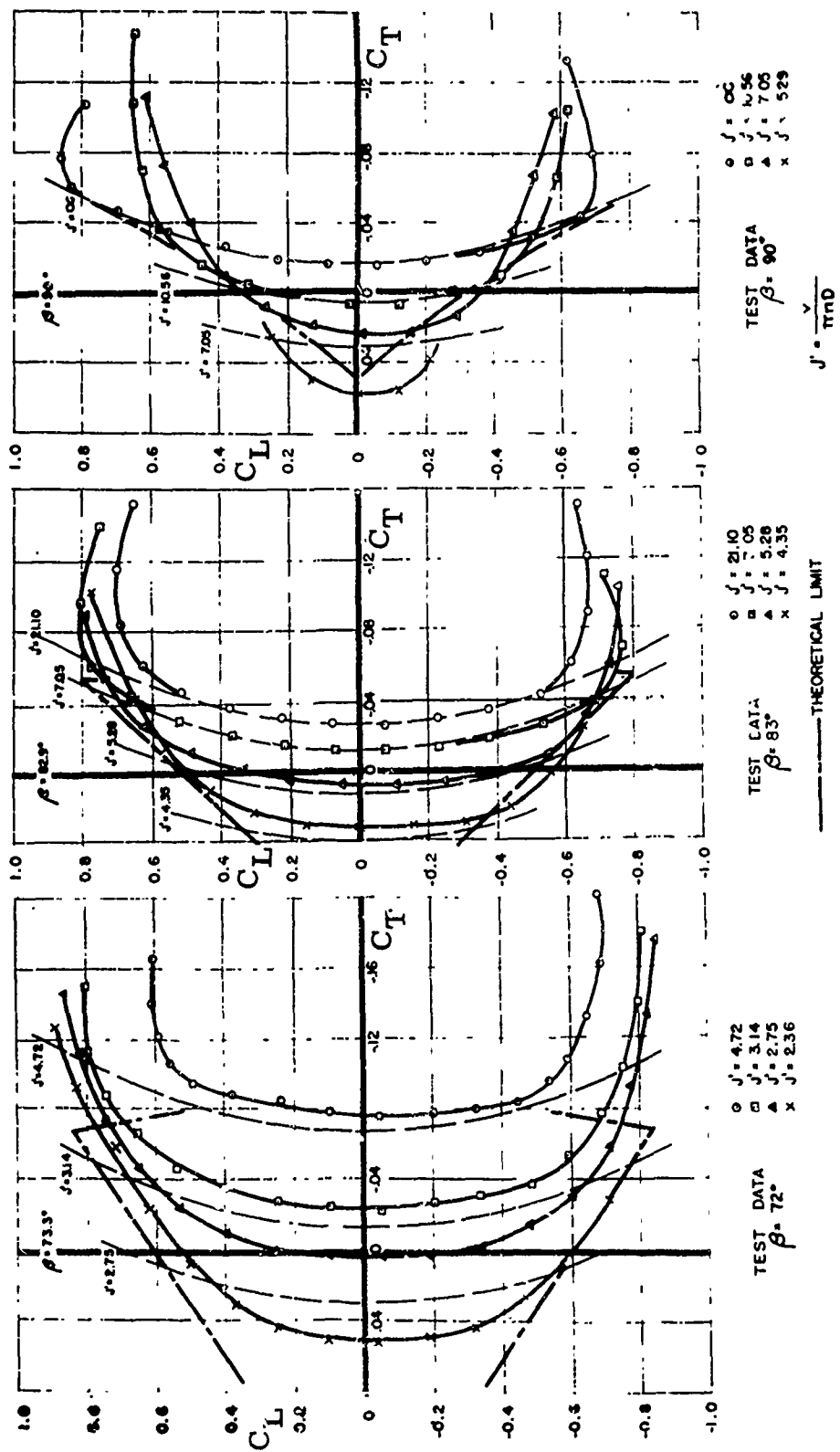

Figure 104. Experimental and Theoretical Lift-Thrust Polars for the High-Pitch Cyclogiro With Three Variations in the Rotor Blade Rocking Amplitude Angle (Refs. 1E and 2E).

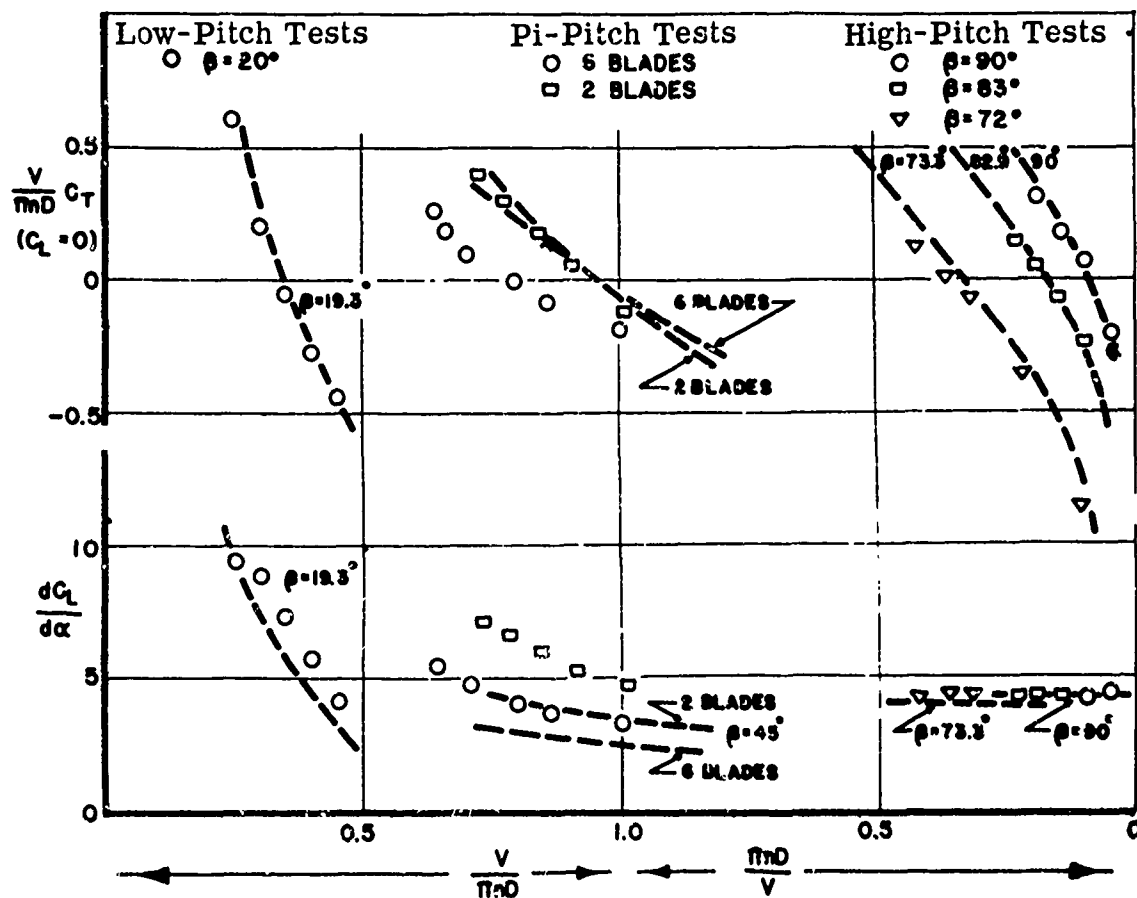

Figure 105. Experimental Values and Theoretical Variations of $dC_L/d\alpha$ and C_T at Zero Lift for Three Full Ranges of Pitch Ratios (Ref. 2E).

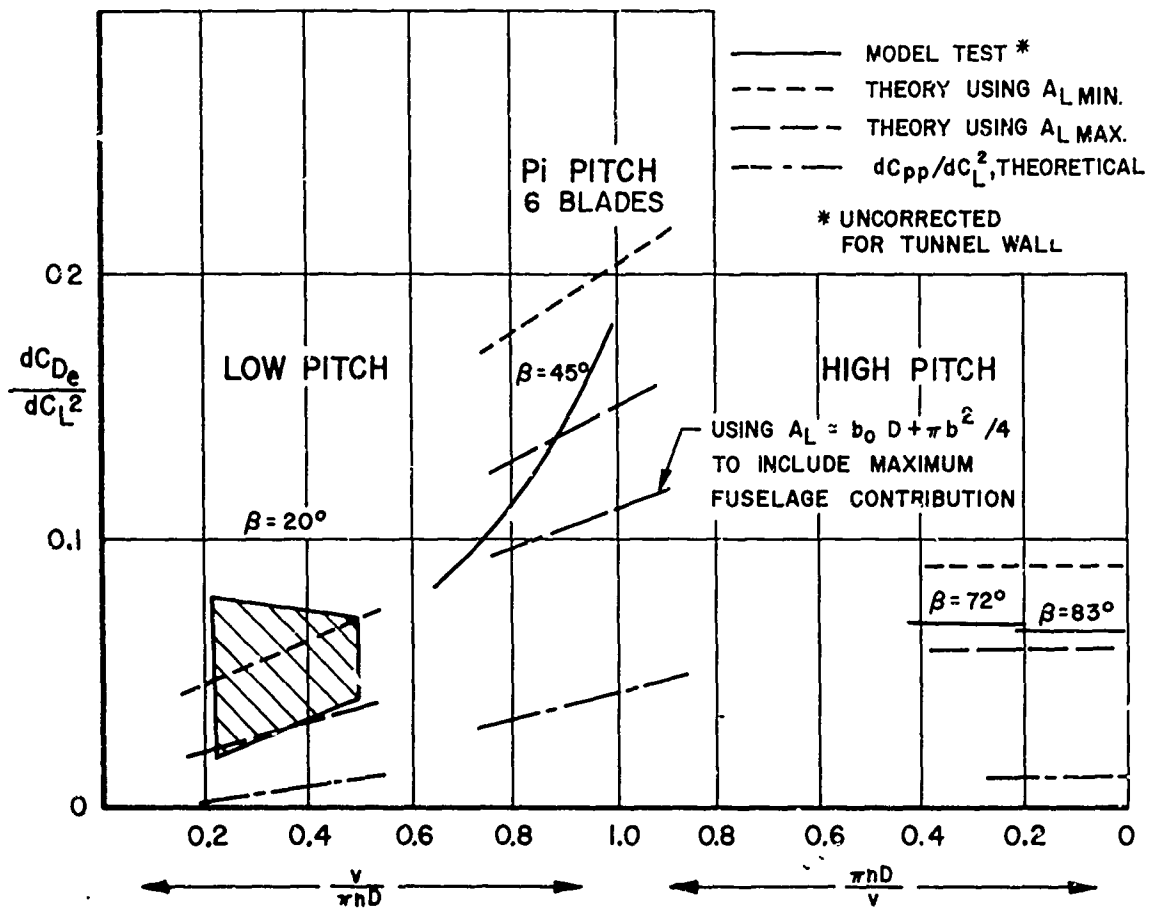

Figure 106. Experimental and Theoretical Values of $\frac{dC_{De}}{dC_L^2}$

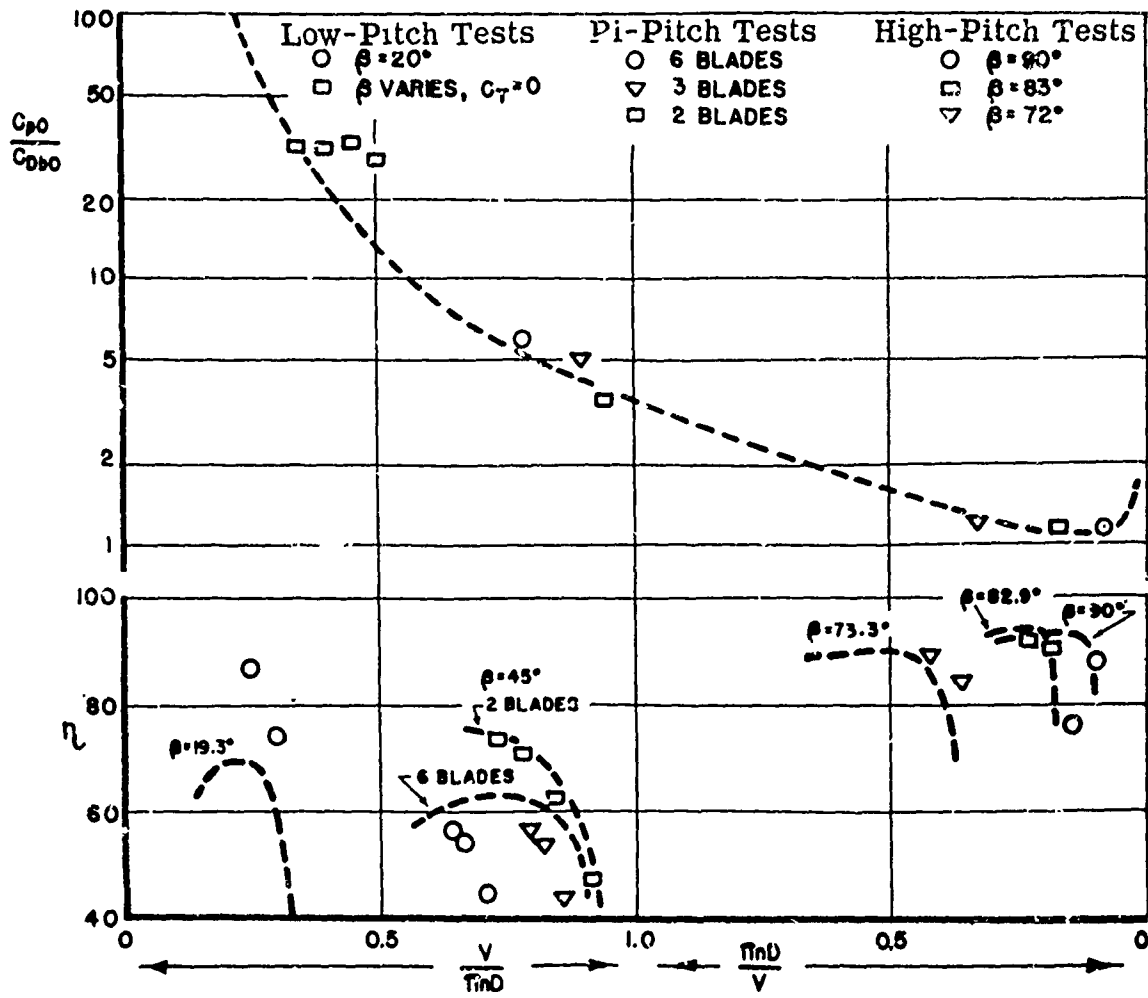

Figure 107. Experimental and Theoretical Values of Equivalent Propulsive Efficiency and of No-Load Power Coefficient for Three Full Ranges of Pitch Ratios (Ref. 2E)

high-pitch configuration. General agreement between theory and experiment can be noted in both cases, at least at low values of C_L .

In Figure 105, Eastman plots thrust (at no lift) against advance ratio in the upper figure and lift against advance ratio in the lower figure. α in the lower figure is the overall cyclogiro rotor angle of attack, which corresponds to the angle of attack of the equivalent wing.

In Figure 106, dC_{D_e}/dC_L^2 , the slope of the "polar curve", is plotted versus advance ratio, the theoretical value being successively based upon several assumed values of the area A_L . In general, test data fall between extreme values of A_L .

In Figure 107, experimental and theoretical values of equivalent propulsive efficiency and of no-load power coefficient are compared.

11. Helicopter With Auxiliary Cycloidal Rotor Propulsion and Control

It has been but one thought more for several engineers to propose the perpendicular attachment of short cyclogiro-type blades to the tip of helicopter blades. If one can overlook the disturbing feeling this may cause, due to the mechanical and aerodynamic difficulties, this scheme is not without interest. The intent is that, as the untilted lifting helicopter rotor revolves, the tip cyclogiro blades feather so as to produce thrust in the azimuth plane of the rotor. The Pemberton Billing proposal (References 37B and 8P) of the helicopter with biplane rotors is an example of this system (Figure 108).

Although the use of such a full system to produce all of the required flight thrust may be questioned, Nemeth (Reference 14N) has suggested the use of smaller tip cycloidal blades to provide a lateral trimming force to balance that originating from the antitorque rotor in a single-rotor helicopter. The Gyrodyne QH-50 coaxial helicopter incorporates small cyclogiro-like blades at the rotor tips to produce differential rotor torque spoiling for yaw control. There exists the possibility that such a secondary cycloidal blade arrangement may have future uses as an ancillary control source in the helicopter rotor.

Proposals and patents have suggested the use of the cycloidal rotor at the tail of the single-rotor helicopter configuration in place of the familiar tail rotor (Figure 109). In one instance, as demonstrated in the patent by Pullin (Reference 52P), the tail-mounted cycloidal rotor rotates about a horizontal axis which is aft and parallel to the centerline of the helicopter. In this case, the cycloidal rotor produces the torque-compensating side thrust. Also in

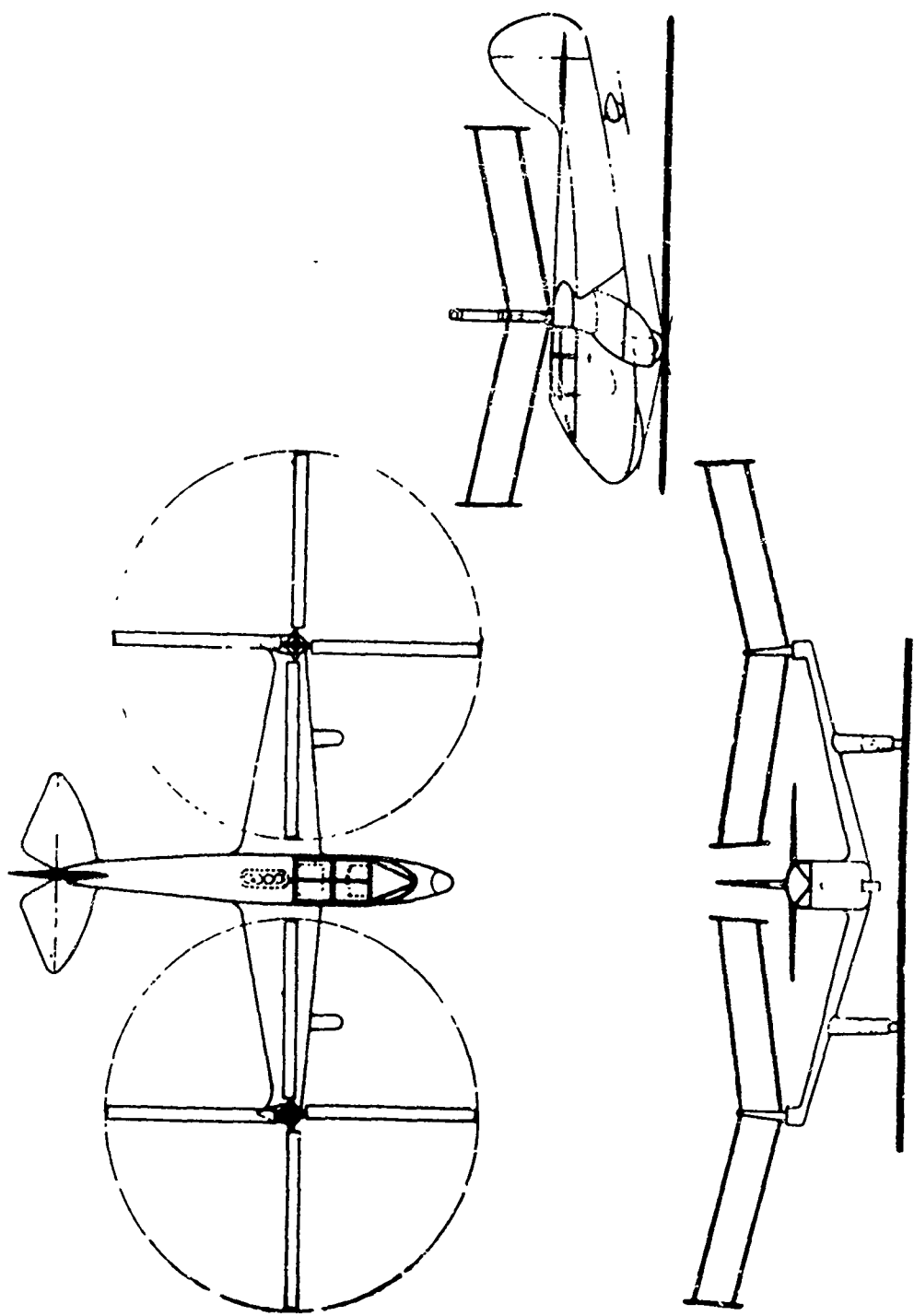

Figure 108. Pemberton Billing Helicopter Project With Tip Rotor Cycloidal Propeller Blades for Azimuthal Thrust (References 37B and 8P).

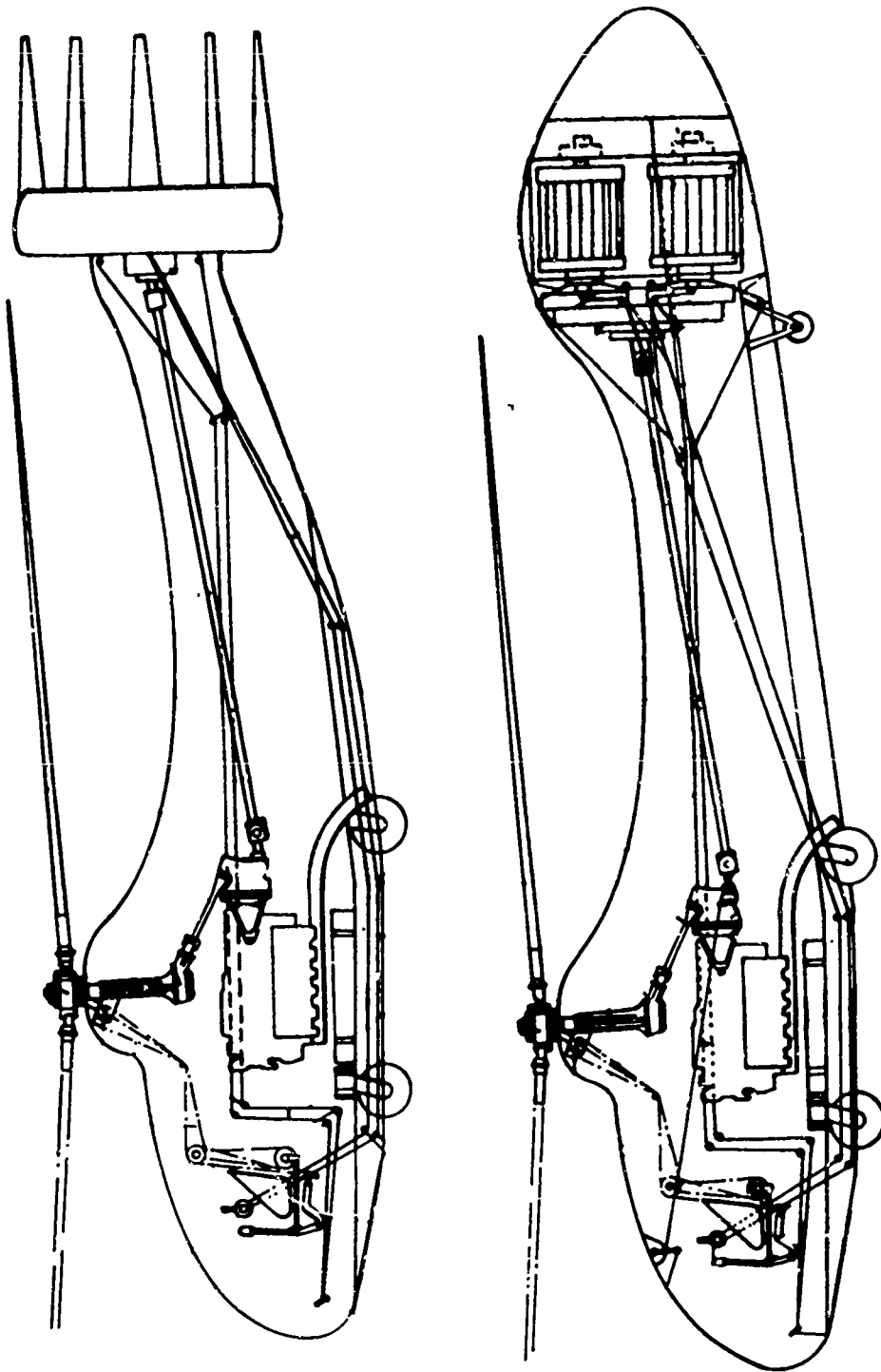

Figure 109. Application of The Cycloidal Rotor for Helicopter Torque Control and Main Rotor Tilt. The Bulk and Drag of The Single Cycloidal Rotor in The Upper Picture is Reduced by The Use of Double Rotors as Shown in The Lower Picture. Design Suggestion by Pullin (Ref. 52P).

this arrangement, this tail rotor may produce a force throughout the azimuth of its rotation by the proper manipulation of its feathering control. It now would become possible to produce a vertically upward tail force that could be used to incline the main helicopter rotor for forward flight.

Of more interest in this respect would be the tail installation of the cycloidal rotor with its axis vertical. In this manner, a combined torque-compensating side force as well as the primary center-line propulsive thrust could be generated. In this latter instance, we could envision a single-rotor compound helicopter with aft cycloidal propulsion.

12. Evaluation of Cyclogiro Aircraft Potential

The potential of the cyclogiro aircraft comes from the fact that it is just about the only known type of aircraft that can combine the high-speed characteristics of the conventional airplane with the low-speed characteristics of the helicopter, without drastic changes in geometry, using the same elements in both flight conditions. This makes the cyclogiro a candidate for the U. S. Army "aircraft composite" mission.

Advances since World War II in propulsion, in materials technology, and in mechanical systems indicate, at least in a preliminary way, that most of the problems identified by Heuver and Eastman can be overcome. Preliminary design of a cyclogiro aircraft for the Army composite mission is presented in the next section.

C. HORIZONTAL-AXIS PROPELLERS WITH CYCLIC PITCH: THE RICHARD HELICOPLANE

1. General Description

In the same way that the cyclogiro rotor can produce lifting as well as propulsive forces by cyclic feathering of its blades, a propeller with a horizontal axis can be made to produce a vertical lift force, as well as a horizontal thrust, by varying in the proper way the pitch of the blade during its circular trajectory.

The concept of articulating conventional propellers can be found in many sources; for example, it was proposed and incorporated by Zimmerman in the XF5U-1 "Flying Pancake" airplane shown in Figure 110. However, the specific concept of incorporating cyclic pitch into a propeller represents the life's work of G. C. Richard, a Frenchman, who first proposed what he called the "helicopter" in 1932, leading to full-scale tests of a 12-foot rotor by O. N. E. R. A. at the Chalais-Meudon wind tunnel in 1948, as shown in Figure 111.



Figure 110. Vought XF5U-1 Aircraft With Potential Performance Range From 0 to 450 Knots. Yawed Propellers Were Subject to Large Vertical Radial-Lift Forces in Forward Flight. See Refs. 66L and 67L.

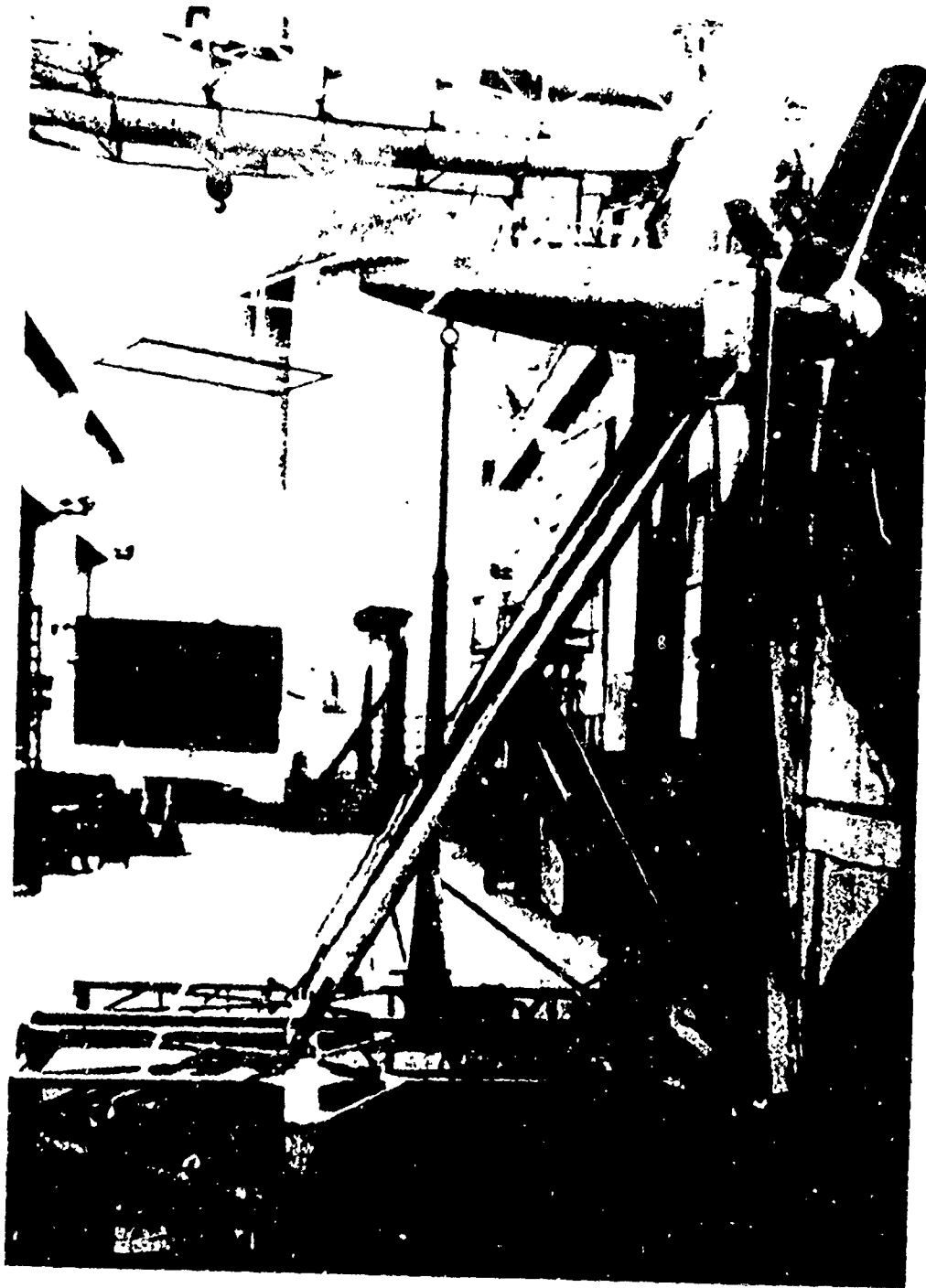

Figure 111. Helicopter Richard Test Propeller in Chalais-Meudon Wind Tunnel (1948). See Refs. 10H, 31R, 34R-36R, 50-80.

The helicopter is defined as an aircraft with one or several rotating wings that have a horizontal axis, oriented in the direction of flight. The blades of the rotors are subjected to a cyclic variation of the aerodynamic circulation, which can itself be obtained by a cyclic variation of the pitch of the blades. In contrast to the helicopter, the helicopter obtains its lift by means of the collective pitch and its forward (or side) propulsion by the cyclic pitch; the helicopter obtains its thrust (forward propulsion) by the collective pitch and its side force (lift) by the cyclic pitch. Thus, it stands to reason that the helicopter will be more efficient in hover, and the helicopter will be more efficient in forward flight.

2. Principle of the Helicopter

The concept can best be described by referring to Figure 112A. Figure 112A shows schematically a conventional propeller, with a fairly large amount of twist, rotating around a horizontal axis and moving with a forward velocity V . Airfoil sections of the two-bladed propeller are shown as they pass through the horizontal plane. The descending blade has a rotational speed v , and the airfoil operates at the angle of attack α , giving rise to a resultant force R , which has components P_1 , normal to the propeller disc, and S in the plane of the disc. Since the angle is constant around the azimuth, the resultant force for the ascending blade B is still R , but its components are P_2 and S' , respectively. The contribution of the two blades to the propeller thrust is $P_1 + P_2$, parallel to the propeller axis. S and S' are equal and opposite, and therefore their vertical resultant is zero. The forces S and S' contribute additively to the propeller torque.

Consider now Figure 112B, which schematizes a cyclically variable pitch propeller, the cyclic variation taking place around the axis $00'$, as shown. Assume that the pitch of the blade at A is the same as in Figure 112A, but that a cyclic-pitch mechanism allows the descending blade to pivot around the axis $00'$ as it describes the arc AMB , so that the change in pitch over the pitch at A is the angle β . Let us assume that the angle β is larger than the original angle α ; since the resultant velocity V_a is constant, the angle of attack α' of the ascending blade B with V_a is in the opposite direction of the corresponding angle at B in Figure 112A. Consider then the aerodynamic resultant R_1 at B . It has a component P_1 , parallel to the free-stream velocity, which is a drag, and an upward component S_1 , which adds to the lift and acts in the same direction as the rotor torque.

The propeller disc is seen to be divided into four quadrants: descending, propulsion, ascending, and propulsion again. In the descending quadrant, a lift force and a propulsive force are created; in the following propulsion quadrant, a propulsive force is created; in the ascending quadrant, a lift force and a negative propulsive force (drag) are created; finally, the last quadrant is also mostly propulsive.

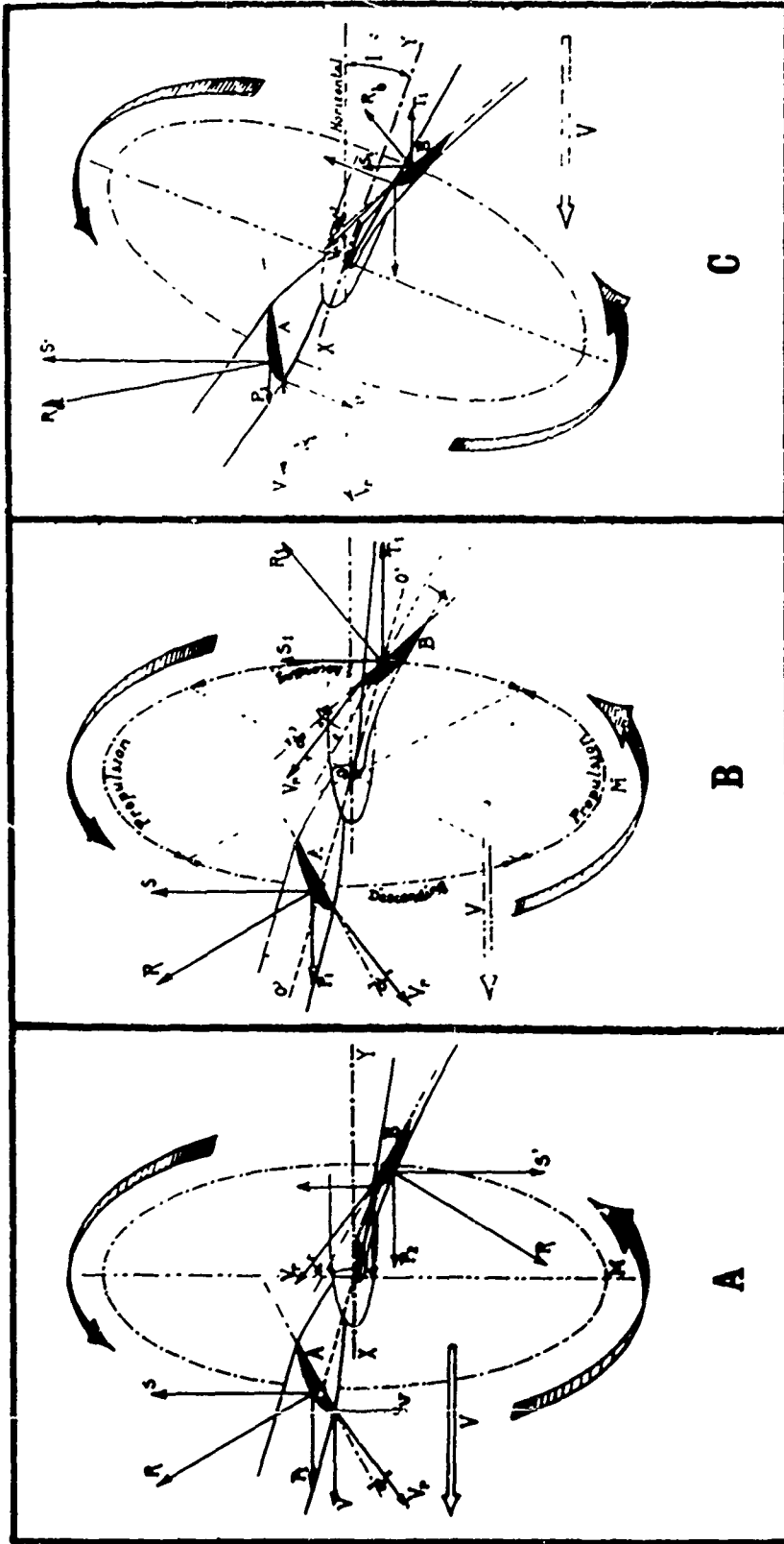

Figure 112. Comparison Between the Operation of the Conventional Propeller (A), Helicopter (B), and the Propeller With Axis Inclined to the Direction of Flight (C).

3. Wind Tunnel Test Results on the Helicopter Principle

Fichard made the first wind tunnel tests of the helicopter principle in 1936, under the sponsorship of the French Air Ministry, in the Issy-les-Moulineaux wind tunnel. He used two counterrotating propellers, 1.20 meters in diameter, driven by a 5-HP motor. The test results were reported in Wind Tunnel Report 107/G, dated 30 November 1936, in which it was categorically stated that "the Richard system, which employs a sinusoidal variation of the blade incidence, simultaneously produces lift and thrust ...".

There is no point in reproducing the numerical results of the earlier tests, since they were superseded by those of later tests, which will now be discussed.

In 1948, the French Office d'Etudes et Recherches Aéronautiques (O. N. E. R. A.) sponsored a series of full-scale tests of a helicopter propeller, consisting of three blades, with a diameter of 4 meters, as shown in Figure 111. A standard variable-pitch propeller hub was used, which was modified by incorporation of a cyclic-pitch mechanism, with tiltable swash plate, covering a wide range of incidences. The rotor was mounted forward of a nacelle, 3.570 meters long and 0.64 meter in diameter, containing also an electric motor, a gearbox, and electrical actuators for the remote control of the pitch mechanism.

A typical rotor blade is shown in Figure 113. These blades were made of wood and were quite heavy (40 kg). They had a trapezoidal shape. The feathering axis was at 38% of the chord. The twist distribution was linear, and the total twist was calculated from standard propeller theory to give maximum efficiency, as a propeller, at cruise velocity, assumed to be 45 meters/second. The resultant total twist is 35° . The blade airfoil was NACA 23015.

The map of test runs actually performed in the Chalais-Meudon wind tunnel in 1948, under the supervision of Richard, is shown in Figure 114. The notation of Figure 114 is as follows:

$$\beta = \frac{\textcircled{H}_1 - \textcircled{H}_2}{2}, \text{ defines the amplitude of the cyclic motion. } \beta = 0 \text{ corresponds to the conventional propeller}$$

V = wind tunnel test section velocity

\textcircled{H}_1 = root chord pitch angle of the descending blade as it crosses the horizontal

\textcircled{H}_2 = root chord pitch angle of the ascending blade as it crosses the horizontal

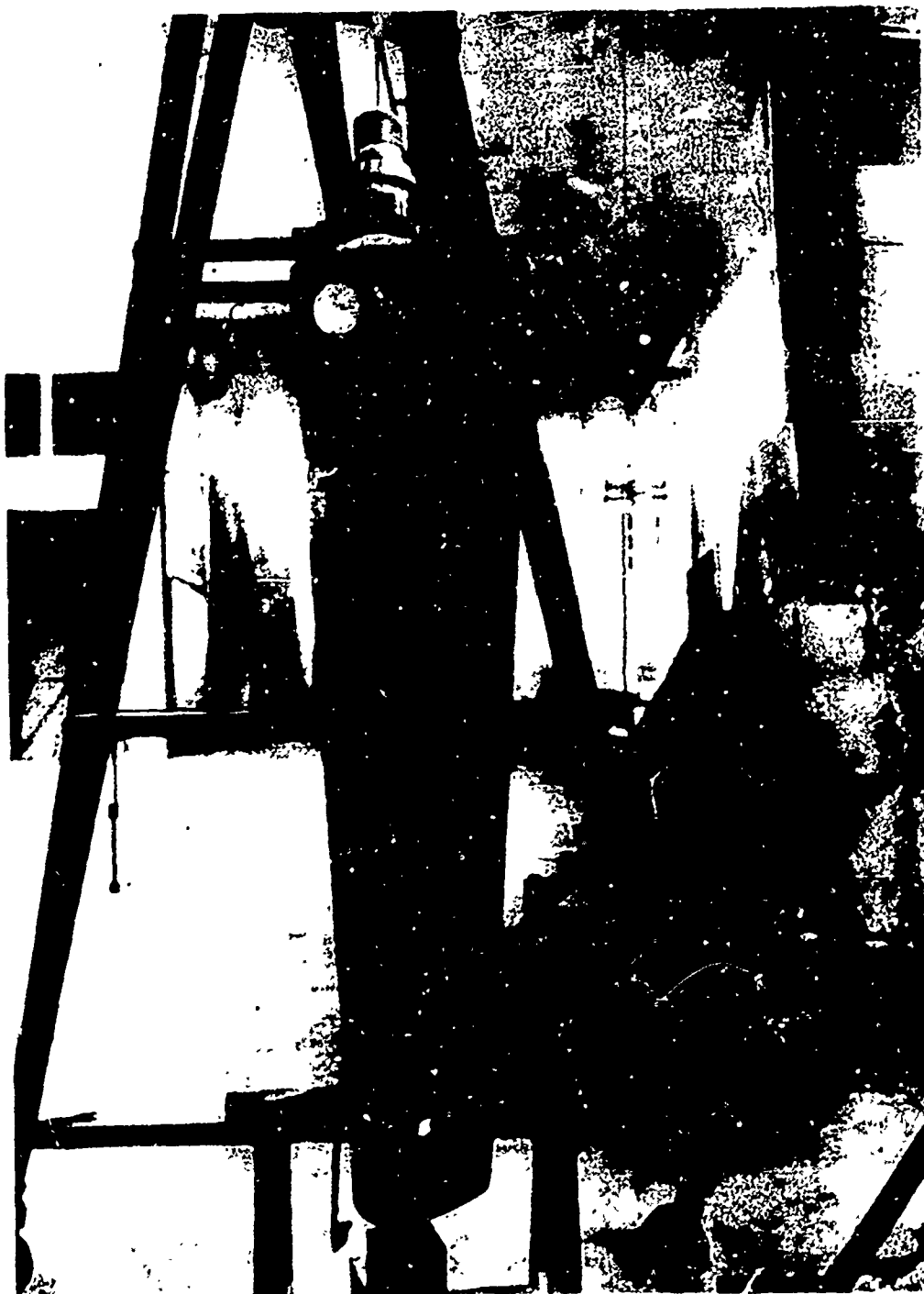

Figure 113. Richard Helicoplane Rotor Blade, French O. N. E. R. A.
1948 Wind Tunnel Tests

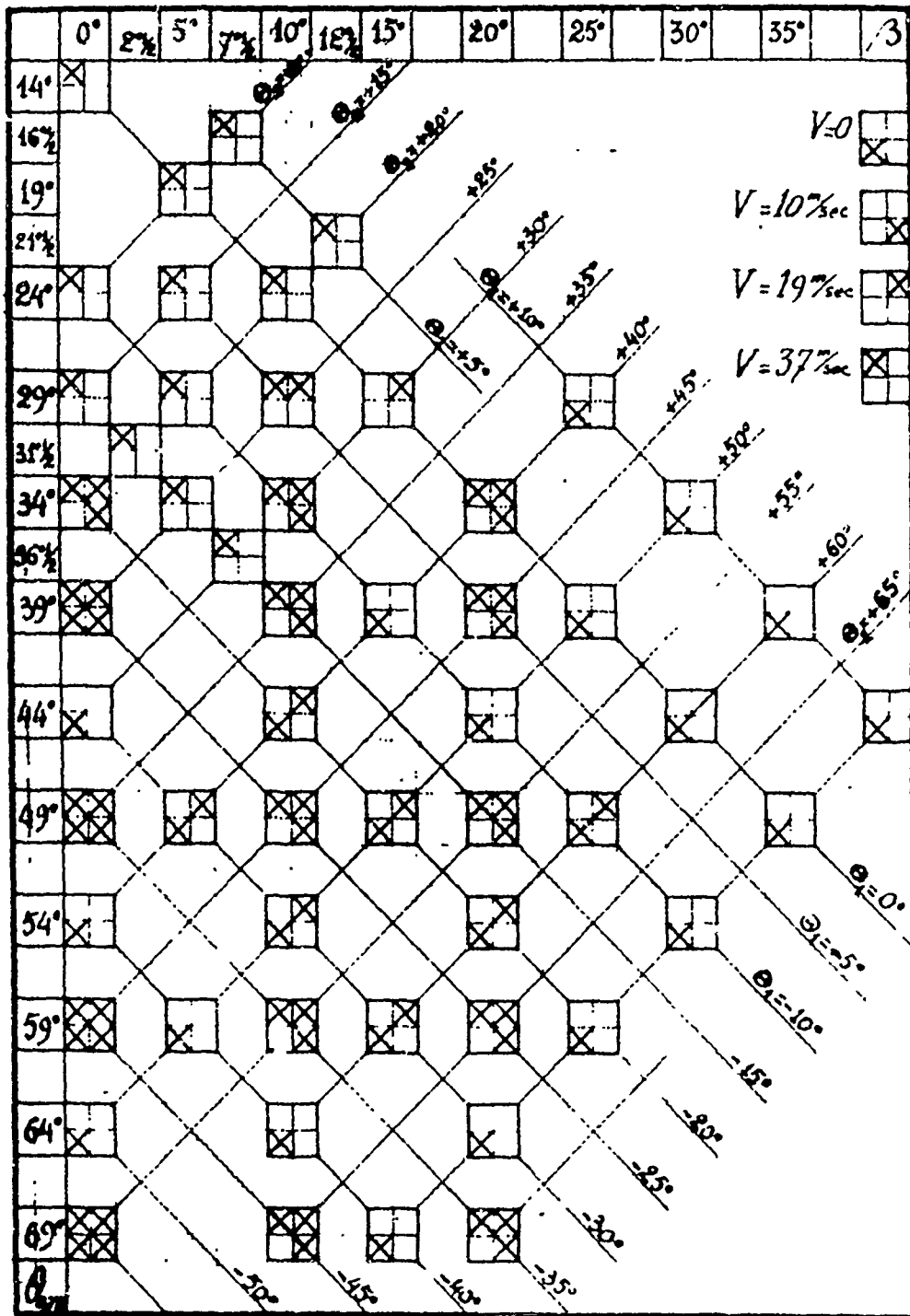

Figure 114. Matrix of Runs Performed, Richard Helicoplane
O.N.E.R.A. 1948 Wind Tunnel Tests

$\Theta_{.7R}$ = rotor collective pitch, measured at the 70% radius station

Before the tests were completed, the program was dropped by O. N. E. R. A., and no formal report was ever written by O. N. E. R. A. However, in 1952, Richard wrote a complete book: "The Helicopter. Principle. Realizations. Tests. Theories.". This book was never published but the manuscript was made available to Aerophysics Company. The comments and figures that follow are extracted from that book.

Tests were first made of the propeller with cyclic pitch and then of the propeller without cyclic pitch but with its axis at an incidence to the free stream. This configuration, which Richard claims to be a special and important case of the helicopter, will be discussed in section II. Finally, the helicopter with cyclic pitch was tested for the runs shown in Figure 114.

The helicopter rotor tests, under static conditions, are summarized in Figure 115. F_z is the vertical force created by the rotor, and P is the applied shaft horsepower.

For one value of the abscissa of Figure 115, corresponding to $\Theta_0 = 59^\circ$, one shows in Figure 116 a typical polar curve; i. e., F_z as a function of F_x , F_x being the horizontal thrust of the rotor. It is thus seen that though a significant vertical force F_z is generated (for example, a maximum of 22.6 kg at $\Theta_0 = 59^\circ$), the helicopter configuration does not lend itself to a vertical takeoff and landing aircraft since there is a corresponding large thrust of about 60 kg. The tests, however, show beyond a shadow of a doubt the ability of the helicopter to create large vertical-lift forces.

As discussed earlier, tests were made at three forward speeds. Results at the highest test speed only, $V = 27$ meters/second, will be briefly described here.

A polar-like curve, showing the variation of F_x , propeller thrust, versus F_z , propeller lift (horizontal-axis propeller), for a given shaft power, $P = 10$ HP, is shown in Figure 117 for given values of the cyclic angle β and for various values of collective pitch Θ_0 . Consider, for example, the round point on the curve farthest to the left. It corresponds to $F_x = 11.6$ kg. For $P = 10$ CV, at $V = 37$ meters/second, this corresponds to a propulsive efficiency of 57%. In addition, the lift is 65 kg. Consider now the intersection of the curve with the F_z axis. At this point, $F_z/P = 11.1$ kg/HP.

Typical results of forward flight performance are presented in Figure 118 for $\Theta_0 = 24^\circ$ and $\beta = \pm 10^\circ$. The effect of tilting the propeller axis over the direction of flight (shown by the angle I) is also represented.

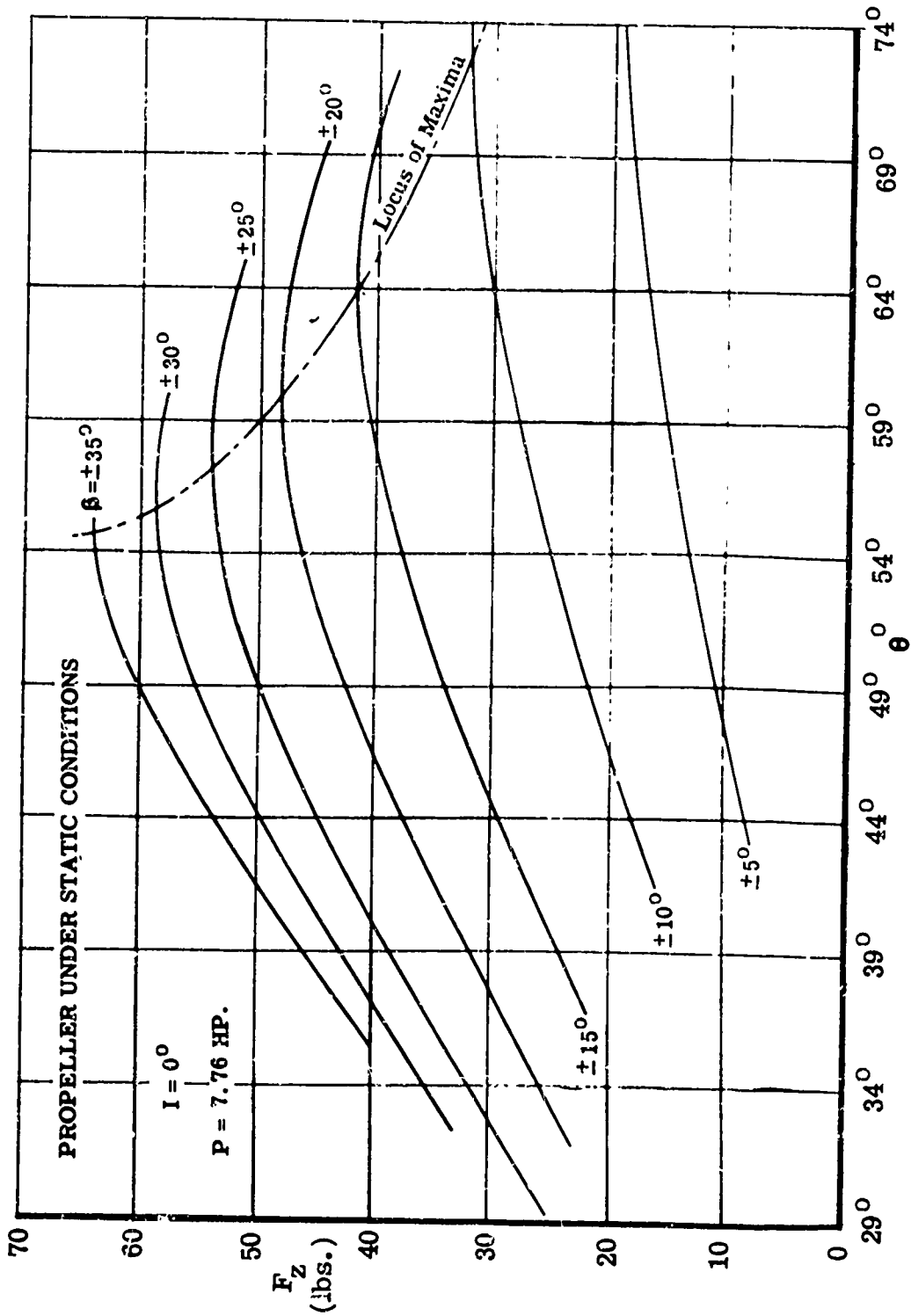

Figure 115. Static Thrust of Horizontal-Axis Richard Helicoplane,
O. N. E. R. A. 1948 Tests.

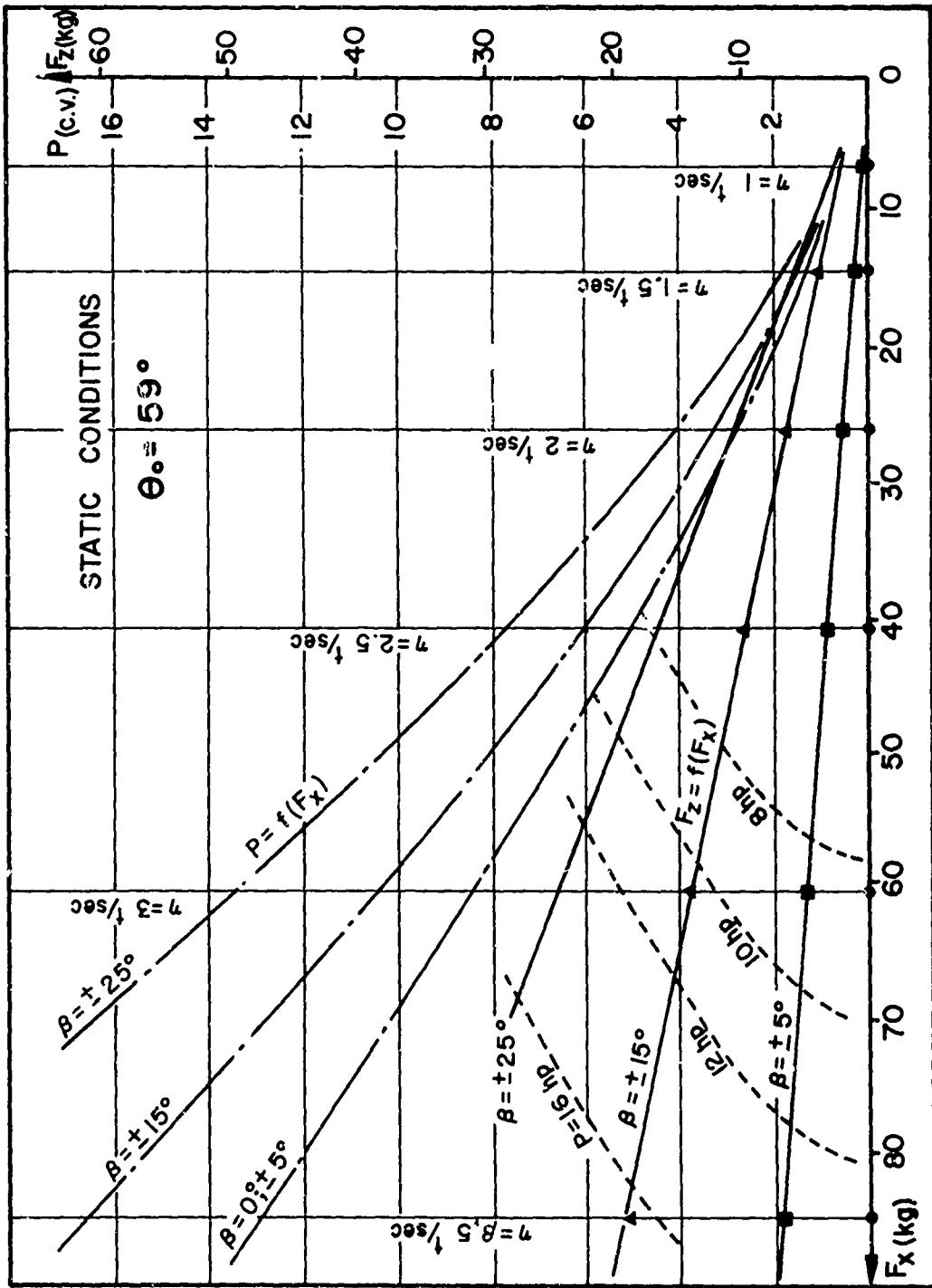

Figure 116. Static Performance, Horizontal-Axis Richard Helicopter, O.N.E.R.A. 1948 tests, $\theta_0 = 59^\circ$

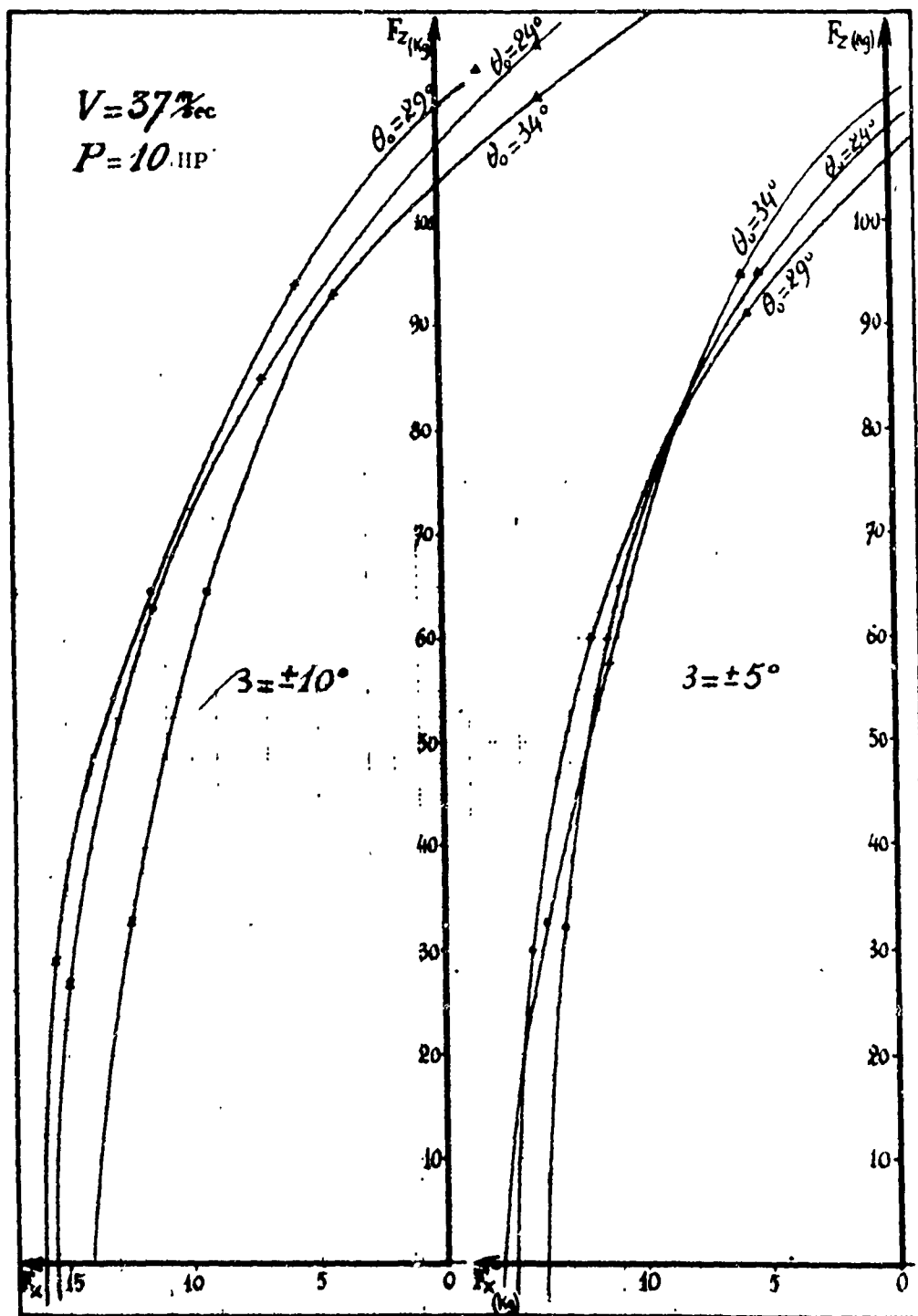

Figure 117. Forward Flight Polar, Horizontal-Axis Richard Helicopters O. N. E. R. A. 1948 Tests.

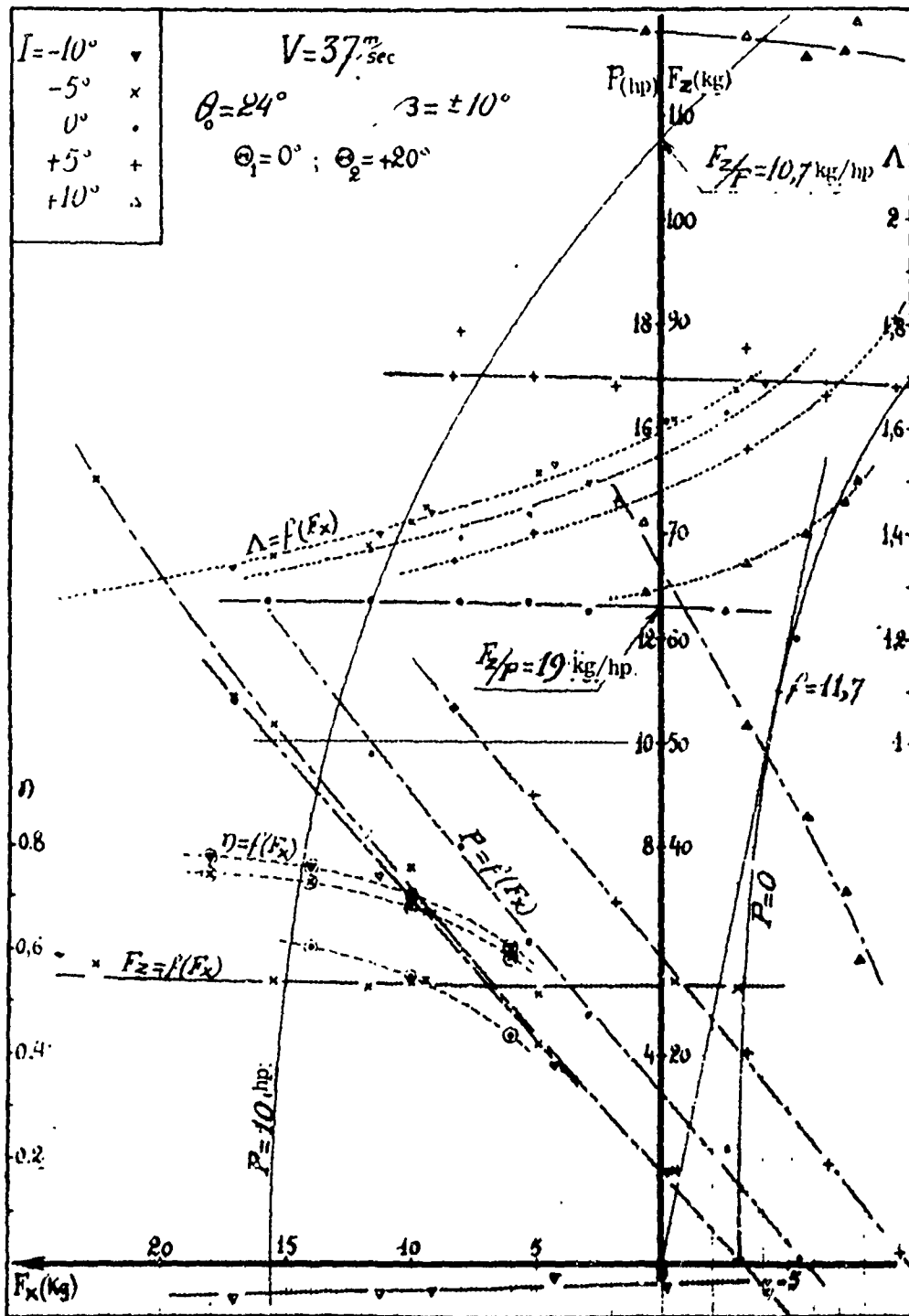

Figure 118. Forward Flight Performance, Horizontal and Inclined-Axis Richard Helicoplane, $I = -10^\circ, -5^\circ, 0^\circ, +5^\circ, +10^\circ$, O. N. E. R. A. 1948 Tests.

The conclusion of the tests reported here is that a propeller with cyclic pitch, such as the Richard helicopter, will simultaneously produce thrust and lift, in forward flight as well as in hover. The lift thus created is not negligible and is such that it is possible to consider the use of such a propeller in a wingless aircraft configuration.

Such an aircraft would even be a STOL aircraft with VTOL capabilities under certain conditions; for example, by tilting the propeller somewhat at hover or by deflecting the slipstream by means of flaps. Its maximum speed would be that of any propeller aircraft.

As will be seen in section II, cyclic-pitch propellers and "thrust wing" or "radial-lift" propellers are operating on the same principle. It may prove to be advantageous to combine the two.

The tests further show that the creation of the lift force is achieved at a low power cost. This represents an efficient scheme of integration of lift and propulsion.

4. Potential of the Helicopter Concept

The O. N. E. R. A. wind tunnel tests demonstrated the correctness of the helicopter concept, but the performance results obtained are by no means optimum, nor is the mechanical configuration that was realized the only or the best one.

First, the blades, shown in Figure 113, were of solid wood and weighed 40 kg each. Thus, part of the power of the rotor was used to overcome the cyclic inertia forces of the blades.

Second, the rotor blades were not optimized, neither for planform nor for twist distribution. Whenever technology makes it possible, it would be desirable to have blades with variable radial twist distribution (at least two segments adjustable, one with respect to the other), that variation being cyclic, if possible.

Third, it is advantageous to have the highest possible blade lift for the ascending blade; hence, the need for a cyclically actuated high-lift device (flap, slot, or boundary layer suction or blowing) during the ascending quadrant of the rotor disc. Richard also suggests that a means to increase the lift of the helicopter is by increasing the speed of the descending blade and decreasing that of the ascending blade. This can be achieved mechanically by offsetting the center of rotation of the rotor.

Thus, it appears that improvements in technology (light blades and light, compact, and reliable mechanical devices) would significantly enhance the potential of the helicopter concept.

Richard proposed an application of the helicopter concept to a light, cheap private plane. He also suggested the incorporation of helicopter rotors to the Chance-Vought XF5U-1 "Flying Pancake". Such a configuration, heavily armored, might make a good "Flying Tank". The helicopter works best with large-diameter propellers, turning at low speed; hence, the noise level is fairly low.

The most likely early use of the helicopter principle is in conjunction with another principle; for example, in conjunction with the radial-lift propeller, which will be discussed next, or in conjunction with a deflected-slipstream wing, similar to that of Kaman's K-16B VTOL airplane.

II. NEAR-HORIZONTAL AXIS "RADIAL-LIFT" CONCEPTS

A. RADIAL-LIFT PROPELLER OR SELF-PROPELLING WING

The side force of a propeller in yaw is well known to aeronautical engineers as an undesirable phenomenon, since it has a destabilizing effect on the directional stability of a propeller aircraft.

Quite obviously, if the axis of a propeller in forward flight is pitched up to the horizontal, the resultant side force on the propeller is a lift. One would be inclined to think that the magnitude of this vertical force is the projection of the thrust over the vertical: $T \sin I$, where T is the propeller thrust, and I is the inclination of the propeller axis over the horizontal. This is not the case. For the proper propeller, one with a fairly large diameter and low RPM, the lift component can be five to ten times the projection of the thrust vector.

This phenomenon was discovered by Richard in France and von Holst in Germany in the thirties. It was applied to the Curtiss-Wright X-100 and X-19 aircraft in the United States in the early sixties. It is used in a current German project, the VFW VC.400 (manufactured by Vereinigte Flugtechnische Werke, in Bremen). It corresponds to a special case of Richard's helicopter, that in which the cyclic circulation on the propeller blades is obtained by tilting the propeller axis, rather than by mechanical means, as was described in the previous section. One of the proponents of the radial-lift propeller is Professor Focke. The concept will thus be described as Professor Focke reported it in the Fifth Cierva Memorial Lecture (Reference 15F).

1. Principle of the Radial-Lift Propeller or Self-Propelling Wing

Focke starts from the premise that, if high subsonic forward speeds are desired for a VTOL aircraft, the vertical-axis rotor route becomes hopeless. He then recounts Dr. von Holst's proposal, which comes not from an engineer but from a physiologist who spent part of his life studying bird flight, as follows.

In Figure 119, a bird, of weight W , is just moving its wing downward, holding its body relatively high by its muscles, thus producing W' which is a little larger than W . The lift is L , the resultant R , the drag D , and the forward thrust T . The procedure looks as if the wing, having the angle of incidence α , were in gliding flight with the angle γ . The bird is proceeding horizontally. If the wing has a good lift-drag ratio, T is considerable and so the bird turns the wing to more incidence. Therefore, lift is maintained during the upward movement, but deceleration occurs, partly absorbing the speed gained during the downward movement. This is ornithopter flight, much discussed at the beginning of aviation but soon abandoned, mainly on grounds of the inertia forces. Von Holst knew this and his thoughts went another way: if one wing is

down and we could have nother one coming from above, the process could go on. The bird cannot do this, but human technique can, as shown in Figure 120.

Let us take an axis, nearly horizontal, slowly rotating; for instance, 4 wings may be fixed on it, each a distance of 90 degrees from the next. Let wing 1 go down first, doing the same job as the bird's wing; and let wing 3 do the same as the bird's wing does going up. In the meantime, wings 2 and 4 do not idle, but they work as a propeller, providing additional thrust. And so it goes on. Von Holst, as a naturalist, created the self-propelling wing coming from the living creatures but offering to the human engineer exciting possibilities, which von Holst explained in detail in a paper published at Göttingen in 1942. Note that every one of these ideas had been expressed by Richard in 1934 and had met with general incredulity.

Let us further examine the adaptation of natural flight to aeronautics. Why did we take out of use in airplanes the conventional propeller for very high speeds? Because there was the geometrical addition of the peripheral and of the forward speed. Here we are seeing nearly the contrary. The cosine of the angle between the direction of flight and the direction of true speed of the wing is 0.88. The wing receives only 13 percent more speed than the flying speed. Figure 120 shows wing 3 in operation. Its high drag must be compensated for by the three other wings. But its true airspeed is even 2 percent lower than the flying speed. Consider what this means if we are later approaching Mach 1. By the very slow rotation, we will scarcely have more difficulty than an airplane in this region, and the same is happening at higher Mach numbers. Another advantage of von Holst's self-propelling wing is the fact that profile drag exists only from the wing and not again a second time from the propeller.

2. VFW Wind Tunnel Tests

In 1957, the German company Vereinigte Flugtechnische Werke (VFW) began extended research, design studies, and wind tunnel tests in the matter of the self-propelling wing. Figure 121 shows the most important results. The inclinations of the axis at speeds from 0 to 600 km/h are given at the top of the figure. The slightly different running of the curves is caused by different rotational speeds between 700 and 900 RPM. Pure calculation is indicated by dashes. The most interesting item is the maximum Mach number 0.736, at a medium speed, going down again with further increasing speeds.

3. Characteristics of the VFW VC.400 VTOL Aircraft

Following many rumored cancellations, two prototypes of the VC.400 tandem tilt-wing aircraft, shown in Figure 122, are being

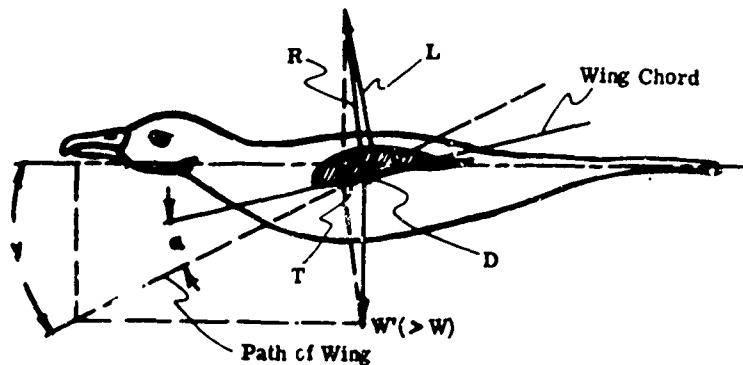

Figure 119. Schematic Representation of Bird Flight After von Holst and Focke. (Ref. 40F).

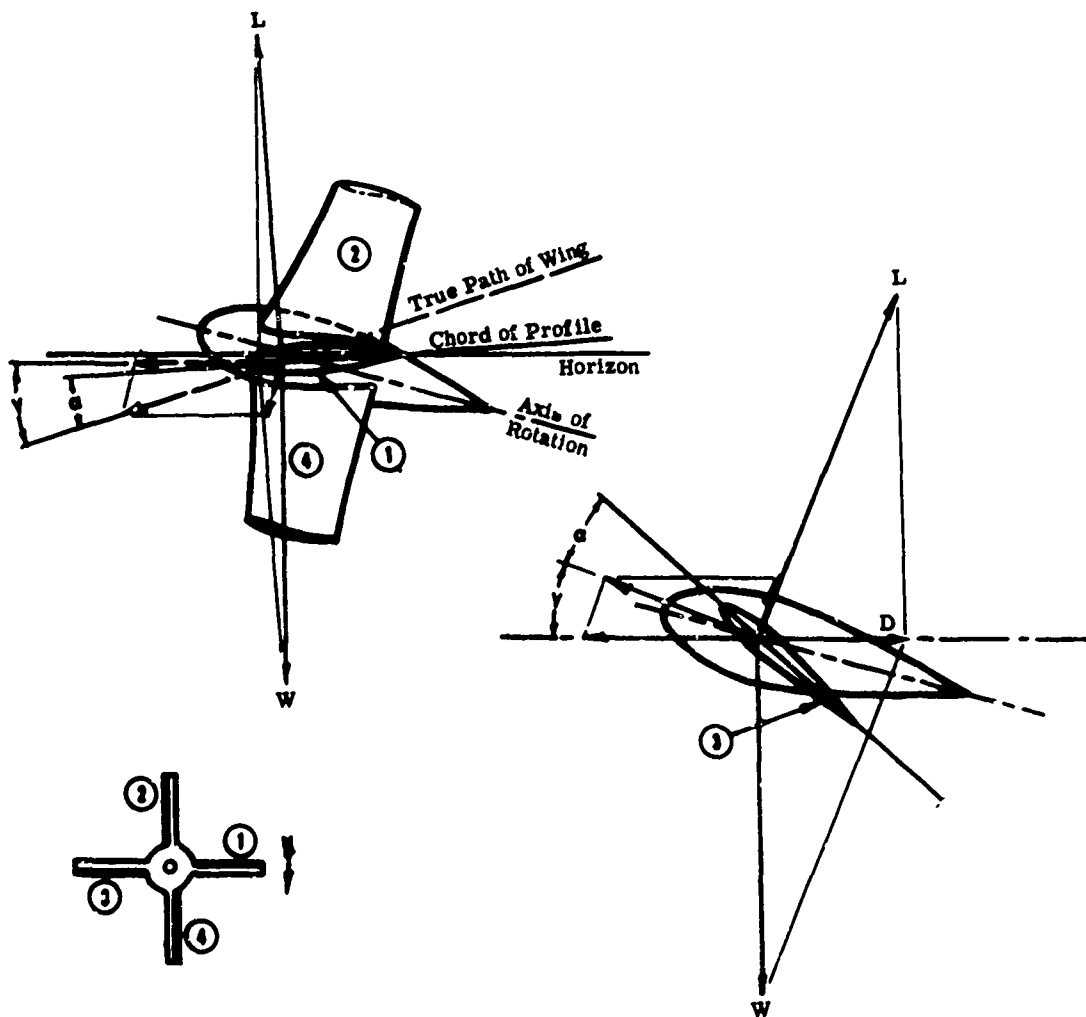

Figure 120. Forces Acting on a Slowly Rotating Inclined-Axis Self-Propelling Wing. Wing (1) Is Descending, (3) Ascending.

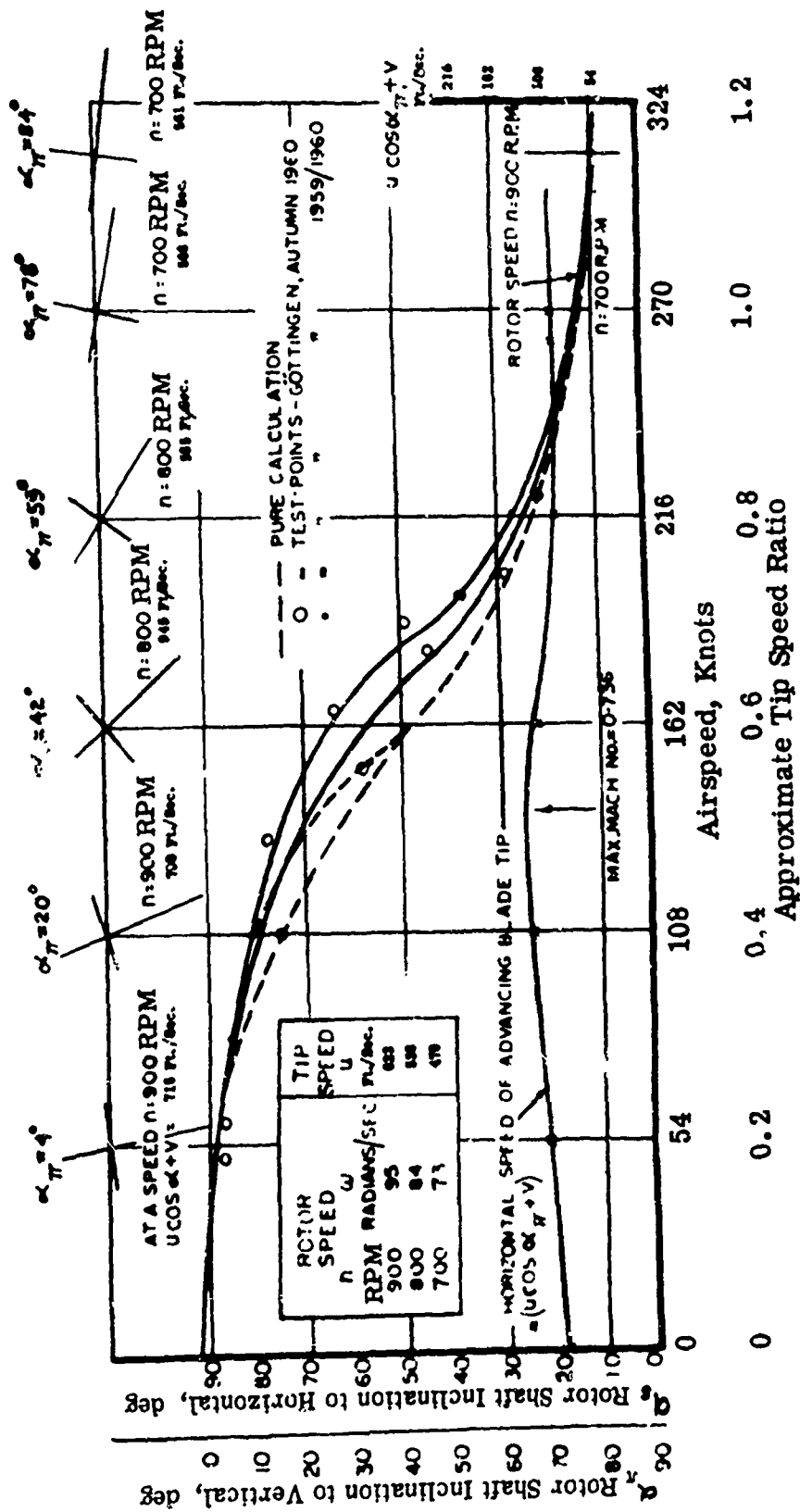

Figure 121. Wind Tunnel Results of the Self-Propelling Wing of Focke and Vereinigte Flugtechnische Werke (VFW) 1959-1960. (Ref. 40F)

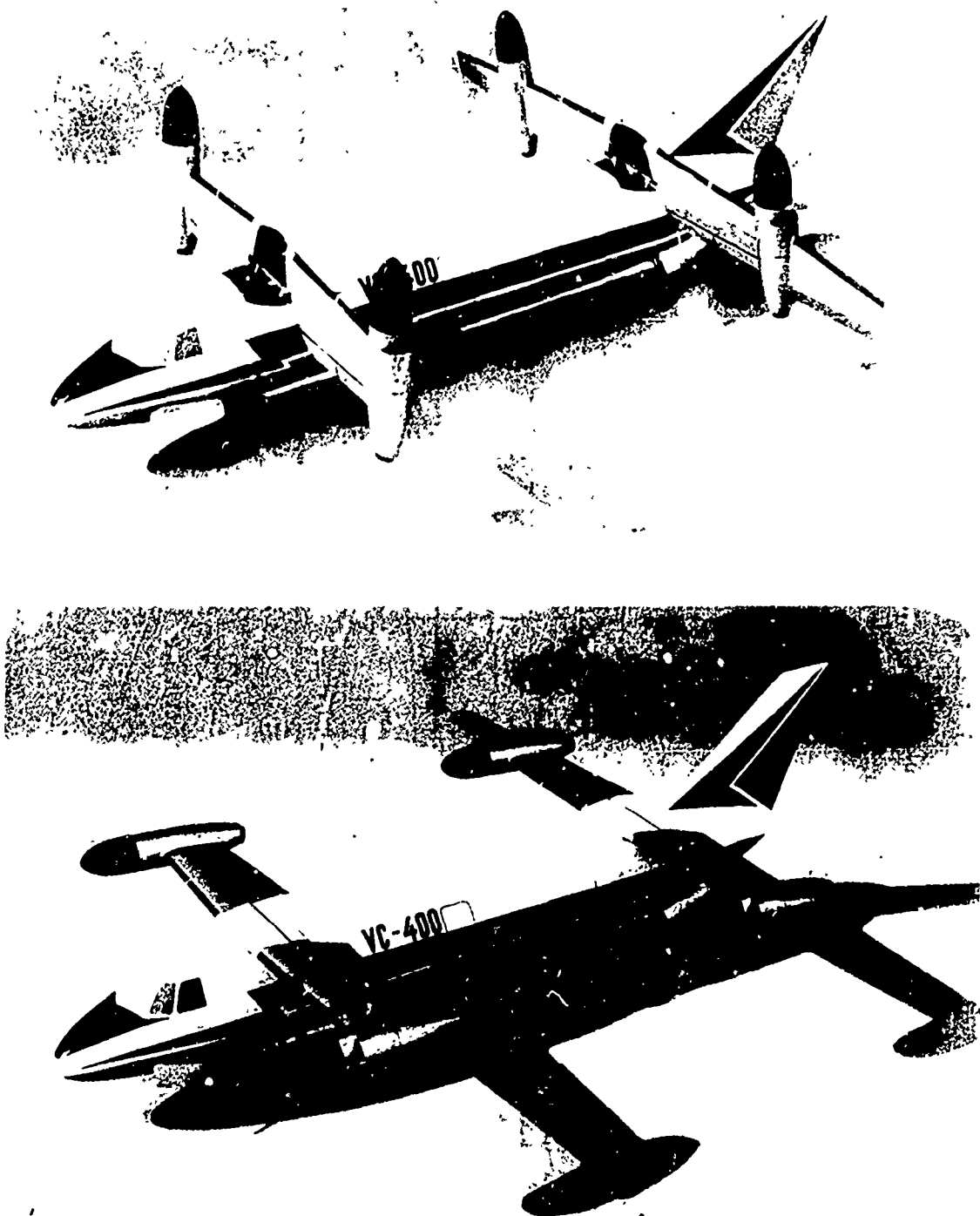

Figure 122. Vereinigte Flugtechnische Werke (VFW) VC. 400 Tilt-Wing VTOL Transport, Shown in Vertical and Horizontal Flight Arrangements.

built for the German Defense Ministry, which is funding the project for possible military transport (Reference: Flight International, 23 May 1968). Component development and testing are well in hand, and three sets of 23-foot propellers and gearboxes have been ordered from Hamilton Standard Division of United Aircraft Corporation. Each of the tandem pairs of propellers is driven by its own 3,960-SHP T64-GE-16 engine, with a common interconnecting transmission. Flight tests of the VC.400-V1 are expected to start in 1970, followed by those of the -V2 in 1971. A civil version with double the number of engines and payload has been projected as the VC.500.

Span: 63 ft. 10 in.

Length: 73 ft. 5 in.

Height: 25 ft. 2.5 in.

Operating Empty Weight: 34,612 lb.

Max. Takeoff (STOL): 63,934 lb.

Max. Speed: 426 knts.

Max. Climb: 6,889 ft./min.

VTOL Radius With 5-Ton Payload: 657 naut. mi.

4. Curtiss-Wright X-100 and X-19 VTOL Aircraft

In the late 1950's and early 1960's, the Curtiss-Wright Corporation engaged in an extensive VTOL program using radial-lift propellers. These efforts are described in Reference 88R. Formulas are given in Reference 56B for the propeller normal force, when the propeller axis is inclined from the horizontal. Curtiss-Wright studies compared the lift-drag ratio obtainable from the inclined propeller with that of a wing. It was concluded that, even at high speed (300 to 400 knots), it was advantageous to have 10 to 20 percent of the aircraft lift carried by the propeller.

The X-100 aircraft, shown in Figure 123, was designed and built to investigate the use of normal force propellers and to determine the flight characteristics of such a vehicle. Thus it was designed using a very heavy wing loading of approximately 170 lb./sq. ft.

The propellers designed for the X-100 aircraft had a hover figure of merit of about 80 percent and a cruise efficiency of 82 percent. By adjusting the blade chord distribution so that the blade was wide inboard and narrow outboard, the normal force produced by the propeller was increased over that of a propeller using conventional blades. This increase in propeller normal force is obtained without a reduction of takeoff or cruise performance. Test results showed that the desired high level of normal force was obtained



Figure 123. Curtiss-Wright X-100 VTOL Aircraft
Employing the Radial-Lift Concept.

with the X-100 propeller. It may be noted that the normal force is maximum in the low-speed range, where it becomes expensive in terms of weight to increase lift by increasing wing area.

The characteristics of the X-100 airplane operating in the conversion regime were extremely encouraging, as the aircraft could easily be flown at all speeds through the conversion and back without the necessity of juggling power, attitude, and propeller tilt angle within narrow operating bands. Propellers operating at high values of normal force do not exhibit a sharp stall, and therefore the aircraft can be flown under wide ranges of angle of attack without encountering stalls.

Based on the data obtained during the development of the X-100 airplane, a new, larger, high-speed VTOL aircraft was designed: the X-19 (Figure 124). This aircraft unfortunately suffered from mechanical design limitations that forced early abandonment of the project.

B. THE HELICOPLANE WITH INCLINED PROPELLER AXIS

It is seen, by referring to the helicopter discussion of section I. C, that an inclined-axis helicopter, without cyclic pitch, is precisely identical to the radial-lift propeller or self-propelling wing.

In the previous discussion, the self-propelling wing was described using the words of Focke and von Holst. However, in his own publications, Richard used almost identical explanations. To clarify this point further, consider Figure 112. It can be seen that the conventional propeller with its axis inclined to the free stream behaves exactly as the cyclic-pitch propeller.

Richard's results, some of which were shown in Figures 115 through 118, show that, on many occasions, it is possible to get a greater efficiency, i. e., a larger lift-drag ratio, using cyclic pitch than simply inclining the propeller. α is the angle of inclination of the propeller. Actually, a choice should be made in each design case of the optimum configuration. In some cases, both should be used.

C. POTENTIAL OF THE RADIAL-LIFT CONCEPTS

The potential of the radial-lift concepts, based on American (Curtiss-Wright), German (von Holst, Focke-Vereinigte Flugtechnische Werke), and French (Richard) experience, appears to be enormous. In spite of the great recent strides forward (Curtiss-Wright and VFW), extensive research is needed. The general helicopter principle, which underlies the whole field, clearly indicates that the lift generation phenomena are unsteady; actually, the circulation around the blade changes direction as the blade moves in its circular trajectory. Therefore, theory is



Figure 124. Curtiss-Wright X-19 VTOL Airplane
Employing the Radial-Lift Concept.

not adequate to predict radial-lift propeller performance. At best, it can justify some of them a posteriori!

III. NON-AERONAUTICAL APPLICATIONS OF HARWAS

The bibliographical search of material relating to horizontal-axis lifting devices has revealed the existence of a large number of aerodynamic, but non-aeronautical, applications of these devices, related to the use of wind power to generate electricity or to pump water, related to ship propulsion using wind power in a sail-like fashion, or related to underwater cycloidal ship propulsion. These applications are briefly reviewed below.

A. WING ROTOR-TYPE WINDMILLS

Modern use of the conventional propeller-type horizontal-axis windmill is still considerable. The modern windmill is technically very advanced and very efficient, making use, for example, of high-aspect-ratio, laminated-plastic, laminar-flow, variable-pitch blades. It is typically used to drive an electric generator.

Wing rotor-type windmills are paradoxically called "horizontal windmills" (Reference 11B), though they have a singular vertical axis about which a wing rotor profile revolves. A typical windmill that employs a double (Savonius) section is shown in Figure 125.

A wing rotor windmill is designed to optimize torque and power. Bach reported in Reference 3B the results of a systematic investigation of a family of Savonius and similar sections for windmill applications. He plotted not only the torque and power coefficients but also the lift and drag coefficients. These are of interest to the designer to insure the design of a structurally sound windmill tower. Bach's lift and drag results are shown in Figures 126 and 127.

One can obtain an idea of the relative efficiency of the wing-rotor-type and of the conventional propeller-type windmill by plotting their respective power and torque coefficients versus the U/V ratio. This is done in Figure 128.

The power coefficient is defined as

$$C_p = \frac{2P}{\rho FV^3}$$

where

P = measured shaft power

F = largest projected frontal area

ρ = density

V = wind speed

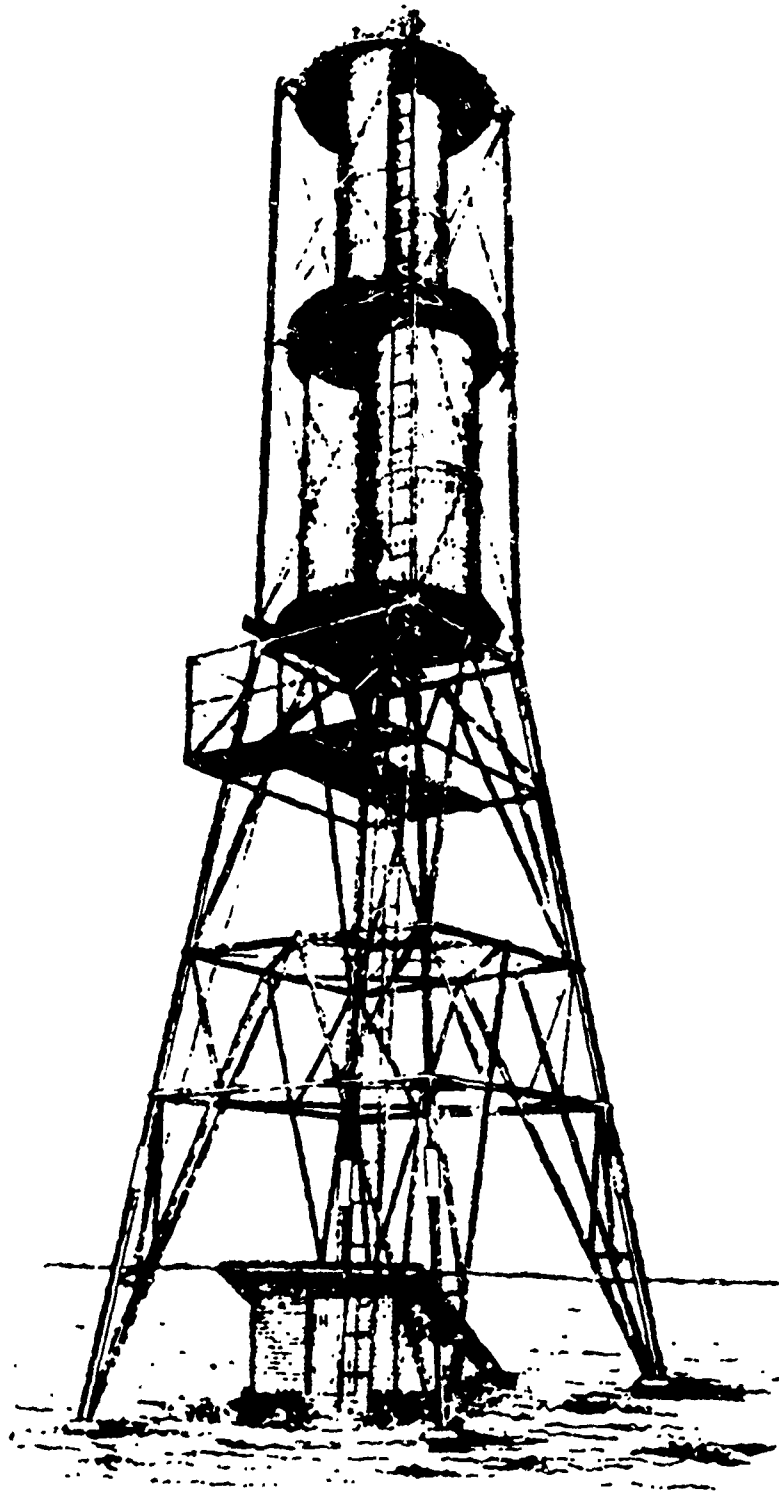

Figure 125. Vertical-Axis Double Savonius Windmill-Type F-13
of the Soviet Wind Energy Institute (Ref. 6K).

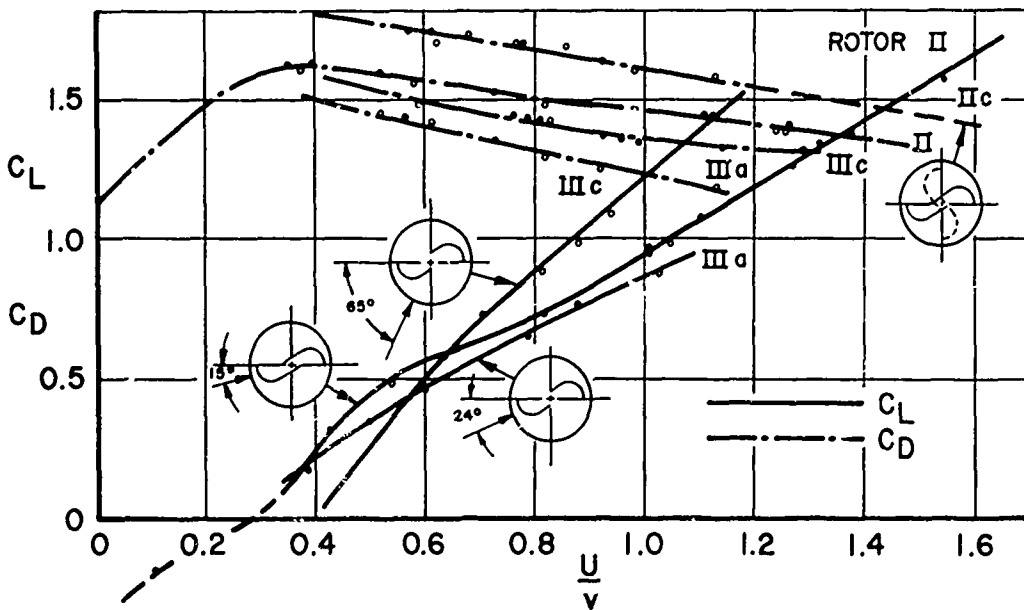
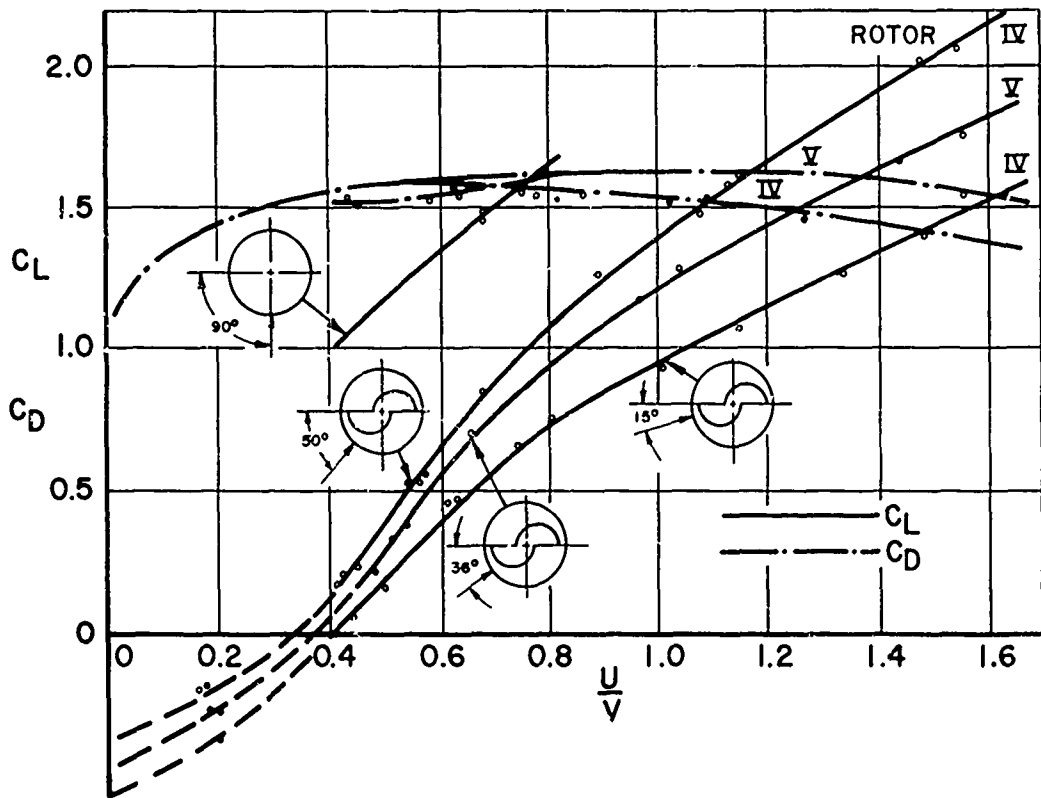

Figure 126. Aerodynamic Performance of a Collection of Basic and Modified Savonius Wing Rotors Through Power Extracting (Braked) U/V Range up to U/V Max. in Free Autorotation. From Ref. 3B.

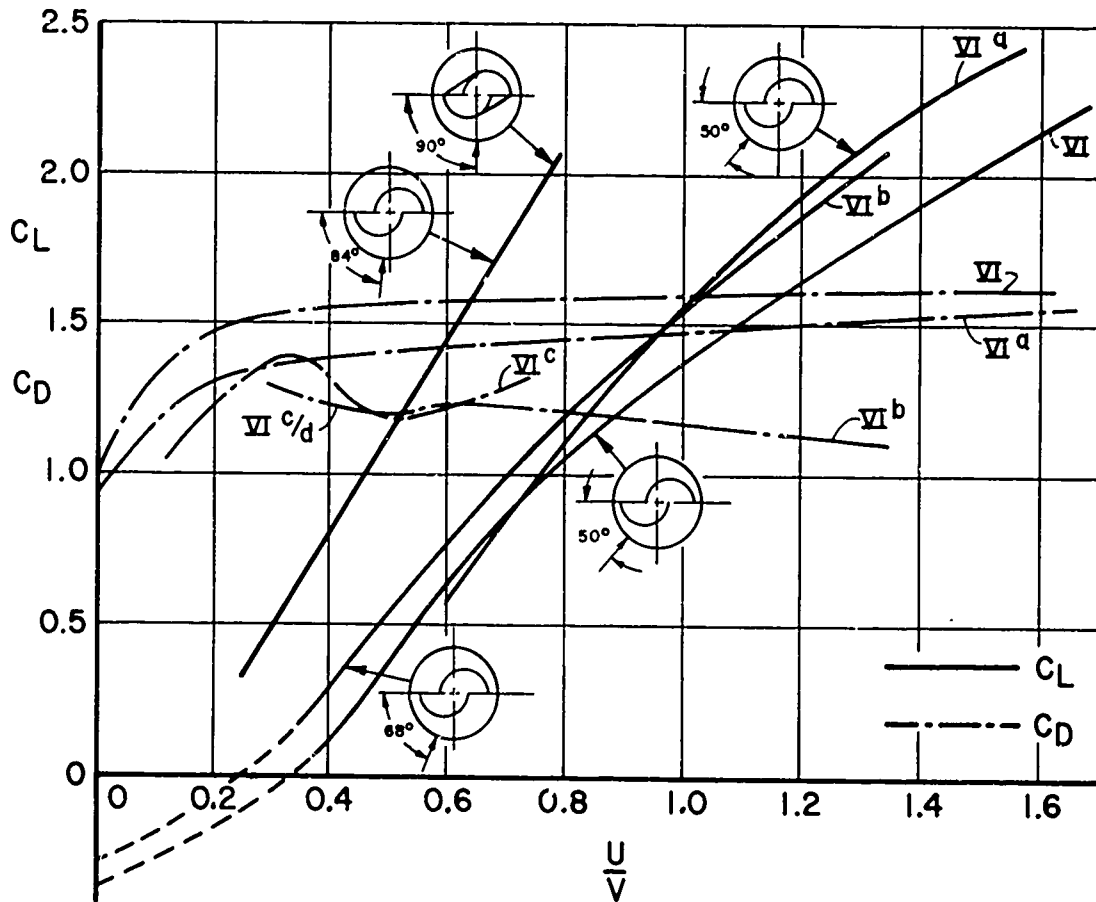

Figure 127. Aerodynamic Performance of a Collection of Basic and Modified Savonius Wing Rotors Through Power Extracting (Braked) U/V Range up to U/V Max. in Free Autorotation. From Ref. 3B. (Rotors: VI, VIa, VIc, IVb) Note: Small Arrows Directed at Rotor Profile Indicate Position of Static Zero or Null Starting Torque Position.

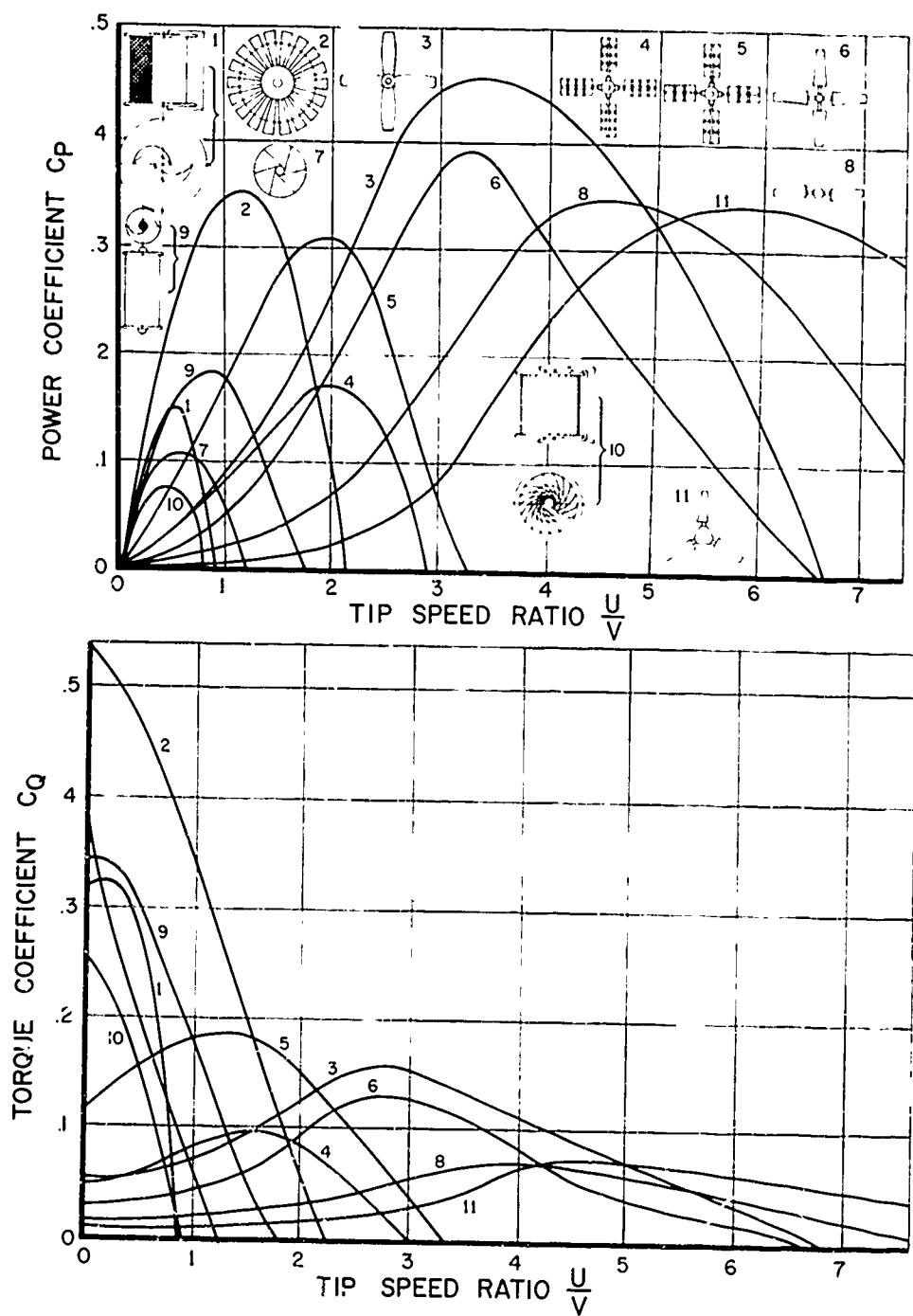

Figure 128. Performance Summary of 11 types of Windmills.

The torque coefficient is defined as

$$C_q = \frac{2Q}{\rho F R V^2}$$

where Q = measured torque.

An inspection of the upper curve of Figure 128 indicates the superiority of the propeller-type windmill (Types 2, 3, 4, 5, 6, 8, and 11) over the wing rotor windmill (Types 1, 7, 9, and 10) in extracting power out of the wind. This comparison is based on identical swept-out rotor disc or projected frontal areas (F).

However, a second look at the torque curves of Figure 128 indicates that the wing rotor windmill shows consistently higher torque coefficients at very low U/V 's than the propeller-type windmill (there is one exception, the familiar "American"-type (2) windmill). Usually the wing rotor windmill will have maximum torque at $U/V = 0$. This is of significant advantage when starting under load, without clutch, is required. Such an arrangement is ideal for the pumping of water, and it is usually for this purpose that the simplicity and directness of the wing rotor or Savonius mills find an application. Conversely, electric generators may have no starting torque, and propeller-type windmills are better adapted to electricity production because of their higher power coefficients.

Figure 125 illustrates the simplicity of the wing rotor mill arrangement. The vertical shaft of the mill is directly connected to a positive-displacement pump which delivers water to a surface reservoir, intermittently, as the wind blows. The mill will turn with the wind approaching from any direction. This arrangement is most useful in remote areas (Reference 48B).

The vertical-axis wing rotor mill has a potential application as an electrical power source, through the proper gearing, for remote, unattended beacons or buoy systems.

B. CYCLOGIRO WINDMILL TURBINE

Like the wing rotor windmill discussed above, the cyclogiro windmill has a vertical, rather than a horizontal, axis. Since the cyclogiro rotor system is capable of autorotation (Figure 100), it is further capable of extracting energy from the wind in the windmill braking state. Many investigators have proposed and patented this type of mill; see, for example, Reference 110S. A typical example is Donaldson's full-size mill, shown in Figure 129.

It is of interest to note that in some of the University of Washington cyclogiro wind tunnel tests, the models were so arranged that the power output from the drive motor running backward as a generator could be

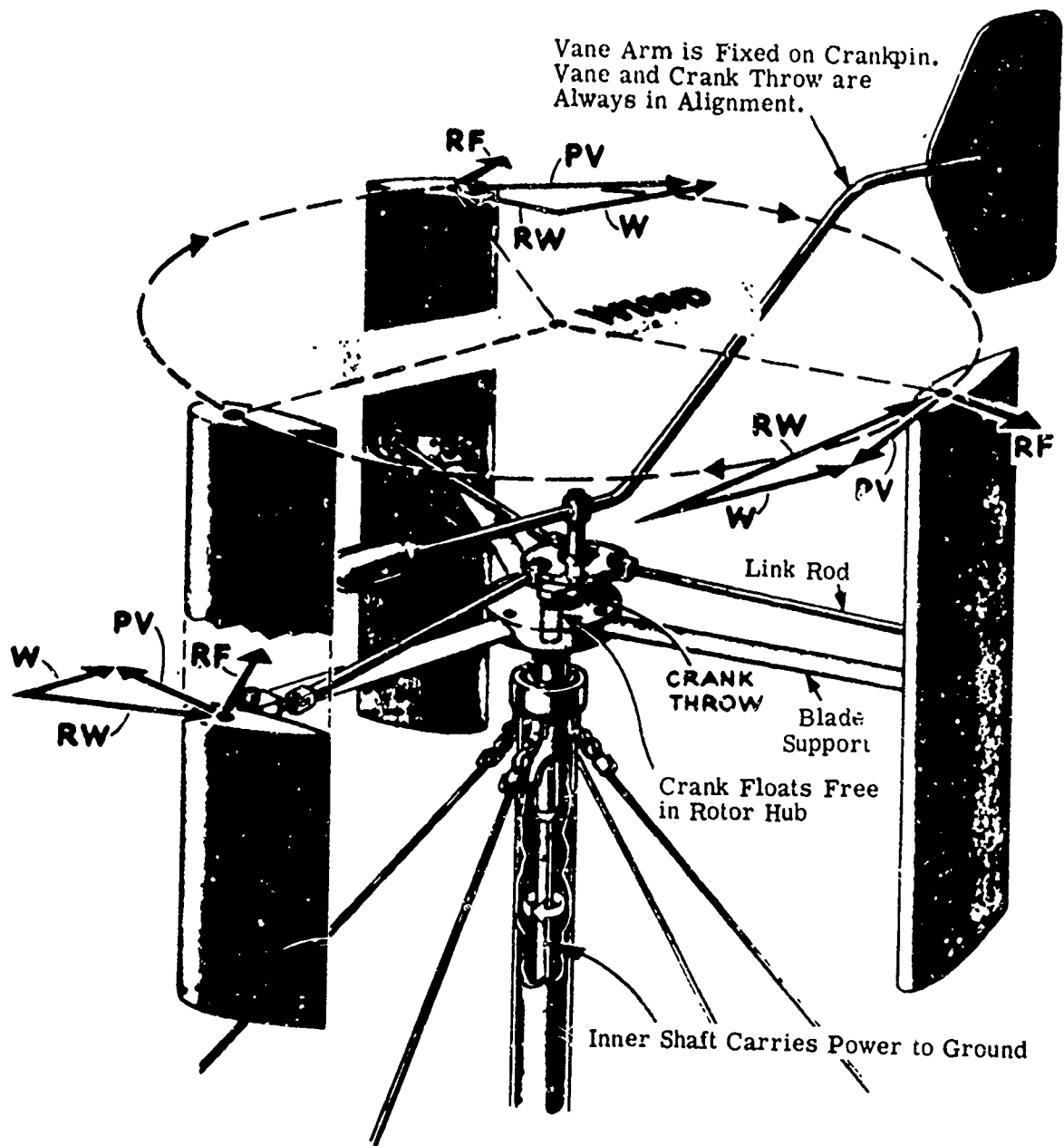

Figure 129. Horizontal Windmill of the Cyclogiro Type by Donaldson (Ref. 19D). Essentially an Autorotating Low-Pitch Cyclogiro Delivering Power Through a Vertical Shaft.

measured under conditions of autorotation or windmilling. This wind generated output is presented as negative values of the power coefficient ($-C_p$) in the data Figures 23 and 24 of Reference 8B and of data Figures 5, 6, 8, and 9 of Reference 2E.

The simple analysis reported in Reference 30P and the preliminary design of Reference 29P suggest that such a mill may be more efficient than the propeller-type windmill. Whether or not this is the case, the vertical-axis cyclogiro mill has one very attractive, unique feature. The success of any wind prime mover depends upon the ability of the designer to spread a given amount of power-extractive structure over a very large "capture" area through which the wind blows. It has been shown that there exist areas of the world where the wind blows with a high degree of constancy and that are close enough to civilization to make industrial use of the power generated. It is therefore always important to make use of the largest swept areas possible. The propeller-type mill's swept blade area seems to be limited by the economics of rotor diameter and of the overall tower height that supports such a piece of equipment. A concept then suggests itself of a cyclogiro-type device that can be made to sweep out large cylindrical areas by running the rotor blades around an immense circular track that could be located on the crown of an air-accelerating hill. This suggestion is embodied in the design of Reference 29P, in which the blades travel on individual wheel systems. The wheels follow a very large diameter circular track, the windmill rotor cylinder describing a right circular cylinder to the approaching wind. Further extensions of this idea suggest the use of the blades travelling in circular moats or on air bearings, etc. Feathering is usually sensed aerodynamically. Through cabling and reduction gearing, a central generator can be driven.

In the Madaras proposal, which was backed by full-scale tests (References 3M through 11M), the rotor blades are replaced by Magnus cylinders running on a large circular railroad track. It has been shown (Reference 110S) that five times as many cylinder rotors would be required, as compared to the airfoil rotor blade system, for an equal extraction of wind power by this means.

C. MAGNUS EFFECT SHIP PROPULSION

A discussion of the practical applications of the Magnus effect would not be complete without mention of its application to ship propulsion. In particular, the full-size experiments in the midtwenties by Flettner (References 19F through 38F) deserve comment. Several Flettner rotor ships were built. Two typical configurations are shown in Figures 130 and 131. The focus of Flettner's experiments was the attempted revival of the sailing merchant ship. It must be remembered that even at that late date the windjammer was still in its last stages of commercial service. Comparative wind tunnel model tests of a windjammer with its lull set of sails were made against the same hull driven by two cylindrical Magnus rotors. The results, for that time, were

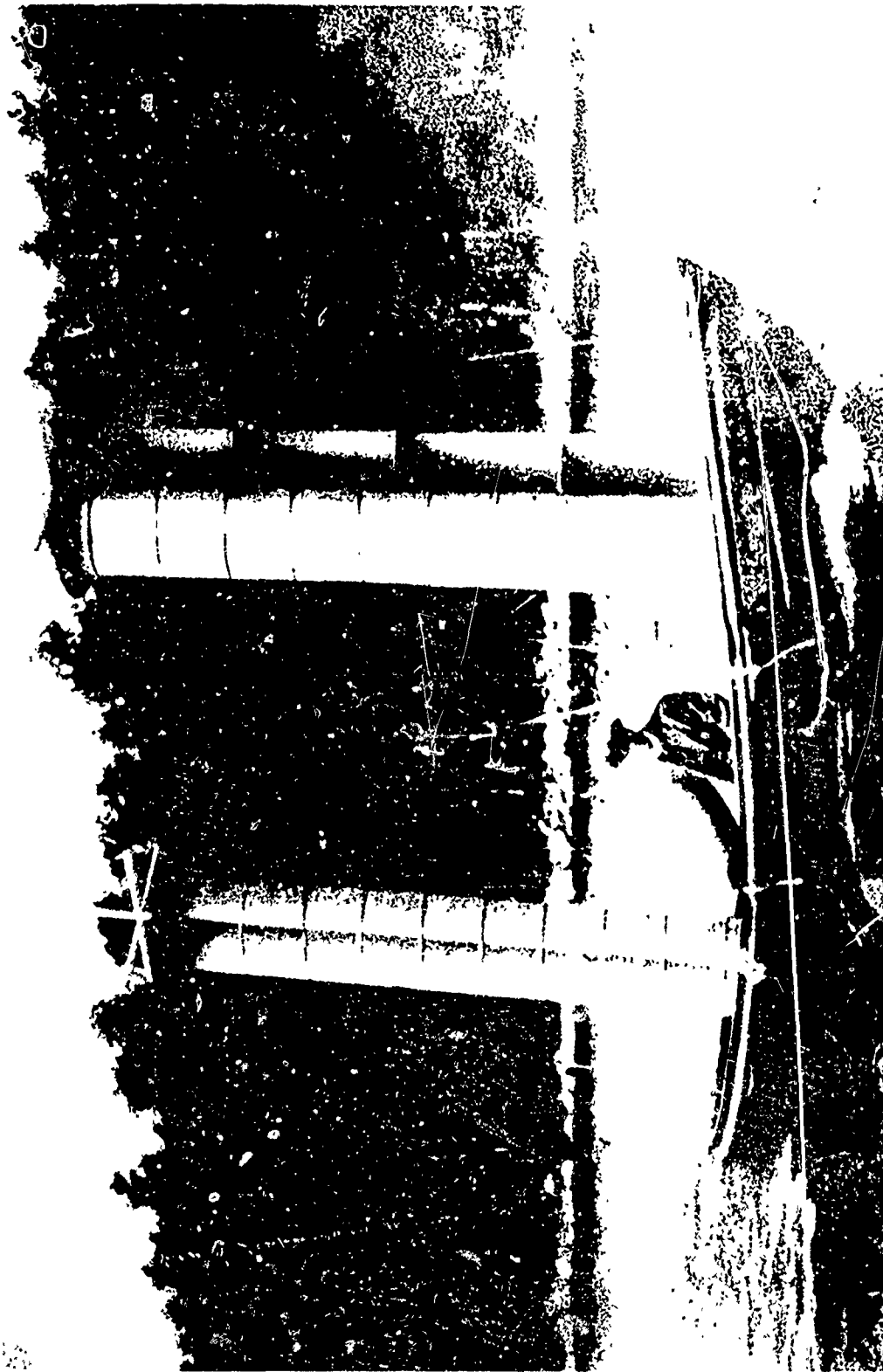

Figure 130. Savonius Autorotating Rotor Sailboat (1925). Semicylindrical Rotor Halves
May Be Reversed To Come About on an Opposite Tack.



Figure 131. Powered Cylindrical Flettner Rotor 37-Ft. Racing Yacht Hull (1925). Rotor Must Be Stopped and Reversed for Coming About. Dia., 3.5 Ft.; H, 19.1 Ft.

indeed very encouraging. One must remember the complexity of the multiple-sail system and rigging of the old merchantman to appreciate the vast improvement that was reflected in the aerodynamic and handling performance of the simple two-Magnus-rotor arrangement. Figure 132 is a performance comparison of the applied Flettner rotor system against the full-rigged barkentine, and an isolated, single, rigid airfoil sail. It is important to note that the total projected area of the barkentine is the same for the singular airfoil sail. The barkentine and Flettner rotor curves also included the measured aerodynamic influence of the ship's hull above the waterline. It is most important to note that the Flettner curve is based on the total rotor projected area of only 12.5% that of the barkentine and sail arrangement. Note that the shaded area of the barkentine polar curves indicates the practical area in which sail trim changes may take place and still keep the craft underway. As would be expected, the isolated airfoil sail, without the obstructions of rigging and the optimization of a fixed profile, has greater L/D (ability to point upwind) and C_N (greater sail force) potentials. It is toward this latter arrangement that modern sail design (sail wing, flex wing, wingsail, etc.) is tending. Thus, the potential of Magnus effect to ship propulsion remains only for pleasure craft and the like (Figure 131). It would be interesting to adapt the autorotating wing rotor to such craft (Figure 129, References 46L and 47L) when better aerodynamic sections become available.

D. CYCLOIDAL SHIP PROPULSION

The following areas of marine cycloidal propulsion have been examined in the light of their application to the general cyclogiro requirements:

1. Rotor blade kinematics, controls, and linkages
2. Rotor blade stress analysis and loads
3. Theoretical treatment of cycloidal propeller performance

As a general consideration, the present state-of-the-art use of cycloidal propulsion is in the amplified low- or pi-pitch ranges, and this fact alone limits any usefulness of marine experience. In item 1, the adaptation of marine blade-feathering systems to low-pitch cyclogiro aircraft configurations is, in many cases, schematically adaptable, but the weight and bulk of the marine blade feathering systems restrict their general use to marine craft. Rotor blade stress analysis and blade load distribution (2) were found to be generally adaptable though scant (References 20K, 30K, and 67M).

Although there is no lack of theoretical treatment of the cycloidal propeller, there is not presently a unified theory that could reflect the rotor performance for the proper range of blade aspect ratio, number, shape, twist, advance and pitch ratios, etc. All of the theoretical work

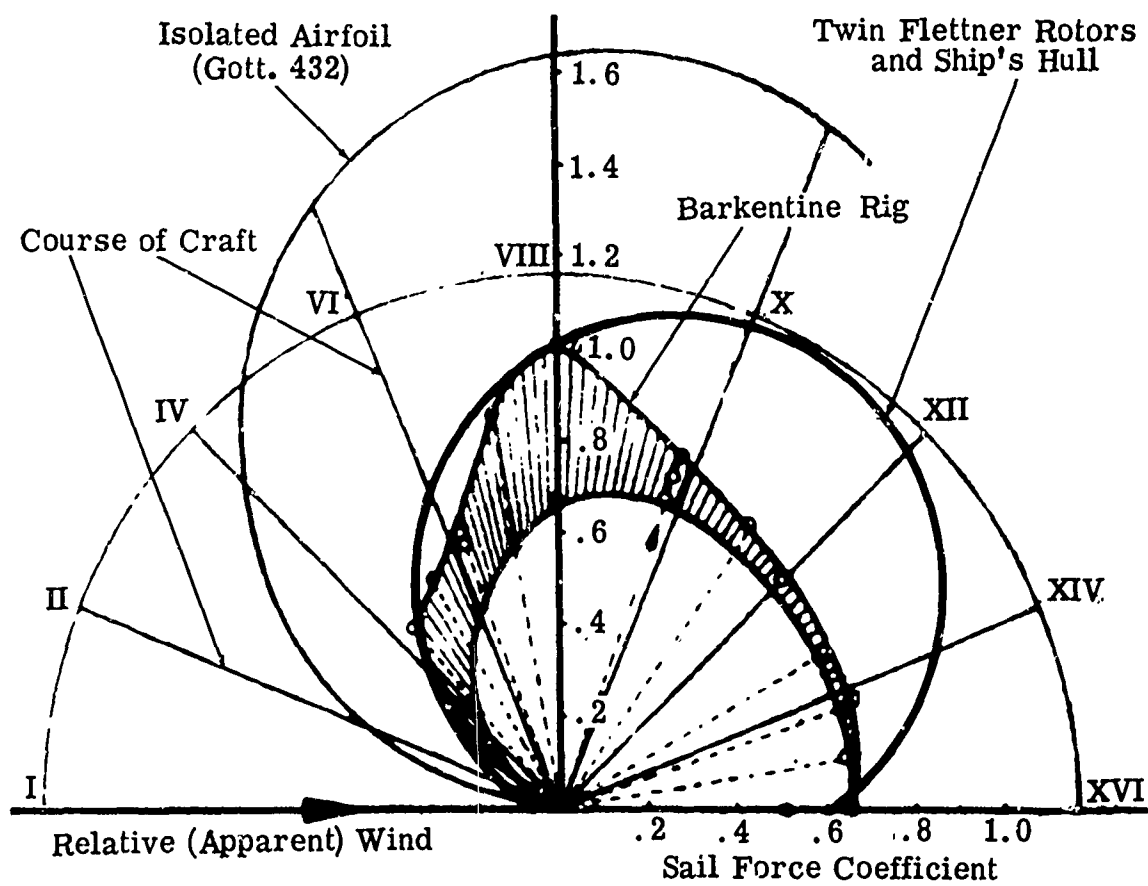

Figure 132. Performance Comparison of a Barkentine Sail and Flettner Rotor. Ship's Hull and Rigging Included.

to date covers the marine requirements (ahead thrust) in the low- or pi-pitch regime. Although the full-feathering cyclogiro could profit from part of this analysis in the area of hover and vertical flight, it is felt that marine theory cannot be of use when forward flight considerations are involved (rotor lift as well as propulsion).

Mueller, in Reference 67M, showed a general performance curve that compares the cycloidal marine propeller with an optimized conventional screw propeller. This plot is reproduced in Figure 133 in the form of the variation with thrust-load coefficient of what Mueller calls the "degree of perfection", also referred to as "real efficiency". The thrust-load coefficient is defined as follows:

$$C_{TL} = \frac{T}{0.5 \rho A_0 V_A^2}$$

where

T = the thrust of the propeller

ρ = the density of water

A_0 = the disc area of the propeller

V_A = the speed of advance of the propeller

The real efficiency is defined as the ratio of the actual efficiency η_0 of a real propeller in unlimited water to the ideal efficiency η_1 of the imaginary actuator-disc propeller of the same disc area A_0 and working at the same thrust-load coefficient C_{TL} .

A comparison of an efficient cycloidal propeller (Voith-Schneider amplified low pitch) with the best screw propeller (controllable propeller) shows a slight performance advantage for the conventional screw. However, at high speeds of advance, the cyclogiro propeller takes over. Thus, the advantage of the cyclogiro propeller does not lie in the fact that it has a higher propulsive efficiency, but in the fact that the efficiency remains constant whatever the direction of motion. In contrast, the performance of a four-blade controllable-pitch screw propeller, in back drive, is also shown in Figure 133. The screw propeller loses nearly one-half of its efficiency in back drive, while the cycloidal propeller loses none. Hence, the logical use of the cycloidal propeller is where flexible control and maneuverability are important: tug boats, floating cranes, fireboats, ferryboats, or for such military applications as mine-sweeping.

The performance curve for a cycloidal propeller with sinusoidal blade motion, which is a variant of the amplified low-pitch system (Reference 67M), is also shown in Figure 133. There, reduced performance is traded for a very simple control system and mechanical

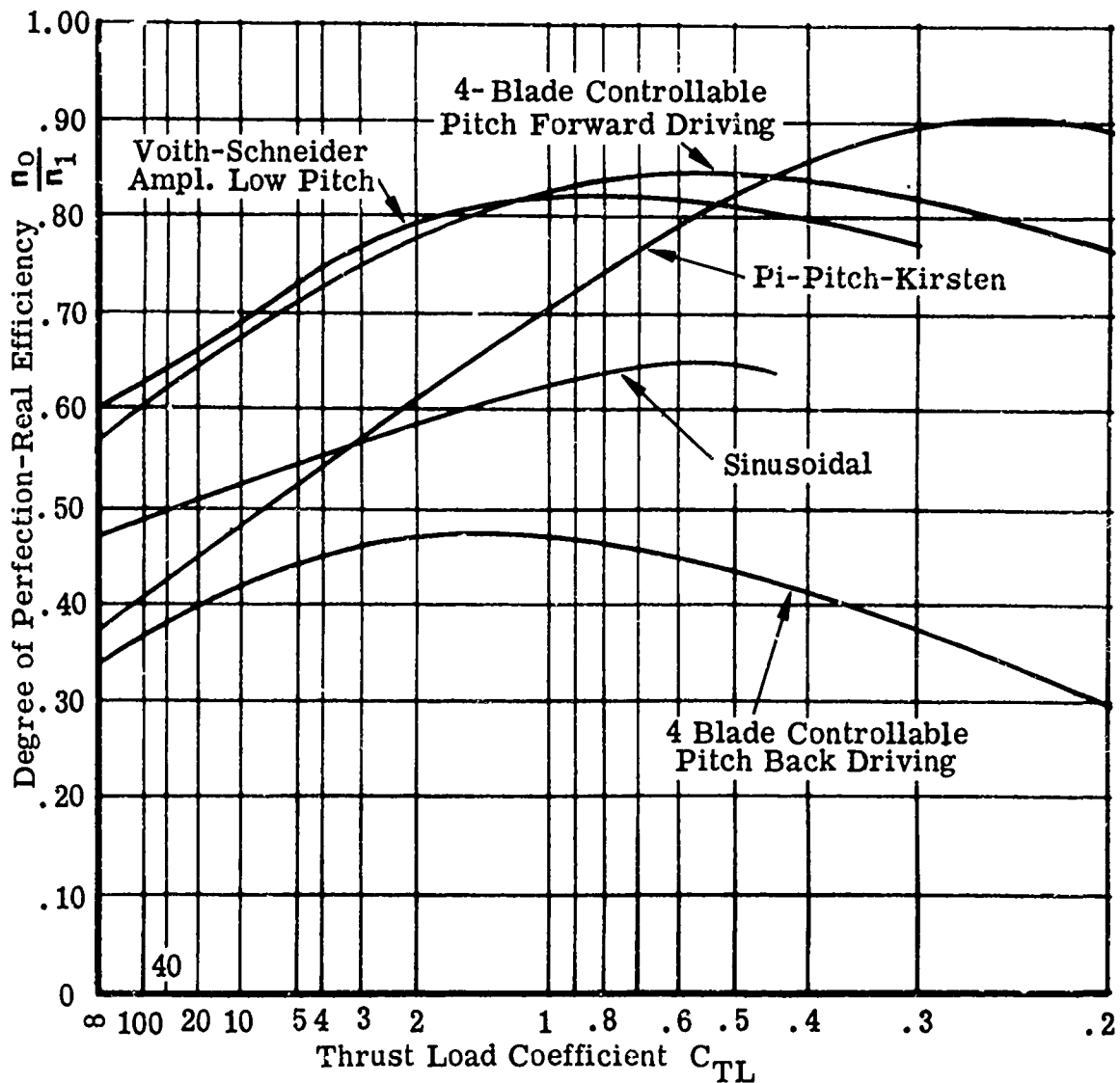

Figure 133. Comparative Performance of Three Types of Marine Vertical Axis Cycloidal Propellers With a Forward and Backward Driving Controllable Pitch Axial Propeller (Ref. 67M).

layout. Only very limited model testing exists for the marine propeller in the high-pitch regimes (Reference 18M).

Mueller (Reference 67M) suggests a means for obtaining a "poor man's" full-feathering cycloidal propeller. In this instance, when the ship is in a harbor or in close quarters, when maneuverability and precise control become desirable, the cycloidal propeller operates strictly in a low or amplified low-pitch regime with the blades normally feathering with respect to the rotor system. Once free of congestion and shipping and in the open sea, the propeller may be momentarily declutched (continuing to rotate without load) or stopped, and the feathering mechanism may be "gear-shifted" over into the high-pitch mode where the blades rock relative to the ship's hull.

The ship may now be accelerated into high pitch and advance ratios of high, forward, unobstructed speeds. This arrangement suggests a high-speed, efficient propeller with the control and maneuvering capability of the vertical-axis propeller. Schematically, this gear-shifting may be represented by rotating the slider blade-feathering link half a turn from the low-pitch to the high-pitch position (when $\psi = 180^\circ$), as shown in Figure 93. Thus, a quasi-full-feathering cycloidal propeller becomes feasible for ship propulsion without the intermediate mid-pitch transition and matching mechanism necessary for a comparable arrangement in aircraft. Two such intermittent full-feathering cycloidal marine propellers have been patented by Schneider (Reference 56S) and more recently by Bilke, et al (References 41B and 42B). The latter mechanisms are very ingenious, simple and with much merit.

SUMMARY OF ANALYSIS

A summary of the status of potential applications of horizontal-axis rotating-wing aircraft systems is presented in Table VII. The most remarkable part of this table is that it shows the extraordinary variety of HARWAS; it also shows the status of advancement of those systems: those that have been fully developed, those on which limited research has been done but which show promise, and those which show promise but on which hardly any research at all has been performed.

It is interesting, at the end of this study, to attempt to outline the common features of the very diverse systems that were reviewed. This will be done in the form of two remarks:

1. The operation of almost all HARWAS is fundamentally based on unsteady aerodynamics. For example, wing rotors, cyclogiro systems, helicopters, and radial-lift propellers rely fundamentally on time-varying lift and drag forces. This automatically explains why less is known about them than about fixed-wing aerodynamics. The operation of fixed-wing aircraft can, at least in first approximation, be understood in terms of steady or quasi-steady flow. This is not possible for HARWAS. There are today no established engineering rules to explain unsteady lift and drag flow phenomena. It could very well be that serious study in this direction is required before there can be a positive understanding of HARWAS aerodynamics.
2. The other common feature of cyclogiros and radial-lift propellers is that they were evolved in an attempt to copy nature, i. e., bird or insect flight. The paradox of modern aviation is that it has achieved enormous success by separating the functions of lift and of propulsion, which is unknown in nature. As stated in the introduction of this report, all early attempts to copy bird flight in aeronautical devices have been markedly unsuccessful. It is the conclusion of this report that, for VTOL and STOL aircraft at least, one has much to learn from the successful integration of lift and propulsion in animal flight. There again, bird flight is a nonstationary process!

Kirsten in the United States, von Holst in Germany, and Richard in France all suggested different versions of HARWAS as a direct consequence of their interest in, and study of, bird flight. It is suggested that their approaches are worth pursuing.

If one were to select the two most promising HARWAS configurations of those listed in Table VII, and an additional constraint was that

these configurations should not be under active study elsewhere at the present time (example: Reference 57W), the two HARWAS systems would be as follows:

1. The rotating airfoil flap (RAF) for application to a STOL aircraft
2. The full-feathering cyclogiro for application to the composite aircraft mission

TABLE VII. SUMMARY AND EVALUATION CHART FOR HORIZONTAL AXIS ROTATING-WING AIRCRAFT SYSTEMS (HARWAS).

SYSTEM		AIRCRAFT APPLICATION	POTENTIAL	NEEDS FURTHER RESEARCH	NEEDS ADVANCED TECHNOLOGY	FULL SIZE TEST OR DEVELOPMENT	ANALYSIS AVAILABLE	STUDY IN DEPTH	RESTRICTIONS	SIGNIFICANT REFERENCE	
HORIZONTAL AXIS LIFTING SYSTEMS	MAGNUS EFFECT AND RELATED SYSTEMS	ROTATING CYLINDER SLAT	Stol	Little				Yes		41W	
		ROTATING CYLINDER IN WING	Stol	None							51W
		ROTATING CYLINDER AT TRAILING EDGE	V/Stol	Fair				Yes			42B
		ROTATING CYLINDER FLAP	V/Stol	Excl.	Yes		Done		Yes	Current Patent	56W
		ROTATING CYLINDER WING	Stol	None			Done				4Z
		ROTATING AIRFOIL SLAT	Stol	None?							50L
		ROTATING AIRFOIL IN WING	Stol	None?							50L
		ROTATING AIRFOIL FLAP	Stol	Excl.	Yes		Req'd.	Yes	Yes		52C
		ROTATING AIRFOIL IN FLAP LEADING EDGE	V/Stol	Good?							32L
		ROTATING AIRFOIL CONVERTIBLE FIXED WING	Stol	Fair			Done		Yes		21C
		WING ROTOR ROTATING AIRFOIL DECELERATOR		Very Good	Yes		Req'd.	Yes		Current Patent	52B
		ORBITING AND THRUST FLAP	V/Stol?	Very Possible	Yes		Req'd.			Current Patent	54B
		TRANSVERSE FLOW FAN AND FLAP	V/Stol?	Very Possible	Yes	Yes ¹	Req'd.	Fan Only		Current Patent	12-21L
		CYCLOGIRO SYSTEM	LOW PITCH	Vtol	Near Hover			Done	Yes	Yes	
AMPLIFIED LOW PITCH	Vtol		Near Hover				Yes	Yes		26H	
PI PITCH	Vtol		Fair			Done	Yes	Yes		30K	
AMPLIFIED HIGH PITCH	V/Stol		Excl.	Yes	Yes ¹	Req'd.	Yes	Yes		8B	
HIGH PITCH	Stol		Excl.	Yes			Yes	Yes		1E	
FULL FEATHERING	V/Stol		Excl.	Yes		Req'd.	In Paris	Yes		2E	
OTHER			None			Done				50L	
CONICAL ROTOR			?	Yes						32R	
Near Horizontal Axis Lift-Thrust Devices	RADIAL-LIFT PROPELLER	Vtol	Excl.	Yes		Done	Yes	Yes		85B	
	CYCLIC LIFTING PROPELLER	Stol?	Very Good?	Yes		Done	Yes	Yes		31-38R	
NON-AERONAUTICAL APPLICATIONS OF HARWAS	Turbine Thrust Devices	WING ROTOR OR SAVONIUS WINDMILL		Good Limited		Done		Yes		3B	
		MAGNUS EFFECT SHIP PROPULSION		Sport Only		Done	Yes	Yes		31F	
		CYCLODAL SHIP PROPULSION		Excl. Limited	Yes		Done	Yes	Yes		30K
		CYCLOGIRO WINDMILL TURBINE		Good?				Yes	Yes		20-30P

NOTE: 1 - As Deflected Slipstream or Tilt Wing. 2 - Fan Wt. Reduction. 3 - Gas Turbine Matching

PRELIMINARY PERFORMANCE AND DESIGN STUDY OF TWO HARWAS CONCEPTS

I. ROTATING AIRFOIL FLAP (RAF) STOL AIRCRAFT

The search for better high-lift devices is more urgent than ever, not only for STOL aircraft but also for conventional high-performance aircraft. Actually, there is no basic difference between the high-lift devices of a conventional airplane and those of such STOL aircraft as the Grumman Mohawk or the De Havilland Caribou. It is a matter of degree: the former type has larger flaps, larger leading-edge slats, a higher power loading, and the maximum favorable interference between the propelling unit and the wing. Recently, the Boeing Aircraft Company advanced the concept of the conventional/short takeoff and landing (C/STOL) aircraft, an airplane with the size and the capacity of the Boeing 737, the favorable economics of conventional takeoff and landing, and the flexibility of STOL performance.

The use of horizontal-axis rotating aerodynamic devices, either autorotating or powered, in conjunction with fixed wings, opens new possibilities for the enhancement of either low-speed lift or low-speed lateral control of CTOL, STOL, or C/STOL aircraft. In the latter mode, the rotating devices could be used as fixed surfaces for the CTOL operation and as rotating surfaces for the STOL operation. Conversion from a fixed to a rotating position is not expected to be a significant problem. As shown in Table VII, at least 10 candidate configurations have been suggested in the past. Out of these, two are of more immediate interest: the rotating cylinder in flap (RCIF) and the rotating airfoil flap (RAF). Extensive research and development are being done at the present time on the RCIF by Alvarez-Calderon and the Ames Research Center of NASA. It is therefore proper here to concentrate on the less-researched RAF.

Aerodynamic test data relating to the RAF are collected, examined, and compared with similar data for other high-lift systems. The results of this analysis are used for a preliminary design exercise in which the present flap system of the DeHavilland DHC-5 Buffalo (shown in Figure 134) is replaced by a rotating airfoil flap system. The fact that all data on the RAF are small scale requires an extrapolation to full scale, which may or may not be valid, but for which similar experience with other high-lift devices is a useful guide. An attempt was made at being conservative, rather than optimistic.

A. AERODYNAMIC CHARACTERISTICS OF THE ROTATING AIRFOIL FLAP (RAF)

As shown in the ANALYSIS section of the report, the Küchemann study (Reference 51K) is the only source of comprehensive data for application of the external RAF to aircraft and will therefore be used here for further discussion as well as for sizing. The data will be examined on a



Figure 134. De Havilland DHC-5 "Buffalo" Transport Aircraft With Double Slotted Flaps Extended for Maximum STOL Takeoff.

comparative basis with other related high-lift systems under conditions as similar as possible.

The comparison is shown in Figure 135 in the form of five polar curves for complete aircraft configurations with different high-lift devices, which have the following in common:

- There are no propeller effects ($T_c' = 0$).
- If the flap is fixed, the flap deflection δ_f is 40° to 45° .
- The flap chord, C_f , is 20 to 25% of the wing chord C_w .
- Airfoil thickness ratio is 15 to 18%.

The five configurations are as follows:

- ① Full-scale airplane, with external fixed flap,
 $\delta_f = 40^\circ$, $C_f = .2 C_w$
- ② Model airplane, Küchemann, with external fixed flap,
 $\delta_f = 45^\circ$, $C_f = .25 C_w$
- ③ Model airplane, Küchemann, with rotating flap,
 $U/V = 4.0$, $C_f = .25 C_w$
- ④ Full-scale STOL airplane, DeHavilland Buffalo, low- C_L end of computed polar curve only,
 $\delta_f = 40^\circ$, $C_f = .25 C_w$
- ⑤ Full-scale airplane model (Ames wind tunnel) of a rotating cylinder flap
 $\delta_f = 40^\circ$, $C_f = .46 C_w$ (including rotating cylinder)
 $U/V = 5.1$

Obviously, the major differences among the five configurations are as follows:

- Scale effect (Reynolds number):

①,④ and ⑤ are full scale; ② and ③ are small scale

- Wing aspect ratio:

- ④ has very large aspect ratio
- ① has large aspect ratio
- ⑤ has fairly small aspect ratio
- ② and ③ are with very small aspect ratio

Thus, the RAF models ② and ③ have joint disadvantages of model data and small wing aspect ratio.

A comparison of ① and ② shows the scale effect and the aspect ratio effect for two airplanes with external fixed flap: the maximum lift coefficient is about the same, but the corresponding drag of ② is one-third larger than that of ①.

The effect of rotating the flap (RAF) is shown by comparing ② ($U/V = 0$) and ③ ($U/V = 4.0$). There is a significant increase in C_{Lmax} , but there is a correspondingly large increase of C_D . The sudden collapse of C_{Lmax} for ③ shows a very sharp stall, representative of the sudden flow breakaway, at the low test Reynolds number.

A comparison of ① and ⑤ shows that at low C_L 's the polar curves are much the same. At very low C_L , ① has a lower drag than ⑤, but ① stalls earlier ($C_L \approx 2.1$). Configuration ⑤ would stall only at $C_L \approx 3.1$.

A comparison of ①, ④, and ⑤ shows that ④ and ⑤ have very similar polar curves, which both extend the polar curve of ① to higher C_L 's. Thus, based on this figure (poweroff condition), a good double-slotted flap and the rotating cylinder flap (RCIF) have about the same characteristics. Although not shown here but in Figures 33 and 36, the influence of propeller slipstream is to dramatically increase the C_{Lmax} of the RCIF, configuration ⑤, from 3.1 to 12. It is to be noted from actual flight tests that the C_{Lmax} of the double-slotted flap only increases to 3.6 with propeller effects.

Finally, a comparison of ③ and ⑤ shows that, under the conditions of similarity stated above, airplane ③ (the RAF) has a higher C_{Lmax} than airplane ⑤ (the RCIF). Further, at $C_L = 3$, the drag of airplane ③ is one-third higher than that of airplane ⑤. It was noted earlier that the one-third factor may correspond to a scale effect. Thus, the lift-drag ratio of configuration ③, full scale, could be about the same as that of configuration ⑤. It remains that ③ has a C_{Lmax} that is 25% higher than ⑤. Stall could also be less abrupt than is shown in Figure 135 for configuration ③.

Assuming now that the propeller slipstream effect is as large on configuration ③ (the RAF) as on configuration ⑤ (the RCIF), one

might speculate that the RAF is capable of very high lift coefficients, of the order of 15.

Naturally, all this is speculation, but it indicates the desirability of following the full-scale wind tunnel tests on the RCIF by similar tests on the RAF.

The aerodynamic problems to be investigated in RAF full-scale tests are as follows:

1. Size; i. e., Reynolds number effect on aerodynamic performance.
2. Effect of propeller slipstream on performance.
3. Effect of wing aspect ratio, flap aspect ratio, airfoil shape, airfoil thickness ratio, and flap tip plate shape.
4. Effect of flap-chord-to-wing-chord ratio and of the position of the flap axis with respect to the fixed-wing trailing edge.
5. Effect, if it exists, as hinted in Reference 42S, of the fixed-wing airfoil on the overall geometry of the RAF.
6. Installation arrangement of the RAF as an external airfoil flap. May not be the optimum aerodynamic or mechanical arrangement. Variations have been described by Tino (Figure 76), Lake (Figure 89), and Henter-Käser (Figure 88).
7. Effect of external and locked RAF on cruise lift-drag ratio and environmental (icing) problems.
8. Pitching moment data on the RAF. Should be obtained for all the tests suggested above.

B. THE RAF AS A CONTROL DEVICE

There are no test data that can be used to substantiate the effectiveness of the RAF as a lateral control device (aileron) for the low-speed operation of a STOL aircraft. It is well known that the minimum approach speed of an aircraft is sometimes dictated by control, not by high-lift considerations. The RAF can be broken down into several spanwise sections rotating independently, and the outer section can be used for lateral control. (See Table VIII).

The tests suggested in the preceding paragraph should definitely include a determination of the lateral control effectiveness of the RAF.

C. POWER REQUIRED TO ROTATE THE RAF

There is a great shortage of data on the power required to activate a rotating airfoil flap. The only data available (Wiese, Reference 56W) concern the power required to rotate isolated airfoils (not in conjunction with a fixed wing) about their 50% chord axis. Wiese's data are shown in Figure 136, and they really have more of a qualitative than a quantitative value. On the contrary, the power required to drive the NASA/Ames RCIF system was exactly determined and is also plotted in Figure 136, where it can be used as a lower boundary.

In Figure 136, the power coefficient C_R is plotted versus U/V .

$$C_R = P / (1/2 \rho U^3 S_f)$$

where

P = power required

ρ = density

U = peripheral velocity of flap

S_f = flap area

Certain trends can be observed from Figure 136, as follows:

- Required power decreases with increasing Reynolds numbers.
- Required power decreases with increasing aspect ratio.
- Required power decreases with the addition and shape of tip plates.
- Possibly, profile shape affects the required power.

It is felt that a reasonable estimate of the variation of C_P with U/V is provided by the curve of Figure 136 corresponding to $AR = 5$ and an elliptical tip plate. The curve is used in the numerical example and design study that follow.

It is of interest to note that the majority of test curves for the lenticular rotating airfoil of Figure 136 (16.7% thickness ratio) do not pass through the origin but tend to originate near $U/V = 1$, in the autorotational condition. Also shown in Figure 136 is configuration (40) of Table III, which autorotates at a U/V of nearly 2. It is possible that this shape would have reduced power requirements in the driven mode as well.

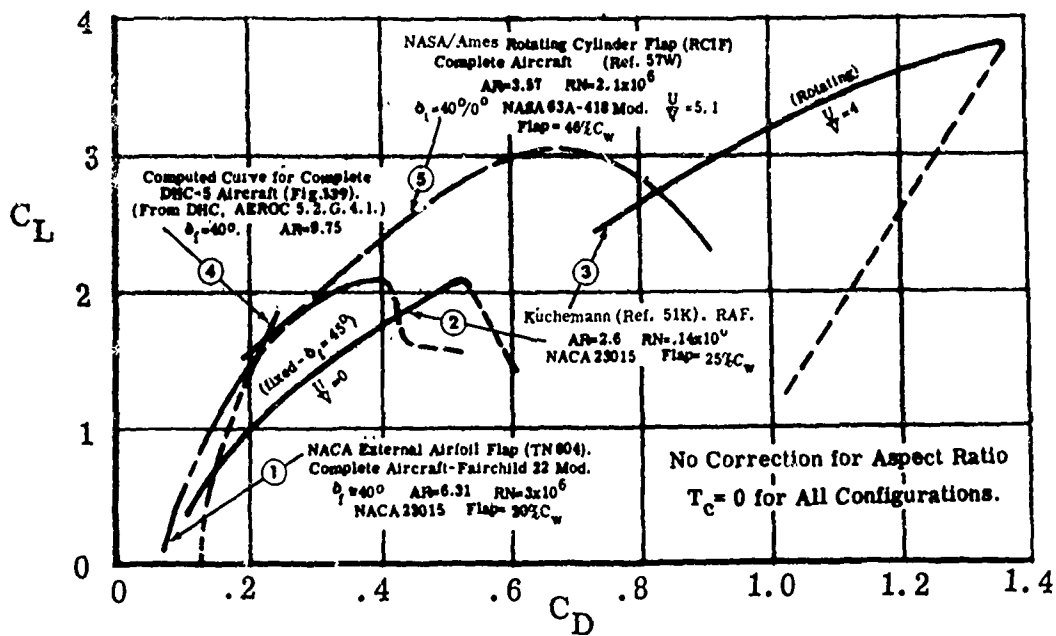

Figure 135. Lift and Drag Polars for Rotating Airfoil Flap and Other Related High-Lift Flap Devices.

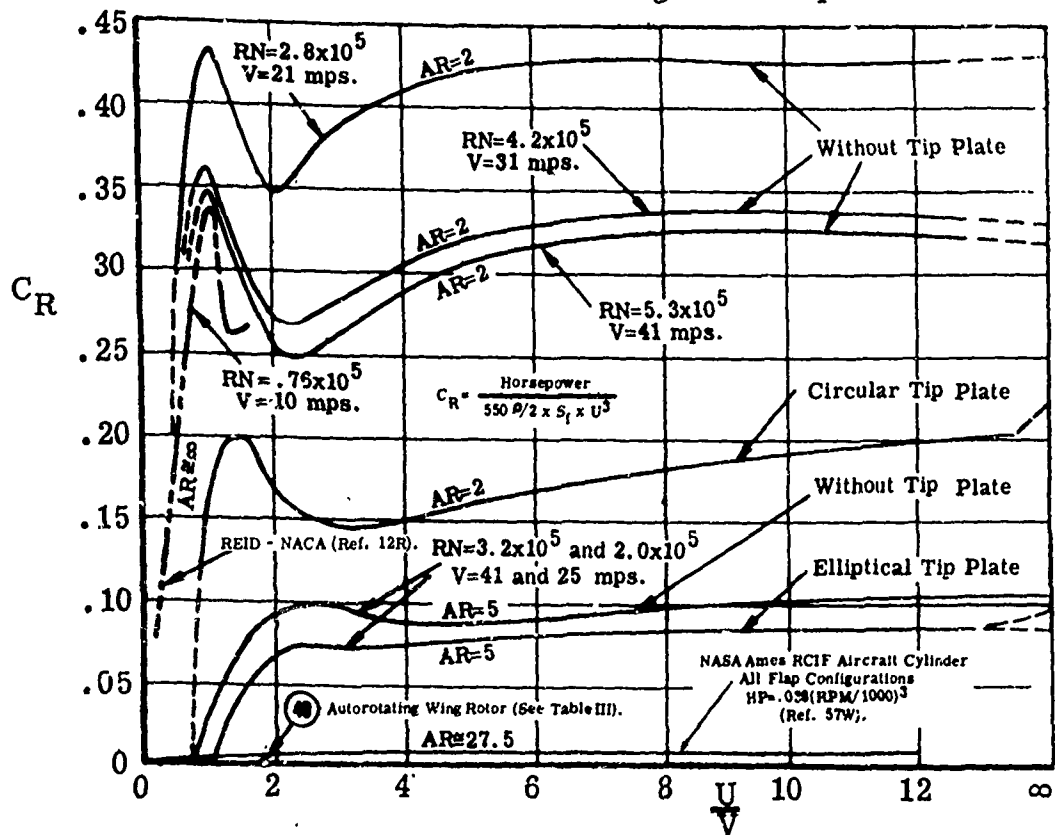

Figure 136. Power Requirements for Rotating an Isolated Lenticular Wing Rotor and RCIF Cylinder Flap.

D. APPLICATION OF THE RAF TO A STOL TRANSPORT AIRCRAFT

To investigate the application of the RAF to aircraft, the following preliminary study was undertaken to understand the problems of RAF adaptation, powering, and practical performance. To this end, it was considered to be desirable to adapt the RAF system, with a minimum of modifications, to an existing STOL transport aircraft. The aircraft selected for this study is the DeHavilland DHC-5 "Buffalo" transport aircraft (Figure 134). The basic characteristics of the RAF-modified version of this aircraft are shown in Figure 137 and are tabulated in Figure 139. For matters of direct comparison, it will be noted that the gross weight (for STOL landing) and the wing area have been kept identical for the RAF-modified and the nonmodified DHC-5. As with other flapwing area conventions, the external nonrotating flap is not included in the total wing area measurement. For the purposes of this discussion, the overall RAF system consists of six flap elements, each with a nominal aspect ratio of five, elliptical tip plates, and a lenticular cross section profile. Thus, the approximate power requirements of each flap section may be determined from the tests by Wiese, Figure 136.

The RAF axis is located in the "optimum" position 2 (Figure 43). The RAF system is further broken down into two inboard rotating flap elements and four outboard rotating flaperons. Referring to Figure 137, the rotating flap element, drive, and control system are represented schematically in plan view. Note that the two outboard flaperons rotate directly together and are split to provide for a midpoint support hanger. In practice, the individual flap elements would be allowed to slide axially on splines or couplings to accommodate wing and flap deflecting during flight. For the same reason, the support bearings would need to be self-aligning. Figure 138 further indicates that the individual port and starboard flap systems acquire their driving power from hydraulic pumps possibly attached to the main flight engine accessory pad. An alternate suggestion would be to drive the flaps from an auxiliary power unit centrally located within the fuselage in the area of the cross-coupling clutch.

The functioning of the "hydraulic mechanical selector mixer system" is tabulated in Table VIII. The effect of various control and power functions in these units is further tabulated to show the flap responses over the full range of flight regimes and for various aircraft missions.

A comparison of the RAF with the existing double-slotted flap of the DHC-5 is of great interest. The existing DHC-5 flap and aileron system is briefly described here. The wing incorporates high lift, full-span, double-slotted flaps along the trailing edge. The outer section of the trailing flap operates as a conventional aileron. The DHC-5 flap system is power-operated via a hydraulic motor; gearboxes, torque tubes, and irreversible screw jacks. The flap system is provided with adequate protection against a malfunction. The flap-aileron system consists of fore sections and trailing sections--inner, mid, and outer on

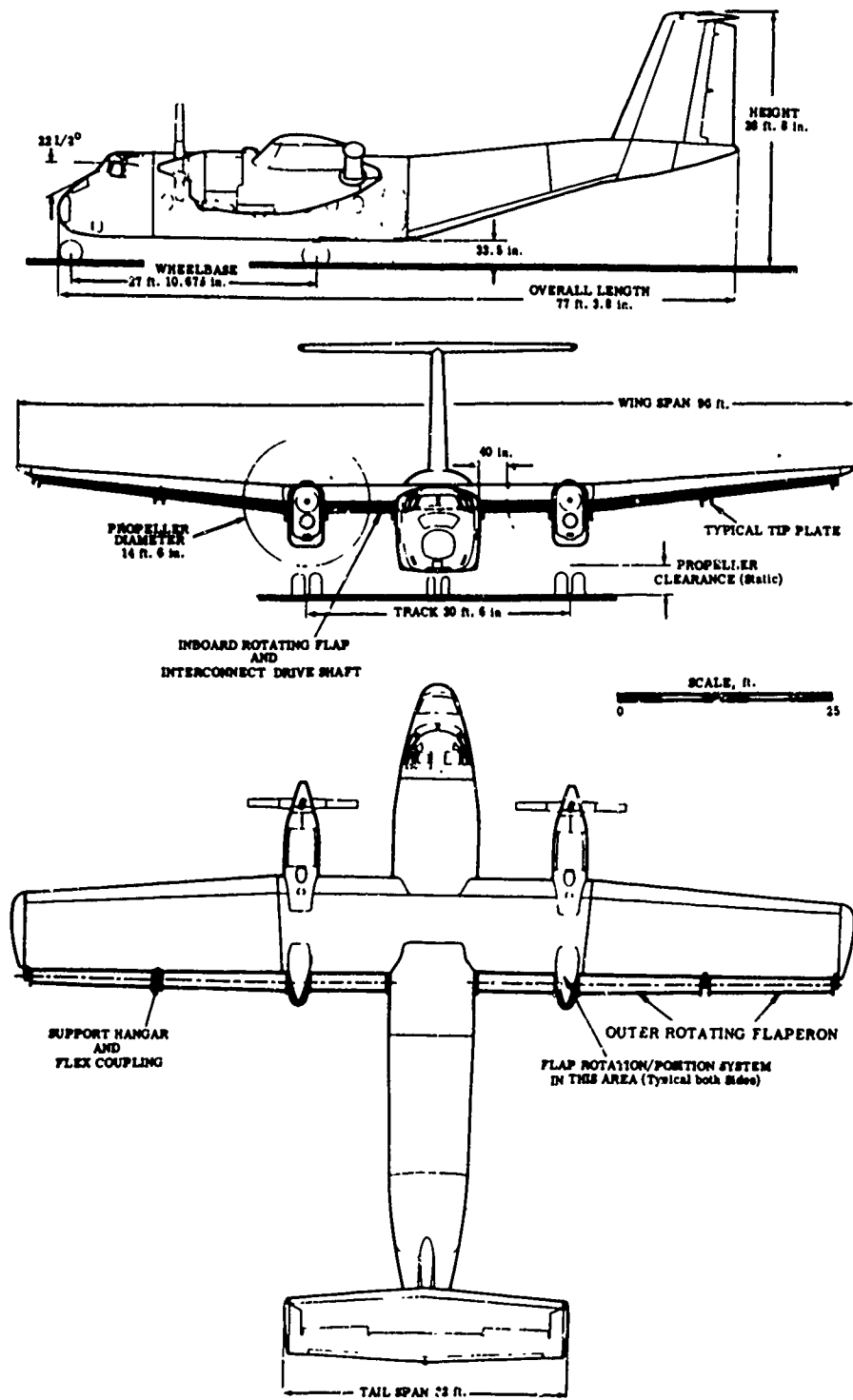

Figure 137. Modification of DeHavilland DHC-5 "Buffalo" Incorporating Full-Span Rotating Airfoil Flaps (RAF) and Aileron (Flaperon) System. Gross Weight and Total Wing Area are Identical.

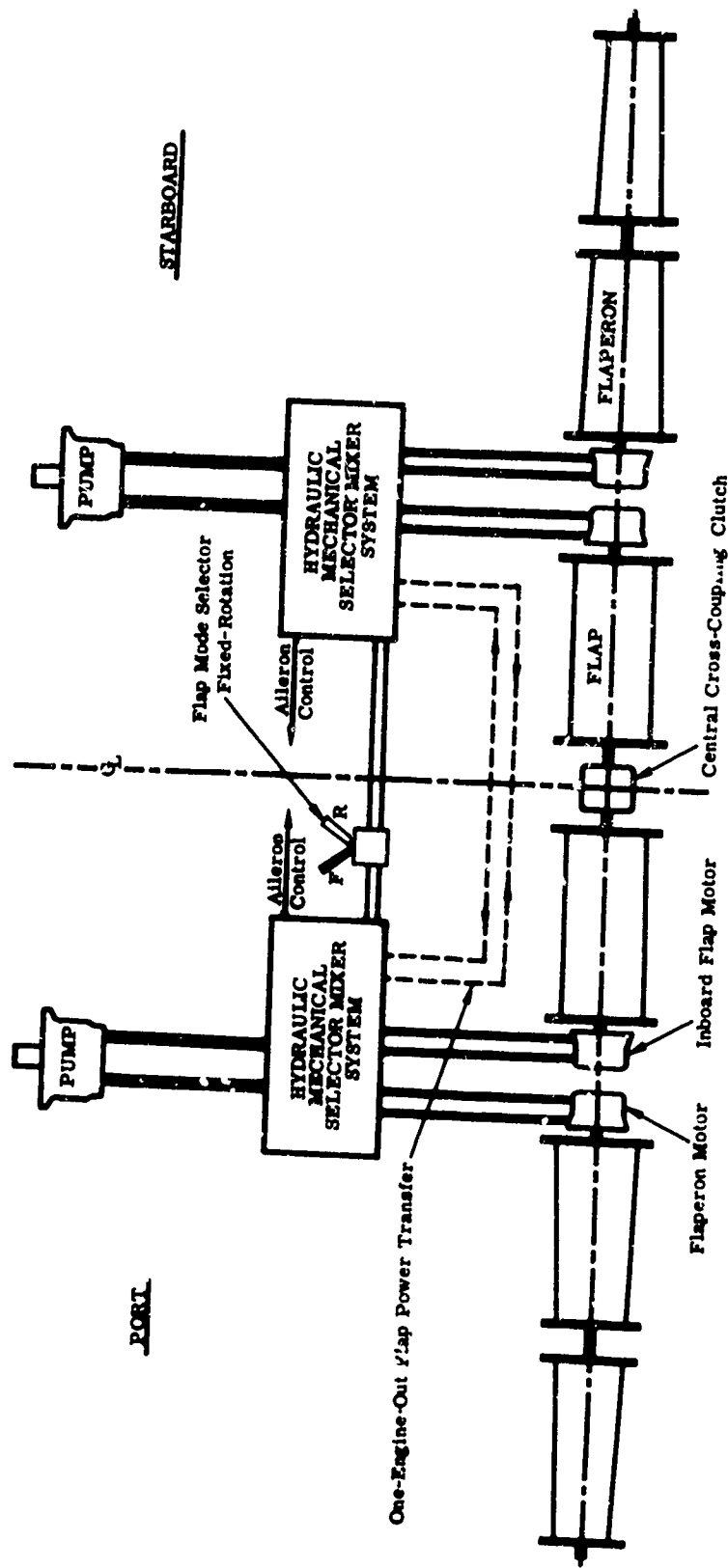

Figure 138. Schematic Representation of the Hydraulic and Mechanical RAF Drive and Control System as Might Apply to Twin-Engine Aircraft. Functioning of the Components Is Described in Table VIII.

FLIGHT OPERATION	CONVENTIONAL		STOL - BOTH ENGINES		STOL - ONE ENGINE OUT.		STOL - BOTH ENGINES OUT.	
	Inboard Flap	Outboard Flap	Inboard Flap	Outboard Flap	Inboard Flap	Outboard Flap	Inboard Flap	Outboard Flap
MECHANICAL AND HYDRAULIC CONTROL REQUIREMENTS	Two independent hydraulic systems with accumulators. One pump drives off of each engine (accessory pump). Fixed flaps operated from cockpit by conventional lever. Additional selector - flap: fixed-rotation. Two positions. Flap: fixed-rotation operated primarily through individual port and starboard motors. Mixed to account for yaw differences. Mechanical back-up/over-ride also required. For schematic of above, see Pg. 138.		Upon selection of flap and flap motor rotation, hydraulic pump in each engine accels drive a corresponding motor (Pg. 138). A selection valve and distributor on box drive the flaps at selected RPM. Mechanical and/or hydraulic cross-coupling insures uniformity of port and starboard inboard flap rotation. Outboard flap motor controlled by proportionalizing valve in interconnectual distribution boxes. Responds to inboard motor movement and may override fixed flap system.		One engine remains effectively in-washing hydraulic power for reduced rotation of flap and flap motor. If flap situation is such the cockpit control (flap: fixed-rotation selector) may be set to fixed mode to conserve power for propeller thrust as well as disconnected distribution boxes (flap: in-washing hydraulic plunger on flap: in-washing rotation by motor or mechanical cross-shaft).		All flap/laggon systems may be converted to operate as fixed adjustable flaps and mechanically controlled ailerons. Alternate hydraulic power for some rotation functions may be sought from accumulator or the filter. Autorotation of inboard flaps may be desirable for lift enhancement during landing approach.	
Flight Regime								
TAKE OFF RUN	δ_1 - Fixed Deflected Down Than for Take Off	Changing Fixed Flap Settings with Power Aileron Deflection	Powered Rotation to Max. U/V and C_L Take Off	Ditto Also Allowance for Differential RPM Modulation	About Take Off	Ditto		
LIFT-OFF	Ditto	Ditto Rigged to Avoid Adverse Yaw	Rotating at Optimum U/V and C_L for Lift-Off	Ditto Used as Full External Aileron	About Take Off	Ditto		
CLIMB OUT	Ditto	Fixed Ditto	Rotation Decreasing	Ditto	About Take Off or Continue with Flap in Cross-Coupled Rotation	Ditto		
CLIMB TO ALTITUDE	Fixed δ_1 Reduced Further	Ditto	Flap Braking and Fixing at Climb δ_1	Ditto	Ditto	Ditto		
CRUISE	Fixed δ_1 = Min. Drag	Ditto (Used as Full External Aileron)	Fixed δ_1 = Min. Drag	Ditto (Used as Full External Aileron) Fixed	Fixed δ_1 = Min. Drag	Ditto (Used as Full External Aileron) Fixed	Fixed	Ditto (Used as Full External Aileron) Fixed
DESCENT	Fixed δ_1 Some	Ditto	Ditto or Reverse Rotation for Neg. C_L	Ditto	Fixed δ_1 = Some	Ditto	Fixed δ_1 = Some	Ditto
APPROACH	Fixed δ_1 = at High C_L Compensate with C_L Avail.	Ditto	Rotating up to C_L max.	Ditto	Rotating Ditto	Rotating	Flaps Fixed to High Avail. C_L or Put into Autorotation as Req'd.	Ditto
FLARE	Ditto	Ditto	Ditto	Ditto	Ditto	Ditto	Ditto	Ditto
LANDING RUN	Ditto	Ditto	Ditto Braked to Stop or Set Fixed δ_1 = 90°	Ditto	Ditto	Ditto	Ditto	Ditto

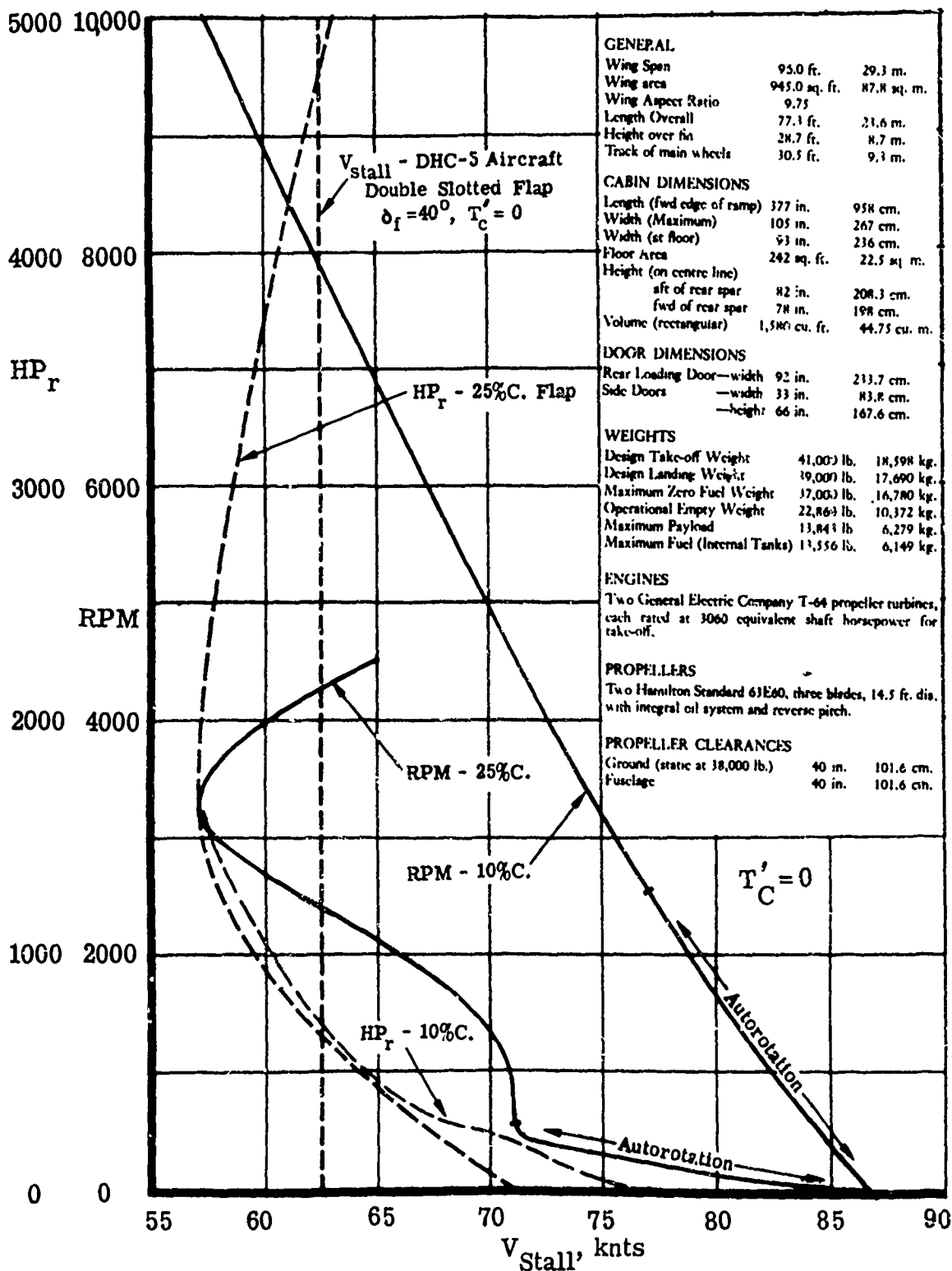

Figure 139. General Characteristics and Horsepower Required to Achieve C_{Lmax} . (V_{Stall}) With RAF on DHC-5 STOL-Type Aircraft.

each wing. The fore and trailing sections are separated from the wing shroud and each other to provide the slotted-flap characteristic for greater aerodynamic efficiency. The relative motion of the two sections is defined by mechanical linkages hinged from, and carried by, the rear wing spar. The outer trailing sections function as ailerons, superimposed on their travel as part of the flap system. To provide additional lateral control of the DHC-5, the aileron system is coupled to the spoilers. The spoilers are coupled to operate asymmetrically in proportion to aileron control commands. The spoilers extend "up" in proportion to "up" commands to the associated aileron. The conventional cable/rod aileron control circuit is coupled to the servo control valves of the hydraulic actuators that function the spoilers. The system is designed such that a failure or seizure of the spoiler actuator cannot impair normal aileron operation. Various safety and gust locks are located throughout the flap system.

The RAF flap mechanism is understood from the representation of Figure 138 and Table VIII. Not indicated are the safety and duplication arrangements required to insure fail-safe flap function in response to hydraulic or mechanical failure.

An aerodynamic performance comparison of the RAF concept with a conventional STOL aircraft is limited by the test data of Küchemann (Reference 51K). The restriction is such that only during a power-off landing ($T_c' = 0$) situation could an equitable comparison be made of these data with the actual DHC-5 flight test data. Thus, the comparative stall speeds of the gliding standard DHC-5 with double-slotted flaps and two RAF systems have been graphically presented in Figure 139. In this situation, standard sea level conditions, equal wing areas (945 ft.²), and equal gross weights (39,100 lbs.) are considered.

An attempt at a performance comparison of the RAF modified "Buffalo" and the original Buffalo is shown in Figure 139. The comparison is made in terms of the stalling speed of the aircraft in the approach condition with power off. The stall speed of the Caribou with flaps retracted is 87 knots. The corresponding stall speed, with fixed double-slotted flap $\delta_f = 40^\circ$, is 63 knots (corresponding to $C_{Lmax} = 3.10$). Two RAF configurations are considered, one with a 10% chord flap and the other with a 25% chord flap. The basis for the performance estimate is Küchemann's data (Reference 51K and Figures 41 and 43). The plots of Figure 139--flap RPM is shown as the solid curves and flap required horsepower as the dashed curves--were established as follows. Values of U/V between 0 and 5.20 are assumed. The corresponding C_{Lmax} for each flap chord, are determined from test data. To each C_{Lmax} , there corresponds a stall speed which is calculated. The corresponding U is then calculated, hence the flap RPM; the coefficient C_R corresponding to the assumed U/V is determined from Figure 136, and the corresponding horsepower is calculated.

It can be seen that the RAF in autorotation will permit the lowering of the stall speed to 77 knots for the 10% flap and to 71 knots for the

25% flap. At U/V's above autorotation, the flap power required rises rapidly. There is a slight power advantage to have a 25% flap rather than a 10% flap.

The power expenditure corresponding to a stall speed equal to that of the basic Buffalo aircraft--63 knots--is about 650 HP. Above that point, power expenditure is out of proportion to potential gains, as 1000 HP is required to lower the stall speed by 10 knots. Note that the hump of the 25% flap RPM curve comes from the apparent sudden stall of the position 2 airfoil.

The above discussion and the data of Figure 139 must, however, be considered unrealistic for two related reasons.

First, the data of Figure 139 are for $T_c' = 0$, and it was shown in the discussion of Figure 135 that there was at least a suspicion that T_c' had a powerful influence on the maximum attainable lift coefficient. Thus, the calculated values of C_{Lmax} used to establish Figure 139 may, in actuality, be pessimistic by a factor of 2 or 3.

Second, because of the lack of meaningful data, it was assumed that the RAF-modified and the original Buffalo had the same gross weight. This fails to account for the weight of the auxiliary motors needed to drive the rotating flaps. It would be interesting to determine the one point for which this is true: the RAF system is simpler than the basic double-flap arrangement, hence a potential weight saving, which can be used in motors to drive the rotating flaps. It is impossible to determine at this time whether this "break-even" point corresponds to a V_{stall} greater or smaller than the 63 knots of the basic Caribou.

All of this indicates that large-scale test data are needed before a meaningful assessment of the RAF system can be made.

E. ADDITIONAL APPLICATIONS OF THE RAF CONCEPT

The RAF concept is ideally suited for application to the COIN aircraft configuration. A conceptual study is shown in Figure 140. The COIN aircraft requires both STOL performance and good control at low speeds. It uses large propellers which immerse the wing nearly totally in their slipstream. The RAF is considered to be a prime means to deflect the propeller slipstream and to prevent wing stall at low speeds.

The outboard RAF unit is independently modulated to provide the strong, effective low-speed control at and near hovering flight. With both engines out, the RAF continues to autorotate and provide substantial lift for power-off emergency landings. The rotating flaps may be programmed and controlled to operate in the manner previously outlined in Table VIII. The compactness of this COIN aircraft may reduce the flap area with a subsequent saving in the flap power required.

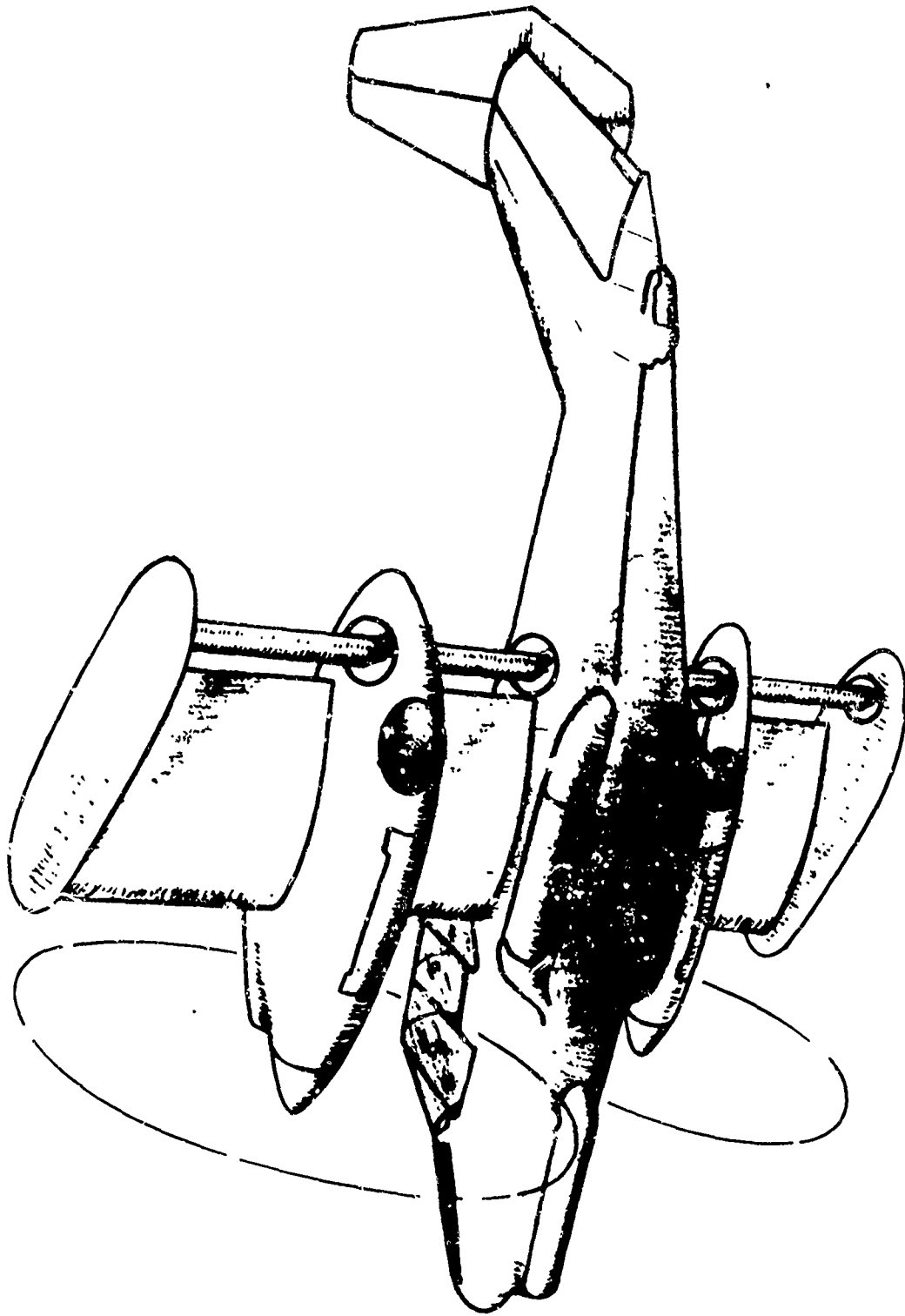

Figure 140. Deflected Slipstream V/STOL Aircraft Utilizing Rotating Airfoil Flap (RAF) for Slipstream and Lateral Control.

II. VTOL CYCLOGIRO TRANSPORT FOR THE COMPOSITE AIRCRAFT MISSION

A. DESIGN PHILOSOPHY

USAAVLABS has conducted much research in the last few years in the areas of the high-performance helicopter, the compound helicopter, and the composite aircraft to provide further increases in Army mobility (References 61C and 68L). The most advanced concept, the composite aircraft, is aimed at combining into one aircraft the hover efficiency and downwash velocities of the helicopter and the high-speed efficiency of fixed-wing-type aircraft, in the speed range of 30 to 350 knots. The cyclogiro aircraft is the only known nonrotary-wing aircraft that has full hover capability with relatively low disc loadings, as demonstrated in the ANALYSIS section of this report. It was therefore reasonable that a preliminary design of a cyclogiro composite aircraft should be compared to other proposed composite aircraft. In view of the newness of the application of the cyclogiro concept to the composite aircraft mission and of the total lack of research in this area for the last twenty years, one is constrained to a conceptual study, rather than a detailed, quantitative one.

The assumptions used in References 61C and 68L for the design objectives are those also used here. They are briefly summarized below:

Payload	3000 lbs
Fuel	3000 lbs
Useful Load	6450 lbs
Hover O.G.E. at 95° F	6000 ft pressure altitude
Disc Loading	10 lb/ft ² or less (except for tilt wing or cyclogiro which have 35 lb/ft ²)
Maximum Speed	300-350 knts
Internal Cargo Compartment	5.5 ft wide x 6 ft high x 14.3 ft long
Power Plant	Current-or-advanced-technology gas turbine sized to meet the concept's power requirements (rubber engines)

The disc loading is chosen at 35 lb/ft² as a compromise between a lighter loading that would give less hover power required but would

present rotor structural problems, and a higher loading that would present the opposite situation: good structural efficiency, poor hover efficiency, and higher rotor parasite area. The disc loading is based on the projected area of the cylinder described by the rotor blades, including the fuselage blanketed area. Like all other parameters of this study, the disc loading is not optimized. Only a detailed aerodynamic and weight study would make it possible to ascertain whether the assumed value is close to optimum or not.

The preliminary design study mainly consists of three elements: a configuration study showing the approximate sizing of the aircraft, a performance study, and a control study showing specific means to achieve control with a cyclogiro rotor. The overall purpose of the study is to indicate that the considerations described in the ANALYSIS section of the report can be meaningfully applied to the design of a cyclogiro transport.

B. GENERAL CHARACTERISTICS OF THE CONFIGURATION

A three-view preliminary drawing of the configuration is shown in Figure 141. A tandem-rotor configuration was chosen, with front and aft rotors rotating in opposite directions. Each rotor consists of three blades. Details of rotor geometry resemble closely those of a configuration that was thoroughly tested by Baker in the University of Washington wind tunnel (Reference 8B, Figures 76 and 77), except that a reduced solidity is used.

Each rotor is basically driven by a gas turbine engine mounted on top of the fuselage, along the centerline. In case of failure, the engines are mechanically interconnected, and a system of overriding clutches permits autorotation in case of total power failure.

Detailed studies made twenty years ago concluded that the weight of a complete cyclogiro rotor-propulsion system including the powerplant was of the same order of magnitude as the weight of the corresponding helicopter rotor powerplant system. Technical advances have considerably reduced the weight of the rotor system, of the transmission, and of the gas turbine powerplant; it is assumed that corresponding advances in cyclogiro rotor technology, the transmission, and the blade-rocking system may make possible a corresponding reduction of the weight of the cyclogiro rotor-propulsion system.

It is assumed that the cyclogiro mechanical loss is 7% of the total horsepower.

The cyclogiro rotor type used here is of the combined high-pitch and amplified high-pitch type, to be described later in some detail. At high speed, it is a high-pitch type; at lower speeds and hover, it is of the amplified high-pitch type. A full-feathering rotor system would result in a higher aerodynamic efficiency; however, it would present

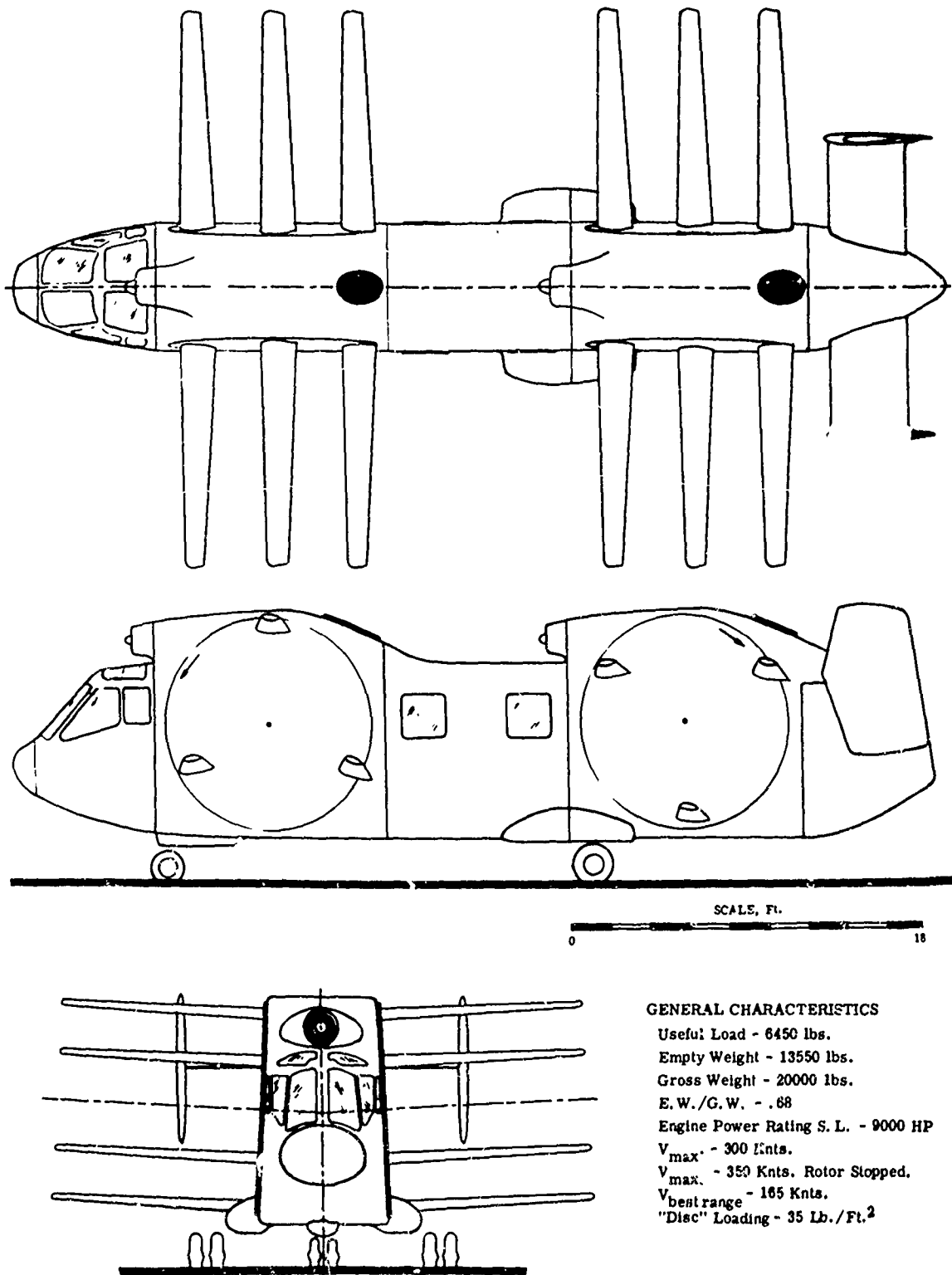

Figure 141. High-Speed Amplified High-Pitch VTOL Cyclogiro Project.

additional and unknown development and mechanical difficulties at this time.

The gross weight of the configuration is assumed to be 20,000 pounds, which may be slightly optimistic in view of the high installed horsepower (9000 SHP). It is assumed to be distributed equally between the two rotors, to the effect that rotor aerodynamic interference between the front and rear rotors is ignored.

A parasite drag area of 15 ft.² is assumed, which is conservative if the landing gear is assumed to be retractable (not shown in the figure).

Any configuration such as that of Figure 141 will look different from that of a fixed-wing aircraft or of a conventional VTOL aircraft, and will have a high fuselage. However, it does not show any unacceptable aerodynamic or structural compromises: the fuselage is hardly larger and heavier than that of a conventional aircraft; the integration of lift and propulsion into the cyclogiro rotors and the absence of antitorque rotors and of any control system external to the rotors tend to make up for the complexity of the rotors themselves. Should be necessary, the aspect ratio (i. e., span) of the cyclogiro rotors could be increased without the configuration looking misshapen.

C. PERFORMANCE CHARACTERISTICS OF THE CONFIGURATION

One possible way to look at performance is as follows. Based on the results of the ANALYSIS section (Figure 99, for example), one can expect, for a properly designed cyclogiro, a hovering figure of merit of 0.8. This gives an HP/W figure of the order of 0.20 for a disc loading of 35 p. s. f.

As far as forward flight is concerned, it was shown that a propulsive efficiency of the order of 0.8 (or even higher) could be achieved. One could thus calculate forward-flight performance or at least estimate maximum speed, based on that figure.

It was decided to follow another approach for this study. In order to avoid giving grounds to extreme and uncritical optimism, the performance of the aircraft was calculated, based on Baker's actual wind tunnel test data (Reference 8B) of a small nonoptimized model. The only deviation from Baker's rotor geometry was to reduce the rotor solidity by a factor of 2. A comparison of Baker's data with theory shows that the results come very short of the theory. Hence, use of Baker's results should correspond to a most pessimistic use of the cyclogiro.

Out of the results of Reference 8B, two curves are reproduced here: Figure 142 shows a polar curve, C_L versus C_D , for various values of J (the symbols are the same as those defined in the ANALYSIS section); Figure 143 shows a lift-power curve, C_L versus C_P , for the same advance ratios. The design points on these curves correspond to

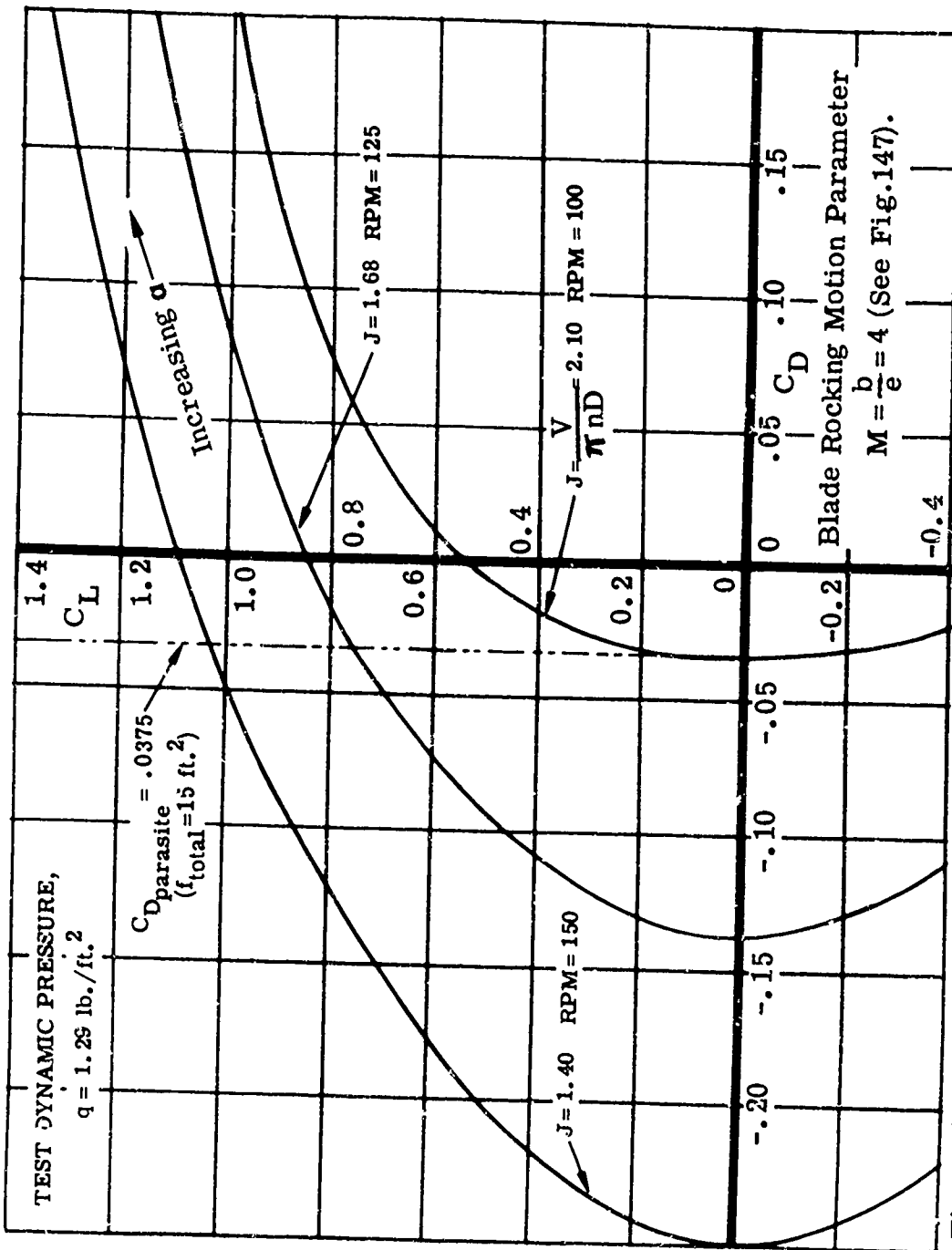

Figure 142. University of Washington High-Pitch Cyclogiro Wind Tunnel Results (Ref. 8B) in Area of Design Interest. Lift (C_L) is Plotted Against Thrust ($-C_D$) at Three Advance Ratios.

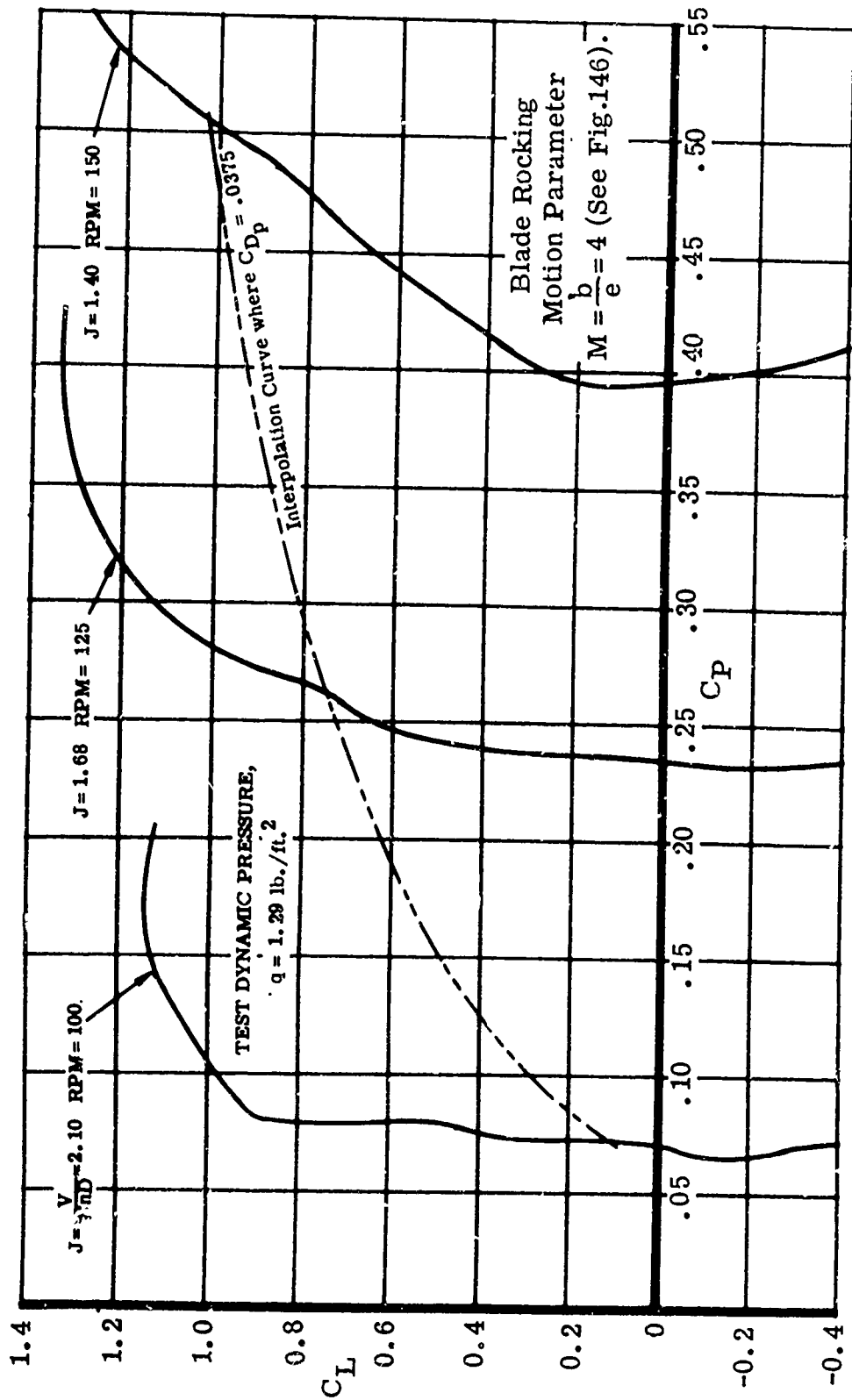

Figure 143. University of Washington Amplified High-Pitch Cyclogiro Wind Tunnel Results (Ref. 8B) in the Area of Design Interest. Vertical Lift (C_L) is Plotted Against the Power Required (C_p) at Three Advance Ratios.

a thrust coefficient equal to minus the drag coefficient, itself corresponding to a parasite drag area of 7.5 ft.² per rotor; i. e., a $C_{Df} = .0375$.

Comparative concept characteristics and calculated performance are shown in Figure 144 for the helicopter, the compound helicopter, the slowed-rotor compound, the composites, the tilt wing, and two cyclogiros (a high-pitch and a stopped-rotor configuration).

It can be seen that the cyclogiro performance is not spectacular, because of the pessimistic assumptions made, but that at least it extends the area of operation of the other configurations toward higher speeds. It could be shown that use of the assumptions first discussed in this paragraph would lead to a drastically improved picture. The limitations of the test results that were used for the performance curves will be discussed at the end of this section.

D. REVIEW OF HIGH-PITCH AND AMPLIFIED HIGH-PITCH BLADE MOTIONS

Cyclogiro blade-rocking motion was discussed in some detail in the ANALYSIS section. However, it is useful to elaborate here on the specific details of a cyclogiro blade motion that will be the basis for the proposed cyclogiro aircraft control system. The geometrical description of the blade-rocking motion that leads to the aerodynamic generation of thrust and lift forces on the cyclogiro rotor, either separately or simultaneously, will be discussed in this section. Application to cyclogiro control will be made in the next paragraph. The cases of the high-pitch cyclogiro (Figure 145) and the amplified high-pitch cyclogiro (Figure 146) will also be discussed.

Consider first, for example, the ideal basic motion of the forward port rotor of the proposed cyclogiro of Figure 141 moving at a constant translational velocity V_T , which corresponds to the velocity V of the ANALYSIS section of the report. This motion is described in Figure 145A, in which the blade chord line is shown at six equidistant stations about the periphery of the rotor orbit. The rotor blade axes revolve geometrically about an instantaneous center o on the mechanical axis of symmetry, which is a line determined by the point o and the center A_p of the orbit circle. One can define also an instantaneous aerodynamic or directional center o' , which is the point of intersection of the normals to the resultant velocity vectors V_r at the six stations, as shown in Figure 145A. Note that the velocity vectors carry subscripts corresponding to their respective stations, 1 through 6.

One may recall here (see Figure 88) that when the point o' is outside the orbit circle, one has a high-pitch arrangement. If o' is on the circle, one has a pi-pitch arrangement; if o' is inside the circle, one has a low-pitch arrangement. Only the high-pitch arrangement will be considered further here.

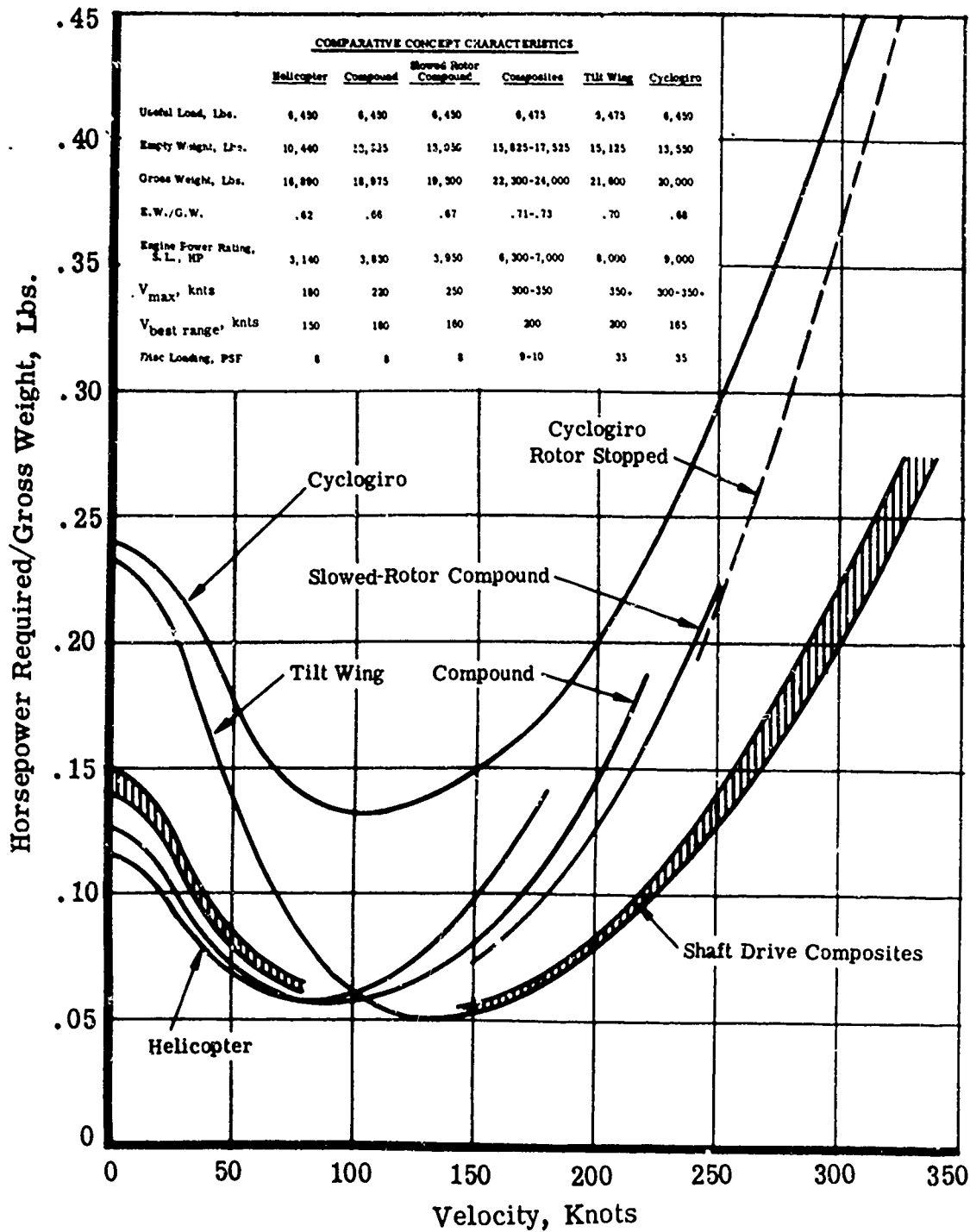

Figure 144. Comparative VTOL Aircraft Concept Characteristics and Forward-Flight Performance.

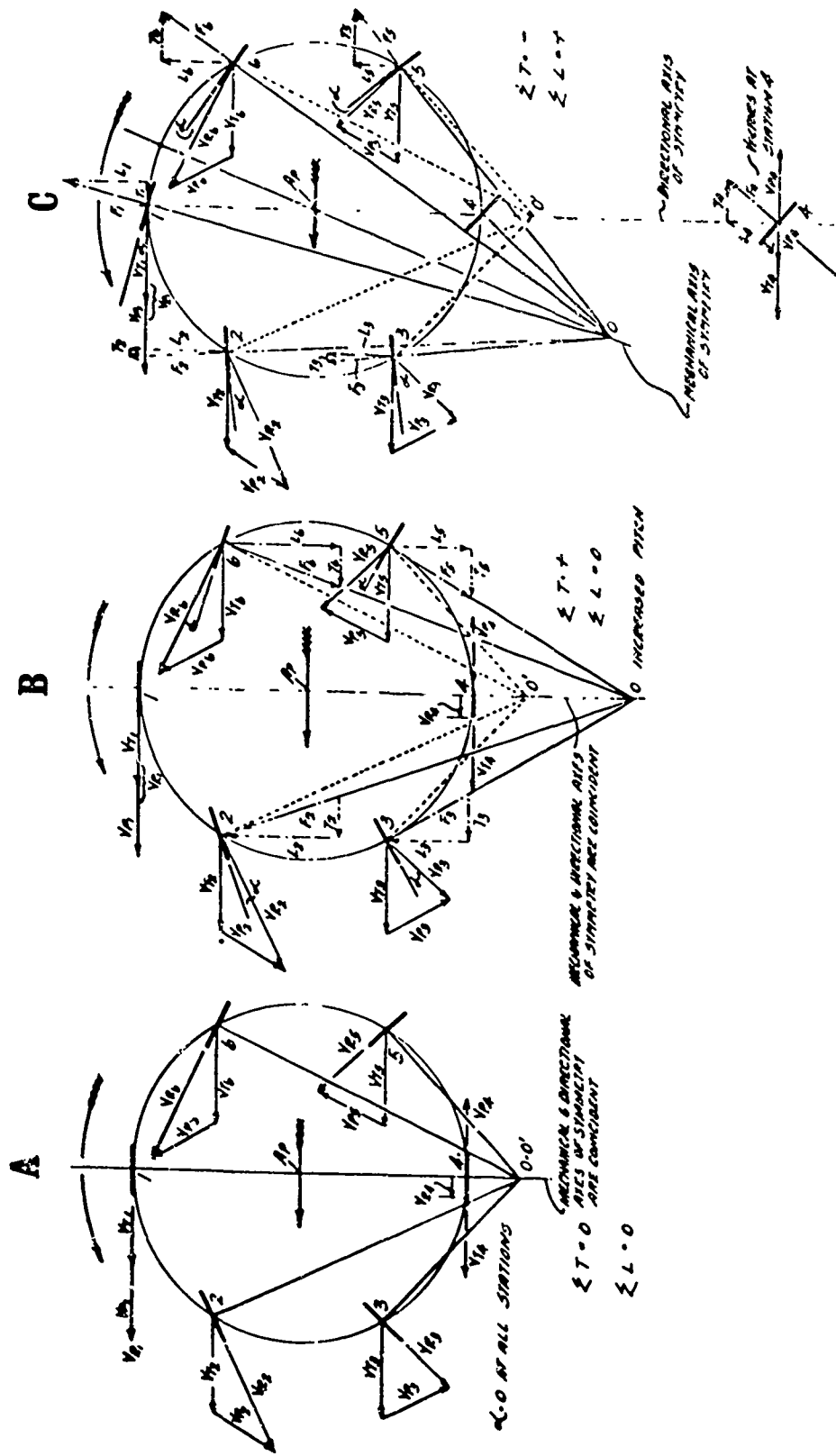

Figure 145. Schematic Diagrams Explaining Geometrically the Blade Rocking Motion for a High-Pitch Cyclopro Rotor.

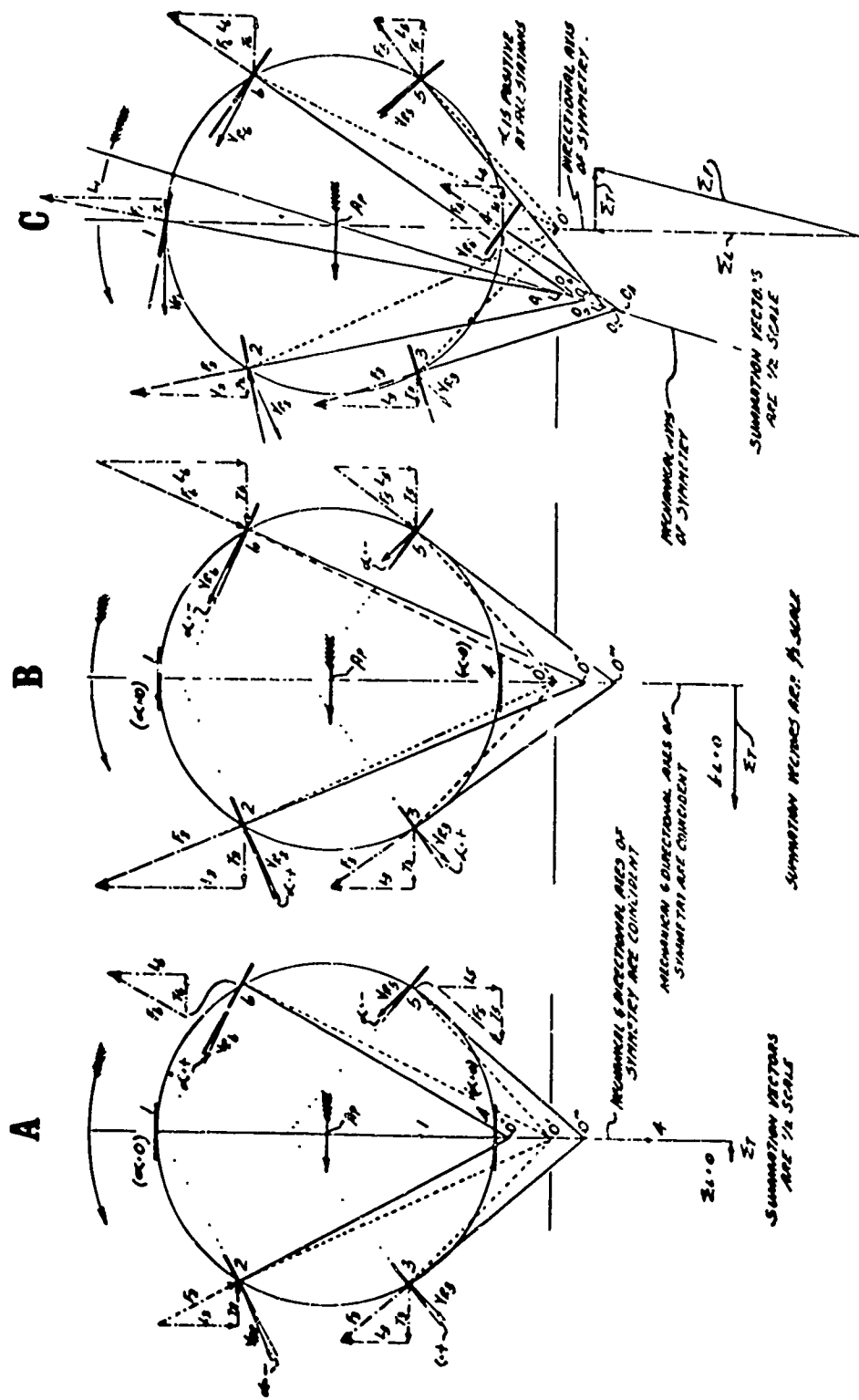

Figure 146. Schematic Diagrams Explaining Geometrically the Blade Rocking Motion for an Amplified High-Pitch Cyclogiro Rotor.

Note that, for the motions of interest here, the instantaneous aerodynamic center o' remains fixed through a blade revolution and is also an "overall" center.

Returning to Figure 145A, it can be seen that the two centers o and o' coincide and that the sum of thrust forces and of lift forces is equal to zero. The resultant net force on the rotor is zero.

Consider now Figure 145B, in which the instantaneous blade mechanical center o is displaced vertically downward along the axis $A_p - o'$. Rotational and translational velocity of the rotor remains the same. The change in feathering at stations 2, 3, 5, and 6 causes the corresponding blades to have an increased angle of attack α_T with respect to the local resultant air velocity V_R . The forces thus generated at the six stations are shown in Figure 145B. In this instance, the vertical-lift components cancel out, but there is an overall net thrust, directed to the left. Thus, mechanically, thrust control of the rotor can be achieved by the mechanical displacement of the mechanical intersection point o away from the aerodynamic intersection point o' .

Consider now Figure 145C, in which point o is not only moved downward from o' but is also moved to the left of the axis $A_p - o'$, the basic local velocities remaining unchanged. In this case, the summation of the lift forces becomes positive. Thus, lift control of the rotor can be produced by moving the mechanical intersection point o to the left. The effect is analogous to that resulting from a change of angle of attack of a fixed wing. Note that the lateral position of o in Figure 145C is extreme and corresponds to a negative thrust. In practice, point o is moved just enough to the left to provide the necessary lift, while retaining enough thrust to overcome the aircraft parasite drag.

A mechanism such as that described in Figure 145 was embodied in the Baker wind tunnel model (Reference 8B) and is shown schematically in Figure 147. The result of the wind tunnel tests was shown in Figure 142. A complete polar curve can be covered by going through a complete range of the "angle-of-attack" parameter α of Figure 145C. For a given advance ratio J (corresponding to the j of the ANALYSIS section), one clearly sees in Figure 142 the passage from a "thrusting" to a "dragging" rotor as the point o of Figure 145C moves to the left.

As discussed in the ANALYSIS section, an ideal rocking motion is undesirable, at least at low pitch, because of excessive accelerations. The scheme of Figure 145 is therefore acceptable for high-speed cyclogiro operation, but an amplified pitch system must be devised for operation at lower speeds and at hover. Specifically, operation becomes impossible when the point o' approaches the orbit circle too closely.

Consider then the amplified high-pitch motion schematically described in Figure 146. The basic difference is that the instantaneous mechanical center o' moves during each blade revolution in its orbit.

Specifically, looking first at Figure 146A for stations 2 and 6, o' is at point o'' , whereas for stations 3 and 5 it is at point o''' . For station 1, o' lies at the position on the axis shown as "1", above point o'' ; for station 4, o' lies somewhat below point o''' , in the position shown as "4".

This device may be construed as superimposing a "higher control harmonic" to the basic cycloidal mechanism. In practice, this harmonic can be introduced by means of an eccentric, as shown in Figure 94, or by the two oscillating sections A and C in the mechanism of Figure 147.

A detailed consideration of the force diagrams of Figure 146A shows that the asymmetry created by the amplified motion only creates a negligible horizontal thrust; its main effect is, as intended, to reduce the maximum blade accelerations, hence blade stresses, in the bottom part of the orbit ($\psi = 180^\circ$).

The steps taken in Figures 146B and 146C are similar to those that were taken in Figures 145B and 145C, with corresponding results; i. e., the generation of a net horizontal thrust force in Figure 146B, and of both a thrust and a vertical-lift force in Figure 146C. The difference is that, instead of just one mechanical center, one has six mechanical centers, o_1 to o_6 , spread as shown in Figure 146C.

Note that low-pitch and amplified low-pitch motion characteristics can be explained, as was done for the high-pitch motion in Figures 145 and 146, by drawing corresponding figures with the instantaneous center o' located inside the rotor orbit.

In summary, basic features of cyclogiro control are as follows:

1. High-pitch motion control is satisfactory for high flight speeds; amplified high-pitch motion control is required for low speeds and hover flight.
2. Horizontal thrust is modulated by a vertical displacement of the mechanical instantaneous center o along the mechanical axis.
3. Vertical lift is modulated by a horizontal displacement of point o away from the mechanical axis.
4. Lift and thrust forces are generated simultaneously by a combined mechanical (angular) horizontal and vertical displacement of point o away from the mechanical axis.
5. Lift and thrust, alone or in combination, can be further modulated by overall rotor RPM changes consistent with structural limitations of the rotor and its blades. Weight and structural considerations dictate that the rotor RPM be as low as possible and that the advance ratio j as high as possible.

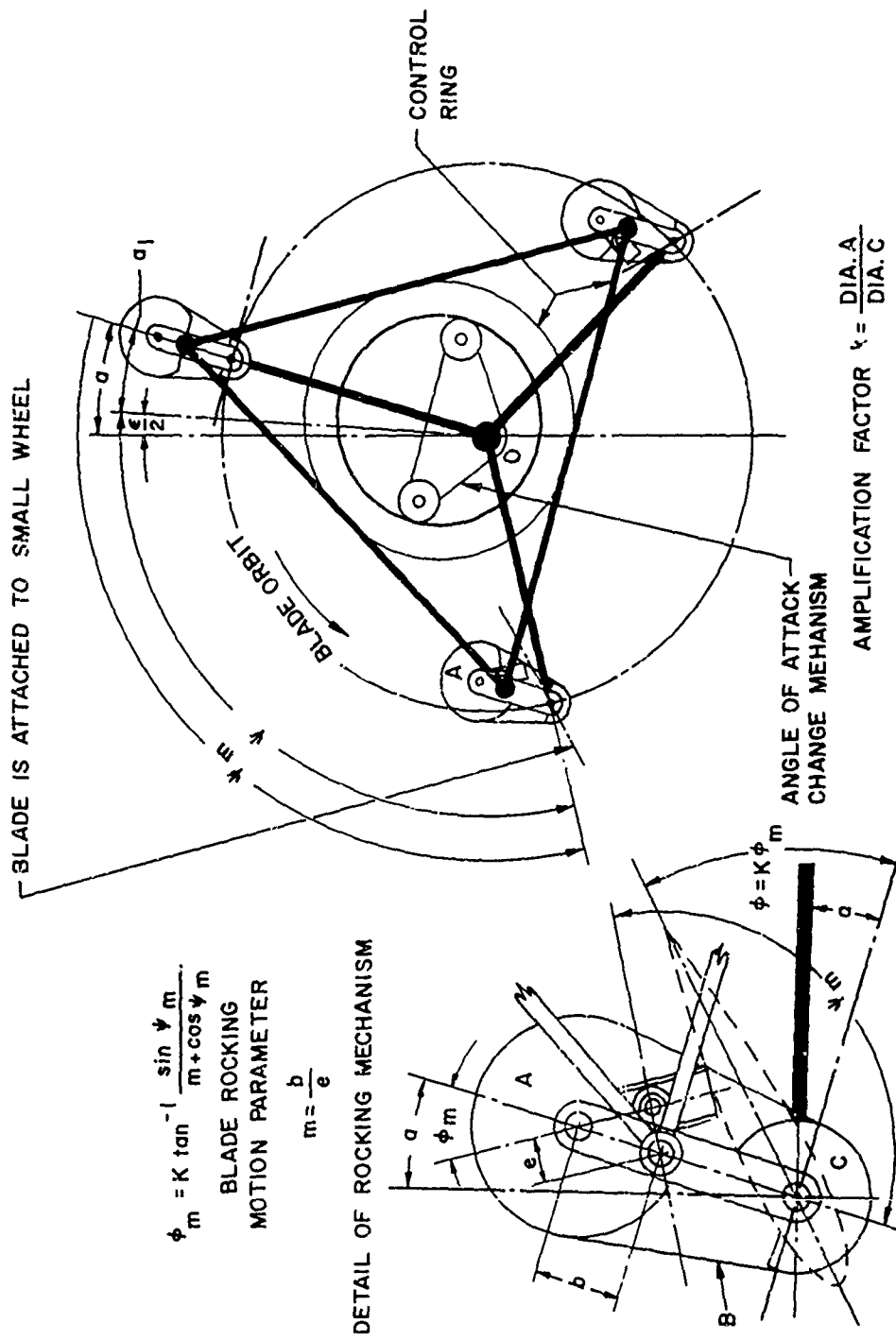

Figure 147. Lightweight Amplified High-Pitch Cyclopro Mechanism from University of Washington Wind Tunnel Tests (Ref. 8B). Three Radial Torque Arms Drive Blades and Feathering Mechanism About Rotor Orbit.

E. CONTROL SYSTEM OF THE CYCLOGIRO PROPOSED DESIGN

Forward motion of the control column will cause a simultaneous vertical displacement of all instantaneous mechanical intersection points o'' and o''' (Figure 146B) in both fore and aft rotors of the tandem cyclogiro project. Forward motion of this column produces forward horizontal translation of the cyclogiro; rearward column motion will cause the craft to move backward.

Lateral displacement of this main control column produces a direct rolling couple about the aircraft centerline, simultaneously increasing the net rotor lift on one side of the aircraft and decreasing it on the other; that is, this lateral movement of the control stick produces an opposite horizontal displacement of the instantaneous mechanical center point o (Figure 145C). From hover, as will be seen, this control motion will produce a roll and lateral crabbing translation by the opposite horizontal displacement of the instantaneous mechanical centers ($o_1 - o_6$) on each side of the aircraft.

The use of the rudder pedals will produce yawing of the aircraft fuselage. At forward speed, the required yawing couple is generated by a fore-and-aft horizontal thrust differential between rotors on the opposite sides of the aircraft. This involves a differential fore-and-aft and side-to-side vertical displacement of the mechanical center point o (Figure 145B). In hover, of course, the use of the rudder pedal produces a turn about the aircraft's vertical z-axis.

Vertical and hovering flight are controlled by the side-mounted "collective pitch" lift stick. At normal and high forward speeds, this stick is full down. Upon slowing down to hover, this stick is manually pulled up, thereby making the necessary adjustment in the horizontal displacement in all of the rotor lift controls. The first function, when this control is moved up, is to introduce the amplified blade motion into the four rotor systems. Further movement upward of this control horizontally displaces the instantaneous mechanical intersection centers ($o_1 - o_6$), in Figure 146C, and consequently increases the collective lift of all four rotor systems. The other components of the control system continue to introduce overriding control motions into the rotor system, insuring direct and positive maneuvering responses about all of the flight axes at very low speeds and in hovering flight.

In all instances, engine output power is modulated by the control system to insure the proper balance between the rotor power required for each flight maneuver and the optimum power available from the engines.

Should a total engine failure occur, the engines would disconnect and the rotors would enter the autorotational state, as follows. The overriding features of the transmission system would:

1. Mechanically effect conversion to amplified blade motion, if the blades were not already in that mode.

2. Displace the instantaneous mechanical intersection points $\theta_1 - \theta_6$ to the extreme position shown in Figure 146C. This is the case where the lift capability is the largest (to be paid for by a drag, which is of no consequence in this instance).

Authorotational data are shown in Reference 8B, Figures 23 and 24. It can be shown that there is considerable autorotational lift available for power-off flight. The glide angle can be estimated from Figure 145C as

$$\theta_g = \tan^{-1} \frac{\sum T}{\sum L}$$

CONCLUSIONS

From Table VII, one might identify several interesting avenues for future research and development:

1. Wing rotors present promise as aerial delivery devices, as they present today the best-known combination of high lift-to-drag ratio and of high maximum lift coefficient. The study of their aerodynamics is very incomplete. Surprisingly, the study of their dynamics has made great progress in the last three years because of military interest in bombslets.

2. Immediate full-scale research and development of a powered rotating airfoil flap, such as the one discussed in this report, to be used also for lateral and directional control, including possibly a rotating rudder, are strongly recommended.

3. Cyclogiros for high-subsonic transport show promise. The development of such aircraft will be hampered by many difficult structural, aerodynamic, and aero-elastic problems. Much engine and power train development directed toward other VTOL systems will be directly usable for the advanced cyclogiro.

4. The Curtiss-Wright X-19 aircraft and the VFW VC. 400 airplane are fascinating projects. The fact that the latter is being pushed actively today in Germany means that this configuration has current interest compared to many concepts cited which are dormant. What is of interest is the fact that the VFW VC. 400 operates essentially on the same principle and has some of the same problems as the cyclogiro, in forward flight. At hover, the situation is completely different, the cyclogiro operating as a helicopter and the VC. 400 requiring significant rotation of the propeller axis in order to achieve significant vertical lift. Richard teaches us that the optimum configuration may be a combination of the radial-lift propeller and the helicopter.

5. Several other configurations appear worthy of future research; for example, the rotating airfoil convertible to fixed wing, the orbiting flap and undulating propeller, and the transverse-fan VTOL.

APPENDIX I. BIBLIOGRAPHICAL LISTING

A

- 1A. Abel, Charles, APPAREIL D'AVIATION AVEC ROUES DE RAREFACTION DE L'AIR, French Patent, No. 597577, September 5, 1925.
- 2A. Acarlentini, Luciano Insolera, AEROMOTERE A PALE DIREVOLI SUI LORO ASSI E ROTANTI NEL PIANO INCUI ASSI GIACCIONO, Italian Patent, No. 444852, February 1, 1949.
- 3A. Ackeret, J., DAS ROTORSCHIFT, Goettingen, Bandenhoed und Ruprecht, 1925, p. 48.
- 4A. Ackeret, J., RECENT EXPERIMENTS AT THE GOTTINGEN AERODYNAMIC INSTITUTE, NACA Technical Memorandum No. TM 323, July 1925 (Trans from: "Zeitschrift fur Flugtechnik und Motorluftschiffahrt", Vol. 16, No. 3, February 14, 1925, pp. 44-52).
- 5A. Addis, Frederick Henry, IMPROVED FLYING MACHINE, British Patent, No. 15890, April 9, 1908.
- 6A. Advisory Group for Aeronautical Research and Development, VTOL/STOL, Bibliography 2, North Atlantic Treaty Organization, Paris, France, June 1960, p. 89.
- 7A. Aerogyres de Chappedelaine, NOTICE SUR L'AEROGYRE DE CHAPPEDELAINE, Press Release and Wind Tunnel Results, Paris, France, 1934 (?).
- 8A. AeroJet General Corporation, AERODYNAMIC DISPERSION STUDY, IRD Final Report No. 8706-23(01)FP, Downe, California, April 1965.
- 9A. Ahlborn, Friedrich, DER SCHWEBFLUG UND DIE FALLEWEGUNG EBENER TAFELN IN DER LUFT, Leipzig, L. Friederichsem and Co., 1897, p. 31 (See also: "Abh. d. Naturwissen Ver Hamburg", Vol. 15, 1897).
- 10A. Ahlborn, Frederick, THE MAGNUS EFFECT IN THEORY AND IN REALITY, NACA Technical Memorandum 567, Washington, D. C., May 1930 (Trans. from: "Zeitschrift fur Flugtechnik und Motorluftschiffahrt", Vol. 21, No. 24, December 28, 1929, pp. 642-653).
- 11A. Aken, Ray W. Van, and Kelly, Howard R., THE MAGNUS FORCE ON SPINNING CYLINDERS, Preprint No. 712, Institute of Aeronautical Sciences, January 1957.
- 12A. Akerman, John, INDUSTRIAL PRODUCTION OF ELECTRIC POWER FROM THE WINDS, Minnesota Technolog, Vol. 12, No. 4, January 1932, pp. 90-91, 98.

CONCLUSIONS

From Table VII, one might identify several interesting avenues for future research and development:

1. Wing rotors present promise as aerial delivery devices, as they present today the best-known combination of high lift-to-drag ratio and of high maximum lift coefficient. The study of their aerodynamics is very incomplete. Surprisingly, the study of their dynamics has made great progress in the last three years because of military interest in bomblets.

2. Immediate full-scale research and development of a powered rotating airfoil flap, such as the one discussed in this report, to be used also for lateral and directional control, including possibly a rotating rudder, are strongly recommended.

3. Cyclogiros for high-subsonic transport show promise. The development of such aircraft will be hampered by many difficult structural, aerodynamic, and aero-elastic problems. Much engine and power train development directed toward other VTOL systems will be directly usable for the advanced cyclogiro.

4. The Curtiss Wright X-19 aircraft and the VFW VC. 400 airplane are fascinating projects. The fact that the latter is being pushed actively today in Germany means that this configuration has current interest compared to many concepts cited which are dormant. What is of interest is the fact that the VFW VC. 400 operates essentially on the same principle and has some of the same problems as the cyclogiro, in forward flight. At hover, the situation is completely different, the cyclogiro operating as a helicopter and the VC. 400 requiring significant rotation of the propeller axis in order to achieve significant vertical lift. Richard teaches us that the optimum configuration may be a combination of the radial-lift propeller and the helicopter.

5. Several other configurations appear worthy of future research; for example, the rotating airfoil convertible to fixed wing, the orbiting flap and undulating propeller, and the transverse-fan VTOL.

APPENDIX I. BIBLIOGRAPHICAL LISTING

A

- 1A. Abel, Charles, APPAREIL D'AVIATION AVEC ROUES DE RAREFACTION DE L'AIR, French Patent, No. 597577, September 5, 1925.
- 2A. Acarlentini, Luciano Insolera, AEROMOTERE A PALE DIREVOLI SUI LORO ASSI E ROTANTI NEL PIANO INCUI ASSI GIACCIONO, Italian Patent, No. 444852, February 1, 1949.
- 3A. Ackeret, J., DAS ROTORSCHIFT, Goettingen, Bandenhoed und Ruprecht, 1925, p. 48.
- 4A. Ackeret, J., RECENT EXPERIMENTS AT THE GOTTINGEN AERODYNAMIC INSTITUTE, NACA Technical Memorandum No. TM 323, July 1925 (Trans from: "Zeitschrift fur Flugtechnik und Motorluftschiffahrt", Vol. 16, No. 3, February 14, 1925, pp. 44-52).
- 5A. Addis, Frederick Henry, IMPROVED FLYING MACHINE, British Patent, No. 15890, April 9, 1908.
- 6A. Advisory Group for Aeronautical Research and Development, VTOL/STOL, Bibliography 2, North Atlantic Treaty Organization, Paris, France, June 1960, p. 89.
- 7A. Aerogyres de Chappedelaine, NOTICE SUR L'AEROGYRE DE CHAPPEDELAINE, Press Release and Wind Tunnel Results, Paris, France, 1934 (?).
- 8A. AeroJet General Corporation, AERODYNAMIC DISPERSION STUDY, IRD Final Report No. 8706-23(01)FP, Downe, California, April 1965.
- 9A. Ahlborn, Friedrich, DER SCHWEBFLUG UND DIE FALLEWEGUNG EBENER TAFELN IN DER LUFT, Leipzig, L. Friederichsem and Co., 1897, p. 31 (See also: "Abh. d. Naturwissen Ver Hamburg", Vol. 15, 1897).
- 10A. Ahlborn, Frederick, THE MAGNUS EFFECT IN THEORY AND IN REALITY, NACA Technical Memorandum 567, Washington, D. C., May 1930 (Trans. from: "Zeitschrift fur Flugtechnik und Motorluftschiffahrt", Vol. 21, No. 24, December 28, 1929, pp. 642-653).
- 11A. Aken, Ray W. Van, and Kelly, Howard R., THE MAGNUS FORCE ON SPINNING CYLINDERS, Preprint No. 712, Institute of Aeronautical Sciences, January 1957.
- 12A. Akerman, John, INDUSTRIAL PRODUCTION OF ELECTRIC POWER FROM THE WINDS, Minnesota Technol., Vol. 12, No. 4, January 1932, pp. 90-91, 98.

- 13A. Albertson, Stanley E., ROTARY WINGED KITE, U.S. Patent, No. 3026073, March 20, 1962.
- 14A. Albertson, Stanley E., Jr., ROTARY WING KITE, U.S. Design Patent, No. 3255985, June 14, 1966.
- 15A. Alexander-Katz, B., DIE DEUTSCHEN-PATENTE UBER FLUG-APPARATE (1879-1911), Verlag von M. Krayn, Berlin, Germany, 1912.
- 16A. (Alexander, Patrick), INTERESTING EXPERIMENTS WITH PROPELLERS AND SPINNING MODELS, Flight, Vol. 3, No. 43(143), October 28, 1911, pp. 945-947.
- 17A. Alphonse, F. La Fon., AIRCRAFT CONSTRUCTION, U.S. Patent, No. 1969804, August 14, 1934.
- 18A. Alvarez-Calderon, Alberto, VTOL AND THE ROTATING CYLINDER FLAP, Article No. 1, Annals of the New York Academy of Sciences, Vol. 107, March 25, 1963, pp. 249-255.
- 19A. Alvarez-Calderon, Alberto, AERODYNAMIC SYSTEM AND APPARATUS, U.S. Patent, No. 3092354, June 4, 1963.
- 20A. Alvarez-Calderon, Alberto, SAFETY AND HIGH LIFT SYSTEM AND APPARATUS FOR AIRCRAFT, U.S. Patent, No. 3121544, February 18, 1964.
- 21A. Alvarez-Calderon, Alberto, HIGH LIFT AND CONTROL SYSTEM FOR AIRCRAFT, U.S. Patent, No. 3140065, July 7, 1964.
- 22A. Alvarez-Calderon, Alberto, ROTATING CYLINDER FLAPS FOR V/STOL AIRCRAFT, Aircraft Engineering, Vol. 36, No. 10(428), October 1964, pp. 304-309.
- 23A. Alvarez-Calderon, Alberto, STABILITY AND CONTROL SYSTEM AND APPARATUS FOR AIRCRAFT, U.S. Patent, No. 3162402, December 22, 1964.
- 24A. Alvarez-Calderon, Alberto, CONVERTIPLANE AND APPARATUS THEREOF, U.S. Patent, No. 3179354, April 20, 1965.
- 25A. Ames, Butler, APPARATUS EMPLOYED IN FLIGHT THROUGH THE AIR, U.S. Patent, No. 1051659, January 28, 1913.
- 26A. (Ames, B.), LIFTING POWER TEST OF AMES' AEROPLANE, The Evening Star, Washington, D. C., July 23, 1910, p. 8.
- 27A. Anderson, C. L., AVIATION, U.S. Patent, No. 1639833, August 23, 1927.

- 28A. Anderson, J., PROPELLING, British Patent, No. 19430, August 18, 1910.
- 29A. Andoi, Tsuneyo, A STUDY ON VOITH-SCHNEIDER PROPELLER, Japan Society of Mechanical Engineers Bulletin, Vol. 2, No. 5, 1959.
- 30A. Andrews, Lawrence E., SPINDLE ROTORS TAKE THE PLACE OF WINGS, Popular Aviation, Vol. 10, No. 4, April 1932, p. 231.
- 31A. Andrews, Walter, V/STOL GETS BIG LIFT IN EXPANDING AVIATION WORK, Aerospace Technology, Vol. 21, No. 11, November 20, 1967, pp. 92, 96.
- 32A. Argentiero, Giuseppe, MACHINE AERIENNE ACTIONEE PAR DES ROTORS A AXES HORIZONTAUX MUNIS DE DEFLECTEURS, French Patent, No. 1190363, January 22, 1958.
- 33A. Ashworth, J., AEROPLANE, U.S. Patent, No. 1284851, November 12, 1918.
- 34A. Augmard, A. G. M., ORNITHO-HELICOPTERE, French Patent, No. 673682, October 8, 1929.
- 35A. Alvarez-Calderon, Alberto and Arnold, Frank R., A STUDY OF THE AERODYNAMIC CHARACTERISTICS OF A HIGH-LIFT DEVICE BASED ON A ROTATING CYLINDER AND FLAP, Technical Report RCF-1, Stanford University, Palo Alto, California, 1961.
- 36A. Acarlentini, Luciano I., AEROMOTORE A PALE GIREVOLI SUI LORO ASSIE ROTANTI NEL PIANO IN CUI ESSI GIACCIONO, Italian Patent, No. 444852, February 1, 1949.
- 37A. (Ames), AMES AEROPLANE IS SHOWN, The Washington Post, No. 12461, July 22, 1910, p. 3.
- 38A. (Ames), TESTING NEW AIRSHIP-REPRESENTATIVE AMES' MACHINE LIFTS HEAVY WEIGHT, Washington Post, No. 12465, July 26, 1910, p. 2.
- 39A. Arteaga, Francisco, de, NOUVELLE AILE POUR AVIONS, French Patent, No. 726091, January 17, 1931.

B

- 1B. Babillot, Gabriel, IMPROVEMENTS IN AND RELATING TO PROPELLERS, British Patent, No. 27771, December 21, 1909.
- 2B. Bab'yuk, Stat'ya I., GELIKO-ZMEI, Samolet, No. 3, March 1932, pp. 45-46.
- 3B. Bach, G., INVESTIGATION ON SAVONIUS ROTORS AND RELATED FLUID MACHINERY, MD Study No. 115, Munitions Development Division, CDEL, Fort Detrick, Frederick, Maryland, June 13, 1967 (Trans. from: "Forschung auf dem Gebiete des Ingenieurwesens", Vol. 2, No. 6, June 1931, pp. 218-231; See also: Wood, G. T., McGill University, Brace Research Institute, June 1964).
- 4B. Baird, H. and Pick, R., AUTOROTATION OF FLAT PLATES, Senior Years Project Report, Department of Mechanical Engineering, University of British Columbia, Vancouver, Canada, April 1964.
- 5B. Bairstow, F. R. S., THE ROTORSHIP AND AERONAUTICS, Nature, Vol. 115, No. 2891, March 28, 1925, pp. 462-464.
- 6B. Baker, J. G., ON THE FALLING OF A STRIP OF PAPER, Philosophical Magazine and Journal of Science, Vol. 16, No. 103, July 1933, pp. 175-178 (See also: Journal of the Royal Aeronautical Society, March 1934, p. 265).
- 7B. (Baker, J. G.), TOY HELPS WAR AGAINST VIBRATION, Popular Mechanics, Vol. 61, No. 2, February 2, 1934, pp. 218-221.
- 8B. Baker, Ralph D., WIND TUNNEL TEST ON AMPLIFIED HIGH PITCH CYCLOGIRO, University of Washington, Aeronautical Laboratory, Seattle, Washington, September 7, 1946.
- 9B. Barrett, John F., Barret, John E., and Wyatt, Frank A., PROPULSEUR PERFECTIONNE POUR AEROPLANES, BATEAUX, MOULINS A VENT ET MOYEN D'EMPENNAGE AUTOMATIQUE DES AILES, French Patent, No. 505764, May 14, 1920.
- 10B. Bartsch, W. K. M., FLYING MACHINES, U.S. Patent, No. 2372926, April 3, 1945.
- 11B. Bathe, Greville, HORIZONTAL WINDMILLS, DRAFT MILLS AND SIMILAR AIRFLOW ENGINES, Allen, Lane and Scott, Philadelphia, Pennsylvania, 1948, 81 pp.
- 12B. Baudin, P., APPAREIL VOLANT, French Patent, No. 852584, October 30, 1939.

- 13B. Beaufort, Pierre, LA TURBINE AERIENNE A ORIENTATION CONSTANTE UTILISE AU MAXIMUM LES VARIATIONS DU VENT, La Science et la Vie, No. 82, April 1924, pp. 344-348.
- 14B. Begg, A. L. N., MECHANICAL FLIGHT, U. S. Patent, No. 1306326, June 10, 1919.
- 15B. Behne, Wilhelm, H. F., FLUGVOPRICHPUNG MIT KEGFLIO GESTELLTEN UMLAUFFLUGELN, German Patent, No. 699160, November 29, 1940.
- 16B. Beier, B., FLYING MACHINE, U.S. Patent, No. 1172338, February 22, 1916.
- 17B. Bekker, M. G., APPLICATION OF A VARIABLE PITCH PROPELLER AS A BOOSTER OF LIFT AND THRUST FOR AMPHIBIAN VEHICLES, Land Locomotion Research Branch Report No. 14, Ordnance Tank Automotive Command, Detroit Arsenal, Michigan, May 1957.
- 18B. Bell, I., AERIAL MACHINES, British Patent, No. 12188, May 20, 1911.
- 19B. Bell, I., PROPELLING, British Patent, No. 12574, November 11, 1914.
- 20B. Beltran, A. A., THE FLETTNER ROTOR SHIP, Special Bibliography No. SB 59-33, Lockheed Technical Information Center, Burbank, California, August 20, 1959, p. 4.
- 21B. Benel, Edmond, AILE ROTATIVE S'APPLIQUANT AUX MACHINES VOLANTES ET AUX MOULINS A VENT, French Patent, No. 392394, September 23, 1907.
- 22B. Benel, E., ENCORE L'AILE ROTATIVE, La Revue de L'Aviation, January 1910, pp. 6-7.
- 23B. Bennett, Ronald E., A COMPILATION OF PERFORMANCE CURVES FOR CYCLOIDAL PROPELLER MODEL, Naval Ship Engineering Center, Washington, D. C., September 1966.
- 24B. Benoit, Jean Emile, DISPOSITIF AMPLIFICATEUR ET REDUC-TEUR DE PORTANCE POUR AILES D'AVIONS - EXPLICATION PLUS PRECISE DE LA SUSTENTATION, French Patent Application and Provisional Description, Dossier No. 6352, 1964.
- 25B. Benzon, Otto, SOME REMARKS ON THE FLETTNER ROTOR, The Rudder, Vol. 41, No. 4, April 1925, p. 22.
- 26B. Berbech, T., AIRPLANE, U.S. Patent, No. 1850786, March 22, 1932.
- 27B. Berbech, T., AIRPLANE, U.S. Patent, No. 1850954, March 22, 1932.

- 28B. Berger, Louis-Jean, SYSTEME DE SECURITE POUR APPAREILS D'AVIATION, TELS QU'AVIONS, HYDRAVIONS, French Patent, No. 674818, October 28, 1929.
- 29B. Bergier, Henri, PROCEDE DE STABILISATION ET DE PROPULSION APPLICABLE AUX HELICES SUSTENTATRICES D'HELICOPTERES, French Patent, No. 816979, January 28, 1937.
- 30B. Bergman, A. G., VERTICAL RISING AIRPLANE, U.S. Patent, No. 1754977, April 15, 1930.
- 31B. Berriman, Algerman E., FLIGHT MANUAL (ROTARY PARACHUTE-DEFINITION), 1st Edition, St. Martin's Publishing Co., Ltd., London, England, p. 36.
- 32B. Betz, A., THE MAGNUS EFFECT, THE PRINCIPLE OF THE FLETTNER ROTOR, NACA Technical Memorandum No. TM 310, April 1925, p. 23 (Trans. from: "Zeitschrift des Vereines Deutscher Ingenieure", January 3, 1925, pp. 9-14).
- 33B. Betz, Albert and Ackeret, Jakob, QUERTRIEBSKORPER, WIE, TRAGFLUGEL, SCHRAUBENFLUGEL U. DGL., German Patent, No. 486206, November 21, 1929.
- 34B. Betz, A., GRUNDSATZLICHESZUM VOITH SCHNEIDER PROPELLER, Hydromechanische Problems des Schiffantriebs, Hamburgischen Schiffbau-Versuchsanstalt, Hamburg, Germany, 1932, pp. 161-170, 420-421.
- 35B. Betz, Albert, INTRODUCTION TO THE THEORY OF FLOW MACHINES, Pergamon Press, London, England, 1966, p. 240.
- 36B. Bidolet, Charles V. A., APPAREIL POUR S'ELEVER ET SE DEPLACER DANS L'AIR, French Patent, No. 404998, July 10, 1909.
- 37B. Billing, Noel Pemberton, IMPROVEMENTS IN OR RELATING TO AIRCRAFT, British Patent, No. 446509, October 25, 1934.
- 38B. BIRD TOY FLOWN LIKE A KITE ON ROD AND REEL, Popular Mechanics, Vol. 59, No. 6, June 1933, p. 912.
- 39B. Black, S. D., ANALYSIS OF THE CYCLOGIRO ROTOR, Memorandum Report No. ENG-52-587-29, AAF Materiel Command, Engineering Division, Wright Field, Ohio, July 12, 1944, p. 32.
- 40B. Blenk, Herman, DER MAGNUSEFFEKT IN THEORIE UND WIRKLICHKEIT, Zeitschrift fur Flugtechnik und Motorluftschiffahrt, Vol. 21, No. 8, February 14, 1930, p. 66.

- 41B. Blicke, K., Hoflich, E., and Hub, W., CYCLOIDAL SHIP PROPELLER, U. S. Patent, No. 3225834, December 28, 1965.
- 42B. Blicke, K., Hoflich, E., and Hub, W., CYCLOIDAL SHIP PROPELLER, U. S. Patent, No. 3268010, April 7, 1965.
- 43B. Blomquist, A. R., AEROPLANE, British Patent, No. 612304, October 8, 1940.
- 44B. Blomquist, Atle Ragnald, DISPOSITIVO DI ROTURE APPLICATO ALLE ALI DEI VELIVOLI PER MIGLIORARNE L'EQUILIBRIO DURANTE LE VARIE FASI DEL VOLO, Italian Patent, No. 384843, June 25, 1941. (See also: Finnish Patent, No. 20550.)
- 45B. Bobrovsky, T. N., ROTOR FLYING MODEL, Model Airplane News, Vol. 4, No. 4, April 1931, pp. 9-15.
- 46B. Bock, G., and Spintzyk, H., VTOL/STOL AIRCRAFT, Bibliography 2 (Revised Edition), Advisory Group for Aeronautical Research and Development, Paris, France, March 1961, p. 161.
- 47B. Bock, G., Klug, H. G., Spintzyk, H., et al, VTOL/STOL AIRCRAFT, Bibliography 2, First Supplement 1961/62, Advisory Group for Aeronautical Research and Development, Paris, France, June 1963, p. 98.
- 48B. Bodek, A., HOW TO CONSTRUCT A CHEAP WIND MACHINE FOR PUMPING WATER, Do-It-Yourself Leaflet No. 5, Brace Research Institute, McGill University, Montreal, Canada, February 1965, p. 11.
- 49B. Bodet, Jean, VOICI UN PROPULSEUR DE NAVIRES QUI SUPPRIME HELICE ET GOVERNAIL, La Science et la Vie, Vol. 44, No. 197, November 1933, pp. 381-384.
- 50B. Boehler, Gabriel D., PROPOSAL FOR AN ANALYTICAL STUDY OF BOMBLET ROTATION MOTIONS, Proposal AP 52, Aerophysics Company, Washington, D. C., May 10, 1963, p. 19.
- 51B. Boehler, Gabriel D., TENTATIVE EVALUATION OF THE WING ROTOR CONCEPT, Aerophysics Company, Washington, D. C., January 1965, p. 13.
- 52B. Boehler, G. D., and Foshag, W. F., WING ROTORS, U.S. Patent, No. 3262656, July 26, 1966.
- 53B. Bolkow, G., MAGNUS EFFECT ROTOR ON AIRCRAFT, British Patent, No. 947547, March 19, 1962.
- 54B. Bollhorn, P., AERIAL MACHINE, British Patent, No. 16121, July 13, 1907.

- 55B. Borghese, Negretto G., and Parizzi, E., LI CICLOVELIERO BORGHESE-PARIZZI, Aeronautica, Vol. 6, No. 2, February 1932, pp. 120-122.
- 56B. Borst, H. V., THE HIGH SPEED VTOL X-100 AND M-200 AIRCRAFT, Aerospace Engineering, Vol. 21, No. 8, August 1962, pp. 8-15.
- 57B. Bose, N. K., HYDRODYNAMICAL PRINCIPLES OF HERR FLETTNER'S "ROTORSHIP", Bulletin of the Calcutta Mathematical Society, Vol. 16, No. 2, 1925, pp. 89-98.
- 58B. Bottcher, Carl, WINDRAD MIT MEHREREN GRUPPEN VON TREIBSCHAUFELN, German Patent, No. 634948, September 7, 1936.
- 59B. Bouasse, H., RESISTANCE DES FLUIDES, Bibliothèque Scientifique de l'Ingenieur et du Physicien, Librairie Delagrave, Paris, France, 1928, pp. 146-151.
- 60B. Boudet, M. H. B., DISPOSITIF D'AILE SUSTENTATRICE ET PROPULSIVE POUR APPAREILS DE NAVIGATION AERIENNE, French Patent, No. 570300, January 15, 1924.
- 61B. Bowers, Peter, REMARKABLE L/D ACHIEVED BY SHORT-SPAN TAILLESS SAILPLANE, Air Progress Homebuilt Aircraft, Spring-Summer 1966, p. 97.
- 62B. Boxell, S., PROPELLING, British Patent, No. 120612, November 12, 1917.
- 63B. Boyea, O. W., AIRPLANE, U.S. Patent, No. 2379875, July 10, 1945.
- 64B. Brauneis, F., DISKUSSION UBER DEN BERGERSCHEN ROTATIONS FLUGELELIEGER, Fachzeitung fur Flugtechnik und Automobilismus, Vol. 1, No. 11, 1913, pp. 18-21.
- 65B. (Brooks), BROOKS EAGLE-WING AIR TREADER, Popular Aviation, Vol. 13, No. 3, September 1933.
- 66B. Brooks, John B., THE EFFECT OF A ROTATING CYLINDER AT THE LEADING AND TRAILING EDGES OF A HYDROFOIL, NAVWEPS Report No. 8042, U.S. Naval Ordnance Test Station, China Lake, California, April 1963, p. 14.
- 67B. Broussin, Louis-Paul, AVION A AILES ROTATIVES, French Patent, No. 1030628, April 10, 1951.

- 68B. Brown Bros. and Co., Ltd., and Donaldson, R. J., IMPROVEMENTS IN OR RELATING TO VANED WHEEL PROPELLERS, British Patent, No. 886438, January 10, 1962.
- 69B. Brown, David A., PERUVIANS STUDY ROTATING-CYLINDER FLAP, Aviation Week, Vol. 81, No. 23, December 7, 1964, pp. 70-71, 73, 76.
- 70B. Brown, George K., SGT. TRUMAN O. OLSON (YMP-Z) EQUIPPED WITH VOITH-SCHNEIDER CYCLOIDAL PROPELLERS - STANDARDIZATION THAT ANALYSIS AND MODEL RESISTANCE TEST RESULTS, DTMB Report C-583, David Taylor Model Basin, Washington, D. C., July 1953, p. 20.
- 71B. Brunk, J. E., Davidson, W. L., and Rakestraw, R. W., THE DYNAMICS OF SPINNING BODIES AT LARGE ANGLES OF ATTACK, Project No. 7856, Air Force Office of Scientific Research, Directorate of Research Analysis, Holloman Air Force Base, New Mexico, January 1962.
- 72B. Brunk, James E., THE DYNAMICS AND AERODYNAMICS OF SELF-SUSTAINED LARGE ANGLE OF ATTACK BODY SPINNING MOTIONS, Report No. 63-1158-1, Alpha Research, Inc., Santa Barbara, California, February 1963.
- 73B. Brunk, J. E., and Flatau, A., FREE SPINNING ARTICULATED ROTOR, U.S. Patent, No. 3291418, December 13, 1966.
- 74B. Brunk, James E., AERODYNAMIC STUDIES OF NON-PLANAR AND NEAR-CIRCULAR MOTIONS, Report 66-3426-1, Alpha Research, Inc., Santa Barbara, California, December 15, 1966.
- 75B. Bryson, William, IMPROVEMENTS IN AIRCRAFT, British Patent, No. 234186, May 1925,
- 76B. Buchmann, Erich, and Birmingham, John T., VIBRATION SURVEY ON U.S. ARMY SHIP LT. COL. JOHN V. D. PAGE (BDL-1X), Research and Development Report No. 1343, David Taylor Model Basin, Washington, D. C., June 1959.
- 77B. Buchmann, Wilhelm, DAS PROBLEM DES WINDKRAFTSCHIFFES, Dinglers Polytechnisches Journal, Vol. 339, No. 22, November 1924, pp. 221-223.
- 78B. Buford, William E., MAGNUS EFFECT IN THE CASE OF ROTATING CYLINDERS AND SHELL, BRL Memorandum Report No. 821, Ballistics Research Laboratory, Aberdeen Proving Ground, Maryland, July 1954.
- 79B. Bump, Harold Wilson, AIRCRAFT SUSTAINED BY CYLINDRICAL ROTORS, U.S. Patent, No. 2985406, May 23, 1961.

- 80B. Bunau-Varilla, E., PERFECTIONNEMENTS AUX AILES D'AVIONS ET AUTRES ORGANES ANALOQUES, French Patent, No. 608870, April 30, 1926.
- 81B. (Burnham), SELF-REGULATING WIND-WHEEL, Scientific American, Vol. 11, No. 1, July 2, 1864, p. 1.
- 82B. Burrill, FLYING MACHINE, U.S. Patent, No. 1529809, March 17, 1925.
- 83B. Busemann, A., MESSUNGEN AN ROTIERENDEN ZYLINDERN, Ergebnisse der Aerodynamischen Versuchsanstalt zu Gottingen, Vol. 4, 1932, pp. 101-105.
- 84B. Brunk, James E., HIGH LIFT WING AND FLAP STRUCTURE FOR AIRCRAFT, U.S. Patent, No. 3289979, December 6, 1966.
- 85B. Brunk, J. E., AUTOROTATIVE MISSILE AND BOOSTER RECOVERY, Sherman M. Fairchild Fund Paper, New York, New York, No. FF-34, 1963, p. 82.
- 86B. Brunk, J. E., APPLICATION OF A SEMI-RECTANGULAR AUTO-ROTATING CYLINDER TO A HIGH-LIFT WING AND FLAP COMBINATION, Alpha Research, Inc., Santa Barbara, California, Report 65-1, 1965.
- 87B. Brewer, Jack D., NASA RESEARCH ON PROMISING V/STOL AIRCRAFT CONCEPTS, No. TM-X-59964, Paper Presented at Second International Congress of Advanced Technology, Hot Springs, Arkansas, October 28, 1968, p. 60.
- 88B. Borst, H. V., DESIGN AND DEVELOPMENT CONSIDERATIONS OF THE X-19 VTOL AIRCRAFT, Annals of the New York Academy of Sciences, Vol. 107, Article 1, March 25, 1963, pp. 265-279.
- 89B. Baer, Wolfgang, BLADE WHEEL PROPELLER, U. S. Patent, No. 3371719, March 5, 1968.
- 90B. Barta, Karl, WASSERFAHRZEUG, German Patent, No. 121109, February 10, 1931.
- 91B. Bosek, Andreas, AUF GRUND DES MAGNUSEFFEKTES WIRKENDER DREHENDER ZYLINDER, German Patent, No. 426815, March 19, 1926.
- 92B. Bucher, Rudolf, STABILIZING SYSTEM FOR AIRCRAFT, U. S. Patent, No. 3380689, April 30, 1968.

C

- 1C. Caldwell, J. E., AEROPLANE, U.S. Patent, No. 1640645, August 30, 1927.
- 2C. Calhoun, Jack A., TETHERED TOY AIRPLANE, U.S. Patent, No. 2593979, April 22, 1952.
- 3C. de Camaret, Jean M. L. G., APPAREIL POUR CAPTER ET TRANSMETTRE L'ENERGIE D'UN FLUIDE EN MOUVEMENT, Swiss Patent, No. 266468, January 31, 1950.
- 4C. Campbell, AEROPLANE, U.S. Patent, No. 1821494, September 1, 1931.
- 5C. Candler, J. Natt, TORQUE CONTROL FOR HELICOPTERS, U.S. Patent, No. 2452355, October 26, 1948.
- 6C. Canellas, Desiderio, COUVERTURE OU BANDE APPLICABLE A TOUTE SORTE D'APPAREILS D'ASCENSION ET DE NAVIGATION AERIENNES, French Patent, No. 380572, October 11, 1907.
- 7C. Capellen, Friedrich Myer, DISPOSITIF APPLICABLE AUX NAVIRES AERIENS DE TOUTES ESPECES, POUR OBTENIR L'AVANCEMENT OU L'ASCENSION, French Patent, No. 415730, May 9, 1910.
- 8C. Carafoli, E., AERODYNAMIQUE DES AILES D'AVION: THEORIE AN APPLICATIONS, Librairie Aeronautique, Paris, France, 1928, pp. 20-63. (See also: Revue Generale de l'Aeronautique, No. 10, 1929, pp. 1-63.)
- 9C. Carnwath, James Robert, ROTATING KITE, U.S. Patent, No. 2494430, January 10, 1950.
- 10C. Cary, Robert Elliott, IMPROVEMENTS IN LIFTING AND PROPELLING MEANS FOR AIRCRAFT, British Patent, No. 208715, December 12, 1923.
- 11C. Cassens, Johann, WINDMOTOR, German Patent, No. 892130, October 5, 1953.
- 12C. Chackfield, J. E., INVESTIGATION OF THE POSSIBILITIES OF ROTATING CYLINDER AS AN AUXILIARY LIFT DEVICE, Journal of the Royal Aeronautical Society, Vol. 68, No. 11, November 1964, pp. 777-780.

- 13C. Chait, B. A., LE ROTOR, Imprimemie-Anvers-Bourse, 1925, p. 86.
- 14C. Chamley, Joseph Windsor, IMPROVED PROPELLING MEANS FOR HELICOPTERS, British Patent, No. 286416, March 8, 1928.
- 15C. Champly, R., LES MOTEURS A VENT - (LES PANANEMONES), Dunod, Paris, France, 1933, pp. 127-139.
- 16C. Chappedelaine, J. L. M. O., PLANEUR PORTATIF A AILES TOURNANTES, French Patent, No. 723527, January 18, 1932.
- 17C. Chappedelaine, J. L. M. O., AVION A AILES ROTATIVES, French Patent, No. 723542, January 18, 1932.
- 18C. Chappedelaine, J. L. M. O., AVION A AILES ROTATIVES, French Patent, No. 763824, January 28, 1933. (See also: Italian Patent, No. 324656, February 11, 1935.)
- 19C. Chappedelaine, Jean Louis Marie Oliver, AEROPLANE WITH ROTATABLE WINGS, British Patent, No. 402992, December 14, 1933.
- 20C. (Chappedelaine), L'AEROGYRE CHAPPEDELAINE, L'Aerophile, Vol. 42, No. 4, April 1934, pp. 148-149.
- 21C. Chappedelaine, Jean, L'AEROGYRE DE CHAPPEDELAINE, Les Ailes, Vol. 14, No. 670, April 19, 1934, pp. 4-5.
- 22C. (Chappedelaine), L'AEROGIRO-CHAPPEDELAINE-CAUDRON, L'Aerotechnica, Vol. 14, No. 6, June 1934, pp. 780-781.
- 23C. (Chappedelaine), L'AEROGYRE DE CHAPPEDELAINE, Les Ailes, Vol. 14, No. 684, July 26, 1934, p. 5.
- 24C. (Chappedelaine), AEROZHIR SHAPEDELENA, Samolet, No. 11(93), November 1934, pp. 33-34.
- 25C. (Chappedelaine), L'AEROGYRE DE CHAPPEDELAINE, L'Aeronautique, Vol. 16, No. 187, December 1934, p. 301.
- 26C. Chappedelaine, Jean Louis, VORNICHTUNG ZUR AUFTRIEBS-REGELUNG FUR ROTORFLUGEL, German Patent, No. 609771, February 27, 1935. (See also: Deutsches Sport Flieger, Vol. 3, No. 4, April 1935, p. 22, and Patent Sammlung des Flugsport, Vol. 6, No. 3, 1935, pp. 10-11.)
- 27C. Chaulet, Georges, QUAND LES CERVEAUX BOUILLONNENT, Le Modele Reduit D'Avions, No. 232, July 1958, pp. 4-5.

- 28C. Chaulet, Georges, LE ROTOPLANE, Le Modele Reduit D'Avion, Vol. 28, No. 297, January 1964, pp. 4-5.
- 29C. Chen, Yueh Hun, AIRFOIL BLADE, ROTATING ON A CYLINDRICAL LOCUS AND APPLICATION TO A WINGLESS TAILLESS VTOL AIRPLANE, Minta Martin Aeronautical Student Fund, New York, New York, 1956 First Award Papers.
- 30C. Cherrier, P., SYSTEME DE SUSTENTATION POUR APPAREIL AERIEN UTILISANT DES SURFACES ALAIRES, MOBILES EN GIRATION ET DONT L'INCIDENCE EST VARIABLE, French Patent, No. 815380, April 12, 1937.
- 31C. Chrikob, TEORIA I PRAKTIKA KRYL'EROGO ROTORA, Samolet, No. 7, July 1932, pp. 38-40.
- 32C. Christiansen, J., WING ROTOR, U.S. Patent, No. 1991378, February 19, 1935.
- 33C. The Cierva Autogiro Co., PERFECTIONNEMENT AUX HELICOPTERES, French Patent, No. 1017976, October 8, 1952. (See also: Swedish Patent, No. 127094.)
- 34C. (Clarkson), VERTICAL FLIGHT, Engineering, No. 2343, November 25, 1910, p. 732.
- 35C. (Clarkson), MR. JOSEPH CLARKSON'S MODEL DIRECT LIFTING MACHINE, Flight, Vol. 2, No. 52(104), December 24, 1910, p. 1060.
- 36C. Clarkson, J., PROPELLING; STEERING, British Patent, No. 16402, July 13, 1912.
- 37C. Clerc, J. F., DIE WEITERE KONSTRUKTIVE ENTWICKLUNG DES VOITH-SCHNEIDER PROPELLERS, Werft-Reederei-Hafenbau, Vol. 15, No. 8, April 15, 1934, pp. 88-90.
- 38C. Clough, Roy L., AUTOGIRO THEORY, Model Airplane News, Vol. 38, No. 1, January 1948, pp. 33-34.
- 39C. Clousing, Lawrence, BUILD THIS MODEL ROTOR SHIP, Popular Aviation, Vol. 12, No. 6, June 1932, pp. 387-388.
- 40C. Codebo, Aristide, UMLAUF SCHLAGFLUGELSYSTEM, German Patent, No. 632908, July 15, 1936.
- 41C. Cole, Dick, BUILDING A NOVEL ROTOR ICEBOAT, Modern Mechanix and Inventions, Vol. 11, No. 4, February 1934, pp. 100-103.

- 42C. Comolet, Raymond, PARADOXE DE L'EFFECT MAGNUS, Mecanique Experimentale des Fluides, Masson et Cie, Editeurs, Paris, France, 1963, pp. 130-132.
- 43C. Compaan, Hendrik Cristoffel, IMPROVEMENTS IN CURRENT MOTORS AND PROPELLERS, British Patent, No. 306772, February 28, 1929.
- 44C. Congreve, William, AERIAL CARRIAGE, Mechanics' Magazine, Vol. 9, No. 240, March 22, 1828, pp. 129-134, and April 12, 1828, pp. 186-187.
- 45C. Constantin, PROBLEME DE LA PROPULSION DES NAVIRES PAR LE VENT, La Nature, No. 2776, January 1, 1928, pp. 14-17.
- 46C. (Cook), VERTICAL RISING AND HOVERING AIRPLANE, Mechanics and Handicraft, July 1936, pp. 40-42, 114-115.
- 47C. Cook, David A., "CYCLODYNE" TEST AND DESIGN NOTES, (By the Author and the Vertol Division of The Boeing Company, Seattle, Washington), 1958-1964.
- 48C. Cordell, Francis G., and Thomsan, Nemyss, IMPROVED WIND MOTOR, Australian Patent, No. 103671, May 4, 1937.
- 49C. Constanzi, Giulio, ELEMENTI DI AERODINAMICA E DI DINAMICA DEL VOLO, Editoriale Aeronautica, Vol. 1, 1938, p. 217.
- 50C. Coursac, Girault P. de, HELICOPLANE RICHARD, Bureau d'Etudes Scientifiques et Techniques (B. E. S. T.), Report No. 1/875A, August 1949.
- 51C. Cowdrey, C. F., A NOTE ON THE USE OF END PLATES TO PREVENT THREE-DIMENSIONAL FLOW AT THE ENDS OF BLUFF CYLINDERS, Report No. 1025, National Physical Laboratory, Teddington, Middlesex, June 1962.
- 52C. Crabtree, L. F., THE ROTATING FLAP AS A HIGH LIFT DEVICE, Technical Note Aero. 2492, Royal Aircraft Establishment, Farnborough, England, April 1957, p. 42.
- 53C. Critzos, Chris C., Heyson, Harry H., and Boswinkle, Robert W., AERODYNAMIC CHARACTERISTICS OF NACA 0012 AIRFOIL SECTION AT ANGLE OF ATTACK FROM 0° TO 180° , NACA Technical Note No. TN 3361, January 1955, p. 21.
- 54C. Crompton, George, Jr., AEROPLANE, U.S. Patent, No. 1716116, June 4, 1929.
- 55C. Crompton, George, Jr., AEROPLANE, U.S. Patent, No. 1799733, April 7, 1931.

- 56C. Crossley, Percy Broadbent, IMPROVEMENTS IN OR RELATING TO AERODYNAMIC OR HYDRODYNAMIC MACHINES, British Patent, No. 241060, October 15, 1925.
- 57C. Crowe, J. H., THE PROBLEM OF VERTICAL FLIGHT, Aircraft Engineering, Vol. 6, No. 70, December 1934, pp. 317-318.
- 58C. Crozat, Rene Jean, MECANISME DIRECTEUR D'AIR SUR LES BORDS D'ATTAQUE DES HELICES ET DES AILES D'AVIONS, French Patent, No. 659081, January 29, 1929.
- 59C. Czarniawski, Cornelius, FLUGZEUG MIT UMLAUFEUDEN KLAPPFLACHEN, German Patent, No. 486053, November 11, 1929.
- 60C. Cole, Dick, BUILD THIS MYSTERIOUS "PERPETUAL" ROTOR, Modern Mechanix and Inventions, Vol. 12, No. 3, July 1934, p. 39.
- 61C. Carpenter, Paul J., DESIGN TRENDS IN FUTURE HELICOPTERS, COMPOUNDS, AND COMPOSITE AIRCRAFT, Presented at International Congress of Subsonic Aeronautics, New York Academy of Sciences, April 3-6, 1967.
- 62C. Castalcicala, Filiberto de la Tour, COUVERTURE ROULANTE POUR AEROPLANES, French Patent, No. 679434, July 27, 1929.
- 63C. Crompton, George Jr., AEROPLANE, U.S. Patent, No. 1902813, March 28, 1933.

D

- 1D. Dallasta, E., APPARATUS FOR LIFTING OR PROPELLING AIRCRAFT, U.S. Patent, No. 2183186, December 12, 1934.
- 2D. Dally, Ovid L., AERIAL VESSEL, U.S. Patent, No. 1665533, April 10, 1928.
- 3D. Damhet, Robert, LES AUTOGYRES ET L'AUTOGIRE, Le Modele Reduit D'Avion, No. 84, November 1945, pp. 6-7.
- 4D. Daniel, Paul G. L., PERFEZIONAMENTI AILE TURBINE A PALE ARTICOLATE, Italian Patent, No. 347083, March 17, 1937.
- 5D. Darche, Paul, MACHINE VOLANTE, French Patent, No. 409612, November 25, 1909.
- 6D. Darrieus, Georges J. M., TURBINE HAVING ITS ROTATING SHAFT TRANSVERSE TO THE FLOW OF THE CURRENT, U.S. Patent, No. 1835018, December 8, 1931.
- 7D. Davies, John, THE AERODYNAMICS OF GOLF BALLS, Journal of Applied Physics, Vol. 20, No. 9, September 1949, pp. 821-828.
- 8D. Deckert, Wallace H., Koenig, David G., and Weiberg, James A., A SUMMARY OF RECENT LARGE SCALE RESEARCH ON HIGH LIFT DEVICES, Conference on V/STOL and STOL Aircraft, Special Publication No. 116, NASA-AMES Research Center, Moffett Field, California, April 4-5, 1966, pp. 63-79.
- 9D. Delanghe, G., LES THEORIES DE L'AERODYNAMIQUE MODERNE SUR L'EFFECT MAGNUS ET LES VOILES TOURNANTES FLETTNER, Le Genie Civil, Vol. 86, Nos. 18 and 19, May 2 and 9, 1925, pp. 425-433 and 453-457.
- 10D. DeLeo, R. V., and Huerta, J., AN EXPERIMENTAL EVALUATION OF AERODYNAMIC CHARACTERISTICS OF TYPICAL FLETTNER ROTOR SHAPES, University of Minnesota, Research Report No. 170, Rosemont Aeronautical Laboratories, Minneapolis, Minnesota, December 1959, p. 128.
- 11D. Delort, Paul, and Saives, Georges, APPAREIL ROTATIF SUSPENSEUR PROPULSEUR POUF REALISER LE VOL MECANIQUE, French Patent, No. 388039, March 11, 1908.
- 12D. Deputte, J. Van, PROPULSEUR AERIEN A AILES ROTATIVES, French Patent, No. 676624, November 29, 1929.

- 13D. Dickerson, Mary C., RESISTANCE CHARACTERISTICS OBTAINED WITH VERTICAL AXIS PROPELLERS FOR LCU(A) REPRESENTED BY MODEL 4952, Research and Development Report No. 1753, David Taylor Model Basin, Washington, D. C., February 1964.
- 14D. Dickerson, Mary C., PROPULSION CHARACTERISTICS OBTAINED WITH VERTICAL AXIS PROPELLERS FOR LCU(A) REPRESENTED BY MODEL 4952, Research and Development Report No. 1753-2, David Taylor Model Basin, Washington, D. C., February 1964.
- 15D. Dickerson, Mary C., POWER CHARACTERISTICS OBTAINED WITH VERTICAL AXIS PROPELLERS FOR LCU(A), REPRESENTED BY MODEL 4952, Research and Development Report No. 1753-3, David Taylor Model Basin, Washington, D. C., February 1964.
- 16D. Dickerson, Mary C., and Ficken, N. L., STEERING CHARACTERISTICS OF A CYCLOIDAL PROPELLER, T and E Report No. HML 206-H-01, Naval Ship Research and Development Center, Washington, D. C., May 1967.
- 17D. Dixon, Margaret Gullanb, and Stangelanb, Anne, TOY AEROPLANE, British Patent, No. 754300, August 8, 1956.
- 18D. Dobias, Vaclav, WINDMOTOR MIT AM UMFANG DES RAHMEN DES WINDRADES ANGEORDNETEN DREHENDEN ZWEIFLUGELIGEN SYMMETRISCHEN SCHAUFELN, German Patent, No. 373438, April 12, 1923.
- 19D. (Donaldson), WINGED WHEEL TURNS WIND INTO POWER, Popular Science Monthly, Vol. 149, No. 5, November 1946, p. 112.
- 20D. (Donaldson), WHIRLWING KITE, Life, Vol. 23, No. 23, December 8, 1947, pp. 57-58.
- 21D. Donaldson, Jesse C., ROTATABLE AIRFOIL KITE, U.S. Patent, No. 2501442, March 21, 1950.
- 22D. Donlan, Charles J., AN INTERIM REPORT ON THE STABILITY AND CONTROL OF TAILLESS AIRPLANES, NACA Report No. 796, 1944, p. 425.
- 23D. Dornier, Peter, MULTIPLE DRIVE FOR AIRCRAFT HAVING WING PROVIDED WITH TRANSVERSE FLOW BLOWERS, U.S. Patent, No. 3065928, November 27, 1962.
- 24D. Dornier, Peter, AIRCRAFT WITH GROUND EFFECT LANDING GEAR, U.S. Patent, No. 3082976, March 26, 1963.

- 25D. Dowd, Raymond E., THE ROLY POLY GLIDER PAPER AERODYNAMICS, Acro Digest, Vol. 20, No. 4, April 1932, pp. 120-122. (See also: Samolet, No. 7, July 1932, p. 42.)
- 26D. Downton, Robert L., AERIAL SHIP, U.S. Patent, No. 264261, September 12, 1882.
- 27D. Dring, Thomas Augustus, IMPROVEMENTS IN FLYING MACHINES, British Patent, No. 320642, October 14, 1929.
- 28D. (Dring), INSECT PLANE DESIGNED TO HOVER IN THE AIR, Popular Science Monthly, Vol. 125, No. 2, August 1934, p. 55.
- 29D. Driver, Henry R., IMPROVEMENT RELATING TO AIRCRAFT, British Patent, No. 483043, April 7, 1938.
- 30D. Drury, Charles Arthur, et al, IMPROVEMENTS IN OR CONNECTED WITH AERIAL MACHINES, British Patent, No. 280641, November 18, 1927.
- 31D. Dryden, Peter, PARADE OF PROGRESS, Parade Magazine, October 1963.
- 32D. Dubin, Louis, SYSTEME DE ROUE A AILES POUR MACHINES VOLANTES, French Patent, No. 414142, March 26, 1910.
- 33D. Dubost, C., AERODYNAMIC LIFTING DEVICE, U.S. Patent, No. 2532899, December 5, 1950.
- 34D. Dunan, Pitre-Leon, APPAREIL AVIATEUR, French Patent, No. 399563, April 24, 1908.
- 35D. Dupleich, Paul, ROTATION IN FREE FALL OF RECTANGULAR WINGS OF ELONGATED SHAPE, NACA Technical Memorandum No. 1201, April 1949, p. 99. (See also: Publications Scientifiques et Techniques, Ministere de L'Air, No. 176, 1941.)
- 36D. De Capoa, Carlo, and Mattei, Simon, P., MACCHINA PER OTTENERE UNA SPINTA UTILE PER LA TRASLAZIONE MEDIANTE IL DUPLICE MOVIMENTO DI ROTAZIONE DI ALCUNI SUOI ORGANI, Italian Patent, No. 264523, April 30, 1929.
- 37D. Desol, Etienne J. L., APPAREIL PROPRE A SOULEVER UN POIDS SUIVANT UNE VERTICALE ET A LE SOUTENIR INDEFINIMENT SUR CETTE VERTICALE, SANS DEPLACEMENT HORIZONTAL, SI L'ATMOSPHERE EST CALME, ET SANS AUTRE POINT D'APPUIQUE L'AIR, ET POUVANT RECEVOIR D'AUTRES APPLICATIONS, French Patent, No. 656176, June 21, 1928.

38D. Dring, Thomas A., FLYING MACHINE, British Patent, No. 1864012,
June 21, 1932.

39D. Dring, Thomas A., FLYING MACHINE, British Patent, No. 1898764,
February 21, 1933.

E

- 1E. Eastman, Fred, Burkheimer, George, and Cotter, W. E., WIND TUNNEL TESTS ON A HIGH PITCH CYCLOGIRO, UWAL Report No. 191-A, University of Washington Aeronautical Laboratory, Seattle, Washington, June 2, 1943.
- 2E. Eastman, Fred S., THE FULL FEATHERING CYCLOGIRO, UWAL Report No. 317, University of Washington Aeronautical Laboratory, Seattle, Washington, March 1951.
- 3E. Eck, Bruno, VENTILATOREN FREILAUFENDE RADIAL RADER OHNE GEHAUSE, Springer Verlag, Berlin/Gottingen/Heidelberg, 1962, pp. 410-411.
- 4E. Eck, Bruno, VENTILATOREN-X. ZWEIMAL DURCHSTROMTE LAUFER QUERSTRANGEBLASE, Springer Verlag, Berlin/Gottingen/Heidelberg, 1962, pp. 144-172.
- 5E. Eckington, James Francis, IMPROVED AIRCRAFT, British Patent, No. 640522, July 19, 1950.
- 6E. Eckler, G. E., FLYING MACHINE, U.S. Patent, No. 1531084, March 24, 1925.
- 7E. EDITORIAL COMMENT - THE ROTOR AND AVIATION, Flight, Vol. 16, No. 48, November 27, 1924, pp. 739-740.
- 8E. Edwards, Joe E., Jr., and Evans, Alfred E., ROTATABLE KITES, U.S. Patent, No. 3079115, February 26, 1963.
- 9E. Einstein, Albert, THE FLETTNER SHIP, Essays in Science, Philosophical Library, Inc., New York, New York, 1933, pp. 92-97.
- 10E. Ellyson, F. W., ZUR VERGESCHICHTE DES FLETTNER-ROTOR-ANTRIEBS, Flugsport, Vol. 18, No. 4, January 1926, pp. 69-73.
- 11E. Eredia, F., CRONACA SCIENTIFICA SU ALCUNE EXPERIEMZE AERODYNAMICHE, Bolletino Della Societo Aeronautica Italiana, No. 10, 1908, pp. 347-349.
- 12E. Ernst, Alfred, DISPOSITIVO DI PROPULSIONE IN UN FLUIDO SPECIALMENTE ADATTO IN AERONAUTICA, Italian Patent, No. 481090, April 22, 1953.
- 13E. Espinosa, C., and Vinay, L., PROPELLING: CONSTRUCTION OF PLANES AND THE LIKE, British Patent, No. 4810, February 27, 1911.

- 14E. Eula, Antonio, L'APPLICAZIONE E DELL'EFFETTO MAGNUS AL L'AERONAUTICA, L'Aerotecnica: Atti dell'Associazione Italiana di Aerotecnica, Rome, Italy, November 23-29, 1926, pp. 298-325.
- 15E. Evans, Arthur J., ROTATING POWER DRUM FOR AIRPLANES, U.S. Patent, No. 1850925, March 22, 1932.
- 16E. Everling, E., MEASUREMENT OF THE AIR FORCES OF A WING SHAPE FOR ANGLES OF INCIDENCE FROM 0° TO 360° , Translated Abstracts of Technische Berichte, 1917, Air Publication, Vol. 2, No. 1121, September 1925, pp. 43-44.
- 17E. Everling, E., ZUR FRAGE DES FLUGELRADES, Deutsche Luftwacht, Ausgabe Luftwissen, Vol. 1, No. 7, July 15, 1934, pp. 221-224.
- 18E. (Exclusivas Industriales (SA)), AVION-JOUET A AILES ROTATIVES, French Patent, No. 1089376, March 16, 1955.
- 19E. Ellyson, F. W., EINIGE LEHRREICHE EXPERIMENTE MIT PROPELLER MODELLEN, VERSCHIEDENEN STABQUERSCHMITTEN UND KUGELFORWUGEN KORPEN, H. P. Fachzeitung fur Automobilismus und Flugtechnik, Vol. 5, Nos. 47 and 48, November 19 and 26, 1911, pp. 27-29, 21-22.
- 20E. Elpidio, Piccoli, MACCHINA AEREA PIU PESANTE DELL ARIA SOLLEVANTESI PER EFFECTO MAGNUS, Italian Patent, No. 260839, October 17, 1928.

F

- 1F. Fahrney, Delmer S., AIRCRAFT WING, U.S. Patent, No. 2183555, September 18, 1937.
- 2F. Fahrney, Delmer S., AIRCRAFT WING, U.S. Patent, No. 2173832, September 26, 1939.
- 3F. (Fairey Aviation Co. and Labelle, Marcel J. O.), IMPROVEMENTS IN OR RELATING TO AIRCRAFT, British Patent, No. 510192, July 25, 1939.
- 4F. Fales, E. N., FLOW OF AIR AROUND A ROTATING CYLINDER, U.S. Air Service Information Circular, Vol. 6, No. 510, McCook Field Report Serial No. 2462, June 1925, p. 5.
- 5F. Fateev, E. M., VETRODVIGATELI, Gosudarstbennoe Energeticheskoe Izdatel'stvo, Moscow, Russia, 1946, pp. 48-54, 62-68.
- 6F. Fateev, E. M., VETRODVIGATELI I VETROUSTANOVKI, Ogiz-Sel'khozgiz, Moscow, Russia, 1948, pp. 87-91.
- 7F. Fatta, G. J. and Zehnle, R. A., ON THE DYNAMICS OF AUTO-ROTATING BODIES, Unpublished Paper, Department of Aerospace Engineering, University of Notre Dame, South Bend, Indiana, December 1966.
- 8F. Favre, Alexandre, AIRCRAFT WING FLAP WITH A LEADING EDGE ROLLER, U.S. Patent, No. 2569983, October 2, 1951.
- 9F. Few, Sonia F., AIRPLANE, U.S. Patent, No. 1816898, August 4, 1931.
- 10F. Ficken, N. L., and Gawlik, S. G., MODEL FLOW STUDIES TO INVESTIGATE PROPELLER EXCITED VIBRATIONS ON U. S. ARMY SHIP LT. COL. JOHN D. D. PAGE (BDI-IX) EQUIPPED WITH VERTICAL AXIS PROPELLERS, Report No. 1412, David Taylor Model Basin, Washington, D. C., March 1960.
- 11F. Ficken, N. L., CONDITIONS FOR THE MAXIMUM EFFICIENCY OPERATION OF CYCLOIDAL PROPELLERS, Paper Presented at the Society of Naval Architects and Marine Engineers, Chesapeake Section, April 6, 1966, p. 49.
- 12F. Finn, A. C., AIRPLANE-LIKE KITE, U.S. Patent, No. 3107888, October 1963.

- 13F. Fischer, H. W., DRIVEN ROTOR WING SYSTEM FOR AIRCRAFT, U.S. Patent, No. 3231220, January 25, 1966.
- 14F. Fischer, Max, POLYTECHNISCHE SCHAU DIE BARBARA, Dinglers Polytechnisches Journal, Vol. 341, No. 10, May 1926, pp. 122-123.
- 15F. FitzPatrick, James L. G., NATURAL FLIGHT AND RELATED AERONAUTICS, Sherman M. Fairchild Publication Fund Paper FF-7, American Institute of Aeronautics and Astronautics, New York, New York, June 1952, p. 118.
- 16F. Fleiner, Max, AILES ROTATIVES, French Patent, No. 636843, June 30, 1927.
- 17F. Fleiner, Max, ROTIERENGER FLUGEL, Swiss Patent, No. 121698, August 1, 1927.
- 18F. Fletcher, C. J., RECOVERY SYSTEM FOR ROCKET BOOSTERS, U.S. Patent, No. 3233547, February 8, 1966.
- 19F. (Flettner), SAILING WITHOUT SAILS, WIND ACTION ON ROTATING CYLINDER MASTS, The Illustrated London News, November 15, 1924.
- 20F. (Flettner), THE FLETTNER ROTOR SHIP, Flight, Vol. 16, No. 48, November 27, 1924, p. 741.
- 21F. (Flettner), VOM MAGNUS EFFEKT UND FLETTNERS WALZEN-SEGEL, Flugsport, Vol. 16, No. 22, November 29, 1924, pp. 424-425.
- 22F. (Flettner), TESTING THE FLETTNER "ROTOR" IN ACTUAL FLIGHT, Flight, December 4, 1924, p. 759.
- 23F. (Flettner), LE BATEAU A CYLINDRES PROPULSEURS, SYSTEME FLETTNER, Le Genie Civil, Vol. 85, No. 23, December 6, 1924, pp. 526-527.
- 24F. Flettner, Anton, DIE ANWENDUNG DER ERKENNTNISSE DER AERODYNAMIK ZUM WINDANTRIEB VON SCHIFFEN, Werft-Reederei-Hafenbau, Vol. 5, No. 23, December 7, 1924, pp. 657-667.
- 25F. (Flettner), FLETTNER'S SAILLESS SHIP EXPLAINED, Power, Vol. 60, No. 27, December 30, 1924, pp. 1054-1056.
- 26F. Flettner, Anton, DIE ANWENDUNG DER ERKENNTNISSE DER AERODYNAMIK ZUM WINDANTRIEB VON SCHIFFEN, Jahrbuch der Schiffbautechnischen Gesellschaft, Verlag van Julius Springer, 1925, pp. 222-251.

- 27F. (Flettner), FAMOUS GERMAN SAIL-LESS SHIP DRIVEN BY SAME WIND FORCES THAT MAKE BASEBALL CURVE, Scientific American, Vol. 132, No. 1, January 1925, p. 12.
- 28F. (Flettner), THE FLETTNER ROTOR SHIP, Engineering, Vol. 19, January 23, 1925, pp. 117-120.
- 29F. Flettner, A., ANWENDUNG DER ERKENNTNISSE DER AERODYNAMIK ZUM WINDVORTRIEB VON SCHIFFEN, Zeitschrift fur Flugtechnik und Motorluftschiffahrt, Vol. 16, No. 3, February 14, 1925, pp. 52-66.
- 30F. (Flettner), THE TRIAL TRIPS OF THE ROTOR SHIP "BACKAU", Engineering Progress, Vol. 6, No. 4, April 1925, p. 96.
- 31F. Flettner, Anton, THE STORY OF THE ROTOR, F. O. Willhofft, New York, New York, 1926, pp. 86-87, 45-110. (See also: "Mein Weg Zum Rotor", Verlegt bei Koehler und Amelang, Leipzig, Germany, 1926.)
- 32F. (Flettner), DIE BARBARA, Dingler's Polytechnisches Journal, Vol. 341, No. 11, June 1926, pp. 122-123.
- 33F. (Flettner), TRIAL TRIPS OF THE 3000 TON ROTOR VESSEL "BARBARA", Nautical Gazette, Vol. 3, No. 7, August 14, 1926, pp. 174-178.
- 34F. (Flettner), THE ROTOR SHIP BARBARA, The Engineer, Vol. 139, No. 3692, October 15, 1926, pp. 422-423.
- 35F. (Flettner), A STILL LARGER ROTOR SHIP, Scientific American, Vol. 136, No. 3, March 1927, p. 199.
- 36F. Flettner, A., ARRANGEMENT FOR EXCHANGING ENERGY BETWEEN A CURRENT AND A BODY THEREIN, U.S. Patent, No. 1674169, June 19, 1928.
- 37F. Flettner, Anton, VENTILATING DEVICE FOR VEHICLES, Australian Patent, No. 1530928, August 28, 1928.
- 38F. (Flettner), THE PASSING OF THE ROTOR SHIP, S. A. E. Journal, Vol. 24, No. 1, January 1929, p. 51.
- 39F. Focke, Henrich Carl Johann, AIRCRAFT WITH ROTARY DEFORMABLE-SECTION SUSTAINING WING, U.S. Patent, No. 2714495, August 2, 1955. (See also: Dutch Patent, Application No. 16432; and Dutch Patent, No. 77261.)
- 40F. Focke, Henrich E. H., GERMAN THINKING ON ROTARY-WING DEVELOPMENT, Journal of the Royal Aeronautical Society, Vol. 69, No. 653, May 1965, pp. 297, 300-302.

- 41F. (Focke), VTOL FLUGZEUGE VON PROF. FOCKE, Der Flieger, Vol. 45, No. 11/12, November-December 1966, p. 302.
- 42F. (Focke), VTOL-GERAT MIT KIPPROTOREN GAR NICHT SO NEU, Der Flieger, Vol. 46, No. 5, May 1967, p. 116.
- 43F. Fojut, Apollinaris, FLUGZEUGANTRIEB MIT IN TRAGFLUGEL-HOHLRAUMEN EINGEBAUTEN DREHKORPERN, German Patent, No. 642106, February 16, 1937.
- 44F. Fokken, A. A., FLYING MACHINE, U.S. Patent, No. 1021925, April 2, 1912.
- 45F. Fon, Alphonse F. La, AIRCRAFT CONSTRUCTION, U.S. Patent, No. 1969804, August 14, 1934.
- 46F. Foret, Edmond, APPAREIL D'AVIATION, French Patent, No. 400021, May 16, 1908.
- 47F. Fortier-Beaulieu, NOTE SUR LES ESSAIS AERODYNAMIQUES DE DIFFERENTS MODELES DE TURBINES AERIENNES, Recherches et Inventions, Vol. 5, No. 14, May 1, 1924, pp. 525-531.
- 48F. Fortier-Beaulieu, ESSAIS SUR UNE TURBINE AERIENNE, Recherches et Inventions, Vol. 5, No. 15, May 15, 1924, pp. 553-555.
- 49F. Foshag, William F., and Boehler, Gabriel D., EXPLORATORY RESEARCH ON WING-ROTORS FOR ARMY AIR MOBILITY APPLICATION, PHASE I, Proposal AP 62, Aerophysics Company, Washington, D. C., March 1964.
- 50F. Foshag, William F., CALIBRATION, ADJUSTMENT, INSPECTION AND ASSEMBLY TECHNIQUES OF TWO AEROPHYSICS CONTROL-LABLE WING ROTOR MODELS, Report No. AR64-351, Aerophysics Company, Washington, D. C., October 1964.
- 51F. Foshag, William F., and Boehler, Gabriel D., EXPLORATORY RESEARCH ON WING ROTORS WITH EMPHASIS ON PRECISE DROP GLIDER APPLICATIONS, Proposal No. 78, Aerophysics Company, Washington, D. C., March 3, 1965.
- 52F. Fournier, Lucien, L'INSTITUT AERODYNAMIQUE DE KOUT-CHINO, La Nature, Vol. 37, No. 1888, July 31, 1909, p. 140.
- 53F. Franklin, Hugh L., SOME ROTATING SHAPE WIND TUNNEL DATA, Technical Memorandum No. 15-12, Weapons Research Division, CWL, Edgewood, Maryland, April 1957, p. 84.
- 54F. Franz, Gunther E., BLADE WHEEL PROPELLER, U.S. Patent, No. 2753006. July 3, 1956.

- 55F. Fraser, J. E., AERIAL VEHICLE, U. S. Patent, No. 175969, October 14, 1913.
- 56F. Frazier, James Edward, PERFECTIONNEMENTS DANS LES AEROPLANES, French Patent, No. 394956, October 6, 1908.
- 57F. Freudenberg, Lenor, DAS ROTOR MOTORSCHIFF "BARBARA", Technische Rundschau, Vol. 32, No. 49, December 3, 1926, pp. 459-460.
- 58F. Frey, Kurt, VERSUCHE MIT RUTIERENDEN ZYLINDERN IN VERBINDUNG MIT TRAGFLACHEN, Zeitschrift für Flugtechnik und Motorluftschiffahrt, Vol. 17, No. 16, August 28, 1926, pp. 342-345. (See also: Aerodinamica, No. 1, January 1927, pp. 1-5.)
- 59F. Frey, Kurt, EXPERIMENTS WITH ROTATING CYLINDERS IN COMBINATION WITH AIRFOILS, NACA Technical Memorandum No. TM 382, October 1926, p. 12.
- 60F. Friche, W. D., AIRPLANE WING, U.S. Patent, No. 1796016, March 10, 1931.
- 61F. Fronz, Francesco, PROPELLING: STEERING, British Patent, No. 1445, January 21, 1908.
- 62F. Fronz, Francesco, ROUE A PALETTES PARTICULIEREMENT APPLICABLE AUX AUTO-BALLONS AEROPLANES ET AUTRES ENGINES DE NAVIGATION AERIENNE, French Patent, No. 386696, January 24, 1908.
- 63F. Fulger, T. H. E., FLYING MACHINE, U.S. Patent, No. 1006074, October 17, 1911.
- 64F. Fuller, W. E., A RADICAL DEPARTURE IN THE CONVENTIONAL TUGBOAT DESIGN AND A NEW USE FOR CYCLOIDAL PROPULSION, American Society of Naval Engineers, Vol. 65, No. 3, August 1953, pp. 639-645.
- 65F. Foshag, William F., ROTOR PLANE EXPERIMENTS, Unpublished, Washington, D. C., 1947.
- 66F. Fritzel, Hugo, LEITKORPERANORDNUNG FÜR ÜBERDRUCKROToren, German Patent, No. 457424, March 12, 1928.

G

- 1G. Gabler, Henri, SYSTEME PROPULSEUR ET SUSTENTATEUR POUR LA NAVIGATION AERIENNE, French Patent, No. 405685, November 20, 1908.
- 2G. Gaddis, Francis, IMPROVEMENTS IN AIRCRAFT, British Patent, No. 275423, August 11, 1927.
- 3G. Galaine, Constant, SYSTEME DE MACHINE VOLANTE, French Patent, No. 403440, May 28, 1909.
- 4G. Gale, Lawrence J., Jones, Ira P., Jr., and Wilson, Jack H., AN INVESTIGATION OF THE SPIN, RECOVERY AND TUMBLING CHARACTERISTICS OF A 1/20 SCALE MODEL OF THE NORTHROP X-4 AIRPLANE, NACA Research Memorandum No. RML9K28, January 4, 1950.
- 5G. Gamba, Franco, DISPOSITIVO DI SOSTENTAMENTO E/O DI PROPULSIONE A PALETTE MOBILI PARTICOLARMENTE PER AEROVELICOLI, Italian Patent, No. 382223, August 12, 1940.
- 6G. Gardner, A. B., CONSTRUCTION FOR AIRCRAFT, U.S. Patent, No. 1975098, October 2, 1934.
- 7G. Gardner, A. B., CONSTRUCTION FOR AIRCRAFT, U.S. Patent, No. 2037377, April 14, 1936.
- 8G. Gay, M., LES TRAVAUX RECENTS DE L'INSTITUT AERODYNAMIQUE DE KOUTCHINO, La Technique Aeronautique, Vol. 1, No. 10, May 15, 1910, pp. 389-391.
- 9G. Gebauer, Julius, MACHINE VOLANTE, French Patent, No. 410848, November 8, 1909.
- 10G. Germani, Gustavo, PROPULSORE CENTRIFUGO A PALE FLESSIBILI PER AVIAZIONE E MARINA E MECCANISMO ID ROTORO E PNEUMFORO, Italian Patent, No. 409743, March 2, 1945.
- 11G. George, Marc, LES AILES A "CYLINDRES TOURNANTS" QUE DOIT DONNER LE ROTOR APPLIQUE AUX AVIONS?, Les Ailes, Vol. 5, No. 198, 1925, p. 1.
- 12G. Giese, Erich, RIESEN-ROTOR-LUFTFAHRZEUGE, Verlag Von Karl Schaffer, Berlin, Germany, 1929, p. 56.

- 13G. Giese, Ernest, ROTORAEROSTAT MED FLERE ROTORER, Danish Patent, No. 41859, March 7, 1930.
- 14G. Giese, E., ROTOR FLYING MACHINE HAVING A PLURALITY OF ROTORS, U.S. Patent, No. 1798153, March 31, 1931.
- 15G. Giqueaux, Maurice, MECANIQUE DES FLUIDES THEORIQUE, Librairie Polytechnique Ch. Beranger, Paris and Liege, France, 1944, pp. 172-175.
- 16G. Glauert, M. B., SOME NOTES ON THE ROHRBACH HELICOPTER, Report No. BA 1074, Royal Aircraft Establishment, Farnborough, England, October 1933.
- 17G. Glauert, M. B., A BOUNDARY LAYER THEORY WITH APPLICATIONS TO ROTATING CYLINDERS, Journal of Fluid Mechanics, Vol. 2, Part 1, 1957, p. 89.
- 18G. Glauert, M. B., THE FLOW PAST A RAPIDLY ROTATING CYLINDER, Proceedings of the Royal Society, Vol. 242, Series A, 1957, pp. 108-115.
- 19G. Gleissner, G. H., THE NUMERICAL INTEGRATION OF A SET OF EQUATIONS FROM MAGNUS FORCE THEORY, NPG Report No. 1457, Naval Proving Ground, China Lake, California, May 1956, p. 51.
- 20G. (Gligorin), VERSUCHIEDENS. DER ROTOR ALS AUFTRIEBSMITTEL, Flugsport, Vol. 17, No. 24, December 9, 1925, p. 487.
- 21G. Glover, J. P., AERIAL MACHINES WITHOUT AEROSTATS: PROPELLING AND STEERING, British Patent, No. 28212, December 5, 1910.
- 22G. Glover, J. P., AERIAL MACHINE, U.S. Patent, No. 1044375, November 12, 1912.
- 23G. Glowacki, Erazm, WIND KRAFT MASCHINE, Austrian Patent, No. 14961, January 25, 1904.
- 24G. Gobb, Ettore, WIND KRAFT MASCHINE MIT GEKRUMMTEN WINDFLUGELN, German Patent, No. 535624, October 13, 1931.
- 25G. Goehner, FLYING MACHINE, U.S. Patent, No. 979472, December 27, 1910.
- 26G. Gohr, W., MACHINE VOLANTE A AILES MOBILES, French Patent, No. 676866, November 29, 1929.
- 27G. Gohr, Wilhelm, FLYING MACHINE WITH MOVABLE SUPPORTING PLANES, British Patent, No. 333680, August 21, 1930.

- 28G. Goldau, Wilhelm, EIN FLUGEL WINDKRAFT-WERK, German Patent, No. 802988, July 8, 1949.
- 29G. Goldau, Wilhelm, EIN FLUGELWINDMOTOR MIT VERTIKALER ASHSE, German Patent, No. 800384, November 2, 1950.
- 30G. Golding, E. W., THE GENERATION OF ELECTRICITY BY WIND POWER, E. E. F. M. Spon, Ltd., London, England, 1955, pp. 196-198, 201, 203.
- 31G. Goldman, Johann, SCHAUFBLRAD MIT BEWEGLICHEN SCHAUFELN, German Patent, No. 304433, March 27, 1931.
- 32G. Goldstrom, Michel, APPAREIL D'AVIATION, French Patent, No. 401069, July 6, 1908.
- 33G. Goldsworthy, E. C., THE VOITH-SCHNEIDER SYSTEM OF PROPULSION, Engineering, September 15, 1939, pp. 315-317.
- 34G. Goldsworthy, E. C., VOITH-SCHNEIDER PROPELLER, British Intelligence Objectives Sub-Committee Final Report No. 509 (Item No. 29), London, England, April 8, 1946, p. 5.
- 35G. Goldsworthy, E. C., and Brown, A. B., CYCLOIDAL VOITH-SCHNEIDER PROPULSION, Transactions of the Institution of Engineers and Shipbuilders in Scotland, Vol. 101, Part 3, 1957-58, pp. 99-147.
- 36G. Goldsworthy, E. C., TRANSVERSE PROPULSION USING VOITH-SCHNEIDER PROPELLERS, Shipbuilding and Shipping Record, Vol. 102, No. 10, September 5, 1963, pp. 312-314.
- 37G. Golinkevich, N. A., O VZAIMODEISTVII LAPASTEI KRYCHATOGO DVIZHITELA, Transactions, VNITOSS, Vol. 6, No. 2, 1955, pp. 93-97.
- 38G. Gras, Emile, ROUE A PELLERES PLATES TOURNANTES PRODUISANT FORCE DE SUSTENTATION ET DE PROPULSION, French Patent, No. 410889, December 2, 1909.
- 39G. Gray, Eugene, AN INTERESTING ROTOR MODEL, Popular Aviation, Vol. 12, No. 3, March 1933, pp. 181-182.
- 40G. Gray, Purlin, and Cook, D. A., FIELD VELOCITY DUE TO CYCLODYNE LIFTING LINE THREE DIMENSIONAL CASE, Atlanta, Georgia, 1967, p. 8.
- 41G. Greene, John E., AN INVESTIGATION OF THE ROLLING MOTION OF CRUCIFORM FIN CONFIGURATIONS, NAVORD Report 6262, Aero Research Report No. 51, U. S. Naval Ordnance Laboratory, White Oak, Maryland, July 1961.

- 42G. Greenhall, G., Rathmill, J., and Thorley, E., ROTARY PROPELLER, British Patent, No. 15940, July 8, 1909.
- 43G. Greenhill, A. G., ON LORD RAYLEIGH'S PAPER ON THE IRREGULAR FLIGHT OF A TENNIS BALL, Messenger of Mathematics, Vol. 11, 1880, pp. 113-117.
- 44G. Gregovich, Sergio, ELICOTTERO A PALE, Italian Patent, No. 453972, December 23, 1949.
- 45G. Gregovich, Sergio, PROPULSORE AEREO A PALE ROTANTI ECCENTRICAMENTE, Italian Patent, No. 475423, December 29, 1952.
- 46G. Grobling, John, AEROPLANE ATTACHMENT, U.S. Patent, No. 2025739, December 31, 1935.
- 47G. Grose, P. P., AIRCRAFT UTILIZING MAGNUS EFFECT, U.S. Patent, No. 2417358, March 11, 1947.
- 48G. Grosgeorges, Emile, APPAREIL VOLANT, French Patent, No. 397218, August 19, 1908.
- 49G. Gross, D. S., WIND TUNNEL TESTS OF ROTATING BODIES - 5TH SERIES, Wind Tunnel Report No. 116, University of Maryland Aeronautical Laboratory, College Park, Maryland, May 1954, p. 101.
- 50G. (Groupement Francais pour le Developpement des Recherches Aeronautiques), DISPOSITIFS POUR EVITER LES DECOLLEMENTS ET TOURBILLONS DE FLUIDES SE DEPLACANT PAR RAPPORT A UNE SURFACE SOLIDE, French Patent, No. 926518, April 21, 1947.
- 51G. (Grubauer), ROTOR WINGS ON PLANE TO BE TESTED IN EUROPE, Popular Mechanics, Vol. 55, No. 1, January 1931, p. 9.
- 52G. Grubauer, Carl, EINEM FLUGZEUG NACHGEBILDETTTER, SPIELZEUG DRACHEN, Swiss Patent, No. 146887, July 16, 1931.
- 53G. Guest, J. B. H., MEANS FOR STABILIZING AND CONTROLLING THE FLIGHT OF AERIAL MACHINES, U.S. Patent, No. 1311389, July 29, 1919.
- 54G. Guest, John B. H., and Tanaka, Tsunesuke, MOYENS POUR STABILISER ET CONTROLER LE VOL D'UNE MACHINE AERIENNE, French Patent, No. 502463, February 21, 1920.
- 55G. (Guest and Popper), ODD AIRCRAFT BUILT IN BROADWAY LOFT, New York Times, Vol. 81, No. 27030, January 26, 1932, p. 23.
- 56G. (Guest and Popper), WILL TRY OUT ROTOR CONES, New York Times, Vol. 81, No. 27042, February 7, 1932, p. 8.

- 57G. (Guest and Popper), WHIRLING SPINDLES REPLACE WINGS ON MYSTERY PLANE, Popular Science Monthly, Vol. 120, No. 4, April 1932, p. 32.
- 58G. (Guest and Popper), WINGLESS AIRCRAFT TO FLY WITH ROTOR PLANES, Popular Mechanics, Vol. 57, No. 4, April 1932, p. 529.
- 59G. Guinness, N. D. R., PROPELLING AIRCRAFT, British Patent, No. 810951, October 11, 1955.
- 60G. Gunn, Ross, CONSTANT SPEED AIR MOTOR, U. S. Patent, No. 1954811, April 17, 1934.
- 61G. Gussoni, Luigi, IL ROTORE SAVONIUS E LE SUE APPLICAZIONI, L'Ingegnere, Vol. 5, No. 10, October 1931, pp. 696-703.
- 62G. Gustafson, Torsten, ON THE MAGNUS EFFECT ACCORDING TO THE ASYMPTOTIC HYDRODYNAMIC THEORY, NACA Translation No. N-25921, June 1954, p. 82.
- 63G. Goldberg, Wayne, AUTOROTATING DELIVERY VEHICLES, The Notre Dame Technical Review, Vol. 18, No. 1, November 1966, pp. 42-43.
- 64G. Goldsworthy, E. C., THE VOITH-SCHNEIDER PROPELLER, The British Intelligence Objectives Sub-Committee, Report No. 28, August 31, 1945.
- 65G. Groh, E., GESCHACHTELTE, PNEUMATISCHE FLETTNER-ROTAREN, German Patent, No. 416586, July 22, 1925.

H

- 1H. Haberman, W. L., and Harley, E. E., PERFORMANCE OF VERTICAL AXIS (CYCLOIDAL) PROPELLERS CALCULATED BY TAMIGUCHI'S METHOD, Report No. 1564, David Taylor Model Basin, Washington, D. C., November 1961.
- 2H. Haberman, W. L., and Caster, E. B., PERFORMANCE OF VERTICAL AXIS (CYCLOIDAL) PROPELLERS ACCORDING TO ISAY'S THEORY, Shipbuilding Progress, Vol. 9, No. 90, February 1962, pp. 81-87.
- 3H. Habicht, Gustav, WINDKRAFT MASCHINE MIT SENKRECHTER DREHACHSE UND GEKRUMMTEN, RADIAL ZUR ACHSE VERLAUFENDEN, TREIBFLACHEN, German Patent, No. 634364, August 25, 1936.
- 4H. Hage, Robert E., SUMMARY OF DEVELOPMENT WORK ON A CYCLOGIRO TYPE OF ROTATING WING AIRCRAFT, Memorandum Report No. TSEAL2-4203-4-1, AAF Air Technical Service Command, Wright-Patterson AFB, Dayton, Ohio, August 16, 1945, p. 4.
- 5H. Hall, Barbara M., SHIPS TURN LIKE CRAB, Science News Letter, Vol. 50, No. 20, November 16, 1946, pp. 314-315.
- 6H. Hallander, Josef A., DISPOSITION APPLICABLE AUX MACHINES VOLANTES A DEUX OR PLUSIEURS PLANS SUSTENTATEURS, French Patent, No. 621303, January 31, 1927.
- 7H. Hammant, W., PROPELLING, British Patent, No. 23129, October 30, 1908.
- 8H. Hammant, W., PERFECTIONNEMENTS DANS LES MACHINES AERIENNES, French Patent, No. 408932, October 30, 1909.
- 9H. Hanriot, Marcel P. F., and Richard, Gilbert C., MACHINE VOLANTE A AILES TOURNANTES AYANT UNE TRAJECTOIRE CIRCULAIRE, French Patent, No. 801225, May 16, 1936.
- 10H. Hanriot, M., and Coupit, R., MACHINE VOLANTE DU TYPE A AILES ROTATIVES, French Patent, No. 807512, October 19, 1936.
- 11H. Hanssmann, Christian, MASCHINE MIT DER LUFT ARBETENDEN FLUGELRAD, Swiss Patent, No. 237845, September 17, 1945.

- 12H. Hanschmann, Horst, FLUGZEUG MIT MAGNUSROTOREN, German Patent, No. 1033039, June 26, 1958.
- 13H. Hanschme, A., AVION A ROUES A AILES, PARTIELLEMENT RECOUVERTES, TOURNANT SUR DES AXES LONGITUDINAUX HORIZONTAUX, French Patent, No. 620815, January 24, 1927.
- 14H. Hansen, Howard Clair, OMNIDIRECTIONAL DRIVE SYSTEM FOR LAND VEHICLES, U.S. Patent, No. 3016966, January 16, 1962.
- 15H. Hardgraves, H., FLYING MACHINE, U.S. Patent, No. 1039679, September 24, 1912.
- 16H. Harks, Bruno, SCHWINGENANTRIEB FUR LUFFAHRZEUGE MIT REIFENFUHRUNG DER SCHWINGENDEN HOLME, German Patent, No. 701691, January 22, 1941.
- 17H. Hartog, Jacob B. Den, MECHANICAL VIBRATIONS, 2nd Edition, McGraw-Hill Book Company, Inc., New York, New York, 1940, pp. 351-353.
- 18H. Heald, R. H., Logan, J. G., Jr., Spivak, H., and Squire, W., AERODYNAMIC CHARACTERISTICS OF A ROTATING MODEL OF THE 5.0 INCH SPIN-STABILIZED ROCKET MODEL 32, Technical Note No. 37, U.S. Navy Bureau of Ordnance, June 1957.
- 19H. Heden, G., BUOYING AND DRIVING MECHANISM FLYING MACHINES, U.S. Patent, No. 1739967, December 17, 1929.
- 20H. Heimann, Erich, DR. KALETSCH'S ROTARY WINGS, Aeromodeller Annual 1966-67, Model Aeronautical Press, Ltd., Hemel Hemstead: Herts, England, pp. 15-20 and Cover.
- 21H. Heinze, Edwin P. A., THE ROHRBACH "PADDLE PLANE", Flight, Vol. 25, No. 5, February 2, 1933, p. 107.
- 22H. Helfer, A., FLYING MACHINE, U.S. Patent, No. 999560, August 1, 1911.
- 23H. Helfer, Arwin, PERFECTIONNEMENT DANS LES MACHINES VOLANTES, French Patent, No. 415955, May 13, 1910.
- 24H. Heller, H. J., PROPELLING, British Patent, No. 6287, March 12, 1910.
- 25H. Henningsen, Paul, D. H. SPRAGEBOG, Chr. Erichsens Forlag, Kobenhavn, 1955, pp. 50-51.
- 26H. Henry, Charles J., A SURVEY OF CYCLOIDAL PROPULSION, Davidson Laboratory Report No. 728, Stevens Institute of Technology, Hoboken, New Jersey, December 1959, p. 28.

- 27H. Herzog, H. O., MORE FACTS ABOUT THE FLETTNER ROTOR SHIP, Scientific American, Vol. 32, No. 2, February 1925, pp. 82-83.
- 28H. Henter, Mathias, and Kaser, Ernest, EINRICHTUNG ZUR ERHOHUNG DES QUERTRIEBES UND ZUM VERHINDERN DES ABLOSENS DER LUFTSTROMUNG AUF DER OBERSEITE VON FLUGZENGTRAFUGELN, German Patent, No. 542471, January 25, 1932.
- 29H. Henter, Mathias, and Kaser, Ernst, EINRICHTUNG ZUR ERHOHUNG DES QUERTRIEBES VON SICH RELATIV ZU DEM DUMGEBENDEN MEDIUM BEWEGENDEN KORPERN, WIE FLUGZEUGTRAGFLUGELN U. DGL, German Patent, No. 586496, October 21, 1933.
- 30H. Heuver, H. M., and Hage, R. E., ANALYTICAL STUDY OF THE PERFORMANCE OF A CYCLOIDAL PROPELLER AND A PRELIMINARY SURVEY OF A FIGHTER TYPE DESIGN, Memorandum Report No. ENG-51/P706-84, AAF Materiel Center Command, Eng. Div., Wright Field, Dayton, Ohio, July 22, 1943.
- 31H. Heuver, H. M., CYCLOIDAL ROTOR FOR AIRCRAFT, U. S. Patent, No. 2580428, January 1, 1952.
- 32H. Hewins, E. F., VERTICAL AXIS PROPELLER INSTALLATION ON THE FERRY NORTHAMPTON, Chesapeake Section, Society of Naval and Marine Engineers, New York, New York, April 1, 1950.
- 33H. Heys, J. Wilhelm van, WIND UN WINDKRAFTANLAGEN, Georg Siemens Verlagsbuchhandlung, Berlin, Germany, 1947, pp. 32-66.
- 34H. Hick, W. G., AERIAL MACHINE, British Patent, No. 18899, August 17, 1909.
- 35H. High, Fred, and McDonnell, P. E., THE FIRST REAL FLYING MACHINE, The International Aero Exhibition Association, Chicago, Illinois, June 9, 1919, p. 19.
- 36H. Hill, R. B., and Nicholas, W. D., CYCLOIDAL PROPELLER, U.S. Patent, No. 3326296, June 20, 1967.
- 37H. Hillis, D., AIRSHIP, U.S. Patent, No. 971379, September 27, 1910.
- 38H. Hinrichs, Ernst, EIN FLACHES GERAT ZUM QUALITATIVEN NACHWEIS DES MAGNUS EFFEKSTES, Luftfahrt und Schule, No. 1, December 1938, pp. 79-80.
- 39H. Hocq, Andre L. N., AEROPLANE AUTOSUSTENTATEUR, French Patent, No. 626458, May 9, 1927.

- 40H. Hodier, R. A., APPAREIL DE PROPULSION AERIENNE PERMETTANT L'ASCENSION VERTICALE ET L'EVOLUTION EN TOUS SENS, French Patent, No. 580877, April 29, 1924.
- 41H. Hoerner, S. F., FLUID-DYNAMIC DRAG, S. F. Hoerner, Midland Park, New Jersey, 1965, pp. 7-12.
- 42H. Hoffman, G., DIE MOGLICHKEITEN VORTEILHAFTER ANWENDUNG DER FLUGELRADPROPELLER IM SCHIFFBAU, Schiffbau-technik, Vol. 6, No. 11, November 1956, pp. 355-357.
- 43H. Hoffmann, Henry and Anneliese, WINDKRAFTMASCHINE MIT SENKRECHTER DREHACHSE BESTEHEND AUS EINEM MITTELKORPER MIT IHN UMGEBENDEN FLUGELN UND ZWEI ENDSCHLEIBEN, German Patent, No. 604333, October 19, 1934.
- 44H. Hoffman, Raoul J., DEVICES FOR LANDING, Popular Aviation, Vol. 25, No. 3, September 1939, pp. 55, 87.
- 45H. Holland, J. D., AN AERIAL PADDLE, Flight, April 23, 1910, p. 317.
- 46H. Holmes, J. P., AIR SHIP, U. S. Patent, No. 397647, February 12, 1889.
- 47H. Holmstrom, Axel, PROPULSEUR A SURFACES TRAVAILLANTES MOBILES, French Patent, No. 418218, June 1, 1910.
- 48H. Holst, Erich von, DER ROTIERENDE FLUGEL ALS MITTEL ZUR HOCHAUFTRIEBSERZE, Jahrbuch 1941 Der Deutschen Luftfahrt-Forschung, 1941, pp. 1372-1376.
- 49H. Holst, E. V., Kucheman, D., and Solf, K., THE PROPELLING WING, No. CGD 760, The Library, United Aircraft Corporation, East Hartford, Connecticut, February 6, 1947.
- 50H. Hoo, Eugenio, PROPULSEUR AERIEN, French Patent, No. 410284, November 26, 1909.
- 51H. Horne, James A., FLYING-MACHINE, U.S. Patent, No. 985034, February 21, 1911.
- 52H. Horstenke, Bruno, EXPERIMENTAL-MODELLFLUG, Flug and Model-Technik, Vol. 13, No. 107, December 1964-January 1965.
- 53H. Horstenke, Bruno, GLIEDERUNGSSYSTEM FUR EXPERIMENTAL-FLUGMODELLE, Flug and Modell-Technik, Vol. 14, No. 3 (112), May-June 1965.
- 54H. (Horstenke, Bruno), FORGOSZEL HELIKOPTER MODELL, Modellezes, Vol. 7, No. 6, June 1965, p. 10.

- 55H. Horstenke, Bruno, HELIPLAN, Flug and Modell-Technik, Vol. 14, No. 1 (108), January-February 1965, pp. 6-7.
- 56H. Horstenke, Bruno, RC-DREHFLUGEL MODELL WIRBELWIND II, Flug and Modell-Technik, Vol. 14, No. 3 (110), March-April 1965, pp. 80-81.
- 57H. Horstenke, Bruno, ROTOR DREHFLUGELMODELL "LIBELLE", Flug and Modell-Technik, Vol. 12, No. 1 (96), January-February 1964, pp. 12-13.
- 58H. (Horstenke, B.), MODELFLUG-PIONIER ING BRUNO HORSTENKE TO JAHRE, Flug and Modell-Technik, Vol. 15, No. 5 (125), June 1966, pp. 175-177.
- 59H. Horstenke, Bruno, NEUE EXPERIMENTAL-FLUGMODELLE, Flug and Modell-Technik, Vol. 16, No. 3 (134), March 1967, pp. 83-84.
- 60H. Houllevigue, L., LES VAGUES ELLES AUSSI SONT UNE SOURCE D'ENERGIE, La Science et la Vie, Vol. 39, No. 166, April 1930, pp. 289-294.
- 61H. Howard, F. A., AIRCRAFT, U.S. Patent, No. 1832396, November 17, 1931.
- 62H. Howell, Alun Raymond, TURBO COMPRESSOR POWER PLANT FOR AIRCRAFT, U.S. Patent, No. 2658700, November 10, 1953.
- 63H. Huckel, Hugo, BLADE FEATHERING MECHANISM FOR PROPELLERS AND THE LIKE, U.S. Patent, No. 974490, November 1, 1910.
- 64H. Hanriot, Marcel P. F., and Richard, Gilbert C., MACHINE VOLANTE A AILES TOURNANTES AYANT UNE TRAJECTOIRE CONIQUE, French Patent, No. 801226, May 16, 1936.

I

- 1I. Ibragimova, T. B., INVESTIGATIONS OF VANE-TYPE PROPELLER MODELS IN FREE WATER, Sudostroyeniye, 1965, pp. 15-24.
- 2I. Ibragimova, T. B., THEORETICAL INVESTIGATION OF THE FIELD OF INDUCED VELOCITIES IN THE VICINITY OF THE BLADES OF VANE-TYPE PROPELLERS, Sudostroyeniye, 1965, pp. 3-14.
- 3I. Ingalls, Albert G., TAKING THE SENSATIONAL OUT OF THE ROTOR SHIP STORY, American Scientific, Vol. 133, No. 2, August 1925, pp. 122-123.
- 4I. (Irvine), THE IRVINE "AEROCYCLOID", Aeronautics (New York), Vol. 4, No. 1, January 1909, pp. 31-32.
- 5I. (Irvine), AERO-CYCLOIDE IRVINE, Revista Tecnica di Aeronautica e Bolletina Della Societa Aeronautica Italiana, Vol. 6, No. 2, February 1909, p. 65.
- 6I. (Irvine), THE IRVINE AEROCYCLOID, Technical World Magazine, Vol. 11, No. 6, August 1909, p. 682.
- 7I. Isay, Wolfgang H., CALCULATION OF THE FLOW THROUGH VOITH-SCHNEIDER PROPELLERS, BuShips Translation No. 372, Bureau of Ships, Washington, D. C., March 1959. (See also: Ingenieur - Archiv, Vol. 24, 1956, pp. 148-170)
- 8I. Isay, W. H., THE VOITH-SCHNEIDER PROPELLER IN THE WAKE OF A SHIP'S HULL, BuShips Translation No. 673, Bureau of Ships, Washington, D. C., March 1959. (See also: Ingenieur - Archiv, Vol. 25, No. 5, 1957, pp. 303-318.)
- 9I. Isay, W. H., ABOUT THE TREATMENT OF FLOW THROUGH A VOITH-SCHNEIDER PROPELLER WITH SMALL ADVANCE RATIO, Davidson Laboratory Technical Note No. 535, Stevens Institute of Technology, Hoboken, New Jersey, January 1959. (See also: Ingenieur - Archiv, Vol. 23, No. 6, pp. 379-401, and BuShips Translation No. 655c.)
- 10I. Isay, W. H., ANWENDUNG UND ERGEBNISSE DER HYDRODYNAMISCHEN THEORIE DES VOITH-SCHNEIDER PROPELLERS, Schiffstechnik, Vol. 9, No. 45, January 1962, p. 27.

- 11I. Isay, Wolfgang H., PROPELLETHEORIE, HYDRODYNAMISCHE PROBLEM, Springer-Verlag, Berlin/Gottingen/Heidelberg, 1964, pp. 141-179.
- 12I. Ittersum, Willem H. A. G. van, KITE, U.S. Patent, No. 2107808, February 8, 1938.
- 13I. Iverson, James D., THE MAGNUS ROTOR AS AN AERODYNAMIC DECELERATOR, Paper Presented at: AIAA Second Aerodynamic Deceleration Systems Conference, No. 68-962, El Centro, California, September 23-25, 1968.

J

- 1J. Jackson, A. R., AIRCRAFT HAVING MOVING AIRFOIL OR WING, U.S. Patent, No. 2408649, October 1, 1946.
- 2J. (Jacobs), REMARKABLE ROTOR PROPELLER FOR AIRPLANES, Popular Science Monthly, Vol. 107, No. 2, August 1925, p. 63.
- 3J. (Jacobs), RECENT NEWS IN SCIENCE, Science and Inventions, August 1926, p. 306.
- 4J. Jagodzinski, Waclaw, SILHICI WLATROWE, Panstwowe Wydawnictwa Technicznk, Warsaw, Poland, 1959, pp. 184-187.
- 5J. Jahnke, Ernst, WIND KRAFTMASCHINE, German Patent, No. 860930, December 29, 1952.
- 6J. James, D. B., and Stone, J. W., THE CHARACTERISTICS OF THIN WINGS AUTOROTATING ABOUT A SPANWISE AXIS, Undergraduate Report No. 63, Department of Aeronautical Engineering, University of Bristol, June 1961.
- 7J. Janasz, Edward, KOTO TOPATKOWE Z PREZECHYLNEWI TOP-ATKAMI DO NAPEDU SAMOLOTOW, Polish Patent, No. 15629, June 19, 1931.
- 8J. Janssens, A., JOUET, Belgium Patent, No. 508119, January 15, 1928.
- 9J. Jaquette, F. du B., MACHINE FOR AERIAL NAVIGATION, U.S. Patent, No. 1594619, August 3, 1926.
- 10J. Jarkowski, Witold, AERO-TECHNIQUE-ANALYSE ELEMENTAIRE DE LA CHUTE PLANE, L'Aviation Illustree, Vol. 10, No. 57, October 15, 1910, pp. 3-4.
- 11J. Jarolimek, Anton, DIE SEGELRADVERSUCHE PROFESSOR WELLNER, Zeitschrift des Oesterreichischen Ingenieur und Architekten-Vereines, Vol. 45, No. 7, February 15, 1895, pp. 89-91.
- 12J. Jarzyna, H., KINEMATYKA PEDNIKA CYKLOIDALNEGO, Archiwum Budowy Maszyn, Vol. 7, No. 1, 1960, pp. 117-138.
- 13J. Jarzyna, H., UPROSZCZONA TEORIA PEDNIKA CYKLOIDALNEGO, Archiwum Budowy Maszyn, Vol. 6, No. 1, 1959, pp. 137-151.

- 11I. Isay, Wolfgang H., PROPELLETHEORIE, HYDRODYNAMISCHE PROBLEM, Springer-Verlag, Berlin/Gottingen/Heidelberg, 1964, pp. 141-179.
- 12I. Ittersum, Willem H. A. G. van, KITE, U.S. Patent, No. 2107808, February 8, 1938.
- 13I. Iverson, James D., THE MAGNUS ROTOR AS AN AERODYNAMIC DECELERATOR, Paper Presented at: AIAA Second Aerodynamic Deceleration Systems Conference, No. 68-962, El Centro, California, September 23-25, 1968.

J

- 1J. Jackson, A. R., AIRCRAFT HAVING MOVING AIRFOIL OR WING, U.S. Patent, No. 2408649, October 1, 1946.
- 2J. (Jacobs), REMARKABLE ROTOR PROPELLER FOR AIRPLANES, Popular Science Monthly, Vol. 107, No. 2, August 1925, p. 63.
- 3J. (Jacobs), RECENT NEWS IN SCIENCE, Science and Inventions, August 1926, p. 306.
- 4J. Jagodzinski, Wacław, SILHIKI WLATROWE, Państwowe Wydawnictwa Techniczne, Warsaw, Poland, 1959, pp. 184-187.
- 5J. Jahnke, Ernst, WIND KRAFTMASCHINE, German Patent, No. 860930, December 29, 1952.
- 6J. James, D. B., and Stone, J. W., THE CHARACTERISTICS OF THIN WINGS AUTOROTATING ABOUT A SPANWISE AXIS, Undergraduate Report No. 63, Department of Aeronautical Engineering, University of Bristol, June 1961.
- 7J. Janasz, Edward, KOTO TOPATKOWE Z PREZECHYLNEWI TOP-ATKAMI DO NAPEDU SAMOLTOW, Polish Patent, No. 15629, June 19, 1931.
- 8J. Janssens, A., JOUET, Belgium Patent, No. 508119, January 15, 1928.
- 9J. Jaquette, F. du B., MACHINE FOR AERIAL NAVIGATION, U.S. Patent, No. 1594619, August 3, 1926.
- 10J. Jarkowski, Witold, AERO-TECHNIQUE-ANALYSE ELEMENTAIRE DE LA CHUTE PLANE, L'Aviation Illustree, Vol. 10, No. 57, October 15, 1910, pp. 3-4.
- 11J. Jarolimek, Anton, DIE SEGELRADVERSUCHE PROFESSOR WELLNER, Zeitschrift des Oesterreichischen Ingenieur und Architekten-Vereines, Vol. 45, No. 7, February 15, 1895, pp. 89-91.
- 12J. Jarzyna, H., KINEMATYKA PEDNIKA CYKLOIDALNEGO, Archiwum Budowy Maszyn, Vol. 7, No. 1, 1960, pp. 117-138.
- 13J. Jarzyna, H., UPROSZCZONA TEORIA PEDNIKA CYKLOIDALNEGO, Archiwum Budowy Maszyn, Vol. 6, No. 1, 1959, pp. 137-151.

- 14J. Jatunn, F. W., FLYING MACHINE, U.S. Patent, No. 992874, May 23, 1911.
- 15J. Jayne, Laurence I., UNIVERSAL PITCH PROPELLER LINKAGE, U.S. Patent, No. 3295609, January 3, 1967.
- 16J. Jensen-Brarlundd, H. P., VARIABLE PITCH PROPELLER, U.S. Patent, No. 1320305, May 31, 1921.
- 17J. Jochum, Marie-Louise, TURBINE A VENT, Swiss Patent, No. 96045, September 10, 1922.
- 18J. Johnson, O. R., FLYING MACHINE, U.S. Patent, No. 1526219, February 10, 1925.
- 19J. Jona, A., L'AEROGIRO DI CHAPPEDELAINE E LE ALI AUTOROTANTI, Rivista Aeronautica, Vol. 10, No. 9, September 1934, pp. 457-466.
- 20J. Jones, Thomas, IMPROVEMENTS IN OR RELATING TO AIRCRAFT PROVIDED WITH ROTATING WINGS, British Patent, No. 456177, July 9, 1935.
- 21J. Jordanoff, Assen C., AERIAL NAVIGATION, U.S. Patent, No. 1613834, January 11, 1927.
- 22J. Joud, Robert-Fernand, APPAREIL VOLANT, French Patent, No. 1195068, April 24, 1958.
- 23J. Joukovski, N. E., DE LA CHUTE DAN L'AIR DE CORPS LEGERS DE FORME ALLONGEE, ANIMES D'UN MOUVEMENT ROTATOIRE, Bulletin de l'Institut Aerodynamique de Koutchino, Vol. 1, No. 4, 1905, pp. 51-56.
- 24J. Just, Walter, THEORIE DES VOITH-SCHNEIDER PROPELLERS, Werft-Reederei-Hafen, Vol. 20, No. 1, January 1939, pp. 4-7.
- 25J. Just, Walter, WINDMOTOR MIT VERTIKALER ACHSE BEI AUFTRIEBAUSCHUTZUNG, Denkschrift, RAW, Berlin, Germany, 1943, p. 10.
- 26J. Just, Walter, THEORY OF VOITH-SCHNEIDER PROPELLERS, Davidson Laboratory Technical Note No. 515, Stevens Institute of Technology, Hoboken, New Jersey, January 1959.
- 27J. Just, Walter, THE CALCULATION OF THE COEFFICIENT OF EFFICIENCY AND STATIC THRUST FOR THE VOITH-SCHNEIDER PROPELLER, BuShips Translation No. 655A, Bureau of Ships, Washington, D. C., Date N/A.

28J. Jones, Thomas, IMPROVEMENT RELATING TO AIR-CRAFT OF
THE GYROPLANE TYPE, British Patent, No. 424140, Febru-
ary 15, 1935.

K

- 1K. Kahn, Louis, LA PROPULSION ANIMALE DANS LES FLUIDES, Possibilites d'Application au Vol a Vitesse Variable, Association Technique Maritime et Aeronautique, Paris, France, June 1929, p. 32.
- 2K. Kahn, Louis L., TURBINE WHEEL PROPELLER OR MOTOR, U.S. Patent, No. 1775593, September 9, 1930.
- 3K. Kahn, Louis Lazare, TRIEBFLACH ENSTFUERUNG FUR LUFT-UND WASSERFAHRZEUGE, PUMPEN, VENTILATOREN, WIND, DAMPF-UND WASSERKRAFT MASCHINEN, German Patent, No. 615162, June 29, 1935.
- 4K. Karman, Th. von, TOWARD NEW HORIZONS, AAF Scientific Advisory Group, 1944, p. 27.
- 5K. Karpov, A. B., Golinkevich, N. A., and Panov, Yu. L., THEORETICAL AND EXPERIMENTAL STUDY OF THE BLADE MOVEMENT OF A VOITH-SCHNEIDER PROPELLER, Translation No. 2469, Department of the Navy, Washington, D. C., October 1967.
- 6K. Kaspar, Frantisek, VETRNE MOTORY A ELEKTRARHY, Elektro-technicky Svaz Ceskoslovensky, Prague, 1948, pp. 34, 269-335.
- 7K. Keegan, John, IMPROVEMENTS IN AND RELATING TO SHIP AND AEROPLANE PROPELLERS, British Patent, No. 239961, September 24, 1925.
- 8K. Keitschbach, Hans, A NEW GERMAN PADDLE SHIP, Popular Aviation, Vol. 12, No. 6, June 1933, p. 359.
- 9K. Kelley, Howard R., AN ANALYTIC METHOD FOR PREDICTING THE MAGNUS FORCES AND MOMENTS ON SPINNING PROJECTILES, Technical Memorandum No. TM 1634, U.S. Naval Ordnance Test Station, White Oak, Maryland, August 1954.
- 10K. Keller, Eduard, FLUGELRAD, Swiss Patent, No. 236832, July 2, 1945.
- 11K. Kempf, G., and Helm, K., ERGEBNISSE NATURGROSSER SCHLEPPVERSUCHE MIT DEN MOTORSCHIFF 'AUGSBURG', Werft-Reederei-Hafen, Vol. 12, October 15, 1931, pp. 347-348.
- 12K. Kibish, John, HELICOPTER, U.S. Patent, No. 1770788, July 15, 1930.

- 13K. (Kiernan, Hastings and Flettner), AMERICA'S FIRST ROTOR BOAT, NAVAL OFFICERS EMPLOY NEW IDEAS IN ODD CRAFT, Popular Science Monthly, Vol. 107, No. 3, September 1925, p. 27.
- 14K. Kies, E. J., SIGN CARRYING WINDMILL CONSTRUCTION, U.S. Patent, No. 2833065, May 6, 1958.
- 15K. Kincannon, L. C., FLYING MACHINE, U.S. Patent, No. 951615, March 8, 1910.
- 16K. King, John E., THE ROTOR PLANE, Science and Invention, Vol. 8, No. 8, December 1930, pp. 699, 750 and Cover.
- 17K. Kirsten, F. J. Kurt, PROPELLER, U.S. Patent, No. 1432700, October 17, 1922.
- 18K. (Kirsten and Icre), REVOLUTIONARY NEW PROPELLERS, Popular Science Monthly, Vol. 101, No. 2, August 1925, p. 42.
- 19K. (Kirsten), LES IDEES NOUVELLES. L'HELICE SERA-T-ELLE, UN JOUR, DETRONEE?, Les Ailes, Vol. 5, No. 228, October 29, 1925, p. 3.
- 20K. Kirsten, Frederick Kurt, CYCLOIDAL PROPULSION APPLIED TO AIRCRAFT, Transactions of the American Society of Mechanical Engineers, Vol. 50, No. AER-50-12, 1928, pp. 25-47.
- 21K. Kirsten, Frederick Kurt, A NEW TYPE OF PROPELLER, S. A. E. Journal, Vol. 22, No. 1, January 1928, pp. 77-80.
- 22K. Kirsten, Frederick Kurt, CHARACTERISTICS OF THE CYCLOIDAL AIRCRAFT, THEIR PERFORMANCE AND STABILITY IN FLIGHT, University of Washington, Seattle, Washington, June 1934.
- 23K. (Kirsten), PADDLE WHEELS DRIVE WINGLESS PLANE, Popular Science Monthly, Vol. 125, No. 5, November 1934, p. 43 and Cover.
- 24K. Kirsten, Frederick Kurt, CYCLOIDAL PROPULSION IN AIR, No. 79, Engineering Experiment Station Series, University of Washington, Seattle, Washington, 1935.
- 25K. (Kirsten), FLYING WITHOUT WINGS -- AN INTERVIEW WITH PROF. F. K. KIRSTEN, The Motor in Australia and Flying, Vol. 27, No. 11, December 1, 1935, pp. 43-44.
- 26K. Kirsten, Frederick Kurt, and Heuver, Herbert M., PROPELLER FOR AIRCRAFT, U.S. Patent, No. 2045233, June 23, 1936.
- 27K. Kirsten, K. F. J., AIRCRAFT, U.S. Patent, No. 2090052, August 17, 1937.

- 28K. (Kirsten), BED-PIPE PROPELLER, Time, Vol. 36, No. 6, August 5, 1940, p. 52.
- 29K. (Kirsten), NEW TYPE PROPELLER FOR SHIPS, Science and Mechanics, Vol. 15, No. 1, February 1947, p. 80.
- 30K. Kirsten, Frederick Kurt, THE CYCLOIDAL PROPELLER IN MARINE APPLICATION, UWAL Report No. 322, University of Washington Aeronautical Laboratory, Seattle, Washington, May 1950.
- 31K. (Kirsten), ARMY EQUIPS NEW TOWBOAT WITH SINUSOIDAL PROPULSION, Marine Engineering, Vol. 59, No. 2, February 1954, pp. 36-39.
- 32K. Klemin, Alexander, IS THE MAGNUS EFFECT APPLICABLE TO AIRCRAFT?, Aviation, Vol. 18, No. 5, February 2, 1925, pp. 127-129.
- 33K. Klemin, A., SAVONIUS WING ROTOR. A FURTHER APPLICATION OF THE MAGNUS EFFECT TO WINDMILL AND TO BOAT PROPULSION, Mechanical Engineering, Vol. 47, No. 11, November 1925, pp. 911-912.
- 34K. Klemin, Alexander, A ROTOR AIRCRAFT, Scientific American, Vol. 143, No. 5, November 1930, p. 392.
- 35K. Klemin, Alexander, THE "PADDLE WHEEL" OR FEATHERING AIRFOIL AIRCRAFT, Scientific American, Vol. 148, No. 6, June 1933, p. 335.
- 36K. Klemin, Alexander, PADDLE WHEEL AIRFOIL SYSTEM, Aviation Engineering, Vol. 8, No. 2, February 1933, pp. 5-8, 30.
- 37K. Klemin, Alexander, PRINCIPLES OF ROTARY AIRCRAFT, Journal of the Franklin Institute, Vol. 227, No. 3, March 1939, pp. 389-390.
- 38K. Klemmer, E. T., and Johnson, P. K., TRIALS CONDUCTED ON A GERMAN R130 - CLASS MINE SWEEPER EQUIPPED WITH VOITH-SCHNEIDER CYCLOIDAL PROPELLERS, DTMB Report No. 649, David Taylor Model Basin, Washington, D. C., December 1948, p. 69.
- 39K. Knight, Montgomery, and Wenzinger, Carl J., WIND TUNNEL TESTS ON A SERIES OF WING MODELS THROUGH A LARGE ANGLE OF ATTACK RANGE, NACA Report No. 317, Part I, 1929.
- 40K. Koch, Gustav, DAS LUFTSCHIFT, EIN BEITRAG BEDURFNIS-NUTZLICHKEITSTRAGE DER PRAKTISCHEN LUFTSCHIFTFAHRT, Gedruckt bei J. Gotteswinter, Munich Germany, 1883, pp. 11-18.

- 41K. Koch, Gustav, DIE LOSUNG DES FLUG PROBLEMS UND DAS LUFTSCHIFF DER ZUKUNFT, J. Schön, Munich, Germany, 1883, p. 32.
- 42K. Koch, Gustav, DAS FLUGPRINCIP UND DIE SCHAUFELRAD-FLUGMASCHINE, Zeitschrift für Luftschiffahrt und Physik der Atmosphäre, Vol. 16, Nos. 10, 11, 12, 1897, pp. 252-260, 275-285, 303-314.
- 43K. Koch, Gustav, VORSCHLAG ZUM BAU EINER SCHAUFELRAD-FLUGMASCHINE, Illustrierte Aeronautische Mitteilungen, Vol. 1, 1897, pp. 49-55.
- 44K. Koch, Gustav, DAS FLUG-SCHIFF, G. Franzsche Hofbuchhandlung, Munich, Germany, 1901, p. 31.
- 45K. (Koch), KOCH'S SYSTEM ZUR HERSTELLUNG VON LENKBAREN LUFTSCHIFFEN, Zeitschrift für Förderung der Luftschiffahrt, Vol. 2, No. 1, 1883, pp. 1-12.
- 46K. Koppen, Vladimir Peter, BEITRAGE ZUR MECHANIK DES FLUGES AND SCHWEBENDEN FALLES, Illustrierte Aeronautische Mitteilungen (Deutsche Luft Fahrt), Vol. 5, 1901, pp. 156-159.
- 47K. Krahn, E., LAMINAR BOUNDARY LAYER ON A ROTATING CYLINDER IN CROSSFLOW, NAVORD Report No. 4022, U. S. Naval Ordnance Laboratory, White Oak, Maryland, 1955.
- 48K. (Kramer), SEEK BETTER AIRPLANES IN NEW DESIGNS, Modern Mechanix and Inventions, Vol. 15, No. 1, November 1935, p. 40.
- 49K. Kreitner, Hans, THE HYDRAULIC FUNDAMENTALS OF VOITH-SCHNEIDER PROPULSION, Davidson Laboratory Technical Note 535, Stevens Institute of Technology, Hoboken, New Jersey, June 1959.
- 50K. Kropp, C., AIR PROPELLER AND THE LIKE, U.S. Patent, No. 1194037, August 8, 1916.
- 51K. Kuchemann, D., DREIKOMPONENTENMESSUNGEN AN EINEN FLUGEL MIT ROTIERENDEN HILFSFLUGEL, Deutsche Luftfahrt-Forschung, No. 1513, December 5, 1941, p. 16.
- 52K. Kuchemann, D., AUFTRIEB UND WIDERSTAND EINES ROTIERENDEN FLUGELN, Deutsche Luftfahrt-Forschung, Aerodynamische Versuchsantalt Goettingen, No. FB-1651, August 1942, p. 8.
- 53K. Kutnar, Virgil, AEROPLANE, U.S. Patent, No. 1873651, August 23, 1932.

54K. Kinateder, Josef, SCHWINGENFLUGZEUG MIT FLOSSENARTIG
AUSSCHWINGENDEN FLÜGELN, German Patent, No. 659169,
April 28, 1928.

55K. Kiwull, Woldemar, ELASTISCHES ROTORSEGEL, German Patent,
No. 422057, November 25, 1925.

L

- 1L. Laanti, FLYING - MACHINE, British Patent, No. 504493, March 21, 1938.
- 2L. Lacaine, Jean, LES AVIONS SANS AILES. LES ROUES SUSTENTATRICES, La Nature, Vol. 61, No. 2914, October 1, 1933, pp. 304-310.
- 3L. Lacaine, Jean, L'AEROCYRE DE CHAPPEDELAINE, La Nature, Vol. 62, No. 2938, October 1, 1934, pp. 293-296.
- 4L. Ladnov, A. A., OB OPREDELENI REAKTSII ZHIDKOSTI NA VRASCHCHAINSCHHEESIA KRYLA (KTEORII DVIZHITELIA VOITH-SCHNEIDER), Trudy I Vsesoivznoi Konferentsii po Gidrodinamike, 23-27 Dekabria 1933, Central Aero-Hydrodynamical Institute, Moscow, Russia, 1935.
- 5L. Lafay, A., SUR LES PRESSIONS MOYENNES SUPPORTEES PAR UN CORPS MAINTENU DANS UN COURANT D'AIR DONT LA VITESSE EST IRREGULIERE, Comptes Rendus des Seances de l'Academie des Sciences, Vol. 151, No. 2, July 11, 1910, pp. 144-146.
- 6L. Lafay, A., SUR L'INVERSION DU PHENOMENE DE MAGNUS, Comptes Rendus des Seances de l'Academie des Sciences, Vol. 151, No. 20, November 14, 1910, pp. 867-868.
- 7L. Lafay, A., SUR UN PROCEDE D'OBSERVATION DES TRAJECTAIRES SUIVIES PAR LES ELEMENTS D'UN COURANT D'AIR GENE PAR DES OBSTACLES DE FORMES VARIABLE, Comptes Rendus des Seances de l'Academie des Sciences, Vol. 152, No. 152, February 6, 1911, pp. 318-320.
- 8L. Lafay, A., LA PHOTOGRAPHIE DU VENT, La Technique Aeronautique, Vol. 3, No. 30, March 15, 1911, pp. 174-177.
- 9L. Lafay, A., SUR LE PHENOMENE DE MAGNUS, Comptes Rendus des Seances de l'Academie des Sciences, Vol. 153, No. 25, December 4, 1911, pp. 1147-1150.
- 10L. Lafay, A., CONTRIBUTION EXPERIMENTALE A L'AERODYNAMIQUE DU CYLINDRE ET A L'ETUDE DU PHENOMENE DE MAGNUS, H. Dunod et E. Pinat, Editeurs, Paris, France, 1912, p. 30.

- 11L. Lafay, A., PREVISION DE L'ACTION D'UN VENT DONT LA DIRECTION VARIE RAPIDEMENT APPLICATION A L'EFFECT KATZMAYR ET A L'AUTOROTATION, Publication Scientifiques et Techniques du Ministere de l'Air - Service des Recherches de l'Aeronautique, No. 24, 1933, pp. 10-16.
- 12L. Laing, Nikolaus, and Eck, Bruno, STRAHLGEBLASE FUR LUFTFAHRZEUGE, German Patent, No. 1040907, October 9, 1958.
- 13L. Laing, Nikolaus, and Eck, Bruno, IMPROVEMENTS RELATING TO AIRCRAFT, British Patent, No. 885663, December 28, 1961.
- 14L. Laing, Nikolaus, and Eck, Bruno, IMPROVEMENTS RELATING TO FLOW MACHINES, British Patent, No. 885664, December 28, 1961.
- 15L. Laing, Nikolaus, and Eck, Bruno, IMPROVEMENTS IN AIRCRAFT WINGS, British Patent, No. 885666, December 28, 1961.
- 16L. Laing, Nikolaus, LIFTING AND PROPULSION MEANS FOR AIRCRAFT, U.S. Patent, No. 3159362, December 1, 1964.
- 17L. Laing, Nikolaus, AIRCRAFT WING STRUCTURE, U.S. Patent, No. 3178131, April 13, 1965.
- 18L. Laing, Nikolaus, AIR CUSHION VEHICLES, British Patent, No. 1005255, September 22, 1965.
- 19L. Laing, Nikolaus, THRUST MEANS FOR POWERING AIRCRAFT, U.S. Patent, No. 3212735, October 19, 1965.
- 20L. Laing, Nikolaus, DEVICE CONSISTING OF A DRIVE AND ROTATING WHEEL PRODUCING THRUST FOR THE PROPULSION OF BOATS, U.S. Patent, No. 3276415, October 4, 1966.
- 21L. Laing, Nikolaus, WING STRUCTURE AND DUCT MEANS FOR AIRCRAFT, U.S. Patent, No. 3291420, December 13, 1966.
- 22L. Lake, Harry F., AIRFOIL AND BOUNDARY-LAYER CONTROL ROTOR, U.S. Patent, No. 2973167, February 28, 1961.
- 23L. Lamb, G. H., PADDLE VS. PROPELLER, Flight, December 24, 1910, pp. 1062-1063.
- 24L. Lamé, Maurice L. V., LE VOL VERTICAL, Ed. Blondel la Rougerie, Paris, France, 1934, pp. 155-159.
- 25L. Lammeren, William Petrus van, HELICOPTER, U.S. Patent, No. 1772119, August 5, 1930.

- 26L. Lammeren, William Petrus van, PROPELLER, U.S. Patent, No. 1812814, June 20, 1931.
- 27L. Lammeren, William Petrus van, PROPELLER FOR HELICOPTERS, U.S. Patent, No. 1880302, October 4, 1932.
- 28L. Lammeren, W. P. A. van, et al, RESISTANCE, PROPULSION AND STEERING OF SHIPS, The Technical Publishing Company, Haarlem, Holland, 1948, pp. 125-126.
- 29L. (Landraf-American Airways), PADDLE-WHEEL PROPELLER LIFT AND DRIVE NOVEL PLANE, Popular Science Monthly, Vol. 128, No. 2, February 1936, p. 31 and Cover.
- 30L. Larsen, Harold C., DESIGN OF A MODEL FOR THE MEASUREMENT OF THE PRESSURE DISTRIBUTION OF AN AXIALLY SYMMETRIC ROTATING BODY, California Institute of Technology, Pasadena, California, 1955, p. 57.
- 31L. Laskowitz, I. B., AUTO-CYCLO-GYRO, U.S. Patent, No. 2079217, May 4, 1937.
- 32L. Laskowitz, I. B., EARLY WIND TUNNEL TEST OF A MODEL CYCLO-GIRO, American Helicopter, Vol. 30, No. 4, March 1953, pp. 10-16.
- 33L. Lasserre, A. E. M., SYSTEME DE PROPULSION POUR AVIONS, BATEAUX ET AUTRES, French Patent, No. 749526, October 22, 1934.
- 34L. Laucks, R., NEW VOITH TUGBOAT, Neuere Voith-Wasser-Trecker, Hansa-Schiffahrt-Schiffbau-Hofen, Vol. 103, No. 16, August 1966, pp. 350-360.
- 35L. Lavesseur, Pierre, SYSTEME DE COMMANDE DES PROPULSEURS A PALETTES POUR APPAREILS D'AERONAUTIQUE ET AUTRES, French Patent, No. 405099, May 26, 1909.
- 36L. Lavrent'yev, V. M., THEORY OF THE VANE-TYPE PROPELLER WITH A LARGE NUMBER OF BLADES, Trudy Tsentral'nogo Nauchnoissledovatel'skogo Instituta Morskogo Flota, No. 49, Transaction of the Central Scientific Research Institute of the Merchant Marine, 1936.
- 37L. Leggelo, Pieter Barteld, IMPROVED MEANS FOR USE IN PROPELLING AEROPLANE, HYDROPLANE AND OTHER CONVEYANCES, British Patent, No. 198031, May 22, 1923.
- 38L. Legras, M. J., L'OPTIMUM DE L'HELICOPLANE, Le Recherche Aeronautique, Vol. 15, No. 5-6, May-June 1950, pp. 9-14.

- 39L. Lehto, E., KOKEISTA PYORIULLA LIERIOILLA, Aero, No. 1, 1925, pp. 10-14.
- 40L. Lemaire, L. L. N., AEROPLANE MONTANT ET ATTERISSANT VERTICALEMENT, French Patent, No. 631178, September 6, 1927.
- 41L. Lensselink, Jacques A. F., PERIODIEKE VLEUGELINSTELLING VOOR ZEILRADVLIEGTULGEN, Dutch Patent, No. 17148, December 10, 1924.
- 42L. Leon, Gabriel, TURBINE, U.S. Patent, No. 1973290, September 11, 1934.
- 43L. LePage, Wynn L., ROTATING WING AIRCRAFT POSSIBILITIES, Journal of the Aeronautical Sciences, Vol. 2, No. 2, March 1935, p. 67.
- 44L. Lepere, G., ETUDE D'UN MOULINET CYLINDRIQUE DU VENTILATEUR, Bulletin de l'Institut Aerotechnique de l'Universite de Paris, Vol. 3, 1913, pp. 86-91.
- 45L. Lerat, Jacques, PARACHUTE AEROGYRE, Le Modele Reduit D'Avion, No. 129, November 1949, p. 7.
- 46L. (Lesh), REVOLVING WING REPLACE SAILS ON ROTOR BOAT, Popular Mechanics, Vol. 59, No. 6, June 1933, p. 45 and Cover.
- 47L. (Lesh), NEW ROTOR SHIP SAILS IN LIGHTEST WINDS, Popular Science Monthly, Vol. 123, No. 1, July 1933, p. 45 and Cover.
- 48L. Lestage, Arthur-Austin, AEROPLANE, French Patent, No. 364285, May 26, 1906.
- 49L. Lewis, Paul M., and Landgraf, Fred, AIRCRAFT, U.S. Patent, No. 2018730, October 29, 1935.
- 50L. Liberatore, Eugene L., SPECIAL TYPES OF ROTARY WING AIRCRAFT, Rotary Wing Aircraft Handbooks and History, Vol. 11, U. S. Department of Commerce, Washington, D. C., 1954, pp. 41-50, 110.
- 51L. Liberatore, Eugene, THE ROTATING WING INDUSTRY, Rotary Wing Aircraft Handbooks and History, Vol. 14, U. S. Department of Commerce, Washington, D. C., 1954, p. 45.
- 52L. Lindkvist, E. E., PROPELLING: STEERING AND BALANCING, British Patent, No. 16484, July 19, 1909.

- 53L. (Lindkvist), APPAREIL LINDKVIST A AILES ROTATIVES, L'Aero-Mechanique, No. 3, October 10, 1909, p. 27.
- 54L. Lindner, Helmut, DER VOITH-SCHNEIDER-PROPELLER ALS ANWENDUNG DES TRAGFLUGEL PRINZIPS, Luftfahrt und Schule, Vol. 3, No. 11, August 1938, pp. 253-259.
- 55L. Lippisch, A., DRACHENVERSUCH MIT ROTOR, Veröffentlichungen Des Forschungs Institutes Der Rhon-Rossitten-Gesellschaft (RRC), No. 2, 1928, pp. 5-7.
- 56L. Lippisch, Alexander M., FLUGZEUGFLUGEL MIT EINEM FLÜGELSCHLITZ EINGEBAUTER SCHAUFELWALZE, German Patent, No. 636244, October 5, 1938.
- 57L. Liptrot, R. N., LA SUSTENTATION DIRECTE, Technique et Science Aeronautique, 3 Serie, Paris, France, October 22, 1945, p. 201.
- 58L. Locicheur, M., RAPPORT SUR L'ACTIVITE DE L'OFFICE NATIONAL DES RECHERCHES SCIENTIFIQUES ET INDUSTRIELLES ET DES INVENTIONS, Recherches et Inventions, Vol. 8, No. 149, January 1, 1927, pp. 7-11.
- 59L. Lock, C. N. H., and Townend, H. C. H., LIFT AND DRAG OF TWO AEROFOILS MEASURED OVER 360° RANGE OF INCIDENCE, Reports and Memorandum No. 958, Aeronautical Research Committee, Farnborough, England, November 1924, p. 9.
- 60L. Longo, Antonio Gaetano, ROTATING WING DEVICE FOR INCREASING THE CARRYING CAPACITY OF AEROPLANE WINGS, U.S. Patent, No. 1846562, February 23, 1932.
- 61L. Loptien, George W., AN INVESTIGATION OF CONE-CYLINDER BODIES IN THE STEADY STATE SPIN MODE AND MAGNUS FORCE EFFECTS ON A CONE-CYLINDER BODY, WADD Technical Note 60-76, U. S. Air Force, August 1960, p. 39.
- 62L. Loudy, F. E., IS THE ROTOPLANE PRACTICAL?, Aviation Mechanics, Vol. 1, No. 5, January-February 1931, pp. 364-366.
- 63L. Low, A. R., THE REACTION OF A STREAM OF VISCOUS FLUID ON A ROTATING CIRCULAR CYLINDER, TAB Journal of the Royal Aeronautical Society, Vol. 29, No. 170-171, February-March 1925, pp. 100-104, 141-144.
- 64L. Luntz, Michel, and Schwarz, Paul, L'HYDRODYNAMIQUE DU CYLINDRE TOURNANT, Publications Scientifiques et Techniques du Ministere de l'Air, No. 71, 1935, p. 46.

- 65L. Lock, C. N. H., NOTE ON THE ROHRBACH "PADDLE PLANE, Technical Note, T. 3432 (817), Aeronautical Research Committee, Farnborough, England, 1933.
- 66L. Lange, Roy H., and Cocke, Bennis, W., Jr., and Proterra, Anthony J., PRELIMINARY FULL-SCALE INVESTIGATION OF A 1/3-SCALE MODEL OF A CONVERTIBLE-TYPE AIRPLANE, Report No. RML 9C29, NACA, 1949.
- 67L. Lange, Roy H., and McLemore, Huel C., STATIC LONGITUDINAL STABILITY AND CONTROL OF A CONVERTIBLE-TYPE AIRPLANE AS AFFECTED BY ARTICULATED AND RIGID-PROPELLER OPERATION, Report TN 2014, NACA, February 1950.
- 68L. Ludi, LeRoy H., COMPOSITE AIRCRAFT DESIGN, Journal of the American Helicopter Society, Vol. 13, No. 1, January 1968, pp. 1-10.
- 69L. Liptrot, R. N., NOTES ON PADDLE-WHEEL DIRECT LIFT AIRCRAFT, Technical Note, T. 3453 (899), Aeronautical Research Committee, Farnborough, England, 1933.

Mc

- 1Mc. McCallum, Dewitt C., AERODROME, U.S. Patent, No. 996105, June 27, 1911.
- 2Mc. McFarland, Marvin W., THE PAPERS OF WILBUR AND ORVILLE WRIGHT, McGraw-Hill Book Company, Inc., New York New York, 1953, pp. 752-753.
- 3Mc. McFarlane, J. A., PROPELLER FOR FLYING MACHINES OR THE LIKE, U.S. Patent, No. 1535613, April 28, 1925.
- 4Mc. McIntyre, Frank W., AIRCRAFT, U.S. Patent, No. 1975116, October 2, 1934.
- 5Mc. McKillop, J. A., A STUDY OF THE FLOW THROUGH A VERTICAL AXIS PROPELLER, Report No. 60/1, Engineering Research Associates, Toronto, Canada, April 1, 1965, p. 44.
- 6Mc. McKnight, C. B., AEROPLANE, U.S. Patent, No. 1845616, February 16, 1932.
- 7Mc. McLaughlin, D. P., FLYING MACHINE OR AIRSHIP, U.S. Patent, No. 991794, May 9, 1911.
- 8Mc. McLaughlin, D. P., PROPELLING AND LIFTING MECHANISM, U.S. Patent, No. 2165757, June 2, 1938.
- 9Mc. McLaughlin, Robert J., IMPROVEMENT IN OR RELATING TO AIRCRAFT, British Patent, No. 439963, December 18, 1935.
- 10Mc. (McPheat), MODEL AIRPLANE NEWS, Vol. 13, No. 2, September 1935, pp. 18-19.
- 11Mc. McPheat, James, A ROLLICKING ROTOR PLANE, Flying Aces, Vol. 28, No. 1, December 1937, pp. 47-49.
- 12Mc. McVernon, J. H., DECELERATION AND DISPERSION STUDY, Termination Report, The Ralph M. Parsons Co., Camp Detrick, Frederick, Maryland, August 1954, p. 11.
- 13Mc. (McWorter), REPORT ON THE "AUTOPLANE", Airplane Section, S and A Branch, War Department, Engineering Division, McCook Field, Dayton, Ohio, August 13, 1919.

- 14Mc. McWorter, J. E., FLYING MACHINE, U.S. Patent, No. 1114167,
October 20, 1914.
- 15Mc. McWorter, J. E., AEROPLANE, U.S. Patent, No. 1115710,
November 2, 1914.
- 16Mc. McWorter, J. E., FLYING MACHINE, U.S. Patent, No. 1438924,
December 12, 1922.

M

- 1M. MacFarland, J. B., AEROPLANE, U.S. Patent, No. 1654006, December 27, 1927.
- 2M. Maccoll, John, AERODYNAMICS OF A SPINNING SPHERE, Journal of the Royal Aeronautical Society, Vol. 32, No. 213, September 1928, pp. 777-798.
- 3M. (Madaras), SIX LARGE LIGHT AND POWER COMPANIES BACK EXPERIMENTAL WIND-ROTOR PLANT, Electrical World, Vol. 98, No. 14, October 3, 1931, p. 574.
- 4M. (Madaras), BIG ELECTRIC PLANT RUN BY WIND, Popular Science Monthly, Vol. 120, No. 1, January 1932, p. 37 and Cover.
- 5M. (Madaras), WIND-DRIVEN ELECTRIC POWER PLANT ON WHEELS, Popular Mechanics, Vol. 57, No. 1, January 1932, pp. 50-51.
- 6M. (Madaras), WIND-ROTOR EXPERIMENT DECIDEDLY SATISFACTORY, Electrical World, Vols. 101-103, October 3, 1931, May 28, 1932, October 28, 1933, pp. 574, 914, 548.
- 7M. (Madaras), ELECTRICITY BY WIND POWER, System and Business Management, Vol. 62, No. 11, November 1933, p. 501.
- 8M. (Madaras), SPINNING TOWERS PRODUCE ELECTRIC CURRENT FROM WIND, Popular Science Monthly, Vol. 124, No. 1, January 1934, p. 18.
- 9M. (Madaras), MADARAS ROTOR POWER PLANT, Scientific American, Vol. 150, No. 2, March 1934, p. 147.
- 10M. Madarasz, Julius Dezso, DISPOSITIF POUR UTILISER LE VENT A LA PRODUCTION DE FORCE MOTRICE, French Patent, No. 134712, November 1, 1929.
- 11M. Madarasz, J. D., WIND ENGINE, U.S. Patent, No. 1791731, February 1931.
- 12M. (Magnus), VOM MAGNUS-EFFEKT UND FLETTNERS WALZEN-SEGEL, Flugsport, Vol. 16, No. 22, November 29, 1924, pp. 424-425.

- 13M. Magnus, G., ON THE DEVIATION OF PROJECTILES ON A REMARKABLE PHENOMENON OF ROTATING BODIES, Scientific Memoirs Selected From the Translations of Foreign Academies of Science, Taylor and Francis, London, England, 1953, pp. 210-231.
- 14M. Main, David W., AIRPLANE, U.S. Patent, No. 2413460, December 31, 1946.
- 15M. Malcor, M., PERFECTIONNEMENTS AUX APPAREILS D'AVIATION, French Patent, No. 637289, January 28, 1923.
- 16M. Malmer, Ivar, ROTORFARTYGET OUT DESS FYSIKALISKA UNDERLAG, J. A. Lindblads Forlag, Uppsala, 1925, p. 76.
- 17M. Malone, C. J., SOME INTERESTING EXPERIMENTS WITH PLANES, Flight, Vol. 2, No. 51(103), December 17, 1910, p. 1035.
- 18M. Manen, J. D. von, RESULTS OF SYSTEMATIC TESTS CONDUCTED WITH CYCLOIDAL PROPELLERS, BuShips Translation No. 870, Bureau of Ships, Washington, D. C., October 1934.
- 19M. Marce, Maurice-Auguste, SYSTEME DE MACHINE VOLANTES, French Patent, No. 405146, July 16, 1909.
- 20M. Marchetti, Alessandro, APPAREIL STABILISATEUR POUR MACHINES A VOLER SOUTENUES PAR DES HELICES, French Patent, No. 537704, March 8, 1922.
- 21M. Marchetti, Alessandro, STABILIZER FOR FLYING APPARATUS SUSTAINED BY PROPELLERS, British Patent, No. 186975, October 3, 1922.
- 22M. Marchetti, Alessandro, STABILIZER FOR FLYING APPARATUS SUSTAINED BY PROPELLERS, U.S. Patent, No. 1519866, December 1924.
- 23M. Marmande, A. M. J., MACHINE VOLANTE A AILES TOURNANTES, French Patent, No. 955822, July 4, 1949.
- 24M. Marquardt, Otfried, VORRICHTUNG ZUR ERZEUGUNG VON AUFFRIED BEI FLUGZEUGEN, Swiss Patent, No. 112318, December 16, 1925.
- 25M. Marquardt, Otfried, AUF DEM MAGNUSEFFEKT BERUHENDER WINDMOTOR, Swiss Patent, No. 114976, May 1926.
- 26M. Marsan, A., AIRPLANE, U.S. Patent, No. 1849547, March 15, 1932.

- 27M. Martin, John C., ON MAGNUS EFFECTS CAUSED BY THE BOUNDARY LAYER DISPLACEMENT THICKNESS ON BODIES OF REVOLUTION AT SMALL ANGLES OF ATTACK, BRL Report 870 (Rev.), Ballistic Research Laboratories, Aberdeen Proving Ground, Maryland, 1955.
- 28M. Martin, William C., AIRCRAFT, U.S. Patent, No. 1898638, February 21, 1933.
- 29M. Martinot, Adrien-Edmond, APPAREIL DE LOCOMOTION AERIENNE, French Patent, No. 389582, April 16, 1908.
- 30M. (Maryland, University of), WIND TUNNEL TESTS OF ROTATING BODIES 4TH SERIES, Wind Tunnel Report WTR 112, University of Maryland, College Park, Maryland, March 1954.
- 31M. (Maryland, University of), WIND TUNNEL TESTS OF ROTATING SHAPES 6TH SERIES, Wind Tunnel Report WTR 130, University of Maryland, College Park, Maryland, September 1954.
- 32M. (Maryland, University of), WIND TUNNEL TESTS OF ROTATING SHAPES 6TH SERIES, Wind Tunnel Report WTR 134, University of Maryland, College Park, Maryland, November 1954.
- 33M. Massey, Henry P., AIRCRAFT, U.S. Patent, No. 1698819, January 15, 1929.
- 34M. Massey, Henry P., AIRCRAFT, U.S. Patent, No. 1714608, May 28, 1929.
- 35M. Massey, Henry P., AIRPLANE, U.S. Patent, No. 1714609, May 28, 1929.
- 36M. Massey, Henry P., AIRCRAFT, U.S. Patent, No. 1820919, September 1, 1931.
- 37M. Massey, Henry P., MEANS AND METHOD FOR INCREASING THE MAGNUS EFFECT, U.S. Patent, No. 2344515, March 21, 1944.
- 38M. Mattioli, Gian Domenico, SULLA DIMINUZIONE DI RESISTENZA DI PROFILO DEI CILINDRI ROTANTI OTTENUTA CON UNA PARETE COASSIALE RISSA, L'Aerotecnica, Vol. 9, No. 4, April 1929, pp. 209-213, 283-284.
- 39M. Mattioli, Gian Domenico, VERFAHREN UND EINRICHTUNG ZUR ERHALTUNG DER AUFTRIEBSKRAFT VON FLUGZEUGTRAG-FLUGELN UND ANDEREN QUERTRIEBSKORPEN BEIM UBERSCHREITEN DES KRITISCHEN ANSTELLWINKELS, German Patent, No. 605663, November 15, 1934.

- 40M. Maurain, C., and Toussaint, A., ETUDE DE ROUES SUSTENTATRICES, Bulletin de l'Institut Aerotechnique de l'Universite de Paris, Vol. 2, 1912, pp. 48-53.
- 41M. Maxwell, J. C., ON A PARTICULAR CASE OF THE DESCENT OF A HEAVY BODY IN A RESISTING MEDIUM, Cambridge and Dublin Mathematical Journal, Vol. 9, 1854, pp. 115-118.
- 42M. Mazzini, Franco, DISPOSIZIONE PER AUMENTARE LA PORTANZA DELLE ALI DI AEROVEICOLI MEDIANTE CANALLI PASSANTI GUARNITI DI VENTDE, Italian Patent, No. 307980, May 19, 1933.
- 43M. Mazzino, Donadoni, DISPOSITIVO PER IL SOSTENTAMENTO DEI VELIVOLI E SIMILI, Italian Patent, No. 250002, May 28, 1926.
- 44M. Medvedeff, Nicholas, AIRCRAFT, U.S. Patent, No. 1854520, April 19, 1932.
- 45M. Medvedeff, Nicholas J., AIRPLANE, U.S. Patent, No. 1890064, December 6, 1932.
- 46M. Meyer, Gunter, FLEUNUNTARE AERODYNAMIK UND FLUGPHYSIK, Fachbach Verlag, Leipzig, Germany, 1955, p. 145.
- 47M. Meyer, Gustav W., WINDKRAFT, Fachbuchverlag Leipzig, Leipzig, Germany, 1954, p. 54.
- 48M. Millevolte, P. L., DYNAMIC STABILITY OF VORTEX GLIDERS, Master's Thesis, University of Minnesota, Minneapolis, Minnesota, July 1966.
- 49M. Minor, V., AEROPLANE, U.S. Patent, No. 1840594, January 12, 1932.
- 50M. Mivelle, J. A., DISPOSITIF DE PROPULSION OU DE SUSTENTATION POUR AVIONS OU AUTRES APPLICATIONS, French Patent, No. 839330, December 26, 1938.
- 51M. Modre, Edward, THE FUTURE OF THE ROTOR SHIP, Popular Aviation, Vol. 16, No. 1, January 1935, p. 19.
- 52M. Moedebeck, Herman, POCKETBOOK OF AERONAUTICS, Whittaker and Company, London, England, 1907, pp. 163-165.
- 53M. Moineau, Rene J. L., IMPROVEMENTS IN AND RELATING TO FLYING MACHINES, British Patent, No. 231856, April 4, 1924.

- 54M. Moineau, Rene J. L., DISPOSITIF POUR LA SUSTENTATION, LA PROPULSION ET LA STABILISATION D'APPAREILS DE NAVIGATION AERIENNE, French Patent, No. 592806, May 8, 1925.
- 55M. Moineau, Rene J. L., MACHINE VOLANTE, French Patent, No. 603775, January 13, 1926.
- 56M. Moineau, R., AVION A VOILURE TOURNANTE, Comptes Rendus des Seances de l'Academie des Sciences, Vol. 182, No. 18, May 3, 1926, pp. 1079-1082.
- 57M. Moineau, Rene Joseph Louis, FLYING MACHINE, U.S. Patent, No. 1656492, January 17, 1928.
- 58M. Mooney, Dermot Joseph, IMPROVEMENT IN LIFTING AND CONTROLLING MEANS FOR AIRCRAFT, British Patent, No. 2711f, May 20, 1927.
- 59M. Moore, C. E., FLYING MACHINE, U.S. Patent, No. 1656600, January 17, 1928.
- 60M. Morel, P., SYSTEME PORTATIF OU TRACTIF TOURNANT POUR AVIONS OU AUTRES USAGES, French Patent, No. 651657, October 1, 1929.
- 61M. Morrissey, Michael F., FLYING MACHINE, U.S. Patent, No. 1255105, January 29, 1918.
- 62M. Mouillard, L. P., L'EMPIRE DE L'AIR, Libraire de l'Academie de Medecine, Paris, France, 1881, pp. 210-217.
- 63M. Mueller, Hans, SCHIFFSMODELLVERSUCHE IM STROMUNGS-GERINNE, Schiffbau, Schiffahrt und Hafenbau, Vol. 37, 1936, pp. 168-173, 206.
- 64M. Mueller, Hans, THE EFFECT OF CAVITATION ON THE OPERATION OF VOITH-SCHNEIDER PROPELLER, BuShip Translation 655D, Bureau of Ships, Washington, D. C., 1938.
- 65M. Mueller, H., DIE STEUERKRAFTE DES VOITH-SCHNEIDER PROPELLERS, Werft-Reederei-Hafen, Vol. 19, No. 13, July 1, 1938, pp. 202-204.
- 66M. Mueller, Hans, UBER DAS ZUSAMMENARBEITEN DES VOITH-SCHNEIDER-PROPELLERS MIT DEM SCHIFF, Schiff und Werft, Vol. 45/25, No. 11/12, June 1944, pp. 113-119.

- 67M. Mueller, Hans F., RECENT DEVELOPMENTS IN THE DESIGN AND APPLICATION OF THE VERTICAL AXIS PROPELLER, Transaction Society of Naval Architects and Marine Engineers, 1955, pp. 4-30.
- 68M. Mueller, Hans, and Helm, Kurt, DER MAKSTABEINFLUSS BEIM VOITH-SCHNEIDER PROPELLER, Werft-Reederei-Hafen, No. 24, December 15, 1942, pp. 334-338.
- 69M. Mueller, Hans, and Schneider, Ernst, BLADE WHEEL, U.S. Patent, No. 2250772, July 29, 1941.
- 70M. Mueller, Paul, AEROPLANE WING, U.S. Patent, No. 1773432, August 19, 1930.
- 71M. Mullinix, Charles D., BRIDLE FOR ROTATABLE AIRFOIL KITE, U.S. Patent, No. 3087698, April 30, 1963.
- 72M. Mullinix, Charles D., BRIDLE CONSTRUCTION FOR ROTATABLE KITE, U.S. Patent, No. 3108770, October 29, 1963.
- 73M. Mann, Victor, WIND TURBINE, British Patent, No. 250636, April 15, 1926.

N

- 1N. Naamlooze Vennootschap Instituut voor Aero-en Hydro-Dynamiek, PLANES, CONSTRUCTION OF: PROPELLING, STEERING, British Patent, No. 219664, July 28, 1923.
- 2N. Nagler, Bruno, PERFECTIONNEMENTS APPORTES AUX ENGINES DE LOCOMOTION AERIENNE AVEC AILES ROTATIVES, French Patent, No. 636321, January 11, 1928.
- 3N. Nagler, Bruno, IMPROVEMENT IN FLYING MACHINES EMPLOYING ROTATING WING SYSTEMS, British Patent, No. 280849, February 9, 1928.
- 4N. Nagler, Bruno, and Hafner, Raoul, SAMOLOT SRUBOWY, Polish Patent, No. 18412, January 16, 1930.
- 5N. Nagler, Bruno, and Hafner, Raoul, HELICOPTERE-VLIEGTUIG MET EEN GESCHOORDE HEFSCHROEF, Dutch Patent, No. 33603, September 15, 1934.
- 6N. Nai, Guido, PROPULSOPE AD EFFETTO MULTIPLO PER ARIA O ACQUA, Italian Patent, No. 415657, October 28, 1946.
- 7N. Nakonechny, B. V., EXPERIMENTAL PERFORMANCE OF A SIX-BLADED VERTICAL AXIS PROPELLER, Report No. 1446, David Taylor Model Basin, Washington, D. C., January 1961.
- 8N. (Neavin), WINGLESS AIRCRAFT IN SPAIN FLIES BACKWARD OR FORWARD, New York Times, Vol. 82, No. 27347, December 8, 1932, p. 7.
- 9N. Needham, Latimer C. H., THE BORGHESE PARIZAI ROTOR SAILPLANE, Sailplane and Glider, Vol. 21, No. 3, March 1953, pp. 17-18.
- 10N. Nelson, Harry T., AIRPLANE, U.S. Patent, No. 2176185, October 17, 1939.
- 11N. (Nelson-Thompson), RIDING ON ROTORS, Mechanix Illustrated, Vol. 53, No. 164, September 1942, pp. 53, 164.
- 12N. Nemeth, Stephen, MACHINE FOR NAVIGATING THE AIR, U.S. Patent, No. 1414577, May 2, 1922.
- 13N. (Nemeth), HELICOPTER, Science and Invention, Vol. 7, No. 6, September 1929, p. 417.

- 14N. Nemeth, Stephen P., HELICOPTER ROTOR VANE FOR BALANCING SIDE THRUST OF ANTITORQUE DEVICES, U.S. Patent, No. 2418274, April 1947.
- 15N. Nerad, Gustav, MASCHINE ZUR ENERGIEAUSNUTZUNG DER STROMENDEN LUFT, SOLCHEN GASES ODER WASSERS, Austrian Patent, No. 103660, July 10, 1926.
- 16N. Netter, L., and Bueschler, F., SYSTEME D'AILES DESTINE, DE PREFERENCE A LA PROPULSION DES VEHICULES AERIENS, French Patent, No. 765659, March 26, 1934.
- 17N. Netter, L., PROPELLING MECHANISM FOR AIRCRAFT AND THE LIKE, U.S. Patent, No. 1990462, February 5, 1935.
- 18N. Netter, Ludwig, and Spever, Otterstadt, R., WENDEFLUGEL-SYSTEM, INSBESONDERE ZUM ANTRIEB VON LUFTFAHRZEUGEN, German Patent, No. 616497, August 1, 1935.
- 19N. Neumark, S., TWO-DIMENSIONAL THEORY OF AN AEROFOIL WITH A ROTATING FLAP, Report Aero. 2041, Royal Aircraft Establishment, Farnborough, England, July 1960.
- 20N. Neumark, S., ROTATING AEROFOILS AND FLAPS, Journal of the Royal Aeronautical Society, Vol. 67, No. 625, January 1963, pp. 47-63.
- 21N. Neveux, LES NOUVEAUX MOULINS A VENT ET LEURS APPLICATIONS, l'Industrie Electrique, Vol. 39, May 10, 1930, pp. 197-208.
- 22N. NEW KITE FLIES LIKE A BIRD, Popular Aviation, Vol. 16, No. 1, January 1935, p. 19.
- 23N. Nicolaidis, J. D., and Griffin, T. F., ON A FLUID MECHANISM FOR ROLL LOCK-IN AND ROLLING SPEED-UP DUE TO ANGLE OF CRUCIFORM CONFIGURATIONS, Report BTN 16, Bureau of Ordnance, Washington, D. C., 1955.
- 24N. Nicolaidis, J. D., ON THE ROLLING MOTION OF MISSILES, Report BTN 33, Bureau of Ordnance, Washington, D. C., 1957.
- 25N. Nicolaidis, J. D., ON MISSILE FLIGHT DYNAMICS, Doctoral Dissertation, Catholic University, Washington, D. C., 1933, p. 164.
- 26N. Nicolaidis, John D., and Zehnle, Robert A., FOUR SPECIAL BOMBLET DESIGNS, Research Paper for Martin-Marietta of Orlando, Florida, Unpublished, Department of Aero-Space Engineering, University of Notre Dame, South Bend, Indiana, 1967.

- 27N. Nicolaus, Friedrich, TRAGFLUGEL MIT IN DREHUNG VERSETZ BAREM, FLACKENARTIGEN KORPER, German Patent, No. 727298, October 30, 1942.
- 28N. Nicolleau, A., LES RECENTES EXPERIENCES D'ALLEGEMENT, L'Aerophile, Vol. 11, No. 6, June 1903, pp. 139-140.
- 29N. Nielsen, C. G., THE FLETTNER ROTOR AND ROTOR SHIP, Ingenieren, Vol. 34, No. 10, March 7, 1925, pp. 121-126.
- 30N. Noeggerath, J. E., PROPELLING: ARRANGEMENT OF LAND WHEELS, FLOATS, British Patent, No. 245134, December 22, 1924.
- 31N. NOVEL WINDMILL USES SPIRAL-SHAPED VANES, Popular Science Monthly, Vol. 126, No. 5, May 1935, p. 28.
- 32N. Nowka, Gustav, NEUE ERKENNTNISSE UBER SCHIFFSANTRIEBE, BuShip Translation No. 411, Bureau of Ships, Washington, D. C., 1944, p. 49.
- 33N. Nuttall, R., MACHINES SUPPORTED BY ROTARY PROPELLERS, British Patent, No. 249131, March 11, 1925.
- 34N. Nikitin, S. A., CALCULATION OF CERTAIN HYDROAERODYNAMIC CHARACTERISTICS OF A ROTATING CYLINDER IN AN OBLIQUE FLOW, Akademiia Nauk Latviiskoi SSR, Ivestiia, Seriia Aviatsii Riga, No. 2, 1968, pp. 92-97.
- 35N. Noeggerath, Emil J., CORPO ROTANTE PROPULSIVO E PER SVILUPPO DI FORZA, Italian Patent, No. 249178, 1926.



10. Oetlieg, C., EINE NEUE DURCH SCHLAG-FLUGRADER BEWEGIE FLUGMASCHINE, Zeitschrift fur Luftschiffahrt und Physik der Atmosphere, Vol. 14, No. 1, 6/7, 1895, pp. 1-9, 25-26, 177-178.
20. O'Gorman, William Francis, AIRPLANE KITE, U.S. Patent, No. 2801063, July 30, 1957.
30. Olivero, Matteo, DISPOSITIVO DI PROPULSIONE A PALE O AD ALI ROTANTI, Italian Patent, No. 392893, March 14, 1942.
40. Olson, C. W., FLYING MACHINE, U.S. Patent, No. 1495641, May 27, 1924.
50. (ONERA), ETUDE DE L'HELICOPLANE "RICHARD" ESSAIS EN AUTOROTATION, Proces-Verbal d'Essai No. 88/S, Ch., Problem No. 59A, Paris, France, January 1948.
60. (ONERA), ETUDE DE L'HELICOPLANE "RICHARD" ESSAIS EN AUTOROTATION, Proces-Verbal d'Essai No. 88/S, Ch-Annexe 1, Problem No. 59A, Paris, France, May 1948.
70. (ONERA), ETUDE DE L'HELICOPLANE "RICHARD" ESSAIS EN AUTOROTATION (FIN), Proces-Verbal d'Essai No. 88/S, Ch-Annexe 2, Problem No. 59A, Paris, France, September 1948.
80. (ONERA), ETUDE DE L'HELICOPLANE "RICHARD" ESSAIS MOTORISES, Proces-Verbal d'Essai No. 88/S, Ch-Annexe 3, Problem No. 59A, Paris, France, November 1948.
90. Orazi, Paolo, SLOW DESCENT DEVICE FOR AIRCRAFT, U.S. Patent, No. 2477031, December 4, 1951.
100. Orazi, Paolo, CONVERTIBLE AIRPLANE HAVING AUTOROTABLE SUSTAINING ELEMENTS, U.S. Patent, No. 2681775, June 22, 1954.
110. Orazi, Paolo, FESSURE ALARI CHE OTTENGONO L'EFFETTO DI ALETTONI SU UN ALA ROTANTE, OVE NON POSSONO ESSER COSTRUITI ALLETTONI, OLTRECHE SU UN ALA FISSA, Italian Patent (Application), No. 472462, November 9, 1955.
120. Orazi, Paolo, ROTARY SUSTAINING WING FOR AIRCRAFT, U.S. Patent, No. 2860846, November 18, 1958.

130. Ottino, F. G., and Wyss, A., MACHINE VOLANTE, French Patent, No. 414268, March 4, 1910.
140. Ottino, Pietro Giuseppe, IMPROVEMENTS IN AERONAUTICAL MACHINES, British Patent, No. 212626, March 12, 1924.
150. Otto, E., MACHINE VOLANTE, French Patent, No. 580887, April 29, 1924.
160. Ostrawiecki, Eugeniusz, LATAJACE POJAZDY PRZYSZ, Skrzydłata Polska, Vol. 23, No. 10(817), March 5, 1967, p. 8.

P

- 1P. Panov, Iv. L., MEASUREMENT OF THE INSTANTANEOUS FORCE ACTING ON A BLADE OF A VERTICAL AXIS PROPELLER, Translation 300, David Taylor Model Basin, Washington, D. C., October 1960 (Trans. from: Sudostroenie, No. 2, 1960, pp. 5-7).
- 2P. Parizzi, E., IL "CICLOVELI" BORGHESE-PARIZZI, Aeronautica, Vol. 6, No. 2, February 1932, pp. 120-122.
- 3P. Pasquier, Joseph Marie, ORGANE ROTATIF SE MOUVANT DANS UN FLUIDE, Swiss Patent, No. 127923, June 1, 1929.
- 4P. Pataud, Henri, PROPULSEUR ELEVATEUR POUR APPAREIL D'AVIATION, French Patent, No. 396626, January 21, 1908.
- 5P. Patterson, J. H., THE FLETTNER ROTOR SHIP, The Pacific Marine Review, Vol. 22, No. 4, April 1925, pp. 168-170.
- 6P. Pedron, Joseph D. R., MACHINE VOLANTE DITE ORTHOPTERE, French Patent, No. 384753, February 13, 1907.
- 7P. Pedron, Joseph D. R., PERFECTIONNEMENTS AUX MACHINES VOLANTES A AILES ROTATIVES, French Patent, No. 400654, June 15, 1908.
- 8P. (Pemberton Billing), THE PEMBERTON BILLING DUROTOFIN, The Aeroplane, Vol. 47, No. 1227, November 1934, pp. 657-658.
- 9P. Petrunin, V., WIND TUNNEL TEST OF FOUR AEROFOILS AT INCIDENCES RANGING FROM 0° TO 360°, Technical Vosushnogo Flota, No. 8-9, September 1936, pp. 34-36.
- 10P. Pichou, Alfred, LE SUSTENTEUR-PROPULSEUR PICHOU, L'Aerophile, Vol. 11, No. 1, January 1903, pp. 18-20.
- 11P. Pichou, Alfred, L'AUTO-AERIENNE PICHOU, L'Aerophile, Vol. 11, No. 2, February 1903, pp. 45-47.
- 12P. Pichou, Alfred, A PROPOS DES RECENTES EXPERIENCES D'ALLEGEMENT LE SUSTENTEUR-PROPULSEUR PICHOU, L'Aerophile, Vol. 11, No. 6, June 1903, p. 138.
- 13P. Pichou, Alfred, LA ROUE SUSTENTATRICE ET PROPULSIVE ET L'ORTHOPTERE A CAISSONS, La Technique Aeronautique, Vol. 5, No. 59, June 1, 1912, pp. 330-339.

- 14P. Picq, Henry, AEROPLANE AUTOMOTEUR, French Patent, No. 375273, May 10, 1907.
- 15P. Pioneer Instrument Co., Inc., SCHACFELRAD MIT ZWEI UMLAUFENDEL GLEICHACHSIG GELAGERTEN BESCHAU FLUNG KRANZEN, BEI DEM DIE SCHAUFELN DES EINEN KRANZES GEGEN UBER DES EINEN KRANZES GEGEN UBER DEM ANDEREN VERSTEILBAR SIND, German Patent, No. 618257, September 4, 1935.
- 16P. (Piskorsch), UMLAUFSCHWINGENFLIEG PISKORSCH, Flugsport, Vol. 25, No. 18, August 20, 1933, pp. 397-398.
- 17P. (Piskorsch), ROTATIONSSCHWINGENFLIEGER, Flugsport, Vol. 25, No. 19, September 13, 1933, pp. 409-410.
- 18P. (Piskorsch), ROTATIONSSCHWINGENFLIEGER - MODELL 2, PISKORSCH, Flugsport, Vol. 25, No. 23, December 6, 1933, p. 541.
- 19P. (Piskorsch), ROTATIONSSCHWINGENFLIEG PISKORSCH, Flugsport, Vol. 26, No. 15, July 1934, pp. 314-315.
- 20P. Pistolesi, E., IL ROTORE SAVONIUS E LE SUE APPLICAZIONI, L'Aerotechnica, Vol. 11, No. 12, December 1931, pp. 1634-1635.
- 21P. Pistolesi, E., and Poggi, L., IL PROBLEMA DELL ALA ROTANTE, L'Aerotechnica, Vol. 10, No. 5, May 1936, pp. 348-359
- 22P. Platou, A. S., THE MAGNUS FORCE ON A ROTATING CYLINDER IN TRANSONIC CROSS FLOWS, BRL Report No. 1150, Ballistic Research Laboratories, Aberdeen Proving Ground, Maryland, September 1961.
- 23P. Platou, Anders S., THE MAGNUS FORCE ON A FINNED BODY, BRL Report No. 1193, Ballistic Research Laboratories, Aberdeen Proving Ground, Maryland, March 1963.
- 24P. Platt, H. H., SUPPORTING AND PROPELLING AIRCRAFT, British Patent, No. 369249, December 11, 1930.
- 25P. Platt, H. H., APPAREIL DE NAVIGATION AERIENNE PLUS LOURD QUE L'AIR, French Patent, No. 709023, May 11, 1931.
- 26P. Platt, Haviland H., AIRCRAFT, U.S. Patent, No. 1795501, March 10, 1931.

- 27P. Platt, Haviland H., THE CASE FOR VERTICAL FLIGHT, Journal of the Royal Aeronautic Society, Vol. 28, No. 282, June 1934, pp. 507-514.
- 28P. Platt, Haviland H., AIRCRAFT, U.S. Patent, No. 2004961, June 18, 1935.
- 29P. Poggi, L., and Stringari, Alessandri, STUDIO DI UN TIPO AEROMOTORE PER GRANDI POTENZE, L'Aerotecnica, Vol. 16, No. 10, October 1936, pp. 709-722.
- 30P. Poggi, L., THEORIA AERODINAMICA ELEMENTARE DEL MOTORE A VENTO AD ALI ROTANTI, L'Aerotecnica, Vol. 16, No. 10, October 1, 1936, pp. 723-731.
- 31P. Pohl, Ernest F., TOY AIRPLANE KITE, U.S. Patent, No. 2827252, March 18, 1958.
- 32P. Pohl, Lothar L., FLYING STRUCTURE, Canadian Patent, No. 619922, May 9, 1961.
- 33P. Pohl, Lothar L., TURBINE SYSTEMS, U.S. Patent, No. 3079126, February 26, 1963.
- 34P. Pohl, Lothar Louis, FLOWMETERS, U.S. Patent, No. 3161048, December 15, 1964. (See also: Machine Design, Vol. 37, No. 5, March 4, 1965, p. 218.)
- 35P. Pohl, Lothar L., TRANSVERSE FLOW TURBINES, U.S. Patent, No. 3203182, August 31, 1965.
- 36P. Poinard, Octave A. L., ROUE PROPULSIVE ET SUSTENTATRICE POUR APPAREILS D'AEROSTATION, French Patent, No. 401581, April 1909.
- 37P. Pope, Alan, THE FORCES AND PRESSURE OVER AN NACA 0015 AIRFOIL THROUGH 180 DEGREES ANGLE OF ATTACK, Report E-102, Georgia Institute of Technology, Daniel Guggenheim School of Aeronautics, Atlanta, Georgia, February 1947. (See also: Aero Digest, Vol. 58, No. 4, April 1949, pp. 76, 78, 100.)
- 38P. Potinier, Camille, PROPULSEUR PRINCIPALEMENT DESTINE A L'AVIATION, French Patent, No. 411398, January 8, 1910.
- 39P. Power Jets, Ltd., FLUGZEUG MIT KRAFTANLAGE, Swiss Patent, No. 268738, September 16, 1950.
- 40P. Powley, C. F. B., PROPELLING AIRCRAFT, British Patent, No. 747172, October 4, 1951.

- 41P. Pozzi, Ugo, and Bertolini, Leopoldo, Italian Patent, No. 266824, August 13, 1929.
- 42P. Prandtl, Ludwig, APPLICATIONS OF MODERN HYDRODYNAMICS TO AERONAUTICS, NACA Technical Report TR 116, 1921.
- 43P. Prandtl, L., APPLICATION OF THE "MAGNUS EFFECT" TO THE WIND PROPULSION OF SHIPS, NACA Technical Memorandum TM 367, June 1926 (Trans. from: Die Naturwissenschaften, Vol. 13, No. 6, February 6, 1925, p. 94).
- 44P. Prandtl, Ludwig, GESAMMELTE ABHANDLUNGEN, Tragflugel und Luftschrauber, Vol. 1, 1961, pp. 241-253.
- 45P. Prewitt, Richard H., ANTON FLETTNER, 1885 TO 1961, Journal of the American Helicopter Society, Vol. 7, No. 2, April 1962, pp. 1-2.
- 46P. Prinz, H. L., AIRCRAFT, U.S. Patent, No. 1845184, February 16, 1932.
- 47P. Pris, R., AERODYNAMIQUE EXPERIMENTALE - ROUES SUS-TENTRICES, Bulletin des Services Techniques, B.S.T. No. 83, Publications Scientifiques et Techniques du Ministere de l'Air, Vol. 1, 1938, pp. 233-234.
- 48P. Proll, A., BETRACHTUNGEN ZUM ROTORPROBLEM, Zeitschrift fur Flugtechnik und Motorluftschiffahrt, Vol. 16, No. 3, February 14, 1925, pp. 66-72.
- 49P. Proll, A., ZUR THEORIE UND BERECHNUNG DES FLETTNER-ROTORs, Schiffbau, Vol. 26, No. 11, June 10, 1925, pp. 345-350.
- 50P. Prosdociimi, Giuseppe A., FLYING MACHINE WITH BEATING AND SLIDING HORIZONTAL LOUVER-LIKE WINGS ROTATING IN OPPOSITE DIRECTIONS, U.S. Patent, No. 1988916, January 22, 1935, p. 5.
- 51P. Ptaszynski, Jan, SAMOLOT Z WIRNIKAM TOPATKOWEIN O PIZECHYLNYCH TOPATKACH I POZIOMET OSI, Polish Patent, No. 20587, June 16, 1933.
- 52P. Pullin, C. G., et al., HELICOPTER WITH PADDLE WHEEL TYPE TAIL ROTOR, U.S. Patent, No. 2788075, April 9, 1957.
- 53P. Purpura, A. C., AIRCRAFT, U.S. Patent, No. 2372291, March 27, 1945.
- 54P. Putnam, Palmer Cosslett, POWER FROM THE WIND, Van Nostrand Co., Inc., New York, New York, 1948, pp. 2, 98, 101-102.

- 55P. Putte, Jan van de, IMPROVEMENTS IN OR RELATING TO DRIVING DEVICES FOR AIRCRAFT, British Patent, No. 313622, June 16, 1928.
- 56P. Pyramont, G., UNE NOUVELLE TURBINE AERIENNE A AXE VERTICAL, La Science et la Vie, No. 51, July 1920, p. 77.
- 57P. Pistolesi, E., IL FENOMENO RAIMONDI, UN NUOVO FENOMENO DI IDRO-AERODINAMICA, L'Aerotecnica, Vol. 9, No. 12, December 1929, pp. 985-995.
- 58P. Pichou, Alfred-Eugene, ORTHOPTERE A CAISSONS, French Patent, No. 396568, November 19, 1908.

Q

- 1Q. QUELQUES REALISATIONS DE ROUES AERIENNES SUSTENTATRICES ET PROPULSIVES, L'Aerophile, Vol. 43, No. 6, June 1935, pp. 174-178.
- 2Q. Quilling, Werner, DER "RC-WIRBELWIND" ERFAHRUNGSBERICHT UBER DEN DREHFLUGLER, Flug und Modell-Technik, Vol. 27, No. 4(147), April 1968.

R

- 1R. Radosevic, Franto, et al., AEROPLANE A RAMES, French Patent, No. 417168, June 15, 1910.
- 2R. Radosevic, R. and A., SYSTEME D'APPAREIL D'AVIATION, French Patent, No. 531295, October 20, 1921.
- 3R. Rahn, W., AERONAUTIC EQUIPMENT, U.S. Patent, No. 1894057, January 10, 1933.
- 4R. (Rahn), WHIRLING VANES LIFT AND DRIVE NEW PLANE, Popular Science Monthly, Vol. 122, No. 3, March 1933, p. 24.
- 5R. Rappaport, Adrian, FLUGZEUG MIT SCHWENNBAREN UND VERRIEGELBAREN TRAGFLUGELN, German Patent, No. 547859, April 6, 1932.
- 6R. Rateau, A., L'ECOULEMENT DES FLUIDES LE LONG DES SURFACES, Bulletin de l'Association Technique Maritime, No. 20, 1909, pp. 211-227.
- 7R. Lord Rayleigh (John William Strutt), ON THE IRREGULAR FLIGHT OF A TENNIS BALL, Messenger of Mathematics, Vol. 7, 1877, pp. 14-16. (See also: Scientific Papers, Vol. 1, 1857, pp. 344-346.)
- 8R. Lord Rayleigh (John William Strutt), ON THE RESISTANCE OF FLUIDS, Scientific Papers 1869-1881, University Press, Oxford, England, 1899, pp. 291-293.
- 9R. Regan, Frank J., and Horanoff, Eugene V., WIND-TUNNEL MAGNUS MEASUREMENTS AT THE NAVAL ORDNANCE LABORATORY, AIAA Journal, Vol. 5, No. 6, June 1967, pp. 1193-1194.
- 10R. Regenscheit, B., VERSUCHE AN EINEM FLUGEL MIT EINEM ROTOP, Forschungsbericht, Aerodynamische Versuchsanstalt Goettingen, Goettingen, Germany, September 9, 1937. (See also: Jahrbuch 1940 den Deutschen Luftfahrtforschung, p. 1589.)
- 11R. Regniault, Alfred, AEROPLANE A ROUES A AUBES MOBILES ALLIEES AU VOL PLANE, French Patent, No. 410270, October 29, 1929.
- 12R. Reid, Elliott G., TESTS OF ROTATING CYLINDER, NACA Technical Note TN 209, December 1924.

- 13R. Reid, Elliott, TESTS OF ROTATING CYLINDER, Flight, Vol. 17, No. 2, January 8, 1925, pp. 17-20.
- 14R. (Reid), LITAVISCHER EINDECKER "DOBKJEWITSCH", Flugsport, Vol. 17, No. 2, January 21, 1925, pp. 25-28.
- 15R. Reid, Elliott G., AIRFOIL LIFT WITH CHANGING ANGLE OF ATTACK, NACA Technical Note TN 266, September 1927.
- 16R. Relf, E. F., and Lavender, T., EXPERIMENTS ON THE FLOW BEHIND A ROTATING CYLINDER IN THE WATER CHANNEL, Reports and Memorandum, No. 1009, Aeronautical Research Council, May 1925, p. 2.
- 17R. Renard, Alfred, LE NAVIRE A VOILES CYLINDRIQUES, La Science et la Vie, Vol. 27, No. 92, February 1925, pp. 132-136.
- 18R. Revis, M. A., ADVERTISING DEVICE OR TOY, U.S. Patent, No. 1945789, February 6, 1934.
- 19R. Riabouchinski, D., RECHERCHES SUR LA PRESSION QUE SUPPORTENT DES PLAQUES RECTANGULAIRES EN ROTATION DANS UN COURANT AERIEN, Bulletin de l'Institut Aerodynamique de Koutchino, Vol. 3, 1909, pp. 30-45.
- 20R. Riabouchinski, D., EXPERIENCE D'HYDRODYNAMIQUE, Bulletin de l'Institut Aerodynamique de Koutchino, Vol. 5, 1914, pp. 88-90. (See also: Bolletino dell Aero-Club di Roma, March 1914.)
- 21R. (Riabouchinski), SUR L'AUTOROTATION DES PROJECTILES, Bulletin de l'Institut Aerodynamique de Koutchino, Vol. 6, 1920, pp. 47-48.
- 22R. Riabouchinski, D., ON THE RESISTANCE OF THE AIR AND HIGH SPEED AND ON THE AUTOMATIC ROTATION OF PROJECTILES, NACA Technical Note TN 49, April 1921, pp. 7-8 (Trans. from: Bulletin de l'Institut Aerodynamique de Koutchino, Vol. 6, 1920, pp. 47-48).
- 23R. Riabouchinski, D. M., SUR LA RESISTANCE DES FLUIDES ET LA REACTION D'UN JET, Revue Generale de l'Aeronautique, Etienne Chiron, Editeur, Paris, France, 1925, pp. 86-92.
- 24R. Riabouchinski, D. M., SUSTENTATEURS-PROPULSEURS A GIROUETTE EXCENTRIQUE, French Patent, No. 603167, April 10, 1926.
- 25R. Riabouchinski, D., SUR LES EXPERIENCES DE COURS ET LES TRAVAUX PRATIQUES DANS L'ENSEIGNEMENT DE L'AERODYNAMIQUE, Cinquieme Congres International de la Navigation Aerienne, Martinus Nitheff, La Haye, France, September 10, 1930, pp. 521-522.

- 26R. Riabouchinski, D., THIRTY YEARS OF THEORETICAL AND EXPERIMENTAL RESEARCH IN FLUID MECHANICS, Journal of the Royal Aeronautical Society, Vol. 34, Nos. 292 and 293, April-May 1935, pp. 316-322, 287-288.
- 27R. Riabouchinski, Dimitri, ETUDE SUR L'HYPERSUSTENTATION ET LA DIMINUTION DE LA RESISTANCE A L'AVANCEMENT, Publications Scientifiques et Techniques du Ministere de l'Air, No. 337 (formerly 167, 1940), 1957, pp. 12-22, 96-122.
- 28R. Riabouchinski, D., TWENTY-FIVE YEARS MORE OF THEORETICAL AND EXPERIMENTAL RESEARCH IN FLUID MECHANICS, Journal of the Royal Aeronautical Society, Vol. 66, No. 620, August 1962, pp. 482-483.
- 29R. Ricci, Giovanni, TURBINA AEREA CILIBRICA PER LA NAVIGAZIONE A VENTO PER SOSTENTAMENTO DI AEROPLANO E PER AEROMOTORE, Italian Patent, No. 272532, March 13, 1930.
- 30R. Richard, G. C., LES VOILURES TOURNANTES PERMETTENT-ELLES DE REALISER LE VOL RAME DES IOSEAUX?, Les Ailes, Vol. 14, No. 686, August 9, 1934, p. 4.
- 31R. Richard, G. C., LE PARADOXE DE L'HELICOPLANE: LA PUISSANCE NECESSAIRE DIMINUE LORSQUE LA VITESSE AUGMENTE, Les Ailes, Vol. 17, No. 812, July 1, 1937, p. 8.
- 32R. Richard, G. C., ETUDE PRELIMINAIRE SUR UNE MACHINE EXPERIMENTALE DANS LAQUELLE LES AILES, OU RAMES, SONT ANIMEES D'UN MOUVEMENT DE ROTATION CONIQUE AUTOUR D'AXES SYMETRIQUEMENT PLACES DE PART ET D'AUTRE DU CORPS DE L'APPAREIL, DIT "GYRORAME", ONERA Report No. 15, Paris, France, February 26, 1947.
- 33R. Richard, G. C., ETUDE D'UN PROJET DE GYRORAME MONO-PLACE A FAIBLE PUISSANCE, Report No. 4/95, 3^{eme} Congres National de l'Aviation Francaise, April 1-5, 1947.
- 34R. Richard, G. C., ETUDE D'UN PROJET D'HELICOPLANE MONO-PLACE A FAIBLE PUISSANCE, Report No. 4/96, 3^{eme} Congres National de l'Aviation Francaise, April 1-5, 1947.
- 35R. Richard, G. C., REALISATION DES ESSAIS ET RESULTATS OBTENUS EN 1948-49 AVEC LE BAN D'ESSAIS "HELICOPLANE", ONERA Report No. 59A, Paris, France, December 1949.
- 36R. Richard, G. C., DEFINITIONS DE PRINCIPE DE L'HELICOPLANE, La Recherche Aeronautique, Vol. 15, Nos. 5-6, May-June 1950, pp. 3-7.

- 37R. Richard, G. C., ETUDE D'UN AVANT-PROJET L'HELICOPLANE RICHARD, Unpublished ONERA Report, Paris, France, June 1952.
- 38R. (Richard), THEORIES MATHEMATIQUES SUR L'HELICOPLANE, Unpublished Typescript, 1952.
- 39R. Richard, Jules, SUR L'EMPLOI DU ROTOR DE SAVONIUS POUR L'UTILISATION DES VAGUES DE LA MER, Bulletin de l'Institut Oceanographique, No. 583, October 15, 1931, pp. 41-43.
- 40R. Richardson, E. G., RECENT MODEL EXPERIMENTS IN AERODYNAMICS, Journal of the Royal Aeronautical Society, Vol. 31, No. 201, September 1927, pp. 822-825.
- 41R. Riegels, Friedrich W., AEROFOIL SECTIONS, Butterworths, London, England, 1960, p. 192.
- 42R. Rimmer, R. C., AERIAL VESSEL, U.S. Patent, No. 1432209, October 17, 1922.
- 43R. Ripoche, Maurice, PERFECTIONNEMENTS APPORTES AUX AVIONS, French Patent, No. 616551, October 29, 1926.
- 44R. Ritter, C., FLYING MACHINE, U.S. Patent, No. 1356088, October 19, 1920.
- 45R. Rizzo, Frank, THE FLETTNER ROTOR SHIP IN THE LIGHT OF THE KUTTA-JOUKOWSKI THEORY AND EXPERIMENTAL RESULTS, NACA Technical Note TN 228, October 1925.
- 46R. Rockwell, C. L., AIRPLANE CONSTRUCTION, U.S. Patent, No. 1774726, September 2, 1930.
- 47R. Rogers, Stanley, ROTORS AND MOTORS, Freak Ships, John Lane The Bodley Head, London, England, 1936, pp. 206-211.
- 48R. (Rohrbach), ROHRBACH METALL-FLUGZEUGBAU G. M. B. H., Janes All the Worlds Aircraft, 1933, p. 179c.
- 49R. (Rohrbach), SIDE-WHEEL PLANE PLANNED IN REICH, New York Times, Vol. 82, No. 27387, January 17, 1933, p. 3.
- 50R. (Rohrbach), SCHAUFELRAD-FLUGZEUGE, Flugsport, Vol. 25, No. 3, February 1, 1933, pp. 55-56.
- 51R. (Rohrbach), THE PADDLE-WHEEL AEROPLANE, The Aeroplane, Vol. 44, No. 7, February 15, 1933, p. 300.
- 52R. (Rohrbach), PADDLEWHEEL PLANE LATEST IN AVIATION, Inventions, April 1933, p. 39.

- 53R. (Rohrbach, Caldwell, Platt), PADDLE WHEEL PLANE NEXT, Popular Science Monthly, Vol. 122, No. 4, April 1933, p. 45.
- 54R. (Rohrbach), PADDLE-WHEEL AEROPLANES, The Aeroplane, Vol. 45, No. 17, October 25, 1933, pp. 745-746.
- 55R. (Rohrbach), A REVOLUTIONARY GERMAN AEROPLANE NOW UNDER CONSTRUCTION, THE FIRST DETAILED DRAWINGS TO BE PUBLISHED HERE, Illustrated London News, Vol. 184, January 20, 1934, pp. 94-95.
- 56R. (Rohrbach), PADDLE WHEEL PLANE TO FLY BACKWARDS, Popular Mechanics, Vol. 61, No. 4, April 1934, pp. 481-482.
- 57R. (Rohrbach), LA MACHINE A VOILURE TOURNANTE DE L'INGENIEUR ROHRBACH, Les Ailes, Vol. 14, No. 684, July 26, 1934, p. 11.
- 58R. Rohrbach, Adolf, AIRCRAFT, U.S. Patent, No. 2123916, July 19, 1938. (See also: Patentsammlung des Flugsport, No. 9, pp. 36-40.)
- 59R. Rohrbach, Adolf, FLUGZEUG MIT UMLAUFFLUGELN, German Patent, No. 671035, January 30, 1939.
- 60R. Rolfe, Douglas, BULLET PROOF ALL METAL ROTOR AIRPLANES, Modern Mechanics and Inventions, Vol. 6, No. 1, May 1931, Cover and p. 95.
- 61R. Rolfe, Douglas, INVENTORS PATENT ODD DESIGNS, Modern Mechanics and Inventions, Vol. 14, May 1935, p. 83.
- 62R. Roller, Ernst, SCHULVERSUCHE ZUR FLUGLEHRE, Carl Heymanns Verlag, Berlin, Germany, 1936, pp. 44-47.
- 63R. Romani, L., and Girault, P., GYRORAME-AERODYNAMIQUE, PLANCHES, Etudes et Techniques Nouvelles, Date N/A.
- 64R. Romer, B. von, KURIOSE FLUGZEUGE, Kohlers Flieger-Kalender, Vol. 2, 1937, pp. 79-80.
- 65R. Romualdi, Arnaldo, AEROPLANE, U.S. Patent, No. 1278750, September 10, 1918.
- 66R. Roos, Willem, IMPROVEMENTS IN OR RELATING TO SUSTAINING DEVICES FOR AIRCRAFT, British Patent, No. 260059, July 31, 1925.
- 67R. Roscher, Paul A., WINDMOTOR, Swiss Patent, No. 117848, December 1, 1926.

- 68R. Rossell, H. E., and Chapman, L. B., PRINCIPLES OF NAVAL ARCHITECTURE, Vol. 2, 1939, p. 125.
- 69R. ROTORNYI VOZDUSHNYI ZMEI, Samolet, No. 1(27), January 1926, pp. 24-30.
- 70R. Roubault, Louis-Henri, NOUVEL APPAREIL DE SUSTENTATION AERIENNE, French Patent, No. 417995, June 30, 1910.
- 71R. Ruckel, P. K., PROPELLING DEVICE FOR AEROPLANES AND THE LIKE, U.S. Patent, No. 1444643, February 6, 1923.
- 72R. Raimondi, Emanuele G. A., RISULTATI SPERIMENTALI RELATIVE AD UN NUOVO FENOMENTO DI AERODINAMICA, Notiziario Tecnico di Aeronautica, Vol. 6, Ministero dell'Aeronautica, Rome, Italy, October 1930, pp. 1-19.
- 73R. Regan, F. J., MAGNUS EFFECTS, AGARD Conference Proceedings, No. 10, Harford House, London, England, 1966.
- 74R. Ricci, Giovanni, TURBINA AEREA CILINDRICA PER LA NAVIGAZIONE A VENTO, PER SOSTENTAMENTO DI AEROPLANO E PER AEROMOTORE, Italian Patent, No. 272532, March 13, 1930.
- 75R. Round, John C., IMPROVEMENT IN WIND ROTOR UTILIZING THE MAGNUS EFFECT, British Patent, No. 248447, March 2, 1926.
- 76R. Rumph, Lewis B., Jr., STATIC THRUST ANALYSIS OF THE CYCLOGIRO LIFTING SYSTEM, Master's Thesis, University of Georgia, 1947, p. 40.

S

- 1S. Sachse, H., KIRSTEN-BOEING PROPELLER, NACA Technical Memorandum TM 351, February 1926, p. 8.
- 2S. Sams, Kenneth, ROTARY PLASTIC KITE, British Patent, No. 953276, March 25, 1964.
- 3S. Sancery, Raymond, POUR UTILISER L'ENERGIE DU VENT: VOICI UNE SOLUTION NOUVELLE, La Science et la Vie, Vol. 33, No. 130, April 1928, pp. 295-302.
- 4S. Sandel, W., ZUR AERODYNAMIK DES MAGNUSEFFEKTES, Zeitschrift des Vereines Deutscher Ingenieure, Vol. 69, No. 21, May 1925, pp. 726-729.
- 5S. Saunders, Harold E., HYDRODYNAMICS IN SHIP DESIGN, Vol. 1, Society of Naval Architects and Marine Engineers, New York, New York, 1957, pp. 213-214, 244-247, 488-439.
- 6S. Saunders, Harold E., HYDRODYNAMICS IN SHIP DESIGN, Vol. 2, Society of Naval Architects and Marine Engineers, New York, New York, 1957, pp. 333, 337, 536, 656-658.
- 7S. Sauvignon, Rene A. G., ROTORS D'AVIONS, French Patent, No. 991806, October 8, 1951.
- 8S. Savonius, Sigurd J., ROOTTORI, Finnish Patent, No. 11121, December 12, 1924.
- 9S. Savonius, S. J., VINGROTOR, Swedish Patent, No. 65940, December 19, 1924.
- 10S. Savonius, Sigurd J., THE WING ROTOR IN THEORY AND PRACTICE, (By the Author), Helsingford, Finland, 1925, p. 39.
- 11S. Savonius, Sigurd J., ROTOR, French Patent, No. 601266, July 23, 1925.
- 12S. (Savonius), THE WING ROTOR, The Engineer, Vol. 140, No. 3634, August 21, 1925, p. 193.
- 13S. (Savonius), SAVONIUS ROTOR, Mechanical World, Vol. 78, No. 2016, August 21, 1925, p. 149.
- 14S. (Savonius), THE WING ROTOR, Mechanical Engineering, Vol. 47, No. 10, October 1925, p. 849.

- 15S. (Savonius), WING ROTOR, Power, Vol. 62, October 13, 1925, p. 572.
- 16S. (Savonius), STROMUNG-SAVONIUS-FLUGEL-WINDWALZE, Zeitschrift für Flugtechnik und Motorluftschiffahrt, Vol. 17, No. 1, January 14, 1926, p. 21.
- 17S. Savonius, Sigurd J., ROTOR, Austrian Patent, No. 103819, July 26, 1926.
- 18S. (Savonius), ROTORS A AILES, SYSTEME SAVONIUS, Le Genie Civil, Vol. 88, No. 10, March 6, 1926, p. 236.
- 19S. Savonius, Sigurd J., IMPROVEMENT IN OR RELATING TO WIND ROTOR FOR PRODUCING ROTARY POWER AND GENERATING CROSS DRIVE, British Patent, No. 244414, September 9, 1926.
- 20S. Savonius, Sigurd J., NAGRA STUDIER I VINDKANAL, Terniska Foreningens: Finland Forhandlingar, Vol. 46, No. 10, October 1926, pp. 105-212.
- 21S. (Savonius), WINDMILL, Iberica de Suplemento, Vol. 14(28), No. 691, September 2, 1927, pp. 10-11.
- 22S. (Savonius), EL FLUGEL ROTOR, Iberica, Vol. 1, December 31, 1927, pp. 390-391.
- 23S. Savonius, Sigurd J., REKLAMANORDNING, Finnish Patent, No. 12540, February 17, 1928.
- 24S. Savonius, Sigurd J., WINDRAD, German Patent, No. 462462, July 17, 1928.
- 25S. Savonius, Sigurd J., ROTOR ADAPTED TO BE DRIVEN BY WIND OR FLOWING WATER, U.S. Patent, No. 1697574, January 1, 1929.
- 26S. (Savonius), ROTOR MOTOR DRIVES PUMP, Modern Mechanics and Inventions, Vol. 1, No. 10, March 1929, p. 78.
- 27S. (Savonius), SUR L'EMPLOI DU DYNAMOMETRE DE STEVENSON POUR L'UTILISATION DES VAGUES DE LA MER, Recherches et Inventions, No. 185, February 1930, pp. 41-43.
- 28S. Savonius, Sigurd J., WINDRAD MIT ZWEI HOHLFLUGELN, DEREN INNEKANTEN EINEN ZENTRALEN WINDDURCHLASSPALT FREIGEBEN UND SICH UBERGREIFEN, German Patent, No. 495518, April 14, 1930.

- 29S. (Savonius), FLY A "ROTOR KITE", THE LATEST FLYING WONDER, Popular Aviation, Vol. 7, No. 4, November 1930, p. 56. (See also: National Power Glider, Vol. 1, No. 5, December 1930, p. 57.)
- 30S. (Savonius), ROTOR KITES, WHY AND HOW THEY FLY, National Power Glider, Vol. 1, No. 6, January 1931, pp. 48, 60.
- 31S. Savonius, S. J., THE S-ROTOR AND ITS APPLICATION, Mechanical Engineering, Vol. 53, No. 5, May 1931, pp. 333-338 and Cover.
- 32S. (Savonius), THE S-ROTOR, Science (Supplement), Vol. 73, No. 1900, May 29, 1931, p. 14.
- 33S. (Savonius), WINDMILL OF THE ROTOR TYPE PROVIDES WATER SUPPLY, Popular Mechanics Magazine, Vol. 56, No. 1, July 1931, p. 98.
- 34S. (Savonius), ROTOR INVENTION MAY BRING BACK WINDMILL, Popular Science Monthly, Vol. 119, No. 2, August 1931, p. 54.
- 35S. (Savonius), PRIZE WINNERS IN P. A. MODEL CONTEST, Popular Aviation, Vol. 12, No. 4, April 1933, p. 242.
- 36S. (Savonius), M AND M READER INVENTS REVOLUTIONARY ROTOR, Modern Mechanics, Vol. 10, October 1933, p. 64.
- 37S. (Savonius), THE SAVONIUS ROTOR, APPENDIX C, Wind Turbine Project, No. 144, New York University, College of Engineering and War Production Board, New York, New York, January 31, 1946, pp. 249-263.
- 38S. Schackleton, W. S., THE ROHRBACH ROTATING WING AEROPLANE, Flight, Vol. 25, No. 1297-98, November 2-9, 1933, pp. 1087-1090, 1122-1124. (See also: Les Ailes, May 11, 1933; Aviation, June 1933; and Flight, February 2, 1933.)
- 39S. Schieber, Walther, ENERGIEQUELLE WINDKRAFT, Faeltrager-Verlag, Berlin, Germany, 1942, pp. 105, 127.
- 40S. Schmidt, L. E., and Murphy, C. H., EFFECT OF SPIN ON AERODYNAMIC PROPERTIES OF BODIES OF REVOLUTION, BRL Memorandum Report No. 715, Ballistic Research Laboratories, Aberdeen Proving Ground, Maryland, August 1933, p. 30.
- 41S. Schmidt, Wilhelm, EINRICHTUNG ZUR ERZEUGUNG EINER STROMMITTELKRAFT, INSBESONDERE AN FLUGZFUEN, German Patent, No. 678398, July 30, 1940.

- 42S. Schraidt, W., and Reichstein, G., FLUGEL MIT ROTOR, Jahrbuch 1941 Der Deutschen Luftfahrt-Forschung, 1941, pp. 1367-1371.
- 43S. Schmidt, Wilhelm, RANDLAUFVERSUCHE MIT EINEM SCHLAG-RUDERMODELL IN LUFT, Deutsche Flugtechnik, Vol. 3, No. 11, November 1959, pp. 338-341.
- 44S. Schmidt, Wilhelm, VORTRIEBSERZEUGUNG DURCH GEWELLTE STROMUNG, Deutsche Flugtechnik, Vol. 4, No. 7, July 1960, pp. 208-209.
- 45S. Schmidt, Wilhelm, STRAHLTRIEB MIT GEWELLETEN STRAHL, Deutsche Flugtechnik, Vol. 4, No. 11, November 1960, pp. 331-332.
- 46S. Schmidt, Wilhelm, ADAPTING A WING WITH A FLAPPING RUDDER TO A WING FLAP, FTD-TT-61-125/1, Translation Services Branch, Foreign Technology Division, WP-AFB, Ohio, January 25, 1962 (Trans. from: Deutsche Flugtechnik, Vol. 4, No. 11, 1960, pp. 350-352).
- 47S. Schmidt, Wilhelm, ANTRIEBSEINRICHTUNG FUR LUFT-LAND-UND WASSER FAHRZEUGE, German Patent, No. 1123565, February 8, 1962.
- 48S. (Schmidt), Forschungszentrum der Luftfahrtindustrie, ANTRIEBSEINRICHTUNG FUR LUFT-LAND-UND WASSERFAHRZEUGE, Austrian Patent, No. 220482, March 26, 1962.
- 49S. (Schmidt), Forschungszentrum der Luftfahrtindustrie, ANTRIEBSEINRICHTUNG FUR FAHRZEUGE MIT TRAGFLUGEL, Austrian Patent, No. 223951, October 25, 1962.
- 50S. Schmidt, Wilhelm, DRIVE MEANS FOR LAND, WATER AND AIRCRAFT, U.S. Patent, No. 3068642, December 18, 1962.
- 51S. (Schmidt), LUFTFAHRT-PATENTE, TRAGFLUGEL FUR FLUGZEUGE MIT AUS DER HINTERKANTE AUSTRETENDEM FLACHEM ANTRIEBSSTRAHL, Flug-Revue International, No. 9, September 1963, p. 31.
- 52S. Schmidt, Wilhelm, DRIVING ARRANGEMENT FOR LAND, WATER AND AIRCRAFT, U.S. Patent, No. 3111928, November 26, 1963.
- 53S. Schmidt, Wilhelm, DRIVING ARRANGEMENT FOR LAND, WATER AND AIRCRAFT, U.S. Patent, No. 3215371, November 2, 1965.

- 54S. Schmidt, Wilhelm, DER WELLPROPELLER, EIN NEUER ANTRIEB FUR WASSER-LAND-UND LUFTFAHRZEUGE, Zeitschrift fur Flugwissenschaften, Vol. 13, No. 12, December 1965, pp. 472-479.
- 55S. Schneider, Ernst, IMPROVEMENTS IN BLADE-WHEELS FOR TURBINES, TURBINE PUMPS OR THE LIKE APPARATUS, British Patent, No. 262393, July 21, 1927.
- 56S. Schneider, E., BLADE WHEEL PROPELLER, PARTICULARLY FOR WATERCRAFT, U.S. Patent, No. 2291062, July 28, 1942.
- 57S. Schneider, Ernst, CYCLOIDAL PROPULSION BLADE KINEMATICS, FLOW AND ENERGY CONDITIONS AND GENERAL CONSIDERATIONS, Davidson Laboratory Technical Note No. 521, Stevens Institute of Technology, Hoboken, New Jersey, February 1959. (Trans. from: Werft-Reederei-Hafen, June 15, 1933, pp. 161-169).
- 58S. Schober, Josef, ROTIERENDES WINDFLUGGERAT MIT EINEM ZWISCHEN SEITLICHEN SCHEIBEN GEHALTENEN FLUGEL, German Patent, No. 1078481, March 24, 1960.
- 59S. Schramm, Hans, DER SCHWINGENFLUG DER TIERE UND SEINE BEDEUTUNG FUR DIE TECHNIK, Flugsport, Vol. 15, No. 34, 1923, pp. 41-46.
- 60S. Schrenk, O., UNTERSUCHUNG VON DACHLUFTERN, Ergebnisse der Aerodynamischen Versuchsanstalt zu Gottingen, No. 4, 1932, pp. 123-126.
- 61S. Schroeder, E. A., PROPELLER, U.S. Patent, No. 1720969, July 1929.
- 62S. Schule, Albert, WINDKRAFTANLAGE, Swiss Patent, No. 224274, February 1, 1943.
- 63S. (Schulmann), ESTONIA CREDITED WITH MAKING ROTOR SHIP, New York Times, Vol. 74, No. 24480, February 1, 1925, pp. VII-13.
- 64S. Schulze, Hans-Georg, and Stiasny, Willi, FLUG DURCH MUSKELKRAFT, Naturkunde und Technik, Verlag Fritz Knapp, Frankfurt, Germany, 1936, pp. 187-189.
- 65S. Schutz, Siegfried, PROPULSEUR POUR AVIATEURS, French Patent, No. 397115, December 5, 1908.
- 66S. Schweizer, Fritz, ANTRIEB VON FLUGZEUGEN MITTELS KREISENDER FLUGEL, German Patent, No. 482697, January 27, 1926.

- 67S. Schwend, Friedrich, FLUGZEUGTRAGFLUGEL, German Patent, No. 585563, October 5, 1933.
- 68S. Scott, Emory F., A REVOLVING WING AIRPLANE, Popular Aviation, Vol. 18, No. 5, May 1936, pp. 323-324, 376.
- 69S. Scotter, Walter Charles, IMPROVEMENT IN PLANES, BLADES OR VANES FOR LIFTING, DRIVING AND LIKE PURPOSES, British Patent, No. 16424, July 20, 1914.
- 70S. Scotter, Walter Charles, IMPROVEMENTS IN OR RELATING TO PLANES, BLADES OR VANES FOR LIFTING, DRIVING AND LIKE PURPOSES, British Patent, No. 275689, August 8, 1927.
- 71S. (Scotter), MOVING WING STOPS STALL, Science and Invention, Vol. 7, No. 9, January 1930, p. 792.
- 72S. Scotter, Walter Charles, and Clarence, Roy, IMPROVEMENT IN OR IN CONNECTION WITH FLYING MACHINES, ALSO APPLICABLE TO PROPELLERS FOR THE SAME AND TO APPARATUS FOR OTHER PURPOSES, British Patent, No. 17981, December 24, 1915.
- 73S. See, Alexandre, LES LOIS EXPERIMENTALES DE L'AVIATION, Librairie Aeronautique, Paris, France, 1911, pp. 94-96.
- 74S. Seeley, L. S., THE STABILIZING POTENTIAL OF THE CYCLOIDAL PROPELLER, Report No. TN-4064-G, Aeromechanics Division, Weapons Development Department, NOTS, China Lake, California, May 1963.
- 75S. Seger, S. M., ANORDNING VID HELIKOPTRAR, Swedish Patent, No. 116478, May 28, 1946.
- 76S. Selden, F. H., ANORDNING VID LUFTFARTYGG, BATAR ELLER DYLIKT, Swedish Patent, No. 98715, April 23, 1940.
- 77S. (Serpellet), APPAREIL DESTINE A S'ELEVER, A SE SOUTENIR, A SE DIRIGER DANS L'ATMOSPHERE, L'Aerophile, Vol. 11, No. 6, June 1903, pp. 131-134.
- 78S. Seybold, G. B., A SAILING SHIP WITHOUT SAILS, NEW WONDER OF SEAS, Popular Science Monthly, Vol. 106, No. 2, February 1925, pp. 35-36, 147-148.
- 79S. Shackleton, W. S., THE ROHRBACH ROTATING WING AIRPLANE, Flight, Vol. 25, No. 44(1297), November 1933, pp. 1087-1090, 1122-1124.
- 80S. Shackleton, W. S., THE ROHRBACH ROTATING WING AIRPLANE, Mechanical Engineering, February 1934, p. 100.

- 81S. Shanahan, R. J., VTOL/STOL AIRCRAFT, Bibliography 2, Second Supplement, 1963/64/65, Advisory Group for Aerospace Research and Development, Paris, France, 1966, p. 329.
- 82S. Shapiro, Jacob, PRINCIPLES OF HELICOPTER ENGINEERING, Temple Press, Ltd., London, England, 1955, pp. 23, 348-349.
- 83S. Shi, Cheng, AN EXPERIMENTAL INVESTIGATION OF THE AUTOROTATION OF A FLAT PLATE, Master's Thesis, University of British Columbia, November 1966.
- 84S. Shirmanow, P. M. I., I. YAWING MOMENT OF AN ISOLATED AIRFOIL, II. TEST OF AN AIRFOIL AT ANGLES OF INCIDENCE FROM 0° TO 360° , No. 36(271), Transactions of the Central Aero-Hydrodynamical Institute (AHI), Moscow, Russia, 1928.
- 85S. Short, Hugh Oswald, IMPROVEMENTS IN AND CONNECTED WITH SUSTAINING DEVICES FOR AIRCRAFT, British Patent, No. 233083, May 7, 1925.
- 86S. SIDEWHEEL AVIATION, Aviation, Vol. 32, March and June 1933, pp. 96 and 183.
- 87S. Sieron, Thomas R., ON THE MAGNUS EFFECTS OF AN INCLINED SPINNING SHELL AT SUBSONIC AND TRANSONIC SPEEDS, WADD Technical Report No. 60-212, Aeronautical Systems Division, Wright-Patterson AFB, Ohio, April 1961.
- 88S. Silvestri, Arnaldo, ALI ROTANTI-VARIAZIONI SUL TEMA, L'Ala D'Italia, Vol. 12, No. 4, August 1934, pp. 39-40.
- 89S. (Sinkins), AN AERIAL PADDLE, Flight, Vol. 4, No. 11, January 22, 1910, p. 66.
- 90S. Simonds, M. H., and Bodek, A., PERFORMANCE TEST OF A SAVONIUS ROTOR, Technical Report No. T10, Brace Research Institute, McGill University, Montreal, Canada, January 1964.
- 91S. Simoulin, Leon, AEROPLANE A PALETTE, French Patent, No. 413874, March 21, 1910.
- 92S. Siwag Propeller-Rotorenbau G. m. b. M., A DEVICE FOR EXTRACTING POWER FROM FLOWING MEDIA, British Patent, No. 387899, July 28, 1931.
- 93S. Smith, A. M. O., ON THE MOTION OF A TUMBLING BODY, Journal of the Aeronautical Sciences, Vol. 20, No. 2, February 1953, pp. 73-84.
- 94S. Smith, Charles E., AEROPLANE PROPELLER, U.S. Patent, No. 1759468, May 20, 1930.

- 95S. Smith, Joseph E., ROTARY KITE, U.S. Patent, No. 2768803, October 30, 1956.
- 96S. Smith, M. A., THE MAGNUS CHARACTERISTICS OF DESIGNEDLY AUTOROTATING BODIES IN A SINGLE DEGREE OF FREEDOM IN AXIAL ROTATION, Unpublished Paper (Thesis), Department of Aero-Space Engineering, University of Notre Dame, South Bend, Indiana, May 1967.
- 97S. (Snell), THE SNELL EXPERIMENTS, Aeronautics (New York), Vol. 4, No. 5, June 1909, p. 193.
- 98S. Snow, Hal J., DRIVE AND MOUNTING FOR CYCLOIDAL PROPELLER, U.S. Patent, No. 3134443, May 26, 1964.
- 99S. Societe Anonyme des Brevets Leon, SCHOEPENRAD MET OIN EEN TROMMEL EN IN EEN TEGENGESTELDE RICHTING OUN HAAR EIGEN AS DRAAIENDE SCHOPEN, Dutch Patent, No. 35006, July 6, 1932.
- 100S. Societe Provencale de Construction Aeronautiques, FLUGZEUG MIT ON EINE WAAGERECHE ACHSE DREHBAREN HILFS-FLUGELN, German Patent, No. 631891, July 15, 1936. (See also: Patent Sammlung des Flugsport, Vol. 6, No. 25, 1936, p. 97.)
- 101S. Socvil, M., MACHINES VOLANTES A ROUES MUNIES DE VOILES, Les Inventions Nouvelles - Revue Universelle, Vol. 7, No. 6, March 20, 1894, pp. 241-244.
- 102S. Soloducha, N., AVION A AILES TOURNANTES, French Patent, No. 1007768, February 13, 1952.
- 103S. Soloviev, U. I., and Churmack, D. A., MARINE PROPULSION DEVICES, BuShips Translation No. 408, Bureau of Ships, Washington, D. C., 1948.
- 104S. Sonntag, Richard, DER KIRSTEN-BOEING-PROPELLER, Schiffbau, Vol. 28, No. 2, January 19, 1927, pp. 31-35.
- 105S. Sonsteness, T., AEROPLANE, U.S. Patent, No. 1831203, June 24, 1930.
- 106S. Sparenberg, J. A., ON THE EFFICIENCY OF A VERTICAL-AXIS PROPELLER, Third Symposium Naval Hydrodynamics, High Performance Ships, Office of Naval Research, Washington, D. C., September 19-22, 1960, pp. 45-66.
- 107S. Spratt, G. A., CURVATURE A RELATIVE TERM, Aeronautics (New York), Vol. 2, No. 3, March 1908, p. 15. (See also: Fly Magazine, Vol. 4, No. 11, September 1912, p. 13.)

- 108S. Springer, R. W., FLYING MACHINE, U.S. Patent, No. 1208395, December 12, 1916.
- 109S. Springer, Ruter William, FLUGVERFAHREN UND FLUGZEUG ZUR AUSFUHRUNG DESSELBEN, Swiss Patent, No. 89773, July 1, 1921, p. 15.
- 110S. Stalker, Edward A., THE EXTRACTION OF ENERGY FROM THE WIND, Journal of the Aeronautical Sciences, Vol. 2, No. 4, July 1935, pp. 162-167.
- 111S. Stefan, Karl H., MAGNUS EFFECT ON A BODY OF REVOLUTION AT VARIOUS ANGLES OF ATTACK, Master's Thesis, Department of Aeronautical Engineering, University of Minnesota. Minneapolis, Minnesota, 1949.
- 112S. Stefanides, E. J., HYDRAULIC DRIVE CONTROLS SPEED OF TOW TANK CARRIAGE, Design News, Vol. 17, No. 26, December 26, 1962, pp. 48-49.
- 113S. Steigert, Robert A., AIRCRAFT OF THE HEAVIER THAN AIR TYPE, U.S. Patent, No. 1875276, August 30, 1932.
- 114S. Stephan, Raymond J., FLYING TOY, U.S. Patent, No. 2548748, April 10, 1951.
- 115S. Stevinson, H. T., and Makow, D., A TUMBLING AEROFOIL RADIO DISTRESS BEACON SYSTEM FOR LOCATING CRASHED AIRCRAFT, National Research Council Report No. MR-22, July 1958.
- 116S. Stilley, G. D., SOME TECHNIQUES FOR STABILITY ANALYSIS OF ROTATING GLIDE VEHICLES, Honeywell, Inc., Ordnance Division, May 1967.
- 117S. Stone, Ralph W., Jr., and Daughtridge, Lee T., Jr., FREE SPINNING, LONGITUDINAL-TRIM, AND TUMBLING TESTS OF 1/17.8 SCALE MODELS OF THE CORNELIUS XFG-1 GLIDER, NACA Wartime Report MR L5K 21(L-738), January 1946.
- 118S. Stone, Ralph W., Jr., and Bryant, Robert L., SUMMARY OF RESULTS OF TUMBLING INVESTIGATIONS MADE IN THE LANGLEY 20 FOOT FREE-SPINNING TUNNEL ON 14 DYNAMIC MODELS, NACA Research Memorandum RM L8J28, December 31, 1948.
- 119S. Strandgren, Carl Bruno, IMPROVEMENTS IN FEATHERING PADDLE WHEEL PROPELLERS AND MOTORS, British Patent, No. 248028, October 28, 1924.

- 120S. Strandgren, Carl Bruno, IMPROVEMENTS IN TURBINE WHEEL PROPELLER AND MOTORS, British Patent, No. 285911, February 25, 1927.
- 121S. Strandgren, Carl Bruno, TURBINE-WHEEL PROPELLER AND MOTOR, U.S. Patent, No. 1639908, August 23, 1927.
- 122S. Strandgren, Carl Bruno, TURBINE WHEEL PROPELLER AND MOTOR, U.S. Patent, No. 1753252, April 8, 1930.
- 123S. Strandgren, Carl Bruno, FLUGELRAD, German Patent, No. 518733, February 19, 1931.
- 124S. Strandgren, Carl Bruno, FLUGELRAD MIT IN EINER PERIODE WAHREND EINES RADUMLAUFES SCHWINGENDEN FLUGELN, German Patent, No. 533202, September 10, 1931.
- 125S. Strandgren, Carl Bruno, TURBINE WHEEL PROPELLER AND MOTOR, U.S. Patent, No. 1885640, November 1, 1932.
- 126S. Strandgren, C. B., PERFECTIONNEMENT AUX ROUES A AILES OU ORGANES ANALOGUES, SUSTENTATRICES ET PROPULSIVES OU MOTRICES, French Patent, No. 747747, April 4, 1933.
- 127S. (Strandgren), LES ESSAIS DE LA ROUE STRANDGREN, Les Ailes, Vol. 13, No. 621, May 11, 1933, p. 8.
- 128S. (Strandgren), FLUGELRADFLUGZEUG STRANDGREN, Flugsport, Vol. 25, No. 14, July 5, 1933, pp. 285-287.
- 129S. Strandgren, C. B., STRANDGREN ROTORS, Mechanical Engineering, Vol. 55, No. 11, November 1933, p. 694.
- 130S. Strandgren, C. B., THE THEORY OF THE STRANDGREN CYCLOGIRO, NACA Technical Memorandum TM 727, November 1933 (Trans. from: L'Aerophile, Vol. 41, No. 7, July 1933, pp. 209-215).
- 131S. (Strandgren), SURVEY OF ENGINEERING PROGRESS, Mechanical Engineering, Vol. 56, No. 2, February 1934, p. 160.
- 132S. Strandgren, C. B., THE STRANDGREN CYCLOGIRO, Mechanical Engineering, Vol. 56, No. 9, September 1934, pp. 535-537, 567-568.
- 133S. Strandgren, Carl Bruno, FEATHERING PADDLE WHEEL, U.S. Patent, No. 2023750, December 10, 1935.
- 134S. (Strandgren), PADDLE WHEEL DRIVES PLANE, Popular Science Monthly, Vol. 129, No. 2, August 1936, p. 37.

- 135S. Strandgren, Carl Bruno, FLUGELRAD, INSBESONDERE AN FLUGZEUGEN, German Patent, No. 635962, September 29, 1936.
- 136S. Strandgren, Carl Bruno, SCHWINGFLUGELRAD, INSBESONDERE ZUR VOR-UND AUFTRIEBSERZEUGUNG AN LUFTFAHRZEUGEN, German Patent, No. 651236, October 9, 1937.
- 137S. Strong, William J. H., ROTOR CRAFT, U.S. Patent, No. 1725316, August 20, 1929.
- 138S. Strubreither, Walter, WIND TURBINE, Austrian Patent, No. 155578, February 25, 1939.
- 139S. Stuart, A. A., REVOLUTIONARY NEW PROPELLERS, Popular Science Monthly, Vol. 107, No. 2, August 1925, p. 42.
- 140S. Suffczynski, Piotr, WINDKRAFTMASCHINE, German Patent, No. 821930, November 22, 1951.
- 141S. Sunguroff, Eugene, PROPULSEUR AERIEN, French Patent, No. 402421, April 26, 1909.
- 142S. Swanson, W. M., AN EXPERIMENTAL INVESTIGATION OF THE MAGNUS EFFECT, Final Report, OOR Project No. 1082, Case Institute of Technology, December 1956.
- 143S. Swanson, W. M., THE MAGNUS EFFECT: A SUMMARY OF INVESTIGATIONS TO DATE, Journal of Basic Engineering Series D (Transactions ASME), Vol. 3, No. 3, September 1961, pp. 461-470. (See also: Mechanical Engineering, Vol. 83, No. 2, February 1961, p. 95.)
- 144S. Szafranski, Frank L., and Rogozynski, John, AIRPLANE CONTROL SIDE PROPELLER MECHANISM, U.S. Patent, No. 1951739, May 8, 1934.
- 145S. Stone, George W., ONE-DEGREE-OF-FREEDOM AUTOROTATION CHARACTERISTICS OF FLAT PLATES AT LOW SUBSONIC SPEEDS, Paper Presented at: Sixth AIAA Aerospace Science Meeting, New York, New York, No. SC-DC-67-1951, July 1967.
- 146S. Sarpkaya, Turgut, SEPERATED UNSTEADY FLOW ABOUT A ROTATING PLATE, Midwestern Mechanics Conference, 10th., Colorado State University, Fort Collins, Colorado. Proceedings. Johnson Publishing Company, Boulder, Colorado. August 21-23, 1967, p.1485-1499.
- 147S. Sare, Ted O., POND MILL, U.S. Patent, No. 3373821, March 19, 1968.

- 148S. Schmidt, Wilhelm, EINRICHTUNG ZUR ERZEUGUNG EINER STROMMITTELKRAFT INSBESONDERE ZUM ANTRIEBE VON FLUGZEUGEN MIT HILFE EINES SCHLAGROTORS, German Patent, No. 714562, December 2, 1941.
- 149S. Struzyna, Vincenz, QUERTRIEBSKORPER INSBESONDERE ZUM ANTRIEB VON SCHIFFEN, German Patent, No. 450962, October 17, 1927.

T

- 1T. Tabor, Harry Z., POWER FOR REMOTE AREAS, International Science and Technology, No. 65, May 1967, p. 54.
- 2T. Taggart, Robert, MARINE PROPULSION, A HISTORY OF PROPULSION DEVELOPMENT, THE VERTICAL AXIS PROPELLER, Technical Report, Vol. 1, Phase 1, USATRECOM, Fort Eustis, Virginia, July 15, 1957, pp. 89-93.
- 3T. Taggart, Robert, MARINE PROPULSION, PHYSICAL PHENOMENA, AND MARINE PROPULSION, Technical Report, Vol. 2, Phase 1, USATRECOM, Fort Eustis, Virginia, July 15, 1957, pp. 44-51.
- 4T. Tamburini, Aurelio, PROPULSORE A SPINTA ORIENTABILE E INVERTIBILE, PER NAVI, Italian Patent, No. 433531, April 10, 1948.
- 5T. Taniguchi, K., AN APPROXIMATE SOLUTION OF THE VOITH-SCHNEIDER PROPELLERS, Journal Zosenkokai, (Transaction of Society of Naval Architects of Japan), Vol. 74, 1944, pp. 153-161.
- 6T. Taniguchi, K., HYDRODYNAMIC INVESTIGATIONS OF THE BLADE WHEEL PROPELLER, Journal Zosenkokai (Transaction of Society of Naval Architects of Japan), Vol. 88, 1950, pp. 63-74.
- 7T. Taniguchi, K., STUDIES ON A TROCHOIDAL PROPELLER, Doctor of Engineering Thesis, Tokyo University, Tokyo, Japan, 1960.
- 8T. Taniguchi, K., SEA TRIAL ANALYSIS OF THE VERTICAL AXIS PROPELLERS, MITSUBISHI EXPERIMENTAL TANK, NAGASAKI, JAPAN, Paper Presented at the Fourth Symposium on Naval Hydrodynamics - Ship Propulsion and Hydroelasticity, Washington, D. C., August 27-31, 1962.
- 9T. Taraknov, A., S KOM INIROVANNV M ROTOROM, Krylia Rodiny, Vol. 16, No. 11, 1965, p. VII.
- 10T. Tarshis, HELICOPTER, U.S. Patent, No. 1807353, May 20, 1931.
- 11T. Tasse, Yvon R., LE VENT, PRODUCTEUR D'ELECTRICITE, Revue Trimestrielle Canadienne (L'Ingenieur), Vol. 21, No. 83, September 1935, pp. 283, 290-292.

- 12T. Taylor, Frederick W. T., AERIAL MACHINE, U.S. Patent, No. 1122171, December 22, 1914.
- 13T. Taylor, J. G., CONFERENCE ON PLATT VERTIGIRO AND CYCLOGIRO DESIGNS, No. A 10.22/1, Air Service Branch, Wright Field, March 1934, p. 2.
- 14T. Teil, Erster, LUDWIG PRANDTL GESAMMELTE ABHANDLUNGEN, Springer-Verlag, Berlin, Germany, 1961, p. 248.
- 15T. TESTING THE FLETTNER "ROTOR" IN ACTUAL FLIGHT, A POSSIBLE FIELD FOR THE LIGHT PLANE, Flight, Vol. 16, No. 49(832), December 4, 1924, p. 759.
- 16T. Thacker, Robert G., and Kelly, Howard R., THE SUBSONIC AERODYNAMIC CHARACTERISTICS OF SPINNING OGIVE-CYLINDERS AT SMALL ANGLES OF ATTACK, NAVORD Report No. 4988, U.S. Naval Ordnance Test Station, China Lake, California, December 14, 1955.
- 17T. Thibault, Emile Henri, VOILURE TOURNANTE POUR AVIONS, French Patent, No. 786589, February 23, 1935.
- 18T. Thibault, Emile H., FLYING MACHINE, U.S. Patent, No. 2106820, February 1, 1938.
- 19T. Thom, A., EXPERIMENTS ON THE AIR FORCES ON ROTATING CYLINDERS, Reports and Memoranda No. 1018, Aeronautical Research Committee, Farnborough, England, February 1925.
- 20T. Thom, A., THE AERODYNAMICS OF A ROTATING CYLINDER, Thesis, University of Glasgow, 1926.
- 21T. Thom, A., THE PRESSURES ROUND A CYLINDER ROTATING IN AN AIR CURRENT, Reports and Memoranda No. 1082, Aeronautical Research Committee, Farnborough, Eng., November 1926.
- 22T. Thom, A., EXPERIMENTS ON THE FLOW PAST A ROTATING CYLINDER, Reports and Memoranda No. 1410, Aeronautical Research Committee, Farnborough, England, March 1931.
- 23T. Thom, A., and Sengupta, S. R., AIR TORQUE ON A CYLINDER ROTATING IN AN AIR STREAM, Reports and Memoranda No. 1520, Aeronautical Research Committee, Farnborough, Eng., October 1932.
- 24T. Thom, A., EFFECTS OF DISCS ON THE AIR FORCES ON A ROTATING CYLINDER, Reports and Memoranda No. 1623, Aeronautical Research Committee, Farnborough, England, January 1934.
- 25T. Thomas, John E., FEATHERING PROPELLER, U.S. Patent, No. 1450159, March 27, 1923.

- 26T. (Thomas), MED-OCEAN AIRPLANE STATION GENERATES OWN POWER, Science and Invention, Vol. 7, No. 1, May 1929, p. 19.
- 27T. Thomas, Lynn C., CAN THE ROTOR PLANE BE PERFECTED?, Popular Aviation, Vol. 21, No. 2, August 1937, pp. 48, 63.
- 28T. Thompson, J. M., et al, AEROPLANE, U.S. Patent, No. 1540667, June 2, 1925.
- 29T. (Thompson), ROTOR ON WING ADDS TO PLANE'S POWER, Popular Science Monthly, Vol. 120, No. 2, February 1932, p. 50.
- 30T. (Thomson, J. J.), A SCIENTIST ON GOLF SCIENCE, Scientific American, Vol. 104, No. 6, February 11, 1911, pp. 136-137.
- 31T. Thrane, Victor, PROPELLING SYSTEM, U.S. Patent, No. 1673957, June 19, 1928.
- 32T. Thurston, Albert Peter, FIFTY YEARS THEORETICAL AND EXPERIMENTAL RESEARCH IN AERONAUTICS, Jubile Scientifique de M. Dimitri F. Riabouchinsky. Memoires sur la Mecanique des Fluides, Publications Scientifiques et Techniques du Ministere de l'Air, Paris, France, 1954, pp. 367, 330-381.
- 33T. Tino, Ovid, SUSTAINING AIRFOIL WITH RETRACTABLE CYLINDRICAL ROTOR, U.S. Patent, No. 2928626, March 15, 1960.
- 34T. Tokarzewski, Mieczyslaw, SNIGLO PLATOWO-WIROWE, Polish Patent, No. 281012, May 19, 1933.
- 35T. Topliff, Oliver, AIRPLANE DRIVE, U.S. Patent, No. 2050903, August 11, 1936.
- 36T. Tour, Castelcicala de la, ROLLING APRON FOR AIRPLANE WINGS, U.S. Patent, No. 1785300, December 16, 1930.
- 37T. Toussaint, Albert, APPENDICE, RESULTATS EXPERIMENTAUX SUR LES ROTORS CIRCULAIRES, Cours de Technique Aeronautique, Editions Scientifiques Riber, Paris, France, Date N/A, pp. 253-257.
- 38T. Tradt, M., DER UNEAU DES MOTORSEGLERS "BUCKAU" ZUM FLETTNER-ROTORSCHIFF UND SEINE ERPROBUNGEN, Werft, Reederei, Hafen, Vol. 22, No. 6, March 25, 1925, pp. 160-167.
- 39T. (Trancon), ROLLFLUGMODELLE VON HANS TRANCON (GRAZ), Fachzeitung fur Flugtechnik und Automobilismus, Vol. 3, No. 25, July 11, 1909, p. 23.

- 40T. Trautman, Oberbaurat, DER MAGNUS-EFFEKT UND SEINE TECHNISCHE ANWENDUNG IN ELEMENTARER MASCHINEN-TECHNISCHER BETRACHTUNG, Dinglers Polytechnisches Journal, Vol. 106, No. 12(340), June 1925, pp. 133-135.
- 41T. Tremolieres, Joseph-Pierre, AEROPLANE, French Patent, No. 381415, November 7, 1907.
- 42T. Trey, Serge, HELICOPTER, U.S. Patent, No. 1785333, December 16, 1930.
- 43T. Trey, Serge, AEROPLANE WING, U.S. Patent, No. 1879594, September 27, 1932.
- 44T. Tschijewsky, Paul, MOTEUR A VENT, Swiss Patent, No. 83570, May 17, 1920.
- 45T. Tsien, H. S., et al, AERODYNAMICS AND AIRCRAFT DESIGN, Vol. 4, Air Materiel Command, Wright Field, Ohio, May 1946, pp. 61-63.
- 46T. TSILINDRI FLETTNERA I NASHA RABOTA S NIMI, Samolet, No. 8(22), August 1925, pp. 20-21.
- 47T. Tsimbalyuka, S. K., O ROTORNOM ZMEE, Samolet, No. 4, April 1933, pp. 41-42.
- 48T. Thoulouze, L. M., CERF-VOLANT, French Patent, No. 1407209, June 17, 1964.

U

- 1U. Uselton, J. C., INVESTIGATION OF THE MAGNUS EFFECT AND THE EFFECTS OF UNSYMMETRICAL LEEWARD VORTEX PATTERN ON A HIGH FINENESS RATIO MODEL AT MACH NUMBER 3 AND 5, Master of Science Thesis, University of Tennessee, 1966.

V

- 1V. (Van Zandt), BUILT TO FLY, Washington Post, Rotogravure Section, October 2, 1938.
- 2V. Van Zandt, H., CONVERTIBLE FIXED-WING PADDLE WHEEL AIRCRAFT, U.S. Patent, No. 2633311, March 31, 1953.
- 3V. Vaughan, E. B., PROPELLING, British Patent, No. 185491, June 2, 1921.
- 4V. Vavry, M., DISPOSITIF POUR LA PROPULSION ET LA SUSTENTATION DES AERONEFS ET MACHINES VOLANTES, French Patent, No. 859454, June 3, 1940.
- 5V. Verdier, Pierre F. M., ORGANE DE SUSTENTATION A AILES MOBILES POUR APPAREILS D'AVIATION, French Patent, No. 390836, June 2, 1908.
- 6V. Vezzani, Renzo, IL PROBLEMA ITALIANO DELL'UTILIZZAZIONE DEL VENTO, Anna dei Lavori Pubblici, Vol. 130, No. 3, March 1942, pp. 170-171.
- 7V. Vielledent, Marius, ROUE A AUBES AVIATRICE, French Patent, No. 386406, January 21, 1908,
- 8V. Villepigue, Auguste-Dews, and Delaigue, A., SYSTEME D'AVIATEUR, French Patent, No. 389734, April 30, 1908.
- 9V. Vlados, Michael, WINDKRAFTMASCHINE MIT EINE WAAGERECHTE ACHSE UMLAUFENDEM HAUPTWINDRAD UND MIT DIESEN DREHBAR VERBUNDENEN UND MITUMLAUFENDEN HILFSWINDRADEN, German Patent, No. 563255, November 3, 1932.
- 10V. Voith, Ditta J. M., PROPULSORE A RUOTA A PALE, SPECIALMENTE PER VEICOLI ACQUATICI, Italian Patent, No. 380844, June 7, 1940.
- 11V. Voith, J. M., VOITH-SCHNEIDER SCHIFFSANTRIEB, Druckschrift, No. 1037, 1942, p. 32.
- 12V. Voith, J. M., DISPOSITIVO DI COMANDO PER PRODURRE LA DEVIAZIONE DELLE PALE NEI PROPULSORI IN FORMA DI RUOTE A PALE, Italian Patent, No. 404648, June 25, 1943.

- 13V. Voith, J. M., DISPOSITIVO DI COMANDO PER PROPULSORI A PASSO VARIABILE, SPECIALMENTE PER PROPULSORI IN-FORME DI RUOTA A PALE, Italian Patent, No. 411026, June 19, 1945.
- 14V. Voith, J. M., PADDLE WHEELS, British Patent, No. 733087, October 28, 1952.
- 15V. Voith, J. M., GMBH, VOITH-SCHNEIDER PROPULSION, J. M. Voith, GMBH, Meidenheim (Brenz), Germany, Date N/A, p. 40.
- 16V. Voith, Walter, et al, IMPROVEMENTS IN AND RELATING TO BLADED WHEELS, British Patent, No. 297803, September 28, 1927.
- 17V. Voith, Walter, et al, IMPROVEMENTS IN AND RELATING TO BLADED WHEELS, British Patent, No. 305226, February 2, 1928.
- 18V. Voith, Walter, Hermann, and Hanns, IMPROVEMENT IN OR RELATING TO BLADE WHEEL PROPELLERS WITH OSCILLATING BLADES, British Patent, No. 418486, March 15, 1934.
- 19V. Voith, Walter, Hermann, and Hanns, IMPROVEMENTS IN OR RELATING TO MEANS FOR ACTUATING THE ROTATABLE BLADES OF BLADE WHEELS, British Patent, No. 438317, November 14, 1935.
- 20V. Voith, Walter, Hermann, and Hanns, IMPROVEMENTS IN OR RELATING TO BLADE WHEEL PROPELLERS, British Patent, No. 501467, February 28, 1937.
- 21V. (Voith-Schneider), EIN NEUER SCHIFFSANTRIEB, Schiffbau und Shiffahrt, Vol. 30, No. 8, April 17, 1929, pp. 197-198.
- 22V. (Voith-Schneider), REPORT ON COMPARISON TESTS BETWEEN THE SCREW PROPELLER AND A SHIP WITH VOITH-SCHNEIDER PROPELLER - MODE NO. 817, Hamburg Model Basin Report 719, BuShips Translation, Bureau of Ships, Washington, D. C., April 9, 1930.
- 23V. (Voith-Schneider), THE VOITH-SCHNEIDER PROPULSION SYSTEM, The Engineer, Vol. 151, No. 3932, May 15, 1931.
- 24V. (Voith-Schneider), SCHAUFELRAD-FLUGZEUGE, Flugsport, Vol. 25, No. 3, February 1, 1933, pp. 55-56.
- 25V. (Voith-Schneider), TESTS BY FLEMING AND FERGUSON, VOITH-SCHNEIDER PROPELLER FERRY, Hamburg Model Basin Report 450, BuShips Translation, Bureau of Ships, Washington, D. C., May 16-19, 1938.

- 26V. (Voith-Schneider), MODEL EXPERIMENTS WITH A 250-BHP MOTORBOAT WITH A VOITH-SCHNEIDER PROPELLER, Hamburg Model Basin Report 675, BuShips Translation, Bureau of Ships, Washington, D. C., October 13, 1941.
- 27V. (Voith-Schneider), STUDY OF A SINGLE VOITH-SCHNEIDER PROPELLER BLADE, TC Board Project 7M-7, Report No. 10, Transportation Corps Board, Fort Monroe, Virginia, November 30, 1945.
- 28V. (Voith-Schneider), GERMAN CRAFT WITH VOITH-SCHNEIDER PROPELLERS, Shipbuilding and Shipping Record, Vol. 84, No. 13, September 23, 1954, pp. 409-413.
- 29V. (Voith-Schneider), VOITH-SCHNEIDER PROPELLERS, Model Technik, Vol. 10, No. 2, 1960, pp. 22-25.
- 30V. (Voith-Schneider), SCALE TESTS WITH VOITH-SCHNEIDER MODEL PROPELLERS, Hamburg Model Basin Report 640, BuShips Translation No. 710, Bureau of Ships, Washington, D. C., April 1960.
- 31V. (Voith-Schneider), SCREW AND VOITH-SCHNEIDER PROPELLERS, Hamburg Model Basin Report Topic 17-a, BuShips Translation No. 712, Bureau of Ships, Washington, D. C., April 1960.
- 32V. (Voith-Schneider), MODEL TESTS ON A HIGH-SPEED RHINE STEAMER WITH SIDE-MOUNTED VOITH-SCHNEIDER PROPELLERS, Hamburg Model Basin Report 352, BuShips Translation No. 713, Bureau of Ships, Washington, D. C., April 1960.
- 33V. (Voith-Schneider), VOITH-SCHNEIDER PROPELLER, Hamburg Model Basin Report 316, BuShips Translation No. 714, Bureau of Ships, Washington, D. C., April 1960.
- 34V. (Voith-Schneider), VERTICAL AXIS PROPELLERS, International Shipbuilding Progress, Vol. 13, No. 148, December 1966, pp. 399-401.
- 35V. Voelker, H., THE INTEGRATION OF THE VOITH-SCHNEIDER PROPULSION INTO SHIP DESIGN, BuShips Translation No. 716, Bureau of Ships, Washington, D. C., June 1960 (Trans. from: Werft-Reederei-Hafen, Vol. 17, No. 13, June 15, 1936, pp. 189-191).
- 36V. Vogel, F., AIRSHIP PROPULSION, U.S. Patent, No. 2364496, December 5, 1944.
- 37V. (Volf), "CYCLONE" WIND MILL, Science and Mechanics, Vol. 5, No. 9, October 1934, p. 550.

W

- 1W. Waal, W. van de, and Janssens, A., AVION JOUET EN MATIERE PLASTIQUE, DONT LES AILES SONT MONTEES PAR ROTATION AROUND D'UN AXE, Belgium Patent, No. 501770, March 31, 1951.
- 2W. Waite, J. N., AERIAL MACHINES WITHOUT AEROSTATS, PROPELLING, STEERING, British Patent, No. 4533, February 21, 1914.
- 3W. Wander, Frederick, Jr., HELIROTOR FOR AEROPLANES, U.S. Patent, No. 1766472, June 24, 1930.
- 4W. Wander, Frederick, Jr., ADJUSTABLE ROTOR FOR AEROPLANES AND HELICOPTER ROTORS, U.S. Patent, No. 1810584, June 16, 1931.
- 5W. Wander, F., Jr., ROTARY WING FOR AEROPLANES, U.S. Patent, No. 1825493, September 29, 1931.
- 6W. Wander, Frederick, Jr., AUTOHELIROTOR, U.S. Patent, No. 1834558, December 1931.
- 7W. Wander, F., Jr., ROTARY WING FOR AEROPLANES, U.S. Patent, No. 1839005, December 29, 1931.
- 8W. Wander, F., Jr., ROTARY WING FOR AIRPLANE AND THE LIKE, U.S. Patent, No. 2065254, December 22, 1936.
- 9W. Warshavsky, A. N. H., FLYING MACHINE, U.S. Patent, No. 944301, December 28, 1909.
- 10W. Watson, Preston Albert, MACHINE VOLANTE, French Patent, No. 395469, October 19, 1908.
- 11W. Weigmann, Carl, MACHINE VOLANTE, French Patent, No. 400813, March 15, 1909.
- 12W. (Weise), MOTEUR A VENT A AXE VERTICAL, Inventions Nouvelles, Vol. 7, 1894, p. 19.
- 13W. Wellner, Georg, UBER DIE MOGLICHKEIT DER LUFTSCHIFFFAHRT, Hof-Buchhandlung Carl Winiker, Brunn, 1883, p. 22.

- 14W. Wellner, G., DIE SEGELRADVERSUCHE, Zeitschrift des Oesterr Ingenieur und Architekten Vereines, Vol. 66, No. 50, 1894, pp. 562-566.
- 15W. Wellner, Georg; FLYING APPARATUS, U.S. Patent, No. 516581, March 1894, p. 4.
- 16W. Wellner, G., RADFLIEGER MIT SCHLAGFLUGELRADERN, Die Flugmaschinen, A. Hartleben's Verlag, Vienna and Leipzig, 1910, pp. 102-104.
- 17W. (Wellner), SEGELRAD FUR FLUGMASCHINEN VON G. WELLNER, Dinglers Polytechnisches Journal, No. 7, 1894, pp. 148-149.
- 18W. Wellner, Georg, DIE SEGELRADFLUGMASCHINE, Zeitschrift fur Luftschiffahrt, und Physik der Atmosphere, Vol. 13, No. 3/4 11, 1894, pp. 86-96, 298, 299.
- 19W. (Wellner), WELLNER'S FLYING MACHINE, Aeronautics (New York), Vol. 1, No. 9, June 1894, pp. 113-114.
- 20W. (Wellner), L'APPAREIL DU PROFESSEUR WELLNER, L'Aeronaute, No. 8, August 1894, pp. 174-175.
- 21W. Wellner, Georg, DIE FLUGMASCHINE SYSTEME, Zeitschrift fur Luftschiffahrt und Physik der Atmosphere, Vol. 19, No. 4, 1900, pp. 83-85.
- 22W. (Wellner), PROFESSOR GEORG WELLNER, Wiener Luftschiffer Zeitung, April 1904, pp. 85-86.
- 23W. Werle, H., LES MOUVEMENTS PLANS, NON STATIONNAIRES, A CIRCULATION CONSTANTE, La Recherche Aeronautique, No. 26, March-April 1952, pp. 13-18.
- 24W. Weyl, A. R., HIGH-LIFT DEVICES AND TAILLESS AEROPLANES, Aircraft Engineering, Vol. 17, No. 200, October 1945, pp. 327-328.
- 25W. Wheatley, John B., SIMPLIFIED AERODYNAMIC ANALYSIS OF THE CYCLOGIRO ROTATING-WING SYSTEM, NACA Technical Note 467, August 1933.
- 26W. Wheatley, John Brooks, CHOICE OF AIRFOILS FOR ROTATING WING AIRCRAFT, Journal of the Aeronautical Sciences, Vol. 1, No. 2, April 1934, pp. 88-90.

- 27W. Wheatley, John Brooks, ROTATING WING AIRCRAFT COMPARED TO THE CONVENTIONAL AIRPLANES, S. A. E. Journal (Transactions), Vol. 34-35, April 1934, pp. 115-116.
- 28W. Wheatley, John, and Windler, Ray, WIND TUNNEL TESTS OF A CYCLOGIRO ROTOR, NACA Technical Note 528, May 1935.
- 29W. (Wheatley), THE NACA RECEIVES CALLERS-THE CYCLOGIRO, Aviation, Vol. 32, No. 6, June 1933, p. 183.
- 30W. (Wheatley), SIMPLIFIED AERODYNAMIC ANALYSIS OF THE CYCLOGIRO ROTATING WING SYSTEM, Mechanical Engineering, Vol. 55, No. 11, November 1933, p. 694.
- 31W. Wiessler, Gaston A. A., AIRCRAFT WITH MIXED TYPE PROPULSION AND SUSTAINING MEANS, U.S. Patent, No. 2507657, May 1950, p. 7.
- 32W. Wiessler, Gaston Antoine Auguste, PERFECTIONNEMENTS APPORTES AUX AERODYNES, French Patent, No. 1010011, March 1952, p. 4.
- 33W. Wilcox, A. C., AIRCRAFT, U.S. Patent, No. 1722651, July 1929, p. 8.
- 34W. Wilfart, Charles M., AUTO-VOLANT, French Patent, No. 357036, July 1905, p. 4.
- 35W. Wilhofft, F. O., INDUSTRIAL APPLICATIONS OF THE FLETTNER ROTOR, Mechanical Engineering, Vol. 49, No. 3, March 1927, pp. 249-253.
- 36W. Wilke, Gerhard, FLUGZEUG MIT UM QUERACHSEN ROTIERENDEN ZYLINDERN, German Patent, No. 474719, April 1929, p. 2.
- 37W. Will, Otto, GYROSCOPE-PROPELLER, U.S. Patent, No. 1270998, July 1918, p. 4.
- 38W. Wilson, C. J., ANALYSIS OF STANDARDIZATION TRIAL RESULTS FOR USS LSM-458 EQUIPPED WITH KIRSTEN-BOEING CYCLOIDAL PROPELLERS, Report No. 649, David Taylor Model Basin, Washington, D. C., December 1948.
- 39W. Windsor, Richard J., WIND TUNNEL TEST OF A ROTATING SPHERE, Wind Tunnel Report No. 82, University of Maryland Aeronautical Laboratory, College Park, Maryland, April 1953.
- 40W. Windsor, Richard J., WIND TUNNEL TEST OF A CYLINDRICAL ROTOR, Wind Tunnel Report No. 86, University of Maryland Aeronautical Laboratory, College Park, Maryland, June 1953.

- 41W. Windsor, Richard J., WIND TUNNEL TESTS OF ROTATING SPHERES - 2ND SERIES, Wind Tunnel Report No. 89, University of Maryland Aeronautical Laboratory, College Park, Maryland, July 1953.
- 42W. Windsor, Richard J., WIND TUNNEL TESTS OF ROTATING SPHERES - 3RD SERIES, Wind Tunnel Report No. 95, University of Maryland Aeronautical Laboratory, College Park, Maryland, September 1953.
- 43W. Wisniewski, Vincent, DISPOSITIF DE PROPULSION POUR AVIONS, French Patent, No. 668047, November 1930, p. 3.
- 44W. Wisniewski, Vincent, PROPELLING DEVICE FOR AIRCRAFT, U.S. Patent, No. 1791079, February 1931, p. 5.
- 45W. Wisniewski, Vincent, SCHLAGFLUGELANORDNUNG FUR FLUGZEUGE, German Patent, No. 535416, October 1931, p. 3.
- 46W. Wisniewski, Vincent, WALZFLUGELANORDNUNG FUR FLUGZEUGE, German Patent, No. 672702, March 1939, p. 3.
- 47W. Wisniewski, Vincent, ANTRIEB FUR WALZFLUGELFLUGZEUGE, German Patent, No. 672703, March 1939, p. 3.
- 48W. Wittmann, Johann Heinrich, VORRICHTUNG ZUR AUFNAHME VON KRAFTEN AUS STROMENDEN MEDIEN, German Patent, No. 467308, October 1928.
- 49W. (Wolff), PRELIMINARY STUDY OF THE INFLUENCE OF A ROTATING CYLINDER ON A WING, Flight, Vol. 17, No. 3(838), January 1925, pp. 30-31.
- 50W. Wolff, E. B., PRELIMINARY INVESTIGATION OF THE EFFECT OF A ROTATING CYLINDER IN A WING, NACA Technical Memorandum No. 307, March 1925.
- 51W. Wolff, E. B. and Koning, C., TESTS FOR DETERMINING THE EFFECT OF A ROTATING CYLINDER FITTED INTO THE LEADING EDGE OF AN AIRPLANE WING, NACA Technical Memorandum 354, March 1926.
- 52W. Wolff, E. B., and Koning, C., DISCUSSION OF THE RESULTS OF THE BOUNDARY-LAYER TESTS OF AN AIRFOIL FITTED WITH ROTARY CYLINDERS, NACA Technical Memorandum No. 434, August 1927 (Trans. from: Verslagen en Verhandelingen van den Rijks-Studiedienst voor de Luchtvaart, Amsterdam, Report No. A130, Vol. 4, 1927, pp. 69-79).

- 53W. Wolford, Clude, KITE, U.S. Patent, No. 160910, November 1950, p. 2.
- 54W. Woog, Joseph C., AVION MOBILE EN TOUS SENS, A PLANS SATELLITES ROTATIFS, French Patent, No. 619905, January 1927.
- 55W. (Wyllie and Ottino), A NOVEL PADDLE FLYING MACHINE, Scientific American, Vol. 119, No. 23, June 1910, p. 1165.
- 56W. Wiese, H., DREHLEISTUNGSMESSUNGEN AN ROTIERENDEN FLUGELN, A. V. A. Gottingen, Bericht 42/A/14, 1942.
- 57W. Weiberg, James A., and Gamse, Berl, LARGE-SCALE WIND-TUNNEL TESTS OF AN AIRPLANE MODEL WITH TWO PROPELLERS AND ROTATING CYLINDER FLAPS, Technical Note TN D-4489, NASA, Washington, D. C., March 1968.
- 58W. Warner, Edward P., AIRPLANE DESIGN-PERFORMANCE, McGraw-Hill Book Company, New York, New York, 1936.
- 59W. Wellner, Georg, DIE FLUGMASCHINEN. THEORIE UND PRAXIS. BERECHNUNG DER DRACHENFLIEGER UN SCHRAUBENFLIEGER, A. Hartleben's Verlag, Vienna and Leipzig, Germany, 1910, pp. 102-104.

Y

- 1Y. Yaggy, Paul F., and Rogallo, Vernon L., A WIND TUNNEL INVESTIGATION OF THREE PROPELLERS THROUGH AN ANGLE OF ATTACK RANGE FROM 0° TO 85° , NASA Technical Note TN D-316, Washington, D. C., May 1960.
- 2Y. Yanchus, Edward L., ROTAPLANE, U.S. Patent, No. 2004885, June 1935.
- 3Y. Yelmgren, K., THE AUTOROTATION OF MAGNUS ROTORS, Unpublished Paper (Thesis), Department of Aero-Space Engineering, University of Notre Dame, South Bend, Indiana, May 1967.

Z

- 1Z. Zaic, Frank (Editor), 1964-65 MODEL AERONAUTIC YEAR BOOK, Model Aeronautic Publications, Northridge, California, 1965, pp. 179-183, 193.
- 2Z. (Zaparka), ROTOR AIRCRAFT, WINGLESS, IS TESTED, New York Times, Vol. 74, No. 26506, August 1930, p. 3.
- 3Z. (Zaparka), ROTOR AIRSHIP KEPT SECRET, The Washington Times, No. 15320, August 1930, p. 7.
- 4Z. (Zaparka), AN AIRSHIP WITHOUT WINGS MAKES ITS APPEARANCE ON LONG ISLAND SOUND: AN AERONAUTICAL ADAPTATION OF THE FLETTNER ROTO SHIP, New York Times, Vol. 74, No. 26510, August 1930, pp. 3-6.
- 5Z. (Zaparka), WHIRLING SPOOLS LIFT THIS PLANE, Popular Science Monthly, Vol. 117, No. 5, November 1930, p. 26.
- 6Z. (Zaparka), NEW ROTOR PLANE HAS NO WINGS, Popular Aviation, Vol. 7, No. 5, December 1930, Cover and p. 32.
- 7Z. (Zaparka), THIS ROTOR AIRPLANE FLIES WITHOUT WINGS, Modern Mechanics and Inventions, Vol. 5, No. 2, December 1930, pp. 94-95.
- 8Z. Zaparka, Edward F., AIRCRAFT, U.S. Patent, No. 1927535, September 1933, p. 8.
- 9Z. Zaparka, Edward F., SUSTAINING SYSTEM AND PROPULSION, U.S. Patent, No. 1927536, September 1933, p. 7.
- 10Z. Zaparka, E. F., AIRCRAFT CONTROL, U.S. Patent, No. 1927537, September 1933, p. 6.
- 11Z. Zaparka, Edward F., SUSTAINING AND CONTROL SURFACE, U.S. Patent, No. 1927538, September 1933, p. 19.
- 12Z. Zaparka, Edward F., AIRCRAFT, U.S. Patent, No. 2039676, May 1936, p. 11.
- 13Z. Zaschka, O. E., DREHFLUGELFLUGZEUGE TRAG-UND HUBSCHRAUBER, C.J.E. Volckmann Nachf E. Wette, Berlin, Germany, 1936, pp. 43-46.

- 14Z. Zhuchenko, M. M., and Ivanov, V. M., SUDOVYE DVIZHITELI, Sudpromgiz, 1956.
- 15Z. Zijnen, B. G. Van der Hegge, DETERMINING THE VELOCITY DISTRIBUTION IN THE BOUNDARY LAYER OF AN AIRFOIL FITTED WITH A ROTARY CYLINDER, NACA Technical Memorandum TM 411, May 1927 (Trans. from: Verslagen en Verhandelingen van den Rijks-Studiedienst voor de Luchtvaart, Amsterdam, Report No. A129, October 1926).
- 16Z. Zings, Theodore, SLOTTED WING FOR AIRCRAFTS, U.S. Patent, No. 2464663, March 1949, p. 6.
- 17Z. Zuerl, Walter, DEUTSCHE FLUGZEUGKONSTRUSTEURE (ADOLF ROHRBACH), Curt Pechstein Verlag, Munich, Germany, 1938, pp. 200-210.
- 18Z. Zytikiewicz, A., FLYING MACHINE, U.S. Patent, No. 1219616, March 1917, p. 14.

B		REFERENCE NO																																				
		1	2	3	4	5	6	7	8	9	10	11	12	13	14	15	16	17	18	19	20	21	22	23	24	25	26	27	28	29	30	31	32	33	34	35		
SYSTEM	1	CYCLOGIRO or CYCLOIDAL PROP.																																				
	2	WING ROTOR																																				
	3	MAGNUS CYLINDER																																				
	4	CROSS-FLOW FAN																																				
	5	OTHER																																				
GENERAL	6	THEORETICAL EXPOSITION																																				
	7	PERFORMANCE																																				
	8	STABILITY																																				
	9	CONTROL or MANEUVERABILITY																																				
	10	LOADS and STRESS ANALYSIS																																				
	11	PHENOMENON DEMONSTRATION																																				
	12	REVIEW																																				
	13	COMMENT of INTEREST																																				
	APPLICATION	14	AIRCRAFT SUSTENTATION																																			
15		AIRCRAFT PROPULSION																																				
16		MARINE PROPULSION																																				
17		COMPLETE AIRCRAFT																																				
18		COMPLETE SHIP																																				
19		ROTATING FLAP or SLAT																																				
20		CONVERTIBLE ROTOR to WING																																				
21		ROTOR-ROTOR																																				
22		DEVICE OTHER THAN AIRCRAFT																																				
GEOMETRY		23	FEATHERING PITCH SYSTEM																																			
	24	ROTOR SYSTEMS per INSTAL.																																				
	25	NUMBER of BLADES per ROTOR																																				
	26	BLADE or ROTOR PROFILE																																				
	27	TIP PATH other than CIRCULAR																																				
TEST	28	AUXILIARY to FIXED WING																																				
	29	WIND TUNNEL																																				
	30	FLIGHT or DROP TEST																																				
	31	TOWING TANK or in WATER																																				
	32	TWO DIMENSIONAL																																				
PARAMETERS VARIED	33	THREE DIMENSIONAL																																				
	34	FLOW PATTERN STUDY																																				
	35	CAVITATION STUDY																																				
	36	STREAM VELOCITY																																				
	37	ROTATION																																				
	38	POWER																																				
	39	BLADE ANGLE																																				
	40	ORBIT ANGLE																																				
	41	ECCENTRICITY																																				
	42	PROFILE SHAPE or THICKNESS																																				
QUANTITIES MEASURED	43	NUMBER of BLADES																																				
	44	ASPECT RATIO																																				
	45	TIP PLATE DIA. or SHAPE																																				
	46	MOMENT of INERTIA																																				
	47	LIFT																																				
	48	DRAG																																				
	49	THRUST																																				
	50	TORQUE																																				
	51	ROTATION																																				
	52	TIP SPEED or ADVANCE RATIO																																				
AVAILABILITY	53	POWER																																				
	54	FORCE DISTRIBUTION																																				
	55	TORQUE DISTRIBUTION																																				
	56	FLIGHT PATH PLOTTED																																				
	57	STABILITY DERIVATIVES																																				
	58	PRESENTATION																																				
	59	CLASSIFIED																																				
	60	COMPANY PROPRIETARY																																				
61	NOT GENERALLY AVAILABLE																																					
62	UNPUBLISHED																																					
63	ENGLISH TRANSLATION																																					
64	NOT SEARCHED																																					

B		REFERENCE NO	71	72	73	74	75	76	77	78	79	80	81	82	83	84
SYSTEM	1	CYCLOGIRO or CYCLOIDAL PROP.					XX						XX			
	2	WING ROTOR														
	3	MAGNUS CYLINDER	XX	XX					XX	XX						
	4	CROSS-FLOW FAN														
	5	OTHER	XX													
GENERAL	6	THEORETICAL EXPOSITION	XX													
	7	PERFORMANCE	XX													
	8	STABILITY	XX													
	9	CONTROL or MANEUVERABILITY														
	10	LOADS and STRESS ANALYSIS														
	11	PHENOMENON DEMONSTRATION														
	12	REVIEW														
	13	COMMENT of INTEREST														
	14	AIRCRAFT SUSTENTATION														
APPLICATION	15	AIRCRAFT PROPULSION														
	16	MARINE PROPULSION														
	17	COMPLETE AIRCRAFT														
	18	COMPLETE SHIP														
	19	ROTATING FLAP or SLAT														
	20	CONVERTIBLE ROTOR to WING														
	21	ROTOR-ROTOR														
	22	DEVICE OTHER THAN AIRCRAFT	D	D	D	D										
	GEOMETRY	23	FEATHERING PITCH SYSTEM													
24		ROTOR SYSTEMS per INSTAL.														
25		NUMBER of BLADES per ROTOR	1	1	3					4						
26		BLADE or ROTOR PROFILE	CC	CC	F					CC						
27		TIP PATH other than CIRCULAR														
28		AUXILIARY to FIXED WING														
TEST	29	WIND TUNNEL														
	30	FLIGHT or DROP TEST	XX													
	31	TOWING TANK or in WATER														
	32	TWO DIMENSIONAL														
	33	THREE DIMENSIONAL														
	34	FLOW PATTERN STUDY														
	35	CAVITATION STUDY														
PARAMETERS VARIED	36	STREAM VELOCITY	XX													
	37	ROTATION	XX													
	38	POWER														
	39	BLADE ANGLE														
	40	ORBIT ANGLE														
	41	ECCENTRICITY														
	42	PROFILE SHAPE or THICKNESS	XX													
	43	NUMBER of BLADES														
	44	ASPECT RATIO														
	45	TIP PLATE DIA. or SHAPE														
QUANTITIES MEASURED	46	MOMENT of INERTIA														
	47	LIFT	XX													
	48	DRAG	XX													
	49	THRUST														
	50	TORQUE														
	51	ROTATION														
	52	TIP SPEED or ADVANCE RATIO														
	53	POWER														
	54	FORCE DISTRIBUTION														
	55	TORQUE DISTRIBUTION														
	56	FLIGHT PATH PLOTTED														
	57	STABILITY DERIVATIVES	XX													
AVAILABILITY	58	PRESENTATION	R	R	R	R	R	R	R	R	R	R	R	R	R	R
	59	CLASSIFIED														
	60	COMPANY PROPRIETARY														
	61	NOT GENERALLY AVAILABLE														
	62	UNPUBLISHED														
	63	ENGLISH TRANSLATION														
	64	NOT SEARCHED														

C	REFERENCE NO →	1 2 3 4 5 6 7 8 9 10 11 12 13 14 15 16 17 18 19 20 21 22 23 24 25 26 27 28 29 30 31 32 33 34 35																																				
		1	2	3	4	5	6	7	8	9	10	11	12	13	14	15	16	17	18	19	20	21	22	23	24	25	26	27	28	29	30	31	32	33	34	35		
SYSTEM	1	CYCLOGIRO or CYCLOIDAL PROP.	X	X	X	X	X	X	X	X	X	X	X	X	X	X	X	X	X	X	X	X	X	X	X	X	X	X	X	X	X	X	X	X	X	X		
	2	WING ROTOR	X	X	X	X	X	X	X	X	X	X	X	X	X	X	X	X	X	X	X	X	X	X	X	X	X	X	X	X	X	X	X	X	X	X		
	3	MAGNUS CYLINDER		X	X	X	X	X	X	X	X	X	X	X	X	X	X	X	X	X	X	X	X	X	X	X	X	X	X	X	X	X	X	X	X	X		
	4	CROSS-FLOW FAN	X	X	X	X	X	X	X	X	X	X	X	X	X	X	X	X	X	X	X	X	X	X	X	X	X	X	X	X	X	X	X	X	X	X		
	5	OTHER			X	X	X	X	X	X	X	X	X	X	X	X	X	X	X	X	X	X	X	X	X	X	X	X	X	X	X	X	X	X	X	X		
GENERAL	6	THEORETICAL EXPOSITION																																				
	7	PERFORMANCE																																				
	8	STABILITY																																				
	9	CONTROL or MANEUVERABILITY	X	X	X	X	X	X	X	X	X	X	X	X	X	X	X	X	X	X	X	X	X	X	X	X	X	X	X	X	X	X	X	X	X	X		
	10	LOADS and STRESS ANALYSIS																																				
	11	PHENOMENON DEMONSTRATION																																				
	12	REVIEW																																				
	13	COMMENT of INTEREST																																				
	APPLICATION	14	AIRCRAFT SUSTENTATION	X	X	X	X	X	X	X	X	X	X	X	X	X	X	X	X	X	X	X	X	X	X	X	X	X	X	X	X	X	X	X	X	X	X	
15		AIRCRAFT PROPULSION	X	X	X	X	X	X	X	X	X	X	X	X	X	X	X	X	X	X	X	X	X	X	X	X	X	X	X	X	X	X	X	X	X	X	X	
16		MARINE PROPULSION																																				
17		COMPLETE AIRCRAFT	X	X	X	X	X	X	X	X	X	X	X	X	X	X	X	X	X	X	X	X	X	X	X	X	X	X	X	X	X	X	X	X	X	X	X	
18		COMPLETE SHIP																																				
19		ROTATING FLAP or SLAT																																				
20		CONVERTIBLE ROTOR to WING																																				
21		ROTOR-ROTOR																																				
22		DEVICE OTHER THAN AIRCRAFT																																				
GEOMETRY		23	FEATHERING PITCH SYSTEM	G	18		2																															
		24	ROTOR SYSTEMS per INSTAL.	22			4				21		44																									
	25	NUMBER of BLADES per ROTOR	4	14		16				246		14	1111111111													22		42										
	26	BLADE or ROTOR PROFILE	WA			WF				SFA		Cn		W	AAARRR												RR		AF									
	27	TIP PATH other than CIRCULAR																																				
	28	AUXILIARY to FIXED WING																																				
TEST	29	WIND TUNNEL																																				
	30	FLIGHT or DROP TEST												X												X	X											
	31	TOWING TANK or in WATER																																				
	32	TWO DIMENSIONAL																																				
	33	THREE DIMENSIONAL																																				
	34	FLOW PATTERN STUDY												X											X	X												
	35	CAVITATION STUDY																																				
PARAMETERS VARIED	36	STREAM VELOCITY																																				
	37	ROTATION																																				
	38	POWER																																				
	39	BLADE ANGLE																																				
	40	ORBIT ANGLE																																				
	41	ECCENTRICITY																																				
	42	PROFILE SHAPE or THICKNESS																																				
	43	NUMBER of BLADES																																				
	44	ASPECT RATIO																																				
	45	TIP PLATE DIA. or SHAPE																																				
46	MOMENT of INERTIA																																					
QUANTITIES MEASURED	47	LIFT																																				
	48	DRAG																																				
	49	THRUST																																				
	50	TORQUE																																				
	51	ROTATION			X								X																									
	52	TIP SPEED or ADVANCE RATIO																																				
	53	POWER																																				
	54	FORCE DISTRIBUTION																																				
	55	TORQUE DISTRIBUTION																																				
	56	FLIGHT PATH PLOTTED																																				
	57	STABILITY DERIVATIVES																																				
AVAILABILITY	58	PRESENTATION	P	P	P	P	P	P	P	P	P	P	P	P	P	P	P	P	P	P	P	P	P	P	P	P	P	P	P	P	P	P	P	P	P			
	59	CLASSIFIED																																				
	60	COMPANY PROPRIETARY																																				
	61	NOT GENERALLY AVAILABLE																																				
	62	UNPUBLISHED																																				
63	ENGLISH TRANSLATION																																					
64	NOT SEARCHED																																					

C		REFERENCE NO	37	38	39	40	41	42	43	44	45	46	47	48	49	50	51	52	53	54	55	56	57	58	
		SYSTEM	1	X	X		X	X	X	X	X	X	X	X	X	X	X	X	X	X	X	X	X	X	X
GENERAL	2		X	X	X	X	X	X	X	X	X	X	X	X	X	X	X	X	X	X	X	X	X	X	X
	3		X	X	X	X	X	X	X	X	X	X	X	X	X	X	X	X	X	X	X	X	X	X	X
	4		X	X	X	X	X	X	X	X	X	X	X	X	X	X	X	X	X	X	X	X	X	X	X
	5		X	X	X	X	X	X	X	X	X	X	X	X	X	X	X	X	X	X	X	X	X	X	X
	6		X	X	X	X	X	X	X	X	X	X	X	X	X	X	X	X	X	X	X	X	X	X	X
APPLICATION	7		X	X	X	X	X	X	X	X	X	X	X	X	X	X	X	X	X	X	X	X	X	X	X
	8		X	X	X	X	X	X	X	X	X	X	X	X	X	X	X	X	X	X	X	X	X	X	X
	9		X	X	X	X	X	X	X	X	X	X	X	X	X	X	X	X	X	X	X	X	X	X	X
	10		X	X	X	X	X	X	X	X	X	X	X	X	X	X	X	X	X	X	X	X	X	X	X
	11		X	X	X	X	X	X	X	X	X	X	X	X	X	X	X	X	X	X	X	X	X	X	X
GEOMETRY	12		X	X	X	X	X	X	X	X	X	X	X	X	X	X	X	X	X	X	X	X	X	X	X
	13		X	X	X	X	X	X	X	X	X	X	X	X	X	X	X	X	X	X	X	X	X	X	X
	14		X	X	X	X	X	X	X	X	X	X	X	X	X	X	X	X	X	X	X	X	X	X	X
	15		X	X	X	X	X	X	X	X	X	X	X	X	X	X	X	X	X	X	X	X	X	X	X
	16		X	X	X	X	X	X	X	X	X	X	X	X	X	X	X	X	X	X	X	X	X	X	X
TEST	17		X	X	X	X	X	X	X	X	X	X	X	X	X	X	X	X	X	X	X	X	X	X	X
	18		X	X	X	X	X	X	X	X	X	X	X	X	X	X	X	X	X	X	X	X	X	X	X
	19		X	X	X	X	X	X	X	X	X	X	X	X	X	X	X	X	X	X	X	X	X	X	X
	20		X	X	X	X	X	X	X	X	X	X	X	X	X	X	X	X	X	X	X	X	X	X	X
	21		X	X	X	X	X	X	X	X	X	X	X	X	X	X	X	X	X	X	X	X	X	X	X
PARAMETERS VARIED	22		X	X	X	X	X	X	X	X	X	X	X	X	X	X	X	X	X	X	X	X	X	X	X
	23		X	X	X	X	X	X	X	X	X	X	X	X	X	X	X	X	X	X	X	X	X	X	X
	24		X	X	X	X	X	X	X	X	X	X	X	X	X	X	X	X	X	X	X	X	X	X	X
	25		X	X	X	X	X	X	X	X	X	X	X	X	X	X	X	X	X	X	X	X	X	X	X
	26		X	X	X	X	X	X	X	X	X	X	X	X	X	X	X	X	X	X	X	X	X	X	X
QUANTITIES MEASURED	27		X	X	X	X	X	X	X	X	X	X	X	X	X	X	X	X	X	X	X	X	X	X	X
	28		X	X	X	X	X	X	X	X	X	X	X	X	X	X	X	X	X	X	X	X	X	X	X
	29		X	X	X	X	X	X	X	X	X	X	X	X	X	X	X	X	X	X	X	X	X	X	X
	30		X	X	X	X	X	X	X	X	X	X	X	X	X	X	X	X	X	X	X	X	X	X	X
	31		X	X	X	X	X	X	X	X	X	X	X	X	X	X	X	X	X	X	X	X	X	X	X
AVAILABILITY	32		X	X	X	X	X	X	X	X	X	X	X	X	X	X	X	X	X	X	X	X	X	X	X
	33		X	X	X	X	X	X	X	X	X	X	X	X	X	X	X	X	X	X	X	X	X	X	X
	34		X	X	X	X	X	X	X	X	X	X	X	X	X	X	X	X	X	X	X	X	X	X	X
	35		X	X	X	X	X	X	X	X	X	X	X	X	X	X	X	X	X	X	X	X	X	X	X
	36		X	X	X	X	X	X	X	X	X	X	X	X	X	X	X	X	X	X	X	X	X	X	X

		REFERENCE NO →	1	2	3	4	5	6	7	8	9	10	11	12	13	14	15	16	17	18	
SYSTEM	1	CYCLOGIRO or CYCLOIDAL PROP.	X																	X	
	2	WING ROTOR	X	X																	X
	3	MAGNUS CYLINDER				X	X	X	X												
	4	CROSS-FLOW FAN			X																
	5	OTHER																	X		
GENERAL	6	THEORETICAL EXPOSITION	X	X				X	X												
	7	PERFORMANCE	X	X											X						X
	8	STABILITY																			X
	9	CONTROL or MANEUVERABILITY																			X
	10	LOADS and STRESS ANALYSIS																			X
	11	PHENOMENON DEMONSTRATION			X				X	X	X										
	12	REVIEW	X	X																	
APPLICATION	13	COMMENT of INTEREST	X	X																	
	14	AIRCRAFT SUSTENTATION	X	X	X			X									X				X
	15	AIRCRAFT PROPULSION	X	X	X			X								X					X
	16	MARINE PROPULSION				X		X													
	17	COMPLETE AIRCRAFT			X											X					X
	18	COMPLETE SHIP														X					
	19	ROTATING FLAP or SLAT														X					
	20	CONVERTIBLE ROTOR to WING																			
	21	ROTOR-ROTOR																			
	22	DEVICE OTHER THAN AIRCRAFT		W	F				K												K
GEOMETRY	23	FEATHERING PITCH SYSTEM	2	2	1	A					10									11	
	24	ROTOR SYSTEMS per INSTAL.	2	2	1	A					1	1	1	2							2
	25	NUMBER of BLADES per ROTOR	3	2	2	1			1	C		1	1	1							3
	26	BLADE or ROTOR PROFILE	A	A	S	L			W			E	L	C							A
	27	TIP PATH other than CIRCULAR																			
TEST	28	AUXILIARY to FIXED WING																			
	29	WIND TUNNEL	X	X													X				X
	30	FLIGHT or DROP TEST																			
	31	TOWING TANK or in WATER																			
	32	TWO DIMENSIONAL																			
	33	THREE DIMENSIONAL	X	X	X																
	34	FL/W PATTERN STUDY	X	X	X																
PARAMETERS VARIED	35	CAVITATION STUDY	X	X	X																
	36	STREAM VELOCITY	X	X																	
	37	ROTATION	X	X																	
	38	POWER	X	X																	
	39	BLADE ANGLE	X	X																	
	40	ORBIT ANGLE	X	X																	
	41	ECCENTRICITY	X	X																	
	42	PROFILE SHAPE or THICKNESS	X	X																	
	43	NUMBER of BLADES	X	X																	
	QUANTITIES MEASURED	44	ASPECT RATIO	X	X																
45		TIP PLATE DA. or SHAPE	X	X																	
46		MOMENT of INERTIA	X	X																	
47		LIFT	X	X																	
48		DRAG	X	X																	
49		THRUST	X	X																	
50		TORQUE	X	X																	
51		ROTATION	X	X																	
52		TIP SPEED or ADVANCE RATIO	X	X																	
AVAILABILITY	53	POWER	X	X																	
	54	FORCE DISTRIBUTION										X									X
	55	TORQUE DISTRIBUTION											X								X
	56	FLIGHT PATH PLOTTED											X								
	57	STABILITY DERIVATIVES																			
	58	PRESENTATION	R	R	R	P	P	P	S	P	S	S	S	S	P	P	P	S	P	P	S
	59	CLASSIFIED																			
60	COMPANY PROPRIETARY																				
61	NOT GENERALLY AVAILABLE																				
62	UNPUBLISHED																				
63	ENGLISH TRANSLATION																				
64	NOT SEARCHED					X											X				

G		REFERENCE NO	36	37	38	39	40	41	42	43	44	45	46	47	48	49	50	51	52	53	54	55	56	57	58	59	60	61	62	63	64
SYSTEM	1	CYCLOGIRO or CYCLOIDAL PROP.	X	X	X	X	X	X	X	X	X	X	X	X	X	X	X	X	X	X	X	X	X	X	X	X	X	X	X	X	
	2	WING ROTOR	X	X	X	X	X	X	X	X	X	X	X	X	X	X	X	X	X	X	X	X	X	X	X	X	X	X	X	X	
	3	MAGNUS CYLINDER	X	X	X	X	X	X	X	X	X	X	X	X	X	X	X	X	X	X	X	X	X	X	X	X	X	X	X	X	
	4	CROSS-FLOW FAN	X	X	X	X	X	X	X	X	X	X	X	X	X	X	X	X	X	X	X	X	X	X	X	X	X	X	X	X	
	5	OTHER	X	X	X	X	X	X	X	X	X	X	X	X	X	X	X	X	X	X	X	X	X	X	X	X	X	X	X	X	
GENERAL	6	THEORETICAL EXPOSITION	X	X	X	X	X	X	X	X	X	X	X	X	X	X	X	X	X	X	X	X	X	X	X	X	X	X	X	X	
	7	PERFORMANCE	X	X	X	X	X	X	X	X	X	X	X	X	X	X	X	X	X	X	X	X	X	X	X	X	X	X	X	X	
	8	STABILITY	X	X	X	X	X	X	X	X	X	X	X	X	X	X	X	X	X	X	X	X	X	X	X	X	X	X	X	X	
	9	CONTROL or MANEUVERABILITY	X	X	X	X	X	X	X	X	X	X	X	X	X	X	X	X	X	X	X	X	X	X	X	X	X	X	X	X	
	10	LOADS and STRESS ANALYSIS	X	X	X	X	X	X	X	X	X	X	X	X	X	X	X	X	X	X	X	X	X	X	X	X	X	X	X	X	
	11	PHENOMENON DEMONSTRATION	X	X	X	X	X	X	X	X	X	X	X	X	X	X	X	X	X	X	X	X	X	X	X	X	X	X	X	X	
	12	REVIEW	X	X	X	X	X	X	X	X	X	X	X	X	X	X	X	X	X	X	X	X	X	X	X	X	X	X	X	X	
	13	COMMENT of INTEREST	X	X	X	X	X	X	X	X	X	X	X	X	X	X	X	X	X	X	X	X	X	X	X	X	X	X	X	X	
APPLICATION	14	AIRCRAFT SUSTENTATION	X	X	X	X	X	X	X	X	X	X	X	X	X	X	X	X	X	X	X	X	X	X	X	X	X	X	X	X	
	15	AIRCRAFT PROPULSION	X	X	X	X	X	X	X	X	X	X	X	X	X	X	X	X	X	X	X	X	X	X	X	X	X	X	X	X	
	16	MARINE PROPULSION	X	X	X	X	X	X	X	X	X	X	X	X	X	X	X	X	X	X	X	X	X	X	X	X	X	X	X	X	
	17	COMPLETE AIRCRAFT	X	X	X	X	X	X	X	X	X	X	X	X	X	X	X	X	X	X	X	X	X	X	X	X	X	X	X	X	
	18	COMPLETE SHIP	X	X	X	X	X	X	X	X	X	X	X	X	X	X	X	X	X	X	X	X	X	X	X	X	X	X	X	X	
	19	ROTATING FLAP or SLAT	X	X	X	X	X	X	X	X	X	X	X	X	X	X	X	X	X	X	X	X	X	X	X	X	X	X	X	X	
	20	CONVERTIBLE ROTOR to WING	X	X	X	X	X	X	X	X	X	X	X	X	X	X	X	X	X	X	X	X	X	X	X	X	X	X	X	X	
	21	ROTOR-ROTOR	X	X	X	X	X	X	X	X	X	X	X	X	X	X	X	X	X	X	X	X	X	X	X	X	X	X	X	X	
	22	DEVICE OTHER THAN AIRCRAFT	X	X	X	X	X	X	X	X	X	X	X	X	X	X	X	X	X	X	X	X	X	X	X	X	X	X	X	X	
	GEOMETRY	23	FEATHERING PITCH SYSTEM	1	7	4	2	7	4	2	4	2	2	2	2	2	2	2	2	2	2	2	2	2	2	2	2	2	2	2	
24		ROTOR SYSTEMS per INSTAL.	1	7	4	2	7	4	2	4	2	4	2	2	2	2	2	2	2	2	2	2	2	2	2	2	2	2	2	2	
25		NUMBER of BLADES per ROTOR	4	1	4	4	2	4	2	2	2	2	2	2	2	2	2	2	2	2	2	2	2	2	2	2	2	2	2	2	
26		BLADE or ROTOR PROFILE	A	FC	L	L	F	C	C	C	C	C	C	C	C	C	C	C	C	C	C	C	C	C	C	C	C	C	C	C	
27		TIP PATH other than CIRCULAR	X	X	X	X	X	X	X	X	X	X	X	X	X	X	X	X	X	X	X	X	X	X	X	X	X	X	X	X	
28		AUXILIARY to FIXED WING	X	X	X	X	X	X	X	X	X	X	X	X	X	X	X	X	X	X	X	X	X	X	X	X	X	X	X	X	
TEST	29	WIND TUNNEL	X	X	X	X	X	X	X	X	X	X	X	X	X	X	X	X	X	X	X	X	X	X	X	X	X	X	X	X	
	30	FLIGHT or DROP TEST	X	X	X	X	X	X	X	X	X	X	X	X	X	X	X	X	X	X	X	X	X	X	X	X	X	X	X	X	
	31	TOWING TANK or in WATER	X	X	X	X	X	X	X	X	X	X	X	X	X	X	X	X	X	X	X	X	X	X	X	X	X	X	X	X	
	32	TWO DIMENSIONAL	X	X	X	X	X	X	X	X	X	X	X	X	X	X	X	X	X	X	X	X	X	X	X	X	X	X	X	X	
	33	THREE DIMENSIONAL	X	X	X	X	X	X	X	X	X	X	X	X	X	X	X	X	X	X	X	X	X	X	X	X	X	X	X	X	
	34	FLOW PATTERN STUDY	X	X	X	X	X	X	X	X	X	X	X	X	X	X	X	X	X	X	X	X	X	X	X	X	X	X	X	X	
	35	CAVITATION STUDY	X	X	X	X	X	X	X	X	X	X	X	X	X	X	X	X	X	X	X	X	X	X	X	X	X	X	X	X	
PARAMETERS VARIED	36	STREAM VELOCITY	X	X	X	X	X	X	X	X	X	X	X	X	X	X	X	X	X	X	X	X	X	X	X	X	X	X	X	X	
	37	ROTATION	X	X	X	X	X	X	X	X	X	X	X	X	X	X	X	X	X	X	X	X	X	X	X	X	X	X	X	X	
	38	POWER	X	X	X	X	X	X	X	X	X	X	X	X	X	X	X	X	X	X	X	X	X	X	X	X	X	X	X	X	
	39	BLADE ANGLE	X	X	X	X	X	X	X	X	X	X	X	X	X	X	X	X	X	X	X	X	X	X	X	X	X	X	X	X	
	40	ORBIT ANGLE	X	X	X	X	X	X	X	X	X	X	X	X	X	X	X	X	X	X	X	X	X	X	X	X	X	X	X	X	
	41	ECCENTRICITY	X	X	X	X	X	X	X	X	X	X	X	X	X	X	X	X	X	X	X	X	X	X	X	X	X	X	X	X	
	42	PROFILE SHAPE or THICKNESS	X	X	X	X	X	X	X	X	X	X	X	X	X	X	X	X	X	X	X	X	X	X	X	X	X	X	X	X	
	43	NUMBER of BLADES	X	X	X	X	X	X	X	X	X	X	X	X	X	X	X	X	X	X	X	X	X	X	X	X	X	X	X	X	
	44	ASPECT RATIO	X	X	X	X	X	X	X	X	X	X	X	X	X	X	X	X	X	X	X	X	X	X	X	X	X	X	X	X	
	45	TIP PLATE DIA. or SHAPE	X	X	X	X	X	X	X	X	X	X	X	X	X	X	X	X	X	X	X	X	X	X	X	X	X	X	X	X	
QUANTITIES MEASURED	46	MOMENT of INERTIA	X	X	X	X	X	X	X	X	X	X	X	X	X	X	X	X	X	X	X	X	X	X	X	X	X	X	X	X	
	47	LIFT	X	X	X	X	X	X	X	X	X	X	X	X	X	X	X	X	X	X	X	X	X	X	X	X	X	X	X	X	
	48	DRAG	X	X	X	X	X	X	X	X	X	X	X	X	X	X	X	X	X	X	X	X	X	X	X	X	X	X	X	X	
	49	THRUST	X	X	X	X	X	X	X	X	X	X	X	X	X	X	X	X	X	X	X	X	X	X	X	X	X	X	X	X	
	50	TORQUE	X	X	X	X	X	X	X	X	X	X	X	X	X	X	X	X	X	X	X	X	X	X	X	X	X	X	X	X	
	51	ROTATION	X	X	X	X	X	X	X	X	X	X	X	X	X	X	X	X	X	X	X	X	X	X	X	X	X	X	X	X	
	52	TIP SPEED or ADVANCE RATIO	X	X	X	X	X	X	X	X	X	X	X	X	X	X	X	X	X	X	X	X	X	X	X	X	X	X	X	X	
	53	POWER	X	X	X	X	X	X	X	X	X	X	X	X	X	X	X	X	X	X	X	X	X	X	X	X	X	X	X	X	
	54	FORCE DISTRIBUTION	X	X	X	X	X	X	X	X	X	X	X	X	X	X	X	X	X	X	X	X	X	X	X	X	X	X	X	X	
	55	TORQUE DISTRIBUTION	X	X	X	X	X	X	X	X	X	X	X	X	X	X	X	X	X	X	X	X	X	X	X	X	X	X	X	X	
	56	FLIGHT PATH PLOTTED	X	X	X	X	X	X	X	X	X	X	X	X	X	X	X	X	X	X	X	X	X	X	X	X	X	X	X	X	
	57	STABILITY DERIVATIVES	X	X	X	X	X	X	X	X	X	X	X	X	X	X	X	X	X	X	X	X	X	X	X	X	X	X	X	X	
AVAILABILITY	58	PRESENTATION	S	S	S	S	S	S	S	S	S	S	S	S	S	S	S	S	S	S	S	S	S	S	S	S	S	S	S		
	59	CLASSIFIED	X	X	X	X	X	X	X	X	X	X	X	X	X	X	X	X	X	X	X	X	X	X	X	X	X	X	X	X	
	60	COMPANY PROPRIETARY	X	X	X	X	X	X	X	X	X	X	X	X	X	X	X	X	X	X	X	X	X	X	X	X	X	X	X	X	
	61	NOT GENERALLY AVAILABLE	X	X	X	X	X	X	X	X	X	X	X	X	X	X	X	X	X	X	X	X	X	X	X	X	X	X	X	X	
	62	UNPUBLISHED	X	X	X	X	X	X	X	X	X	X	X	X	X	X	X	X	X	X	X	X	X	X	X	X	X	X	X	X	
	63	ENGLISH TRANSLATION	X	X	X	X	X	X	X	X	X	X	X	X	X	X	X	X	X	X	X	X	X	X	X	X	X	X	X	X	
	64	NOT SEARCHED	X	X	X	X	X	X	X	X	X	X	X	X	X	X	X	X	X	X	X	X	X	X	X	X	X	X	X	X	

		REFERENCE NO	1	2	3	4	5	6	7	8	9	10	11	12
SYSTEM	1	CYCLOGIRO or CYCLOIDAL PROP.	X	X	X	X	X	X	X	X	X	X	X	X
	2	WING ROTOR												
	3	MAGNUS CYLINDER	X											
	4	CROSS-FLOW FAN												
	5	OTHER												
GENERAL	6	THEORETICAL EXPOSITION	X	X	X	X	X	X	X	X	X	X	X	X
	7	PERFORMANCE	X	X	X	X	X	X	X	X	X	X	X	X
	8	STABILITY												
	9	CONTROL or MANEUVERABILITY												
	10	LOADS and STRESS ANALYSIS												
	11	PHENOMENON DEMONSTRATION												
	12	REVIEW												
APPLICATION	13	COMMENT of INTEREST	X	X	X	X	X	X	X	X	X	X	X	X
	14	AIRCRAFT SUSTENTATION	X	X	X	X	X	X	X	X	X	X	X	X
	15	AIRCRAFT PROPULSION												
	16	MARINE PROPULSION	X	X	X	X	X	X	X	X	X	X	X	X
	17	COMPLETE AIRCRAFT	X	X	X	X	X	X	X	X	X	X	X	X
	18	COMPLETE SHIP	X	X	X	X	X	X	X	X	X	X	X	X
	19	ROTATING FLAP or SLAT												
	20	CONVERTIBLE ROTOR to WING												
	21	ROTOR-ROTOR												
	22	DEVICE OTHER THAN AIRCRAFT												
GEOMETRY	23	FEATHERING PITCH SYSTEM												
	24	ROTOR SYSTEMS per INSTAL	2	1	1	1	1	1	1	1	1	1	1	1
	25	NUMBER of BLADES per ROTOR	1	4	4	4	4	4	4	4	4	4	4	4
	26	BLADE or ROTOR PROFILE	C	E	F	F	F	F	F	F	F	F	F	F
	27	TIP PATH other than CIRCULAR												
	28	AUXILIARY to FIXED WING												
TEST	29	WIND TUNNEL												
	30	FLIGHT or DROP TEST												
	31	TOWING TANK or in WATER	X	X	X	X	X	X	X	X	X	X	X	X
	32	TWO DIMENSIONAL												
	33	THREE DIMENSIONAL	X	X	X	X	X	X	X	X	X	X	X	X
	34	FLOW PATTERN STUDY												
	35	CAVITATION STUDY												
PARAMETERS VARISE	36	STREAM VELOCITY												
	37	ROTATION												
	38	POWER												
	39	BLADE ANGLE												
	40	ORBIT ANGLE												
	41	ECCENTRICITY												
	42	PROFILE SHAPE or THICKNESS												
	43	NUMBER of BLADES												
	44	ASPECT RATIO												
	45	TIP PLATE DIA or SHAPE												
	46	MOMENT of INERTIA												
QUANTITIES MEASURED	47	LIFT												
	48	DRAW												
	49	THRUST												
	50	TORQUE												
	51	ROTATION												
	52	TIP SPEED or ADVANCE RATIO												
	53	POWER												
	54	FORCE DISTRIBUTION												
AVAILABILITY	55	TORQUE DISTRIBUTION												
	56	FLIGHT PATH PLOTTED												
	57	STABILITY DERIVATIVES												
	58	PRESERVATION	S	S	S	S	S	S	S	S	S	S	S	S
	59	CLASSIFIED												
	60	COMPANY PROPRIETARY												
	61	NOT GENERALLY AVAILABLE												
	62	UNPUBLISHED												
	63	ENGLISH TRANSLATION	X	X	X	X	X	X	X	X	X	X	X	X
	64	NOT BUREAU												

K		REFERENCE NO	1	2	3	4	5	6	7	8	9	10	11	12	13	14	15	16	17	18	19	20	21	22	23	24	25	26	27	28	29	30	31	32	33	34	35		
SYST.	1	CYCLOGIR or CYCLOIDAL PRG.	X	X	X	X	X	X	X	X	X	X	X	X	X	X	X	X	X	X	X	X	X	X	X	X	X	X	X	X	X	X	X	X	X	X	X	X	
	2	WING ROTOR																																					
	3	MAGNUS CYLINDER										X																											X
	4	CROSS-FLOW FAN																																					X
	5	OTHER					X																																X
GENERAL	6	THEORETICAL EXPOSITION	X																																				
	7	PERFORMANCE	X																																				
	8	STABILITY	X																																				
	9	CONTROL or MANEUVERABILITY	X																																				
	10	LOADS and STRESS ANALYSIS	X																																				
	11	PHENOMENON DEMONSTRATION	X																																				
	12	REVIEW	X																																				
	13	COMMENT of INTEREST	X																																				
	14	AIRCRAFT SUSTENTATION	X	X	X	X	X	X	X	X	X	X	X	X	X	X	X	X	X	X	X	X	X	X	X	X	X	X	X	X	X	X	X	X	X	X	X	X	
APPLICATION	15	AIRCRAFT PROPULSION	X	X	X	X	X	X	X	X	X	X	X	X	X	X	X	X	X	X	X	X	X	X	X	X	X	X	X	X	X	X	X	X	X	X	X	X	
	16	MARINE PROPULSION	X	X	X	X	X	X	X	X	X	X	X	X	X	X	X	X	X	X	X	X	X	X	X	X	X	X	X	X	X	X	X	X	X	X	X	X	
	17	COMPLETE AIRCRAFT	X	X	X	X	X	X	X	X	X	X	X	X	X	X	X	X	X	X	X	X	X	X	X	X	X	X	X	X	X	X	X	X	X	X	X	X	
	18	COMPLETE SHIP																																					
	19	ROTATING FLAP or SLAT	X	X	X	X	X	X	X	X	X	X	X	X	X	X	X	X	X	X	X	X	X	X	X	X	X	X	X	X	X	X	X	X	X	X	X	X	
	20	CONVERTIBLE ROTOR to WING	X	X	X	X	X	X	X	X	X	X	X	X	X	X	X	X	X	X	X	X	X	X	X	X	X	X	X	X	X	X	X	X	X	X	X	X	
	21	ROTOR-ROTOR	X	X	X	X	X	X	X	X	X	X	X	X	X	X	X	X	X	X	X	X	X	X	X	X	X	X	X	X	X	X	X	X	X	X	X	X	
	22	DEVICE OTHER THAN AIRCRAFT																																					
	GEOMETRY	23	FEATHERING PITCH SYSTEM	3	3	3				8		4	1	7						2	2	2	2	2	2	2	2	3	2	2	3	1					1		
24		ROTOR SYSTEMS per INSTAL.	4	4								1	2					2			6	5	4				4												
25		NUMBER of BLADES per ROTOR	1	1	1			2	3		3	4			1	1				6		6				4	6	6								2	2		
26		BLADE or ROTOR PROFILE	A	A	A			S	P		P				CA					AA		AA				AAA					A		S	S					
27		TIP PATH other than CIRCULAR	X	X	X																																		
28		AUXILIARY to FIXED WING	X	X	X																																		
TEST		29	WIND TUNNEL																					X															
	30	FLIGHT or DROP TEST																					X																
	31	TOWING TANK or in WATER																					X																
	32	TWO DIMENSIONAL																					X																
	33	THREE DIMENSIONAL																					X																
	34	FLOW PATTERN STUDY																					X																
	35	CAVITATION STUDY																					X																
PARAMETERS VARIED	36	STREAM VELOCITY																																					
	37	ROTATION																																					
	38	POWER																																					
	39	BLADE ANGLE																																					
	40	ORBIT ANGLE																																					
	41	ECCENTRICITY																																					
	42	PROFILE SHAPE or THICKNESS																																					
	43	NUMBER of BLADES																																					
	44	ASPECT RATIO																																					
	45	TIP PLATE DIA. or SHAPE																																					
QUANTITIES MEASURED	46	MOMENT of INERTIA																																					
	47	LIFT																																					
	48	DRAG																																					
	49	THRUST																																					
	50	TORQUE																																					
	51	ROTATION																																					
	52	TIP SPEED or ADVANCE RATIO																																					
	53	POWER																																					
	54	FORCE DISTRIBUTION																																					
	55	TORQUE DISTRIBUTION																																					
	56	FLIGHT PATH PLOTTED																																					
	57	STABILITY DERIVATIVES																																					
AVAILIBILIT	58	PRESENTATION																																					
	59	CLASSIFIED																																					
	60	COMPANY PROPRIETARY																																					
	61	NOT GENERALLY AVAILABLE																																					
	62	UNPUBLISHED																																					
	63	ENGLISH TRANSLATION																																					
64	NOT SEARCHED																																						

		REFERENCE NO	36	37	38	39	40	41	42	43	44	45	46	47	48	49	50	51	52	53	54	55	56	57	58	59	60	61	62	63	64	
SYSTEM	1	CYLOGIRO or CYCLOIDAL PROP.																														
	2	WING ROTOR																														
	3	MAGNUS CYLINDER																														
	4	CROSS-FLOW FAN																														
	5	OTHER																														
GENERAL	6	THEORETICAL EXPOSITION																														
	7	PERFORMANCE																														
	8	STABILITY																														
	9	CONTROL or MANEUVERABILITY																														
	10	LOADS and STRESS ANALYSIS																														
	11	PHENOMENON DEMONSTRATION																														
	12	REVIEW																														
	13	COMMENT of INTEREST																														
	APPLICATION	14	AIRCRAFT SUSTENTATION																													
15		AIRCRAFT PROPULSION																														
16		MARINE PROPULSION																														
17		COMPLETE AIRCRAFT																														
18		COMPLETE SHIP																														
19		ROTATING FLAP or SLAT																														
20		CONVERTIBLE ROTOR to WING																														
21		ROTOR-ROTOR																														
22		DEVICE OTHER THAN AIRCRAFT																														
COMPTTY		23	FEATHERING PITCH SYSTEM																													
	24	ROTOR SYSTEMS per INSTAL.																														
	25	NUMBER of BLADES per ROTOR																														
	26	BLADE or ROTOR PROFILE																														
	27	TIP PATH other than CIRCULAR																														
	28	AUXILIARY to FIXED WING																														
TEST	29	WIND TUNNEL																														
	30	FLIGHT or DROP TEST																														
	31	TOWING TANK or in WATER																														
	32	TWO DIMENSIONAL																														
	33	THREE DIMENSIONAL																														
	34	FLOW PATTERN STUDY																														
	35	CAVITATION STUDY																														
PARAMETERS VAPED	36	STREAM VELOCITY																														
	37	ROTATION																														
	38	POWER																														
	39	BLADE ANGLE																														
	40	ORBIT ANGLE																														
	41	ECCENTRICITY																														
	42	PROFILE SHAPE or THICKNESS																														
	43	NUMBER of BLADES																														
	44	ASPECT RATIO																														
	45	TIP PLATE DIA. or SHAPE																														
46	MOMENT of INERTIA																															
QUANTITIES MEASURED	47	LIFT																														
	48	DRAG																														
	49	THRUST																														
	50	TORQUE																														
	51	ROTATION																														
	52	TIP SPEED or ADVANCE RATIO																														
	53	POWER																														
	54	FORCE DISTRIBUTION																														
	55	TORQUE DISTRIBUTION																														
	56	FLIGHT PATH PLOTTED																														
	57	STABILITY DERIVATIVES																														
AVAILABILITY	58	PRESENTATION																														
	59	CLASSIFIED																														
	60	COMPANY PROPRIETARY																														
	61	NOT GENERALLY AVAILABLE																														
	62	UNPUBLISHED																														
	63	ENGLISH TRANSLATION																														
	64	NOT SEARCHED																														

MC		REFERENCE NO	N W T L A S T C O S I N E X P E R I M																							
SYS. EM	1	CYCLOGIRO or CYCLOIDAL PROP.	X	X					X	X	X	X	X	X	X											
	2	WING ROTOR	X	X	X	X	X	X	X	X	X	X	X	X	X	X	X	X	X	X	X	X	X	X	X	X
	3	MAGNUS CYLINDER														X										
	4	CROSS-FLOW FAN																								
	5	OTHER																								
GENERAL	6	THEORETICAL EXPOSITION																								
	7	PERFORMANCE																								
	8	STABILITY																								
	9	CONTROL or MANEUVERABILITY																								
	10	LOADS and STRESS ANALYSIS																								
	11	PHENOMENON DEMONSTRATION																								
	12	REVIEW																								
	13	COMMENT of INTEREST																								
APPLICATION	14	AIRCRAFT SUSTENTATION																								
	15	AIRCRAFT PROPULSION																								
	16	MARINE PROPULSION																								
	17	COMPLETE AIRCRAFT																								
	18	COMPLETE SHIP																								
	19	ROTATING FLAP or SLAT																								
	20	CONVERTIBLE ROTOR to WING																								
	21	ROTOR-ROTOR																								
	22	DEVICE OTHER THAN AIRCRAFT																								
	GEOMETRY	23	FEATHERING PITCH SYSTEM																							
24		ROTOR SYSTEMS per INSTAL	2	1																			2	2	2	2
25		NUMBER of BLADES per ROTOR	1	1	1																		1	2	2	2
26		BLADE or ROTOR PROFILE	FF	A																			6	5	5	5
27		TIP PATH other than CIRCULAR																								
28		AUXILIARY to FIXED WING																								
TEST	29	WIND TUNNEL	X																							
	30	FLIGHT or DROP TEST																								
	31	TOWING TANK or in WATER																								
	32	TWO DIMENSIONAL																								
	33	THREE DIMENSIONAL																								
	34	FLOW PATTERN STUDY																								
	35	CAVITATION STUDY																								
PARAMETERS VARIED	36	STREAM VELOCITY																								
	37	ROTATION																								
	38	POWER																								
	39	BLADE ANGLE																								
	40	ORBIT ANGLE																								
	41	ECCENTRICITY																								
	42	PROFILE SHAPE or THICKNESS																								
	43	NUMBER of BLADES																								
	44	ASPECT RATIO																								
	45	TIP PLATE DIA. or SHAPE																								
	46	MOMENT of INERTIA																								
QUANTITIES MEASURED	47	LIFT																								
	48	DRAG																								
	49	THRUST																								
	50	TORQUE																								
	51	ROTATION																								
	52	TIP SPEED or ADVANCE RATIO																								
	53	POWER																								
	54	FORCE DISTRIBUTION																								
	55	TORQUE DISTRIBUTION																								
	56	FLIGHT PATH PLOTTED																								
	57	STABILITY DERIVATIVES																								
AVAILABILITY	58	PRESENTATION																								
	59	CLASSIFIED																								
	60	COMPANY PROPRIETARY																								
	61	NOT GENERALLY AVAILABLE																								
	62	UNPUBLISHED																								
	63	ENGLISH TRANSLATION																								
	64	NOT SEARCHED																								

M		REFERENCE NO								
SYSTEM	1	CYCLOGIRO or CYCLOIDAL FROP.	X							
	2	WING ROTOR	X							
	3	MAGNUS CYLINDER	X							
	4	CROSS-FLOW FAN	X							
	5	OTHER	X							
GENERAL	6	THEORETICAL EXPOSITION	X							
	7	PERFORMANCE	X							
	8	STABILITY	X							
	9	CONTROL or MANEUVERABILITY	X							
	10	LOADS and STRESS ANALYSIS	X							
	11	PHENOMENON DEMONSTRATION	X							
	12	REVIEW	X							
	13	COMMENT of INTEREST	X							
APPLICATION	14	AIRCRAFT SUSTENTATION	X							
	15	AIRCRAFT PROPULSION	X							
	16	MARINE PROPULSION	X							
	17	COMPLETE AIRCRAFT	X							
	18	COMPLETE SHIP	X							
	19	ROTATING FLAP or SLAT	X							
	20	CONVERTIBLE ROTOR to WING	X							
	21	ROTOR-ROTOR	X							
	22	DEVICE OF AIR TEAN AIRCRAFT	X							
	GEOMETRY	23	FEATHERING PITCH SYSTEM	X						
24		ROTOR SYSTEMS per INSTAL.	X							
25		NUMBER of BLADES per ROTOR	X							
26		BLADE or ROTOR PROFILE	X							
27		TIP PATH other than CIRCULAR	X							
28		AUXILIARY to FIXED WING	X							
TEST	29	WIND TUNNEL	X							
	30	FLIGHT or DROP TEST	X							
	31	TOWING TANK or in WATER	X							
	32	TWO DIMEN. L	X							
	33	THREE DIMEN. IAL	X							
	34	FLOW PATTERN STUDY	X							
	35	CAVITATION STUDY	X							
PARAMETERS VARIED	36	STREAM VELOCITY	X							
	37	ROTATION	X							
	38	POWER	X							
	39	BLADE ANGLE	X							
	40	ORBIT ANGLE	X							
	41	ECCENTRICITY	X							
	42	PROFILE SHAPE or THICKNESS	X							
	43	NUMBER of BLADES	X							
	44	ASPECT RATIO	X							
	45	TIP PLATE DIA. or SHAPE	X							
	46	MOMENT of INERTIA	X							
QUANTITIES MEASURED	47	LIFT	X							
	48	DRAG	X							
	49	THRUST	X							
	50	TORQUE	X							
	51	ROTATION	X							
	52	TIP SPEED or ADVANCE RATIO	X							
	53	POWER	X							
	54	FORCE DISTRIBUTION	X							
	55	TORQUE DISTRIBUTION	X							
	56	FLIGHT PATH PLOTTED	X							
	57	STABILITY DERIVATIVES	X							
AVAILABILITY	58	PRESENTATION	X							
	59	CLASSIFIED	X							
	60	COMPANY PROPRIETARY	X							
	61	NOT GENERALLY AVAILAELE	X							
	62	UNPUBLISHED	X							
	63	ENGLISH TRANSLATION	X							
	64	NOT SEARCHED	X							

M		REFERENCE NO →		36	37	38	39	40	41	42	43	44	45	46	47	48	49	50	51	52	53	54	55	56	57	58	59	60	61	62	63	64	65	66	67	68	69	70					
SYSTEM	1	CYCLOGIRO or CYCLOIDAL PROP.						X										X		X	X	X	X			X	X	X	X	X	X	X	X	X	X	X	X	X	X				
	2	WING ROTOR																																							X		
	3	MAGNUS CYLINDER			X	X														X																							
	4	CROSS-FLOW FAN																																									
	5	OTHER																																									
GENERAL	6	THEORETICAL EXPOSITION																																									
	7	PERFORMANCE																																									
	8	STABILITY																																									
	9	CONTROL or MANEUVERABILITY																																									
	10	LOADS and STRESS ANALYSIS																																									
	11	PHENOMENON DEMONSTRATION																																									
	12	REVIEW																																									
	13	COMMENT of INTEREST																																									
	APPLICATION	14	AIRCRAFT SUSTENTATION					X	X					X					X	X	X	X	X	X	X	X	X	X	X	X	X	X	X	X	X	X	X	X	X	X	X	X	
15		AIRCRAFT PROPULSION																																									
16		MARINE PROPULSION																																									
17		COMPLETE AIRCRAFT																																									
18		COMPLETE SHIP																																									
19		ROTATING FLAP or SLAT									X	X																															
20		CONVERTIBLE ROTOR to WING																																									
21		ROTOR-ROTOR																																									
22		DEVICE OTHER THAN AIRCRAFT																																									
GEOMETRY		23	FEATHERING PITCH SYSTEM																																								
	24	ROTOR SYSTEMS per INSTAL.																																									
	25	NUMBER of BLADES per ROTOR																																									
	26	BLADE or ROTOR PROFILE																																									
	27	TIP PATH other than CIRCULAR																																									
	28	AUXILIARY to FIXED WING																																									
TEST	29	WIND TUNNEL																																									
	30	FLIGHT or DROP TEST																																									
	31	TOWING TANK or in WATER																																									
	32	TWO DIMENSIONAL																																									
	33	THREE DIMENSIONAL																																									
	34	FLOW PATTERN STUDY																																									
	35	CAVITATION STUDY																																									
PARAMETERS VARIED	36	STREAM VELOCITY																																									
	37	ROTATION																																									
	38	POWER																																									
	39	BLADE ANGLE																																									
	40	ORBIT ANGLE																																									
	41	ECCENTRICITY																																									
	42	PROFILE SHAPE or THICKNESS																																									
	43	NUMBER of BLADES																																									
	44	ASPECT RATIO																																									
	45	TIP PLATE DIA. or SHAPE																																									
	46	MOMENT of INERTIA																																									
QUANTITIES MEASURED	47	LIFT																																									
	48	DRAG																																									
	49	THRUST																																									
	50	TORQUE																																									
	51	ROTATION																																									
	52	TIP SPEED or ADVANCE RATIO																																									
	53	POWER																																									
	54	FORCE DISTRIBUTION																																									
	55	TORQUE DISTRIBUTION																																									
	56	FLIGHT PATH PLOTTED																																									
	57	STABILITY DERIVATIVES																																									
AVAILABILITY	58	PRESENTATION																																									
	59	CLASSIFIED																																									
	60	COMPANY PROPRIETARY																																									
	61	NOT GENERALLY AVAILABLE																																									
	62	UNPUBLISHED																																									
	63	ENGLISH TRANSLATION																																									
	64	NOT SEARCHED																																									

M		REFERENCE NO	71	72
SYSTEM	1	CYCLOGIRO or CYCLOIDAL PROP.		
	2	WING ROTOR	XX	
	3	MAGNUS CYLINDER		
	4	CROSS-FLOW FAN		
	5	OTHER		
GENERAL	6	THEORETICAL EXPOSITION		
	7	PERFORMANCE		
	8	STABILITY		
	9	CONTROL or MANEUVERABILITY	XX	
	10	LOADS and STRESS ANALYSIS		
	11	PHENOMENON DEMONSTRATION		
	12	REVIEW		
	13	COMMENT of INTEREST		
APPLICATION	14	AIRCRAFT SUSTENTATION		
	15	AIRCRAFT PROPULSION		
	16	MARINE PROPULSION		
	17	COMPLETE AIRCRAFT		
	18	COMPLETE SHIP		
	19	ROTATING FLAP or SLAT		
	20	CONVERTIBLE ROTOR to WING		
	21	ROTOR-ROTOR		
	22	DEVICE OTHER THAN AIRCRAFT	KK	
	GEOMETRY	23	FEATHERING PITCH SYSTEM	
24		ROTOR SYSTEMS per INSTAL.		
25		NUMBER of BLADES per ROTOR		
26		BLADE or ROTOR PROFILE	KR	
27		TIP PATH other than CIRCULAR		
28		AUXILIARY to FIXED WING		
TEST	29	WIND TUNNEL		
	30	FLIGHT or DROP TEST		
	31	TOWING TANK or in WATER		
	32	TWO DIMENSIONAL		
	33	THREE DIMENSIONAL		
	34	FLOW PATTERN STUDY		
	35	CAVITATION STUDY		
PARAMETERS VARIED	36	STREAM VELOCITY		
	37	ROTATION		
	38	POWER		
	39	BLADE ANGLE		
	40	ORBIT ANGLE		
	41	ECCENTRICITY		
	42	PROFILE SHAPE or THICKNESS		
	43	NUMBER of BLADES		
	44	ASPECT RATIO		
	45	TIP PLATE DIA. or SHAPE		
	46	MOMENT of INERTIA		
QUANTITIES MEASURED	47	LIFT		
	48	DRAG		
	49	THRUST		
	50	TORQUE		
	51	ROTATION		
	52	TIP SPEED or ADVANCE RATIO		
	53	POWER		
	54	FORCE DISTRIBUTION		
	55	TORQUE DISTRIBUTION		
	56	FLIGHT PATH PLOTTED		
	57	STABILITY DERIVATIVES		
AVAILABILITY	58	PRESENTATION	FP	
	59	CLASSIFIED		
	60	COMPANY PROPRIETARY		
	61	NOT GENERALLY AVAILABLE		
	62	UNPUBLISHED		
	63	ENGLISH TRANSLATION		
	64	NOT SEARCHED		

		REFERENCE NO	1	2	3	4	5	6	7	8	9	10	11	12	13	14	15
SYSTEM	1	CYCLOGIRO or CYCLOIDAL PROP.	X	X													
	2	WING ROTOR	X							X	X	X	X				
	3	MAGNUS CYLINDER															
	4	CROSS-FLOW FAN															
	5	Other				X	X	X	X								
GENERAL	6	THEORETICAL EXPOSITION	X														
	7	PERFORMANCE	X			X	X	X	X								
	8	STABILITY															
	9	CONTROL or MANEUVERABILITY							X	X		X					
	10	LOADS and STRESS ANALYSIS															
	11	PHENOMENON DEMONSTRATION															
	12	REVIEW															
	13	COMMENT of INTEREST															
APPLICATION	14	AIRCRAFT SUSTENTATION	X	X			X	X	X	X	X	X	X				
	15	AIRCRAFT PROPULSION	X														
	16	MARINE PROPULSION															
	17	COMPLETE AIRCRAFT							X	X				X			
	18	COMPLETE SHIP															
	19	ROTATING FLAP or SLAT												X			
	20	CONVERTIBLE ROTOR to WING															
	21	ROTOR-ROTOR							X								
	22	DEVICE OTHER THAN AIRCRAFT		K													
	GEOMETRY	23	FEATHERING PITCH SYSTEM	2													14
24		ROTOR SYSTEMS per INSTAL.	2								22					2 to 2	
25		NUMBER of BLADES per ROTOR	3	1		3	3	3	3	1	1					1 to 1	
26		BLADE or ROTOR PROFILE	P	~							AA					APF	
27		TIP PATH other than CIRCULAR															
28		AUXILIARY to FIXED WING								X							
TEST	29	WIND TUNNEL				X	X	X	X								
	30	FLIGHT or DROP TEST															
	31	TOWING TANK or in WATER															
	32	TWO DIMENSIONAL															
	33	THREE DIMENSIONAL				X	X										
	34	FLOW PATTERN STUDY															
	35	CAVITATION STUDY															
PARAMETERS VARIED	36	STREAM VELOCITY				X	X	X	X								
	37	ROTATION				X	X	X	X								
	38	POWER															
	39	BLADE ANGLE				X	X										
	40	ORBIT ANGLE															
	41	ECCENTRICITY															
	42	PROFILE SHAPE or THICKNESS															
	43	NUMBER of BLADES															
	44	ASPECT RATIO															
	45	TIP PLATE DIA. or SHAPE															
	46	MOMENT of INERTIA															
QUANTITIES MEASURED	47	LIFT				X	X	X	X								
	48	DRAG				X	X	X	X								
	49	THRUST															
	50	TORQUE															
	51	ROTATION															
	52	TIP SPEED or ADVANCL RATIO				X	X	X	X								
	53	POWER															
	54	FORCE DISTRIBUTION	X														
	55	TORQUE DISTRIBUTION															
	56	FLIGHT PATH PLOTTED															
	57	STABILITY DERIVATIVES															
AVAILABILITY	58	PRESENTATION	S P I P P R R R R P P P P P P P P														
	59	CLASSIFIED															
	60	COMPANY PROPRIETARY															
	61	NOT GENERALLY AVAILABLE				X	X	X	X								
	62	UNPUBLISHED															
	63	ENGLISH TRANSLATION											X				
	64	NOT SEARCHED		X	X								X				X

		REFERENCE NO		
SYSTEM	1	CYCLOGIRO or CYCLOIDAL PROP.	X	
	2	WING ROTOR	X	
	3	MAGNUS CYLINDER		
	4	CROSS-FLOW FAN		
	5	OTHER		
GENERAL	6	THEORETICAL EXPOSITION		
	7	PERFORMANCE	X	
	8	STABILITY		
	9	CONTROL or MANEUVERABILITY		
	10	LOADS and STRESS ANALYSIS		
	11	PHENOMENON DEMONSTRATION		
	12	REVIEW		
	13	COMMENT of INTEREST	X	
	APPLICATION	14	AIRCRAFT SUSTENTATION	X
		15	AIRCRAFT PROPULSION	X
		16	MARINE PROPULSION	
		17	COMPLETE AIRCRAFT	X
		18	COMPLETE SHIP	
19		ROTATING FLAP or SLAT		
20		CONVERTIBLE ROTOR to WING		
21		ROTOR-ROTOR		
22		DEVICE OTHER THAN AIRCRAFT		
GEOMETRY		23	FEATHERING PITCH SYSTEM	
	24	ROTOR SYSTEMS per INSTAL	2	
	25	NUMBER of BLADES per ROTOR	1	
	26	BLADE or ROTOR PROFILE	~	
	27	TIP PA' H other than CIRCULAR		
	28	AUXILIARY to FIXED WING		
	TEST	29	WIND TUNNEL	
30		FLIGHT or DROP TEST	X	
31		TOWING TANK or in WATER		
32		TWO DIMENSIONAL		
33		THREE DIMENSIONAL		
34		FLOW PATTERN STUDY		
35		CAVITATION STUDY		
PARAMETERS VARIED	36	STREAM VELOCITY		
	37	ROTATION	X	
	38	POWER		
	39	BLADE ANGLE		
	40	ORBIT ANGLE		
	41	ECCENTRICITY		
	42	PROFILE SHAPE or THICKNESS		
	43	NUMBER of BLADES		
	44	ASPECT RATIO		
	45	TIP PLATE DIA. or SHAPE		
	46	MOMENT of INERTIA		
QUANTITIES MEASURED	47	LIFT	X	
	48	DRAG		
	49	THRUST		
	50	TORQUE		
	51	ROTATION		
	52	TIP SPEED or ADVANCE RATIO		
	53	POWER	X	
	54	FORCE DISTRIBUTION		
	55	TORQUE DISTRIBUTION		
	56	FLIGHT PATH PLOTTED		
	57	STABILITY DERIVATIVES		
AVAILABILITY	58	PRESENTATION	SS	
	59	CLASSIFIED		
	60	COMPANY PROPRIETARY		
	61	NOT GENERALLY AVAILABLE		
	62	UNPUBLISHED		
	63	ENGLISH TRANSLATION		
	64	NOT SEARCHED		

	REFERENCE NO →	37	38	40	41	42	43	44	45	46	47	48	49	50	51	52	53	54	55	56	57	58	59	60	61	62	63	64	65	66	67	68	69	70
		37	38	39	40	41	42	43	44	45	46	47	48	49	50	51	52	53	54	55	56	57	58	59	60	61	62	63	64	65	66	67	68	69
SYSTEM	1 CYCLOGIRO or CYCLOIDAL PROP.											X	X	X	X	X	X	X	X	X	X	X	X	X	X	X	X	X	X	X	X	X	X	
	2 WING ROTOR			X								X	X	X	X	X	X	X	X	X	X	X	X	X	X	X	X	X	X	X	X	X	X	
	3 MAGNUS CYLINDER			X							X	X	X	X	X	X	X	X	X	X	X	X	X	X	X	X	X	X	X	X	X	X	X	
	4 CROSS-FLOW FAN					X													X						X	X	X	X	X	X	X	X	X	
	5 OTHER	X	X																															
GENERAL	6 THEORETICAL EXPOSITION		X	X						X											X													
	7 PERFORMANCE		X	X	X					X							X	X	X	X	X	X	X	X	X	X	X	X	X	X	X	X	X	
	8 STABILITY		X	X						X																								
	9 CONTROL or MANEUVERABILITY							X															X											
	10 LOADS and STRESS ANALYSIS																	X	X	X	X	X	X	X	X	X	X	X	X	X	X	X	X	
	11 PHENOMENON DEMONSTRATION																																	
	12 REVIEW				X																													
	13 COMMENT of INTEREST				X							X	X	X	X	X	X	X	X	X	X	X	X	X	X	X	X	X	X	X	X	X	X	
	14 AIRCRAFT SUSTENTATION	X	X			X			X	X	X	X	X	X	X	X	X	X	X	X	X	X	X	X	X	X	X	X	X	X	X	X	X	X
APPLICATION	15 AIRCRAFT PROPULSION	X	X			X			X	X	X	X	X	X	X	X	X	X	X	X	X	X	X	X	X	X	X	X	X	X	X	X	X	
	16 MARINE PROPULSION	X	X			X			X	X	X	X	X	X	X	X	X	X	X	X	X	X	X	X	X	X	X	X	X	X	X	X	X	
	17 COMPLETE AIRCRAFT					X			X	X	X	X	X	X	X	X	X	X	X	X	X	X	X	X	X	X	X	X	X	X	X	X	X	
	18 COMPLETE SHIP					X			X	X	X	X	X	X	X	X	X	X	X	X	X	X	X	X	X	X	X	X	X	X	X	X	X	
	19 ROTATING FLAP or SLAT					X			X	X	X	X	X	X	X	X	X	X	X	X	X	X	X	X	X	X	X	X	X	X	X	X	X	
	20 CONVERTIBLE ROTOR to WING					X			X	X	X	X	X	X	X	X	X	X	X	X	X	X	X	X	X	X	X	X	X	X	X	X	X	
	21 ROTOR-ROTOR					X			X	X	X	X	X	X	X	X	X	X	X	X	X	X	X	X	X	X	X	X	X	X	X	X	X	X
	22 DEVICE OTHER THAN AIRCRAFT				X																													
GEOMETRY	23 FEATHERING PITCH SYSTEM																																	
	24 ROTOR SYSTEMS per INSTAL					2		2		2																								
	25 NUMBER of BLADES per ROTOR					3		1		1						2		2	2	2	2													
	26 BLADE or ROTOR PROFILE																																	
	27 TIP PATH other than CIRCULAR																																	
	28 AUXILIARY to FIXED WING																																	
TEST	29 WIND TUNNEL				X			X																										
	30 FLIGHT or DROP TEST																																	
	31 TOWING TANK or in WATER				X													X	X	X	X	X	X	X	X	X	X	X	X	X	X	X	X	
	32 TWO DIMENSIONAL				X																													
	33 THREE DIMENSIONAL				X				X																									
	34 FLOW PATTERN STUDY				X				X																									
	35 CAVITATION STUDY				X				X																									
PARAMETERS VARIED	36 STREAM VELOCITY				X			X																										
	37 ROTATION				X			X																										
	38 POWER				X			X																										
	39 BLADE ANGLE				X			X																										
	40 ORBIT ANGLE				X			X																										
	41 ECCENTRICITY				X			X																										
	42 PROFILE SHAPE or THICKNESS				X			X																										
	43 NUMBER of BLADES				X			X																										
QUANTITIES MEASURED	44 ASPECT RATIO				X			X																										
	45 TIP PLATE DIA. or SHAPE				X			X																										
	46 MOMENT of INERTIA				X			X																										
	47 LIFT				X			X																										
	48 DRAG				X			X																										
	49 THRUST				X			X																										
	50 TORQUE				X			X																										
	51 ROTATION				X			X																										
AVAILABILITY	52 TIP SPEED or ADVANCE RATIO				X			X																										
	53 POWER				X			X																										
	54 FORCE DISTRIBUTION				X			X																										
	55 TORQUE DISTRIBUTION				X			X																										
	56 FLIGHT PATH PLOTTED				X			X																										
	57 STABILITY DERIVATIVES				X			X																										
	58 PRESENTATION				X			X																										

R		REFERENCE NO	71	72	73
SYST M	1	CYCLOGIRO or CYCLOIDAL PROP.	X		
	2	WING ROTOR			
	3	MAGNUS CYLINDER	X	X	
	4	CROSS-FLOW FAN			
	5	OTHER			
GENERAL	6	THEORETICAL EXPOSITION			
	7	PERFORMANCE	X		
	8	STABILITY			
	9	CONTROL or MANEUVERABILITY			
	10	LOAD and STRESS ANALYSIS			
	11	PHENOMENON DEMONSTRATION	X		
	12	REVIEW			
	13	COMMENT of INTEREST			
APPLICATION	14	AIRCRAFT SUSTENTATION	X		
	15	AIRCRAFT PROPULSION	X		
	16	MARINE PROPULSION			
	17	COMPLETE AIRCRAFT	X		
	18	COMPLETE SHIP			
	19	ROTATING FLAP or SLAT			
	20	CONVERTIBLE ROTOR to WING			
	21	ROTOR-ROTOR			
	22	DEVICE OTHER THAN AIRCRAFT	X		
	GEOMETRY	23	FEATHERING PITCH SYSTEM	A	
24		ROTOR SYSTEMS per INSTAL.	2		
25		NUMBER of BLADES per ROTOR	6		
26		BLADE or ROTOR PROFILE	FC		
27		TIP PATH other than CIRCULAR			
28		AUXILIARY to FIXED WING			
TEST	29	WIND TUNNEL			
	30	FLIGHT or DROP TEST			
	31	TOWING TANK or in WATER			
	32	TWO DIMENSIONAL			
	33	THREE DIMENSIONAL	X		
	34	FLOW PATTERN STUDY			
	35	CAVITATION STUDY			
PARAMETERS VARIED	36	STREAM VELOCITY			
	37	ROTATION	X		
	38	POWER			
	39	BLADE ANGLE			
	40	ORBIT ANGLE			
	41	ECCENTRICITY			
	42	PROFILE SHAPE or THICKNESS	X		
	43	NUMBER of BLADES			
	44	ASPECT RATIO			
	45	TIP PLATE DIA. or SHAPE			
	46	MOMENT of INERTIA			
QUANTITIES MEASURED	47	LIFT	X		
	48	DRAG			
	49	THRUST			
	50	TORQUE			
	51	ROTATION	X		
	52	TIP SPEED or ADVANCE RATIO			
	53	POWER			
	54	FORCE DISTRIBUTION			
	55	TORQUE DISTRIBUTION			
	56	FLIGHT PATH PLOTTED			
	57	STABILITY DERIVATIVES			
AVAILABILITY	58	PRESENTATION	PSR		
	59	CLASSIFIED			
	60	COMPANY PROPRIETARY			
	61	NOT GENERALLY AVAILABLE			
	62	UNPUBLISHED			
	63	ENGLISH TRANSLATION			
	64	NOT SEARCHED	X		

		REFERENCE NO		1	2	3	4	5	6	7	8	9	10	11	12	13	14	15	16	17	18	19	20	21	22	23	24	25	26	27	28	29	30	31	32	33	34	35				
SYSTEM	1	CYCLOGIRO or CYCLOIDAL PROP.																																								
	2	WING ROTOR		X	X	X	X	X	X	X	X	X	X	X	X	X	X	X	X	X	X	X	X	X	X	X	X	X	X	X	X	X	X	X	X	X	X	X	X	X	X	
	3	MAGNETIC CYLINDER		X	X	X	X	X	X	X	X	X	X	X	X	X	X	X	X	X	X	X	X	X	X	X	X	X	X	X	X	X	X	X	X	X	X	X	X	X	X	X
	4	CROSS-FLOW FAN		X	X	X	X	X	X	X	X	X	X	X	X	X	X	X	X	X	X	X	X	X	X	X	X	X	X	X	X	X	X	X	X	X	X	X	X	X	X	X
	5	OTHER		X	X	X	X	X	X	X	X	X	X	X	X	X	X	X	X	X	X	X	X	X	X	X	X	X	X	X	X	X	X	X	X	X	X	X	X	X	X	X
GENERAL	6	THEORETICAL EXPOSITION																																								
	7	PERFORMANCE		X	X	X	X	X	X	X	X	X	X	X	X	X	X	X	X	X	X	X	X	X	X	X	X	X	X	X	X	X	X	X	X	X	X	X	X	X	X	X
	8	STABILITY																																								
	9	CONTROL or MANEUVERABILITY																																								
	10	LOADS and STRESS ANALYSIS																																								
	11	PHENOMENON DEMONSTRATION																																								
	12	REVIEW		X	X	X	X	X	X	X	X	X	X	X	X	X	X	X	X	X	X	X	X	X	X	X	X	X	X	X	X	X	X	X	X	X	X	X	X	X	X	X
	13	COMMENT of INTEREST																																								
	14	AIRCRAFT SUSTENTATION																																								
	15	AIRCRAFT PROPULSION																																								
APPLICATION	16	MARINE PROPULSION																																								
	17	COMPLETE AIRCRAFT																																								
	18	COMPLETE SHIP																																								
	19	ROTATING FLAP or SLAT																																								
	20	CONVERTIBLE ROTOR to WING																																								
	21	ROTOR-ROTOR																																								
	22	DEVICE OTHER THAN AIRCRAFT		W	W	W	W	W	W	W	W	W	W	W	W	W	W	W	W	W	W	W	W	W	W	W	W	W	W	W	W	W	W	W	W	W	W	W	W	W	W	
	23	FEATHERING PITCH SYSTEM		W	W	W	W	W	W	W	W	W	W	W	W	W	W	W	W	W	W	W	W	W	W	W	W	W	W	W	W	W	W	W	W	W	W	W	W	W	W	
	24	ROTOR SYSTEMS per INSTAL.		1	1	1	1	1	1	1	1	1	1	1	1	1	1	1	1	1	1	1	1	1	1	1	1	1	1	1	1	1	1	1	1	1	1	1	1	1	1	
	25	NUMBER of BLADES per ROTOR		1	2																																					
26	BLADE or ROTOR PROFIL		F	S																																						
27	TIP PATH other than CIRCULAR		F	S																																						
28	AUXILIARY to FIXED WING																																									
TEST	29	WIND TUNNEL																																								
	30	FLIGHT or DROP TEST																																								
	31	TOWING TANK or in WATER																																								
	32	TWO DIMENSIONAL																																								
	33	THREE DIMENSIONAL																																								
	34	FLOW PATTERN STUDY																																								
	35	CAVITATION STUDY																																								
PARAMETERS VARIED	36	STREAM VELOCITY																																								
	37	ROTATION																																								
	38	POWER																																								
	39	BLADE ANGLE																																								
	40	ORBIT ANGLE																																								
	41	ECCENTRICITY																																								
	42	PROFILE SHAPE or THICKNESS																																								
	43	NUMBER of BLADES																																								
	44	ASPECT RATIO																																								
	45	TIP PLATE DIA. or SHAPE																																								
46	MOMENT of INERTIA																																									
QUANTITIES MEASURED	47	LIFT																																								
	48	DRAG																																								
	49	THRUST																																								
	50	TORQUE																																								
	51	ROTATION																																								
	52	TIP SPEED or ADVANCE RATIO																																								
	53	POWER																																								

		REFERENCE NO	141	142	143	144
SYSTEM	1	CYCLOGIRO or CYCLOIDAL PROF.	X	X		
	2	WING ROTOR				
	3	MAGNUS CYLINDER	X	X		
	4	CROSS-FLOW FAN				
	5	OTHER				
GENERAL	6	THEORETICAL EXPOSITION		X		
	7	PERFORMANCE		X		
	8	STABILITY				
	9	CONTROL or MANEUVERABILITY				
	10	LOADS and STRESS ANALYSIS				
	11	PHENOMENON DEMONSTRATION				
	12	REVIEW		X		
	13	COMMENT of INTEREST				
	14	AIRCRAFT SUSTENTATION			X	
APPLICATION	15	AIRCRAFT PROPULSION	X	X		
	16	MARINE PROPULSION				
	17	COMPLETE AIRCRAFT	X			
	18	COMPLETE SHIP				
	19	ROTATING FLAP or SLAT				
	20	CONVERTIBLE ROTOR to WING				
	21	ROTOR-ROTOR				
	22	DESIGNS OTHER THAN AIRCRAFT				
	23	FEATHERING PITCH SYSTEM	6			
	GEOMETRY	24	ROTOR SYSTEMS per INSTAL.	2		
25		NUMBER of BLADES per ROTOR	4	i		
26		BLADE or ROTOR PROFILE	F	C		
27		TIP PATH other than CIRCULAR				
28		AUXILIARY to FIXED WING				
29		WIND TUNNEL	X	X		
TEST	30	FLIGHT or DROP TEST				
	31	TOWING TANK or in WATER				
	32	TWO DIMENSIONAL		X		
	33	THREE DIMENSIONAL		X		
	34	FLOW PATTERN STUDY		X		
	35	CAVITATION STUDY		X		
PARAMETERS VARIED	36	STREAM VELOCITY		X		
	37	ROTATION		X		
	38	POWER				
	39	BLADE ANGLE				
	40	ORBIT ANGLE				
	41	ECCENTRICITY				
	42	PROFILE: SHAPE or THICKNESS				
	43	NUMBER of BLADES				
	44	ASPECT RATIO				
	45	TIP PLATE D'A. or SHAPE		X		
	46	MOMENT of INERTIA				
QUANTITIES MEASURED	47	LIFT		X		
	48	DRAG		X		
	49	THRUST				
	50	TORQUE				
	51	ROTATION				
	52	TIP SPEED or ADVANCE RATIO		X		
	53	POWER				
	54	FORCE DISTRIBUTION				
	55	TORQUE DISTRIBUTION				
	56	FLIGHT PATH PLOTTED				
	57	STABILITY DERIVATIVES				
AVAILABILITY	58	PRESENTATION	PRISPI			
	59	CLASSIFIED				
	60	COMPANY PROPRIETARY				
	61	NOT GENERALLY AVAILABLE				
	62	UNPUBLISHED				
	63	ENGLISH TRANSLATION				
	64	NOT SEARCHED		X		

		REFERENCE NO	36	37	38	39	40	41	42	43	44	45	46	47
SYSTEM	1	CYCLOGIRO or CYCLOIDAL PROP.												
	2	WING ROTOR												
	3	MAGNUS CYLINDER	X	X	X									
	4	CROSS-FLOW FAN												
	5	OTHER												
GENERAL	6	THEORETICAL EXPOSITION												
	7	PERFORMANCE		X	X									
	8	STABILITY												
	9	CONTROL or MANEUVERABILITY												
	10	LOADS and STRESS ANALYSIS												
	11	PHENOMENON DEMONSTRATION												
	12	REVIEW												
	13	COMMENT of INTEREST												
APPLICATION	14	AIRCRAFT SUSTENTATION	X		X		X	X	X					
	15	AIRCRAFT PROPULSION												
	16	MARINE PROPULSION		X		X								
	17	COMPLETE AIRCRAFT												
	18	COMPLETE SHIP		X										
	19	ROTATING FLAP or SLAT												
	20	CONVERTIBLE ROTOR to WING												
	21	ROTOR-ROTOR												
	22	DEVICE OTHER THAN AIRCRAFT												
	23	FEATHERING PITCH SYSTEM												
GEOMETRY	24	ROTOR SYSTEMS per INSTAL.												
	25	NUMBER of BLADES per ROTOR	1	1								12		
	26	BLADE or ROTOR PROFILE	C	F								SR		
	27	TIP PATH other than CIRCULAR												
	28	AUXILIARY to FIXED WING												
TEST	29	WIND TUNNEL	X											
	30	FLIGHT or DROP TEST												
	31	TOWING TANK or in WATER												
	32	TWO DIMENSIONAL												
	33	THREE DIMENSIONAL	X											
	34	FLOW PATTERN STUDY												
	35	CAVITATION STUDY												
PARAMETERS VARIED	36	SIRFAM VFLOCITY												
	37	ROTATION												
	38	POWER												
	39	BLADE ANGLE												
	40	ORBIT ANGLE												
	41	ECCENTRICITY												
	42	PROFILE SHAPE or THICKNESS												
	43	NUMBER of BLADES												
	44	ASPECT RATIO												
	45	TIP PLATE DIA. or SHAPE	X	X										
	46	MOMENT of INERTIA												
QUANTITIES MEASURED	47	LIFT	X											
	48	DRAG	X											
	49	THRUST												
	50	TORQUE												
	51	ROTATION												
	52	TIP SPEED or ADVANCE RATIO												
	53	POWER												
	54	FORCE DISTRIBUTION												
	55	TORQUE DISTRIBUTION												
	56	FLIGHT PATH PLOTTED												
	57	STABILITY DERIVATIVES												
AVAILABILITY	58	PRESENTATION	P	B	S	S	P	P	P	P	P	R	S	S
	59	CLASSIFIED												
	60	COMPANY PROPRIETARY												
	61	NOT GENERALLY AVAILABLE												
	62	UNFULSHED												
	63	ENGLISH TRANSLATION												
	64	NOT SEARCHED	X											

		REFERENCE NO →	1	2	3	4	5	6	7	8	9	10	11	12	13	14	15	16	17	18	19	20	21	22	23	24	25	26	27	28	29	30	31	32	33	34	35		
SYSTEM		1	CYCLOGIRO or CYCLOIDAL PROP	X	X	X	X	X	X	X	X	X	X	X	X	X	X	X	X	X	X	X	X	X	X	X	X	X	X	X	X	X	X	X	X	X	X		
		2	WING ROTOR					X																															
		3	MAGNUS CYLINDER																																				
		4	CROSS-FLOW FAN																																				
		5	OTHER								X																												
GENERAL		6	THEORETICAL EXPOSITION																																				
		7	PERFORMANCE																X						X		X	X				X	X						
		8	STABILITY																																				
		9	CONTROL or MANEUVERABILITY																	X																			
		10	LOADS and STRESS ANALYSIS																																				
		11	PHENOMENON DEMONSTRATION																																				
		12	REVIEW												X					X												X	X		X				
APPLICATION		13	COMMENT of INTEREST	X																																			
		14	AIRCRAFT SUSTENTATION	X	X	X	X	X																			X												
		15	AIRCRAFT PROPULSION	X	X	X	X	X																															
		16	MARINE PROPULSION												X	X	X	X	X	X	X	X	X	X	X	X	X	X	X	X	X	X	X	X	X	X	X	X	
		17	COMPLETE AIRCRAFT	X	X	X	X	X																															
		18	COMPLETE SHIP											X													X	X	X	X	X	X	X	X	X	X	X	X	X
		19	ROTATING FLAP or SLAT																														X	X		X	X		
		20	CONVERTIBLE ROTOR to WING	X																																			
		21	ROTOR-ROTOR																																				
GEOMETRY		22	DEVICE OTHER THAN AIRCRAFT		W			W			W																												
		23	FEATHERING PITCH SYSTEM	1	2	4					7	2																											
		24	ROTOR SYSTEMS per INSTAL.		2							2																		2									
		25	NUMBER of BLADES per ROTOR		3		8					6																		3									
		26	BLADE or ROTOR PROFILE		A		F					7									A								A			A							
		27	TIP PATH other than CIRCULAR		A		F					7																											
TEST		28	AUXILIARY to FIXED WING																																				
		29	WIND TUNNEL																																				
		30	FLIGHT or DROP TEST																																				
		31	TOWING TANK or in WATER																	X								X			X	X		X					
		32	TWO DIMENSIONAL																																				
		33	THREE DIMENSIONAL																																				
		34	FLOW PATTERN STUDY																																				
PARAMETERS VARIED		35	CAVITATION STUDY																																				
		36	STREAM VELOCITY																																				
		37	ROTATION																																				
		38	POWER																																				
		39	BLADE ANGLE																																				
		40	ORBIT ANGLE																																				
		41	ECCENTRICITY																																				
		42	PROFILE SHAPE or THICKNESS																																				
		43	NUMBER of BLADES																																				
QUANTITIES MEASURED		44	ASPECT RATIO																																				
		45	TIP PLATE DIA. or SHAPE																																				
		46	MOMENT of INERTIA																																				
		47	LIFT																																				
		48	DRAG																																				
		49	THRUST																								X		X	X									
		50	TORQUE																																				
		51	ROTATION																																				
AVAILABILITY		52	TIP SPEED or ADVANCE RATIO																																				
		53	POWER																																				
		54	FORCE DISTRIBUTION																																				
		55	TORQUE DISTRIBUTION																																				
		56	FLIGHT PATH PLOTTED																																				
		57	STABILITY DERIVATIVES																																				
		58	PRESENTATION		S	P	P	P	R	S	P	P	P	R	P	P	P	P	P	P	P	P	P	P	P	P	P	P	P	P	P	P	P	P	P	P	P	P	
		59	CLASSIFIED																																				
AVAILABILITY		60	COMPANY PROPRIETARY																																				
		61	NOT GENERALLY AVAILABLE																																				
		62	UNPUBLISHED																																				
		63	ENGLISH TRANSLATION																							X		X	X				X	X	X	X	X	X	
64	NOT SEARCHED					X	X	X	X																														

V		REFERENCE NO	57
SYSTEM	1	CYCLOGIRO or CYCLOIDAL PROP.	X
	2	WING ROTOR	X
	3	MAGNUS CYLINDER	
	4	CROSS-FLOW FAN	
	5	OTHER	X
GENERAL	6	THEORETICAL EXPOSITION	
	7	PERFORMANCE	
	8	STABILITY	
	9	CONTROL or MANEUVERABILITY	
	10	LOADS and STRESS ANALYSIS	
	11	PHENOMENON DEMONSTRATION	
	12	REVIEW	
	13	COMMENT of INTEREST	X
APPLICATION	14	AIRCRAFT SUSTENTATION	X
	15	AIRCRAFT PROPULSION	X
	16	MARINE PROPULSION	
	17	COMPLETE AIRCRAFT	X
	18	COMPLETE SHIP	
	19	ROTATING FLAP or SLAT	
	20	CONVERTIBLE ROTOR to WING	
	21	ROTOR-ROTOR	X
	22	DEVICE OTHER THAN AIRCRAFT	W
	GEOMETRY	23	FEATHERING PITCH SYSTEM
24		ROTOR SYSTEMS per INSTAL.	
25		NUMBER of BLADES per ROTOR	
26		BLADE or ROTOR PROFILE	
27		TIP PATH other than CIRCULAR	
28		AUXILIARY to FIXED WING	
TEST	29	WIND TUNNEL	
	30	FLIGHT or DROP TEST	
	31	TOWING TANK or in WATER	
	32	TWO DIMENSIONAL	
	33	THREE DIMENSIONAL	
	34	FLOW PATTERN STUDY	
	35	CAVITATION STUDY	
PARAMETERS VARIED	36	STREAM VELOCITY	
	37	ROTATION	
	38	POWER	
	39	BLADE ANGLE	
	40	ORBIT ANGLE	
	41	ECCENTRICITY	
	42	PROFILE SHAPE or THICKNESS	
	43	NUMBER of BLADES	
	44	ASPECT RATIO	
	45	TIP PLATE DIA or SHAPE	
QUANTITIES MEASURED	46	MOMENT of INERTIA	
	47	LIFT	
	48	DRAG	
	49	THRUST	
	50	TORQUE	
	51	ROTATION	
	52	TIP SPEED or ADVANCE RATIO	
	53	POWER	
	54	FORCE DISTRIBUTION	
	55	TORQUE DISTRIBUTION	
	56	FLIGHT PATH PLOTTED	
	57	STABILITY DERIVATIVES	
AVAILABILITY	58	PRESENTATION	PS
	59	CLASSIFIED	
	60	COMPANY PROPRIETARY	
	61	NOT GENERALLY AVAILABLE	
	62	UNPUBLISHED	
	63	ENGLISH TRANSLATION	
	64	NOT SEARCHED	

	W	REFERENCE NO																																			
		1	2	3	4	5	6	7	8	9	10	11	12	13	14	15	16	17	18	19	20	21	22	23	24	25	26	27	28	29	30	31	32	33	34	35	
SYSTEM	1	CYCLOGIRO or CYCLOIDAL PROP																																			
	2	WING ROTOR																																			
	3	MAGNUS CYLINDER																																			
	4	CROSS-FLW FAN																																			
	5	OTHER																																			
GENERAL	6	THEORETICAL EXPOSITION																																			
	7	PERFORMANCE																																			
	8	STABILITY																																			
	9	CONTROL or MANEUVERABILITY																																			
	10	LCADS and STRESS ANALYSIS																																			
	11	PHENOMENON DEMONSTRATION																																			
	12	REVIEW																																			
	13	COMMENT of INTEREST																																			
	APPLICATION	14	AIRCRAFT SUSTENTATION																																		
15		AIRCRAFT PROPULSION																																			
16		MARINE PROPULSION																																			
17		COMPLETE AIRCRAFT																																			
18		COMPLETE SHIP																																			
19		ROTATING FLAP or SLAT																																			
20		CONVERTIBLE ROTOR to WING																																			
21		ROTOR-ROTOR																																			
22		DEVICE OTHER THAN AIRCRAFT																																			
GEOMETRY		23	FEATHERING PITCH SYSTEM																																		
	24	ROTOR SYSTEMS per INSTAL.																																			
	25	NUMBER of BLADES per ROTOR																																			
	26	BLADE or ROTOR PROFILE																																			
	27	TIP PATH other than CIRCULAR																																			
	28	AUXILIARY to FIXED WING																																			
	TEST	29	WIND TUNNEL																																		
		30	FLIGHT or DROP TEST																																		
31		TOWING TANK or in WATER																																			
32		TWO DIMENSIONAL																																			
33		THREE DIMENSIONAL																																			
34		FLOW PATTERN STUDY																																			
35		CAVITATION STUDY																																			
PARAMETERS VARIED	36	STREAM VELOCITY																																			
	37	ROTATION																																			
	38	POWER																																			
	39	BLADE ANGLE																																			
	40	ORBIT ANGLE																																			
	41	ECCENTRICITY																																			
	42	PROFILE SHAPE or THICKNESS																																			
	43	NUMBER of BLADES																																			
	44	ASPECT RATIO																																			
	45	TIP PLATE DIA. or SHAPE																																			
	46	MOMENT of INERTIA																																			
QUANTITIES MEASURED	47	LIFT																																			
	48	DRAG																																			
	49	THRUST																																			
	50	TORQUE																																			
	51	ROTATION																																			
	52	TIP SPEED or ADVANCE RATIO																																			
	53	POWER																																			
	54	FORCE DISTRIBUTION																																			
	55	TORQUE DISTRIBUTION																																			
	56	FLIGHT PATH PLOTTED																																			
	57	STABILITY DERIVATIVES																																			
AVAILABILITY	58	PRESENTATION																																			
	59	CLASSIFIED																																			
	60	COMPANY PROPRIETARY																																			
	61	NOT GENERALLY AVAILABLE																																			
	62	UNPUBLISHED																																			
	63	ENGLISH TRANSLATION																																			
	64	NOT SEARCHED																																			

W		REFERENCE NO	36	37	38	39	40	41	42	43	44	45	46	47	48	49	50	51	52	53	54	55	56	57		
SYSTEM	1	CYC LOGIRO or CYCLOIDAL PROP.		X			X	X	X	X	X	X	X	X							X	X				
	2	WING ROTOR			X	X	X	X						X								X				
	3	MAGNUS CYLINDER	X																	X						
	4	CROSS-FLOW FAN																								
	5	OTHER																								
GENERAL	6	THEORETICAL EXPOSITION																								
	7	PERFORMANCE		X	X	X	X											X	X							
	8	STABILITY																								
	9	CONTROL or MANEUVERABILITY												X												
	10	LOADS and STRESS ANALYSIS																								
	11	PHENOMENON DEMONSTRATION																								
	12	REVIEW																								
	13	COMMENT of INTEREST																								
	APPLICATION	14	AIRCRAFT SUSTENTATION	X				X	X	X	X	X	X	X				X	X		X	X				
15		AIRCRAFT PROPULSION		X				X	X	X	X	X	X									X				
16		MARINE PROPULSION			X																					
17		COMPLETE AIRCRAFT								X	X	X										X				
18		COMPLETE SHIP		X																						
19		ROTATING FLAP or SLAT																								
20		CONVERTIBLE ROTOR to WING																								
21		ROTOR-ROTOR																								
22		DEVICE OTHER THAN AIRCRAFT				B	B	B	B							K						K				
GEOMETRY		23	FEATHERING PITCH SYSTEM		2						2	2	2	2									2	2		
		24	ROTOR SYSTEMS per INSTAL.		2	1	1	1	1	1	1	2	2	2	1								1	2	1	
	25	NUMBER of BLADES per ROTOR		1	1	1	1	1	1	2	2	2	2	2	1						1	1	4	4		
	26	BLADE or ROTOR PROFILE	C	A	C	C	C	C	A	A	A	A	A	A	S	C					C	R	F	F		
	27	TIP PATH other than CIRCULAR																								
	28	AUXILIARY to FIXED WING	X																							
	TEST	29	WIND TUNNEL			X	X	X	X						X	X										
		30	FLIGHT or DROP TEST		X																					
31		TOWING TANK or in WATER																								
32		TWO DIMENSIONAL																								
33		THREE DIMENSIONAL			X	X	X	X						X	X											
34		FLOW PATTERN STUDY																								
35		CAVITATION STUDY																								
PARAMETERS VARIED	36	STREAM VELOCITY			X	X	X	X						X	X											
	37	ROTATION			X	X	X	X						X	X											
	38	POWER																								
	39	BLADE ANGLE													X											
	40	ORBIT ANGLE																								
	41	ECCENTRICITY																								
	42	PROFILE SHAPE or THICKNESS				X	X	X																		
	43	NUMBER of BLADES																								
	44	ASPECT RATIO																								
	45	TIP PLATE DIA. or SHAPE																								
	46	MOMENT of INERTIA																								
QUANTITIES MEASURED	47	LIFT		X	X	X	X						X	X												
	48	DRAG		X	X	X	X																			
	49	THRUST																								
	50	TORQUE																								
	51	ROTATION																								
	52	TIP SPEED or ADVANCE RATIO		X	X	X	X																			
	53	POWER																								
	54	FORCE DISTRIBUTION																								
	55	TORQUE DISTRIBUTION																								
	56	FLIGHT PATH PLOTTED																								
	57	STABILITY DERIVATIVES																								
AVAILABILITY	58	PRESENTATION		P	P	R	R	R	R	R	R	R	P	P	P	P	P	P	R	R	P	P	P	P		
	59	CLASSIFIED																								
	60	COMPANY PROPRIETARY																								
	61	NOT GENERALLY AVAILABLE																								
	62	UNPUBLISHED																								
63	ENGLISH TRANSLATION																									
64	NOT SEARCHED		X	X																		X				

Y		REFERENCE NO	REF
SYSTEM	1	CYCLOGIRO or CYCLOIDAL PROP.	
	2	WING ROTOR	X
	3	MAGNUS CYLINDER	
	4	CROSS-FLOW FAN	
	5	OTHER	X
GENERAL	6	THEORETICAL EXPOSITION	
	7	PERFORMANCE	X
	8	STABILITY	
	9	CONTROL or MANEUVERABILITY	
	10	LOADS and STRESS ANALYSIS	
	11	PHENOMENON DEMONSTRATION	
	12	REVIEW	
	13	COMMENT of INTEREST	
	APPLICATION	14	AIRCRAFT SUSTENTATION
15		AIRCRAFT PROPULSION	X
16		MARINE PROPULSION	
17		COMPLETE AIRCRAFT	
18		COMPLETE SHIP	
19		ROTATING FLAP or SLAT	
20		CONVERTIBLE ROTOR to WING	
21		ROTOR-ROTOR	
22		DEVICE OTHER THAN AIRCRAFT	
GEOMETRY		23	FEATHERING PITCH SYSTEM
	24	ROTOR SYSTEMS per INSTAL.	
	25	NUMBER of BLADES per ROTOR	
	26	BLADE or ROTOR PROFILE	
	27	TIP PATH other than CIRCULAR	
	28	AUXILIARY to FIXED WING	
TEST	29	WIND TUNNEL	X
	30	FLIGHT or DROP TEST	
	31	TOWING TANK or in ... E.	
	32	TWO DIMENSIONAL	
	33	THREE DIMENSIONAL	X
	34	FLOW PATTERN STUDY	
	35	CAVITATION STUDY	
PARAMETERS VARIED	36	STREAM VELOCITY	X
	37	ROTATION	X
	38	POWER	X
	39	BLADE ANGLE	X
	40	ORBIT ANGLE	
	41	ECCENTRICITY	
	42	PROFILE SHAPE or THICKNESS	
	43	NUMBER of BLADES	
	44	ASPECT RATIO	
	45	TIP PLATE DIA. or SHAPE	
	46	MOMENT of INERTIA	
QUANTITIES MEASURED	47	LIFT	X
	48	DRAG	X
	49	THRUST	X
	50	TORQUE	X
	51	ROTATION	X
	52	TIP SPEED or ADVANCE RATIO	X
	53	POWER	X
	54	FORCE DISTRIBUTION	
	55	TORQUE DISTRIBUTION	
	56	FLIGHT PATH PLOTTED	
	57	STABILITY DERIVATIVES	
AVAILABILITY	58	PRESENTATION	X P P
	59	CLASSIFIED	
	60	COMPANY PROPRIETARY	
	61	NOT GENERALLY AVAILABLE	
	62	UNPUBLISHED	
	63	ENGLISH TRANSLATION	
	64	NOT SEARCHED	X X

Z		REFERENCE NO		1 2 3 4 5 6 7 8 9 10 11 12 13 14 15 16 17 18																	
		1	2	3	4	5	6	7	8	9	10	11	12	13	14	15	16	17	18		
SYSTEM	1	CYCLOGIRO or CYCLOIDAL PROP.																			
	2	WING ROTOR																			
	3	MAGNUS CYLINDER																			
	4	CROSS-FLOW FAN																			
	5	OTHER																			
GENERAL	6	THEORETICAL EXPOSITION																			
	7	PERFORMANCE																			
	8	STABILITY																			
	9	CONTROL or MANEUVERABILITY																			
	10	LOADS and STRESS ANALYSIS																			
	11	PHENOMENON DEMONSTRATION																			
	12	REVIEW																			
	13	COMMENT of INTEREST																			
APPLICATION	14	AIRCRAFT SUSTENTATION																			
	15	AIRCRAFT PROPULSION																			
	16	MARINE PROPULSION																			
	17	COMPLETE AIRCRAFT																			
	18	COMPLETE SHIP																			
	19	ROTATING FLAP or SLAT																			
	20	CONVERTIBLE ROTOR to WING																			
	21	R-ROTOR																			
	22	DEVICE OTHER THAN AIRCRAFT																			
	GEOMETRY	23	FEATHERING PITCH SYSTEM																		
24		ROTOR SYSTEMS per INSTAL.																			
25		NUMBER of BLADES per ROTOR																			
26		BLADE or ROTOR PROFILE																			
27		TIP PATH other than CIRCULAR																			
28		AUXILIARY to FIXED WING																			
29		WIND TUNNEL																			
TEST	30	FLIGHT or DROP TEST																			
	31	TOWING TANK or in WATER																			
	32	TWO DIMENSIONAL																			
	33	THREE DIMENSIONAL																			
	34	FLOW PATTERN STUDY																			
	35	CAVITATION STUDY																			
	36	STREAM VELOCITY																			
PARAMETERS VARIED	37	ROTATION																			
	38	POWER																			
	39	BLADE ANGLE																			
	40	ORBIT ANGLE																			
	41	ECCENTRICITY																			
	42	PROFILE SHAPE or THICKNESS																			
	43	NUMBER of BLADES																			
	44	ASPECT RATIO																			
	45	TIP PLATE DIA or SHAPE																			
	46	MOMENT of INERTIA																			
QUANTITIES MEASURED	47	LIFT																			
	48	DRAG																			
	49	THRUST																			
	50	TORQUE																			
	51	ROTATION																			
	52	TIP SPEED or ADVANCE RATIO																			
	53	POWER																			
	54	FORCE DISTRIBUTION																			
	55	TORQUE DISTRIBUTION																			
	56	FLIGHT PATH PLOTTED																			
	57	STABILITY DERIVATIVES																			
AVAILABILITY	58	PRESENTATION																			
	59	CLASSIFIED																			
	60	COMPANY PROPRIETARY																			
	61	NOT GENERALLY AVAILABLE																			
	62	UNPUBLISHED																			
	63	ENGLISH TRANSLATION																			
	64	NOT SEARCHED																			

Unclassified

Security Classification

DOCUMENT CONTROL DATA - R & D		
<i>(Security classification of title, body of abstract and indexing annotation must be entered when the overall report is classified)</i>		
1. ORIGINATING ACTIVITY (Corporate author) Aerophysics Company 1341 New Hampshire Avenue, N. W. Washington, D. C. 20036		2a. REPORT SECURITY CLASSIFICATION Unclassified
		2b. GROUP
3. REPORT TITLE REVIEW AND PRELIMINARY EVALUATION OF LIFTING HORIZONTAL-AXIS ROTATING-WING AERONAUTICAL SYSTEMS (HARWAS)		
4. DESCRIPTIVE NOTES (Type of report and inclusive dates)		
5. AUTHOR(S) (First name, middle initial, last name) Foshag, William F. and Boehler, Gabriel D.		
6. REPORT DATE March 1969	7a. TOTAL NO OF PAGES 418	7b. NO OF REFS 1204
8a. CONTRACT OR GR. NT NO DAAJ 02-67-C-0046	8b. ORIGINATOR'S REPORT NUMBER(S) USAAVLABS Technical Report 69-13	
9. PROJECT NO IF 162204A14231	9d. OTHER REPORT NO(S) (Any other numbers that may be assigned this report)	
10. DISTRIBUTION STATEMENT This document has been approved for public release and sale its distribution is unlimited.		
11. SUPPLEMENTARY NOTES	12. SPONSORING MILITARY ACTIVITY US Army Aviation Materiel Laboratories Fort Eustis, Virginia	
13. ABSTRACT The results of a Review and Preliminary Evaluation of Lifting Horizontal-Axis Rotating-Wing Aeronautical Systems (HARWAS) are presented. Among the purely aeronautical applications, near-horizontal axis as well as horizontal axis devices are considered. The former cover the radial-lift propeller or "self-propelling" wing; the latter cover Magnus effect and related systems; cyclogiro systems and horizontal-axis propeller systems with cyclic pitch. A limited investigation of non-aeronautical applications of HARWAS is also made, which covers wing-rotor type windmills, cyclogiro windmill turbines, Magnus effect ship propulsion and cycloidal ship propulsion. Approximately 1200 references are listed. A series of cross-index tables is also included to provide a quick means for the reader to determine the content and availability of the references. An analysis of the various lift systems pertinent to the HARWAS field is made with a view to potential air vehicle applications. Over 20 original aeronautical applications are identified and evaluated in the light of recent advances in power plants, transmissions and lightweight structural techniques. This analysis points out the extraordinary variety of HARWAS and identifies promising new aeronautical systems. A preliminary performance and design study of two promising HARWAS concepts is also reported. The two concepts are the STOL logistics aircraft using a rotating airfoil flap and the amplified high-pitch cyclogiro for application to the composite aircraft mission.		

DD FORM 1473
1 NOV 65

REPLACES DD FORM 1473 1 JAN 64, WHICH IS
OBSOLETE FOR ARMY USE

Unclassified

Security Classification

Unclassified
Security Classification

14. KEY WORDS	LINK A		LINK B		LINK C	
	ROLE	WT	ROLE	WT	ROLE	WT
Aerodynamic Characteristics Performance (Engineering) Rotary Wing Vertical Take-off Planes Short Take-off Planes Airfoils Magnus Forces Wing Rotors Bomblets Savonius Rotors Flettner Rotors Rotating Cylinders Autorotation Gliders Flaps Slats Rotating Cylinder Flaps Rotating Airfoil Flaps Orbiting and Undulating Flaps Cyclogiros Cycloidal Propellers Propellers (Aerial) Radial-Lift Propellers Sails Windmills						

Unclassified

Security Classification

3644-69