

UNCLASSIFIED

AD NUMBER

AD844885

LIMITATION CHANGES

TO:

Approved for public release; distribution is unlimited.

FROM:

Distribution authorized to DoD only; Administrative/Operational Use; DEC 1968. Other requests shall be referred to NASA Marshall Space Flight Center, Huntsville, AL.

AUTHORITY

AE DC ltr 12 Jul 1974

THIS PAGE IS UNCLASSIFIED

AEDC-TR-68-238

ARCHIVE COPY  
DO NOT LOAN

*cy1*

**FLIGHT SUPPORT TESTING  
OF THE J-2 ROCKET ENGINE IN  
PROPULSION ENGINE TEST CELL (J-4)  
(TESTS J4-1901-03 THROUGH J4-1901-06)**



**N. R. Vetter**  
ARO, Inc.

PROPERTY OF U. S. AIR FORCE  
FORM 300-69-0-0001

**December 1968**

This document has been approved for public release  
its distribution is unlimited.

*By: AF-15  
Date: 12/24/74  
Signed: [Signature]  
[Signature]*

Each transmittal of this document outside the Department of Defense must have prior approval of NASA, Marshall Space Flight Center (I-E-J), Huntsville, Alabama 35812.

**LARGE ROCKET FACILITY  
ARNOLD ENGINEERING DEVELOPMENT CENTER  
AIR FORCE SYSTEMS COMMAND  
ARNOLD AIR FORCE STATION, TENNESSEE**

PROPERTY OF U. S. AIR FORCE  
AFSC LIBRARY  
F43300-69-0-0001



# ***NOTICES***

When U. S. Government drawings specifications, or other data are used for any purpose other than a definitely related Government procurement operation, the Government thereby incurs no responsibility nor any obligation whatsoever, and the fact that the Government may have formulated, furnished, or in any way supplied the said drawings, specifications, or other data, is not to be regarded by implication or otherwise, or in any manner licensing the holder or any other person or corporation, or conveying any rights or permission to manufacture, use, or sell any patented invention that may in any way be related thereto.

Qualified users may obtain copies of this report from the Defense Documentation Center.

References to named commercial products in this report are not to be considered in any sense as an endorsement of the product by the United States Air Force or the Government.

FLIGHT SUPPORT TESTING  
OF THE J-2 ROCKET ENGINE IN  
PROPULSION ENGINE TEST CELL (J-4)  
(TESTS J4-1901-03 THROUGH J4-1901-06)

N. R. Vetter  
ARO, Inc.

This document has been approved for public release  
its distribution is unlimited.

*Per A. F. Vetter  
7/4  
At 12 July 74  
Signed William D.  
Cole.*

Each transmittal of this document outside the Department of Defense must have prior approval of NASA, Marshall Space Flight Center (I-E-J), Huntsville, Alabama 35812.



**FOREWORD**

The work reported herein was sponsored by the National Aeronautics and Space Administration (NASA), Marshall Space Flight Center (MSFC) (I-E-J), under System 921E, Project 9194.

The results of the tests presented were obtained by ARO, Inc. (a subsidiary of Sverdrup & Parcel and Associates, Inc.), contract operator of the Arnold Engineering Development Center (AEDC), Air Force Systems Command (AFSC), Arnold Air Force Station, Tennessee, under Contract F40600-69-C-0001. Program direction was provided by NASA/MSFC; engineering liaison was provided by North American Rockwell Corporation, Rocketdyne Division, manufacturer of the J-2 rocket engine, and McDonnell Douglas Corporation, Douglas Aircraft Company, Missile and Space Systems Division, manufacturer of the S-IVB stage. The testing reported herein was conducted between July 23 and August 15, 1968, in Propulsion Engine Test Cell (J-4) of the Large Rocket Facility (LRF) under ARO Project No. KA1901. The manuscript was submitted for publication on September 25, 1968.

Information in this report is embargoed under the Department of State International Traffic in Arms Regulations. This report may be released to foreign governments by departments or agencies of the U. S. Government subject to approval of NASA, Marshall Space Flight Center (I-E-J), or higher authority. Private individuals or firms require a Department of State export license.

This technical report has been reviewed and is approved.

Edgar D. Smith  
Major, USAF  
AF Representative, LRF  
Directorate of Test

Roy R. Croy, Jr.  
Colonel, USAF  
Director of Test

## ABSTRACT

Fourteen firings of the Rocketdyne J-2 rocket engine (S/N J-2036-1) were conducted at pressure altitude conditions during four test periods (J4-1901-03 through J4-1901-06) between July 23 and August 15, 1968, in Test Cell J-4 of the Large Rocket Facility. This testing was in support of the J-2 engine application to the S-II and S-IVB stages of the Saturn V vehicle. The firings were accomplished at pressure altitudes between 78,000 and 110,000 ft at engine start. The primary objective of these firings was to evaluate engine start transients under various combinations of starting conditions with start tank energy being the major variable. The total accumulated firing duration for these four test periods was 223.2 sec.

This document is subject to special export controls and each transmittal to foreign governments or foreign nationals may be made only with prior approval of NASA, Marshall Space Flight Center (I-E-J), Huntsville, Alabama 35812.

This document has been approved for public release  
its distribution is unlimited. *Per AF Letter  
dtg 12 July 74,  
Signed William  
O. Cole*

## CONTENTS

	<u>Page</u>
ABSTRACT . . . . .	iii
NOMENCLATURE . . . . .	ix
I. INTRODUCTION . . . . .	1
II. APPARATUS . . . . .	1
III. PROCEDURE . . . . .	7
IV. RESULTS AND DISCUSSION . . . . .	8
V. SUMMARY OF RESULTS. . . . .	17
REFERENCES. . . . .	17

## APPENDIXES

## I. ILLUSTRATIONS

Figure

1. Test Cell J-4 Complex. . . . .	21
2. Test Cell J-4, Artist's Conception . . . . .	22
3. Engine Details . . . . .	23
4. S-IVB Battleship Stage/J-2 Engine Schematic . . . . .	24
5. Engine Schematic . . . . .	25
6. Engine Start Logic Schematic. . . . .	26
7. Engine Start and Shutdown Sequence . . . . .	27
8. Engine Start Conditions for the Pump Inlets, Start Tank, and Helium Tank . . . . .	29
9. Thermal Conditioning History of Engine Components, Firing 03A . . . . .	31
10. Engine Transient Operation, Firing 03A . . . . .	32
11. Fuel Pump Start Transient Performance, Firing 03A . . . . .	36
12. Engine Ambient and Combustion Chamber Pressure, Firing 03A . . . . .	37
13. Thermal Conditioning History of Engine Components, Firing 03B . . . . .	38
14. Engine Transient Operation, Firing 03B . . . . .	39

<u>Figure</u>	<u>Page</u>
15. Fuel Pump Start Transient Performance, Firing 03B . . .	43
16. Engine Ambient and Combustion Chamber Pressure, Firing 03B . . . . .	44
17. Thermal Conditioning History of Engine Components, Firing 03C . . . . .	45
18. Engine Transient Operation, Firing 03C . . . . .	46
19. Fuel Pump Start Transient Performance, Firing 03C . . .	50
20. Engine Ambient and Combustion Chamber Pressure, Firing 03C . . . . .	51
21. Thermal Conditioning History of Engine Components, Firing 03D . . . . .	52
22. Engine Transient Operation, Firing 03D . . . . .	53
23. Fuel Pump Start Transient Performance, Firing 03D . . .	55
24. Engine Ambient and Combustion Chamber Pressure, Firing 03D . . . . .	56
25. Thermal Conditioning History of Engine Components, Firing 04A . . . . .	57
26. Engine Transient Operation, Firing 04A . . . . .	58
27. Fuel Pump Start Transient Performance, Firing 04A . . .	62
28. Engine Ambient and Combustion Chamber Pressure, Firing 04A . . . . .	63
29. Thermal Conditioning History of Engine Components; Firing 04B . . . . .	64
30. Engine Transient Operation, Firing 04B . . . . .	65
31. Fuel Pump Start Transient Performance, Firing 04B . . .	69
32. Engine Ambient and Combustion Chamber Pressure, Firing 04B . . . . .	70
33. Thermal Conditioning History of Engine Components, Firing 04C . . . . .	71
34. Engine Transient Operation, Firing 04C . . . . .	72
35. Fuel Pump Start Transient Performance, Firing 04C . . .	76
36. Engine Ambient and Combustion Chamber Pressure, Firing 04C . . . . .	77

<u>Figure</u>	<u>Page</u>
37. Thermal Conditioning History of Engine Components, Firing 04D . . . . .	78
38. Engine Transient Operation, Firing 04D . . . . .	79
39. Fuel Pump Start Transient Performance, Firing 04D . . . . .	81
40. Engine Ambient and Combustion Chamber Pressure, Firing 04D . . . . .	82
41. Thermal Conditioning History of Engine Components, Firing 05A . . . . .	83
42. Engine Transient Operation, Firing 05A . . . . .	84
43. Engine Ambient and Combustion Chamber Pressure, Firing 05A . . . . .	86
44. Thermal Conditioning History of Engine Components, Firing 06A . . . . .	87
45. Engine Transient Operation, Firing 06A . . . . .	88
46. Fuel Pump Start Transient Performance, Firing 06A . . . . .	92
47. Engine Ambient and Combustion Chamber Pressure, Firing 06A . . . . .	93
48. Thermal Conditioning History of Engine Components, Firing 06B . . . . .	94
49. Engine Transient Operation, Firing 06B . . . . .	95
50. Fuel Pump Start Transient Performance, Firing 06B . . . . .	99
51. Engine Ambient and Combustion Chamber Pressure, Firing 06B . . . . .	100
52. Thermal Conditioning History of Engine Components, Firing 06C . . . . .	101
53. Engine Transient Operation, Firing 06C . . . . .	102
54. Fuel Pump Start Transient Performance, Firing 06C . . . . .	106
55. Engine Ambient and Combustion Chamber Pressure, Firing 06C . . . . .	107
56. Thermal Conditioning History of Engine Components, Firing 06D . . . . .	108
57. Engine Transient Operation, Firing 06D . . . . .	109
58. Fuel Pump Start Transient Performance, Firing 06D . . . . .	113

<u>Figure</u>	<u>Page</u>
59. Engine Ambient and Combustion Chamber Pressure, Firing 06D . . . . .	114
60. Thermal Conditioning History of Engine Components, Firing 06E . . . . .	115
61. Engine Transient Operation, Firing 06E . . . . .	116
62. Fuel Pump Start Transient Performance, Firing 06E . . . . .	118
63. Engine Ambient and Combustion Chamber Pressure, Firing 06E . . . . .	119
II. TABLES	
I. Major Engine Components . . . . .	120
II. Summary of Engine Orifices . . . . .	121
III. Engine Modifications (Between Tests J4-1901-03 and J4-1901-06). . . . .	122
IV. Engine Component Replacements (Between Tests J4-1901-03 and J4-1901-06). . . . .	122
V. Engine Purge and Component Conditioning Sequence . . . . .	123
VI. Summary of Test Requirements and Results . . . . .	124
VII. Engine Valve Timings . . . . .	127
VIII. Engine Performance Summary . . . . .	129
III. INSTRUMENTATION. . . . .	130
IV. METHOD OF CALCULATION (PERFORMANCE PROGRAM). . . . .	143

**NOMENCLATURE**

A	Area, in. <sup>2</sup>
ASI	Augmented spark igniter
ES	Engine start, designated as the time that helium control and ignition phase solenoids are energized
GG	Gas generator
MOV	Main oxidizer valve
STDV	Start tank discharge valve
$t_0$	Defined as the time at which the opening signal is applied to the start tank discharge valve solenoid
VSC	Vibration safety counts, defined as the time at which engine vibration was in excess of 150 g rms in a 960- to 6000-Hz frequency range

**SUBSCRIPTS**

f	Force
m	Mass
t	Throat

## SECTION I INTRODUCTION

Testing of the Rocketdyne J-2 rocket engine using an S-IVB battleship stage has been in progress since July, 1966, at AEDC in support of J-2 engine application on the Saturn IB and Saturn V launch vehicles for the NASA Apollo Program. The 14 firings reported herein were conducted during test periods J4-1901-03 through J4-1901-06 in Propulsion Engine Test Cell (J-4) (Figs. 1 and 2, Appendix I) of the Large Rocket Facility (LRF). These firings were to investigate engine start transients for S-IVB first burn and 80-min orbital restarts and S-II starts utilizing a 230,000-lbf-thrust configuration engine. The firings were accomplished at pressure altitudes ranging from 78,000 to 110,000 ft (geometric pressure altitude, Z, Ref. 1) at engine start. Engine components were conditioned to temperatures predicted for an S-IVB first burn, 80-min restart, or S-II start. Data collected to accomplish the test objectives are presented herein. The results of the previous test period are presented in Ref. 2.

## SECTION II APPARATUS

### 2.1 TEST ARTICLE

The test article was a J-2 rocket engine (Fig. 3) designed and developed by Rocketdyne Division of North American Rockwell Corporation. The engine uses liquid oxygen and liquid hydrogen as propellants and has a thrust rating of 230,000 lbf at an oxidizer-to-fuel mixture ratio of 5.5. An S-IVB battleship stage was used to supply propellants to the engine. A schematic of the battleship stage is presented in Fig. 4.

Listings of major engine components and engine orifices for this test period are presented in Tables I and II, respectively (Appendix II). All engine modifications and component replacements performed since the previous test period are presented in Tables III and IV, respectively.



### 2.1.1 J-2 Rocket Engine

The J-2 rocket engine (Figs. 3 and 5, Ref. 3) features the following major components:

1. Thrust Chamber - The tubular-walled, bell-shaped thrust chamber consists of an 18.6-in. -diam combustion chamber (8.0 in. long from the injector mounting to the throat inlet) with a characteristic length ( $L^*$ ) of 24.6 in., a 170.4-in.<sup>2</sup> throat area, and a divergent nozzle with an expansion ratio of 27.1. Thrust chamber length (from the injector flange to the nozzle exit) is 107 in. Cooling is accomplished by the circulation of engine fuel flow downward from the fuel manifold through 180 tubes and then upward through 360 tubes to the injector.
2. Thrust Chamber Injector - The injector is a concentric-orificed (concentric fuel orifices around the oxidizer post orifices), porous-faced injector. Fuel and oxidizer injector orifice areas are 25.0 and 16.0 in.<sup>2</sup>, respectively. The porous material, forming the injector face, allows approximately 3.5 percent of total fuel flow to transpiration cool the face of the injector.
3. Augmented Spark Igniter - The augmented spark igniter unit is mounted on the thrust chamber injector and supplies the initial energy source to ignite propellants in the main combustion chamber. The augmented spark igniter chamber is an integral part of the thrust chamber injector. Fuel and oxidizer are ignited in the combustion area by two spark plugs.
4. Fuel Turbopump - The turbopump is composed of a two-stage turbine-stator assembly, an inducer, and a seven-stage axial-flow pump. The pump is self lubricated and nominally produces, at rated conditions, a head rise of 38,215 ft (1248 psia) of liquid hydrogen at a flow rate of 8585 gpm for a rotor speed of 27,265 rpm.
5. Oxidizer Turbopump - The turbopump is composed of a two-stage turbine-stator assembly and a single-stage centrifugal pump. The pump is self lubricated and nominally produces, at rated conditions, a head rise of 2170 ft (1107 psia) of liquid oxygen at a flow rate of 2965 gpm for a rotor speed of 8688 rpm.
6. Gas Generator - The gas generator consists of a combustion chamber containing two spark plugs, a pneumatically operated control valve containing oxidizer and fuel poppets, and an injector assembly. The oxidizer and fuel poppets provide a fuel lead to the gas generator combustion chamber. The high energy gases produced by the gas generator are directed to the fuel

turbine and then to the oxidizer turbine (through the turbine crossover duct) before being exhausted into the thrust chamber at an area ratio ( $A/A_t$ ) of approximately 11.

7. Propellant Utilization Valve - The motor-driven propellant utilization valve is mounted on the oxidizer turbopump and bypasses liquid oxygen from the discharge to the inlet side of the pump to vary engine mixture ratio.
8. Propellant Bleed Valves - The pneumatically operated fuel and oxidizer bleed valves provide pressure relief for the boiloff of propellants trapped between the battleship stage prevalues and main propellant valves at engine shutdown.
9. Integral Hydrogen Start Tank and Helium Tank - The integral tanks consist of a 7258-in.<sup>3</sup> sphere for hydrogen with a 1000-in.<sup>3</sup> sphere for helium located within it. Pressurized gaseous hydrogen in the start tank provides the initial energy source for spinning the propellant turbopumps during engine start. The helium tank provides a helium pressure supply to the engine pneumatic control system.
10. Oxidizer Turbine Bypass Valve - The pneumatically actuated oxidizer turbine bypass valve provides control of the fuel turbine exhaust gases directed to the oxidizer turbine in order to control the oxidizer-to-fuel turbine spinup relationship. The fuel turbine exhaust gases which bypass the oxidizer turbine are discharged into the thrust chamber.
11. Main Oxidizer Valve - The main oxidizer valve is a pneumatically actuated, two-stage, butterfly-type valve located in the oxidizer high pressure duct between the turbopump and main injector. The first-stage actuator positions the main oxidizer valve at the 14-deg position to obtain initial thrust chamber ignition; the second-stage actuator ramps the main oxidizer valve full open to accelerate the engine to main-stage operation.
12. Main Fuel Valve - The main fuel valve is a pneumatically actuated butterfly-type valve located in the fuel high pressure duct between the turbopump and the fuel manifold.
13. Pneumatic Control Package - The pneumatic control package controls all pneumatically operated engine valves and purges.
14. Electrical Control Assembly - The electrical control assembly provides the electrical logic required for proper sequencing of engine components during operation.

15. Primary and Auxiliary Flight Instrumentation Packages - The instrumentation packages contain sensors required to monitor critical engine parameters. The packages provide environmental control for the sensors.

### 2.1.2 S-IVB Battleship Stage

The S-IVB battleship stage is approximately 22 ft in diameter and 49 ft long and has a maximum propellant capacity of 46,000 lb of liquid hydrogen and 199,000 lb of liquid oxygen. The propellant tanks, fuel above oxidizer, are separated by a common bulkhead. Propellant pre-valves, in the low pressure ducts (external to the tanks) interfacing the stage and the engine, retain propellant in the stage until being admitted into the engine to the main propellant valves and serve as emergency engine shutoff valves. Propellant recirculation pumps in both fuel and oxidizer tanks are utilized to circulate propellants through the low pressure ducts and turbopumps before engine start to stabilize hardware temperatures near normal operating levels and to prevent propellant temperature stratification. Vent and relief valve systems are provided for both propellant tanks.

Pressurization of the fuel and oxidizer tanks was accomplished by facility systems using hydrogen and helium, respectively, as the pressurizing gases. The engine-supplied gaseous hydrogen for fuel tank pressurization during S-IVB and S-II flight was routed to the facility venting system.

## 2.2 TEST CELL

Test Cell J-4, Fig. 2, is a vertically oriented test unit designed for static testing of liquid-propellant rocket engines and propulsion systems at pressure altitudes of 100,000 ft. The basic cell construction provides a 1.5-million-lbf-thrust capacity. The cell consists of four major components (1) test capsule, 48 ft in diameter and 82 ft in height, situated at grade level and containing the test article; (2) spray chamber, 100 ft in diameter and 250 ft in depth, located directly beneath the test capsule to provide exhaust gas cooling and dehumidification; (3) coolant water, steam, nitrogen (gaseous and liquid), hydrogen (gaseous and liquid), and liquid oxygen and gaseous helium storage and delivery systems for operation of the cell and test article; and (4) control building, containing test article controls, test cell controls, and data acquisition equipment. Exhaust machinery is connected with the spray chamber and maintains a minimum test cell pressure before and after the engine firing and exhausts the products of combustion from the

engine firing. Before a firing, the facility steam ejector, in series with the exhaust machinery, provides a pressure altitude of 100,000 ft in the test capsule. A detailed description of the test cell is presented in Ref. 4.

The battleship stage and the J-2 engine were oriented vertically downward on the centerline of the diffuser-steam ejector assembly. This assembly consisted of a diffuser duct (20 ft in diameter by 150 ft in length), a centerbody steam ejector within the diffuser duct, a diffuser insert (13.5 ft in diameter by 30 ft in length) at the inlet to the diffuser duct, and a gaseous nitrogen annular ejector above the diffuser insert. The diffuser insert was provided for dynamic pressure recovery of the engine exhaust gases and to maintain engine ambient pressure altitude (attained by the steam ejector) during the engine firing. The annular ejector was provided to suppress steam recirculation into the test capsule during steam ejector shutdown. The test cell was also equipped with (1) a gaseous nitrogen purge system for continuously inerting the normal air in-leakage of the cell; (2) a gaseous nitrogen repressurization system for raising test cell pressure, after engine cut-off, to a level equal to spray chamber pressure and for rapid emergency inerting of the capsule; and (3) a spray chamber liquid nitrogen supply and distribution manifold for initially inerting the spray chamber and exhaust ducting and for increasing the molecular weight of the hydrogen-rich exhaust products.

An engine component conditioning system was provided for temperature conditioning engine components. The conditioning system utilized a liquid hydrogen-helium heat exchanger to provide cold helium gas for component conditioning. Engine components requiring temperature conditioning were the thrust chamber, crossover duct, start tank discharge valve (test 05 only), and main oxidizer valve second-stage actuator. Helium was routed internally through the crossover duct and tubular-walled thrust chamber and externally over the start tank discharge valve. Main oxidizer valve conditioning was achieved by opening the pre valves and permitting propellants into the engine.

### 2.3 INSTRUMENTATION

Instrumentation systems were provided to measure engine, stage, and facility parameters. The engine instrumentation was comprised of (1) flight instrumentation for the measurement of critical engine parameters and (2) facility instrumentation which was provided to verify the flight instrumentation and to measure additional engine parameters. The flight instrumentation was provided and calibrated by the engine manufacturer; facility instrumentation was initially calibrated and periodically

recalibrated at AEDC. Appendix III contains a list of all measured test parameters and the locations of selected sensing points.

Pressure measurements were made using strain-gage and capacitance-type pressure transducers. Temperature measurements were made using resistance temperature transducers and thermocouples. Oxidizer and fuel turbopump shaft speeds were sensed by magnetic pick-up. Fuel and oxidizer flow rates to the engine were measured by turbine-type flowmeters which are an integral part of the engine. The propellant recirculation flow rates were also monitored with turbine-type flowmeters. Vibrations were measured by accelerometers mounted on the oxidizer injector dome and on the turbopumps. Primary engine and stage valves were instrumented with linear potentiometers and limit switches.

The data acquisition systems were calibrated by (1) precision electrical shunt resistance substitution for the pressure transducers and resistance temperature transducer units; (2) voltage substitution for the thermocouples; (3) frequency substitution for shaft speeds and flowmeters; and (4) frequency-voltage substitution for accelerometers.

The types of data acquisition and recording systems used during this test period were (1) a multiple-input digital data acquisition system (Microsadic<sup>®</sup>) scanning each parameter at 40 samples per second and recording on magnetic tape; (2) single-input, continuous-recording FM systems recording on magnetic tape; (3) photographically recording galvanometer oscillographs; (4) direct-inking, null-balance potentiometer-type X-Y plotters and strip charts; and (5) optical data recorders. Applicable systems were calibrated before each test (atmospheric and altitude calibrations). Television cameras, in conjunction with video tape recorders, were used to provide visual coverage during an engine firing, as well as for replay capability for immediate examination of unexpected events.

## 2.4 CONTROLS

Control of the J-2 engine, battleship stage, and test cell systems during the terminal countdown was provided from the test cell control room. A facility control logic network was provided to interconnect the engine control system, major stage systems, the engine safety cutoff system, the observer cutoff circuits, and the countdown sequencer. A schematic of the engine start control logic is presented in Fig. 6. The sequence of engine events for a normal start and shutdown is presented in Figs. 7a and b. Two control logics for sequencing the stage prevalves

and recirculation systems with engine start for simulating engine flight start sequences are presented in Figs. 7c and d.

### SECTION III PROCEDURE

Preoperational procedures were begun several hours before the test period. All consumable storage systems were replenished, and engine inspections, leak checks, and drying procedures were conducted. Propellant tank pressurants and engine pneumatic and purge gas samples were taken to ensure that specification requirements were met. Chemical analysis of propellants was provided by the propellant suppliers. Facility sequence, engine sequence, and engine abort checks were conducted within a 24-hr time period before an engine firing to verify the proper sequence of events. Facility and engine sequence checks consisted of verifying the timing of valves and events to be within specified limits; the abort checks consisted of electrically simulating engine malfunctions to verify the occurrence of an automatic engine cutoff signal. A final engine sequence check was conducted immediately preceding the test period.

Oxidizer dome, gas generator oxidizer injector, and thrust chamber jacket purges were initiated before evacuating the test cell. After completion of instrumentation calibrations at atmospheric conditions, the test cell was evacuated to approximately 0.5 psia with the exhaust machinery, and instrumentation calibrations at altitude conditions were conducted. Immediately before loading propellants on board the vehicle, the cell and exhaust-ducting atmosphere was inerted. At this same time, the cell nitrogen purge was initiated for the duration of the test period, except for the engine firing. The vehicle propellant tanks were then loaded, and the remainder of the terminal countdown was conducted. Temperature conditioning of the various engine components was accomplished as required, using the facility-supplied engine component conditioning system. Engine components which required temperature conditioning were the thrust chamber, the crossover duct, start tank discharge valve (test 05 only), and main oxidizer valve second-stage actuator. Table V presents the engine purges and thermal conditioning operations during the terminal countdown and immediately following the engine firing.

## SECTION IV RESULTS AND DISCUSSION

### 4.1 TEST SUMMARY

Fourteen firings of the Rocketdyne J-2 rocket engine (J-2036-1) were conducted on July 23 and 31 and August 8 and 15, 1968, during test periods J4-1901-03 through J4-1901-06. These firings were in support of the S-II/S-V and S-IVB/S-V J-2 engine application and flight support testing. Testing was accomplished at pressure altitudes ranging from 78,000 to 110,000 ft at engine start.

Test requirements and specific test results are summarized in Table VI. Start and shutdown transient operating times for selected engine valves are presented in Table VII. Figure 8 shows engine start conditions for pump inlets and start and helium tanks. The total firing duration for the four test periods was 223.2 sec. Calculated engine performance for the five 32.5-sec duration firings is presented in Table VIII. Methods of calculations shown are presented in Appendix IV. Specific test objectives and a brief summary of each firing are presented below.

<u>Firing</u>	<u>Test Objectives</u>	<u>Results</u>
03A	Simulate S-IVB first burn to evaluate augmented spark igniter ignition characteristics.	Augmented spark igniter ignition was detected at $t_0 + 0.222$ sec. Thrust chamber ignition occurred at $t_0 + 0.979$ sec.
03B	Simulate S-IVB 80-min restart with maximum start tank energy and low fuel pump inlet pressure.	Thrust chamber ignition occurred at $t_0 + 0.961$ sec, and thrust chamber pressure reached 550 psia at $t_0 + 1.993$ sec. Gas generator outlet temperature first peak was 1750°F with a second peak of 1930°F.
03C	Simulate S-IVB first burn to evaluate maximum gas generator outlet temperature first peak.	Gas generator outlet temperature first peak was 1640°F.

<u>Firing</u>	<u>Test Objectives</u>	<u>Results</u>
03D	Repeat firing 03B with start tank gas 50°F colder.	Thrust chamber ignition occurred at $t_0 + 0.939$ sec. Gas generator outlet temperature first peak was 2000°F with a second peak of 2190°F. Firing was terminated at $t_0 + 1.264$ sec by engine safety cutoff system.
04A	Simulate S-IVB first burn to evaluate engine start transient with maximum start tank energy and warmest thrust chamber.	Thrust chamber ignition occurred at $t_0 + 0.962$ sec, and thrust chamber pressure reached 550 psia at $t_0 + 1.821$ sec. Gas generator outlet temperature first peak was 1870°F.
04B	Simulate S-IVB 80-min restart to evaluate gas generator outlet temperature transient with minimum start tank temperature.	Gas generator outlet temperature first peak was 1940°F, and the second peak was 2120°F.
04C	Simulate S-IVB first burn to evaluate augmented spark igniter ignition and gas generator outlet temperature transient with maximum start tank energy and propellant pump inlet pressures.	Augmented spark igniter ignition was detected 0.210 sec after engine start. Gas generator outlet temperature first peak was 1960°F.
04D	Simulate S-IVB 80-min restart to evaluate augmented spark igniter ignition and gas generator outlet temperature transient with maximum starting energy.	Augmented spark igniter ignition was detected 0.260 sec after engine start. Gas generator outlet temperature first peak was 2010°F, and the second peak was 2160°F.
05A	Simulate S-II firing to evaluate augmented spark igniter ignition with minimum augmented spark igniter mixture ratio, maximum fuel pump inlet pressure, and warmest thrust chamber.	There was no indication of augmented spark igniter ignition before main-stage control solenoid "on" command, at which time the firing was terminated by the engine logic.



<u>Firing</u>	<u>Test Objectives</u>	<u>Results</u>
06A	Simulate S-IVB 6-hr restart to evaluate engine start characteristics with minimum starting energy.	Thrust chamber ignition occurred at $t_0 + 1.091$ sec, and thrust chamber pressure reached 550 psia at $t_0 + 3.233$ sec. Gas generator outlet temperature first peak was 1450°F.
06B	Simulate S-IVB 80-min restart to evaluate gas generator outlet temperature transient with minimum start tank temperature.	Gas generator outlet temperature first peak was 1730°F, and the second peak was 1760°F.
06C	Simulate S-IVB first burn to evaluate engine start characteristics with minimum starting energy.	Thrust chamber ignition occurred at $t_0 + 1.062$ sec, and thrust chamber pressure reached 550 psia at $t_0 + 2.124$ sec. Gas generator outlet temperature first peak was 2020°F.
06D	Simulate S-IVB 80-min restart to evaluate gas generator outlet temperature transient with minimum start tank and thrust chamber temperature.	Gas generator outlet temperature first peak was 1930°F. There was no second peak.
06E	Determine the effect of a -200°F oxidizer injector dome on start transient combustion stability with starting conditions similar to firing 06A.	Total vibration safety counts duration was less than 10 msec before engine cutoff command.

## 4.2 TEST RESULTS

### 4.2.1 Firing J4-1901-03A

The programmed 32.5-sec duration firing was successfully accomplished. Test conditions at engine start are presented in Table VI. Thermal conditioning histories of various engine components are shown in Fig. 9. Start and shutdown transient operating times of selected engine valves are presented in Table VII. Engine start and shutdown transients are shown in Fig. 10. Fuel pump start transient performance

is shown in Fig. 11. Pressure altitude at engine start was 100,000 ft. Engine ambient and combustion chamber pressure histories are shown in Fig. 12.

Test conditions were selected to simulate an S-IVB first burn. Augmented spark igniter ignition was detected at  $t_0 + 0.222$  sec. Thrust chamber ignition (chamber pressure attains 100 psia) occurred at  $t_0 + 0.979$  sec, and chamber pressure reached 550 psia at  $t_0 + 1.848$  sec. Engine vibration in excess of 150 g occurred for 20 msec beginning at  $t_0 + 0.978$  sec. Gas generator outlet temperature first peak was 1560°F with no second peak.

#### 4.2.2 Firing J4-1901-03B

The programmed 7.5-sec duration firing was successfully accomplished. Test conditions at engine start are presented in Table VI. Thermal conditioning histories of various engine components are shown in Fig. 13. Start and shutdown transient operating times of selected engine valves are presented in Table VII. Engine start and shutdown transients are shown in Fig. 14. Fuel pump start transient performance is shown in Fig. 15. Pressure altitude at engine start was 106,000 ft. Engine ambient and combustion chamber pressure histories are shown in Fig. 16.

Test conditions were selected to simulate an S-IVB 80-min restart with maximum start tank energy. Augmented spark igniter ignition was detected 0.248 sec after engine start. Thrust chamber ignition occurred at  $t_0 + 0.961$  sec, and chamber pressure reached 550 psia at  $t_0 + 1.993$  sec. Engine vibration in excess of 150 g occurred for 6 msec beginning at  $t_0 + 0.960$  sec. Gas generator outlet temperature first peak was 1750°F with a second peak of 1930°F.

#### 4.2.3 Firing J4-1901-03C

The programmed 32.5-sec duration firing was successfully accomplished. Test conditions at engine start are presented in Table VI. Thermal conditioning histories of various engine components are shown in Fig. 17. Start and shutdown transient operating times of selected engine valves are presented in Table VII. Engine start and shutdown transients are shown in Fig. 18. Fuel pump start transient performance is shown in Fig. 19. Pressure altitude at engine start was 106,000 ft. Engine ambient and combustion chamber pressure histories are shown in Fig. 20.

Test conditions were selected to simulate an S-IVB first burn with a worst-case gas generator outlet temperature first peak. Augmented spark igniter ignition was detected 0.162 sec after engine start. Thrust chamber ignition occurred at  $t_0 + 1.073$  sec, and chamber pressure reached 550 psia at  $t_0 + 1.951$  sec. Engine vibration in excess of 150 g occurred for 35 msec beginning at  $t_0 + 0.964$  sec. Gas generator outlet temperature first peak was 1640°F with no second peak.

#### 4.2.4 Firing J4-1901-03D

The programmed 7.5-sec duration firing was terminated at  $t_0 + 1.264$  sec by the engine safety cutoff system because of excessive gas generator outlet temperature. Test conditions at engine start are presented in Table VI. Thermal conditioning histories of various engine components are shown in Fig. 21. Start and shutdown transient operating times of selected engine valves are presented in Table VII. Engine start and shutdown transients are shown in Fig. 22. Fuel pump start transient performance is shown in Fig. 23. Pressure altitude at engine start was 104,000 ft. Engine ambient and combustion chamber pressure histories are shown in Fig. 24.

Test conditions were selected to repeat firing 03B with start tank gas 50°F colder. Augmented spark igniter ignition was detected 0.212 sec after engine start. Thrust chamber ignition occurred at  $t_0 + 0.939$  sec. Engine vibration in excess of 150 g occurred for 5 msec beginning at  $t_0 + 0.945$  sec. Gas generator outlet temperature first peak was 2000°F with a second peak of 2190°F.

#### 4.2.5 Firing J4-1901-04A

The programmed 32.5-sec duration firing was terminated at  $t_0 + 25.02$  sec by the inadvertent opening (resulting from incorrect procedure) of the thrust chamber purge valve. Test conditions at engine start are presented in Table VI. Thermal conditioning histories of various engine components are shown in Fig. 25. Start and shutdown transient operating times of selected engine valves are presented in Table VII. Engine start and shutdown transients are shown in Fig. 26. Fuel pump start transient performance is shown in Fig. 27. Pressure altitude at engine start was 78,000 ft. Engine ambient and combustion chamber pressure histories are shown in Fig. 28.

Test conditions were selected to simulate an S-IVB first burn with maximum start tank energy and the warmest expected thrust chamber. Augmented spark igniter ignition was detected 0.243 sec after engine start. Thrust chamber ignition occurred at  $t_0 + 0.962$  sec, and chamber

pressure reached 550 psia at  $t_0 + 1.821$  sec. Engine vibration in excess of 150 g occurred for 5 msec beginning at  $t_0 + 0.978$  sec. Gas generator outlet temperature first peak was 1870°F with a second peak of 1750°F.

#### 4.2.6 Firing J4-1901-04B

The programmed 7.5-sec duration firing was successfully accomplished. Test conditions at engine start are presented in Table VI. Thermal conditioning histories of various engine components are shown in Fig. 29. Start and shutdown transient operating times of selected engine valves are presented in Table VII. Engine start and shutdown transients are shown in Fig. 30. Fuel pump start transient performance is shown in Fig. 31. Pressure altitude at engine start was 100,000 ft. Engine ambient and combustion chamber pressure histories are shown in Fig. 32.

Test conditions were selected to simulate an S-IVB 80-min restart with minimum start tank temperature. Augmented spark igniter ignition was detected 0.180 sec after engine start. Thrust chamber ignition occurred at  $t_0 + 0.945$  sec, and chamber pressure reached 550 psia at  $t_0 + 2.005$  sec. Engine vibration in excess of 150 g occurred for 15 msec beginning at  $t_0 + 1.046$  sec. Gas generator outlet temperature first peak was 1940°F with a second peak of 2120°F.

#### 4.2.7 Firing J4-1901-04C

The programmed 32.5-sec duration firing was successfully accomplished. Test conditions at engine start are presented in Table VI. Thermal conditioning histories of various engine components are shown in Fig. 33. Start and shutdown transient operating times of selected engine valves are presented in Table VII. Engine start and shutdown transients are shown in Fig. 34. Fuel pump start transient performance is shown in Fig. 35. Pressure altitude at engine start was 100,000 ft. Engine ambient and combustion chamber pressure histories are shown in Fig. 36.

Test conditions were selected to simulate an S-IVB first burn with maximum starting energy and maximum propellant pump inlet pressures. Augmented spark igniter ignition was detected 0.210 sec after engine start. Thrust chamber ignition occurred at  $t_0 + 0.958$  sec, and chamber pressure reached 550 psia at  $t_0 + 1.807$  sec. Engine vibration in excess of 150 g occurred for 26 msec beginning at  $t_0 + 0.956$  sec. Gas generator outlet temperature first peak was 1960°F with no second peak.

#### 4.2.8 Firing J4-1901-04D

The programmed 2.0-sec duration firing was successfully accomplished. Test conditions at engine start are presented in Table VI. Thermal conditioning histories of various engine components are shown in Fig. 37. Start and shutdown transient operating times of selected engine valves are presented in Table VII. Engine start and shutdown transients are shown in Fig. 38. Fuel pump start transient performance is shown in Fig. 39. Pressure altitude at engine start was 100,000 ft. Engine ambient and combustion chamber pressure histories are shown in Fig. 40.

Test conditions were selected to simulate an S-IVB 80-min restart with maximum starting energy. Augmented spark igniter ignition was detected 0.260 sec after engine start. Thrust chamber ignition occurred at  $t_0 + 0.948$  sec, and chamber pressure reached 550 psia at  $t_0 + 1.984$  sec. Engine vibration in excess of 150 g occurred for 9 msec beginning at  $t_0 + 0.948$  sec. Gas generator outlet temperature first peak was 2010°F with a second peak of 2160°F.

#### 4.2.9 Firing J4-1901-05A

The programmed 32.5-sec duration firing was terminated at  $t_0 + 0.448$  sec (main-stage command) by the engine logic because augmented spark igniter ignition had not been detected. Test conditions at engine start are presented in Table VI. Thermal conditioning histories of various engine components are shown in Fig. 41. Start and shutdown transient operating times of selected engine valves are presented in Table VII. Engine start and shutdown transients are shown in Fig. 42. Pressure altitude at engine start was 104,000 ft. Engine ambient and combustion chamber pressure histories are shown in Fig. 43.

Test conditions were selected to simulate an S-II firing with minimum augmented spark igniter mixture ratio, maximum fuel pump inlet pressure, and warmest expected thrust chamber.

#### 4.2.10 Firing J4-1901-06A

The programmed 32.5-sec duration firing was successfully accomplished. Test conditions at engine start are presented in Table VI. Thermal conditioning histories of various engine components are shown in Fig. 44. Start and shutdown transient operating times of selected engine valves are presented in Table VII. Engine start and shutdown transients are shown in Fig. 45. Fuel pump start transient performance is shown in Fig. 46. Pressure altitude at engine start was 89,000 ft.

Engine ambient and combustion chamber pressure histories are shown in Fig. 47.

Test conditions were selected to simulate an S-IVB 6-hr orbital coast restart with minimum starting energy. Augmented spark igniter ignition was detected 0.362 sec after engine start. Thrust chamber ignition occurred at  $t_0 + 1.091$  sec, and chamber pressure reached 550 psia at  $t_0 + 3.233$  sec. Engine vibration in excess of 150 g occurred for 75 msec beginning at  $t_0 + 1.054$  sec. Gas generator outlet temperature first peak was 1450°F with no second peak.

#### 4.2.11 Firing J4-1901-06B

The programmed 7.5-sec duration firing was successfully accomplished. Test conditions at engine start are presented in Table VI. Thermal conditioning histories of various engine components are shown in Fig. 48. Start and shutdown transient operating times of selected engine valves are presented in Table VII. Engine start and shutdown transients are shown in Fig. 49. Fuel pump start transient performance is shown in Fig. 50. Pressure altitude at engine start was 99,000 ft. Engine ambient and combustion chamber pressure histories are shown in Fig. 51.

Test conditions were selected to simulate an S-IVB 80-min restart with minimum start tank temperature. Augmented spark igniter ignition was detected 0.235 sec after engine start. Thrust chamber ignition occurred at  $t_0 + 0.953$  sec, and chamber pressure reached 550 psia at  $t_0 + 2.013$  sec. Engine vibration in excess of 150 g occurred for 21 msec beginning at  $t_0 + 0.950$  sec. Gas generator outlet temperature first peak was 1730°F with a second peak of 1760°F.

#### 4.2.12 Firing J4-1901-06C

The programmed 32.5-sec duration firing was successfully accomplished. Test conditions at engine start are presented in Table VI. Thermal conditioning histories of various engine components are shown in Fig. 52. Start and shutdown transient operating times of selected engine valves are presented in Table VII. Engine start and shutdown transients are shown in Fig. 53. Fuel pump start transient performance is shown in Fig. 54. Pressure altitude at engine start was 103,000 ft. Engine ambient and combustion chamber pressure histories are shown in Fig. 55.

Test conditions were selected to simulate an S-IVB first burn with minimum starting energy. Augmented spark igniter ignition was

detected 0.242 sec after engine start. Thrust chamber ignition occurred at  $t_0 + 1.062$  sec, and chamber pressure reached 550 psia at  $t_0 + 2.124$  sec. Engine vibration in excess of 150 g occurred for 33 msec beginning at  $t_0 + 1.052$  sec. Gas generator outlet temperature first peak was 2020°F with no second peak.

#### 4.2.13 Firing J4-1901-06D

The programmed 7.5-sec duration firing was successfully accomplished. Test conditions at engine start are presented in Table VI. Thermal conditioning histories of various engine components are shown in Fig. 56. Start and shutdown transient operating times of selected engine valves are presented in Table VIII. Engine start and shutdown transients are shown in Fig. 57. Fuel pump start transient performance is shown in Fig. 58. Pressure altitude at engine start was 103,000 ft. Engine ambient and combustion chamber pressure histories are shown in Fig. 59.

Test conditions were selected to simulate an S-IVB 80-min restart with minimum start tank temperature and coldest thrust chamber. Augmented spark igniter ignition was detected 0.212 sec after engine start. Thrust chamber ignition occurred at  $t_0 + 0.972$  sec, and chamber pressure reached 550 psia at  $t_0 + 2.090$  sec. Engine vibration in excess of 150 g occurred for 25 msec beginning at  $t_0 + 0.960$  sec. Gas generator outlet temperature first peak was 1930°F with no second peak.

#### 4.2.14 Firing J4-1901-06E

The programmed 1.25-sec duration firing was successfully accomplished. Test conditions at engine start are presented in Table VI. Thermal conditioning histories of various engine components are shown in Fig. 60. Start and shutdown transient operating times of selected engine valves are presented in Table VII. Engine start and shutdown transients are shown in Fig. 61. Fuel pump start transient performance is shown in Fig. 62. Pressure altitude at engine start was 110,000 ft. Engine ambient and combustion chamber pressure histories are shown in Fig. 63.

Test conditions were selected to permit a determination of the effect of a -200°F oxidizer injector dome on start transient combustion stability with start conditions similar to firing 06A. Augmented spark igniter ignition was detected 0.237 sec after engine start, and thrust chamber ignition occurred at  $t_0 + 1.093$  sec. Total duration of engine vibration in excess of 150 g was less than 10 msec before cutoff command. Gas generator outlet temperature first peak was 1840°F with no second peak.

### 4.3 POST-TEST INSPECTION

The augmented spark igniter assembly was replaced following test 05 because of excessive seal leakage at the augmented spark igniter-to-injector interface. No other engine component damage was incurred during test periods J4-1901-03 through J4-1901-06.

## SECTION V SUMMARY OF RESULTS

The results of testing the J-2 rocket engine in Test Cell J-4 during test periods J4-1901-03 through J4-1901-06 between July 23 and August 15, 1968, are summarized as follows:

1. All primary objectives were satisfactorily accomplished.
2. Augmented spark igniter ignition was not detected before main-stage signal under conditions simulating an S-II start at minimum augmented spark igniter mixture ratio.
3. An oxidizer injector dome temperature of  $-200^{\circ}\text{F}$  had no detectable effect on start transient combustion stability.
4. Except for a leaking seal at the augmented spark igniter-to-injector interface, no engine component damage was incurred.

## REFERENCES

1. Dubin, M., Sissenwine, N., and Wexler, H. U. S. Standard Atmosphere, 1962. December 1962.
2. Counts, H. J., Jr., and Kunz, C. H. "Altitude Developmental and Flight Support Testing of the J-2 Rocket Engine in Propulsion Engine Test Cell (J-4) (Tests J4-1801-42 through J4-1901-02)." AEDC-TR-68-223, November 1968.
3. "J-2 Rocket Engine, Technical Manual Engine Data." R-3825-1, August 1965.
4. Test Facilities Handbook (7th Edition). "Large Rocket Facility, Vol. 3." Arnold Engineering Development Center, July 1968.



**APPENDIXES**

- I. ILLUSTRATIONS**
- II. TABLES**
- III. INSTRUMENTATION**
- IV. METHOD OF CALCULATION (PERFORMANCE PROGRAM)**

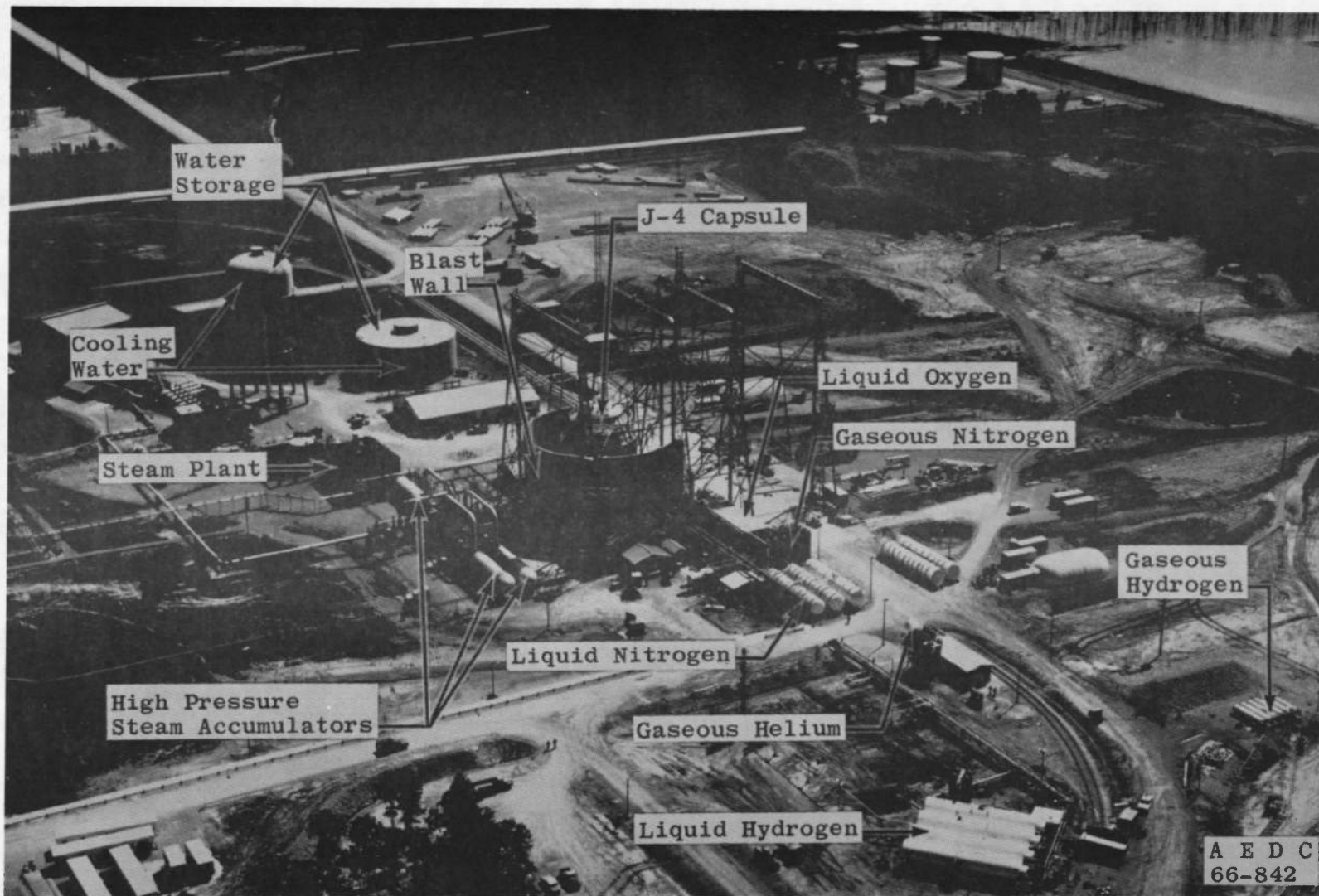

Fig. 1 Test Cell J-4 Complex

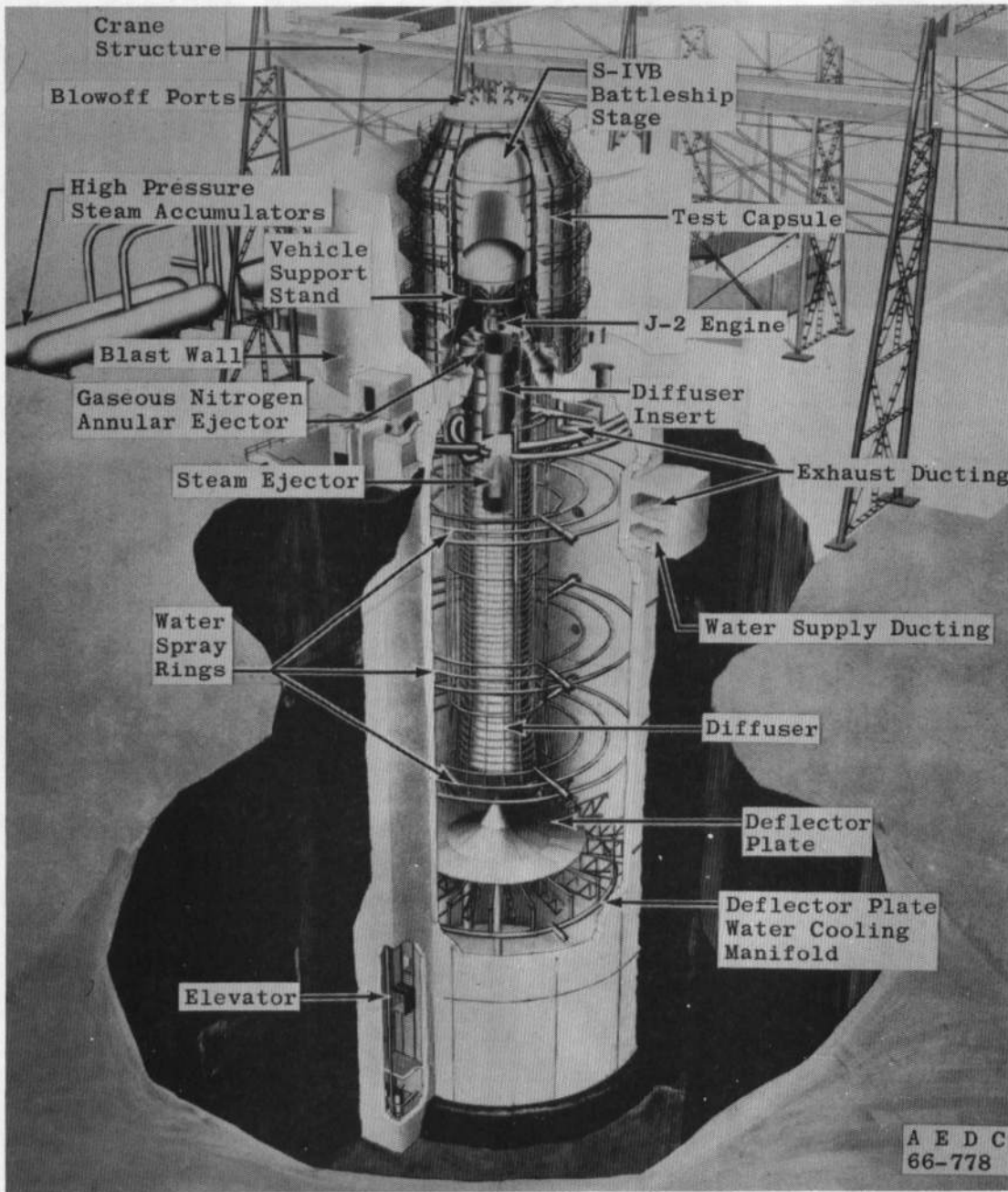

Fig. 2 Test Cell J-4, Artist's Conception

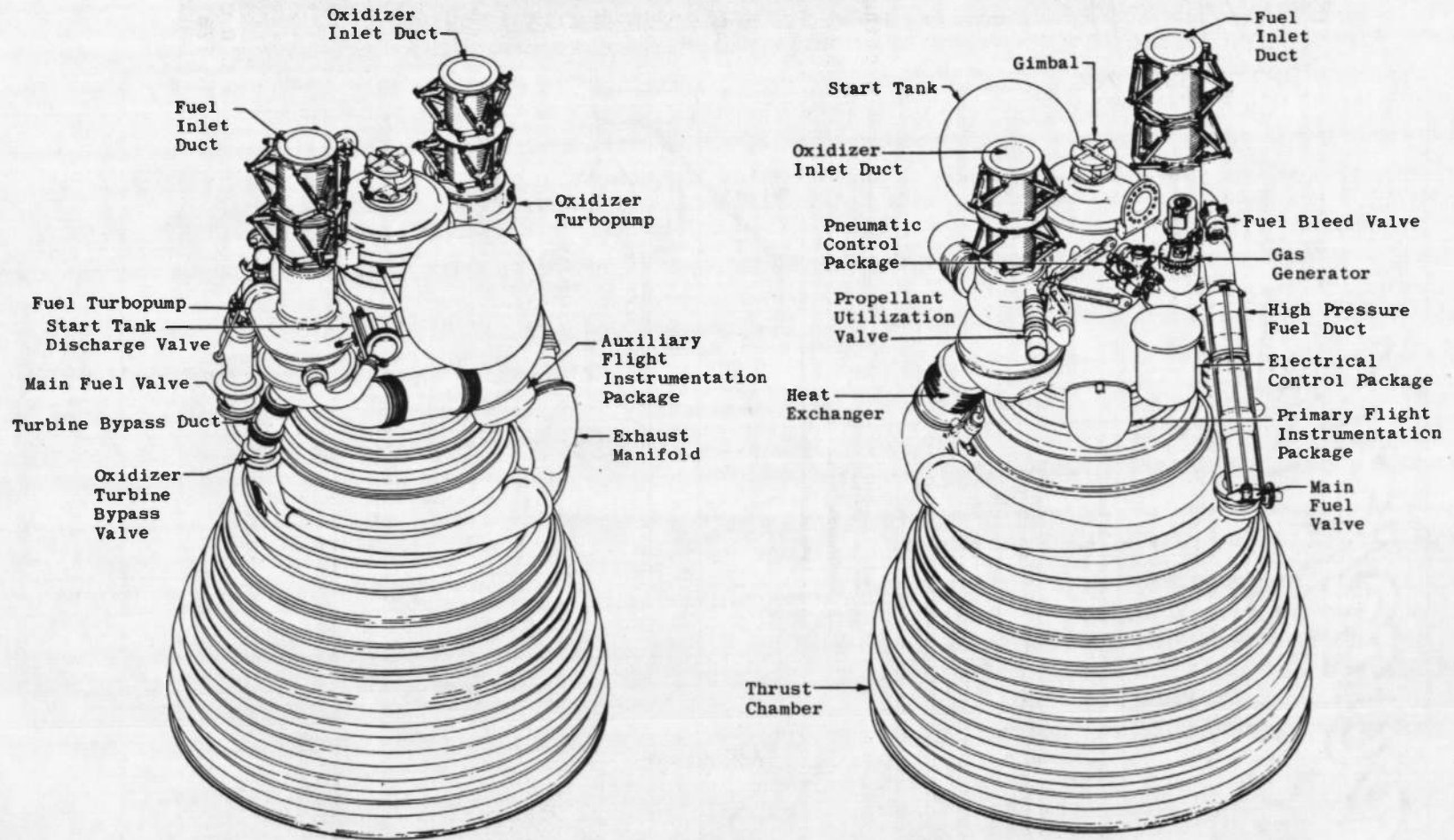

Fig. 3 Engine Details

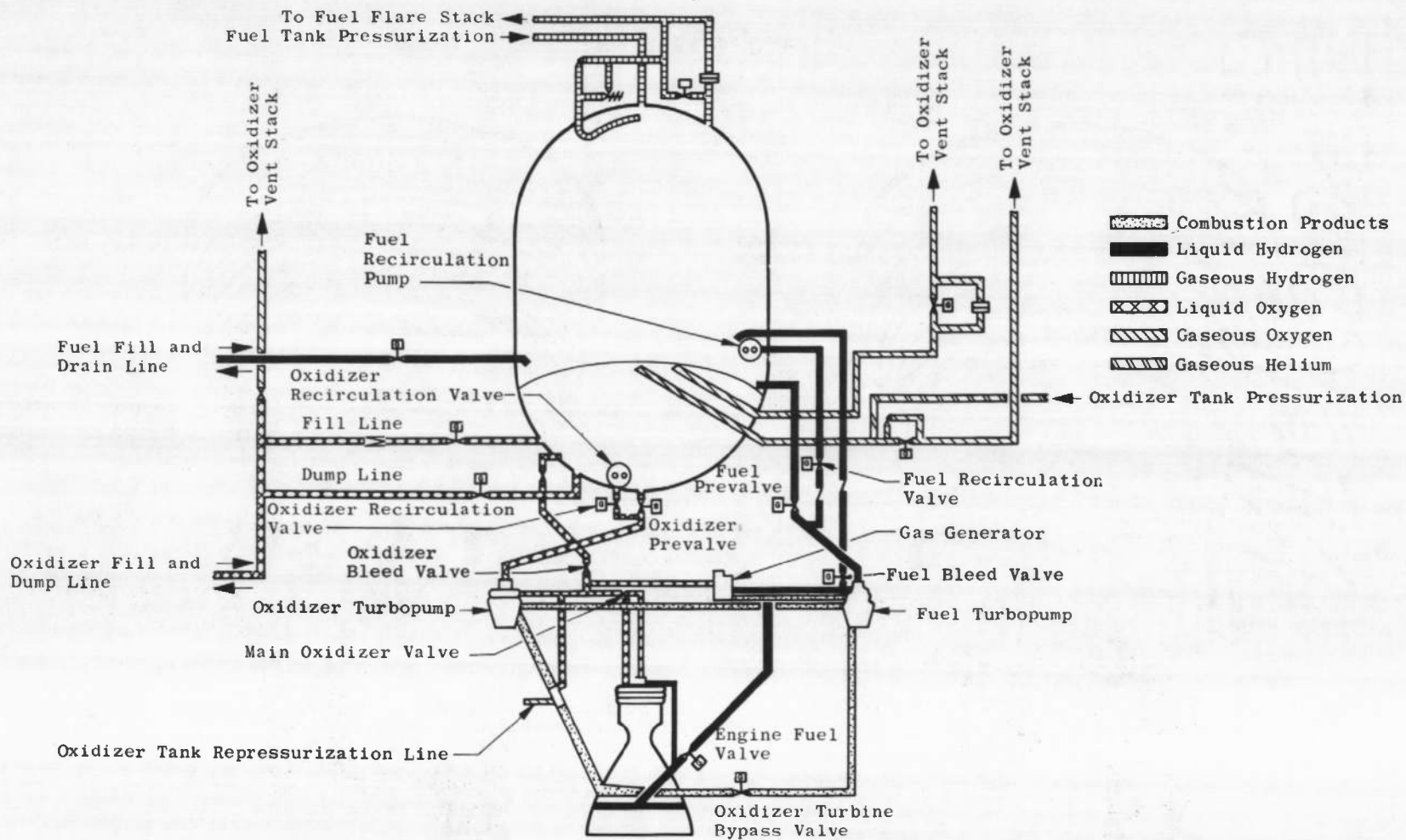
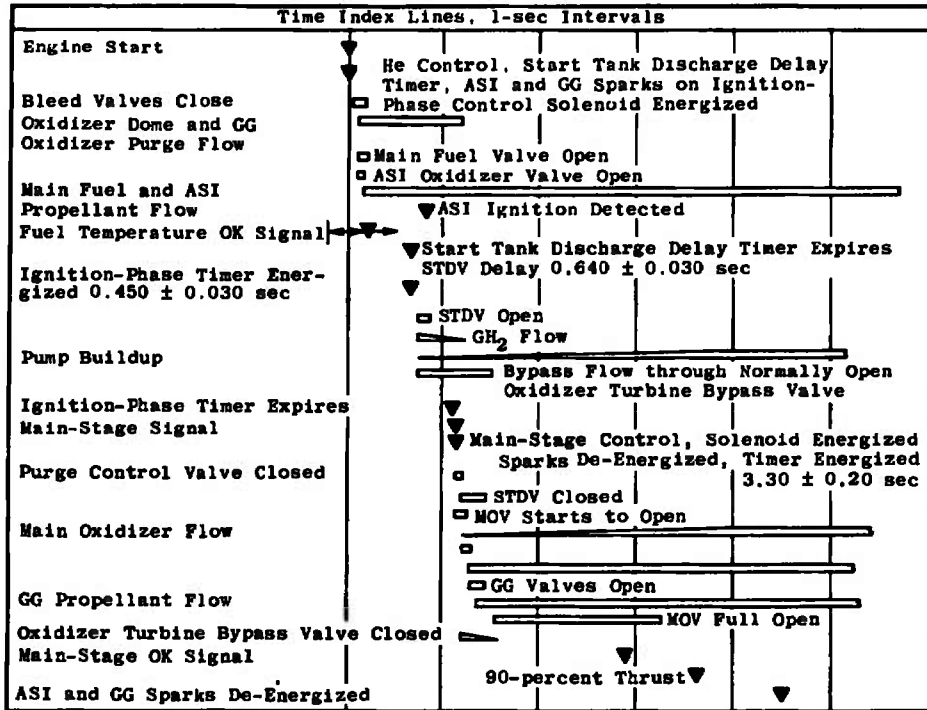
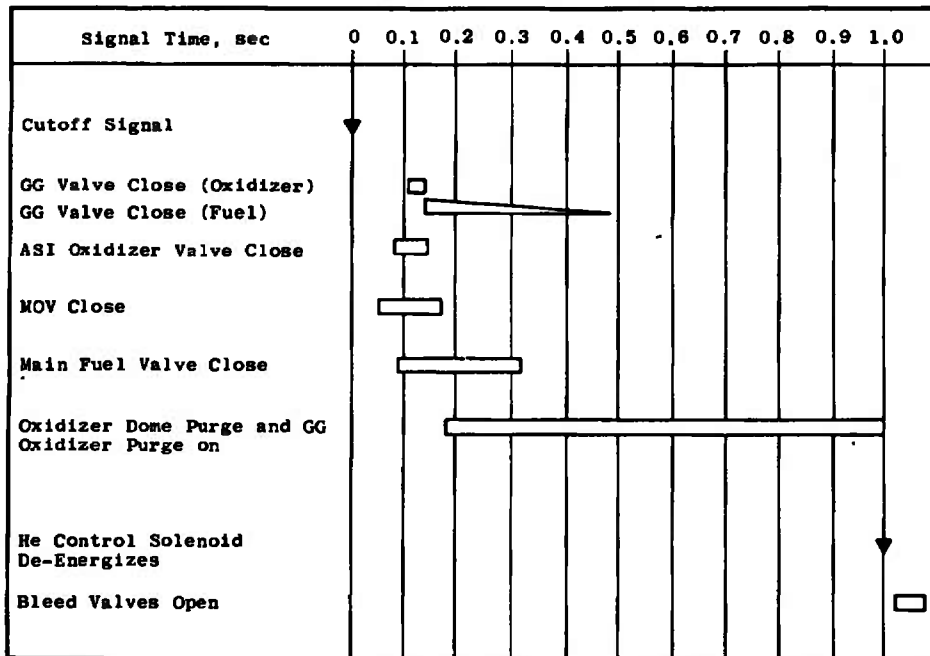

Fig. 4 S-IVB Battleship Stage /J-2 Engine Schematic



a. Start Sequence



b. Shutdown Sequence

Fig. 7 Engine Start and Shutdown Sequence

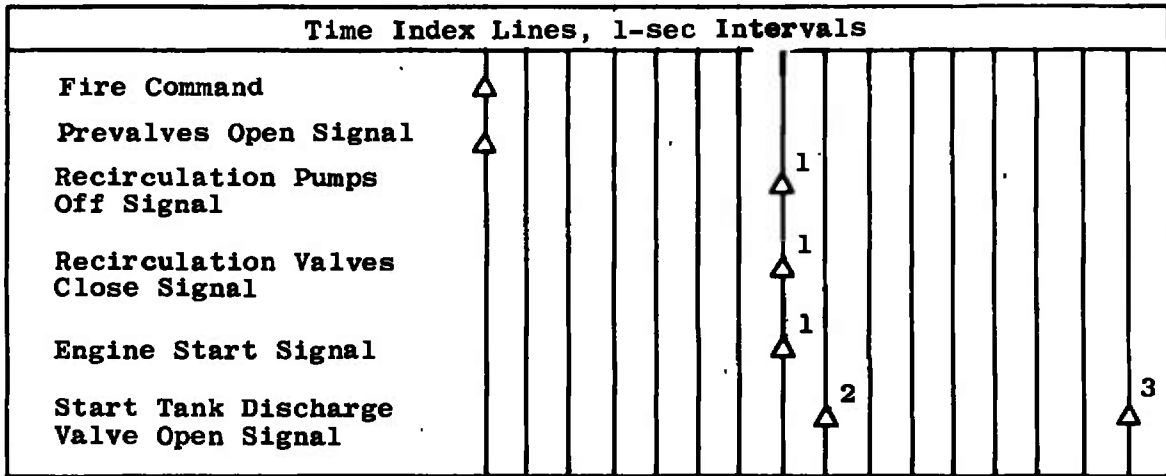

<sup>1</sup>Nominal Occurrence Time (Function of Prevalves Opening Time)

<sup>2</sup>One-sec Fuel Lead (S-II/S-V and S-IVB/S-IB)

<sup>3</sup>Eight-sec Fuel Lead (S-IVB/S-V and S-IB Orbital Restart)

c. "Normal" Start Sequence

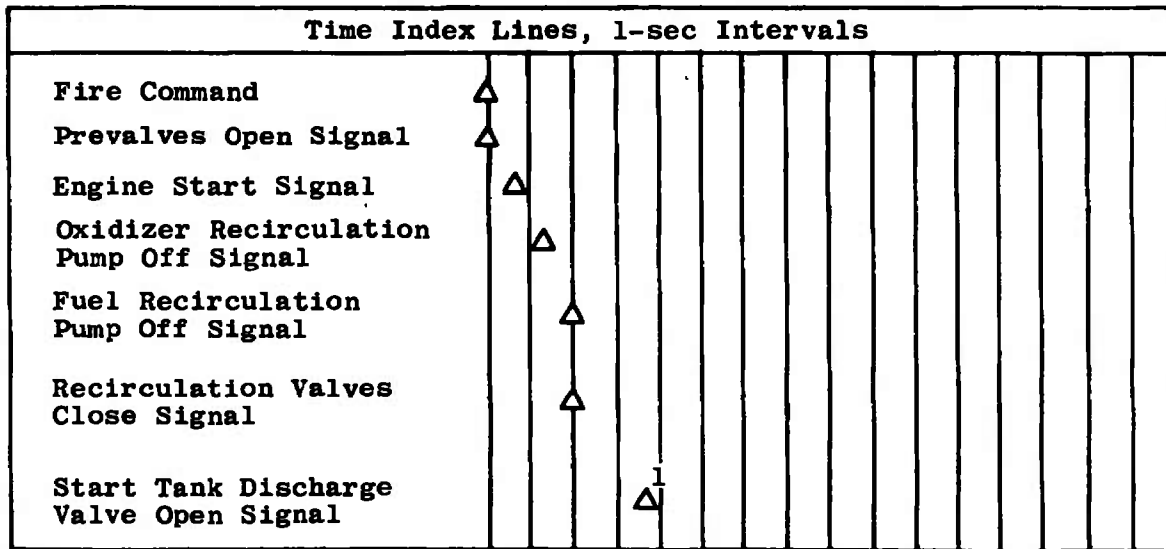

<sup>1</sup>Three-sec Fuel Lead (S-IVB/S-V First Burn)

d. "Auxiliary" Start Sequence

Fig. 7 Concluded



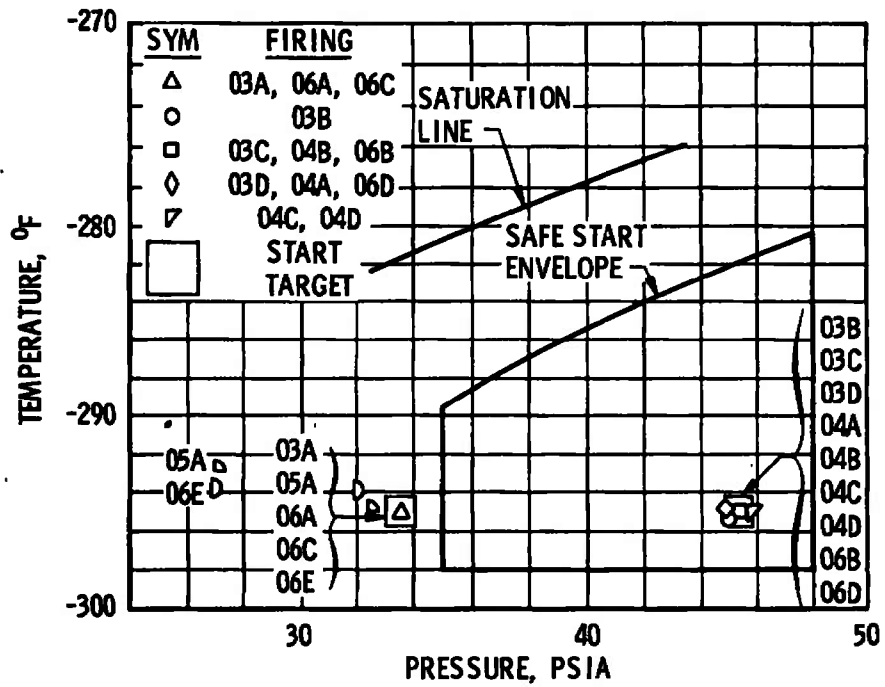

a. Oxidizer Pump Inlet

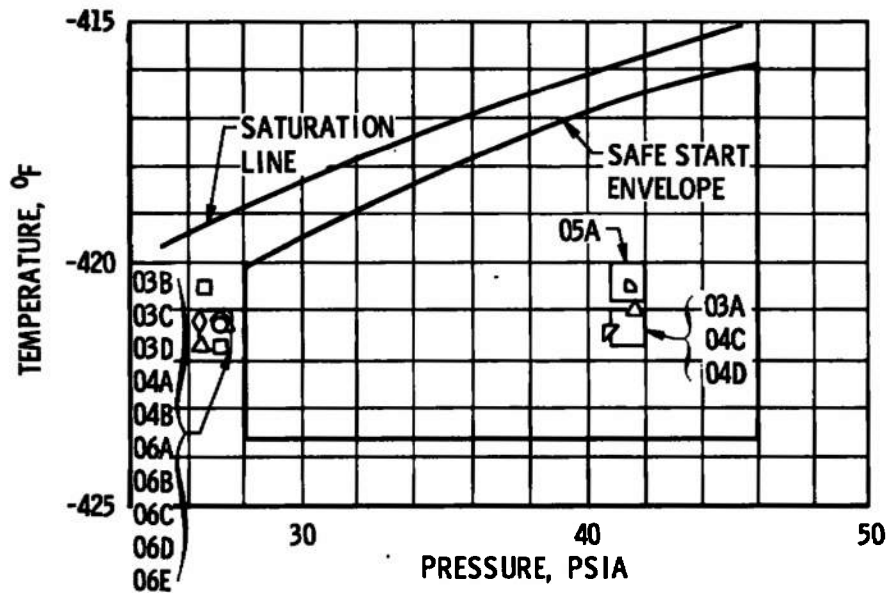

b. Fuel Pump Inlet

Fig. 8 Engine Start Conditions for the Pump Inlets, Start Tank, and Helium Tank



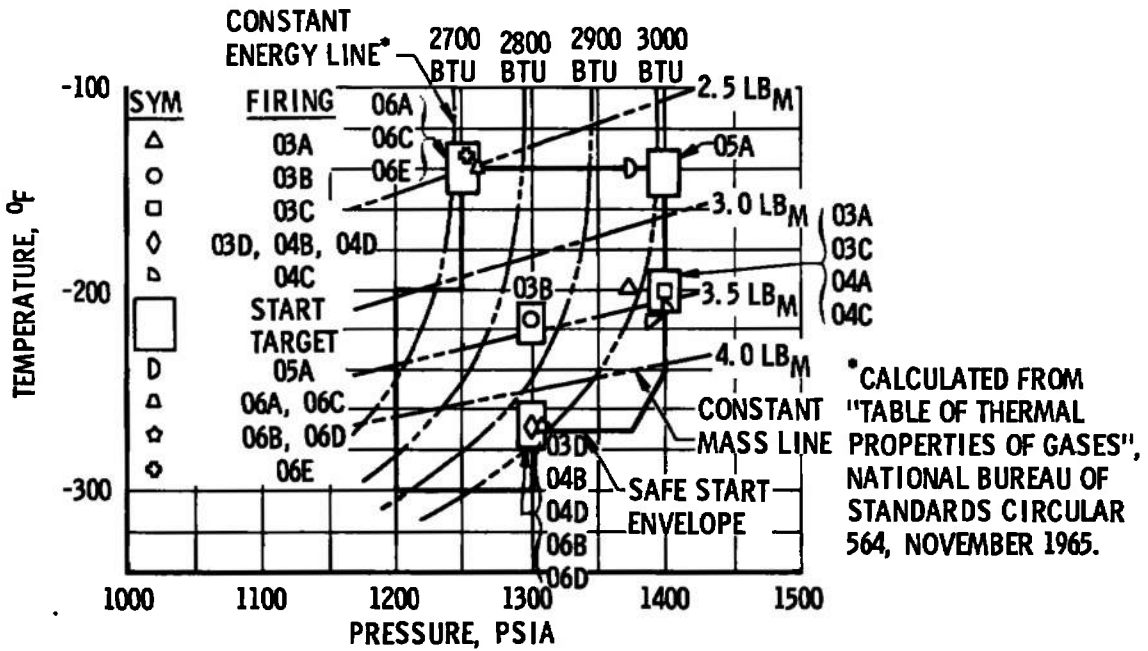

c. Start Tank

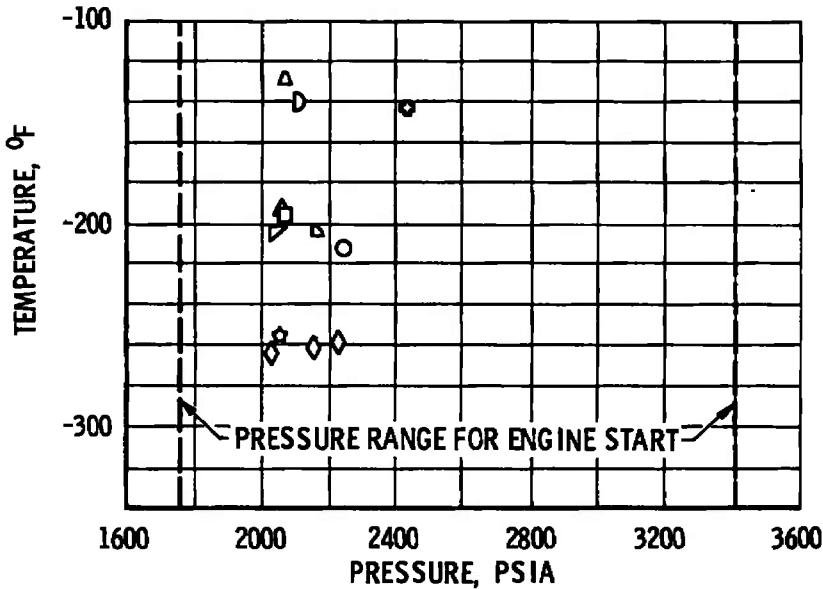

d. Helium Tank

Fig. 8 Concluded

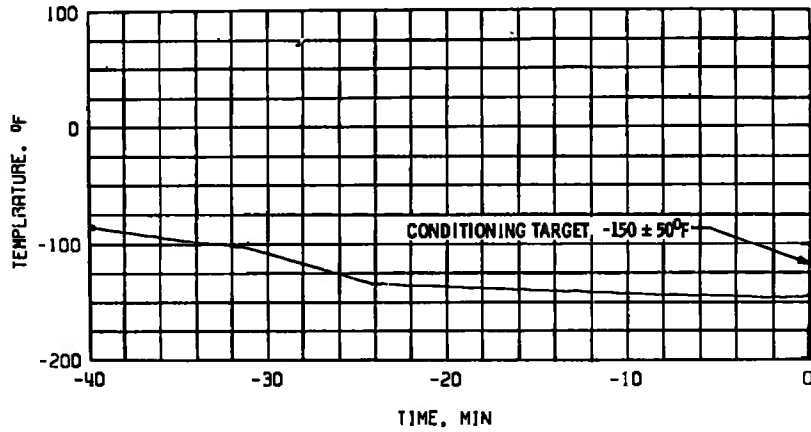

a. Main Oxidizer Valve Second-Stage Actuator, TSOVC-1

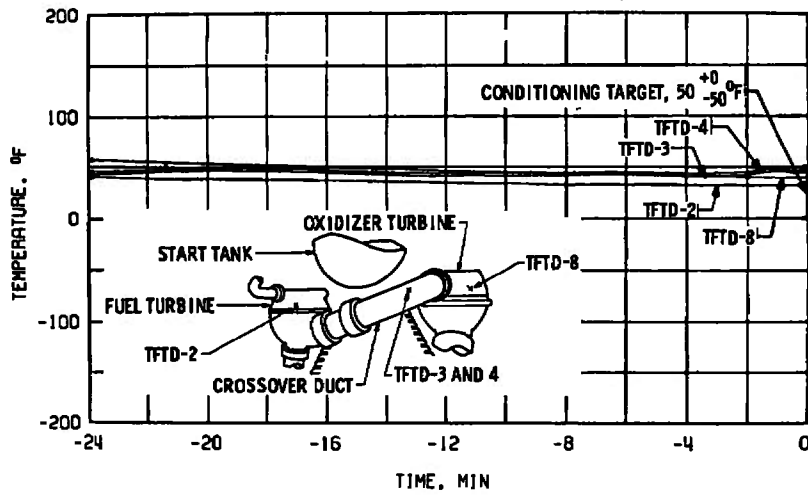

b. Crossover Duct, TFTD

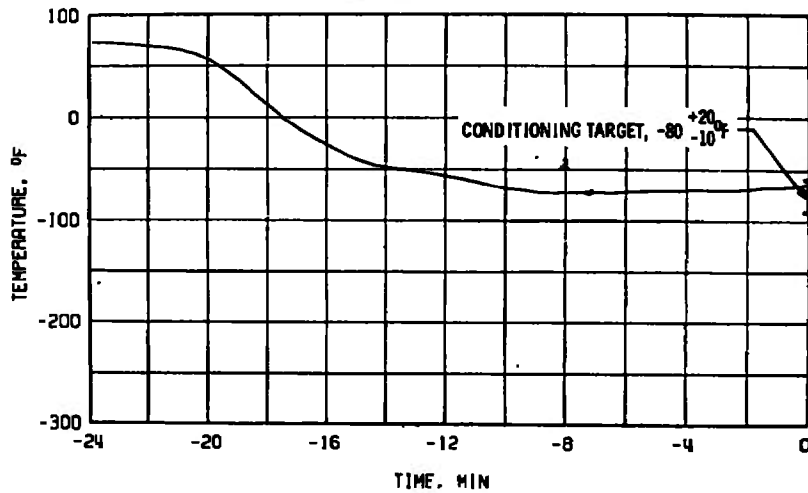

c. Thrust Chamber Throat, TTC-1P

Fig. 9 Thermal Conditioning History of Engine Components, Firing 03A

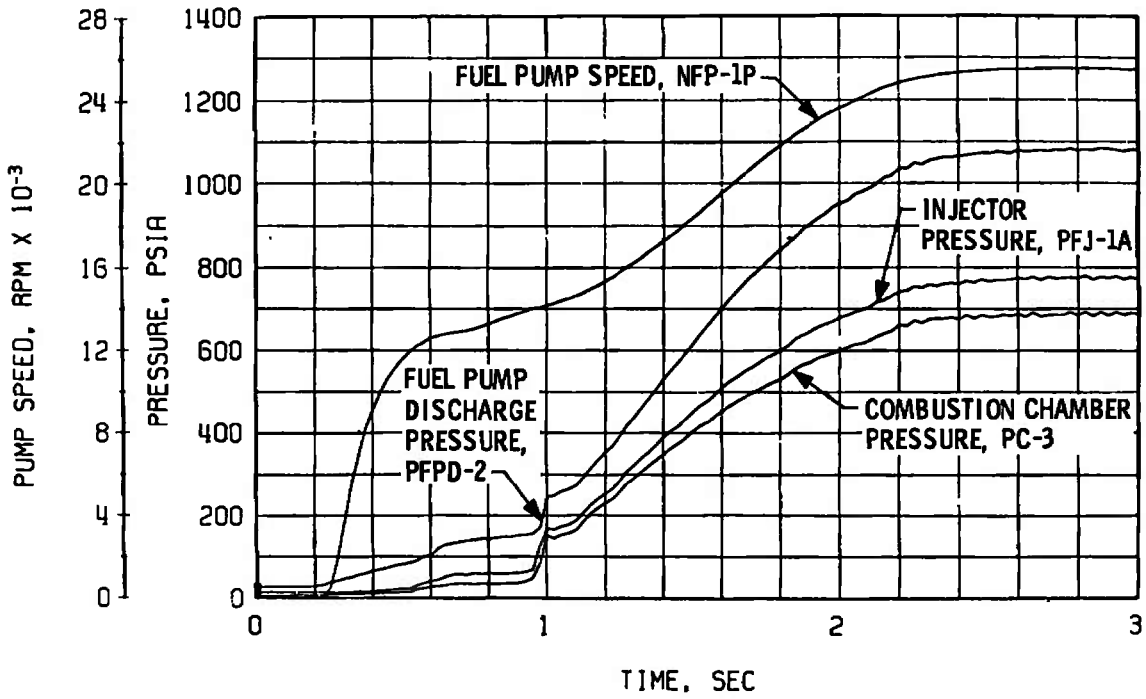

a. Thrust Chamber Fuel System, Start

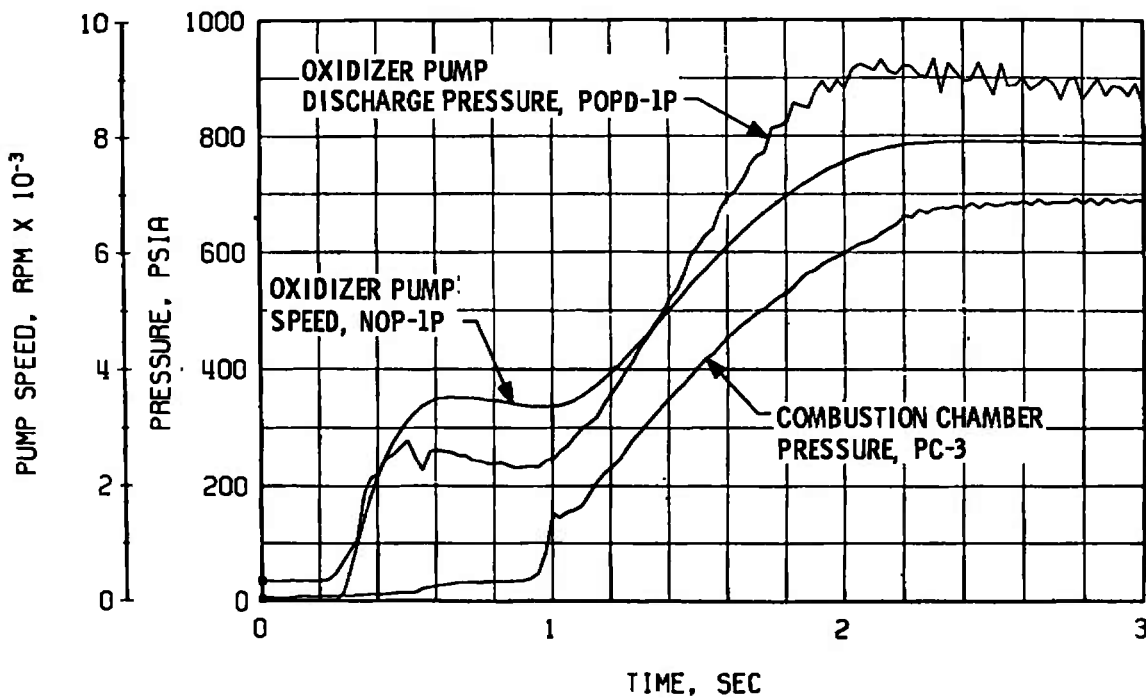

b. Thrust Chamber Oxidizer System, Start

Fig. 10 Engine Transient Operation, Firing 03A

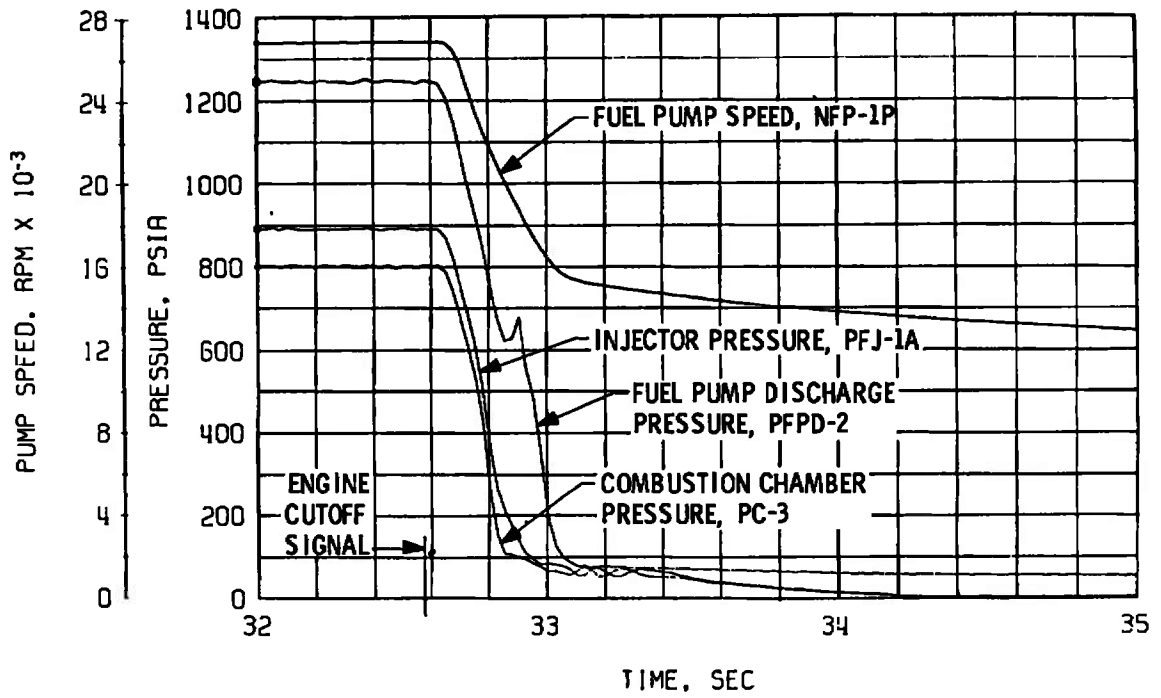

c. Thrust Chamber Fuel System, Shutdown

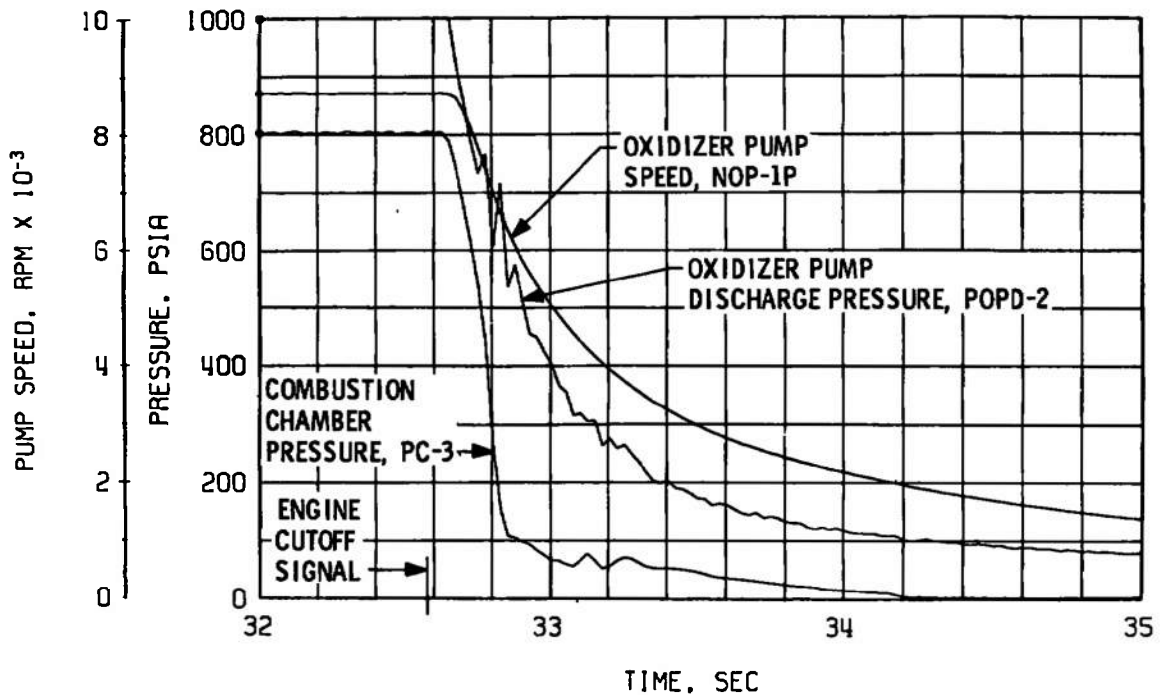

d. Thrust Chamber Oxidizer System, Shutdown

Fig. 10 Continued

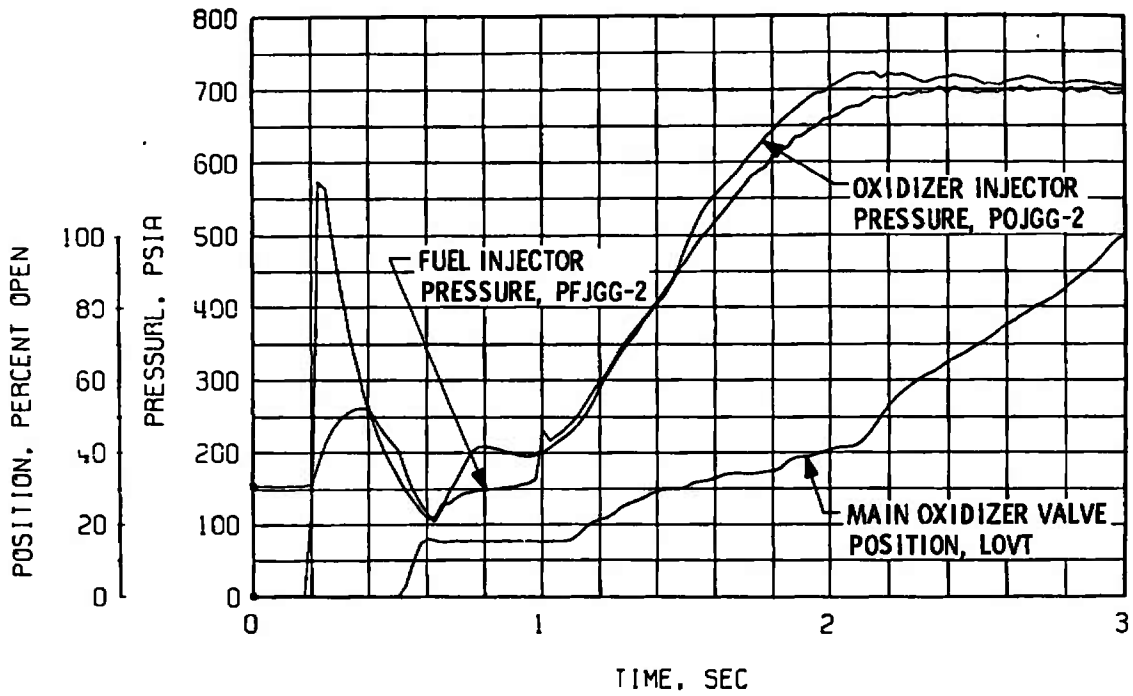

e. Gas Generator Injector Pressures and Main Oxidizer Valve Position, Start

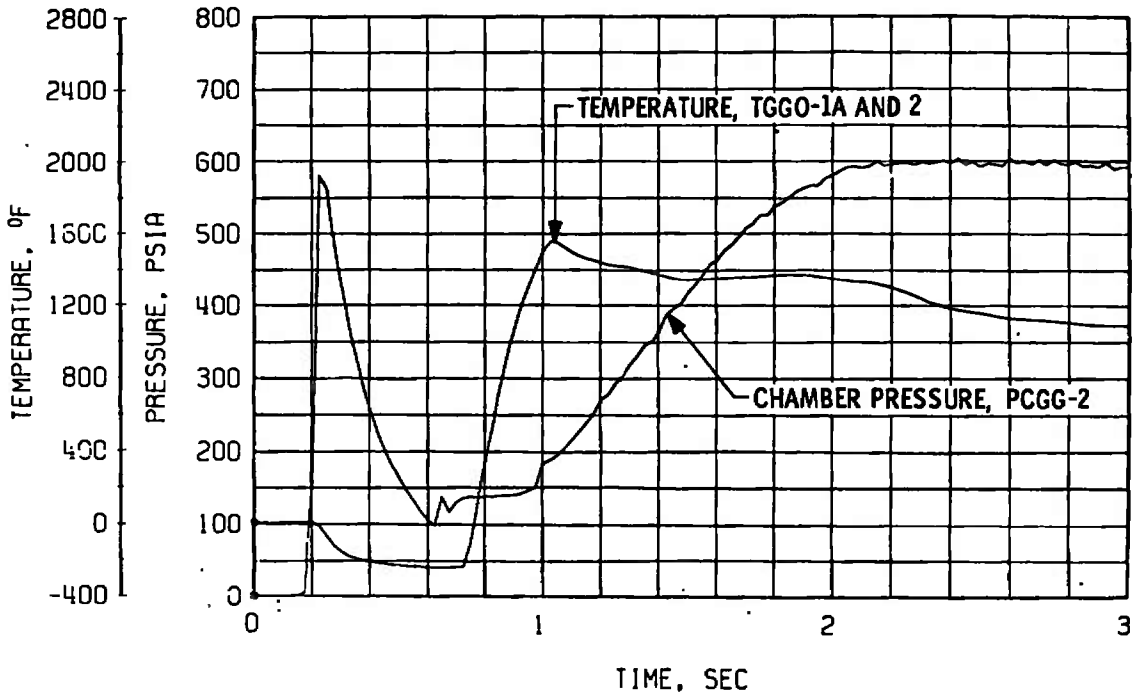

f. Gas Generator Chamber Pressure and Temperature, Start

Fig. 10 Continued

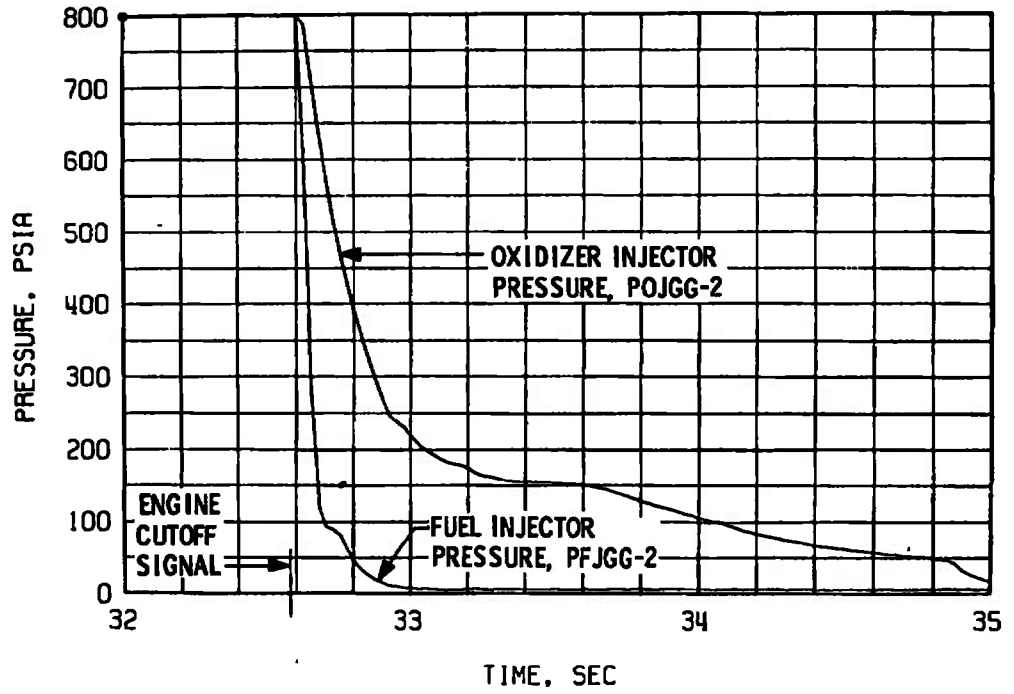

g. Gas Generator Injector Pressures, Shutdown

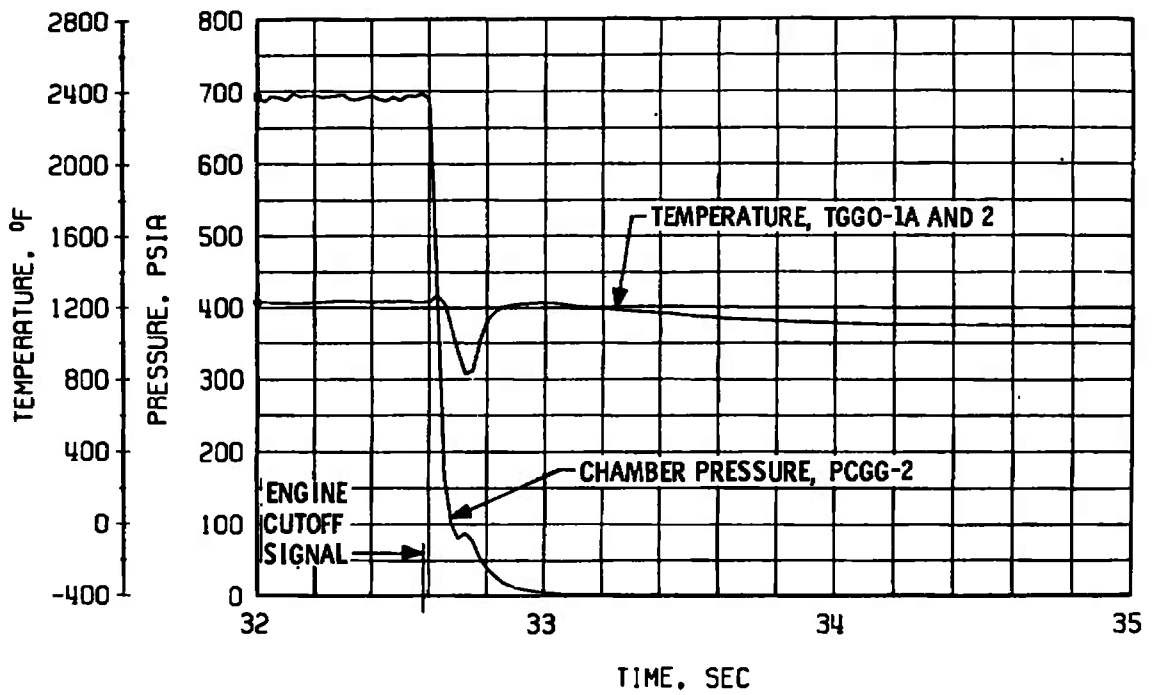

h. Gas Generator Chamber Pressure and Temperature, Shutdown

Fig. 10 Concluded

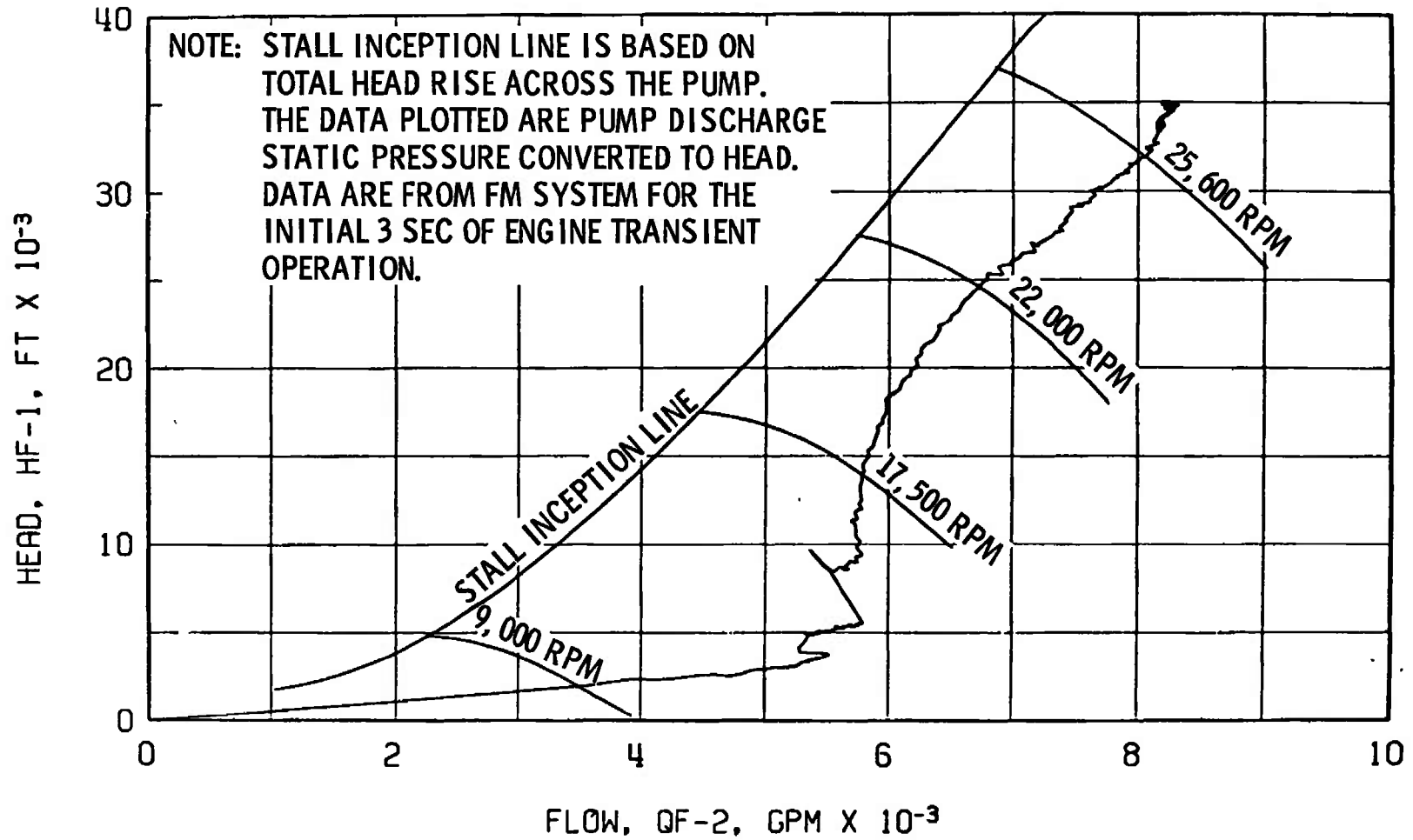

Fig. 11 Fuel Pump Start Transient Performance, Firing 03A

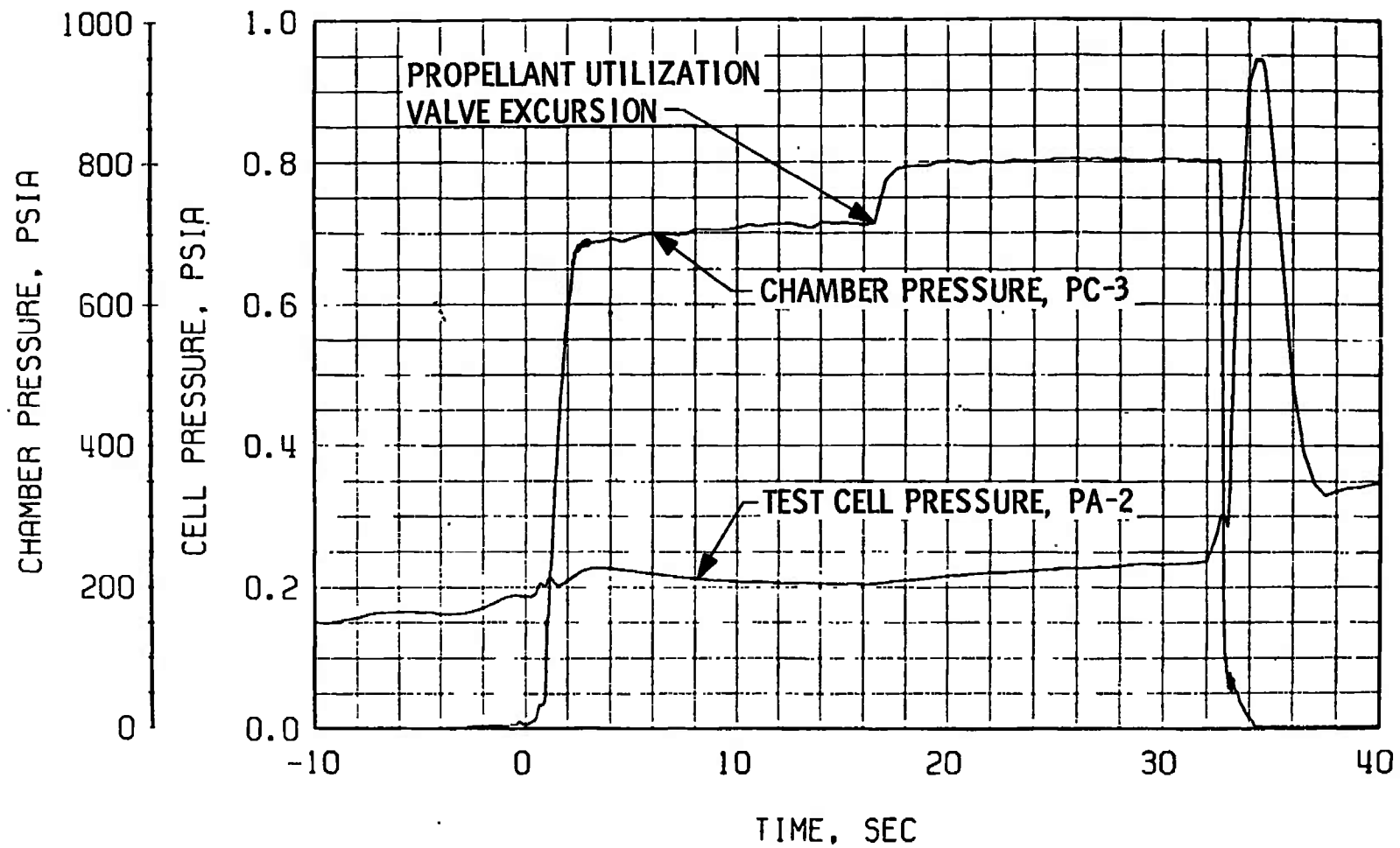
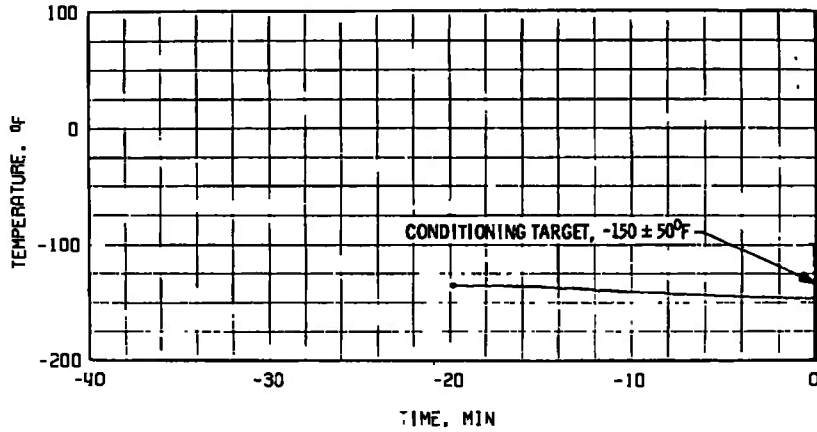
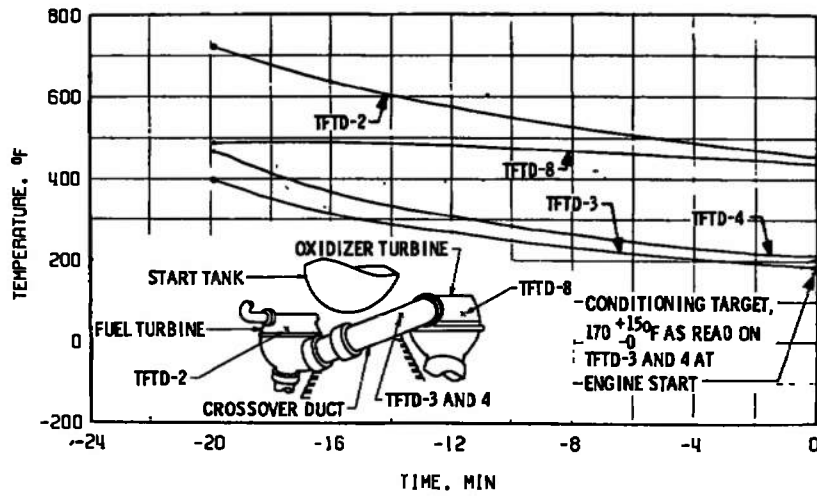

Fig. 12 Engine Ambient and Combustion Chamber Pressure, Firing 03A





a. Main Oxidizer Valve Second-Stage Actuator, TSOVC-1



b. Crossover Duct, TFD

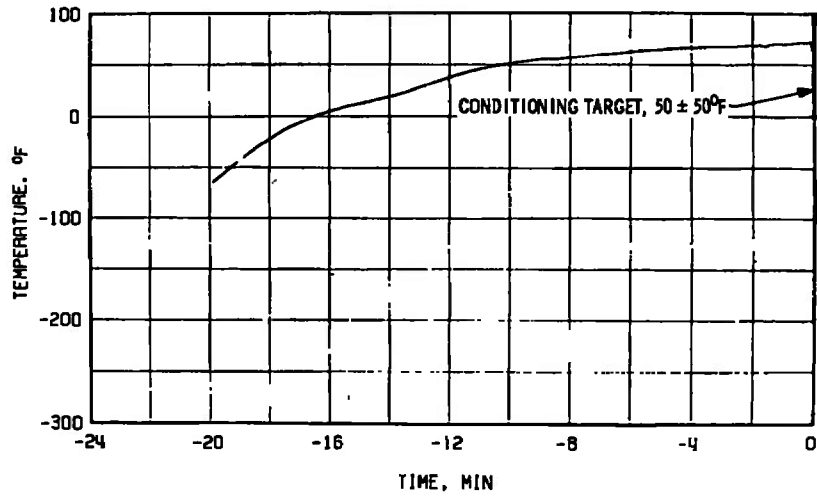

c. Thrust Chamber Throat, TTC-1P

Fig. 13 Thermal Conditioning History of Engine Components, Firing 03B

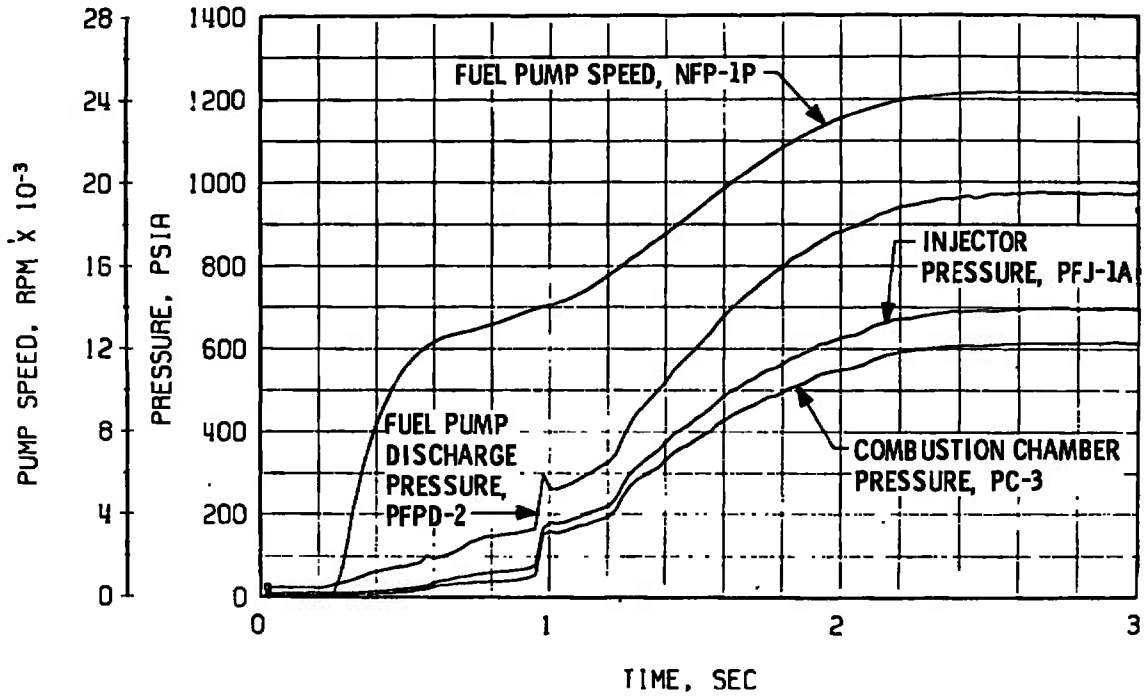

a. Thrust Chamber Fuel System, Start

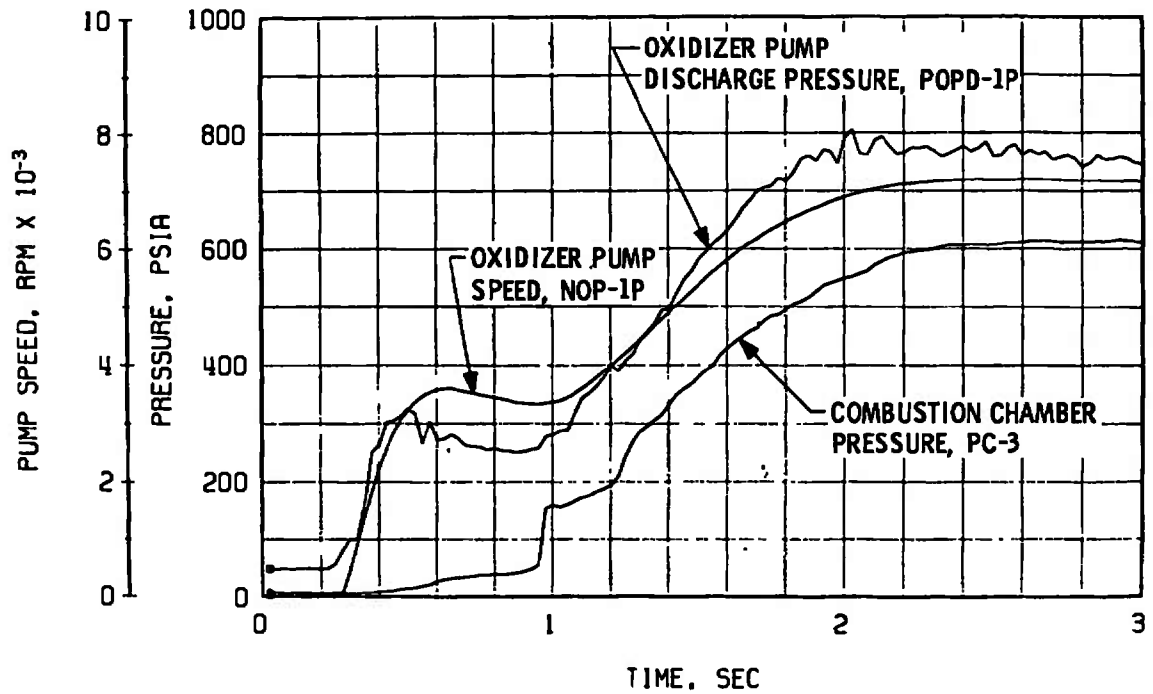

b. Thrust Chamber Oxidizer System, Start  
 Fig. 14 Engine Transient Operation, Firing 03B

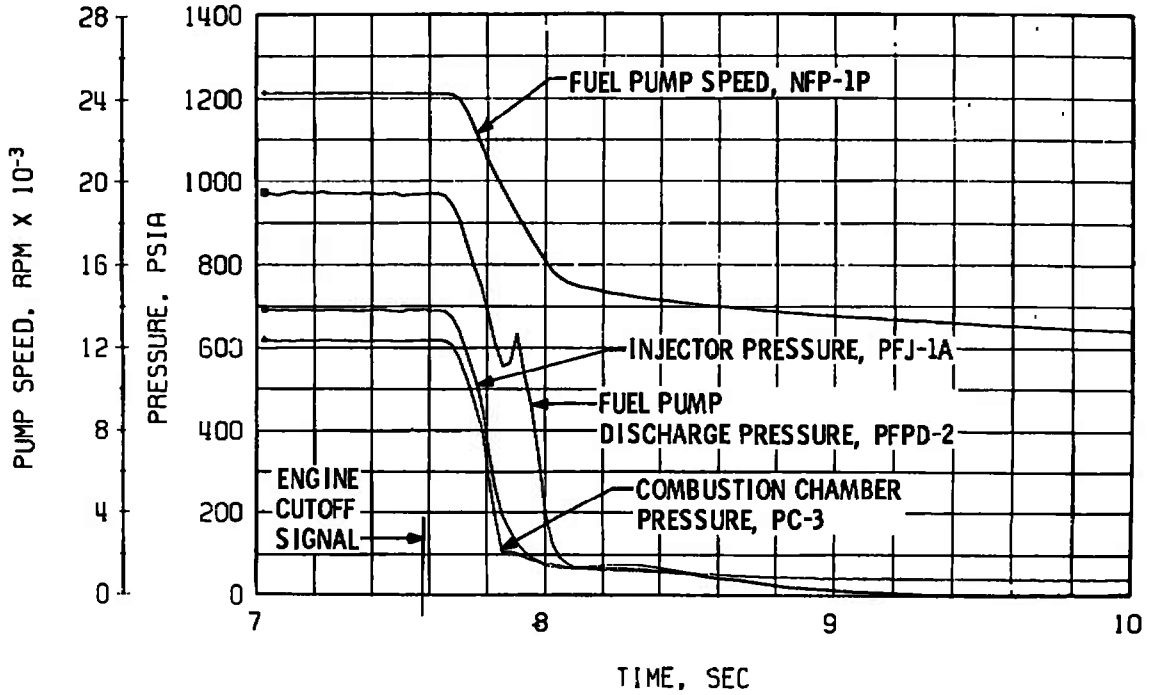

c. Thrust Chamber Fuel System, Shutdown

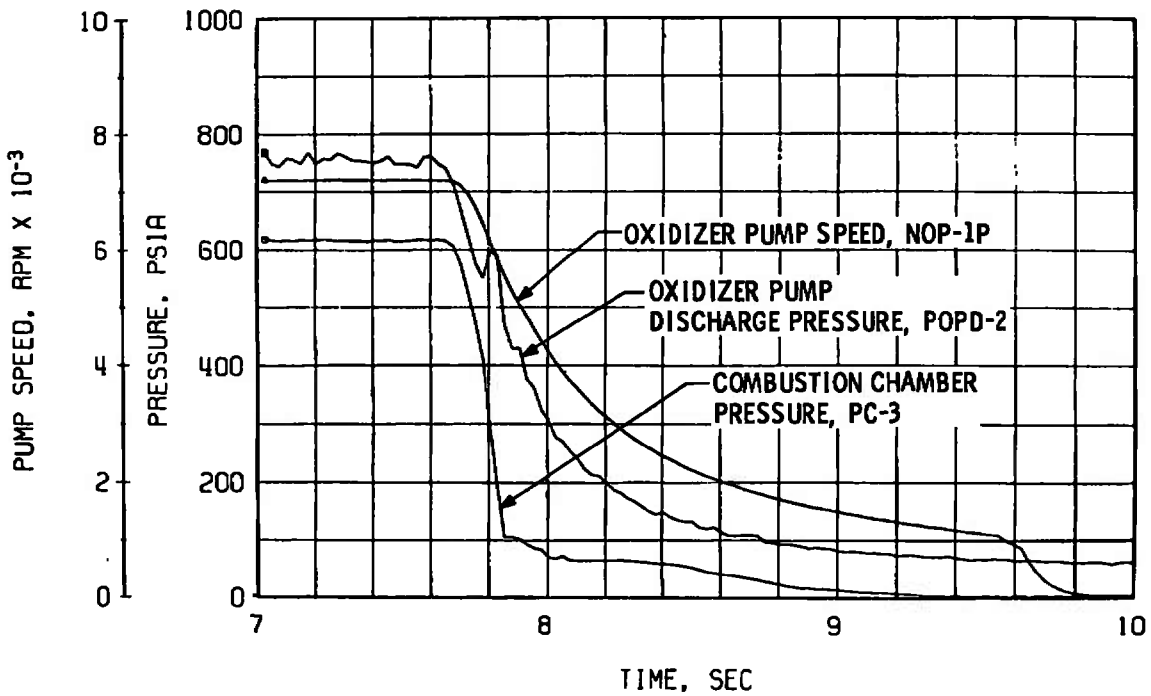

d. Thrust Chamber Oxidizer System, Shutdown

Fig. 14 Continued

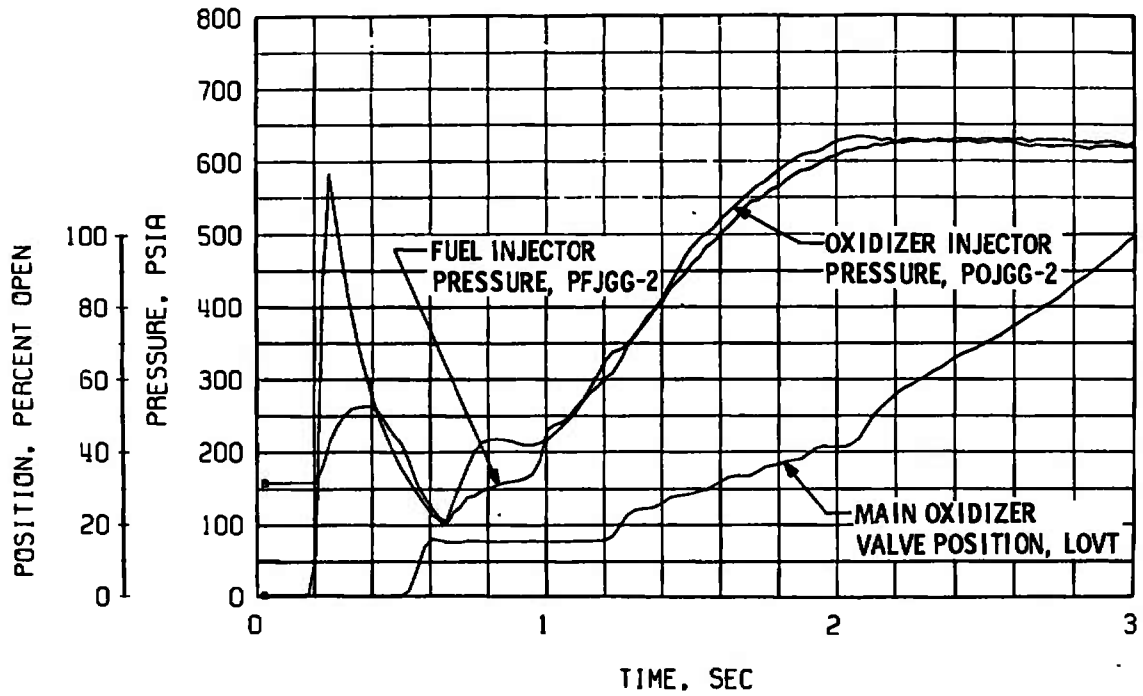

e. Gas Generator Injector Pressures and Main Oxidizer Valve Position, Start

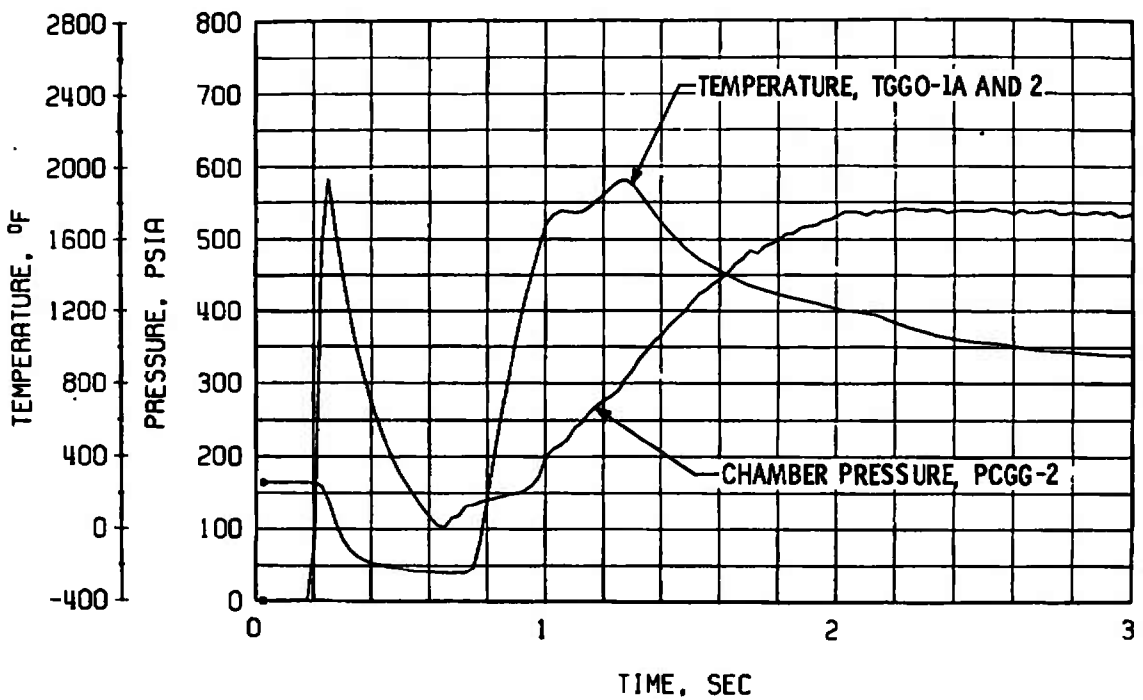

f. Gas Generator Chamber Pressure and Temperature, Start

Fig. 14 Continued

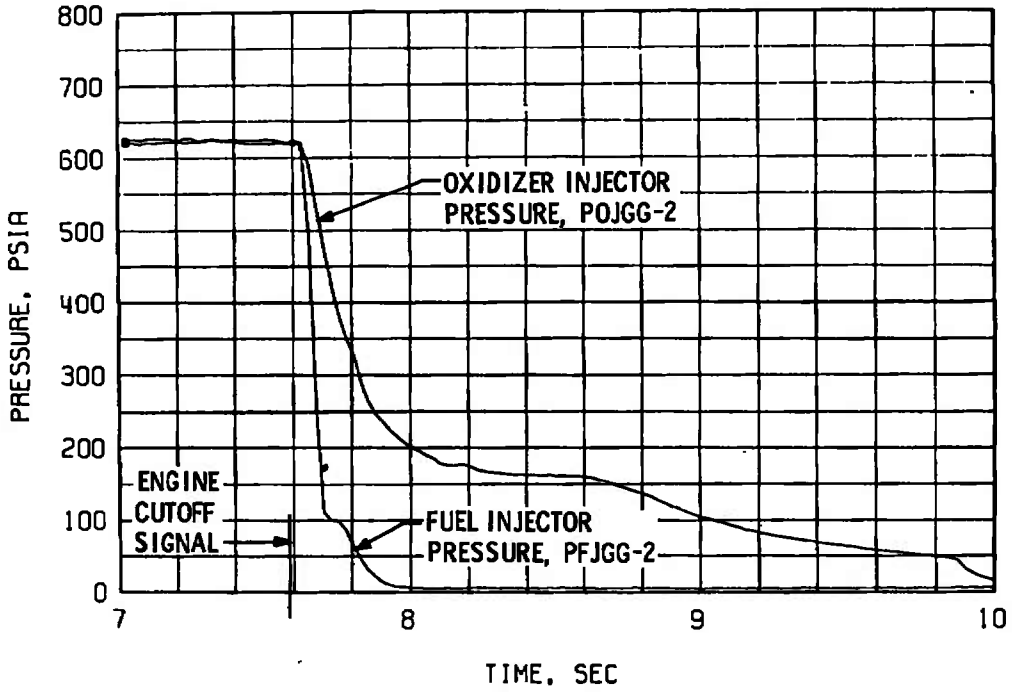

g. Gas Generator Injector Pressures, Shutdown

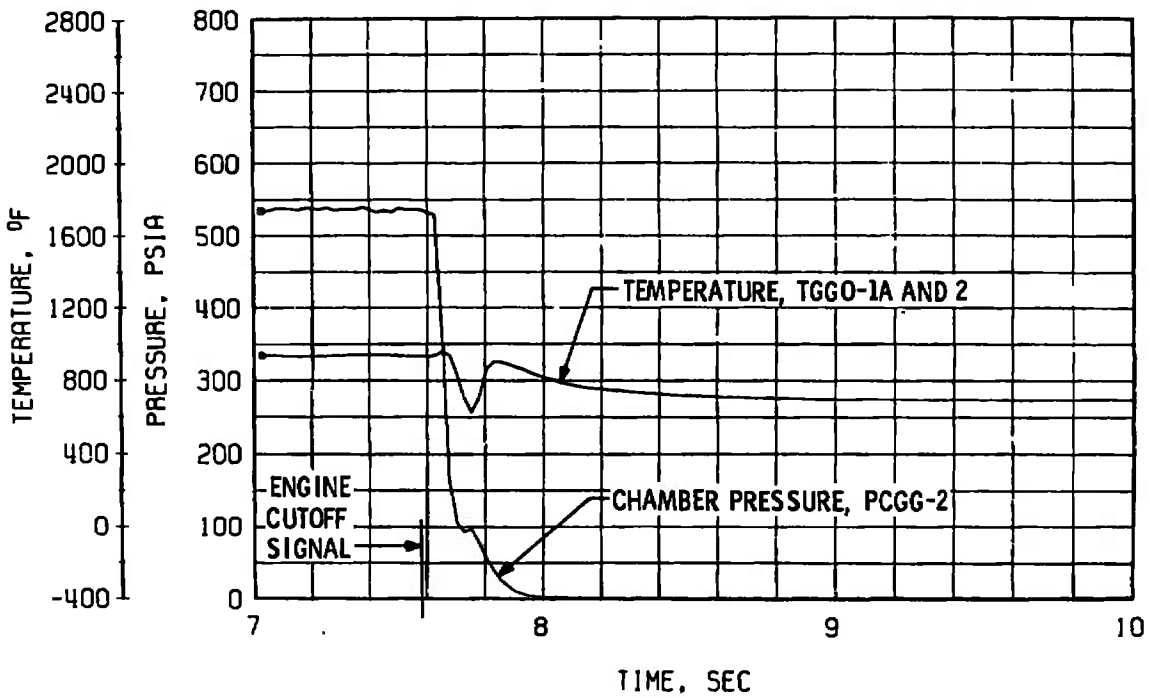

h. Gas Generator Chamber Pressure and Temperature, Shutdown

Fig. 14 Concluded

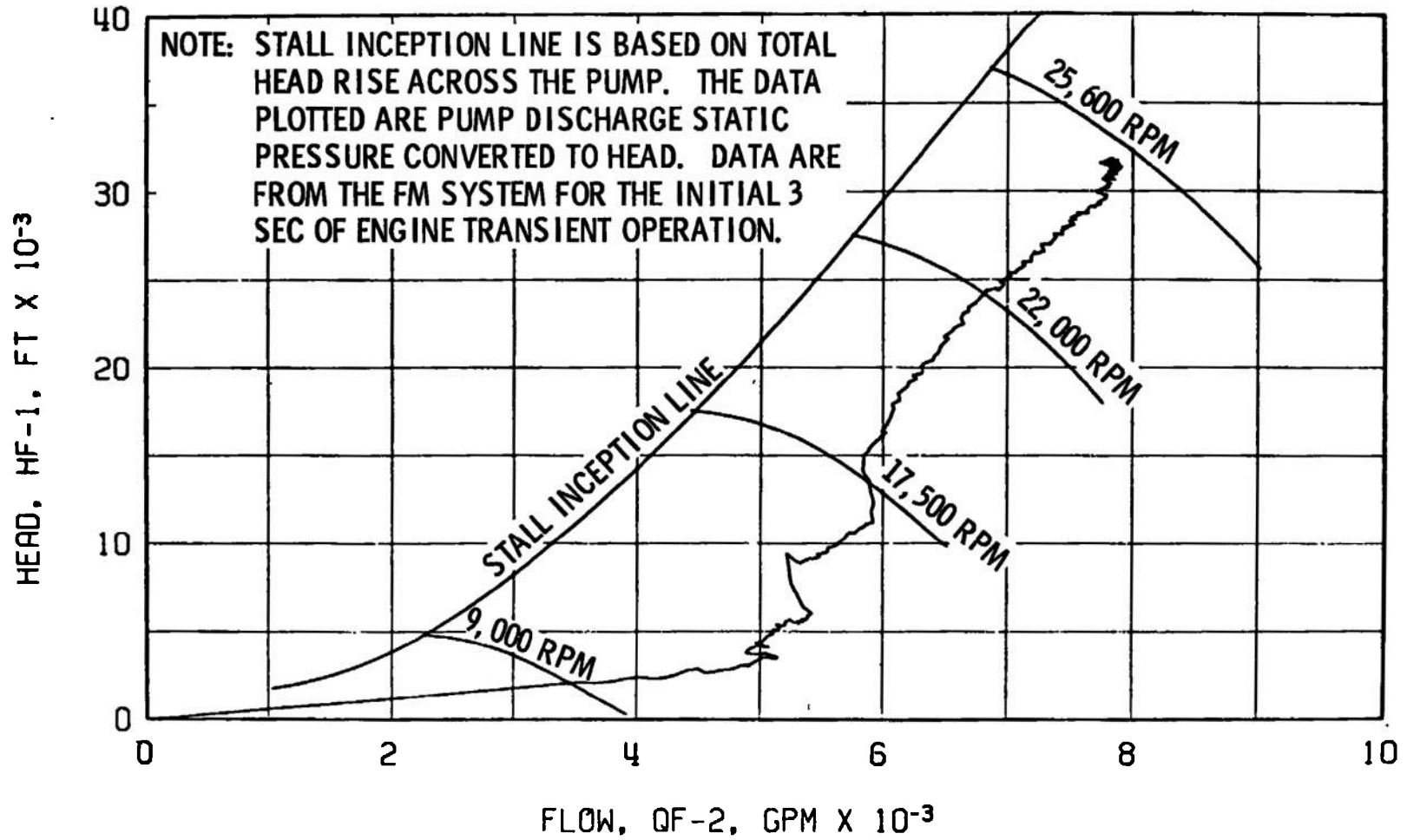

Fig. 15 Fuel Pump Start Transient Performance, Firing 03B

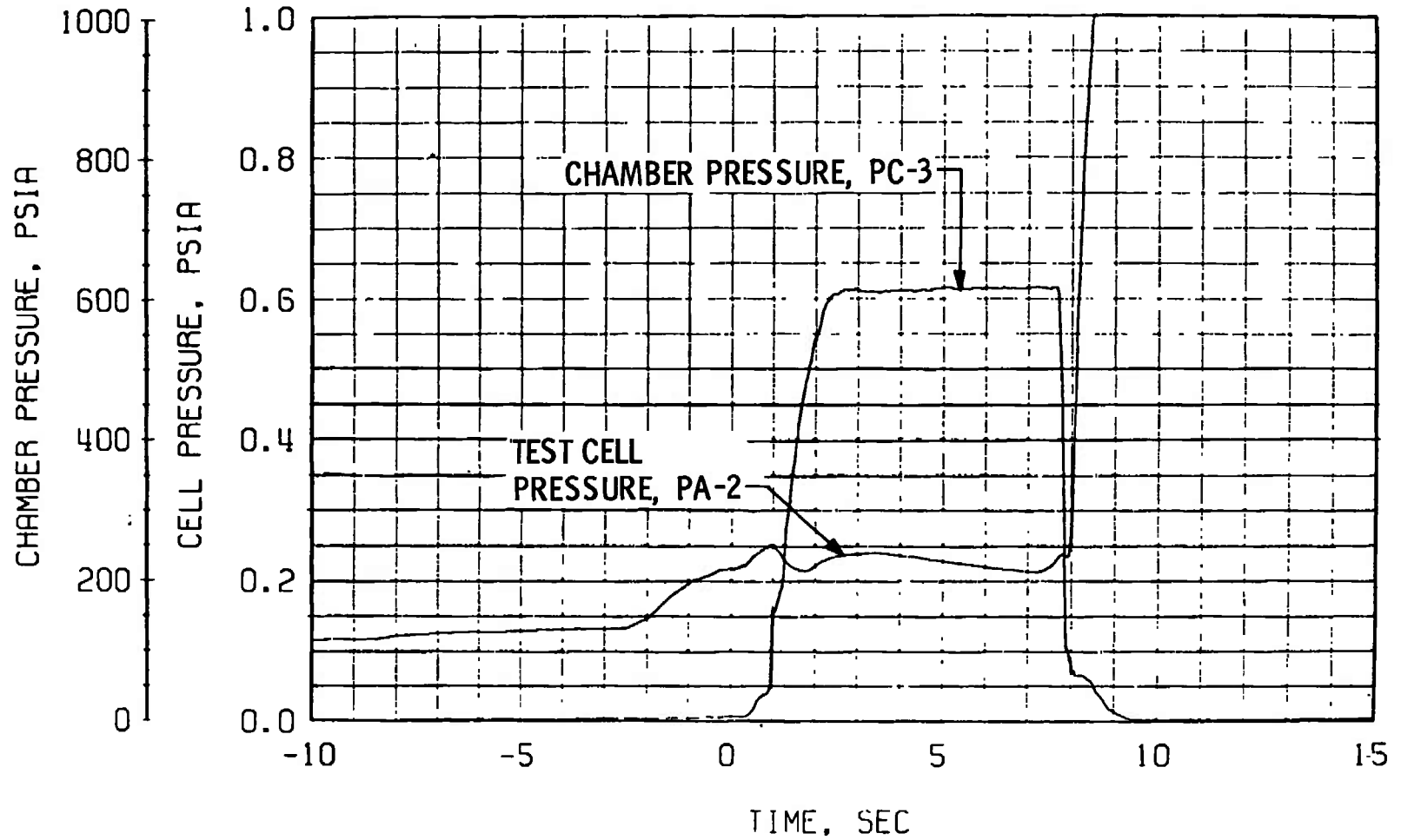
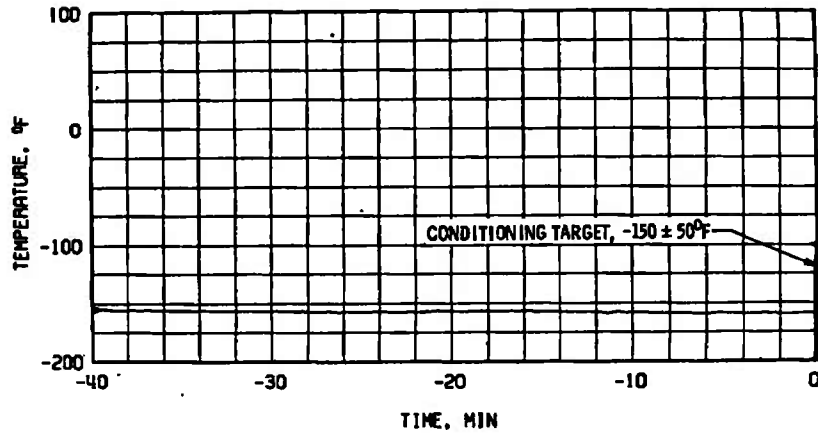
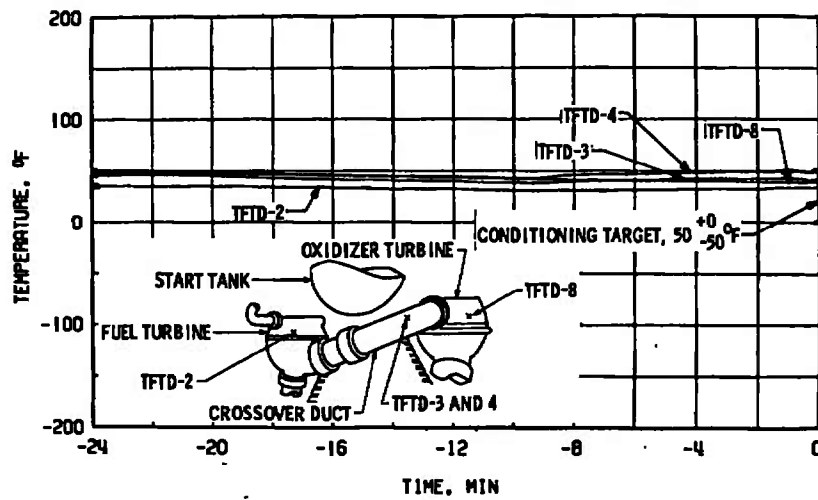

Fig. 16 Engine Ambient and Combustion Chamber Pressure, Firing 03B



a. Main Oxidizer Valve Second-Stage Actuator, TSOVC-1



b. Crossover Duct, TTFD

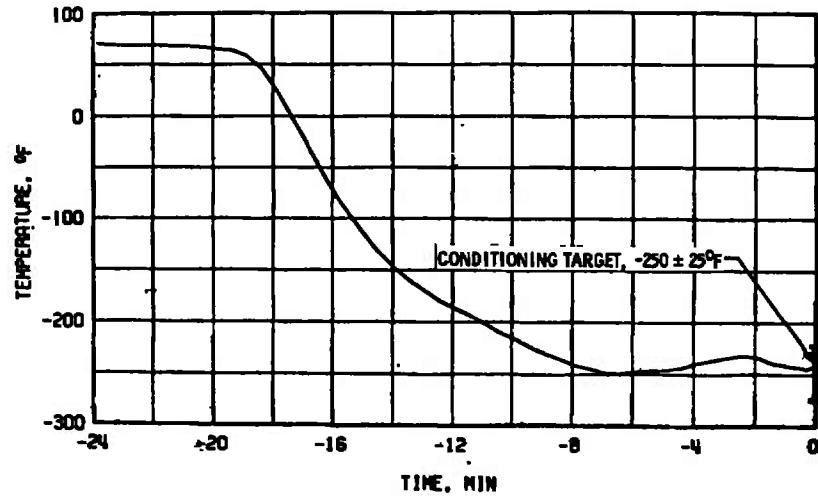

c. Thrust Chamber Throat, TTC-1P

Fig. 17 Thermal Conditioning History of Engine Components, Firing 03C



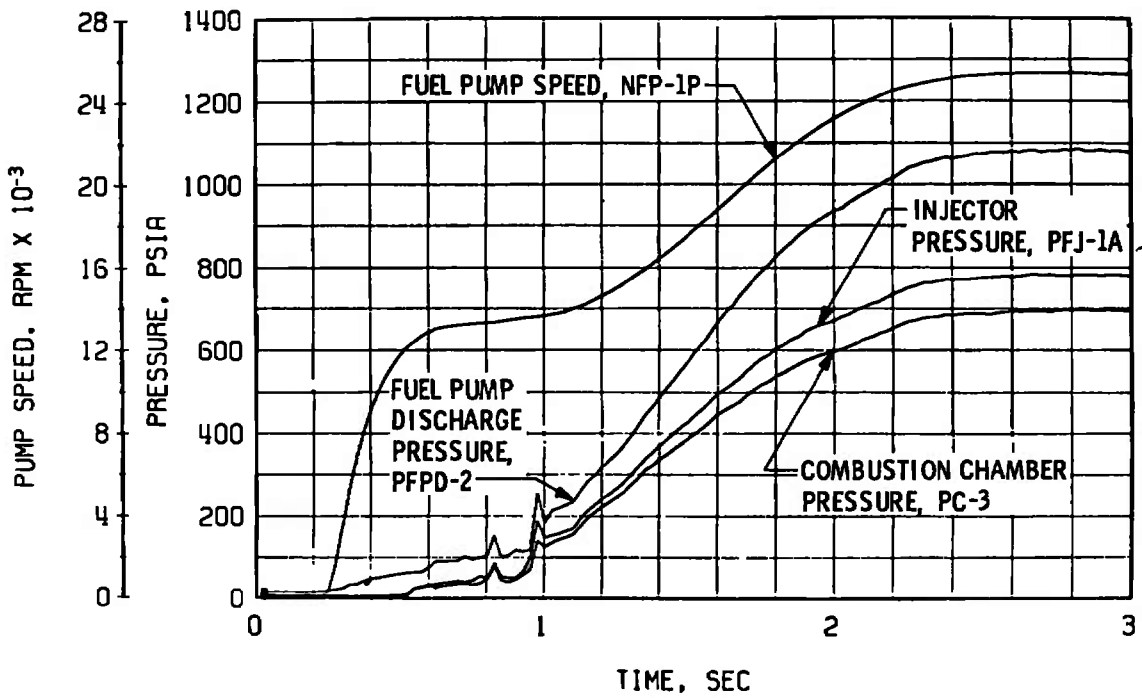

a. Thrust Chamber Fuel System, Start

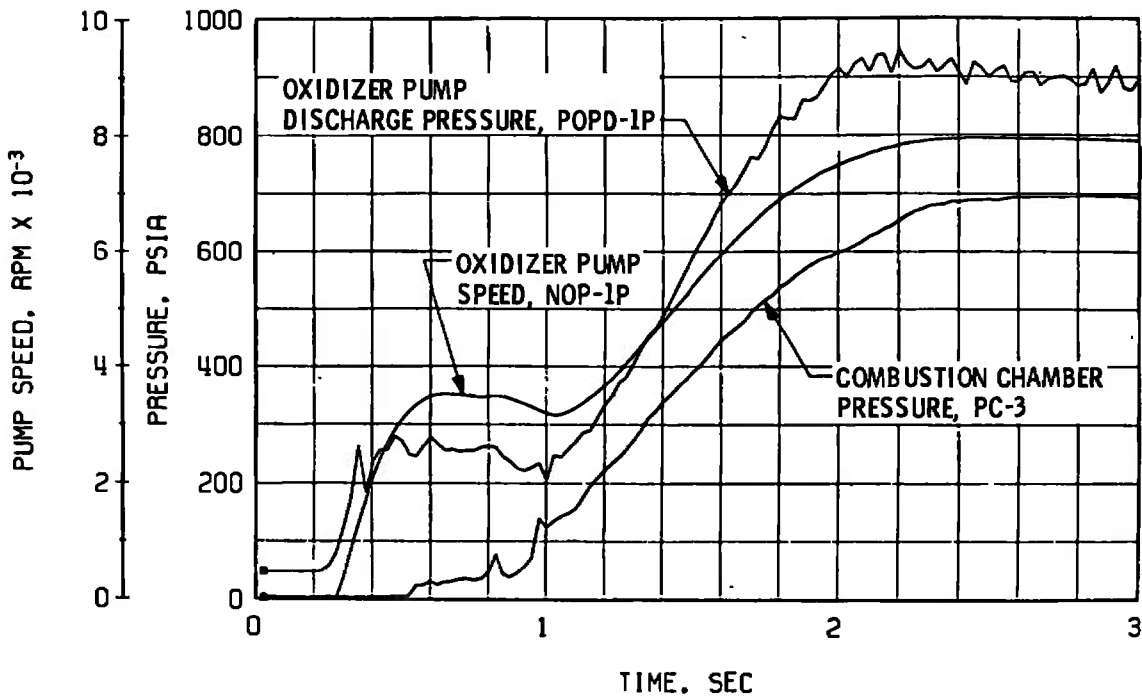

b. Thrust Chamber Oxidizer System, Start

Fig. 18 Engine Transient Operation, Firing 03C

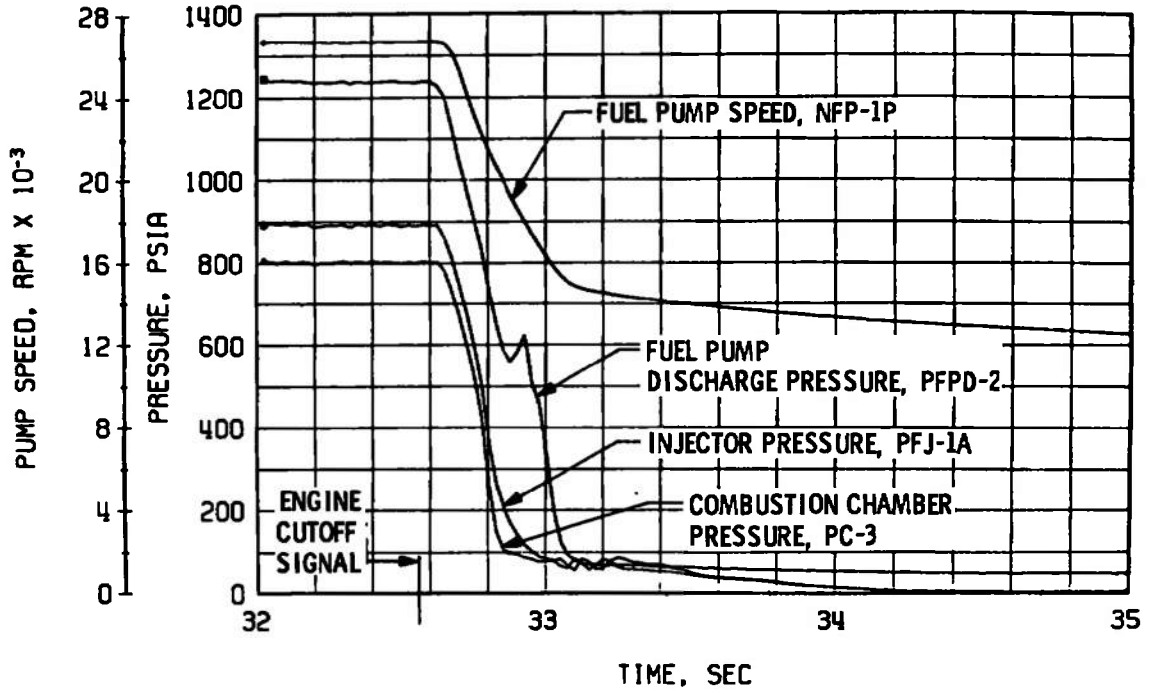

c. Thrust Chamber Fuel System, Shutdown

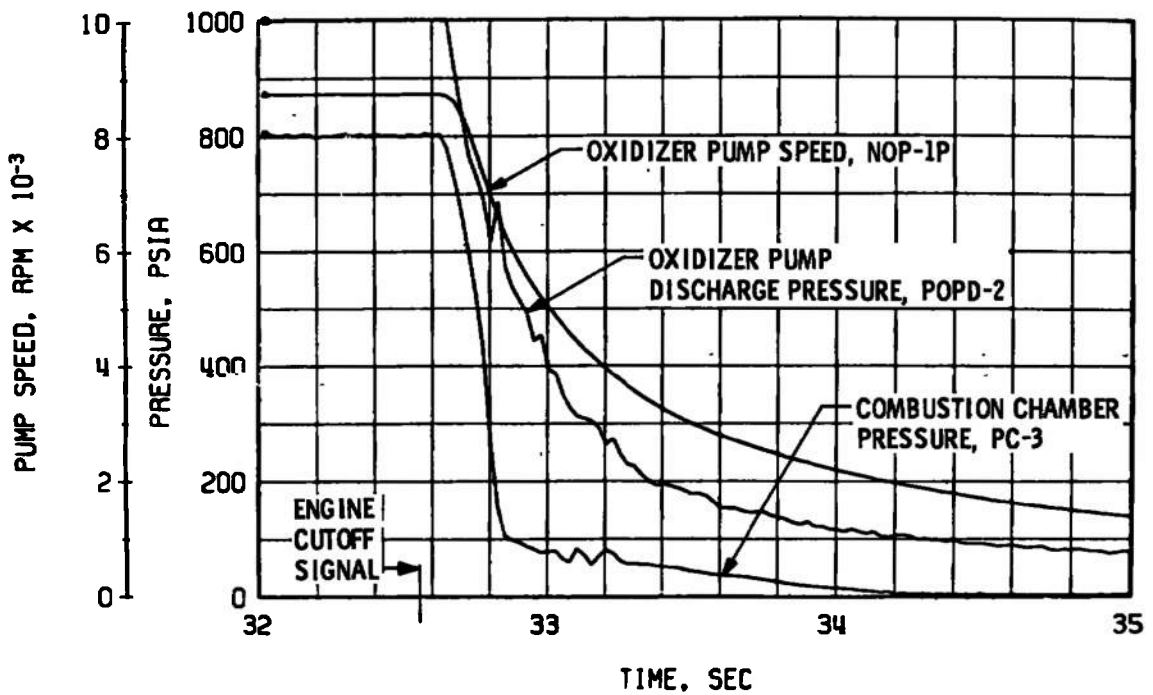

d. Thrust Chamber Oxidizer System, Shutdown

Fig. 18 Continued

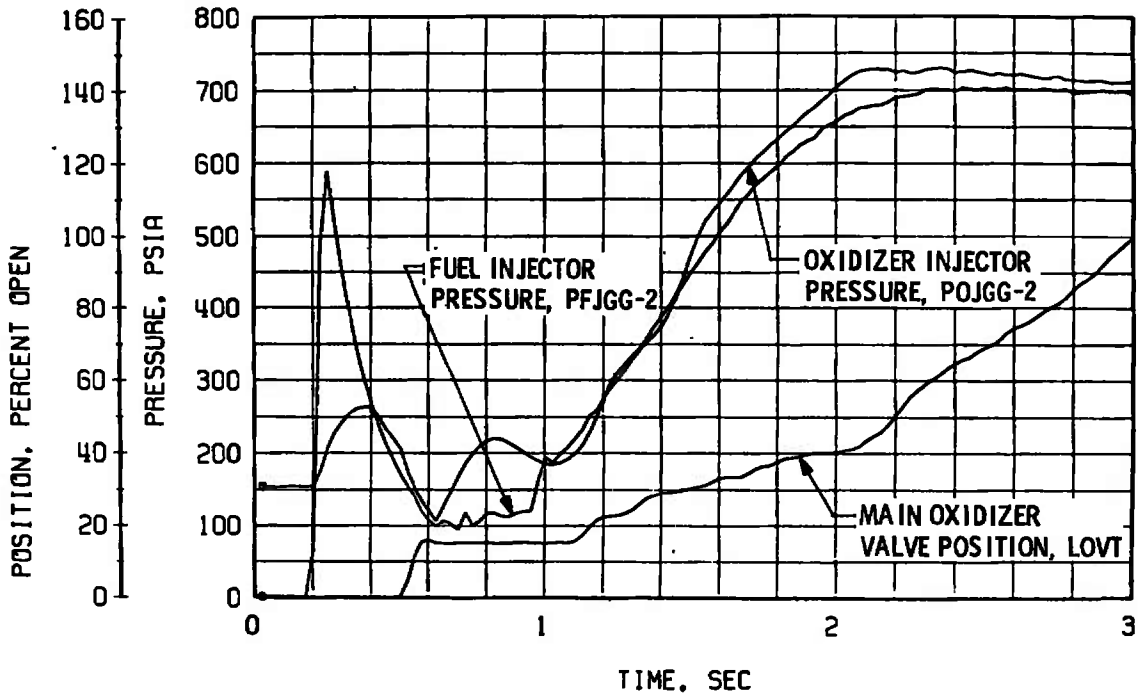

e. Gas Generator Injector Pressures and Main Oxidizer Valve Position, Start

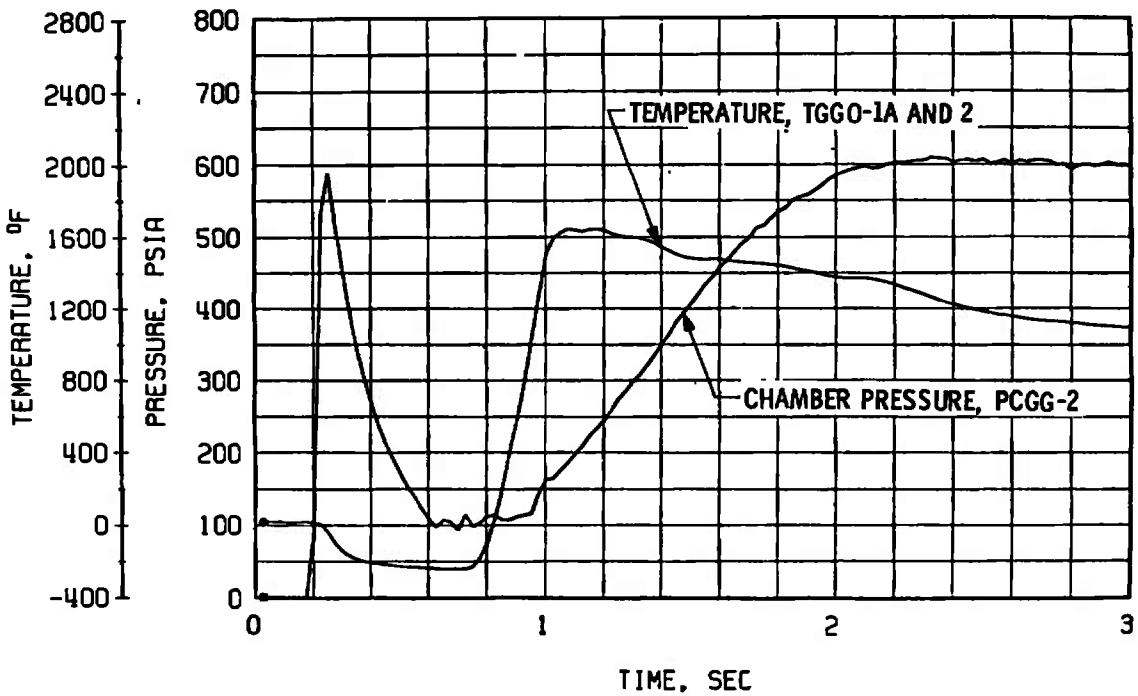

f. Gas Generator Chamber Pressure and Temperature, Start

Fig. 18 Continued

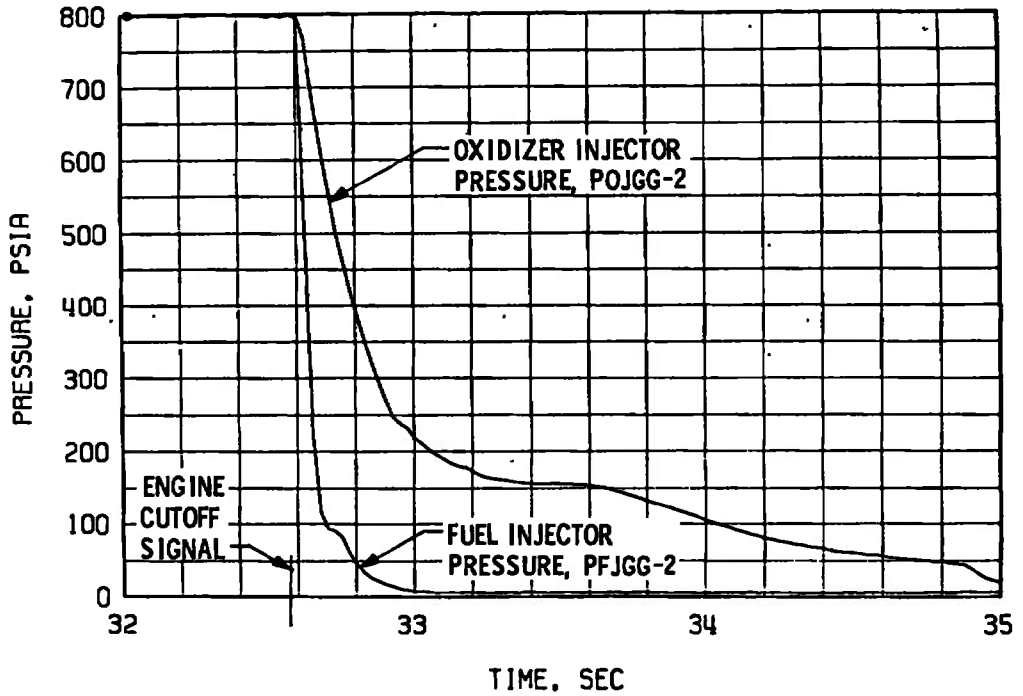

g. Gas Generator Injector Pressures, Shutdown

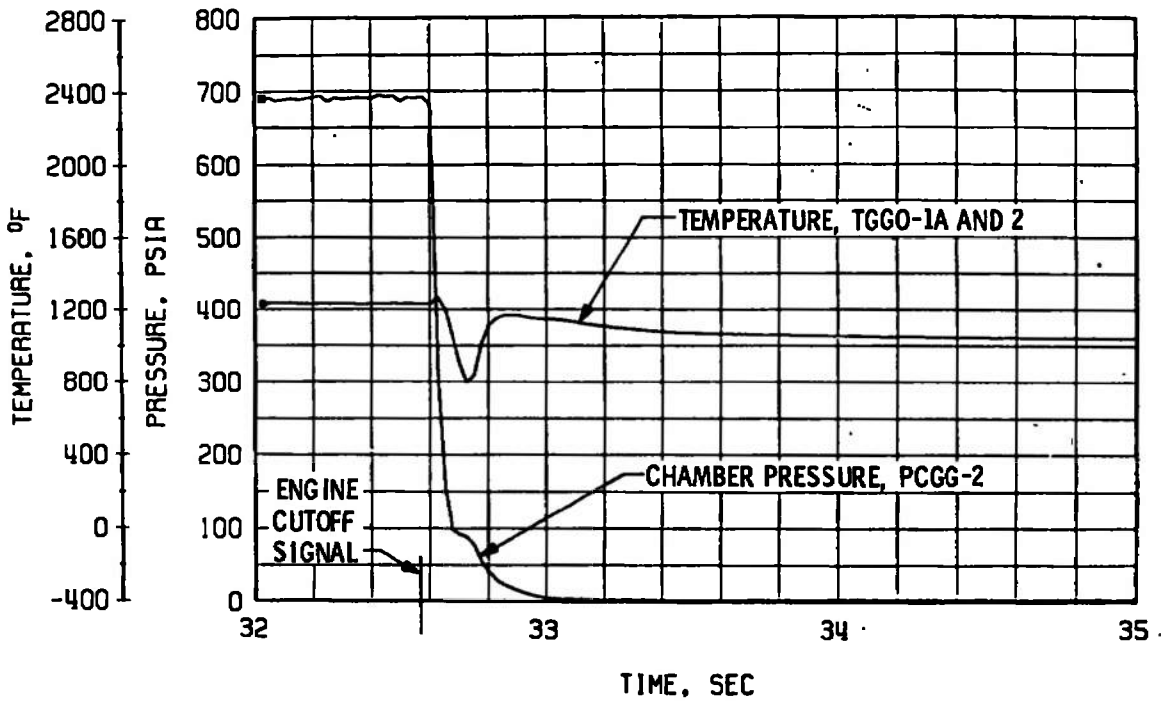

h. Gas Generator Chamber Pressure and Temperature, Shutdown

Fig. 18 Concluded

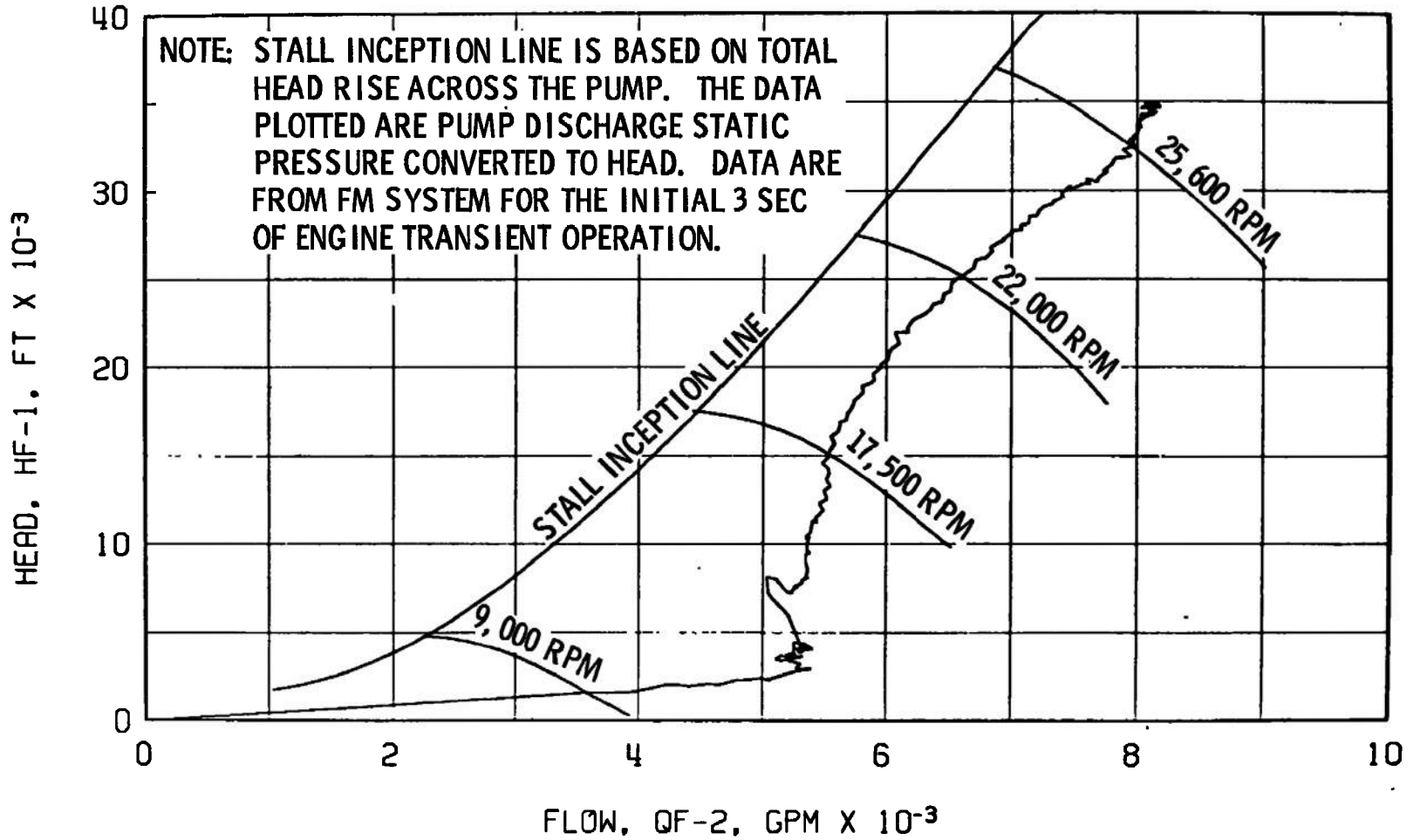

Fig. 19 Fuel Pump Start Transient Performance, Firing 03C

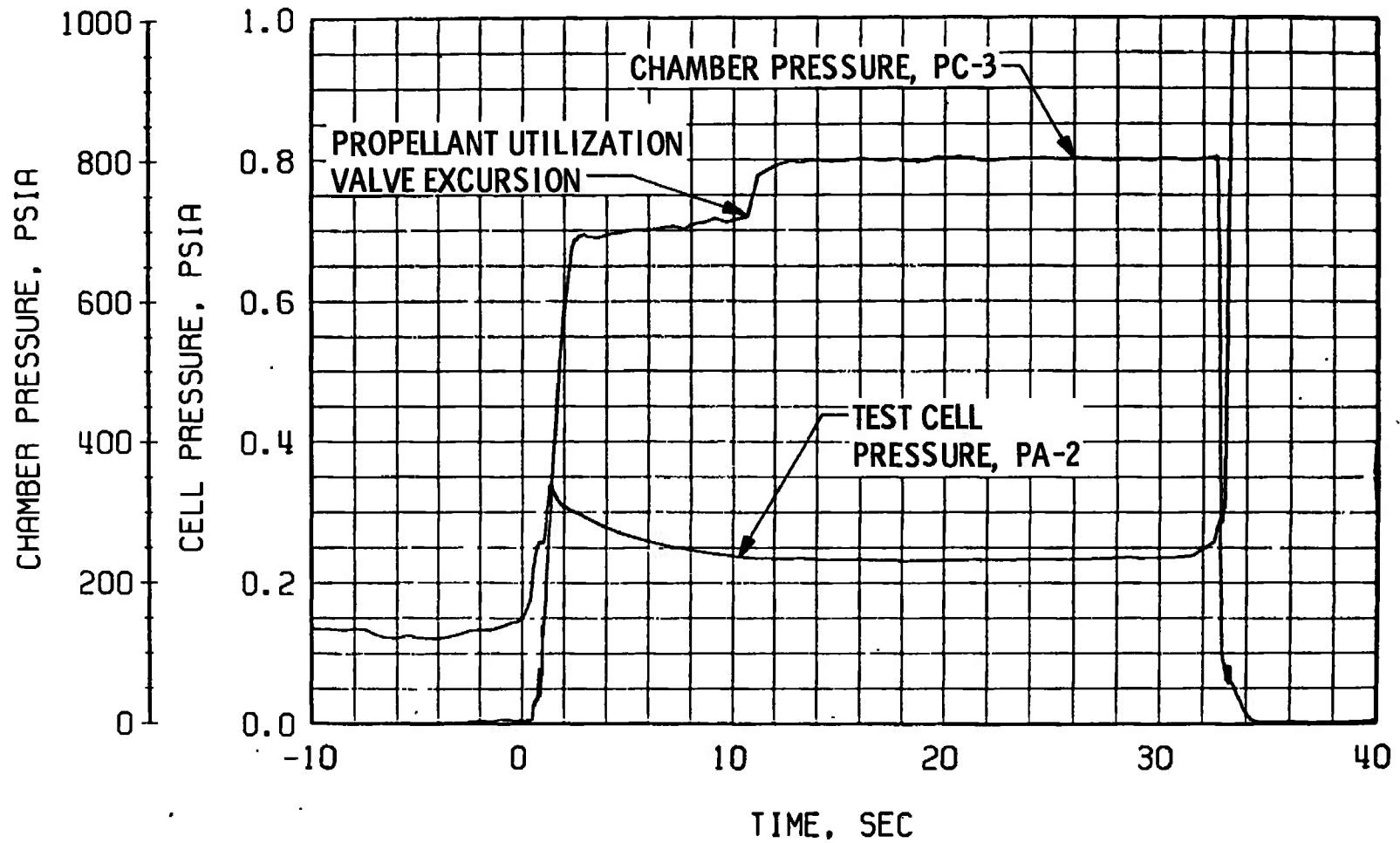
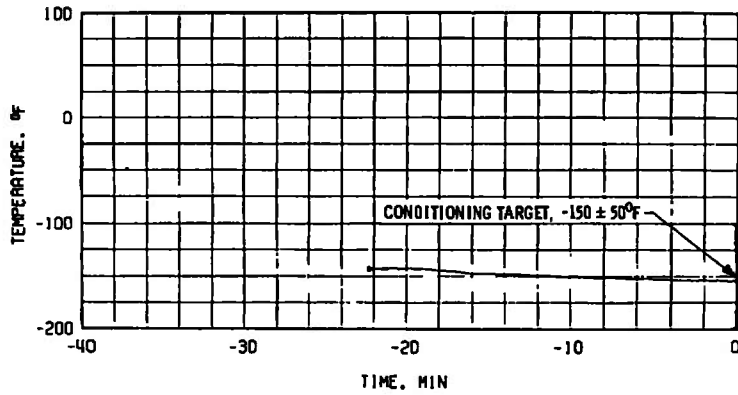
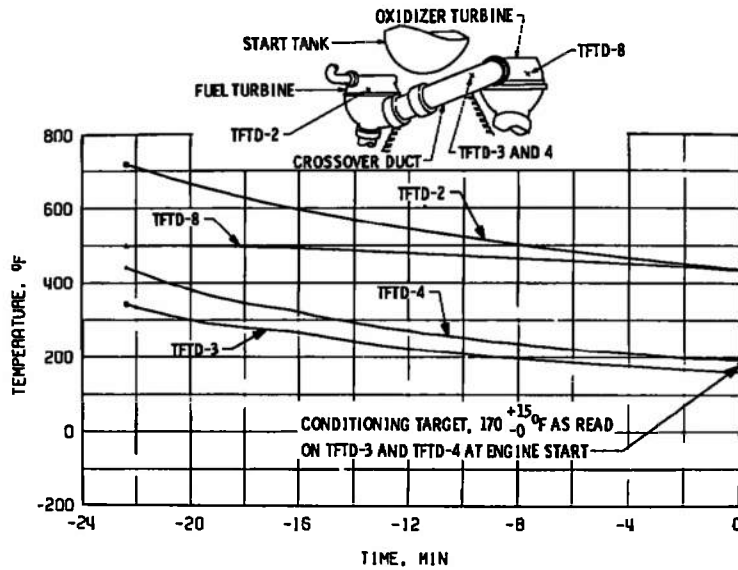

Fig. 20 Engine Ambient and Combustion Chamber Pressure, Firing 03C



a. Main Oxidizer Valve Second-Stage Actuator, TSOVC-1



b. Crossover Duct, TFTD

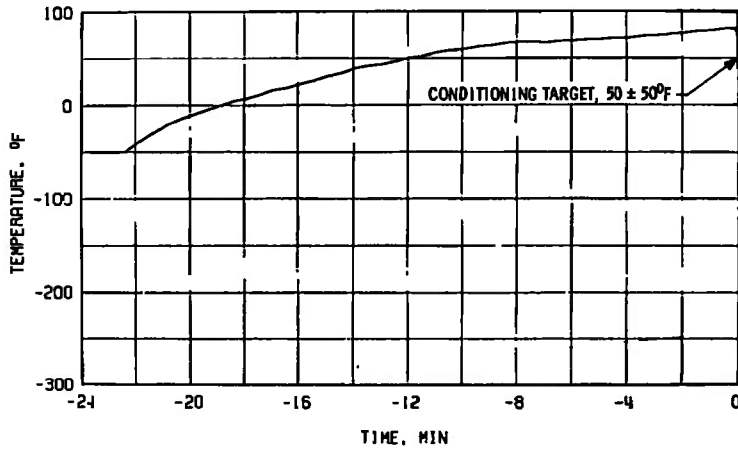

c. Thrust Chamber Throat, TTC-1P

Fig. 21 Thermal Conditioning History of Engine Components, Firing 03D

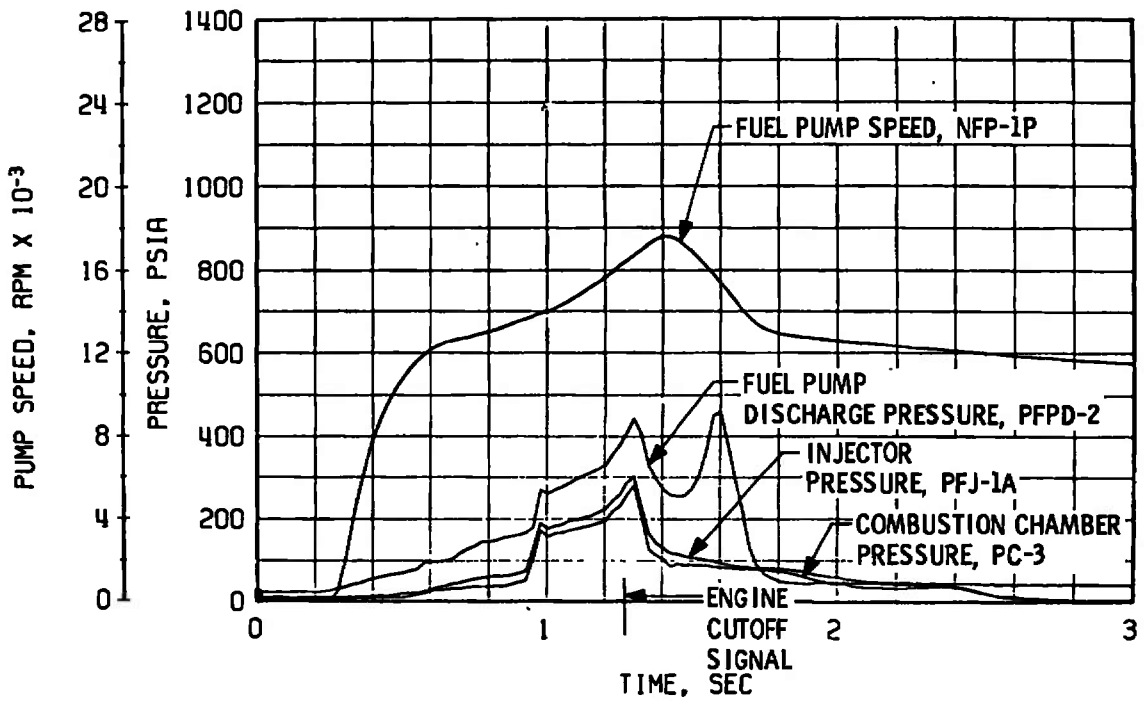

a. Thrust Chamber Fuel System, Start and Shutdown

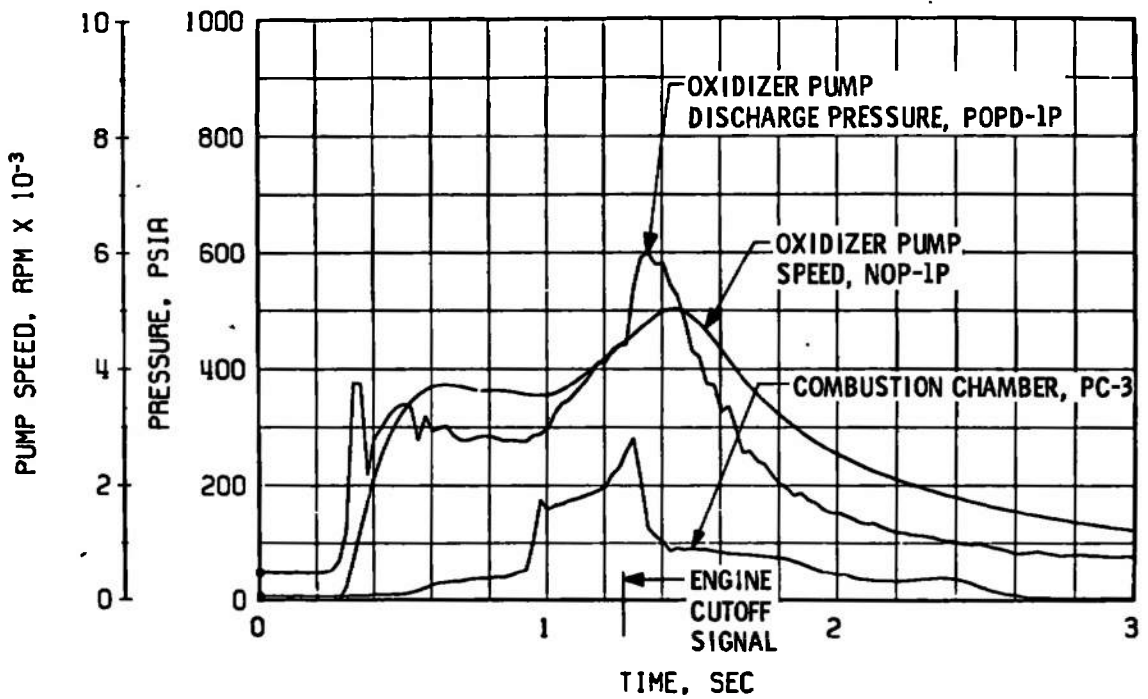

b. Thrust Chamber Oxidizer System, Start and Shutdown

Fig. 22 Engine Transient Operation, Firing 03D



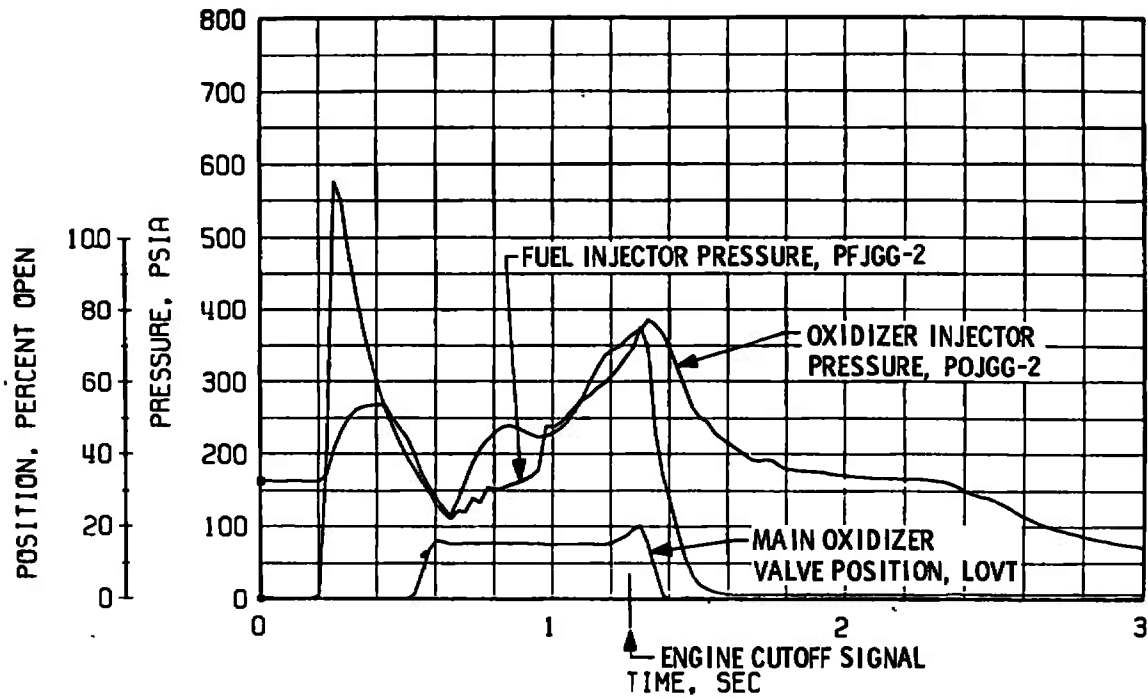

c. Gas Generator Injector Pressures and Main Oxidizer Valve Position, Start and Shutdown

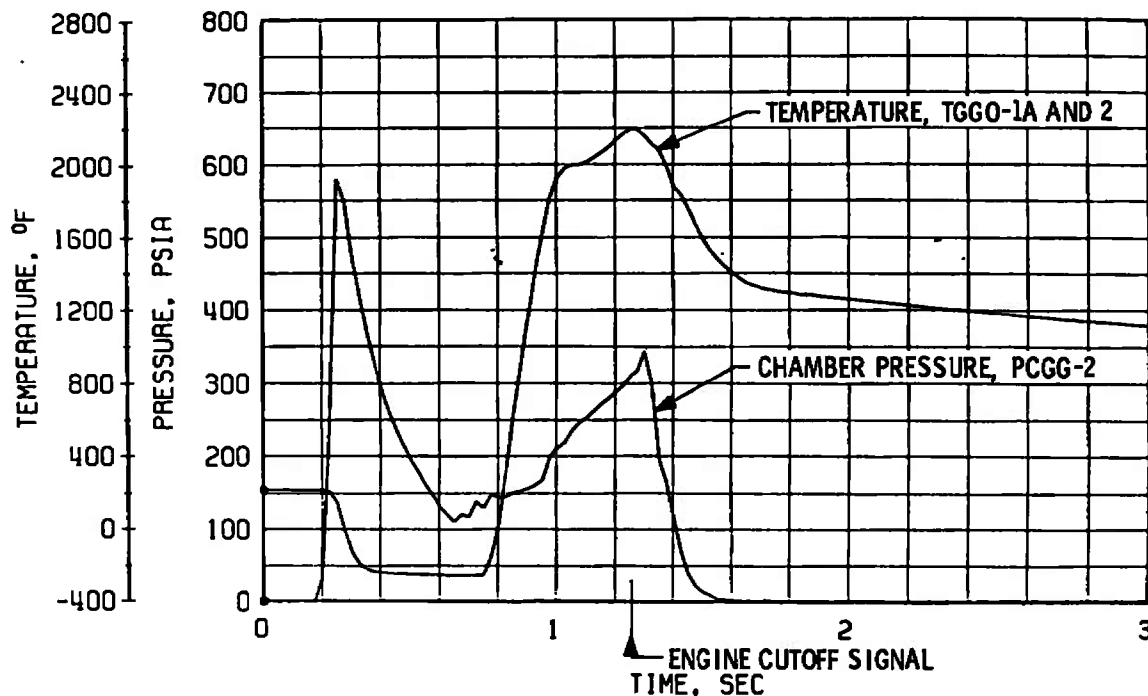

d. Gas Generator Chamber Pressure and Temperature, Start and Shutdown

Fig. 22 Concluded

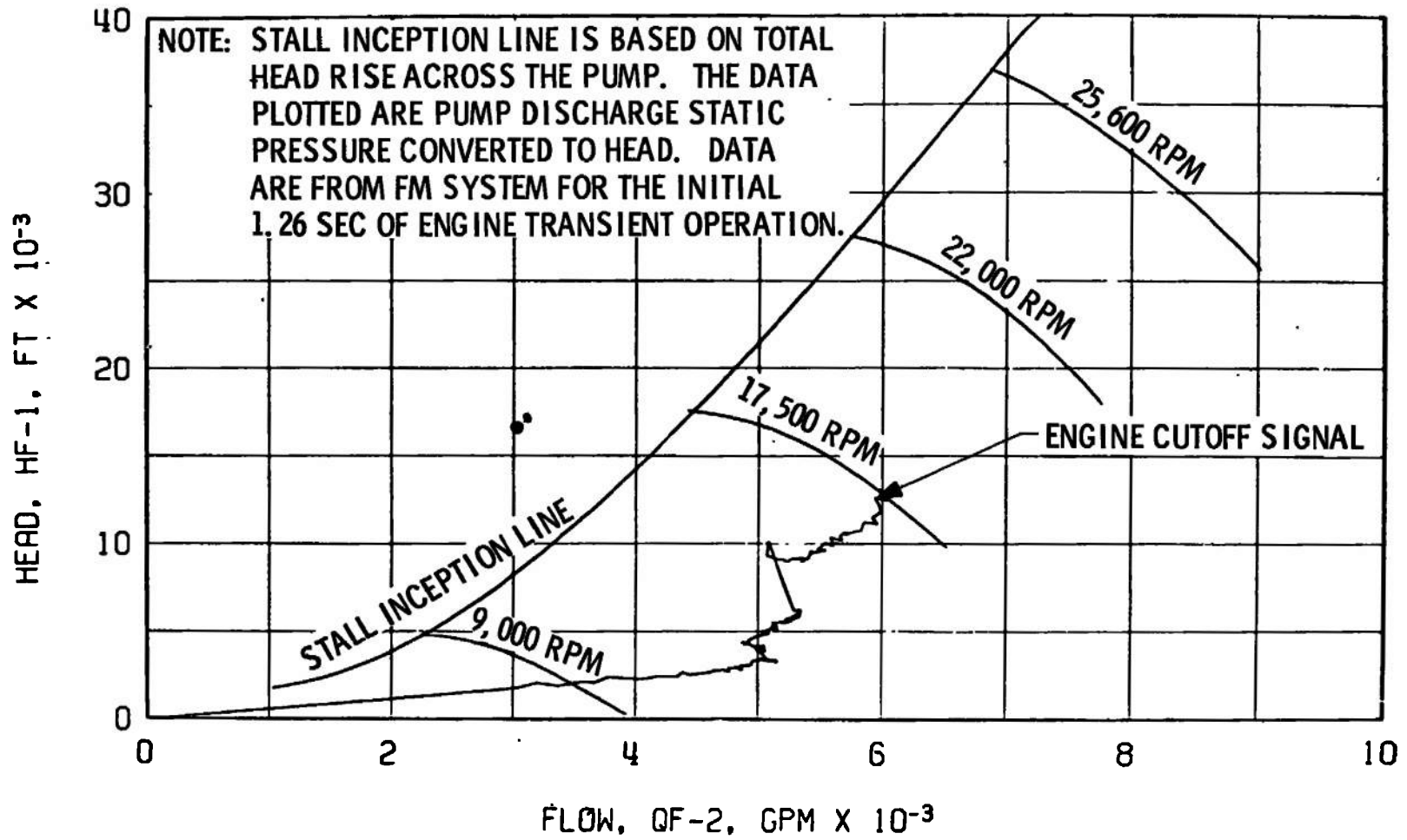

Fig. 23 Fuel Pump Start Transient Performance, Firing 03D

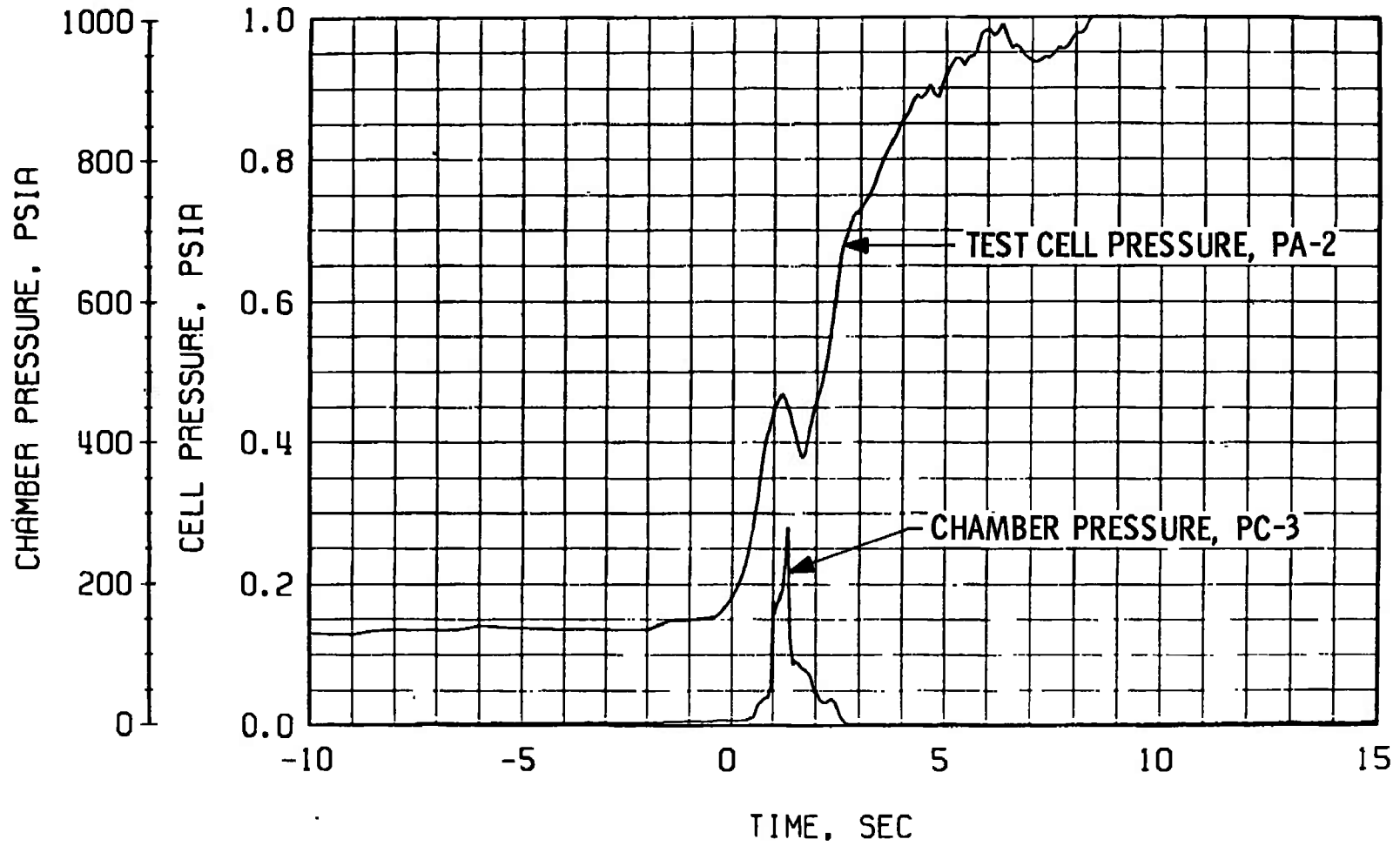
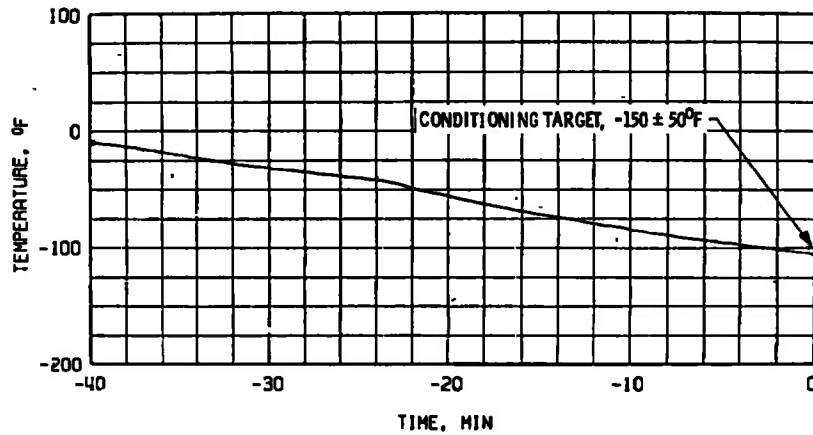
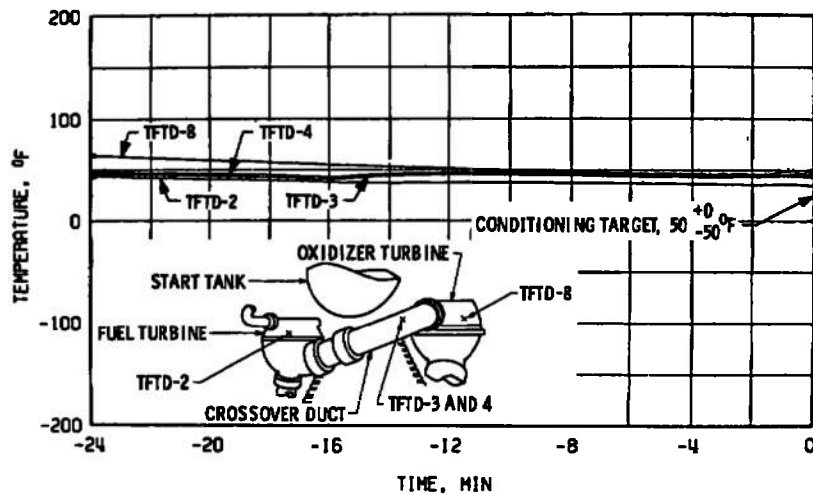

Fig. 24 Engine Ambient and Combustion Chamber Pressure, Firing 03D



a. Main Oxidizer Valve Second-Stage Actuator, TSOVC-1



b. Crossover Duct, TTFD

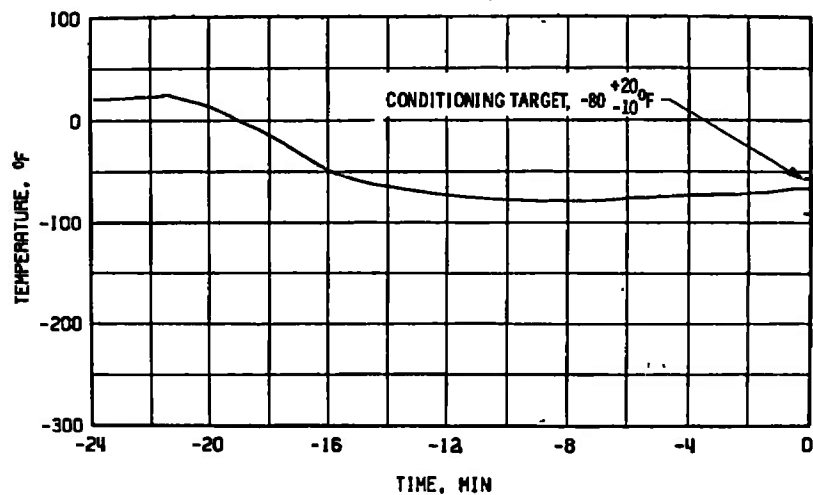

c. Thrust Chamber Throat, TTC-1P

Fig. 25 Thermal Conditioning History of Engine Components, Firing 04A

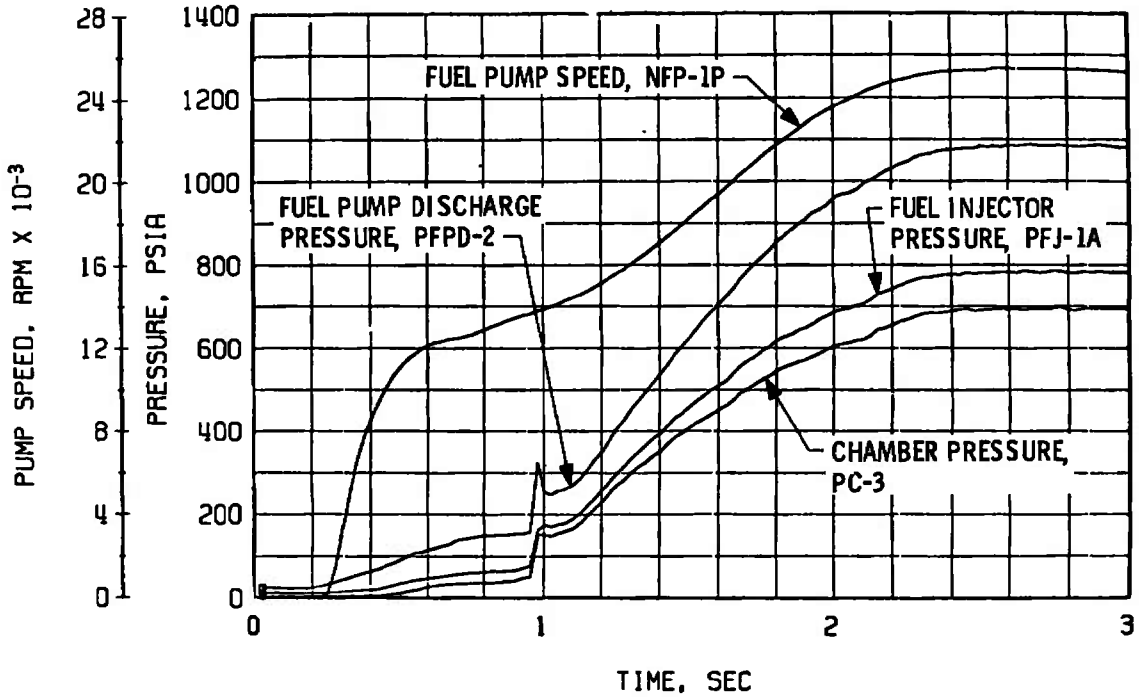

a. Thrust Chamber Fuel System, Start

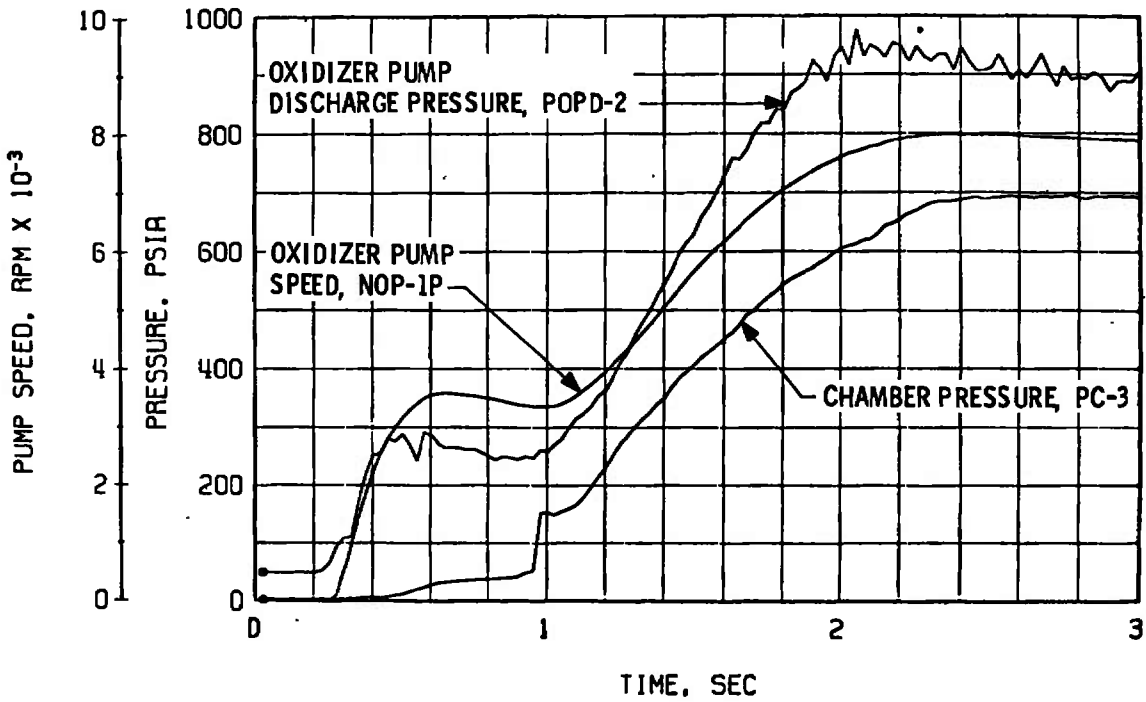

b. Thrust Chamber Oxidizer System, Start

Fig. 26 Engine Transient Operation, Firing U4A

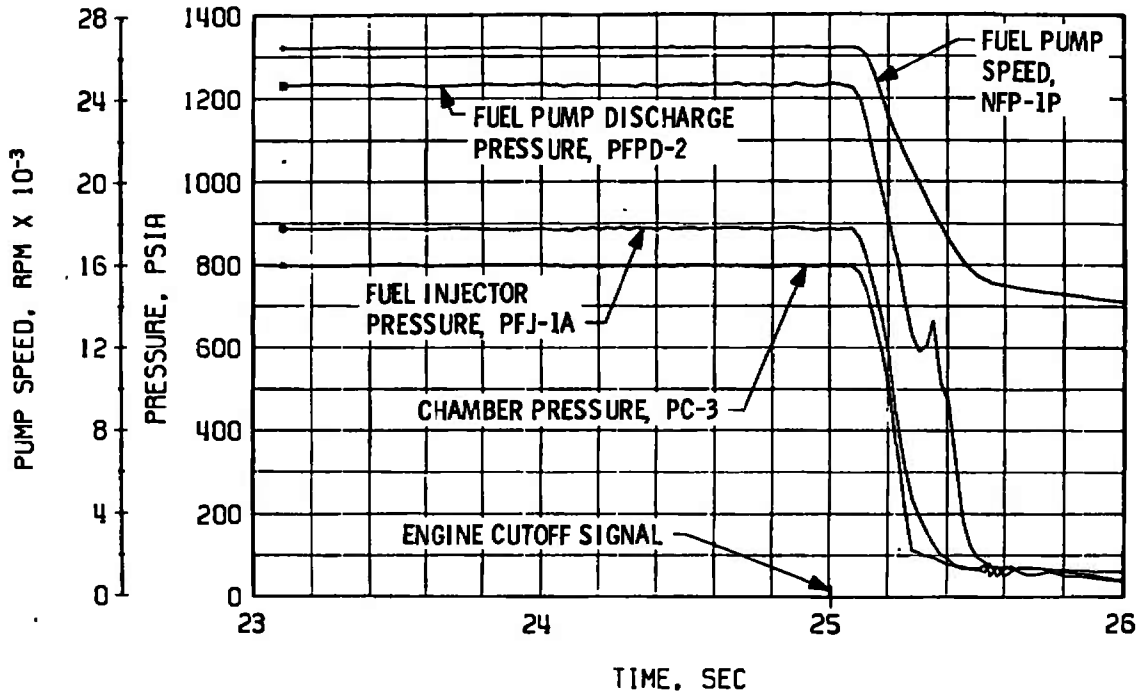

c. Thrust Chamber Fuel System, Shutdown

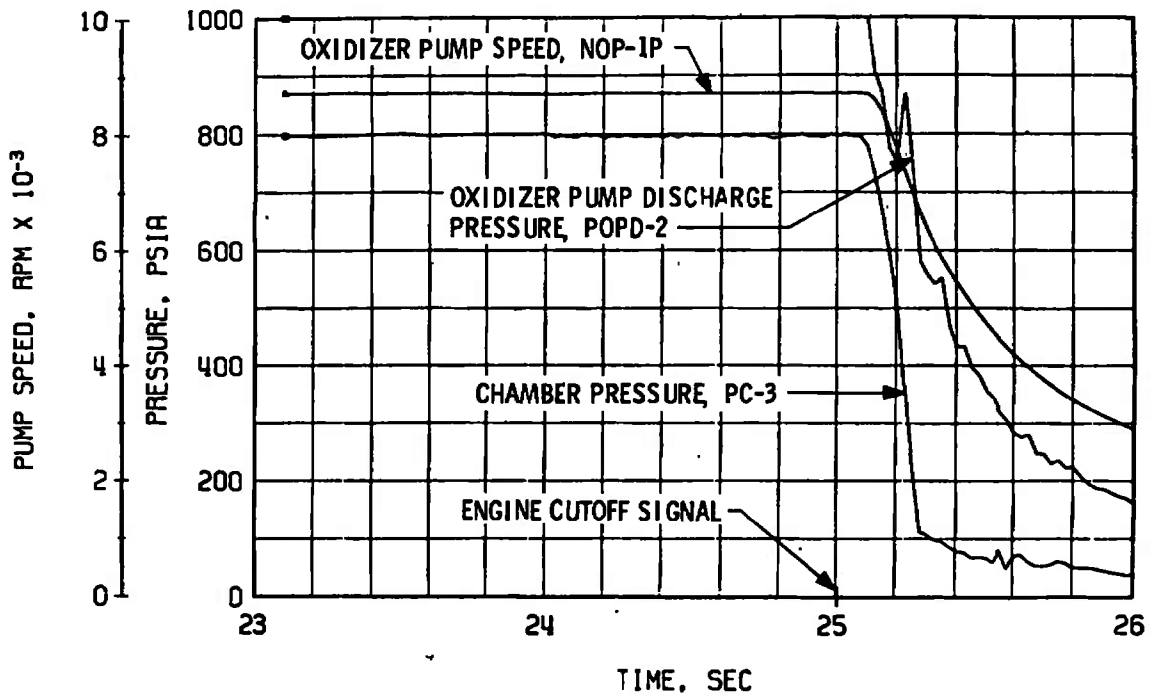

d. Thrust Chamber Oxidizer System, Shutdown

Fig. 26 Continued

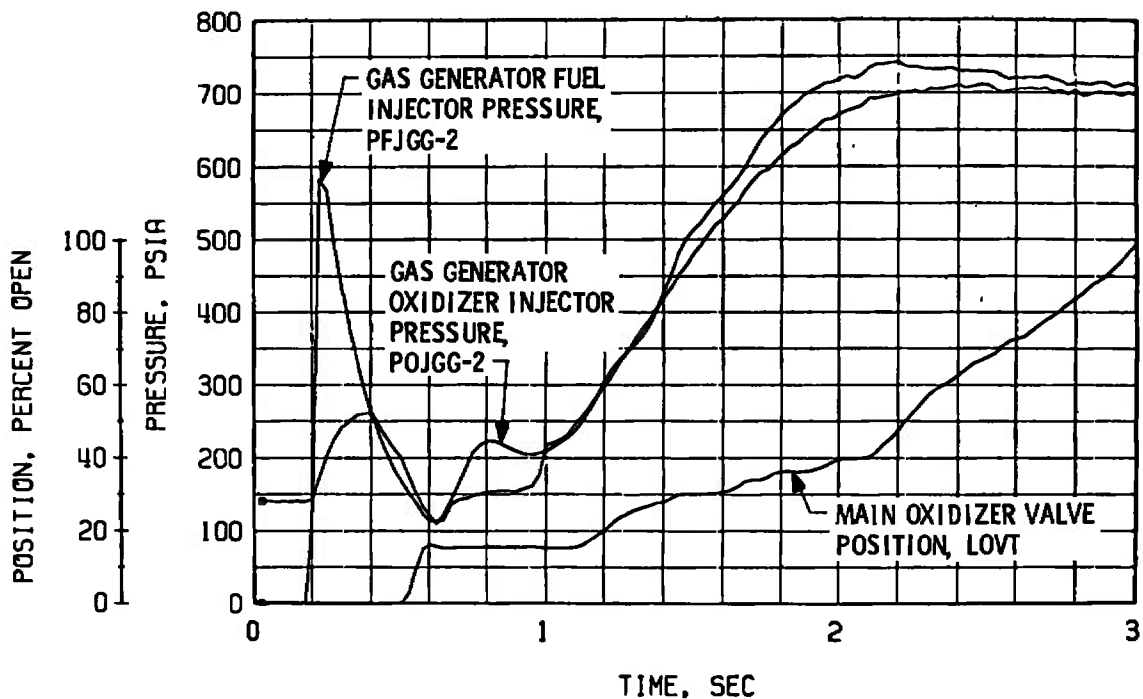

e. Gas Generator Injector Pressure and Main Oxidizer Valve Position, Start

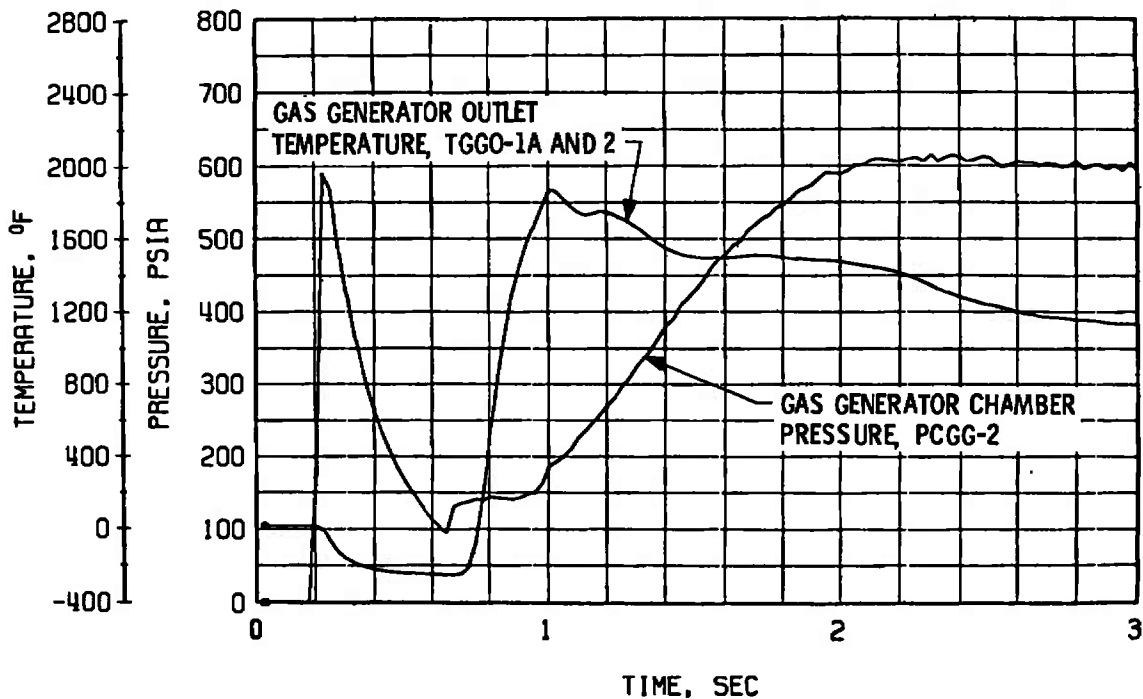

f. Gas Generator Chamber Pressure and Temperature, Start

Fig. 26 Continued

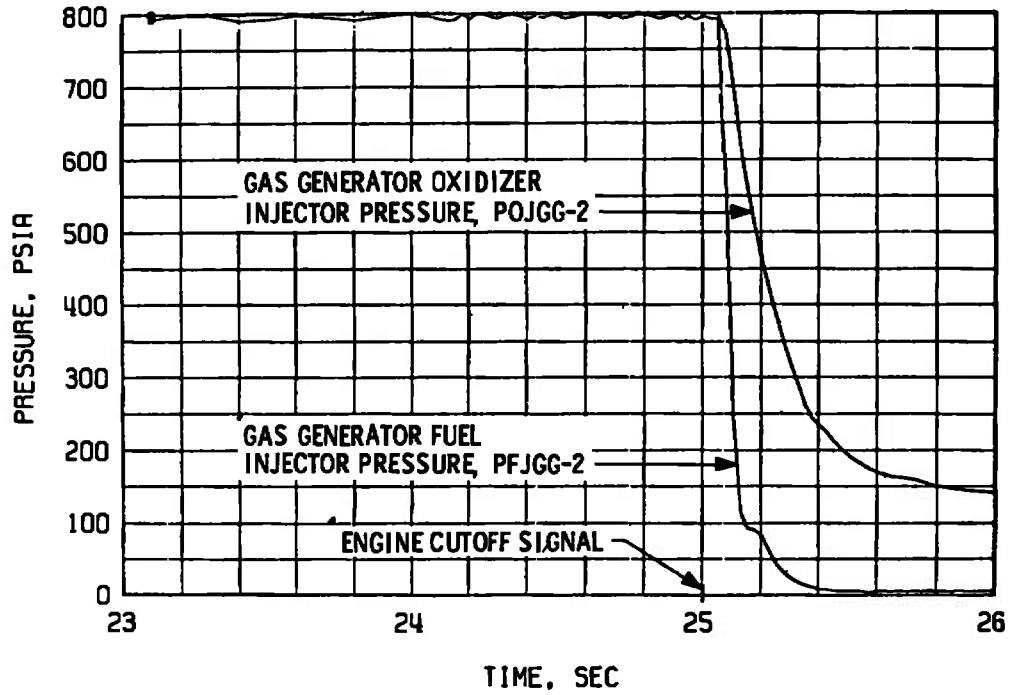

g. Gas Generator Injector Pressures, Shutdown

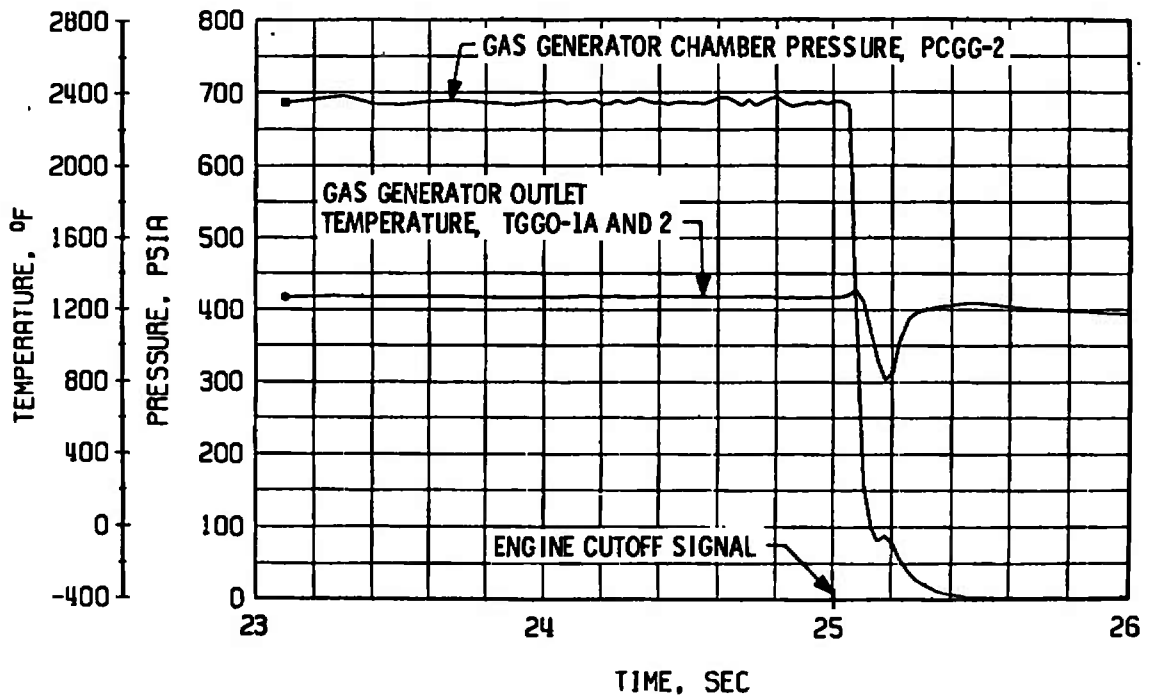

h. Gas Generator Chamber Pressure and Temperature, Shutdown

Fig. 26 Concluded



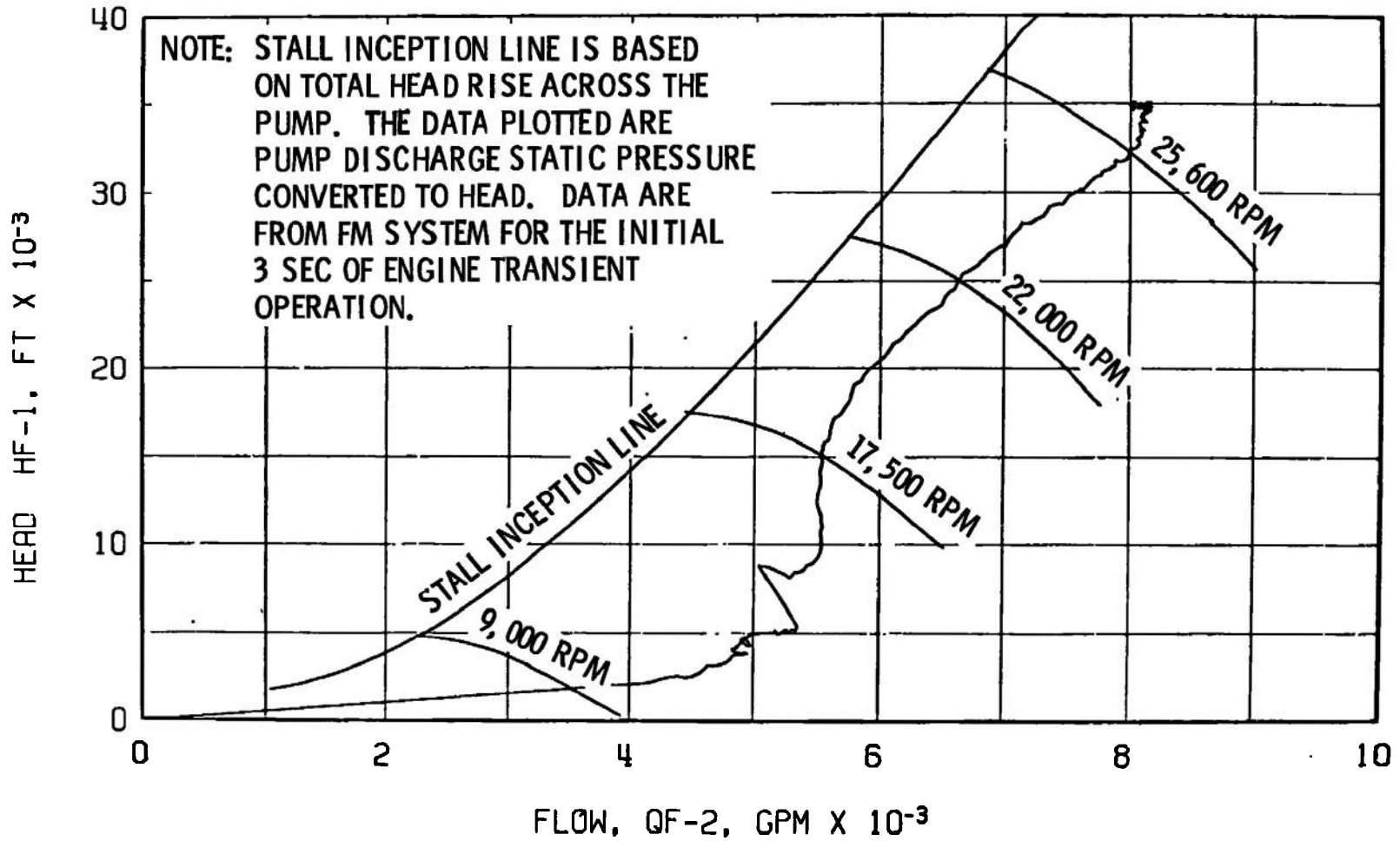

Fig. 27 Fuel Pump Start Transient Performance, Firing 04A

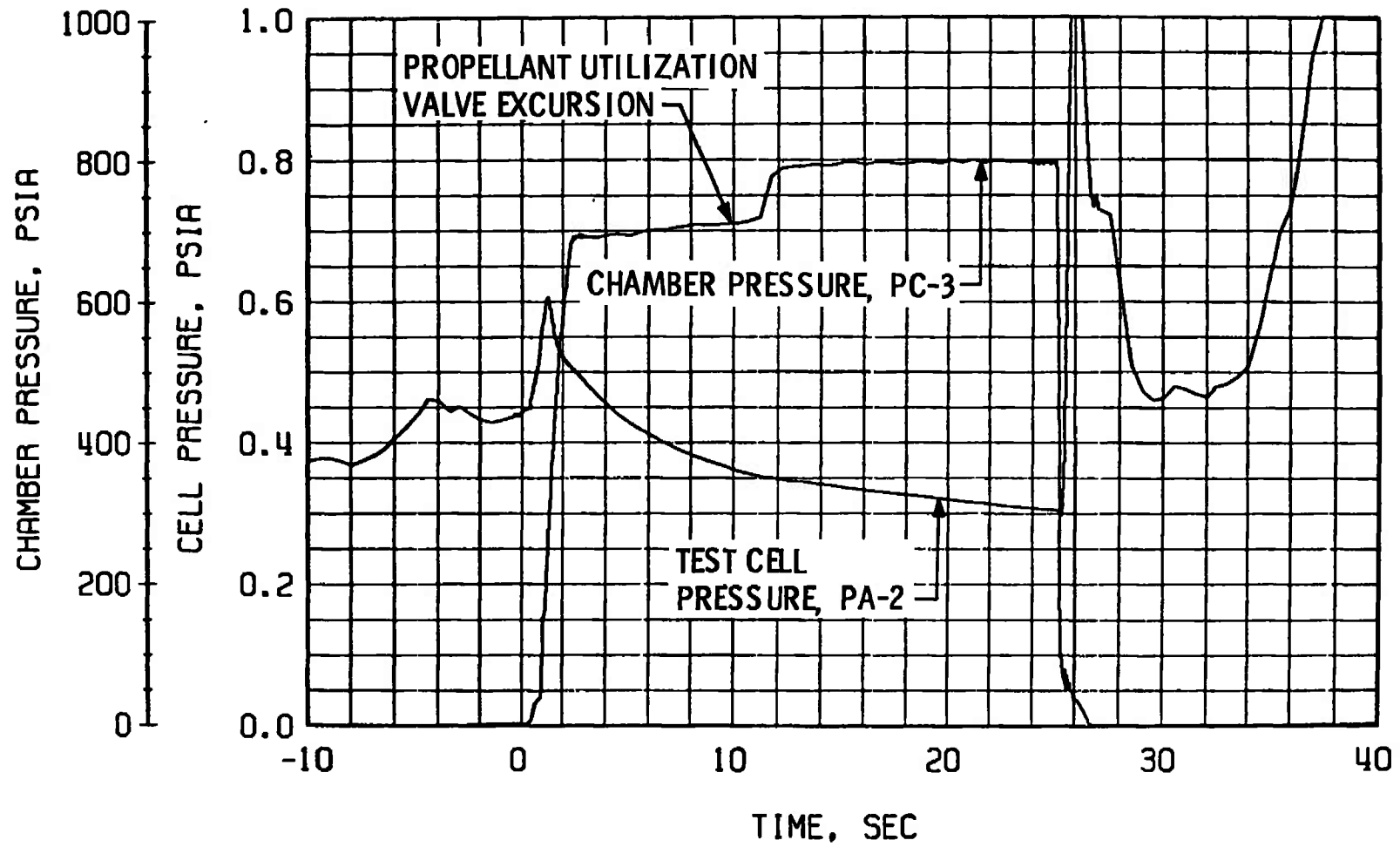
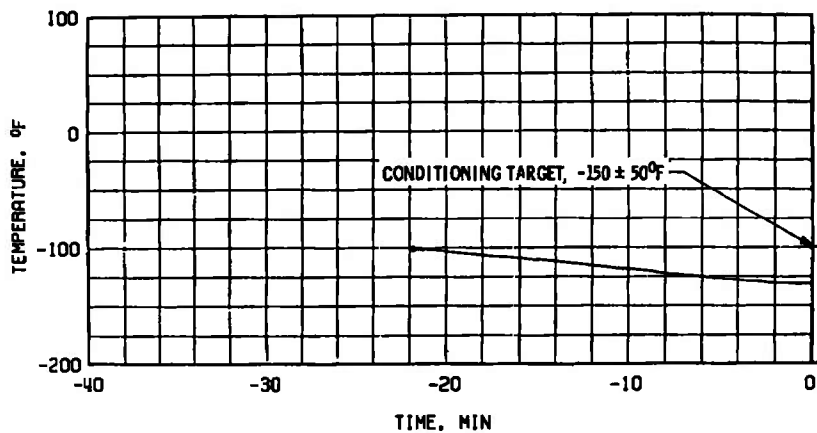
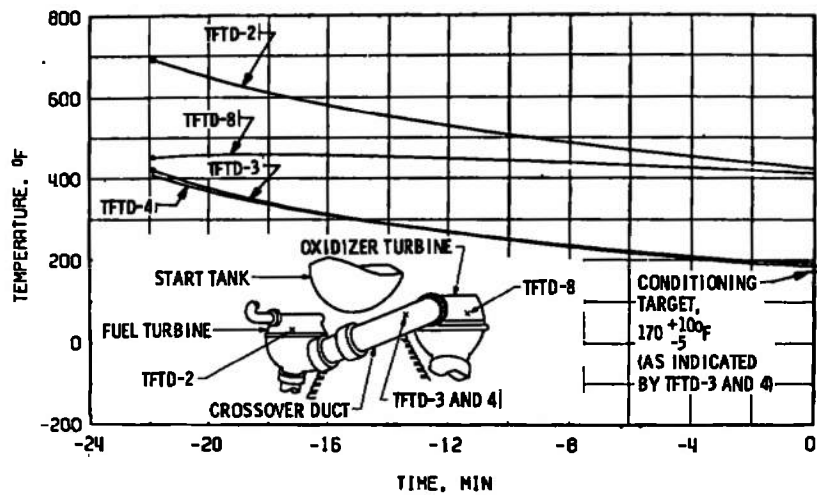

Fig. 28 Engine Ambient and Combustion Chamber Pressure, Firing 04A



a. Main Oxidizer Valve Second-Stage Actuator, TSOVC-1



b. Crossover Duct, TFTD

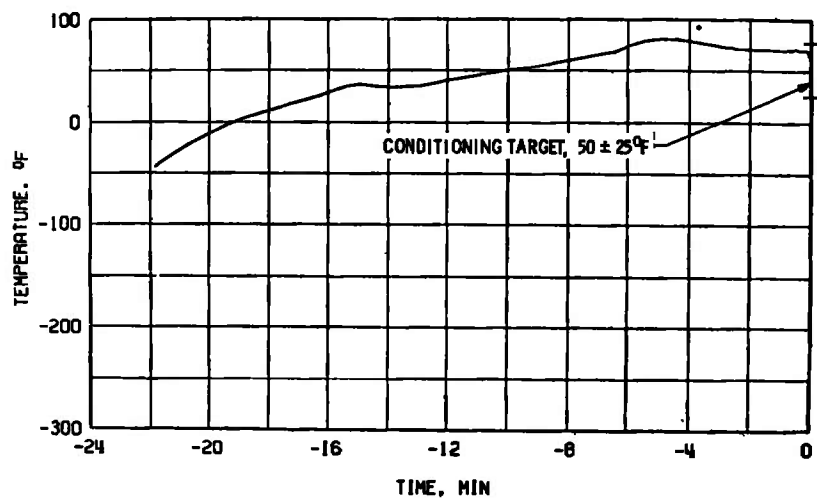

c. Thrust Chamber Throat, TTC-1P

Fig. 29 Thermal Conditioning History of Engine Components, Firing 04B

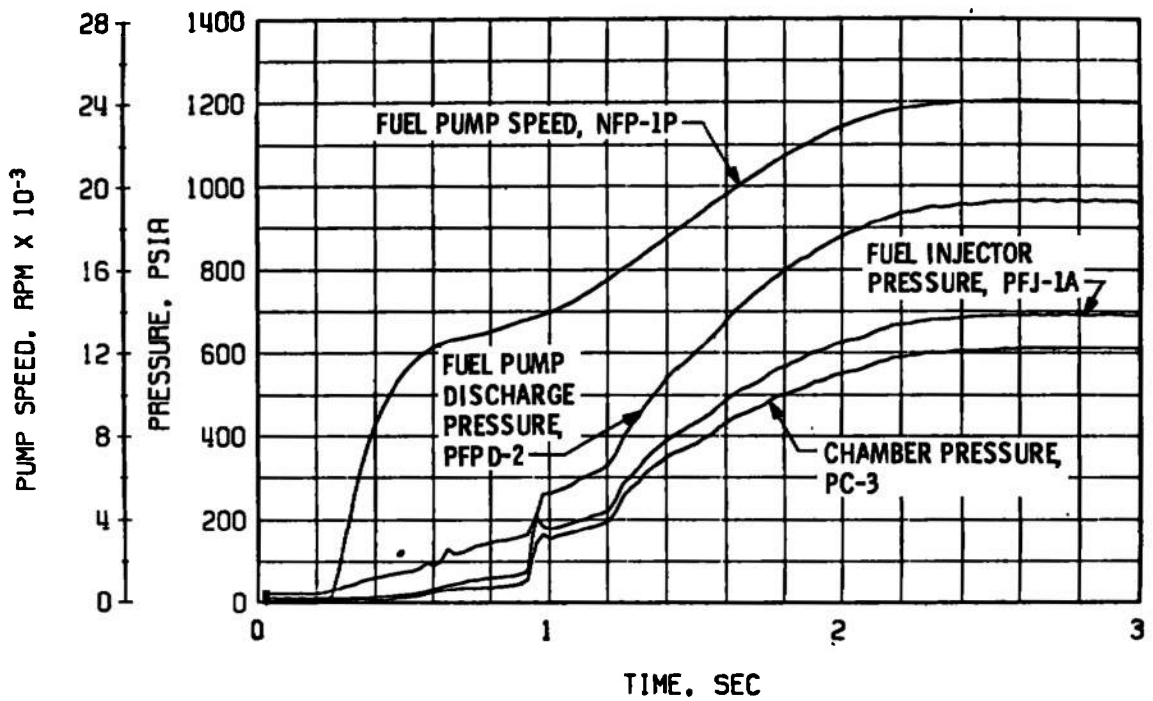

a. Thrust Chamber Fuel System, Start

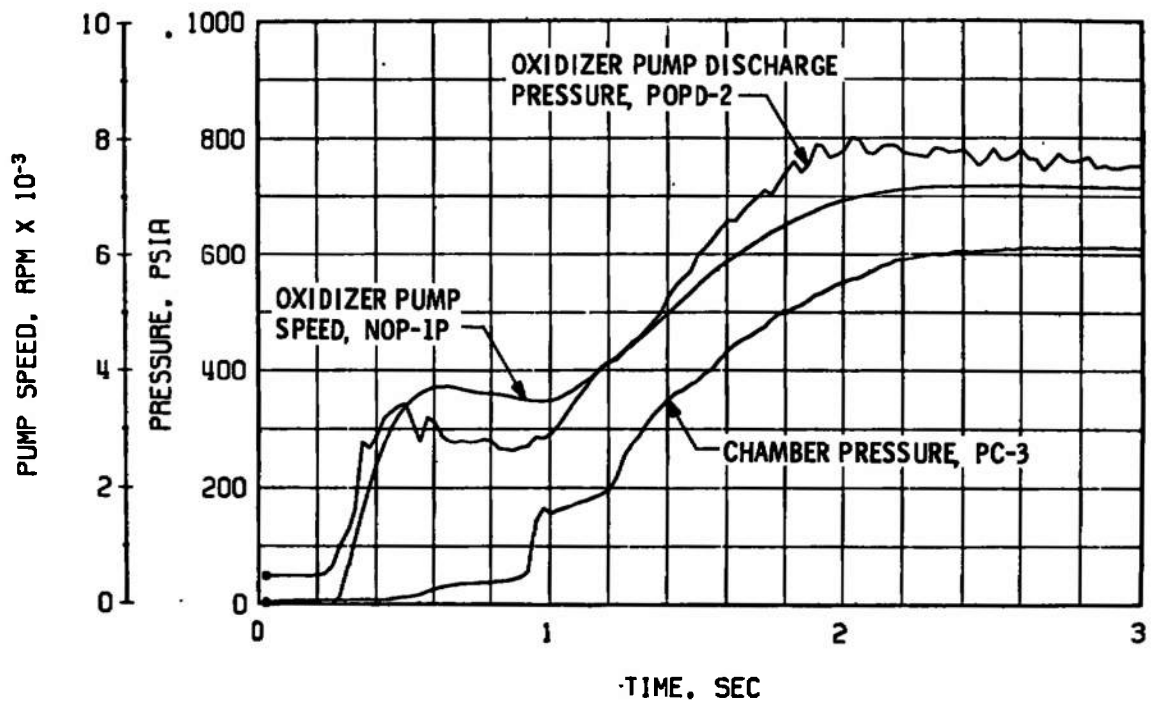

b. Thrust Chamber Oxidizer System, Start

Fig. 30 Engine Transient Operation, Firing 04B

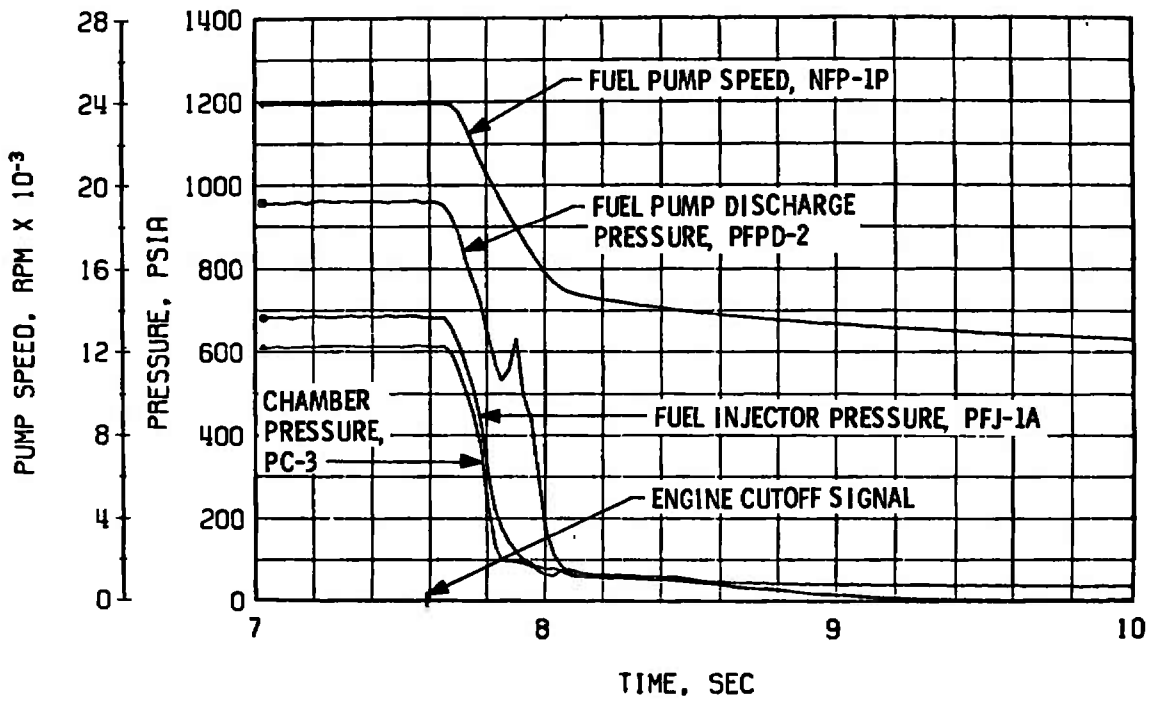

c. Thrust Chamber Fuel System, Shutdown

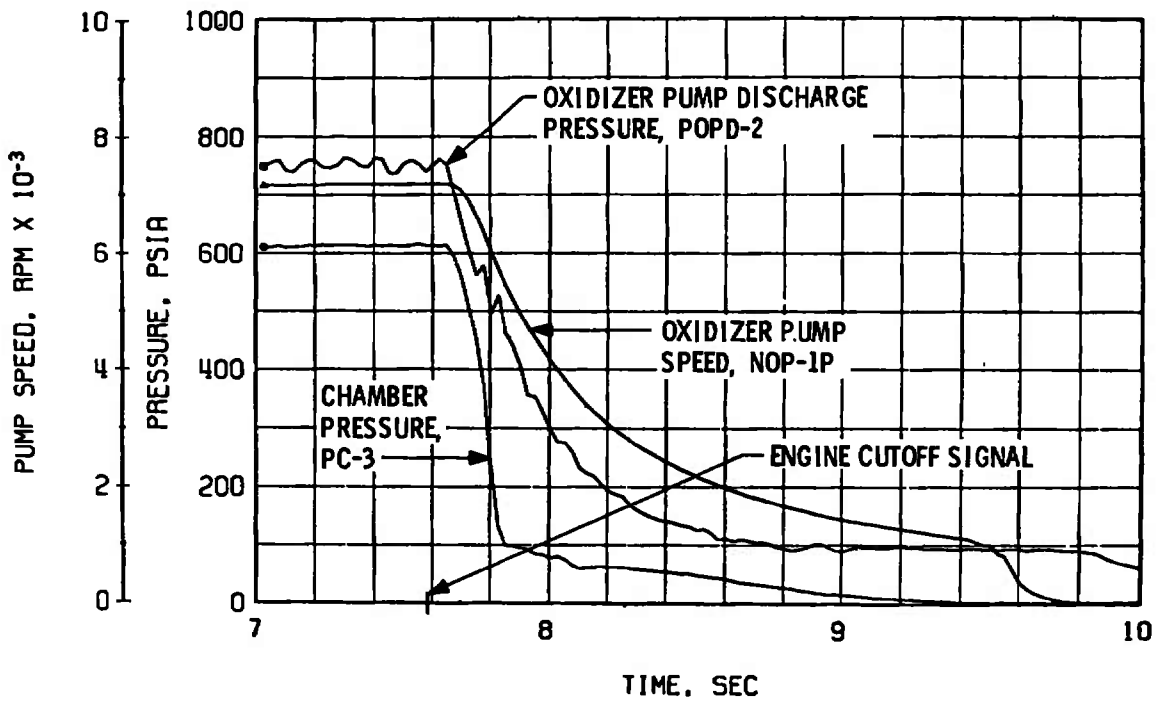

d. Thrust Chamber Oxidizer System, Shutdown

Fig. 30 Continued

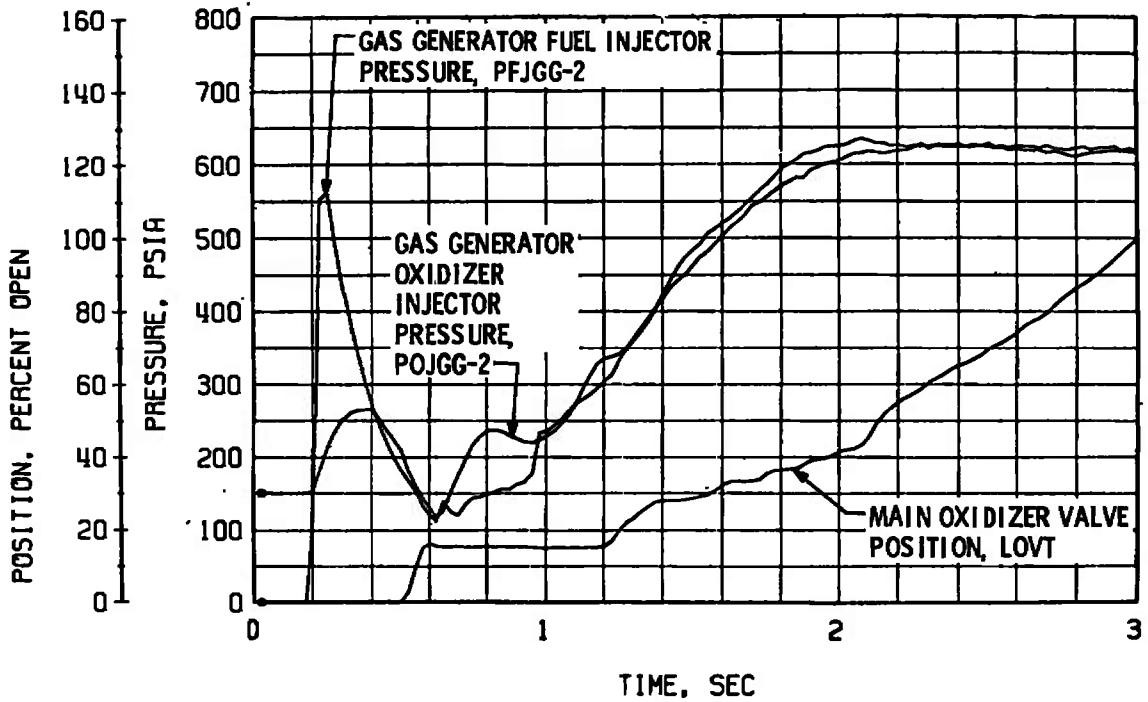

e. Gas Generator Injector Pressures and Main Oxidizer Valve Position, Start

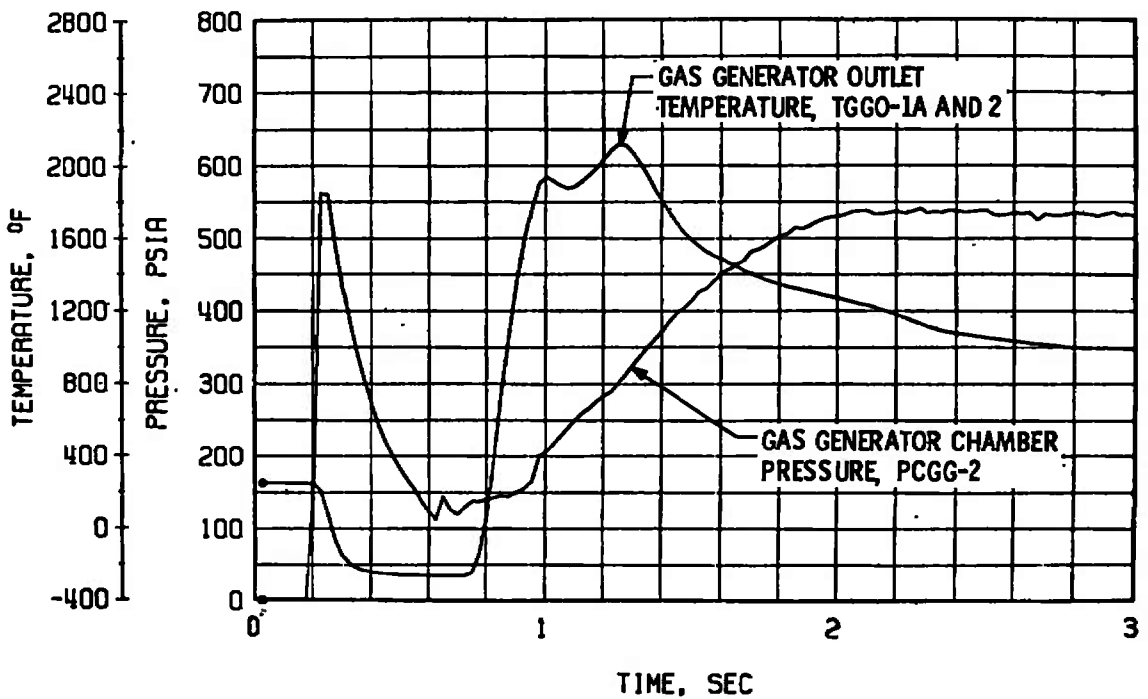

f. Gas Generator Chamber Pressure and Temperature, Start

Fig. 30 Continued

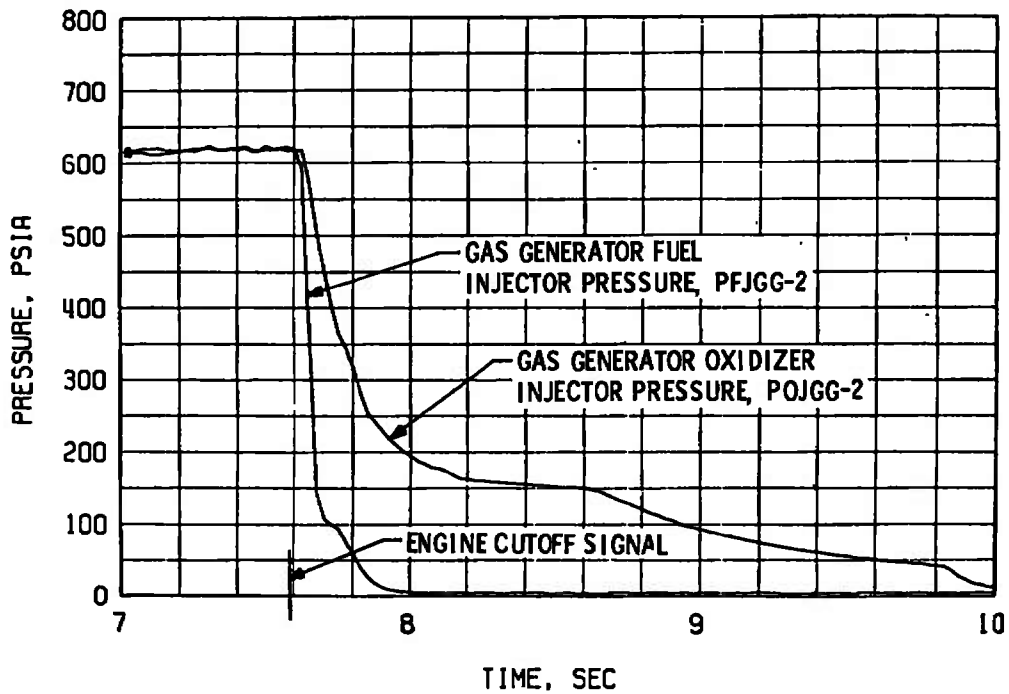

g. Gas Generator Injector Pressures, Shutdown

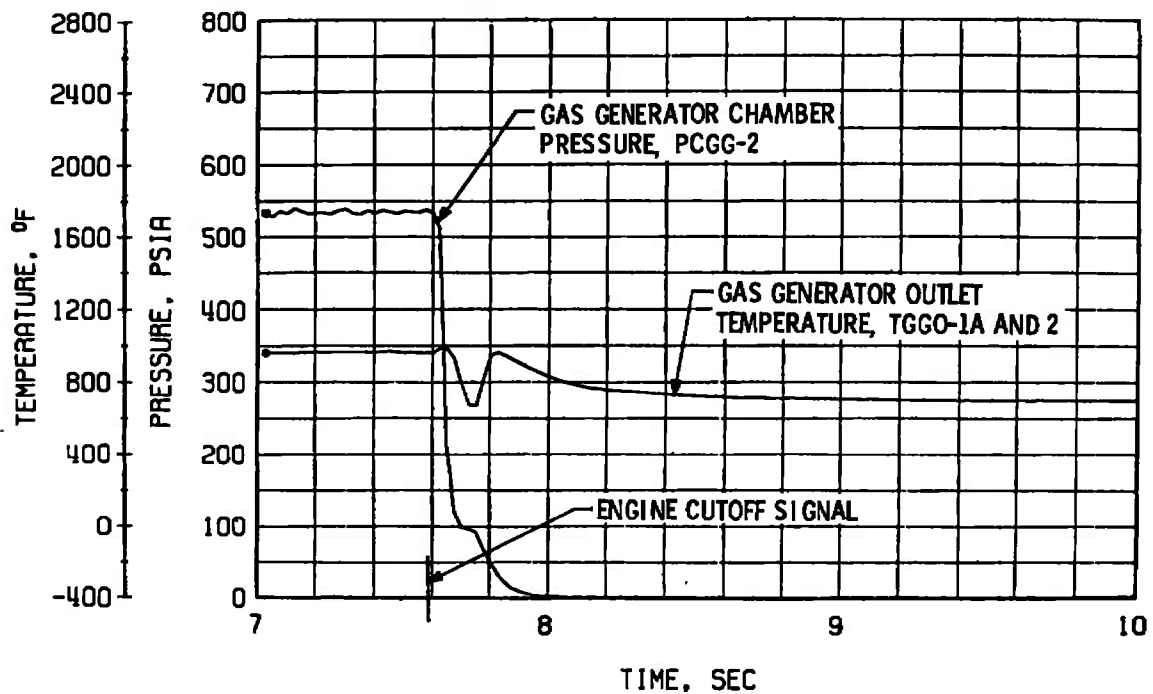

h. Gas Generator Chamber Pressure and Temperature, Shutdown

Fig. 30 Concluded

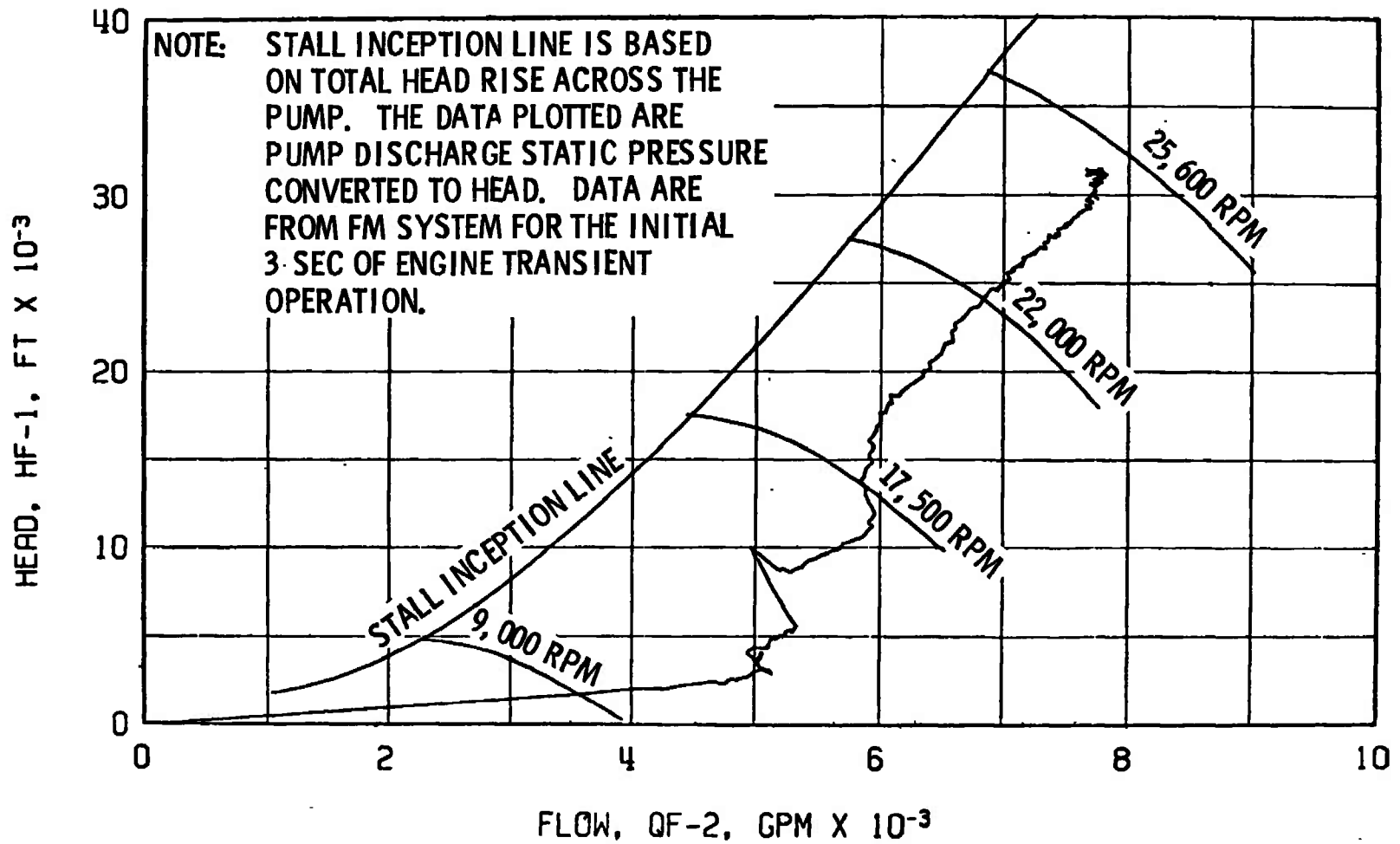

Fig. 31 Fuel Pump Start Transient Performance, Firing 04B



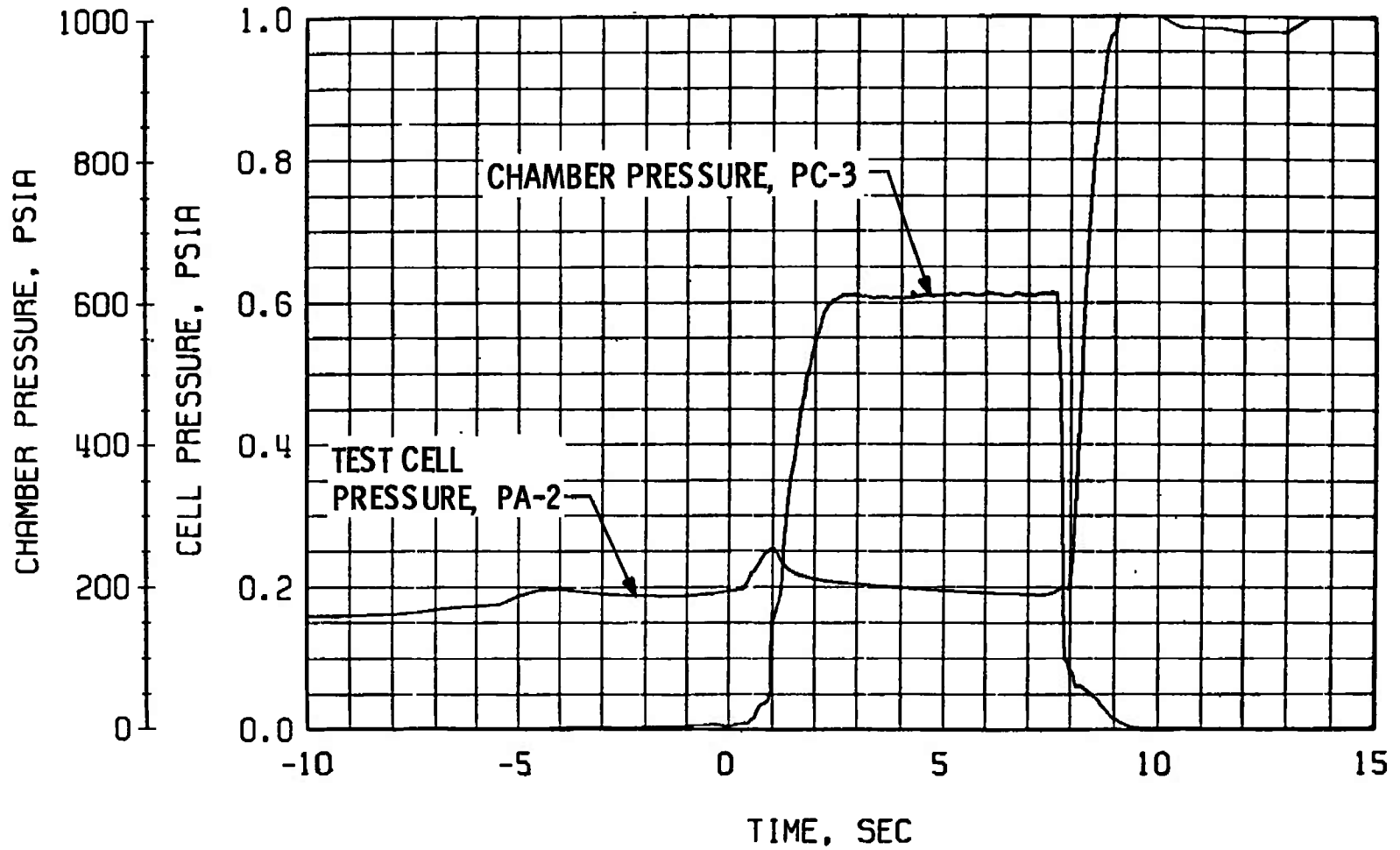
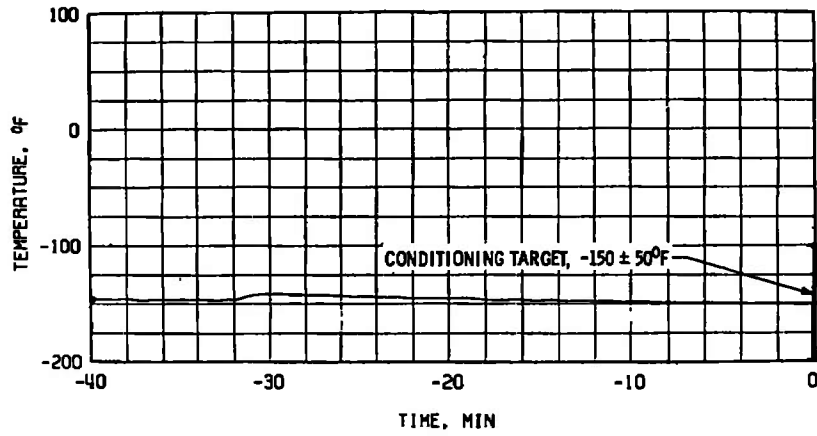
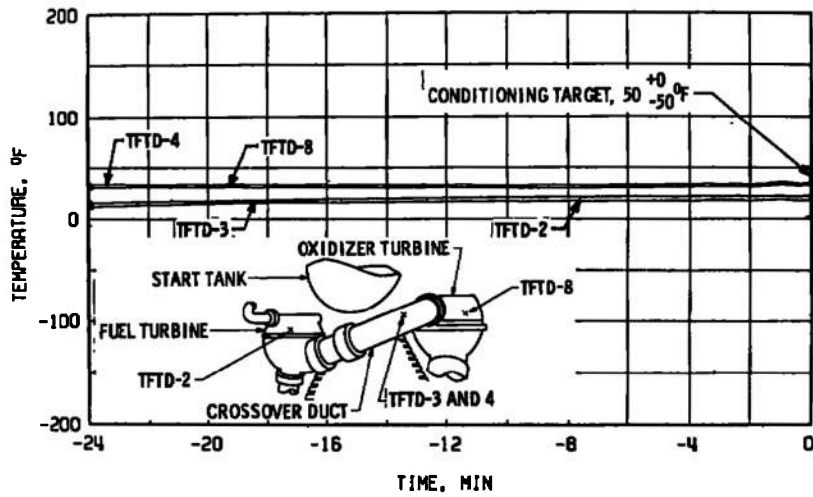

Fig. 32 Engine Ambient and Combustion Chamber Pressure, Firing 04B



a. Main Oxidizer Valve Second-Stage Actuator, TSOVC-1



b. Crossover Duct, TFTD

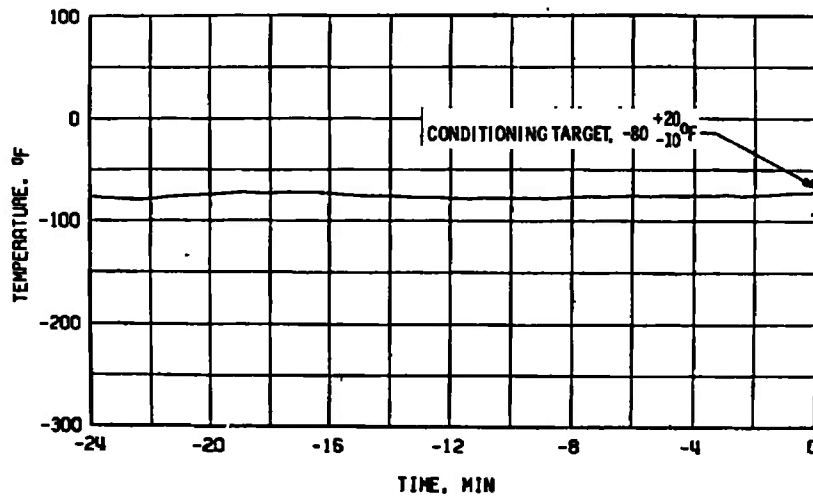

c. Thrust Chamber Throat, TTC-1P

Fig. 33 Thermal Conditioning History of Engine Components, Firing 04C

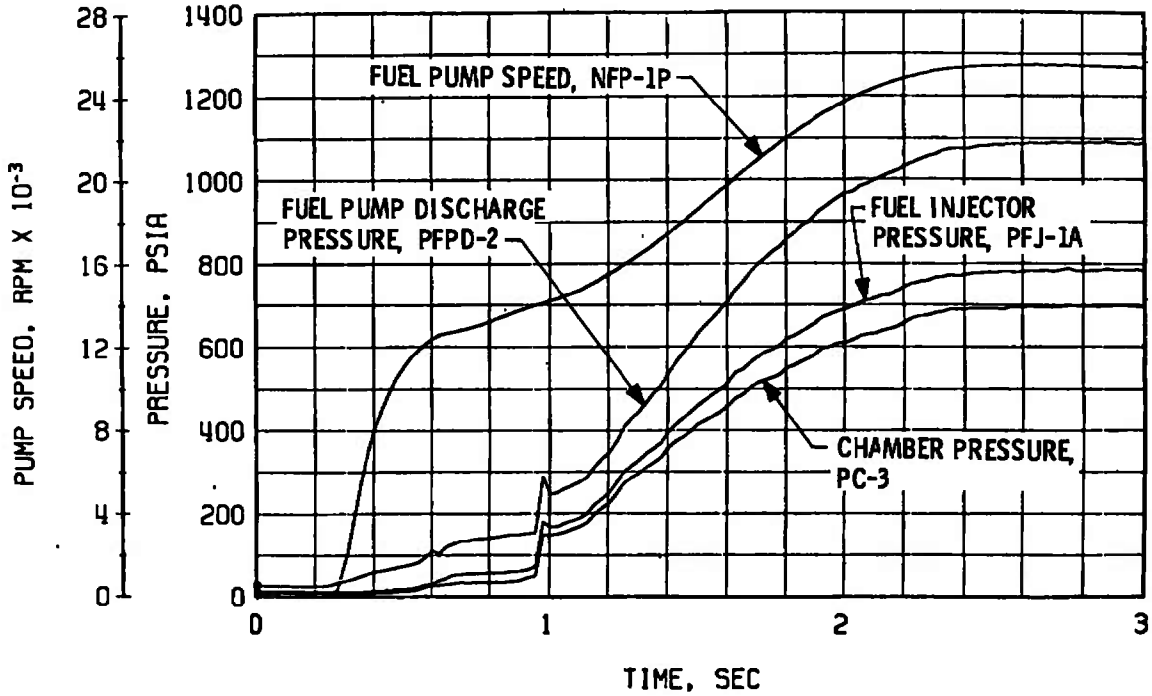

a. Thrust Chamber Fuel System, Start

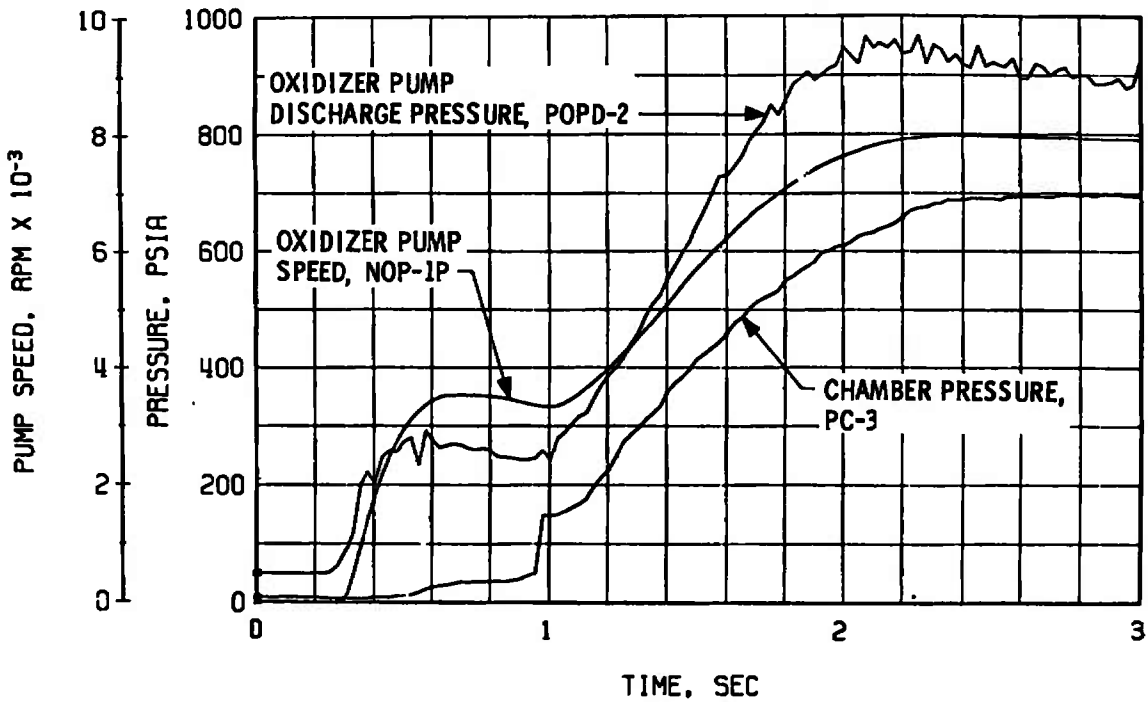

b. Thrust Chamber Oxidizer System, Start

Fig. 34 Engine Transient Operation, Firing 04C

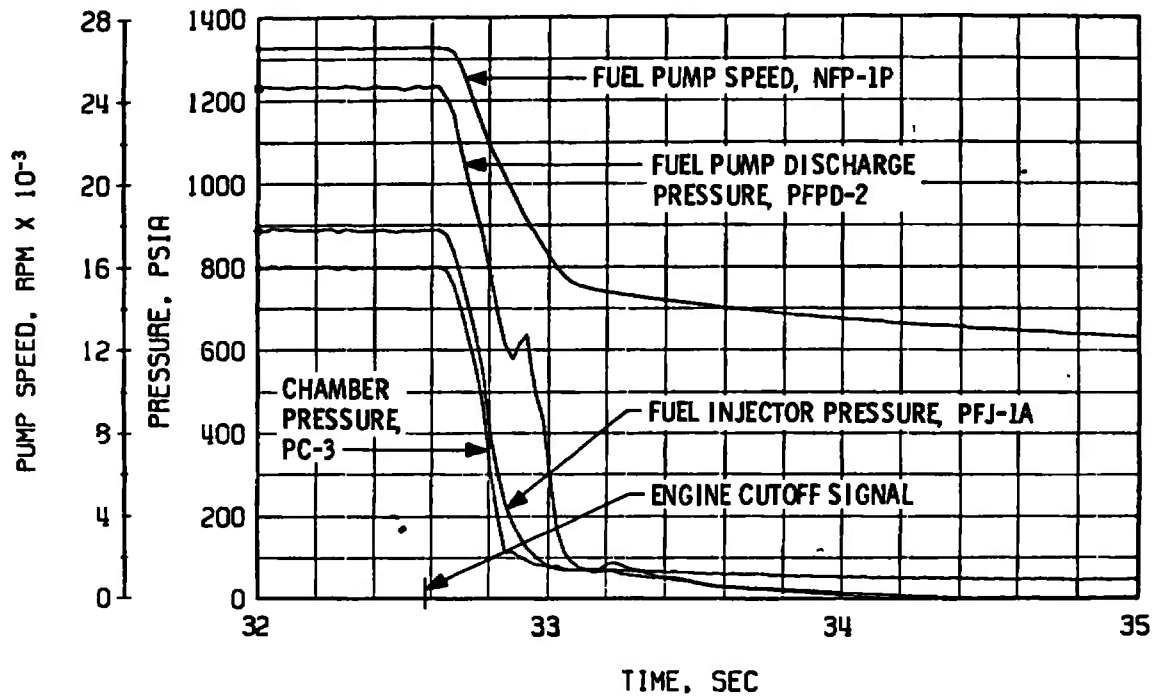

c. Thrust Chamber Fuel System, Shutdown

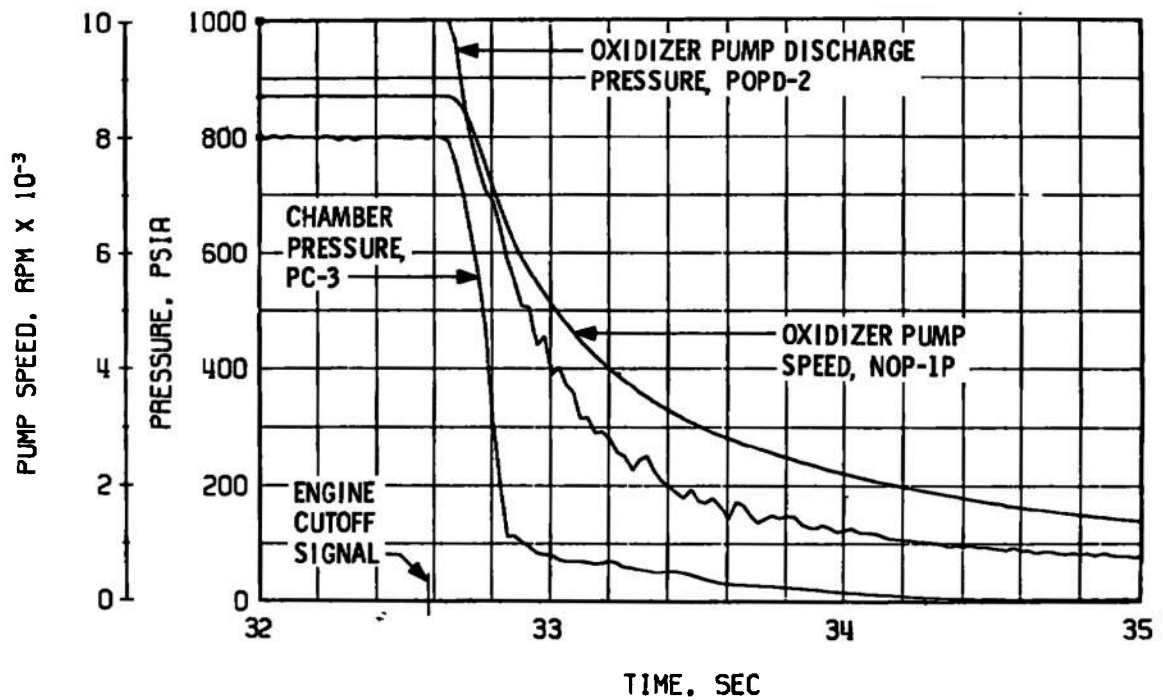

d. Thrust Chamber Oxidizer System, Shutdown

Fig. 34 Continued

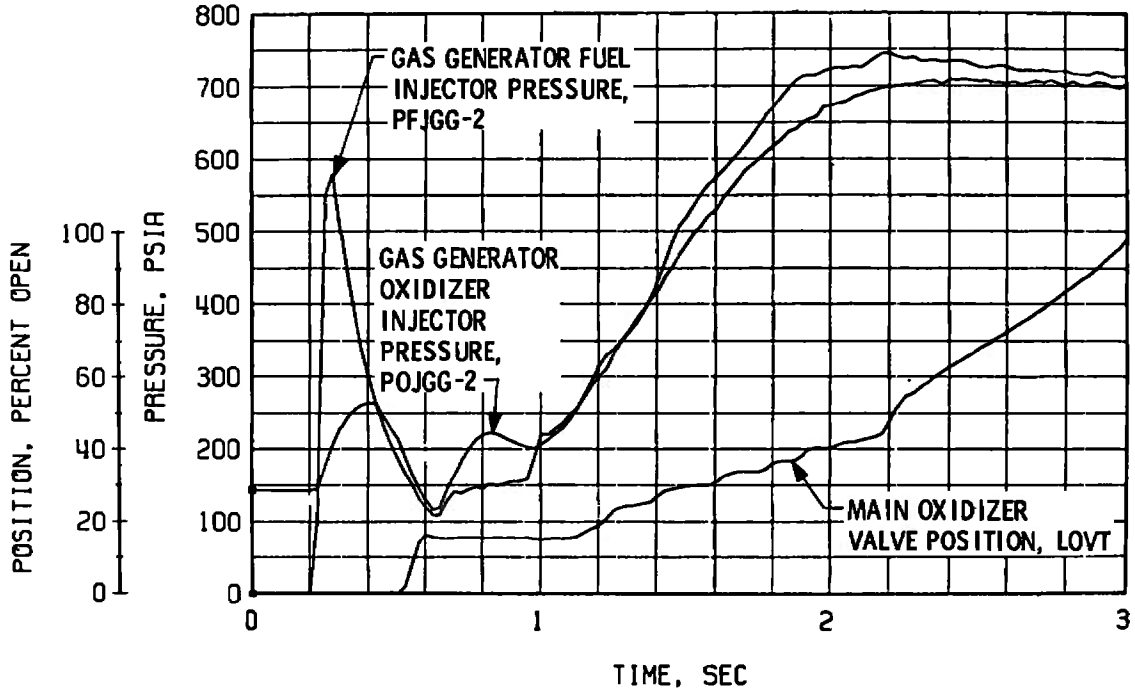

e. Gas Generator Injector Pressures and Main Oxidizer Valve Position, Start

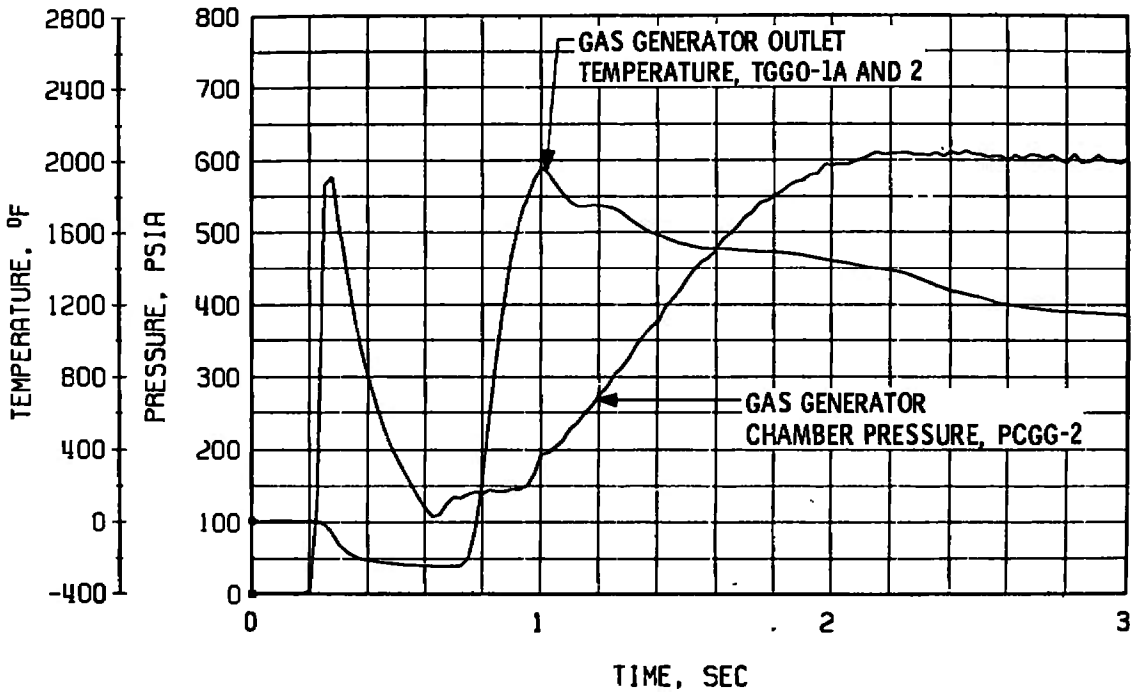

f. Gas Generator Chamber Pressure and Temperature, Start

Fig. 34 Continued

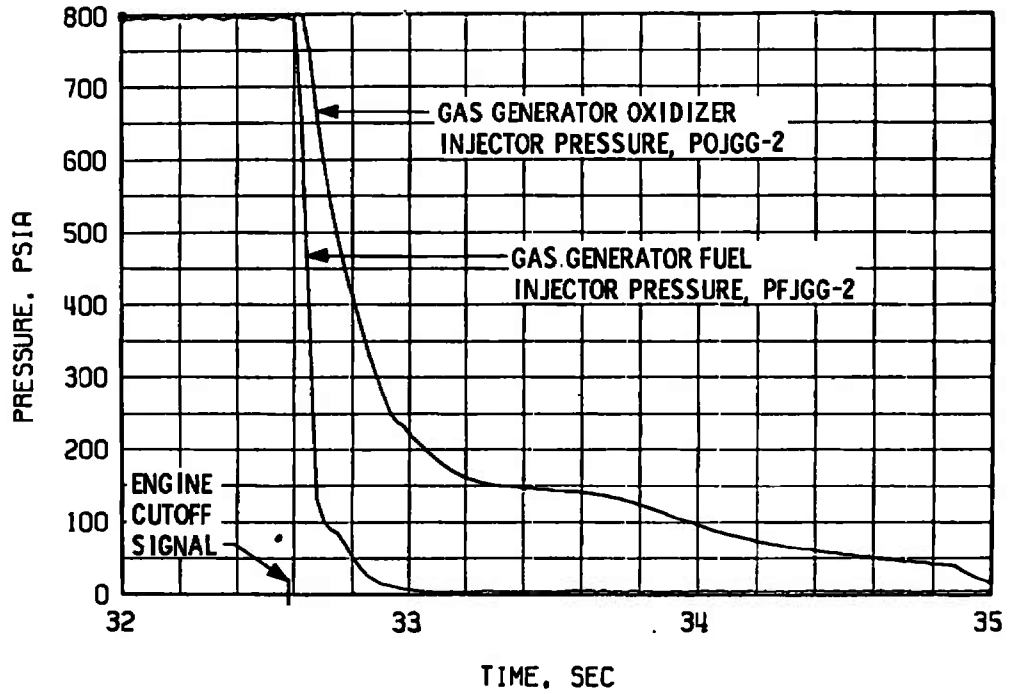

g. Gas Generator Injector Pressures, Shutdown

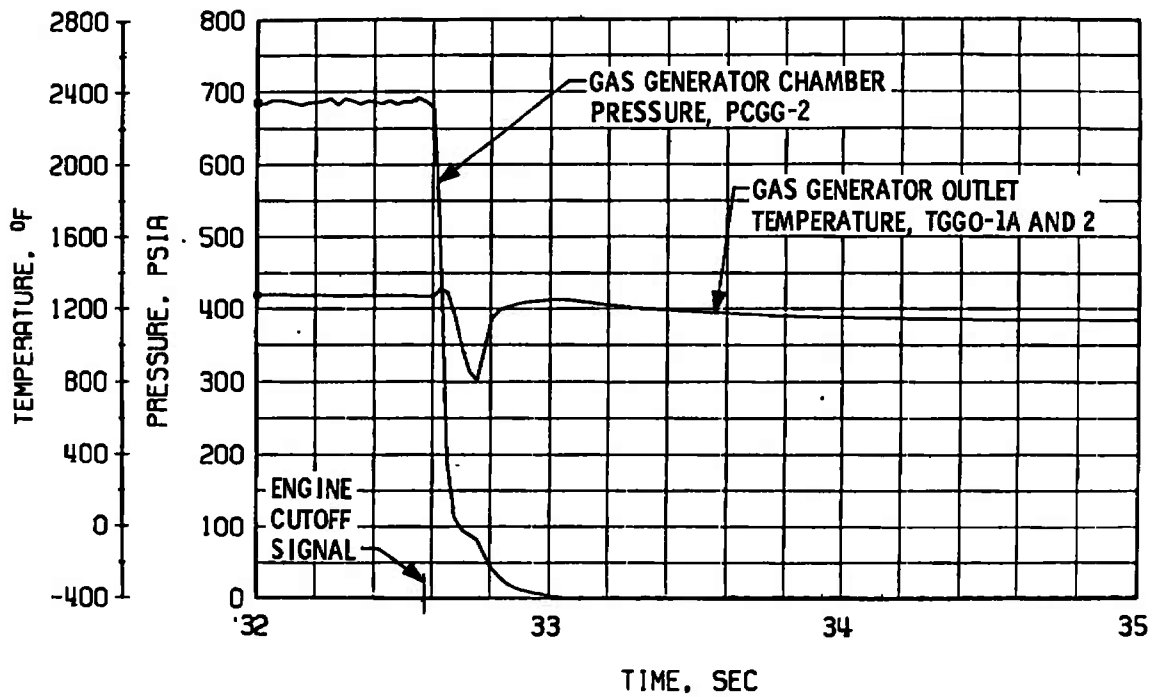

h. Gas Generator Chamber Pressure and Temperature, Shutdown

Fig. 34 Concluded

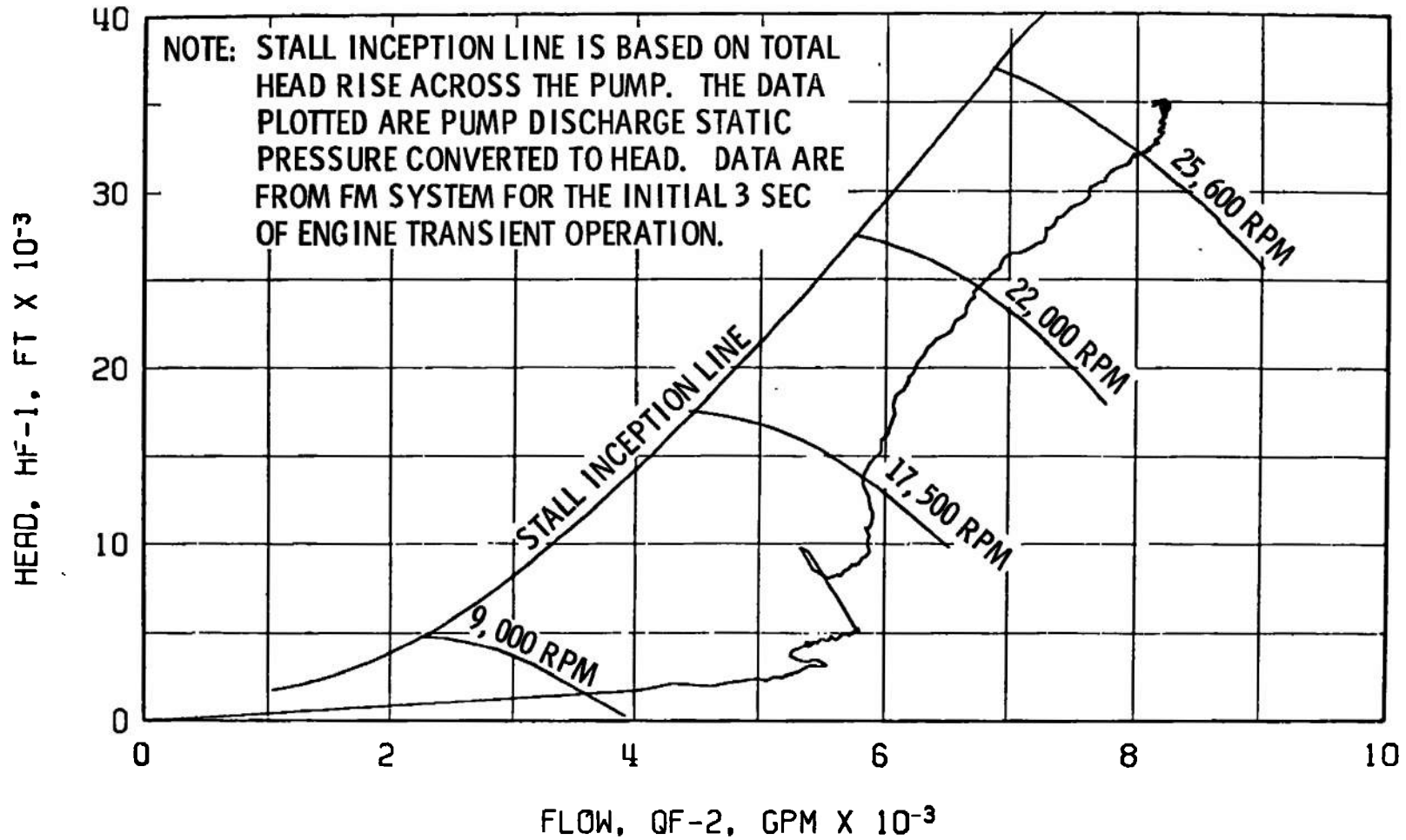

Fig. 35 Fuel Pump Start Transient Performance, Firing 04C

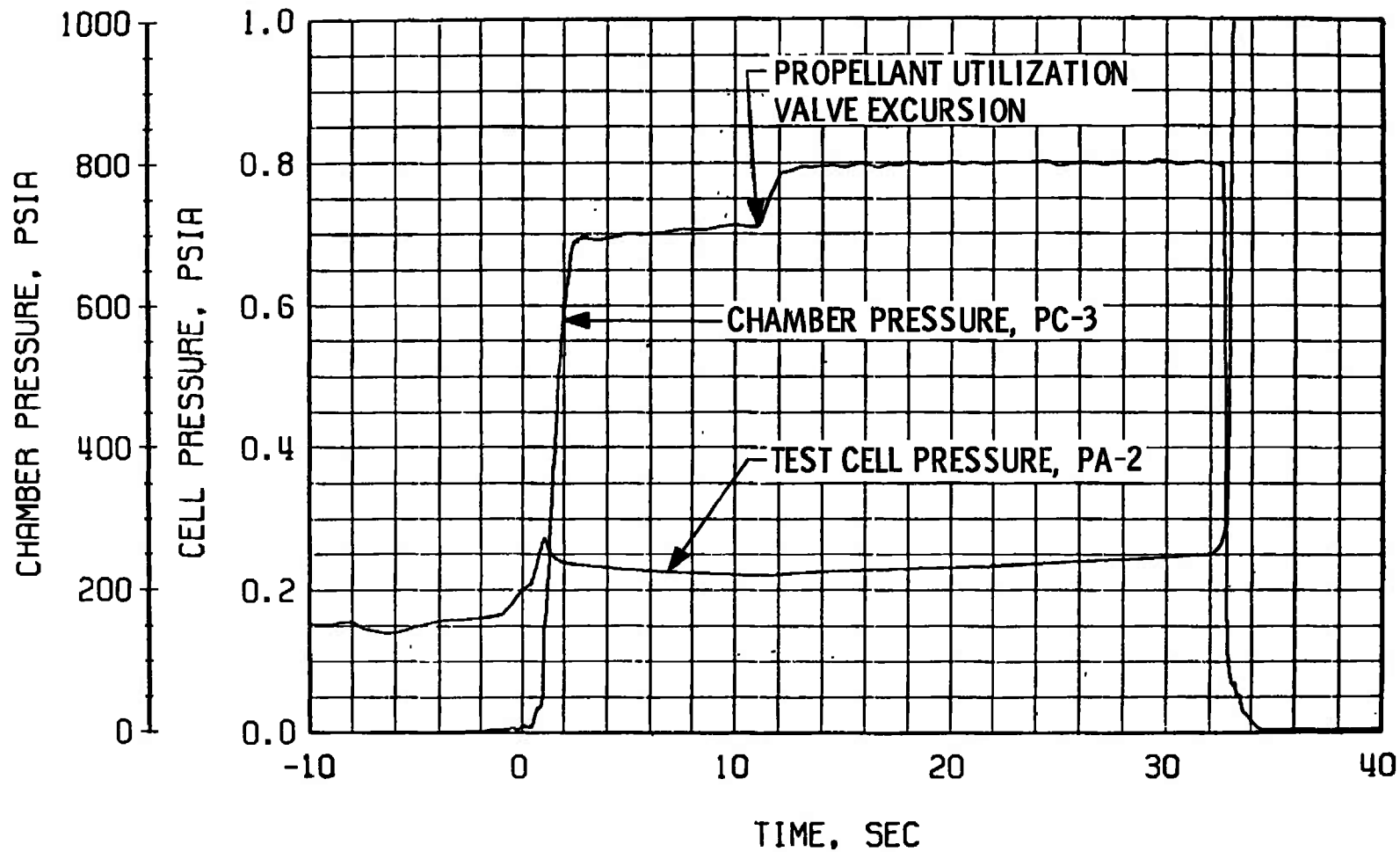
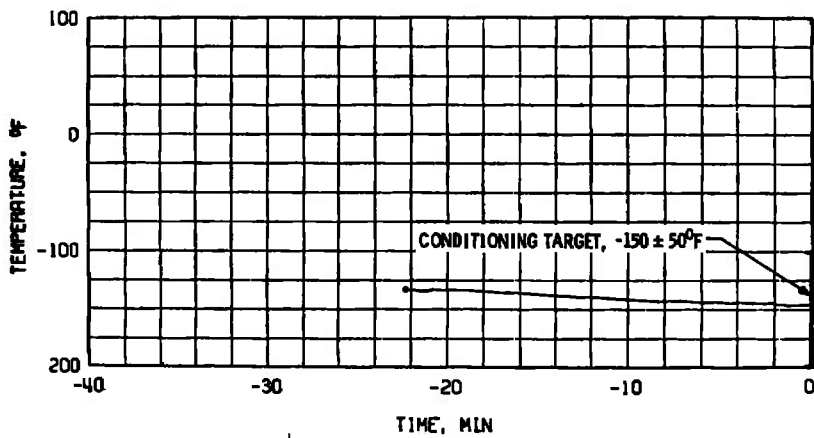
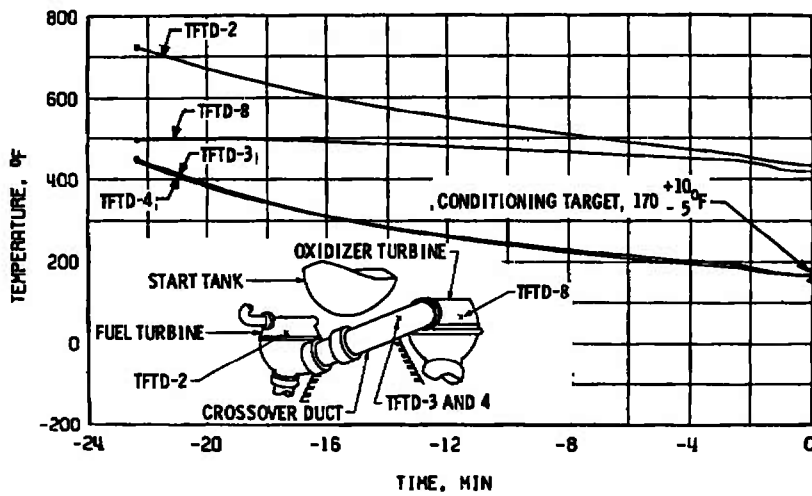

Fig. 36 Engine Ambient and Combustion Chamber Pressure, Firing 04C





a. Main Oxidizer Valve Second-Stage Actuator, TSOVC-1



b. Crossover Duct, TFTD

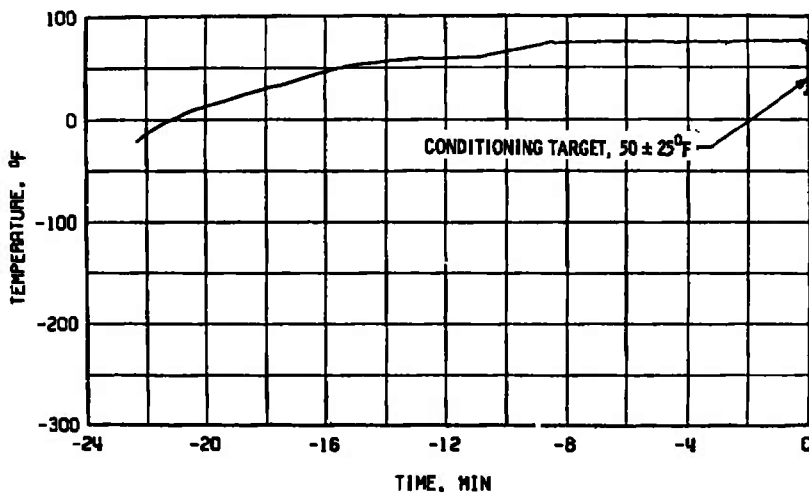

c. Thrust Chamber Throat, TTC-1P

Fig. 37 Thermal Conditioning History of Engine Components, Firing 04D

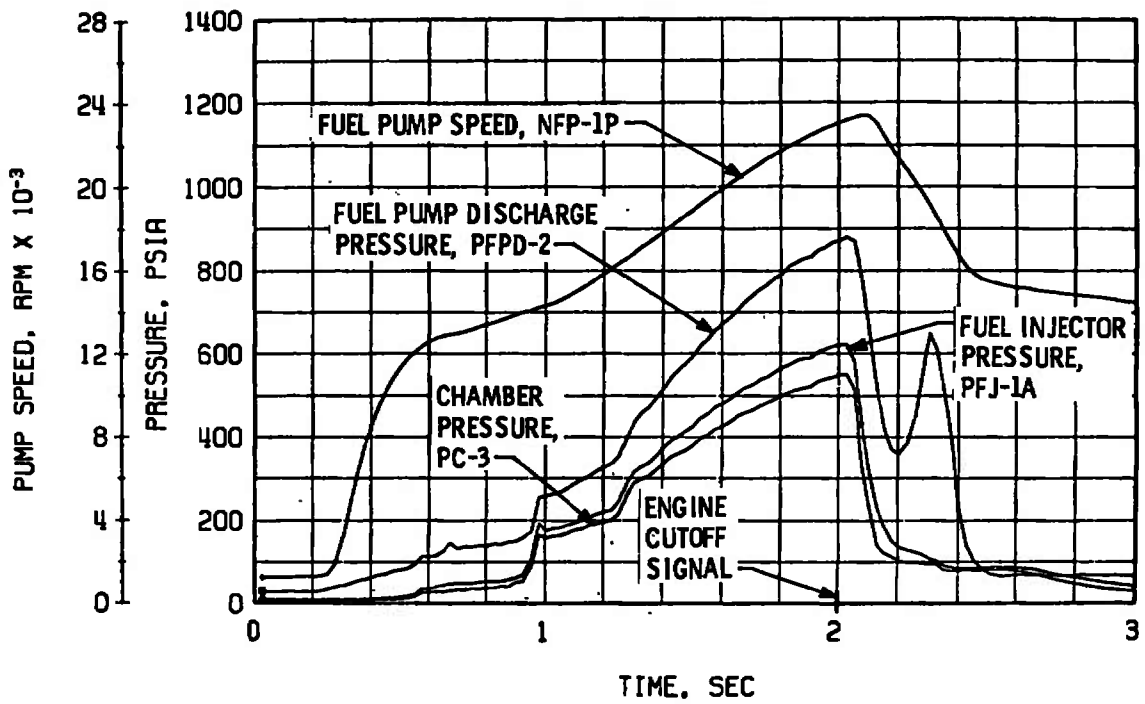

a. Thrust Chamber Fuel System, Start and Shutdown

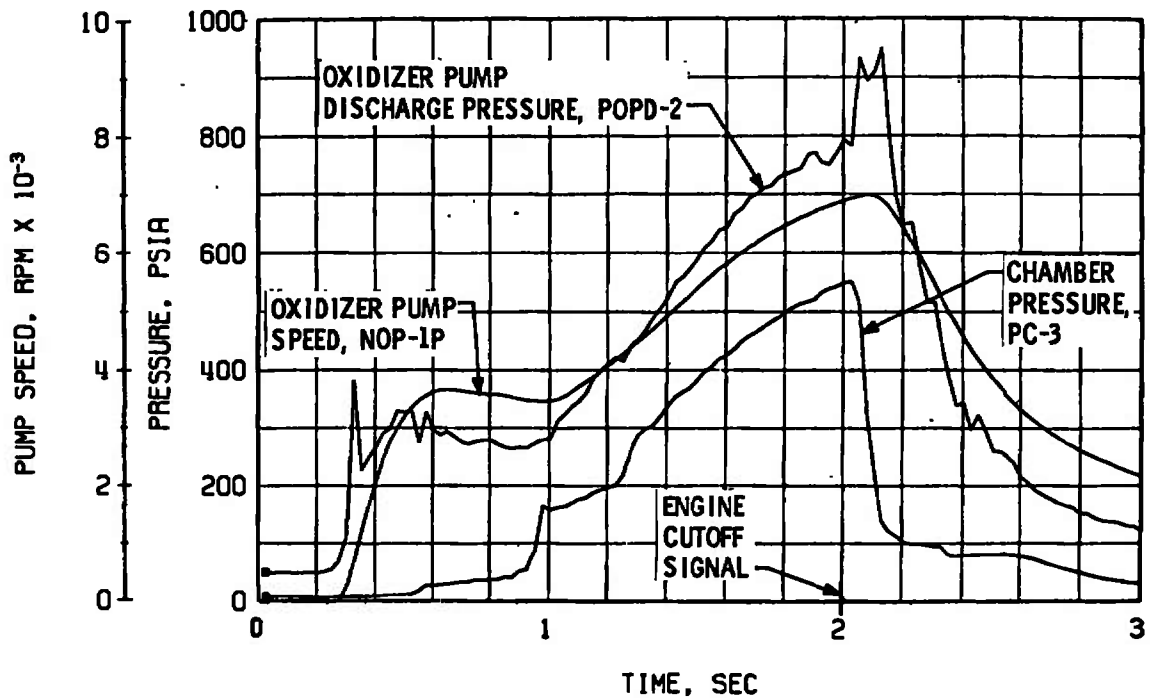

b. Thrust Chamber Oxidizer System, Start and Shutdown

Fig. 38 Engine Transient Operation, Firing 04D

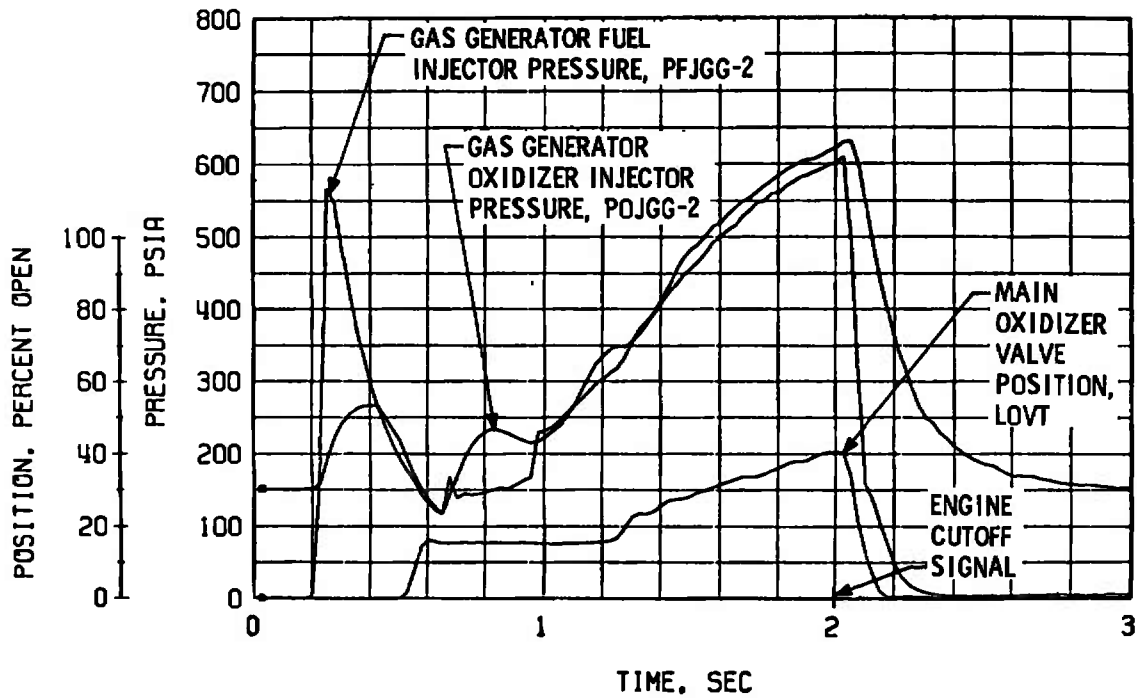

c. Gas Generator Injector Pressures and Main Oxidizer Valve Position, Start and Shutdown

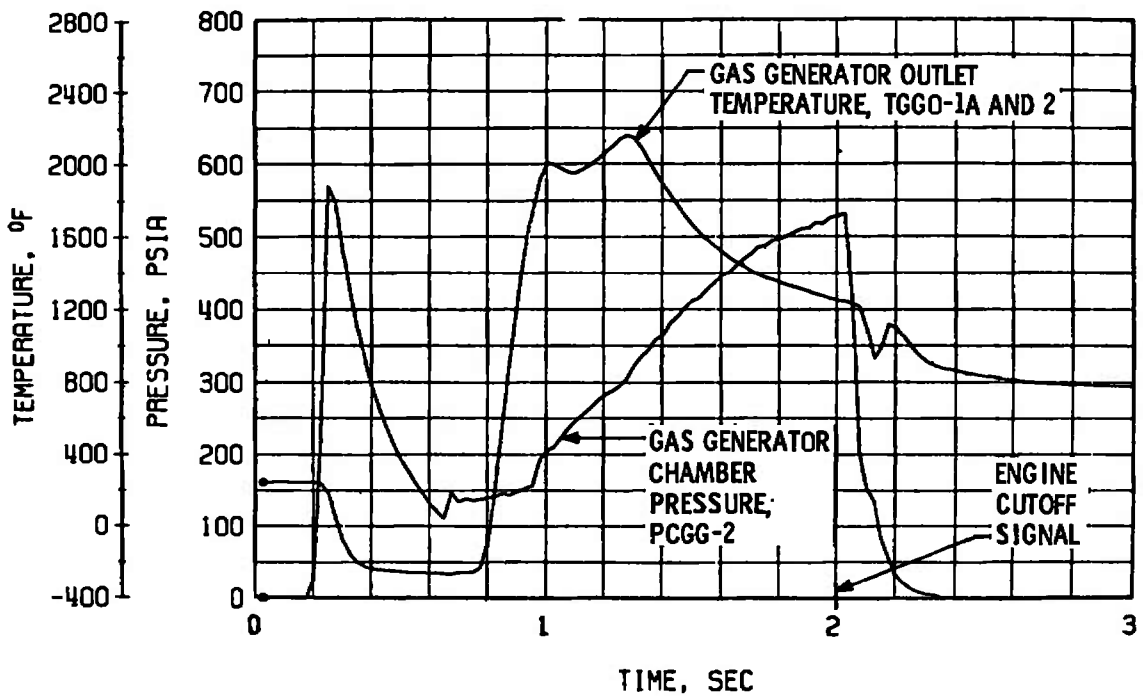

d. Gas Generator Chamber Pressure and Temperature, Start and Shutdown

Fig. 38 Concluded

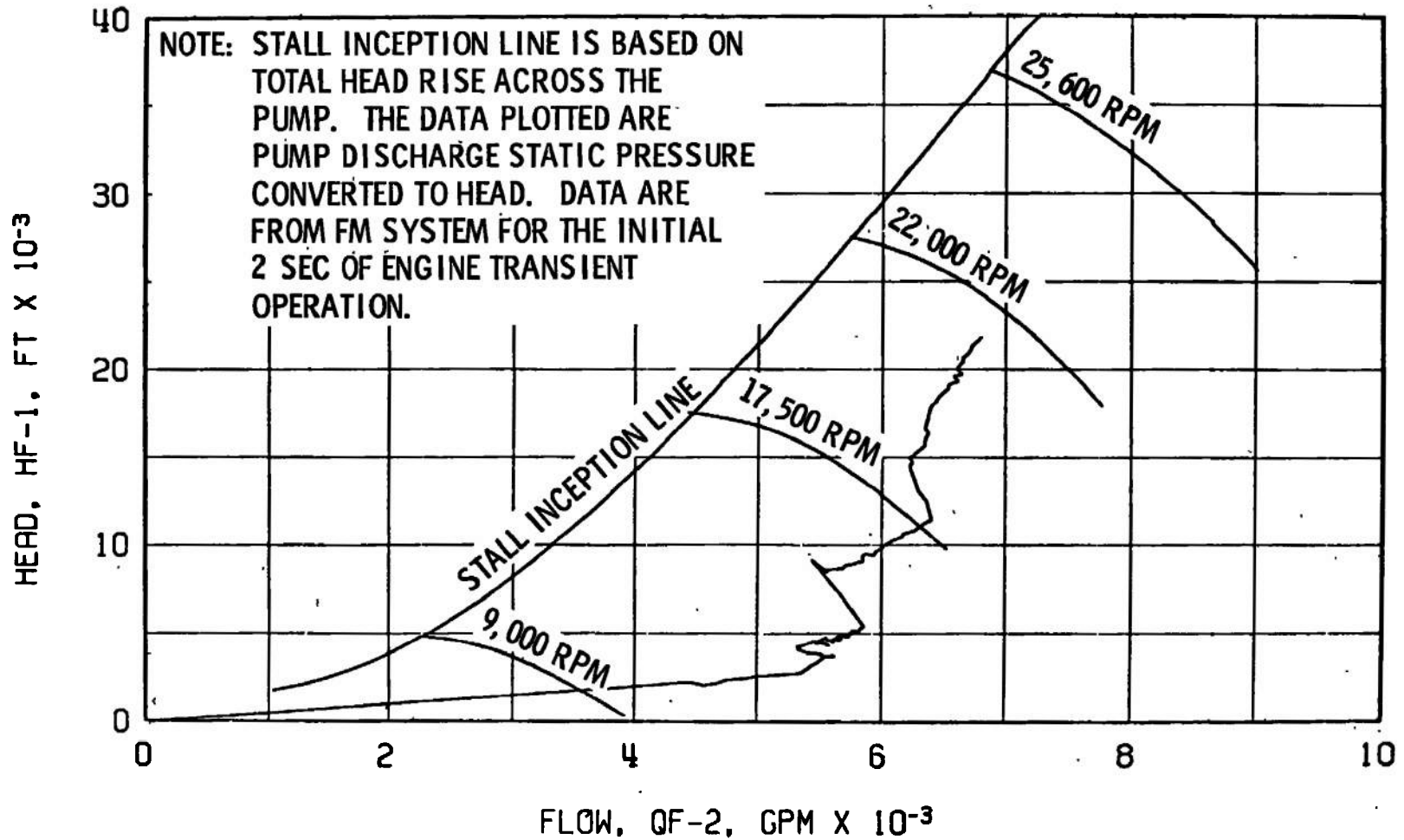

Fig. 39 Fuel Pump Start Transient Performance, Firing 04D

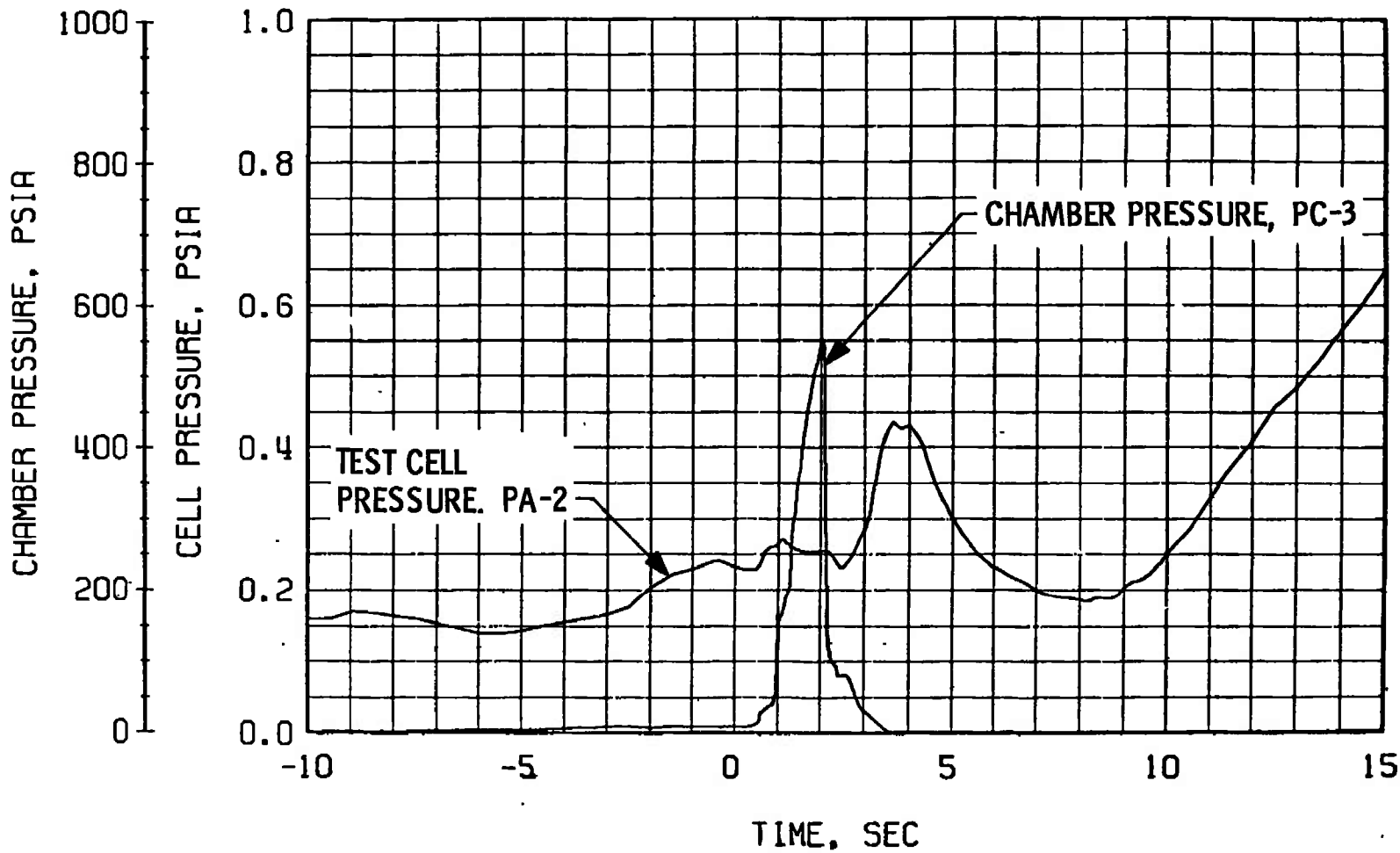
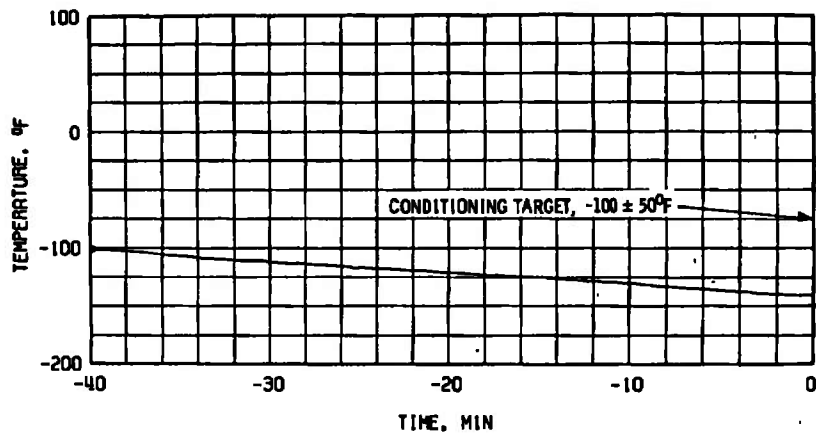
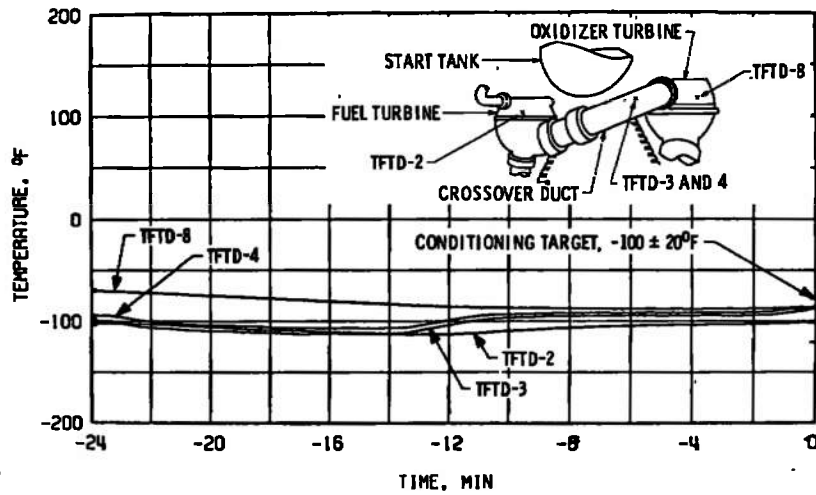

Fig. 40 Engine Ambient and Combustion Chamber Pressure, Firing 04D



a. Main Oxidizer Valve Second-Stage Actuator, TSOVC-1



b. Crossover Duct, TFTD

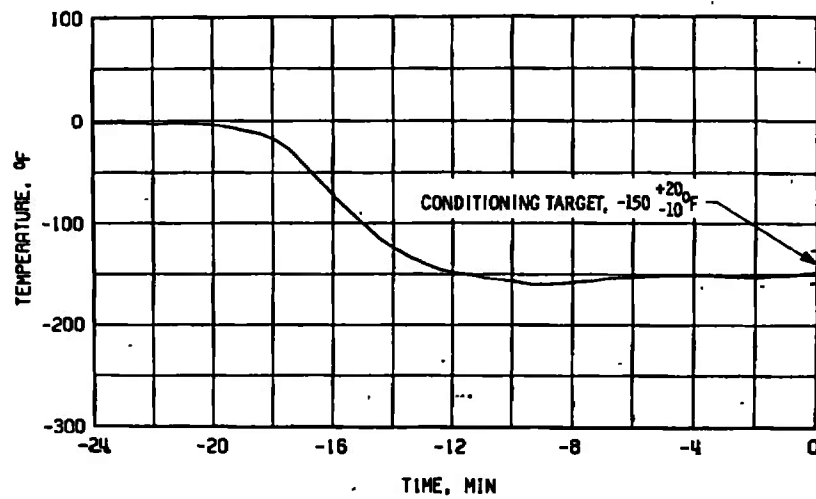

c. Thrust Chamber Throat, TTC-1P

Fig. 41 Thermal Conditioning History of Engine Components, Firing 05A

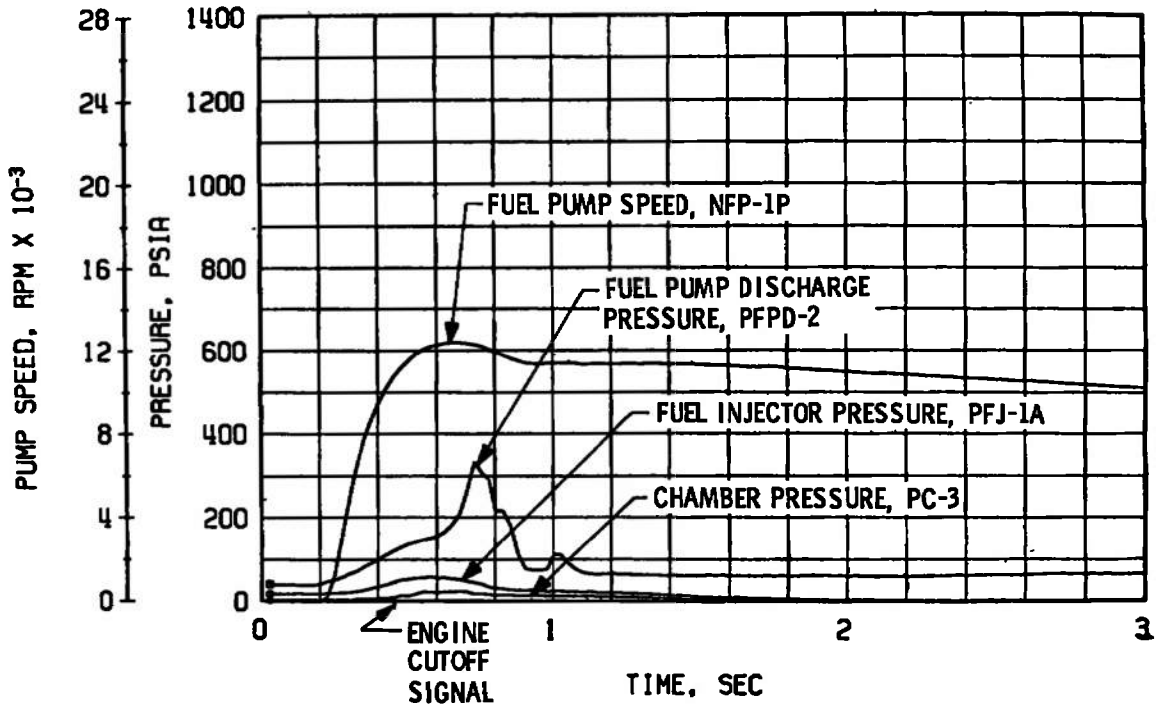

a. Thrust Chamber Fuel System, Start and Shutdown

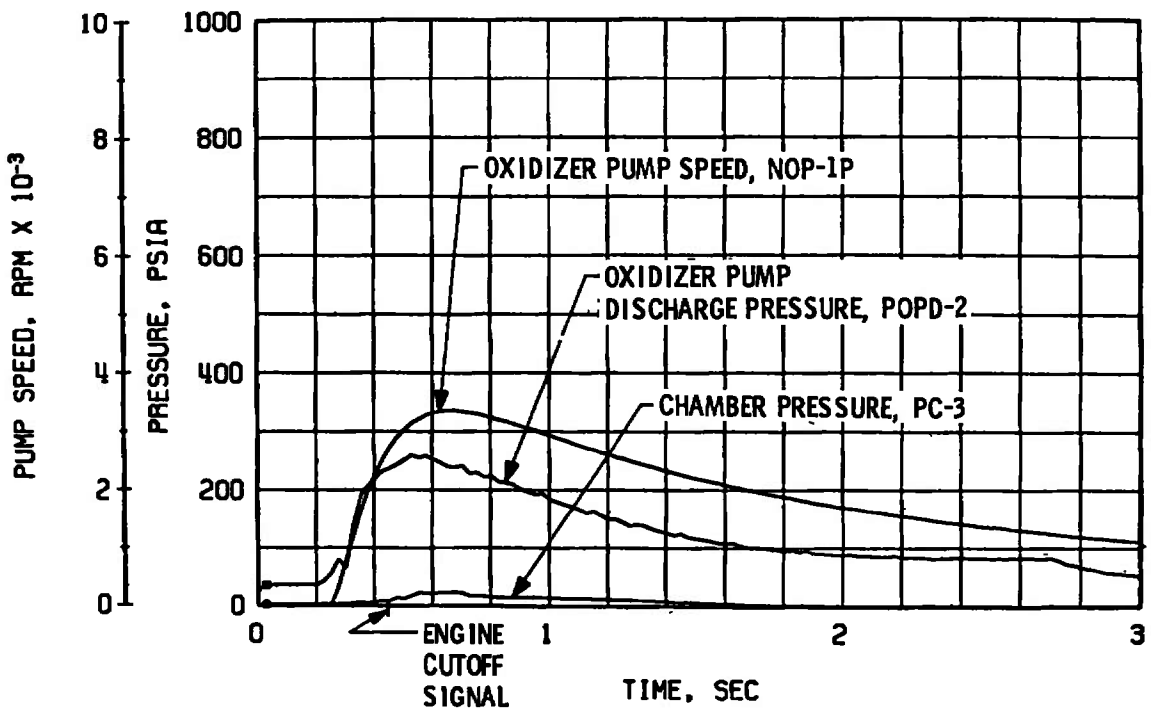

b. Thrust Chamber Oxidizer System, Start and Shutdown

Fig. 42 Engine Transient Operation, Firing 05A

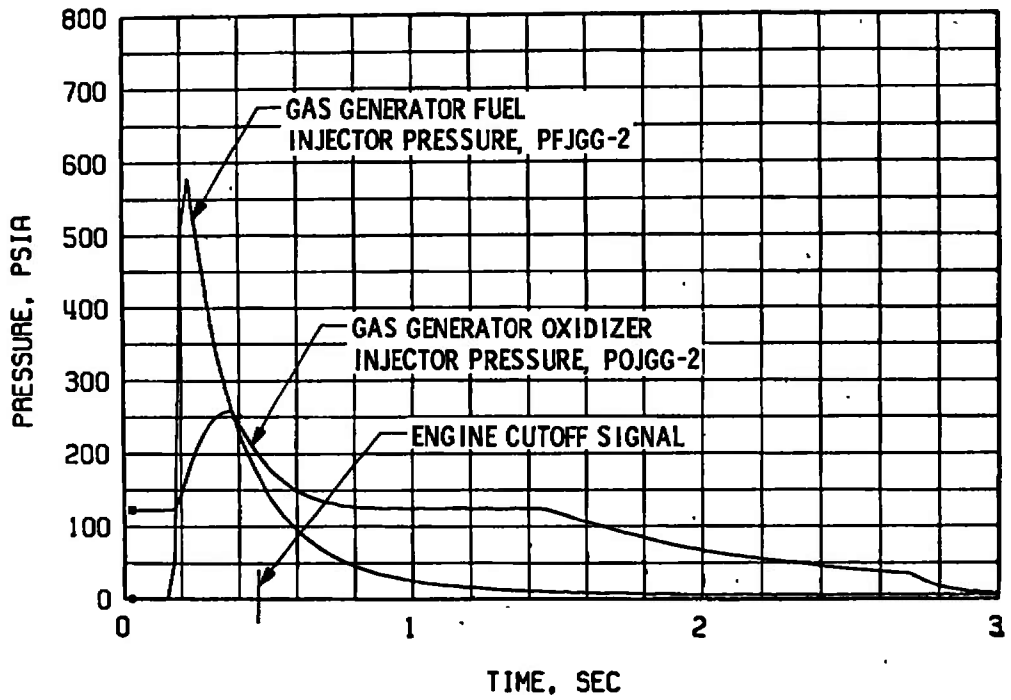

c. Gas Generator Injector Pressures, Start and Shutdown

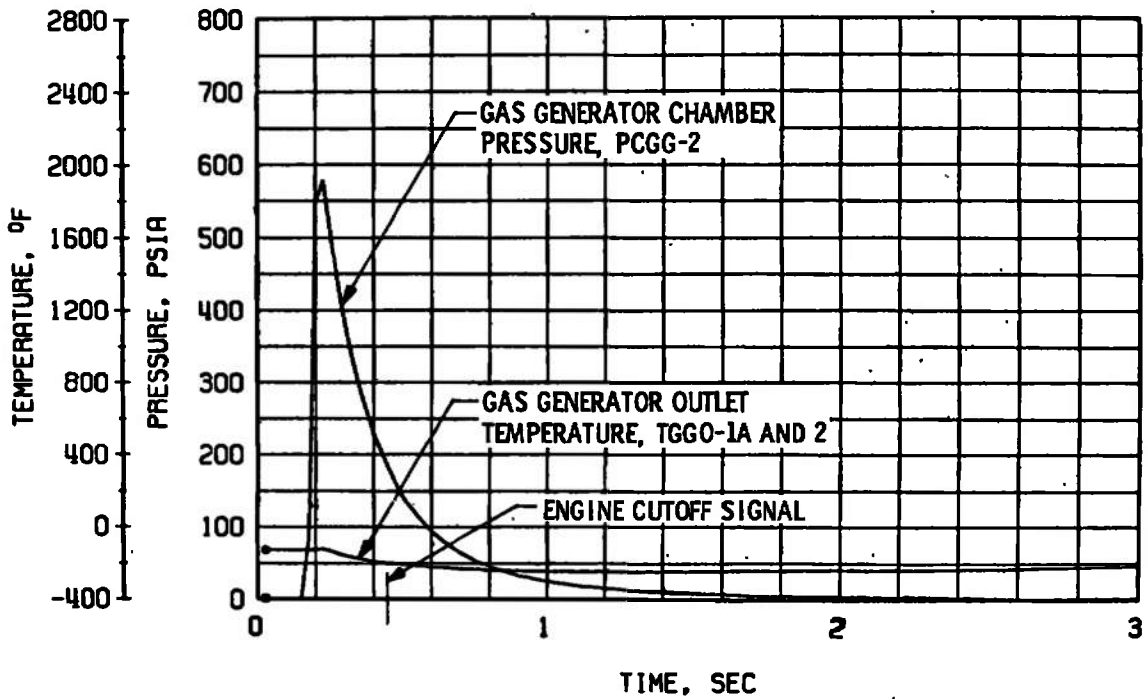

d. Gas Generator Chamber Pressure and Temperature, Start and Shutdown

Fig. 42 Concluded



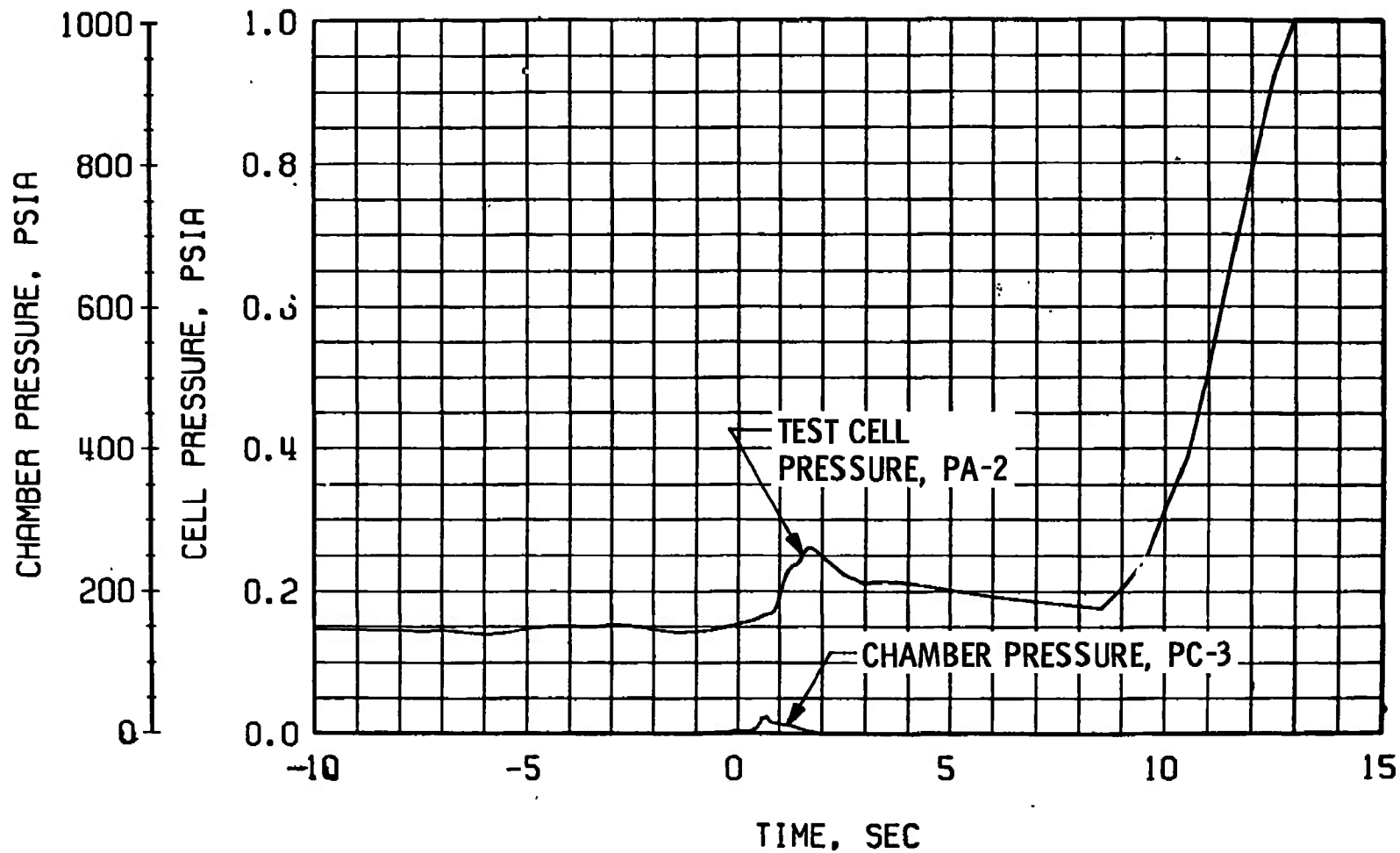
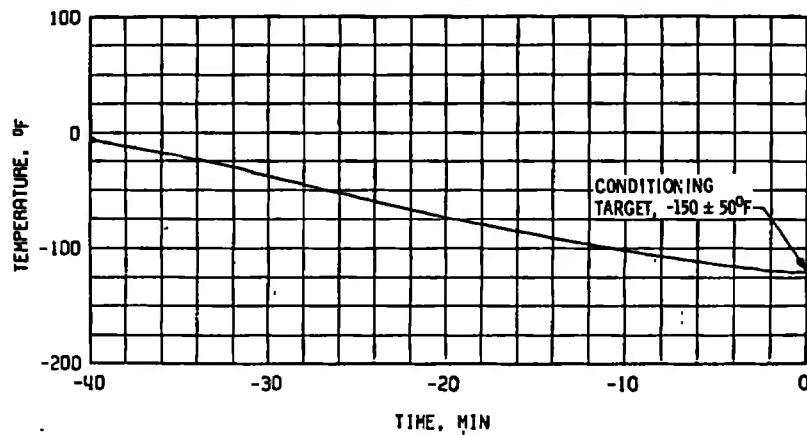
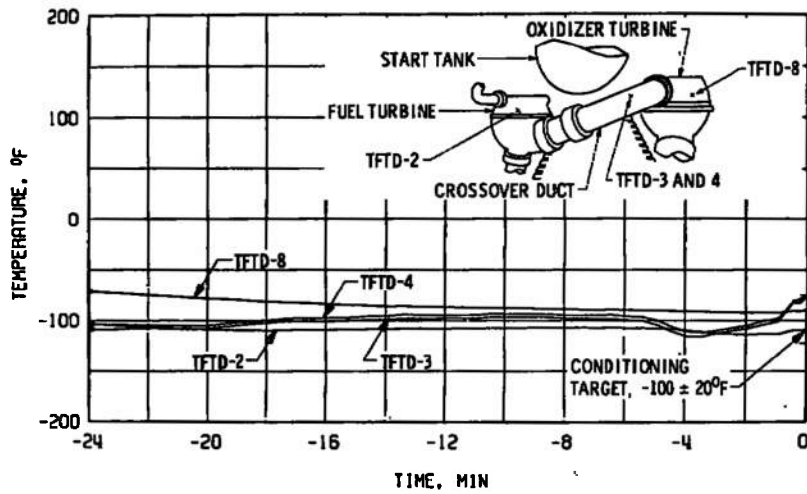

Fig. 43 Engine Ambient and Combustion Chamber Pressure, Firing 05A



a. Main Oxidizer Valve Second-Stage Actuator, TSOVC-1



b. Crossover Duct, TFTD

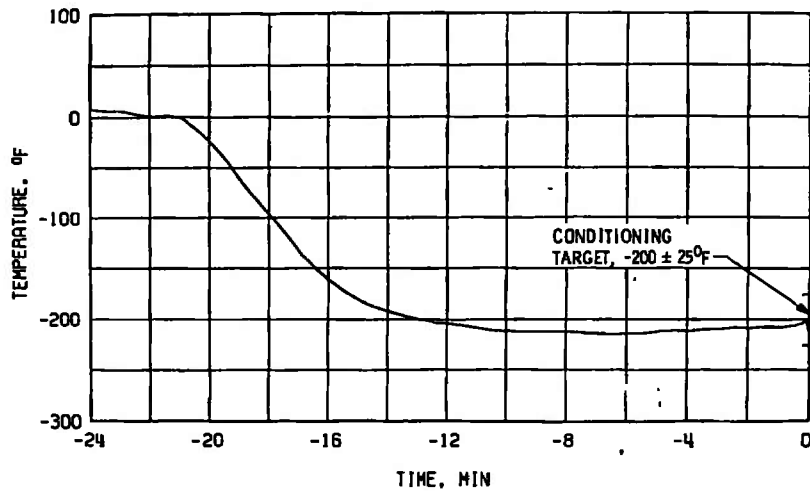

c. Thrust Chamber Throat, TTC-1P

Fig. 44 Thermal Conditioning History of Engine Components, Firing 06A

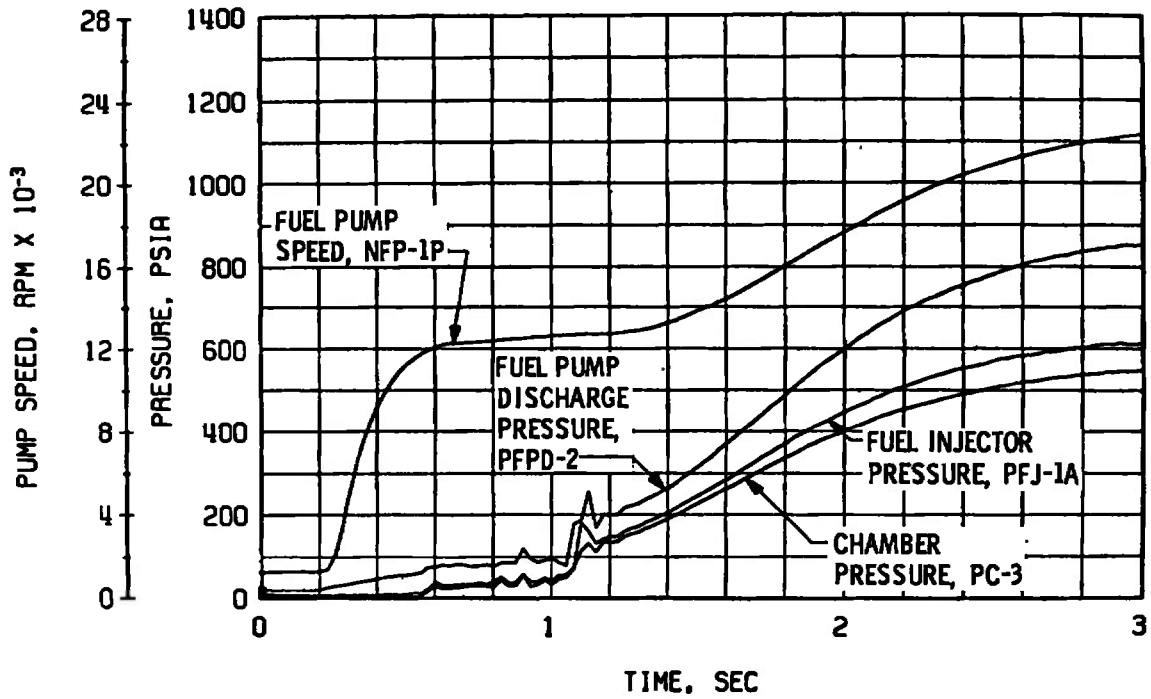

a. Thrust Chamber Fuel System, Start

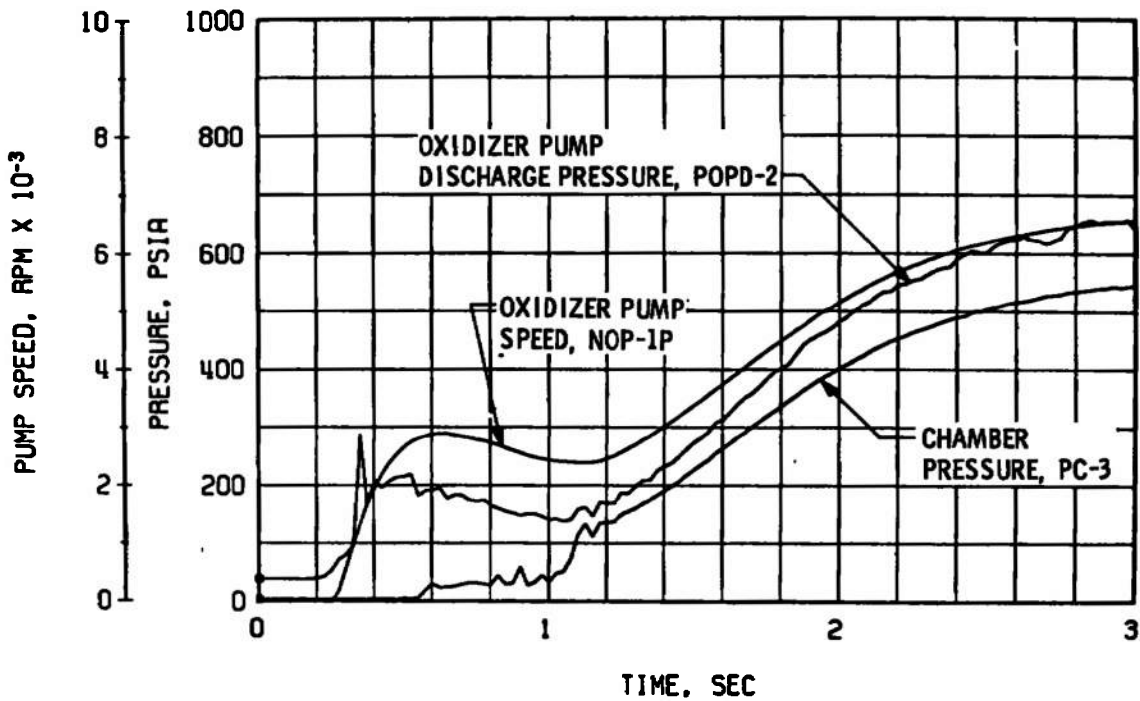

b. Thrust Chamber Oxidizer System, Start

Fig. 45 Engine Transient Operation, Firing 06A

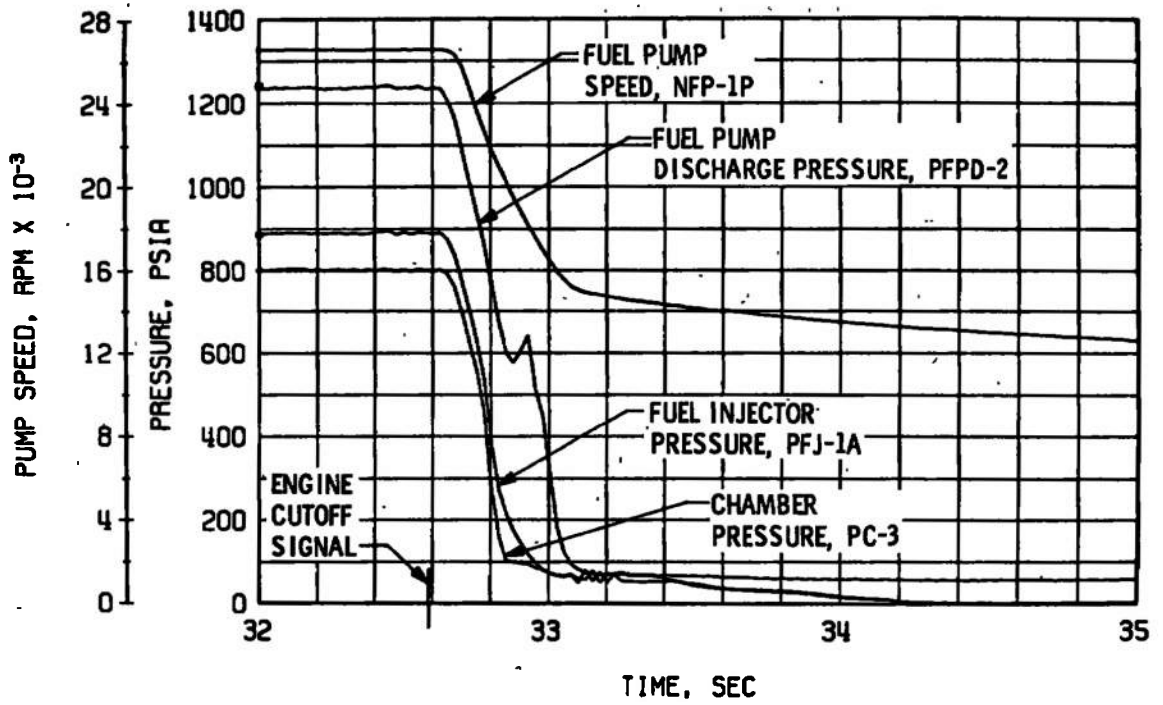

c. Thrust Chamber Fuel System, Shutdown

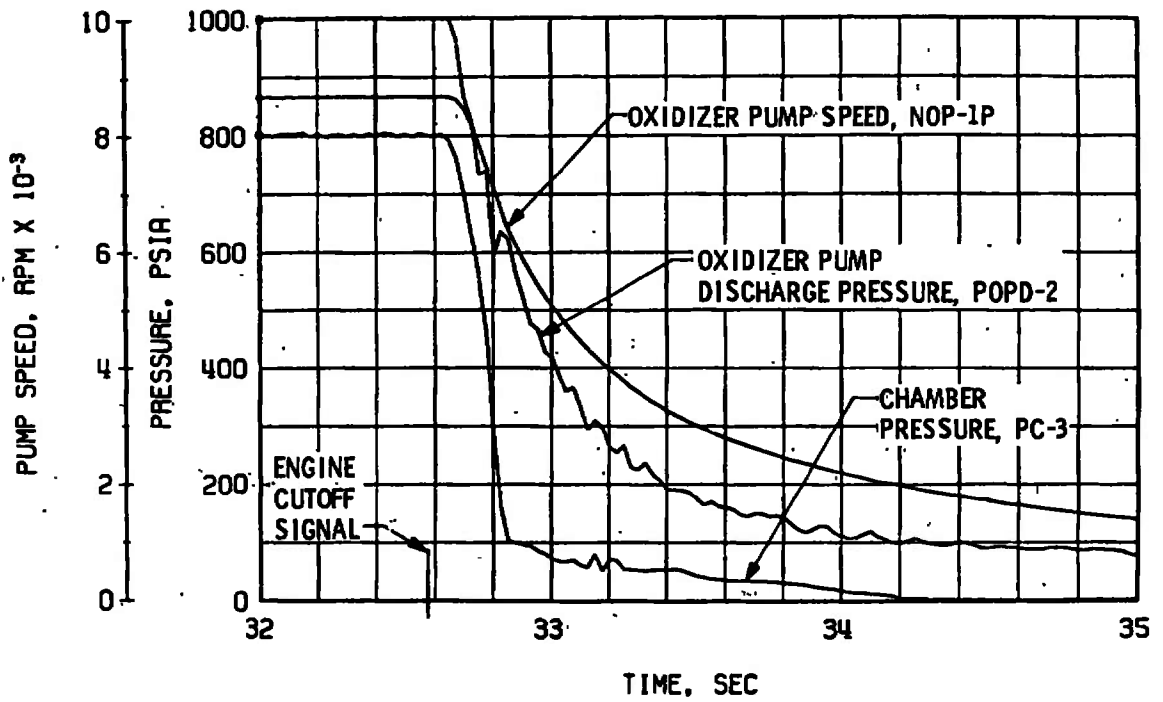

d. Thrust Chamber Oxidizer System, Shutdown

Fig. 45 Continued

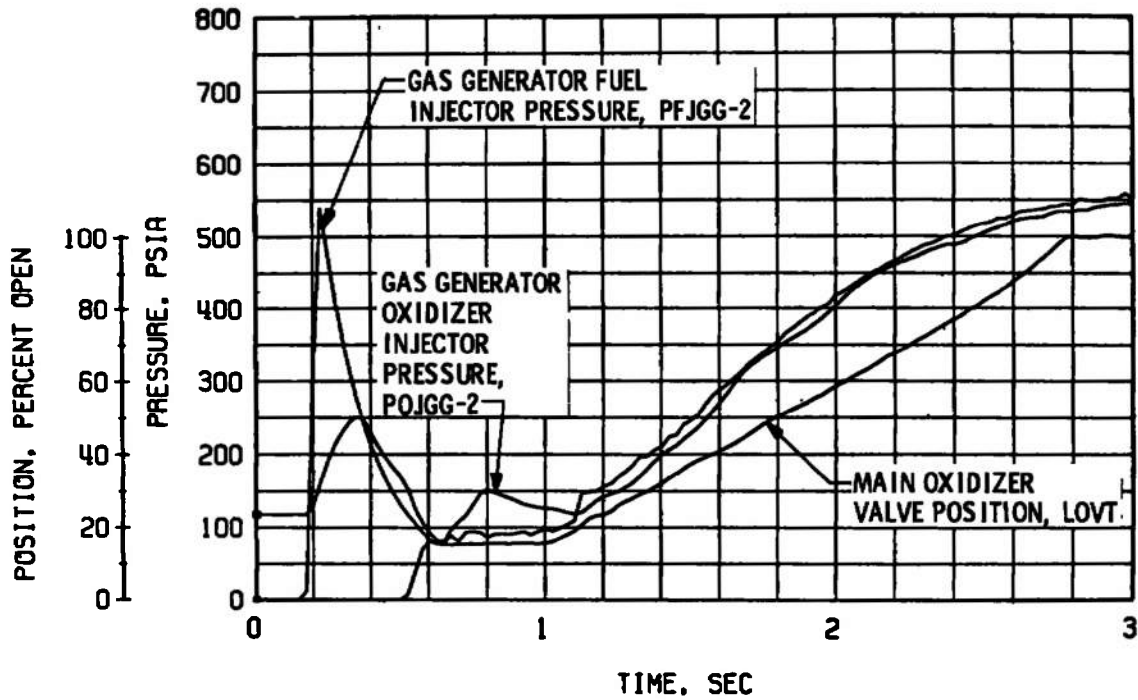

e. Gas Generator Injector Pressures and Main Oxidizer Valve Position, Start

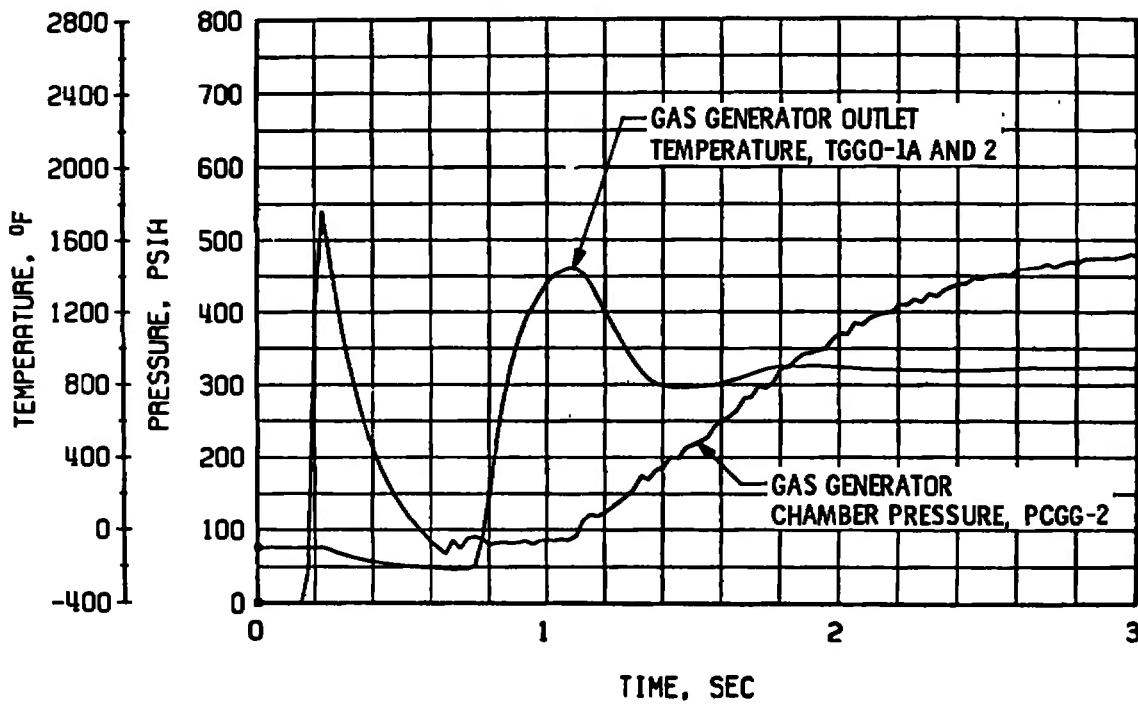

f. Gas Generator Chamber Pressure and Temperature, Start

Fig. 45 Continued

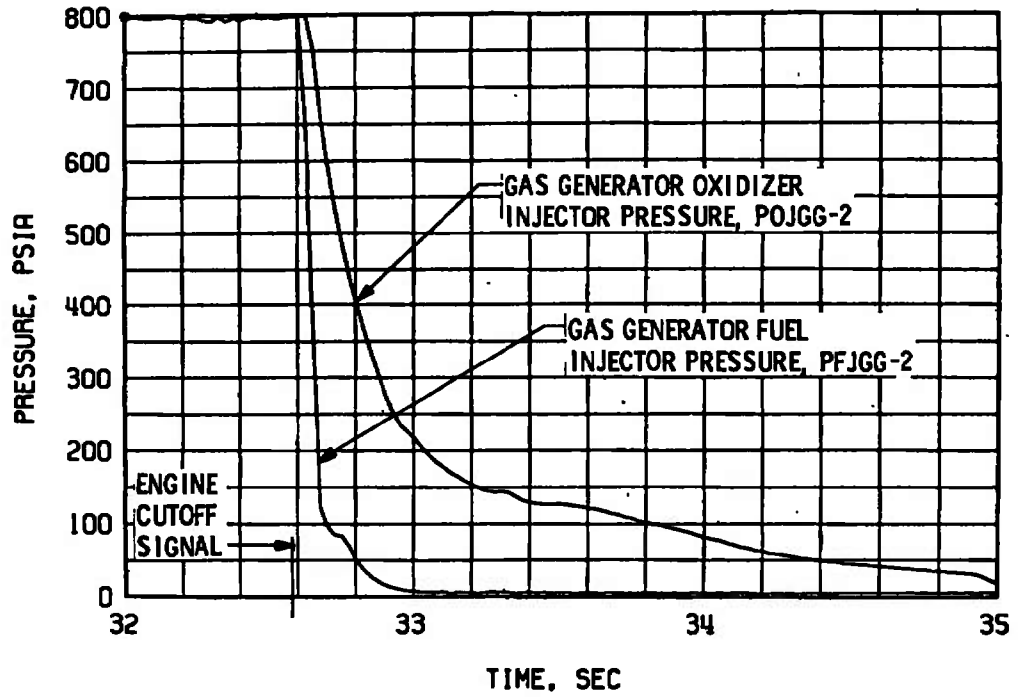

g. Gas Generator Injector Pressures, Shutdown

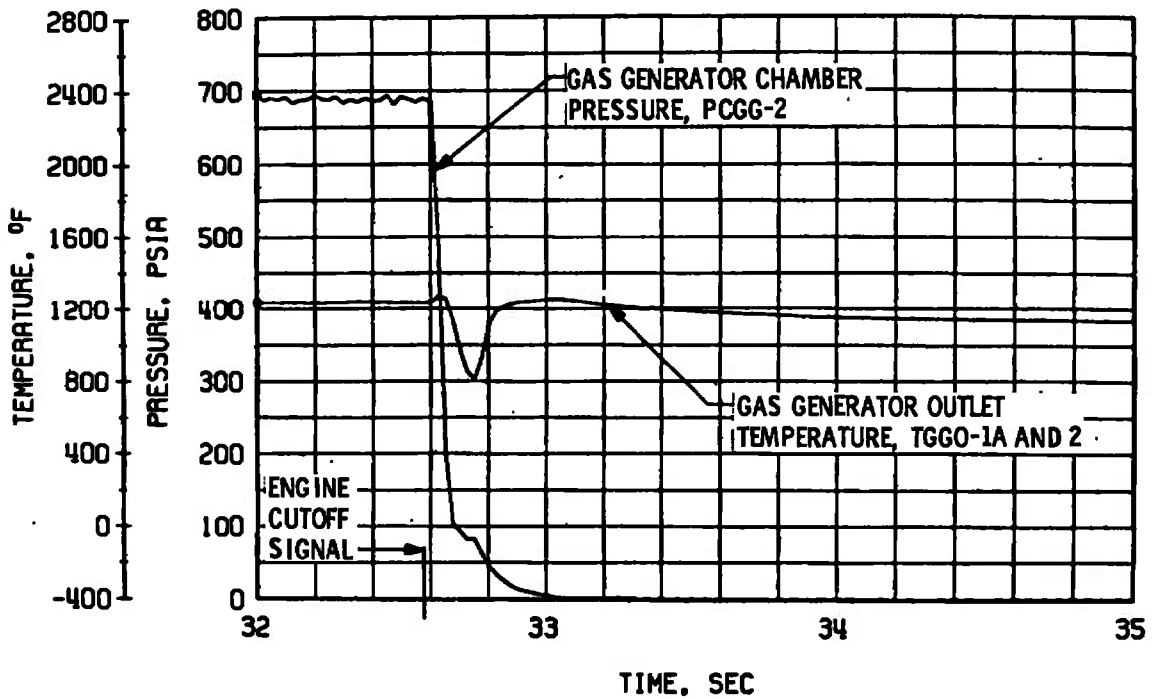

h. Gas Generator Chamber Pressure and Temperature, Shutdown

Fig. 45 Concluded

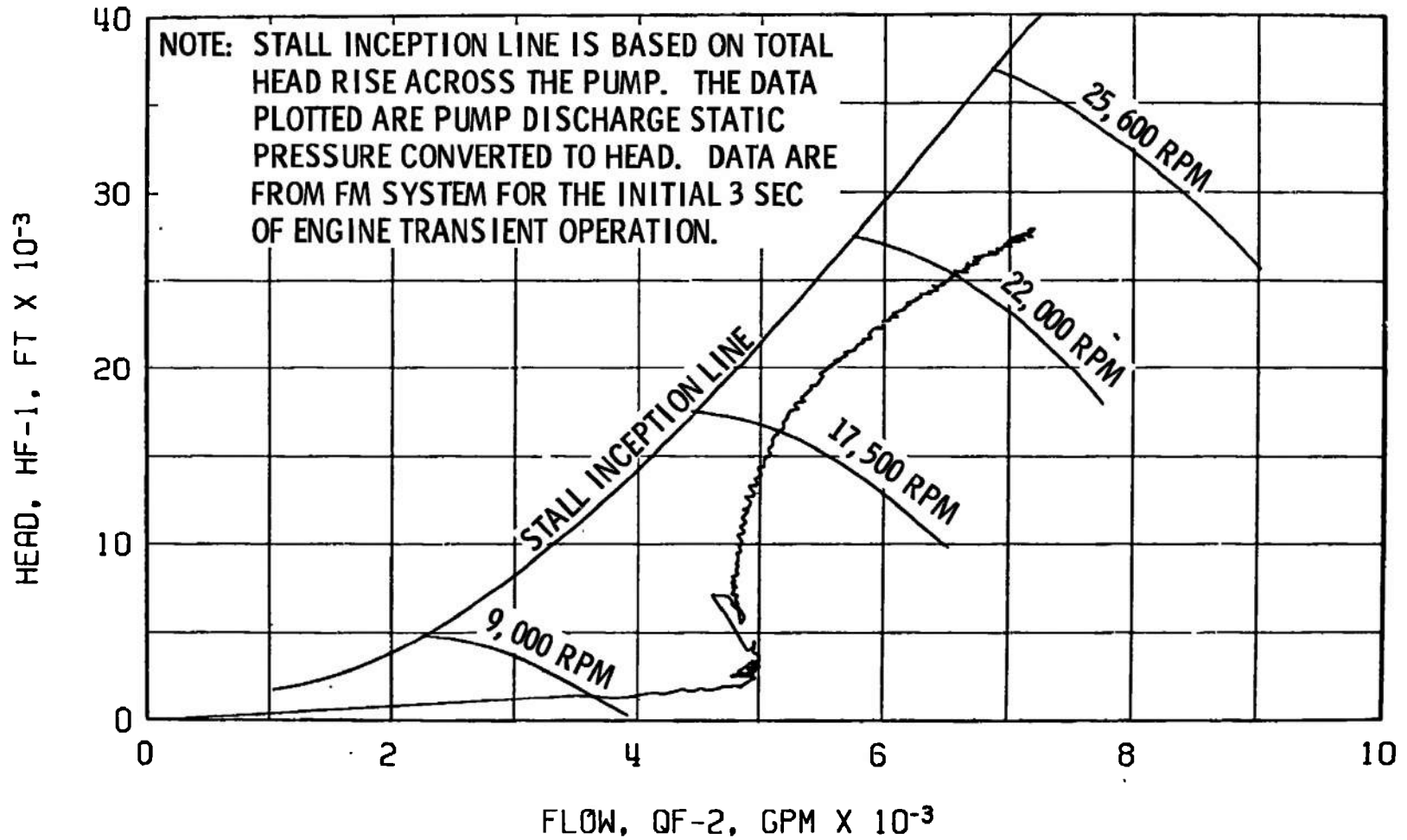

Fig. 46 Fuel Pump Start Transient Performance, Firing 06A

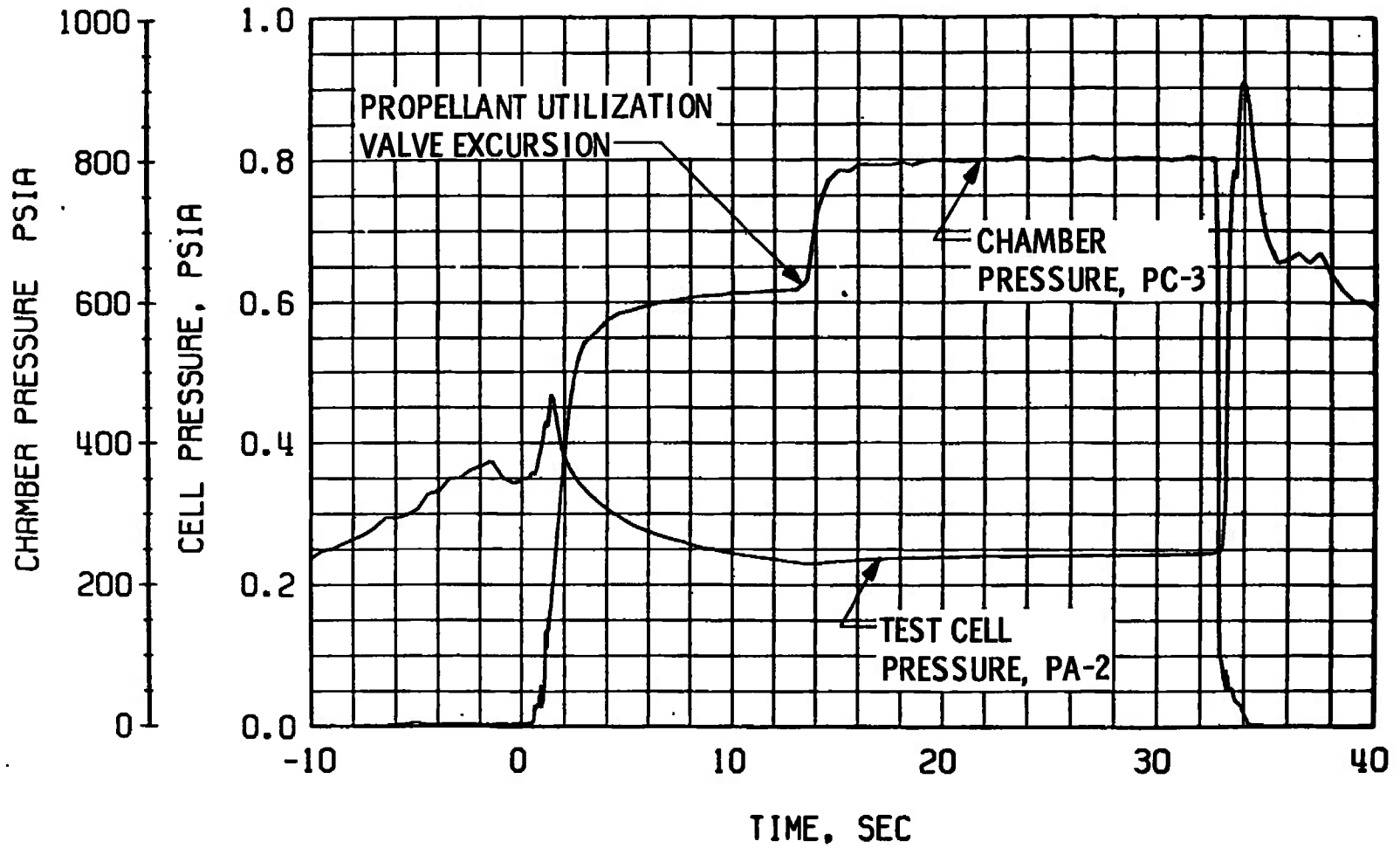
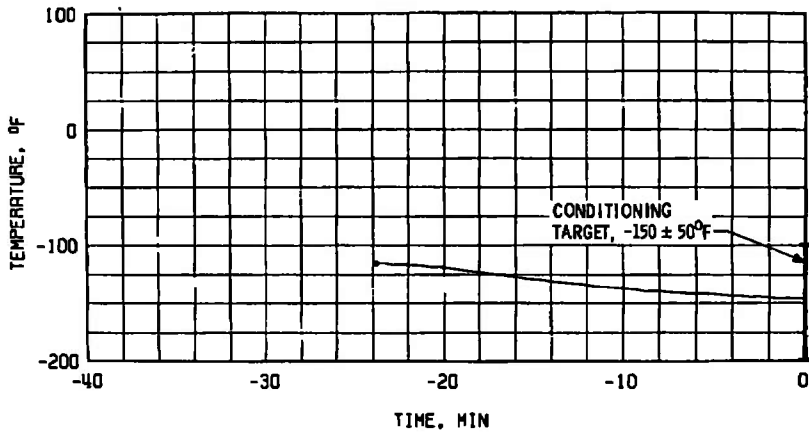
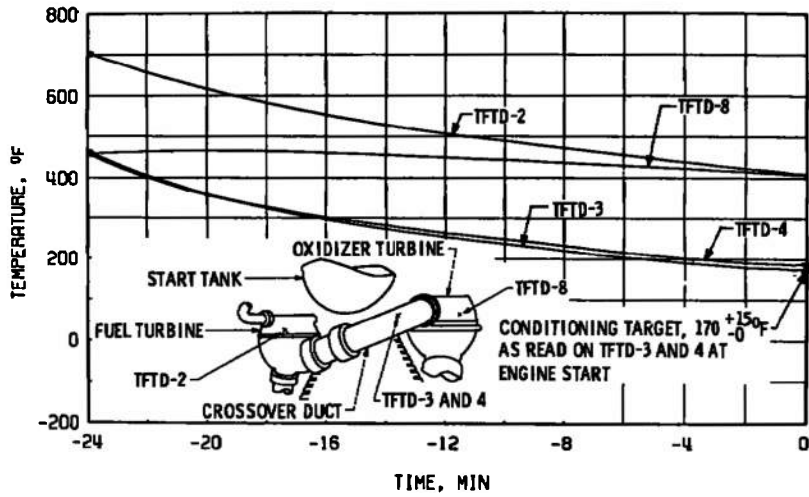

Fig. 47 Engine Ambient and Combustion Chamber Pressure, Firing 06A





a. Main Oxidizer Valve Second-Stage Actuator, TSOVC-1



b. Crossover Duct, TTFD

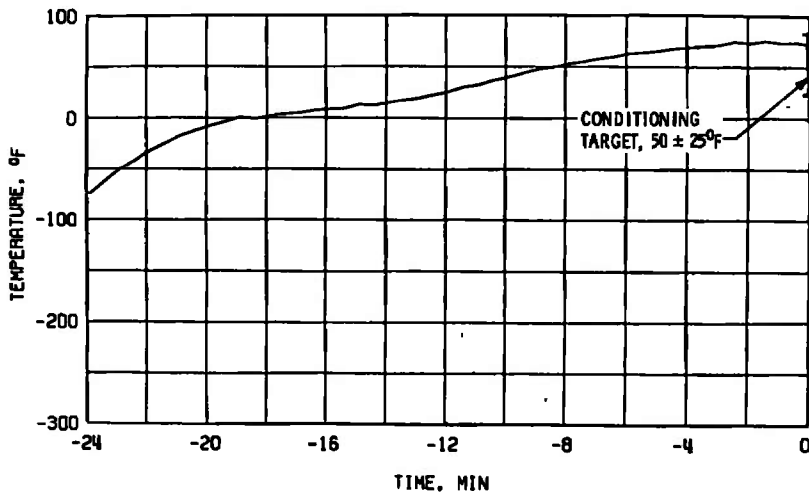

c. Thrust Chamber Throat, TTC-1P

Fig. 48 Thermal Conditioning History of Engine Components, Firing 06B

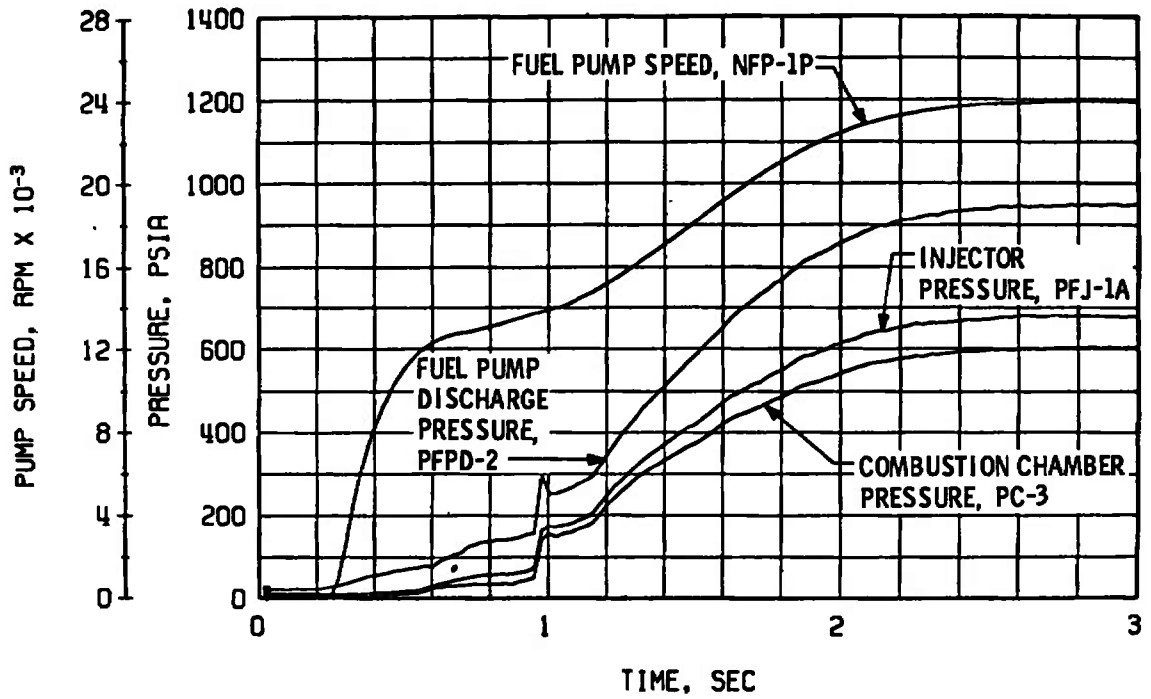

a. Thrust Chamber Fuel System, Start

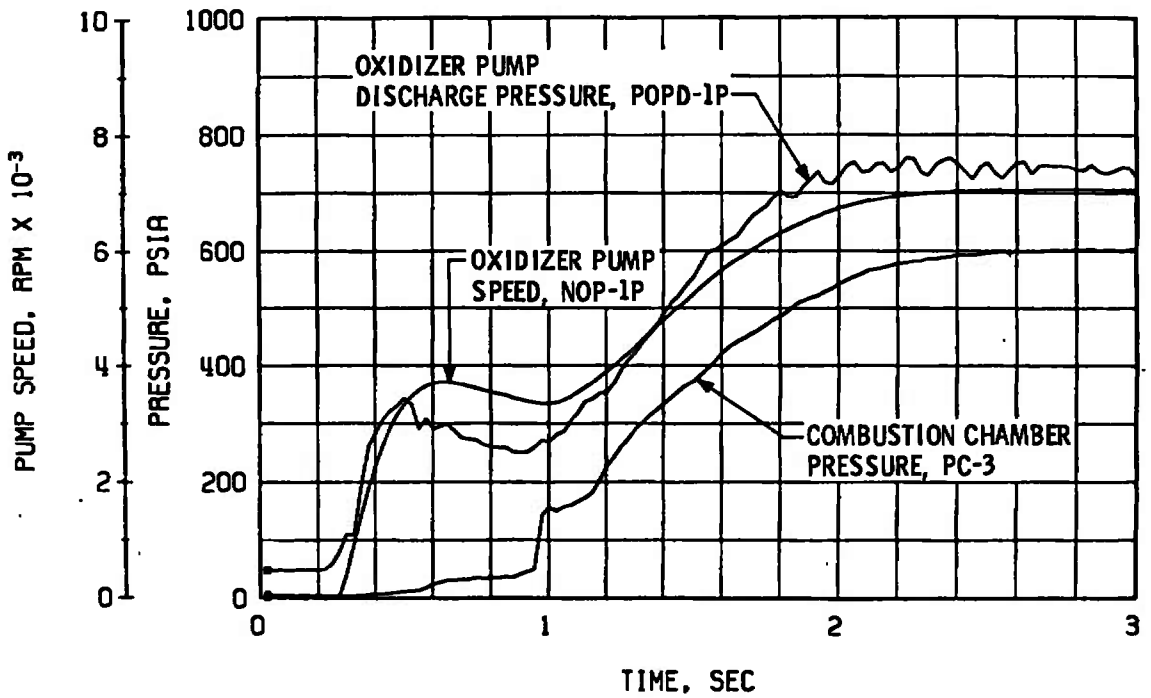

b. Thrust Chamber Oxidizer System, Start

Fig. 49 Engine Transient Operation, Firing 06B

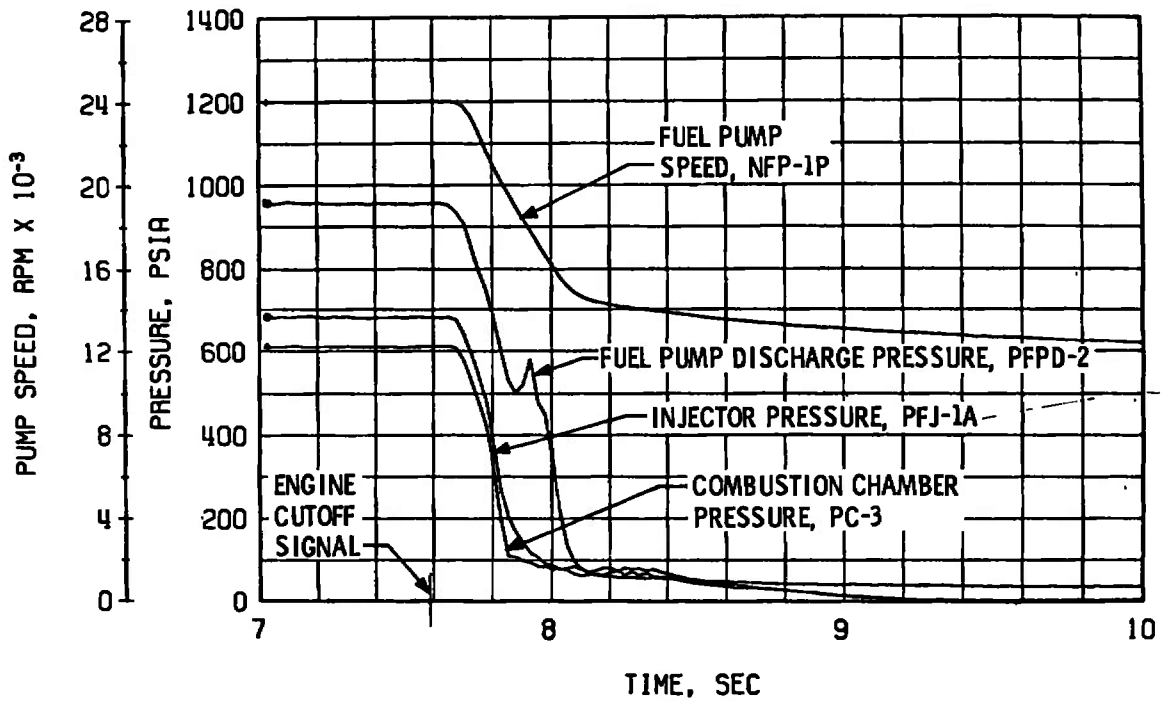

c. Thrust Chamber Fuel System, Shutdown

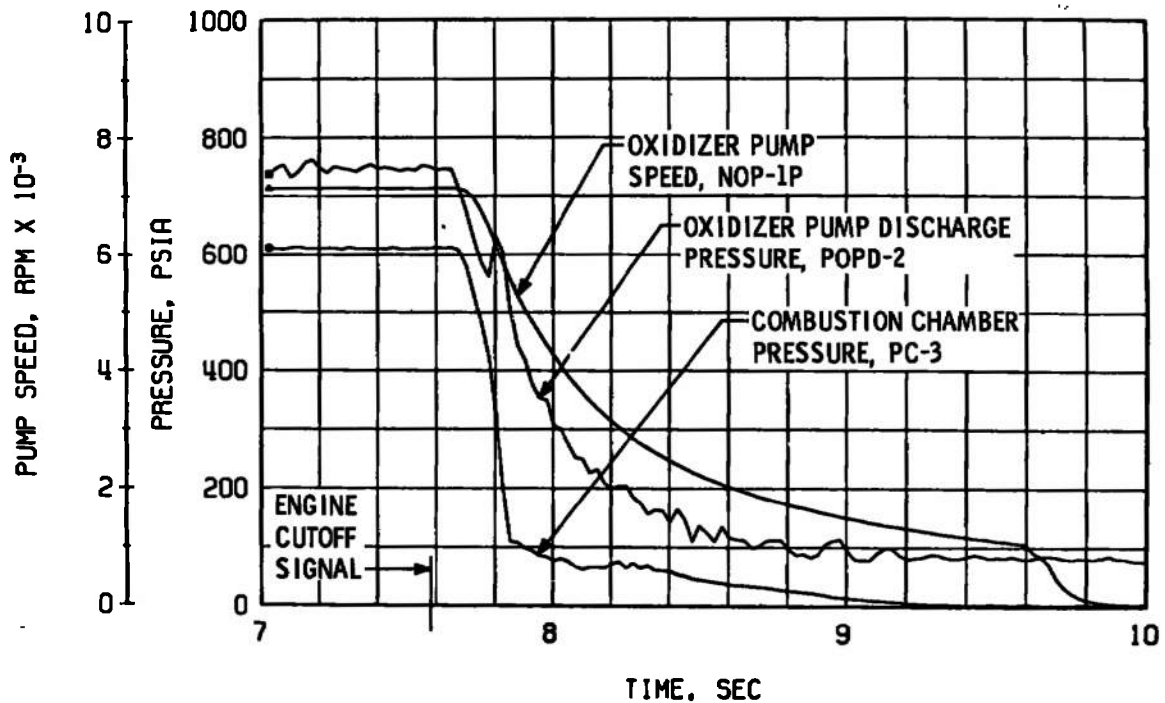

d. Thrust Chamber Oxidizer System, Shutdown

Fig. 49 Continued

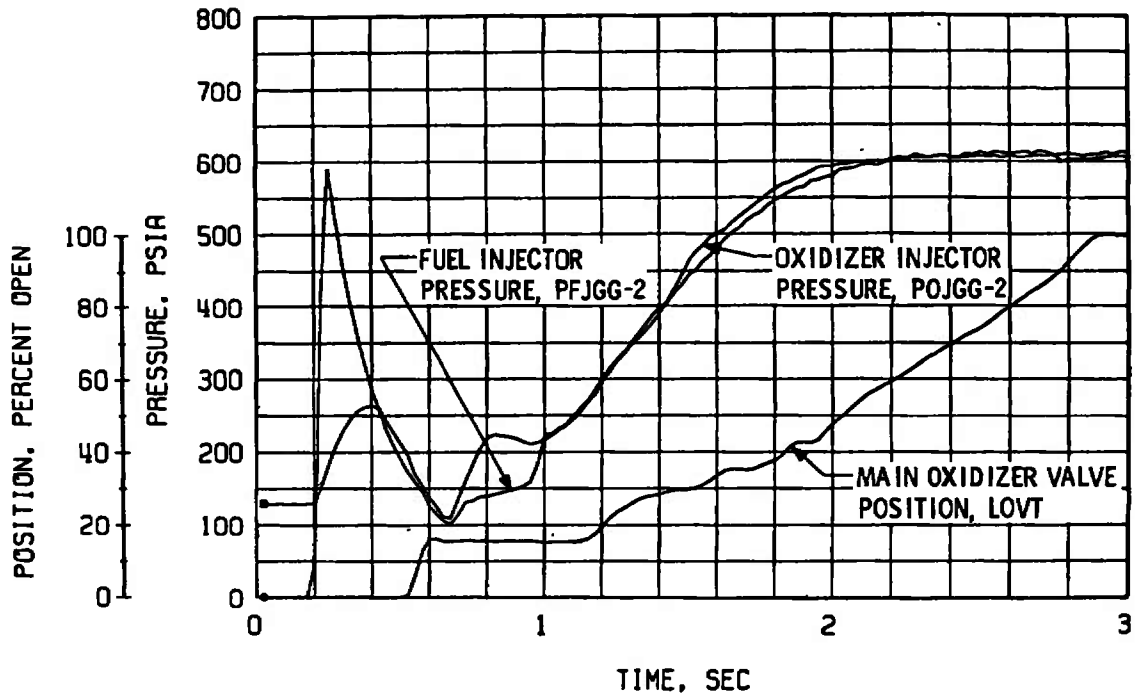

e. Gas Generator Injector Pressures and Main Oxidizer Valve Position, Start

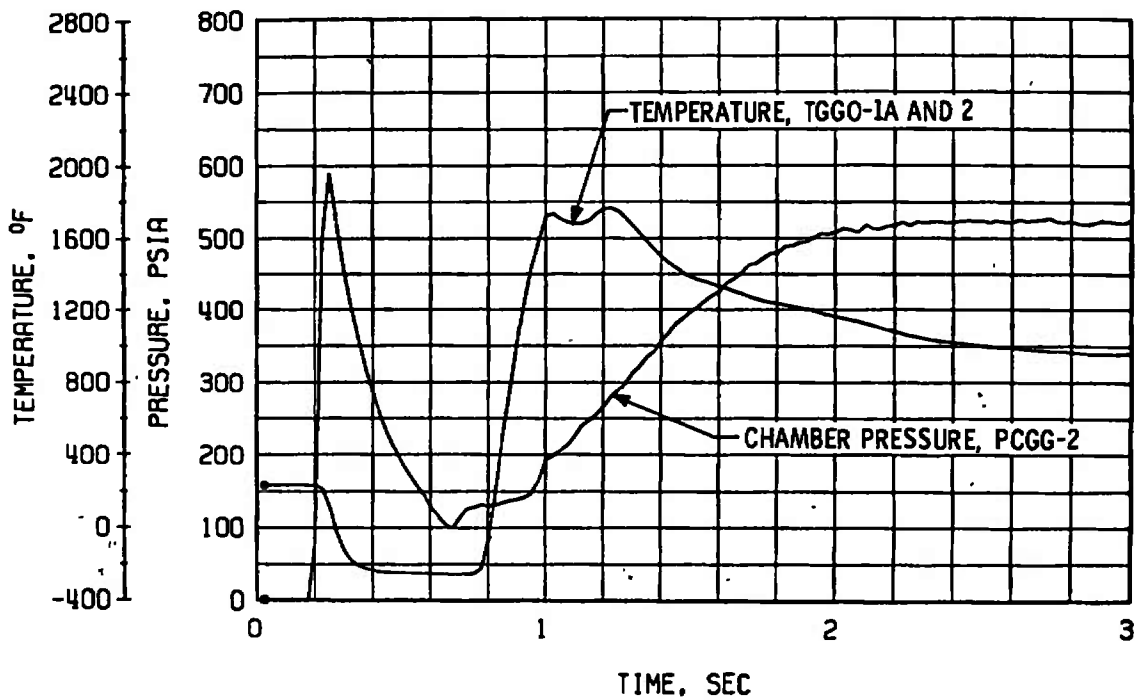

f. Gas Generator Chamber Pressure and Temperature, Start

Fig. 49 Continued

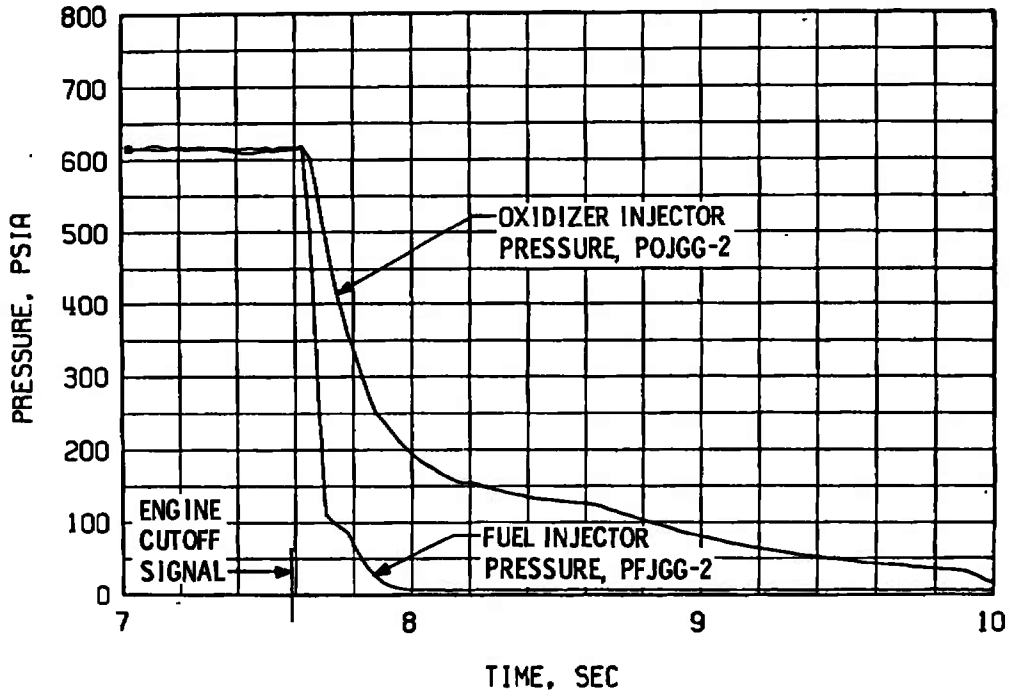

g. Gas Generator Injector Pressure, Shutdown

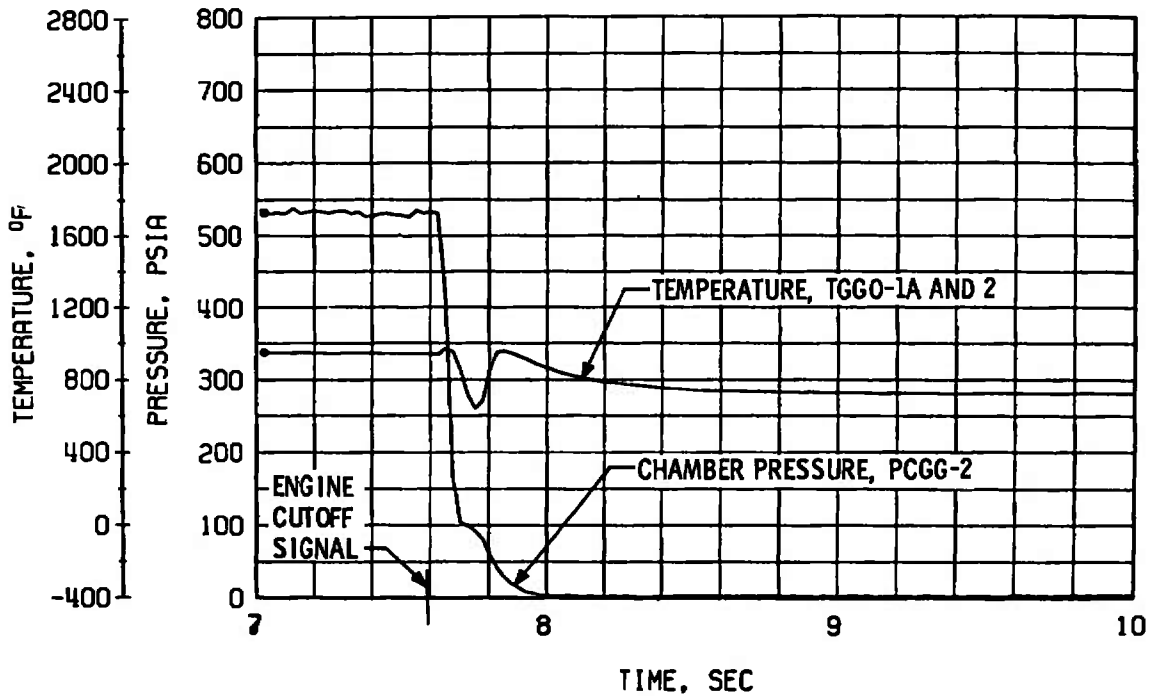

h. Gas Generator Chamber Pressure and Temperature, Shutdown

Fig. 49 Concluded

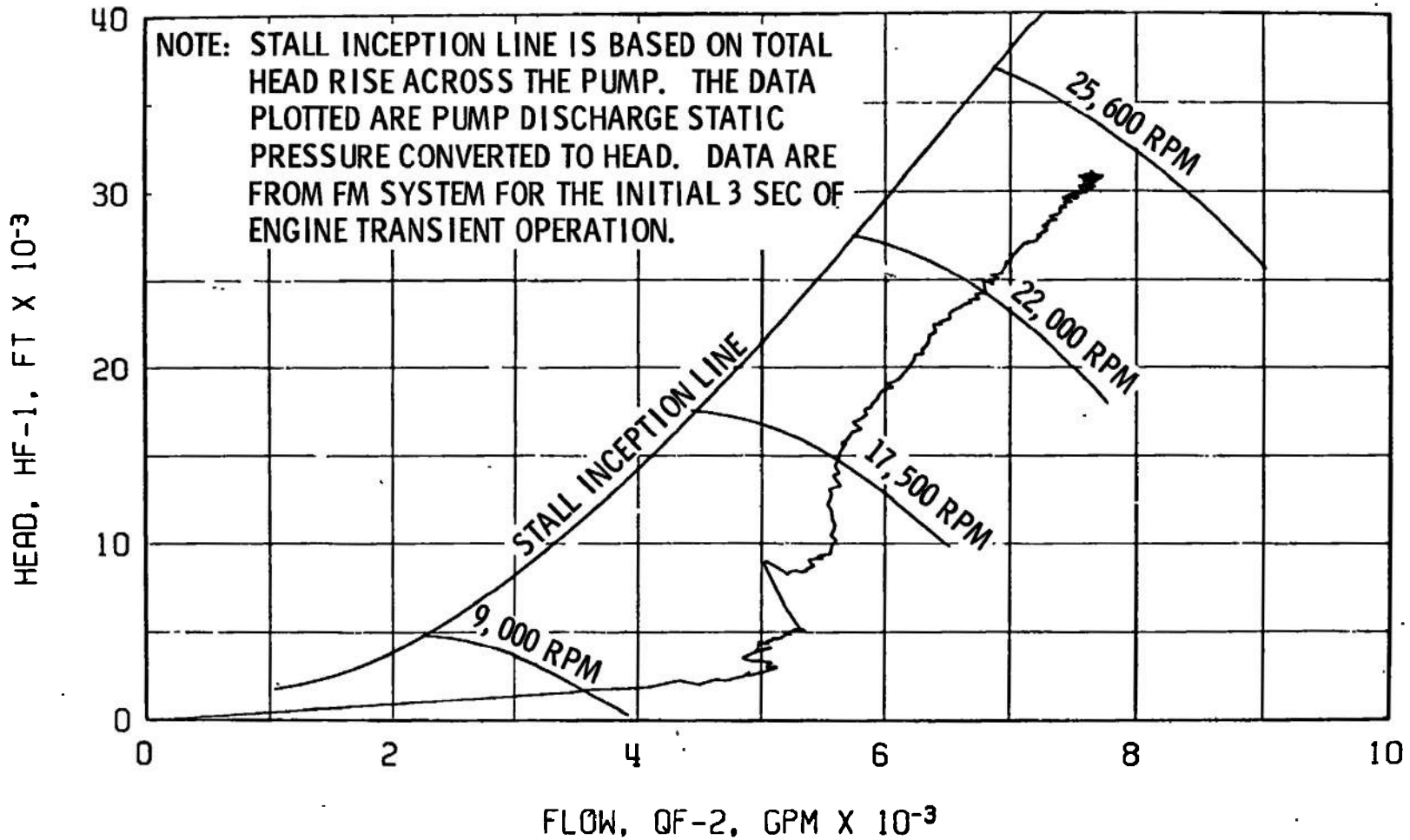

Fig. 50 Fuel Pump Start Transient Performance, Firing 06B

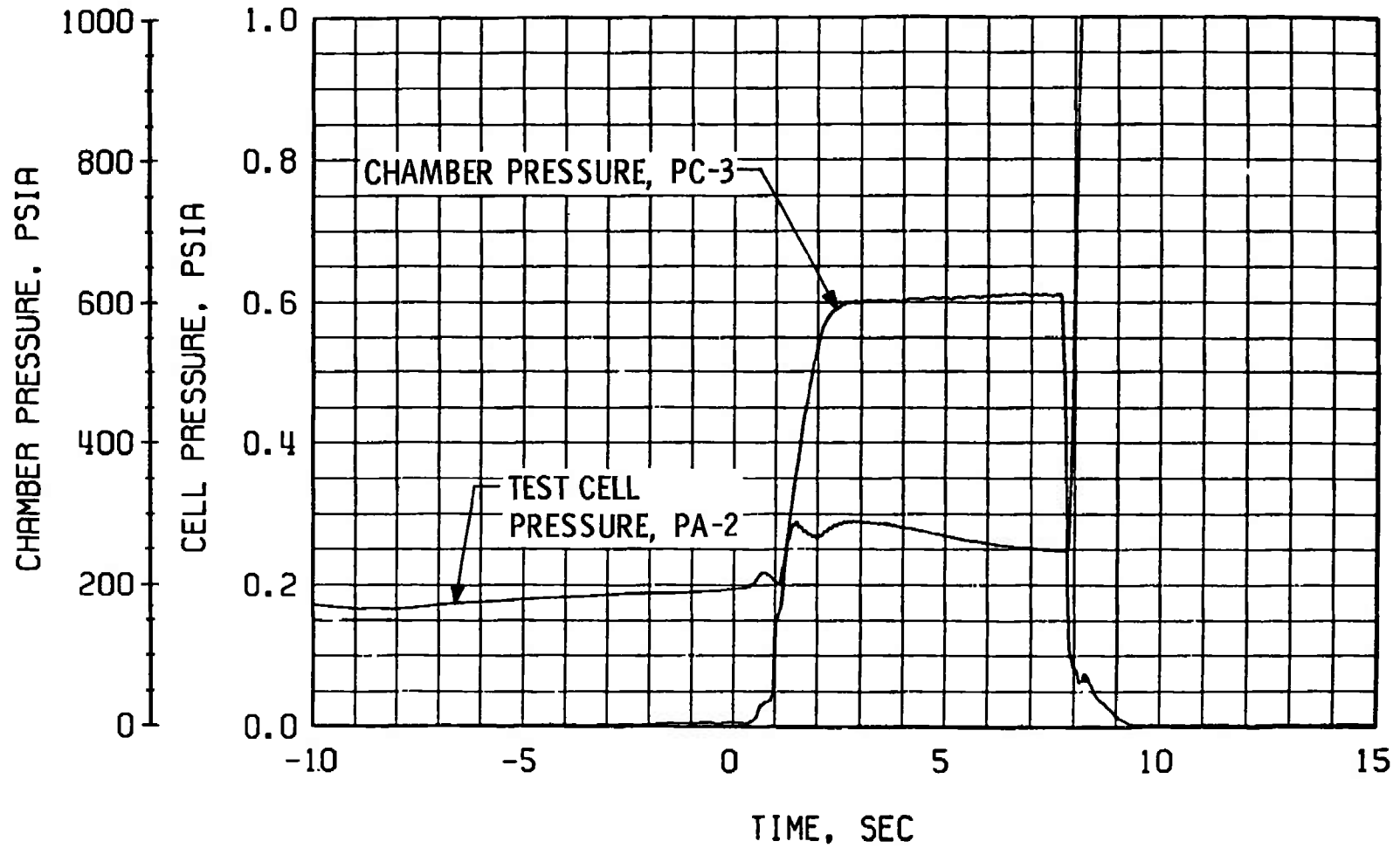
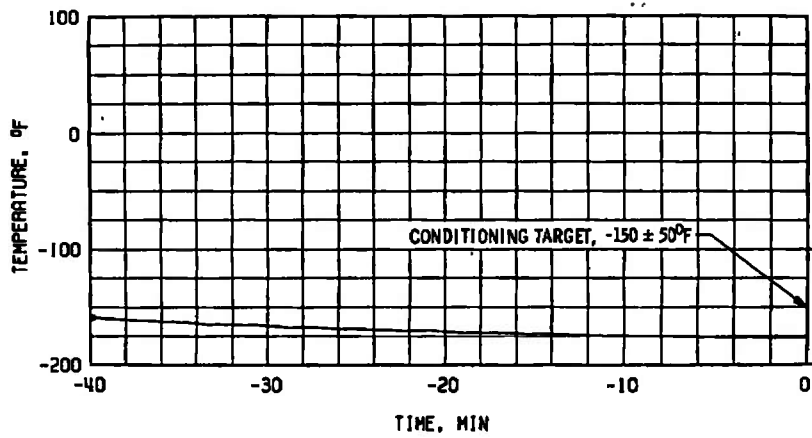
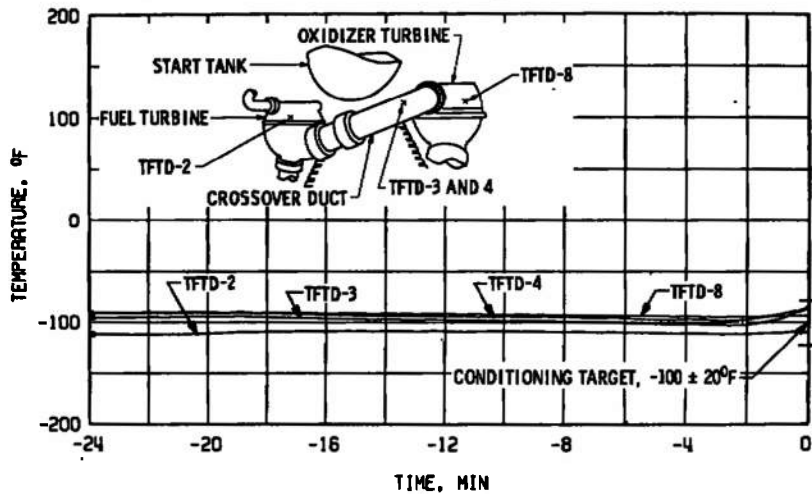

Fig. 51 Engine Ambient and Combustion Chamber Pressure, Firing 06B



a. Main Oxidizer Valve Second-Stage Actuator, TSOVC-1



b. Crossover Duct, TFTD

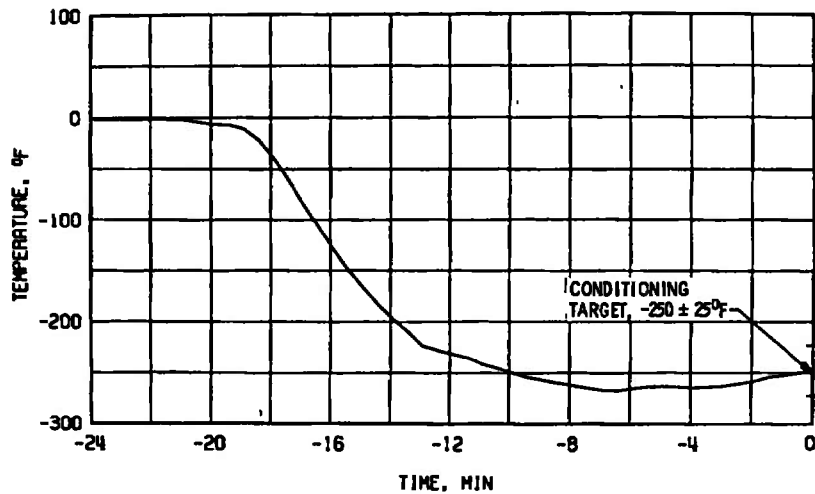

c. Thrust Chamber Throat, TTC-1P

Fig. 52 Thermal Conditioning History of Engine Components, Firing 06C



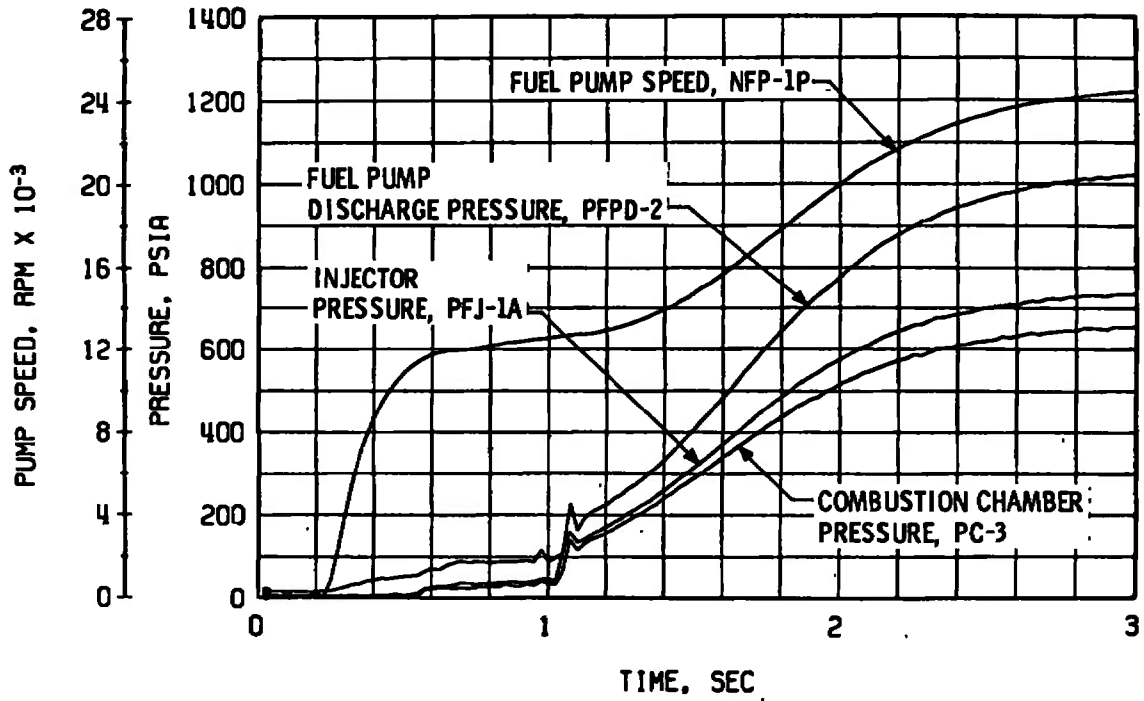

a. Thrust Chamber Fuel System, Start

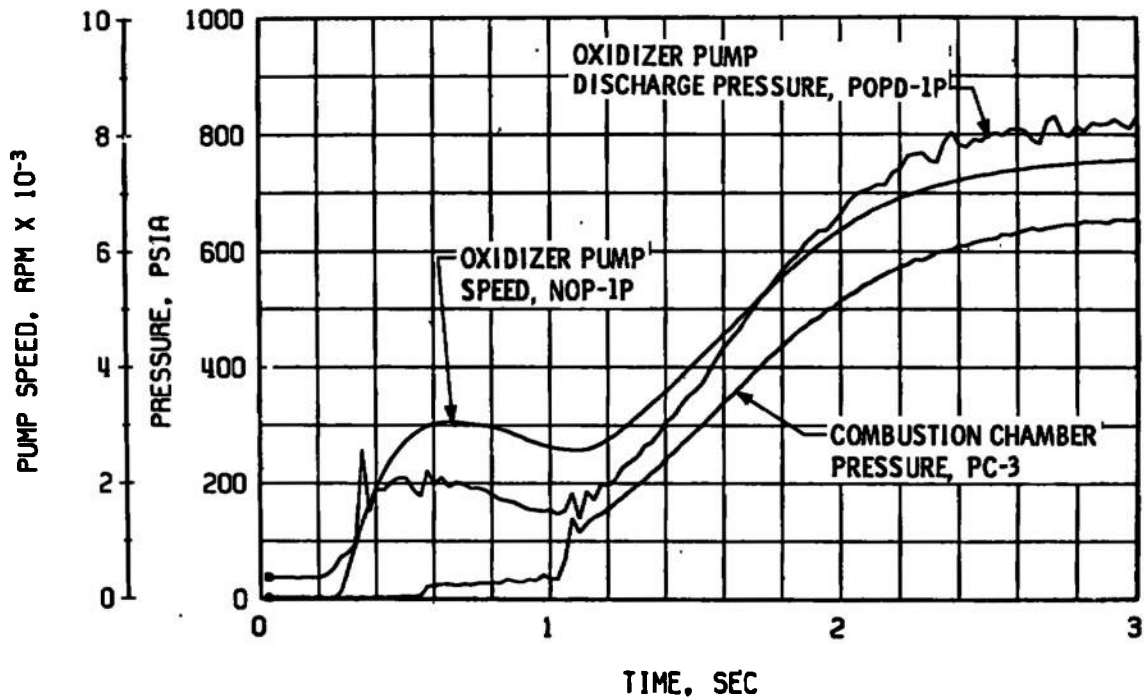

b. Thrust Chamber Oxidizer System, Start

Fig. 53 Engine Transient Operation, Firing 06C

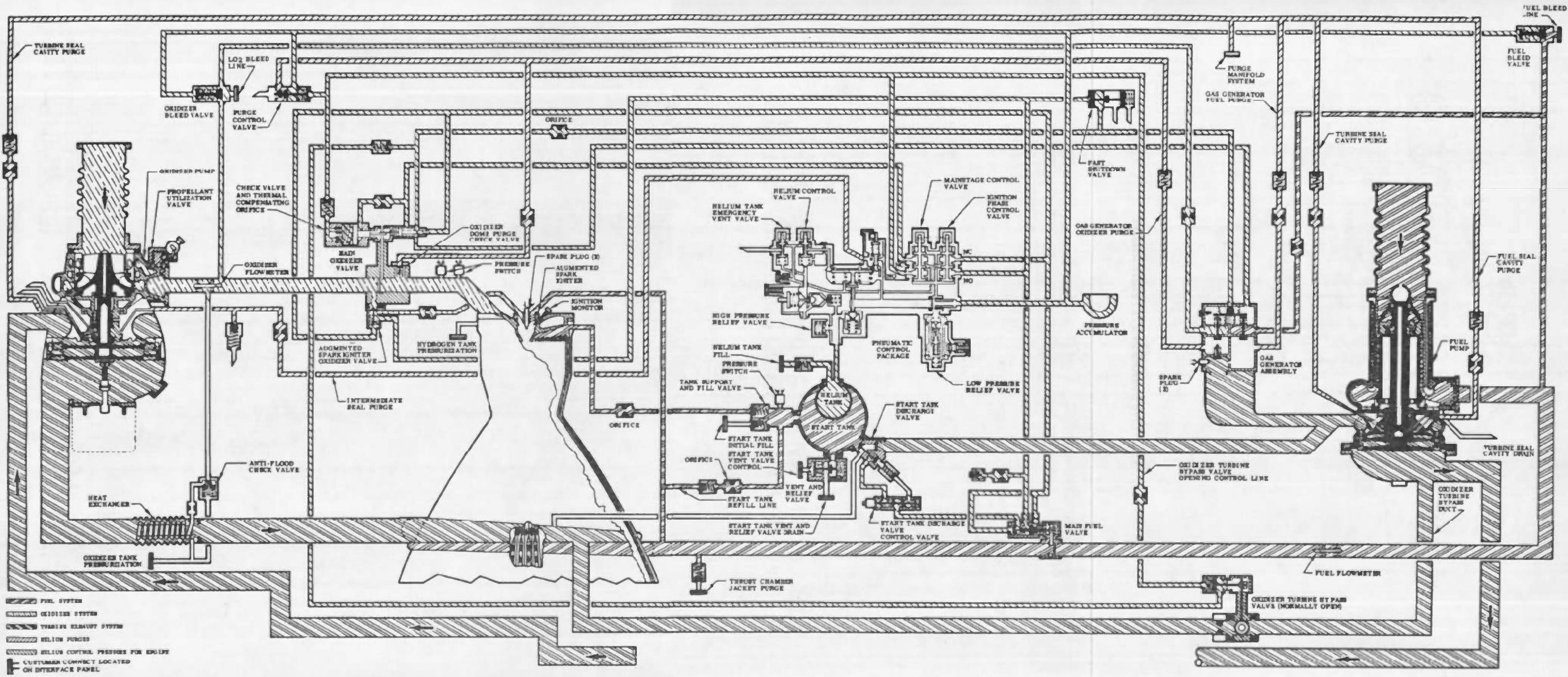

Fig. 5 Engine Schematic

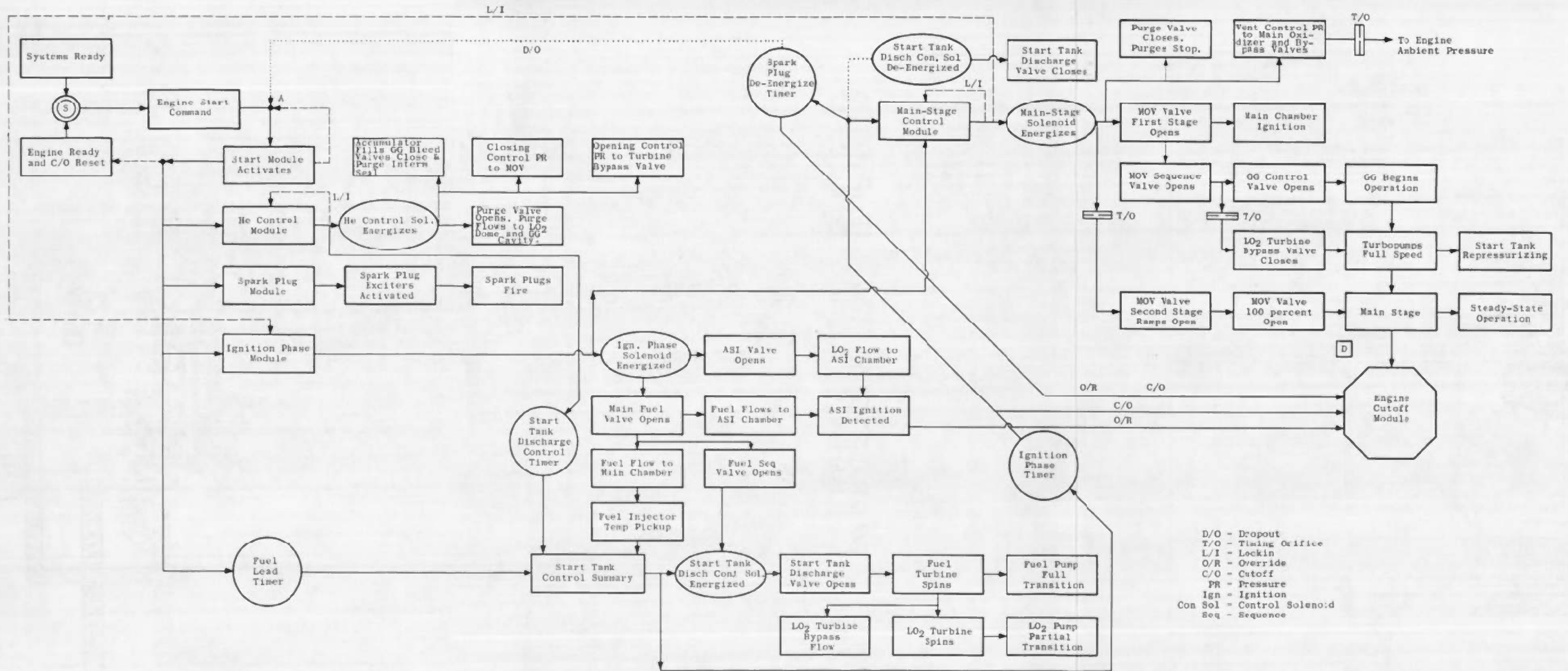
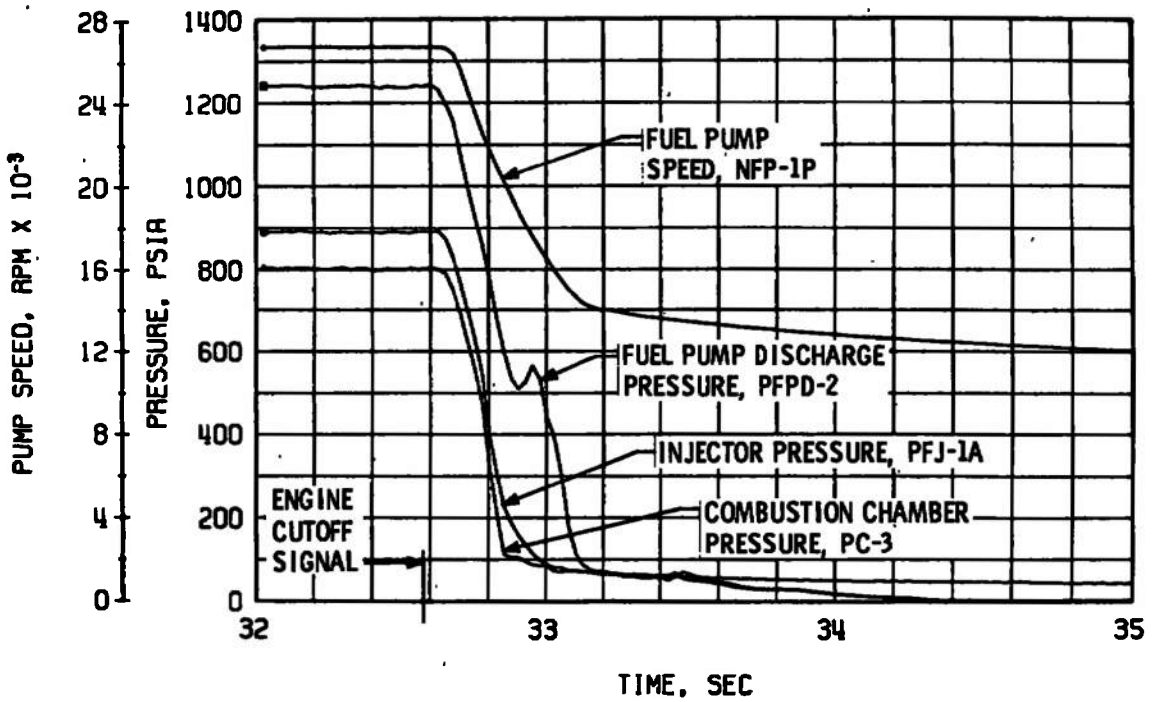
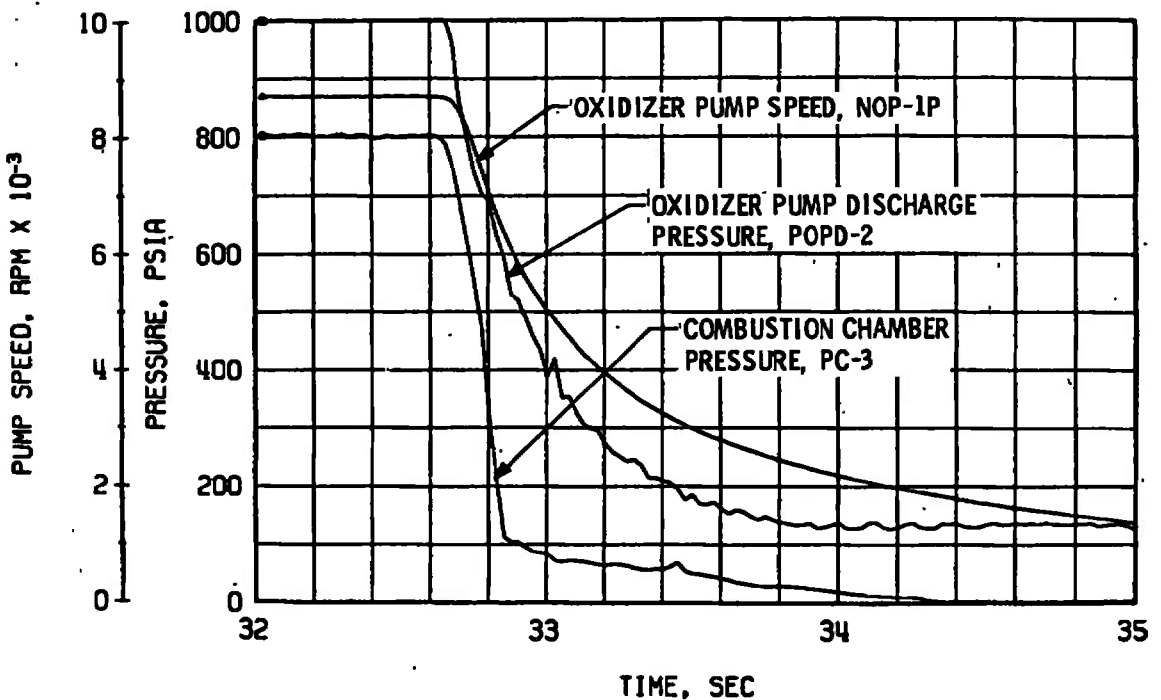

Fig. 6 Engine Start Logic Schematic



c. Thrust Chamber Fuel System, Shutdown



d. Thrust Chamber Oxidizer System, Shutdown

Fig. 53 Continued



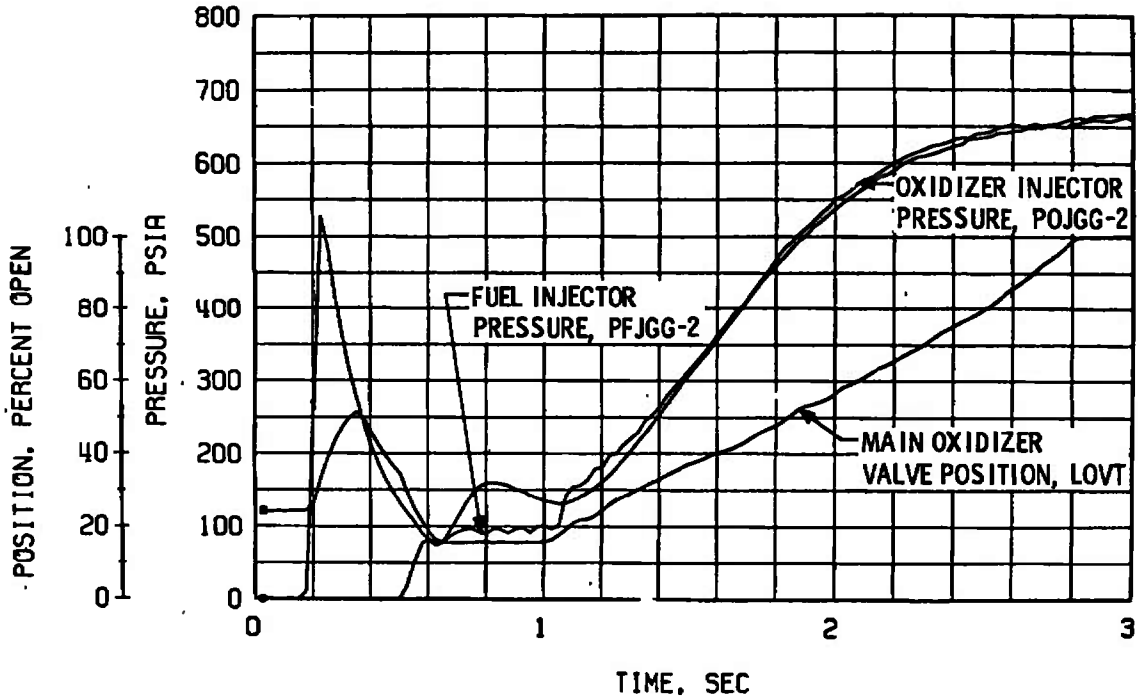

e. Gas Generator Injector Pressures and Main Oxidizer Valve Position, Start

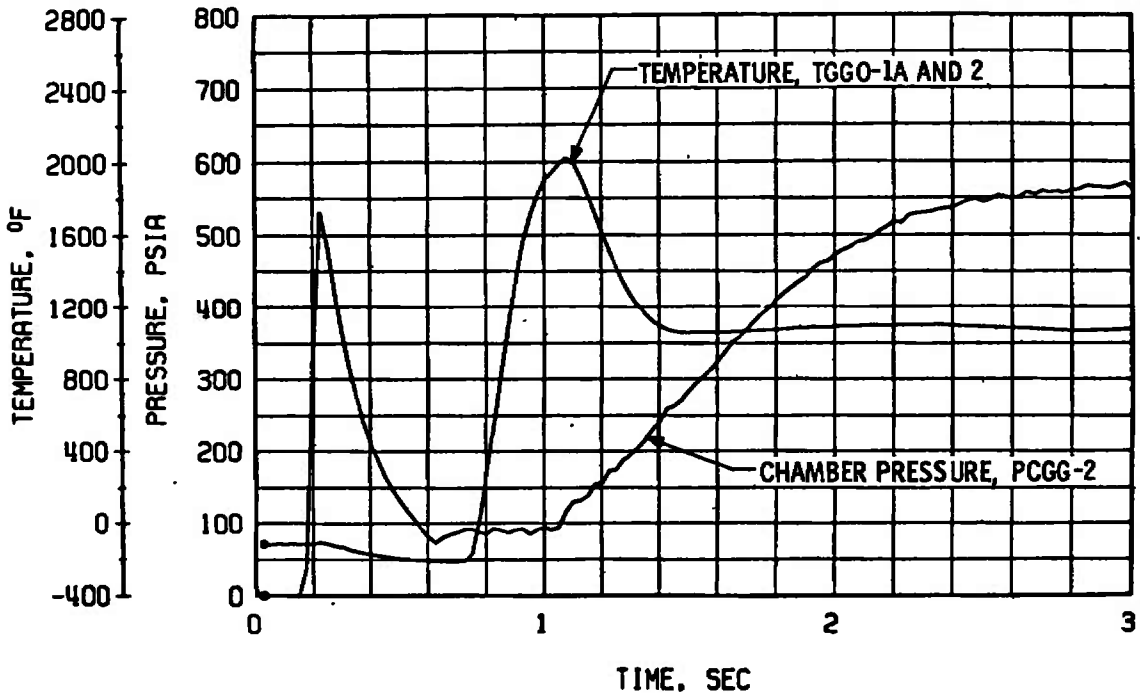

f. Gas Generator Chamber Pressure and Temperature, Start

Fig. 53 Continued

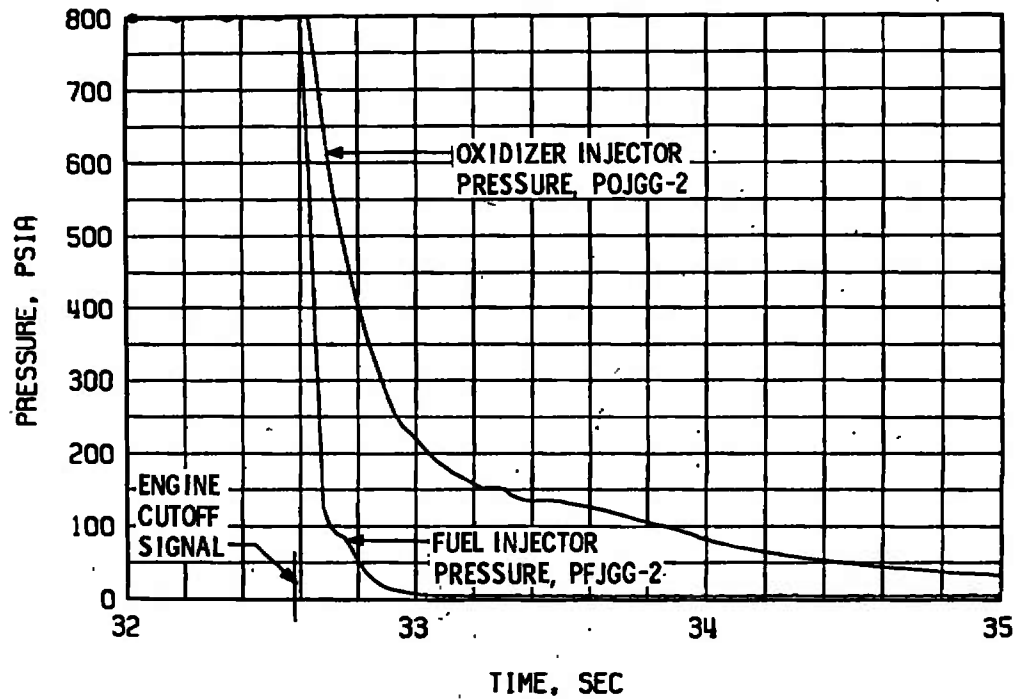

g. Gas Generator Injector Pressures, Shutdown

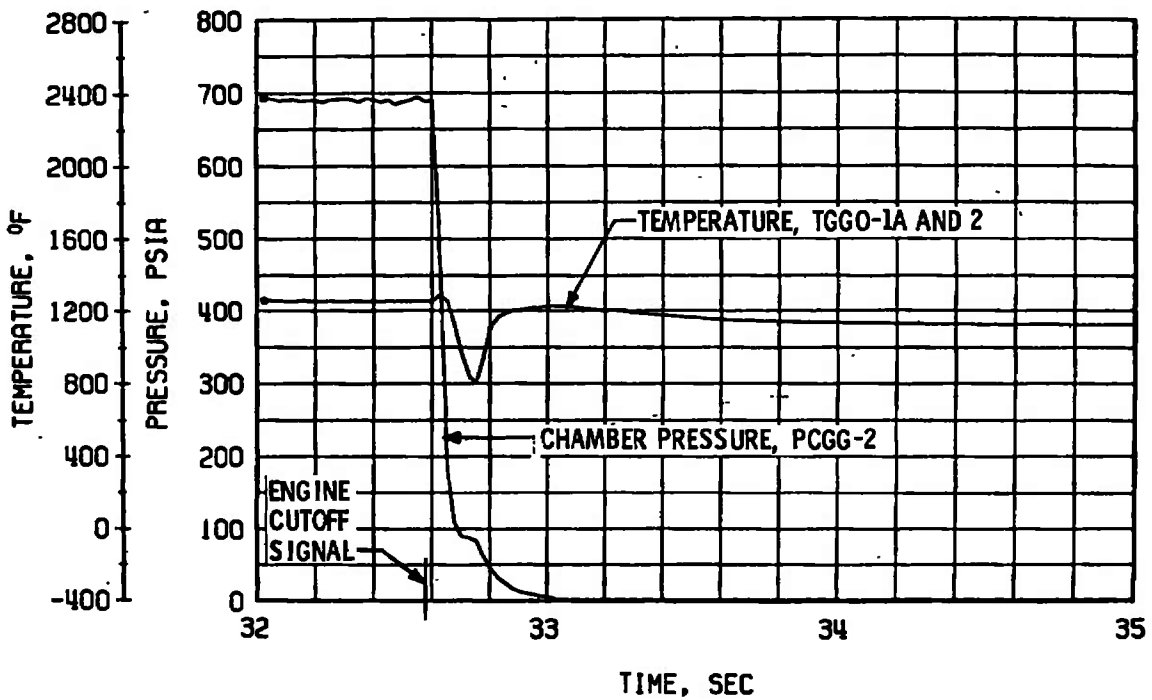

h. Gas Generator Chamber Pressure and Temperature, Shutdown

Fig. 53 Concluded

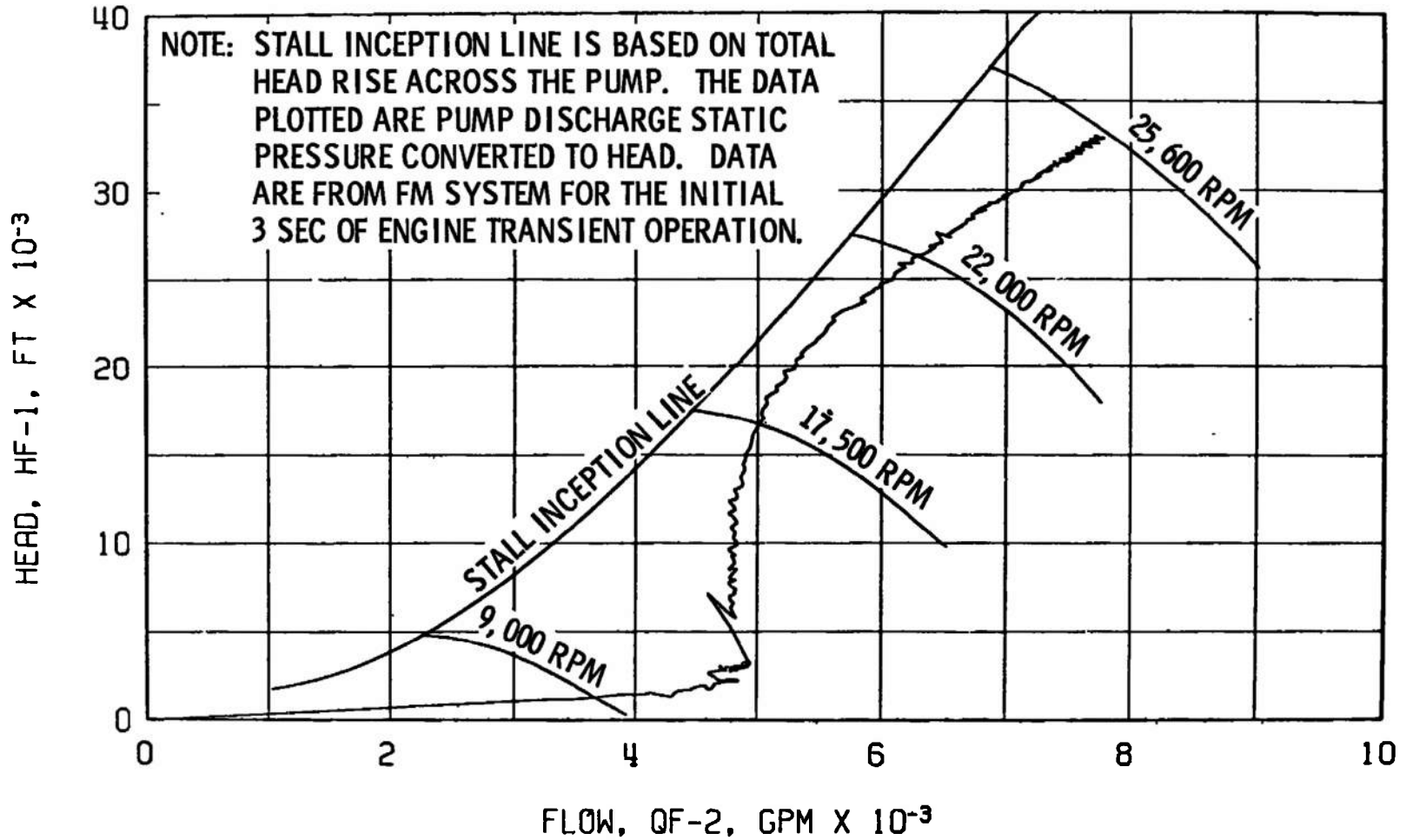

Fig. 54 Fuel Pump Start Transient Performance, Firing 06C

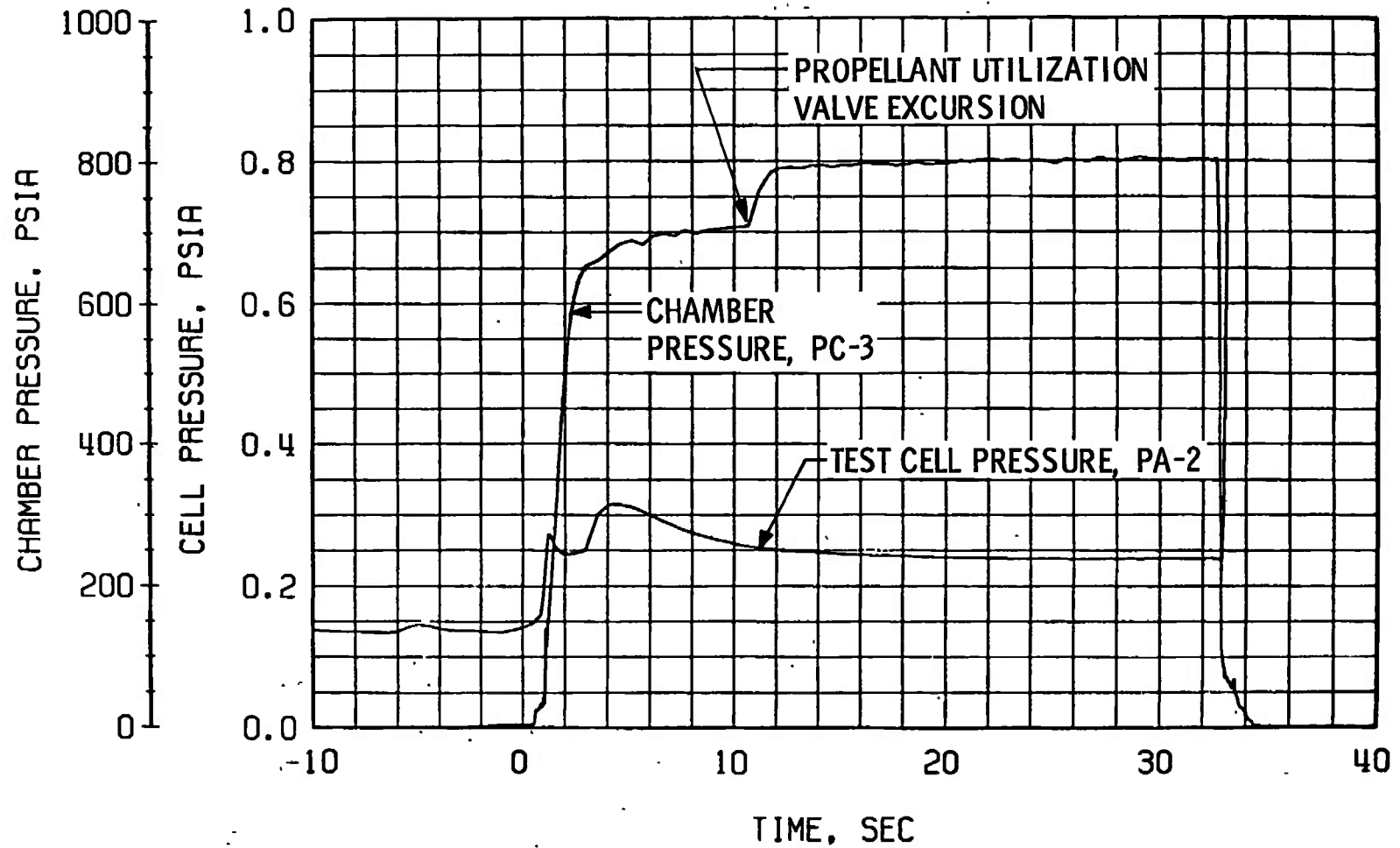
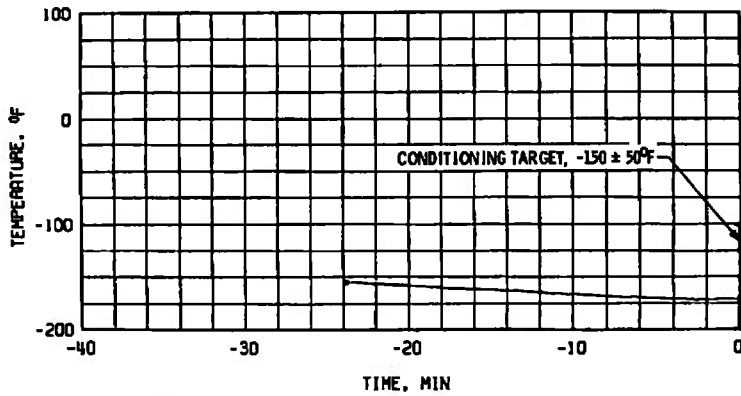
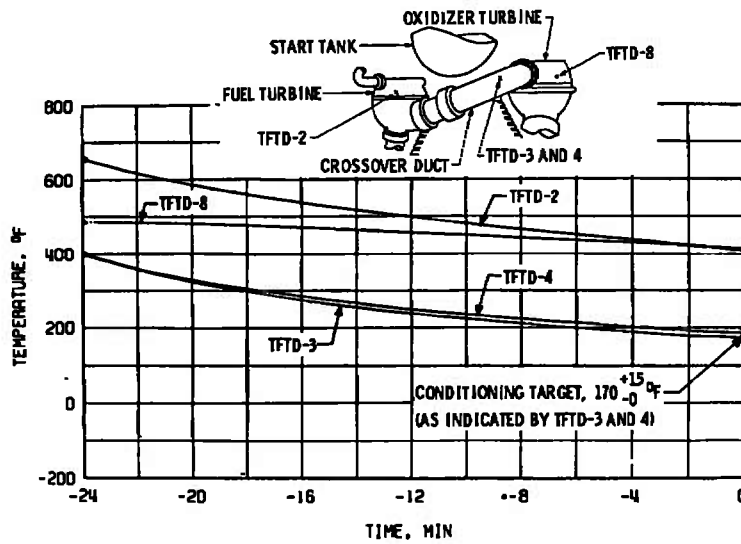

Fig. 55 Engine Ambient and Combustion Chamber Pressure, Firing 06C





a. Main Oxidizer Valve Second-Stage Actuator, TSOVC-1



b. Crossover Duct, TFTD

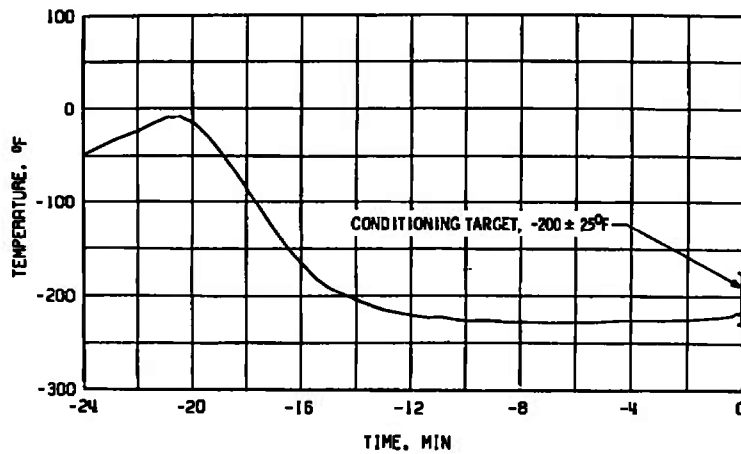

c. Thrust Chamber Throat, TTC-1P

Fig. 56 Thermal Conditioning History of Engine Components, Firing 06D

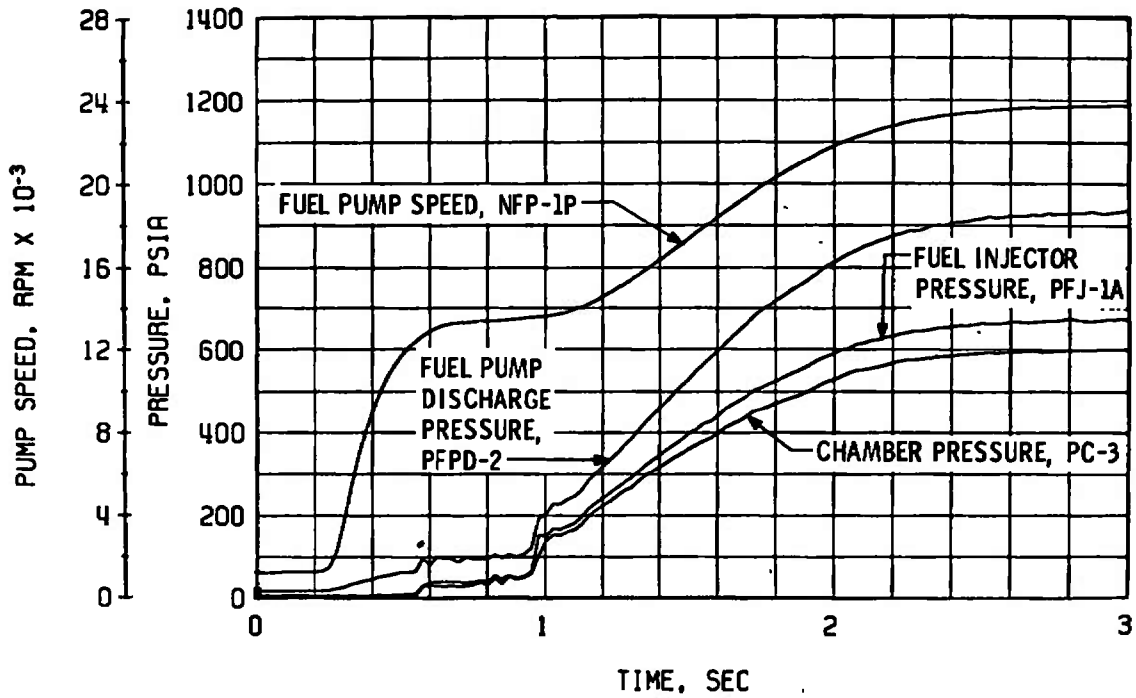

a. Thrust Chamber Fuel System, Start

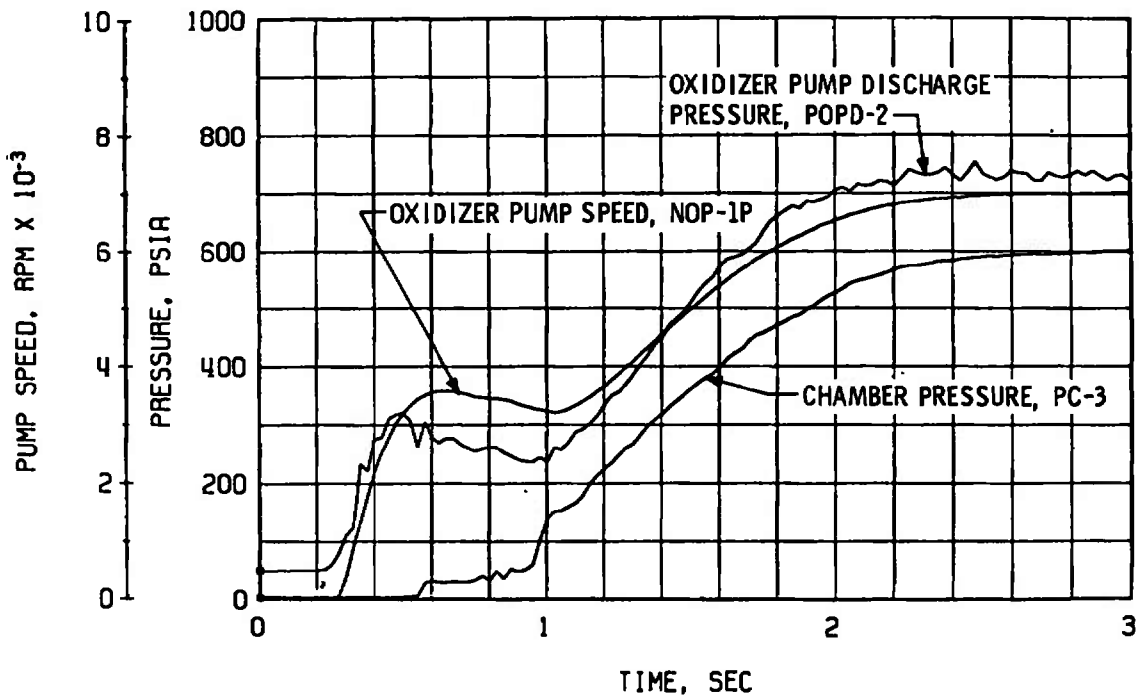

b. Thrust Chamber Oxidizer System, Start

Fig. 57 Engine Transient Operation, Firing 06D

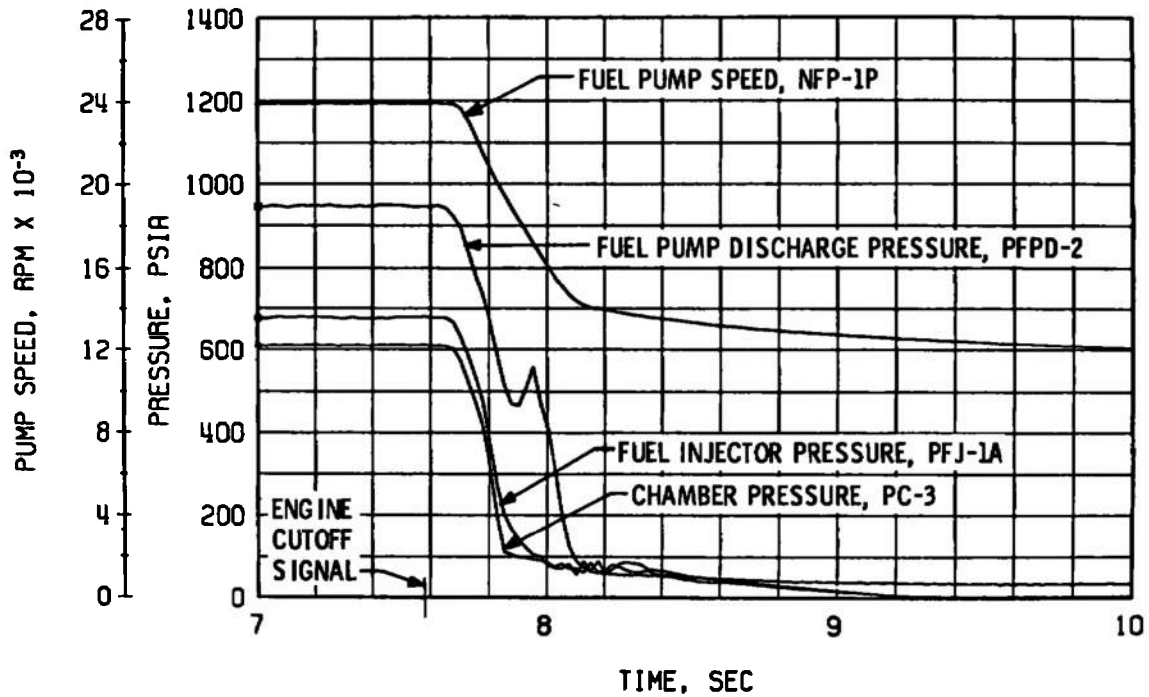

c. Thrust Chamber Fuel System, Shutdown

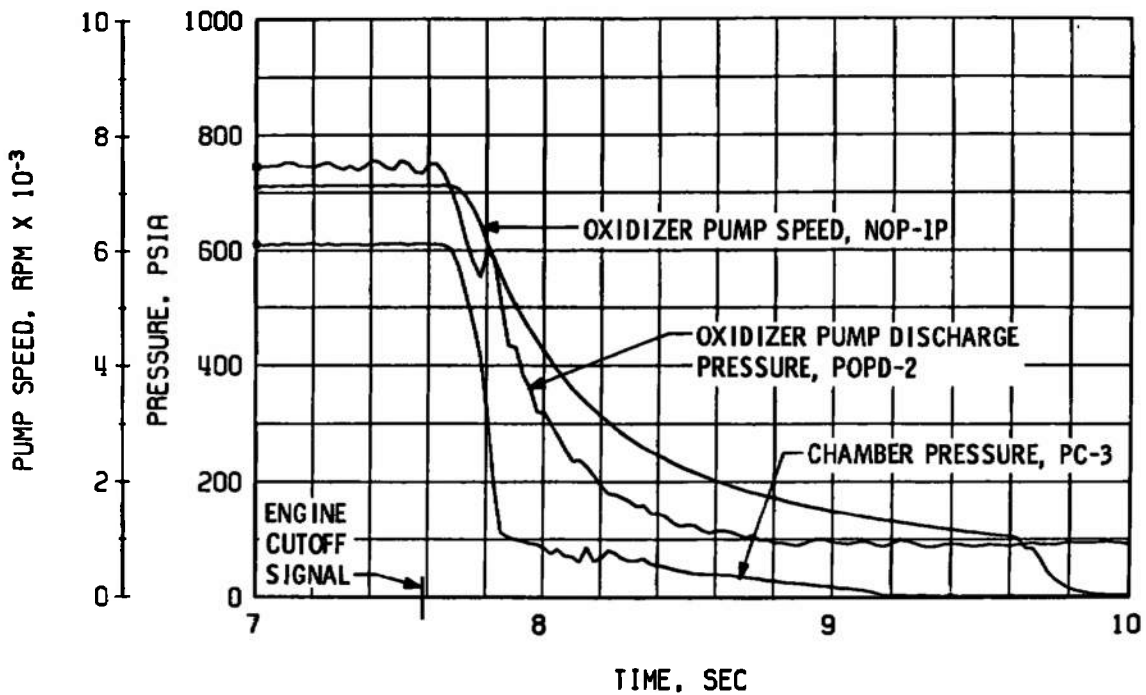

d. Thrust Chamber Oxidizer System, Shutdown

Fig. 57 Continued

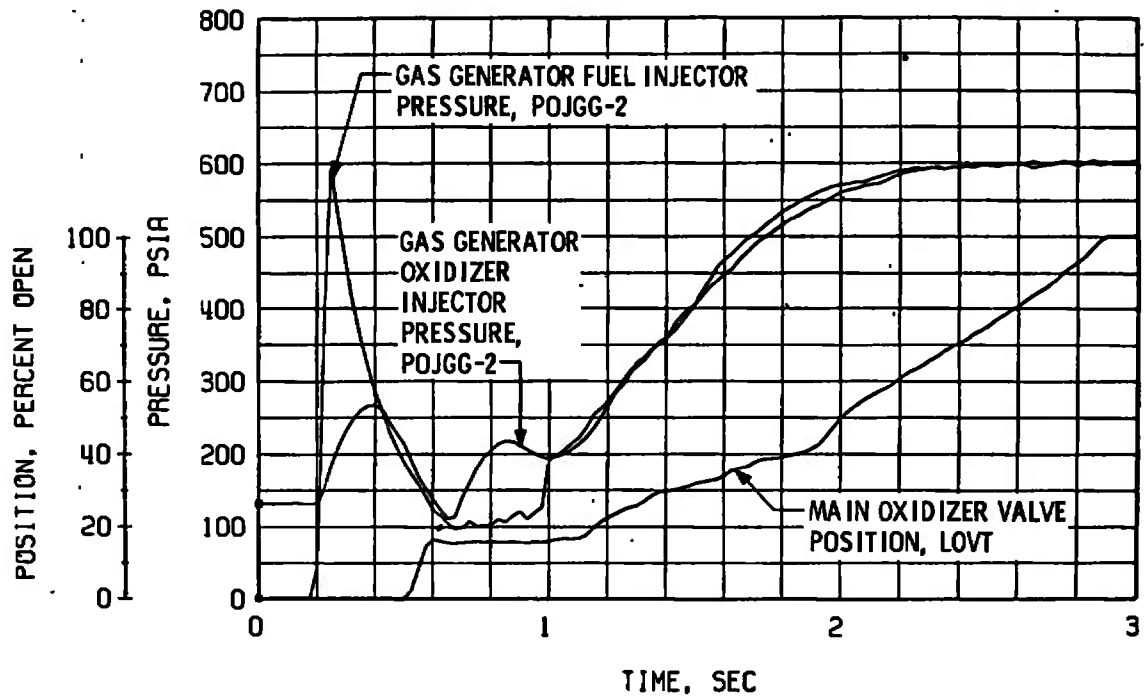

e. Gas Generator Injector Pressures and Main Oxidizer Valve Position, Start

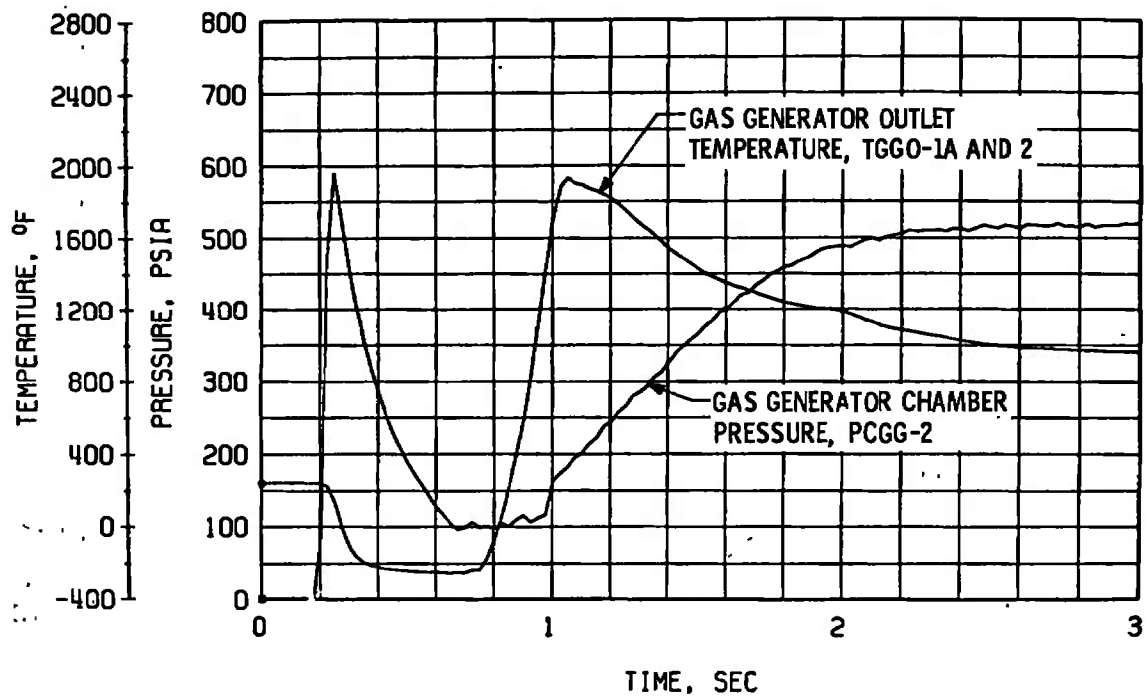

f. Gas Generator Chamber Pressure and Temperature, Start

Fig. 57 Continued

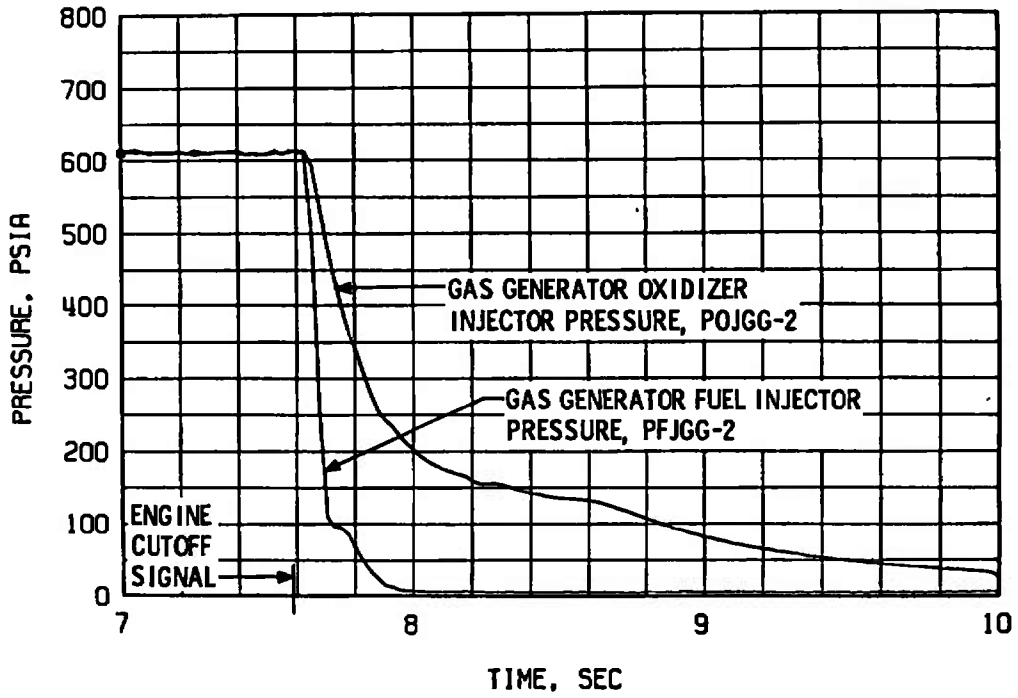

g. Gas Generator Injector Pressures, Shutdown

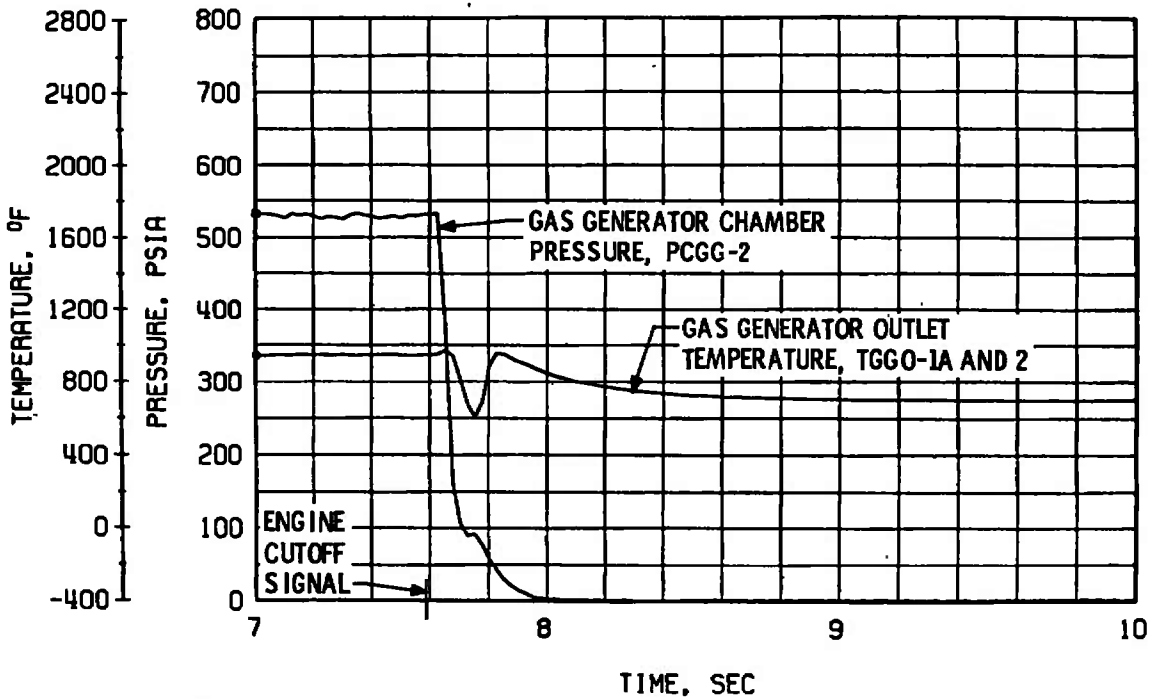

h. Gas Generator Chamber Pressure and Temperature, Shutdown

Fig. 57 Concluded

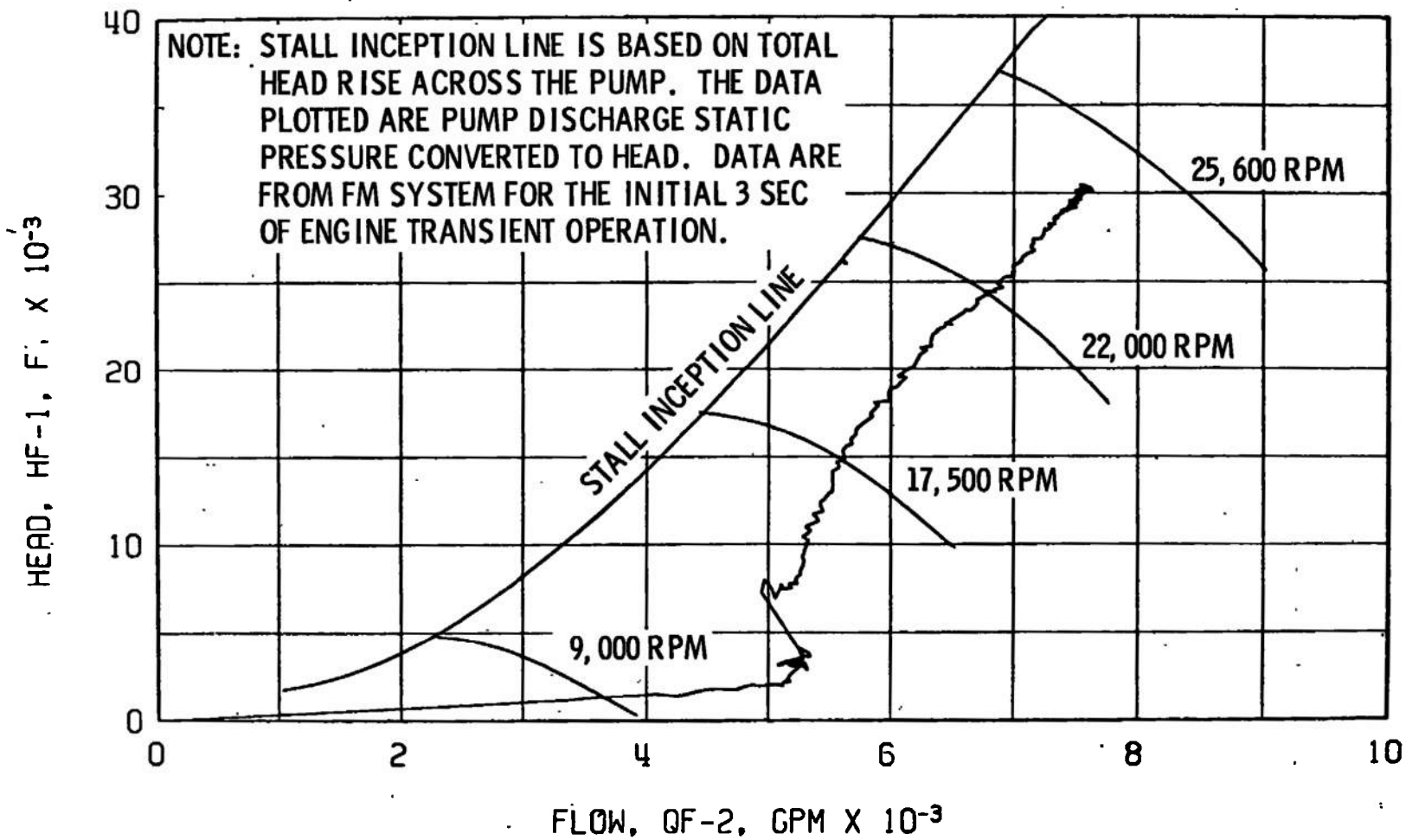

Fig. 58 Fuel Pump Start Transient Performance, Firing 06D

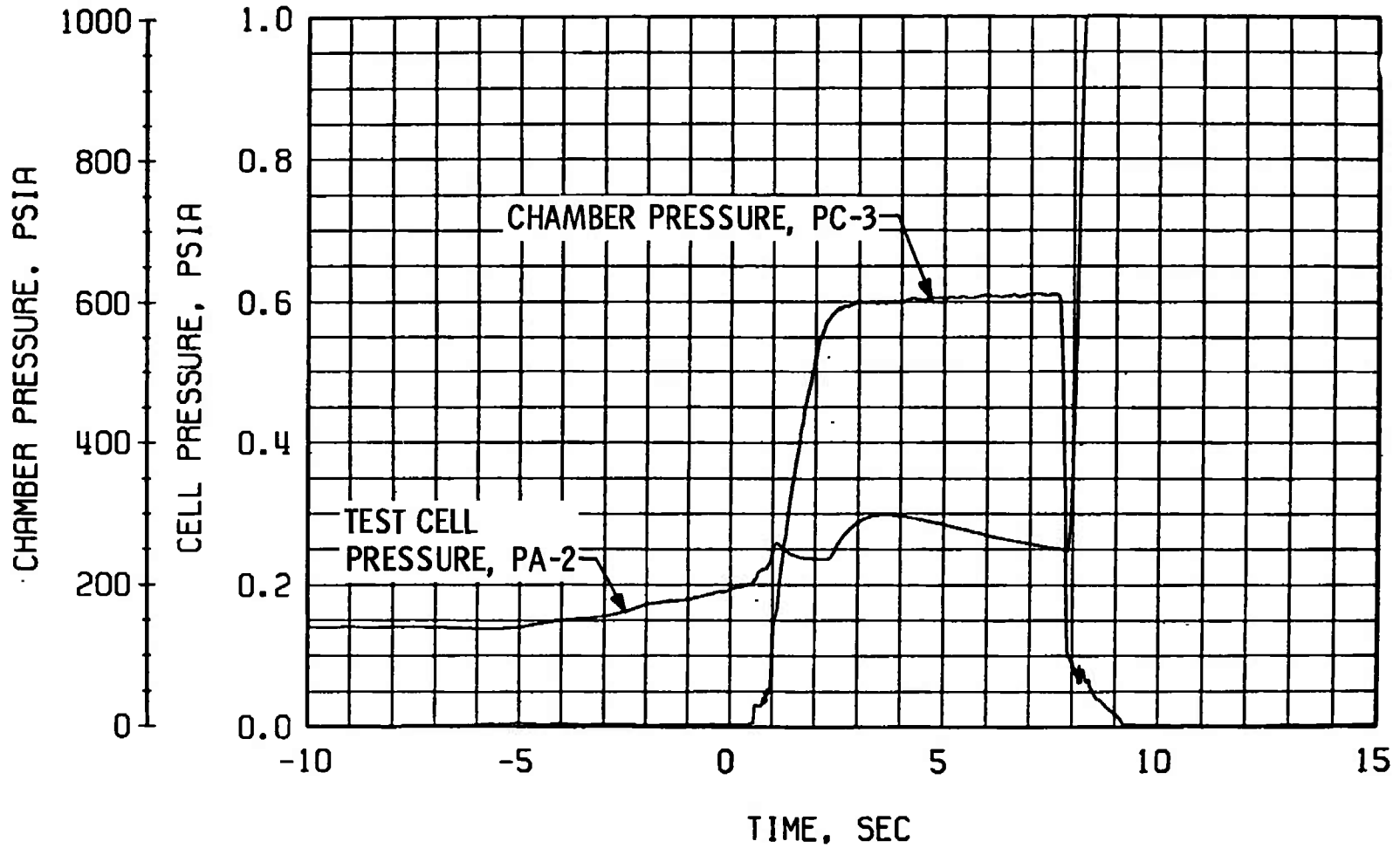
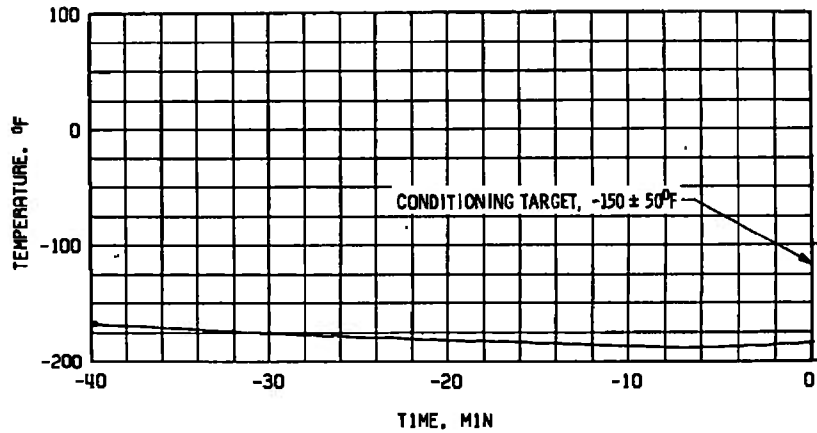
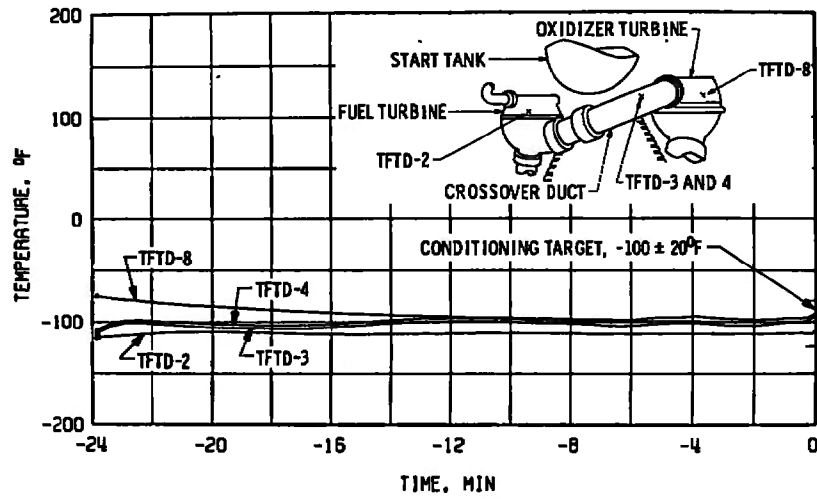

Fig. 59 Engine Ambient and Combustion Chamber Pressure, Firing 06D



a. Main Oxidizer Valve Second-Stage Actuator, TSOVC-1



b. Crossover Duct, TFD

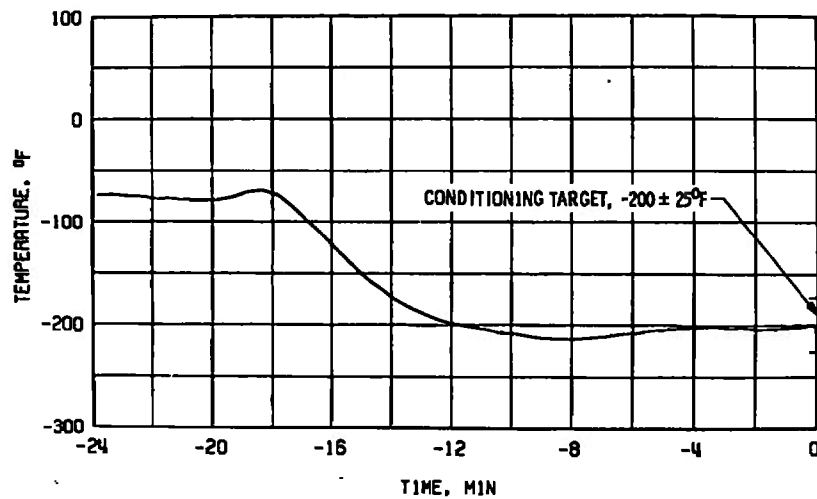

c. Thrust Chamber Throat, TTC-1P

Fig. 60 Thermal Conditioning History of Engine Components, Firing 06E



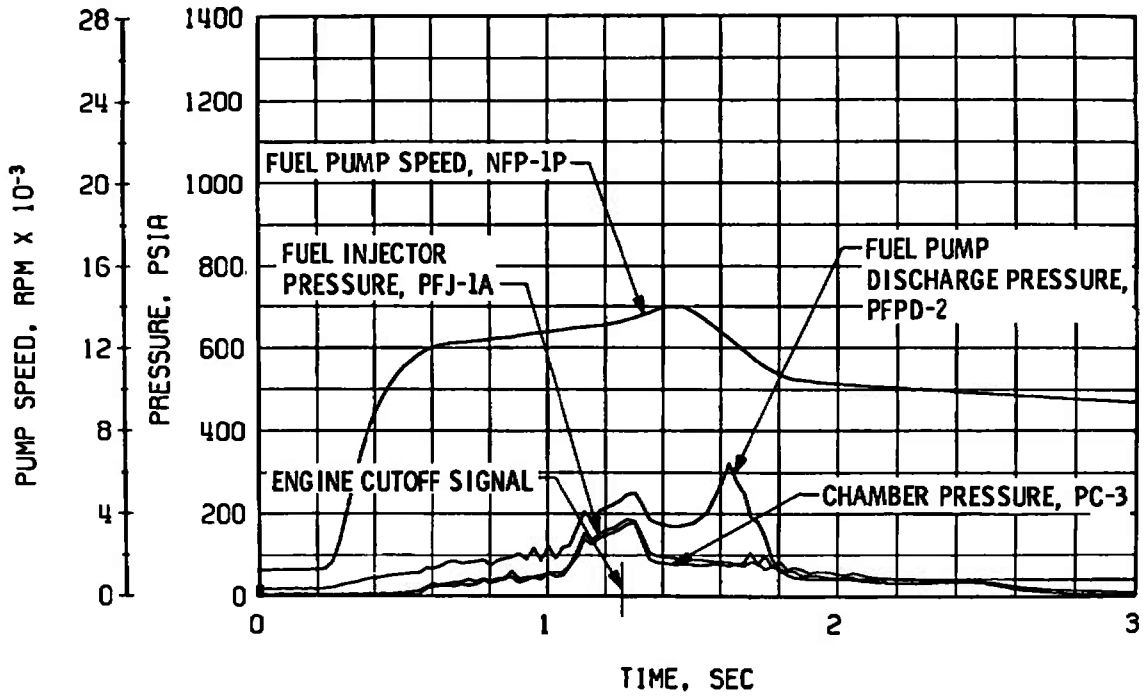

a. Thrust Chamber Fuel System, Start and Shutdown

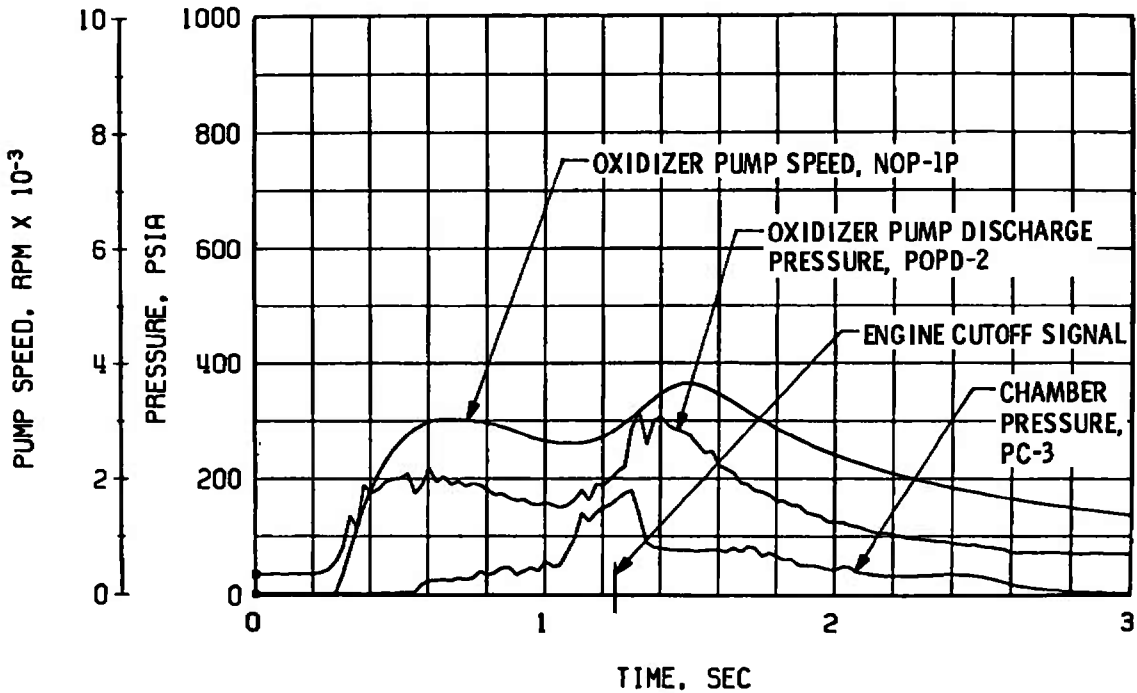

b. Thrust Chamber Oxidizer System, Start and Shutdown

Fig. 61 Engine Transient Operation, Firing 06E

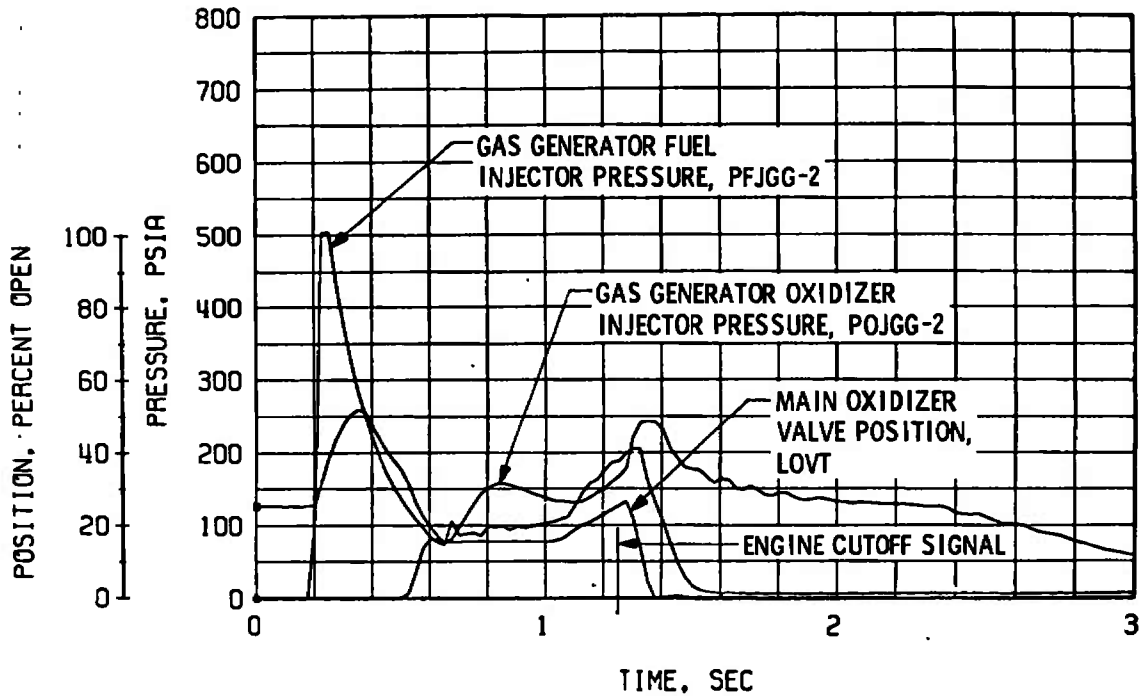

c. Gas Generator Injector Pressures and Main Oxidizer Valve Position, Start and Shutdown

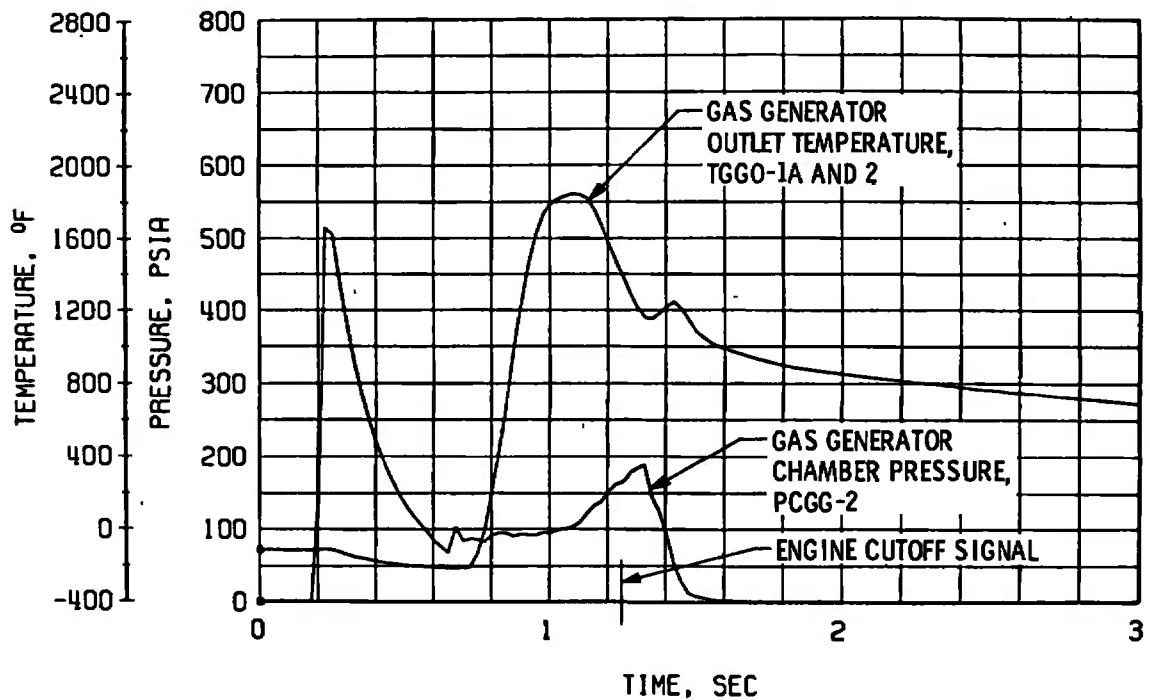

d. Gas Generator Chamber Pressure and Temperature, Start and Shutdown

Fig. 61 Concluded

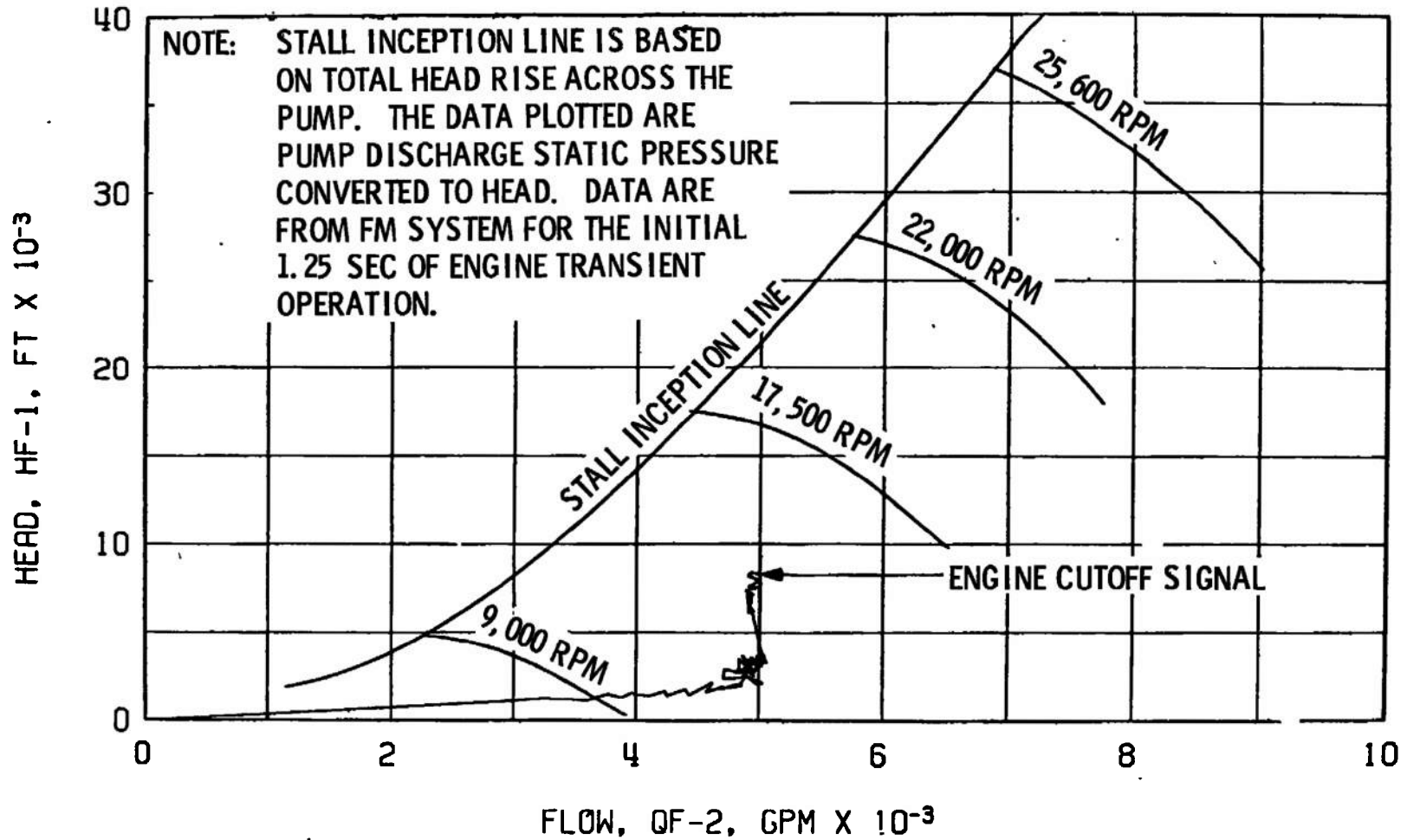

Fig. 62 Fuel Pump Start Transient Performance, Firing 06E

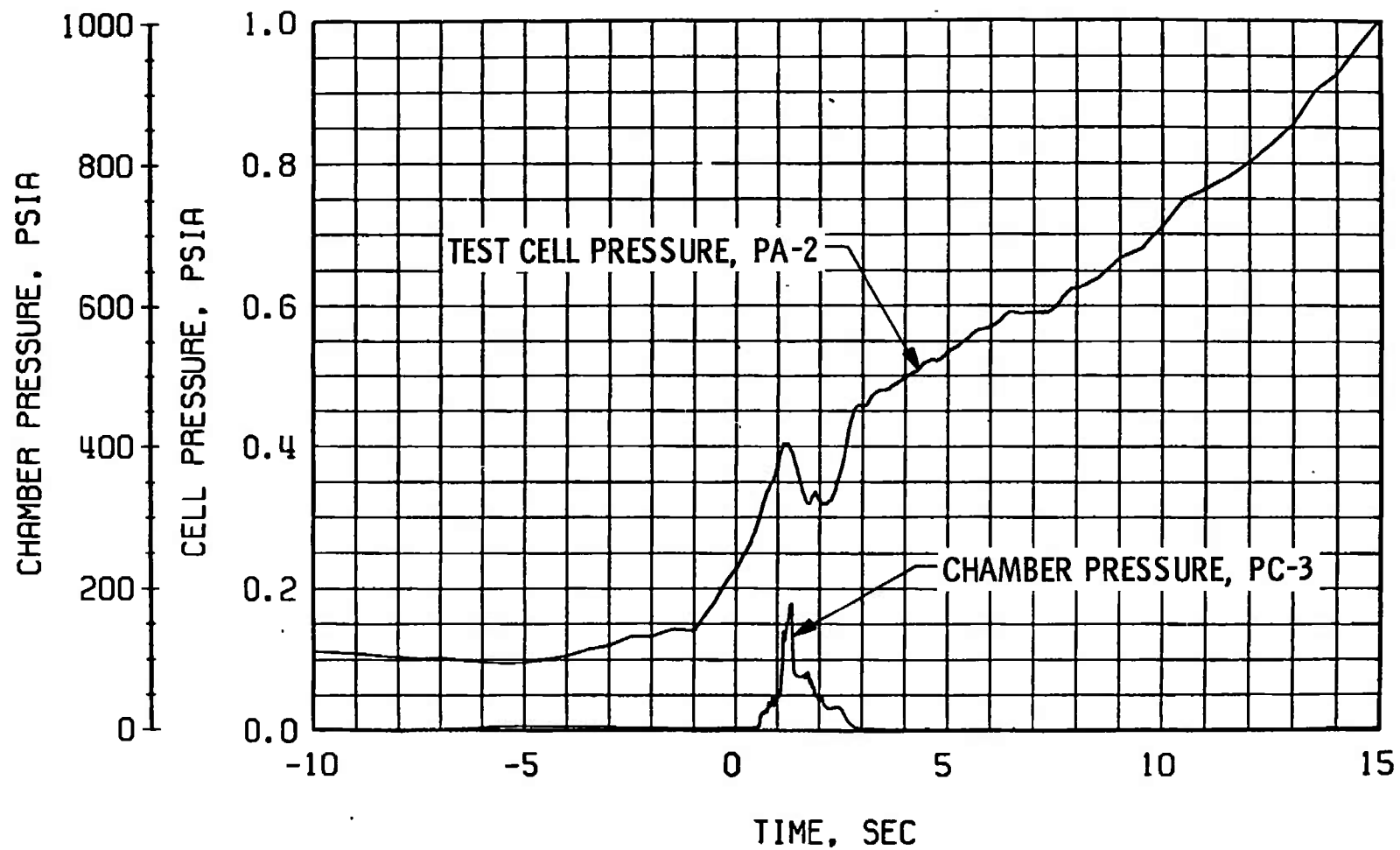

Fig. 63 Engine Ambient and Combustion Chamber Pressure, Firing 06E

**TABLE I**  
**MAJOR ENGINE COMPONENTS**

Part Name	P/N	S/N
Augmented Spark Igniter (Tests 03 and 04)	206280-161	4084016
Augmented Spark Igniter (Tests 05 and 06)	309360-91	4071414
Augmented Spark Igniter Oxidizer Valve	308880	4079065
Auxiliary Flight Instrumentation Package	704090-21	4075163
Electrical Control Package	502670-51	4081742
Fuel Bleed Valve	309034	4084042
Fuel Flowmeter	251225	4074110
Fuel Injector Temperature Transducer	NA5-27441	AA 13283F66
Fuel Turbopump Assembly	460390-181	4073647
Gas Generator Control Valve	309040-31	4055754
Gas Generator Fuel Injector and Combustor	308360-11	4090408
Gas Generator Oxidizer Injector and Poppet Assembly	303323	4092975
Helium Control Valve (Three-Way)	WA5-27273	372452
Helium Regulator Assembly	558130-11	4061139
Helium Tank Vent Valve	NA5-27273	379313
Ignition Phase Control Valve (Four-Way)	558069	8313398
Main Fuel Valve	409920	4074288
Main Oxidizer Valve	411031-21	4072666
Main-Stage Control Valve (Four-Way)	558069	8284312
Oxidizer Bleed Valve	309029	4078081
Oxidizer Flowmeter	251216	4075154
Oxidizer Turbine Bypass Valve	409940	4073096
Oxidizer Turbopump Assembly	458175-111	6610105
Pressure-Actuated Purge Control Valve	558126	4073862
Pressure-Actuated Shutdown Valve Assembly	558127-11	4074549
Primary Flight Instrumentation Package	704095-21	4074730
Propellant Utilization Valve	251351-51	4075182
Restartable Ignition Detect Probe	500750	2125567
Start Tank	307579	0098
Start Tank Discharge Valve	304386	4086957
Start Tank Fill/Relief Valve	557998	4091617
Start Tank Vent and Relief Valve	557848	4080517
Thrust Chamber Body	15-205875	4062445
Thrust Chamber Injector Assembly	208021-11	4089721

**TABLE II  
SUMMARY OF ENGINE ORIFICES**

Orifice Name	Part Number	Diameter, Inches Unless Otherwise Noted	Date Effective	Comments
Gas Generator Fuel Supply Line	RD251-4107	0.488	July 15, 1968	
Gas Generator Oxidizer Supply Line	RD251-4106	0.284	July 15, 1968	
Oxidizer Turbine Bypass Valve Nozzle	RD273-8002	1.520	July 15, 1968	
Main Oxidizer Closing Control Line	710437-083 411039X4	8.30 scfm 8.75 scfm	July 5, 1968 August 5, 1968	Thermostatic Orifice
Oxidizer Turbine Exhaust Manifold	RD251-9004	10.00	(1)	
Augmented Spark Igniter Oxidizer Supply Line	309358	0.125	June 9, 1968	
Augmented Spark Igniter/Fuel Supply Line	---	0.266 0.302	July 26, 1968 August 5, 1968	No Orifice Used for Test 03

(1)As delivered to AEDC

**TABLE III  
ENGINE MODIFICATIONS  
(BETWEEN TESTS J4-1901-03 AND J4-1901-06)**

Modification Number	Completion Date	Description of Modification
Test J4-1901-04		
RFD <sup>1</sup> -AEDC 37-1-68	August 5, 1968	Rerouting of Start Tank Discharge Valve Drain Line
RFD-AEDC 19-68	August 5, 1968	Retiming Main Oxidizer Valve to 1650 <sup>+10</sup> -20 msec
RFD-AEDC 42-68	August 5, 1968	Retiming Gas Generator Oxidizer Valve Opening Delay to 150 <sup>+5</sup> -0 msec
Test J4-1901-05		

<sup>1</sup>RFD - Rocketdyne Field Directive

**TABLE IV  
ENGINE COMPONENT REPLACEMENTS  
(BETWEEN TESTS J4-1901-03 AND J4-1901-06)**

Replacement	Completion Date	Component Replaced
Test J4-1901-04		
UCR <sup>1</sup> R005151	August 5, 1968	Augmented Spark Igniter Assembly
Test J4-1901-05		

<sup>1</sup>UCR - Unsatisfactory Condition Report

**TABLE V  
ENGINE PURGE AND COMPONENT CONDITIONING SEQUENCE**

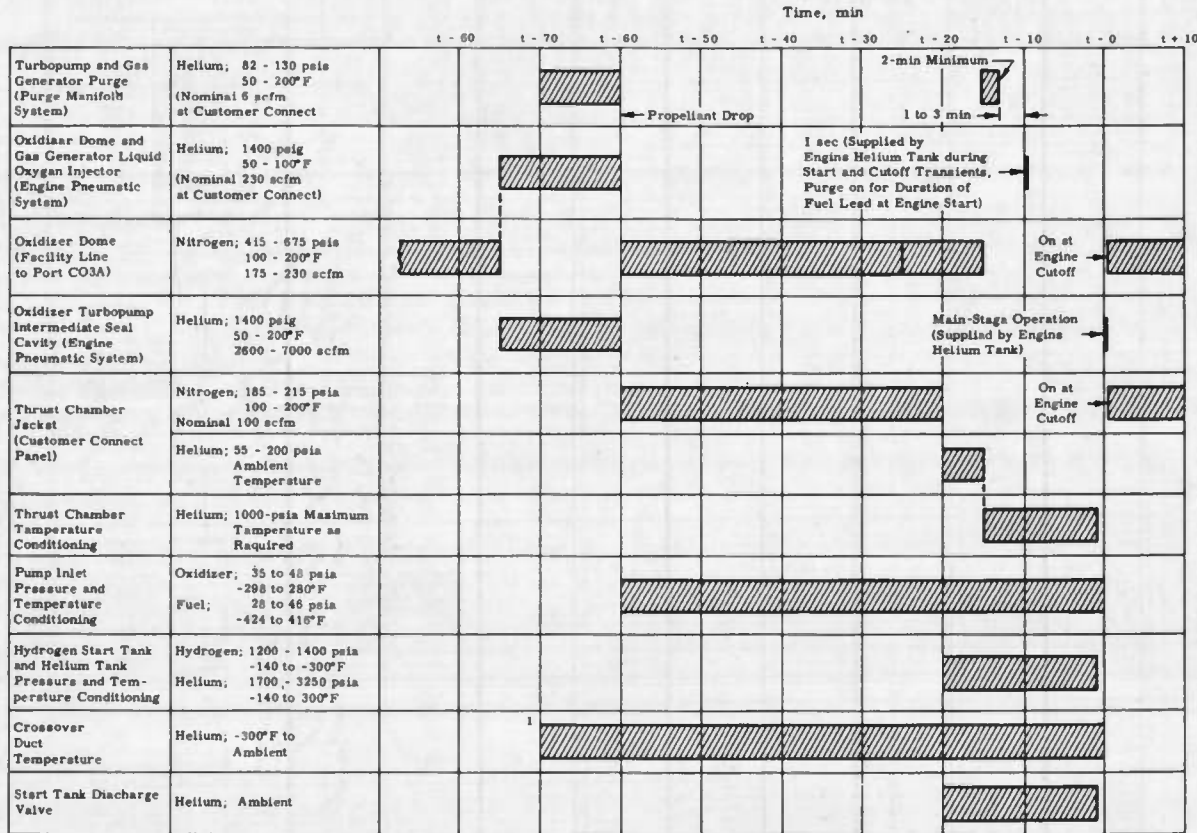

<sup>1</sup>Conditioning Temperature to be Maintained for the Last 30 min of Pre-Fire



TABLE VI  
SUMMARY OF TEST REQUIREMENTS AND RESULTS

Firing Number: J4-1901-03		A		B		C		D	
		Target	Actual	Target	Actual	Target	Actual	Target	Actual
Time of Day, hr/Firing Date		1343	7/23/68	1408	7/23/68	1637	7/23/68	1704	7/23/68
Pressure Altitude at Engine Start, ft (Ref. 1)		100,000	100,000	100,000	108,000	100,000	106,000	100,000	104,000
Firing Duration, sec <sup>ⓐ</sup>		32.5	32.575	7.5	7.588	32.5	32.576	7.5	1.264
Fuel Pump Inlet Conditions at Engine Start	Pressure, psia	41.0 <sup>+1</sup> <sub>-0</sub>	41.6	26.5 <sup>+1</sup> <sub>-0</sub>	27.1	26.5 <sup>+1</sup> <sub>-0</sub>	27.1	28.5 <sup>+1</sup> <sub>-0</sub>	27.0
	Temperature, °F	-421.4 ± 0.4	-421.0	-421.4 ± 0.4	-421.3	-421.4 ± 0.4	-421.7	-421.4 ± 0.4	-421.2
Oxidizer Pump Inlet Conditions at Engine Start	Pressure, psia	33.0 <sup>+1</sup> <sub>-0</sub>	33.6	45.0 <sup>+1</sup> <sub>-0</sub>	45.1	45.0 <sup>+1</sup> <sub>-0</sub>	45.8	45.0 <sup>+1</sup> <sub>-0</sub>	45.0
	Temperature, °F	-285.0 ± 0.4	-285.0	-285.0 ± 0.4	-285.3	-285.0 ± 0.4	-285.1	-285.0 ± 0.4	-285.1
Start Tank Conditions at Engine Start	Pressure, psia	1400 ± 10	1389	1300 ± 10	1301	1400 ± 10	1369	1300 ± 10	1297
	Temperature, °F	-200 ± 10	-200	-215 ± 10	-214	-200 ± 10	-203	-265 ± 10	-266
Helium Tank Conditions at Engine Start	Pressure, psia		2065		2240		2065		2023
	Temperature, °F		-193		-213		-196		-265
Thrust Chamber Temperature Conditions at Engine Start/t <sub>0</sub> , °F	Throat	-90 <sup>+26</sup> <sub>-10</sub>	-64	+50 ± 50	+72	-250 ± 25	-242	+50 ± 50	+62
	Average Engine Start/t <sub>0</sub>		-62	-214	+42	-277	-256	+45	-262
Crossover Duct Temperature at Engine Start, °F <sup>ⓑ</sup>	TFTD-2		+34		+455		+33		+436
	TFTD-4	50 <sup>+0</sup> <sub>-50</sub>	+48	170 <sup>+15</sup> <sub>-0</sub>	+186	50 <sup>+0</sup> <sub>-50</sub>	+50	170 <sup>+15</sup> <sub>-0</sub>	+161
	TFTD-6		+40		+436		+39		+434
Main Oxidizer Valve Second-Stage Actuator Temperature at Engine Start, °F <sup>ⓑ</sup>		-150 ± 50	-146	-150 ± 50	-148	-150 ± 50	-159	-150 ± 50	-154
Fuel Lead Time, sec <sup>ⓐ</sup>		3.0	3.018	8.0	7.821	3.0	3.021	8.0	7.937
Propellant In Engine Time, min		30	129	---	25	30	149	---	27
Propellant Recirculation Time, min		10	12.5	10	10	10	15	10	16
Start Sequence Logic		Normal	Normal	Normal	Normal	Normal	Normal	Normal	Normal
Gas Generator Oxidizer Supply Line Temperature at Engine Start, °F	TOBS-2A		+54		+16		+37		+4
	TOBS-3		+28		+18		+28		+19
	TOBS-4		+54		+48		+53		+51
Start Tank Discharge Valve Body Temperature at Engine Start, °F			+31		-4		-28		-41
Vibration Safety Counts Duration, msec, and Occurrence Time, sec, from t <sub>0</sub>			20		8		35		3
Gas Generator Outlet Temperature, °F	Initial Peak		1560		1750		1640		2190
	Second Peak				1930				
Thrust Chamber Ignition (P <sub>c</sub> = 100 psia) Time, sec (Ref. t <sub>0</sub> ) <sup>ⓐ</sup>			0.978		0.961		1.073		0.939
Main Oxidizer Valve Second-Stage Initial Movement, sec (Ref. t <sub>0</sub> ) <sup>ⓐ</sup>			1.095		1.163		1.085		1.186
Main-Stage Pressure No. 2, asec (Ref. t <sub>0</sub> ) <sup>ⓐ</sup>			1.579		1.645		1.604		---
Time Chamber Pressure Attains 550 psia, sec (Ref. t <sub>0</sub> ) <sup>ⓐ</sup>			1.848		1.993		1.951		---
Propellant Utilization Valve Position, Engine Start/t <sub>0</sub> + 10 sec		Null	Null	Open	Open	Null	Null	Open	Open
		Closed	Closed			Closed	Closed		

Notes: <sup>ⓐ</sup>Data reduced from oscillogram.  
<sup>ⓑ</sup>Component conditioning to be maintained within limits for last 15 min before engine start.  
<sup>ⓒ</sup>Component conditioning to be maintained within limits for last 30 min before engine start or coast duration, whichever is longer.

TABLE VI (Continued)

Firing Number: J4-1901-	04A		04B		04C		04D		05A		
	Target	Actual	Target	Actual	Target	Actual	Target	Actual	Target	Actual	
Time of Day, hr/Firing Date	1245	7/31/68	1312	7/31/68	1500	7/31/68	1527	7/31/68	1533	8/8/68	
Pressure Altitude at Engine Start, ft (Ref. 1)	100,000	78,000	100,000	100,000	100,000	100,000	100,000	100,000	100,000	104,000	
Firing Duration, sec <sup>ⓐ</sup>	32.5	25.020	7.5	7.586	32.5	32.575	7.5	1.994	32.5	0.446	
Fuel Pump Inlet Conditions at Engine Start	Pressure, psia	26.5 <sup>+1</sup> <sub>-0</sub>	27.9	28.5 <sup>+1</sup> <sub>-0</sub>	27.0	41.0 ± 1	40.8	41.0 ± 1	40.8	41.0 ± 1	41.3
	Temperature, °F	-421.4 ± 0.4	-421.5	-421.4 ± 0.4	-421.1	-421.4 ± 0.4	-421.5	-421.4 ± 0.4	-421.3	-420.4 ± 0.4	-420.8
Oxidizer Pump Inlet Conditions at Engine Start	Pressure, psia	45.0 <sup>+1</sup> <sub>-0</sub>	45.2	45.0 <sup>+1</sup> <sub>-0</sub>	45.4	45.0 <sup>+1</sup> <sub>-0</sub>	45.8	45.0 <sup>+1</sup> <sub>-0</sub>	45.8	33.0 ± 1	32.7
	Temperature, °F	-295.0 ± 0.4	-295.1	-295.0 ± 0.4	-295.2	-295.0 ± 0.4	-295.1	-295.0 ± 0.4	-294.6	-294.5 ± 0.4	-294.6
Start Tank Conditions at Engine Start	Pressure, psia	1400 ± 10	1381	1300 ± 10	1291	1400 ± 10	1400	1300 ± 10	1294	1400 ± 10	1374
	Temperature, °F	-200 ± 10	-216	-265 ± 10	-266	-200 ± 10	-207	-265 ± 10	-262	-140 ± 10	-142
Helium Tank Conditions at Engine Start	Pressure, psia		2041		2160		2158		2207		2122
	Temperature, °F		-204		-262		-204		-259		-140
Thrust Chamber Temperature Conditions at Engine Start, °F <sup>ⓑ</sup>	Throat	-80 <sup>+50</sup> <sub>-10</sub>	-87	+50 ± 25	+71	-80 <sup>+20</sup> <sub>-10</sub>	-71	+50 ± 25	+76	-160 <sup>+20</sup> <sub>-10</sub>	-154
	Average Engine Start, °F		-71		+33		-79		+36		-142
Crossover Duct Temperature at Engine Start, °F <sup>ⓑ</sup>	TFTD-2		+35		+424		+16		+433		-101
	TFTD-3/-4	+50 <sup>+0</sup> <sub>-50</sub>	+45	+170 <sup>+10</sup> <sub>-5</sub>	+185	+50 <sup>+0</sup> <sub>-50</sub>	+34	+170 <sup>+10</sup> <sub>-5</sub>	+167	-100 ± 20	-66
	TFTD-5		+44		+412		+22		+419		-87
	Main Oxidizer Valve Second-Stage Actuator Temperature at Engine Start, °F <sup>ⓑ</sup>	-150 ± 50	-106	-150 ± 50	-132	-150 ± 50	-151	-150 ± 50	-146	-100 ± 50	-142
Fuel Load Time, sec <sup>ⓐ</sup>	3.0	3.019	6.0	7.934	3.0	3.021	6.0	7.936	1.0	0.999	
Propellant in Engine Time, min	30		---		30		---		3.0		
Propellant Recirculation Time, min	10	10	10	17.5	10	24.5	10	10	10	10	
Start Sequence Logic	Normal	Normal	Normal	Normal	Normal	Normal	Normal	Normal	Normal	Normal	
Gas Generator Oxidizer Supply Line Temperature at Engine Start, °F	TOBS-2A		+50		+29		+41		+10		+24
	TOBS-3		+44		+31		+37		+27		+36
	TOBS-4		+59		+49		+52		+37		+58
Start Tank Discharge Valve Body Temperature at Engine Start, °F		+55		+3		-61		-53		50 ± 25	+61
Vibration Safety Counts Duration, msec, and Occurrence Time, sec, from t <sub>0</sub>		5		10		26		9		---	---
			0.978		1.049		0.958		0.948		---
Gas Generator Outlet Temperature, °F	Initial Peak		1670		1940		1960		2010		---
	Second Peak		1750		2120				2160		
Thrust Chamber Ignition (P <sub>c</sub> = 100 psia) Time, sec (Ref. t <sub>0</sub> ) <sup>ⓐ</sup>		0.962		0.945		0.958		0.948		---	
Main Oxidizer Valve Second-Stage Initial Movement, sec (Ref. t <sub>0</sub> ) <sup>ⓐ</sup>		1.085		1.198		1.111		1.222		---	
Main-Stage Pressure No. 2, sec (Ref. t <sub>0</sub> ) <sup>ⓐ</sup>		1.582		1.637		1.579		1.542		---	
Time Chamber Pressure Attains 550 psia, sec (Ref. t <sub>0</sub> ) <sup>ⓐ</sup>		1.821		2.005		1.807		1.984		---	
Propellant Utilization Valve Position, Engine Start/t <sub>0</sub> + 10 sec	Null	Null	Open	Open	Null	Null	Open	Open	Null	Null	
	Closed	Closed			Closed	Closed			Closed		

Notes: <sup>ⓐ</sup> Data reduced from oscillogram.  
<sup>ⓑ</sup> Component conditioning to be maintained within limits for last 15 min before engine start.  
<sup>ⓒ</sup> Component conditioning to be maintained within limits for last 30 min before engine start or coast duration, whichever is longer.

TABLE VI (Concluded)

Firing Number: J4-1901-06		A		B		C		D		E	
		Target	Actual	Target	Actual	Target	Actual	Target	Actual	Target	Actual
Time of Day, hr/Firing Date		1446	6/15/68	1514	6/15/68	1848	6/15/68	1917	6/15/68	2027	6/15/68
Pressure Altitude at Engine Start, ft (Ref. 1)		100,000	69,000	100,000	66,000	100,000	103,000	100,000	103,000	100,000	110,000
Firing Duration, sec <sup>ⓐ</sup>		32.5	32.574	7.5	7.589	32.5	32.574	7.5	7.585	1.25	1.251
Fuel Pump Inlet Conditions at Engine Start	Pressure, psia	26.5 <sup>+1</sup> <sub>-0</sub>	27.2	26.5 <sup>+1</sup> <sub>-0</sub>	26.8	26.5 <sup>+1</sup> <sub>-0</sub>	26.2	26.5 <sup>+1</sup> <sub>-0</sub>	26.4	26.5 <sup>+1</sup> <sub>-0</sub>	27.2
	Temperature, °F	-421.4 ± 0.4	-421.3	-421.4 ± 0.4	-420.6	-421.4 ± 0.4	-421.7	-421.4 ± 0.4	-421.2	-421.4 ± 0.4	-421.2
Oxidizer Pump Inlet Conditions at Engine Start	Pressure, psia	33.0 ± 1	33.7	45.0 <sup>+1</sup> <sub>-0</sub>	45.4	33.0 <sup>+1</sup> <sub>-0</sub>	33.7	45.0 <sup>+1</sup> <sub>-0</sub>	45.2	33.0 <sup>+1</sup> <sub>-0</sub>	32.0
	Temperature, °F	-295.0 ± 0.4	-295.4	-295.0 ± 0.4	-285.2	-295.0 ± 0.4	-294.9	-295.0 ± 0.4	-294.7	-295.0 ± 0.4	-293.9
Start Tank Conditions at Engine Start	Pressure, psia	1250 ± 10	1258	1300 ± 10	1313	1250 ± 10	1263	1300 ± 10	1312	1250 ± 10	1254
	Temperature, °F	-140 ± 10	-143	-265 ± 10	-267	-140 ± 10	-140	-265 ± 10	-285	-140 ± 10	-137
Helium Tank Conditions at Engine Start	Pressure, psia		2091		2081		2096		2081		2445
	Temperature, °F		-129		-257		-136		-261		-144
Thrust Chamber Temperature Conditions at Engine Start/t <sub>0</sub> , °F	Throat	-200 ± 25	-203	+50 ± 25	+72	-250 ± 25	-246	-200 ± 25	-217	-200 ± 25	-169
	Average Engine Start/t <sub>0</sub>		-185		+24		-241		-206		-372
Crossover Duct Temperatures at Engine Start, °F <sup>ⓑ</sup>	TFTD-2		-109		+409		-110		+409		-110
	TFTD-3/-4	-100 ± 20	-76	±170 <sup>+15</sup> <sub>-0</sub>	+174	-100 ± 20	-88	+170 <sup>+15</sup> <sub>-0</sub>	+173	-100 ± 20	-95
	TFTD-5		-60		+406		-93		+415		-100
	TFTD-6		-60		+406		-93		+415		-100
Main Oxidizer Valve Second-Stage Actuator Temperatures at Engine Start, °F <sup>ⓑ</sup>		-150 ± 50	-121	-150 ± 50	-147	-150 ± 50	-176	-150 ± 50	-171	-150 ± 50	-184
Fuel Load Time, sec <sup>ⓐ</sup>		8.0	7.936	6.0	7.939	3.0	3.022	6.0	7.936	6.0	7.936
Propellant in Engine Time, min		30		---		30		---		30	
Propellant Recirculation Time, min		10	10	10	14	10	10	10	11.5	10	10
Start Sequence Logic		Normal	Normal	Normal	Normal	Normal	Normal	Normal	Normal	Normal	Normal
Gas Generator Oxidizer Supply Line Temperatures at Engine Start, °F	TOBS-2A		+32		+3		-6		-10		-19
	TOBS-3		+30		+19		+19		-5		+9
	TOBS-4		+46		+50		+41		+34		+42
Start Tank Discharge Valve Body Temperature at Engine Start, °F			+78		+24		+12		-16		+26
Vibration Safety Counts Duration, msec, and Occurrence Time, sec, from t <sub>0</sub>			75		21		33		25		
Gas Generator Outlet Temperature, °F			1450		1730		2020		1930		1640
Thrust Chamber Ignition (P <sub>c</sub> = 100 psia) Time, sec (Ref. t <sub>0</sub> ) <sup>ⓐ</sup>			1.091		0.953		1.092		0.972		1.093
Main Oxidizer Valve Second-Stage Initial Movement, sec (Ref. t <sub>0</sub> ) <sup>ⓐ</sup>			0.967		1.115		1.004		1.098		1.014
Main-Stage Pressure No. 2, sec (Ref. t <sub>0</sub> ) <sup>ⓐ</sup>			2.161		1.768		1.804		1.859		---
Time Chamber Pressure Attains 550 psia, sec (Ref. t <sub>0</sub> ) <sup>ⓐ</sup>			3.233		2.013		2.124		2.090		---
Propellant Utilization Valve Position, Engine Start/t <sub>0</sub> + 10 sec		Open	Open	Open	Open	Null	Null	Open	Open	Null	Null
		Closed	Closed	Closed	Closed	Closed	Closed	Closed	Closed	Closed	Closed

Notes: <sup>ⓐ</sup>Data reduced from oscillogram.  
<sup>ⓑ</sup>Component conditioning to be maintained within limits for last 15 min before engine start.  
<sup>ⓒ</sup>Component conditioning to be maintained within limits for last 30 min before engine start or coast duration, whichever is longer.

**TABLE VII  
ENGINE VALVE TIMINGS**

Firing Number J4-1801-	Start																							
	Start Tank Discharge Valve						Main Fuel Valve			Main Oxidizer Valve First Stage			Main Oxidizer Valve Second Stage			Gas Generator Fuel Poppet			Gas Generator Oxidizer Poppet			Oxidizer Turbine Bypass Valve		
	Time of Opening Signal	Valve Delay Time, sec	Valve Opening Time, sec	Time of Closing Signal	Valve Delay Time, sec	Valve Closing Time, sec	Time of Opening Signal	Valve Delay Time, sec	Valve Opening Time, sec	Time of Opening Signal	Valve Delay Time, sec	Valve Opening Time, sec	Time of Opening Signal	Valve Delay Time, sec	Valve Opening Time, sec	Time of Opening Signal	Valve Delay Time, sec	Valve Opening Time, sec	Time of Opening Signal	Valve Delay Time, sec	Valve Opening Time, sec	Time of Closing Signal	Valve Delay Time, sec	Valve Closing Time, sec
03A	0.0	0.128	0.111	0.450	0.128	0.248	-3.018	0.076	0.102	0.450	0.056	0.052	0.450	0.645	1.882	0.450	0.108	0.030	0.450	0.185	0.077	0.450	0.211	0.286
03B	0.0	0.131	0.113	0.450	0.131	0.251	-7.821	0.073	0.108	0.450	0.058	0.052	0.450	0.733	1.798	0.450	0.112	0.033	0.450	0.191	0.088	0.450	0.208	0.291
03C	0.0	0.136	0.118	0.449	0.131	0.258	-3.021	0.085	0.088	0.448	0.057	0.051	0.448	0.848	1.902	0.448	0.112	0.031	0.448	0.167	0.078	0.448	0.209	0.289
03D	0.0	0.137	0.121	0.450	0.135	0.253	-7.837	0.073	0.114	0.450	0.056	0.052	0.450	0.736	---	0.450	0.113	0.030	0.450	0.186	0.091	0.450	0.201	0.288
Final Sequence	0.0	0.086	0.088	0.449	0.126	0.238	-1.000	0.055	0.103	0.449	0.048	0.047	0.449	0.588	1.743	0.448	0.082	0.033	0.449	0.141	0.071	0.449	0.182	0.281
04A	0.0	0.127	0.109	0.450	0.128	0.244	-3.018	0.079	0.103	0.450	0.058	0.051	0.450	0.635	1.898	0.450	0.106	0.031	0.450	0.183	0.080	0.450	0.218	0.286
04B	0.0	0.130	0.118	0.450	0.132	0.248	-7.834	0.074	0.114	0.450	0.058	0.052	0.450	0.746	1.765	0.450	0.108	0.031	0.450	0.188	0.088	0.450	0.206	0.287
04C	0.0	0.137	0.128	0.449	0.134	0.258	-3.021	0.073	0.111	0.449	0.056	0.053	0.449	0.662	1.883	0.449	0.111	0.031	0.448	0.187	0.084	0.449	0.218	0.286
04D	0.0	0.136	0.123	0.448	0.135	0.259	-7.838	0.076	0.113	0.448	0.055	0.053	0.448	0.774	---	0.448	0.112	0.032	0.448	0.182	0.092	0.448	0.207	0.280
Final Sequence	0.0	0.086	0.082	0.450	0.127	0.241	-0.877	0.058	0.106	0.450	0.051	0.044	0.450	0.604	1.737	0.450	0.084	0.032	0.450	0.142	0.068	0.450	0.187	0.288
05A	0.0	0.123	0.108	0.446	1.718	0.431	-1.001	0.088	0.086	---	---	---	---	---	---	---	---	---	---	---	---	---	---	---
Final Sequence	0.0	0.090	0.089	0.450	0.126	0.238	-1.000	0.057	0.101	0.450	0.053	0.048	0.450	0.475	1.850	0.450	0.078	0.038	0.450	0.153	0.081	0.450	0.188	0.282
06A	0.0	0.119	0.103	0.450	0.116	0.248	-7.838	0.083	0.088	0.450	0.056	0.051	0.450	0.537	1.761	0.450	0.107	0.038	0.450	0.188	0.084	0.450	0.202	0.286
06B	0.0	0.126	0.114	0.451	0.128	0.242	-7.839	0.081	0.115	0.451	0.057	0.051	0.451	0.664	1.743	0.451	0.117	0.033	0.451	0.207	0.108	0.451	0.211	0.288
06C	0.0	0.123	0.112	0.448	0.125	0.251	-3.022	0.085	0.116	0.448	0.059	0.055	0.448	0.556	1.787	0.448	0.118	0.038	0.448	0.188	0.101	0.448	0.217	0.298
06D	0.0	0.132	0.117	0.448	0.127	0.251	-7.836	0.084	0.119	0.448	0.058	0.053	0.448	0.648	1.767	0.448	0.118	0.038	0.448	0.212	0.104	0.448	0.213	0.283
06E	0.0	0.133	0.111	0.449	0.124	0.251	-7.838	0.082	0.116	0.449	0.058	0.052	0.448	0.565	---	0.448	0.116	0.035	0.448	0.203	0.108	0.448	0.203	0.281
Final Sequence	0.0	0.092	0.083	0.446	0.126	0.237	-0.898	0.047	0.082	0.446	0.052	0.047	0.448	0.480	1.846	0.448	0.088	0.037	0.448	0.154	0.078	0.448	0.185	0.280

- Notes: 1. All valve signal times are referenced to  $t_0$ .  
 2. Valve delay time is the time required for initial valve movement after the valve "open" or "closed" solenoid has been energized.  
 3. Final sequence check is conducted without propellant and within 12 hr before testing.  
 4. Data reduced from oscillogram.

TABLE VII (Concluded)

Firing Number J4-1901-	Shutdown														
	Main Fuel Valve			Main Oxidizer Valve			Gas Generator Fuel Poppet			Gas Generator Oxidizer Poppet			Oxidizer Turbine Bypass Valve		
	Time of Closing Signal	Valve Delay Time, sec	Valve Closing Time, sec	Time of Closing Signal	Valve Delay Time, sec	Valve Closing Time, sec	Time of Closing Signal	Valve Delay Time, sec	Valve Closing Time, sec	Time of Closing Signal	Valve Delay Time, sec	Valve Closing Time, sec	Time of Opening Signal	Valve Delay Time, sec	Valve Opening Time, sec
03A	32.573	0.108	0.302	32.573	0.086	0.183	32.573	0.068	0.013	32.573	0.032	0.013	32.573	0.251	0.518
03B	7.586	0.099	0.290	7.586	0.078	0.176	7.586	0.075	0.016	7.586	0.036	0.015	7.586	0.234	0.486
03C	32.573	0.111	0.330	32.573	0.088	0.184	32.573	0.069	0.015	32.573	0.031	0.015	32.573	0.252	0.513
03D	1.263	0.096	0.295	1.263	---	---	1.263	0.081	0.020	1.263	0.041	0.018	1.263	0.158	0.504
Final Sequence	4.704	0.081	0.224	4.704	0.053	0.123	4.704	0.090	0.037	4.704	0.061	0.022	4.704	0.218	0.574
04A	25.020	0.107	0.301	25.020	0.081	0.176	25.020	0.068	0.014	25.020	0.031	0.013	25.020	0.247	0.543
04B	7.586	0.101	0.294	7.586	0.076	0.174	7.586	0.074	0.015	7.586	0.036	0.015	7.586	0.217	0.492
04C	32.573	0.108	0.315	32.573	0.086	0.186	32.573	0.069	0.015	32.573	0.031	0.014	32.573	0.249	0.528
04D	1.994	0.096	0.293	1.994	---	---	1.994	0.076	0.016	1.994	0.036	0.014	1.994	0.198	0.499
Final Sequence	6.447	0.081	0.224	6.447	0.062	0.121	6.447	0.094	0.037	6.447	0.061	0.024	6.447	0.222	0.588
05A	0.448	0.098	0.271	---	---	---	---	---	---	---	---	---	---	---	---
Final Sequence	4.634	0.079	0.226	4.634	0.053	0.123	4.634	0.092	0.034	4.634	0.059	0.026	4.634	0.218	0.578
06A	32.573	0.107	0.313	32.573	0.083	0.178	32.573	0.066	0.012	32.573	0.031	0.013	32.573	0.254	0.574
06B	7.588	0.103	0.316	7.588	0.078	0.174	7.588	0.074	0.016	7.588	0.036	0.015	7.588	0.233	0.525
06C	32.571	0.121	0.365	32.571	0.089	0.191	32.571	0.074	0.015	32.571	0.033	0.014	32.571	0.276	0.616
06D	7.584	0.109	0.341	7.584	0.081	0.179	7.584	0.079	0.016	7.584	0.037	0.015	7.584	0.245	0.522
06E	1.247	0.109	0.347	1.247	---	---	1.247	0.087	0.026	1.247	0.051	0.022	1.247	0.169	0.564
Final Sequence	6.695	0.079	0.222	6.695	0.064	0.118	6.695	0.093	0.037	6.695	0.059	0.026	6.695	0.218	0.576

- Notes: 1. All valve signal times are referenced to  $t_0$ .  
 2. Valve delay time is the time required for initial valve movement after the valve "open" or "closed" solenoid has been energized.  
 3. Final sequence check is conducted without propellants and within 12 hr before testing.  
 4. Data reduced from oscillogram.

**TABLE VIII  
ENGINE PERFORMANCE SUMMARY**

Firing Number J4-1901-		03A		03C		04C		06A		06C	
		Site	Normalized	Site	Normalized	Site	Normalized	Site	Normalized	Site	Normalized
Overall Engine Performance	Thrust, lbf	230,597	227,639	229,956	227,390	229,450	226,787	229,959	227,274	230,360	227,645
	Chamber Pressure, psia	788.9	775.1	786.8	774.4	785.5	772.4	787.4	773.9	788.6	775.4
	Mixture Ratio	5.498	5.507	5.584	5.574	5.583	5.597	5.606	5.621	5.638	5.819
	Fuel Weight Flow, lb <sub>m</sub> /sec	84.11	82.57	83.25	81.87	82.76	81.27	82.59	81.07	82.54	81.37
	Oxidizer Weight Flow, lb <sub>m</sub> /sec	462.3	454.7	463.2	456.4	462.0	454.9	463.1	455.7	465.3	457.2
	Total Weight Flow, lb <sub>m</sub> /sec	546.4	537.3	546.5	538.3	544.8	536.2	545.6	536.8	547.9	538.6
Thrust Chamber Performance	Mixture Ratio	5.701	5.715	5.773	5.787	5.788	5.806	5.818	5.837	5.849	5.832
	Total Weight Flow, lb <sub>m</sub> /sec	539.3	530.2	539.4	531.2	537.8	529.2	538.6	529.8	540.8	531.8
	Characteristic Velocity, ft/sec	8017	8011	7994	7989	8005	7999	8012	8005	7992	7995
Fuel Turbopump Performance	Pump Efficiency, percent	73.8	73.8	73.8	73.8	73.7	73.7	73.9	73.9	74.0	74.0
	Pump Speed, rpm	26,829	26,573	26,640	26,449	26,518	26,319	26,529	26,329	26,671	26,478
	Turbine Efficiency, percent	60.8	60.6	60.3	60.2	59.4	59.2	59.4	59.2	59.4	59.3
	Turbine Pressure Ratio	7.38	7.38	7.30	7.29	7.33	7.33	7.34	7.34	7.33	7.33
	Turbine Inlet Temperature, °F	1230	1210	1230	1214	1273	1256	1242	1225	1261	1239
	Turbine Weight Flow, lb <sub>m</sub> /sec	7.11	7.03	7.08	7.01	7.02	6.94	7.07	6.98	7.08	7.00
Oxidizer Turbopump Performance	Pump Efficiency, percent	80.3	80.2	80.3	80.3	80.3	80.3	80.3	80.3	80.4	80.3
	Pump Speed, rpm	8707	8633	8724	8650	8695	8620	8673	8602	8702	8624
	Turbine Efficiency, percent	48.4	48.2	48.7	48.4	49.2	48.9	48.9	48.7	49.1	48.9
	Turbine Pressure Ratio	2.58	2.58	2.60	2.59	2.59	2.58	2.59	2.59	2.58	2.58
	Turbine Inlet Temperature, °F	827.4	813.3	831.6	819.7	843.7	832.0	832.9	821.1	847.5	831.4
	Turbine Weight Flow, lb <sub>m</sub> /sec	6.23	6.16	8.19	6.13	6.14	6.07	6.18	6.11	6.19	6.13
Gas Generator Performance	Mixture Ratio	0.957	0.946	0.957	0.948	0.983	0.973	0.964	0.955	0.976	0.963
	Chamber Pressure, psia	691.3	681.4	688.0	679.2	686.6	677.2	688.0	678.3	691.2	681.6

- Notes: 1. Site data are calculated from test data.  
 2. Normalized data are corrected to standard pump inlet and engine ambient pressure conditions.  
 3. Input data are test data averaged from 29 to 30 sec, except as noted.  
 4. Site and normalized data were computed using the Rocketdyne PAST 640 modification zero computer program.

**APPENDIX III  
INSTRUMENTATION**

The instrumentation for AEDC tests J4-1901-03 through J4-1901-06 is tabulated in Table III-1. The location of selected major engine instrumentation is shown in Fig. III-1.



**TABLE III-1  
INSTRUMENTATION LIST**

<u>AEDC Code</u>	<u>Parameter</u>	<u>Tap No.</u>	<u>Range</u>	<u>Micro-sacie</u>	<u>Magnetic Tape</u>	<u>Oscillo-graph</u>	<u>Strip Chart</u>	<u>X-Y Plotter</u>
	<u>Current</u>		<u>amp</u>					
ICC	Control		0 to 30	x		x		
IIC	Ignition		0 to 30	x		x		
	<u>Event</u>							
EASIOV	Augmented Spark Igniter Oxidizer Valve		Open/Closed	x		x		
EECL	Engine Cutoff Lockin		On/Off	x		x		
EECO	Engine Cutoff Signal		On/Off	x	x	x		
EES	Engine Start Command		On/Off	x		x		
EFBVC	Fuel Bleed Valve Closed Limit		Open/Closed	x				
EFPVC/O	Fuel Prevalve Closed/Open Limit		Closed/Open	x				
EHCS	Helium Control Solenoid		On/Off	x		x		
EID	Ignition Detected		On/Off	x		x		
EIPCS	Ignition Phase Control Solenoid		On/Off	x		x		
EMCS	Main-Stage Control Solenoid		On/Off	x		x		
EMP-1	Main-Stage Pressure No. 1		On/Off	x		x		
EMP-2	Main-Stage Pressure No. 2		On/Off	x		x		
EOBVC	Oxidizer Bleed Valve Closed Limit		Open/Closed	x				
EOPVC	Oxidizer Prevalve Closed Limit		Closed	x		x		
EOPVO	Oxidizer Prevalve Open Limit		Open	x		x		
ESTDCS	Start Tank Discharge Control Solenoid		On/Off	x	x	x		
RASIS-1	Augmented Spark Igniter No. 1		On/Off			x		
RASIS-2	Augmented Spark Igniter No. 2		On/Off			x		
RGGS-1	Gas Generator Spark No. 1		On/Off			x		
RGGS-2	Gas Generator Spark No. 2		On/Off			x		
	<u>Flow</u>		<u>gpm</u>					
QF-1A	Fuel	PPF	0 to 9000	x		x		
QF-2	Fuel	PFPA	0 to 9000	x	x	x		
QF-1SAM	Fuel Flow Stall Approach Monitor		0 to 9000	x		x		
QFRP	Fuel Recirculation		0 to 160	x				
QO-1A	Oxidizer	POF	0 to 3000	x		x		
QO-2	Oxidizer	POFA	0 to 3000	x	x	x		
QORP	Oxidizer Recirculation		0 to 50	x				
	<u>Position</u>		<u>Percent Open</u>					
LFVT	Main Fuel Valve		0 to 100	x		x		
LGGVT	Gas Generator Valve		0 to 100	x		x		
LOTBVT	Oxidizer Turbine Bypass Valve		0 to 100	x		x		
LOVT	Main Oxidizer Valve		0 to 100	x		x		
LPUTOP	Propellant Utilization Valve		0 to 100	x		x	x	
LSTDVT	Start Tank Discharge Valve		0 to 100	x		x		



TABLE III-1 (Continued)

<u>AEDC Code</u>	<u>Parameter</u>	<u>Tap No.</u>	<u>Range</u>	<u>Micro-sadic</u>	<u>Magnetic Tape</u>	<u>Oscillo-graph</u>	<u>Strip Chart</u>	<u>X-Y Plotter</u>
	<u>Pressure</u>		<u>psia</u>					
PA1	Test Cell		0 to 0.5	x		x		
PA2	Test Cell		0 to 1.0	x	x			
PA3	Test Cell		0 to 5.0	x			x	
PC-1P	Thrust Chamber	CG1	0 to 1000	x				
PC-3	Thrust Chamber	CG1A	0 to 1000	x	x	x		
PCBO-1	Constant Bleed Orifice		0 to 50	x				
PCDP	Crossover Duct Purge		0 to 100	x				
PCGG-1P	Gas Generator Chamber		0 to 1000	x	x	x		
PCGG-2	Gas Generator Chamber	GG1A	0 to 1000	x				
PFBL	Fuel Bleed Line		0 to 500 <sup>1</sup>	x		x		
PFJ-1A	Main Fuel Injection	CF2	0 to 1000	x		x		
PFJGG-1A	Gas Generator Fuel Injection	GF4	0 to 1000	x		x		
PFJGG-2	Gas Generator Fuel Injection	GF4	0 to 1000	x		x		
PFPC-1A	Fuel Pump Balance Piston Cavity	PF5	0 to 1000	x				
PFPD-1P	Fuel Pump Discharge	PF3	0 to 1500	x				
PFPD-2	Fuel Pump Discharge	PF2	0 to 1500	x	x	x		
PFPI-1	Fuel Pump Inlet		0 to 100	x		x		x
PFPI-2	Fuel Pump Inlet		0 to 100	x		x		x
PFPI-3	Fuel Pump Inlet		0 to 200		x			
PFPSPD-1	Fuel Pump Primary Seal Drain		0 to 200	x				
PFRPO	Fuel Recirculation Pump Outlet		0 to 60	x				
PFRPR	Fuel Recirculation Pump Return		0 to 50	x				
PFST-1P	Fuel Start Tank	TF1	0 to 1500	x		x		
PFST-2	Fuel Start Tank	TF1	0 to 1500	x				x
PFUT	Fuel Tank Ullage		0 to 100	x				
PTVI	Fuel Tank Pressurization Line Nozzle Inlet		0 to 1000	x				
PFVL	Fuel Tank Pressurization Line Nozzle Throat		0 to 1000	x				
PHECMO	Pneumatic Control Module Outlet		0 to 750	x				
PHEOP	Oxidizer Recirculation Pump Purge		0 to 150	x				
PHET-1P	Helium Tank	NN1	0 to 3500	x		x		
PHFT-2	Helium Tank	NN1	0 to 3500	x				x
PHRO-1A	Helium Regulator Outlet	NN2	0 to 750	x				
POJ-1A	Main Oxidizer Injection	CO3	0 to 1000	x		x		
POJ-2	Main Oxidizer Injection	CO3A	0 to 1000	x		x		
POJ-3	Main Oxidizer Injection		0 to 2000		x			
POJGG-1A	Gas Generator Oxidizer Injection	GO5	0 to 1000	x		x		
POJGG-2	Gas Generator Oxidizer Injection	GO5	0 to 1000	x				
POPEC-1A	Oxidizer Pump Bearing Coolant	PO7	0 to 500	x				

TABLE III-1 (Continued)

<u>AEDC Code</u>	<u>Parameter</u>	<u>Tap No.</u>	<u>Range</u>	<u>Micro-sadic</u>	<u>Magnetic Tape</u>	<u>Oscillograph</u>	<u>Strip Chart</u>	<u>X-Y Plotter</u>
<u>Pressures</u>								
<u>psia</u>								
POPD-1P	Oxidizer Pump Discharge	PO3	0 to 1500	x				
POPD-2	Oxidizer Pump Discharge	PO2	0 to 1500	x	x	x		
POPI-1	Oxidizer Pump Inlet		0 to 100	x				x
POPI-2	Oxidizer Pump Inlet		0 to 200	x				x
POPI-3	Oxidizer Pump Inlet		0 to 100			x		
POPSC-1A	Oxidizer Pump Primary Seal Cavity	PO6	0 to 50	x				
PORPO	Oxidizer Recirculation Pump Outlet		0 to 115	x				
PORPR	Oxidizer Recirculation Pump Return		0 to 100	x				
POTI-1A	Oxidizer Turbine Inlet	TG3	0 to 200	x				
POTO-1A	Oxidizer Turbine Outlet	TG4	0 to 100	x				
POUT	Oxidizer Tank Ullage		0 to 100	x				
POVCC	Main Oxidizer Valve Closing Control		0 to 500	x				
POVI	Oxidizer Tank Pressurization Line Nozzle Inlet		0 to 1000	x				
POVL	Oxidizer Tank Pressurization Line Nozzle Throat		0 to 1000	x				
PPUVI-1A	Propellant Utilization Valve Inlet	PO8	0 to 1500	x				
PPUVO-1A	Propellant Utilization Valve Outlet	PO9	0 to 500	x				
PTCFJP	Thrust Chamber Fuel Jacket Purge		0 to 100	x				
PTCP	Thrust Chamber Purge		0 to 1000	x				
PTEP	Turbopump and Gas Generator Purge		0 to 250	x				
<u>Speeds</u>								
<u>rpm</u>								
NFP-1P	Fuel Pump	PFV	0 to 30,000	x	x	x		
NFRP	Fuel Recirculation Pump		0 to 15,000	x				
NOP-1P	Oxidizer Pump	POV	0 to 12,000	x	x	x		
NORP	Oxidizer Recirculation Pump		0 to 15,000	x				
<u>Temperatures</u>								
<u>°F</u>								
TA1	Test Cell (North)		-50 to +800	x				
TA2	Test Cell (East)		-50 to +800	x				
TA3	Test Cell (South)		-50 to +800	x				
TA4	Test Cell (West)		-50 to +800	x				
TAIP-1A	Auxiliary Instrument Package		-300 to +200	x				
TAIPAA	Auxiliary Instrument Package Area Ambient		-200 to +500	x				
TCDP	Crossover Duct Purge		-150 to +150	x				
TECP-1P	Electrical Controls Package	NST1A	-300 to +200	x			x	
TEHAA	Engine Handler Attach Area Ambient		-200 to +500	x				

TABLE III-1 (Continued)

<u>AEDC Code</u>	<u>Parameter</u>	<u>Tap No.</u>	<u>Range</u>	<u>Micro-sadic</u>	<u>Magnetic Tape</u>	<u>Oscillo-graph</u>	<u>Strip Chart</u>	<u>X-Y Plotter</u>
<u>Temperatures</u>			<u>°F</u>					
TFASIL-2	Augmented Spark Igniter Fuel Line Skin		-400 to +300	x				
TFASIL-4	Augmented Spark Igniter Fuel Line Skin		-425 to +500	x				
TFBV-1A	Fuel Bleed Valve	GFT1	-425 to -375	x				
TFD-1	Fire Detection		0 to 1000	x			x	
TFDAA	Fuel High Pressure Duct Area Ambient		-200 to +500	x				
TFJ-1P	Main Fuel Injection	CFT2	-425 to +250	x		x		
TFJ-2 <sup>2</sup>	Main Fuel Injection		-450 to +250	x				
TFPD-1P	Fuel Pump Discharge	PFT1	-425 to -400	x	x	x		
TFPD-2	Fuel Pump Discharge	PFT1	-425 to -400	x				
TFPI-1	Fuel Pump Inlet		-425 to -400	x				x
TFPI-2	Fuel Pump Inlet		-425 to -400	x				x
TFRPO	Fuel Recirculation Pump Outlet		-425 to -350	x				
TFRPR	Fuel Recirculation Pump Return Line		-425 to -250	x				
TFRT-1	Fuel Tank		-425 to -410	x				
TFRT-3	Fuel Tank		-425 to -410	x				
TFST-1P	Fuel Start Tank	TFT1	-350 to +100	x				
TFST-2	Fuel Start Tank	TFT1	-350 to +100	x				x
TFTD-2	Fuel Turbine Discharge Duct		-200 to -1000	x			x	
TFTD-3	Fuel Turbine Discharge Duct		-200 to +1000	x			x	
TFTD-4	Fuel Turbine Discharge Duct		-200 to +1000	x			x <sup>2</sup>	
TFTD-8	Fuel Turbine Discharge Duct		-200 to +1400	x			x	
TFTO	Fuel Turbine Outlet	TFT2	0 to 1800	x				
TFTSD-1	Fuel Turbine Seal Drain Line		-300 to +100	x				
TGGO-1A and 2	Gas Generator Outlet	GGT1	0 to 2500	x		x	x	
TGGVRS	Gas Generator Valve Retaining Screw		-100 to +100	x			x <sup>3</sup>	
THET-1P	Helium Tank	NNT1	-350 to +100	x				x
TNODP	Oxidizer Dome Purge		0 to +300	x				
TOASIL-1	Augmented Spark Igniter Oxidizer Line Skin		-425 to -500	x				
TOASIL-2	Augmented Spark Igniter Oxidizer Line Skin		-400 to +300	x				
TOBS-1	Oxidizer Bootstrap Line		-300 to +250	x				
TOBS-2	Oxidizer Bootstrap Line		-300 to +250	x				
TOBS-2B	Oxidizer Bootstrap Line		-300 to +250	x				
TOBV-1A	Oxidizer Bleed Valve	GOT2	-300 to -250	x				
TODAA	Oxidizer Dome Area Ambient		-200 to +500	x				
TODS-1	Oxidizer Dome Skin		-300 to +100	x			x	
TODS-2	Oxidizer Dome Skin		-300 to +100	x			x <sup>4</sup>	

TABLE III-1 (Continued)

<u>AEDC Code</u>	<u>Parameter</u>	<u>Tap No.</u>	<u>Range</u>	<u>Micro-sadic</u>	<u>Magnetic Tape</u>	<u>Oscillo-graph</u>	<u>Strip Chart</u>	<u>X-Y Plotter</u>
	<u>Temperaturea</u>		<u>°F</u>					
TOPB-1A	Oxidizer Pump Bearing Coolant	POT4	-300 to -250	x				
TOPD-1P	Oxidizer Pump Discharge	POT3	-300 to -250	x	x	x	x	
TOPD-2	Oxidizer Pump Discharge	POT3	-300 to -250	x				
TOPI-1	Oxidizer Pump Inlet		-310 to -270	x				x
TOPI-2	Oxidizer Pump Inlet		-310 to -270	x				x
TORPO	Oxidizer Recirculation Pump Outlet		-300 to -250	x				
TORPR	Oxidizer Recirculation Pump Return		-300 to -140	x				
TORT-1	Oxidizer Tank		-300 to -287	x				
TORT-1B	Oxidizer Tank		-300 to -287	x				
TORT-3	Oxidizer Tank		-300 to -287	x				
TOTI-1P	Oxidizer Turbine Inlet	TGT3	-300 to 1200	x			x	
TOTO-1P	Oxidizer Turbine Outlet	TGT4	0 to 1000	x				
TOVL	Oxidizer Tank Pressurization Line Nozzle Throat		-300 to +100	x				
TPIP-1P	Primary Instrument Package		-300 to +200	x				
TPIPA	Primary Instrument Package Area Ambient		-200 to +500	x				
TSC2-1	Thrust Chamber Skin		-300 to +500	x				
TSC2-12	Thrust Chamber Skin		-300 to +500	x				
TSC2-13	Thrust Chamber Skin		-300 to +500	x			x	
TSC2-17	Thrust Chamber Skin		-300 to +500	x				
TSC2-20	Thrust Chamber Skin		-300 to +500	x				
TSC2-24	Thrust Chamber Skin		-300 to +500	x				
TSOVC-1	Oxidizer Valve Actuator Cap		-325 to +150	x			x	
TSTDVAA	Start Tank Discharge Valve Area Ambient		-200 to +500	x				
TSTDVDL	Start Tank Discharge Valve Drain Line		-100 to +200	x				
TSTDVOC	Start Tank Discharge Valve Opening Control Port		-300 to +200	x				x <sup>3</sup>
TTC-1P	Thrust Chamber Jacket (Control)	CS1	-425 to +500	x			x	
TTC-2	Thrust Chamber Jacket		-425 to +100	x				
TTCP <sup>5</sup>	Thrust Chamber Purge		-345 to -504	x				
TTFP	Turbopump Purge		-150 to +150	x			x	

TABLE III-1 (Concluded)

<u>AEDC Code</u>	<u>Parameter</u>	<u>Tap No.</u>	<u>Range</u>	<u>Micro-sadic</u>	<u>Magnetic Tape</u>	<u>Oscillo-graph</u>	<u>Strip Char.</u>	<u>X-Y Plotter</u>
	<u>Vibrations</u>		<u>g's</u>					
UAS1F-1	Augmented Spark Igniter Fuel Orifice Block Tangential		±150	x				
UAS1V-1	Augmented Spark Igniter Oxidizer Valve Axial		±150	x				
UAS1V-3	Augmented Spark Igniter Oxidizer Valve Tangential		±150	x				
UFPR	Fuel Pump Radial 90 deg		±300		x	x		
UMFV-1	Main Fuel Valve Radial		±150	x				
UMFV-3	Main Fuel Valve Tangential		±150	x				
UOPR	Oxidizer Pump Radial 90 deg		±200	x				
UOTBV-1	Oxidizer Turbine Bypass Valve Axial		±150		x			
UTCD-1	Thrust Chamber Dome		±500		x	x		
UTCD-2	Thrust Chamber Dome		±500		x	x		
UTCD-3	Thrust Chamber Dome		±500		x			
UTCD-4	Thrust Chamber Dome		±1000			x		
U1VSC	No. 1 Vibration Safety Counts		On/Off			x		
U2VSC	No. 2 Vibration Safety Counts		On/Off			x		
U3VSC	No. 3 Vibration Safety Counts		On/Off			x		
	<u>Voltage</u>		<u>volts</u>					
VCB	Control Bus		0 to 36	x		x		
VIB	Ignition Bus		0 to 36	x		x		
VIDA	Ignition Detect Amplifier		9 to 16	x		x		
VPUTEF	Propellant Utilization Valve Excitation		0 to 5	x				

- 
- Notes: 1. Range changed from 0 to 100 psia beginning with test 04  
2. Added beginning with test 04  
3. Deleted beginning with test 05  
4. Added beginning with test 05  
5. Added beginning with test 06

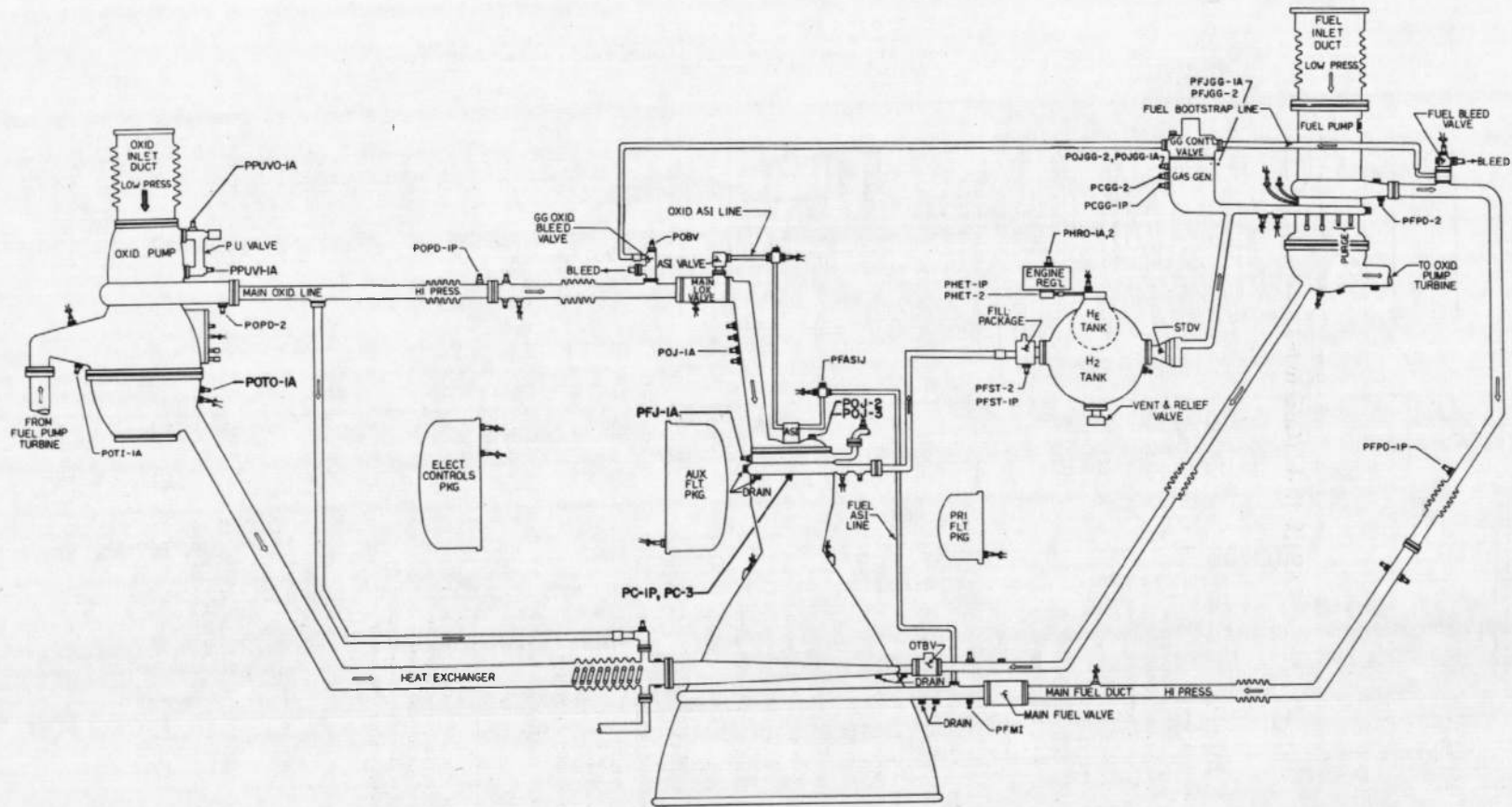

a. Engine Pressure Tap Locations  
 Fig. III-1 Instrumentation Locations

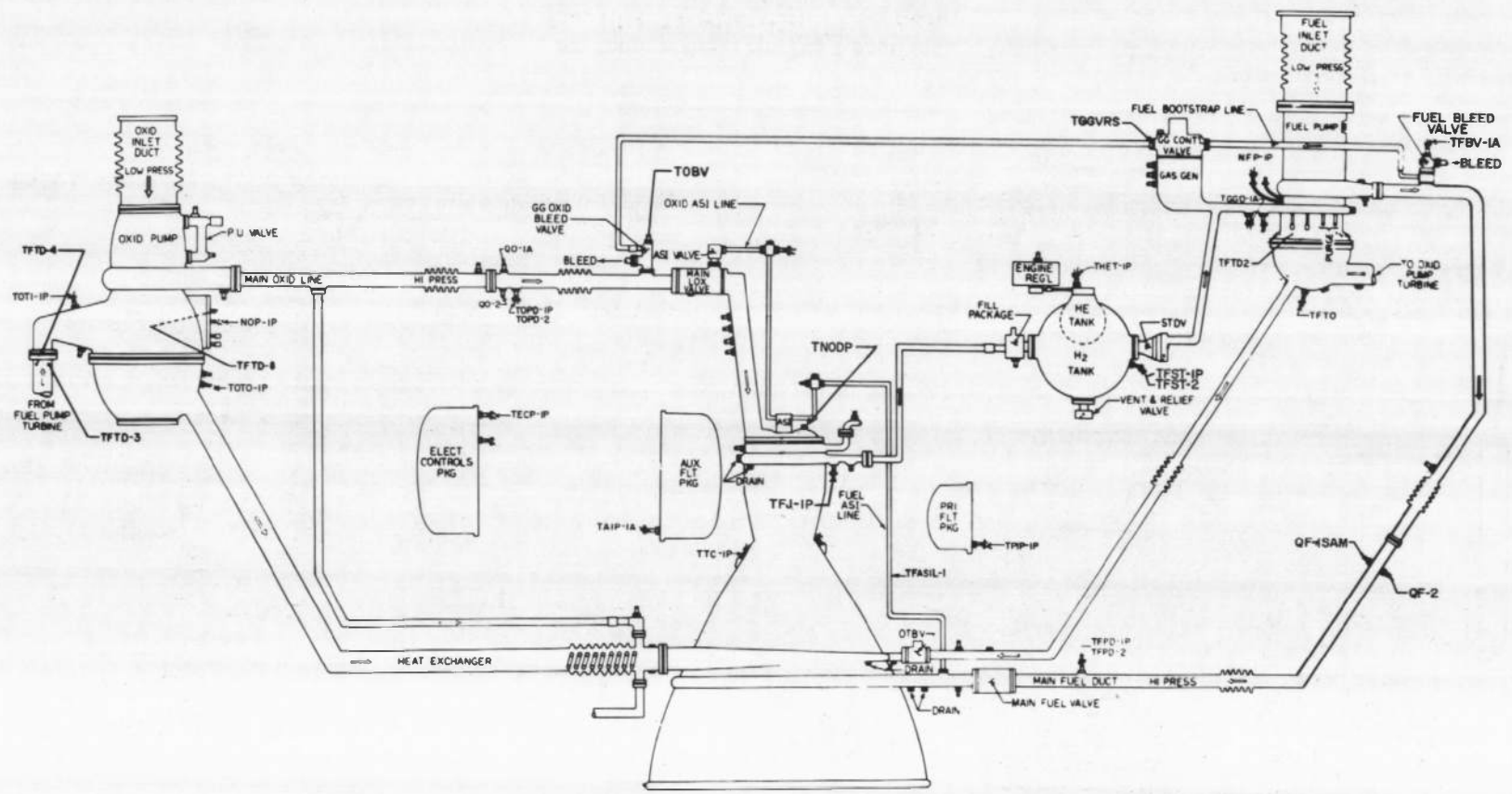

b. Engine Temperature, Flow, and Speed Instrumentation Locations  
 Fig. III-1 Continued

1-2020C-1

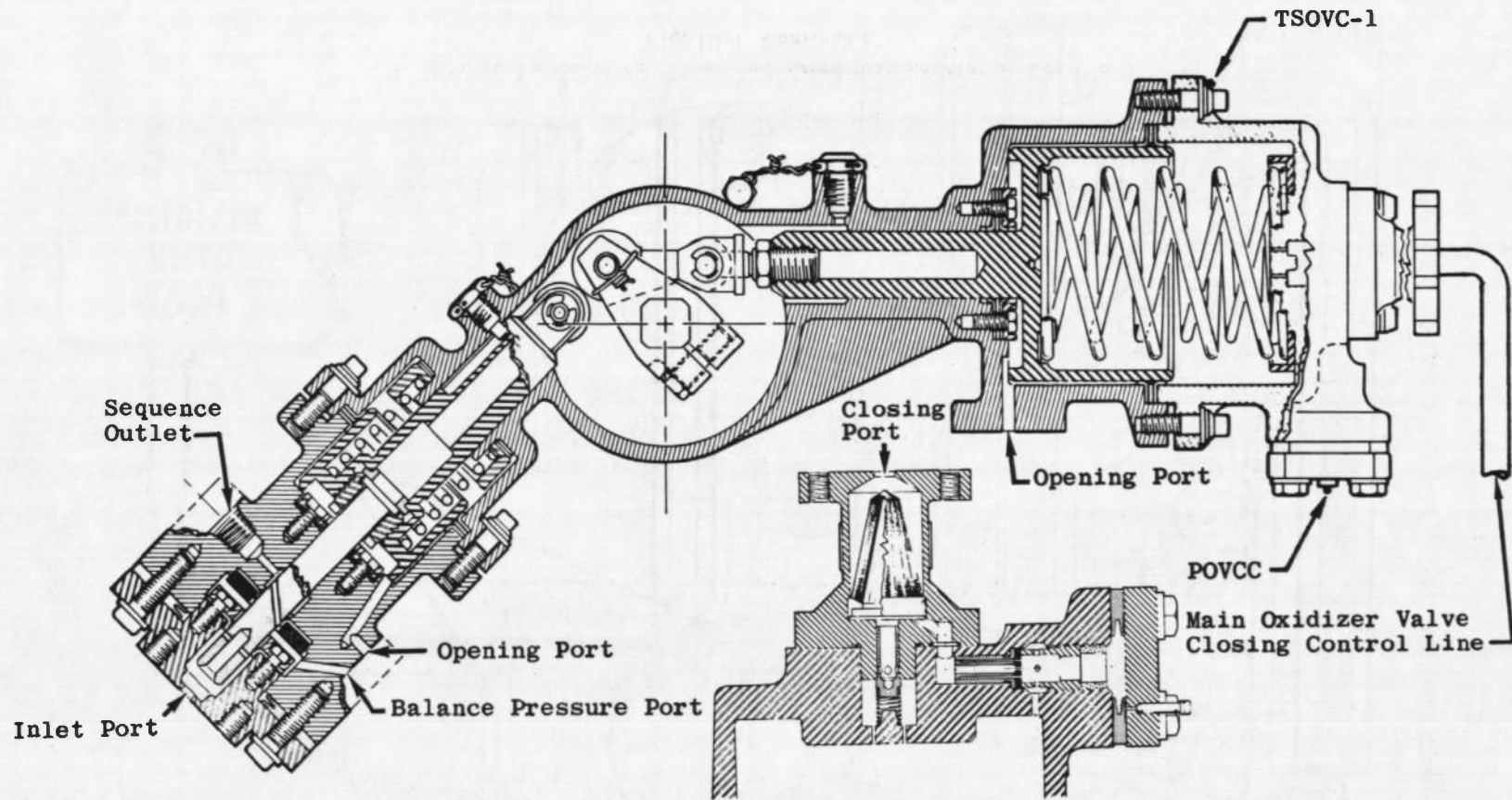

c. Main Oxidizer Valve  
Fig. III-1 Continued



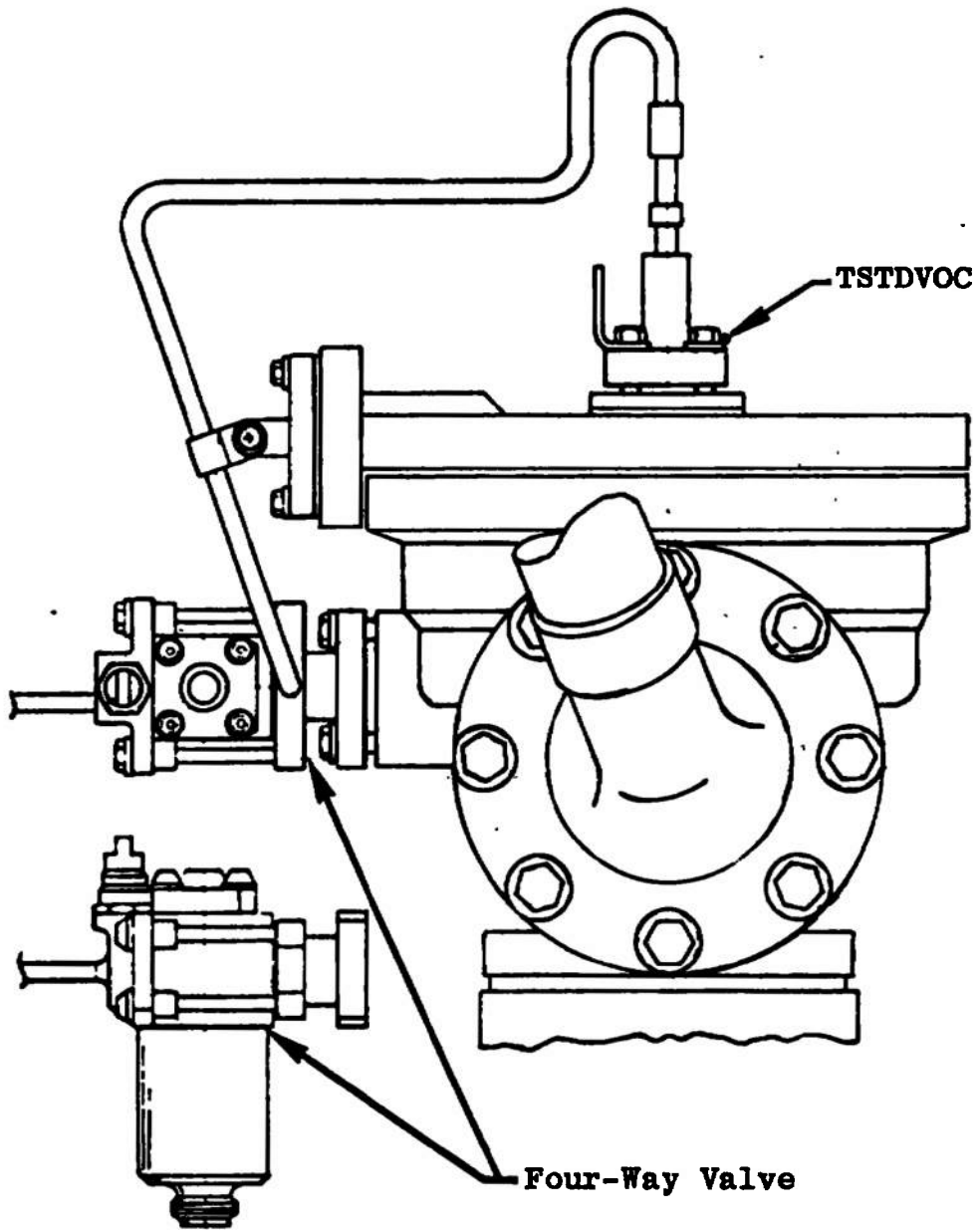

d. Start Tank Discharge Valve  
Fig. III-1 Continued

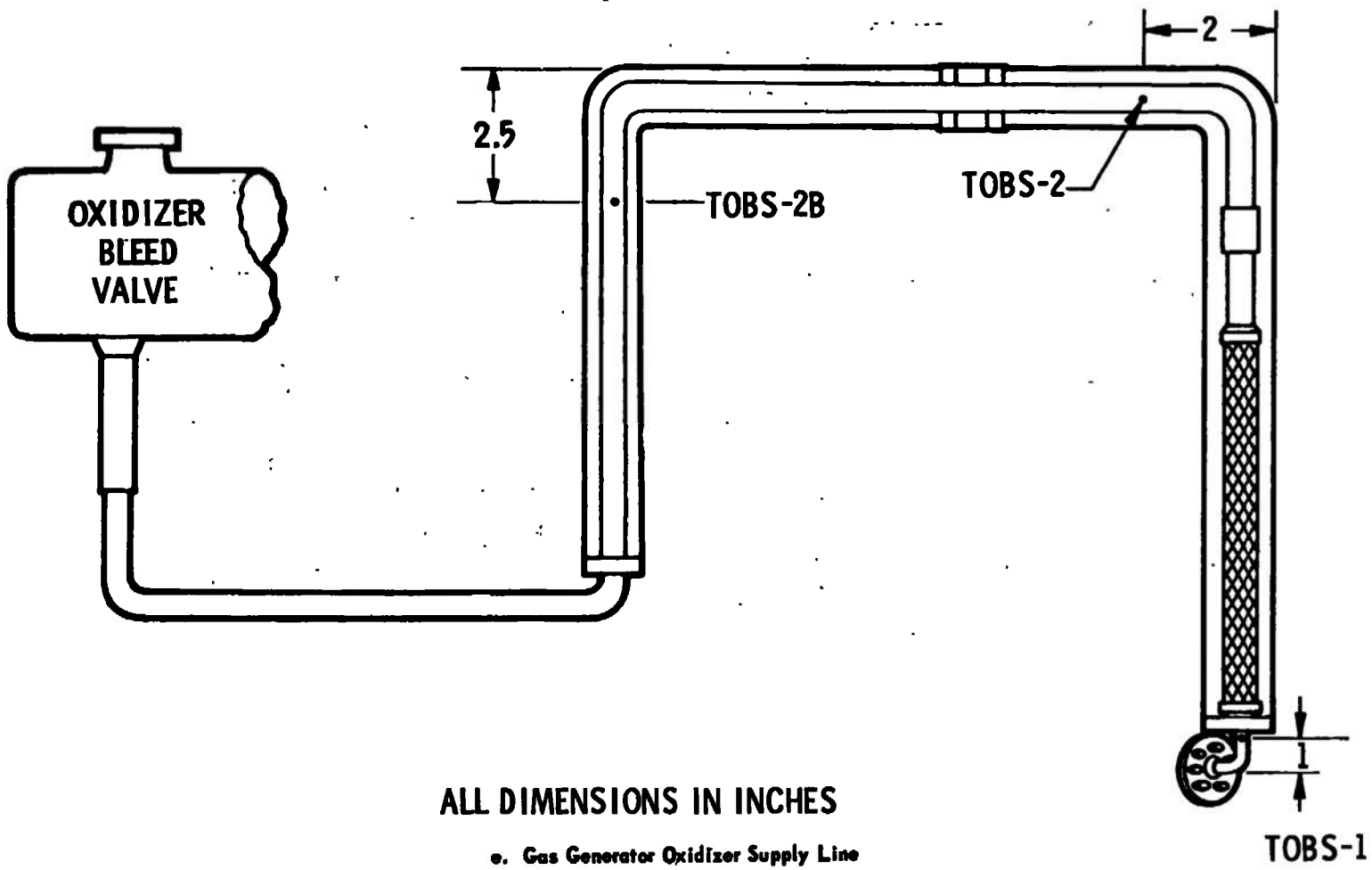

ALL DIMENSIONS IN INCHES

e. Gas Generator Oxidizer Supply Line

Fig. III-1 Continued

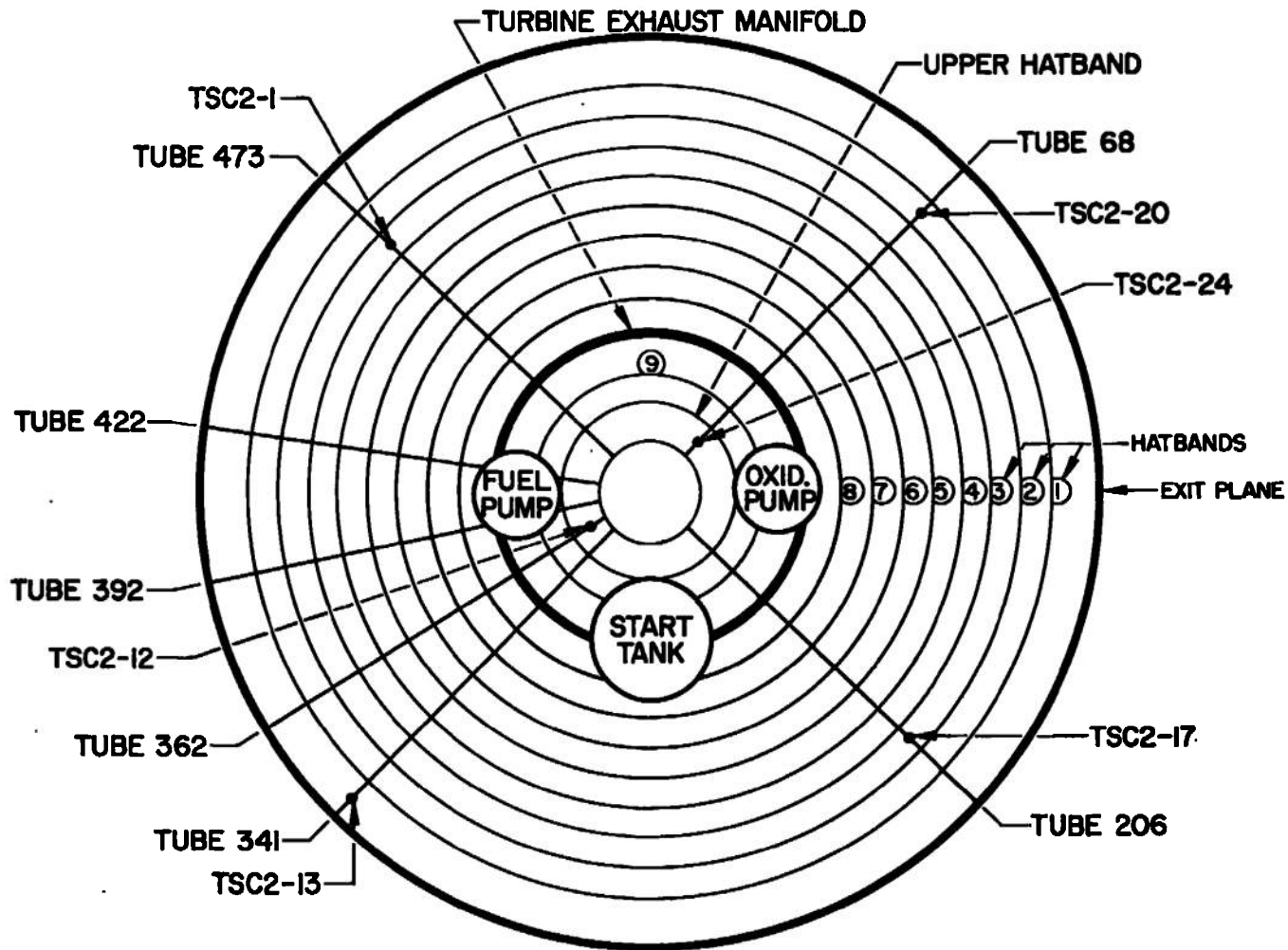

**VIEW LOOKING AFT**

f. Thrust Chamber

Fig. III-1 Concluded

**APPENDIX IV  
METHOD OF CALCULATION (PERFORMANCE PROGRAM)**

**TABLE IV-1  
PERFORMANCE PROGRAM DATA INPUTS**

Item No.	Parameter
1	Thrust Chamber (Injector Face) Pressure, psia
2	Thrust Chamber Fuel and Oxidizer Injection Pressures, psia
3	Thrust Chamber Fuel Injection Temperature, °F
4	Fuel and Oxidizer Flowmeter Speeds, Hz
5	Fuel and Oxidizer Engine Inlet Pressures, psia
6	Fuel and Oxidizer Pump Discharge Pressures, psia
7	Fuel and Oxidizer Engine Inlet Temperatures, °F
8	Fuel and Oxidizer (Main Valves) Temperatures, °F
9	Propellant Utilization Valve Center Tap Voltage, volts
10	Propellant Utilization Valve Position, volts
11	Fuel and Oxidizer Pump Speeds, rpm
12	Gas Generator Chamber Pressure, psia
13	Gas Generator (Bootstrap Line at Bleed Valve) Temperature, °F
14	Fuel* and Oxidizer Turbine Inlet Pressure, psia
15	Oxidizer Turbine Discharge Pressure, psia
16	Fuel and Oxidizer Turbine Inlet Temperature, °F
17	Oxidizer Turbine Discharge Temperature, °F

\*At AEDC, fuel turbine inlet pressure is calculated from gas generator chamber pressure.

## NOMENCLATURE

A	Area, in. <sup>2</sup>
B	Horsepower
C	Coefficient
C*	Characteristic velocity, ft/sec
D	Diameter, in.
F	Thrust, lbf
H	Head, ft
h	Enthalpy, Btu/lb <sub>m</sub>
I	Impulse
M	Molecular weight
N	Speed, rpm
P	Pressure, psia
Q	Flow rate, gpm
R	Resistance, sec <sup>2</sup> /ft <sup>3</sup> -in. <sup>2</sup>
r	Mixture ratio, O/F
T	Temperature, °F
TC*	Theoretical characteristic velocity, ft/sec
W	Weight flow, lb/sec
Z	Differential pressure, psi
β	Ratio
γ	Ratio of specific heats
η	Efficiencies
θ	Degrees
ρ	Density, lb/ft <sup>3</sup>

## SUBSCRIPTS

A	Ambient
AA	Ambient at thrust chamber exit
B	Bypass nozzle

BIR	Bypass nozzle inlet (Rankine)
BNI	Bypass nozzle inlet (total)
C	Thrust chamber
CF	Thrust chamber, fuel
CO	Thrust chamber, oxidizer
CV	Thrust chamber, vacuum
E	Engine
EF	Engine fuel
EM	Engine measured
EO	Engine oxidizer
EV	Engine, vacuum
e	Exit
em	Exit measured
F	Thrust
FM	Fuel measured
FV	Thrust, vacuum
f	Fuel
G	Gas generator
GF	Gas generator fuel
GO	Gas generator oxidizer
H1	Hot gas duct No. 1
H1R	Hot gas duct No. 1 (Rankine)
H2R	Hot gas duct No. 2 (Rankine)
IF	Inlet fuel
IO	Inlet oxidizer
ITF	Isentropic turbine fuel
ITO	Isentropic turbine oxidizer
N	Nozzle
NB	Bypass nozzle (throat)

NV	Nozzle, vacuum
O	Oxidizer
OC	Oxidizer pump calculated
OF	Outlet fuel pump
OFIS	Outlet fuel pump isentropic
OM	Oxidizer measured
OO	Oxidizer outlet
PF	Pump fuel
PO	Pump oxidizer
PUVO	Propellant utilization valve oxidizer
RNC	Ratio bypass nozzle, critical
SC	Specific, thrust chamber
SCV	Specific thrust chamber, vacuum
SE	Specific, engine
SEV	Specific, engine vacuum
T	Total
TEF	Turbine exit fuel
TEFS	Turbine exit fuel (static)
TF	Fuel turbine
TIF	Turbine inlet fuel (total)
TIFM	Turbine inlet, fuel, measured
TIFS	Turbine inlet fuel isentropic
TIO	Turbine inlet oxidizer
TO	Turbine oxidizer
t	Throat
V	Vacuum
v	Valve
XF	Fuel tank repressurant
XO	Oxidizer tank repressurant

## PERFORMANCE PROGRAM EQUATIONS

## THRUST

Thrust Chamber, Vacuum

$$F_{CV} = C (P_C)^2 + B (P_C) + A$$

Empirical Determination from Curve Fit of Thrust  
versus  $P_C$ 

Thrust Chamber

$$F_C = F_{CV} - P_{AA} A_e$$

$$A_e = A_{em} + 12.8$$

$$P_{AA} = \text{Measured Cell Pressure}$$

Engine, Vacuum

$$F_{EV} = F_{CV}$$

Engine

$$F_E = F_C$$

## MIXTURE RATIO

Engine

$$r_E = \frac{W_{EO}}{W_{EF}}$$

$$W_{EO} = W_{OM} - W_{XO}$$

$$W_{EF} = W_{FM} - W_{XF}$$

Thrust Chamber

$$r_C = \frac{W_{CO}}{W_{CF}}$$

$$W_{CO} = W_{OM} - W_{XO} - W_{GO}$$

$$W_{CF} = W_{FM} - W_{XF} - W_{GF}$$

$$W_{XO} = \text{Standard } 0.9 \text{ lb/sec}$$

$$W_{XF} = \text{Standard } 2.1 \text{ lb/sec}$$

$$W_{CO} = W_T - W_{GF}$$

$$W_{GF} = \frac{W_T}{1 + r_G}$$

$$W_T = \frac{P_{TIF} A_{TIF} K_7}{TC * TIF}$$

$$K_7 = 32.174$$



Normalized engine and thrust chamber vacuum data calculated as measured, except all flows are normalized using standard inlet pressures, temperatures, and densities listed below:

- $P_{IO} \text{ STD} = 39 \text{ psia}$
- $P_{IF} \text{ STD} = 30 \text{ psia}$
- $\rho_{IO} \text{ STD} = 70.79 \text{ lb/ft}^3$
- $\rho_{IF} \text{ STD} = 4.40 \text{ lb/ft}^3$
- $T_{IO} \text{ STD} = -295.2^\circ\text{F}$
- $T_{IF} \text{ STD} = 422.5^\circ\text{F}$

**SPECIFIC IMPULSE**

Engine

$$I_{SE} = \frac{F_E}{W_E}$$

$$W_E = W_{EO} + W_{EF}$$

Engine, Vacuum

$$I_{SEV} = \frac{F_{EV}}{W_{EV}}$$

$W_{EV} = W_E$  Normalized using standard inlet pressures, temperatures, and densities

Chamber

$$I_{SC} = \frac{F_C}{W_C}$$

$$W_C = W_{CO} + W_{CF}$$

Chamber, Vacuum

$$I_{SCV} = \frac{F_{CV}}{W_{CV}}$$

$W_{CV} = W_C$  Normalized using standard inlet pressures, temperatures, and densities

**CHARACTERISTIC VELOCITY**

Thrust Chamber

$$C^* = \frac{K_7 P_C A_t}{W_C}$$

$$K_7 = 32.174$$

Thrust Chamber, Vacuum

$$C^*_V = \frac{K_7 P_{CV} A_t}{W_{CV}}$$

$$K_7 = 32.174$$

Nozzle

$$C_N^* = \frac{C^*}{K_6}$$

$$K_6 = 1.086$$

Nozzle, Vacuum

$$C_{NV}^* = \frac{C_V^*}{K_6}$$

$$K_6 = 1.086$$

### THRUST COEFFICIENT

Engine

$$C_F = \frac{F_C}{P_C A_t}$$

Engine, Vacuum

$$C_{FV} = \frac{F_{CV}}{P_C A_t}$$

### DEVELOPED PUMP HEAD

Oxidizer

$$H_O = K_4 \left( \frac{P_{OO}}{\rho_{OO}} - \frac{P_{IO}}{\rho_{IO}} \right)$$

$$K_4 = 144$$

$\rho$  = National Bureau of Standards Values  $f(P,T)$

Fuel

$$H_F = 778.16 \Delta h_{OFIS}$$

$$\Delta h_{OFIS} = h_{OFIS} - h_{IF}$$

$$h_{OFIS} = f(P,T)$$

$$h_{IF} = f(P,T)$$

Fuel and Oxidizer Vacuum

Conditions normalized using standard inlet pressures, temperatures, and densities.

### PUMP EFFICIENCIES

Fuel, Isentropic

$$\eta_F = \frac{h_{OFIS} - h_{IF}}{h_{OF} - h_{IF}}$$

$$h_{OF} = f(P_{OF}, T_{OF})$$

## Oxidizer, Isentropic

$$\eta_0 = \eta_{0C} Y_0$$

$$\eta_{0C} = K_{40} \left( \frac{Q_{PO}}{N_0} \right)^2 + K_{50} \left( \frac{Q_{PO}}{N_0} \right) + K_{60}$$

$$Y_0 = 1.000$$

$$K_{40} = -5.053 \quad K_{50} = 3.861 \quad K_{60} = 0.0733$$

## TURBINES

## Oxidizer, Efficiency

$$\eta_{TO} = \frac{B_{TO}}{B_{ITO}}$$

$$B_{TO} = K_5 \frac{W_{PO} H_0}{\eta_0}$$

$$K_5 = 0.001818$$

$$W_{PO} = W_{OM} + W_{PUVO}$$

$$W_{PUVO} = \sqrt{\frac{Z_{PUVO} \rho_{00}}{R_v}}$$

$$Z_{PUVO} = A + B (P_{00})$$

$$A = -1597$$

$$B = 2.3828$$

$$\text{if } P_{00} \geq 1010$$

$$\text{set } P_{00} = 1010$$

$$\ln R_v = A + B (\theta_{PUVO}) + C(\theta_{PUVO})^3 + D \left( \frac{\theta_{PUVO}}{7} \right)^7 + E \theta_{PUVO} \left( \frac{\theta_{PUVO}}{7} \right)^7 + F \left[ \left( \frac{\theta_{PUVO}}{7} \right)^7 \right]^2$$

$$A = 5.566 \times 10^{-1}$$

$$B = 1.500 \times 10^{-2}$$

$$C = 7.941 \times 10^{-6}$$

$$D = 1.234$$

$$E = -7.255 \times 10^{-2}$$

$$F = 5.069 \times 10^{-2}$$

## Fuel, Efficiency

$$\eta_{TF} = \frac{B_{TF}}{B_{ITF}}$$

$$B_{ITF} = K_{10} \Delta h_F W_T$$

$$\Delta h_F = h_{TIF} - h_{TEF}$$

$$B_{TF} = B_{PF} = K_5 \left( \frac{W_{PF} H_F}{\eta_F} \right)$$

$$W_{PF} = W_{FM}$$

$$K_{10} = 1.415$$

$$K_5 = 0.001818$$

#### Oxidizer, Developed Horsepower

$$B_{TO} = B_{PO}$$

$$B_{PO} = K_5 \left( \frac{W_{PO} H_O}{\eta_O} \right)$$

$$K_5 = 0.001818$$

#### Fuel, Developed Horsepower

$$B_{TF} = B_{PF}$$

$$B_{PF} = K_5 \left( \frac{W_{PF} H_F}{\eta_F} \right)$$

$$W_{PF} = W_{FM}$$

#### Fuel, Weight Flow

$$W_{TF} = W_T$$

$$W_{TO} = W_T - W_B$$

$$W_B = \left[ \frac{2K_7 \gamma_{H_2}}{\gamma_{H_2} - 1} (P_{RNC}) \frac{2}{\gamma_{H_2}} \right]^{1/2} \left[ 1 - (P_{RNC}) \frac{\gamma_{H_2} - 1}{\gamma_{H_2}} \right]^{1/2} \frac{A_{NB} P_{BNI}}{(R_{H_2} T_{BIR})^{1/2}}$$

$$P_{RNC} = f(\beta_{NB}, \gamma_{H_2})$$

$$\beta_{NB} = D_{NB}/D_B$$

$$\gamma_{H_2}, M_{H_2} = f(T_{H_2R}, r_G)$$

$$A_{NB} = K_{13} (D_{NB})^2$$

$$K_{13} = 0.7854$$

$$T_{BIR} = T_{TIO} + 460$$

$$P_{BNI} = P_{TEFS}$$

$$P_{TEFS} = \text{Iteration of } P_{TEF}$$

$$P_{TEF} = P_{TEFS} \left[ 1 + K_8 \left( \frac{W_T}{P_{TEFS}} \right)^2 \frac{T_{H2R}}{D_{TEF}^4 M_{H2}} \left( \frac{\gamma_{H2} - 1}{\gamma_{H2}} \right) \right] \frac{\gamma_{H2}}{\gamma_{H2} - 1}$$

$K_8 = 38.90$

**GAS GENERATOR**

**Mixture Ratio**

$$r_G = D_1 (T_{H1})^3 + C_1 (T_{H1})^2 + B_1 (T_{H1}) + A_1$$

$A_1 = 0.2575$

$B_1 = 5.586 \times 10^{-4}$

$C_1 = -5.332 \times 10^{-9}$

$D_1 = 1.1312 \times 10^{-11}$

$T_{H1} = T_{TIFM}$

**Flows**

$$TC^*_{TIF} = D_2 (T_{H1})^3 + C_2 (T_{H1})^2 + B_2 (T_{H1}) + A_2$$

$A_2 = 4.4226 \times 10^3$

$B_2 = 3.2267$

$C_2 = -1.3790 \times 10^{-3}$

$D_2 = 2.6212 \times 10^{-7}$

$$P_{TIF} = P_{TIFS} \left[ 1 + K_8 \left( \frac{W_T}{P_{TIFS}} \right)^2 \frac{T_{H1R}}{D_{TIF}^4 M_{H1}} \frac{\gamma_{H1} - 1}{\gamma_{H1}} \right] \frac{\gamma_{H1}}{\gamma_{H1} - 1}$$

$K_8 = 38.8983$

Note:  $P_{TIF}$  is determined by iteration.

$T_{H1R} = T_{TIFM} + 460$

$M_{H1}, \gamma_{H1}, C_p, r_{H1} = f(T_{H1R}, r_G)$

## DOCUMENT CONTROL DATA - R &amp; D

(Security classification of title, body of abstract and indexing annotation must be entered when the overall report is classified)

1. ORIGINATING ACTIVITY (Corporate author) Arnold Engineering Development Center ARO, Inc., Operating Contractor Arnold Air Force Station, Tennessee		2a. REPORT SECURITY CLASSIFICATION <b>UNCLASSIFIED</b>	
		2b. GROUP N/A	
3. REPORT TITLE <b>FLIGHT SUPPORT TESTING OF THE J-2 ROCKET ENGINE IN PROPULSION ENGINE TEST CELL (J-4) (TESTS J4-1901-03 THROUGH J4-1901-06)</b>			
4. DESCRIPTIVE NOTES (Type of report and inclusive dates) <b>July 23 through August 15, 1968 - Interim Report</b>			
5. AUTHOR(S) (First name, middle initial, last name) <b>N: R. Vetter, ARO, Inc.</b>			
6. REPORT DATE <b>December 1968</b>		7a. TOTAL NO. OF PAGES <b>161</b>	7b. NO. OF REFS <b>4</b>
8a. CONTRACT OR GRANT NO. <b>F40600-69-C-0001</b>		9a. ORIGINATOR'S REPORT NUMBER(S) <b>AEDC-TR-68-238</b>	
b. PROJECT NO. <b>9194</b>		9b. OTHER REPORT NO(S) (Any other numbers that may be assigned this report) <b>N/A</b>	
c. System <b>921E</b>			
d.			
10. DISTRIBUTION STATEMENT <b>Each transmittal of this document outside the Department of Defense must have prior approval of NASA, Marshall Space Flight Center (I-E-J), Huntsville, Alabama 35812.</b>			
11. SUPPLEMENTARY NOTES <b>Available in DDC.</b>		12. SPONSORING MILITARY ACTIVITY <b>NASA, Marshall Space Flight Center (I-E-J), Huntsville, Alabama 35812</b>	
13. ABSTRACT <p>Fourteen firings of the Rocketdyne J-2 rocket engine (S/N J-2036-1) were conducted at pressure altitude conditions during four test periods (J4-1901-03 through J4-1901-06) between July 23 and August 15, 1968, in Test Cell J-4 of the Large Rocket Facility. This testing was in support of the J-2 engine application to the S-II and S-IVB stages of the Saturn V vehicle. The firings were accomplished at pressure altitudes between 78,000 and 110,000 ft at engine start. The primary objective of these firings was to evaluate engine start transients under various combinations of starting conditions with start tank energy being the major variable. The total accumulated firing duration for these four test periods was 223.2 sec.</p> <p>This document is subject to special export controls and each transmittal to foreign governments or foreign nationals may be made only with prior approval of NASA, Marshall Space Flight Center (I-E-J), Huntsville, Alabama 35812.</p>			

This document has been approved for public release  
its distribution is unlimited.

Per AF Letter #1  
12 July 74, signed  
William O. Cole

14.

KEY WORDS

LINK A

LINK B

LINK C

ROLE

WT

ROLE

WT

ROLE

WT

J-2 rocket engines  
liquid propellants  
altitude simulation  
flight simulation  
startup  
performance tests  
performance evaluation

*16-3*

*1. Rocket motors -- J-2*

*2 " " -- Ignition*

*3 " " -- Performance*