

UNCLASSIFIED

AD NUMBER

AD844666

LIMITATION CHANGES

TO:

Approved for public release; distribution is unlimited.

FROM:

Distribution authorized to U.S. Gov't. agencies and their contractors;
Administrative/Operational Use; DEC 1968. Other requests shall be referred to Air Force Office of Scientific Research, Arlington, VA.

AUTHORITY

AFOSR ltr 12 Nov 1971

THIS PAGE IS UNCLASSIFIED

AEDC-TR-68-257

**ARCHIVE COPY
DO NOT LOAN**

cy

**FORCE TESTS ON A SLOTTED
DELTA WING WITH VARYING LEADING-EDGE
CAMBER AT SUPERSONIC MACH NUMBERS**



**E. J. Lucas and W. R. Martindale
ARO, Inc.**

December 1968

F40600-69-C-0001

This document has been approved for public release
its distribution is unlimited. *PER TAB 72-19,
Dtd 1 Oct, 72.*

This document is subject to special export controls
and each transmittal to foreign governments or foreign
nationals may be made only with prior approval of
Air Force Office of Scientific Research (SREM),
Arlington, Virginia 22209.



**VON KÁRMÁN GAS DYNAMICS FACILITY
ARNOLD ENGINEERING DEVELOPMENT CENTER
AIR FORCE SYSTEMS COMMAND
ARNOLD AIR FORCE STATION, TENNESSEE**

PROPERTY OF U. S. AIR FORCE
AEDC LIBRARY
F40600-69-C-0001

NOTICES

When U. S. Government drawings specifications, or other data are used for any purpose other than a definitely related Government procurement operation, the Government thereby incurs no responsibility nor any obligation whatsoever, and the fact that the Government may have formulated, furnished, or in any way supplied the said drawings, specifications, or other data, is not to be regarded by implication or otherwise, or in any manner licensing the holder or any other person or corporation, or conveying any rights or permission to manufacture, use, or sell any patented invention that may in any way be related thereto.

Qualified users may obtain copies of this report from the Defense Documentation Center.

References to named commercial products in this report are not to be considered in any sense as an endorsement of the product by the United States Air Force or the Government.

FORCE TESTS ON A SLOTTED
DELTA WING WITH VARYING LEADING-EDGE
CAMBER AT SUPERSONIC MACH NUMBERS

E. J. Lucas and W. R. Martindale
ARO, Inc.

This document is subject to special export controls and each transmittal to foreign governments or foreign nationals may be made only with prior approval of Air Force Office of Scientific Research (SRO), Arlington, Virginia 22209.

This document has been approved for public release
its distribution is unlimited. PER TAB 72-19,
D+2 10ct, 72.

FOREWORD

The work reported herein was done at the request of the Air Force Office of Scientific Research (AFOSR), Air Force Systems Command (AFSC), for Aerospace Research Associates, West Covina, California, under Program Element 6144501F, Project 9781.

The results of tests presented were obtained by ARO, Inc. (a subsidiary of Sverdrup & Parcel and Associates, Inc.), contract operator of the Arnold Engineering Development Center (AEDC), AFSC, Arnold Air Force Station, Tennessee, under Contract F40600-69-C-0001. The test program was conducted from August 20 through 28, 1968, under ARO Project No. VT0864, and the manuscript was submitted for publication on October 16, 1968.

Information in this report is embargoed under the Department of State International Traffic in Arms Regulations. This report may be released to foreign governments by departments or agencies of the U. S. Government subject to approval of the Air Force Office of Scientific Research (SREM), or higher authority within the Department of the Air Force. Private individuals or firms require a Department of State export license.

This technical report has been reviewed and is approved.

Eugene C. Fletcher
Lt Colonel, USAF
AF Representative, VKF
Directorate of Test

Roy R. Croy, Jr.
Colonel, USAF
Director of Test

ABSTRACT

Tests were conducted in the 40-in. supersonic wind tunnel of the von Kármán Gas Dynamics Facility on a 70-deg-sweep delta wing. A gap between the leading edge and main body was varied from a sealed condition to a nominal 0.030-in. opening for three leading edges of various camber. The aerodynamic characteristics of these configurations were obtained at Mach numbers 1.5, 2.0, and 3.0 at angles of attack from -12 to 12 deg and Reynolds numbers, based on the 10-in. model root chord, from 1.3×10^6 to 6.0×10^6 . Results are presented showing the variation in lift/drag for various combinations of gap width and leading-edge camber.

This document is subject to special export controls and each transmittal to foreign governments or foreign nationals may be made only with prior approval of Air Force Office of Scientific Research (SREM), Arlington, Virginia 22209.

This document has been approved for public release
its distribution is unlimited. PER TAB 7249,
Dtd 1 Oct, 72

CONTENTS

	<u>Page</u>
ABSTRACT	iii
NOMENCLATURE	vi
I. INTRODUCTION	1
II. APPARATUS	
2.1 Wind Tunnel	1
2.2 Model	1
2.3 Instrumentation	2
III. RESULTS AND DISCUSSION	2
REFERENCES	4

APPENDIXES

I. ILLUSTRATIONS

Figure

1. Model Photographs	
a. Basic Configuration (Zero Camber, Gap Sealed) Installed in Tunnel A	7
b. Centerbody with Leading Edges	8
2. Model Geometry	9
3. Comparison of Theoretical and Experimental Results for Zero Camber Leading Edge, Gap Sealed ($Re_\ell = 3.4 \times 10^6$)	
a. Lift Coefficient	10
b. Drag Coefficient	11
c. Lift-to-Drag Ratio	12
4. Effect of Camber on Wing Aerodynamic Loads, Gap Sealed ($Re_\ell = 3.4 \times 10^6$)	
a. Lift Coefficient	13
b. Drag Coefficient	14
c. Lift-to-Drag Ratio	15
5. Variation of $(L/D)_{\max}$ and α at $(L/D)_{\max}$ with Chamber, Gap Sealed ($Re_\ell = 3.4 \times 10^6$)	16

<u>Figure</u>	<u>Page</u>
6. Gap Effects on Wing Aerodynamic Loads, Zero Camber Leading Edge ($Re_\ell = 3.4 \times 10^6$)	
a. Variation of L/D with Angle of Attack	17
b. Variation of $(L/D)_{max}$ and α at $(L/D)_{max}$	18
 II. TABLE	
I. Test Summary	19

NOMENCLATURE

A_b	Model base area, 6.37 in. ²
C_A	Axial-force coefficient, $C_{A_t} - C_{A_b}$
C_{A_b}	Base axial-force coefficient, $(p_\infty - p_b) A_b / q_\infty S$
C_{A_t}	Total axial-force coefficient, total axial force/ $q_\infty S$
C_D	Drag coefficient, $C_A \cos \alpha + C_N \sin \alpha$
C_L	Lift coefficient, $C_N \cos \alpha - C_A \sin \alpha$
C_N	Normal-force coefficient, normal force/ $q_\infty S$
L/D	Lift-to-drag ratio
M_∞	Free-stream Mach number
p_b	Model base pressure, psia
p_∞	Free-stream static pressure, psia
q_∞	Free-stream dynamic pressure, psia
Re_ℓ	Free-stream Reynolds number, based on model root chord length of 10.00 in.
S	Reference area (model planform area), 36.40 in. ²
w	Gap width (nominal), in. (see Fig. 2)
α	Angle of attack, deg
θ_c	Leading-edge camber angle, deg

SUBSCRIPT

max	Maximum
-----	---------

SECTION I INTRODUCTION

Static force tests were conducted in the 40-in. supersonic tunnel (Gas Dynamic Wind Tunnel, Supersonic (A)) of the von Kármán Gas Dynamics Facility (VKF) to investigate the effects of gap width and leading-edge camber on the lift and drag of a delta wing model. The three leading-edge configurations, cambered 0, 7, and 11 deg, were tested with nominal gap widths of 0, 0.010, 0.020, and 0.030 in.

Data were obtained at nominal Mach numbers of 1.5, 2.0, and 3.0 at Reynolds numbers, based on wing root chord, of 1.3×10^6 to 6.0×10^6 . The angle of attack was varied from -12 to 12 deg.

SECTION II APPARATUS

2.1 WIND TUNNEL

Tunnel A is a continuous, closed-circuit, variable density wind tunnel with an automatically driven flexible plate-type nozzle and a 40- by 40-in. test section. The tunnel can be operated at Mach numbers from 1.5 to 6 at maximum stagnation pressures from 29 to 200 psia, respectively, and stagnation temperatures up to 750°R ($M_\infty = 6$). Minimum operating pressures range from about one-tenth to one-twentieth of the maximum pressures. A description of the tunnel and airflow calibration information may be found in Ref. 1.

2.2 MODEL

The model was a 70-deg-sweep delta wing with a 10-deg included thickness angle (angle between upper and lower surfaces in a longitudinal cross section) and a 10.00-in. centerline chord length. Photographs of the model basic configuration (zero camber leading edge, gap sealed), installed in Tunnel A and of the model with the three leading edges are presented in Figs. 1a and b (Appendix I), respectively. The three leading edges were cambered 0-, 7-, and 11-deg in a plane parallel to the free-stream flow (see Fig. 2). The gap between the main body and the leading edge, w , was measured normal to the centerbody-leading edge junction as shown in Fig. 2.

It should be noted that the gap was not uniform (maximum deviation from nominal value was ± 0.010 in.) along the leading edge. An epoxy was used to seal the gap for the sealed gap configurations. Also, the leading edge was thicker than the centerbody at their junction, and a discontinuity (0.006 to 0.025 in.) existed in the model surface contour. A summary of the configurations tested is given in Table I (Appendix II).

2.3 INSTRUMENTATION

Model force measurements were made with a six-component, moment-type, strain-gage balance supplied and calibrated by VKF. Before the tests, loading in a single plane, that is, normal force or axial force only, and combined static loadings, that is, normal and axial force together, were applied to the balance which simulated the range of model loadings anticipated for the test. The range of uncertainties listed below corresponds to the difference between the applied loads and the values calculated with the balance equations used in the final data reduction. The minimum uncertainties are for loadings on the particular component only (i. e., no combined loading effects), and the maximum uncertainties are for combined loading conditions.

<u>Balance Component</u>	<u>Design Load</u>	<u>Static Loading</u>	<u>Uncertainties</u>
Normal force, lb	200	± 10 to ± 80	± 0.07 to ± 0.10
Axial force, lb	50	3 to 15	± 0.04 to ± 0.05

Model base pressures were measured with 15-psid transducers which were calibrated for ranges of 1, 5, and 15 psia and are considered accurate to within 0.3 percent of full scale of the range being used for measurement. The tunnel sector angle of attack is considered accurate to within ± 0.1 deg, and the centerline flow uniformity is within ± 0.5 percent in Mach number.

SECTION III RESULTS AND DISCUSSION

Lift and drag coefficients and the lift-to-drag ratio of the basic configuration are compared with computed theoretical values in Fig. 3. The lift coefficients are compared with conical flow theory (Ref. 2) and conical flow theory including vortex lift (Ref. 3) in Fig. 3a. The vortex lift theory applies only in the case of subsonic leading edges which for this model occurred at Mach numbers 1.5 and 2.0. Conical flow theory predicts the initial slope of the lift curve at all Mach numbers. Inclusion of

vortex lift indicates the trend of the nonlinearity of the lift curve in the subsonic leading edge case but tends to overestimate the magnitude for this configuration.

The drag coefficients are compared in Fig. 3b with calculated values which are the sum of zero angle-of-attack pressure drag (Ref. 2), zero angle-of-attack laminar (Ref. 4) or turbulent (Ref. 5) skin-friction drag, and induced drag (product of C_L and the angle of attack in radians, where C_L is computed from Ref. 2). The experimental values generally fall between the laminar and turbulent curves, indicating that boundary-layer transition occurred on the model at this Reynolds number.

Experimental and estimated lift-to-drag ratios are compared in Fig. 3c. Lift was calculated from conical flow theory (see Fig. 3a), and the drag values are for laminar or turbulent boundary layers (see Fig. 3b). It is considered simply fortuitous that the experimental data at $M_\infty = 1.5$ agree so well with the laminar L/D curve since these data should be closer to the turbulent curve than the data at the higher Mach numbers. As can be readily observed, the theoretical maximum L/D is very sensitive to the condition of the model boundary layer.

Leading-edge camber effects on lift, drag, and lift-to-drag ratios are presented in Fig. 4. The lift (Fig. 4a) and drag (Fig. 4b) decreased with increasing camber in such a manner that the lift-to-drag ratio (Fig. 4c) tended to increase with camber at or above α at $(L/D)_{\max}$.

The change in the maximum lift-to-drag ratio with camber is summarized in Fig. 5. Maximum lift-to-drag ratio increased between 0- and 7-deg camber when the leading edges were subsonic ($M_\infty = 1.5$ and 2.0), then decreased between 7 and 11 deg. The supersonic leading-edge case ($M_\infty = 3.0$) produced a reduction in $(L/D)_{\max}$ with increasing camber. The angle of attack at which the lift-to-drag ratio was a maximum increased with increasing camber angle.

A small decrease in lift and increase in drag were observed for increasing gap width, producing the reduction in the lift-to-drag ratios presented in Fig. 6. Variations in the lift-to-drag ratios as a function of α for two gap widths and a summary of the lift-to-drag ratio versus gap width illustrate this reduction with gap width in Figs. 6a and b, respectively. The angle of attack for maximum lift-to-drag ratio did not vary appreciably with the change in gap width.

REFERENCES

1. Test Facilities Handbook (7th Edition). "von Kármán Gas Dynamics Facility, Vol. 4." Arnold Engineering Development Center, July 1968.
2. Puckett, A. E. and Stewart, H. J. "Aerodynamic Performance of Delta Wings at Supersonic Speeds." Journal of the Aeronautical Sciences, Vol. 14, October 1947, p. 567.
3. Polhamus, E. C. "A Concept of the Vortex Lift of Sharp-Edge Delta Wings Based on a Leading-Edge-Suction Analogy." NASA-TN-D-3767, December 1966.
4. VanDriest, E. R. "The Laminar Boundary Layer with Variable Fluid Properties." North American Aviation Report No. AL-1866, January 1954.
5. Douglas Aircraft Company Staff. "USAF Stability and Control DATCOM." Flight Control Division, Air Force Flight Dynamics Laboratory, Wright-Patterson Air Force Base, Ohio, October 1960.

APPENDIXES
I. ILLUSTRATIONS
II. TABLE

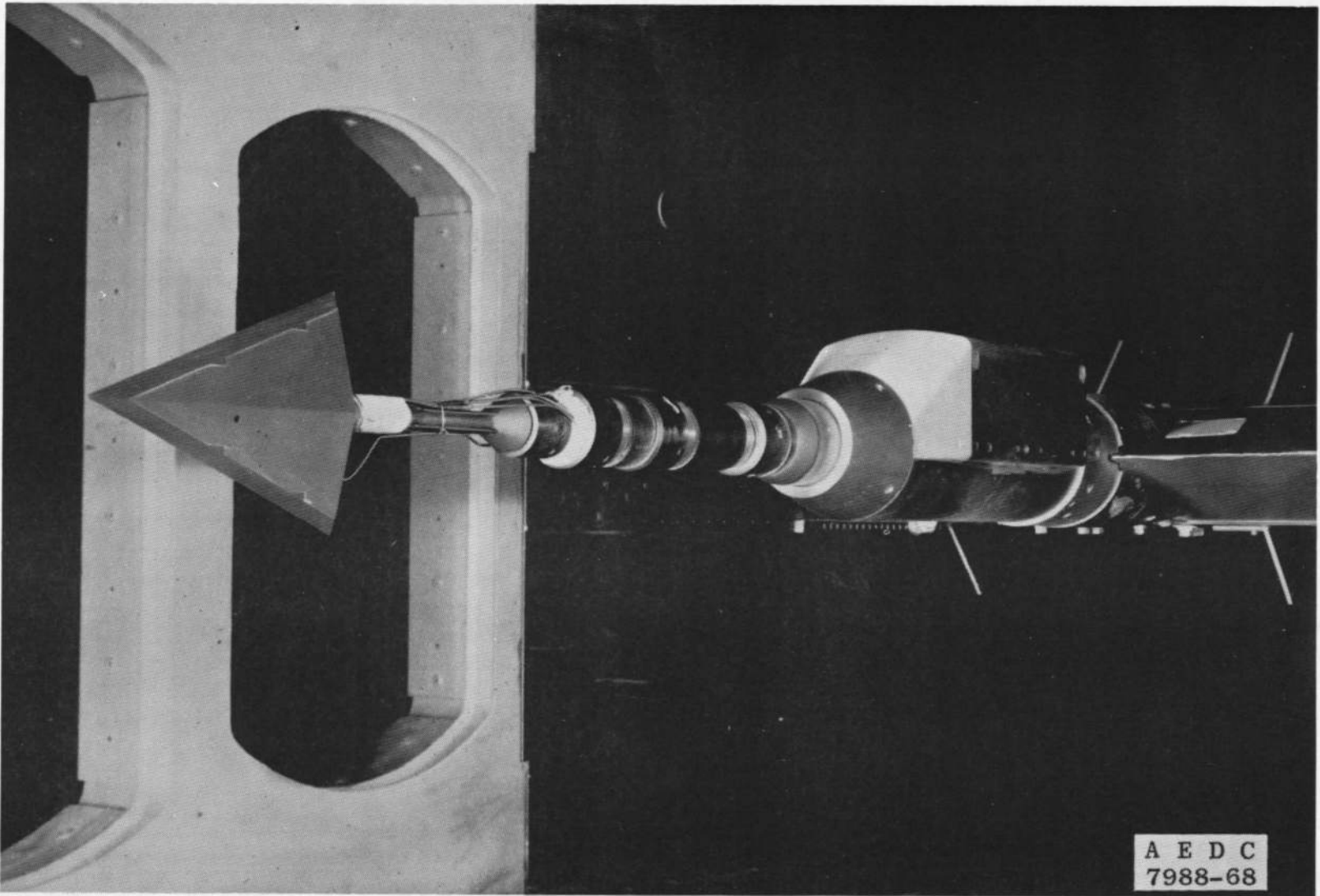

a. Basic Configuration (Zero Camber, Gap Sealed) Installed in Tunnel A

Fig. 1 Model Photographs

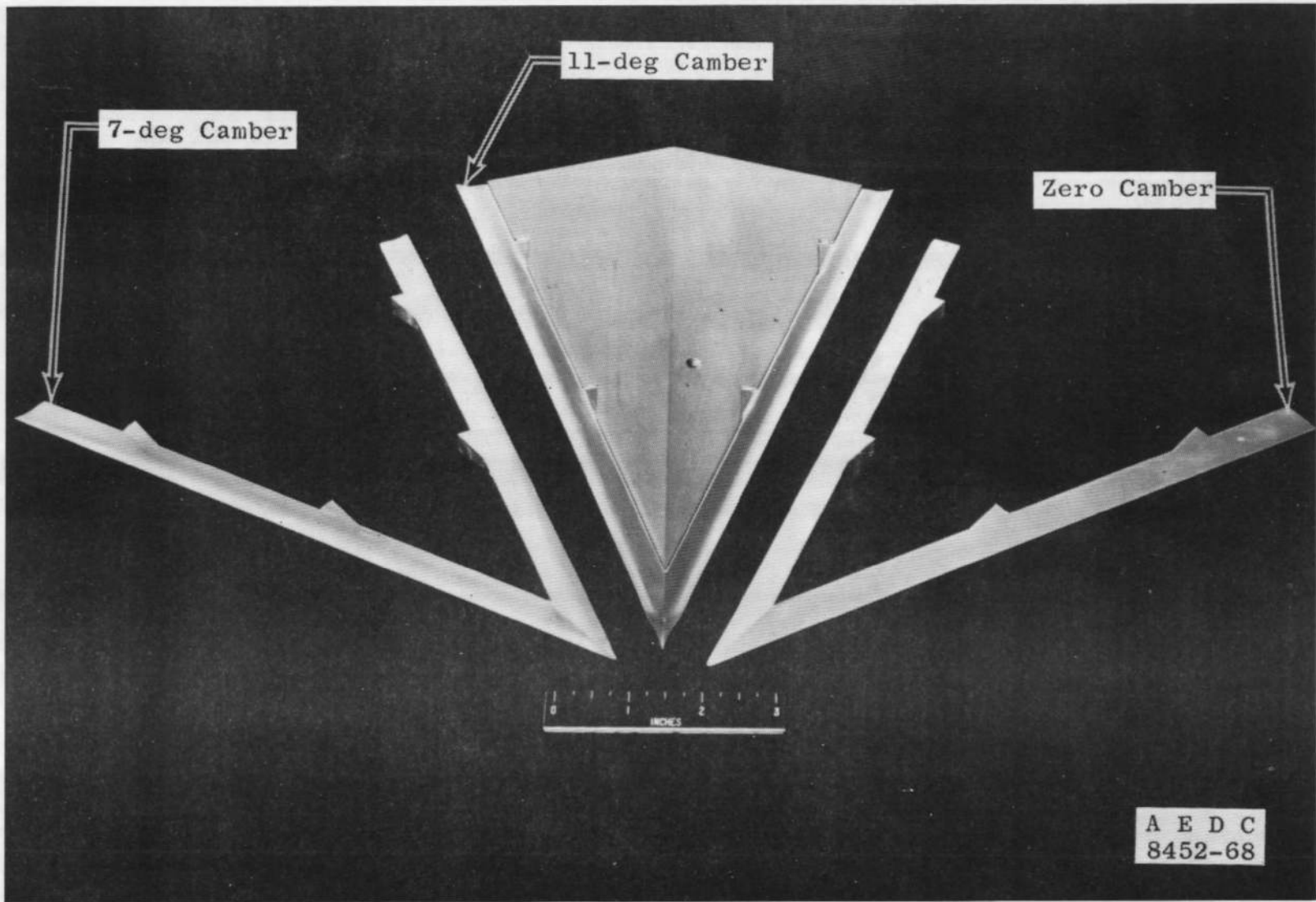

b. Centerbody with Leading Edges
Fig. 1 Concluded

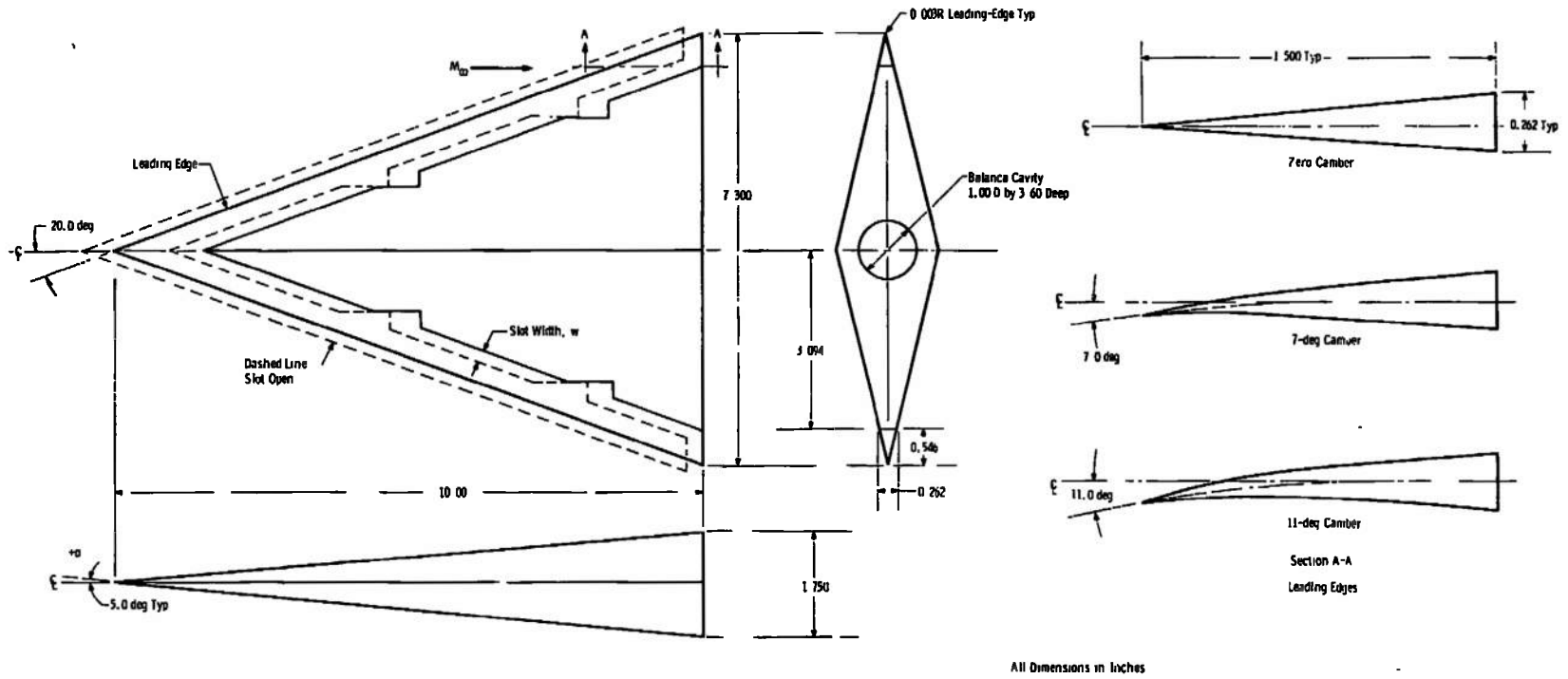
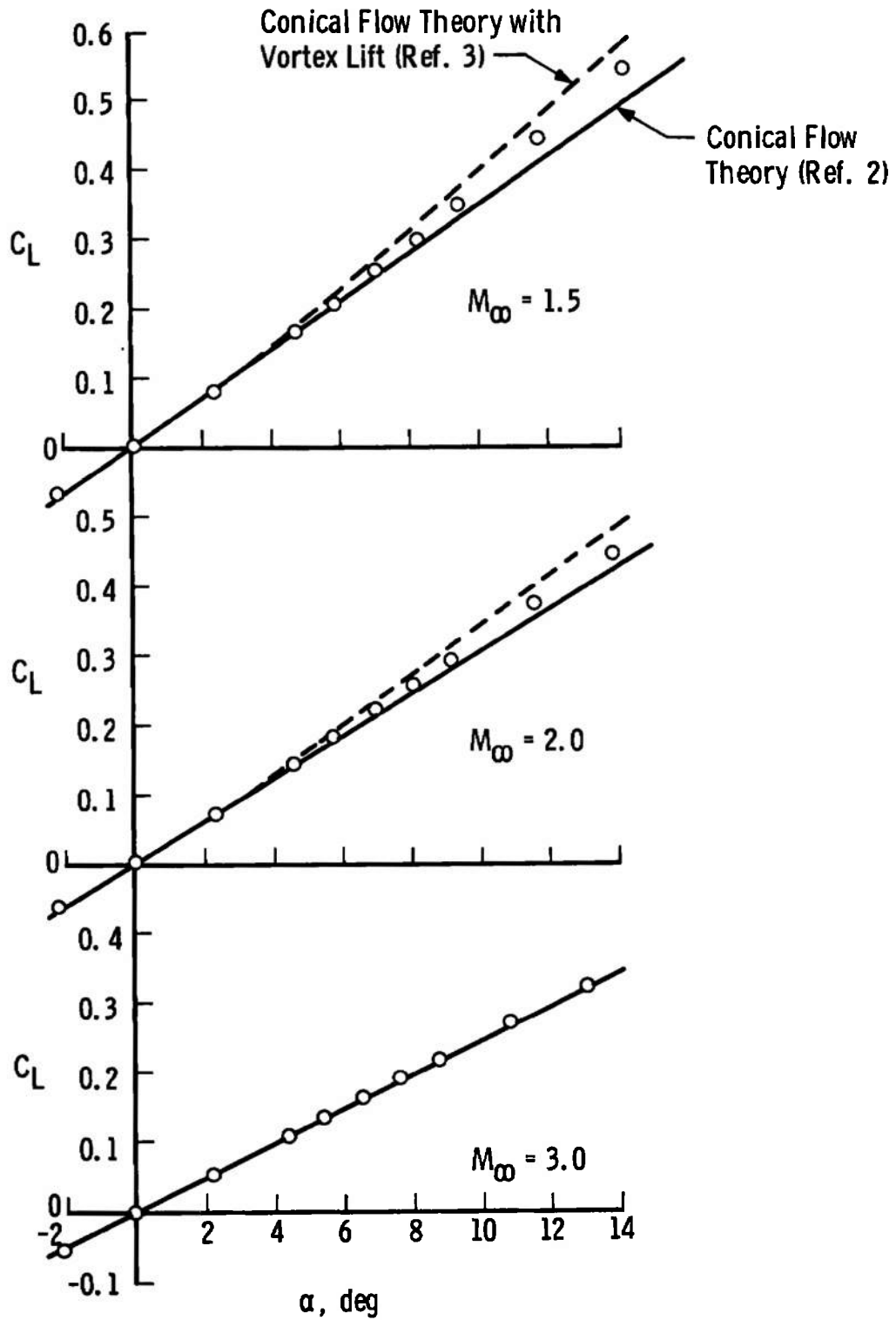
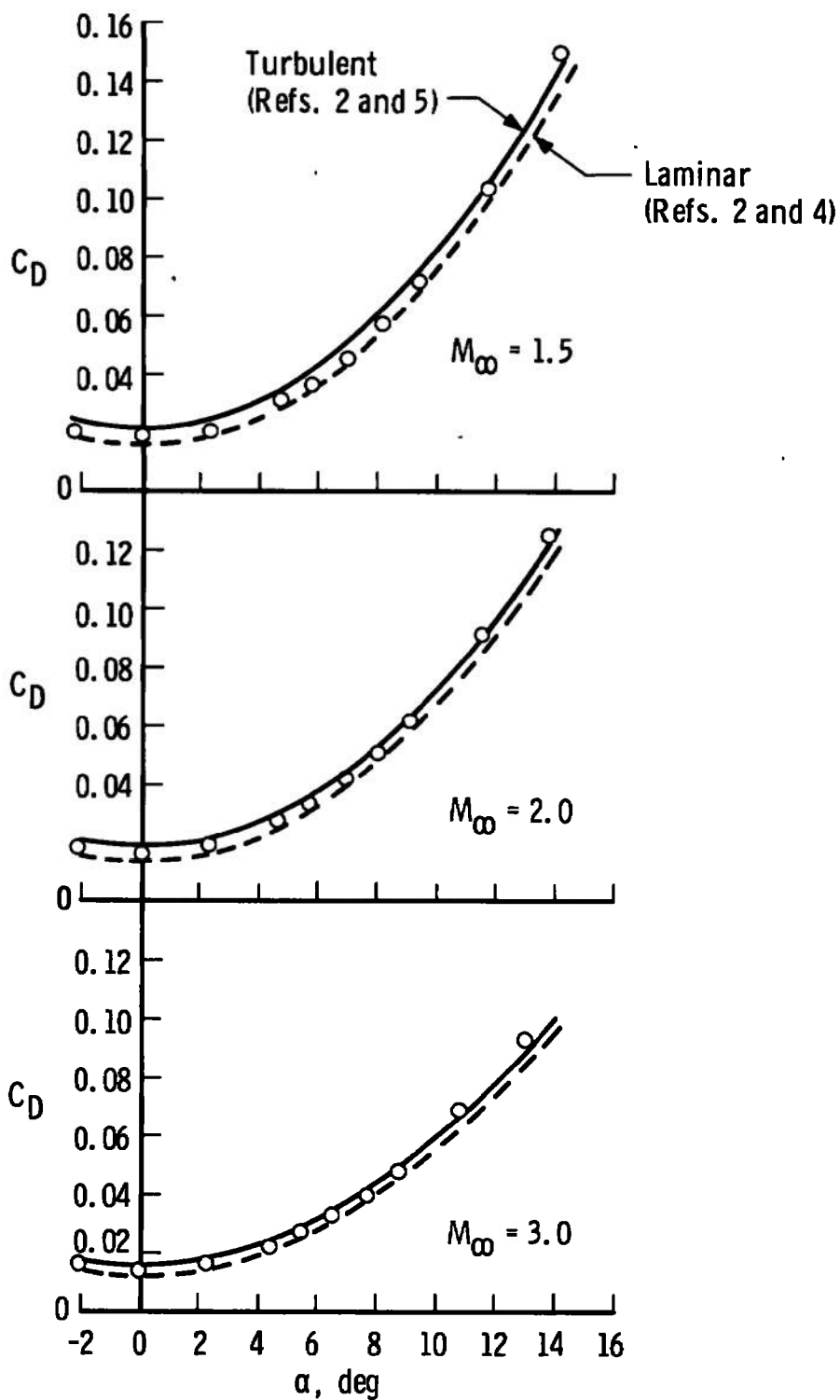

Fig. 2 Model Geometry



a. Lift Coefficient

Fig. 3 Comparison of Theoretical and Experimental Results for Zero Camber Leading Edge, Gap Sealed ($Re_l = 3.4 \times 10^6$)



b. Drag Coefficient
 Fig. 3 Continued

Note: Conical Flow Theory (Ref. 2) Used for C_L

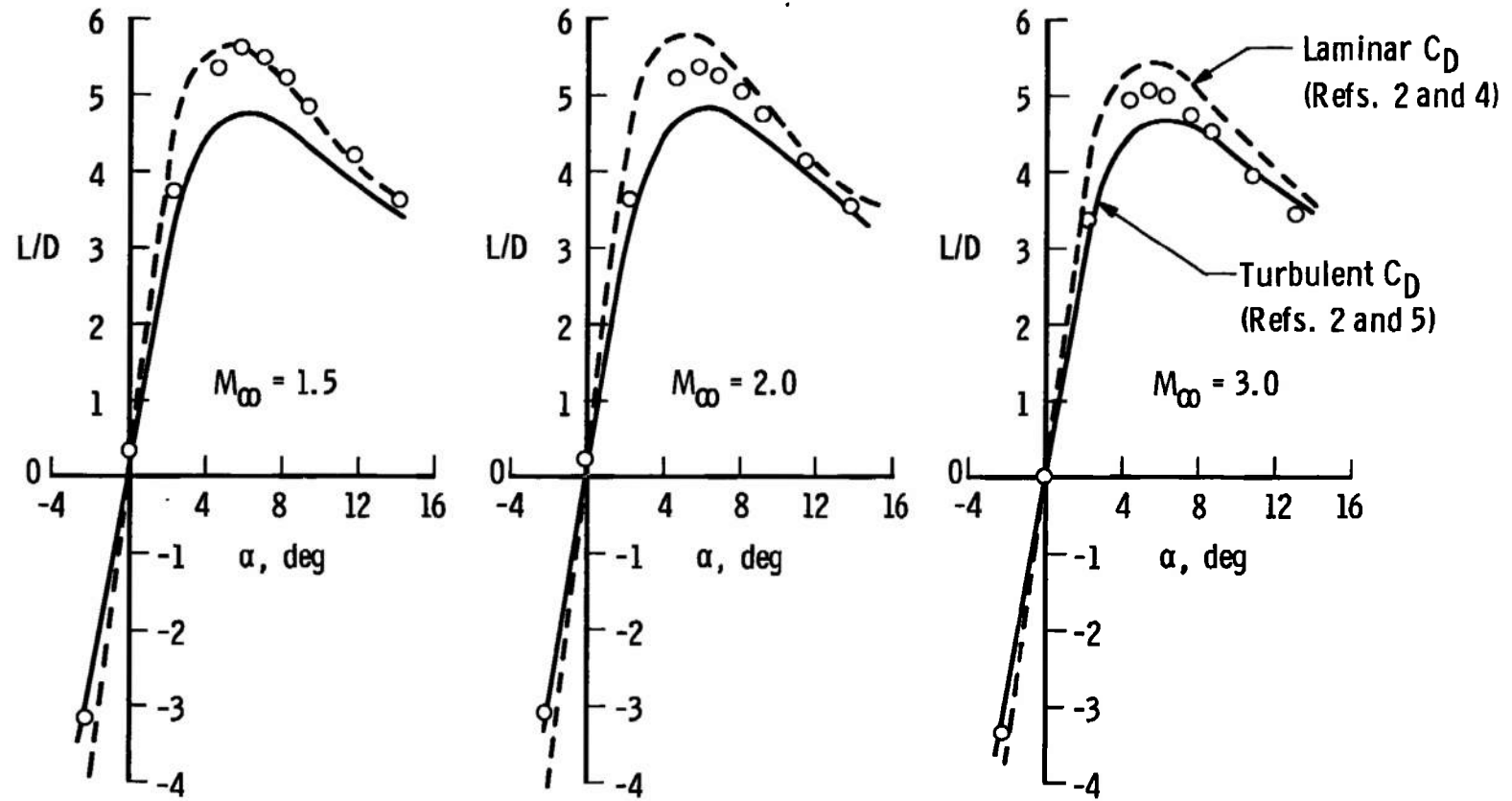

12

c. Lift-to-Drag Ratio
Fig. 3 Concluded

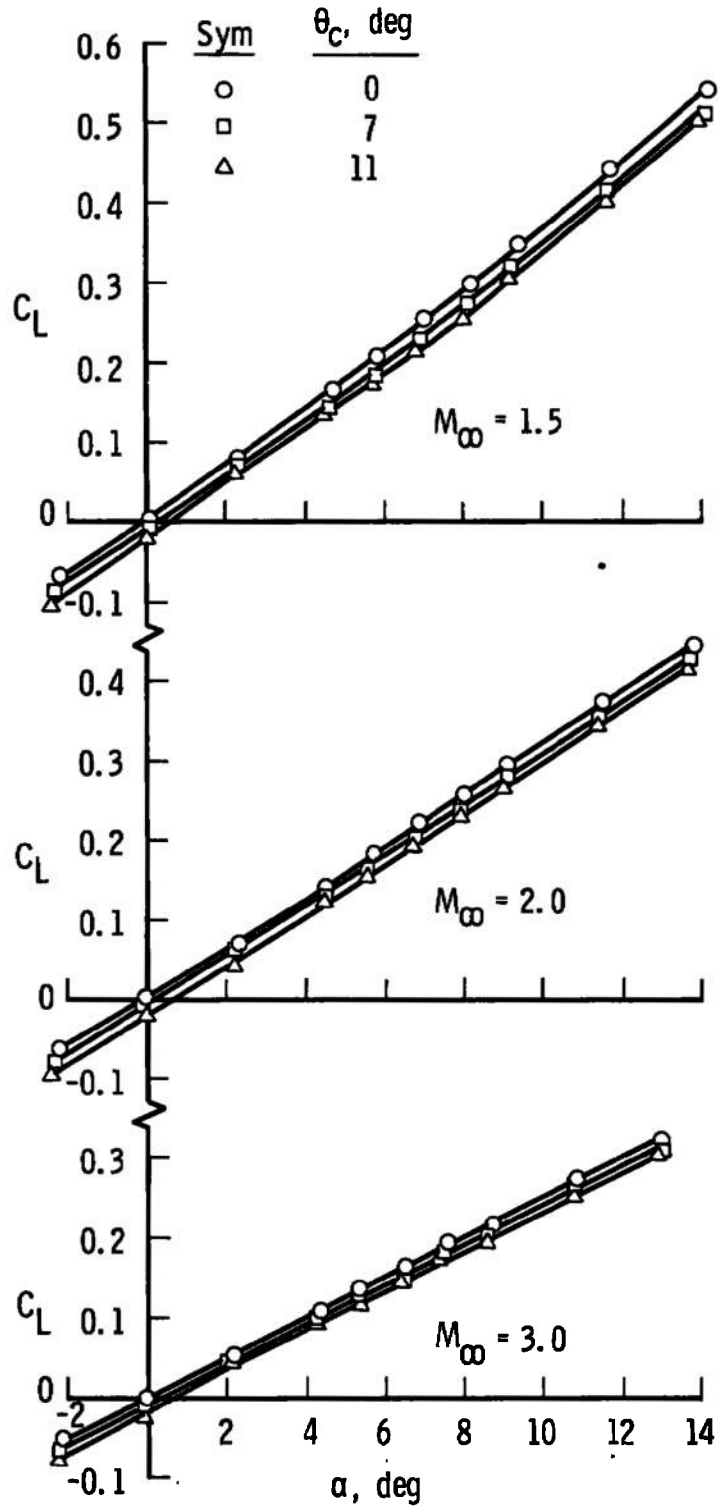

a. Lift Coefficient

Fig. 4 Effect of Camber on Wing Aerodynamic Loads, Gap Sealed ($Re_l = 3.4 \times 10^6$)

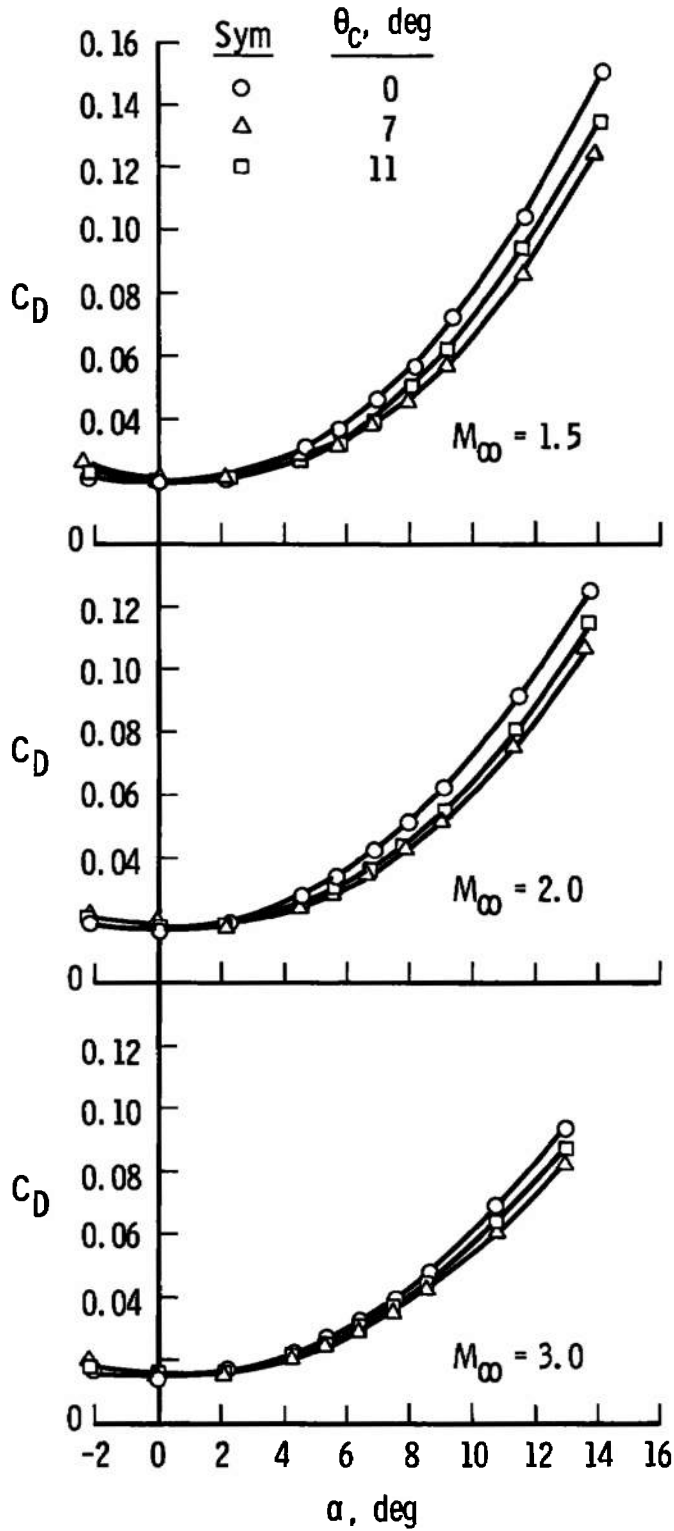

b. Drag Coefficient
Fig. 4 Continued

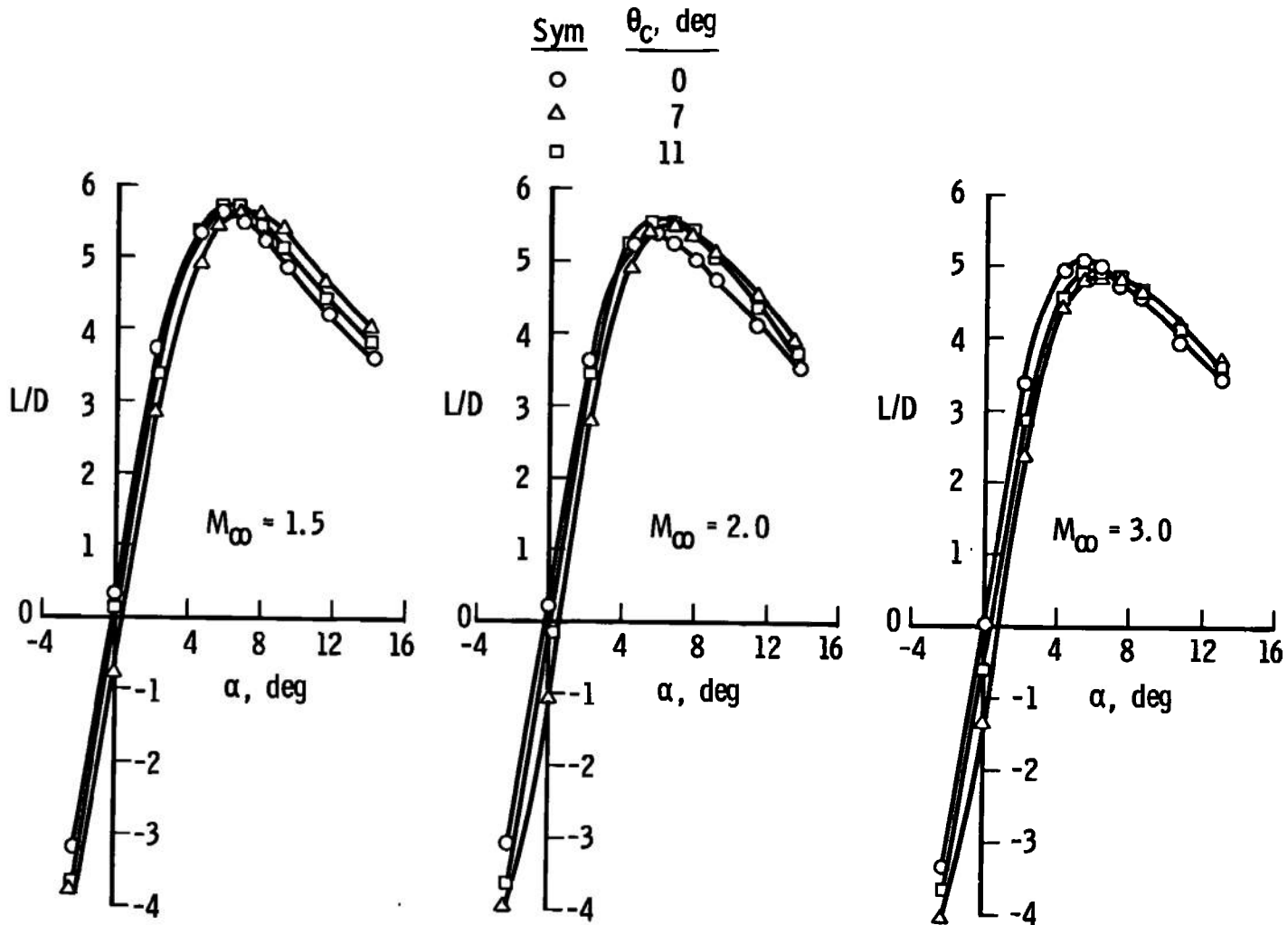

c. Lift-to-Drag Ratio
 Fig. 4 Concluded

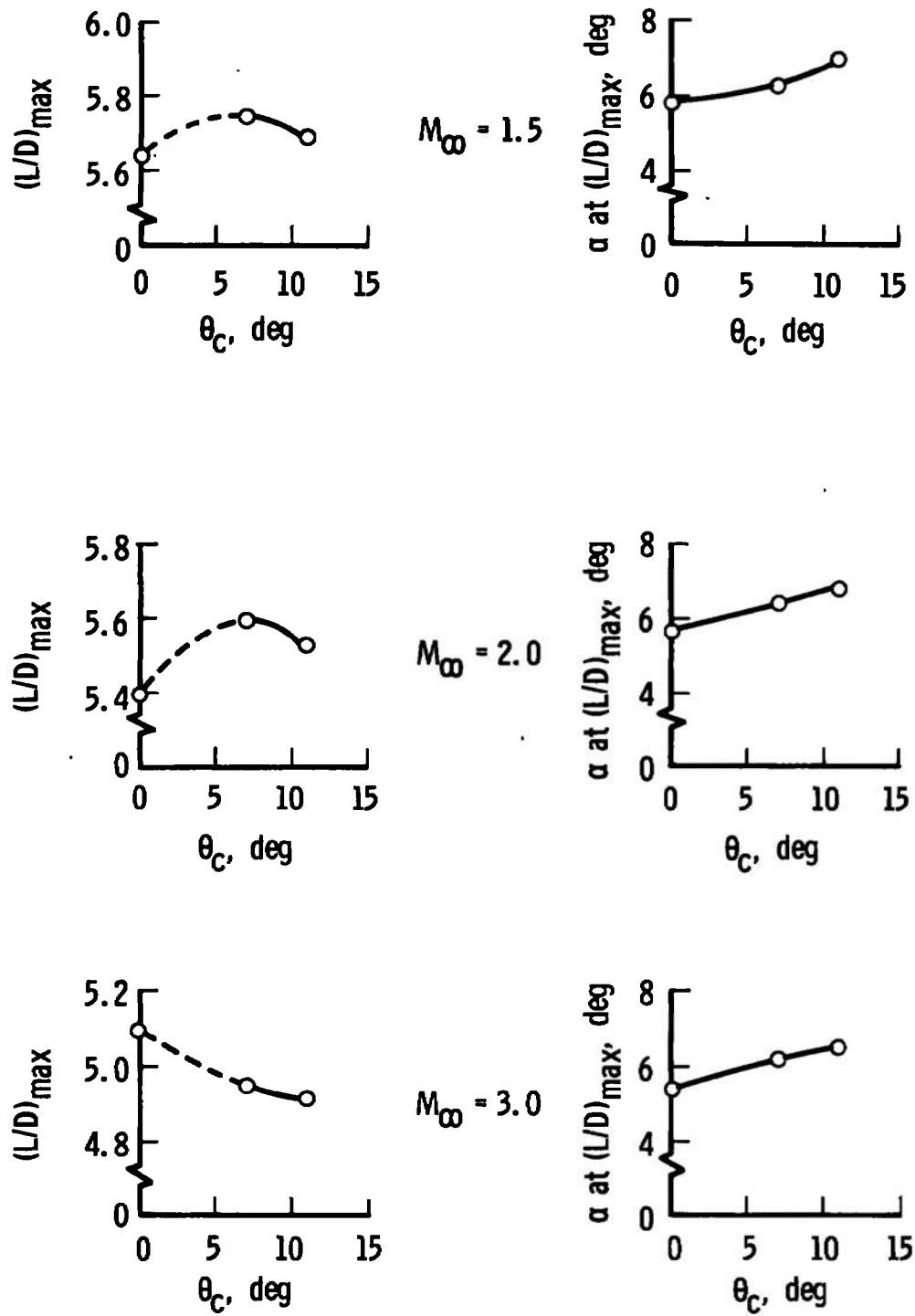
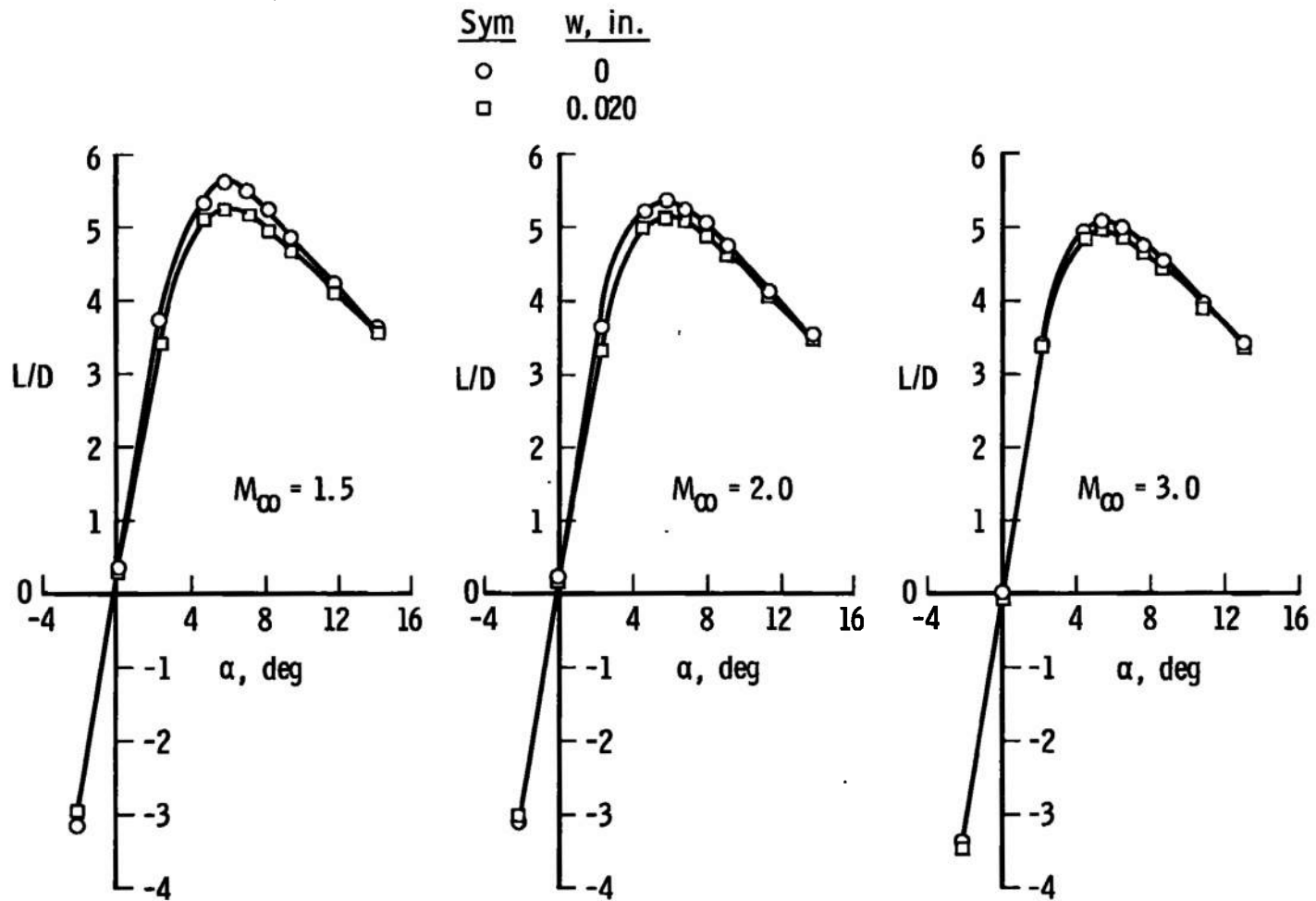
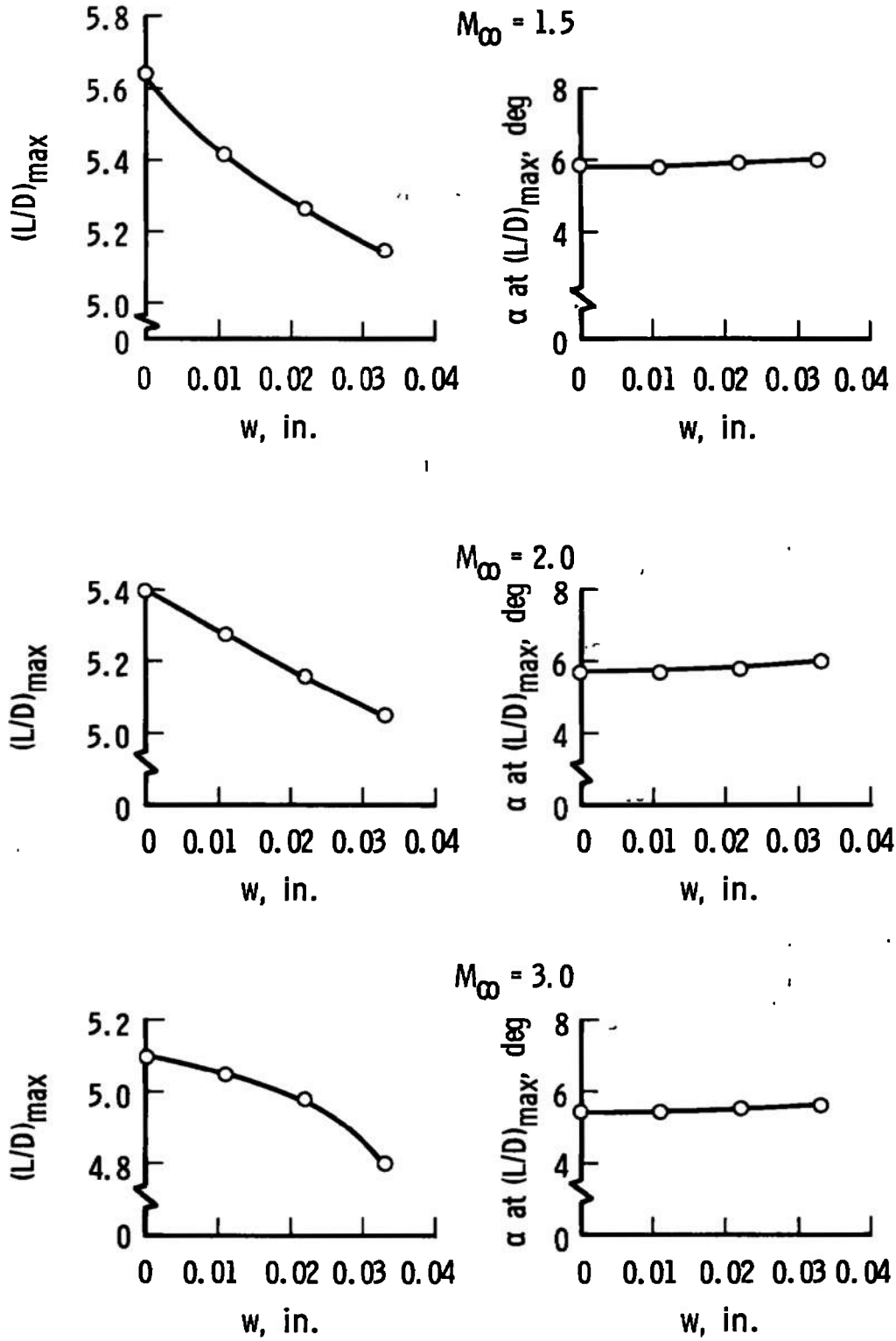

Fig. 5 Variation of $(L/D)_{max}$ and α at $(L/D)_{max}$ with Camber, Gap Sealed ($Re_l = 3.4 \times 10^6$)



a. Variation of L/D with Angle of Attack

Fig. 6 Gap Effects on Wing Aerodynamic Loads, Zero Camber Leading Edge ($Re_l = 3.4 \times 10^6$)



b. Variation of $(L/D)_{max}$ and α at $(L/D)_{max}$

Fig. 6 Concluded

TABLE I
TEST SUMMARY

Configuration		Angle of Attack, α , deg	$Re_l \times 10^{-6}$	M_∞	
Leading-Edge Camber, θ_c , deg	Gap, w, in.				
*0	*0	-2 to 12	1.5 and 3.4	1.5	
↓	0	↓	3.4	2.0	
	0		3.0		
	0.005		1.5		
	0.005		2.0		
	0.005		3.0		
	0.010		1.5		
	0.010		2.0		
	0.010		3.0		
	0.020		1.5 and 3.4		
	0.020		2.0		
	0.020		3.0		
	0.030		1.5		
	0.030		2.0		
	0.030		3.0		
	7		0	1.5	
	↓		0	2.0	
			0	3.0	
0.010		1.5			
0.010		2.0			
0.010		3.0			
0.020		1.5			
0.020		2.0			
0.020		3.0			
0.030		1.5			
0.030		2.0			
0.030		3.0			
7	0	-2 to 12	3.0		
↓	0	-10 to 12	1.5		
	0	-12 to 12	2.0		
	0	-12 to 12	3.0		
	0.010	-2 to 12	1.5		
	0.010	-2 to 12	2.0		
	0.010	-2 to 12	3.0		
	0.020	-10 to 12	1.5		
	0.020	-12 to 12	2.0		
	0.020	-12 to 12	3.0		
	11	0.020	-2 to 12	3.4	3.0

*Basic Configuration

DOCUMENT CONTROL DATA - R & D

(Security classification of title, body of abstract and indexing annotation must be entered when the overall report is classified)

1. ORIGINATING ACTIVITY (Corporate author) Arnold Engineering Development Center ARO, Inc., Operating Contractor Arnold Air Force Station, Tennessee		2a. REPORT SECURITY CLASSIFICATION UNCLASSIFIED	
		2b. GROUP N/A	
3. REPORT TITLE FORCE TESTS ON A SLOTTED DELTA WING WITH VARYING LEADING-EDGE CAMBER AT SUPERSONIC MACH NUMBERS			
4. DESCRIPTIVE NOTES (Type of report and inclusive dates) August 20 through 28, 1968 - Final Report			
5. AUTHOR(S) (First name, middle initial, last name) E. J. Lucas and W. R. Martindale, ARO, Inc.			
6. REPORT DATE December 1968		7a. TOTAL NO. OF PAGES 25	7b. NO OF REFS 5
8a. CONTRACT OR GRANT NO. F40600-69-C-0001		9a. ORIGINATOR'S REPORT NUMBER(S) AEDC-TR-68-257	
b. PROJECT NO 9781		9b. OTHER REPORT NO(S) (Any other numbers that may be assigned this report) N/A	
c. Program Element 6144501F			
d.			
10. DISTRIBUTION STATEMENT This document is subject to special export controls and each transmittal to foreign governments or foreign nationals may be made only with prior approval of Air Force Office of Scientific Research (SREM), Arlington, Virginia 22209.			
11. SUPPLEMENTARY NOTES Available in DDC		12. SPONSORING MILITARY ACTIVITY Air Force Office of Scientific Research (SREM), Arlington, Va. 22209	
13. ABSTRACT <p>Tests were conducted in the 40-in. supersonic wind tunnel of the von Kármán Gas Dynamics Facility on a 70-deg-sweep delta wing. A gap between the leading edge and main body was varied from a sealed condition to a nominal 0.030-in. opening for three leading edges of various camber. The aerodynamic characteristics of these configurations were obtained at Mach numbers 1.5, 2.0, and 3.0 at angles of attack from -12 to 12 deg and Reynolds numbers, based on the 10-in. model root chord, from 1.3×10^6 to 6.0×10^6. Results are presented showing the variation in lift/drag for various combinations of gap width and leading-edge camber.</p> <p>This document is subject to special export controls and each transmittal to foreign governments or foreign nationals may be made only with prior approval of Air Force Office of Scientific Research (SREM), Arlington, Virginia 33309.</p> <p>This document has been approved for public release its distribution is unlimited.</p>			

14.

KEY WORDS

LINK A

LINK B

LINK C

ROLE

WT

ROLE

WT

ROLE

WT

swept wings
 delta wings
 camber
 aerodynamic characteristics
 wind tunnel tests
 supersonic flow
 lift
 drag

1. Stalled wings.
2. Triangular wing --
 aerodynamic characteristics.
3. Triangular wings -- Lift
4. " " -- Drag.
5. " " -- Supersonic flow

1-1