

UNCLASSIFIED

AD NUMBER

AD842097

LIMITATION CHANGES

TO:

Approved for public release; distribution is unlimited.

FROM:

Distribution authorized to U.S. Gov't. agencies and their contractors;
Administrative/Operational Use; OCT 1968. Other requests shall be referred to Arnold Engineering Development Center, Arnold AFB, TN.

AUTHORITY

AEDC ltr dtd 27 Jun 1973

THIS PAGE IS UNCLASSIFIED

Charles E. Robinson

AEDC-TR-68-178



**APOLLO BLOCK II SPS ENGINE (AJ10-137)
ENVIRONMENTAL TESTS AND MOD I-C BIPROPELLANT
VALVE QUALIFICATION TESTS
(PHASE VI, PART I)**

**G. H. Schulz, A. L. Berg, and C. E. Robinson
ARO, Inc.**

October 1968

This document is subject to special export controls and each transmittal to foreign governments or foreign nationals may be made only with prior approval of NASA-MSC (EP-2), Houston, Texas 77058.

**ROCKET TEST FACILITY
ARNOLD ENGINEERING DEVELOPMENT CENTER
AIR FORCE SYSTEMS COMMAND
ARNOLD AIR FORCE STATION, TENNESSEE**

NOTICES

When U. S. Government drawings specifications, or other data are used for any purpose other than a definitely related Government procurement operation, the Government thereby incurs no responsibility nor any obligation whatsoever, and the fact that the Government may have formulated, furnished, or in any way supplied the said drawings, specifications, or other data, is not to be regarded by implication or otherwise, or in any manner licensing the holder or any other person or corporation, or conveying any rights or permission to manufacture, use, or sell any patented invention that may in any way be related thereto.

Qualified users may obtain copies of this report from the Defense Documentation Center.

References to named commercial products in this report are not to be considered in any sense as an endorsement of the product by the United States Air Force or the Government.

APOLLO BLOCK II SPS ENGINE (AJ10-137)
ENVIRONMENTAL TESTS AND MOD I-C BIPROPELLANT
VALVE QUALIFICATION TESTS
(PHASE VI, PART I)

G. H. Schulz, A. L. Berg, and C. E. Robinson
ARO, Inc.

This document is subject to special export controls and each transmittal to foreign governments or foreign nationals may be made only with prior approval of NASA-MSD (EP-2), Houston, Texas 77058.

FOREWORD

The contents of this report are the results of an altitude qualification testing program of the Aerojet-General Corporation (AGC), Block II AJ10-137, liquid-propellant rocket engine. This test phase (Phase VI) was a continuation of previous testing (Phase V) during which the thrust chamber bipropellant valve did not meet qualification requirements and was subsequently modified for retesting as reported herein. This program was sponsored by the National Aeronautics and Space Administration, Manned Spacecraft Center (NASA-MSC), under System 921E/9281. Technical liaison was provided by AGC, subcontractor of North American Rockwell, Space Division (NAR-SD), for the development of the Apollo Service Module (SM) Engine. Quality assurance surveillance was provided by AGC, NAR, and ARO, Inc.

The test program was requested to support the Apollo project under MIPR-29844G. Testing was conducted by ARO, Inc. (a subsidiary of Sverdrup & Parcel and Associates, Inc.), contract operator of the Arnold Engineering Development Center (AEDC), Air Force Systems Command (AFSC), Arnold Air Force Station, Tennessee, under Contract F40600-69-C-0001. The testing was conducted in Propulsion Engine Test Cell (J-3) of the Rocket Test Facility (RTF) between February 1 and April 4, 1968, under ARO Project No. RM1731. This manuscript was submitted for publication on July 17, 1968.

Information in this report is embargoed under the Department of State International Traffic in Arms Regulations. This report may be released to foreign governments by departments or agencies of the U.S. Government subject to approval of NASA-MSC (EP-2), or higher authority. Private individuals or firms require a Department of State export license.

This technical report has been reviewed and is approved.

Donald W. Ellison
Lt Colonel, USAF
AF Representative, RTF
Directorate of Test

Roy R. Croy, Jr.
Colonel, USAF
Director of Test

ABSTRACT

Simulated altitude testing of the Apollo SPS Block II engine was conducted for the qualification of a new design bipropellant valve (Mod I-C). Also, tests were conducted to investigate postfire propellant evaporative cooling in the engine injector and to evaluate electric strip heaters on the engine propellant lines, bipropellant valve, and injector. One-hundred-seventeen test firings were made for a total of 863 sec of firing time during nine test periods. Propellants were nitrogen tetroxide and 50/50 hydrazine/UDMH. Engine operation and performance were satisfactory, but the bipropellant valve developed leaks in the valve ball seals and shaft seals greater than specification limits. Propellant evaporative cooling produced injector local temperatures down to 17°F from 30°F starting conditions. Cold test conditions (30°F) had little effect on engine operation other than to slightly slow down bipropellant valve operation and to extend the ignition transient.

This document is subject to special export controls and each transmittal to foreign governments or foreign nationals may be made only with prior approval of NASA-MSD (EP-2), Houston, Texas 77058.

CONTENTS

| | <u>Page</u> |
|--------------------------------------|-------------|
| ABSTRACT. | iii |
| NOMENCLATURE. | vii |
| I. INTRODUCTION | 1 |
| II. APPARATUS | 1 |
| III. PROCEDURE. | 8 |
| IV. RESULTS AND DISCUSSION | 15 |
| V. SUMMARY OF RESULTS | 27 |
| REFERENCES | 29 |

APPENDIXES

I. ILLUSTRATIONS

Figure

| | |
|---|----|
| 1. The Apollo SPS Block II Engine | 33 |
| 2. Block II Bipropellant Valve | |
| a. General Arrangement. | 34 |
| b. Flow Diagram | 34 |
| 3. Bipropellant Valve Ball and Seal Details | |
| a. Prototype (Phase V) | 35 |
| b. Mod I-C Design (Phase VI) | 35 |
| 4. Face View of Injector S/N 104 | 36 |
| 5. Nozzle Extension S/N 054, Posttest Period FJ | 37 |
| 6. Electrical Strip Heaters | |
| a. Engine Line Heater Installation | 38 |
| b. Injector Heater Installation | 39 |
| 7. Schematic of F-3 Fixture | 40 |
| 8. Test Cell J-3 | |
| a. Complex. | 41 |
| b. Schematic | 42 |
| 9. Arrangement of Thrust System. | 43 |
| 10. Engine and Nozzle Extension Instrumentation Location | |
| a. General Locations | 44 |
| b. Injector Thermocouple Locations. | 45 |

| <u>Figure</u> | <u>Page</u> |
|---|-------------|
| 11. Injector Temperature History following Short Firing FJ-33 | |
| a. T_j -15. | 46 |
| b. T_j -4 | 46 |
| c. T_{fj} | 46 |
| 12. Effect of Multiple Firings on Injector Temperatures | |
| a. Multiple Firings with 4-min Interval. | 47 |
| b. Multiple Firings with 6-min Interval. | 47 |
| 13. Typical Shutdown Pressure Profile | 48 |
| 14. Propellant Temperature Influence on Time from FS1 to Ignition. | 49 |
| 15. Typical Ignition Transients | |
| a. Thrust | 50 |
| b. Impulse. | 50 |
| 16. Propellant Temperature Influence on Average Rise Rate of Chamber Pressure | 51 |
| 17. Ignition Transient Chamber Pressure Profiles | 52 |
| 18. TCV Ball Positions during Ignition Transient, Test FJ-36 | 53 |
| 19. Typical Shutdown Thrust and Impulse Transients | |
| a. Thrust | 54 |
| b. Impulse. | 54 |
| 20. Total Impulse of Bit Firings | 55 |
| 21. Total Impulse of Bit Firings at Off-Design Conditions | 56 |
| 22. Average Propellant Flow of Impulse Bit Firings. | 57 |
| 23. Vacuum Specific Impulse Compared with Previous Test Data Characteristic Curve | |
| a. $p_c = 90$ to 96 psia | 58 |
| b. $p_c = 97$ to 102 psia. | 58 |
| c. $p_c = 103$ to 114 psia | 58 |
| 24. Effect of Chamber Pressure on Vacuum Specific Impulse. | 59 |
| 25. Propellant Line Heater Operation | |
| a. Fuel Line Temperature | 60 |
| b. Oxidizer Line Temperature. | 60 |
| 26. Injector Heater Operation | 61 |

| | <u>Page</u> |
|---|-------------|
| II. TABLES | |
| I. Test Summary | 62 |
| II. Cold Temperature Test Prefire Conditions | 65 |
| III. Bipropellant Valve S/N 128 Leakage Rates with GN ₂ | 66 |
| IV. Bipropellant Valve S/N DV-2 Leakage Rates with GN ₂ | 67 |
| V. Summary of Ignition Transient Impulse Data | 68 |
| VI. Summary of Shutdown Transient Impulse Data | 69 |
| VII. Impulse Bit Data Summary | 71 |
| VIII. Engine Performance Summary | 73 |
| III. TCV LEAKAGE CHECKS | 74 |

NOMENCLATURE

| | |
|-----------------|--|
| A | Area, in. ² |
| C _F | Thrust coefficient |
| c* | Characteristic velocity, ft/sec |
| F | Force, lbf |
| FS1 | Fire switch, start |
| FS2 | Fire switch, shutdown |
| g _c | Gravitational conversion factor, proportionality constant, lb _m -ft/lbf-sec ² |
| I _{sp} | Specific impulse, lbf-sec/lb _m |
| I _t | Total impulse, lbf-sec |
| O/F | Mixture ratio, lb _m (oxidizer)/lb _m (fuel) |
| p | Pressure, psia |
| T | Temperature, °F |
| t | Time |
| ḡ | Propellant flow rate, lb _m /sec |

SUBSCRIPTS

| | |
|------------|---|
| 1, 2, 3... | Position |
| a | Axial |
| c | Chamber |
| cal | Calibrate |
| calc | Calculated |
| e | Nozzle exit |
| f | Fuel |
| i | Initial |
| j | Injector |
| l | Line |
| n | Nozzle |
| o | Oxidizer |
| p | Propellant |
| t | Tank, throat, total |
| tcv | Thrust chamber valve (bipropellant valve) |
| vac | Corrected to vacuum |

SECTION I INTRODUCTION

The Apollo spacecraft consists of a Command Module (CM, three-man capsule), Service Module (SM) which contains the main propulsion system and propellant tankage, and the Lunar Module (LM). The AJ10-137 is the main propulsion engine installed in the SM.

Three phases of simulated altitude testing were conducted to develop and qualify the engine (designated the Block I configuration, Refs. 1 through 10), but difficulties encountered during altitude testing necessitated further development (Phase IV, Refs. 11 and 12) and qualification testing (Phase V, Ref. 13). The latter engine configuration was designated Block II, and this design was qualified during Phase V testing except for the thrust chamber bipropellant valve (TCV), which developed leaks slightly greater than the specified limits.

Phase VI was conducted primarily for qualification testing of the AJ10-137 engine redesigned bipropellant valve. This report covers the Mod I-C bipropellant valve qualification testing of this engine in Propulsion Engine Test Cell (J-3). In addition, test results are included of the electrical heaters which were being considered for use on the propellant lines and injector of the flight vehicles and of the postfire propellant evaporative cooling in the injector. One engine was tested with two bipropellant valve assemblies for a total of 863 sec of firing time during nine test periods. A summary of the individual test periods and test firings is presented in Table I (Appendix II).

SECTION II APPARATUS

2.1 TEST ARTICLE

The Aerojet AJ10-137 rocket engine is a pressure-fed, liquid-propellant engine which includes a self-contained nitrogen pressure-actuated bipropellant valve, a doublet impingement injector, a film-cooled ablative combustion chamber, electric gimbal actuators, and a 60:1 expansion ratio radiation-cooled nozzle extension. The overall height of the complete engine assembly (Fig. 1, Appendix I) is approximately 13 ft, and the engine assembly weighs approximately 850 lb.

The Block II engine used for this testing was designed to operate at a nominal 1.60 mixture ratio (O/F) and a chamber pressure of 99 psia with a minimum of 50 starts over an operating life of 750 sec. The liquid, storable, hypergolic propellants were nitrogen tetroxide (N_2O_4) as the oxidizer (MSC-PPD-2A) and Aerozine-50[®] (AZ-50) as the fuel (MIL-P-27402). The N_2O_4 had a nominal 0.6 percent by weight nitric oxide additive.

During this Phase VI testing, gimbal actuators were not included in the engine assembly; engine gimbal movement was restrained by stiff links. The radiation-cooled nozzle extension was attached to the combustion chamber at the 6:1 area ratio. The major components used in each engine assembly are identified as follows:

| <u>Engine S/N</u> | <u>Test Period</u> | <u>TCV S/N</u> | <u>Injector S/N</u> | <u>Chamber S/N</u> | <u>Nozzle Extension S/N</u> | <u>Balance Orifices</u> |
|-----------------------|------------------------|--------------------|-------------------------|------------------------|-------------------------------------|-----------------------------|
| 54D | FA,FB, FC | 128 | 104 | 351 | 054 | Dual bore |
| 54E | FD | 128 | 104 | 351 | 054 | Single bore |
| 54F | FE,FF, FG,FH, FJ | DV-2 | 094 | 351 | 054 | Dual bore |

2.1.1 Thrust Chamber Valve and Propellant Lines

A pneumatic, pressure-operated, bipropellant valve was used. Gaseous nitrogen stored in two spheres at pressures up to 2500 psia and regulated to approximately 220 psia provided actuation pressure. Electrical command signals were required for opening and closing the valve.

The bipropellant valve assembly consisted of eight ball valves: two in each of two parallel fuel passages and two in each of two parallel oxidizer passages (Fig. 2). One fuel passage and one oxidizer passage constituted an independent valve bank; thus the TCV had two valve banks, designated valve banks A and B. The redundant valve banks allowed normal engine operation if one of the banks became inoperative. Complete redundancy in the TCV was provided since each of four TCV actuators operated one fuel and one oxidizer ball valve and since one nitrogen sphere and regulator provided pressure for operation of one valve bank. Each of two solenoid-operated enable valves was connected to a pair of actuators; thus, valve bank A, bank B, or both banks could be utilized to fire the engine.

The TCV was connected to the propellant supply system by the engine propellant lines. The propellant lines contained flexible bellows sections to permit engine gimbaling and screen filters at the line inlets.

Trim orifices were installed at the TCV inlet ports to adjust the pressure losses in the parallel valve passages so that engine operation using either valve bank would produce nearly the same engine performance. Engine balance orifices were installed at the engine propellant line inlets (interfaces) to adjust the engine overall pressure losses so that nominal engine operating conditions would result from engine standard inlet conditions of propellant pressure and temperature. Orifice sizes for all test periods are listed below:

| Test Period | Engine S/N | TCV S/N | Orifice Diameter, in. | | | | | | Target Balance Condition |
|----------------|---------------|------------|-----------------------|-------|----------|-------|--|-------|--------------------------------|
| | | | TCV Trim Orifices | | | | Engine Interface Balance Orifices | | |
| | | | Bank A | | Bank B | | Oxidizer | Fuel | |
| | | | Oxidizer | Fuel | Oxidizer | Fuel | | | |
| FA | 54D | 128 | 1.783 | 1.930 | 1.930 | 1.517 | 1.940 | 1.404 | Dual Bore |
| FB | 54D | 128 | 1.783 | 1.930 | 1.930 | 1.517 | 1.766 | 1.380 | Dual Bore |
| FC | 54D | 128 | 1.783 | 1.930 | 1.930 | 1.517 | 1.785 | 1.361 | Dual Bore |
| FD | 54E | 128 | 1.783 | 1.930 | 1.930 | 1.517 | 1.935 | 1.446 | Single Bore |
| FE | 54F | DV-2 | 1.732 | 1.786 | 1.747 | 1.475 | 2.042 | 1.407 | Dual Bore |
| FF | ↓ | ↓ | ↓ | ↓ | ↓ | ↓ | ↓ | ↓ | ↓ |
| FG | ↓ | ↓ | ↓ | ↓ | ↓ | ↓ | ↓ | ↓ | ↓ |
| FH | ↓ | ↓ | ↓ | ↓ | ↓ | ↓ | ↓ | ↓ | ↓ |
| FJ | ↓ | ↓ | ↓ | ↓ | ↓ | ↓ | ↓ | ↓ | ↓ |

The TCV used in this testing was a new design, designated the Mod I-C, which included seal rings on the upstream side, in addition to those on the downstream side, of all ball valves (Fig. 3). The number of springs holding the seals was also increased, and the individual spring loading was decreased to provide more uniform load distribution for better seating. The seal material was also changed from tetrafluoroethylene (TFE) to a glass-filled TFE. The ball shafts were changed from stub shafts to shafts extending completely through in order to improve the rigidity and alignment and to reduce the lateral movement of the balls (see Fig. 3b).

2.1.2 Propellant Injector

Two injectors were used during this testing; both S/N 104 and S/N 94 were the Block II flight design (Mod 4) (Fig. 4). Injector S/N 94 included a tap in the central fuel manifold for the installation of a thermocouple probe to measure fuel evaporative cooling effects. Both injectors contained orifices arranged in a doublet configuration with all oxidizer and selected fuel orifices counterbored to stabilize the injected streams and thereby prevent random chamber pressure pulses (Ref. 13). The injector configuration included a center hub baffle and five equally spaced radial baffles for improved combustion stability. These baffles were regeneratively cooled with fuel and provided fuel distribution to the outer fuel manifold rings. The injector had a single row of nonimpinging orifices adjacent to the injector/combustion chamber interface, which diverted approximately 5 percent of the total fuel flow into a fuel-rich, lower-temperature film for protection of the ablative chamber.

Injector S/N 104 had been tested previously at AEDC (Ref. 13) for a total of 1507 sec; the testing reported herein added 827 sec for a total of 2334 sec of test time at AEDC. Injector S/N 94 was tested for a total of 37 sec during the current test.

An explosive pulse charge was attached to the injector for demonstrating combustion stability for the first firing of the FA, FC, and FE test periods (as done in Phase V, Ref. 13).

2.1.3 Combustion Chamber

The ablatively cooled combustion chamber was the same Block II design as used previously (Ref. 13). Chamber S/N 351 was used for all tests covered by this report.

2.1.4 Exhaust Nozzle Extension

The radiation-cooled nozzle extension used during this testing was the standard Block II flight design (columbium-titanium configuration) used previously (Phase V, Ref. 13). Nozzle S/N 054, used during this testing, had been tested previously for a total of 2262 sec (Ref. 13) and for 863 sec during this phase, for a total of 3125 sec of engine firing time. This nozzle is shown in Fig. 5 as it appeared after test period FJ.

2.1.5 Electric Strip Heaters

Strip heaters on the engine propellant lines, bipropellant valve, and injector were preprototype designs which were being evaluated by

NAR for spacecraft use. The heaters were supplied by NAR and were installed on the engine by adhesive bonding under the direction of NAR prior to test period FE, as shown in Fig. 6.

The engine line and bipropellant valve heaters were continuous strips from the engine interface, looped over propellant line bellows, looped over the line/valve interface, and extended about 5 in. onto the valve body (Fig. 6a). Line heaters were also installed on the F-3 fixture from the engine interface to about 3 ft upstream of the interface. Each of the line heater strips contained two separate heating elements. The engine line strips and F-3 fixture strips were connected to provide two line heating circuits, A and B, each of which was designed for half the total heating capacity. The two circuits could be used separately or collectively and were designed for operation at 23 vdc. The line heater installation for this test was somewhat compromised by a shortage of heater strips; therefore, two F-3 line heater-type strips were substituted for one engine oxidizer line heater strip. The installed wattage distribution for this test was as follows:

| <u>Circuit Designation</u> | <u>Heat Distribution, watts</u> | | |
|--------------------------------|---------------------------------|-------------------------|------------------------------------|
| | <u>F-3 Lines</u> | <u>Engine Lines</u> | <u>Bipropellant Valve Body</u> |
| Fuel "A" | 19.6 | 55.0 | 15.0 |
| Oxidizer "A" | 19.6 | 47.1 | 7.5 |
| Fuel "B" | 19.6 | 55.0 | 15.0 |
| Oxidizer "B" | 19.6 | 47.1 | 7.5 |

After installation, the propellant line heaters were wrapped with approximately 40 layers of 0.35-mil-thick aluminized Mylar[®] for thermal insulation.

The one-piece injector heater (see Fig. 6b) contained two separate heating elements also designated A and B, each of which included half the heating capacity and could be operated individually or collectively and independently of the line heaters. Each injector heater circuit was nominally designed to produce 300 w at 23 v dc.

The heater circuits were operated with approximately 28 v dc for the line heaters and 23 v dc for the injector heater during the evaluation tests.

2.2 NAR F-3 FIXTURE

The F-3 fixture was a heavy-duty model of the Apollo SPS propellant system which was designed and built by NAR to reproduce the hydrodynamics of the SM spacecraft as closely as practical for ground testing. The spacecraft "zero-g" cans and propellant utilization system were not available for this program. The internal size and shape of the propellant tanks were identical to those of the spacecraft, except for modifications necessitated by ground testing requirements. The Block II tandem arrangement of two tanks was used for each propellant, a 1050-gal "sump" tank and a 1310-gal "storage" tank. A schematic diagram of the F-3 fixture is presented in Fig. 7.

A facility gaseous helium system was used for tank pressurization. This system provided various tank pressures for testing at off-design propellant flow rates.

Two heat shields were installed to protect instrumentation, plumbing, and the F-3 fixture from the nozzle extension thermal radiation. One was a facility shield with black Teflon[®] retained on a sheet steel structure by a steel screen. The second was an NAR-supplied, flight-type, stainless steel shield attached to the combustion chamber/nozzle extension interface.

2.3 INSTALLATION

The F-3 fixture and AJ10-137 engine were installed in the Propulsion Engine Test Cell (J-3), a vertical test cell for testing rocket engines at pressure altitudes of approximately 115,000 ft (Fig. 8 and Ref. 14). A 40-ft-high by 18-ft-diam aluminum test cell capsule lined with thermopanel to permit temperature conditioning of the cell was installed over the test article to form the pressure-sealed test chamber.

A rigid cage structure was installed inside the F-3 fixture, and another inner cage was installed inside the rigid cage. The inner cage was attached to the rigid cage by means of flexure assemblies to permit axial force measurements (Fig. 9). The engine was mounted inside the inner cage.

Pressure altitudes were maintained before and after test engine firings with a steam-driven ejector located in the test cell exhaust duct and connected in series with facility exhaust compressors. During the steady-state portion of a firing, pressure altitude was maintained with a supersonic engine exhaust diffuser (Fig. 8b). Ejector steam was supplied by the AEDC boiler plant and supplemented by steam from steam accumulators.

Additional test facility systems included ground level propellant storage tanks; helium storage and regulation for F-3 propellant tank pressurization; gaseous nitrogen for test article purging, leak checking, and valve operation; and heat exchangers for temperature conditioning propellants and test cell capsule. Equipment for test article operation located in the J-3 control room included the AGC firing console and combustion stability monitor (CSM).

2.4 INSTRUMENTATION

Instrumentation was provided to measure engine axial force; chamber pressure; propellant system pressures, temperatures, and flow rates; engine temperatures; test cell pressures; capsule wall and cell air temperatures; and engine accelerations. Instrumentation locations are shown in Fig. 10.

2.4.1 Axial Force

Axial force, F_a , (Fig. 9) was measured with a dual-bridge, strain-gage-type load cell with a rated capacity of 50,000 lb_f. In-place calibration was accomplished with a hydraulically actuated, axial loading system containing a calibration load cell ($F_{a_{cal}}$, Fig. 9). The calibration load cell and data load cell were laboratory calibrated prior to the first test period with traceability to the National Bureau of Standards (NBS).

During this test program, the engine gimbal stiff links included load cells to measure the pitch and yaw forces normally restrained by the actuators.

2.4.2 Pressures

Combustion chamber, propellant, and test cell pressures were measured with strain-gage-type transducers. One of the two chamber pressure transducers was close coupled for improved response, and the other one was provided with in-place calibration in a manner which permitted pressurization and comparison to a secondary standard pressure transducer. Test cell pressure was also measured by two capacitance-type precision pressure transducers. All transducers were laboratory calibrated prior to installation for this test program with traceability to NBS.

2.4.3 Temperatures

Chromel®-Alumel® (CA) thermocouples were used to measure exterior surface temperatures of the combustion chamber, nozzle extension, injector, TCV, propellant lines and tanks, test cell walls, and test cell air temperature. In addition, propellant temperatures were measured with resistance temperature transducer (RTT) immersion probes, which were laboratory calibrated with traceability to NBS.

2.4.4 Propellant Flow Rates

Propellant flow rate measurement was accomplished with one flowmeter in each F-3 fixture propellant feedline upstream of the engine interface. The flowmeters were turbine-type, axial-flow, volumetric flow sensors with two induction coil signal generators. The flowmeters were calibrated in place with propellants. The calibration techniques are presented in Ref. 15.

SECTION III PROCEDURE

3.1 QUALITY ASSURANCE

Quality control was maintained throughout this program to ensure that proper procedures were used and documentation of all activities was accomplished. Surveillance was provided by AGC, NAR, and ARO, Inc.

3.2 AJ10-137 ENGINE

Engine components shipped to AEDC for testing had propellant and pneumatic systems internal surfaces in Level I (Ref. 16) clean condition. Engine S/N 54D was assembled in the RTF, Class 10,000, Clean Room (Ref. 14). After completion of test period FD, the engine was moved from the test cell to the clean room facilities for disassembly and rebuilding for the next test period.

All engine assembly was the responsibility of AGC. The buildup of each engine was conducted by ARO, Inc., under the supervision of AGC engineering and quality control personnel. After engine assembly and documentation were completed, the engine was inspected and

accepted by ARO, Inc. This engine was then the responsibility of ARO, Inc., until completion of testing.

Prior to installation, the ablative thrust chamber was weighed, and diameter measurements of the thrust chamber throat and nozzle extension exit were made. The TCV, propellant lines, and thrust chamber were leak checked, and the TCV was functionally checked. (See Appendix III for the TCV leak check procedure and leakage rates.) Prior to test period FE, heaters and insulation were installed on the injector and propellant lines (Fig. 6).

3.3 PROPELLANTS

Propellant cleanliness requirements for this test (Ref. 16) state that no particles larger than 500 microns or fibers larger than 1500 by 50 microns shall be present in the propellants. This cleanliness requirement was met in the F-3 fixture before each test period.

3.4 INSTALLATION

All test hardware was installed and all testing activities were conducted using written procedures. ARO, Inc., quality control verification points were incorporated in all applicable procedures, and all procedures were approved by AGC prior to initiation of the test program.

During installation in the test cell, leak checks of the nozzle extension-to-thrust chamber flange interface and the facility plumbing were performed. Checkout of the instrumentation was performed. The propellant flowmeters were calibrated in the test configuration using propellants as the flowing media, and propellant samples were taken to verify that the propellants met the applicable specifications for cleanliness and chemical assay. Mock firings were conducted to ensure that all automatically sequenced events occurred and that the TCV operated satisfactorily. Propellants were pumped from the ground storage tanks to the F-3 fixture tanks in the test cell and were sampled again for cleanliness. Calibrations of all instrumentation were completed at ambient atmospheric pressure. Prior to test periods FE and subsequently, the propellants and test cell capsule were temperature conditioned (see Table II).

3.5 TESTING

The test cell was closed and evacuated to approximately 0.4 psia using the facility exhaust compressors. Altitude calibrations of the instrumentation were conducted, and propellants were bled into the engine. A steam ejector was then used to further reduce the test cell pressure to approximately 0.04 psia, and the engine was fired.

All firing durations of 1.1 sec or less were controlled using the AGC firing console. The longer duration firings were initiated and shut down either manually or by the facility sequencer. The desired TCV banks were selected manually before or during the firing, as required, from the AGC firing console. All other firing operations within 60 sec of firing initiation and for 60 sec after shutdown were controlled automatically by the facility sequencer.

After each firing, the temperatures of the test article were recorded, and a few critical temperatures were monitored in the control room.

Additional propellant samples for cleanliness determination and additional altitude calibrations were taken approximately midway during each test period.

After the final firing of a test period, the injector and TCV were purged with GN₂ and then aspirated at 0.4 psia for 45 min. Between test periods, a trickle purge of GN₂ was supplied to the injector header to provide a dry gas barrier between the ambient atmosphere and the propellant valve.

When the engine was removed from the test cell after test periods FD and FJ, thrust chamber throat and nozzle extension exit diameter measurements were made. Leak checks of the TCV, nozzle extension attachment flange, and thrust chamber were conducted before FA and after FD test periods. After completion of the test program, the ablative thrust chamber was weighed.

3.6 PERFORMANCE DATA ACQUISITION, REDUCTION, AND ACCURACY

All primary performance parameters were recorded continuously on magnetic tape in modulated frequency form. Digital computers were used to decode the magnetic tape, produce engineering units data tabulations, and compute performance from the reduced data as follows:

1. Steady-state engine performance,
2. Incremental and total impulse during ignition,
3. Incremental and total impulse during shutdown, and
4. Incremental and total impulse for each impulse bit operation.

The equations used for engine performance calculations were in accord with general standard practice with modification to account for the area variation of the ablative chamber throat. The combustion chamber pressure was measured at the outer edge of the injector face. Steady-state performance calculations were made from measured data which were averaged over 4-sec time intervals for firings of 7 sec or longer duration.

The estimated errors (two standard deviations) in the measured parameters for engine performance were determined from the pretest in-place calibrations and from the methods outlined in Refs. 15 and 17, and were as follows:

| <u>Parameter</u> | <u>2σ Error, \pm percent</u> |
|------------------|---|
| F_a | 0.30 |
| P_c | 0.50 |
| \dot{w}_f | 0.28 |
| \dot{w}_o | 0.36 |
| p (cell) | 3.70 |

The estimated errors (two standard deviations) in the calculated performance parameters were obtained by statistically combining the above errors, which produced

| <u>Parameter</u> | <u>2σ Error, \pm percent</u> |
|------------------|---|
| \dot{w}_t | 0.24 |
| F_{vac} | 0.30 |
| $I_{sp_{vac}}$ | 0.40 |

3.6.1 Ballistic Performance

Nonuniform variations of the nozzle effective throat area during a firing and the impossibility of measuring throat area between firings during a particular test period necessitated calculation of characteristic velocity (c^*) using the following assumptions:

1. Characteristic velocity, corrected to a mixture ratio of 1.6, is constant for a particular injector and chamber combination.
2. Characteristic velocity is a function of mixture ratio, propellant temperature, and combustion chamber pressure.

The initial characteristic velocity (c^*_i) for a given injector and chamber combination was calculated using (1) the measured data from 2 to 6 sec of the initial firing of a new chamber, (2) the pretest measured nozzle throat area, and (3) the relationship,

$$c^*_i = p_c A_t g_c / \dot{w}_t$$

The c^* for nominal operating conditions (nom) of $O/F = 1.6$, propellant temperature of $70^\circ F$, and a combustion chamber pressure of 99 psia was derived using the following empirical equation supplied by AGC:

$$\begin{aligned} c^*_{nom} = & c^*_i + 870.5(1.6 - (O/F)) + 273.83 ((O/F)^2 - 2.56) \\ & + 0.31878 (p_c - p_{c_{nom}}) - 12.953 (T_p - 70) \\ & + 0.07414 (T_p^2 - 4900) + 5.466 ((O/F) \cdot T_p - 112) \\ & - 0.03119 ((O/F) \cdot T_p^2 - 7840) \end{aligned}$$

This c^*_{nom} was retained as representative of the given injector/chamber assembly and was used in data reduction for the remainder of the assembly testing. The actual c^* for any conditions other than nominal operating conditions during subsequent firings was derived by reversing the process and applying the actual inlet conditions correction to the standard c^*_{nom} .

The throat area of the nozzle for subsequent firings was calculated using the c^* derived above, the measured chamber pressure, and the measured propellant flow rates in the relationship:

$$A_{t_{calc}} = c^* \dot{w}_t / g_c p_c$$

The measured axial thrust was corrected to vacuum conditions using measured test cell pressure as follows:

$$F_{vac} = F_a + p(\text{cell}) \cdot A_e$$

This vacuum thrust was used with calculated nozzle throat area and measured chamber pressure to determine vacuum thrust coefficient as follows:

$$C_{F_{vac}} = F_{vac}/p_c \cdot A_{t_{calc}}$$

or with substitution for F_{vac} and $A_{t_{calc}}$:

$$C_{F_{vac}} = I_{sp_{vac}} \cdot g_c/c^*$$

Thus, $C_{F_{vac}}$ is no longer a direct function of the ratio F_{vac}/p_c and is not considered a meaningful measurement of nozzle performance because of the variation of throat area.

3.6.2 Ignition and Shutdown Transient Performance Data

Transient performance data were obtained using the AEDC Transient Impulse Computer Program RDR-38 to determine the magnitude and repeatability of the impulse associated with the transient portions of the engine firings (start and shutdown).

The total impulse of the start transient covered the time period from ignition (chamber pressure ≥ 1 psia) to 100 percent of steady-state vacuum thrust. The impulse was derived using the vacuum thrust coefficient (not corrected to standard inlet conditions), throat area, and measured chamber pressure in the relationship:

$$I_t = C_{F_{vac}} A_t \int_{t_1}^{t_2} p_c dt$$

The values of $C_{F_{vac}}$ and A_t for the ignition and shutdown transients were input from the steady-state performance at period 1 and period 2, respectively, as shown below and were assumed constant throughout the transient.

| <u>Firing Duration, sec</u> | <u>Period 1, sec</u> | <u>Period 2, sec</u> |
|-----------------------------|----------------------|----------------------|
| 10 | FS1 + 4 to FS1 + 8 | FS2 - 4 to FS2 |
| ≥ 23 | FS1 + 6 to FS1 + 10 | FS2 - 4 to FS2 |

The total impulse of the shutdown transient was calculated in a similar manner except that the integral covered the time period from the shutdown signal to 0.3-psia chamber pressure.

Steady-state performance was not calculated for firings of less than 7-sec duration. For these short firings, the values of $C_{F_{vac}}$ and A_t were obtained from the steady-state performance summary of the firing conducted nearest the transient of interest at the same operating conditions (p_c , O/F, and valve bank).

Intermediate impulse values of the start and shutdown transients were also derived at 10-percent intervals of steady-state chamber pressure up to the 100-percent level. The digital computer program was used to calculate the time at which the percentage thrust levels occurred, the thrust rise or decay rates, and the integrated impulse at the specified percentage levels of steady-state chamber pressure.

Measured combustion chamber pressure of the ignition transient was reduced at 0.005-sec intervals (200 intervals/sec) from the magnetic tape data records obtained from both low-range and full-range channels obtained from a single close-coupled chamber pressure transducer. Shutdown combustion chamber pressure was reduced at 0.02-sec intervals (50 intervals/sec). The close-coupled low-range chamber pressure transducer data were used for increased accuracy at pressures below 12 psia.

Beginning with the FF test period, there were no firings of sufficient duration to calculate steady-state performance until firing FJ-36 (last firing of FJ test period). The values of $C_{F_{vac}}$ and A_t calculated from the measured data of FJ-36 were used to derive the ignition and the shutdown impulse for the FF, FG, FH, and FJ test period firings.

3.6.3 Impulse Bit Firings

The method used to calculate the total impulse of the impulse bit firings (duration ≤ 1 sec) was identical to the method used for the ignition and shutdown transients except the impulse was totaled for the entire firing from ignition through thrust decay to $p_c = 0.3$ psia. Since the impulse bit firings were too short to establish steady-state engine performance, $C_{F_{vac}}$ and A_t were obtained from the nearest steady-state firing at the same engine operating conditions (p_c , O/F, and valve bank selection).

Beginning with FF test period, there were no performance firings (duration ≥ 7 sec) made until the last firing in the FJ test period (FJ-36). The throat area was measured after FJ-36, and the measurement was used to calculate steady-state performance for this firing.

The values of $C_{F_{vac}}$ and A_t used to reduce the impulse bit firings for the FF through the FJ test periods were obtained from the final steady-state performance summary period of firing FJ-36 (FS1 + 6 to FS1 + 10 sec).

The total propellant quantity for impulse bit operation was determined from total flowmeter signal cycles (recorded on magnetic tape) and the flowmeter calibration factor constant for the normal flow rate range. Total quantity would be somewhat in error by neglecting the flowmeter transient characteristics and low flow rate nonlinearities, but it was thought that the consequent discrepancies would not be sufficient to detract from the significance of the characteristics.

SECTION IV RESULTS AND DISCUSSION

4.1 INTRODUCTION

This testing was conducted to qualify the Mod I-C bipropellant valve in simulated service conditions for spacecraft use (test periods FA through FD, Table I) and to investigate the refrigeration effects of postfire evaporation of propellant residuals in the injector (test periods FF through FJ, Tables I and II). Documentation included the engine transient characteristics as influenced by the Mod I-C valve and the off-design test conditions. Prototype electric strip heaters for the propellant lines and injector were tested (test periods FF, FG, and FH) to evaluate their engine warming capability. Engine performance was computed from measured data from firings which were of sufficient duration to provide steady-state engine operation.

This report reviews the test results obtained and provides a comparison of these results with engine specification requirements and results of previous testing.

4.2 MOD I-C BIPOPELLANT VALVE TESTS

Bipropellant valve S/N 128 was installed on engine S/N 54 in the RTF clean room following preinstallation bench pressure/leak tests. The preinstallation tests verified that the valve had not incurred any deterioration in transit from the engine manufacturer.

Pressure/leak tests of the bipropellant valve were also made with the valve and instrumentation installed on the engine before the

engine was moved to the test cell. As shown in Table III, the leakages detected in these tests were within the specified limits for acceptance except for the upstream seal of oxidizer ball No. 4.

The engine was removed from the test cell after test period FD, which completed the portion of testing prescribed for valve certification. The valve had been actuated under service conditions for 40 test firings as shown in Table I, plus a total of four actuation cycles of both banks for pretest functional checks and posttest propellant purges. The valve seal leakage measurements after test period FD showed excessive leakage of the upstream seals of oxidizer balls No. 1, 2, and 4 and the downstream seal of oxidizer ball No. 1 (Table III). Although some of the ball seals exceeded the allowable leakage, it should be noted that in no case did all four seals of either oxidizer bore leak excessively.

The oxidizer ball shaft seal leakages were excessive after test period FD (Table III). These leakages might have had serious consequences in a flight situation if propellants proceeded into the central mechanism cavity of the valve body; therefore, the S/N 128 valve was returned to the engine manufacturer for further analysis and evaluation. The deterioration of the shaft seals was apparently the result of a design deficiency.

Bipropellant valve S/N DV-2 (rebuilt as a Mod I-C) was installed on the engine to permit completion of the programmed off-design testing, although certain ball seal and shaft seal leakages were already excessive prior to test period FE. It is interesting to note that four downstream and nearly all upstream ball seals improved with use; deterioration occurred only in two downstream seals (Table IV). This valve was also returned to the engine manufacturer for evaluation before completion of all posttest pressure/leakage tests at AEDC.

Posttest inspection of the two bipropellant valves revealed nitrate salt deposits in both valves in the inlet and discharge ports. Only traces of deposits were noted in valve S/N DV-2. It was concluded that the excessive leakages of the valve S/N 128 ball seals were probably the result of seal abrasion by precipitated salt particles.

4.3 POSTFIRE PROPELLANT EVAPORATION/REFRIGERATION EFFECTS

The effects of postfire propellant evaporation on the engine injector temperature (investigated in test periods FF through FJ) are shown by the temperature characteristics of the injector depicted in Fig. 11 for a typical short firing (0.35 sec) and the succeeding coast period.

Prefire temperature of propellants and test cell walls to 30°F (see Table II) were used to determine the possible minimum temperature in the injector which might result in frozen propellants.

The area of the injector that became the coldest during this coast period was located near the oxidizer header connection which is an area of relatively small mass (thin wall sections) exposed to evaporation of the relatively large bulk quantity of oxidizer leaving the header. This can be seen by a comparison of the various temperatures shown in Fig. 11. This figure also shows that the portion of the injector near the oxidizer header incurred a 9°F temperature reduction from propellant evaporation.

Also shown in Fig. 11, certain of the temperatures generally reached a bottom twice. The first minimum was shortly after the firing (3 to 28 sec), after which the temperature rose slightly and then dropped to the second minimum at various times less than 300 sec after the firing. The temperatures which reached the lowest levels did so in the shortest times. The lowest temperatures after any firing were between 16 and 18°F for both the locations near the oxidizer header and occurred during test period FJ. In all cases, the temperatures reached a minimum before the end of the coast interval between firings and were rising steadily prior to the next firing.

Test periods FG, FH, and FJ included multiple short firings (0.35 sec, see Table I) with short coast intervals of 8, 4, and 6 min, respectively. This procedure was used to minimize combustion heating, to detect any cumulative cooling effect, and to attempt to define an "optimum" coast interval which would produce the lowest injector temperatures. Although insufficient testing was done to define the optimum coast interval, Fig. 12 shows the cumulative cooling of a series of short firings. The tests conducted resulted in minimum injector temperatures of about 18°F, and the characteristics of the graphs in Figs. 11 and 12 indicate that shorter coast intervals could produce lower temperatures.⁴

A typical chamber pressure and test cell pressure history following engine shutdown is presented in Fig. 13. Thrust chamber pressure and test cell pressure became equal approximately 3.5 sec after the engine shutdown signal. Also shown are the pressure decay curves for the oxidizer and fuel headers. The fuel header pressure generally followed the chamber pressure decay curve, but the oxidizer header pressure was 1 to 2 psia above chamber pressure for about 5 sec after the shutdown signal. Since the cell pressure decay was fairly rapid, chamber pressure also decreased rapidly. However, after the chamber

throat became unchoked and the fuel and oxidizer header pressures and cell pressure became equal, the evaporative cooling was a function of test cell pressure, which is not indicative of that cooling which would occur at higher vacuums.

4.4 ENGINE TRANSIENT CHARACTERISTICS

4.4.1 Ignition Transient Characteristics

The total impulse (lbf-sec) developed during the engine ignition transients was determined for test firings with duration greater than 1 sec by the method described in Section 3.6.2. A tabulation of the impulse developed from ignition to 90 percent of steady-state thrust appears in Table V. A summary of the average impulse from ignition to 90 percent of steady-state chamber pressure at the various propellant temperatures is presented below:

| TCV S/N | TCV Bank | P _c Level, psia | Target Propellant Temp., °F | From FS1 to 90-percent Steady-State Chamber Pressure | | | | | |
|-----------------------|-------------|----------------------------------|-----------------------------------|--|--|----------------|--------------|---------------------------------|----------------|
| | | | | Impulse, lb _f -sec | Run-to-Run Deviation, lb _f -sec | 1σ, percent | Time, sec | Run-to-Run Deviation, sec | 1σ, percent |
| Specification Values* | | 99 | 70±10 | 350-850 | ±200 | - | 0.475-0.675 | - | - |
| 128 | A | 99 | 70±10 | 606 | +39 -80 | ±7.7 | 0.638 | +0.006 -0.008 | ±0.85 |
| | A | 94 | | 502 | +33 -111 | ±11.1 | 0.639 | +0.017 -0.007 | ±1.50 |
| | B | 99 | | 647 | +74 -171 | ±11.9 | 0.602 | +0.005 -0.012 | ±0.84 |
| | AB | 99 | | 377 | +35 -91 | ±9.1 | 0.522 | +0.009 -0.012 | ±1.03 |
| | A or B | 110 | 110 ⁺⁵ ₋₀ | 1063 | +146 -117 | ±11.0 | 0.643 | +0.027 -0.027 | ±4.40 |
| DV-2 | AB | 106 | 30±5 | 312 | +89 -76 | ±18.5 | 0.581 | +0.055 -0.032 | ±4.50 |

* Reference 16

The transient specification values are from the Advance Change Notice No. 5 of Ref. 16 and are applicable to dual-bore engine operation only at standard inlet conditions (i. e., prefire interface pressure of 178 ± 4 psia and $70 \pm 10^\circ\text{F}$ temperature propellants). Since many of the tests were conducted with 30 and 110°F propellants, the average data were grouped by target chamber pressures and propellant temperatures for data analysis.

The average impulse values, run-to-run deviations, and the times from FS1 to 90 percent of steady-state chamber pressure were within

specified limits for valve S/N 128 at standard inlet conditions for both single- and dual-bore operation. The average ignition impulse for single-bore operation with propellants at 110°F was 1063 lbf-sec. Data were available from only one dual-bore operation with propellants at 110°F (FD-29), and the resulting impulse from FS1 to 90 percent of steady-state chamber pressure was 1083 lbf-sec.

The average ignition impulse obtained using valve S/N DV-2 in dual-bore operation with propellants at 30°F was 312 lbf-sec.

The time from FS1 to ignition (initial p_c rise) decreased with increasing propellant temperatures as indicated in Fig. 14 (approximately 1 msec/°F).

It should be noted that the abnormally large ignition impulse obtained during FB 2 (Table V) was a consequence of the poor prefire propellant bleed-in which abnormally prolonged the chamber pressure rise.

Typical thrust and impulse data from ignition transients for single- and dual-bore operations are shown in Fig. 15. Dual-bore operation is shown to produce the earliest and most rapid advance to full thrust. Single-bore operation produces the greatest transient impulse by the longer time interval to full thrust.

4.4.2 Effect of Cold Propellants on Ignition Characteristics

Average thrust rise rates were calculated using chamber pressure data rise rate converted to thrust (lbf/sec) by multiplying by $C_F A_t$. Average rise rate at 90 percent of steady-state versus propellant temperature for dual-bore valve operation is presented in Fig. 16. In general, lower propellant and engine temperatures resulted in greater rise rates; the average rise rate obtained with 30°F propellants was approximately 760,000 lbf/sec compared with the approximately 200,000 lbf/sec with 110°F propellants.

Several firings exhibited rise rates considerably greater than average during portions of the ignition transient. For example, test FG-26 with propellant and hardware temperatures of 60 and 30°F, respectively, had a rapid chamber pressure rise approximately four times the average rate up to 70 percent of the steady-state level. Thus, the cold hardware serving to chill the initial propellant charge seems to be a controlling influence of the ignition characteristic. The time from FS1 to ignition for test FG-26 was 0.488 sec compared with the average time of 0.479 sec for all the firings in this period. The

valve actuation times during test FG-26 were normal except for the upstream-oxidizer/downstream-fuel balls set of bank B, which reached full-open approximately 0.02 sec earlier than usual; however, it is not the set of controlling valves and consequently should have had little influence on the chamber pressure rise rate.

Tests FF-10, FF-12, and FJ-36 all exhibited varying degrees of discontinuity in the ignition chamber pressure profiles as indicated in Fig. 17. The initial chamber pressure rise rate was faster than usual up to 20 to 35 psia, decayed by 4 to 10 psia, and then recovered and continued toward the steady-state level at a slower than average rate. The valve actuation times of the controlling set of ball valves for five firings and the average time for these tests are compared with the average time for 60°F propellant temperatures as follows:

| <u>Test No.</u> | <u>Propellant Temp., °F</u> | <u>FS1 to Initial Open, sec</u> | <u>FS1 to Full Open, sec</u> | <u>Opening Time, sec</u> | <u>FS2 to Initial Close, sec</u> | <u>FS2 to Full Close, sec</u> | <u>Closing Time, sec</u> |
|-----------------|---------------------------------|---|--------------------------------------|------------------------------|--|---------------------------------------|------------------------------|
| FF-05 | 30±5 | 0.140 | 1.050 | 0.910 | 0.110 | 0.380 | 0.270 |
| FF-06 | 30±5 | 0.135 | 1.200 | 1.065 | 0.130 | 0.470 | 0.340 |
| FF-10 | 30±5 | 0.135 | 1.095 | 0.960 | 0.160 | 0.485 | 0.325 |
| FF-12 | 30±5 | 0.140 | 1.100 | 0.960 | 0.180 | 0.480 | 0.300 |
| FJ-36 | 30±5 | 0.150 | 1.070 | 0.920 | 0.170 | 0.530 | 0.360 |
| Avg. Data | 30±5 | 0.138 | 1.022 | 0.884 | 0.153 | 0.478 | 0.325 |
| Avg. Data | 60±3 | 0.143 | 0.907 | 0.764 | 0.173 | 0.500 | 0.327 |

As indicated, all five of these firings had opening times for the controlling ball which were greater than the average time; thus the transient propellant flow rate may have been insufficient to maintain the initial p_c rise rate. A review of valve ball position traces on oscillograph data also indicated discontinuities in the rate of ball travel of tests FF-06, -08, -10, and -12 and FJ-36 such as shown in Fig. 18. This was most noticeable during tests FF-10, FF-12, and FJ-36, which were the ignitions which exhibited discontinuities in the chamber pressure profiles. Both GN₂ storage sphere and regulated actuation pressures were normal during tests FF-06 and FF-08. Regulated actuation pressure data are not available for tests FF-10 and FF-12, but storage sphere pressures were normal. Also, sphere pressures were 1930 and 1160 psia for banks A and B, respectively, after test FJ-36, and regulated actuation pressure for B bank was the normal 200 psia (bank A data not available). There is no indication in the data available that the irregular valve operation was caused by improper actuation pressures.

The cause of the irregular valve operation has not been identified but is concluded (1) to be related to the cold temperatures, (2) to account for the longer actuation times, and (3) to have caused the irregular ignition transients.

4.4.3 Shutdown Transient Characteristics

The shutdown transient impulse was calculated as outlined in Section 3.6.2 for test firings longer than 1-sec duration, and the impulse developed during each is presented in Table VI. A summary of the average shutdown impulse from FS2 to 10 percent of steady-state chamber pressure for the various valve bank operations, chamber pressure levels, and propellant temperatures is presented below:

| TCV S/N | TCV Bank | P _c Level, psia | Target Propellant Temp., °F | From FS2 to 10-percent Steady-State Chamber Pressure | | | | | |
|--------------------------|-------------|----------------------------------|-----------------------------------|--|--|----------------|--------------|---------------------------------|----------------|
| | | | | Impulse, lb _f -sec | Run-to-Run Deviation, lb _f -sec | 1σ, percent | Time, sec | Run-to-Run Deviation, sec | 1σ, percent |
| Specification Values* | | 99 | 70±10 | 7000- 12,000 | +300 | - | 0.900-1.150 | - | - |
| 128 | A | 94 | 70±10 | 8745 | +139 -194 | +2.0 | 0.975 | +0.022 -0.045 | +4.0 |
| | B | 96 | | ** 8549 | +28 | - | ** 0.959 | +0.004 -0.003 | - |
| | AB | 99 | | 9710 | +240 -193 | +2.3 | 0.954 | +0.008 -0.014 | +1.2 |
| | A or B | 110 | 110±5 | 9478 | +238 -184 | +2.1 | 0.789 | +0.018 -0.015 | +1.9 |
| DV-2 | AB | 106 | 30±5 | 9292 | +445 -419 | +3.8 | 0.810 | +0.057 -0.083 | +7.1 |

* Reference 16

** Includes only two firings

The average shutdown impulse values, run-to-run deviations, and times were within the specification limits with the standard 70°F temperature propellants for all valve bank operations although only dual-bore operation is applicable to the specification. The average shutdown transient impulse (FS2 to 10 percent) with dual-bore TCV configuration and propellants at 30 ± 5°F was 9292 lb_f-sec, but run-to-run deviations of +445 and -419 lb_f-sec occurred. The corresponding average shutdown impulse value for single-bore operation with propellants at 110°F was 9478 lb_f-sec with run-to-run deviations of +238 and -184 lb_f-sec.

The average impulse values, run-to-run deviations, and times from 10 to 1 percent of steady-state chamber pressure for various TCV operations and propellant temperatures are presented below:

| TCV S/N | TCV Bank | P _c Level, psia | Target Propellant Temp., °F | From 10- to 1-percent Steady-State Chamber Pressure | | | | | |
|-----------------------|----------|----------------------------|-----------------------------|---|--|-------------|-----------|---------------------------|-------------|
| | | | | Impulse, lb _f -sec | Run-to-Run Deviation, lb _f -sec | 1σ, percent | Time, sec | Run-to-Run Deviation, sec | 1σ, percent |
| Specification Values* | | 99 | 70±10 | 500-950 | - | - | - | - | - |
| 128 | A | 94 | 70±10 | 651 | +36 -50 | ±6.8 | 1.098 | +0.189 -0.122 | ±15.1 |
| | B | 95 | | 658 | +105 -90 | ±14.9 | 1.121 | +0.148 -0.236 | ±18.4 |
| | AB | 99 | | 614 | +18 -20 | ±3.1 | 1.031 | +0.239 -0.137 | ±20.2 |
| | A or B | 110 | 110±5 | 499 | +26 -22 | ±4.5 | 0.717 | +0.032 -0.012 | ±3.0 |
| DV-2 | AB | 106 | 30±5 | 1583 | +188 -234 | ±10.4 | 1.541 | +0.065 -0.069 | ±3.3 |

* Reference 16

The average impulse for all TCV operations with 70°F propellants was within specification. Even with off-design conditions of 110°F propellants and single-bore TCV operation, the specification (for 70°F) lower limit impulse was very nearly met, and run-to-run deviations were small. The corresponding impulse and time with dual-bore operation and 30°F propellants was 1583 lb_f-sec, which was beyond the 70°F specification upper limit. Thus, between 10 and 1 percent of steady state, the chamber pressure decay followed the general trend of occurring more slowly with the lower temperature propellants.

The average impulse, run-to-run deviations, and times for the final tailoff, 1 percent of steady state to 0.3-psia chamber pressure, with various TCV combinations and propellant temperatures, are presented below:

| TCV S/N | TCV Bank | P _c Level, psia | Target Propellant Temp., °F | From 1-percent Steady State P _c to P _c = 0.3 psia | | | | | |
|-----------------------|----------|----------------------------|-----------------------------|---|--|-------------|-----------|---------------------------|-------------|
| | | | | Impulse, lb _f -sec | Run-to-Run Deviation, lb _f -sec | 1σ, percent | Time, sec | Run-to-Run Deviation, sec | 1σ, percent |
| Specification Values* | | 99 | 70±10 | 100 (nominal) | - | - | - | - | - |
| 128 | A | 94 | 70±10 | 86 | +41 -30 | ±42.7 | 0.698 | +0.200 -0.164 | ±26.4 |
| | B | 99 | | 88 | +40 -25 | ±39.8 | 0.639 | +0.195 -0.116 | ±26.6 |
| | B | 95 | | 99 | +25 -41 | ±36.1 | 0.830 | +0.415 -0.306 | ±44.9 |
| | A or B | 110 | 110±5 | 44 | +13 -16 | ±27.7 | 0.314 | +0.052 -0.092 | ±21.0 |
| DV-2 | AB | 106 | 30±5 | 160 | +152 -79 | ±60.1 | 1.574 | +1.597 -1.230 | ±63.1 |

* Reference 16

The average impulse values for this final tailoff with 70°F propellants were all within 14 percent of the specification-stated nominal value of 100 lb_f-sec. Single-bore TCV operation and 110°F propellants produced

an average tailoff impulse of 44 lbf-sec, and dual-bore operation with 30°F propellants produced 160 lbf-sec impulse. Again, the cold propellant temperatures retarded the chamber pressure decay, which resulted in larger tailoff impulse. The colder propellants also produced less repeatable tailoff impulse and time.

Typical shutdown transients for the various TCV operation combinations are presented in Fig. 19.

4.4.4 Impulse Bit Operation

The total impulse for the impulse bit firings (duration ≤ 1 sec) was determined by the method described in Section 3.6.3. The impulse developed in each impulse bit firing is given in Table VII. The total impulse versus firing duration for different TCV operations and propellant temperatures are presented in Figs. 20 and 21, which show that the total impulse was almost a linear function of firing duration. Dual-bore TCV operation produced higher total impulse than did either single-bore operation, as shown in Fig. 20; for example, 0.8-sec firings with 70°F propellant temperatures and dual-bore operation produced impulse approximately 35 percent higher than bank A single-bore operation and 17 percent higher than bank B operation.

The total impulse versus firing duration data which were obtained with dual-bore operation and propellant temperatures of 30 and 60°F are presented in Fig. 21. The 60°F propellants produced larger total impulse than did the 30°F propellant; the differences ranged from approximately 33 percent for a 0.36-sec firing to 7 percent for a 1-sec firing. These differences are likely the result of the differences in average dual-bore TCV actuation times for the controlling balls which are presented below:

| Propellant Temp, °F | Time from FS1 | | Opening Transit Time, sec | Time from FS2 | | Closing Transit Time, sec |
|------------------------|----------------------------|----------------------|------------------------------------|--------------------------|-----------------------|------------------------------------|
| | Initial Opening, sec | Full Open, sec | | Initial Close, sec | Full Close, sec | |
| 30 ± 5 | 0.145 | 1.022 | 0.877 | 0.153 | 0.478 | 0.325 |
| 60 ± 3 | 0.147 | 0.907 | 0.760 | 0.173 | 0.500 | 0.327 |

As shown, the average TCV time to full open was longer with the propellants at colder temperatures. The valve closing times were essentially the same with either temperature (although the valve started closing 0.02 sec earlier with the colder propellants). Consequently, the valve was full open 0.11 sec longer with the 60°F propellants.

By extrapolation, the curves of Fig. 20 indicate that the minimum signal durations to obtain any impulse with 70°F propellants were 0.33 sec with dual-bore operation and 0.34 sec with single-bore operation. When using cold propellants (30°F), slightly longer signal durations would be required to obtain any impulse.

4.4.5 Propellant Flow during Bit Operation

The average total propellant flow (lb_m) is shown in Fig. 22 for the bit firings with different TCV combinations and 70°F propellant temperatures. The total quantities with dual-bore TCV operation for a 0.85-sec firing were approximately 39 lb_m of oxidizer and 24 lb_m of fuel. The dual-bore oxidizer quantity was approximately 28 percent greater than that for bank A single-bore operation and 14 percent greater than that for bank B single-bore operation. The dual-bore fuel quantity was approximately 21 percent greater than that with bank A single-bore operation and about 12 percent greater than that with just bank B single-bore operation. Extrapolation of the trend shown in Fig. 22 indicates that dual-bore firing signal duration must exceed approximately 0.25 sec to flow any oxidizer and 0.28 sec to flow any fuel.

4.5 ENGINE PERFORMANCE

The two parameters which were used to define engine ballistic performance were vacuum specific impulse and characteristic velocity (based on chamber pressure measured at the injector face). Because of the uncertainty of the throat area, the $I_{sp_{vac}}$ data are considered the most accurate indication of performance (see Section 3.6.1). These performance data were obtained during 22 of the test firings conducted with injector S/N 104. Data were obtained at mixture ratios ranging from 1.35 to 1.71 and chamber pressures from 81 to 117 psia. Testing was conducted with propellant temperatures from 60 to 110°F with the majority of the testing at the 60°F temperature. Performance data were obtained from one test firing with injector S/N 094, at a mixture ratio of 1.76, chamber pressure of 105 psia, and 30°F propellant temperatures. A summary of the test firings with the performance data is presented in Table VIII.

The thrust coefficient, which was calculated as described in Section 3.6.1, is not considered an exact indication of nozzle performance because of chamber throat area variations and the constant c^* assumption. Therefore, no evaluation of the thrust coefficient parameter is attempted, but the data are included in Table VIII.

4.5.1 Vacuum Specific Impulse ($I_{sp_{vac}}$)

The $I_{sp_{vac}}$ as a function of mixture ratio, which had been determined for injector S/N 104 during previous testing (at a chamber pressure of 97 psia, Phase V, Ref. 13), was characterized with the least-squares curve:

$$I_{sp_{vac}} = 214.084 + 123.292 (O/F) - 38.215 (O/F)^2$$

The Phase VI testing did not provide sufficient data for a similar analysis, but a comparison (Fig. 23) of the $I_{sp_{vac}}$ from this testing with the Phase V curve was made with three groups of $I_{sp_{vac}}$ within small p_c ranges: (1) from 90 through 96 psia, (2) from 97 through 102 psia, and (3) from 103 to 114 psia.

The comparison of the first data group with the previous testing curve is shown in Fig. 23a to agree within 0.3 percent. The one standard deviation (1σ) of the first data group was 0.316 $lb_f\text{-sec}/lb_m$ (excluding firings FA-1, in which the oxidizer flowmeter was erratic, and FB-2, in which the flowmeters were affected by gas ingestion from the insufficient prefire bleed-in).

The characteristic curve was shifted by changing the intercept to fit the $I_{sp_{vac}}$ data of the second and third groups as shown in Figs. 23b and c. The shifts resulted in curve equations for these data groups as follows:

$$I_{sp_{vac}} = 214.33 + 123.292 (O/F) - 38.215 (O/F)^2$$

$$I_{sp_{vac}} = 215.30 + 123.292 (O/F) - 38.215 (O/F)^2$$

The comparison of the Phase VI $I_{sp_{vac}}$ with the shifted curves produced one standard deviations (1σ) for the second and third groups of 0.551 and 0.307 $lb_f\text{-sec}/lb_m$, respectively.

The resulting variation of $I_{sp_{vac}}$ as a function of chamber pressure is implied by the shifted curves at the mixture ratio of 1.6. These values are shown in Fig. 24 and indicate that engine performance varied approximately linearly with chamber pressure in the range of chamber pressure tested. The variation was 0.08 $lb_f\text{-sec}/lb_m/\text{psi}$. A similar analysis of previous testing data of injector S/N 104 indicated a slope of about 0.04 $lb_f\text{-sec}/lb_m/\text{psi}$ (Ref. 13).

4.5.2 Characteristic Velocity (c^*)

Characteristic velocity calculations were to have been based on the first test firing with the unused chamber as described in Section 3.6.1. However, the erratic operation of the oxidizer flowmeter during the first firing (FA-1) and improper propellant bleed-in for the second firing (FB-2) necessitated deferring calculation of c^*_i until the third firing (FB-3) after some 40 sec of previous firing time had been conducted. The prefire measured throat area was used with a calculated area change and the chamber pressure and propellant flow rate data of the third firing to produce a c^*_i corrected to nominal operating conditions of 5901 ft/sec. A comparison of this corrected c^*_i value with the two obtained in previous testing indicated that the deferred calculation of c^* was valid, as shown below:

| <u>Engine S/N</u> | <u>Injector S/N</u> | <u>c^*_i Nominal Operating Conditions, ft/sec</u> |
|-------------------|---------------------|--|
| 54* | 104 | 5894.3 |
| 54A* | 104 | 5943.6 |
| 54D | 104 | 5901.3 |

*Ref. 13

4.6 PROPELLANT LINE AND INJECTOR HEATER PERFORMANCE

4.6.1 Line Heaters Performance

The engine line heaters had only one complete operative circuit (of the two intended circuits) for the evaluations made during test periods FF, FG, and FH. The other circuit incurred element open circuits prior to evaluation at altitude pressure, as shown below:

| Test Period | <u>Oxidizer Line Resistance (Ω), ohms</u> | | | | <u>Fuel Line Resistance (Ω), ohms</u> | | | |
|----------------|---|-----------------------|-----------------------|-----------------------|---|-----------------------|-----------------------|-----------------------|
| | <u>A (Design)</u> | <u>A (Actual)</u> | <u>B (Design)</u> | <u>B (Actual)</u> | <u>A (Design)</u> | <u>A (Actual)</u> | <u>B (Design)</u> | <u>B (Actual)</u> |
| FE | 8.2 | 14.3 | 8.2 | 10.8 | 9.7 | 10.3 | 9.7 | 27.6* |
| FF | ↓ | 14.8 | ↓ | 11.1 | ↓ | 10.9 | ↓ | 28.6* |
| FG, FH | ↓ | 14.3 | ↓ | 10.7 | ↓ | 10.4 | ↓ | 27.6* |

* Contained open elements.

Thus, the heater performance could be documented with only one normal single-circuit mode of operation. The propellant line temperature changes which resulted during line heater operation are shown in Fig. 25. The heating capability of the one normal circuit of these prototype heaters was unsatisfactorily small and provided too little heat to establish a definite heating rate.

4.6.2 Injector Heater Performance

The strip heater on the injector was evaluated during test periods FF and FH, in which heater performance was obtained as shown in Fig. 26. In period FF, the propellants and test cell were conditioned to 30°F, and the heater raised the temperature of the injector (at the outer rim) to approximately 90°F from intermediate temperatures between test firings. In test period FH, the temperatures of the propellants and test cell were approximately 30°F, and the heater was used to raise the injector temperature at the outer rim from 34 to 90°F. The heating was done with the combination of both heater circuits (A plus B) which produced an average heating rate of about 1.2°F/min.

SECTION V SUMMARY OF RESULTS

The results of testing to qualify the Mod I-C bipropellant valve for spacecraft use are summarized as follows:

1. The Mod I-C bipropellant valve developed leakage of ball seals and shaft seals during test operation which was in excess of specification limits for valve qualification.
2. Postfire propellant evaporation caused temperature reductions in the injector of as much as 9°F; the minimum injector temperatures reached were about 17°F at from 30 sec to 2.5 min after engine shutdown.
3. Ignition transient impulse and time were within specification limits at standard inlet conditions with both dual-bore and single-bore TCV operation.
4. Ignition transient impulse was proportional to propellant temperature.

5. Cold (30°F) propellants produced irregularities in the ignition transient pressure rise characteristic and rate and in the TCV operation rate.
6. Shutdown transient impulse and time were within specification limits at standard inlet conditions with both dual-bore and single-bore TCV operation.
7. Shutdown transient impulse was 1.5 to 7.3 percent less repeatable with cold propellants than with 70°F propellants.
8. The impulse of the impulse bit firings was approximately proportional to firing duration and 17 to 35 percent greater with dual-bore than with single-bore TCV operation.
9. The impulse of the impulse bit firings was approximately proportional to propellant temperature.
10. The minimum duration firing signals for any measurable impulse were approximately:
 - a. 0.33 sec for dual-bore TCV operation,
 - b. 0.34 sec for single-bore, and
 - c. Slightly longer with cold propellants.
11. The minimum duration firing signals for any measurable propellant flow at standard inlet conditions were approximately:
 - a. 0.25 sec for oxidizer (dual-bore operation),
 - b. 0.28 sec for fuel (dual-bore operation), and
 - c. Slightly longer with single-bore TCV operation.
12. Engine performance ($I_{sp_{vac}}$ and c^*) agreed within 0.3 percent of that of previous testing with the same injector.
13. Propellant line and TCV electric strip heaters had an insufficient heating capability to produce significant temperature rises in the lines.
14. Injector electric heater operation at maximum capacity produced an average rise of the injector outer rim temperature of about 1.2°F/min.

REFERENCES

1. DeFord, J. F. "Simulated Altitude Testing of the Aerojet-General Corporation AJ10-137 Rocket Engine (Report I - Phase I Development Test)." AEDC-TDR-64-81 (AD350408), May 1964.
2. McIlveen, M. W. "Simulated Altitude Testing of the Aerojet-General Corporation AJ10-137 Rocket Engine (Report II - Phase I Development Test)." AEDC-TR-64-82 (AD350407), May 1964.
3. Vetter, N. R. and DeFord, J. F. "Simulated Altitude Testing of the Aerojet-General Corporation AJ10-137 Rocket Engine-Mixture Ratio Survey (Report III - Phase I Development Test)." AEDC-TDR-64-146 (AD352141), July 1964.
4. McIlveen, M. W. "Simulated Altitude Testing of the Aerojet-General Corporation AJ10-137 Rocket Engine (Report IV - Phase I Development Test)." AEDC-TDR-64-147 (AD352327), August 1964.
5. Vetter, N. R. and DeFord, J. F. "Simulated Altitude Testing of the Aerojet-General Corporation AJ10-137 Rocket Engine-Mission Duty Cycles (Report V - Phase I Development Test)." AEDC-TDR-64-158 (AD352700), August 1964.
6. Vetter, N. R. and McIlveen, M. W. "Simulated Altitude Testing of the Aerojet-General Corporation AJ10-137 Rocket Engine-Abort Duty Cycle (Report VI - Phase I Development Test)." AEDC-TDR-64-171, September 1964.
7. Schulz, G. H. and DeFord, J. F. "Simulated Altitude Testing of the Apollo Service Module Propulsion System (Report I - Phase II Development Test)." AEDC-TR-65-233 (AD368743), January 1966.
8. Robinson, C. E. and Runyan, R. B. "Thrust Vector Determination for the Apollo Service Module Propulsion Engine using a Six-Component Force Balance." AEDC-TR-65-250 (AD475564), December 1965.
9. Schulz, G. H. and DeFord, J. F. "Simulated Altitude Testing of the Apollo Service Module Propulsion System (Report II - Phase II Development Test)." AEDC-TR-66-17 (AD369807), February 1966.

10. Gall, E. S., McIlveen, M. W., and Berg, A. L. "Qualification Testing of the Block I Apollo AJ10-137 Service Module Engine." AEDC-TR-66-129 (AD374879), August 1966.
11. Pelton, J. M. and McIlveen, M. W. "Block II AJ10-137 Apollo Service Module Engine Testing at Simulated High Altitude Report I - Phase IV Development)." AEDC-TR-66-169 (AD376952L), November 1966.
12. DeFord, J. F., McIlveen, M. W., and Berg, A. L. "Block II AJ10-137 Apollo Service Module Engine Testing at Simulated High Altitude (Report II - Phase IV Development)." AEDC-TR-67-47 (AD812441); April 1967.
13. Gall, E. S., McIlveen, M. W., and Berg, A. L. "Qualification Tests of the Apollo Block II Service Module Engine (AJ10-137)." AEDC-TR-67-63 (AD813868), May 1967.
14. Test Facilities Handbook (Sixth Edition). "Rocket Test Facility, Vol. 2." Arnold Engineering Development Center, November 1966.
15. Berg, A. L. "Rocket Propellant Inplace Flowmeter Calibration System-Propulsion Engine Test Cell (J-3)." AEDC-TR-68-41 (AD833157), May 1968.
16. Aerojet-General Corporation Specification AGC-46848A. "Engine, AJ10-137 (Apollo), Altitude Qualification Test Procedure for." March 17, 1967.
17. Bartlett, C. R. "An Analysis of the Accuracy of Liquid-Propellant Rocket Engine Performance Measurements in Satellite Rocket Cell J-3." AEDC-TDR-62-207 (AD290495), December 1962.

APPENDIXES
I. ILLUSTRATIONS
II. TABLES
III. TCY LEAKAGE CHECKS

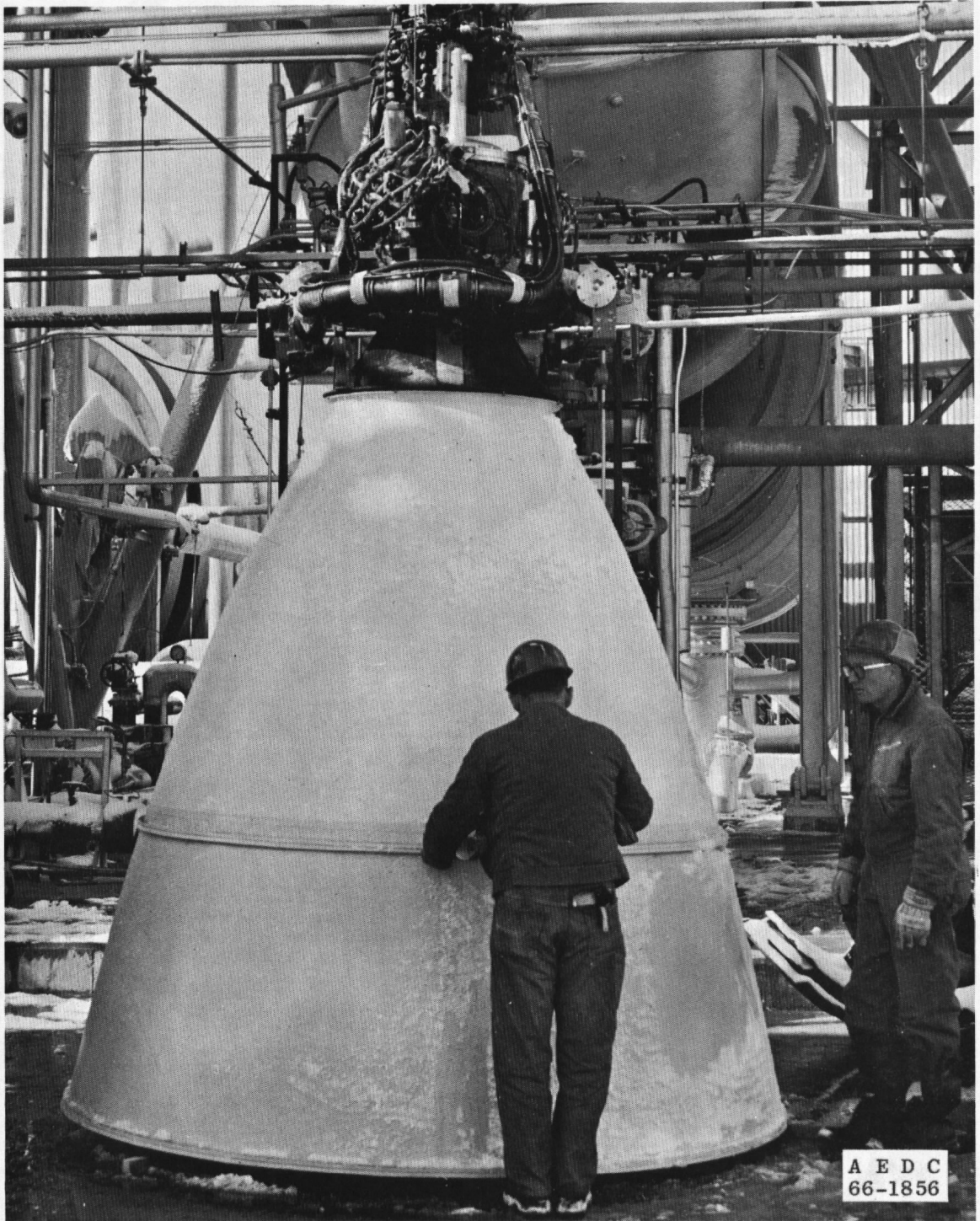
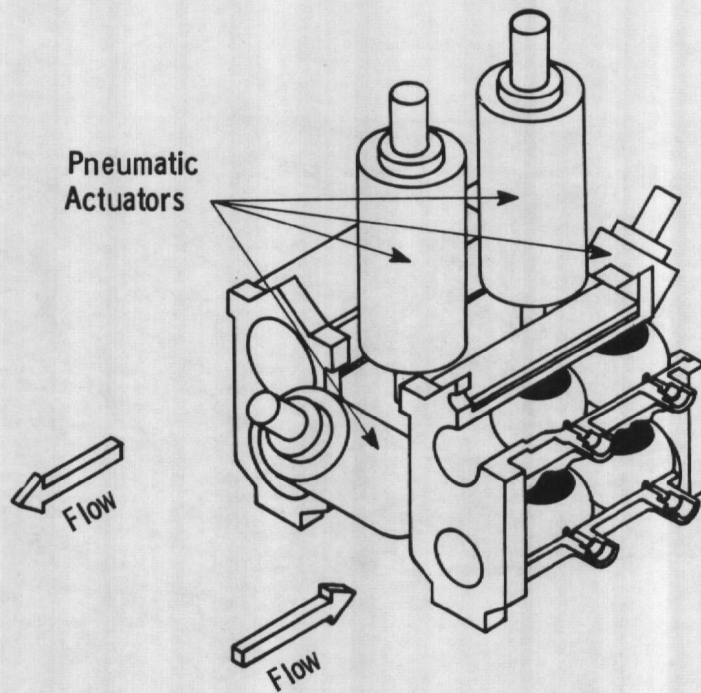
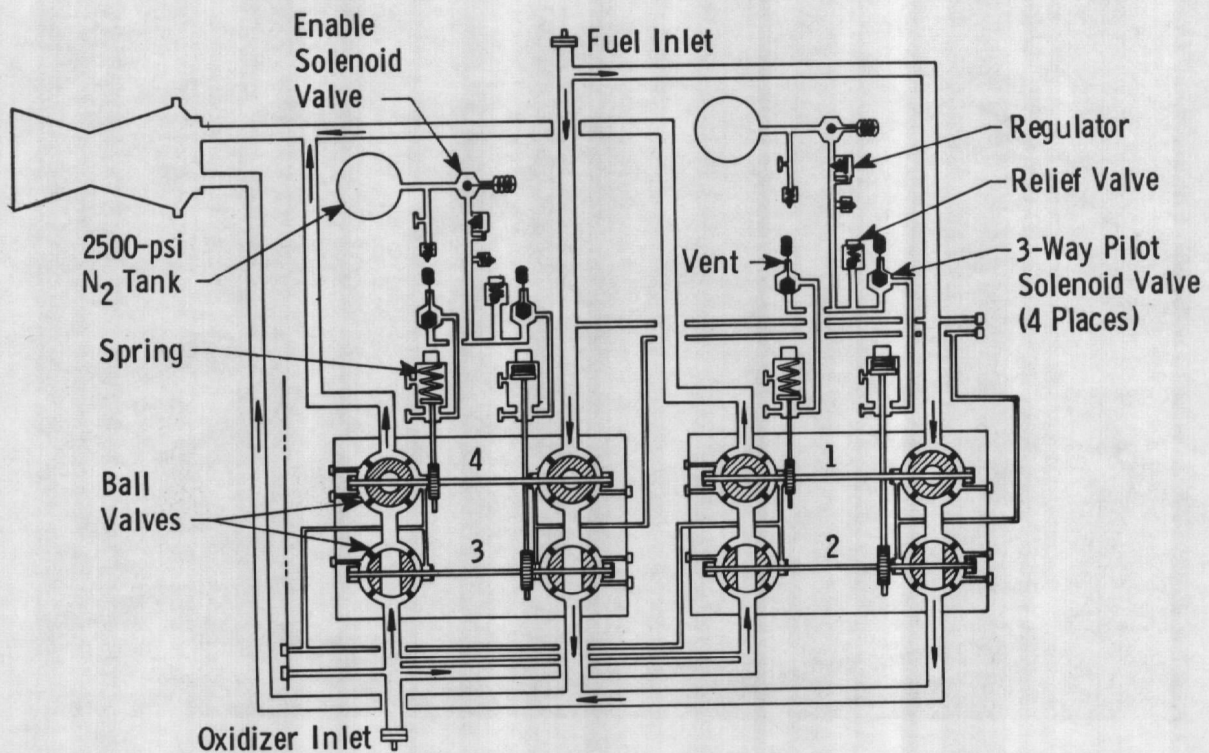

Fig. 1 The Apollo SPS Block II Engine



a. General Arrangement



b. Flow Diagram

Fig. 2 Block II Bipropellant Valve

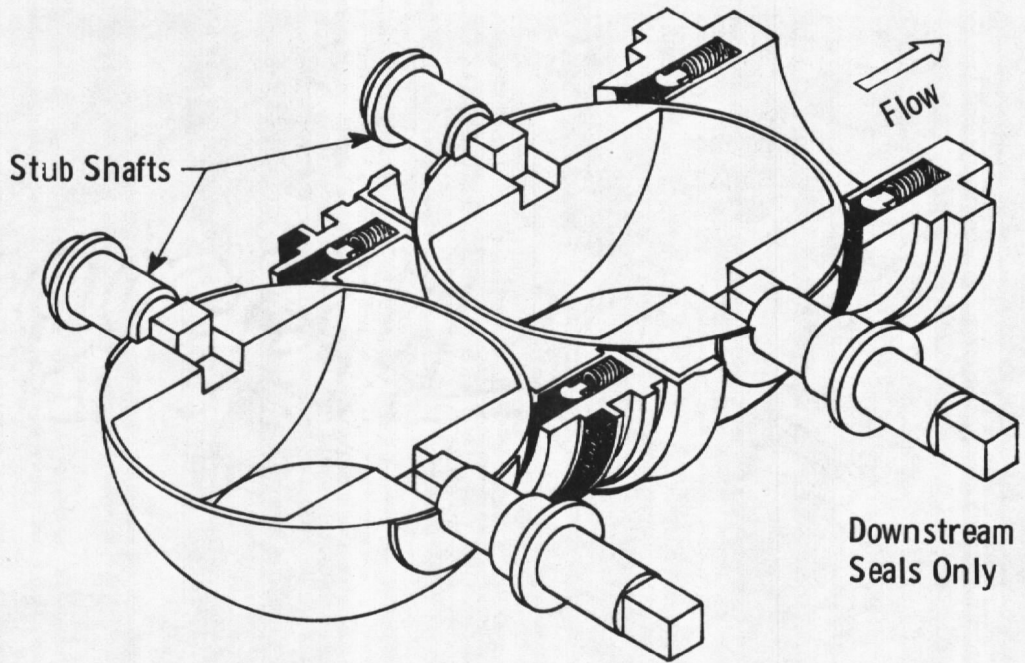

a. Prototype (Phase V)

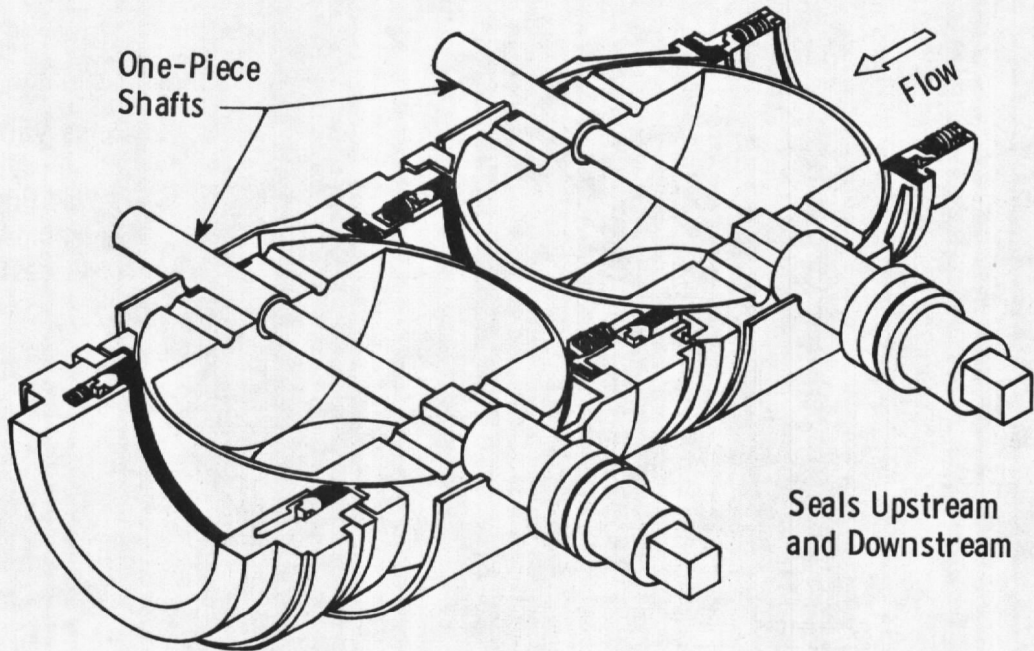

b. Mod I-C Design (Phase VI)

Fig. 3 Bipropellant Valve Ball and Seal Details

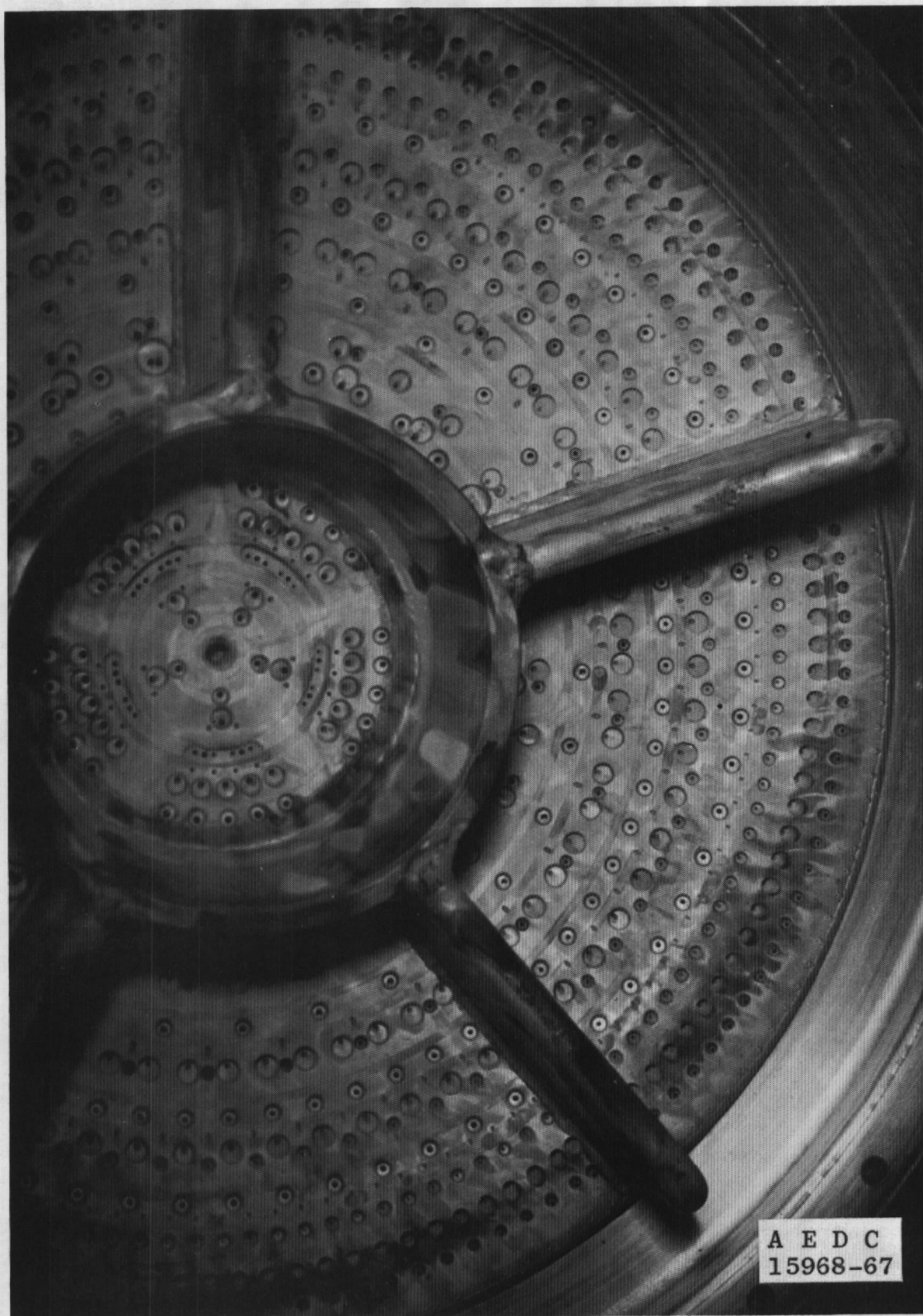

Fig. 4 Face View of Injector S/N 104

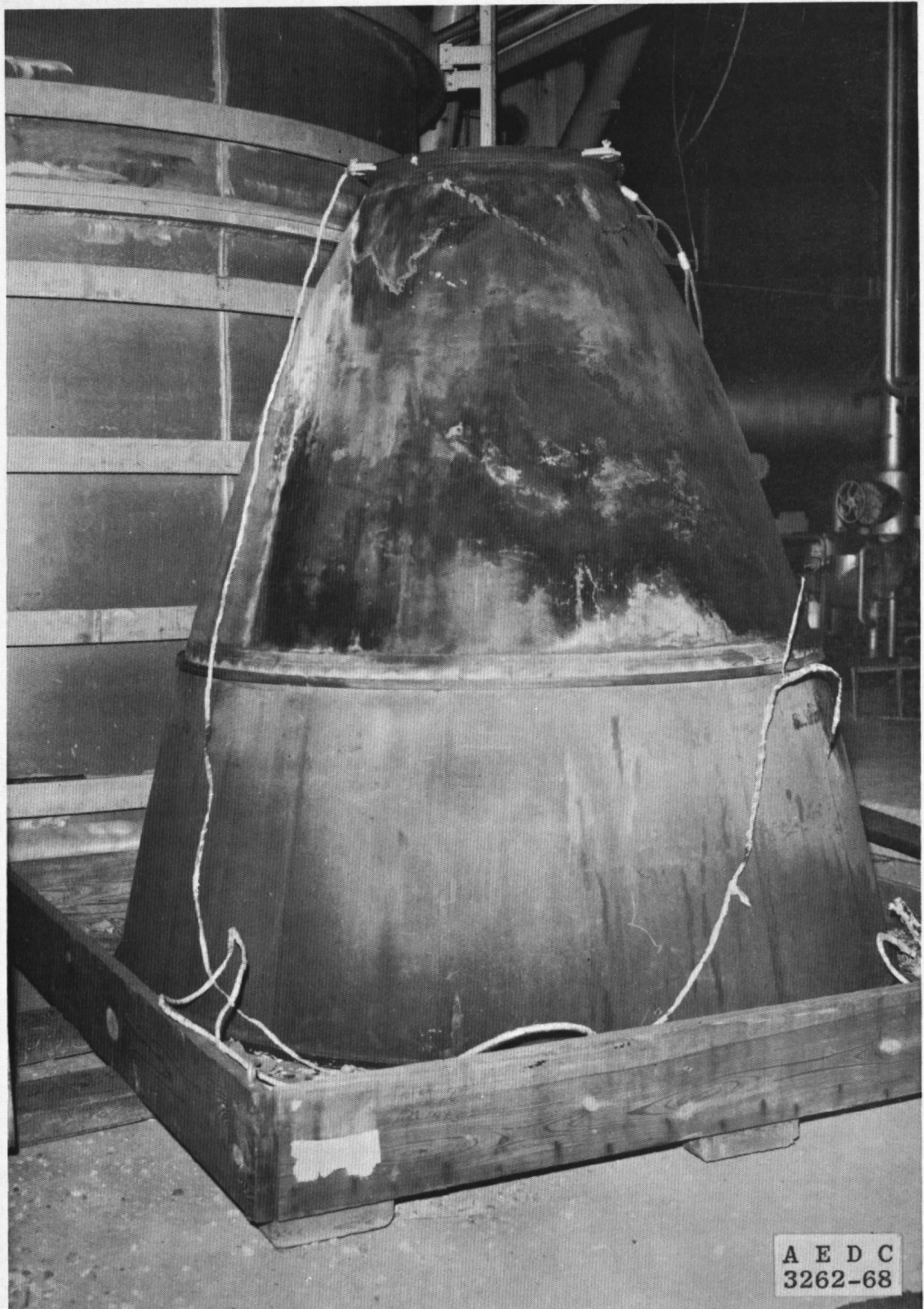
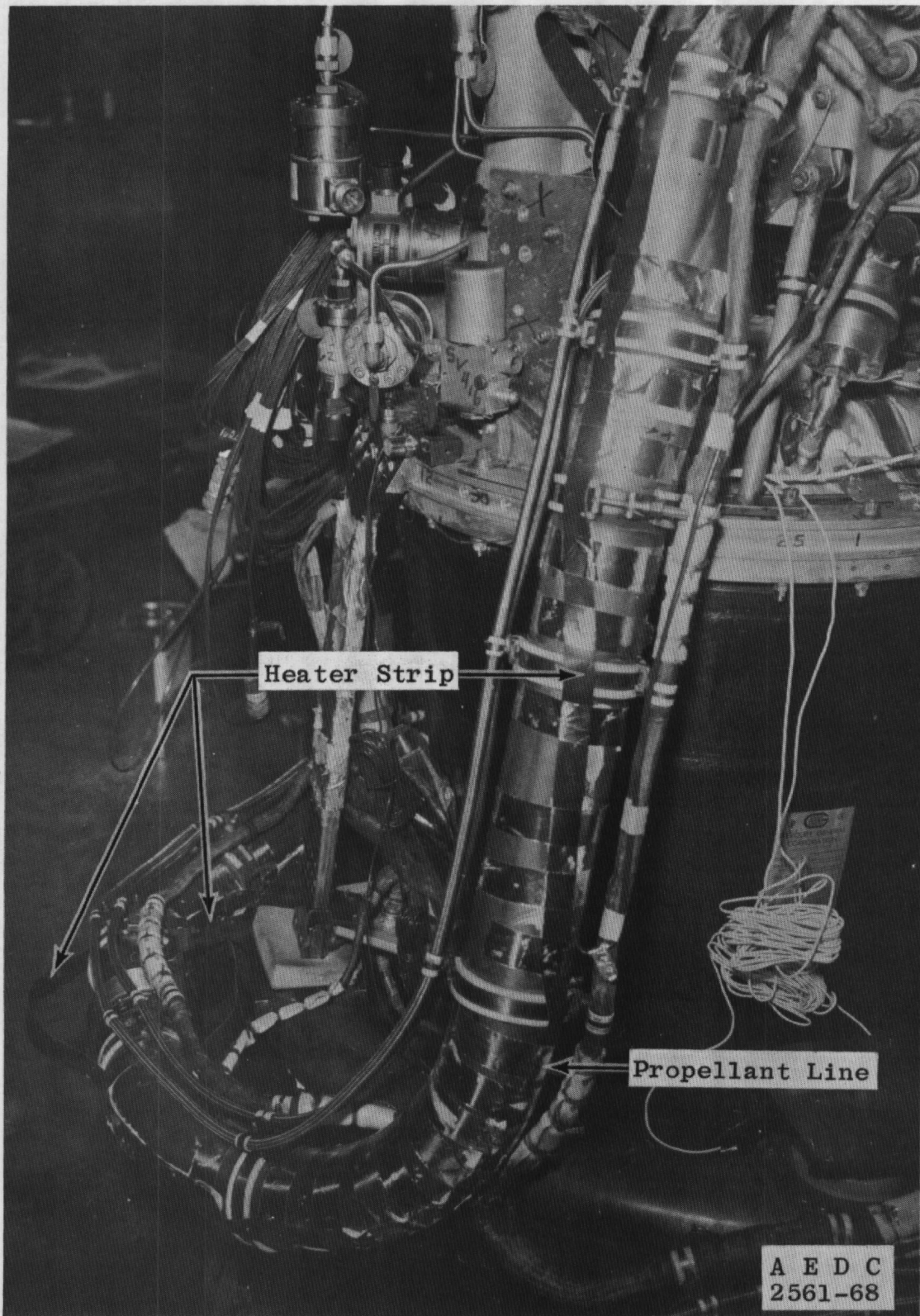
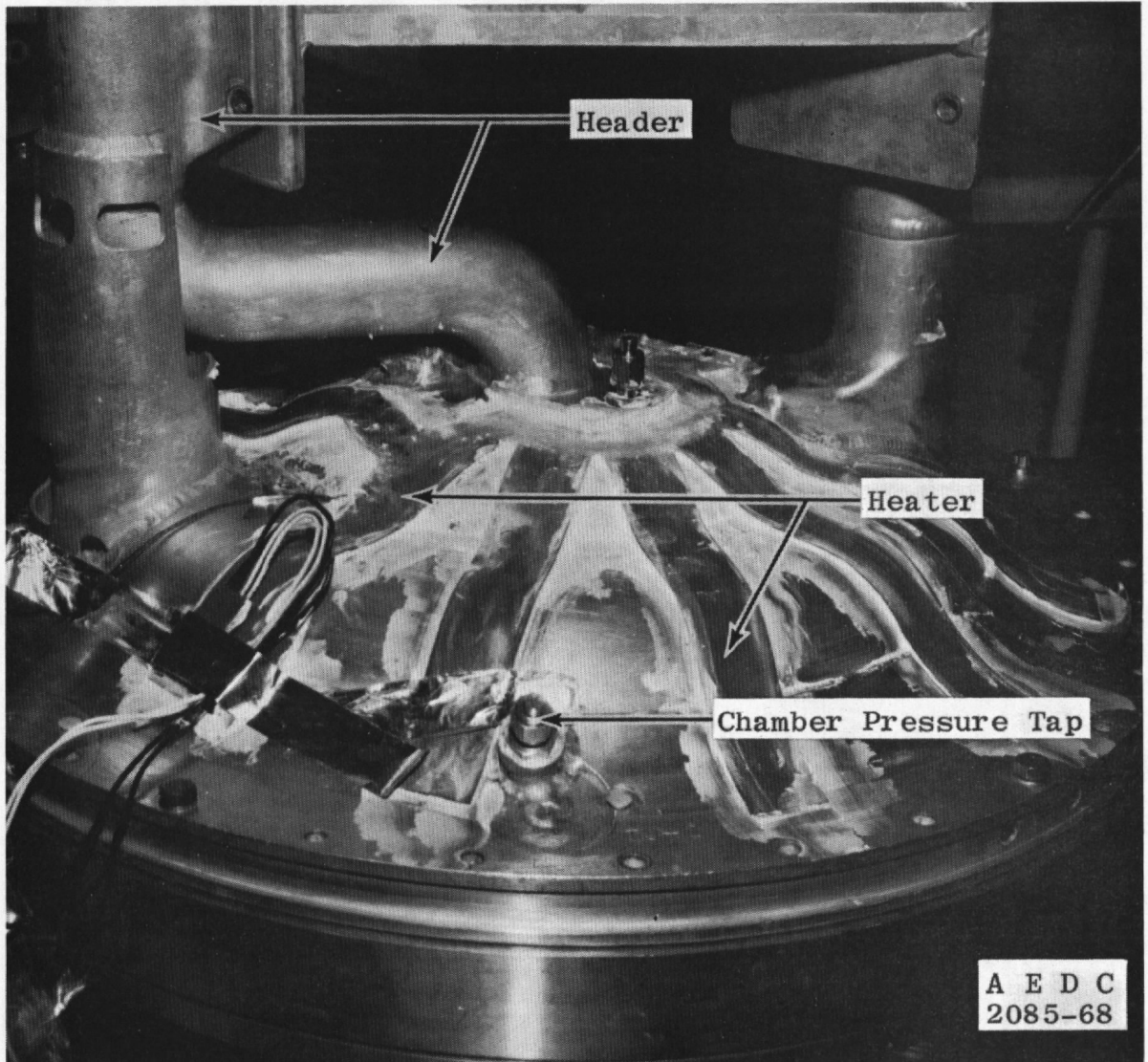

Fig. 5 Nozzle Extension S/N 054, Posttest Period FJ



a. Engine Line Heater Installation
Fig. 6 Electrical Strip Heaters



b. Injector Heater Installation
Fig. 6 Concluded

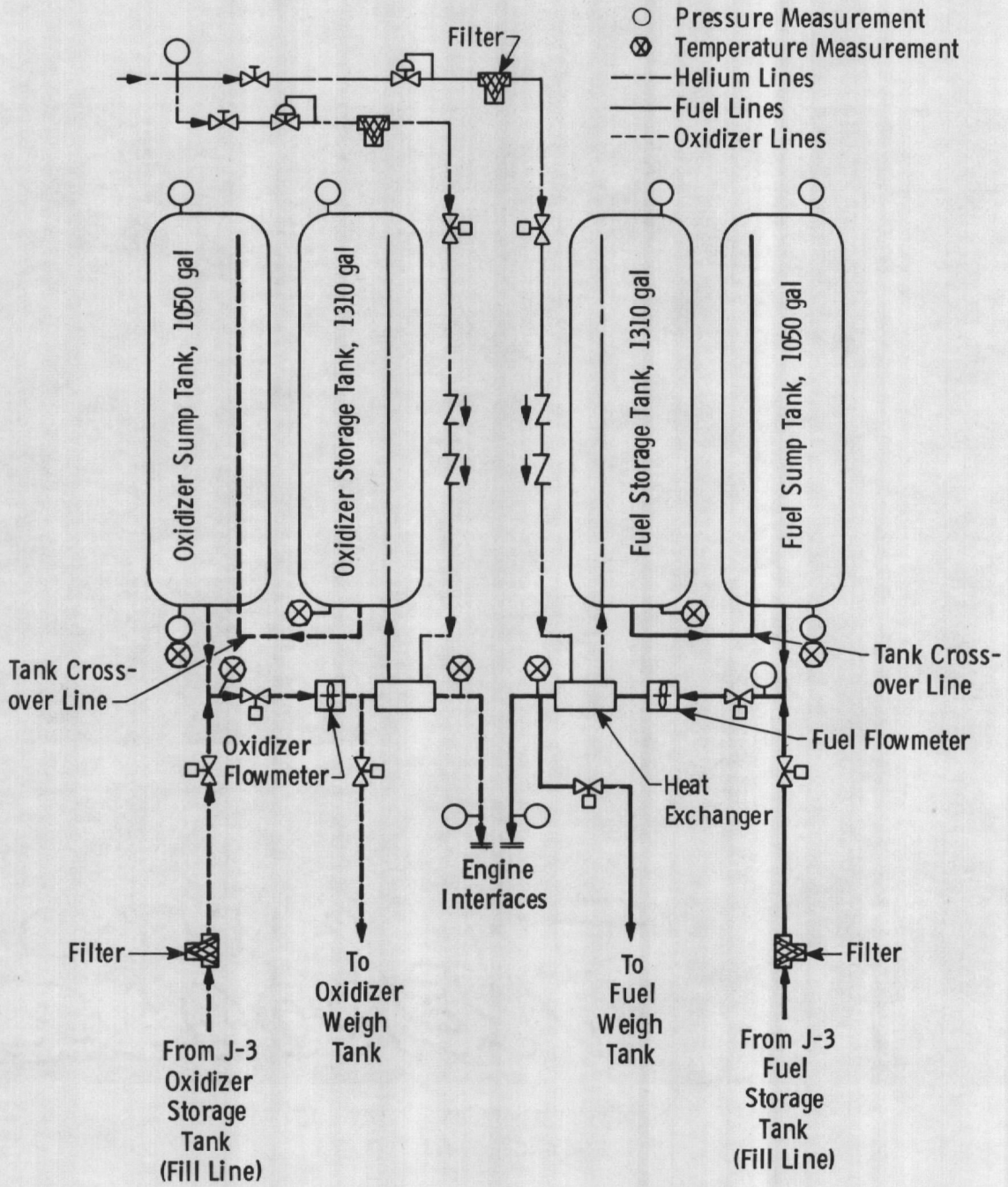
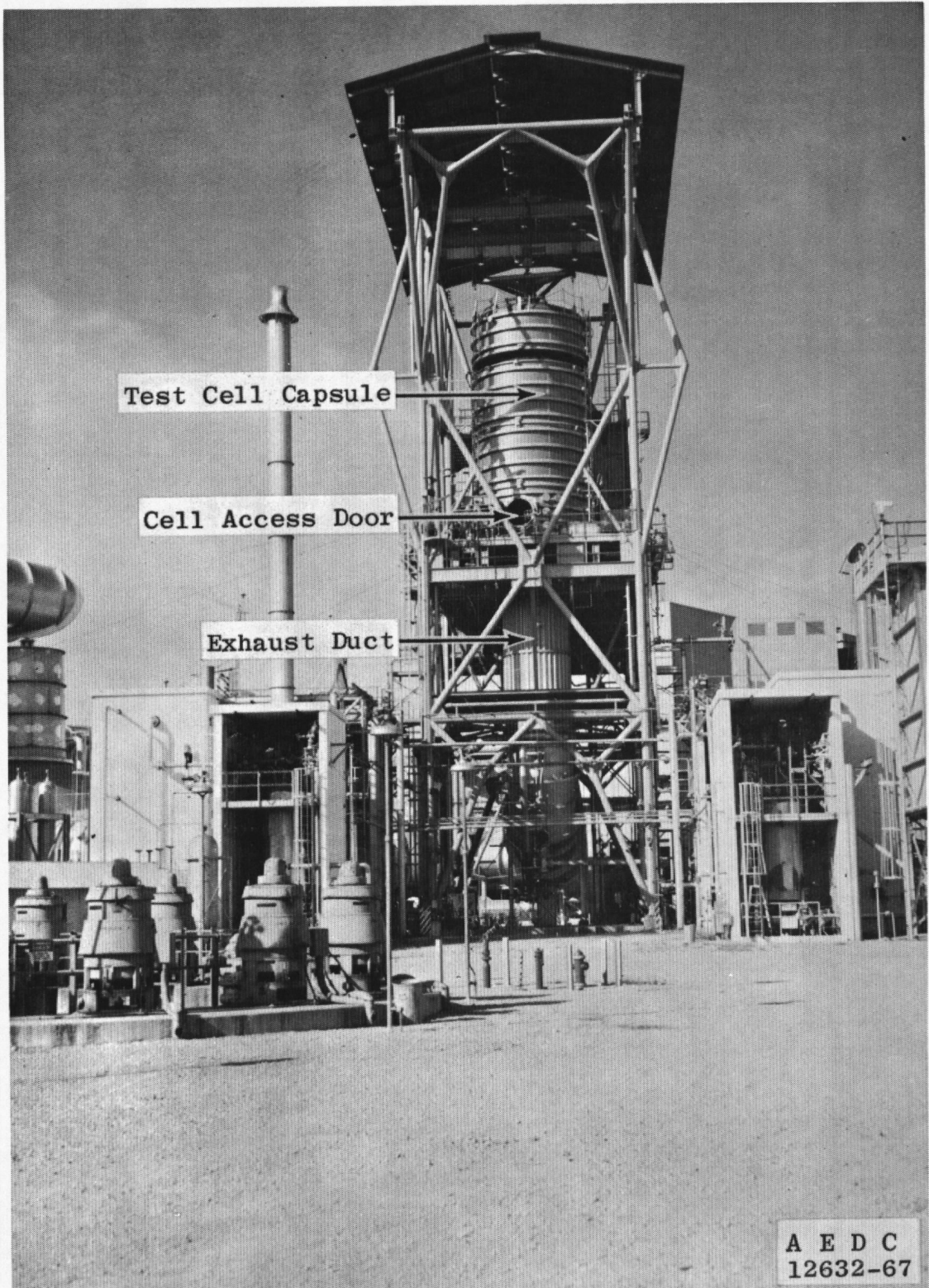
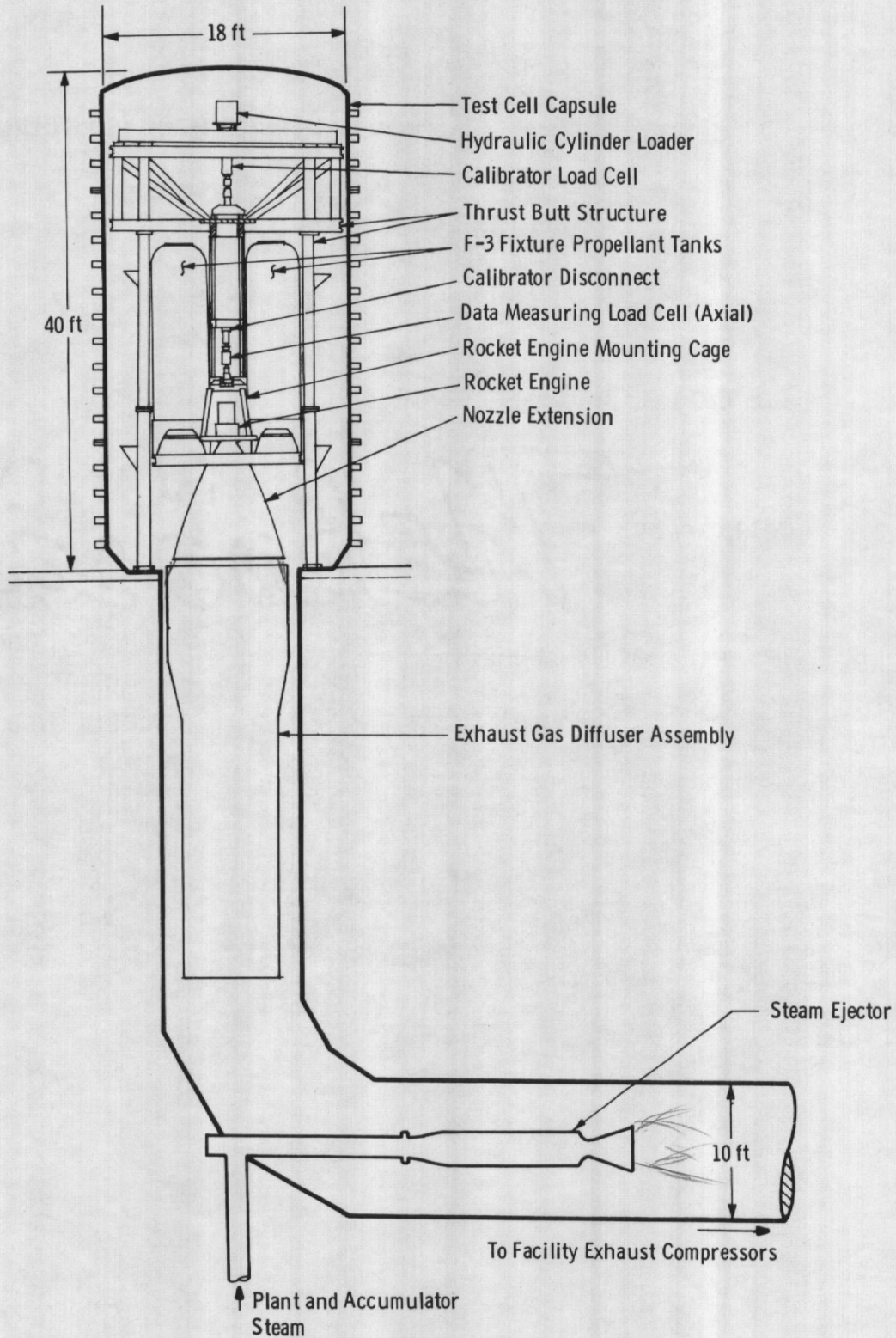

Fig. 7 Schematic of F-3 Fixture



a. Complex

Fig. 8 Test Cell J-3



b. Schematic
Fig. 8 Concluded

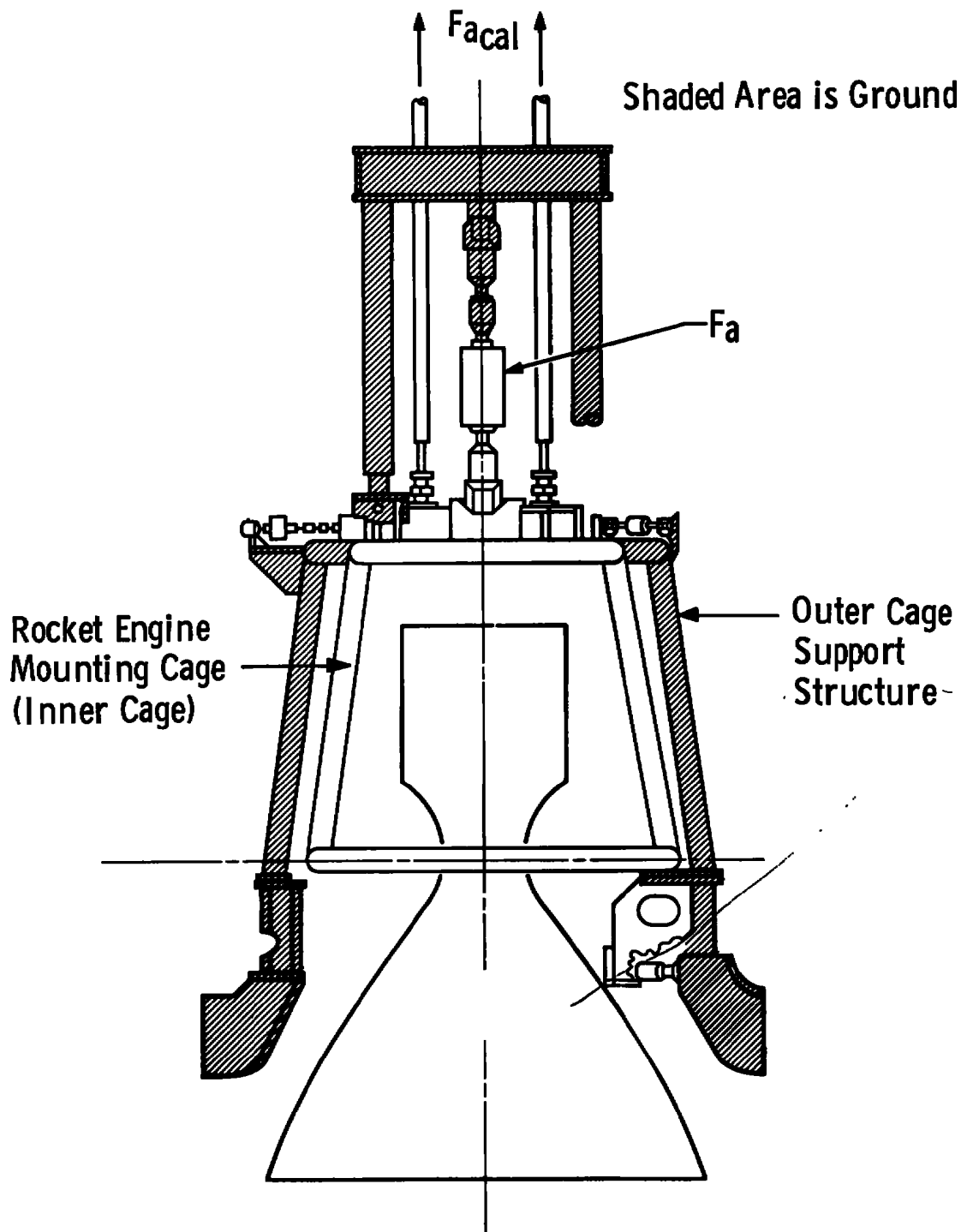
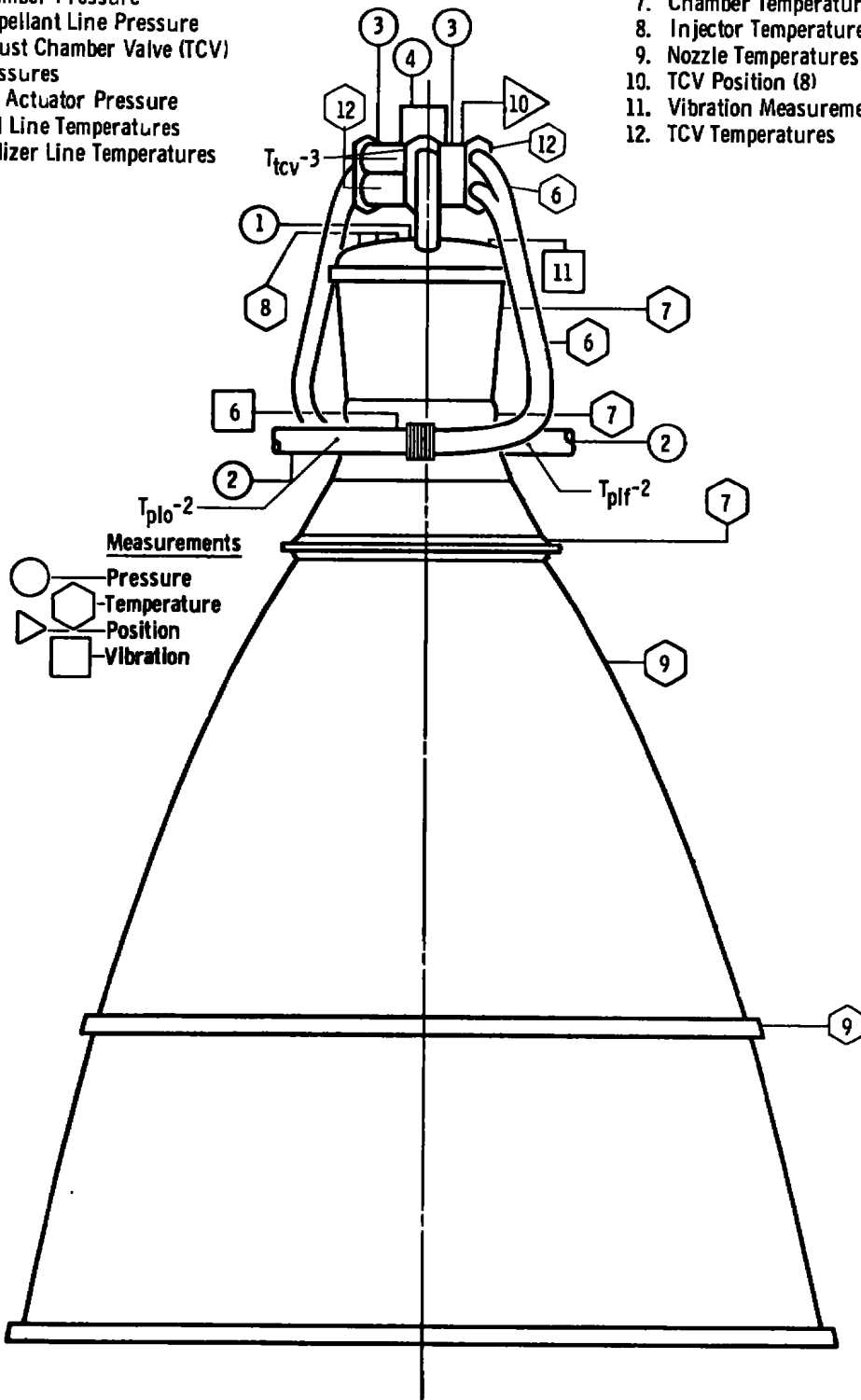

Fig. 9 Arrangement of Thrust System

- 1. Chamber Pressure
- 2. Propellant Line Pressure
- 3. Thrust Chamber Valve (TCV) Pressures
- 4. TCV Actuator Pressure
- 5. Fuel Line Temperatures
- 6. Oxidizer Line Temperatures

- 7. Chamber Temperatures
- 8. Injector Temperatures
- 9. Nozzle Temperatures
- 10. TCV Position (8)
- 11. Vibration Measurements
- 12. TCV Temperatures



a. General Locations

Fig. 10 Engine and Nozzle Extension Instrumentation Location

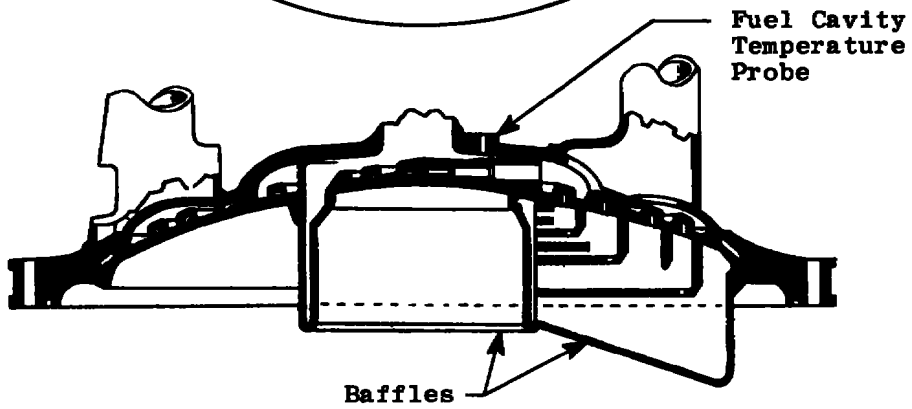
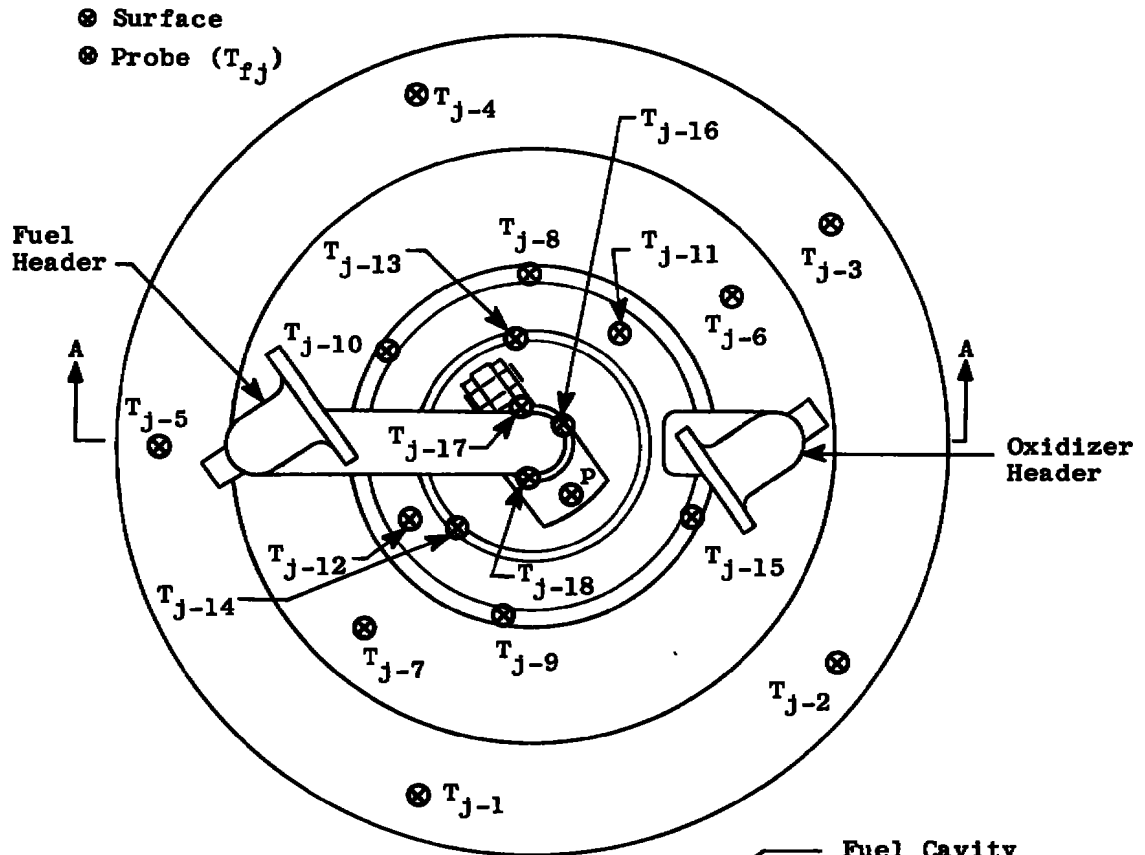

Section AA

b. Injector Thermocouple Locations

Fig. 10 Concluded

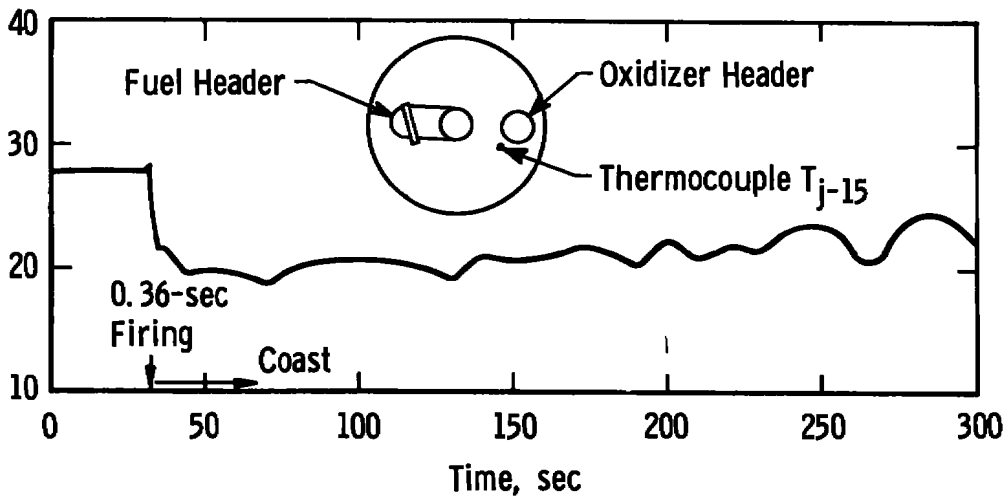

a. T_{j-15}

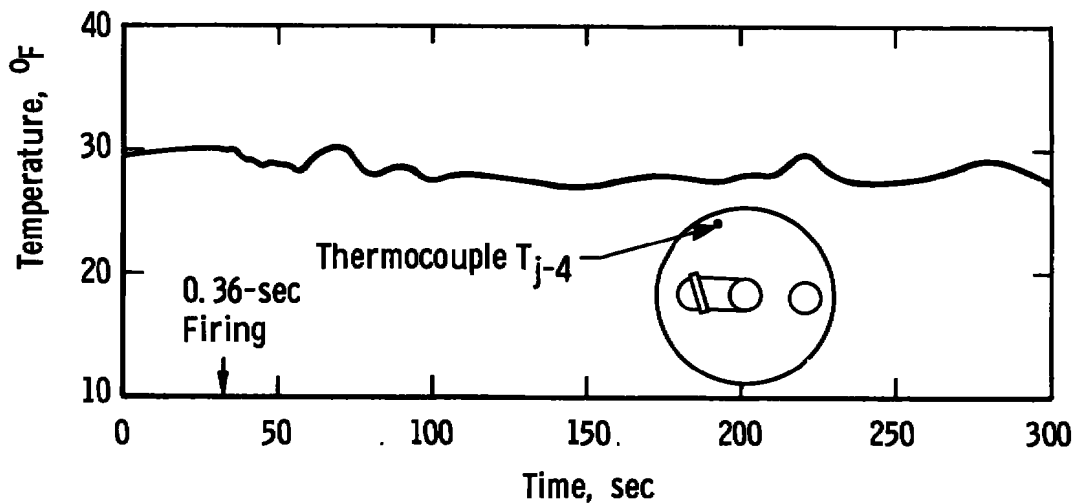

b. T_{j-4}

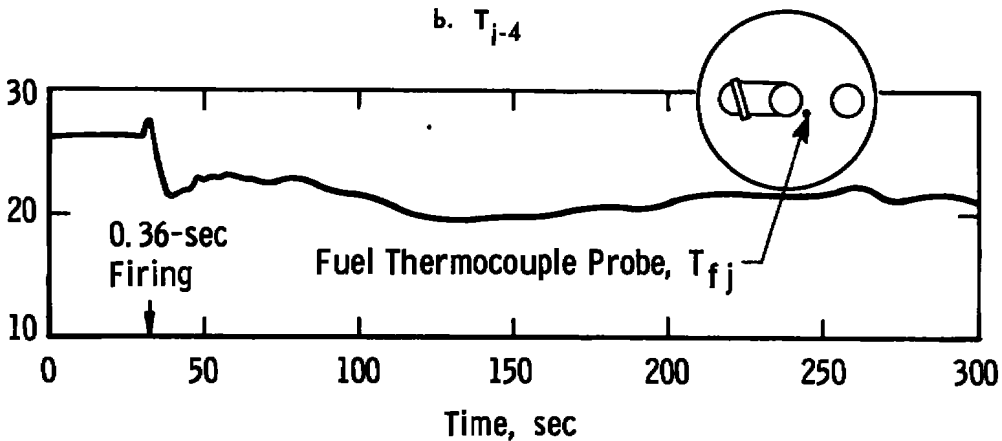

c. T_{fj}

Fig. 11 Injector Temperature History following Short Firing FJ-33

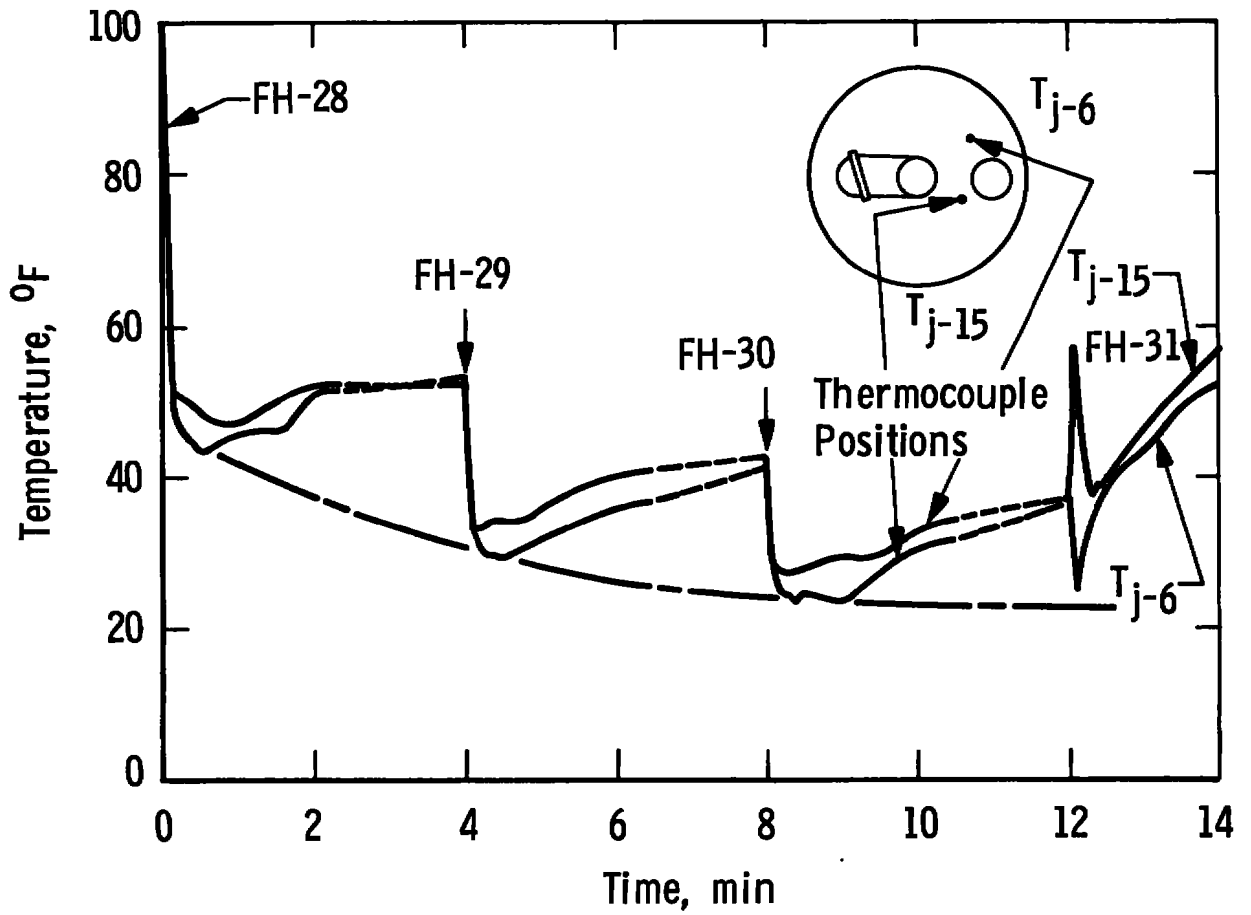

a. Multiple Firings with 4-min Interval

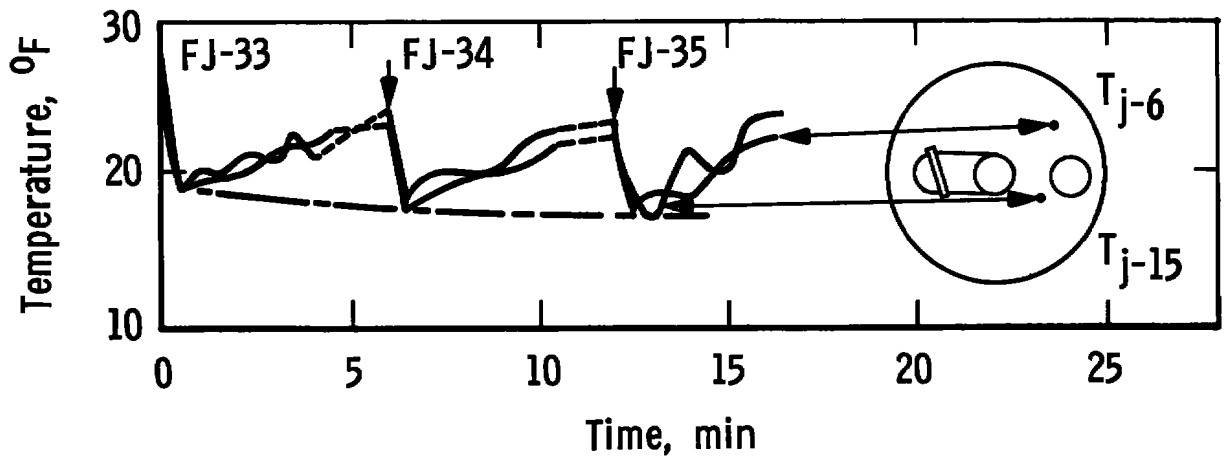

b. Multiple Firings with 6-min Interval

Fig. 12 Effect of Multiple Firings on Injector Temperatures

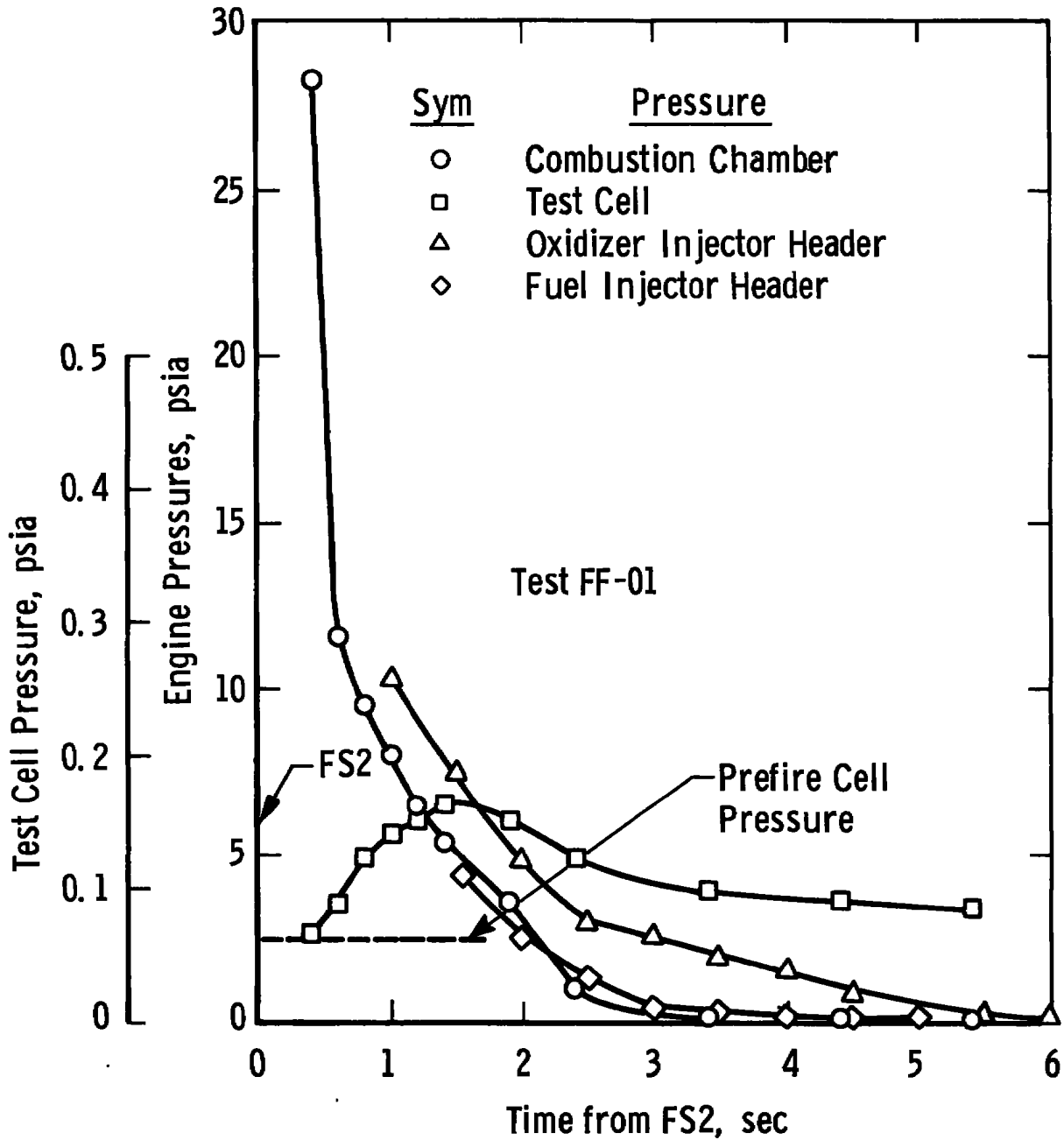

Fig. 13 Typical Shutdown Pressure Profile

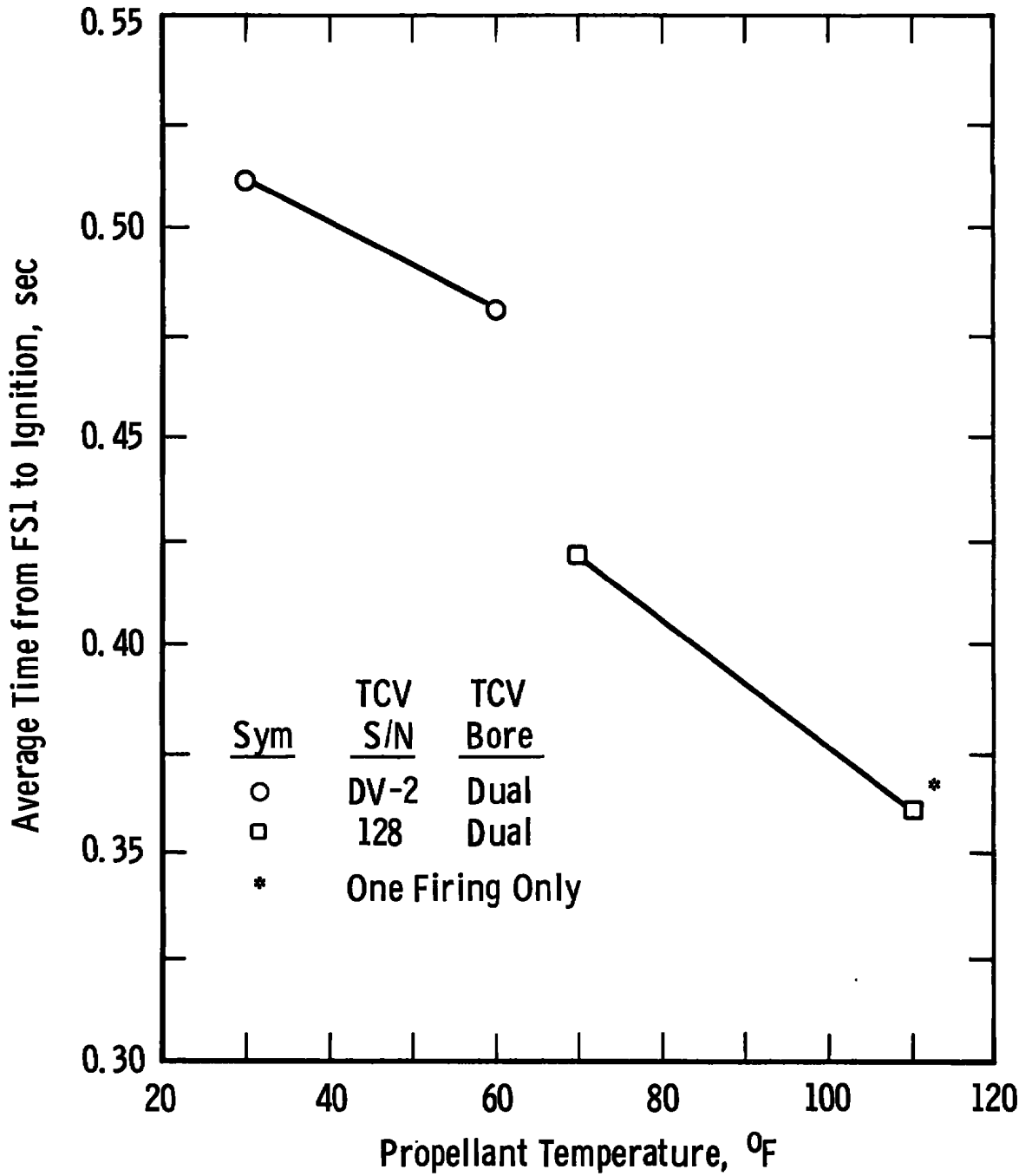
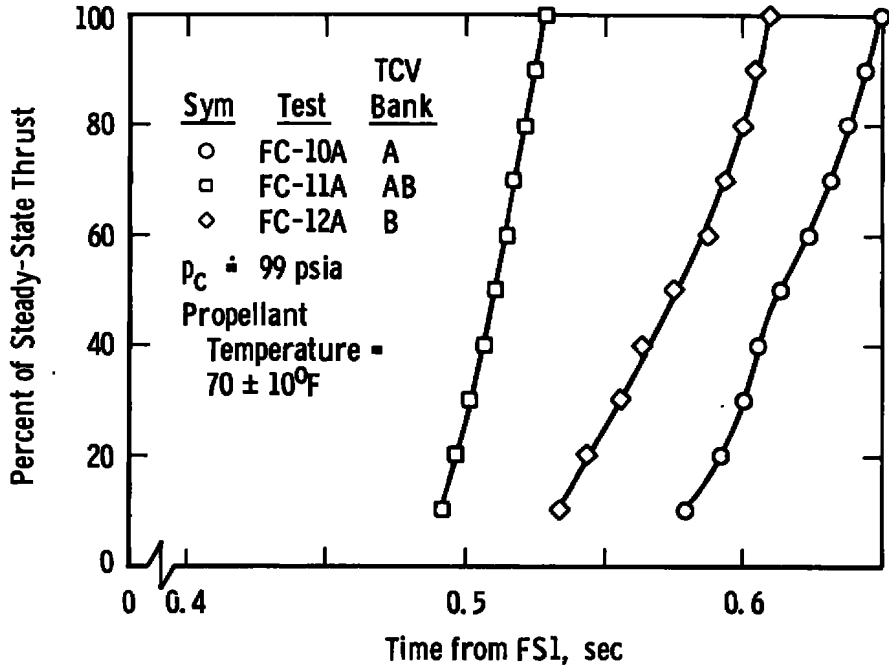
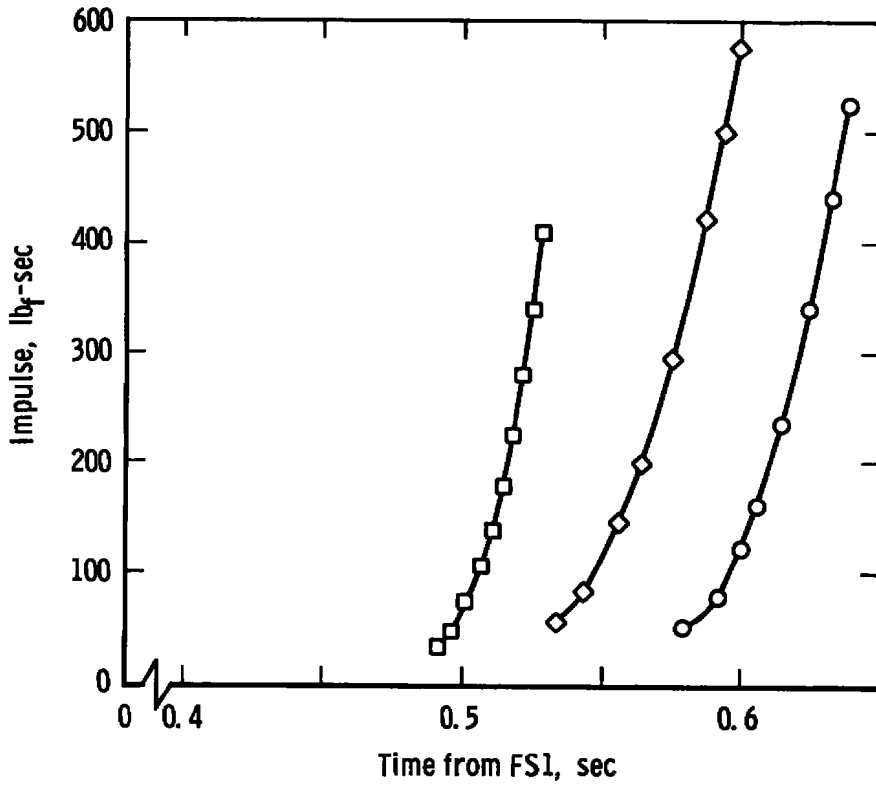

Fig. 14 Propellant Temperature Influence on Time from FS1 to Ignition



a. Thrust



b. Impulse

Fig. 15 Typical Ignition Transients

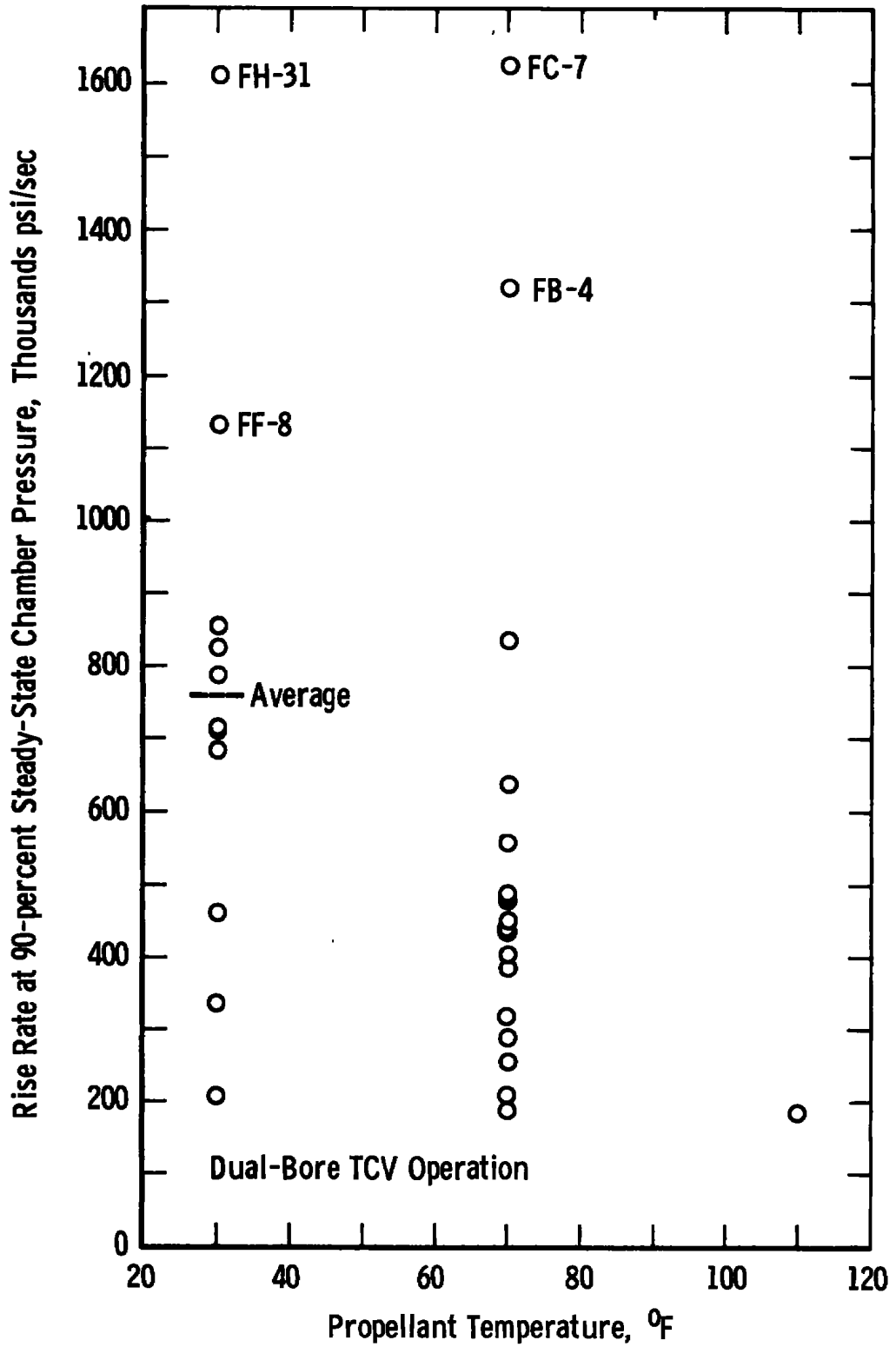

Fig. 16 Propellant Temperature Influence on Average Rise Rate of Chamber Pressure

| Test No. | Temperatures, °F | | | |
|----------|------------------|----------|--------------|------------|
| | Fuel | Oxidizer | Injector Rim | Valve Body |
| FF-10 | 29 | 29 | 32 | 28 |
| FF-12 | 34 | 30 | 35 | 29 |
| FJ-36 | 49 | 31 | 28 | 28 |
| FC-9A | 79 | 130 | 90 | |
| FH-27 | 31 | 32 | 38 | 37 |

All Dual-Bore Operation

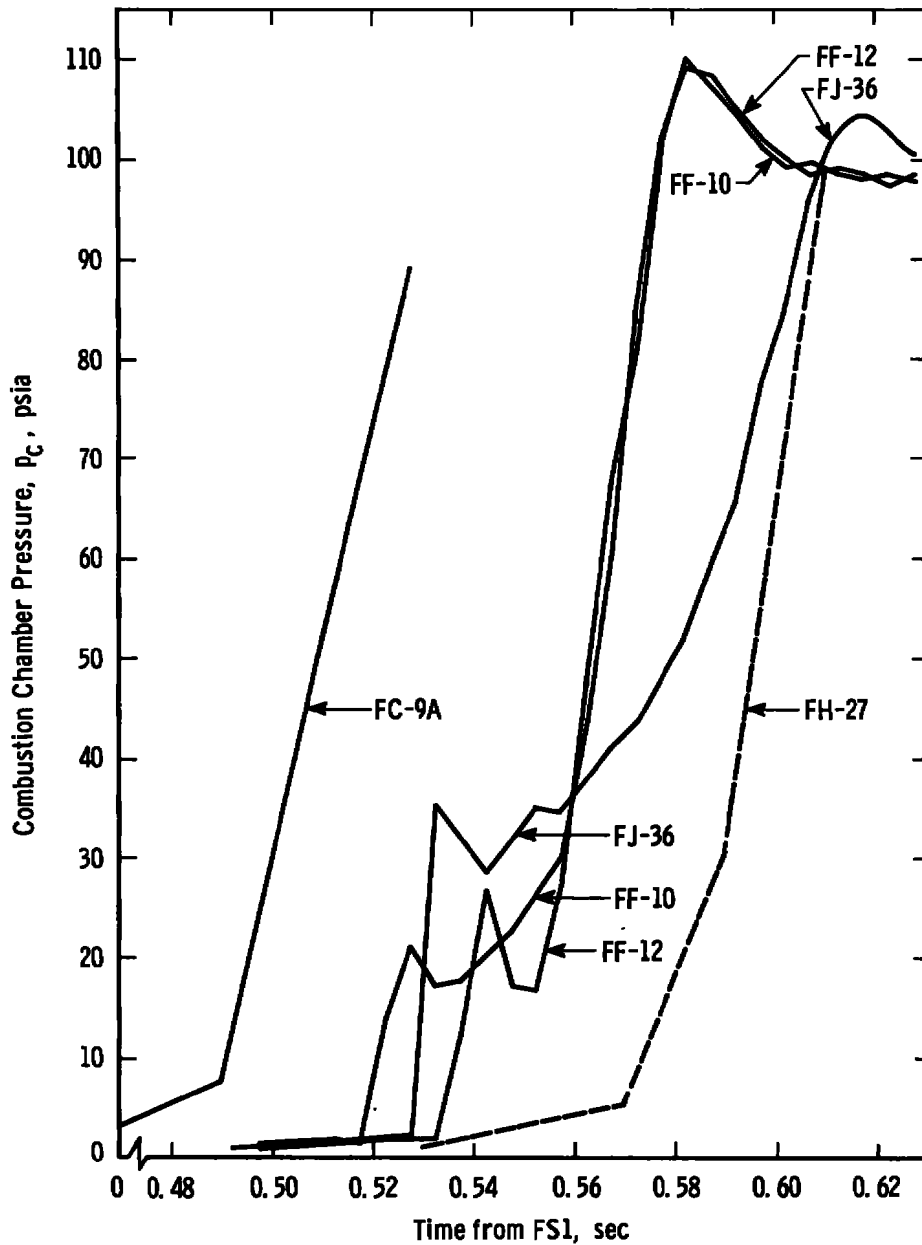

Fig. 17 Ignition Transient Chamber Pressure Profiles

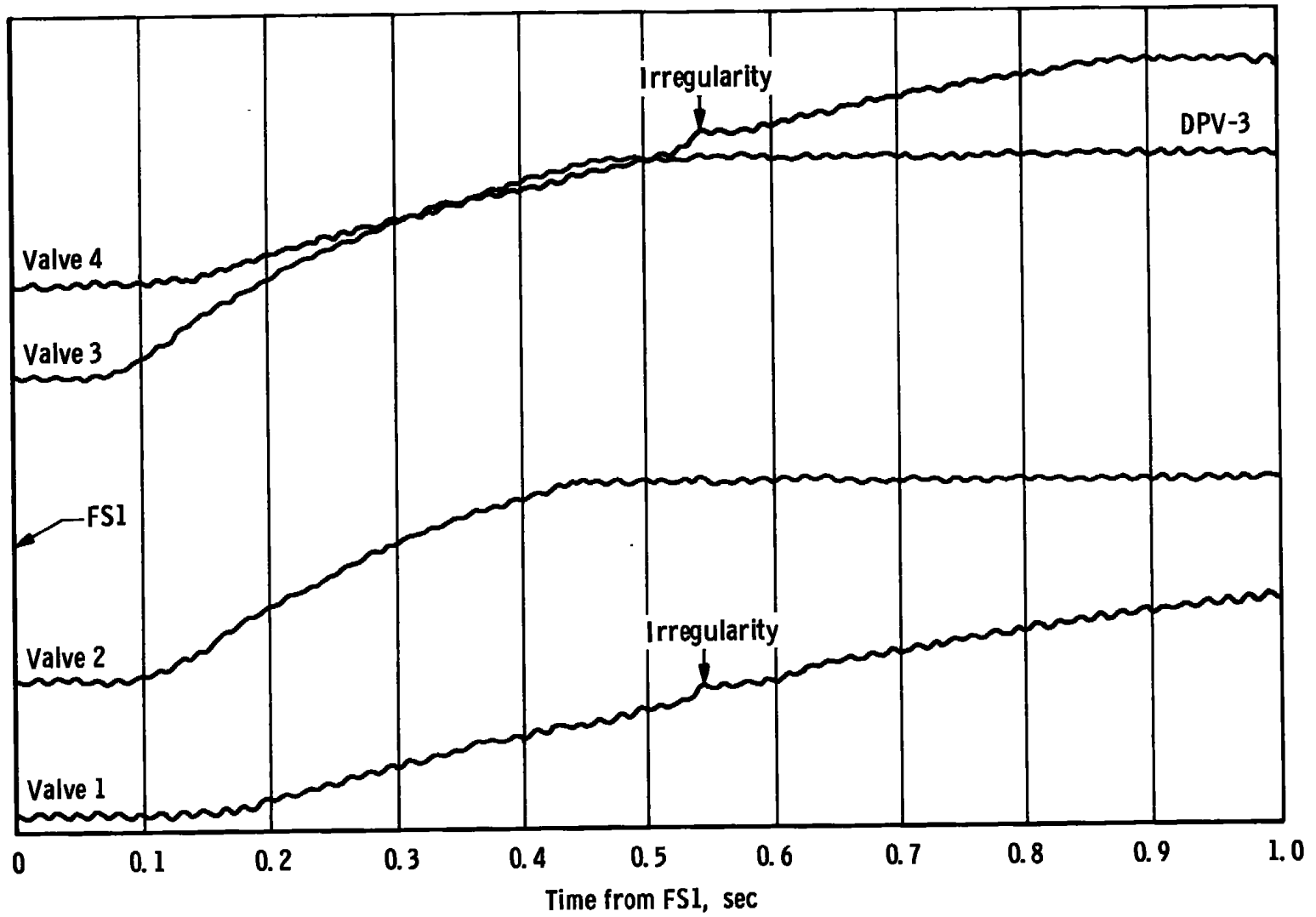
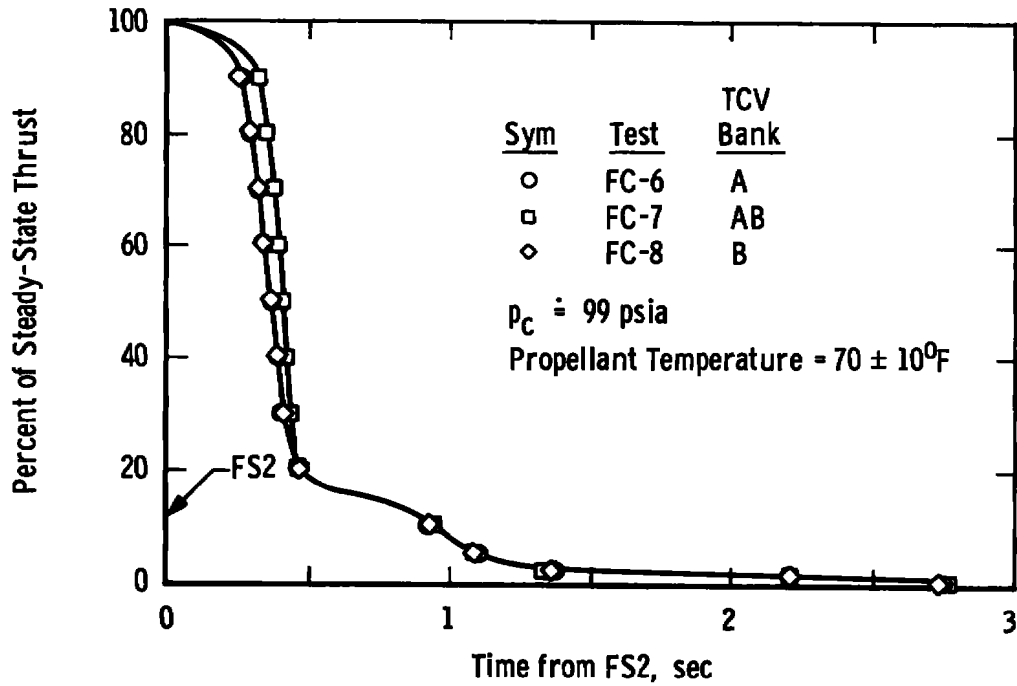
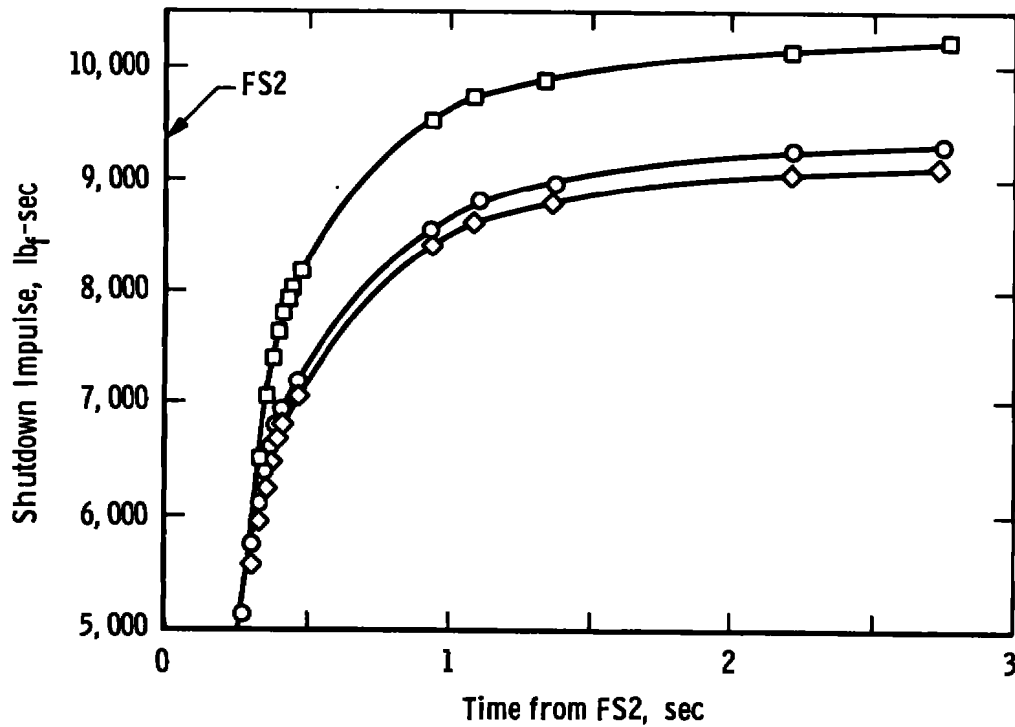

Fig. 18 TCV Ball Positions during Ignition Transient, Test FJ-36



a. Thrust



b. Impulse

Fig. 19 Typical Shutdown Thrust and Impulse Transients

| Sym | TCV Bank | TCV S/N | Propellant Temperature, °F | p _c Level, psia |
|-----|----------|---------|----------------------------|----------------------------|
| ○ | A | 128 | 70 ± 10 | 99 |
| □ | AB | 128 | 70 ± 10 | 99 |
| ◇ | B | 128 | 70 ± 10 | 99 |

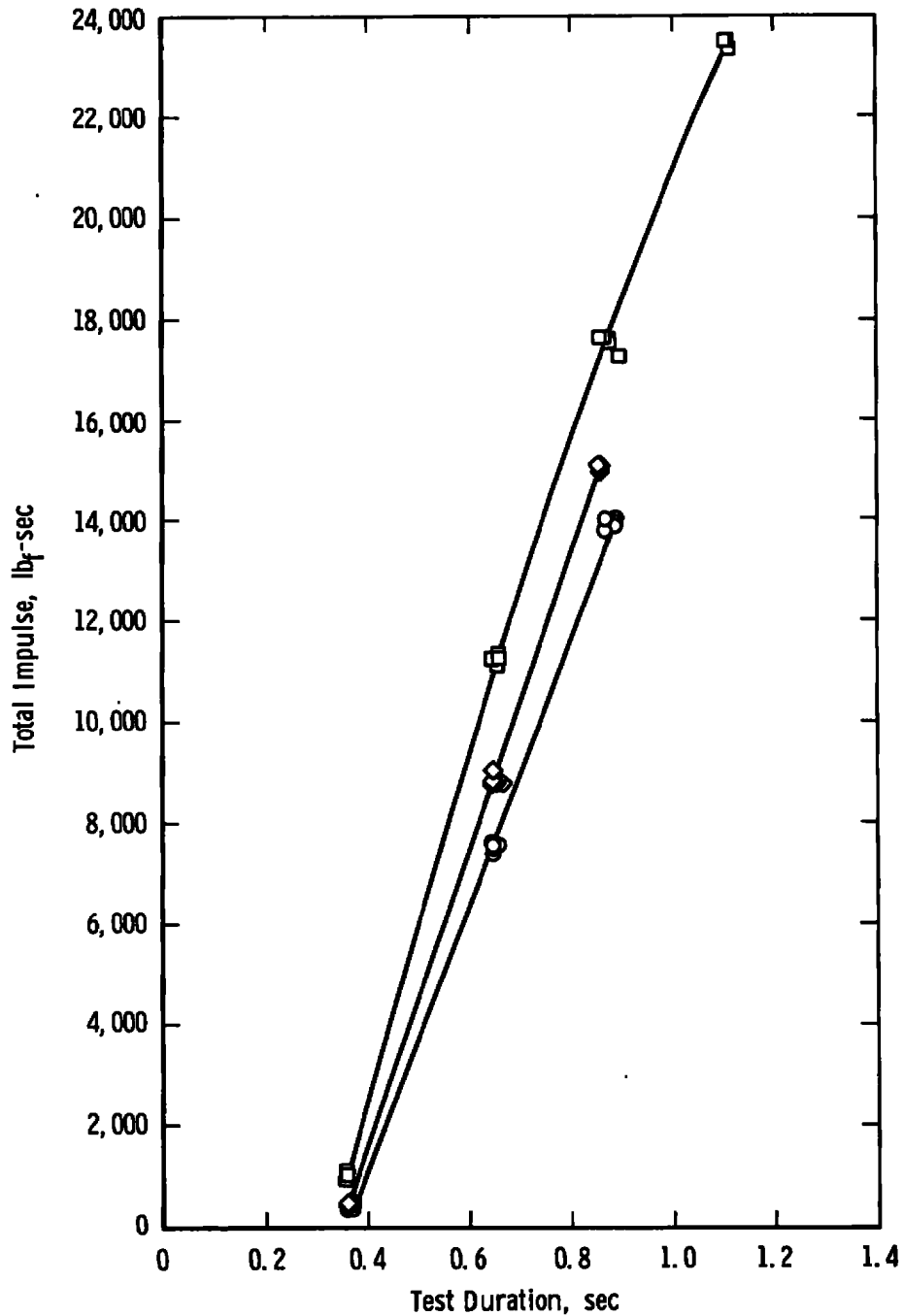

Fig. 20 Total Impulse of Bit Firings

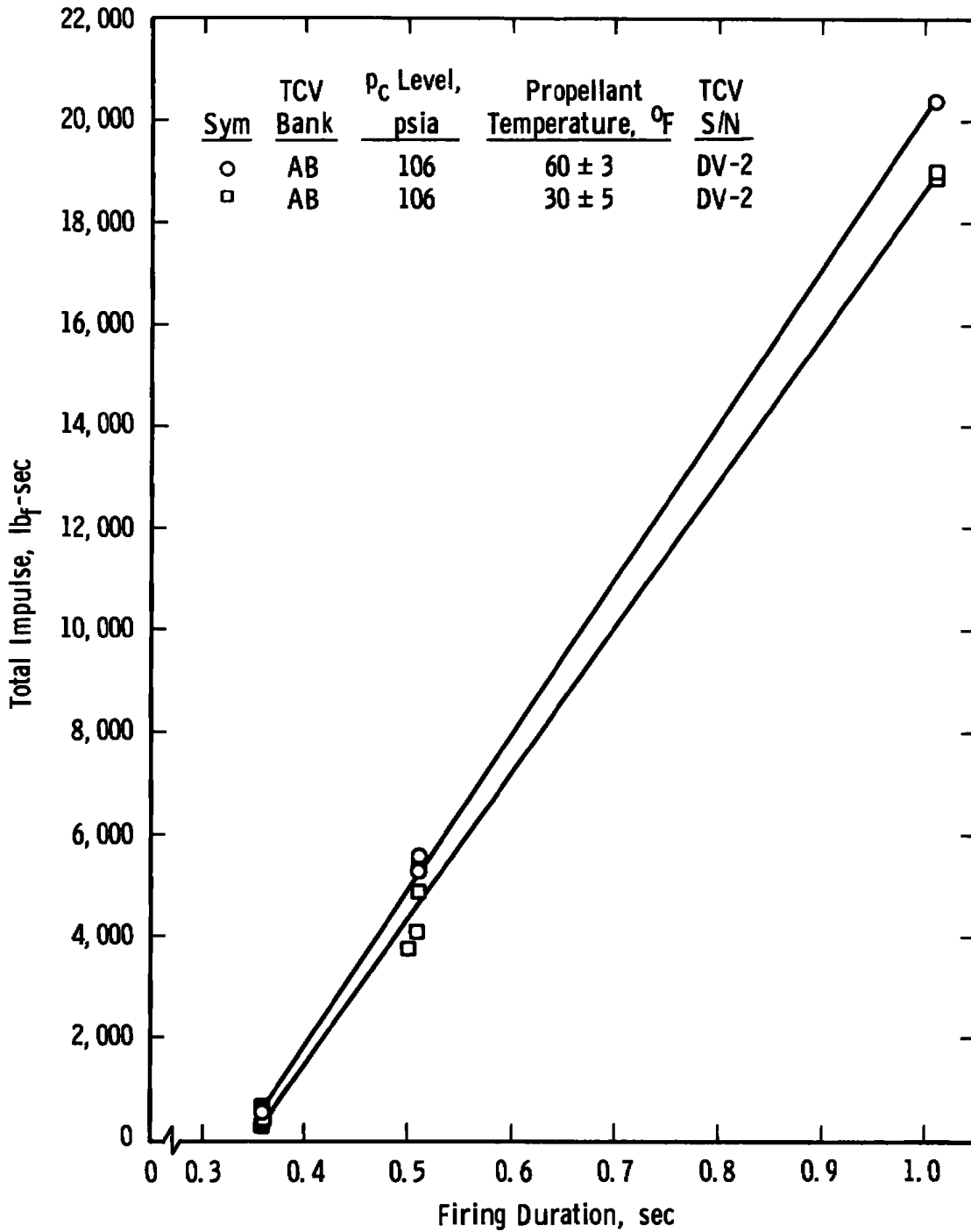

Fig. 21 Total Impulse of Bit Firings at Off-Design Conditions

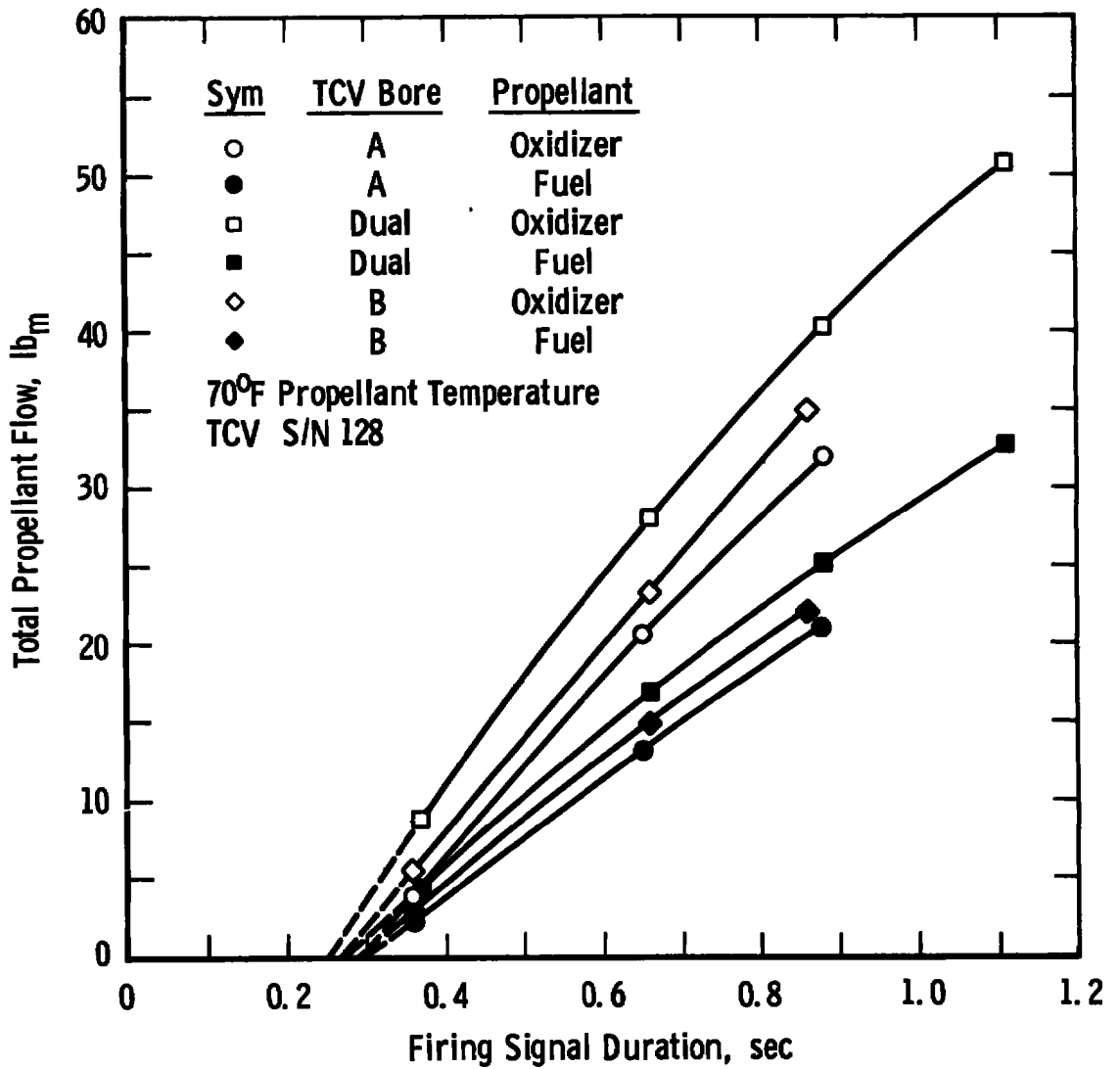

Fig. 22 Average Propellant Flow of Impulse Bit Firings

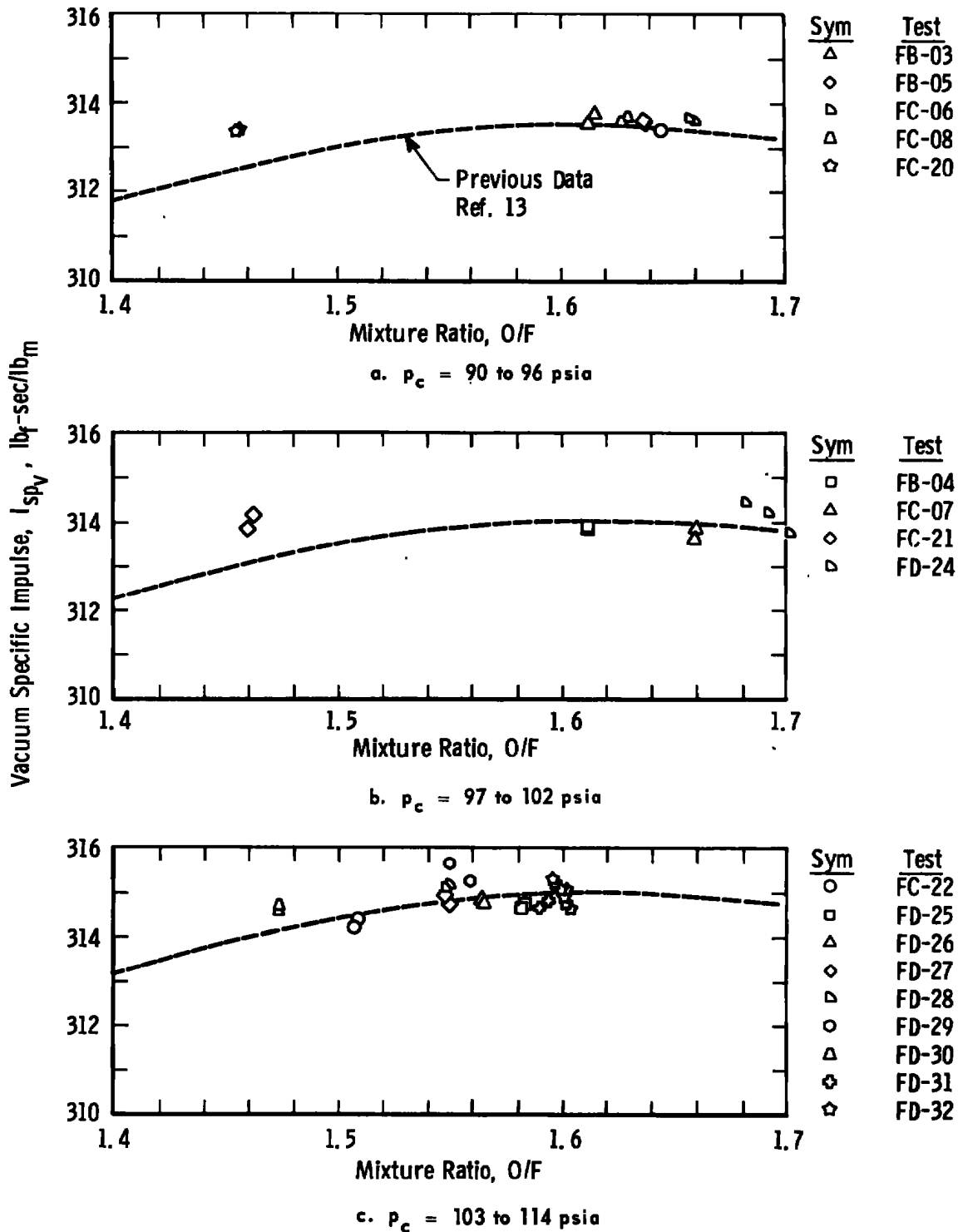

Fig. 23 Vacuum Specific Impulse Compared with Previous Test Data Characteristic Curve

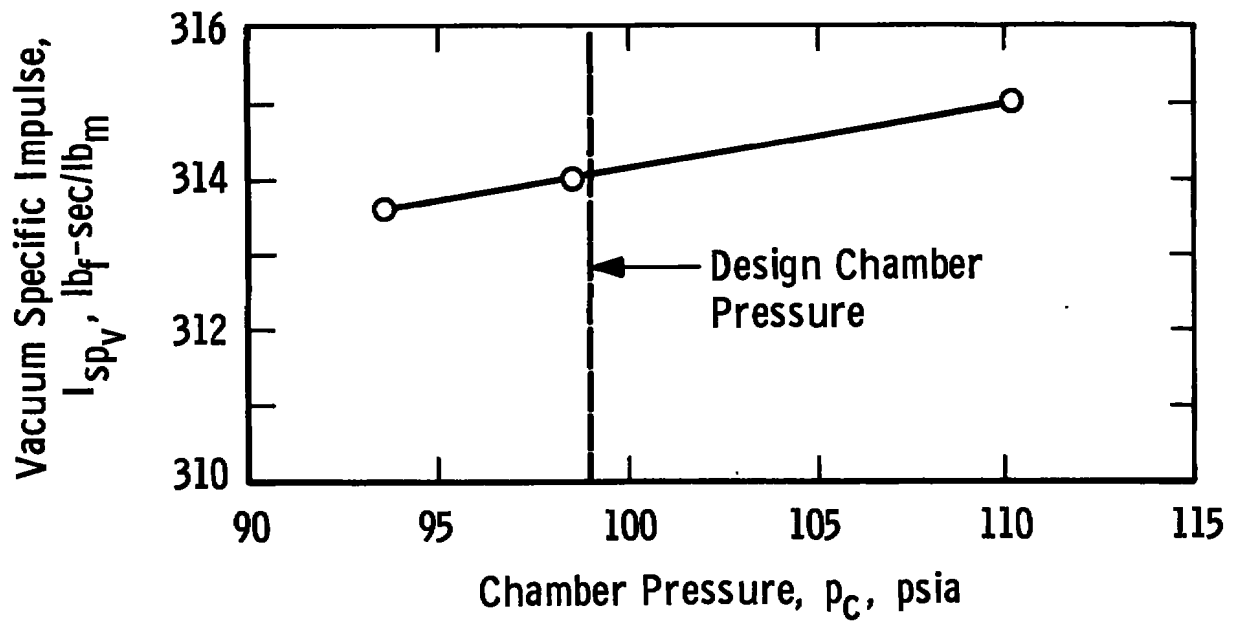
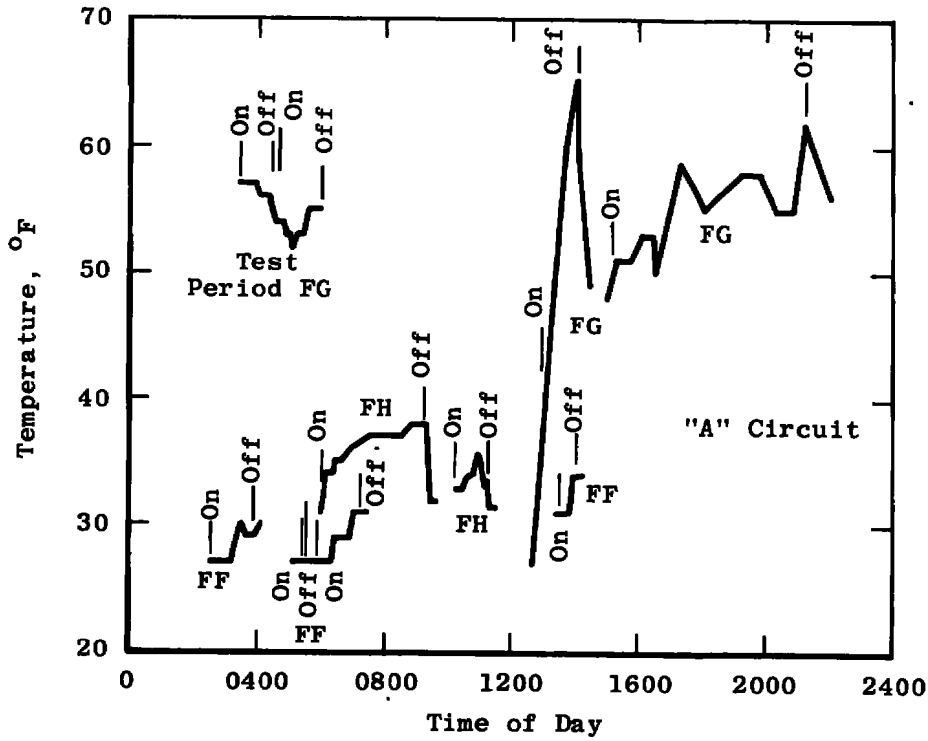
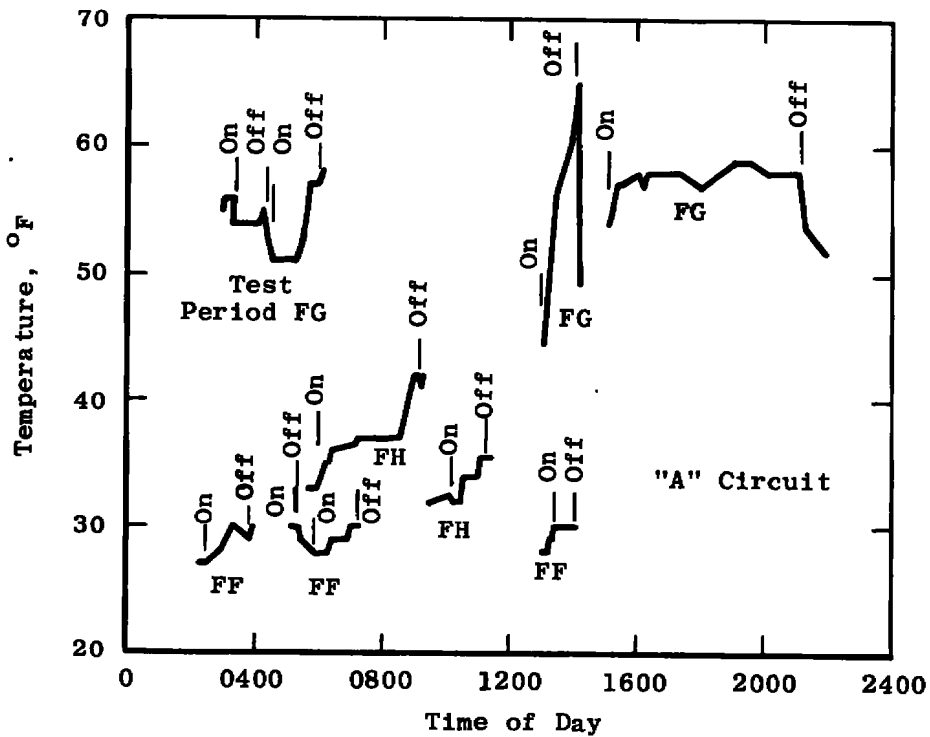

Fig. 24 Effect of Chamber Pressure on Vacuum Specific Impulse



a. Fuel Line Temperature



b. Oxidizer Line Temperature

Fig. 25 Propellant Line Heater Operation

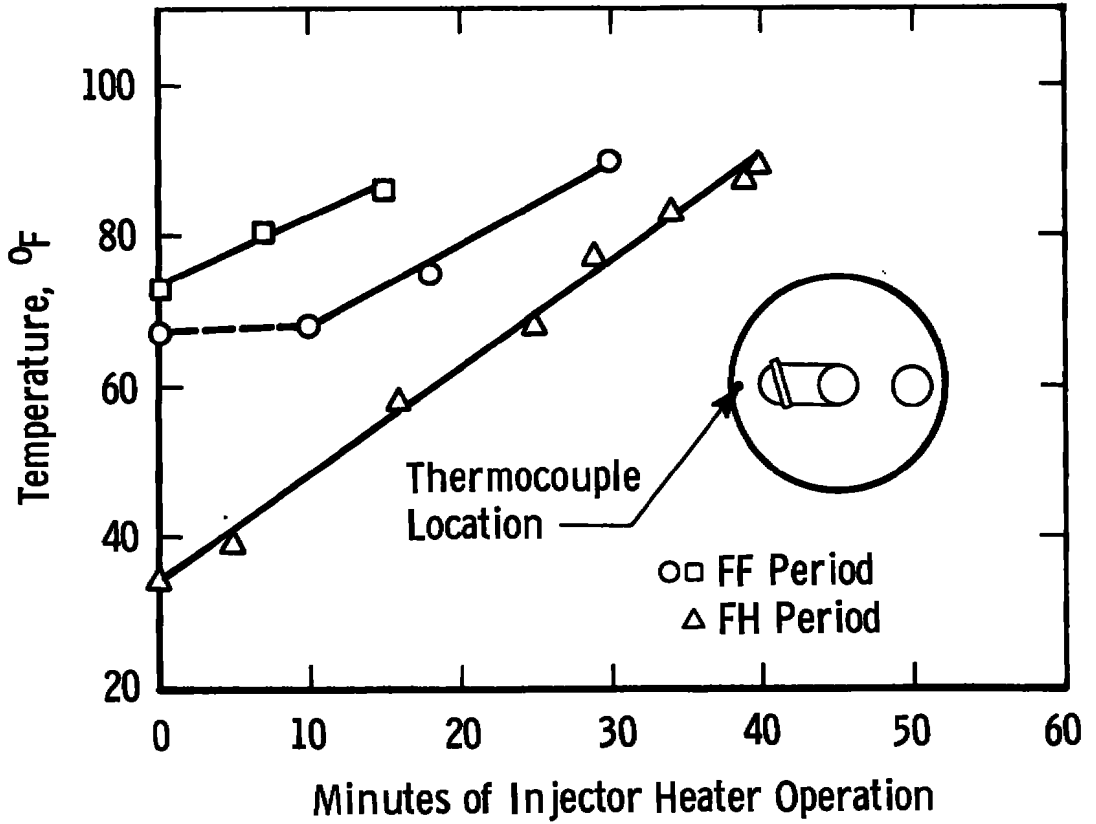

Fig. 26 Injector Heater Operation

TABLE I
TEST SUMMARY

| Date | Time (CST) | Test No. | Actual Duration, sec | TCV Bank | Target P _c , psia | Target O/F | Remarks |
|------|------------|----------|----------------------|--------------|------------------------------|------------|--|
| 2/1 | 0025 | FA-1 | 30.3 | A AB B | 99 | 1.6 | Flowmeters erratic |
| 2/7 | 1120 | FB-2 | 9.9 | A | 99 | 1.6 | Engine not bled in completely, firing invalid |
| 2/8 | 0002 | FB-3 | 10.6 | A | 99 | 1.6 | Repeat of FB-2 |
| | 0032 | FB-4 | 10.9 | AB | 99 | 1.6 | |
| | 0102 | FB-5 | 10.7 | B | 99 | 1.6 | |
| 2/13 | 1012 | FC-6 | 11.0 | A | 99 | 1.6 | |
| | 1042 | FC-7 | 10.3 | AB | 99 | 1.6 | |
| | 1112 | FC-8 | 10.2 | B | 99 | 1.6 | |
| | 1401 | FC-9 | 5.5 | AB | 99 | 1.6 | 5 firings of 1.11 sec each at 1-min intervals. |
| | 1436 | FC-10 | 4.4 | A | 99 | 1.6 | 5 firings of 0.88 sec each at 1-min intervals. |
| | 1512 | FC-11 | 4.4 | AB | 99 | 1.6 | " |
| | 1546 | FC-12 | 4.3 | B | 99 | 1.6 | 5 firings of 0.86 sec each at 1-min intervals |
| | 1621 | FC-13 | 3.3 | A | 99 | 1.6 | 5 firings of 0.65 sec each at 1-min intervals |
| | 1656 | FC-14 | 3.3 | AB | 99 | 1.6 | 5 firings of 0.66 sec each at 1-min intervals |
| | 1731 | FC-15 | 3.3 | B | 99 | 1.6 | " |
| | 2005 | FC-16 | 1.8 | A | 99 | 1.6 | 5 Firings of 0.37 sec each at 1-min intervals |
| | 2039 | FC-17 | 1.8 | AB | 99 | 1.6 | " |
| | 2114 | FC-18 | 1.8 | B | 99 | 1.6 | 5 firings of 0.36 sec each at 1-min intervals |
| | 2147 | FC-19 | 10.1 | AB | 79 | 1.6 | |
| | 2217 | FC-20 | 10.6 | AB | 89 | 1.6 | |
| | 2247 | FC-21 | 10.3 | AB | 99 | 1.6 | |

TABLE I (Continued)

| Date | Time (CST) | Test No. | Actual Duration, sec | TCV Bank | Target P _c , psia | Target O/F | Remarks | |
|------|------------|----------|----------------------|----------|------------------------------|------------|--|--|
| 2/13 | 2317 | FC-22 | 10.4 | AB | 107 | 1.6 | Propellant temperatures 110 to 115°F | |
| | 2347 | FC-23 | 9.9 | AB | 115 | 1.6 | | |
| 2/23 | 1138 | FD-24 | 30.0 | A | | | | |
| | | | | AB | 99 | 1.6 | | |
| | | | | B | | | | |
| | 2116 | FD-25 | 10.5 | A | 110 | 1.6 | | |
| | 2146 | FD-26 | 10.5 | A | 110 | 1.6 | | |
| | 2216 | FD-27 | 10.5 | B | 110 | 1.6 | | |
| | 2246 | FD-28 | 10.7 | B | 110 | 1.6 | | |
| | 2320 | FD-29 | 450.5 | AB | 110 | 1.6 | | |
| | | | | | | | | Oxidizer depletion stopped engine at 445 sec |
| | | | | | | | | Oxidizer flowmeter test |
| 2/24 | 0456 | FD-30 | 10.2 | AB | 110 | 1.6 | | |
| | 0759 | FD-31 | 10.5 | AB | 117 | 1.6 | | |
| | 0843 | FD-32 | 75.6 | AB | 117 | 1.6 | | |
| | 1125 | FD-33 | 5.1 | AB | 117 | 1.6 | | |
| | 1126 | FD-34 | 5.0 | AB | 117 | 1.6 | | |
| | 1127 | FD-35 | 5.0 | AB | 117 | 1.6 | | |
| | 1209 | FD-36 | 1.00 | A | 117 | 1.6 | | |
| | 1210 | FD-37 | 1.00 | B | 117 | 1.6 | | |
| | 1213 | FD-38 | 1.00 | AB | 117 | 1.6 | | |
| | 1214 | FD-39 | 1.01 | AB | 117 | 1.6 | | |
| | 1215 | FD-40 | 1.00 | AB | 117 | 1.6 | | |
| 3/23 | 0118 | FF-1 | 1.01 | AB | 99 | 1.6 | Cold temperature conditioning (see Table II) | |
| | 0412 | FF-2 | 0.36 | AB | 99 | 1.6 | | |
| | 0427 | FF-3 | 0.50 | AB | 99 | 1.6 | | |
| | 0451 | FF-4 | 0.51 | AB | 99 | 1.6 | | |
| | 0510 | FF-5 | 1.01 | AB | 99 | 1.6 | | |
| | 0540 | FF-6 | 1.99 | AB | 99 | 1.6 | | |
| | 0738 | FF-7 | 0.36 | AB | 99 | 1.6 | | |
| | 0739 | FF-8 | 1.88 | AB | 99 | 1.6 | | |
| | 1206 | FF-9 | 0.36 | AB | 99 | 1.6 | | |
| | 1208 | FF-10 | 1.90 | AB | 99 | 1.6 | | |
| | 1419 | FF-11 | 0.36 | AB | 99 | 1.6 | | |

TABLE I (Concluded)

| Date | Time (CST) | Test No. | Actual Duration, sec | TCV Bank | Target P _c , psia | Target O/F | Remarks |
|------|------------|----------|----------------------|----------|------------------------------|------------|--|
| 3/23 | 1422 | FF-12 | 1.91 | AB | 99 | 1.6 | Cold temperature conditioning (see Table II) |
| | 1502 | FF-13 | 0.36 | AB | 99 | 1.6 | |
| | 1503 | FF-14 | 0.36 | AB | 99 | 1.6 | |
| | 1539 | FF-15 | 0.52 | AB | 99 | 1.6 | |
| | 1540 | FF-16 | 0.51 | AB | 99 | 1.6 | |
| 4/2 | 2308 | FG-17 | 1.01 | AB | 99 | 1.6 | |
| 4/3 | 0115 | FG-18 | 0.36 | AB | 99 | 1.6 | |
| | 0148 | FG-19 | 0.36 | AB | 99 | 1.6 | |
| | 0221 | FG-20 | 0.51 | AB | 99 | 1.6 | |
| | 0303 | FG-21 | 2.00 | AB | 99 | 1.6 | |
| | 0430 | FG-22 | 0.51 | AB | 99 | 1.6 | |
| | 0618 | FG-23 | 0.35 | AB | 99 | 1.6 | |
| | 0626 | FG-24 | 0.36 | AB | 99 | 1.6 | |
| | 0634 | FG-25 | 0.36 | AB | 99 | 1.6 | |
| | 0642 | FG-26 | 2.05 | AB | 99 | 1.6 | |
| | 4/4 | 0936 | FH-27 | 1.08 | AB | 99 | |
| 1220 | | FH-28 | 0.36 | AB | 99 | 1.6 | |
| 1224 | | FH-29 | 0.36 | AB | 99 | 1.6 | |
| 1228 | | FH-30 | 0.35 | AB | 99 | 1.6 | |
| 1232 | | FH-31 | 2.01 | AB | 99 | 1.6 | |
| 4/4 | 2213 | FJ-32 | 0.36 | AB | 99 | 1.6 | |
| | 2229 | FJ-33 | 0.36 | AB | 99 | 1.6 | |
| | 2235 | FJ-34 | 0.36 | AB | 99 | 1.6 | |
| | 2241 | FJ-35 | 0.35 | AB | 99 | 1.6 | |
| | 2247 | FJ-36 | 10.10 | AB | 99 | 1.6 | |

TABLE II
COLD TEMPERATURE TEST PREFIRE CONDITIONS

| Test No. | Test Duration, sec | Posttest Coast, min | Pretest Engine Temperatures, °F | | | | Remarks |
|----------|--------------------|---------------------|---------------------------------|---------------------|-------------------------------|---------------------------|--------------|
| | | | Injector (T_j-5) | TCV ($T_{tcv}-3$) | Oxidizer Line ($T_{plo}-2$) | Fuel Line ($T_{plf}-2$) | |
| FF-1 | 1.01 | 174 | 28 | 25 | 29 | 27 | TCV bleed-in |
| FF-2 | 0.36 | 15 | 31 | 27 | 31 | 30 | |
| FF-3 | 0.50 | 24 | 35 | 28 | 30 | 29 | |
| FF-4 | 0.51 | 19 | 35 | 28 | 31 | 27 | |
| FF-5 | 1.01 | 30 | 32 | 26 | 30 | 27 | |
| FF-6 | 1.99 | 118 | 34 | 25 | 30 | 27 | |
| FF-7 | 0.36 | 1 | 35 | 27 | 31 | 29 | |
| FF-8 | 1.88 | 267 | - | 28 | 30 | 29 | |
| FF-9 | 0.35 | 2 | 32 | 28 | 29 | 29 | |
| FF-10 | 1.90 | 131 | 32 | 28 | 29 | 29 | |
| FF-11 | 0.36 | 3 | 35 | 29 | 30 | 34 | |
| FF-12 | 1.91 | 40 | 35 | 29 | 30 | 34 | |
| FF-13 | 0.36 | 0.5 | 90 | 35 | 30 | 34 | |
| FF-14 | 0.36 | 36 | - | - | - | - | |
| FF-15 | 0.52 | 1 | 86 | 36 | 31 | 34 | |
| FF-16 | 0.52 | - | - | - | - | - | |
| FG-17 | 1.01 | 67 | 30 | - | 60 | 51 | TCV bleed-in |
| FG-18 | 0.36 | 33 | 35 | 38 | 58 | 61 | |
| FG-19 | 0.36 | 33 | 34 | 42 | 57 | 57 | |
| FG-20 | 0.51 | 42 | 32 | 42 | 54 | 56 | |
| FG-21 | 2.00 | 87 | 30 | 38 | 52 | 55 | |
| FG-22 | 0.51 | 108 | 35 | 33 | 54 | 56 | |
| FG-23 | 0.35 | 8 | 32 | 36 | 58 | 60 | |
| FG-24 | 0.36 | 8 | 32 | 40 | 59 | 58 | |
| FG-25 | 0.36 | 8 | 33 | 42 | 59 | 57 | |
| FG-26 | 2.05 | - | 34 | 43 | 59 | 56 | |
| FH-27 | 1.08 | 164 | - | - | - | - | TCV bleed-in |
| FH-28 | 0.36 | 4 | 89 | - | 35 | 32 | |
| FH-29 | 0.36 | 4 | - | - | - | - | |
| FH-30 | 0.35 | 4 | - | - | - | - | |
| FH-31 | 2.01 | - | - | - | - | - | |
| FJ-32 | 0.36 | 13 | 32 | 29 | 32 | 32 | |
| FJ-33 | 0.36 | 6 | 28 | 28 | 32 | 36 | |
| FJ-34 | 0.36 | 6 | 28 | 28 | 32 | 40 | |
| FJ-35 | 0.35 | 6 | 28 | 28 | 31 | 46 | |
| FJ-36 | 10.10 | - | 28 | 28 | 31 | 49 | |

TABLE III
 BIROPELLANT VALVE S/N 128 LEAKAGE RATES WITH GN₂

| Seal Identification | Specified Leakage Limit, cc/hr | Pre-FA Leakage, cc/hr | | | | Post-FD leakage, cc/hr | | | |
|-------------------------|--------------------------------|-----------------------|--------------|--------------|----------|------------------------|--------------|--------------|----------|
| | | 2-5 psig | 100-105 psig | 200-205 psig | 2-5 psig | 2-5 psig | 100-105 psig | 200-205 psig | 2-5 psig |
| <u>Downstream Seals</u> | | | | | | | | | |
| Fuel Ball 1 | 150 | 0 | 0 | 0 | 0 | 0 | 0 | 0 | 0 |
| Fuel Ball 2 | 150 | 0 | 0 | 0 | 0 | 0 | 0 | 0 | 0 |
| Fuel Ball 3 | 150 | 10 | 50 | 0 | 0 | 0 | 0 | 0 | 0 |
| Fuel Ball 4 | 150 | 0 | 0 | 0 | 0 | 0 | 0 | 0 | 0 |
| Oxidizer Ball 1 | 150 | 0 | 0 | 0 | 0 | 0 | 7,200 | 32,400 | 0 |
| Oxidizer Ball 2 | 150 | 0 | 0 | 0 | 0 | 0 | 0 | 0 | 0 |
| Oxidizer Ball 3 | 150 | 5 | 0 | 0 | 0 | 0 | 0 | 0 | 0 |
| Oxidizer Ball 4 | 150 | 0 | 0 | 0 | 0 | 0 | 0 | 0 | 0 |
| <u>Upstream Seals</u> | | | | | | | | | |
| Fuel Ball 1 | 150 | 0 | 0 | 0 | 0 | 0 | 0 | 5 | 0 |
| Fuel Ball 2 | 150 | 5 | 0 | 2.5 | 0 | 5 | 0 | 0 | 3 |
| Fuel Ball 3 | 150 | 0 | 5 | 12.5 | 0 | 7.5 | 0 | 2.5 | 2.5 |
| Fuel Ball 4 | 150 | 1 | 25 | 50 | 2.5 | 5 | 0 | 5 | 0 |
| Oxidizer Ball 1 | 150 | 0 | 0 | 0 | 0 | 0 | 0 | 510 | 0 |
| Oxidizer Ball 2 | 150 | 0 | 37.5 | 60 | 0 | 0 | 28 | 500 | 0 |
| Oxidizer Ball 3 | 150 | 0 | 0 | 0 | 0 | 0 | 0 | 0 | 0 |
| Oxidizer Ball 4 | 150 | 0 | 240 | 140 | 5 | 0 | 45 | 900 | 0 |
| <u>Shaft Seals</u> | | | | | | | | | |
| (valve closed) | | | | | | | | | |
| Fuel Balls 1 + 4 | 20 | 0 | 0 | 0 | 0 | 0 | 0 | 0 | 0 |
| Fuel Balls 2 + 3 | 40 | 0 | 0 | 0 | 0 | 0 | 0 | 0 | 0 |
| Oxidizer Balls 1 + 4 | 40 | 0 | 0 | 22.5 | 0 | 14,200 | 10,800 | 4,800 | 450 |
| Oxidizer Balls 2 + 3 | 20 | 0 | 0 | 0 | 0 | 0 | 0 | 0 | 0 |
| (valve open) | | | | | | | | | |
| | | 2-5 psig | 70-72 psig | | 2-5 psig | 2-5 psig | 70-72 psig | | 2-5 psig |
| Fuel, all | 40 | 0 | 0 | | 0 | 0 | 0 | | 0 |
| Oxidizer, all | 40 | 2.5 | 0 | | 0 | 17,280 | 34,200 | | 17,960 |

TABLE IV
BIPROPELLANT VALVE S/N DV-2 LEAKAGE RATES WITH GN₂

| Seal Identification | Specified Leakage Limit, cc/hr | Pre-FE Leakage, cc/hr | | | | Post-FJ Leakage, cc/hr | | | |
|-------------------------|--------------------------------|-----------------------|--------------|--------------|----------|------------------------|--------------|--------------|----------|
| | | 2-5 psig | 100-105 psig | 200-205 psig | 2-5 psig | 2-5 psig | 100-105 psig | 200-205 psig | 2-5 psig |
| <u>Downstream Seals</u> | | | | | | | | | |
| Fuel Ball 1 | 150 | 1 | 40 | 60 | 0 | 0 | 0 | 0 | 0 |
| Fuel Ball 2 | 150 | 0 | 10 | 20 | 0 | 0 | 0 | 0 | 0 |
| Fuel Ball 3 | 150 | 0 | 40 | 60 | 10 | 0 | 0 | 0 | 0 |
| Fuel Ball 4 | 150 | 0 | 0 | 0 | 0 | 0 | 0 | 0 | 0 |
| Oxidizer Ball 1 | 150 | 70 | 2400 | 3600 | 50 | 0 | 1200 | 1800 | 0 |
| Oxidizer Ball 2 | 150 | 10 | 240 | 480 | 10 | 0 | 46 | 168 | 0 |
| Oxidizer Ball 3 | 150 | 0 | 10 | 20 | 0 | 0 | 184 | 272 | 0 |
| Oxidizer Ball 4 | 150 | 10 | 1200 | 2400 | 60 | 0 | 1800 | 4320 | 8 |
| <u>Upstream Seals</u> | | | | | | | | | |
| Fuel Ball 1 | 150 | 0 | 765 | 45 | 17.5 | 0 | 0 | 0 | 0 |
| Fuel Ball 2 | 150 | 0 | 0 | 0 | 0 | 0 | 0 | 0 | 0 |
| Fuel Ball 3 | 150 | 0 | 0 | 5 | 0 | 0 | 0 | 0 | 0 |
| Fuel Ball 4 | 150 | 95 | 1640 | 200 | 120 | 0 | 0 | 0 | 0 |
| Oxidizer Ball 1 | 150 | 5 | 15 | 55 | 0 | 0 | 0 | 40 | 0 |
| Oxidizer Ball 2 | 150 | 0 | 0 | 0 | 0 | 0 | 0 | 0 | 0 |
| Oxidizer Ball 3 | 150 | 5 | 32.5 | 5 | 0 | 0 | 0 | 0 | 0 |
| Oxidizer Ball 4 | 150 | 5 | 75 | 200 | 1 | 0 | 0 | 0 | 0 |
| <u>Shaft Seals</u> | | | | | | | | | |
| (valve closed) | | | | | | | | | |
| Fuel Balls 1 + 4 | 20 | 0 | 0 | 0 | 0 | } 0* | 0* | 0* | 0* |
| Fuel Balls 2 + 3 | 40 | 0 | 0 | 0 | 0 | | 0* | 0* | 0* |
| Oxidizer Balls 1 + 4 | 40 | 1285 | 3600 | 1920 | 420 | } 0* | 0* | 84* | 0* |
| Oxidizer Balls 2 + 3 | 20 | 100 | 1150 | 1200 | 7.5 | | 0* | 0* | 0* |
| (valve open) | | | | | | | | | |
| | | 2-5 psig | 72 psig | | 2.5 psig | | | | |
| Fuel, all | 40 | 0 | 0 | | 0 | 0* | 0* | 0* | 0* |
| Oxidizer, all | 40 | 70 | 3780 | | 72 | 0* | 9900* | 28,800* | 0* |

* Test performed at AGC/Sacramento: Leakage for all seals together.

TABLE V
SUMMARY OF IGNITION TRANSIENT IMPULSE DATA

| Test Number | Engine Serial Number | Thrust Chamber Valve Bank | Chamber Pressure Level, psia | From FS1 to 90 Percent of Steady-State Thrust | |
|-------------|----------------------|---------------------------|------------------------------|---|------------------|
| | | | | Time, sec | Impulse, lbf-sec |
| FA-01 | 54D | * | 96 | 0.652 | 272 |
| FB-02 | 54D | A | 94 | 1.273 | 2939** |
| -03 | ↓ | A | 94 | 0.656 | 391 |
| -04 | ↓ | AB | 99 | 0.531 | 203 |
| -05 | ↓ | B | 95 | 0.590 | 476 |
| FC-06 | 54D | A | 94 | 0.656 | 279 |
| -07 | ↓ | AB | 97 | 0.530 | 146 |
| -08 | ↓ | B | 93 | 0.596 | 504 |
| -09A | ↓ | AB | 97 | 0.527 | 396 |
| -09B | ↓ | ↓ | ↓ | 0.520 | 429 |
| -09C | ↓ | ↓ | ↓ | 0.515 | 368 |
| -09D | ↓ | ↓ | ↓ | 0.510 | 286 |
| -09E | ↓ | ↓ | ↓ | 0.516 | 379 |
| -10A | ↓ | A | 94 | 0.644 | 623 |
| -10B | ↓ | ↓ | ↓ | 0.641 | 629 |
| -10C | ↓ | ↓ | ↓ | 0.636 | 606 |
| -10D | ↓ | ↓ | ↓ | 0.630 | 526 |
| -10E | ↓ | ↓ | ↓ | 0.640 | 645 |
| -11A | ↓ | AB | 97 | 0.526 | 337 |
| -11B | ↓ | ↓ | ↓ | 0.522 | 355 |
| -11C | ↓ | ↓ | ↓ | 0.521 | 384 |
| -11D | ↓ | ↓ | ↓ | 0.520 | 412 |
| -11E | ↓ | ↓ | ↓ | 0.518 | 408 |
| -12A | ↓ | B | 93 | 0.604 | 661 |
| -12B | ↓ | ↓ | ↓ | 0.603 | 693 |
| -12C | ↓ | ↓ | ↓ | 0.604 | 631 |
| -12D | ↓ | ↓ | ↓ | 0.602 | 691 |
| -12E | ↓ | ↓ | ↓ | 0.602 | 688 |
| -13A | ↓ | A | 94 | 0.646 | 533 |
| -13B | ↓ | ↓ | ↓ | 0.634 | 533 |
| -13C | ↓ | ↓ | ↓ | 0.632 | 512 |
| -13D | ↓ | ↓ | ↓ | 0.635 | 535 |
| -13E | ↓ | ↓ | ↓ | 0.633 | 505 |
| FC-14A | 54D | AB | 97 | 0.528 | 382 |
| -14B | ↓ | ↓ | ↓ | 0.527 | 363 |
| -14C | ↓ | ↓ | ↓ | 0.526 | 355 |
| -14D | ↓ | ↓ | ↓ | 0.523 | 394 |
| -14E | ↓ | ↓ | ↓ | 0.523 | 406 |
| -15A | ↓ | B | 93 | 0.604 | 721 |
| -15B | ↓ | ↓ | ↓ | 0.607 | 685 |
| -15C | ↓ | ↓ | ↓ | 0.606 | 654 |
| -15D | ↓ | ↓ | ↓ | 0.604 | 688 |
| -15E | ↓ | ↓ | ↓ | 0.605 | 676 |
| -19 | ↓ | AB | 82 | 0.554 | 332 |
| -20 | ↓ | ↓ | 91 | 0.539 | 338 |
| -21 | ↓ | ↓ | 102 | 0.531 | 370 |
| -22 | ↓ | ↓ | 109 | 0.525 | 419 |
| -23 | ↓ | ↓ | 117 | 0.526 | 488 |

*First 10 sec Valve Bank A, next 10 sec Bank A and B, last 10 sec Bank B

**Poor Propellant Bleed-in

TABLE V (Concluded)

| Test Number | Engine Serial Number | Thrust Chamber Valve Bank | Chamber Pressure Level, psia | From FS1 to 90 Percent of Steady-State Thrust | | |
|-------------|----------------------|---------------------------|------------------------------|---|--------------------|--------------------|
| | | | | Time, sec | Impulse, lbf-sec | |
| FD-24 | 54E ↓ | * | 97 | 0.683 | 639 | |
| -25 | | A | 110 | 0.671 | 946 | |
| -26 | | A | 109 | 0.665 | 999 | |
| -27 | | B | 109 | 0.623 | 1098 | |
| -28 | | B | 109 | 0.616 | 1210 | |
| -29 | | AB | 112 | 0.559 | 1083 | |
| -30 | | | | 108 | Data not Available | Data not Available |
| -31 | | | | 114 | | |
| -32 | | | | 114 | | |
| -33 | | | | 113 | | |
| -34 | | | | | | |
| -35 | | | | | | |
| -36 | | | A | | | |
| -37 | | | B | | | |
| -38 | | | AB | | | |
| -39 | | | | | | |
| -40 | | | | | | |
| FF-01 | 54F ↓ | AB | 106 | 0.636 | 390 | |
| -05 | | | | 0.590 | 328 | |
| -06 | | | | 0.587 | 273 | |
| -08 | | | | 0.560 | 239 | |
| -10 | | | | 0.576 | 345 | |
| -12 | | | | 0.576 | 400 | |
| -15 | | | | 0.549 | 266 | |
| -16 | | | | 0.558 | 318 | |
| FG-17 | 54F ↓ | AB | 106 | 0.602 | 376 | |
| -20 | | | | 0.566 | 293 | |
| -21 | | | | 0.560 | 306 | |
| -22 | | | | 0.548 | 238 | |
| -26 | | | | 0.542 | 250 | |
| FH-27 | 54F ↓ | AB | 106 | 0.609 | 320 | |
| -31 | | AB | | 0.572 | 236 | |
| FJ-36 | 54F | AB | 106 | 0.607 | 798 | |

*First 10 sec Valve Bank A, next 10 sec Bank A and B, last 10 sec Bank B

TABLE VI
SUMMARY OF SHUTDOWN TRANSIENT IMPULSE DATA

| Test Number | Engine Serial Number | Thrust Chamber Valve Bank | Chamber Pressure Level, psia | From FS2 to 1 Percent of Steady-State Thrust | |
|-------------|----------------------|---------------------------|------------------------------|--|-------------------------------|
| | | | | Time, sec | Impulse, lb _f -sec |
| FA-01 | 54D | * | 96 | 2.165 | 9,284 |
| FB-02 | 54D | A | 94 | 2.029 | 9,571 |
| -03 | ↓ | A | 94 | 1.953 | 9,400 |
| -04 | ↓ | AB | 99 | 1.856 | 10,257 |
| -05 | ↓ | B | 95 | 1.849 | 9,145 |
| FC-06 | 54D | A | 94 | 2.216 | 9,215 |
| -07 | ↓ | AB | 97 | 2.210 | 10,149 |
| -08 | ↓ | B | 93 | 2.206 | 9,047 |
| -19 | ↓ | AB | 82 | 2.822 | 9,085 |
| -20 | ↓ | ↓ | 91 | 1.984 | 9,675 |
| -21 | ↓ | ↓ | 102 | 1.887 | 10,566 |
| -22 | ↓ | ↓ | 109 | 1.852 | 11,144 |
| -23 | ↓ | ↓ | 117 | 1.757 | 11,610 |
| FD-24 | 54E | * | 97 | 1.706 | 9,164 |
| -25 | ↓ | A | 110 | 1.513 | 10,193 |
| -26 | ↓ | A | 109 | 1.544 | 10,088 |
| -27 | ↓ | B | 109 | 1.479 | 9,850 |
| -28 | ↓ | B | 109 | 1.488 | 9,778 |
| -29 | ↓ | AB | 112 | Data not Available | Data not Available |
| -30 | ↓ | ↓ | 108 | ↓ | ↓ |
| -31 | ↓ | ↓ | 114 | ↓ | ↓ |
| -32 | ↓ | ↓ | 114 | ↓ | ↓ |
| -33 | ↓ | ↓ | 113 | ↓ | ↓ |
| -34 | ↓ | ↓ | ↓ | ↓ | ↓ |
| -35 | ↓ | ↓ | ↓ | ↓ | ↓ |
| -36 | ↓ | A | ↓ | ↓ | ↓ |
| -37 | ↓ | B | ↓ | ↓ | ↓ |
| -38 | ↓ | AB | ↓ | ↓ | ↓ |
| -39 | ↓ | ↓ | ↓ | ↓ | ↓ |
| -40 | ↓ | ↓ | ↓ | ↓ | ↓ |
| FF-06 | 54F | AB | 106 | 3.090 | 10,505 |
| -08 | ↓ | ↓ | ↓ | 3.210 | 11,217 |
| -10 | ↓ | ↓ | ↓ | 2.241 | 10,717 |
| -12 | ↓ | ↓ | ↓ | 2.339 | 10,847 |
| FG-21 | 54F | AB | 106 | 1.930 | 11,477 |
| -26 | ↓ | ↓ | ↓ | 1.906 | 11,165 |
| FH-31 | 54F | AB | 106 | 2.429 | 11,320 |
| FJ-36 | 54F | AB | 106 | 3.720 | 13,435 |

*First 10 sec Valve Bank A, next 10 sec Banks A and B, last 10 sec Bank B

TABLE VII
IMPULSE BIT DATA SUMMARY

| Test Number | Engine Serial Number | Thrust Chamber Valve Bank | Chamber Pressure Level, psia | Test Duration, sec | Impulse, lb _f -sec |
|-------------|----------------------|---------------------------|------------------------------|--------------------|-------------------------------|
| FC-09A | 54D | AB | 97 | 1.12 | 23,298 |
| -09B | ↓ | ↓ | ↓ | 1.11 | 23,507 |
| -09C | ↓ | ↓ | ↓ | 1.11 | 23,569 |
| -09D | ↓ | ↓ | ↓ | 1.11 | 23,543 |
| -09E | ↓ | ↓ | ↓ | 1.11 | 23,542 |
| -10A | ↓ | A | 94 | 0.87 | 13,779 |
| -10B | ↓ | ↓ | ↓ | 0.89 | 13,875 |
| -10C | ↓ | ↓ | ↓ | 0.89 | 14,022 |
| -10D | ↓ | ↓ | ↓ | 0.87 | 13,999 |
| -10E | ↓ | ↓ | ↓ | 0.89 | 13,957 |
| -11A | ↓ | AB | 97 | 0.90 | 17,248 |
| -11B | ↓ | ↓ | ↓ | 0.88 | 17,523 |
| -11C | ↓ | ↓ | ↓ | 0.88 | 17,584 |
| -11D | ↓ | ↓ | ↓ | 0.86 | 17,632 |
| -11E | ↓ | ↓ | ↓ | 0.87 | 17,642 |
| -12A | ↓ | B | 93 | 0.86 | 14,927 |
| -12B | ↓ | ↓ | ↓ | 0.86 | 15,057 |
| -12C | ↓ | ↓ | ↓ | 0.86 | 15,066 |
| -12D | ↓ | ↓ | ↓ | 0.86 | 15,081 |
| -12E | ↓ | ↓ | ↓ | 0.86 | 15,102 |
| -13A | ↓ | A | 94 | 0.65 | 7,338 |
| -13B | ↓ | ↓ | ↓ | 0.65 | 7,535 |
| -13C | ↓ | ↓ | ↓ | 0.65 | 7,539 |
| -13D | ↓ | ↓ | ↓ | 0.65 | 7,443 |
| -13E | ↓ | ↓ | ↓ | 0.66 | 7,542 |
| -14A | ↓ | AB | 97 | 0.66 | 11,088 |
| -14B | ↓ | ↓ | ↓ | 0.65 | 11,236 |
| -14C | ↓ | ↓ | ↓ | 0.66 | 11,240 |
| -14D | ↓ | ↓ | ↓ | 0.66 | 11,294 |
| -14E | ↓ | ↓ | ↓ | 0.66 | 11,360 |
| -15A | ↓ | B | 93 | 0.65 | 9,027 |
| -15B | ↓ | ↓ | ↓ | 0.65 | 8,810 |
| -15C | ↓ | ↓ | ↓ | 0.67 | 8,769 |
| -15D | ↓ | ↓ | ↓ | 0.65 | 8,767 |
| -15E | ↓ | ↓ | ↓ | 0.66 | 8,774 |
| -16A | ↓ | A | 94 | 0.37 | 470 |
| -16B | ↓ | ↓ | ↓ | 0.36 | 413 |
| -16C | ↓ | ↓ | ↓ | 0.37 | 370 |
| -16D | ↓ | ↓ | ↓ | 0.37 | 376 |
| -16E | ↓ | ↓ | ↓ | 0.36 | 361 |
| -17A | ↓ | AB | 97 | 0.36 | 908 |
| -17B | ↓ | ↓ | ↓ | 0.36 | 1,065 |
| -17C | ↓ | ↓ | ↓ | 0.37 | 1,097 |
| -17D | ↓ | ↓ | ↓ | 0.37 | 1,060 |
| -17E | ↓ | ↓ | ↓ | 0.37 | 1,030 |
| -18A | ↓ | B | 93 | 0.36 | 494 |
| -18B | ↓ | ↓ | ↓ | 0.36 | 444 |
| -18C | ↓ | ↓ | ↓ | 0.36 | 446 |
| -18D | ↓ | ↓ | ↓ | 0.36 | 440 |
| -18E | ↓ | ↓ | ↓ | 0.36 | 445 |

TABLE VII (Concluded)

| Test Number | Engine Serial Number | Thrust Chamber Valve Bank | Chamber Pressure Level, psia | Test Duration, sec | Impulse, lb _f -sec |
|--|----------------------|---------------------------|------------------------------|--|--|
| FD-36 -37 -38 -39 -40 | 54E ↓ | A B AB ↓ | 113 ↓ | Data not Available ↓ | Data not Available ↓ |
| FF-01 -02 -03 -04 -05 -07 -09 -11 -13 -14 -15 -16 | 54F ↓ | AB ↓ | 106 ↓ | 1.01 0.36 0.50 0.51 1.01 0.36 0.36 0.36 0.36 0.36 0.51 0.51 | 18,916 296 3,704 4,081 18,895 356 372 328 530 632 5,306 4,824 |
| FG-17 -18 -19 -20 -22 -23 -24 -25 | 54F ↓ | AB ↓ | 106 ↓ | 1.01 0.36 0.36 0.51 0.51 0.35 0.36 0.36 | 20,343 530 554 5,287 5,590 636 564 597 |
| FH-27 -28 -29 -30 | 54F ↓ | AB ↓ | 106 ↓ | 1.08 0.36 0.36 0.35 | 19,462 423 396 424 |
| FJ-32 -33 -34 -35 | 54F ↓ | AB ↓ | 106 ↓ | 0.36 0.36 0.35 0.35 | 492 396 460 605 |

APPENDIX III TCV LEAKAGE CHECKS

Each of the eight balls in the TCV (Section 2.1.1) is equipped with an upstream, a downstream, and two shaft seals (Fig. 3). The purpose of the upstream and downstream seals is to prevent propellant from leaking past the valve balls into the injector manifolds when the valve balls are in the closed position. A secondary purpose is to prevent propellants from leaking into the voids on the sides of the balls through which the ball shafts pass. The purpose of the shaft seals is to prevent any leakage which might occur past the ball seals, from leaking along the shafts to the inside cavity of the valve housing.

Leakage checks of the various TCV seals were conducted prior to test periods FA and FE and after test period FJ. The procedures used to determine the leakage rates are included in the following sections. All rates were determined by applying GN₂ pressure across the seal, or seals, in question and measuring the leakage on the downstream side with a water displacement leak meter. The leakage rates obtained at the various pressures applied are shown in Table III. Also shown where applicable, are the maximum specification leakage rates (Ref. 16).

DOWNSTREAM BALL SEAL

The downstream seals on each of the eight balls were individually leak checked by applying equal GN₂ pressures on both sides of the upstream ball seals. (It was necessary to apply equal pressure across the upstream ball seal to prevent it from being forced open by reverse pressure.)

UPSTREAM BALL SEAL

The upstream seals on each of the eight balls were individually leak checked by applying pressure to the upstream side of each ball and measuring the leakage at the ports to the cavities between the ball seals.

BALL SHAFT SEALS (BALLS CLOSED)

Leakage past the ball shaft seals was measured in ball pairs; i. e., the two upstream oxidizer ball shaft seals were leak checked as a unit, the two downstream oxidizer ball shaft seals were checked as a unit,

the two upstream fuel ball shaft seals were checked together, and the two downstream fuel ball shaft seals were leak checked together. In each case, the upstream side of a pair of like propellant balls was pressurized and an equal pressure was applied to the cavity between the upstream and downstream ball seals of each ball. Leakage past the pair of shaft seals was measured at the exit of the shaft seal drain manifolds.

BALL SHAFT SEAL (BALLS OPEN)

The sum of the leakage past the four ball shaft seals on a particular propellant side with all four balls open was determined by pressurizing the flow passages of the valve and measuring the leakage at the exit of the ball shaft seal drain manifold.

DOCUMENT CONTROL DATA - R & D

(Security classification of title, body of abstract and indexing annotation must be entered when the overall report is classified)

| | | | |
|--|--|---|--|
| 1. ORIGINATING ACTIVITY (Corporate author) Arnold Engineering Development Center ARO, Inc., Operating Contractor Arnold Air Force Station, Tenn. 37389 | | 2a. REPORT SECURITY CLASSIFICATION UNCLASSIFIED | |
| | | 2b. GROUP N/A | |
| 3. REPORT TITLE APOLLO BLOCK II SPS ENGINE (AJ10-137) ENVIRONMENTAL TESTS AND MOD I-C BIPROPELLANT VALVE QUALIFICATION TESTS (PHASE VI, PART I) | | | |
| 4. DESCRIPTIVE NOTES (Type of report and inclusive dates) Final Report February 1 to April 4, 1968 | | | |
| 5. AUTHOR(S) (First name, middle initial, last name) G. H. Schulz, A. L. Berg, and C. E. Robinson, ARO, Inc. | | | |
| 6. REPORT DATE October 1968 | 7a. TOTAL NO. OF PAGES 83 | 7b. NO. OF REFS 17 | |
| 8a. CONTRACT OR GRANT NO F40600-69-C-0001 | 9a. ORIGINATOR'S REPORT NUMBER(S) AEDC-TR-68-178 | | |
| b. PROJECT NO 9281 | 9b. OTHER REPORT NO(S) (Any other numbers that may be assigned this report) | | |
| c. System 921E | N/A | | |
| d. | | | |
| 10. DISTRIBUTION STATEMENT This document is subject to special export controls and each transmittal to foreign governments or foreign nationals may be made only with prior approval of NASA-MSC (EP-2), Houston, Texas 77058. | | | |
| 11. SUPPLEMENTARY NOTES Available in DDC. | | 12. SPONSORING MILITARY ACTIVITY NASA-MSC (EP-2) Houston, Texas 77058 | |
| 13. ABSTRACT Simulated altitude testing of the Apollo SPS Block II engine was conducted for the qualification of a new design bipropellant valve (Mod I-C). Also, tests were conducted to investigate postfire propellant evaporative cooling in the engine injector and to evaluate electric strip heaters on the engine propellant lines, bipropellant valve, and injector. One-hundred-seventeen test firings were made for a total of 863 sec of firing time during nine test periods. Propellants were nitrogen tetroxide and 50/50 hydrazine/UDMH. Engine operation and performance were satisfactory, but the bipropellant valve developed leaks in the valve ball seals and shaft seals greater than specification limits. Propellant evaporative cooling produced injector local temperatures down to 17°F from 30°F starting conditions. Cold test conditions (30°F) had little effect on engine operation other than to slightly slow down bipropellant valve operation and to extend the ignition transient. This document is subject to special export controls and each transmittal to foreign governments or foreign nationals may be made only with prior approval of NASA-MSC (EP-2), Houston, Texas 77058. | | | |

| 14. KEY WORDS | LINK A | | LINK B | | LINK C | |
|--|--------|----|--------|----|--------|----|
| | ROLE | WT | ROLE | WT | ROLE | WT |
| APOLLO rocket engines liquid propellants valves qualification tests altitude simulation heating equipment evaporative cooling | | | | | | |