

AD-779 466

HYDRAULIC SYSTEM NOISE STUDY

OKLAHOMA STATE UNIVERSITY

PREPARED FOR
ARMY MOBILITY EQUIPMENT RESEARCH AND
DEVELOPMENT CENTER

DECEMBER 1973

DISTRIBUTED BY:

NTIS

National Technical Information Service
U. S. DEPARTMENT OF COMMERCE

UNCLASSIFIED

AD - 779 466

SECURITY CLASSIFICATION OF THIS PAGE (When Data Entered)

REPORT DOCUMENTATION PAGE		READ INSTRUCTIONS BEFORE COMPLETING FORM
1. REPORT NUMBER FPRC-3M3	2. GOVT ACCESSION NO.	3. RECIPIENT'S CATALOG NUMBER
4. TITLE (and Subtitle) HYDRAULIC SYSTEM NOISE STUDY		5. TYPE OF REPORT & PERIOD COVERED Annual, Section III of 5 June 1972 - November 1973
		6. PERFORMING ORG. REPORT NUMBER FPRC-3M3
7. AUTHOR(s) Staff of the Fluid Power Research Center		8. CONTRACT OR GRANT NUMBER(s) Contract No. DAAK02-73-C-0172
9. PERFORMING ORGANIZATION NAME AND ADDRESS Fluid Power Research Center Oklahoma State University Stillwater, Oklahoma 74074		10. PROGRAM ELEMENT, PROJECT, TASK AREA & WORK UNIT NUMBERS
11. CONTROLLING OFFICE NAME AND ADDRESS Directorate of Research, Development, & Engineering U.S. Army Mobility Equipment Command Ft. Belvoir, Virginia 22060		12. REPORT DATE December 1973
14. MONITORING AGENCY NAME & ADDRESS (if different from Controlling Office)		13. NUMBER OF PAGES 1 131
		15. SECURITY CLASS. (of this report) UNCLASSIFIED
		15a. DECLASSIFICATION/DOWNGRADING SCHEDULE
16. DISTRIBUTION STATEMENT (of this Report) Approved for Public Release: Distribution Unlimited		
17. DISTRIBUTION STATEMENT (of the abstract entered in Block 20, if different from Report)		
18. SUPPLEMENTARY NOTES N/A		
Reproduced by NATIONAL TECHNICAL INFORMATION SERVICE U.S. Department of Commerce Springfield VA 22151		
19. KEY WORDS (Continue on reverse side if necessary and identify by block number)		
Hydraulic Noise		Airborne Noise
Sound Measurement		Fluid-Borne Noise
Component Sound Levels		Structure-Borne Noise
20. ABSTRACT (Continue on reverse side if necessary and identify by block number)		
<p>The purpose of the OSU-MERDC Hydraulic Specification Program is to develop industrially acceptable test procedures and requirement specifications relative to the performance of hydraulic components and systems to facilitate the military's <i>buy commercial</i> approach. Although the program has been aimed toward components and systems for future 3000 psi operating pressure levels, it was intended that the test procedures be applicable to any pressure level. (over)</p>		

DD FORM 1473 1 JAN 73

EDITION OF 1 NOV 68 IS OBSOLETE

UNCLASSIFIED

SECURITY CLASSIFICATION OF THIS PAGE (When Data Entered)

UNCLASSIFIED

SECURITY CLASSIFICATION OF THIS PAGE(When Data Entered)

This report presents a detailed account of the experimental verification part of the hydraulic noise study. Test procedures for the measurement of hydraulic component noise developed under this contract are presented and experimentally verified. A summary of the work performed on measurement facility verification is presented. The acoustical properties of selected military fluid power components are presented and compared to a spectrum of current production components from industry. Specific recommendations are made for continuing the effort to understand and control hydraulic noise.

UNCLASSIFIED

SECURITY CLASSIFICATION OF THIS PAGE(When Data Entered)

TABLE OF CONTENTS

<u>Chapter</u>	<u>Page</u>
I. INTRODUCTION.....	5
II. TEST PROCEDURE DEVELOPMENT & UTILIZATION.....	9
Test Code -- Airborne Noise.....	9
Test Code -- Fluid-borne Noise.....	10
Test Code -- Structure-borne Noise.....	11
III. FACILITY VERIFICATION.....	13
Introduction.....	13
Diffusivity Optimization.....	13
Reverberant Facility Verification at OSU FPRC.....	15
Conclusion.....	18
IV. EXPERIMENTAL EVALUATION OF THE NOISE PRODUCED BY FLUID POWER PUMPS.....	21
Introduction.....	21
Acoustical Evaluation of Military Pump Group 5R714 As Received.....	22
Contaminant Sensitivity Test of Military Pump Group 5R714.....	22
Acoustical Evaluation of Military Pump Group 5R714 After Contaminant Testing.....	23
Structure-borne Noise Levels for Military Pump Group 5R714.....	29
Acoustical Comparison of Pump Group 5R714 with a Survey of Fluid Power Pumps.....	29
V. CONDUIT EVALUATION.....	39
Transfer Functions.....	41
VI. ACOUSTICAL MEASUREMENTS OF RELIEF VALVES.....	45
Introduction.....	45
Tests at OSU-FPRC Acoustics Laboratory.....	45
Future Testing.....	46
VII. PRACTICAL METHODS FOR REDUCING FLUID POWER SYSTEM NOISE.....	55

<u>Chapter</u>	<u>Page</u>
VIII. SUMMARY, CONCLUSIONS, & RECOMMENDATIONS.....	59

Appendices

A. SELECTED REFERENCES.....	64
B. INSTRUMENTATION.....	66
C. ISOLATION MATERIALS.....	70
D. ACOUSTICAL FACILITY SURVEY.....	72
E. A USER'S GUIDE TO THE ACOUSTICAL DATA REDUCTION PROGRAMS.	78
F. TEST CODE FOR MEASURING AND REPORTING SOUND GENERATED BY HYDRAULIC PUMPS.....	113
G. TEST CODE FOR MEASURING AND REPORTING FLUID-BORNE NOISE EMITTED BY HYDRAULIC FLUID POWER PUMPS.....	124

LIST OF TABLES

TABLE	PAGE
3-1. Constant Factors for Standard Deviation Approximation.....	15
4-1. Test Sequence and Coding for Pump Group 5R714 for the Military D7F(DV29).....	21
4-2. Test Conditions for Pump Group 5R714 Acoustical Evaluation.	22
4-3. Contaminant Tolerance Profile of Pump Group 5R714 for 1000 Hour Life... ..	23
4-4. SBN Levels for Pump Group 5R714.....	30
4-5. Results of an Acoustical Survey of Fluid Power Pumps.....	37
5-1. Total Noise Levels (dB) of Hydraulic Conduit.....	40
5-2. Comparison of Measured and Predicted Levels from Frequency Analysis.....	44
6-1. Sound Power Results of Relief Valves.....	48
7-1. Summary of Proposed Evaluations.....	55
E-1. Acoustical Data Reduction Routines and Calling Programs....	81
E-2. Data File ABN##.....	91
E-3. ABN Sample Output.....	92
E-4. Data File ABN.....	99
E-5. FBM Sample Output.....	100
E-6. Data File SBN.....	106
E-7. SBN Sample Output.....	107
F-1. Standard Deviation (in dB) of Sound Power Level Determination.....	114
F-2. Documents to be Used for Test Facility Performance Qualification.....	114

TABLE	PAGE
F-3. Tolerance Limits for Test Parameters.....	116
F-4. Coordinates for Four-Point Microphone Array... ..	118
F-5A. Example Data for Each Pump Tested.....	119
F-5B. Example Data Summary for One Operating Condition.....	119
G-1. Test Conditions Accuracy.....	126
G-2A. Example Data For Each Pump Test.....	127
G-2B. Example Data Summary for One Operating Condition.....	129

LIST OF FIGURES

FIGURE	PAGE
1-1. 1972-74 Hydraulic System Noise Study Program Objectives.....	6
1-2. Illustration of Component Acoustical Evaluations for 1972-73 Program.....	8
3-1. Pure Tone Standard Deviation in OSU-FPRC Reverberant Facility for Each of Three Diffusers Operating Separately at Various Speeds.....	14
3-2. Standard Deviation of Measurements at One Position and Several Positions Versus Frequency Without Diffusers Operating.....	16
3-3. Pure Tone Standard Deviation Versus Frequency for OSU-FPRC Reverberant Facility.....	17
3-4. Standard Deviation of Measurements in OSU-FPRC Rever- berant Facility for a Broad Band Source with Three Diffusers Operating.....	19
3-5. Standard Deviation of Measurements in OSU-FPRC Reverberant Facility for a Pure Tone Source with Three Diffusers Operating.....	20
4-1. ABN Levels for Pump Group 5R714 for Military D7F(DV29) Tested as Received.....	24
4-2. FBN Levels for Pump Group 5R714 Tested as Received.....	25

FIGURE	PAGE
4-3. Contaminant Tolerance Profile of Pump Group 5R714 for 1000 Hour Life.....	26
4-4. ABN Levels for Pump Group 5R714 After Contaminant Test.....	27
4-5. FBN Levels for Pump Group 5R714 After Contaminant Test.....	28
4-6. ABN Versus FBN for Pump Group 5R714 (NP-21) and Four Survey Pumps.....	31
4-7. Histograms of Total Sound Power for Survey Pumps with Sound Power Level for Pump Group 5R714 shown by (21).....	33
4-8. Histograms of dBA/Horsepower for Survey Pumps with dBA/H.P. for Pump Group 5R714 Shown by (21).....	34
4-9. Histograms of FBN for Survey Pumps FBN Level for Pump Group 5R714 shown by (21).....	35
4-10. Histograms of FBN/Horsepower for Survey Pumps with FBN Level for Pump Group 5R714 shown by (21).....	36
5-1. Test Facility with Conduit Evaluation Equipment Installed.....	42
5-2. Two Types of Transfer Functions Developed for Fluid Power Conduit.....	43
6-1. Airborne Noise Level Versus Horsepower for Valve 2.....	49
6-2. Noise Levels of Fluid-borne and Airborne Noise With Respect to Flow Rate.....	50
6-3. Spectra of Pump and Valve Sound Power Levels.....	51
6-4. Fluid-borne Noise Levels Versus Horsepower for Valve 2...	52
6-5. Structure-borne Noise Level Versus Horsepower.....	53
6-6. Pressure-Flow Characteristics of Relief Valve 6Y1746.....	54
7-1. Proposed Schedule for 1973-74 Areas of Investigation.....	56
D-1. Schematic of Electronic Noise Box (ENB).....	76
F-1. Four-Point Measurement Array for Non-Reverberant Environments with Small Sources.....	120

FOREWORD

This report was prepared by the staff of the Fluid Power Research Center of the School of Mechanical and Aerospace Engineering at Oklahoma State University of Agriculture and Applied Science. The study was initiated by the Mobility Equipment Research and Development Center, Fort Belvoir, Virginia. Authorization for the study reported herein was granted under Contract No. DAAK02-72-C-0172. The time period covered by this report is from 9 November 1972 to 8 November 1973.

The Contracting Officer's Representative was Mr. Hansel Y. Smith, and Mr. John Karhnak served as the Contracting Officer's Technical Representative. In addition, Mr. Paul Hopler has effectively represented the Contracting Officer both administratively and technically in various phases of this contract. The active participation of Messrs. Smith, Karhnak, and Hopler during critical phases of this work contributed significantly to the overall success of the program. Project members are grateful for the assistance of Mr. Sam Wehr, U.S. Army MERDC, and Mr. John Hufeld, Caterpillar Tractor Co.

In addition to pursuing the goals and objectives of this contract to fruition, members of the Fluid Power Research Center (FPRC) staff have also participated with MERDC personnel in various activities not supported by the program. These efforts were financed through the Basic Fluid Power Research (BFPR) Program, which is a consortium of some 35 industrial fluid power users and suppliers who have sponsored work at the FPRC for the past seven years. These companies have recognized the merits and the derivable benefits of this Hydraulic Specification Study Program and have readily contributed both time and money to its success.

A great many fluid power component test procedures have been developed and verified as a result of this program. The guidance and advice of the fluid power industry were heavily relied upon during all phases of this development and verification work. However, true industrial acceptance can only be achieved when such test procedures receive national and international adoption by recognized standard-making bodies of the fluid power industry. To this end, members of the FPRC staff have worked closely with the National Fluid Power Association (NFPA), the Society of Automotive Engineers (SAE), the American National Standards Institute (ANSI), and the International Standards Organization (ISO).

Specifically, in behalf of MERDC and the fluid power industry, the FPRC has played an active role in the activities of the following committees and sub-committees:

- * Filter and Separator Section of NFPA
- * Contamination Coordinating Committee of NFPA

- * Pump Section of NFPA
- * Valve Section of NFPA
- * Sound Measurement Coordinating Committee
- * Sub-Committee IV (hydraulic Components) of SAE
- * Sub-Committee 6 of TC 131 (Fluid and Contamination Control) of ISO
- * Sub-Committee 8 of TC 131 (Component Testing) of ISO
- * Working Group 1 of SC-6 (Filter Performance Testing) ISO/TC 131
- * Working Group 1 of SC-8 (Sound Measurement) ISO/TC 131

During the reporting period of this document, the main efforts in technical information transfer have been directed toward the areas of filter performance, pump contaminant sensitivity, valve performance, and sound measurement. The results of this work, to date, served as the basis for eight nationally and internationally accepted test procedures. The fruits of such accomplishments should prove very beneficial to MERDC in their quest for adequate component control in the procurement of commercial equipment.

The FPRC team has also assisted MERDC in their effort to effectively monitor and evaluate the results of tests using test procedures developed under this program. For example, a computer program was developed which rigorously examines the data accumulated during a multi-pass filter performance test. This program not only reduces the data to a usable form but also evaluates the recorded data to see that all of the test requirements have been met. The success of this computer program together with the industrial acceptance of the filter test procedures has allowed MERDC to issue a military filter specification and establish a well received QPL program.

This report represents only one of four major sections of the annual report on the Hydraulic Specification Program. The titles of the various sections are listed below:

- SECTION I: Hydraulic Cylinder and Seals Specification Study
- SECTION II: Hydraulic System Controls Study
- SECTION III: Hydraulic System Noise Study
- SECTION IV: Hydraulic Hose Specification Study

The study represented by this report was conducted under the general guidance of Dr. E. C. Fitch, Program Director. Mr. L. R. Elliott served as Project Engineer for the noise study and was commendably guided by Mr. G.E. Maroney, Program Manager. Dr. Fitch, Mr. Maroney, and Mr. Elliott were ably supported by the Fluid Power Research Center's Acoustics Laboratory, experimentally by Mr. T. G. Snyder, Mr. J. R. Wells, and Mr. S. E. Smith, and in general coordination by Mr. R. K. Tessmann.

This report presents a detailed account of the experimental verification part of the hydraulic noise study. Test procedures for the measurement of hydraulic component noise developed under this contract are presented and experimentally verified. A summary of the work per-

formed on measurement facility verification is presented. The acoustical properties of selected military fluid power components are presented and compared to a spectrum of current production components from industry. Specific recommendations are made for continuing the effort to understand and control hydraulic noise.

Chapter I

INTRODUCTION

The importance of understanding the generation, transmission, and radiation of acoustic energy within and from fluid power systems is increasing as the engineer in industry solves the non-fluid power oriented noise problems on current production mobile equipment. The noise problems associated with fluid power systems can be somewhat more complex than other noise problems on mobile equipment, due to the high concentration of energy within a relatively small volume and the necessity to distribute that small volume and, hence, the energy to all parts of a machine. The magnitude of the difficulties that are to be encountered during the solution of any fluid power system problem is evident only after one realizes that fluid power systems are not point sources of noise. They are highly distributed and interact with other systems and the total machine. A knowledge of the interactions between components within a given system and the interactions of total systems is mandatory for proper solution of noise problems in complex machines. The starting point to understanding these interactions is, logically, the measurement of the acoustical characteristics of the components that make up fluid power systems and the systems which might interact with the fluid power system. The intelligible acquisition of this type of information is based to a large degree upon the validity of the data acquisition method used.

The development of acceptable measurement techniques is a necessary and desirable by-product of the program objectives that are diagrammed in Fig. 1-1. The combination of basic acoustical theory into a usable and reliable form of test procedure was the initial and has been a continuing effort at the Fluid Power Research Center. Discussion of the current status of the proposed airborne and fluid-borne noise measurement procedures is presented in Chapter II of this report. Drafts of the airborne and fluid-borne test procedures are found in Appendices F and G respectively.

Prior to implementing the test procedures discussed in Chapter II, the test environment in which the measurements are to be obtained must be evaluated to determine its suitability as an acoustical test facility. A discussion of the International Organization for Standardization (ISO) Recommended Techniques for verifying the measurement properties of acoustical test facilities and an experimental technique for optimizing reverberant environment diffusivity are presented in Chapter III of this report. The results of the application of both the optimization procedure and the proper verification procedure on the Fluid Power Research Center's reverberant test facility are discussed in detail.

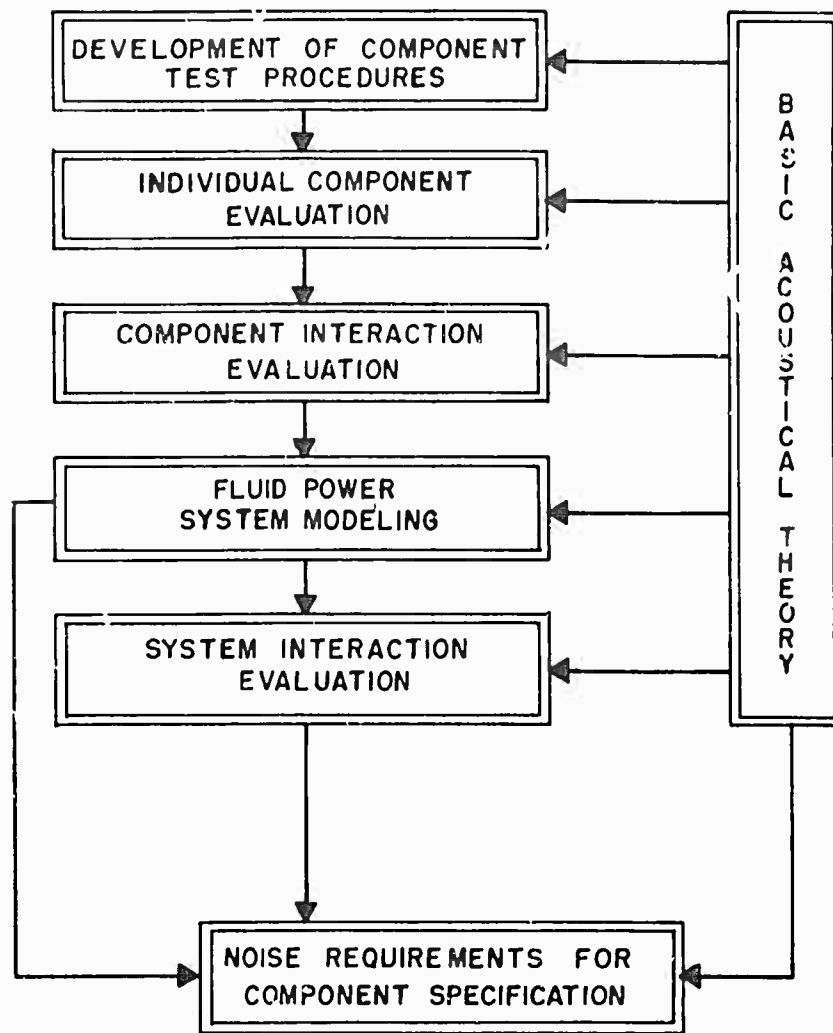

Fig. 1-1. 1972-1974 Hydraulic System Noise Study Program Objectives.

The acoustical evaluation of specific components from the military D7F Crawler Tractor (DV29) and the comparison of their properties with other production components from the fluid power industry have been major objectives of the 1972-73 program. These objectives are graphically illustrated in Fig. 1-2. An extensive set of tests were performed on pump group 5R714 from the D7F. The pump group was acoustically evaluated before and after contamination testing. The results of the contaminant test, acoustic tests, and acoustical comparison of pump group 5R714 with 22 other fluid power pumps are presented in Chapter IV.

It has become evident that a great deal of acoustical energy is contained in and radiated from the conduits of fluid power systems. The fluid-borne noise (pressure ripple) in the working fluid functions as a driving force for conduit vibrations. Vibration of the outer surface of conduits can excite any structural member to which they are attached or radiate pressure waves (sound) directly into the air. It is possible to derive transfer functions that will predict the amount of airborne noise that can be expected from a given number of feet of a particular type of conduit for a known fluid-borne noise forcing function. This type of information is necessary if one of the ultimate objectives is the prediction of fluid power system noise levels. The derivation of conduit transfer functions and a comparison of the predicted and experimental results of tests performed on two 54" sections of 3/4" Caterpillar flexible conduit and two 54" sections of 1" Caterpillar flexible conduit are presented in Chapter V.

Two versions of the military relief valve 5R717 were examined to determine their acoustical output. The housings for the two relief valves were different. The military version (5R717) is built within a large manifold, and the commercial version (6J1746) contains standard pipe-threaded ports. The pressure-flow characteristics of the 6J1746 relief valve are presented with the results of the airborne noise measurements in Chapter VI.

Chapter VII contains a discussion of the progress that has been accomplished on the contract extension which started June 1973. The final chapter contains a brief summary of the material presented in this report, conclusions that may be drawn from the material present herein, and specific recommendations based on the results contained in this report.

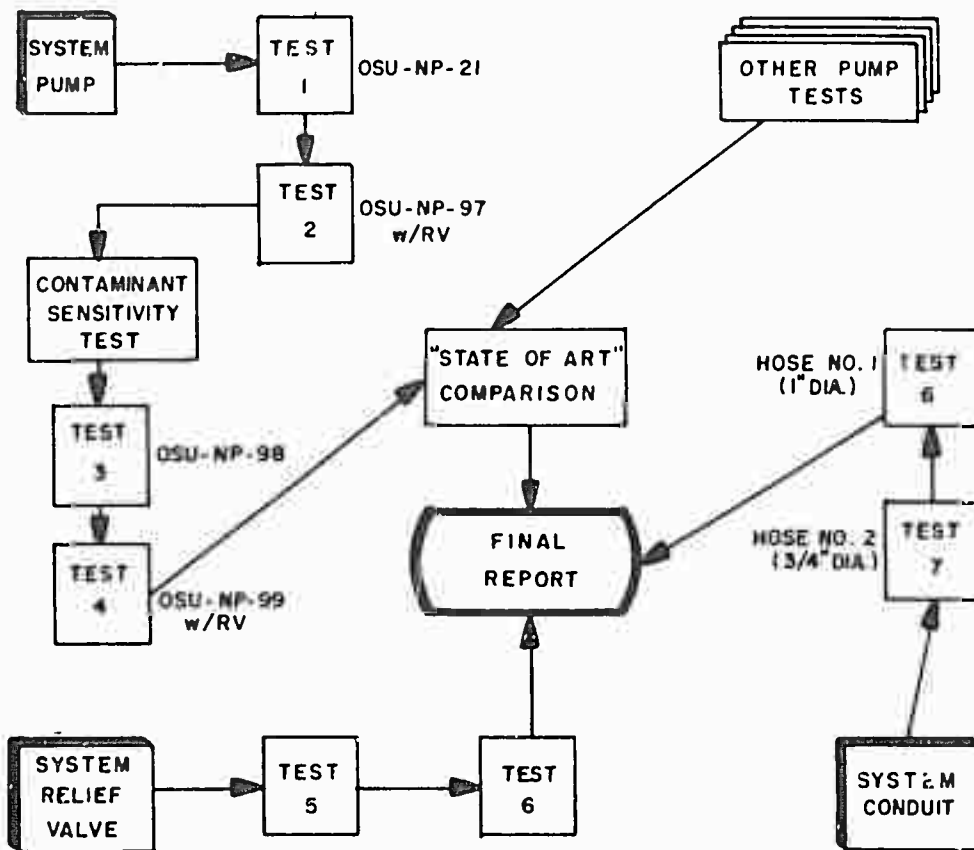
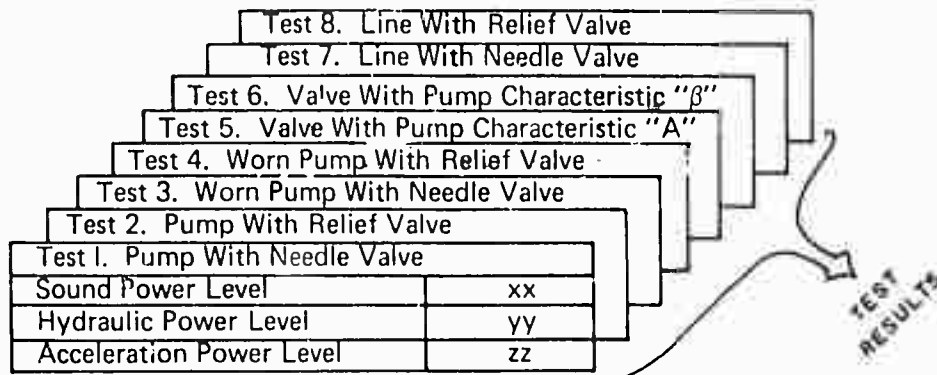

Fig. 1-2. Illustration of Component Acoustical Evaluations for 1972-1973 Program.

CHAPTER II

TEST PROCEDURE DEVELOPMENT & UTILIZATION

The goals of the '72-'73 project and the '73-'74 project are predicated on the availability and use of acceptable acoustical test procedures. The industrial acceptance of an airborne test procedure for pump noise during the past year adds validity to the data presented in this report, since the reported data were obtained using a test code which complies with the accepted method. Because of the dynamic status of noise test codes for fluid power components, it is imperative that project personnel actively participate in the development and verification of those procedures. The active participation of project members will insure the proper interpretation of the data acquired on this project.

This chapter summarizes the development of test codes for measuring hydraulic component airborne noise (ABN) and fluid-borne noise (FBN). Structure-borne noise (SBN) measurement methods are also discussed in this chapter. Proposed procedures for measuring fluid component airborne and fluid-borne noise are presented in Appendices F and G respectively. Specific methods used to obtain the results reported in this document are compared to the recommended procedures.

-TEST CODE -- AIRBORNE NOISE -

The 1972 Annual Report, "Hydraulic System Noise Study," (AD 757776) presented a "Test Code for Measuring and Reporting Airborne Noise Emitted By Hydraulic Fluid Power Pumps," which was developed by a Tri-Level Conference on Noise. The Tri-Level Conference was convened by the American National Standards Institute, the U.S. Technical Advisory Group (USTAG) to the International Organization for Standardization (ISO), and the National Fluid Power Association. One project member participated in the Tri-Level Conference and subsequently was elected as a U.S. member of ISO Working Group I to Sub-Committee 8, Technical Committee 131 (ISO/TC 131/SC8/WG1).

Appendix F presents a "Test Code for Measuring and Reporting Sound Generated by Hydraulic Pumps," which is a draft of the thinking outlined by ISO/TC 131/SC8/WG1 during their first meeting of 3-4 May 1973. The document developed by the Tri-Level Conference served as a starting point for the WG1 document. WG1 members established excellent rapport during their first meeting. It is anticipated that the document they develop

will be realistic and practical. The schedule established by WG1 includes forwarding a final draft document to SC8 by June 1974.

The basic approach outlined in the WG1 test code can readily be extended to hydraulic motors, valves, and conduits. The **procedure** is consistent with previous NFPA documents and thus should be well accepted by the U.S. fluid power industry.

For a given operating condition, the WG1 test code requires the reporting of sound power level at each octave center frequency between 125 Hz and 8000 Hz plus the weighted sound power of the pump in dBA.

All of the airborne noise data presented in this report were obtained using a test method which is consistent with the requirements presented in Appendix F. The data obtained using a test facility which meets the ISO performance requirements of a precision reverberant environment.

Project personnel plan to follow the development of the airborne noise test code by participating in WG1. The WG1 meeting is scheduled for May 1974. It is anticipated that WG1 will be able to extend the basic test code to airborne noise test codes for other hydraulic components.

- TEST CODE -- FLUID-BORNE NOISE -

Development of a test code for measuring and reporting the fluid-borne noise generated by hydraulic pumps appears to have been relegated to a secondary position by the industry. This is probably due to the fact that the industry has more experience with airborne test code development.

Appendix G presents one approach to measuring pump fluid-borne noise. The basic approach represented by the document in Appendix G is to install an attenuator downstream of the pump which attenuates the pump ripple such that no acoustic energy is reflected back to the pump. This approach "eliminates" standing waves in the high pressure line, creating essentially a "free-field" environment for pressure measurements. Resultant pressure measurements between the pump and the attenuator could be related to the pump flow ripple given the apparent bulk modulus in the high-pressure line and the volume of the line.

Another approach recommended for measuring pump flow ripple effects is based on locating the load device directly adjacent to the pump. This approach would minimize the effects of standing waves if the connecting line were short enough so that the first standing wave frequency was well above the fundamental frequency of the pump.

The first method requires the use of an "anechoic termination" in each facility. One project objective for next year is the evalua-

tion of an attenuator which is advertised to provide a fluid-borne noise anechoic termination.

The second method requires the use of a relatively short (3" or less) outlet tubing. The small volume of the outlet conduit could make it difficult to accurately determine an "apparent" bulk modulus. One solution to this problem might be a standard test fixture. This approach will be studied during next year's investigations.

It is anticipated that NFPA will initiate a fluid-borne noise test code development effort during the next year. Project members will cooperate in every possible manner to help insure that this important area progresses at a reasonable rate. Regardless of industrial efforts, the project will be used for future fluid-borne measurements.

The fluid-borne noise data reported in this document are reported relative to $20\mu\text{N}/\text{M}^2$. The pump data were obtained using basically the same fluid circuit for each test. For the pump tests, a pressure transducer was located adjacent to the pump outlet. The measurements are relative but should not be considered absolute, since they would, in general, be different in a different hydraulic circuit. The performance parameter of interest relative to the pump is the flow ripple as a function of pressure, viscosity, shaft speed, etc.

The fluid-borne noise reported for the relief valves was recorded using one transducer in the high-pressure line adjacent to the valve. These measurements are a function of the pump and the circuit. But, the resultant spectra of level versus frequency should show any special noise contributions due to the valve.

The measurements of fluid-borne noise associated with the hydraulic conduits were made using three transducer locations. The three measurements were averaged to establish the correlations between fluid-borne noise and airborne noise for the conduits.

- TEST CODE -- STRUCTURE-BORNE NOISE -

The structure-borne noise data presented in this report were obtained using the guidelines presented in Mil-Std-740B. All measurements on the pumps and valves were made using a magnetic attaching device. The measurements on the conduits were made by fastening the transducer to a threaded stud, which was welded to a hose clamp fastened to the conduit.

Single-point measurements at various locations on the pumps and valves were made for comparison purposes only. A direct correlation between structure-borne measurements and airborne measurements would normally require a large amount of structure-borne data.

Structure-borne measurements on the conduits were the result of an average of three measurements at each axial location. Each of the three



measurements at one axial position was made at a different angular orientation on the surface of the conduit.

Component airborne noise is the integrated result of structure-borne noise, which in turn causes airborne noise. In both cases, structure-borne noise is the intermediate vibration. Because of the importance of fluid-borne and airborne noise test codes, project personnel have concentrated on these areas. No major development effort on a structure-borne test code is anticipated until the airborne and fluid-borne procedures are completed.

CHAPTER III

FACILITY VERIFICATION

- INTRODUCTION -

Through growing concern and legislation on noise control, it has become essential that acoustical test facilities can be able to produce accurate and repeatable acoustical measurements. Before testing programs can be initiated which yield reproducible results, the performance of acoustical environments must be evaluated. Meaningful comparison of data produced by different measurement facilities is dependent on the accuracy obtained within each facility. Guidelines have been set forth by the International Organization for Standardization (ISO) for the verification of acoustical environments. The ISO procedures allow precision measurements to be made in anechoic, semi-anechoic, and reverberant environments which meet specific requirements. In accordance with these guidelines, a verification of the measurement properties of the OSU-FPRC reverberant environment has been performed.

Diffusivity is a measure of the variation of sound level in a reverberant environment [1]. The repeatability that can be achieved in a reverberant facility is directly related to the diffusivity that is attained in the environment. Diffusivity modification in reverberant environments can be attained through the use of rotating planes and moving microphones. Three diffusers are used in the Fluid Power Research Center's Reverberant Room to improve its diffusivity. Fig. 3-1 shows the effect of the three diffusers on measurement standard deviation for different pure tone sounds and varying diffuser RPM. Figs. 3-1a and 3-1b are two-dimensional planes, and Fig. 3-1c is a three dimensional diffuser.

From Figs. 3-1a and 3-1b, it is seen that the large two-dimensional diffusers are very effective in dispersing low-frequency standing waves. Large two-dimensional diffusers are practical for several reasons. One reason being simplicity of design. A thorough discussion of the advantages and disadvantages of both types of diffusers is presented in Ref. [2].

- DIFFUSIVITY OPTIMIZATION -

There are several guidelines that can be used to optimize the diffusivity of acoustical environments [2]. The recommended sound source to be used in determining the optimal diffuser speed is pure tone, since the largest variation in sound occurs with this type of signal. The sound-producing equipment should not be a significant source of noise variation. With the microphone at one position and without diffusers in operation, the

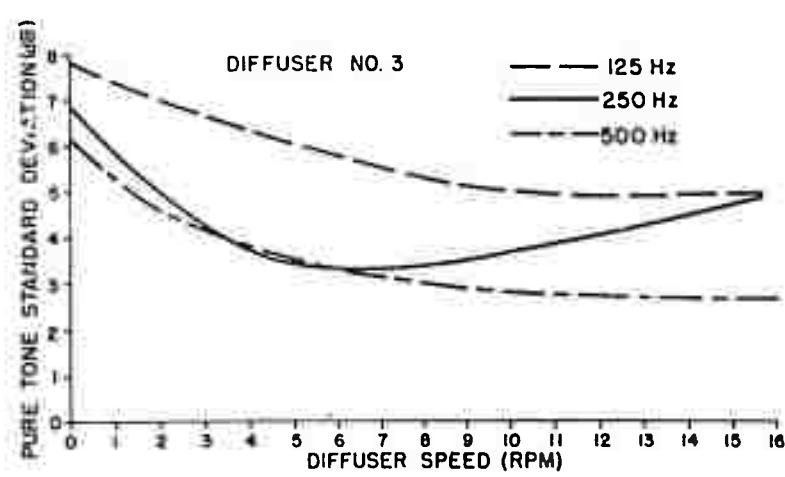
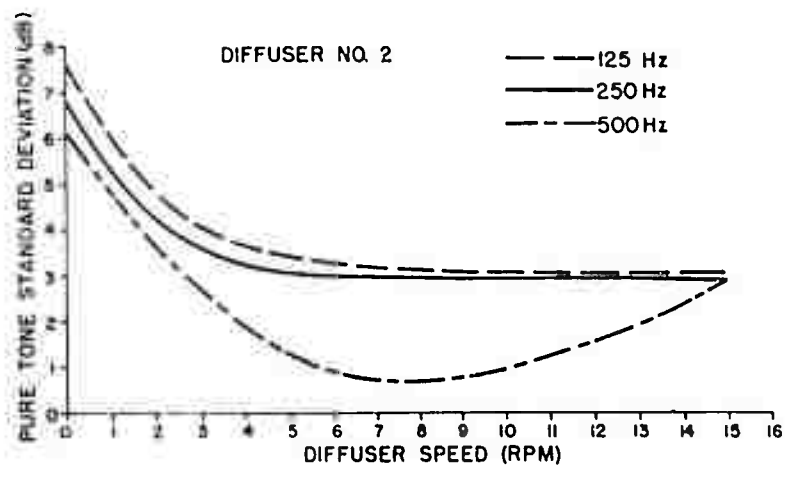
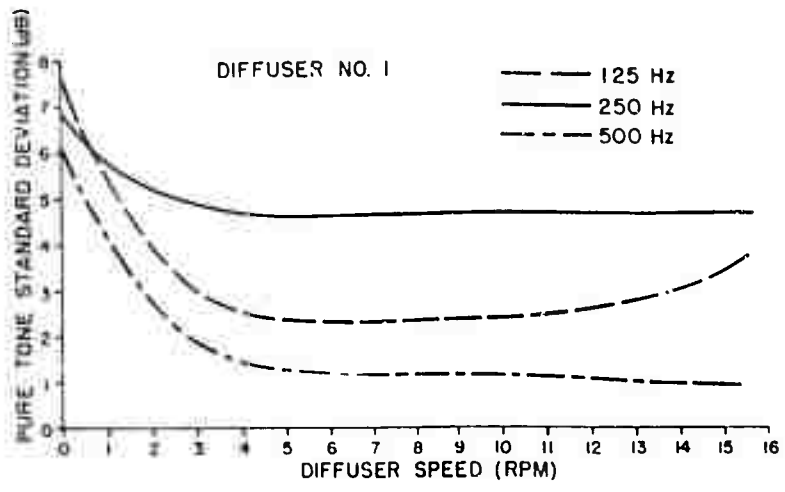

Fig. 3-1. Pure Tone Standard Deviation in OSU-FPRC Reverberant Facility for Each of Three Diffusers Operating Separately at Various Speeds.

the stability of the source and instrumentation will be indicated by the amount of variation of the measured sound level. Fig. 3-2 shows the difference in standard deviation that should occur for several measurements at one position and one measurement at several positions.

The first step in diffusivity optimization is locating the frequency with the largest standard deviation for a given facility. This frequency will normally be the lowest frequency of interest. This critical frequency may be located experimentally by measuring the sound level at six or more positions in the room for each 1/3 octave center frequency without the diffusers operating. The standard deviation may be approximated with the equation:

$$\sigma = X \cdot R$$

σ = standard deviation
 R = range of the measurements
 X = constant from Table 3-1

TABLE 3-1: Constant Factors for Standard Deviation Approximation

Number of Measurements	$\sigma/R = X$
2	0.886
3	0.591
4	0.486
5	0.430
6	0.395

Optimal diffuser speeds are determined using curves of standard deviation versus diffuser rpm, such as shown in Fig. 3-1. Once the diffuser speeds are selected, facility verification can begin. Fig. 3-3 shows the magnitude of standard deviation without diffusers in operation and with diffusers operating in the OSU-FPRC or acoustical test facility. The standard deviations shown in Fig. 3-3 were obtained using 10 and 6 microphone positions for the no-diffuser and diffuser curves respectively.

- REVERBERANT FACILITY VERIFICATION AT OSU FPRC -

The latest ISO recommended procedures for verification of the measurement properties of acoustical test facilities contain techniques for broad-band and pure-tone noise sources. A minimum of six measurements are required at each center frequency of interest. The standard deviation is computed with the following equation:

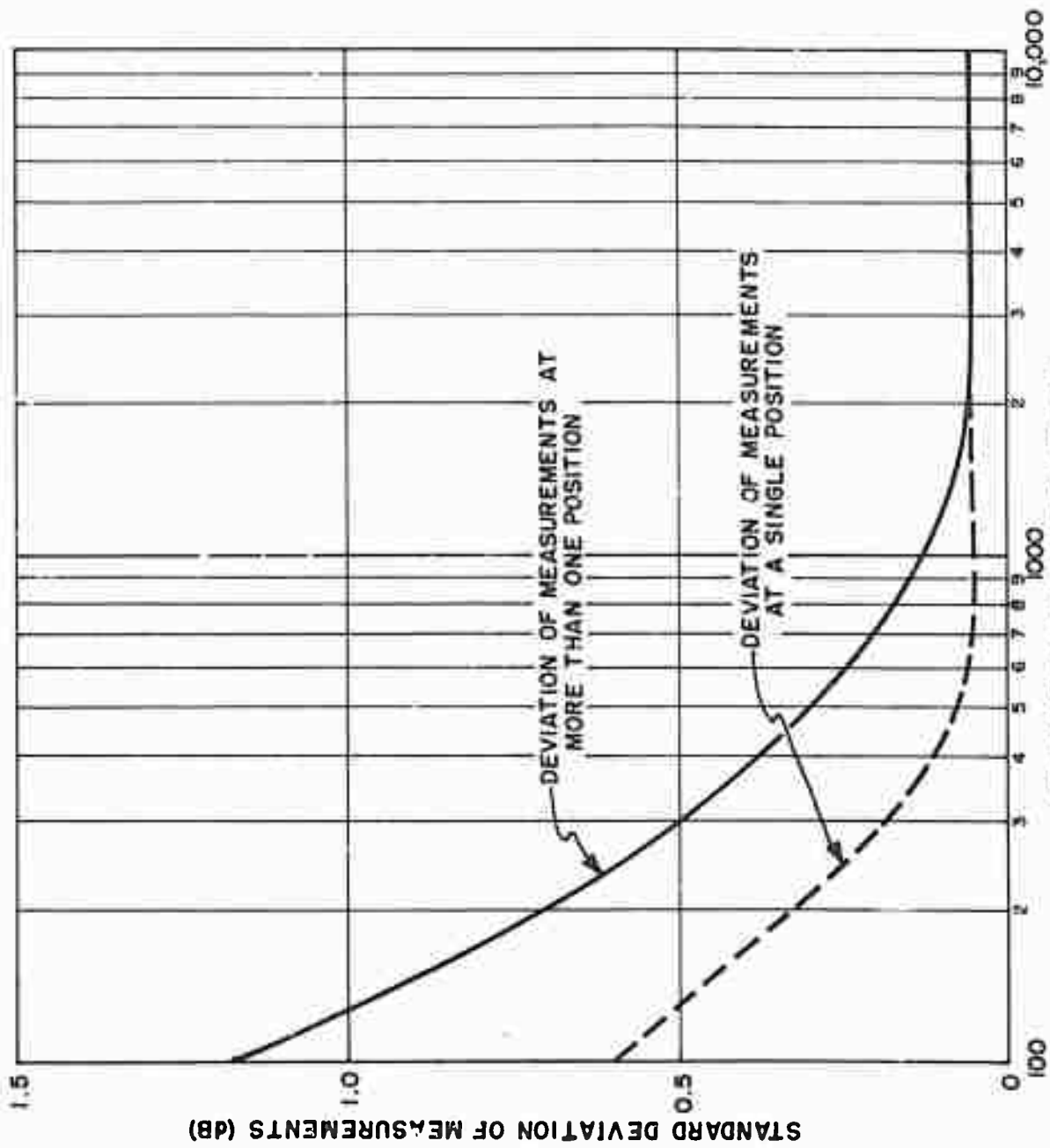

Fig. 3-2. Standard Deviation of Measurements at One Position and Several Positions Versus Frequency Without Diffusers Operating.

SOUND POWER GRAPH

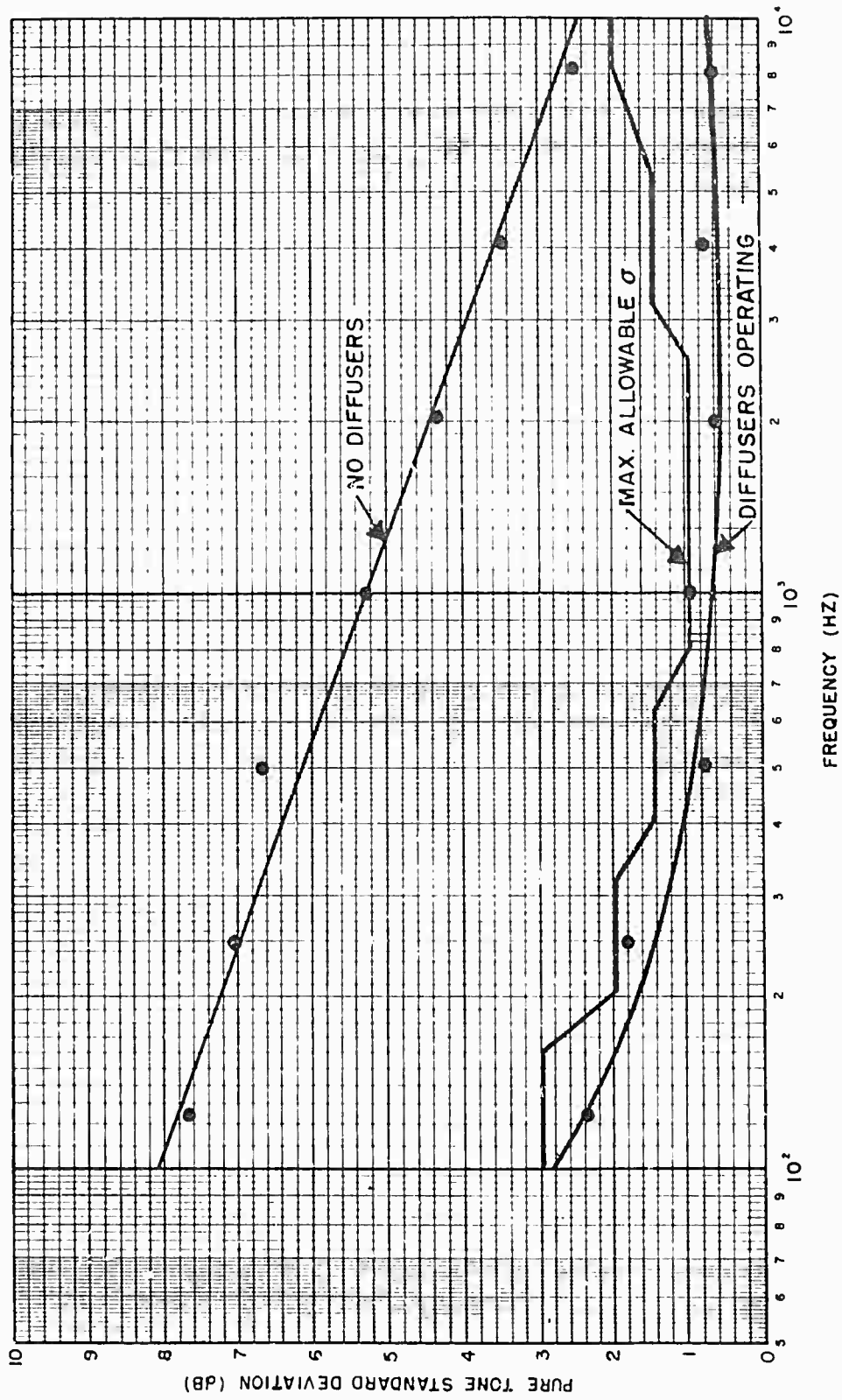

Fig. 3-3. Pure Tone Standard Deviation Versus Frequency for OSU-FPRC Reverberant Facility.

$$S = \left[\sum_{i=1}^N (X_i - \bar{X})^2 \right]^{1/2} (N - 1)^{-1/2}$$

Where: S = standard deviation
 X_i = sound level measurement at i^{th} position in decibels
 \bar{X} = arithmetic mean of N measurements in decibels

Fig. 3-4 shows verification results as standard deviation versus frequency for broad-band sources. Fig. 3-5 shows the verification results for a pure-tone source. The standard deviation of an acoustical measurement facility must be less than the maximum allowable standard deviation shown in the two figures to be used as a precision measurement facility according to the recommendations for the International Organization for Standardization.

- CONCLUSION -

Verification of measurement facilities is a must in order to obtain repeatable and reproducible data. The ISO recommendations provide a practical analysis of acoustical properties of measurement facilities. According to ISO recommended test procedures the OSU-FPRC Acoustical Test Facility is a precision environment.

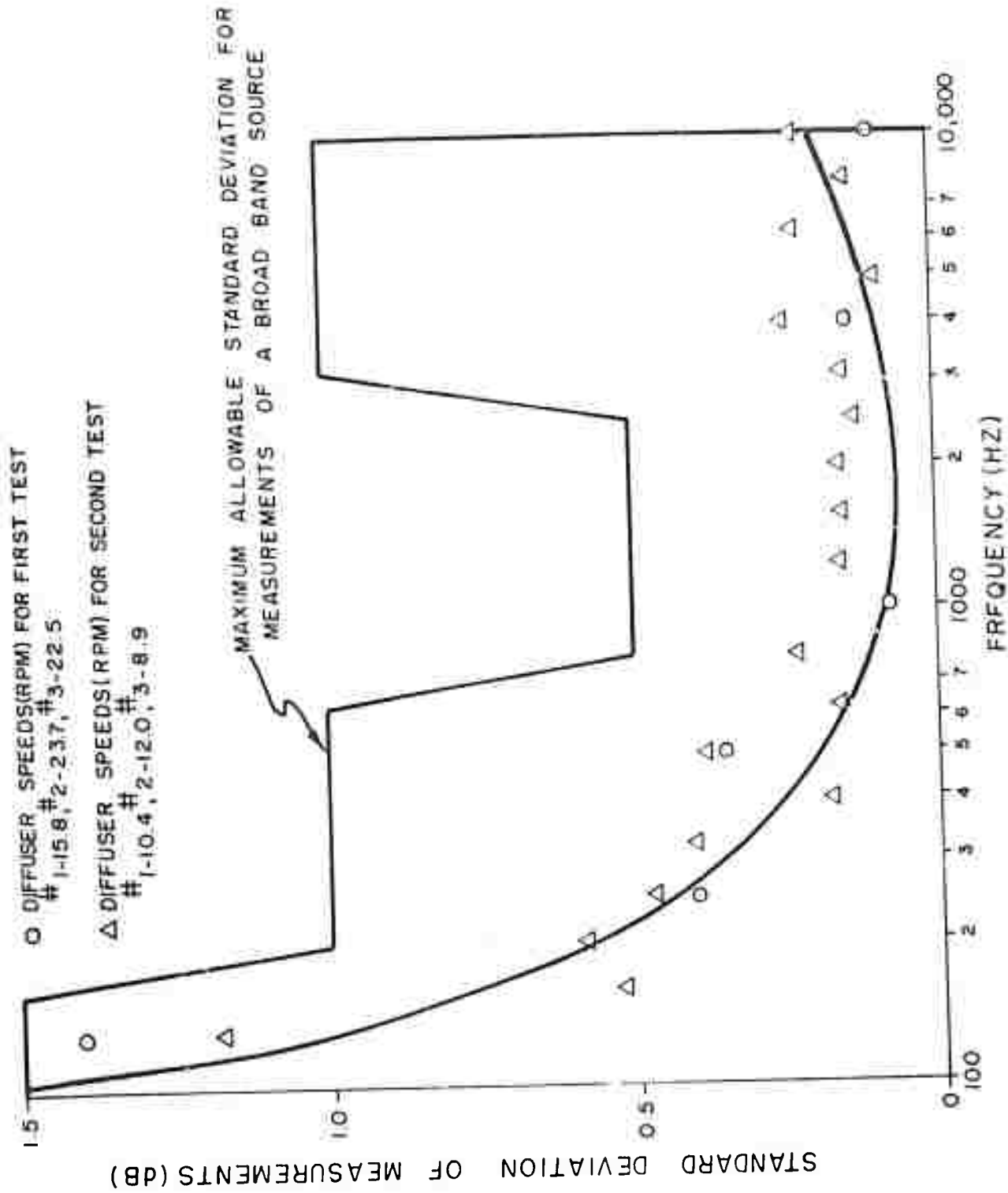

Fig. 3-4. Standard Deviation of Measurements in OSU-FPRC Reverberant Facility for a Broad Band Source With Three Diffusers Operating.

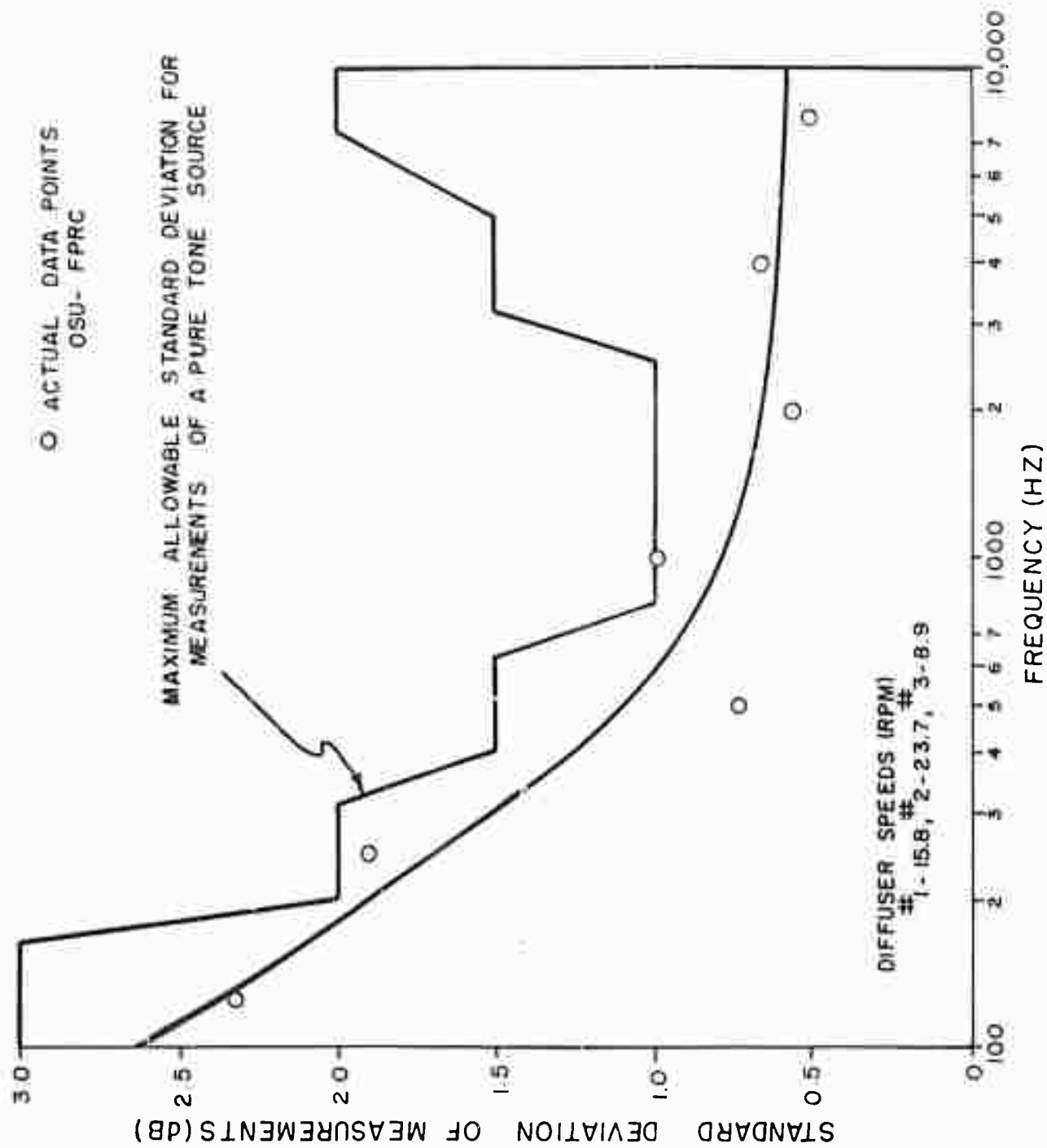

Fig. 3-5. Standard Deviation of Measurements in OSU-FPRC Reverberant Facility for a Pure
 Tone Source With Three Diffusers Operating.

CHAPTER IV

EXPERIMENTAL EVALUATION OF THE NOISE PRODUCED BY FLUID POWER PUMPS

- INTRODUCTION -

A major portion of the total effort in acoustics at the Fluid Power Research Center has been directed toward measurement of the noise generated by fluid power pumps. All three types of noise (ABN, FBN, and SBN) have been considered, with the greater advances being attained in the area of ABN measurement. The experimental evaluation presented in this chapter serves two purposes. The airborne noise data obtained during the measurement of the survey pumps provides an indication of the rankordering capability of the airborne noise test procedure which is discussed in Chapter II. The data compiled during the measurement of a spectrum of fluid power pumps provides a basis for comparing the 5R714 pump group for the military crawler tractor D7F(DV29) with the noise levels produced by comparable fluid power pumps.

The 5R714 pump group which consists of one dual pump was subjected to a series of tests that are outlined in Table 4-1. Each of the five numbered tests is a series of tests designed to provide information about the pump group through out its operating range. All of the tests were performed on the same pump group. The series of tests indicated by Tests 1, 2, 4, and 5 were conducted in the OSU-FPRC acoustics laboratory reverberant facility. Test number 3 was carried out in accordance with OSU-P-7 (the latest version of the contaminant sensitivity test for fluid power pumps).

TABLE 4-1

TEST SEQUENCE AND CODING FOR PUMP GROUP 5R714 FOR THE MILITARY D7F(DV29)

<u>Test No.</u>	<u>Test Code OSU-NP-</u>	<u>Pump Group Configuration</u>	<u>Test Type</u>	<u>Load Device</u>
1	21	As Received	ABN,FBN,SBN	Needle Valve
2	97	As Received	ABN,FBN,SBN	Relief Valve
3	21	As Received	Contamination	Needle Valve
4	98	After Contamination Test	ABN,FBN,SBN	Needle Valve
5	99	After Contamination Test	ABN,FBN,SBN	Relief Valve

- ACOUSTICAL EVALUATION OF MILITARY PUMP GROUP 5R714 AS RECEIVED -

The acoustical characteristics of the pump group (in its new condition) were determined by Tests 1 and 2. Airborne and fluid-borne noise measurements were obtained at each of the four sets of operating conditions shown in Table 4-2. Unless otherwise stated, the operating pressure of the pump group was the same for both pump outlets. Structure-borne measurements were made at 2080 RPM and 1875 PSI.

TABLE 4-2

TEST CONDITIONS FOR PUMP GROUP 5R714 ACOUSTICAL EVALUATION

<u>Test Condition</u>	<u>Shaft Speed (RPM)</u>	<u>System Pressure (PSI)</u>
1	2080	1875
2	2080	200
3	600	1875
4	600	60

The results of the Test Number 1 from Table 4-1 are shown in Figs. 4-1 and 4-2. The airborne noise levels are presented in Fig. 4-1, and the fluid-borne noise levels are contained in Fig. 4-2. It is evident from Fig. 4-1 that the airborne noise is more adversely dependent upon the shaft speed than system pressure. The same trend can be seen in the fluid-borne noise plot (Fig. 4-2). The fluid-borne noise level is significantly more dependent upon the shaft speed of the pump than on the operating pressure of the system. This trend has been observed to be true for all of the pumps tested thus far at the Fluid Power Research Center. A more thorough discussion of this phenomena will be presented later in this chapter.

- CONTAMINANT SENSITIVITY TEST OF MILITARY PUMP GROUP 5R714 -

After Tests 1 and 2 from Table 4-1 were completed, the 5R714 pump group was removed from the acoustical test facility and installed in the Fluid Power Research Center's pump contaminant sensitivity test stand. The results of the contaminant sensitivity test performed according to OSU-P-7 are shown in Table 4-3 and plotted in Fig. 4-3. A lengthy discussion of component contaminant testing will not be presented in this text; the subject is more than adequately covered in Ref. [3].

TABLE 4-3

CONTAMINANT TOLERANCE PROFILE OF PUMP GROUP 5R714 FOR 1000 HOUR LIFE

<u>Size</u>	<u>No. > Size</u>
200.00	2.6375E-02
160.00	5.1375E-02
120.00	1.2309E-01
100.00	2.0512E-01
80.00	3.7700E-01
70.00	5.3325E-01
60.00	8.0669E-01
50.00	1.5567E-00
40.00	3.7442E 00
30.00	1.1682E 01
20.00	5.5557E 01
15.00	1.5774E 02
10.00	6.5774E 02
5.00	4.1952E 03
4.00	7.0702E 03
3.00	1.2476E 04
2.00	2.3414E 04
1.00	3.7789E 04

- ACOUSTICAL EVALUATION OF MILITARY PUMP GROUP 5R714
AFTER CONTAMINANT TESTING -

The 5R714 pump group was installed in the reverberant test facility after completion of the contaminant testing, and a second series of acoustical tests were performed. The second series of tests was identical in every way to the tests performed on the pump group before contaminant testing. The results of those tests are plotted in Figs. 4-4 and 4-5. Fig. 4-4 contains the results of the airborne noise evaluation, while the fluid-borne noise data are plotted in Fig. 4-5.

Comparison of Figs. 4-1 and 4-4 indicates the airborne noise level of the pump group at the lowest horsepower test condition increased 15 dBA after contamination testing. The two intermediate horsepower points inverted with one increasing 5 dBA and the other decreasing 3 dBA. The maximum horsepower point was essentially unaffected by the degradation caused by contaminant testing.

Similar results are evident upon comparison of the fluid-borne noise data in Figs. 4-2 and 4-5. The low horsepower point increased 10 dBA, and

PUMP NOISE CHART
 FLUID POWER RESEARCH CENTER
 OKLAHOMA STATE UNIVERSITY

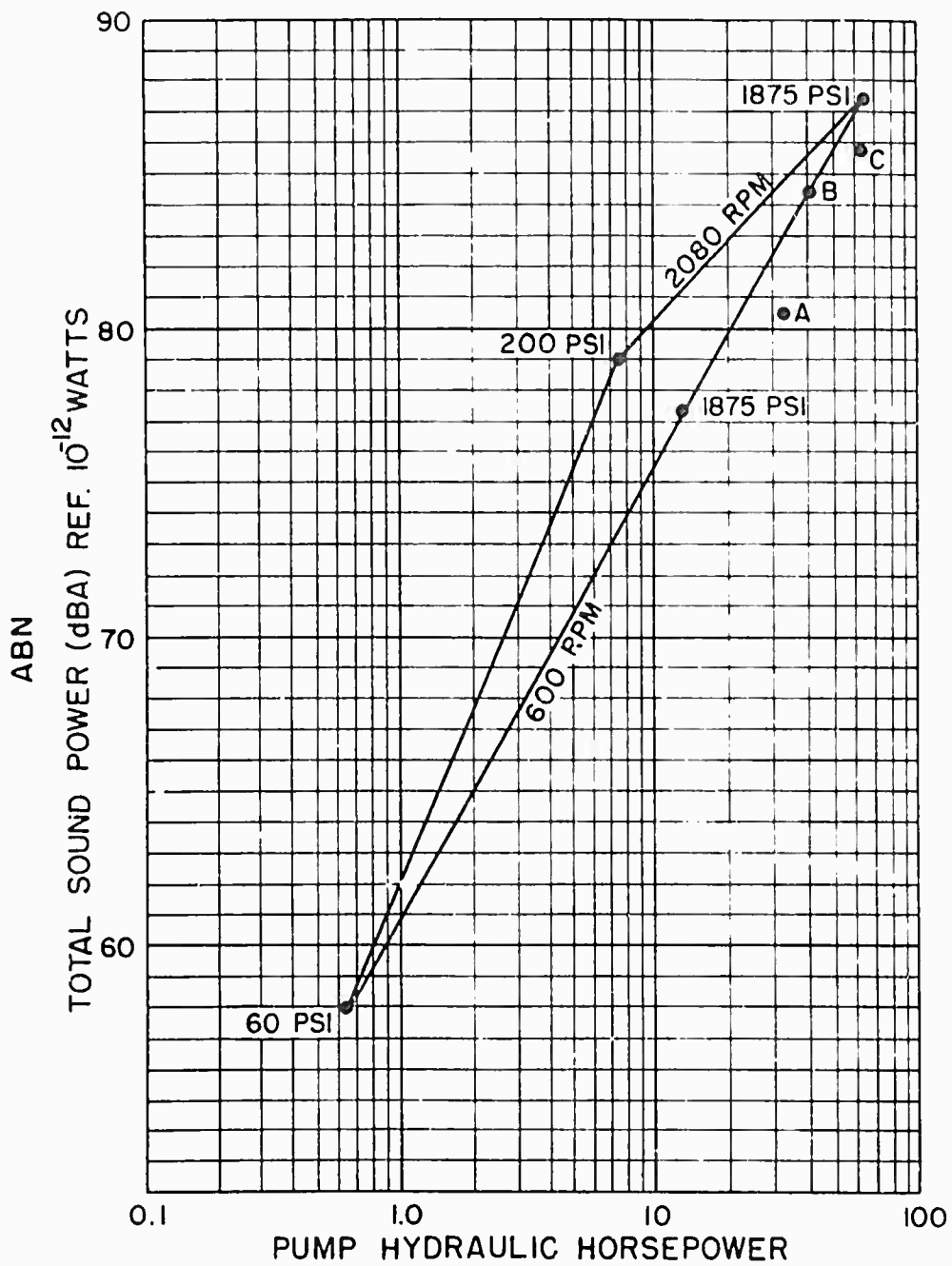

Fig. 4-1. ABN levels for pump group 5R714 for military D7F(DV29) tested as received. Pressures shown are the same for both pump outputs. Point (A) 2080 RPM, shaft side pump 200 PSI, end pump 1875 PSI; point (B) 2080 RPM, shaft side pump 1875 PSI, end pump 200 PSI; point (C) 2080 RPM, 1875 PSI with relief valve loading. All other points use needle valve load.

PUMP NOISE CHART
 FLUID POWER RESEARCH CENTER
 OKLAHOMA STATE UNIVERSITY

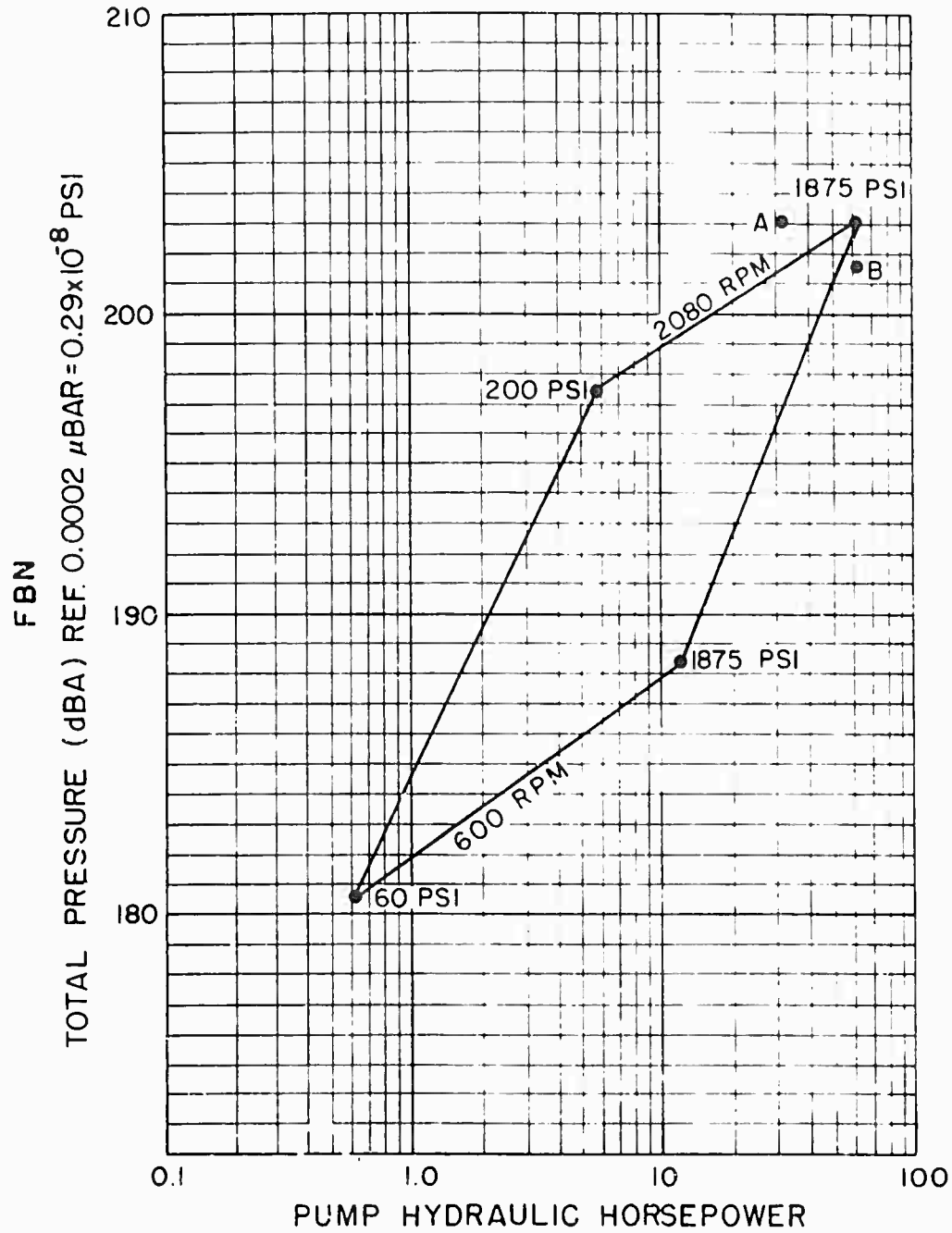

Fig. 4-2. FBN levels for pump group 5R714 tested as received. FBN measurements are for end pump of pump group. Pressures shown are the same for both pump outputs, Point (A), 2080 RPM, 1875 PSI, end pump, 200 PSI shaft pump. Point (B), 2080 RPM, 1875 PSI with relief valve loading. All other points use needle valve load.

DEVELOPED BY FLUID POWER RESEARCH CENTER
OKLAHOMA STATE UNIVERSITY

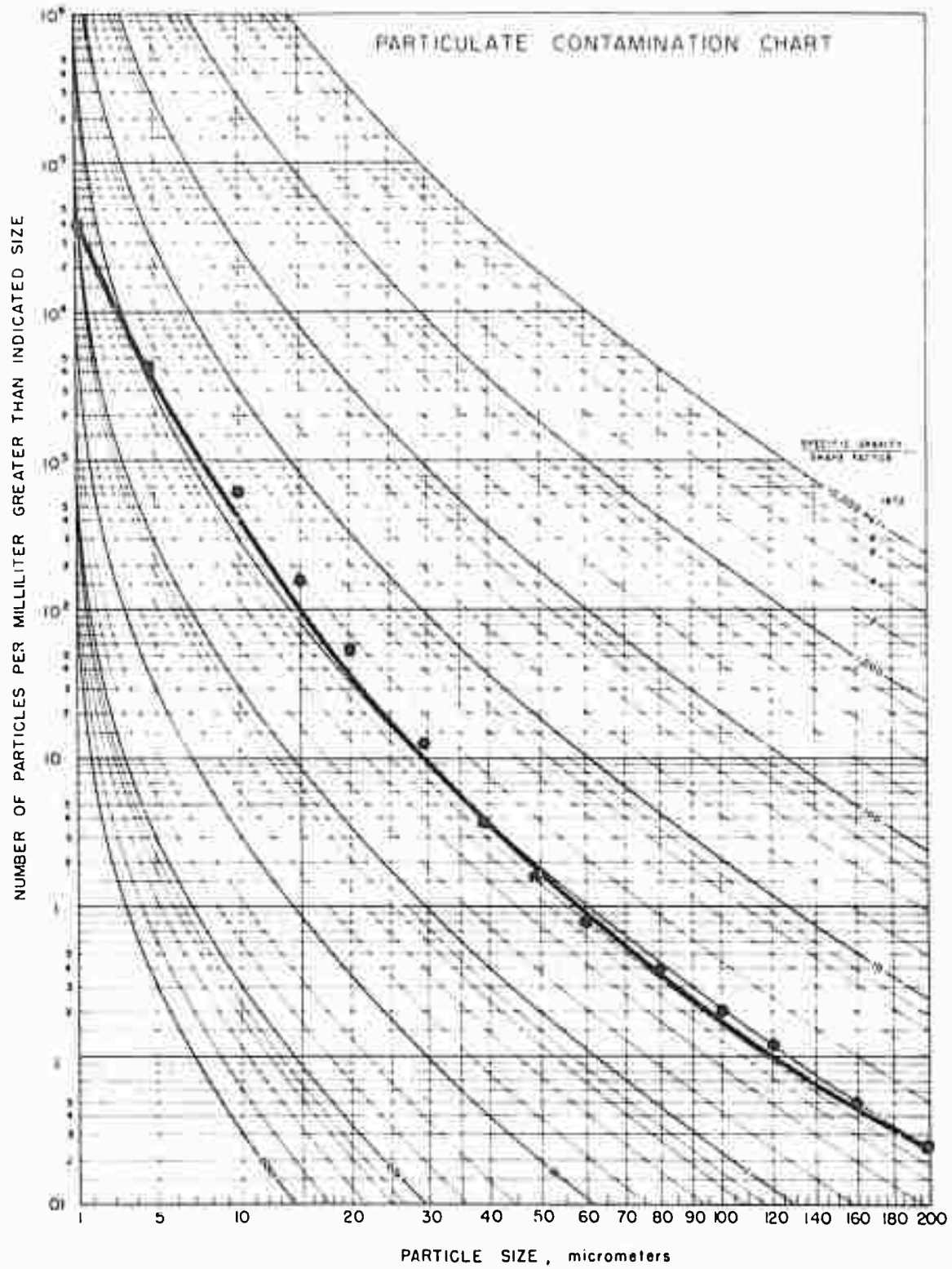

Fig. 4-3. Contaminant Tolerance Profile of Pump Group 5R714 for 1000 Hour Life.

PUMP NOISE CHART
 FLUID POWER RESEARCH CENTER
 OKLAHOMA STATE UNIVERSITY

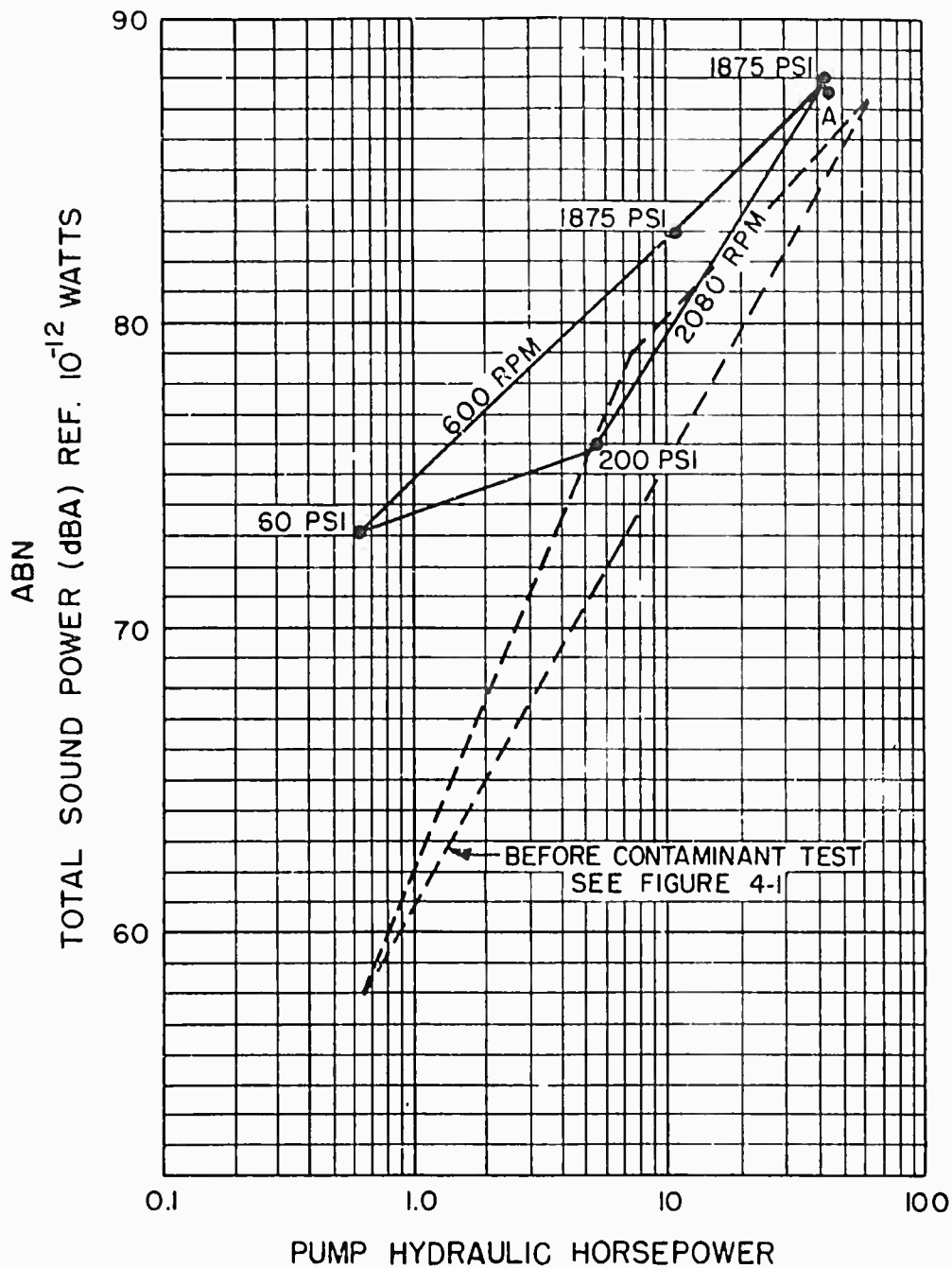

Fig. 4-4. ABN levels for pump group 5R714 after contaminant test. Pressures shown are the same for both pump outputs, Point (A) 2080 RPM, 1875 PSI, with relief valve loading. All other points use needle valve load.

PUMP NOISE CHART
 FLUID POWER RESEARCH CENTER
 OKLAHOMA STATE UNIVERSITY

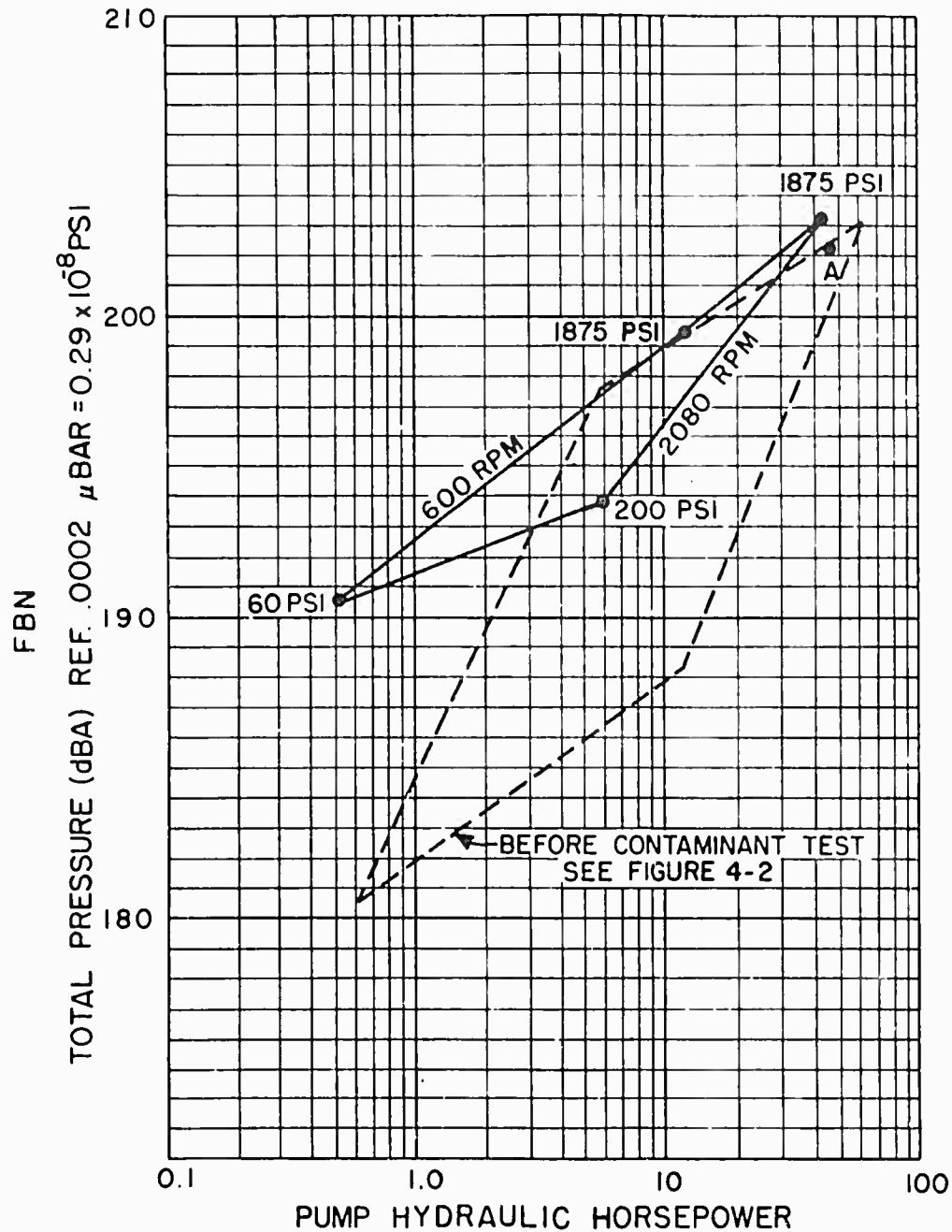

Fig. 4-5. FBN levels for pump group 5R714 after contaminant test. FBN measurements are for end pump of pump group. Pressures shown are the same for both pump outputs Point (A) 2080 RPM, 1875 PSI with relief valve loading. All other points use needle valve load.

the maximum horsepower condition remained unchanged. The two intermediate points alternately increased 11 dBA and decreased 3.5 dBA.

The data compiled during the examination of one pump or any small number of pumps does not provide sufficient information upon which broad generalities may be based. It is for this reason that a theory of cause and effect concerning the noise level changes before and after contamination testing of pump group 5R714 will not be presented to any extent other than to note that the changes were consistent in both direction and magnitude for fluid-borne and airborne noise.

- STRUCTURE-BORNE NOISE LEVELS FOR MILITARY PUMP GROUP 5R714 -

As discussed in Chapter II, the fluid power industry does not possess an acceptable procedure for the measurement of structure-borne noise (SBN). There are several reasons that preclude the development of an easily implemented SBN measurement procedure. One of these reasons includes the number of measurements that must be taken to provide an accurate estimate of the vibration level of any surface. Due to the lack of an acceptable SBN test procedure and the difficulties involved with the development of such a procedure, very little structure-borne noise data have been accumulated at the Fluid Power Research Center. The data presented in Table 4-4 were obtained by placing the measurement transducer (magnetically held accelerometer) at the same position on the pump for each test condition. The reference values for computation of decibel structure-borne noise levels are shown at the bottom of Table 4-4.

- ACOUSTICAL COMPARISON OF PUMP GROUP 5R714
WITH A SURVEY OF FLUID POWER PUMPS -

One of the major objectives of the acoustical evaluation program for 1973 has been the comparison of the acoustical characteristics of military pump group 5R714 with a survey of the acoustical characteristics of current production fluid power pumps. The greatest difficulty encountered throughout the program is that of determining a meaningful basis of comparison. If pumps are compared on total sound power alone, only the directly radiated airborne noise is considered during the comparison. It is conceivable that a very quiet pump, with respect to the directly radiated energy, could possess a very high fluid-borne noise level. The high fluid-borne noise level would produce high fluid power system noise levels, which could not be predicted from the airborne noise radiated from the pump. It should be pointed out that a pump that has a high airborne noise level generally has a high fluid-borne noise level, see Fig. 4-6. Therefore, fluid power pumps cannot be compared by any one measurement to determine which pump is best to minimize noise in a given fluid power system.

TABLE 4-4

SBN LEVELS FOR PUMP GROUP 5R714

<u>Configuration</u>	<u>Location</u>	<u>Total Levels (dBA)</u>		
		<u>Acc</u>	<u>Vel</u>	<u>Dis</u>
New N.V. Load	Right Side	131.8	122.1	124.4
	Rear	135.4	126.5	133.1
	Rear	136.9	127.9	131.2
	Mounting Flange Right Side	132.8	125.5	131.1
New R.V. Load	Right Side	132.0	122.3	125.3
Worn* N.X. Load	Rear	134.0	126.2	133.0
	Right Side	132.4	124.8	133.4
	Mounting Flange Right Side	133.8	126.5	134.3
	Right Side	133.8	126.5	134.3
Worn* R.V. Load	Right Side	134.7	130.7	140.2
	Rear	132.5	127.4	136.6
REFERENCE LEVELS		10^{-5} m/S ²	10^{-8} m/S	10^{-11} m

All vibration levels measured at 2080 RPM, 1875 PSI.

*After contamination testing.

If it is desired to provide a comparison that will indicate which of two pumps will minimize the sound level of a given fluid power system, all of the acoustical noise levels (ABN, FBN, SBN) must be measured for the components to be compared. As mentioned previously, structure-borne noise levels were not measured at all for the survey pumps due to the lack of an acceptable measurement procedure. Hence, only the airborne and fluid-borne noise levels will be compared in this report.

The airborne noise data taken on military pump group 5R714 before contamination testing and with needle valve loading is compared with the

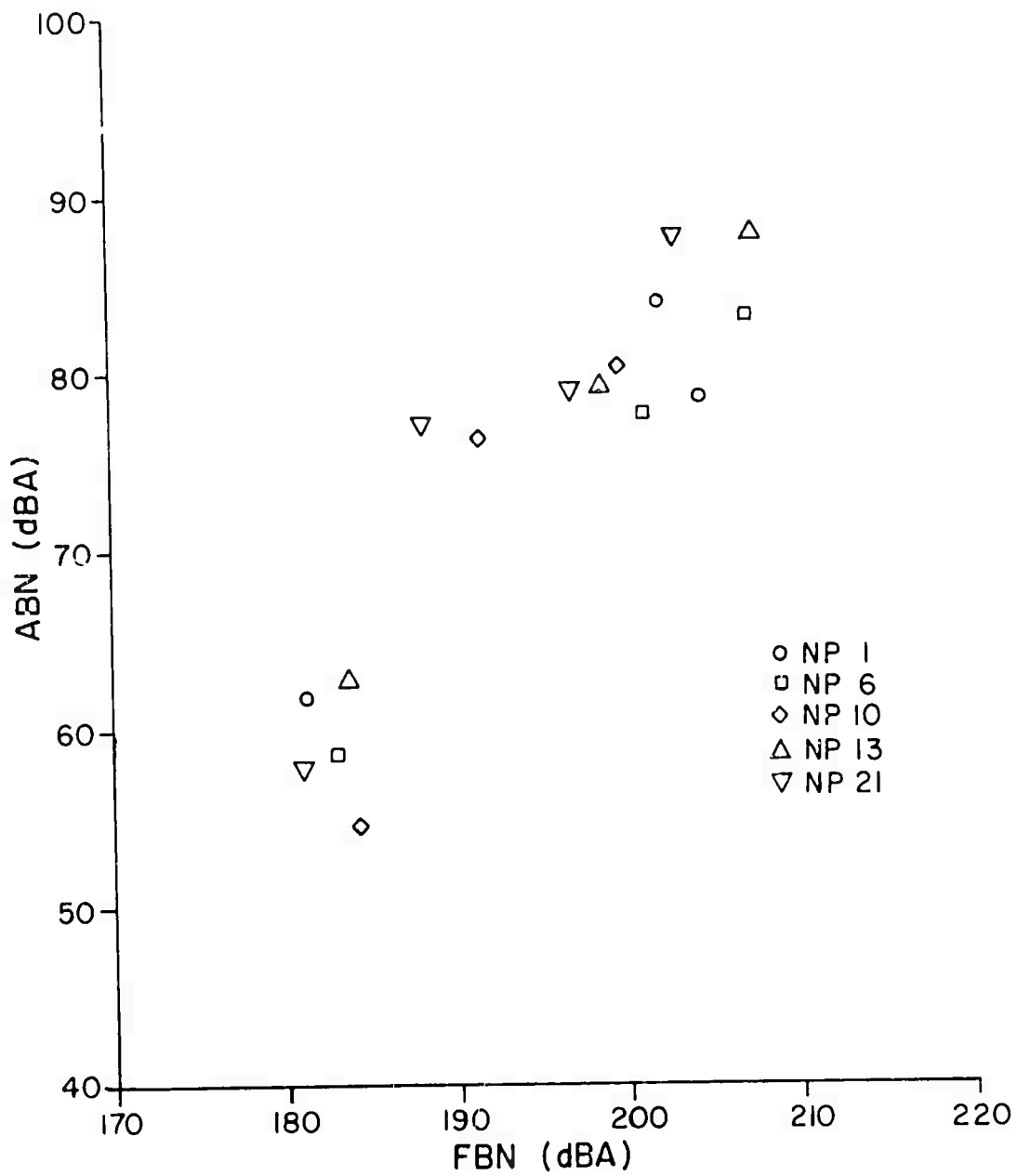

Fig. 4-6. ABN Versus FBN for Pump Group 5R714 (NP-21) and Four Survey Pumps.

data obtained from a survey of the airborne noise levels of fluid power pumps in Fig. 4-7. The pump survey data is presented in the form of histograms for each test condition. The noise level of pump group 5R714 is marked by (21) on the abscissa for each test condition. For the comparison shown in Fig. 4-7, pump group 5R714 appears to be slightly higher in directly radiated sound than the mean of the pumps in the survey. It should be noted that the flow rate, hence the output horsepower, is considerably higher for pump group 5R714 than the mean horsepower of the survey pumps. Recognizing this fact, a plot of total sound power (dBA) per horsepower would rate pump group 5R714 below the mean (dBA/HP) for the survey pumps. Fig. 4-8 contains histograms of (dBA/HP) for the survey pumps with the (dBA/HP) level for pump group 5R714 marked on the abscissa by (21).

The same type of plots are presented for fluid-borne noise in Figs. 4-9 and 4-10. The fluid-borne noise (FBN) and the FBN/HP level of pump group 5R714 is slightly below the mean fluid-borne noise level and mean FBN/HP for the survey pumps. Again, the comparison of both noise level and noise level per horsepower are necessary to adequately rate the pump.

A third method of comparison contrasts the slopes of the sound power versus horsepower graph shown in Fig. 4-1 with the mean of the slopes generated by the survey pumps. The mean slopes of the survey pumps are represented by Eqs. 4-1 and 4-2:

$$\Delta SPL = 2.0 \log_{10} (\Delta P) \quad (4-1)$$

$$\Delta SPL = 4.2 \log_{10} (\Delta N) \quad (4-2)$$

ΔP = change in pump output pressure

ΔN = change in pump shaft speed

ΔSPL = change in sound power level

In contrast, the same type of equations for pump group 5R714 are:

$$\Delta SPL = 4.25 \log_{10} (\Delta P)$$

$$\Delta SPL = 4.75 \log_{10} (\Delta N)$$

It is evident from the coefficient of the log term that the sound pressure level of pump group 5R714 decreases more rapidly with decreasing horsepower than the average of the survey pumps.

The overall survey results are presented in Table 4-5.

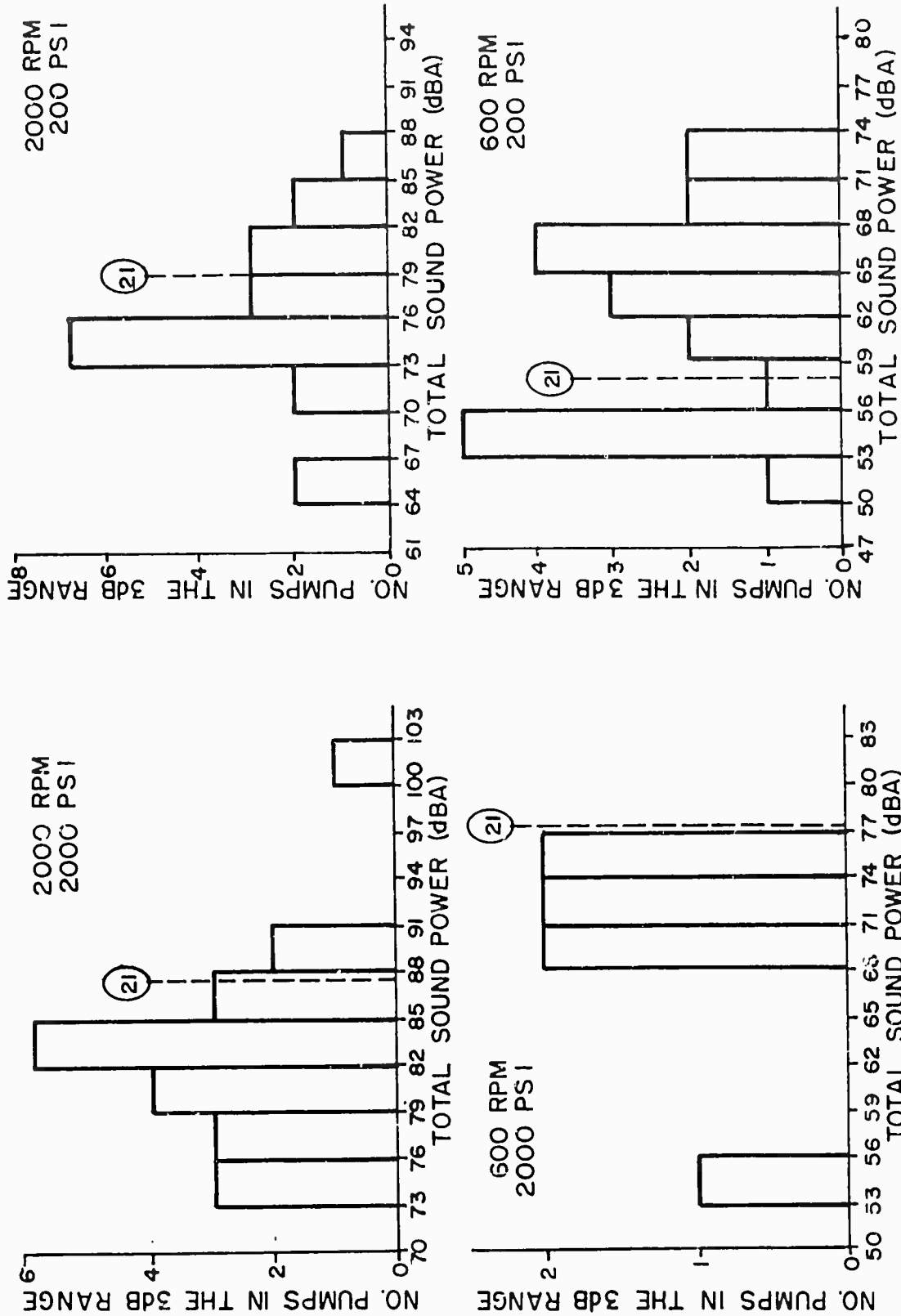

Fig. 4.7. Histograms of Total Sound Power for Survey Pumps with Sound Power Level for Pump Group 5R714 Shown By (21).

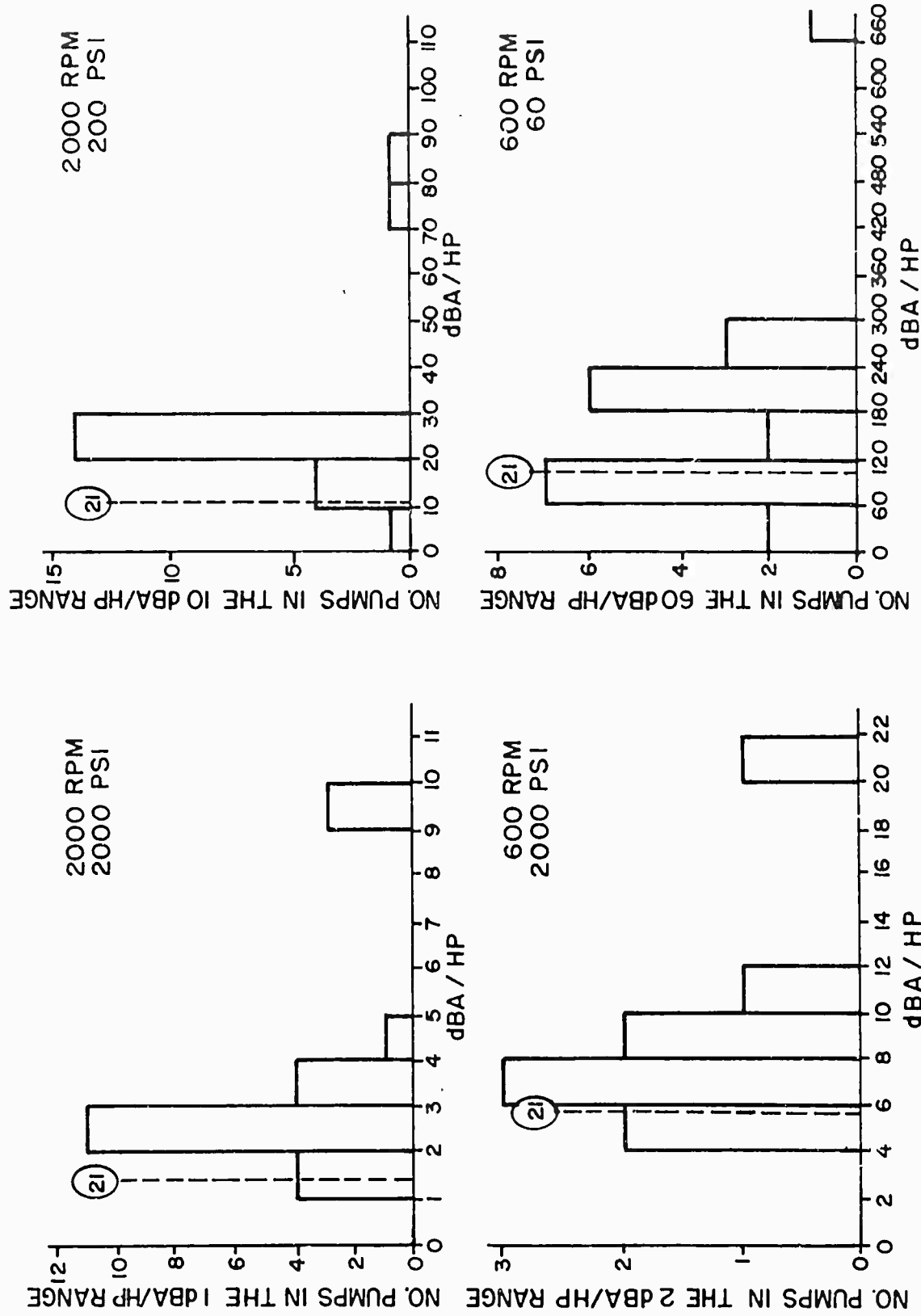

Fig. 4-8 Histograms of dBA/Horsepower for Survey Pumps with dBA/H.P. for Pump Group 5R714 Shown By (21).

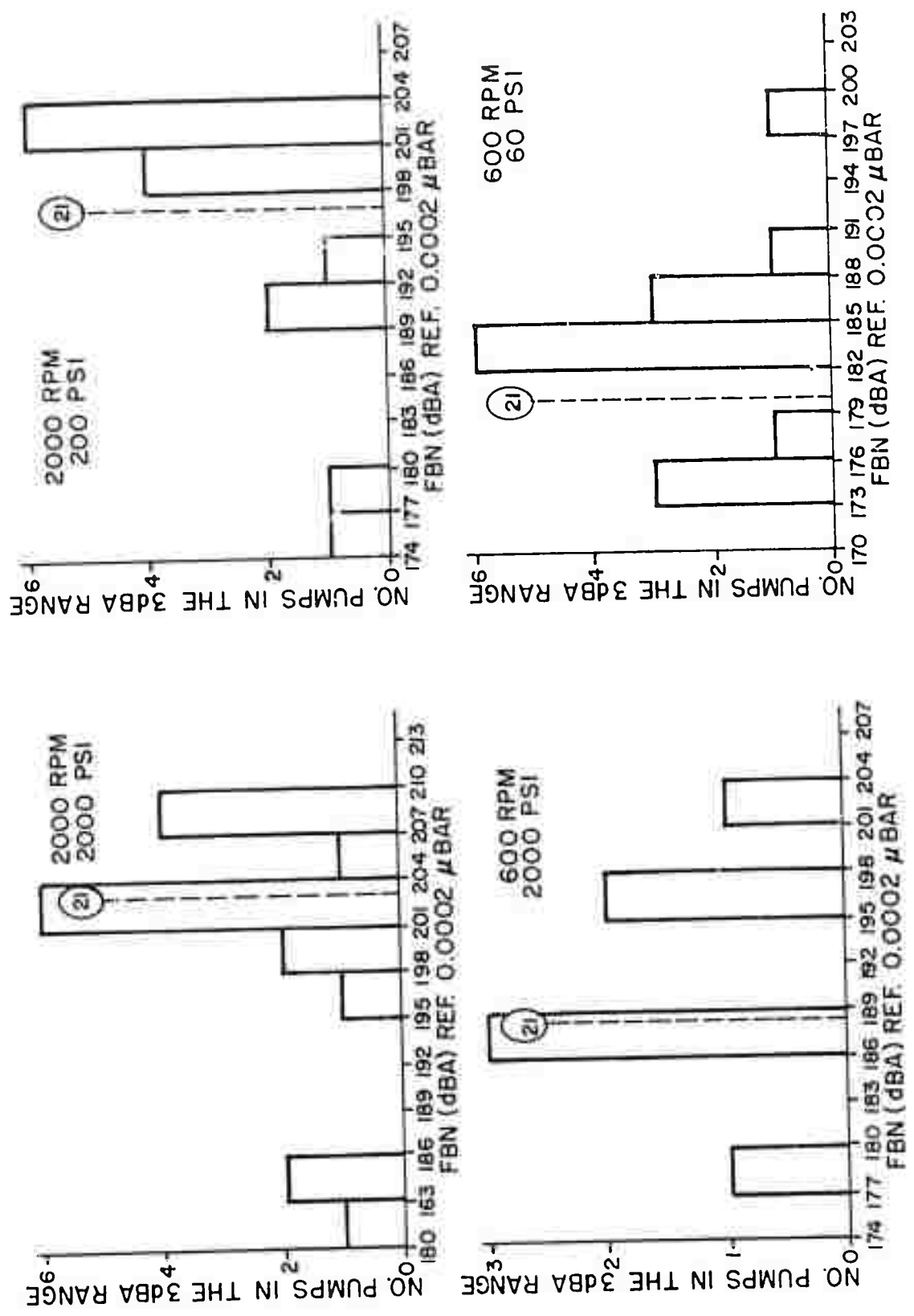

Fig. 4-9. Histograms of FBN for Survey Pumps With FBN Level for Pump Group 5R714 Shown By (21).

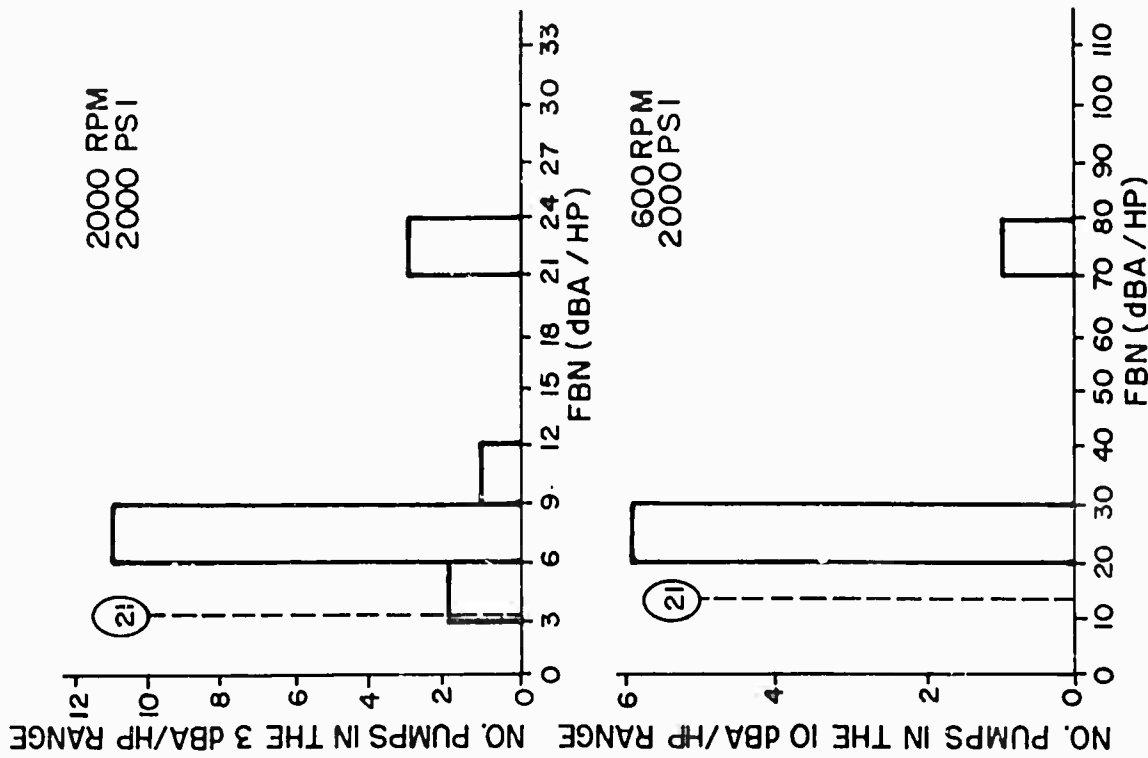
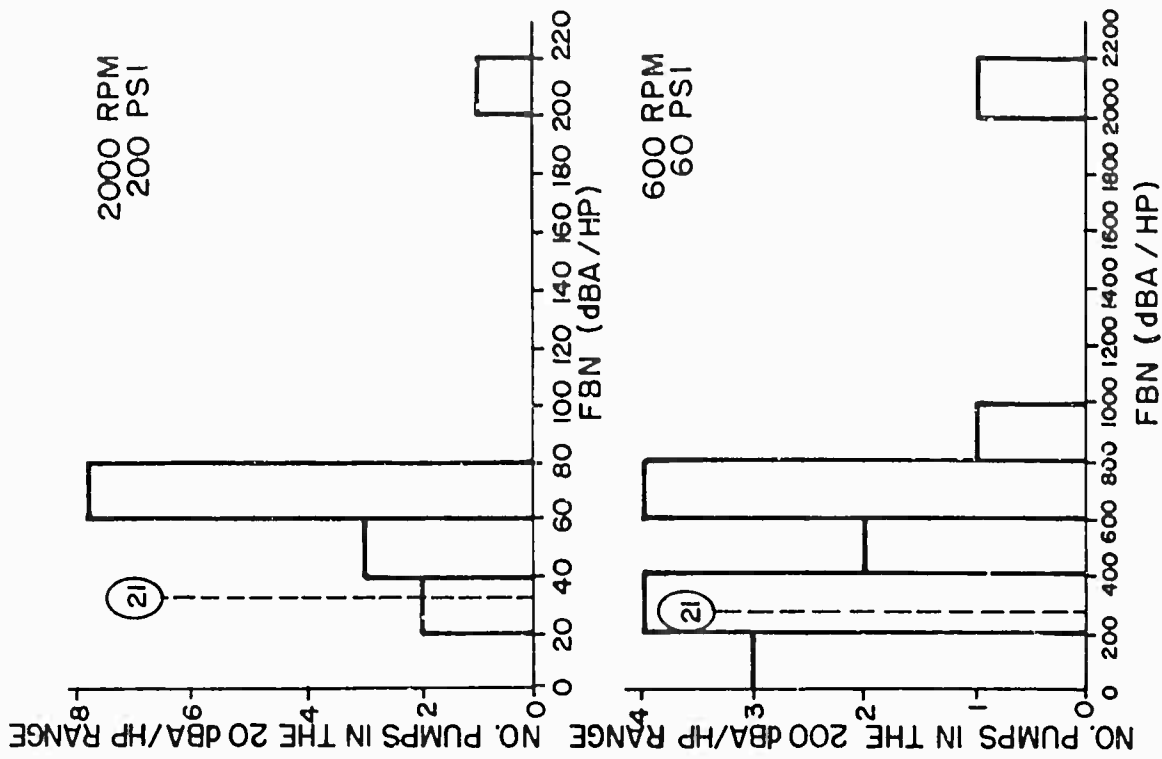

Fig. 4-10. Histograms of FBN/Horsepower for Survey Pumps with FBN Level for Pump Group 5R714 Shown by (21).

TABLE 4-5: Results of an Acoustical Survey of Fluid Power Pumps.

OSL- SP- #	PUMP TYPE	MAINT SILEN- ED (RPM)	SYSTEM PRESSURE (PSI)	NOISE POWER (dBA)	NOISE LEVEL (dBA)	NOISE LEVEL (dB)	NOISE LEVEL (dB)	NOISE LEVEL (dB)	NOISE LEVEL (dB)	NOISE LEVEL (dB)	NOISE LEVEL (dB)	NOISE LEVEL (dB)	NOISE LEVEL (dB)	NOISE LEVEL (dB)	NOISE LEVEL (dB)	NOISE LEVEL (dB)	NOISE LEVEL (dB)	NOISE LEVEL (dB)	NOISE LEVEL (dB)	
1	F.C.	2000	2000	100	100	100	100	100	100	100	100	100	100	100	100	100	100	100	100	100
2	F.C.	2000	2000	100	100	100	100	100	100	100	100	100	100	100	100	100	100	100	100	100
3	F.C.	2000	2000	100	100	100	100	100	100	100	100	100	100	100	100	100	100	100	100	100
4	F.C.	2000	2000	100	100	100	100	100	100	100	100	100	100	100	100	100	100	100	100	100
5	F.C.	2000	2000	100	100	100	100	100	100	100	100	100	100	100	100	100	100	100	100	100
6	F.C.	2000	2000	100	100	100	100	100	100	100	100	100	100	100	100	100	100	100	100	100
7	F.C.	2000	2000	100	100	100	100	100	100	100	100	100	100	100	100	100	100	100	100	100
8	F.C.	2000	2000	100	100	100	100	100	100	100	100	100	100	100	100	100	100	100	100	100
9	F.C.	2000	2000	100	100	100	100	100	100	100	100	100	100	100	100	100	100	100	100	100
10	VAN	2000	2000	100	100	100	100	100	100	100	100	100	100	100	100	100	100	100	100	100
11	F.C.	2000	2000	100	100	100	100	100	100	100	100	100	100	100	100	100	100	100	100	100
12	F.C.	2000	2000	100	100	100	100	100	100	100	100	100	100	100	100	100	100	100	100	100
13	PISTON	2000	2000	100	100	100	100	100	100	100	100	100	100	100	100	100	100	100	100	100
14	VAN	2000	2000	100	100	100	100	100	100	100	100	100	100	100	100	100	100	100	100	100

A ASK level of pump is this condition may be lower than reported value. Reported value is approximating the background level in the area.

F FAS level of pump at this condition may be lower than reported value. Reported value is approximating the background level in the area.

CHAPTER V

CONDUIT EVALUATION

Prediction of fluid power system sound levels is dependent upon the accuracy with which one can estimate the sound level of the components that make up the system. Systems consist of both active and passive components with respect to acoustic energy generation. Fluid power pumps and valves can be considered active acoustic components because they usually generate noise. Reservoirs and conduits are usually passive acoustic components because they do not normally generate noise as a by-product of their normal function within the system. Passive components must be forced by some form of energy transmission to produce noise. This chapter considers the airborne noise produced by two types of fluid power conduit for a known fluid-borne noise forcing function. The conduits used during this evaluation were supplied by Caterpillar Tractor Co. and are hose assemblies from the military D7F(DV29). Two 5/8" hose assemblies connected together were used during the experimental phase of this portion of the program. Two diameters of hose (1" = #1 and 3/4" = #2) were tested.

The fluid-borne noise level was measured at three positions in the conduit. The use of three transducer positions allows the computation of the maximum dynamic pressure level in the conduit by using Eq. (5-1):

$$L_x = 10 \log_{10} \left(10^{L_1/10} + 10^{L_3/10} - 2 \cos 2K\delta 10^{L_2/10} \right) + \log_{10} \frac{1}{1 - \cos 2K\delta} \quad (5-1)$$

Where:

K = frequency/phase velocity

L_1 = measured level at conduit inlet

L_2 = measured level at conduit midsection

L_3 = measured level at conduit outlet

δ = distance between measurement positions

By measuring the ABN, FBN, and SBN of each conduit for a particular set of operating conditions, the investigators were able to derive transfer functions that allow the accurate prediction of ABN for a known FBN level. A detailed discussion of the techniques used to derive the transfer functions will not be presented in this text but may be found in Ref. [4]. What is of more direct interest at this time is the overall sound output that may be expected from a given length of conduit. The overall results of the experimental evaluation are shown in Table 5-1. It should be noted that the only source of sound in the measurement environment was

TABLE 5-1: TOTAL NOISE LEVELS (dB) OF HYDRAULIC CONDUIT

Pump #	Hose #	Pressure psi	N RPM	Impedance	FBN p	SBN v	ABN A weighted	ABN
22	1	2000	2000	N.V.	123.5	129.5	74.7	75.5
22	1	1000	2000	N.V.	123.3	132.8	83.4	83.1
22	1	2000	1000	N.V.	111.8	129.2	64.1	67.5
22	1	2000	2000	R.V.	121.4	131.3	78.0	77.8
6	1	2000	2000	N.V.	113.8	126.9	57.3	62.9
6	2	2000	2000	N.V.	116.0	116.5	64.4	70.6
6	2	1000	2000	N.V.	114.5	120.5	71.3	71.8
6	2	2000	1000	N.V.	115.5	121.2	70.2	72.2
6	2	2000	2000	R.V.	117.7	125.1	75.5	76.9

Hose - 1 -- Rubber covered Hose Specifications Wire Braid, 1" I.D.

Hose - 2 -- Rubber covered Hose Specifications Wire Braid, 3/4" I.D.

Pump #22 - 9.1 in³/rev

Pump #6 - 4.04 in³/rev

Type = 4 Ply Spiral Wrapped
 Operating Pressure (O.P.) of 3/4" = 3000 psi Operating Pressure (O.P.) of 1" = 4000 psi
 Minimum Burst Pressure for both 3/4" and 1" Hoses = 4 x O.P.)

the conduit.

A diagram of the test facility is shown in Fig. 5-1. The pressure transducer locations are numbered in the diagram.

- TRANSFER FUNCTIONS -

Two types of transfer function were developed for each conduit tested. The two methods relate the fluid-borne noise to the resultant airborne noise in different ways. The transfer function, G_1 , relates fluid-borne noise directly to airborne noise as shown in Fig. 5-2a. Surprisingly accurate results were obtained from this rather simple model. The second technique involves the transformation of energy from fluid-borne to structure-borne and finally to airborne noise as shown in Fig. 5-2b. The transfer functions for both conduits are presented in Reference [4]. A comparison of the predicted and measured sound levels for each test condition is shown in Table 5-2.

ABN levels between 70 and 80 dB were found to be produced by 8 feet of flexible hydraulic conduit. Comparison of these levels to ABN levels produced by hydraulic pumps and motors indicated that the hydraulic conduit does contribute a significant amount of ABN.

Average pressure, pump speed, and downstream impedance were found to have significant influence on the ABN output of a hydraulic conduit. A reduction of the average operating pressure from 2000 to 1000 psi caused a substantial increase in both SBN and ABN total levels. Reduction of pump speed shifts the FBN profile toward lower frequencies resulting in a large increase of SBN amplitudes in the low-frequency range. A relief valve was found to increase the total ABN level of the conduits tested 3 to 6 dB above the levels produced by a needle valve.

The transformation of FBN into SBN by the hydraulic conduits investigated can be described as dynamic system which exhibits relatively high sensitivity to low-frequency FBN. The transformation of SBN into ABN can be basically described as a system with relative high sensitivity to high-frequency SBN.

This investigation establishes substantial evidence that correlations describing the relationship between FBN, SBN, and ABN can be developed. Models based on total dB levels provide the best overall effectiveness in predicting total ABN levels for both conduits tested. Only the one inch conduit was considered to be effectively described by models developed from frequency analysis techniques. Even though models developed from frequency analysis did not adequately describe Conduit #2, it is thought that digital models describing the complete transformation of FBN into ABN in two separate steps has the greatest potential for accurate prediction of ABN levels. A more complete discussion of this topic can be found in Reference [4].

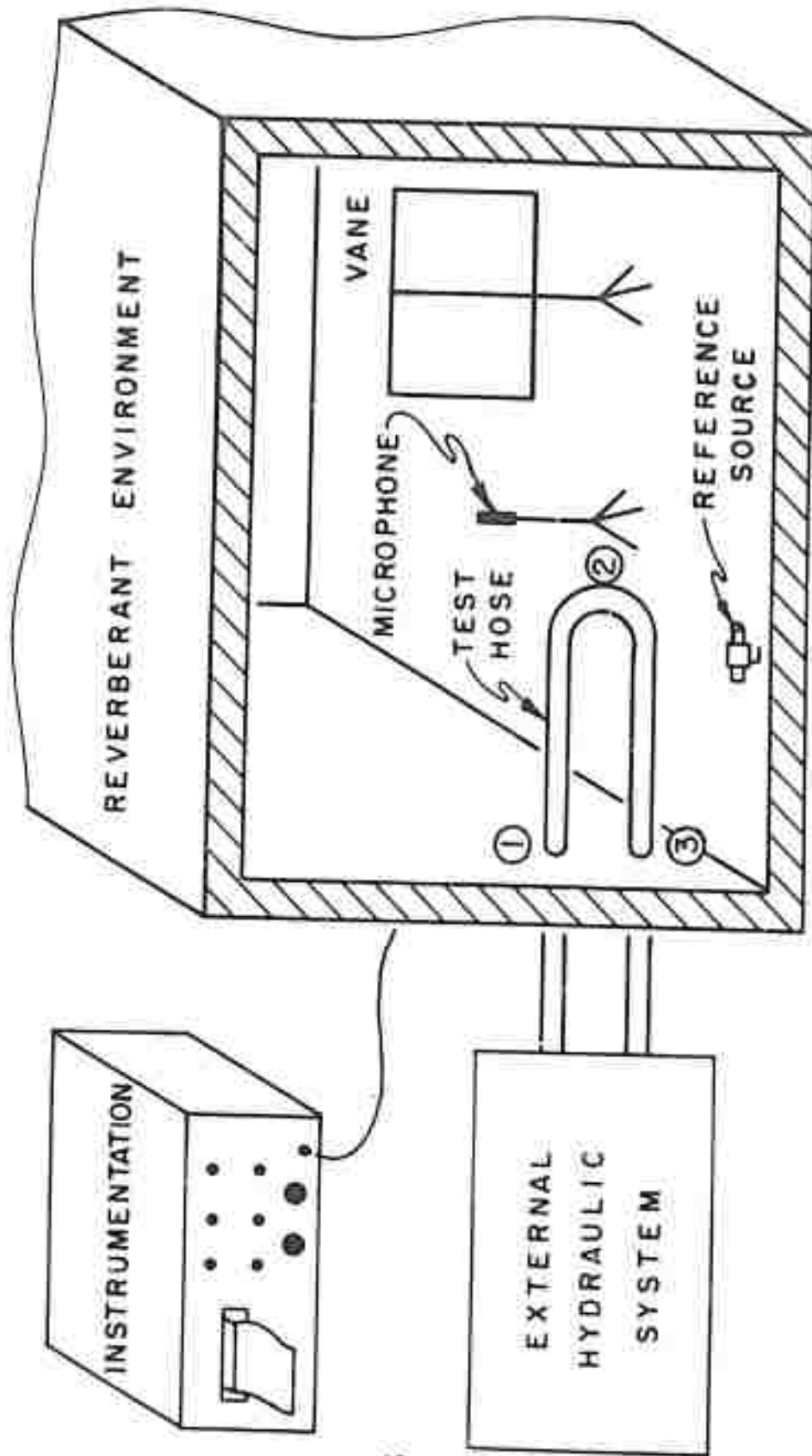

Fig. 5-1. Test Facility With Conduit Evaluation Equipment Installed.



(a)



(b)

Fig. 5-2. Two Types of Transfer Functions Developed for Fluid Power Conduits.

TABLE 5-2: COMPARISON OF MEASURED AND PREDICTED LEVELS FROM FREQUENCY ANALYSIS

Test Conditions				Airborne Noise						
Hose #	Pump #	P psi	S rpm	IMP	Measured		Digital Model			
					dB	dBA	$G_1(s)$ dB	$G_1(s)$ dBA	$G_2(s) \cdot G_3(s)$ dB	$G_2(s) \cdot G_3(s)$ dBA
1	22	2000	2000	NV	75.5	74.7	77.5	77.7	78.0	76.5
1	22	2000	1000	NV	67.6	64.1	69.8	68.4	70.1	66.5
1	22	1000	2000	NV	83.1	83.4	81.0	81.2	81.5	81.3
1	22	2000	2000	RV	76.9	75.5	74.5	73.6	75.1	74.0
1	6	2000	2000	NV	72.2	70.2	69.5	67.7	70.4	67.9
2	6	2000	2000	NV	70.6	64.4	64.5	60.2	65.3	60.3
2	6	2000	1000	NV	62.9	57.3	65.1	60.5	64.6	59.2
2	6	2000	2000	RV	73.7	72.4	65.2	60.7	65.3	61.0
P - Pressure								NV - Needle Valve		RV - Relief Valve

CHAPTER VI

ACOUSTICAL MEASUREMENTS OF RELIEF VALVES

- INTRODUCTION -

Very little literature is available regarding relief valve noise. Relief valve noise has become more important because of governmental regulations on noise pollution and the concern for employee environment. This chapter presents a summary of relief valve noise tests conducted at the OSU-FPRC acoustics laboratory and provides guidelines for future tests.

The noise from relief valves originates primarily in three domains: fluid-borne noise, structure-borne noise, and airborne noise [5]. The measurement of structure-borne noise is a problem because many points over the surface of the valve must be measured to provide an accurate estimate of the level of the valve surface. The difficulties involved with SBN measurement preclude the luxury of a great deal of SBN data in this report. Fluid-borne noise is easily measured with a piezoelectric transducer. The measurements presented in this chapter were made on the high-pressure side of the relief valve. Fluid-borne noise in relief valves is the result of turbulence, cavitation, and interaction with other components. The directly radiated airborne noise was measured in the OSU-FPRC reverberant facility in accordance with the ABN measurement procedure presented in Appendix F.

- TESTS AT THE OSU-FPRC ACOUSTICS LABORATORY -

The relief valve testing at the OSU-FPRC laboratory included two pilot operated relief valves. Both were identical in functional design and specifications. Relief Valve #2 (RV2) is built into a manifold for bolting directly to a hydraulic system. RV2 is the military version (5R717) of relief valve group 6J1746 supplied by Caterpillar. It is considerably larger physically than RV1, which was ported for standard hydraulic conduits. Both valves were connected to the controlling system using flexible hydraulic conduit, which was wrapped with 2" foam rubber. The line was then covered completely with a layer of leaded vinyl material, overlapped, and sealed with duct tape. All connecting lines were treated this way to attenuate as much system noise as possible for a more accurate noise measurement from the relief valve.

The testing was conducted in the OSU-FPRC sound reverberation room. This room is equipped with rotating plane diffusers and is certified

according to ISO recommended procedures [6,7].

All data (ABN, FBN, SBN) was acquired through the use of a third-octave analyzer, which average the input signal at 1/3 octave center frequencies between 100 and 10,000 Hz. All of the output data were corrected and put into usable form with a computer program designed for this purpose. (See Appendix E)

Both valves were tested under a constant pressure of 2000 psi and 65.5°C. RV1 was tested only at 20 gpm flow rate because, when higher rates were applied, it had high internal leakage. RV2 was tested at flow rates of 20, 40, and 60 gpm. The noise levels are tabulated in Table 6-1 with corresponding horsepower levels at each flow rate. RV2 shows a critical flow rate at about 40 gpm, where the ABN begins to increase noticeably. At about 60 gpm, a chatter developed within the valve. The flow rate was increased momentarily, and the valve was found to chatter at higher flow rates. The rated flow for this valve was 80 gpm, which was much higher than the flow at the onset of chattering. Fig. 6-1 shows the approximate relationship between airborne noise and horsepower. The almost vertical trend emphasizes how critical the flow rate is for the valve tested.

A comparison of the fluid-borne noise output with the airborne noise output reveals an increase in airborne noise with an increase of fluid-borne noise. This is shown graphically versus flow rate in Fig. 6-2. Typical spectrums for relief valve and pump noise are shown in Fig. 6-3. The relief valve emits predominantly high frequency noise caused by flow and the pump is a low frequency source. In Fig. 6-4, the fluid-borne noise appears to increase as the logarithm of horsepower.

It would seem that the structure-borne noise would also increase as the fluid-borne and airborne noise increases. The structure-borne noise output is tabulated in Table 6-1 and decreases with an increase in flow rate. This is illustrated graphically in Fig. 6-5. Note that the structure-borne noise measurement was taken at only one point on the relief valve surface, and the point tested may have been in a nodal region.

The pressure-flow characteristics for RV1 are shown in Fig. 6-6. Data is presented for both increasing and decreasing flow rates. The data was obtained in FPRC systems laboratory.

- FUTURE TESTING -

The main objectives of any testing program should include accuracy and repeatability. The facility in which a relief valve is tested for airborne noise should be certified for acoustical testing according to accepted procedures. For an accurate measurement of the sound power output of a valve all other noise-producing apparatus should be covered with acoustical attenuating material.

The recommended frequency range at which measurements should be made is between 100 and 10,000 Hz. This should include all relevant noise data for the relief valve and has been accepted by the NFPA for other acoustical testing procedures.

All relief valves should be tested at their specified working pressure and flow rates relevant to actual use up to the rated flow. As is evident from the data given, there is always the possibility of instability before reaching rated flow.

TABLE 6-1: SOUND POWER RESULTS OF RELIEF VALVES

AIRBORNE SOUND POWER

Valve	Pressure (psi)	Flow (gpm)	Horsepower	dBA
1	2000	20.0	23.3	84.2
2	2000	20.0	23.3	81.9
2	2000	40.0	46.7	79.4
2	2400	60.0	84.0	91.8

FLUID-BORNE NOISE LEVELS

Valve	Pressure (psi)	Flow (gpm)	horsepower	dBA
1	2000	20.0	23.3	240.8
1	2000	30.8	35.9	235.0
2	2000	20.0	23.3	229.9
2	2000	40.0	46.7	234.7
2	2000	60.0	70.0	240.6

STRUCTURE-BORNE NOISE LEVELS

Valve	Pressure (psi)	Flow (gpm)	Horsepower	dBA
1	2000	20.0	23.3	135.2
2	2000	20.0	23.3	123.5
2	2000	40.0	46.7	124.9
2	2000	60.0	70.0	114.8

VALVE NOISE CHART
FLUID POWER RESEARCH CENTER
OKLAHOMA STATE UNIVERSITY

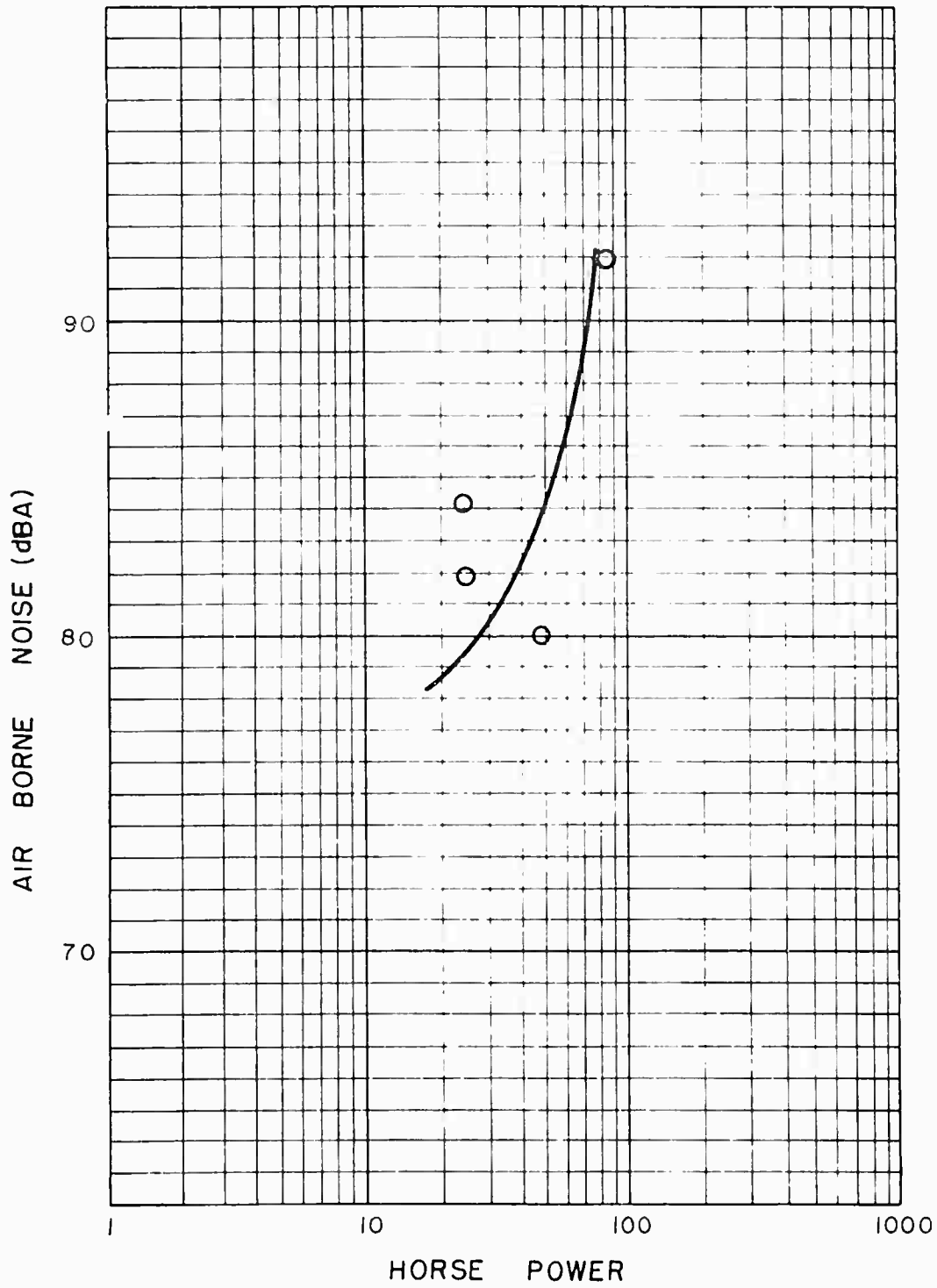

Fig. 6-1. Airborne Noise Level Versus Horsepower for Valve 2.

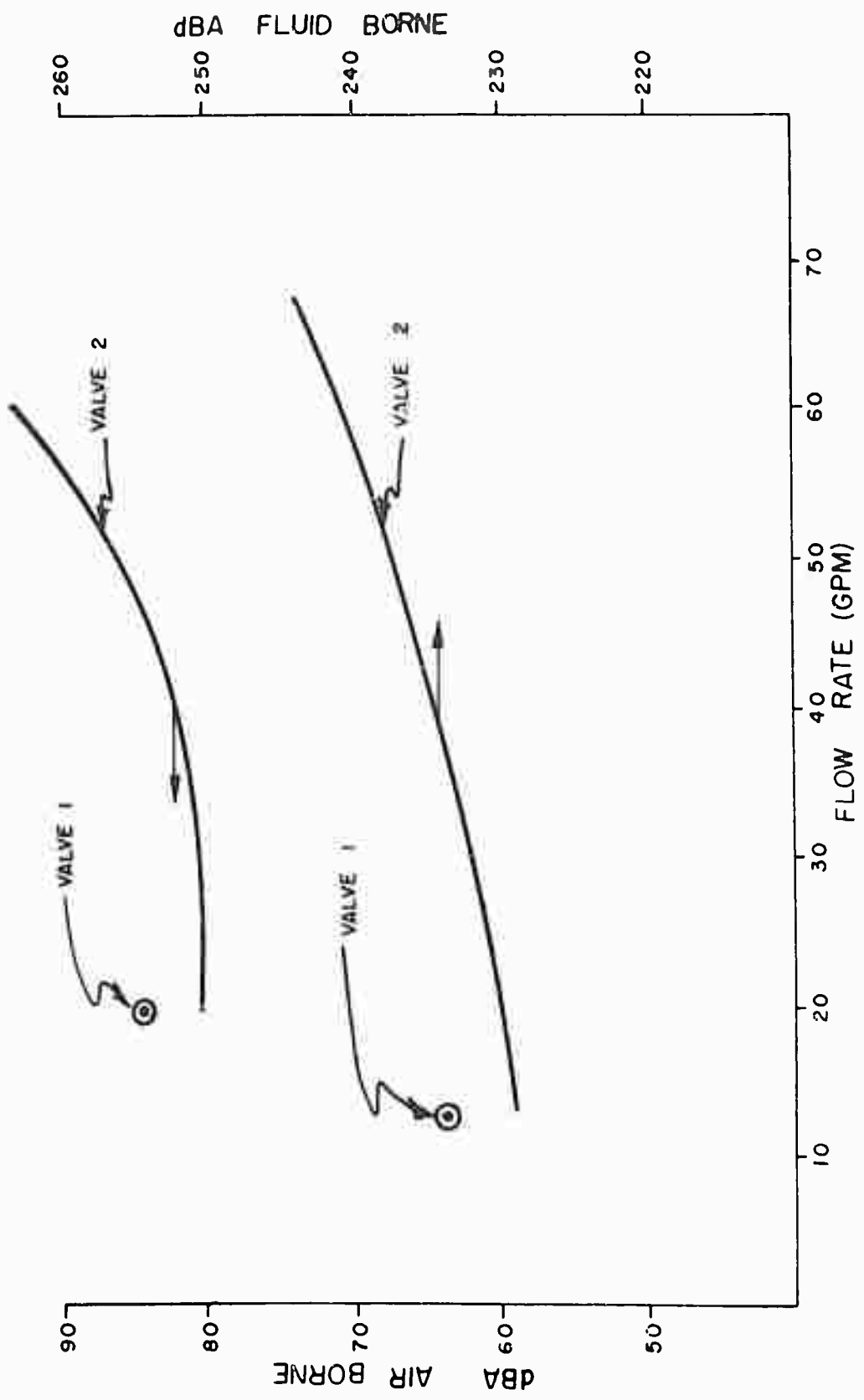

Fig. 6-2. Noise Levels of Fluid-Borne and Airborne Noise With Respect to Flow Rate.

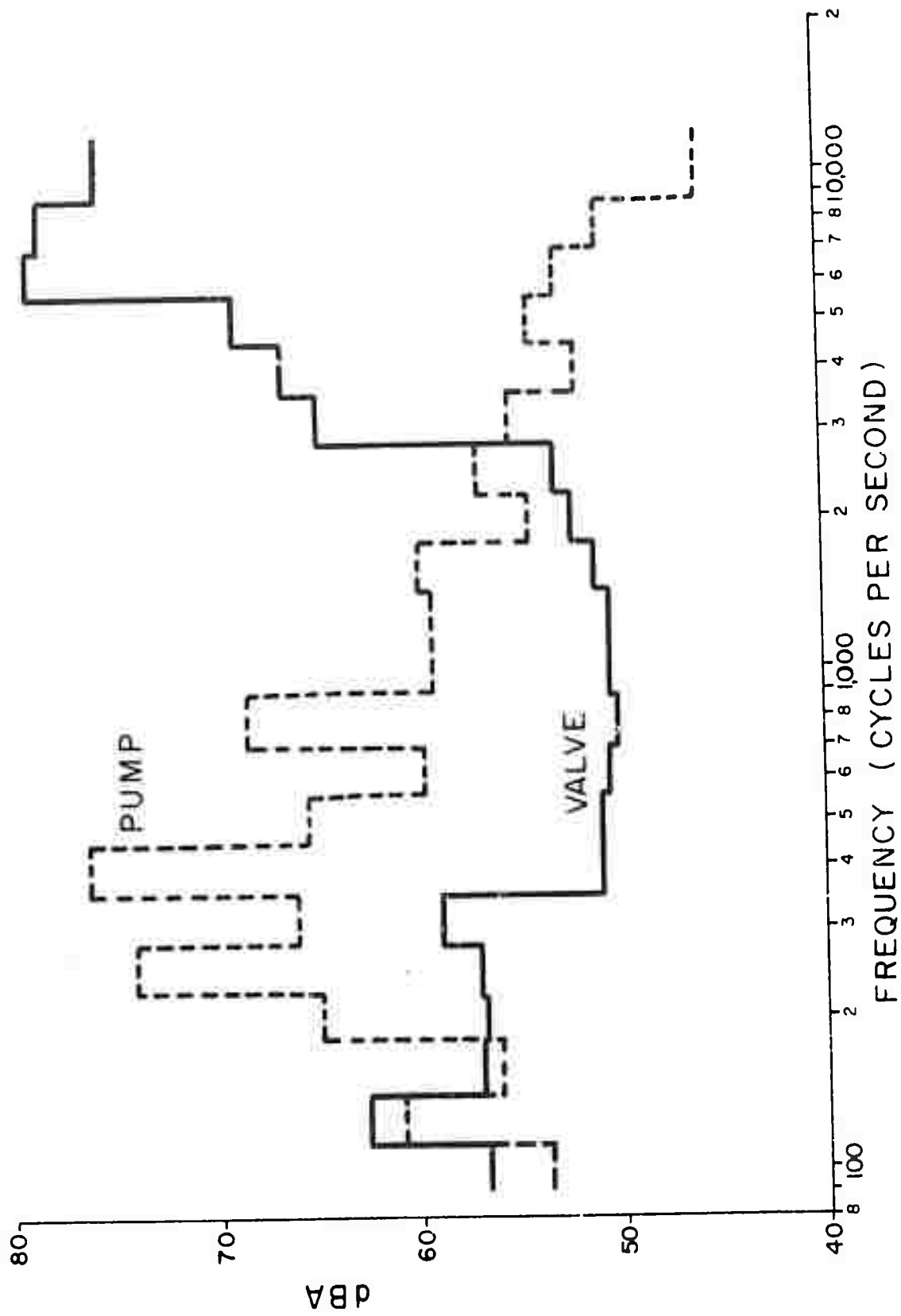

Fig. 6-3. Spectra of Pump and Valve Sound Power Levels.

VALVE NOISE CHART
FLUID POWER RESEARCH CENTER
OKLAHOMA STATE UNIVERSITY

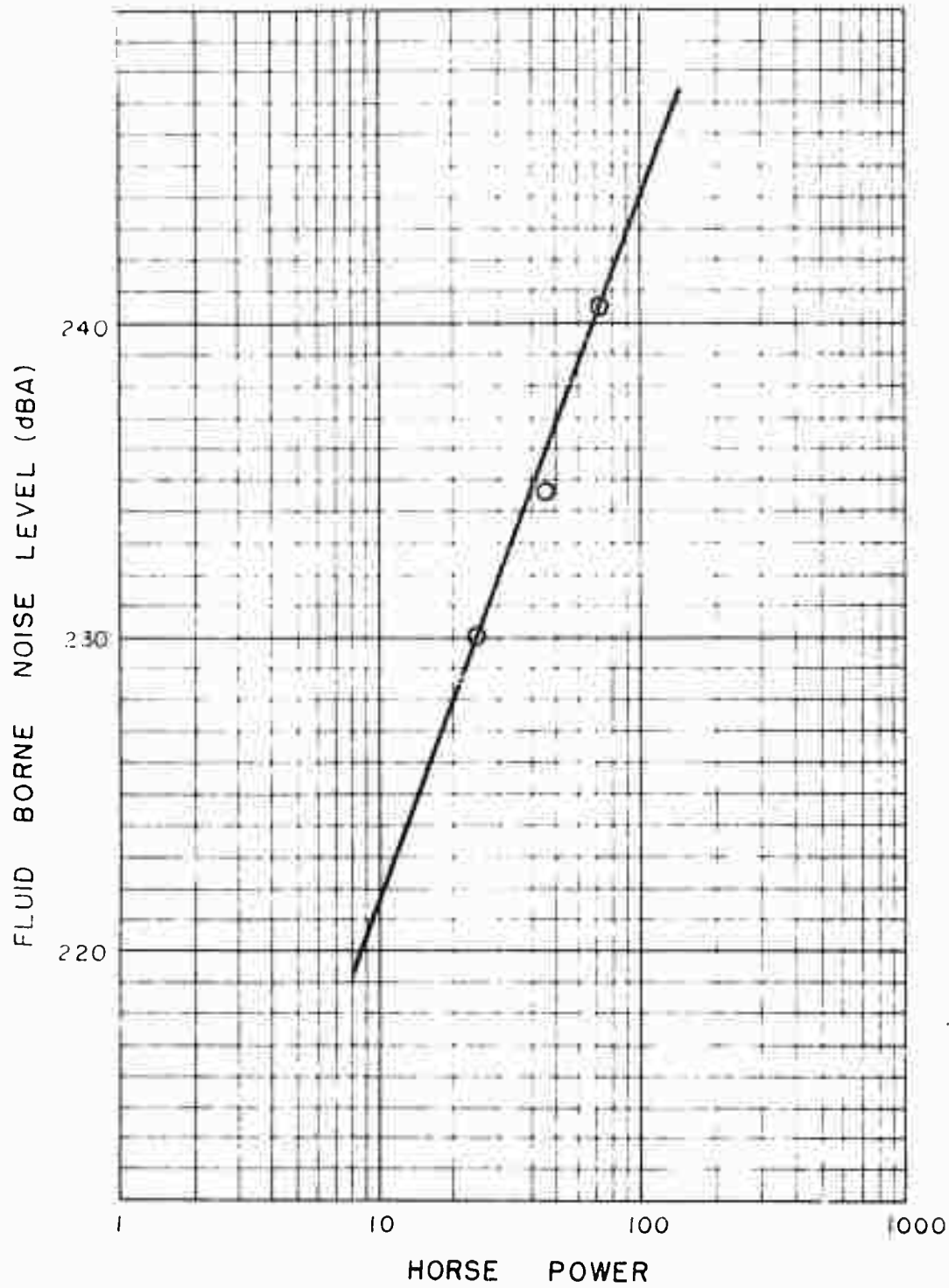

Fig. 6-4. Fluid-Borne Noise Levels Versus Horsepower for Valve 2.

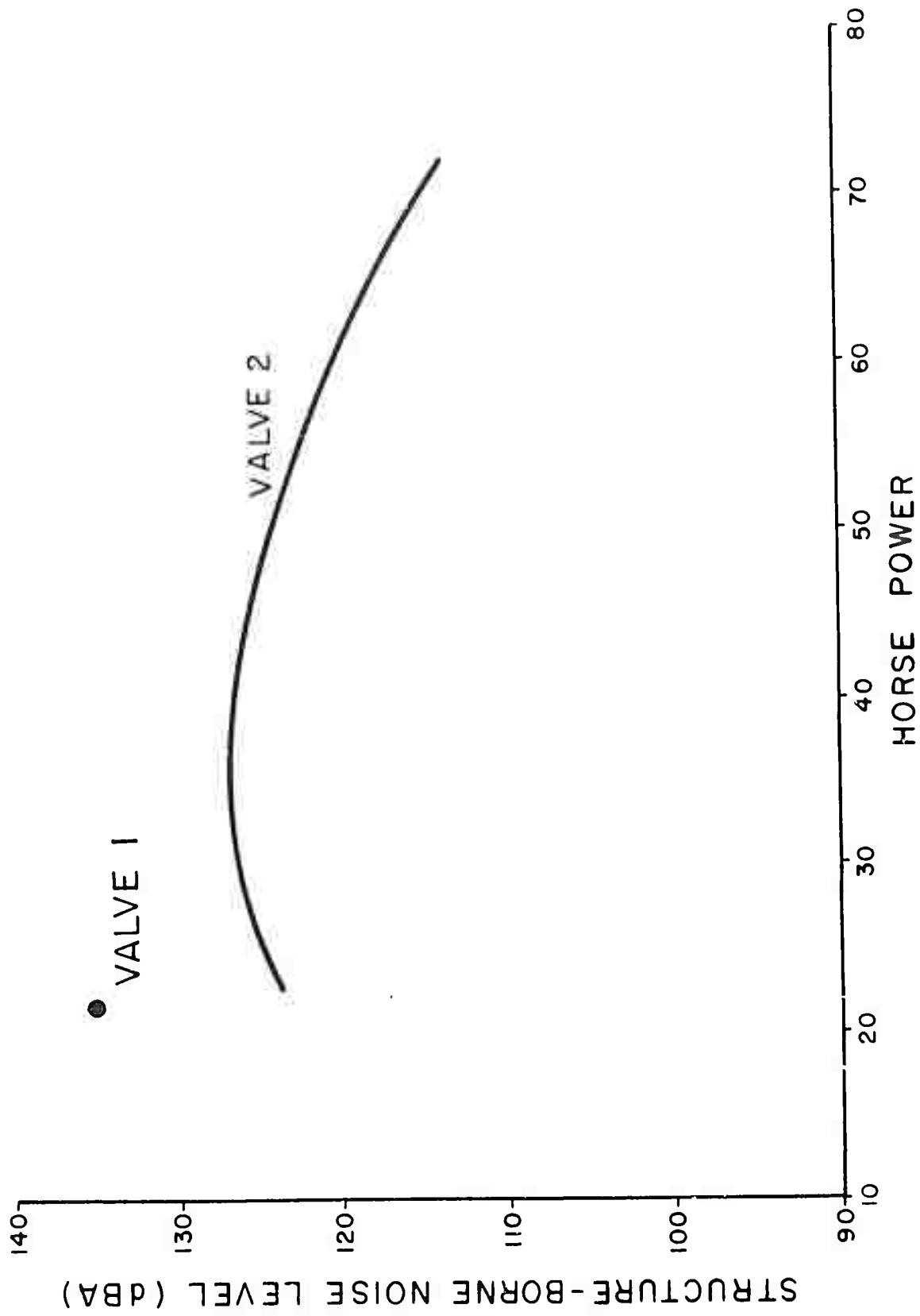

Fig. 6-5. Structure-Borne Noise Level Versus Horsepower.

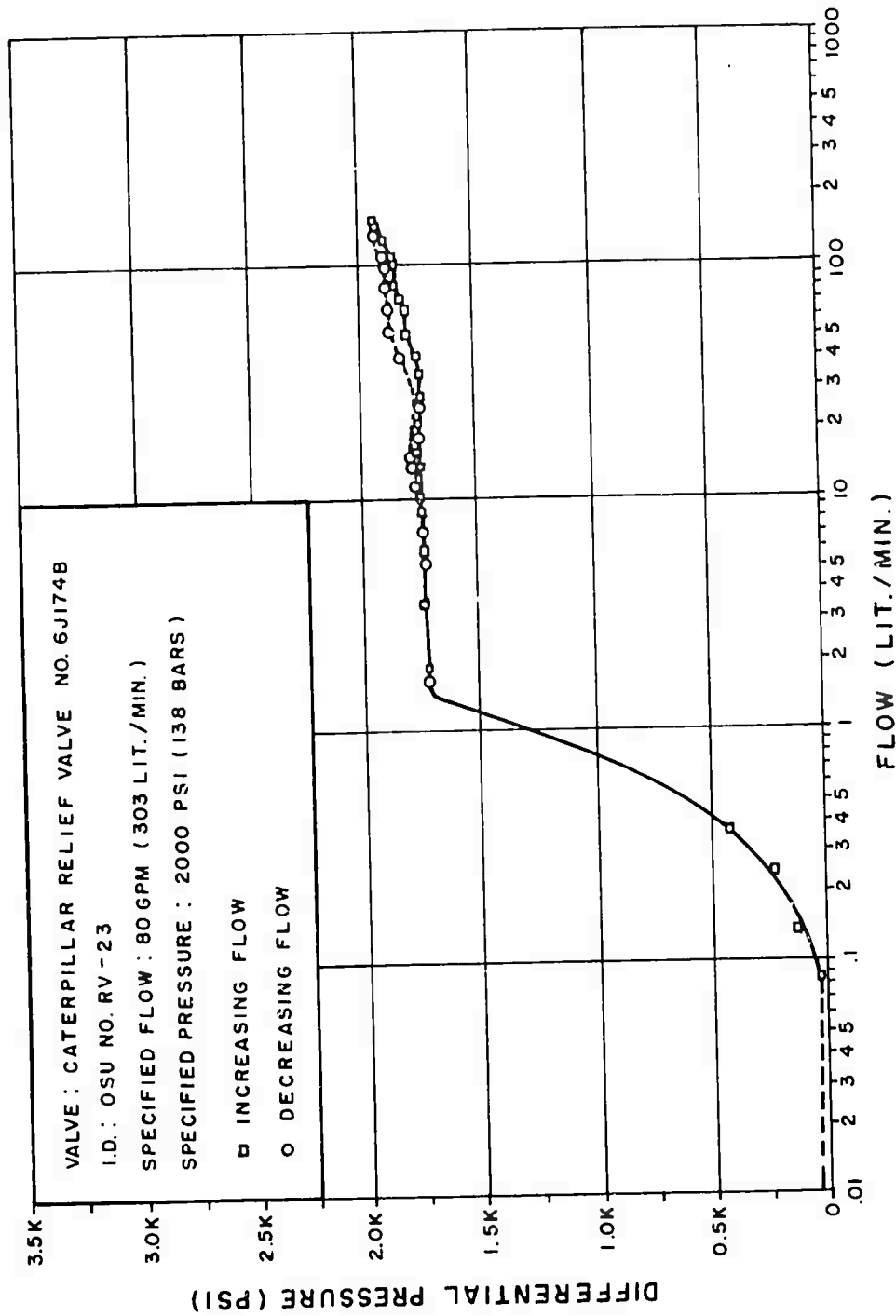

Fig. 6-6. Pressure-Flow Characteristics of Relief Valve 6J1746.

CHAPTER VII

PRACTICAL METHODS FOR REDUCING FLUID POWER SYSTEM NOISE

The material presented thus far in this report is the result of a study initiated by Oklahoma State University, Proposal No. ER 72-R-101, entitled "Proposal for a Study to Evaluate the Acoustical Characteristics of Selected Components in a Fluid Power System." This study ended on 1 June 1973. The noise program was extended from June 1 1973 to May 1974 under the same contract number. The proposed effort for this time period is contained in Oklahoma State University Proposal No. ER-73-R-54, "Proposal for a Study to Evaluate Practical Methods for Reducing and Predicting Fluid Power System Noise." This chapter contains a brief discussion of the proposed effort for the 1973-74 year and a tentative schedule for the individual areas of investigation. Table 7-1 lists the general areas that are to be studied, and figure 7-1 relates a proposed time schedule for each area.

Measurement of fluid-borne noise is a critical area of investigation for the next year. Several of the system oriented noise control efforts that are to be performed rely on the accurate and repeatable measurement of fluid-borne noise. New instrumentation has been obtained to aid during the measurement of fluid-borne noise. This instrumentation, when used with the theory mentioned in Chapter V and discussed in [9], shows promise of providing the accuracy and repeatability that must be attained to make a fluid-borne noise measurement procedure feasible. This instrumentation will be used during the evaluation of several fluid-borne noise attenuation devices. Both accumulator and "muffler" type fluid-borne noise attenuators have been purchased for evaluation and are projected to be tested in early December 1973.

TABLE 7-1: SUMMARY OF PROPOSED EVALUATIONS

<u>Topic Number</u>	<u>Title</u>
1	Fluid-borne Noise Measurement
2	Fluid-borne Noise Attenuation
3	Pump Sound Vs, % Air in Fluid
4	Reservoir Noise
5	Airborne Conduit Noise Isolation
6	Airborne Pump Noise Isolation
7	Pump Airborne Noise Model
8	System Airborne Noise Model

TOPIC NUMBER	1973								1974				
	JUN	JUL	AUG	SEP	OCT	NOV	DEC	JAN	FEB	MAR	APR	MAY	
1	■	■	■	■	■	■	■	■	■	■	■	■	
2													
3										■	■	■	
4										■	■	■	
5													
6											■	■	
7	■	■	■	■	■	■	■	■	■	■	■	■	
8	■	■	■	■	■	■	■	■	■	■	■	■	

Fig. 7-1. Proposed Schedule for 1973-1974 Areas of Investigation.

Air in hydraulic oil is a major problem in fluid power systems [3]. Due to its effect on the fluid properties of the oil, a change in the fluid properties can subject parts of the system to cavitation, causing them to fail prematurely. System control can be altered due to variations in compressibility of the fluid. And, the acoustical characteristics of the system can deviate from those expected from a system without air in the oil. Noticeable increases in the sound power of pumps have been observed upon introduction of air into the system. A quantitative analysis of this phenomenon will be initiated during the current fiscal year.

Large radiating surfaces provide efficient couplings to air for structure-borne and fluid-borne noise in fluid power systems. Hydraulic reservoirs provide the surface area necessary to act as an acoustic radiator. A reservoir from the 6000 lb rough terrain forklift has been obtained for testing at the Fluid Power Research Center. The reservoir will be evaluated to determine its acoustic radiation and modified to minimize that radiation. All modifications to the reservoir will be examined for their practicality as retrofit-type modifications to existing machines as well as production changes.

Recent investigations have shown that a great deal of airborne acoustic energy is radiated from the conduits in fluid power systems due mainly to the fluid-borne noise in the conduits. Until the fluid-borne noise can be reduced to an acceptable level, more expedient methods must be used to minimize the airborne noise radiated from the system. Several types of conduit isolation are being produced by industry. Those which appear to be suitable for use with hydraulic systems will be evaluated and compared with the laboratory isolation techniques and will be investigated for minimizing the directly radiated airborne noise from fluid power pumps.

The final area of investigation involves acoustically modeling both fluid power components and fluid power systems. This particular section of the overall program will be studied continually due to the applicability of each phase of the overall program on component and system modeling.

CHAPTER VIII

SUMMARY, CONCLUSIONS, & RECOMMENDATIONS

The results of this project provide the fluid power industry and the U.S. Army with several necessary tools for the control of fluid power system noise. Considerable importance has been given to the development of standard test procedures for the measurement of noise generated by fluid power systems. All three types of noise (ABN, FBN, & SBN) have been considered thus far in the OSU-MERDC Program. As mentioned previously, the most significant advances have been attained in the area of airborne noise measurement. An airborne noise test procedure has been developed by industry with the aid of project personnel and is being verified by project personnel.

The sound level ordering ability of this procedure has been evaluated for various fluid power components in the OSU-FPRC reverberant measurement facility. A program to determine the reproducibility of measurements taken in different facilities using the previously mentioned test procedure has been initiated. This program includes over 30 different facilities in the United States, Europe, and Japan. Fundamental investigations have been initiated to determine the most reliable measurement techniques to be used in subsequent fluid-borne and structure-borne noise measurement procedures.

A draft fluid-borne noise measurement procedure (Appendix G) is the result of these investigations.

Facility verification has been a necessary area of investigation to insure the accuracy and repeatability of acoustical measurements. The ISO procedures, when used as recommended, will provide repeatable measurements in a given facility. The reproducibility between facilities is being examined at present through the OSU-FPRC acoustical facility survey. (See Appendix D).

The components that have been successfully examined for this project include pumps, valves, and conduits. The program outlined for 1973-74 will extend the investigation of airborne noise emitted by fluid power components to hydraulic reservoirs.

Several conclusions may be drawn from the various areas investigated during the 1972-73 MERDC Program in acoustics:

1. An industrial accepted procedure for the measurement of directly emitted airborne noise from fluid power pumps has been developed and is being verified with the aid of project personnel. The procedure provides the capability of rank ordering fluid power components on an airborne noise basis.

2. The airborne noise measurement procedure for fluid power pumps can be extended for use with other fluid power components with proper engineering judgment.
3. The sound level radiated from an average pump out of the spectrum of fluid power pumps evaluated at the Fluid Power Research Center is comparable to the sound level radiated from an eight foot length of hydraulic hose. This indicates that the reduction and/or elimination of the fluid-borne noise in fluid power systems will produce significant decreases in fluid power system sound levels.
4. The use of a properly employed three-transducer measurement array should negate the standing wave deterrent to fluid-borne noise measurement.
5. The relief valve tested at the Fluid Power Research center produced total sound power levels in excess of 90 dBA when operating 25% below its rated flow rate. This excessive noise production has been observed to be commonplace for both relief valves and needle valves.

One of the major objectives of the FPRC-MERDC Acoustics Program is the development of fluid power acoustics to such a degree that component specifications for the purpose of fluid power system sound level reduction is practical. Many of the necessary building blocks to reach this objective have been constructed and discussed in this report. There are, however, several areas that must be investigated before reliable component specifications are realized. The following recommendations are directed toward reaching two objectives: 1) to make practical the specification of fluid power components based on their acoustical characteristics, and 2) to provide the fluid power industry with the tools that are necessary to produce quiet fluid power components and systems.

1. The current airborne test procedure should be examined to determine its ability to produce reproducible measurements between laboratories.
2. Continued effort should be concentrated on the development of a fluid-borne noise measurement procedure.
3. Isolation mechanisms which minimize ABN, FBN, and SBN paths should be investigated and evaluated for their applicability in fluid power systems.
4. The development of fluid power component noise models must be extended to all fluid power components.
5. The acoustical interaction of fluid power components should be investigated.
6. The results of recommendations 4 and 5 should be implemented

to produce a technique for predicting fluid power system sound levels from the acoustical characteristics of fluid power components or predicting the change in system sound level that can be expected from changing a given component.

APPENDIX A
SELECTED REFERENCES

SELECTED REFERENCES

1. Elliott, L. R., "Acoustical Diffusivity Theory," Basic Fluid Power Research Program Annual Report No. 6, Paper No. 72-AV-2B, Fluid Power Research Center, Oklahoma State University, September 1972.
2. Elliott, L. R., "Getting the Most From a Reverberant Noise Facility," Basic Fluid Power Research Program Annual Report No. 7, Paper No. P73-AV-6, Fluid Power Research Center, Oklahoma State University, September 1973.
3. Basic Fluid Power Research Program Annual Report Number 5, Section 71-2, "Contamination Control," July 1971, Chapter VII, Oklahoma State University
4. Wells, John R., "A Theoretical and Experimental Investigation of the Acoustical Characteristics of Fluid Power Conduit," Master's Report, July 1973, Oklahoma State University
5. Elliott, L. R., G. E. Maroney, and E. C. Fitch, "An Experimental Survey of Fluid Power Pump Sound Levels," 29th National Conference on Fluid Power, Cleveland, Ohio, 25-27 September 1973.
6. ISO Recommendation, Proposed, Draft International Standard ISO/DIS 2880. Acoustics - Determination of Sound Power Emitted by Small Noise Sources in Reverberation Rooms - Part I
7. ISO Recommendation, Proposed, Draft International ISO/DIS 2946. Acoustics-Determination of Sound Power Emitted by Small Noise Sources in Reverberation Rooms - Part II
8. "Hydraulic System Noise Study (U), "Section III, Annual Report No. FPRC-2M3, Prepared for the U.S. Army Mobility Equipment Research and Development Center, Ft. Belvoir, Virginia, Contract Nos. DAAK02-71-0074 and DAAK02-72-C-0172, November 1972
9. CONESCO, "Study of Fluid-Borne Noise and the Development of Fluid Acoustic Filter Test Specifications and Design Rules," Report to Department of the Navy Bureau of Ships Code 648, Report No. F-121-1, May 1964, (AD443713)

APPENDIX B
INSTRUMENTATION

INSTRUMENTATION

I. GENERAL RADIO

A.	1521-A.....	Strip Chart Recorder
B.	1523.....	Level Recorder
C.	1523-P1.....	Preamplifier Plug In
D.	1523-P3.....	1/3 Octave band Analyzer
E.	1523-9621.....	25 dB Potentiometer
	1523-9622.....	50 dB Potentiometer
	1523-9624.....	100 dB Potentiometer
F.	1560-9531.....	Microphone
G.	1560-9580.....	Tripod
H.	1560-9666.....	Microphone Cable
I.	1560-P13.....	Vibration Pickup System
J.	1560-P42.....	Microphone Preamplifier
K.	1562-A.....	Sound Level Calibrator
L.	1382.....	Random Noise Generator
M.	1910A.....	Recording Wave Analyzer
N.	1933.....	Precision Sound Level Meter and Octave Band Analyzer
O.	135A.....	X-Y Recorder
P.	130BR.....	Oscilloscope
Q.	400 LR.....	Vacuum Tube Voltmeter

II. HEWLETT PACKARD

A.	3300-A.....	Function Generator
B.	205AG.....	Signal Generator
C.	202CR.....	Signal Generator
D.	410B.....	Vacuum Tube Voltmeter

III. BRUEL & KJAER

A.	2107.....	Frequency Analyzer
----	-----------	--------------------

IV. BOGEN

A.	CH13-35A.....	Amplifier
----	---------------	-----------

V. TEKTRONIX

A.	502.....	Dual-Beam Oscilloscope
B.	RM31A.....	Oscilloscope

VI. PCB PIEZOTRONICS, INC.

A.	118A02.....	Quartz Crystal Pressure Transducer
----	-------------	---------------------------------------

- B. 402A.....Pressure Amplifier
- C. 482-A.....ICP Power Supply
- D. 483A02.....ICP Power Supply

VII. BELL & HOWELL

- A. 4-402-0001.....Pressure Transducer

VIII. DAYTRONIC

- A. Type 91.....Strain Gauge Transducer
Input Module
- B. Model 300.....Transducer Amplifier
Indicator
- C. Type P.....Galvanometer Driver Output
Module

IX. KENWOOD

- A. KA-4004.....Amplifier

X. TEAC

- A. 1230.....Tape Deck

XI. BECKMAN

- A. 7370R.....Universal EPJT Meter

XII. KROHN-HITE

- A. 44CAR.....Oscillator

XIII. RUTHERFORD

- A. B7B.....Pulse Generator

XIV. ACTION LABORATORIES, INC.

- A. 328-A.....Phase Angle Meter

APPENDIX C
ISOLATION MATERIALS

ISOLATION MATERIAL

The following materials are being used to acousitcally treat fluid lines, pump mounts, pump drive systems, and the drive support system:

1. "Duct Board" -- Rigid fiberglass with aluminum back.
Owens-Corning Type 475-FR(SD)
2. Leaded Vinyl -- John Schneller & Associates, Sound/Eaze
TLB-M, TLB-L
3. Leaded Vinyl -- Singer Partitions, Inc.; Super Sound Stopper
4. Aluminum Foil Reinforced₃Insulation -- Supplier, L. A. King
Co.; Type MRA; 0.6 lb/ft³, 1 in insulation with foil scrim
kraft, light duty, NFBU rated, manufactured by Certainteed
-- St. Gobain
5. Foamrubber -- 2 in Thick, 21 oz/ft³ (21,000 gm/m³)
6. High Temperature Damping Compound #70305 -- Sound Solutions
% Ponto Sales Engineers, Tulsa
7. Pipe and Valve Covering 1#/ft² -- Sound Solutions % Ponto
Sales Engineers, Tulsa
8. Sound Off (Damping Material) -- Sound Solutions % Ponto
Sales Engineers, Tulsa
9. Dee Bee Dropper #20221 -- Sound Solutions % Ponto Sales
Engineers, Tulsa.

APPENDIX D
ACOUSTICAL FACILITY SURVEY

ACOUSTICAL FACILITY SURVEY

Concurrent operation of two acoustical surveys has taken place during the last year at Fluid Power Research Center. The survey of fluid power pump sound levels is presented in Chapter IV. This appendix deals with the second survey, which will provide data that will describe the amount of correlation that can be expected from measurements of the same source in different laboratories. An electronic source has been designed and constructed at the Fluid Power Research Center to be used as the common source to be tested by all survey participants.

The function of the electronic noise source (ENS) is to produce a constant sound level in three different modes; namely, broad band, pure tone, and oscillating pure tone. The electronic stability for the source has been evaluated to be approximately 1.12%. A list of electronic components for the ENS and a schematic have been provided in this appendix.

The acoustical facility survey participants include organizations from Japan, Germany, England, Scotland, and France. Data that have been received shows the white noise standard deviation to be 0.36 dBA, and the pure tone standard deviation to be 2.1 dB.

LIST OF ELECTRONIC COMPONENTS

<u>Component</u>	<u>Manufacturer</u>	<u>Model Number</u>
Power Supply	ACDE Electronics, Inc.	OA15D1 .1-1
Power Supply	Elgenco	3609-A
White Noise Generator	Elgenco	3606A55124
Low Frequency Oscillator	W. H. Ferwalt, Inc.	SP01088
Voltage Controlled Oscillator	W. H. Ferwalt, Inc.	VC068513
Operational Amplifiers	Analog Devices	144A
Audio Amplifier	Arvee Engineering	202
Speaker	Altec Lansing	755-E

CORRESPONDENCE LIST FOR ACOUSTIC FACILITY SURVEY

Dr. D. Unruh
Cessna Fluid Power Division
P. O. Box 1028
Hutchinson, Kansas 67501

Mr. B. Coats
Vehicle Components Division
Technical Center, Bldg. G
Caterpillar Tractor Co.
100 N. E. Adams Street
Peoria, Illinois 61602

Mr. J. Bolinger
Sundstrand Hydro-Transmission
2800 East 13th Street
Ames, Iowa 50010

Mr. T. A. Klausung
Denison Research Center
P. O. Box 1230
Columbus, Ohio 43216

Mr. C. T. Caliri
Cincinnati Milacron, Inc.
4701 Marburg Avenue
Cincinnati, Ohio 45209

Mr. G. A. Morrell
Clark Equipment Co.
P. O. Box 188
Cassopolis, Michigan 49031

Mr. H. N. Underwood
Borg-Warner Corporation
Roy C. Ingersoll Research Center
Wolf and Algonquin Roads
Des Plaines, Illinois 60018

Mr. Z. J. Lansky
Parker-Hannifin Corporation
17325 Euclid Avenue
Cleveland, Ohio 44112

Mr. W. R. Brown
Eaton Corporation
Research Center
26201 Northwestern Highway
Southfield, Michigan 48076

Mr. T. Kostek
Commercial Shearing, Inc.
1775 Logan Avenue
Youngstown, Ohio 44501

Mr. J. Harris
J. I. Case Company
CC 124
Environmental & Electric Labor-
atory

Corporate Test Center
24th & Center Streets
Racine, Wisconsin 53403

Mr. W. C. Smith
IBM Corporation
Dept. 447, Bldg. 030-1
Rochester, Minnesota 55901

Mr. J. Hayes
Cummings Engine Co.
Technical Center
1900 McKinley Avenue
Columbus, Indiana 47201

Mr. F.A.M. Willekens
afd. Werktuigbouwkunde
Technische Hogeschool
Eindhoven, The Netherlands

Mr. F. W. Baggett
Serck Developments
Gloucester Trading Estate
Hucclecote
Gloucester GL3 4XE
England

Correspondence List for Acoustic Facility Survey

Professor D. McCandlish
Bath University
Bath, England

Mr. J. Currie
Special Projects Division
Department of Trade & Industry
National Engineering Laboratory
East Kilbride
Glasgow G75 0QU
Scotland

Professor H. K. Müller
University of Stuttgart
Stuttgart
German Federal Republic

Dr. Wilhelm Grotheer
Robert Bosch GmbH
Technisch-Wissenschaftlicher Mitarbeiter
Leiter der Abteilung ARustik
7016 Gerlingen-Schillerhöhe
Robert-Bosch-Platz 1
German Federal Republic

Mr. G. JeMontille
GETIM
2 Av. Felix Louat 60304
Senlis, France

Dr. Shigen Tsuji
Professor of Engineering
Tokyo Institute of Technology
12-2 Ookayama
Meguro-Ku, Tokyo, Japan

Mr. Kendall McBroom
Project Engineer
Advance Products
CORAD Division
Donaldson Company, Inc.
1400 West 94th Street
Minneapolis, Minnesota 55440

Mr. James R. McBurnett
Chief Analytical Engineer
Tyrone Hydraulics, Inc.
P.O. Box 511
Corinth, Miss. 38834

Mr. J. W. Broome
Vice President of Engineering
Racine Hydraulics & Machinery Inc.
2000 Albert Street
Racine, Wisconsin 53404

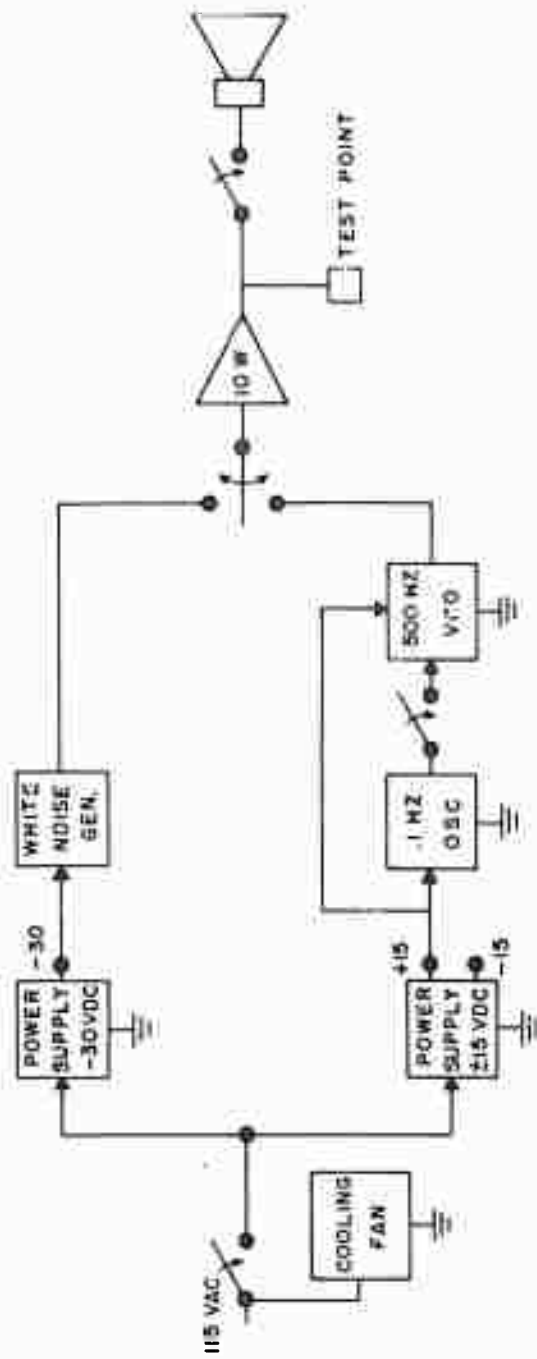

Fig. D-1. Schematic of Electronic Noise Box (ENB).

APPENDIX E

A USER'S GUIDE TO THE ACOUSTICAL DATA REDUCTION PROGRAMS

A USER'S GUIDE TO THE ACOUSTICAL DATA REDUCTION PROGRAMS

Calculations in acoustical data reduction require many detailed and repetitive steps to be accurate. Because of the tremendous flow of noise data through the OSU-FPRC acoustics laboratory, the use of the computer in this capacity has become a necessity.

Three programs are given in this user's guide -- one for each of fluid-borne, structure-borne, and airborne noise. The input data to be used consist of noise levels taken from a third-octave band analyzer at the 21 center frequencies between 100 and 10,000 Hz. The program will average, on a power basis, up to ten sets of measured source levels and up to tens sets of reference or background data. The programs are consistent with each other in general form and appearance of output. Each program is written in the FORTRAN IV language for use on the IBM 360/65 system.

The airborne noise data reduction program is longer than the other two due to the large number of background corrections necessary. The procedure it uses complies to the current ISO proposed test codes for reverberant environment testing. The airborne noise program computes the corrected values for sound power, total A-weighted sound power, and A-weighted sound pressures at three feet from the source in a free field over a reflecting plane.

The fluid-borne noise program corrects the measured noise levels with instrumentation background noise data and the correction factor for the dynamic pressure transducer. This program then computes A-weighted power and pressure levels relative to $20\mu\text{N/m}^2$. This is consistent with the techniques for airborne noise data reduction and aids in the derivation of transfer functions from fluid-borne to airborne noise.

The structure-borne noise program also uses instrumentation background noise and transducer correction factors to correct the input. Acceleration levels are read into the program to compute displacement, velocity, and acceleration for each 1/3 octave frequency, as well as total vibrational levels.

- COMPUTATIONAL PROCEDURE -

The method of data reduction for airborne and fluid-borne noise is illustrated and explained in detail along with similar programs in Ref. [8] and will not be discussed here.

The input for the structure-borne noise program consists of acceler-

ation levels taken from 1/3 octave band analyzer, correction factors for the transducer at each frequency, and a conversion factor of the transducer for converting output voltage to meters/second². The acceleration levels are first converted from decibels to an output voltage level using the formula :

$$A = (5 \times 10^{-6}) 10^{a/20}$$

Where: A = acceleration output voltage from transducer
a = acceleration input level from 1/3 octave analyzer in decibels

The levels for the vibrational source and background noise are both converted to power. Then, the vibrational source levels are corrected using the noise levels and transducer and correction factors with:

$$CA = (1 + UP) (VIB - B)$$

Where: CA = corrected acceleration output voltage
UP = transducer correction factor
VIB = vibrational source acceleration output voltage from transducer
B = background acceleration output voltage from transducer

If the background noise level is greater than or equal to the vibrational source level, then CA is set to the minimum measurable acceleration level. The voltage-to-acceleration transducer factor is then divided into these values. Then, using the basic formula for converting vibrational acceleration to velocity and displacement, the values are divided by their frequency, once for velocity and twice for displacement. The decibel quantities are then found relative to 10^{-5} m/s² for acceleration, 10^{-8} m/s for velocity, and 10^{-11} m for displacement.

- PROGRAM MODIFICATIONS -

All of the programs can be modified to reduce noise data from any source as long as the input data are of the right form. For example, if one were reducing airborne noise data from a relief valve, the appropriate correction factors in the data file, such as drive shaft noise, should be set to zero.

The structure-borne noise program uses a "voltage-to-acceleration" transducer correction factor. If a transducer is used which reads directly in acceleration on the 1/3 octave analyzer, this factor should be set to unity.

- PROGRAM IMPLEMENTATION -

Each program has two main parts -- the program and the data file.

The data file can be stored at the end of the program, or it can be stored separately and run together with the program. This is more acceptable if many runs are to be made with limited storage space. If disc storage is available, all comment cards should be removed and the program modified so that the data file will automatically call the program when it is run. The data file for this purpose is named a "calling program" and is a regular data file with the job control statements preceding the data. If a great quantity of data needs to be reduced regularly, this is by far the most economical way.

The programs used at the OSU-FPRC acoustics laboratory are used mainly with a disc-stored program and calling program. However, the same programs with separate data files are stored in the library for occasional modifications and listings. The relationships of the programs and the name of the programs are shown in Table E-1. Note that the programs on disc are not worked with after they are stored but are called by their respective calling program.

Listings of all of the programs and data files are presented in the remainder of this appendix. A listing of the disc-loading routine and disc-calling program are also included.

TABLE E-1

ACOUSTICAL DATA REDUCTION ROUTINES AND CALLING PROGRAMS

Purpose of Program	Main Program Stored in Library	Data File Stored in Library For Main Program	Main Program on Disc	Calling Program
Airborne* Noise	NOISY	abn ##	AIR	air ##
Fluid-borne Noise	PULSY	fbn	PSI	psi
Structure-borne Noise	SHAKY	sbn	VIB	vib

*The suffix "##" stands for the RPM of the system (in hundreds) on which the data file should be used. The data files will be different for different speeds because of the drive system background noise data and correction factors.

Main Program
NOISY
for
ABN Data Reduction

Preceding page blank

	DIMENSION A(21,10),LUB(21,10),LPH(21,10),C(21),P(21),T(21),	00000050
	1VC(21),BO(21),LO(21),BOP(21),HP(21),LP(21),CP(21),CO(21),DO(21),	00000060
	2DP(21),D2(21),E(21),FP(21),FP(21),D1(21),B1(21),B1P(21),D1P(21)	00000070
	3,GP(21),GU(21),HC(21),HP(21),DAP(21),T1(21),T1P(21),OP(21),OO(21)	00000080
	4),PQ(21),PP(21),HAP(21),QP(21),QJ(21),AP(21),RQ(21),RP(21),SP(21)	00000090
	5) SO(21),BAN(21),SOA(21),SDP(21),XP(21),XO(21),R2P(21),	00000100
	R2D(21),R2DP(21),KP(21),KO(21),RS(21)	00000110
	DOUBLE PRECISION A,LUB,LRH,C,P,TO,VO,BO,LO,BOP,BP,LP,CP,CO,	00000120
	100, OP,D2,EO,EP,FP,D1,B1,H1P,D1P,GP,GJ,HO,HP,DAP,T1,T1P,OP,OO,	00000130
	2PO,PP,HAP,QP,QJ,AP,RQ,RP,SP,SO,BAC,SAU,SDP,XP,XO,B2P,SPT,DB,	00000140
	3TP,DBT,R2D,R2DP,KP,KO,RS	00000150
C	-----	00000160
C	READ THE 1/3 OCTAVE CENTER FREQUENCIES TO BE	00000170
C	USED IN THIS PROGRAM	00000180
C	-----	00000190
C		00000200
C	READ(5,20)(A(I,1),I=1,21)	00000210
	20 FORMAT(7F10.3)	00000220
	CONTINUE	00000230
C		00000240
C	-----	00000430
C	THE NEXT 21 NUMBERS ARE THE SOUND POWER CALIBRATION	00000450
C	VALUES. A(I,4) BEING THOSE USED FOR CORRECTING THE UNKNOWN,	00000460
C	AND RS(I) BEING THOSE USED TO CORRECT ALL OTHER MEASUREMENTS.	00000461
C	-----	
C	READ(5,20)(A(I,4),I=1,21)	00000480
	CONTINUE	00000490
	READ(5,20)(RS(I),I=1,21)	00000500
C		00000510
C	-----	00000710
C	THE NEXT 21 NUMBERS ARE THE CORRECTION FACTORS	00000720
C	USED TO CONVERT TO DBA	00000730
C	-----	00000740
C		00000750
C	READ(5,20)C(I),I=1,21)	00000760
	CONTINUE	00000770
C		00000970
C	-----	00000990
C	READ IN (N) AND (M) WHERE (N) IS THE NUMBER OF	00000990
C	MEASUREMENTS OF THE UNKNOWN SOURCE TO BE AVERAGED AND	00001000
C	(M) IS THE NUMBER OF MEASUREMENTS OF THE REFERENCE	00001010
C	SOURCE TO BE AVERAGED	00001020
C	-----	00001030
C		00001040
C		00001050
C	READ(5,10)N,M	00001060
C	-----	00001070
C	READ THE VALUES FOR THE FLUID POWER SYSTEM PARAMETERS	00001080
C	NP=OSU PUMP NUMBER, NPR=SYSTEM PRESSURE, NI=INLET	00001090
C	PRESSURE, NS= SYSTEM RPM, FR=FLUID RATE, TFM= SYSTEM	00001100
C	TEMPERATURE	00001110
C	-----	00001120
C		00001130
C		00001140
C	READ(5,25)NP	00001150
	READ(5,25)NPR	00001160

	READ(5,25)NI	00001170
	PFAD(5,25)NS	00001180
	READ(5,28)FR	00001190
	READ(5,28)TEM	00001200
25	FORMAT(15)	00001210
28	FORMAT(F5.1)	00001220
26	FORMAT(25X,29HSYSTEM PARAMETERS FOR OSU-NP-,12)	00001230
10	FORMAT(215)	00001240
C	-----	00001250
C	READ THE VALUES FOR THE UNKNOWN SOURCE (LUB)	00001260
C	-----	00001270
C	READ(5,20)((LUB(I,J),I=1,21),J=1,N)	00001280
	IF(N.EQ.1)GO TO 21	00001290
C	-----	00001300
C	COMPUTE THE AVERAGE OF (N) MEASUREMENTS OF (LUB)	00001310
C	-----	00001320
	DO 40 I=1,21	00001330
	AV=0.0	00001340
	DO 30 J=1,N	00001350
	AV=AV+LUB(I,J)	00001360
30	CONTINUE	00001370
	A(I,2)=AV/N	00001380
40	CONTINUE	00001390
	GO TO 45	00001400
21	DO 22 I=1,21	00001410
	A(I,2)=LUB(I,1)	00001420
22	CONTINUE	00001430
C	-----	00001440
C	READ THE VALUES FOR THE REFERENCE SOURCE (LRB)	00001450
C	-----	00001460
C	45 READ(5,20)((LRB(I,J),I=1,21),J=1,M)	00001470
C	-----	00001480
C	READ THE VALUES FOR THE OUTSIDE SOUND LEVEL (T1)	00001490
C	-----	00001500
C	READ(5,20)(T1(I),I=1,21)	00001510
	IF(M.EQ.1)GO TO 23	00001520
C	-----	00001530
C	COMPUTE THE AVERAGE OF (M) MEASUREMENTS OF (LRB)	00001540
C	-----	00001550
	DO 70 I=1,21	00001560
	AB=0.0	00001570
	DO 60 J=1,M	00001580
	AB=AB+LRB(I,J)	00001590
60	CONTINUE	00001600
	A(I,3)=AB/M	00001610
70	CONTINUE	00001620
	GO TO 75	00001630
23	DO 24 I=1,21	00001640
		00001650
		00001660
		00001670
		00001680
		00001690
		00001700
		00001710
		00001720
		00001730
		00001740
		00001750

	A(I,3)=LRB(I,1)	00001760
	24 CONTINUE	00001770
C	-----	00001780
C	READ THE TRANSMISSION LOSS FOR THE ROOM WALL (TO)	00001790
C	-----	00001800
C		00001810
C	75 READ(5,20)(TO(I),I=1,21)	00001820
C	-----	00001830
C		00001840
C	READ THE VANE BACKGROUND (VO)	00001850
C	-----	00001860
C		00001870
C	READ(5,20)(VO(I),I=1,21)	00001880
C	-----	00001890
C		00001900
C	READ THE BUILDING BACKGROUND (BO)	00001910
C	-----	00001920
C		00001930
C	READ(5,20)(BO(I),I=1,21)	00001940
C	-----	00001950
C		00001960
C	READ THE REFERENCE SOURCE FOR CORRECTING (VO) AND (BO)	00001970
C	-----	00001980
C		00001990
C	READ(5,20)(LO(I),I=1,21)	00002000
C	-----	00002010
C		00002020
C	READ THE DRIVE BACKGROUND IN THE ROOM (D2)	00002030
C	-----	00002040
C		00002050
C	READ(5,20)(D2(I),I=1,21)	00002060
C	-----	00002070
C		00002080
C	READ THE DRIVE BACKGROUND OUTSIDE OF THE ROOM (D1)	00002090
C	-----	00002100
C		00002110
C	READ(5,20)(D1(I),I=1,21)	00002120
C	-----	00002130
C		00002140
C	READ THE BUILDING BACKGROUND OUTSIDE OF THE ROOM (B1)	00002150
C	-----	00002160
C		00002170
C	READ(5,20)(B1(I),I=1,21)	00002180
C	-----	00002190
C		00002200
C	READ THE REFERENCE SOURCE FOR CORRECTING (D2)	00002210
C	-----	00002220
C		00002230
C	READ(5,20)(R2D(I),I=1,21)	00002240
C	-----	00002250
C		00002260
C	COMPUTE THE SOUND POWER OF THE UNKNOWN SOURCE IN DBA	00002270
C	-----	00002280
C		00002290
C	DO 80 I=1,21	00002300
C	R2DP(I)=10.**((R2D(I)-74.)/10.)	00002310
C	B7P(I)=B0(I)+RS(I)-L0(I)	00002320
C		00002330

BP(I)=10.**((BOP(I)-74.)/10.)	00002340
KP(I)=R2DP(I)-BP(I)	00002350
LP(I)=10.**((LO(I)-74.)/10.)	00002360
CP(I)=LP(I)-BP(I)	00002370
IF(BP(I).GE.LP(I))CP(I)=1.0/10.**3.5	00002380
CO(I)=10.*DLOG10(CP(I))+74.	00002390
DO(I)=V7(I)+RS(I)-CO(I)	00002400
DP(I)=10.**((DO(I)-74.)/10.)	00002410
B2P(I)=DP(I)	00002420
XP(I)=LP(I)-B2P(I)	00002430
IF(B2P(I).GE.LP(I))XP(I)=1.0/10.**3.5	00002440
XU(I)=10.*DLOG10(XP(I))+74.	00002450
KO(I)=10.*DLOG10(KP(I))+74.	00002460
EO(I)=C2(I)+RS(I)-KO(I)	00002470
FP(I)=10.**((EO(I)-74.)/10.)	00002480
BP(I)=FP(I)-B2P(I)	00002490
IF(B2P(I).GE.FP(I))FP(I)=1.0/10.**3.5	00002500
DIP(I)=10.**((DI(I)-74.)/10.)	00002510
B1P(I)=10.**((B1(I)-74.)/10.)	00002520
IP(I)=DIP(I)-B1P(I)	00002530
IF(DIP(I).GE.DIP(I))IP(I)=1.0/10.**3.5	00002540
GO(I)=10.*DLOG10(IP(I))+74.	00002550
HO(I)=GO(I)-TO(I)	00002560
HP(I)=10.**((HO(I)-74.)/10.)	00002570
DAP(I)=FP(I)-HP(I)	00002580
IF(HP(I).GE.FP(I))DAP(I)=1.0/10.**3.5	00002590
TIP(I)=10.**((TI(I)-74.)/10.)	00002600
CP(I)=TIP(I)-B1P(I)	00002610
IF(B1P(I).GE.TIP(I))CP(I)=1.0/10.**3.5	00002620
OP(I)=10.*DLOG10(CP(I))+74.	00002630
PO(I)=OO(I)-TO(I)	00002640
PP(I)=10.**((PO(I)-74.)/10.)	00002650
BAP(I)=PP(I)+DAP(I)+B2P(I)	00002660
AP(I)=10.**((AI(I,3)-74.)/10.)	00002670
JP(I)=AP(I)-B2P(I)	00002680
IF(B2P(I).GE.AP(I))JP(I)=1.0/10.**3.5	00002690
QP(I)=10.*DLOG10(JP(I))+74.	00002700
RO(I)=A(I,2)+A(I,4)-OO(I)	00002710
RP(I)=10.**((RO(I)-74.)/10.)	00002720
SP(I)=RP(I)-BAP(I)	00002730
IF(BAP(I).GE.RP(I))SP(I)=1.0/10.**3.5	00002740
A(I,5)=A(I,4)-OO(I)	00002750
SO(I)=10.*DLOG10(SP(I))+74.	00002760
A(I,6)=SO(I)	00002770
HAO(I)=10.*DLOG10(BAP(I))+74.	00002780
A(I,7)=HAO(I)	00002790
P(I)=A(I,6)-7.0	00002800
A(I,10)=A(I,6)*C(I)	00002810
A(I,9)=(10.**((A(I,10)/10.))/10.**12.	00002820
A(I,8)=OO(I)	00002830
A(I,11)=A(I,1)	00002840
SOA(I)=SO(I)+C(I)	00002850
SOP(I)=(10.**((SOA(I)/10.))/10.**12.	00002860
HO CONTINUE	00002870
TP=0.0	00002880
SPT=0.0	00002890
DB=0.0	00002900
DD 90 I=1,21	00002910

```

SPT=SPT+SP(I)
DB=DB+A(I,10)
TP=TP+SOP(I)
90 CONTINUE
DBT=10.*DLOG10(SPT)+74.
DBA1=10.*DLOG10(TP*10.**12.)
DB7=DBA1-7.0
PPS=NPR
HPR=(PRS*FR)/1714.
-----
PRINT THE OUTPUT TABLE FOR THE UNKNOWN SOURCE (LUB)
-----
WRITE(6,150)
WRITE(6,150)
WRITE(6,160)
WRITE(6,170)
WRITE(6,120)
WRITE(6,130)
WRITE(6,120)
WRITE(6,100)((A(I,J),J=1,11),I=1,21)
WRITE(6,120)
WRITE(6,135)DBT
WRITE(6,133)TP
WRITE(6,140)DBA1
WRITE(6,136)DB7
WRITE(6,120)
WRITE(6,20)NPR
WRITE(6,20)HPR
WRITE(6,27)NPR,NI,NS,FR,TFM
WRITE(6,120)
WRITE(6,125)
100 FORMAT(1X,F6.0,3F7.1,F6.1,3F7.1,3X,08.2,F7.1,2X,F6.0)
120 FORMAT(1X,8JH-----)
1-----)
125 FORMAT(////)
130 FORMAT(2X,80HFREQ LUB LRB LR CORR LU BA VA
1 PWK DBA FREQ )
133 FORMAT(1X,57HTOTAL "A" WEIGHTED POWER -----)
1---,08.2)
134 FORMAT(9X,63H"ACTUAL LEVELS ARE LESS THAN OR EQUAL TO THOSE PRESEN
1TED BELOW")
135 FORMAT(1X,35HUNWEIGHTED SOUND POWER -----,F6.2,1X,2HCB)
136 FORMAT(1X,67HTHREE FEET FROM THE SOURCE IN A HEMISPHERICALLY DIVER
1GENT FIELD **,F6.2,1X,6HDBA **)
140 FORMAT(1X,67H"A" WEIGHTED SOUND POWER -----)
1-----,F6.2,1X,3HDBA)
150 FORMAT(//)
160 FORMAT(37X,8HNSJ-FPRC)
170 FORMAT(26X,29HACOUSTICS LABORATORY DATA LOG)
27 FORMAT(1X,9HPRESSURE=,14,3HPSI,2X,6HINLET=,12,3HPSI,
12X,6H SPEED=,14,3H RPM,2X,10HFLOW RATE=,F4.1,1HG,2X,
212HTEMPERATURE=,F4.1,1HC)
201 FORMAT(32X,12HNOISE POWER=,F6.2,2HHP)
STOP
END
00002920
00002930
00002940
00002950
00002960
00002970
00002980
00002984
00002985
00002990
00003000
00003010
00003020
00003030
00003040
00003050
00003060
00003070
00003080
00003090
00003100
00003110
00003120
00003130
00003140
00003150
00003160
00003170
00003180
00003185
00003190
00003200
00003210
00003220
00003230
00003240
00003250
00003260
00003270
00003280
00003290
00003300
00003310
00003320
00003330
00003340
00003350
00003360
00003370
00003380
00003390
00003400
00003410
00003420
00003425
00003430
00003440

```

- DATA FILE STRUCTURE FOR AIRBORNE NOISE WITH PARAMETERS

LISTED IN ORDER OF OCCURRENCE IN DATA FILE -

A(I,1) The 21 third-octave center frequencies at which measurements are taken (7F10.3).

A(I,4) The 21 values of reference source output to be used for environmental correction (7F10.3).

RS(I) The 21 values of reference source used with R2D(I).

C(I) The 21 correction factors for converting dB to dBA (7F10.3).

N & M N is the number of sets of unknown source data to be averaged. M is the number of sets of reference source data to be averaged (2I5).

NP Pump identification number (I5).

NPR System pressure (I5).

NI Inlet pressure (I5).

NS System rpm (I5).

FR Flow rate in gpm (F5.1).

TEM System temperature (F5.1).

LUB(I,N) N sets of unknown source output data (7F10.1).

LRB(I,M) M sets of reference source output data (7F10.1).

T(I) The 21 outside sound level values (7F10.1).

TO(I) The 21 values of transmission loss for the reverberant room (7F10.1).

VO(I) The 21 values of diffuser noise background.

BO(I) The 21 values of building noise background.

LO(I) The 21 values of the reference source correcting VO and BO.

- D2(I) The 21 values of drive system background inside the room.
- D1(I) The 21 values of drive system background outside the room.
- B1(I) The 21 values of building background outside of the room.
- R2D(I) The 21 values of the reference source for correcting D2.

TABLE E-2: Data File ABN ##.

60.	00000060	100.	125.	160.	200.	250.	315.	400.
70.	00000070	500.	630.	800.	1000.	1250.	1600.	2000.
80.	00000080	2500.	3150.	4000.	5000.	6300.	8000.	10000.
90.	00000090	71.9	75.1	75.0	75.3	74.9	76.2	75.2
100.	00000100	76.3	75.8	75.4	75.0	74.5	75.1	74.7
110.	00000110	75.8	74.9	74.6	75.1	74.5	75.0	71.6
120.	00000120	72.	75.5	75.5	75.5	75.5	76.	75.
130.	00000130	76.	75.5	76.	75.5	75.5	76.	75.5
140.	00000140	76.	75.5	75.	75.	72.5	75.	71.5
150.	00000150	-19.1	-16.1	-13.2	-10.8	-8.6	-6.5	-4.8
160.	00000160	-3.3	-1.9	-0.8	0.0	0.5	1.0	1.2
170.	00000170	1.2	1.2	1.0	0.5	-0.2	-1.1	-2.4
180.	00000180	1	1					
190.	00000190	4						
200.	00000200	2000						
210.	00000210	0						
220.	00000220	600						
230.	00000230	6.0						
240.	00000240	38.0						
250.	00000250	65.9	56.6	57.	64.	58.6	63.3	67.
260.	00000260	57.5	57.8	53.2	51.3	51.	48.7	44.2
270.	00000270	45.9	45.3	49.2	45.4	46.2	47.9	47.2
280.	00000280	68.3	71.7	74.	75.3	77.6	77.	76.3
290.	00000290	73.8	73.2	74.	75.8	75.3	75.7	75.
300.	00000300	75.9	75.6	74.2	75.4	74.	73.2	69.2
310.	00000310	85.	74.	67.9	69.5	68.8	71.	70.1
320.	00000320	63.3	66.7	62.8	60.5	60.2	58.2	61.
330.	00000330	61.8	58.2	56.9	57.5	57.	59.6	54.6
340.	00000340	20.	21.5	24.	26.	28.	29.5	32.5
350.	00000350	34.5	34.5	34.5	34.5	34.5	34.5	34.5
360.	00000360	34.5	34.5	36.	39.	42.	44.5	47.
370.	00000370	48.4	49.8	40.2	39.	39.	39.	39.
380.	00000380	39.	39.	40.	42.2	39.	39.	39.
390.	00000390	39.	39.	39.	39.	39.	39.	39.
400.	00000400	46.8	48.5	39.	39.	39.	39.	39.
410.	00000410	39.	39.	39.	39.	39.	39.	39.
420.	00000420	39.	39.	39.	39.	39.	39.	39.
430.	00000430	69.3	70.8	73.3	74.6	73.8	74.3	73.2
440.	00000440	73.6	73.7	73.8	74.8	74.9	75.	74.3
450.	00000450	75.	74.6	73.2	72.8	73.	72.7	67.
460.	00000460	54.	55.8	53.2	74.3	57.2	57.6	57.
470.	00000470	55.	56.2	60.9	53.9	56.8	60.6	52.1
480.	00000480	52.6	51.7	45.8	45.3	47.3	47.3	42.
490.	00000490	69.3	54.3	70.2	64.3	64.3	61.4	65.4
500.	00000500	64.	60.	62.3	62.	58.8	58.	54.7
510.	00000510	51.9	49.	52.	49.8	51.	53.4	47.3
520.	00000520	46.3	48.6	43.7	43.6	39.	39.	39.
530.	00000530	39.	39.	39.	39.	39.	39.	39.
540.	00000540	39.	39.	39.	39.	34.	39.	39.
550.	0000055	70.	71.7	73.	75.8	76.1	76.7	75.
560.	00000560	73.5	74.2	76.2	74.2	75.2	75.1	75.
570.	00000570	75.5	75.	73.9	73.5	74.1	73.9	68.3
590.	00000590	//						

TABLE E-2: ABN Sample Output.

OSU-FPRC
ACOUSTICS LABORATORY DATA LOG

FREQ	LUB	LRB	LK	LUFR	LU	BA	VA	PWR	CBA	FREQ
100.	65.5	68.3	71.9	3.7	67.5	65.4	51.1	0.69D-07	48.4	100.
125.	56.6	71.7	75.1	3.5	39.0	60.3	54.6	0.19D-09	22.9	125.
160.	57.0	74.0	75.0	1.0	54.4	55.5	42.4	0.13D-07	41.2	160.
200.	64.0	75.3	75.3	0.0	39.0	74.0	39.9	0.66D-09	28.2	200.
250.	58.6	77.6	74.9	-2.7	39.0	56.7	40.7	0.11D-08	30.4	250.
315.	63.3	77.0	76.2	-0.8	61.1	57.0	40.7	0.29D-06	54.6	315.
400.	67.0	76.3	75.2	-1.1	55.3	57.0	40.4	0.11D-05	60.5	400.
500.	57.5	73.8	76.3	2.5	56.4	57.5	41.4	0.20D-06	53.1	500.
630.	57.8	73.2	75.8	2.6	57.3	57.5	40.8	0.34D-06	55.4	630.
800.	53.2	74.0	75.4	1.4	39.0	62.7	42.2	0.55D-04	38.2	800.
1000.	51.2	75.8	75.0	-0.8	39.0	57.2	42.9	0.79D-08	39.0	1000.
1250.	51.0	75.3	74.5	-0.8	39.0	57.1	39.6	0.89D-08	39.5	1250.
1600.	48.7	75.7	75.1	-0.6	39.0	61.5	40.0	0.10D-07	40.0	1600.
2000.	44.2	75.0	74.7	-0.3	39.0	52.6	40.2	0.10D-07	40.2	2000.
2500.	45.9	75.9	75.8	-0.1	39.0	53.1	40.0	0.10D-07	40.2	2500.
3150.	45.3	75.6	74.9	-0.7	39.0	52.2	39.9	0.10D-07	40.2	3150.
4000.	49.2	74.2	74.6	0.4	46.2	46.9	40.8	0.53D-07	47.2	4000.
5000.	45.4	73.4	75.1	1.7	35.3	46.8	41.2	0.38D-08	55.8	5000.
6300.	46.2	74.0	74.5	0.5	39.8	45.7	38.5	0.92D-08	39.6	6300.
8000.	47.9	73.2	75.0	1.8	43.8	48.4	41.3	0.19D-07	42.7	8000.
10000.	47.2	68.2	71.6	3.4	49.1	45.2	43.5	0.47D-07	46.7	10000.

UNWEIGHTED SOUND POWER ----- 70.70 DB
TOTAL "A" WEIGHTED POWER ----- 0.22D-05
"A" WEIGHTED SOUND POWER ----- 63.50 DBA
THREE FEET FROM THE SOURCE IN A HEMISPHERICALLY DIVERGENT FIELD ** 56.50 DBA **

SYSTEM PARAMETERS FOR OSU-NP- 4
PRESSURE=2000PSI INLET= 0PSI SPEED= 600RPM FLJW RATE= 6.0G TEMPERATURE=38.0C
CURSE POWER= 7.0JHP

Main Program

PULSY

For

FBN Data Reduction

```

DIMENSION A(21,9),PJB(21,10),PRA(21,10),C(21),P(21),
1:P2(21),AP3(21),CP(21),UP(21)
DOUBLE PRECISION A,PJB,PRA,C,P,AP2,AP3,CP,DB,UP,TP,DH1,DH2
C
C -----
C READ THE 21 1/2 OCTAVE CENTER FREQUENCIES
C TO BE USED IN THIS PROGRAM
C -----
C
20 READ(5,20)(A(I,1),I=1,21)
   FORMAT(7F10.1)
   CONTINUE
C
C -----
C THE NEXT 21 NUMBERS ARE THE CORRECTION FACTORS
C USED TO CONVERT TO DBA
C -----
C
   READ(5,20)(C(I),I=1,21)
   CONTINUE
C
C -----
C READ IN THE NUMBER OF MEASUREMENTS TO BE AVERAGED--I N
C MEASUREMENTS FOR THE PRESSURE SOURCE, M FOR THE
C BACKGROUND NOISE, FORMAT(2I5)
C -----
C
   READ(5,10)N,M
   10 FORMAT(2I5)
C
C -----
C READ IN THE TRANSDUCER CORRECTION FACTOR
C FORMAT(F10.2)
C -----
C
   READ(5,11)TX
   11 FORMAT(F10.2)
C
C -----
C READ IN THE VALUES FOR THE FLUID POWER SYSTEM PARA-
C METERS. NP=PUMP NUMBER, NPR=PUMP OUTLET PRESSURE,
C IP=INLET PRESSURE, NS=SYSTEM RPM, FR=FLOW RATE,
C TEM=SYSTEM TEMPERATURE
C -----
C
   READ(5,12)NP
   READ(5,12)NPR
   READ(5,12)IP
   READ(5,12)NS
   READ(5,11)FR
   12 READ(5,11)TEM
   FORMAT(15)
   NP=NP
   NPR=(FR*NP)/1714.
C
C -----
C READ IN THE MEASURED VALUES FOR THE PRESSURE SOURCE
C FORMAT(7F10.1)
C -----

```

```

00000050
00000060
00000070
00000080
00000090
00000100
00000110
00000120
00000130
00000140
00000150
00000160
00000350
00000360
00000370
00000380
00000390
00000400
00000410
00000420
00000420
00000420
00000430
00000440
00000450
00000460
00000470
00000480
00000490
00000500
00000510
00000520
00000530
00000540
00000550
00000560
00000570
00000580
00000590
00000600
00000610
00000620
00000630
00000640
00000650
00000660
00000670
00000680
00000690
00000700
00000701
00000702
00000703
00000704
00000705
00000706
00000710
00000720
00000721
00000722
00000723
00000724
00000725
00000726
00000727
00000730
00000740
00000750
00000750
00000760
00000770
00000780
00000790
00000795
00000796
00000800
00000810
00000820
00000830
00000840

```



```

C
C   READ(5,20)((PUB(I,J),I=1,21),J=1,N)
C
C   -----
C   FIND THE AVERAGE OF N MEASUREMENTS FOR EACH 1/3 OCTAVE
C   BAND FOR THE PRESSURE SOURCE
C   -----
C
C   DO 40 I=1,21
C   AV=0.0
C   DO 30 J=1,N
C   AV=AV+PUB(I,J)
30 CONTINUE
C   A(I,2)=AV/N
40 CONTINUE
C
C   -----
C   READ IN THE MEASURED VALUES FOR THE BACKGROUND,
C   FORMAT(7F10.1)
C   -----
C
C   READ(5,20)((PRB(I,J),I=1,21),J=1,M)
C
C   -----
C   FIND THE AVERAGE OF M MEASUREMENTS FOR EACH 1/3 OCTAVE
C   BAND FOR THE BACKGROUND
C   -----
C
C   DO 70 I=1,21
C   AB=0.0
C   DO 60 J=1,M
C   AB=AB+PRB(I,J)
50 CONTINUE
C   A(I,3)=AB/M
70 CONTINUE
C   DO 80 I=1,21
C
C   -----
C   CORRECT THE PRESSURE SOURCE WITH THE BACKGROUND
C   -----
C
C   AP2(I)=10.**((A(I,2)-74.)/10.)
C   AP3(I)=10.**((A(I,3)-74.)/10.)
C   CP(I)=AP2(I)-AP3(I)
C   IF(AP3(I).GE.AP2(I))CP(I)=1/10.**3.5
C
C   -----
C   COMPUTE THE CORRECTED PRESSURE LEVELS
C   -----
C
C   A(I,4)=10.*DLOG10(CP(I))+74.
C
C   -----
C   COMPUTE THE "A" WEIGHTED PRESSURE LEVELS
C   -----
C
C   A(I,5)=A(I,4)+C(I)
C
C   -----

```

```

00000850
00000860
00000880
00000890
00000900
00000910
00000920
00000930
00000940
00000950
00000960
00000970
00000980
00000990
00001000
00001010
00001020
00001030
00001040
00001050
00001060
00001070
00001080
00001090
00001100
00001110
00001120
00001130
00001140
00001150
00001160
00001170
00001180
00001190
00001200
00001210
00001220
00001230
00001240
00001250
00001260
00001270
00001280
00001290
00001300
00001310
00001320
00001330
00001340
00001350
00001360
00001370
00001380
00001390
00001400
00001410
00001420
00001430

```

```

C      COMPUTE THE POWER ASSOCIATED WITH THE "A" WEIGHTED
C      PRESSURE LEVELS
C      -----
C      A(I,6)=(10.**((A(I,5)/10.))*(1./10.**12.))
C      -----
C      COMPUTE THE POWER ASSOCIATED WITH THE UNWEIGHTED
C      PRESSURE LEVELS
C      -----
C      UP(I)=10.**((A(I,4)-74.)/10.)
C      -----
C      COMPUTE THE "A" WEIGHTED PRESSURE LEVELS RELATIVE TO
C      20 MN/M**2
C      -----
C      A(I,7)=A(I,5)+TX
C      A(I,8)=A(I,1)
80  CONTINUE
C      TP=J.0
C      DB=J.0
C      DO 90 I=1,21
C      DB=DB+A(I,6)
C      TP=TP+CP(I)
90  CONTINUE
C      -----
C      COMPUTE THE TOTAL UNWEIGHTED PRESSURE LEVEL
C      -----
C      DB1=10.*DLG10(TP)+74.
C      -----
C      COMPUTE THE TOTAL "A" WEIGHTED PRESSURE LEVEL
C      -----
C      CRA=10.*DLG10(DB*(10.**12.))
C      -----
C      COMPUTE THE TOTAL "A" WEIGHTED PRESSURE LEVEL RELATIVE
C      TO 20 MN/M**2
C      -----
C      DBA2=JBA+TX
C      -----
C      PRINT THE OUTPUT TABLE
C      -----
C      WRITE(6,109)
C      WRITE(6,120)
C      WRITE(6,130)
C      WRITE(6,150)
C      WRITE(6,140)
C      WRITE(6,150)
C      WRITE(6,100)((A(I,J),J=1,8),I=1,21)
C      WRITE(6,150)
00001440
00001450
00001460
00001470
00001480
00001490
00001500
00001510
00001520
00001530
00001540
00001550
00001560
00001570
00001580
00001590
00001600
00001610
00001620
00001630
00001640
00001650
00001660
00001670
00001680
00001690
00001700
00001710
00001720
00001730
00001740
00001750
00001760
00001770
00001780
00001790
00001800
00001810
00001820
00001830
00001840
00001850
00001860
00001870
00001880
00001890
00001900
00001910
00001920
00001930
00001940
00001950
00001960
00001970
00001980
00001990
00002000
00002010

```

WRITE(6,101)DB1	00002020
WRITE(6,102)DBA	00002030
C	00002040
WRITE(6,103)DB	00002050
WRITE(6,104)DBA2	00002060
WRITE(6,150)	00002070
WRITE(6,170)NP	00002080
WRITE(6,105)POR	00002085
WRITE(6,175)NPR,IP,NS,FR,TEM	00002090
WRITE(6,150)	00002100
WRITE(6,169)	00002110
100 FORMAT(1X,F6.0,4F10.2,4X,D8.2,F10.2,F11.0)	00002120
101 FORMAT(1X,30HTOTAL PRESSURE -----,F6.2,1X,2HDB)	00002130
102 FORMAT(1X,40H"A" WEIGHTED PRESSURE -----,F6.2,4H DBA)	00002140
103 FORMAT(1X,49HTOTAL "A" WEIGHTED POWER -----,	00002150
108.2)	00002160
104 FORMAT(1X,61H"A" WEIGHTED PRESSURE RELATIVE TO 20 MN/M**2 -----	00002170
1-----,F7.2,4H DBA)	00002180
105 FORMAT(32X,12HHORSE POWER=,F6.2,2HHP)	00002185
110 FORMAT(4F10.3)	00002190
120 FORMAT(37X,8HOSU-FPRC)	00002200
130 FORMAT(26X,29HACOUSTICS LABORATORY DATA LOG)	00002210
140 FORMAT(2X,4HFREQ,6X,5HPRESS,6X,3HBKG,6X,4HCORR,7X,3H"A",6X,	00002220
15HPWER,6X,6HREL-20,6X,4HFREQ)	00002230
150 FORMAT(80H =====)	00002240
1=====)	00002250
169 FCRMAT(////)	00002260
170 FORMAT(25X,29HSYSTEM PARAMETERS FOR OSU-NP-,12)	00002270
175 FORMAT(1X,9HPRESSURE=,14,3HPSI,2X,6HINLET=,11,3HPSI,2X,	00002280
16HSPEED=,14,3HPPM,2X,10HFLOW RATE=,F4.1,1HG,2X,	00002290
212HTEMPERATURE=,F4.1,1HC)	00002300
STOP	00002310
END	00002320

- DATA FILE STRUCTURE FOR FLUID-BORNE NOISE WITH PARAMETERS

LISTED IN ORDER OF OCCURRENCE IN DATA FILE -

A(I,1) The 21 third-octave center frequencies to be used in
 the program (7F10.1).

C(I,1) The 21 correction factors to convert dB to dBA.

N, M N - The number of sets of unknown source measurements
 to be averaged.

 M - The number of instrumentation background noise
 measurements to be averaged (2I5).

TX Transducer correction factor (I5).

NP Pump identification number (I5).

NPR System pressure (I5).

IP

NS System rpm (I5).

FR Flow rate in gpm (F5.1).

TEM System temperature (F5.1).

PUB(I,N) The N sets of 21 measured values for the unknown noise
 source.

PRB(I,M) The M sets of 21 measured values for the background noise
 measurements.

TABLE E-4: Data File FBN.

60.	000000060	100.	125.	160.	200.	250.	315.	400.
70.	000000070	500.	630.	800.	1000.	1250.	1600.	2000.
80.	000000080	2500.	3150.	4000.	5000.	6300.	8000.	10000.
90.	000000090	-19.1	-16.1	-13.2	-10.8	-8.6	-6.5	-4.8
100.	00000100	-3.3	-1.9	-0.8	0.0	0.5	1.0	1.2
110.	00000110	1.2	1.2	1.0	0.5	-0.2	-1.1	-2.4
120.	00000120	.	1					
130.	00000130	126.						
140.	00000140							
150.	00000150	200						
160.	00000160	0						
170.	00000170	600						
180.	00000180	6.8						
190.	00000190	38.0						
200.	00000200	74.3	61.2	57.3	59.	49.8	53.2	52.9
210.	00000210	42.5	41.6	39.	42.4	42.1	39.	39.6
220.	00000220	39.	39.	39.	39.	39.	39.	40.4
230.	00000230	39.	39.	51.2	51.4	44.4	52.1	44.7
240.	00000240	39.	39.	39.	39.	39.	39.	39.
250.	00000250	39.	39.	39.	39.	39.	39.	39.
270.	00000270	//						

TABLE E-5: FBN Sample Output.

USJ-FPRC
ACOUSTICS LABORATORY DATA LOG

FREQ	PRESS	BKG	CURR	"A"	PJWER	REL-20	FREQ
100.	74.30	39.00	74.30	55.20	0.330-06	179.20	100.
125.	61.20	39.00	61.17	45.07	0.320-07	169.07	125.
160.	57.30	51.20	56.08	42.88	0.190-07	159.88	160.
200.	59.00	51.40	58.17	47.37	0.550-07	171.37	200.
250.	45.90	44.40	48.32	39.72	0.940-08	163.72	250.
315.	53.20	52.10	46.70	40.20	0.100-07	164.20	315.
400.	52.90	44.70	52.19	47.39	0.550-07	171.39	400.
500.	42.50	39.00	39.93	36.63	0.460-08	160.53	500.
630.	41.60	39.00	38.14	36.24	0.420-08	160.24	630.
800.	39.00	39.00	39.00	38.20	0.560-08	162.20	800.
1000.	42.40	39.00	39.75	39.75	0.940-08	153.75	1000.
1250.	42.10	39.00	39.18	39.68	0.930-08	143.68	1250.
1600.	39.00	39.00	39.00	40.00	0.100-07	144.00	1600.
2000.	39.50	39.00	30.71	31.91	0.160-08	155.91	2000.
2500.	39.00	39.00	39.00	40.20	0.100-07	164.20	2500.
3150.	39.00	39.00	39.00	40.20	0.100-07	164.20	3150.
4000.	39.00	39.00	39.00	40.00	0.100-07	164.00	4000.
5000.	39.00	39.00	39.00	39.50	0.890-08	163.50	5000.
6300.	39.00	39.00	39.00	38.80	0.760-08	162.80	6300.
8000.	39.00	39.00	39.00	37.90	0.520-08	161.90	8000.
10000.	40.40	39.00	34.80	32.40	0.170-08	156.40	10000.

TOTAL PRESSURE ----- 74.72 DB
 "A" WEIGHTED PRESSURE ----- 57.87 DBA
 TOTAL "A" WEIGHTED POWER ----- 0.610-06
 "A" WEIGHTED PRESSURE RELATIVE TO 20 μN/M**2 ----- 181.97 DBA

SYSTEM PARAMETERS FOR USJ-NP- 3
 INLET=OPSI SPEED=500RPM FLOW RATE=5.8G TEMPERATURE=33.0C
 HORSE POWER= 0.79HP

Main Program
SHAKY
For
SBN Data Reduction

	DIMENSION A(21,10),VUB(21,10),VRB(21,10),C(21),JRI(21),	00000050
	AP2(21),AP3(21),CP(21),UP(21)	00000060
	DOUBLE PRECISION A,VUB,VRB,C,AP2,AP3,CP,DB,UP,TP,DBI,DBA,	00000070
	IAC,VE,DI	00000080
C	-----	00000090
C	READ THE 21 1/3 OCTAVE CENTER FREQUENCIES TO BE	00000100
C	USED IN THIS PROGRAM. FORMAT(7F10.1)	00000110
C	-----	00000120
C	READ(5,20)(A(I,1),I=1,21)	00000130
C	70 FORMAT(7F10.1)	00000140
	CONTINUE	00000150
		00000160
		00000170
		00000630
		00000640
C	-----	00000650
C	READ IN THE NUMBER OF MEASUREMENTS TO BE AVERAGED--I N	00000660
C	MEASUREMENTS FOR THE VIBRATION SOURCE, M FOR THE	00000670
C	BACKGROUND NOISE, FORMAT(2I5)	00000680
C	-----	00000690
C	READ(5,10)N,M	00000691
C	10 FORMAT(2I5)	00000692
		00000693
		00000694
C	-----	00000695
C	READ IN THE "VOLTAGE TO ACCELERATION" TRANSDUCER	00000696
C	CORRECTION FACTOR (F10.8)	00000697
C	-----	00000698
C	READ(5,99)TX	00000699
C	99 FORMAT(F10.8)	00000701
		00000711
		00000712
		00000713
C	-----	00000714
C	READ IN THE SYSTEM PARAMETERS. NP=PUMP NUMBER,	00000715
C	NPR=SYSTEM OUTLET PRESSURE, IP=SYSTEM INLET PRESSURE,	00000716
C	NS=SYSTEM RPM, FR=SYSTEM FLOW RATE, TEM=SYSTEM	00000717
C	TEMPERATURE	00000718
C	-----	00000720
	READ(5,12)NP	00000730
	READ(5,12)NPR	00000740
	READ(5,12)IP	00000750
	READ(5,12)NS	00000760
	READ(5,11)FR	00000770
	READ(5,11)TEM	00000780
	11 FORMAT(F5.1)	00000790
	12 FORMAT(I5)	00000800
		00000810
		00000820
		00000830
		00000840
		00000850
		00000860
		00000880
		00000890
C	-----	00000900
C	FIND THE AVERAGE OF N MEASUREMENTS FOR EACH 1/3 OCTAVE	00000910
C	BAND FOR THE VIBRATION SOURCE	00000920
C	-----	

C		00000930
	DC 40 I=1,21	00000940
	AV=0.0	00000950
	DO 30 J=1,N	00000960
	AV=AV+VUB(I,J)	00000970
30	CONTINUE	00000980
	A(I,2)=AV/N	00000990
40	CONTINUE	00001000
C	-----	00001010
C	READ IN THE MEASURED VALUES FOR THE BACKGROUND,	00001020
C	FORMAT(7F10.1)	00001030
C	-----	00001040
C	READ(5,20)((VRB(I,J),I=1,21),J=1,M)	00001050
C	-----	00001060
C	FIND THE AVERAGE OF M MEASUREMENTS FOR EACH 1/3 OCTAVE	00001070
C	BAND FOR THE BACKGROUND	00001080
C	-----	00001090
C	DO 70 I=1,21	00001100
	AB=0.0	00001110
	DO 60 J=1,M	00001120
	AB=AB+VRB(I,J)	00001130
60	CONTINUE	00001140
	DB(I)=AB/M	00001150
70	CONTINUE	00001160
C	-----	00001170
C	READ IN THE TRANSDUCER CORRECTION FACTORS AT	00001180
C	EACH 1/3 OCTAVE CENTER FREQUENCY	00001190
C	-----	00001200
C	READ(5,20)(UP(I),I=1,21)	00001202
C	-----	00001204
C	COMPUTE THE ACCELERATION, VELOCITY, AND	00001206
C	DISPLACEMENT	00001210
C	-----	00001211
C	DO 80 I=1,21	00001212
	AP2(I)=(5./10.**6)*(10.**A(I,2)/20.)	00001214
	AP3(I)=(5./10.**6)*(10.**DB(I)/20.)	00001216
	CP(I)=AP2(I)-AP3(I)+UP(I)*(AP2(I)-AP3(I))	00001220
	IF (AP3(I).GE.AP2(I))CP(I)=1./10.**3.5	00001230
	A(I,3)=CP(I)/TX	00001240
	A(I,5)=A(I,3)/A(I,1)	00001250
	A(I,7)=A(I,5)/A(I,1)	00001255
	A(I,4)=20.*(DLOG10(A(I,3))+5.)	00001260
	A(I,6)=20.*(DLOG10(A(I,5))+8.)	00001270
	A(I,8)=20.*(DLOG10(A(I,7))+11.)	00001280
	A(I,9)=A(I,1)	00001290
80	CONTINUE	00001300
	AC=0.0	00001310
	VF=0.0	00001320
	DI=0.0	00001330
	DO 91 I=1,21	00001340
		00001350
		00001360
		00001370

```

AC=AC+A(1,3)
VE=VE+A(1,5)
DI=DI+A(1,7)
81 CONTINUE
ACC=20.*(DLOG10(AC)+5.)
VEL=20.*(DLOG10(VE)+8.)
DIS=20.*(DLOG10(DI)+11.)
WRITE(6,169)
WRITE(6,120)
WRITE(6,130)
WRITE(6,150)
WRITE(6,140)
WRITE(6,101)
WRITE(6,150)
WRITE(6,100)((A(1,J),J=1,2),I=1,21)
WRITE(6,150)
WRITE(6,90)ACC,VEL,DIS
WRITE(6,95)AC,VE,DI
WRITE(6,150)
WRITE(6,170)NP
WRITE(6,175)NPP,IP,NS,FR,TEM
WRITE(6,150)
WRITE(6,169)
90 FORMAT(1X,17HTOTAL LEVELS (DB),9X,F6.1,13X,F6.1,13X,F6.1)
95 FORMAT(1X,12HTOTAL LEVELS,5X,E8.2,11X,E8.2,11X,F8.2)
100 FORMAT(1X,F6.0,F7.1,F12.2,F7.1,E12.2,F7.1,E12.2,F7.1,F9.0)
101 FORMAT(10X,2HDB,6X,6HM/S**2,5X,2HDB,7X,3HM/S,7X,2HDB,8X,1HM,8X,2H
18)
120 FORMAT(37X,8HOSU-FPRC)
130 FORMAT(26X,29HACOUSTICS LABORATORY DATA LOG)
140 FORMAT(2X,4HFRFJ,3X,5HINPUT,5X,12HACCELERATION,9X,8HVELOCITY,9X,12
1HDISPLACEMENT,6X,4HFREQ)
150 FORMAT(8CH *****
1 *****)
169 FORMAT(////)
170 FORMAT(25X,29HSYSTEM PARAMETERS FOR OSU-NP-,12)
175 FORMAT(1X,9HPRESSURE=,14,3HPSI,2X,6HINLET=,11,3HPSI,2X,
16HSPEED=,14,3HPPM,2X,10HFLOW RATE=,F4.1,1HG,2X,
212HTEMPERATURE=,F4.1,1HC)
STOP
END
00001380
00001390
00001400
00001410
00001420
00001430
00001440
00001490
00001490
00001500
00001510
00001520
00001530
00001540
00001550
00001560
00001570
00001580
00001590
00001600
00001610
00001620
00001630
00001640
00001650
00001660
000001670
00001590
00001690
00001700
00001710
00001720
00001730
00001740
00001750
00001760
00001770
00001780
00001790
00001800
00001810

```

- DATA FILE STRUCTURE FOR STRUCTURE-BORNE NOISE WITH PARAMETERS

LISTED IN ORDER OF OCCURRENCE IN DATA FILE -

A(I, 1)	The 21 third-octave center frequencies to be used (7F10.1).
N, M	N - The number of sets of unknown noise source measurements to be averaged. M - The number of sets of instrumentation background noise to be averaged (2I5).
NP	Pump identification number (I5).
NPR	System pressure (I5).
IP	
NS	System rpm (I5).
FR	Flow rate in gpm (F5.1).
TEM	System temperature (F5.1).
VUB(I,N)	The N sets of 21 measured values for the unknown source (7F10.1).
VBR(I,M)	The M sets of 21 instrumentation background noise measurements (7F10.1).
UP(I)	The 21 transducer correction factors.

TABLE E-6: Data File SBN.

000000060	110.	125.	160.	200.	250.	315.	400.
000000070	500.	630.	800.	1000.	1250.	1600.	2000.
000000080	2500.	3150.	4000.	5000.	6300.	8000.	10000.
000000090	1	1					
00000100	.00759184						
00000110	52						
00000120	2000						
00000130	5						
00000140	1985						
00000150	60.0						
00000160	65.5						
00000170	47.9	50.2	57.1	58.0	55.7	56.0	48.3
00000180	49.1	49.1	48.2	48.1	51.5	50.3	48.1
00000190	48.8	52.8	53.4	55.9	64.2	65.7	68.2
00000200	50.7	54.8	54.1	53.8	51.8	54.2	46.5
00000210	46.7	46.	45.7	45.8	46.6	46.1	46.7
00000220	45.7	46.	46.8	46.	46.5	46.1	46.3
00000230	0.0	0.0	0.0	0.0	-.0035	-.0064	-.01
00000240	-.0118	-.0145	-.0175	-.02	-.0177	-.006	0.0
00000250	.0065	.013	.02	.026	.0325	.039	.045
00000270	//						

TABLE E-7: SBN Sample Output.

OSU-FPRC
ACOUSTICS LABORATORY DATA LOG

FREQ	INPUT DB	ACCELERATION M/S**2	DB	VELOCITY M/S	DB	DISPLACEMENT M	DB	FREQ
110.	47.9	0.420-01	72.4	0.380-03	91.6	0.340-05	110.7	110.
125.	50.2	0.420-01	72.4	0.330-03	90.5	0.270-05	108.5	125.
160.	57.1	0.140 00	82.8	0.860-03	98.7	0.540-05	114.6	160.
200.	58.0	0.200 00	86.0	0.100-02	100.0	0.500-05	114.0	200.
250.	55.7	0.140 00	83.2	0.580-03	95.3	0.230-05	107.3	250.
315.	56.0	0.770-01	77.8	0.250-03	87.8	0.780-06	97.8	315.
400.	48.3	0.320-01	70.0	0.790-04	78.0	0.200-06	85.9	400.
500.	49.1	0.560-01	74.9	0.110-03	80.9	0.220-06	87.0	500.
630.	49.1	0.560-01	74.9	0.880-04	78.9	0.140-06	82.9	630.
800.	48.2	0.420-01	72.4	0.520-04	74.3	0.650-07	76.3	800.
1000.	48.1	0.380-01	71.6	0.380-04	71.6	0.380-07	71.6	1000.
1250.	51.5	0.100 00	80.4	0.840-04	78.5	0.670-07	76.5	1250.
1600.	50.3	0.820-01	78.3	0.510-04	74.2	0.320-07	70.1	1600.
2000.	48.1	0.250-01	67.9	0.120-04	61.1	0.620-08	55.9	2000.
2500.	48.8	0.550-01	74.8	0.220-04	66.8	0.880-08	58.9	2500.
3150.	52.8	0.160 00	84.0	0.500-04	74.0	0.160-07	64.0	3150.
4000.	53.4	0.170 00	84.5	0.420-04	72.4	0.100-07	60.4	4000.
5000.	55.9	0.290 00	89.1	0.570-04	75.2	0.110-07	61.2	5000.
6300.	64.2	0.960 00	99.6	0.150-03	83.7	0.240-07	67.7	6300.
8000.	65.7	0.120 01	101.4	0.150-03	83.4	0.180-07	65.3	8000.
10000.	68.2	0.160 01	104.2	0.160-03	84.2	0.160-07	64.2	10000.
TOTAL LEVELS (DB)			114.8		113.2		126.2	
TOTAL LEVELS		0.550 01		0.460-02		0.200-04		

SYSTEM PARAMETERS FOR OSU-NP-52
PRESSURE=2000PSI INLET=5PSI SPEED=1985RPM FLOW RATE=60.6G TEMPERATURE=65.5C

Disc Load and Call Routines
For
Oklahoma State University Computer System

```

00000010 //NOISE*** JOB ( ,1), 'NOISE',MSGLEVEL=(0,0),
00000011 // CLASS=B
00000020 /*ROUTE PRINT RJO
00000030 // EXEC FORTHCL
00000040 //FOPT.SYSIN DD *
00000050 DIMENSION

```

MAIN PROGRAM

```

00002480 END
00002490 //IKFD.SYSMOD DD DSN=OSU.ACT12687.FPRC,DISP=OLD
00002500 //IKFD.SYSIN DD *
00002510 NAME DRA(R)
00002520 //

```

CALLING PROGRAM AND DATA

```

00000010 //DRAXXXXX JOB ( ,1), 'ELLIOTT',MSGLEVEL=(0,0)
00000020 /*ROUTE PRINT RJO
00000030 // EXEC PGM=DRA
00000040 //STEPLIB DD DSN=OSU.ACT12687.FPRC,DISP=SHR
00000050 //FT05F001 DD *
00000060 1 1
00000070 10 200 0 2000 26.8 38.0
00000080 57.3 62.7 56.8 59.9 74.2 66.8 61.3
00000090 63.9 71.1 71.4 64.8 59. 58.2 56.7
00000100 58.6 57. 56.9 57.3 58.3 59. 56.3
00000110 68.7 71.7 72.8 75.9 75.7 75.7 74.7
00000120 73.3 73.7 74.2 74.2 74.7 75.1 74.0
00000130 75.2 74.9 73.6 73.1 73.3 72.9 67.3
00000140 61.7 64.5 61.5 70.9 86. 78.8 68.
00000150 77.9 74.2 81.8 80.3 78.8 71. 69.8
00000160 69.5 66. 68.7 69.8 70.3 69. 64.3
00000170 20. 21.5 24. 26. 28. 29.5 32.5
00000180 34.5 34.5 34.5 34.5 34.5 34.5 34.5
00000190 34.5 34.5 36. 39. 42. 44.5 47.
00000200 52.2 56.2 57. 49. 50. 53.9 58.3
00000210 57.6 54.5 54. 51.2 50.3 51. 48.2
00000220 51.9 49. 46.6 45. 45.2 45.8 41.7
00000230 47.2 39. 39. 39. 39. 39. 39.
00000240 39. 39. 39. 39. 39. 39. 39.
00000250 39. 39. 39. 39. 39. 39. 39.
00000260 72. 72. 74. 76.3 77. 77.3 75.7
00000270 74. 74. 74.2 74.3 75. 75. 74.9
00000280 75.1 74.5 73.1 72.6 72.8 72.4 66.7
00000290 60.8 69. 61.1 56.7 61.1 60.6 58.
00000300 61.6 59. 63.8 59. 57.6 63.8 54.8
00000310 54.8 54.6 48.8 50.2 48.2 45.7 43.5
00000320 61.2 66.6 64.2 71.5 75.8 70. 71.3
00000330 83.6 76.3 78.2 78.7 76.1 73.2 73.3
00000340 72.3 69. 69.6 75.1 75.2 72.9 65.7
00000350 48.3 48.6 43.3 43.6 39. 39. 39.
00000360 39. 39. 39. 39. 39. 39. 39.
00000370 39. 39. 39. 39. 39. 39. 39.
00000380 70.9 71.1 73.5 75.6 75.8 76.4 74.9
00000390 73.6 74.2 74.6 74.6 75.2 75.3 75.
00000400 75.3 75.2 74. 73.8 74.2 73.8 68.3
0000410 //FT06F001 DD SYSOUT=A
0000420 //

```

Reproduced from
 best available copy.

APPENDIX F

TEST CODE FOR MEASURING AND REPORTING SOUND

GENERATED BY HYDRAULIC PUMPS

NOTE: This document represents the project staff's interpretation of the guidelines outlined at the May 1973 meeting of ISO/TC 131/SC8/WG1. Supplementary information has been added, when it was thought that such information would help to clarify the intent of the document. A draft document from ISO/TC 131/SC8/WG1 should be completed by mid-1974.

C O N T E N T S

	Page
1. INTRODUCTION	113
2. SCOPE	113
3. FIELD OF APPLICATION	113
4. MEASUREMENT UNCERTAINTY	113
5. TERMS AND DEFINITIONS	113
6. SYMBOLS	115
7. REFERENCES	115
8. THE TEST ENVIRONMENT - ACOUSTICAL & MECHANICAL	115
9. INSTRUMENTATION - HYDRAULIC, MECHANICAL & ACOUSTICAL	115
10. INSTALLATION	115
11. MECHANICAL EQUIPMENT	115
12. OPERATING CONDITIONS AND TEST PROCEDURE	116
13. METHODS OF ACOUSTICAL MEASUREMENT AND POSITION OF MEASURING POINTS	117
14. QUANTITIES TO BE MEASURED	118
15. CALCULATION AND INTERPRETATION OF RESULTS	118
16. TEST REPORT	118

TEST CODE FOR MEASURING AND REPORTING SOUND
GENERATED BY HYDRAULIC PUMPS

1.0 INTRODUCTION¹

In hydraulic fluid power systems, power is transmitted and controlled through a liquid under pressure within an enclosed circuit. Pumps convert mechanical power into hydraulic fluid power. Some noise is created during the power conversion process. The sound level which results because of noise emitted by the pump is an important consideration in component selection.

2.0 SCOPE

To prescribe procedures for the determination of the sound power level of a hydraulic pump under controlled conditions of installation and operation suitable for providing a basis for comparing the airborne noise levels of pumps:

- 2.1 in terms of A-weighted sound power level.
- 2.2 in terms of octave-band, sound-power levels. For general purposes, the frequency range of interest includes the octave bands with center frequencies from 125 to 8000 Hz.
- 2.3 excludes the determination of directivity characteristics of the acoustic radiations.

3.0 FIELD OF APPLICATION

This document is applicable to all types of hydraulic fluid power pumps operating under stated steady-state conditions, irrespective of size except for limitation imposed by size of test environment.

4.0 MEASUREMENT UNCERTAINTY

Measurements made in accordance with this international standard tend to result in standard deviations which are equal to or less than those given in Table I. The standard deviations taken into account the cumulative effect of all causes of measurement uncertainty, excluding variations in the sound power of the source from test to test. For a source which emits noise with a relatively flat spectrum in the 100 to 10,000 Hz frequency range, the A-weighted sound power level is determined with a standard deviation not more than 2 dBa.

5.0 TERMS AND DEFINITIONS²

¹Text will be modified by WG1 ²To be completed by WG1

TABLE I: STANDARD DEVIATION (IN dB) OF SOUND POWER LEVEL DETERMINATION

Test Environment (See Section 8)	Grade of Measurement	Octave Band f_m				
		125	250	500	1000-4000	8000
Anechoic	Precision	1.0	1.0	1.0	0.5	1.0
Semi-Anechoic	Precision	1.5	1.5	1.5	1.0	1.5
Reverberant	Precision	3.0	2.0	1.5	1.5	3.0
Semi-Anechoic	Engineering	3.0	2.0	2.0	1.5	2.5
Semi-Reverberant	Engineering	5.0	3.0	2.0	2.0	3.0

TABLE II: DOCUMENTS TO BE USED FOR TEST FACILITY PERFORMANCE QUALIFICATION

Environment in Facility	Grade of Measurement	Applicable Document
Anechoic	Precision	Annex A of DISxxx (Part V document)
Semi-Anechoic	Precision	Annex A of DISxxx (Part V document)
Reverberant	Precision	See Annex to DIS 2946
Semi-Anechoic	Engineering	Annex A of DISxxxx Part IV
Semi-Reverberant	Engineering	See Section 3 of DISxxxxx (part III document)

6.0 SYMBOLS¹

7.0 REFERENCES¹

8.0 TEST ENVIRONMENT

Tests are to be made using one of the acoustical environments listed in Table II. The test facility must meet the measurement performance requirements (standard deviation limits) indicated in the appropriate document.

9.0 INSTRUMENTATION

9.1 Instrumentation to measure oil flow, oil pressure, pump speed, and oil temperature is to be in accordance with the proposed SC6 pump testing document for 'industrial class' accuracy of testing.

9.2 Instrumentation of the acoustical measurements shall comply with Section 4 of the ISO/TC 43 documents on the "Determination of Sound Power Emitted By Noise Sources."

10.0 INSTALLATION

10.1 The hydraulic circuit is to include oil filter, oil cooler, and reservoir and restrictor valves as required to meet the pump hydraulic test conditions.

10.2 The test fluid and filtration level shall be in accordance with manufacturer's recommendations.

10.3 Inlet and discharge line diameters shall be to the manufacturer's recommended installation practice.

10.4 Exercise extra care in assembling inlet lines to prevent air leakage into the circuit.

10.5 Locate inlet restrictor valves required as far as is practical upstream of the pump to minimize aeration to pump inlet port.

10.6 Locate the inlet pressure gauge at the same height as the inlet fitting or calibrate gauge for height difference.

11.0 MECHANICAL EQUIPMENT

11.1 Wrap all fluid lines and load valves in the test space with acoustical barrier material as desired. A suitable material will have at least 10 dB transmission loss at 100 Hz and higher frequencies.

- 11.2 Locate the drive motor outside the test space and drive the pump through a long shaft or isolate the motor in an enclosure. Construct the pump mounting so that it will minimize the sound radiated by it due to pump vibrations. Vibration isolation techniques can be employed even if the pump is usually solidly mounted.
- 11.4 The size of flange mountings shall be as small as practical to minimize interference with radiation of sound towards the shaft end of the pump.

12.0 OPERATING CONDITIONS & TEST PROCEDURE

12.1 Background Measurements

12.1.1 Disconnect the drive shaft coupling at the pump.

12.1.2 Operate the pump drive system at the speeds at which pump will be tested.

12.1.3 Obtain the background mean levels in each octave band of interest and the "A" weighted total level or linear total level in dB.

NOTE: It is recommended that the background levels be obtained while the system is operating under test conditions with the pump covered by a sound isolator with a noticeable transmission loss. If, after properly covering the pump, the recorder sound level does not noticeably decrease, then it is highly probable that the measured level is not associated with the pump, and the test should be rejected.

12.2 Pump Measurements

12.2.1 Connect the pump drive coupling.

12.2.2 The pump should be operated for a sufficient time to purge air from the system.

12.2.3 Operate the pump at conditions specified for the test. Stabilize all variables including fluid condition. Maintain conditions within limits specified in Table III.

TABLE III

<u>Test Parameter</u>	<u>Maintain Within±</u>
Flow	2%
Pressure	2%
Speed	2%
Temperature	3°C.

- 12.2.4 Measure temperatures and pressures at pump inlet and discharge fittings or at test station provided by manufacturer.
- 12.2.5 Measure pump mean sound pressure levels in each octave of interest and the "A" weighted total level or linear total level in dB.
- 12.2.6 Near the end of a test series or after one hour of testing, repeat the conditions run early in the series. Invalidate the test series if the measured sound level does not duplicate that of the earlier test within 2 dBA, uncorrected.
NOTE: Some pumps must wear-in before their sound levels become stabilized. Step 12.2.6 is only necessary with new or rebuilt pumps.

10.3 Calculation of Sound Power Levels

- 12.3.1 Correct octave band pressure levels and "A" weighted sound levels for background noise in accordance with the appropriate section of the ISO/TC 43 documents on the "Determination of Sound Power Emitted By Noise Sources."
- 12.3.2 Void the test if the difference between the pump and background levels is less than 4 dBA. Exception: A manufacturer can use such data where the error prejudicial to his product is deemed acceptable.
- 12.3.3 Calculate octave band power levels and A-weighted sound power in accordance with the appropriate section of the ISO/TC 43 documents on the "Determination of Sound Power Emitted By Noise Sources," which applies to the space being used for the measurements.

13.0 METHODS OF ACOUSTICAL MEASUREMENT AND POSITION OF MEASURING POINTS¹

- 13.1 When measurements are made under free field, free field over a reflecting surface or semi-reverberant conditions, the microphone positions shall be arranged over a hemispherical surface centered about the center of the projection of the pump on the reflecting plane.
 - 13.1.1 The radius of the hemispherical surface shall be more than twice the maximum dimension of the pump (ignoring minor projections such as the shaft) but no less than one meter.

¹Final recommendations to be prepared by Dr. Brownsey, Chairman WG-1. Notes are from previous documents.

- 13.1.2. Use at least four positions located central to equal areas of the hemispherical surface. (See Table IV and Fig. 4.

TABLE IV: COORDINATES FOR FOUR-POINT MICROPHONE ARRAY

$\frac{X}{r}$	$\frac{Y}{r}$	$\frac{Z}{r}$
-.40	.74	.53
-.40	-.74	.53
.84	0	.53
0	0	1.00

- 13.2 For measurements made under reverberant conditions, a single microphone position can be used if adequate diffusion has been shown to exist in accordance with Paragraph 8.0.

14.0 QUANTITIES TO BE MEASURED²

15.0 CALCULATION AND INTERPRETATION OF RESULTS²

16.0 TEST REPORT

- 16.1 An A-weighted sound power level and octave band sound power levels for the bands of interest shall be reported for each set of operating conditions specified.

- 16.2 A complete set of operating conditions consists of:

- 16.2.1 Shaft Speed
- 16.2.2 Discharge Pressure
- 16.2.3 Inlet Pressure
- 16.2.4 Inlet Temperature
- 16.2.5 Fluid Viscosity (cs, SUS)
- 16.2.6 Output Flow (%Displacement)
- 16.2.7 Case Pressure

- 16.3 The following data shall also be recorded for each pump tested:

- 16.3.1 Pump Description
- 16.3.2 Date of Test
- 16.3.3 Type of Fluid
- 16.3.4 Compensator Pressure Setting
- 16.3.5 Location of Test
- 16.3.6 Type of Test Space
- 16.3.7 Results of Test Space Verification

²Paragraph 14.0 to be prepared by UK delegation to WGI. Paragraph 15.0 to be prepared by French delegation to WGI.

TABLE V-A: EXAMPLE DATA FOR EACH PUMP TESTED

Pump Description _____ Date of Test _____
 Fluid _____ Compensator Pressure Setting _____
 Location of Test _____ Type of Test Facility _____
 Results of Test Facility Verification _____

TABLE V-B: EXAMPLE DATA SUMMARY FOR ONE OPERATING CONDITION

Shaft Speed _____ Discharge Pressure _____
 Inlet Temperature _____ Inlet Pressure _____
 Fluid Viscosity _____ Output Flow _____
 Case Pressure _____ % Displacement _____

Octave Band Center Frequency (Hz)	125	250	500	1000	2000	4000	8000
Sound Power Level (dB)							

Sound Power _____ dBA

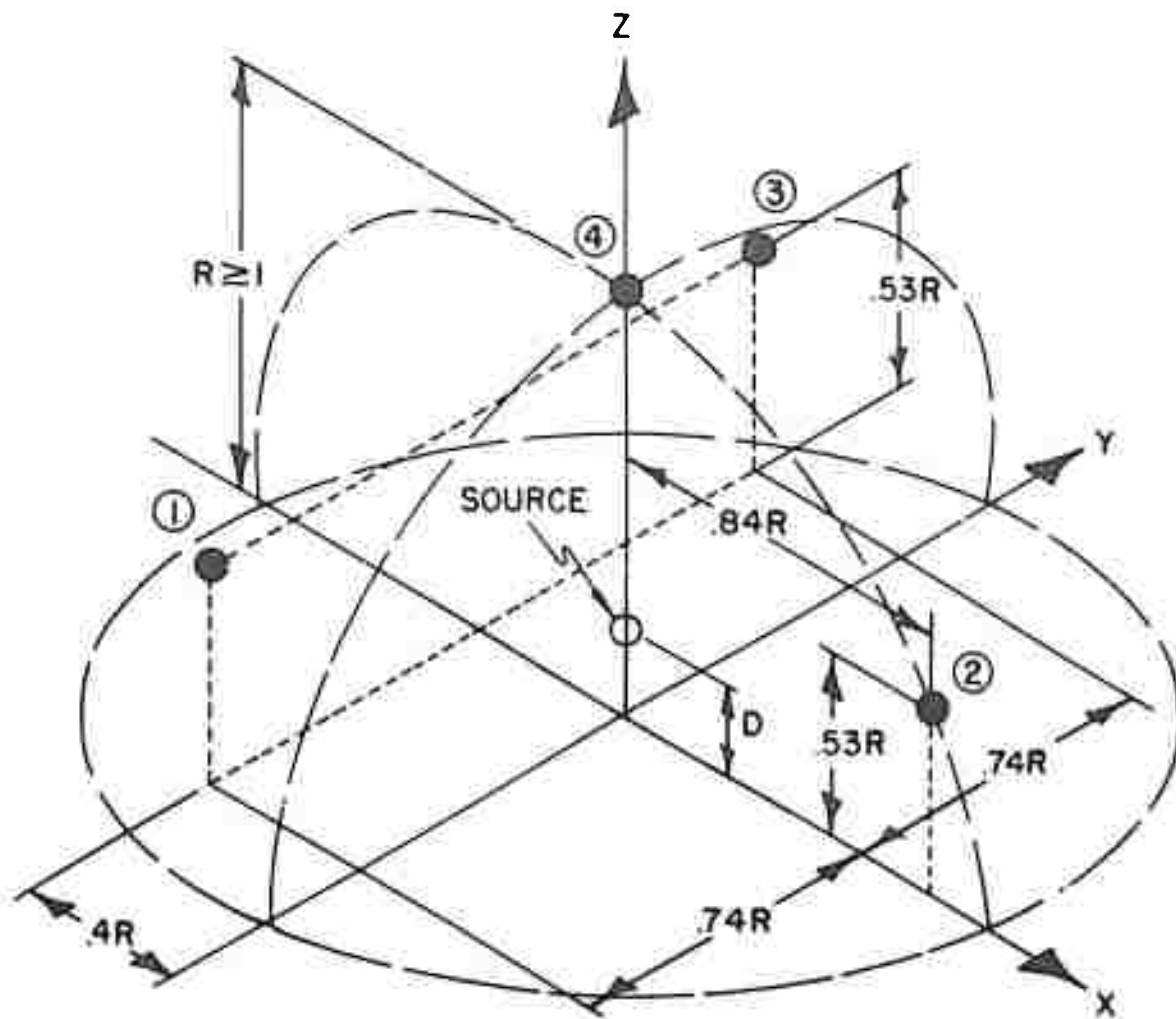

ALL DIMENSIONS IN METERS
 $D \leq 1/6 R$
 X-Y PLANE IS THE REFLECTING PLANE

Fig. F-1. Four-Point Measurement Array for Non-Reverberant Environments With Small Sources.

APPENDIX G

TEST CODE FOR MEASURING AND REPORTING FLUID-BORNE NOISE

EMITTED BY HYDRAULIC FLUID POWER PUMPS

NOTE: This document is a rough draft of one basic approach to measuring pump fluid-borne noise. It is intended only as a guide for the development of a test code. Another basic approach is outlined in Chapter II.

REFERENCES*

1. American National Standard Glossary of Terms for Fluid Power, ANSI/B93.2, and Supplements Thereto. (ISO/TC 131/SC 1 USA-___).
2. ISO Recommendation R495, General Requirements for the Preparation of Test Codes for Measuring the Noise Emitted by Machines.
3. ISO Recommendation R1000, International Standard Rules for the Use of Units of the International System of Units and a Selection of the Decimal Multiples and Sub-Multiples of SI Units.
4. ISO Recommendation R1680, Test Code for the Measurement of the Airborne Noise Emitted by Rotating Electrical Machinery.
5. Society of Automotive Engineers Aerospace Recommended Practice, Determination of Hydraulic Pressure Drop, SAE/ARP 24B-1968.

*Unless otherwise noted, all references shall be in accordance with the latest revision.

C O N T E N T S

	Page
INTRODUCTION	124
1. SCOPE	124
2. PURPOSE	124
3. TERMS AND DEFINITIONS	124
4. UNITS	124
5. LETTER SYMBOLS	124
6. GENERAL	124
7. TEST EQUIPMENT	125
8. TEST CONDITIONS ACCURACY	126
9. TEST PROCEDURES	126
10. DATA PRESENTATION	127
11. JUSTIFICATION STATEMENT	128

TABLES

1. TEST CONDITIONS ACCURACY	126
2. EXAMPLE DATA SUMMARY	129

TEST CODE FOR MEASURING AND REPORTING FLUID-BORNE NOISE
EMITTED BY HYDRAULIC FLUID POWER PUMPS

- INTRODUCTION -

In hydraulic fluid power systems, power is transmitted and controlled through a liquid under pressure within an enclosed circuit. Pumps convert mechanical power into hydraulic fluid power. Pressure pulsations are created in the hydraulic fluid during the power conversion process. These pressure pulsations transmit vibrational energy to fluid conduits and other components. The transmitted pulsations may ultimately cause airborne noise. A pump's potential for directly causing airborne noise is an important consideration in component selection. The results of this procedure might be used to compare the pressure pulsations caused by two different pumps.

1.0 SCOPE

To include the measurement and reporting of the pressure pulsations caused by any hydraulic fluid power pump.

2.0 PURPOSE

To provide a means of comparing pressure pulsations associated with hydraulic fluid power pumps where the comparable data have been measured and reported according to a specific test procedure.

3.0 TERMS AND DEFINITIONS

4.0 UNITS

4.1 The International System of Units (SI) is used in accordance with Ref. No. 3.

4.2 Approximate conversions to "Customary U.S." units are given for informational purposes. These appear in parenthesis after their SI counterparts.

5.0 LETTER SYMBOLS

6.0 GENERAL

6.1 Set up and maintain apparatus per sections 7 and 8.

6.2 Run all tests per Section 9.

6.3 Present data from Section 9 per Section 10.

7.0 TEST EQUIPMENT

7.1 Hydraulic Equipment

- 7.1.1 The hydraulic circuit is to include oil filter, oil cooler, and reservoir and restrictor valves as required to meet the pump hydraulic test conditions.
- 7.1.2 The test fluid and filtration level shall be in accordance with manufacturer's recommendations.
- 7.1.3 Exercise extra care in assembling inlet lines to prevent air leaking into the circuit.
- 7.1.4 Locate inlet restrictor valves upstream of the pump as far as practical to minimize aeration to pump inlet port.
- 7.1.5. Locate the inlet pressure gauge at the same height as the inlet fitting or calibrate gauge for height difference.
- 7.1.6 Use a needle valve (load valve) to create the required pump outlet pressure.
- 7.1.7 Locate the load valve at least 25 feet downstream of the pump outlet.
- 7.1.8 Locate a piezometer tube, constructed per Ref. 5 and of the same tube size as the pump outlet, as close as practical to the pump outlet.
- 7.1.9 Install a pressure pulsation attenuator, which dampens 20 dB at 100 Hz and higher frequencies, downstream of the piezometer tube but upstream of the load valve.

7.2 Mechanical Equipment

- 7.2.1 Construct the pump mount so that it will not add to or detract from the pressure pulsations.

7.3 Test Circuit

- 7.3.1 Verify the suitability of the test circuit per the appropriate procedure.

7.4 Measuring Instruments

7.4.1 Acoustical Analysis Instruments

- 7.4.1.1 Secure instrumentation that complies with the measuring instrument requirements of Ref. 4.

7.4.1.2 Calibrate the measuring instruments per Ref. 4.

7.4.2 Measure temperatures and pressures at the pump inlet and discharge fittings.

7.4.3 Pressure Instrumentation

7.4.3.1 Secure a dynamic pressure transducer and associated conditioning equipment which has an output voltage linearly proportional to pressure within $\pm 4\%$ over a frequency range of 100 Hz to 10,000 Hz and a time constant of less than 15 seconds.

7.4.3.2 Insure that each unit in the pressure instrumentation system is calibrated at least every six months.

8.0 TEST CONDITIONS ACCURACY

Set up and maintain equipment accuracy within the limits of Table I.

TABLE I: TEST CONDITIONS ACCURACY

Test Conditions	SI Unit	U.S. Unit	Maintain Within \pm
Flow	l/min	U.S. GPM	2%
Pressure, Pump Inlet	(Positive) bar (Negative)mm Hg	psig in Hg	2% 2%
Pressure	bar	psig	2%
Speed	RPM	RPM	2%
Temperature	°C	°F	3°C(5°F)

9.0 TEST PROCEDURE

9.1 Transducer Preparations

9.1.1 Attach pressure transducer to piezometer tube with a minimum of tubing.

9.1.2 Insure that no air is trapped in the connecting line between the transducer and the piezometer tube.

9.2 Pulsation Measurements

9.2.1 Operate the pump at conditions specified in the test requirement.

- 9.2.2 Insure that the pump has been operated at test conditions for one hour previously or operate at specified conditions for one hour.
- 9.2.3 Stabilize all test conditions.
- 9.2.4 Wait 60 seconds after reaching a stabilized operating condition before proceeding to Clause 9.2.5.
- 9.2.5 Obtain measured pulsation mean levels in dB at each octave band center frequency between 125 Hz and 8000 Hz.
- 9.2.6 Convert measurements of Clause 9.2.6 to dB values relative to 20 μ N/M.
- 9.2.7 Record the results of Clause 9.2.6 (See Table II.)

10. DATA PRESENTATION

- 10.1 Prepare a data summary using the results of Section 9.
- 10.2 Use Table II as an example summary.
- 10.3 Include the following information on the summary:
 - 10.3.1 Pump Description
 - 10.3.2 Fluid Viscosity (cSt, SUS)
 - 10.3.3 Date of Test
 - 10.3.4 Location of Test
 - 10.3.5 Shaft Speed
 - 10.3.6 Discharge Pressure.
 - 10.3.7 Inlet Pressure
 - 10.3.8 Inlet Temperature
 - 10.3.9 Type of Fluid
 - 10.3.10 Output Flow (for variable displacement units; also state percentage displacements, i.e. 90%, 5%, etc.)
 - 10.3.11 Case Pressure

10.3.12 Compensator Setting

10.3.13 Type of Pressure Transducer

10.3.14 Results of Test Circuit Verification

11. JUSTIFICATION STATEMENT

(To be included following completion of the review process.)

TABLE II-A: EXAMPLE DATA FOR EACH PUMP TEST

Pump Description _____ Date of Test _____
 Fluid _____ Compensator Pressure Setting _____
 Location of Test _____ Type of Test Circuit _____
 Results of Test Circuit Verification _____

TABLE II-B: EXAMPLE DATA SUMMARY FOR ONE OPERATING CONDITION

Shaft Speed _____ Discharge Pressure _____
 Inlet Temperature _____ Inlet Pressure _____
 Fluid Viscosity _____ Output Flow _____
 Case Pressure _____ % Displacement _____

Octave Band Center Frequency (Hz)	125	250	500	1000	2000	4000	8000
Sound Pressure Level (dB)							

Fluid-borne Noise Level _____ dBA (re $20\mu\text{N}/\text{M}^2$)