

AD-760 139

EXPERIMENTAL STUDIES OF THE PARTIAL AND  
TOTAL PRESSURE DEPENDENCE OF WATER VAPOR  
ABSORPTION COEFFICIENTS FOR HIGHLY TRANS-  
MITTING CO LASER LINES

R. K. Long, et al

Ohio State University

Prepared for:

Rome Air Development Center  
Defense Advanced Research Projects Agency

February 1973

DISTRIBUTED BY:

**NTIS**

National Technical Information Service  
U. S. DEPARTMENT OF COMMERCE  
5285 Port Royal Road, Springfield Va. 22151



RADC-TR-73-125  
Technical Report  
February 1973



EXPERIMENTAL STUDIES OF THE PARTIAL AND TOTAL PRESSURE  
DEPENDENCE OF WATER VAPOR ABSORPTION COEFFICIENTS  
FOR HIGHLY TRANSMITTING CO LASER LINES

(3271-4)

AD 760139

The Ohio State University  
**ElectroScience Laboratory**

Department of Electrical Engineering  
Columbus, Ohio 43212

Sponsored by  
Defense Advanced Research Projects Agency  
ARPA Order No. 1279



Approved for public release;  
distribution unlimited.

The views and conclusions contained in this document are those of the authors and should not be interpreted as necessarily representing the official policies, either expressed or implied, of the Defense Advanced Research Projects Agency or the U. S. Government.

NATIONAL TECHNICAL  
INFORMATION SERVICE  
U.S. GOVERNMENT PRINTING OFFICE  
WASHINGTON, D.C. 20540

Rome Air Development Center  
Air Force Systems Command  
Griffiss Air Force Base, New York

43 R

EXPERIMENTAL STUDIES OF THE PARTIAL AND TOTAL PRESSURE  
DEPENDENCE OF WATER VAPOR ABSORPTION COEFFICIENTS  
FOR HIGHLY TRANSMITTING CO LASER LINES

R. K. Long  
F. S. Mills  
G. L. Trusty

Contractor: The Ohio State University  
Contract Number: F30602-72-C-0016  
Effective Date of Contract: 23 June 1971  
Contract Expiration Date: 31 March 1973  
Amount of Contract: \$130,000.00  
Program Code No. OE20

Principal Investigator: Dr. Ronald K. Long  
Phone: 614 422-6077

Research Associate: Mr. Frank S. Mills  
Phone: 614 422-6726

Contract Engineer: James W. Cusack  
Phone: 315 330-3145

Approved for public release;  
distribution unlimited.

This research was supported by the Defense  
Advanced Research Projects Agency of the  
Department of Defense and was monitored by  
James W. Cusack RADC (OCSE), GAFB, NY 13441  
under Contract F30602-72-C-0016.

*ib*

## TABLE OF CONTENTS

|   | Page |
|---|------|
| I. INTRODUCTION                           | 1    |
| II. EXPERIMENTAL TECHNIQUE                | 1    |
| III. LINES STUDIED                        | 1    |
| IV. EXPERIMENTAL RESULTS                  | 4    |
| A. 8.89 Torr Water Vapor With Nitrogen    | 4    |
| B. 8.26 Torr Water Vapor With Nitrogen    | 5    |
| C. 5.77 Torr Water Vapor With Nitrogen    | 5    |
| D. Pure Water Vapor                       | 33   |
| V. INTERPRETATION OF RESULTS              | 33   |
| A. Pure Water Vapor Results               | 33   |
| B. Nitrogen Broadened Water Vapor Results | 33   |
| VI. CONCLUSIONS                           | 37   |
| REFERENCES                                | 38   |

## I. INTRODUCTION

This report presents additional measurements of water vapor absorption at CO laser wavelengths. In these measurements the total pressure dependence of the absorption is studied. The next report will present more extensive results (i.e., more CO lines and more water vapor partial pressures) at a single total pressure (760 Torr).

## II. EXPERIMENTAL TECHNIQUE

A schematic diagram of the experiment is shown in Fig. 1. The absorption cell was set for 48 traversals corresponding to a path length of 0.7317 km.

The CO laser source was designed by Dr. Charles Freed and was loaned to Ohio State University by MIT Lincoln Laboratory. It is a highly stabilized design and uses a diffraction grating for line selection. Due to the close spacing of the CO transitions more than one line appears in the output for some grating settings.

The lines selected for study are listed in Table I. The studies presented in this report used list A of Table I. Later measurements which will be described in the next report used list A and list B.

---

TABLE I  
CO LINES USED IN EXPERIMENTS

| <u>List A (Unblended)</u> |      |       | <u>List C (Blends)</u> |      |       |
|---------------------------|------|-------|------------------------|------|-------|
| 1978.586                  | 5-4  | P(15) | 1936.001               | 6-5  | P(19) |
| 1974.373                  | 5-4  | P(16) | 1933.529               | 7-6  | P(12) |
| 1952.907                  | 6-5  | P(15) | 1935.486               | 7-6  | P(13) |
| 1927.299                  | 7-6  | P(15) | 1874.459               | 10-9 | P(9)  |
| 1970.129                  | 5-4  | P(17) | 1913.891               | 8-7  | P(12) |
| 1948.729                  | 6-5  | P(16) | 1940.276               | 6-5  | P(18) |
| 1880.348                  | 9-8  | P(14) | 1876.309               | 9-8  | P(15) |
| 1854.933                  | 10-9 | P(14) | 1914.774               | 7-6  | P(18) |
| <br>                      |      |       |                        |      |       |
| <u>List B (Unblended)</u> |      |       |                        |      |       |
| 1931.409                  | 7-6  | P(14) |                        |      |       |
| 1905.841                  | 8-7  | P(14) |                        |      |       |
| 1957.051                  | 6-5  | P(14) |                        |      |       |

---

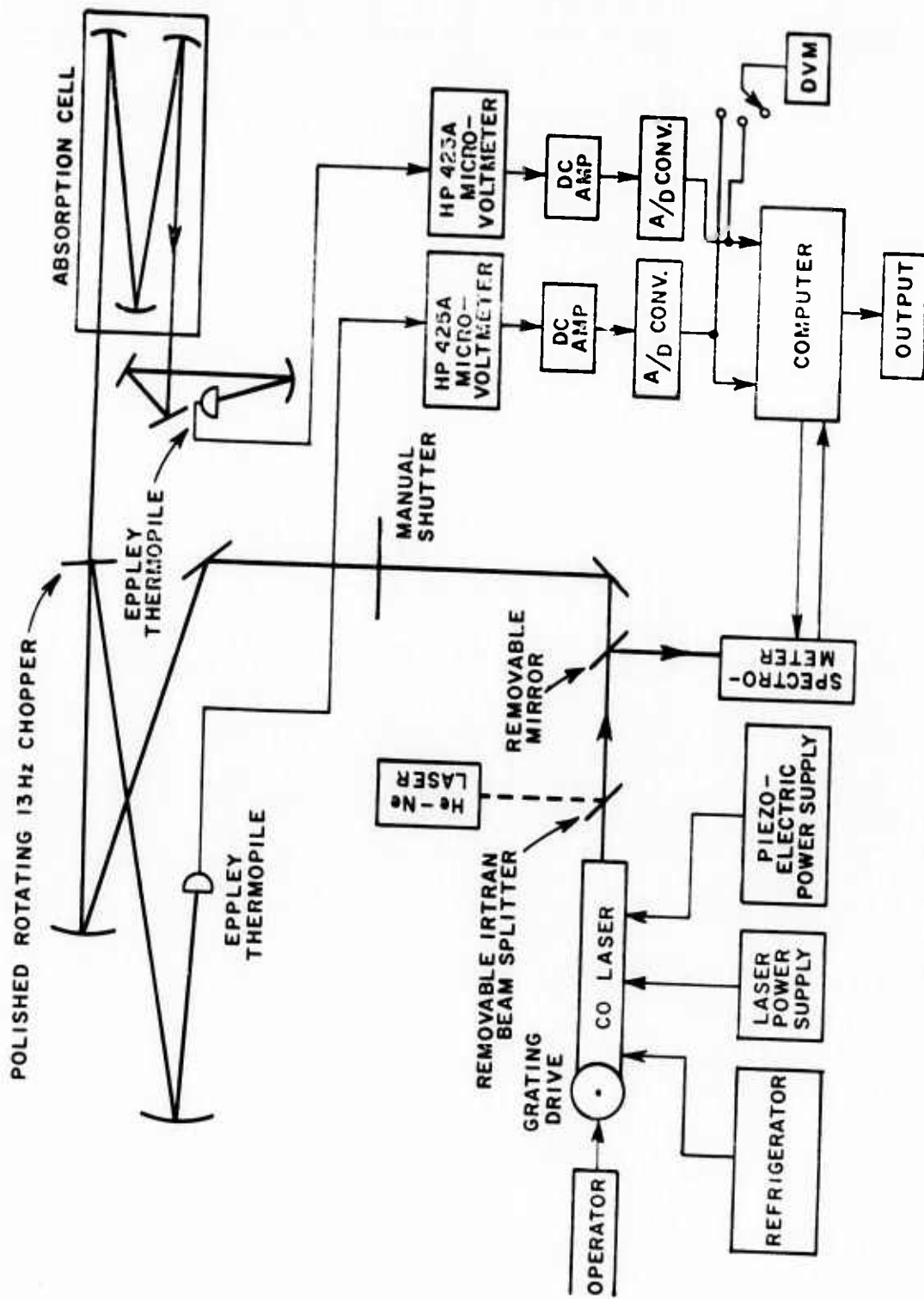

Fig. 1. Experimental configuration for absorption measurements, Ohio State University ElectroScience Laboratory facility.

DOCUMENT CONTROL DATA - R & D

|  |  |  |                       |
|--|--|--|-----------------------|
| 1. ORIGINATING AGENCY (Corporate author)<br>ElectroScience Laboratory, Department of<br>Electrical Engineering, The Ohio State<br>University, Columbus, Ohio 43212   |  | 2. REPORT NUMBER<br>Unclassified   |                       |
| 3. REPORT TITLE<br>EXPERIMENTAL STUDIES OF THE PARTIAL AND TOTAL PRESSURE<br>DEPENDENCE OF WATER VAPOR ABSORPTION COEFFICIENTS<br>FOR HIGHLY TRANSMITTING CO LASER LINES   |  |  |                       |
| 4. PERIODICITY (Type of report and inclusive dates)<br>Quarterly Report March 23, 1972 to June 23, 1972  |  |  |                       |
| 5. AUTHOR (Last name, middle initial, first name)<br>Long, R.K., Mills, F.S., Trusty, G.L.   |  |  |                       |
| 6. REPORT DATE<br>February 1973  |  | 7a. TOTAL NO. OF PAGES<br>38   | 7b. NO. OF PAGES<br>3 |
| 8a. CONTRACT OR GRANT NO.<br>F30602-72-C-0016  |  | 9a. ORIGINATOR'S REPORT NUMBER (RIS)<br>ElectroScience Laboratory 3271-4   |                       |
| 8b. PROJECT NO.  |  | 9b. OTHER REPORT NUMBER (Any other numbers that may be assigned to this report)<br>RADC-TR-72-125                |                       |
| 10. DISTRIBUTION STATEMENT<br>Approved for public release; distribution unlimited.   |  |  |                       |
| 11. SUPPLEMENTARY NOTES<br>Monitored by<br>James W. Cusack, RADC/OCSE<br>Griffiss AFB, NY 13440  |  | 12. SPONSORING/MONITORING AGENCY<br>Advanced Research Projects Agency<br>1400 Wilson Blvd<br>Arlington, VA 22209 |                       |
| 13. ABSTRACT<br>This report describes additional laboratory water vapor absorption measurements at CO laser frequencies. A companion report (3271-5) which is being issued at the same time includes a more extensive discussion of the experimental methods which are common to the measurements in this report (3271-4) and that one (3271-5). |  |  |                       |

DD FORM 1 NOV 65 1473

UNCLASSIFIED

Security Classification

KEY WORDS

LINE A

LINE B

LINE C

NO. 1

NO. 2

NO. 3

NO. 4

CO laser  
Water vapor absorption  
Laser propagation  
Spectroscopy  
Atmospheric transmittance

1a



For all measurements presented in this report only unblended lines were used. Some attempt was made to make measurements at some of the blended lines, list C of Table I, but the results were not satisfactory. Additional effort which is not planned at this time would be required to refine the procedures.

The transmittance is obtained as the ratio of the transmittance of the evacuated cell (background) to the transmittance when the sample is present. The background ratios were measured before and after the sample measurement. Due to the long mixing time required for the water vapor-nitrogen sample, twelve to twenty-four hours elapsed between the "before" and "after" background measurements. These two background ratios did not agree as closely as desired. As the experimental techniques were refined the ratios were more nearly repeatable (within 5%). The variation appeared to be a random one. In the data reduction the average of the two ratios was used.

### III. LINES STUDIED

A calculation using the Calfee-Benedict line-data tables and a Lorentz line shape was used to select the CO lines to be studied.

Five sets of data will be described. Three of them use the following lines:

|    |          |      |       |
|----|----------|------|-------|
| 12 | 1854.933 | 10-9 | P(14) |
| 11 | 1880.348 | 9-8  | P(14) |
| 9  | 1927.299 | 7-6  | P(15) |
| 10 | 1948.729 | 6-5  | P(16) |
| 4  | 1952.907 | 6-5  | P(15) |
| 8  | 1970.129 | 5-4  | P(17) |
| 2  | 1974.374 | 5-4  | P(16) |

The fourth uses the above plus:

|   |          |     |       |
|---|----------|-----|-------|
| 1 | 1978.586 | 5-4 | P(15) |
|---|----------|-----|-------|

The fifth uses:

|    |          |      |       |
|----|----------|------|-------|
| 12 | 1854.933 | 10-9 | P(14) |
| 11 | 1880.343 | 9-8  | P(14) |
| 13 | 1905.841 | 8-7  | P(14) |
| 9  | 1927.299 | 7-6  | P(15) |
| 6  | 1931.409 | 7-6  | P(14) |
| 10 | 1948.7   | 6-5  | P(16) |
| 4  | 1952.907 | 6-5  | P(15) |
| 18 | 1957.057 | 6-5  | P(14) |
| 8  | 1970.129 | 5-4  | P(17) |
| 2  | 1974.374 | 5-4  | P(16) |

The number to the left of the wavenumber is a relative rank of that line for transmittance through an atmosphere having 10 Torr water vapor and 760 Torr total pressure as determined from the previously mentioned calculation, with one representing the best transmittance line.

#### IV. EXPERIMENTAL RESULTS

##### A. 8.89 Torr Water Vapor

Two experiments were performed at this partial pressure. Table II summarizes the results of the first experiment. Eight CO lines

TABLE II  
EXPERIMENTAL RESULTS FOR 8.89 TORR WATER VAPOR AND TOTAL PRESSURES OF 126 TO 767 TORR

1. Entries are transmittance on path length listed

DATE = 4/15/72  
PATH LENGTH = .7317  
WATER VAPOR PRESS. = 8.89

| WAVENUMBER<br>cm <sup>-1</sup> | P = 8.89 |   | P = 126 |      | P = 346 |       | P = 620 |       | P = 767 |      |
|--------------------------------|----------|---|---------|------|---------|-------|---------|-------|---------|------|
|                                | T        | k | T       | k    | T       | k     | T       | k     | T       | k    |
|                                | OBS      |   | OBS     |      | OBS     |       | OBS     |       | OBS     |      |
| 1854.933                       |          |   | .775    | .348 | .385    | 1.305 | .214    | 2.107 | .126    | 2.33 |
| 1880.348                       |          |   | .852    | .219 | .531    | .865  | .327    | 1.53  | .236    | 1.97 |
| 1927.299                       |          |   | .859    | .208 | .500    | .947  | .361    | 1.39  | .283    | 1.73 |
| 1948.729                       |          |   | .894    | .153 | .596    | .707  | .457    | 1.07  | .328    | 1.52 |
| 1952.907                       |          |   | .925    | .107 | .725    | .440  | .629    | .634  | .538    | .847 |
| 1970.129                       |          |   | .925    | .107 | .661    | .566  | .469    | 1.03  | .373    | 1.35 |
| 1974.374                       |          |   | .964    | .050 | .962    | .053  | .807    | .293  | .698    | .491 |
| 1978.586                       |          |   | -       | -    | -       | -     | .856    | .212  | .751    | .391 |

were studied for the 8.89 Torr H<sub>2</sub>O and total pressures (N<sub>2</sub> added) of 126, 346, 620, and 767 Torr. Table II gives the measured transmittance of the 0.7317 km path for each pressure. A second column for each pressure gives the corresponding absorption coefficient in km<sup>-1</sup>. Table III gives similar results for an experiment which included only one broadening pressure, 52.8 Torr in Table I.

TABLE III  
EXPERIMENTAL RESULTS FOR 8.89 TORR WATER VAPOR AND FOR A MIXTURE  
OF 8.89 TORR WATER VAPOR AND A TOTAL PRESSURE OF 52.8 TORR

1. Entries are transmittance  
on path length listed

DATE = 6/16/72  
PATH LENGTH = .7317  
WATER VAPOR PRESS. = 8.89

| WAVENUMBER<br>cm <sup>-1</sup> | P = 8.89 |      | P = 52.8 |      |
|--------------------------------|----------|------|----------|------|
|                                | T<br>OBS | k    | T<br>OBS | k    |
| 1854.933                       | .756     | .382 | .666     | .556 |
| 1880.348                       | .807     | .293 | .749     | .395 |
| 1927.299                       | .902     | .141 | .818     | .275 |
| 1948.729                       | .874     | .184 | .827     | .260 |
| 1952.907                       | .899     | .146 | .880     | .175 |
| 1970.129                       | .869     | .192 | .813     | .283 |
| 1974.374                       | .921     | .112 | .890     | .159 |

Figures 2-9 also present results of these experiments. In this case, although the data was taken at  $l = .7317$  km, the results have been scaled to transmittance on a one km path assuming that  $\ln T = -kl$ . The calculated curve is obtained by using the Calfee-Benedict Tables (1) and a Lorentz line shape (2). BOUND was  $25 \text{ cm}^{-1}$ ,  $T = 76^\circ\text{F}$ , and the self broadening coefficient was assumed to be 5. The curves shown were hand sketched to provide an approximate fit to the measured or computed points.

There is no apparent reason for the fact that the 126 Torr data does not agree with the data at other pressures. We tentatively conclude that an error was made in recording these results.

#### B. 8.26 Torr Water Vapor

This experiment was similar to the previous ones. The partial pressure of water vapor was 8.26 Torr and the total pressures were 58, 128.5, 330, 539, and 760.5 Torr. The results are presented in Table IV and Figs. 10-16. By the time these measurements were taken the experimental technique had improved somewhat resulting in generally better data particularly at the lower pressures.

#### C. 5.77 Torr Water Vapor

A measurement was made at 5.77 Torr water vapor for total pressures of 102, 302, 497, and 759 Torr. This data is presented in Table V and Figs. 17-26. Except for an expected greater scatter for the higher transmittance lines the results are consistent with previous values.

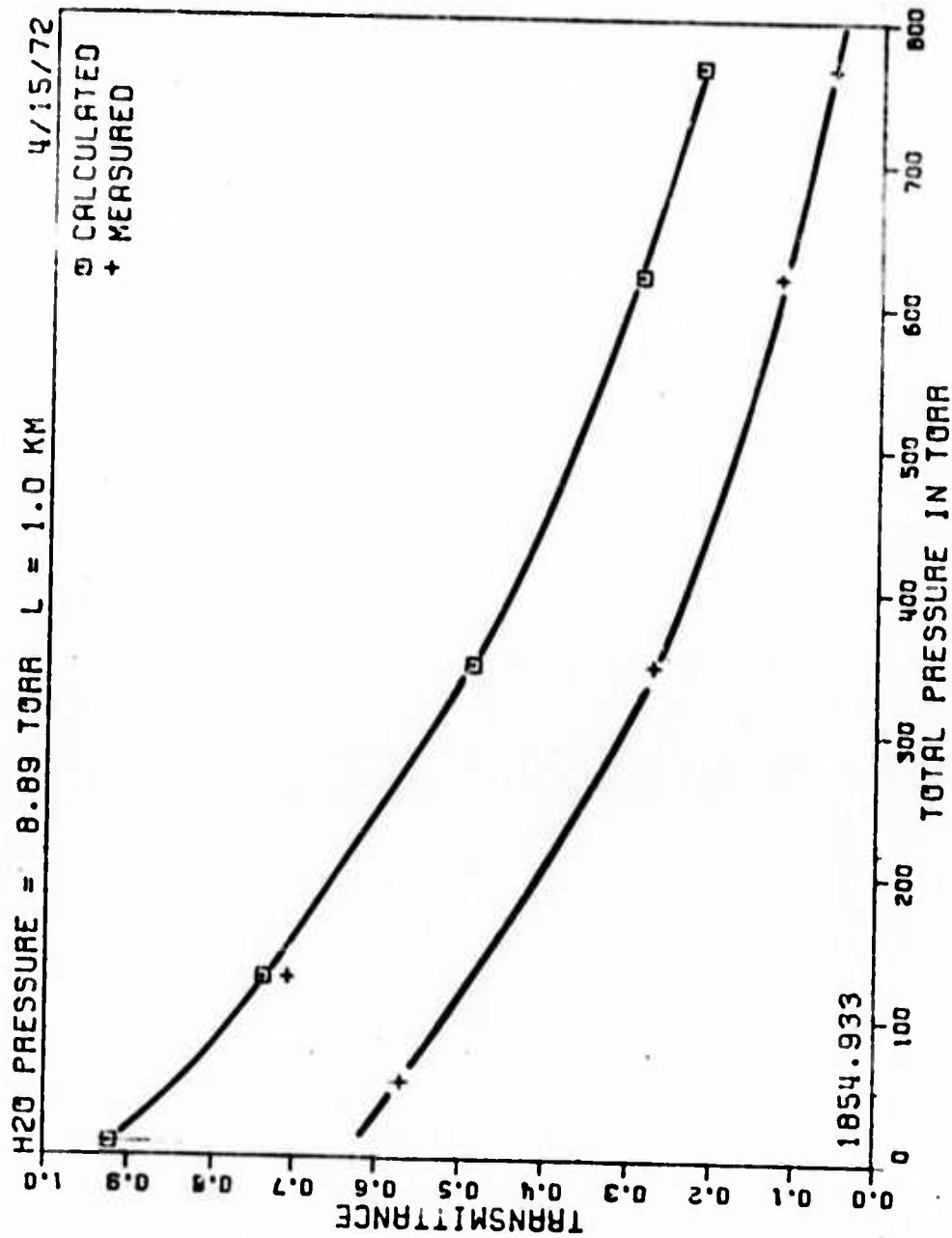

Fig. 2. Calculated and measured transmittance at 1854.933  $\text{cm}^{-1}$  for 8.85 torr water vapor.

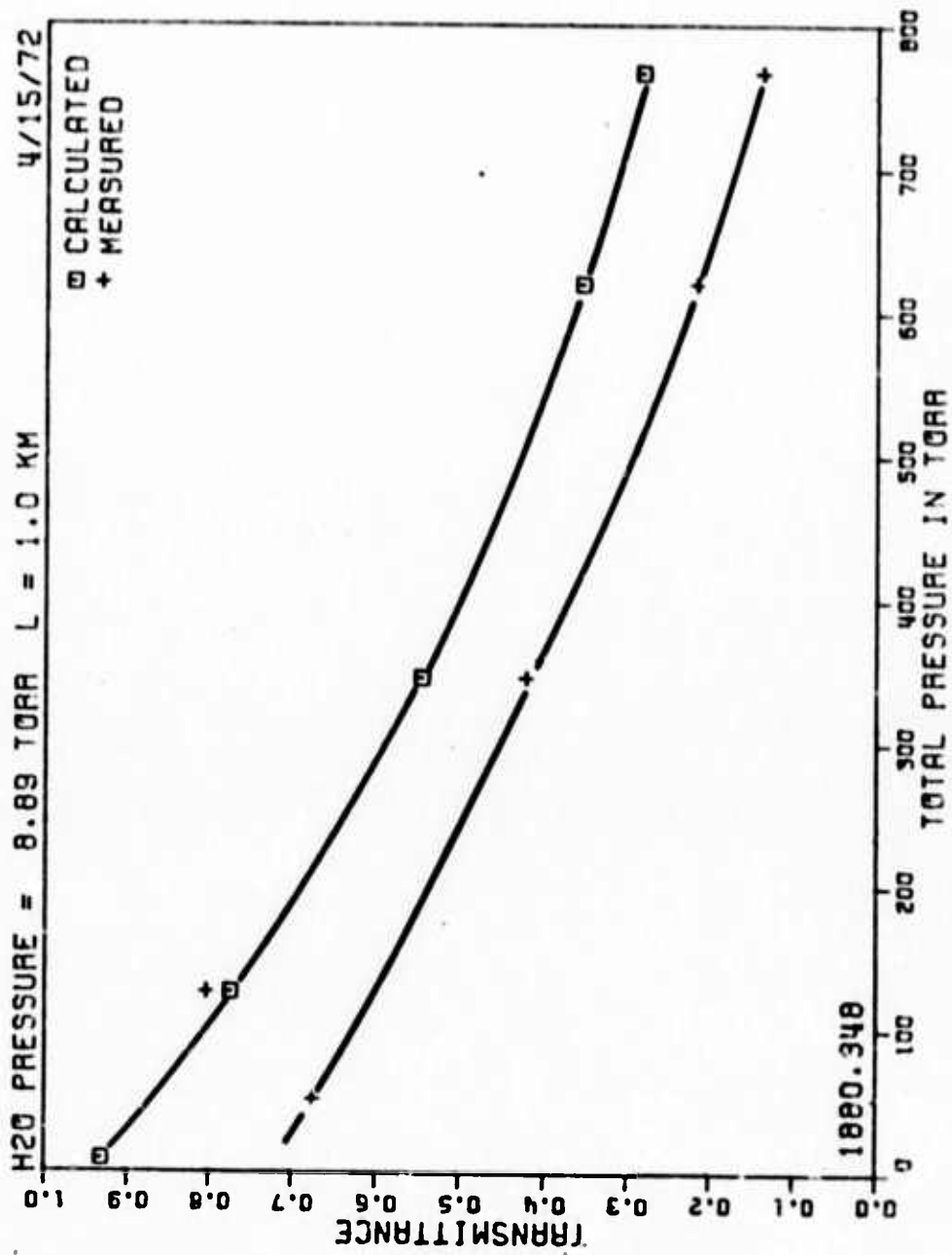

Fig. 3. Calculated and measured transmittance at 1880.348  $\text{cm}^{-1}$  for 8.25 torr water vapor.

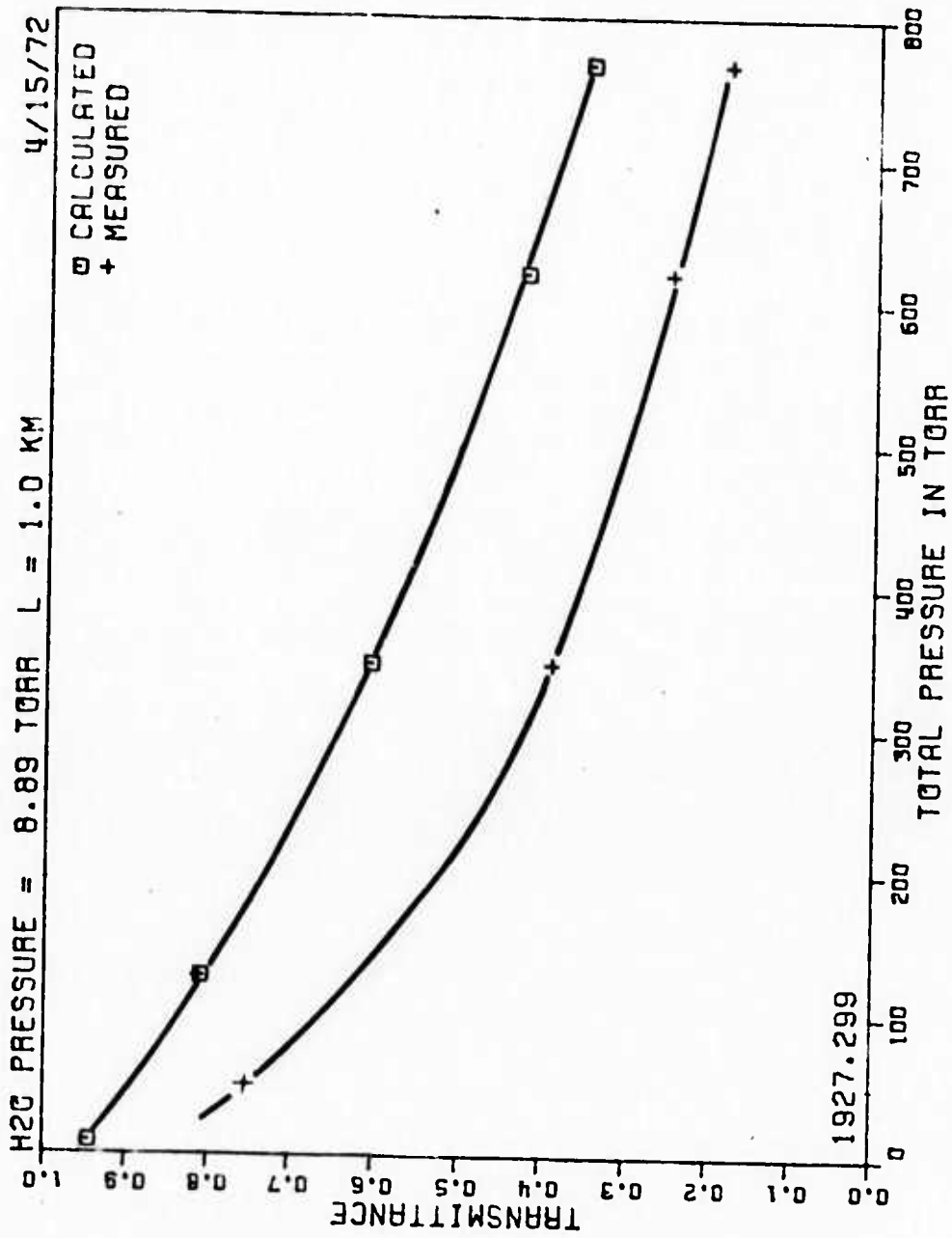

Fig. 4. Calculated and measured transmittance at 1927.299  $\text{cm}^{-1}$  for 8.85 torr water vapor.

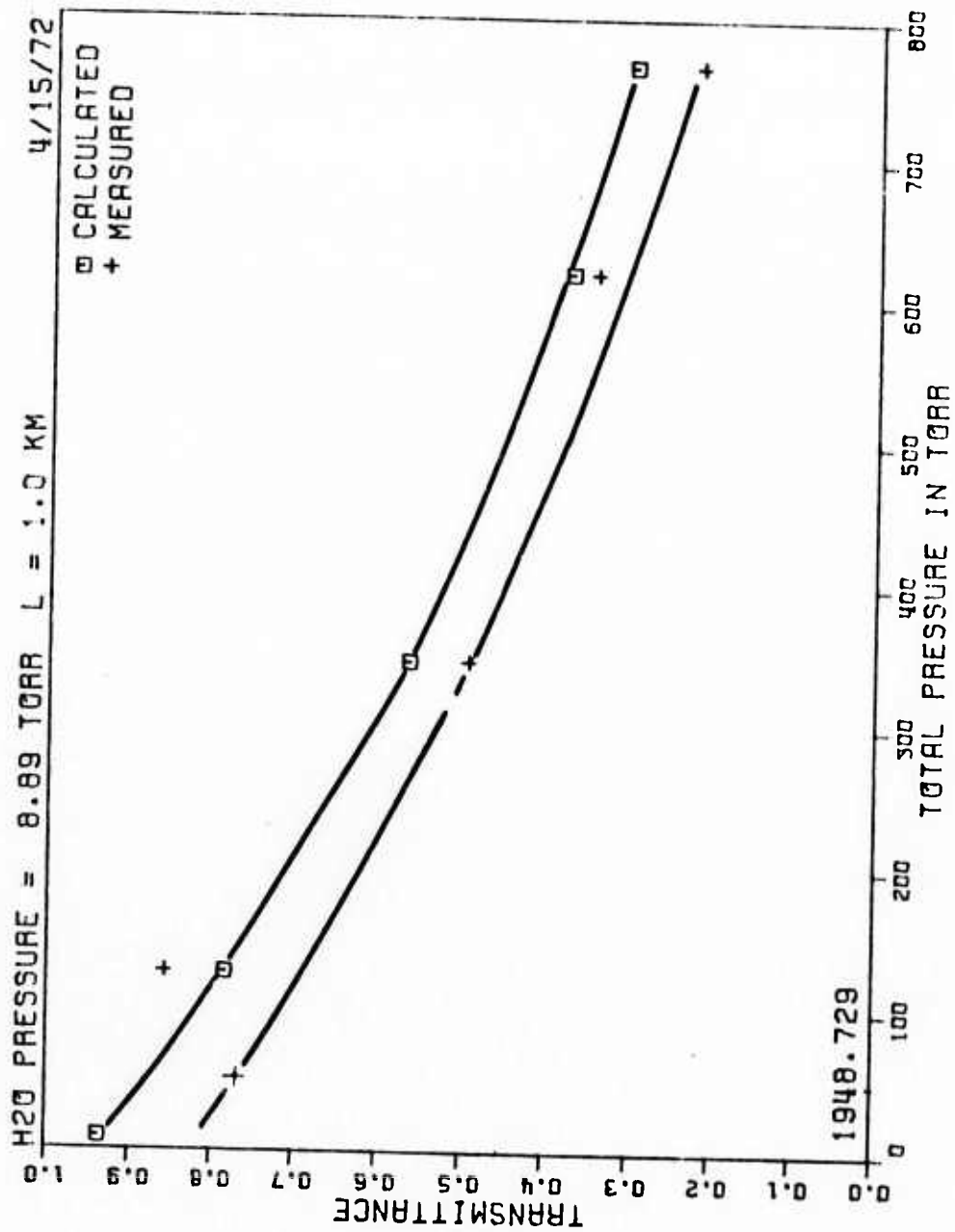

Fig. 5. Calculated and measured transmittance at 1948.729  $\text{cm}^{-1}$  for 8.85 torr water vapor.

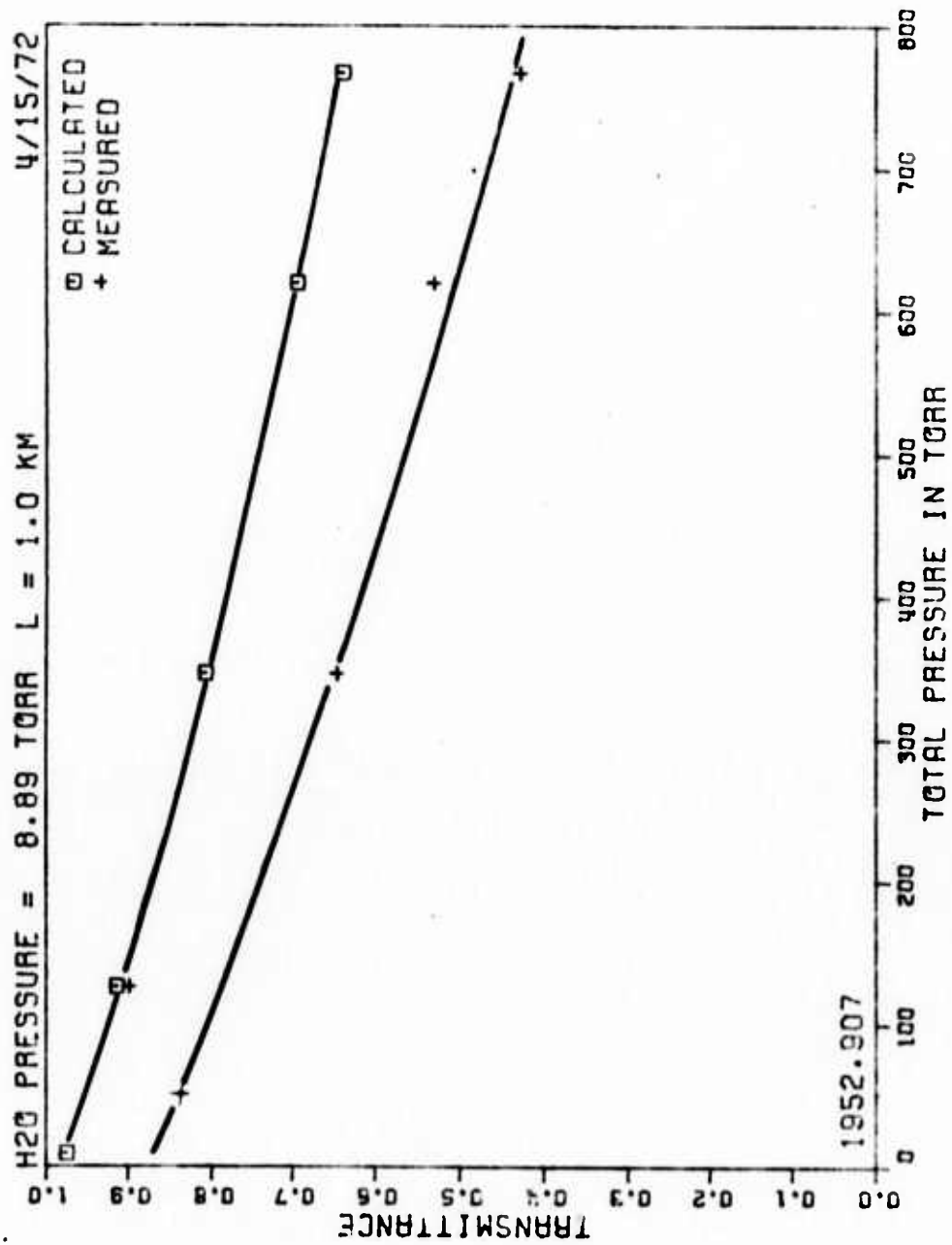

Fig. 6. Calculated and measured transmittance at 1952.907  $\text{cm}^{-1}$  for 8.85 torr water vapor.



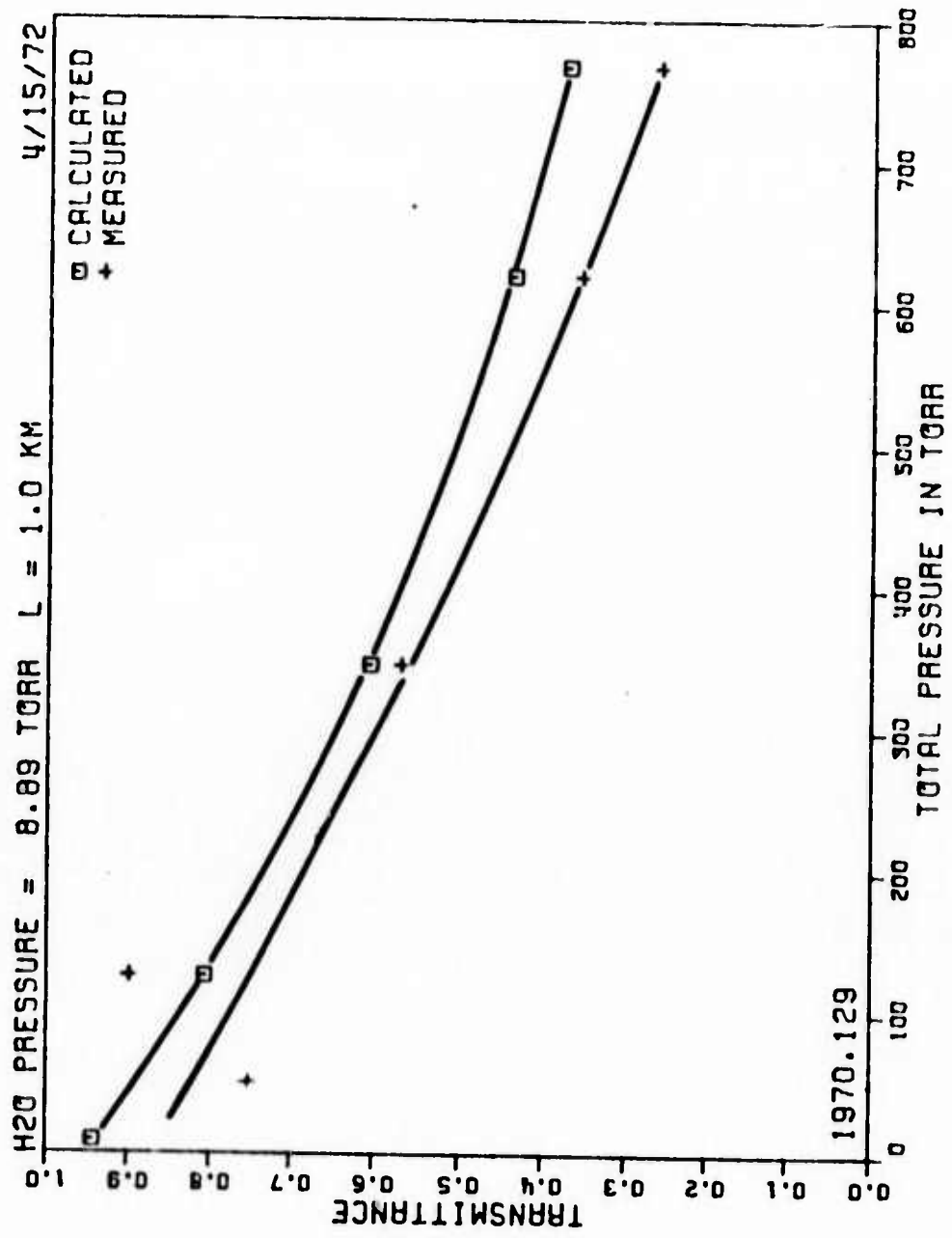

Fig. 7. Calculated and measured transmittance at 1970.129  $\text{cm}^{-1}$  for 8.85 torr water vapor.

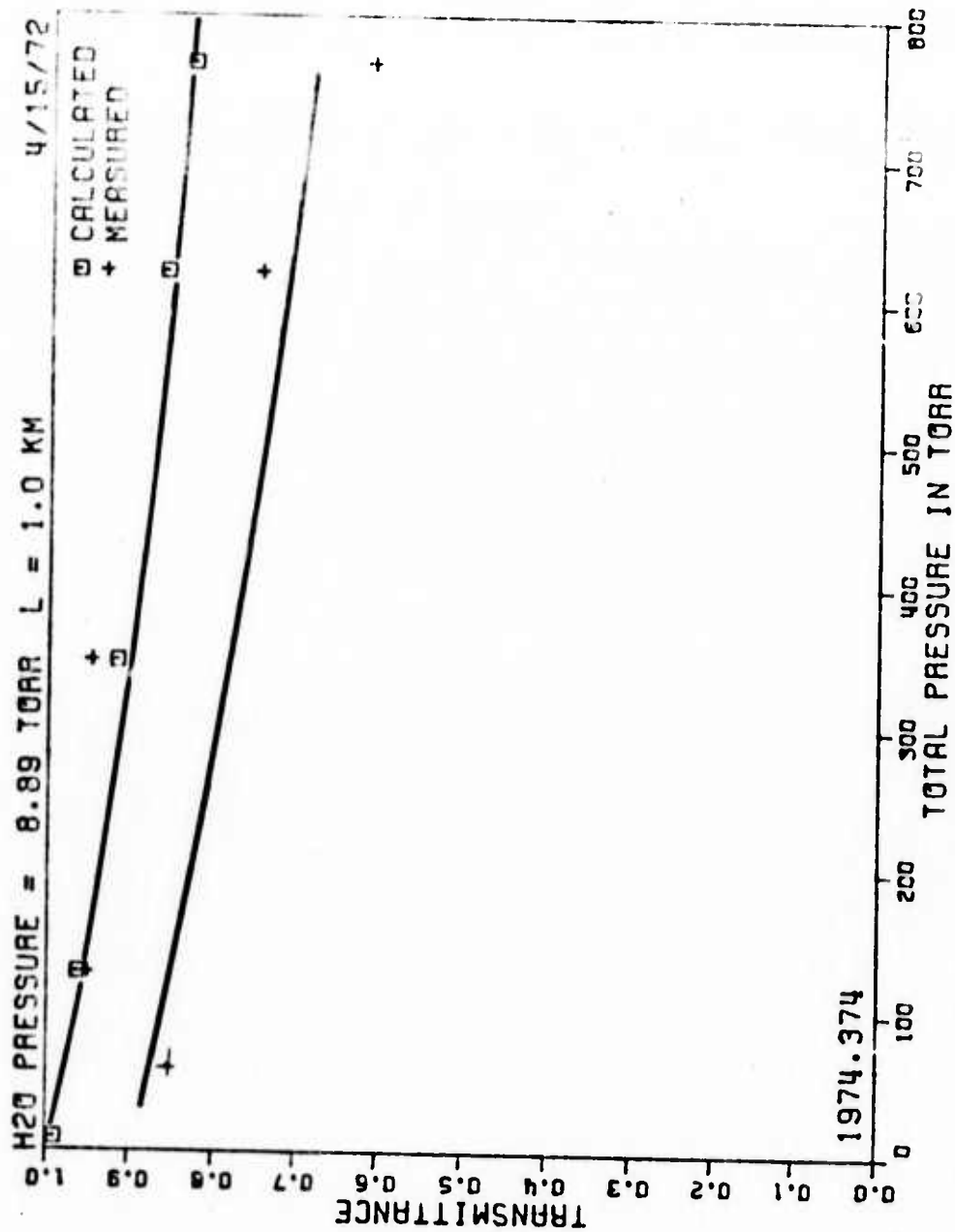

Fig. 8. Calculated and measured transmittance at 1974.374  $\text{cm}^{-1}$  for 8.85 torr water vapor.

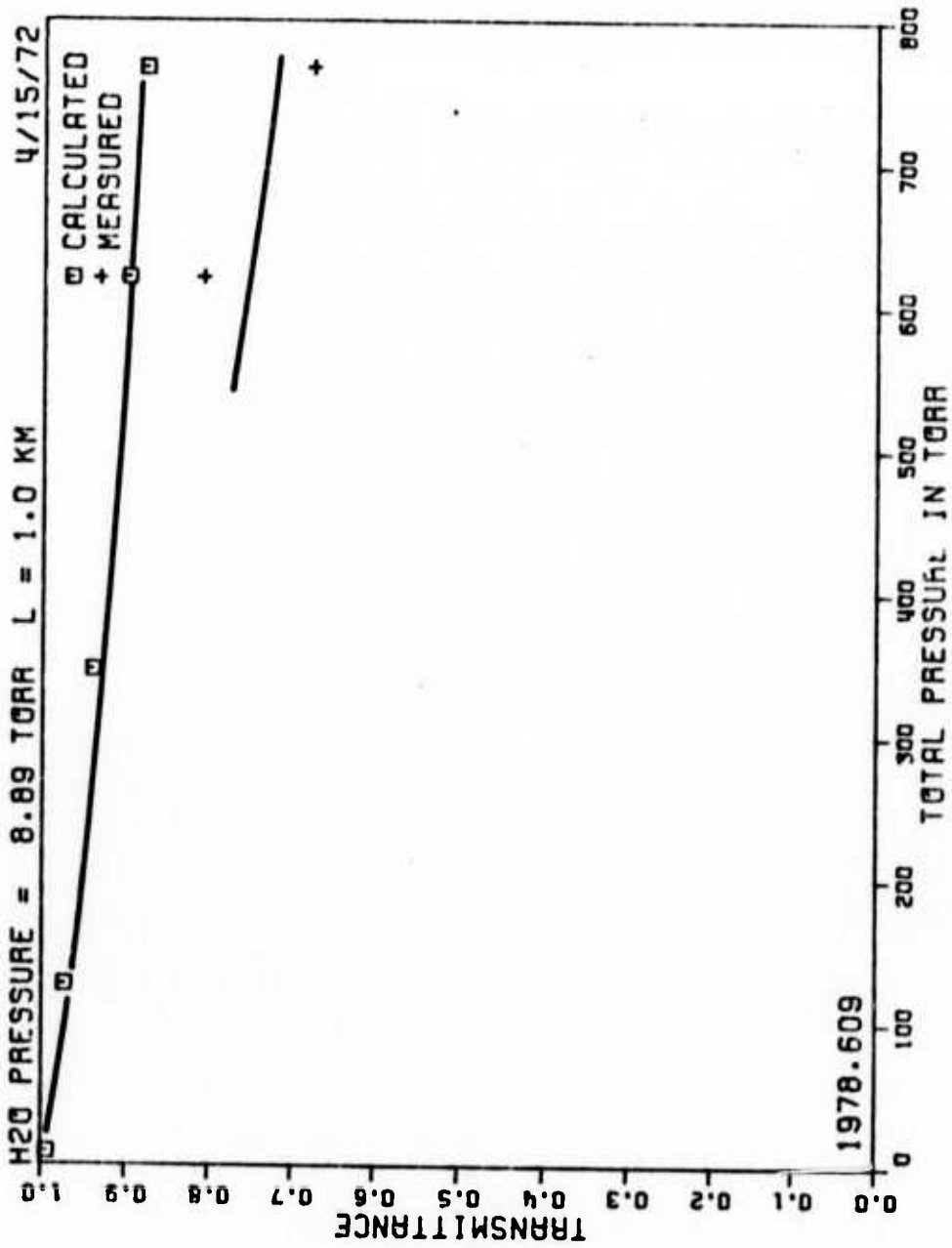

Fig. 9. Calculated and measured transmittance at 1978.609  $\text{cm}^{-1}$  for 8.85 torr water vapor.

TABLE IV  
 EXPERIMENTAL RESULTS FOR 8.89 TORR WATER VAPOR AND FOR A MIXTURE  
 OF 8.26 TORR WATER VAPOR AND A TOTAL PRESSURE OF 58 TO 760 TORR

DATE 6/21/72  
 PATH LENGTH = .7317  
 WATER VAPOR PRESS. = 8.26

1. Entries are transmittance  
 on path length listed

| WAVENUMBER<br>cm <sup>-1</sup> | P = 8.26 |      | P = 58   |      | P = 128.5 |      | P = 330  |      | P = 539  |      | P = 760.5 |      |
|--------------------------------|----------|------|----------|------|-----------|------|----------|------|----------|------|-----------|------|
|                                | T<br>OBS | k    | T<br>OBS | k    | T<br>OBS  | k    | T<br>OBS | k    | T<br>OBS | k    | T<br>OBS  | k    |
| 1854.933                       | .792     | .319 | .677     | .533 | .579      | .747 | .394     | 1.27 | .227     | 2.03 | .144      | 2.65 |
| 1880.348                       | .835     | .246 | .748     | .397 | .682      | .523 | .536     | .852 |          |      | .267      | 1.80 |
| 1927.299                       | .893     | .155 | .834     | .248 | .773      | .352 | .532     | .863 | .434     | 1.14 | .328      | 1.52 |
| 1948.729                       | .920     | .114 | .833     | .250 | .768      | .361 | .571     | .766 | .455     | 1.08 | .368      | 1.37 |
| 1952.907                       | .927     | .104 | .873     | .186 | .829      | .256 | .704     | .480 | .626     | .640 | .579      | .747 |
| 1970.129                       | .912     | .126 | .829     | .256 | .829      | .256 | .631     | .629 | .481     | 1.00 | .410      | 1.22 |
| 1974.374                       | .929     | .101 | .882     | .172 | .896      | .150 | .919     | .115 | .799     | .307 | .778      | .343 |

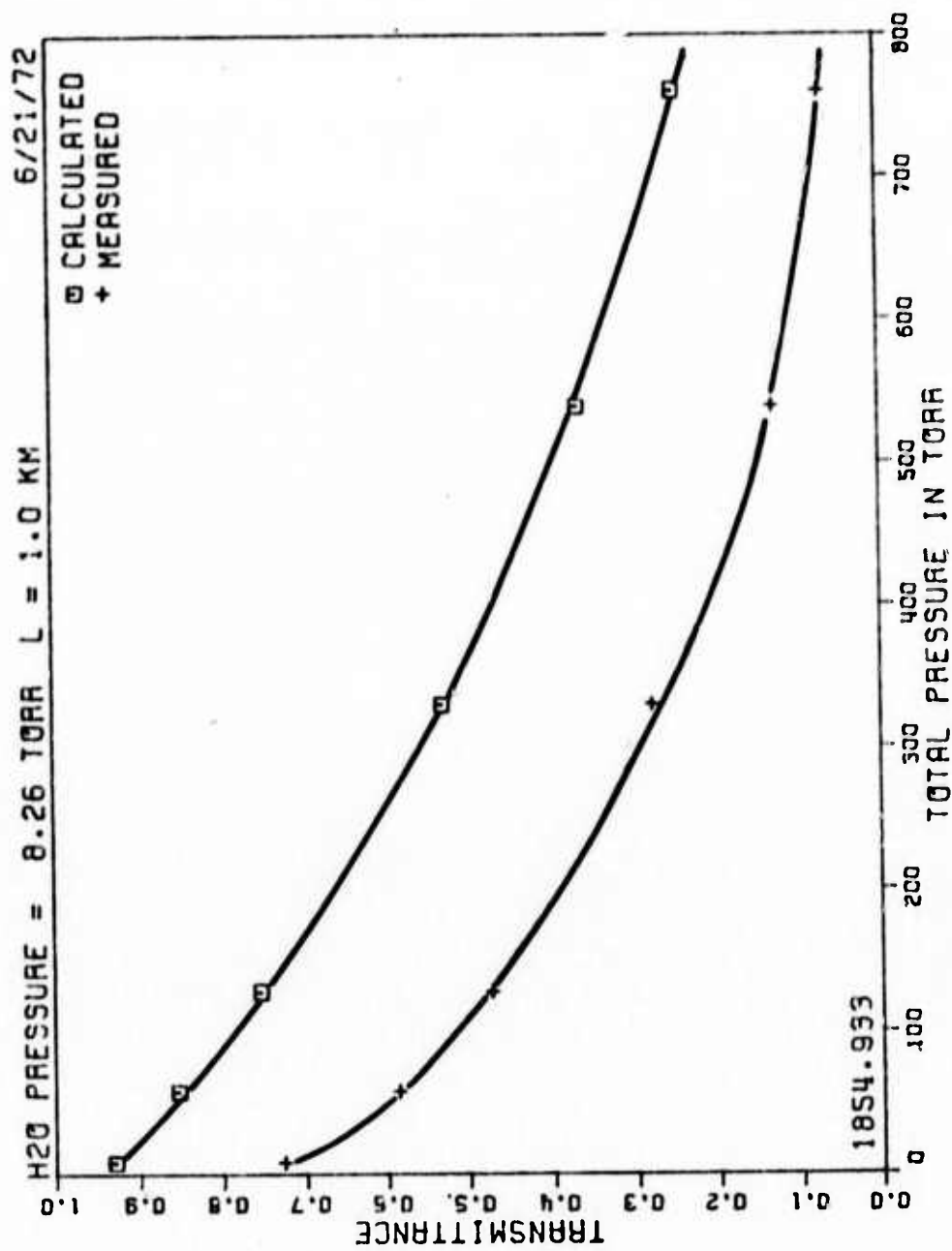

Fig. 10. Calculated and measured transmittance at 1854.933  $\text{cm}^{-1}$  for 8.26 torr water vapor.

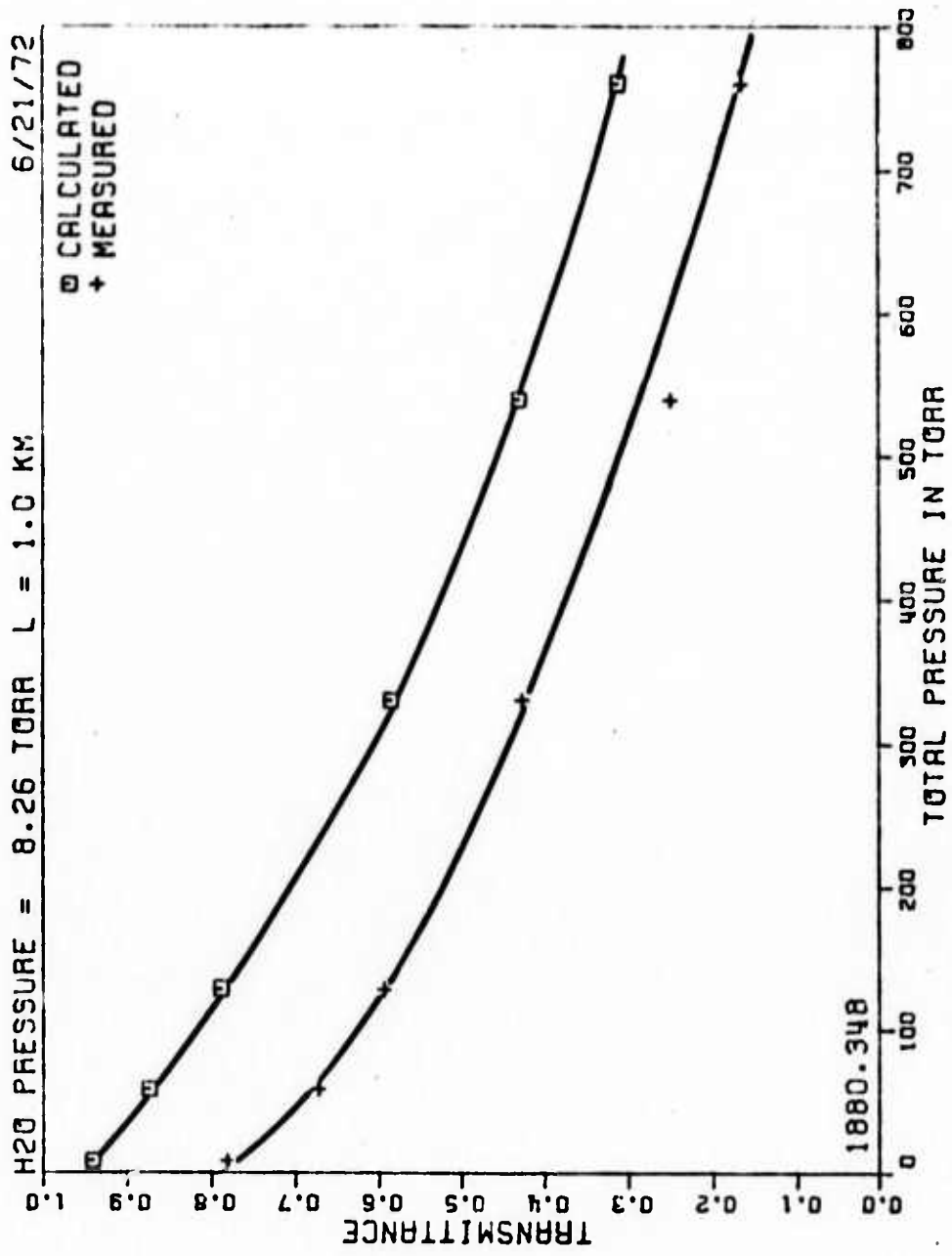

Fig. 11. Calculated and measured transmittance at 1880.348  $\text{cm}^{-1}$  for 8.26 torr water vapor.

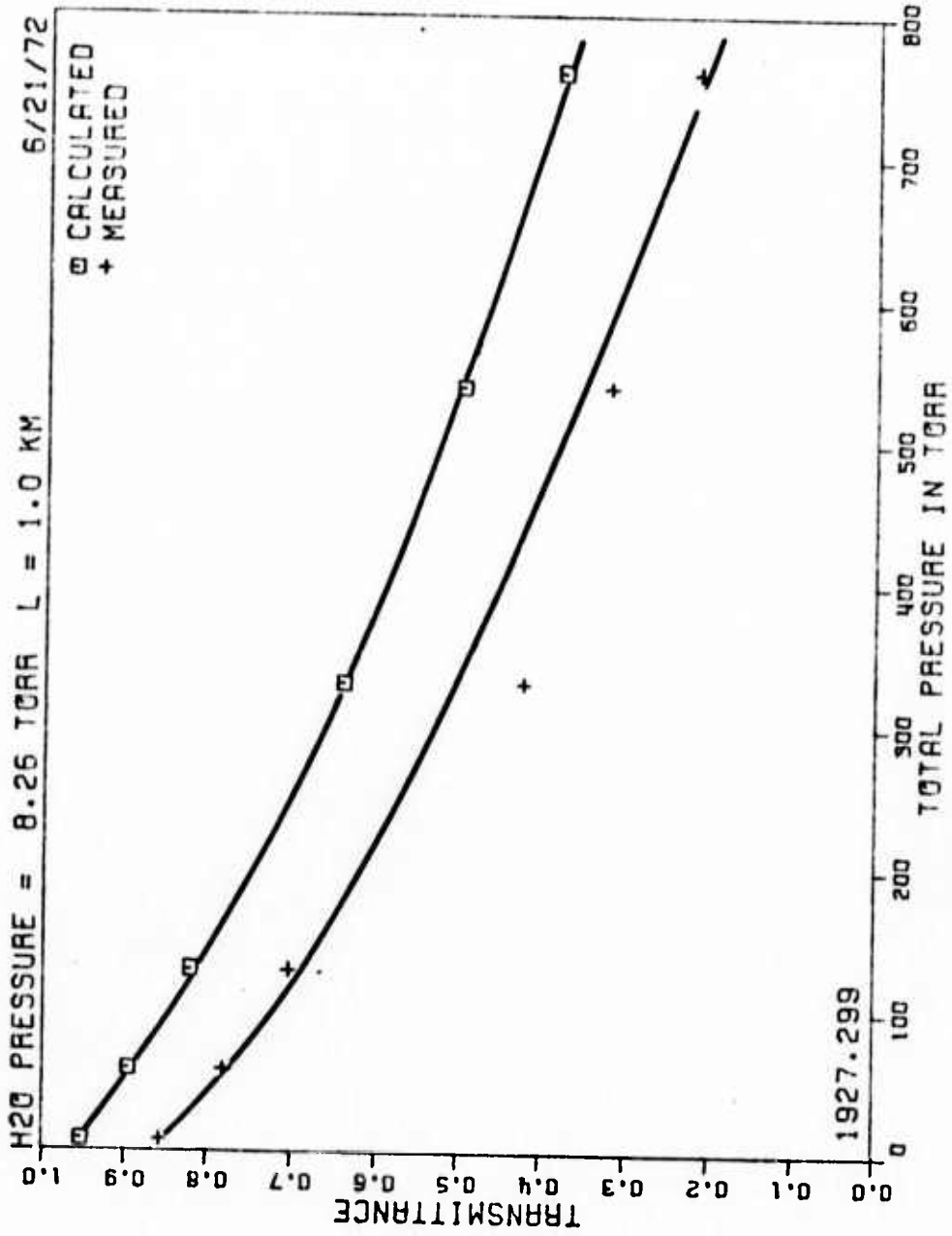

Fig. 12. Calculated and measured transmittance at 1927.299  $\text{cm}^{-1}$  for 8.26 torr water vapor.

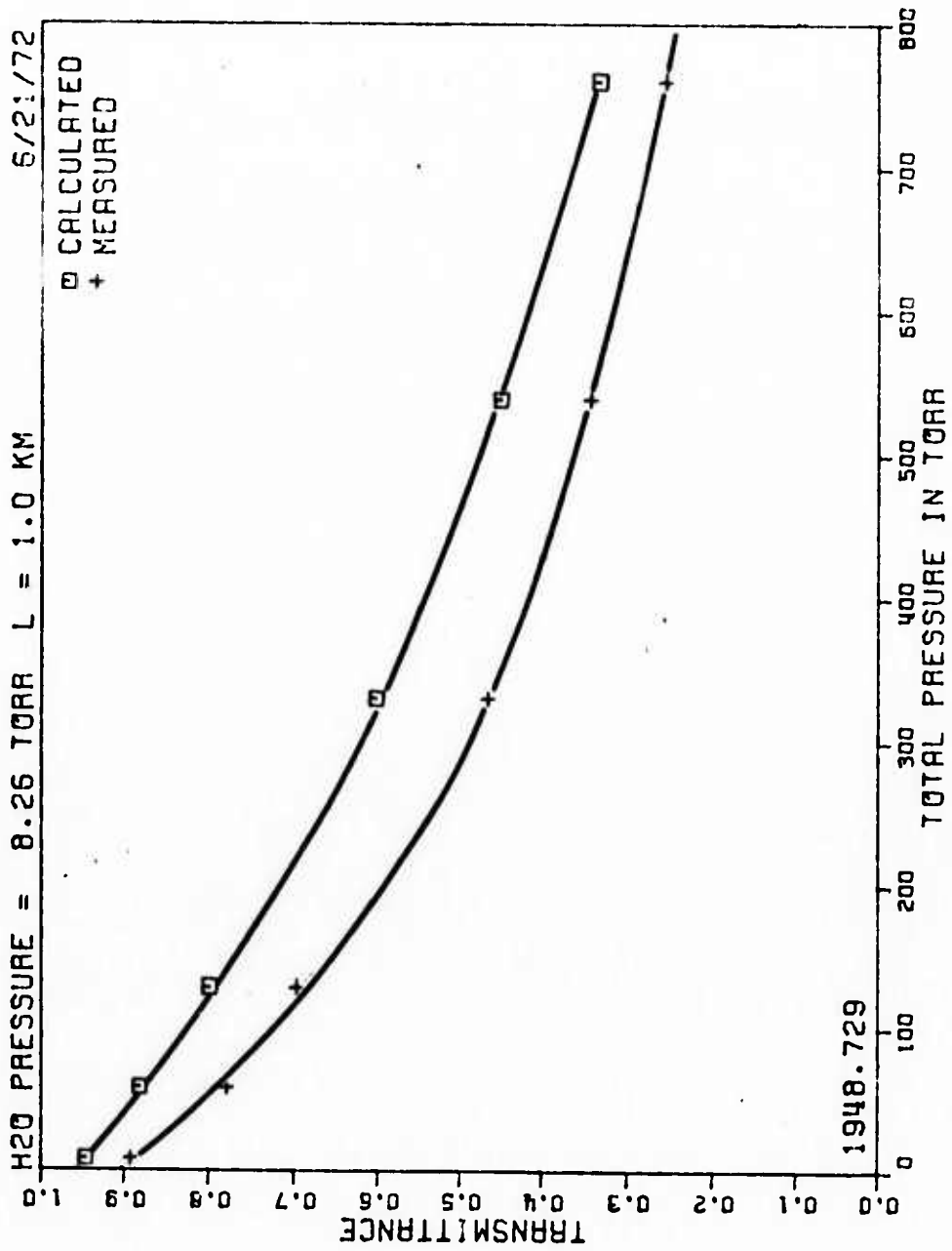

Fig. 13. Calculated and measured transmittance at 1948.729 cm<sup>-1</sup> for 8.26 torr water vapor.



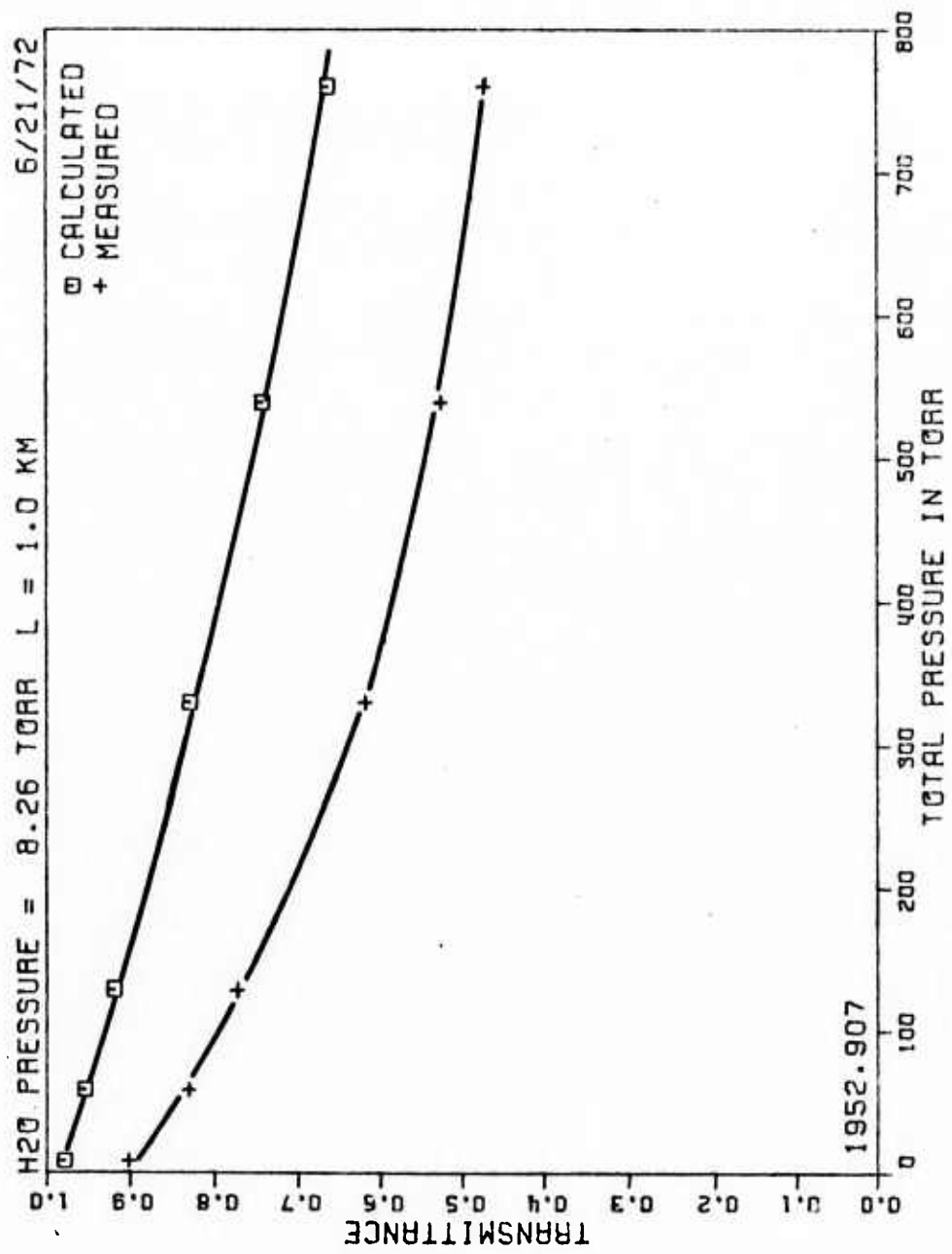

Fig. 14. Calculated and measured transmittance at 1952.907  $\text{cm}^{-1}$  for 8.26 torr water vapor.

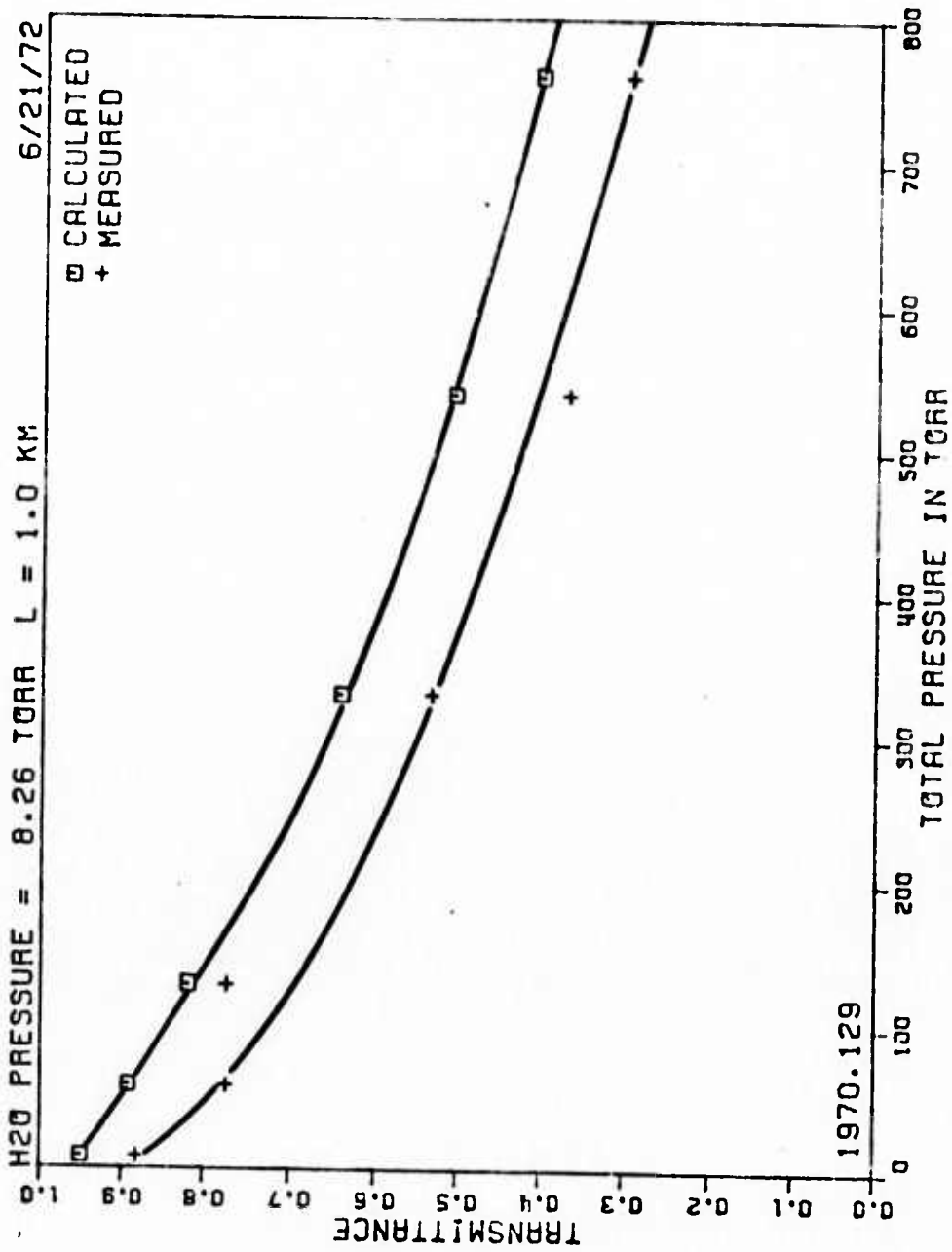

Fig. 15. Calculated and measured transmittance at 1970.129  $\text{cm}^{-1}$  for 8.26 torr water vapor.

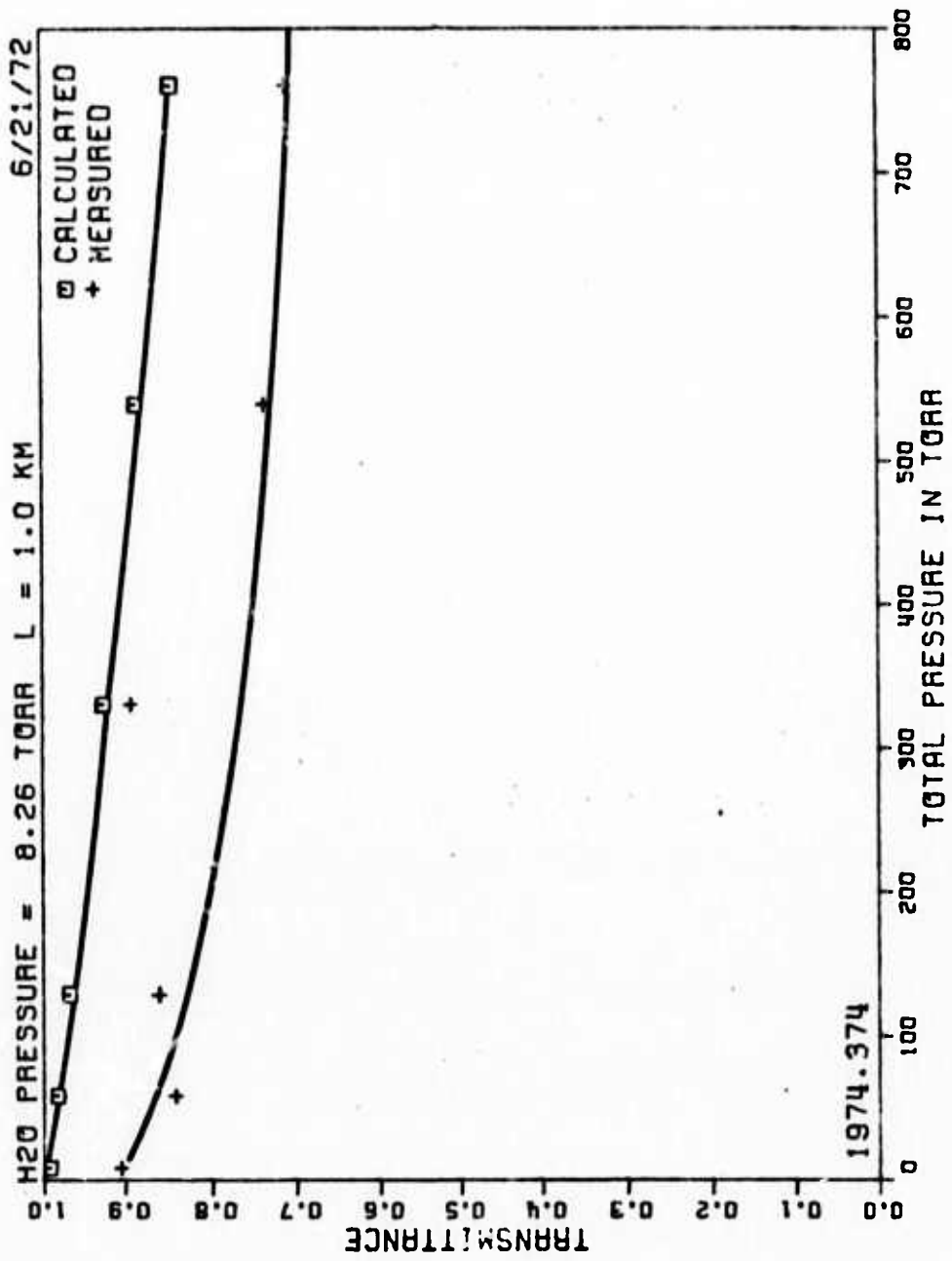

Fig. 16. Calculated and measured transmittance at 1974.374  $\text{cm}^{-1}$  for 8.26 torr water vapor.

TABLE V  
 EXPERIMENTAL RESULTS FOR 5.77 TORR WATER VAPOR AND FOR A MIXTURE  
 OF 8.26 TORR WATER VAPOR AND A TOTAL PRESSURE OF 102 TO 759 TORR

DATE 6/24/72  
 PATH LENGTH = .7317  
 WATER VAPOR PRESS. = 5.77

1. Entries are transmittance  
 on path length listed

| WAVENUMBER<br>cm <sup>-1</sup> | P = |      | P = 5.77 |      | P = 102 |      | P = 302 |      | P = 497 |      | P = 759 |      |
|--------------------------------|-----|------|----------|------|---------|------|---------|------|---------|------|---------|------|
|                                | OBS | CALC | T        | k    | T       | k    | T       | k    | T       | k    | T       | k    |
| 1854.933                       |     |      | .877     | .179 | .690    | .507 | .492    | .969 | .397    | 1.26 | .249    | 1.90 |
| 1880.348                       |     |      | .897     | .149 | .749    | .395 | .605    | .687 | -       | -    | .393    | 1.28 |
| 1905.841                       |     |      | .878     | .178 | .708    | .472 | .534    | .857 | .424    | 1.17 | .266    | 1.81 |
| 1927.299                       |     |      | .831     | .098 | .866    | .197 | .694    | .499 | -       | -    | .418    | 1.19 |
| 1931.409                       |     |      | .933     | .095 | .898    | .147 | .781    | .338 | -       | -    | .546    | .827 |
| 1948.729                       |     |      | .993     | .01  | .914    | .123 | .713    | .462 | -       | -    | .473    | 1.02 |
| 1952.907                       |     |      | .999     |      | .924    | .100 | .822    | .268 |         |      | .689    | .509 |
| 1957.051                       |     |      | .519     | .896 | .183    | 2.32 | .133    | 2.76 |         |      | .220    | 2.07 |
| 1970.129                       |     |      | .992     | .011 | .904    | .138 | .713    | .462 |         |      | .528    | .873 |
| 1974.374                       |     |      | .968     | .044 | .940    | .085 | .870    | .190 |         |      | .852    | .219 |

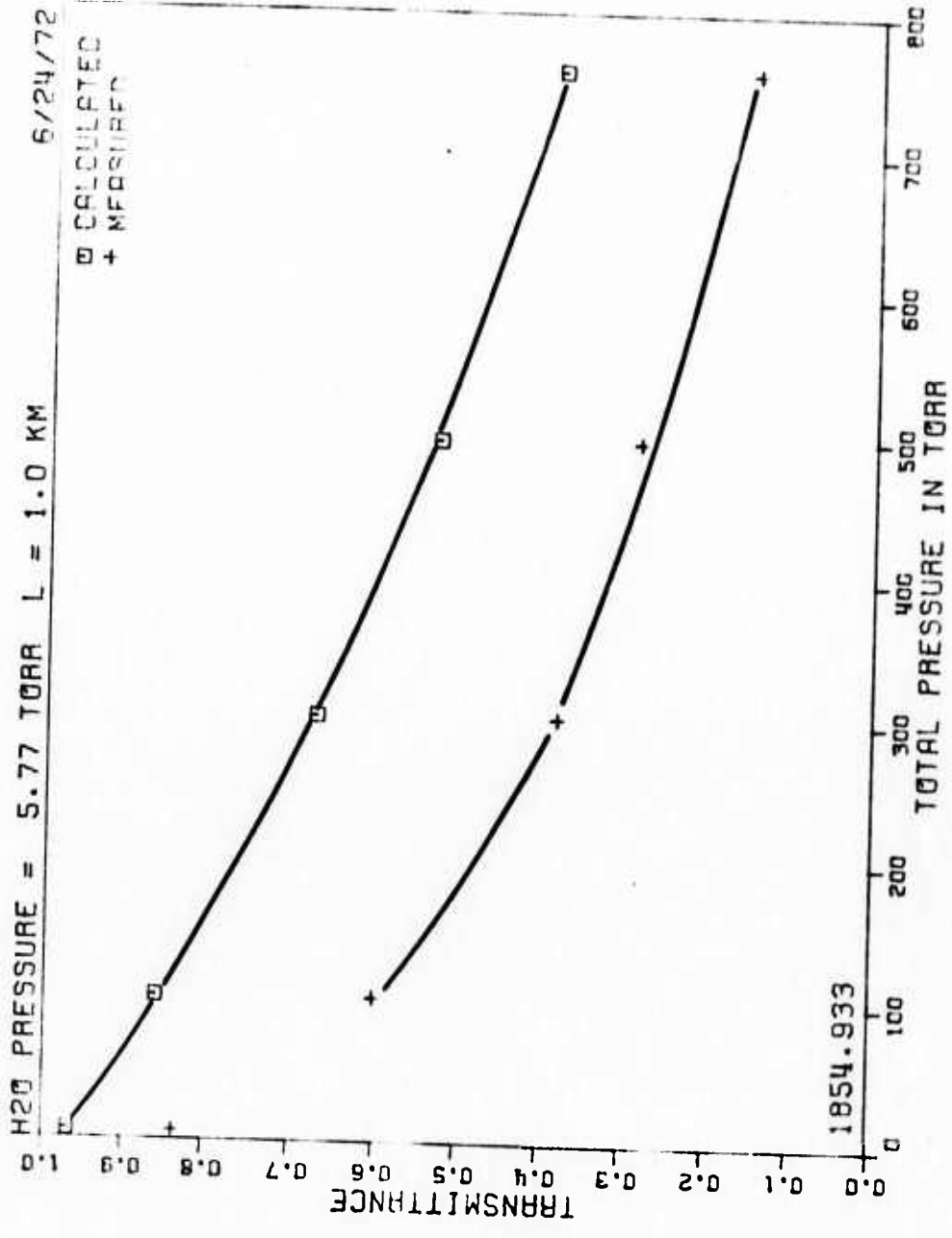

Fig. 17. Calculated and measured transmittance at 1854.933 cm<sup>-1</sup> for 5.77 torr water vapor.

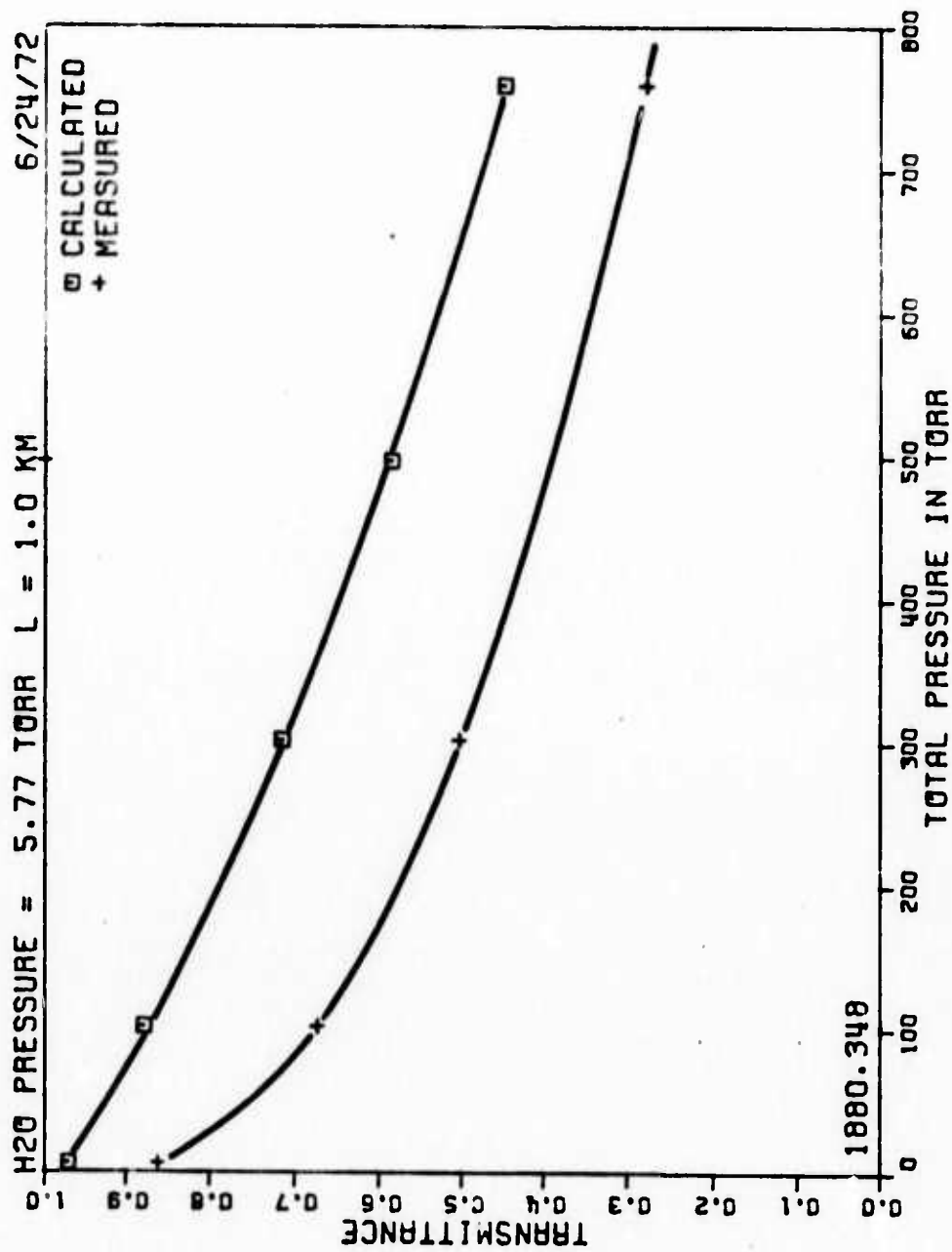

Fig. 18. Calculated and measured transmittance at 1880.348  $\text{cm}^{-1}$  for 5.77 torr water vapor.

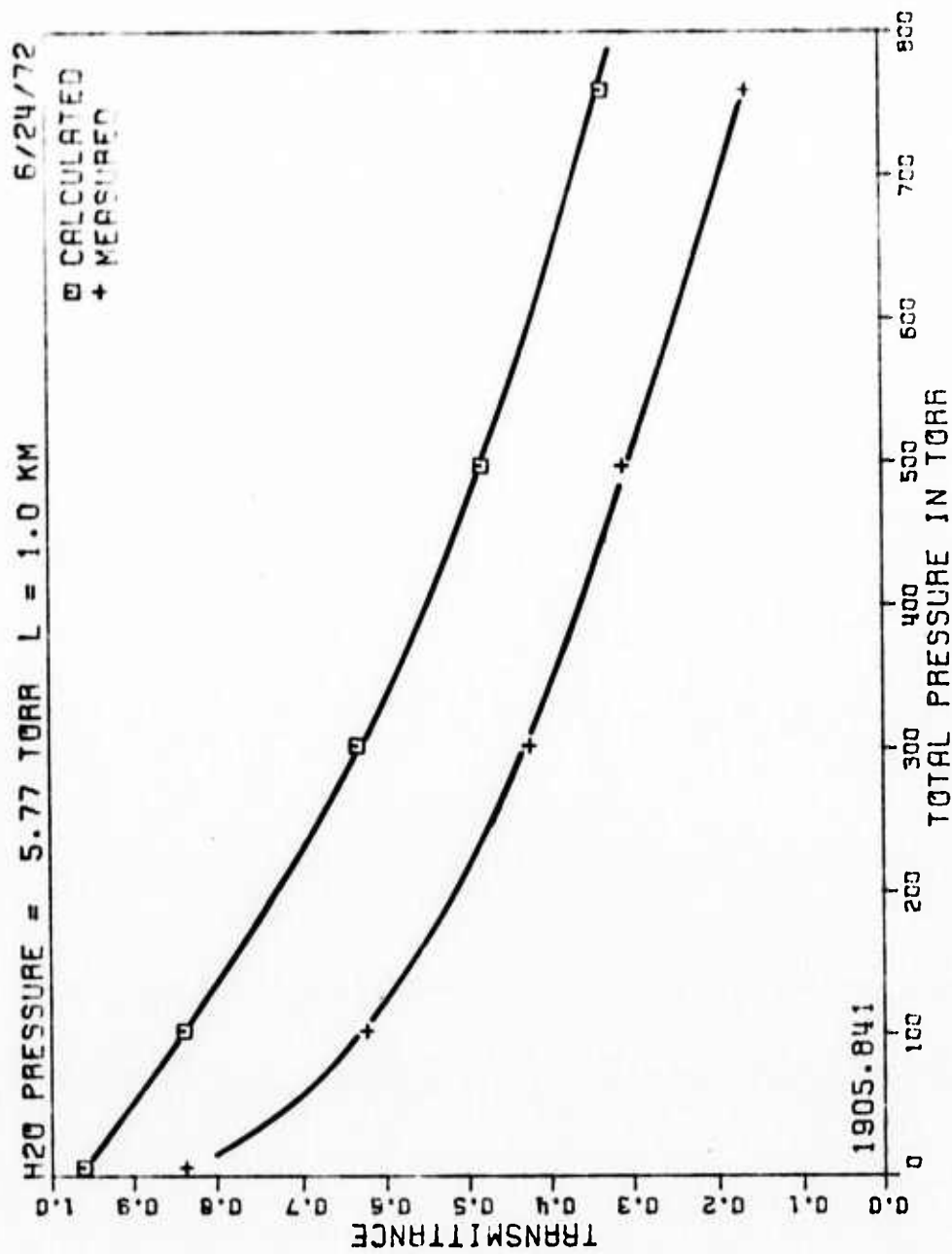

Fig. 19. Calculated and measured transmittance at 1905.841  $\text{cm}^{-1}$  for 5.77 torr water vapor.

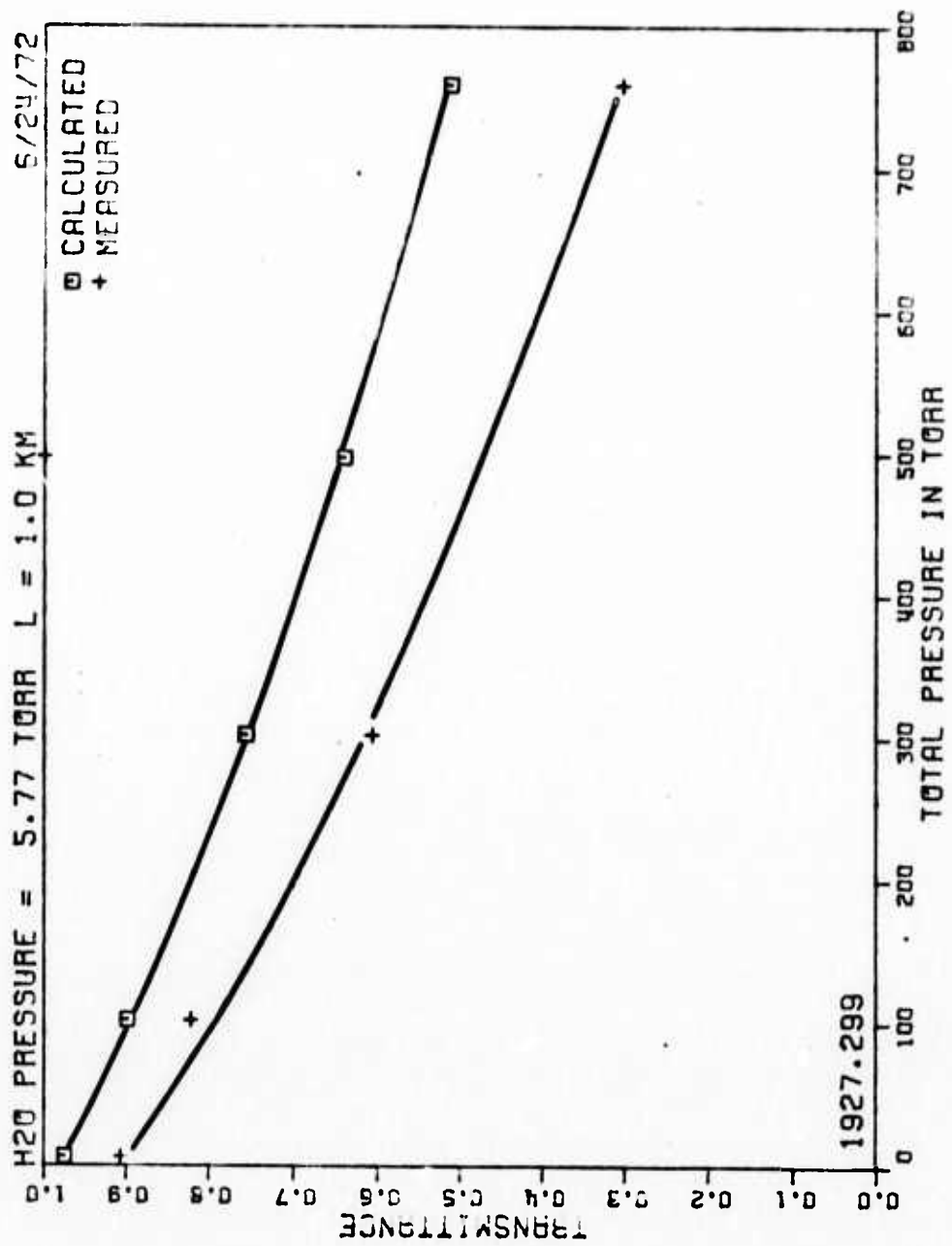

Fig. 20. Calculated and measured transmittance at 1927.299  $\text{cm}^{-1}$  for 5.77 torr water vapor.



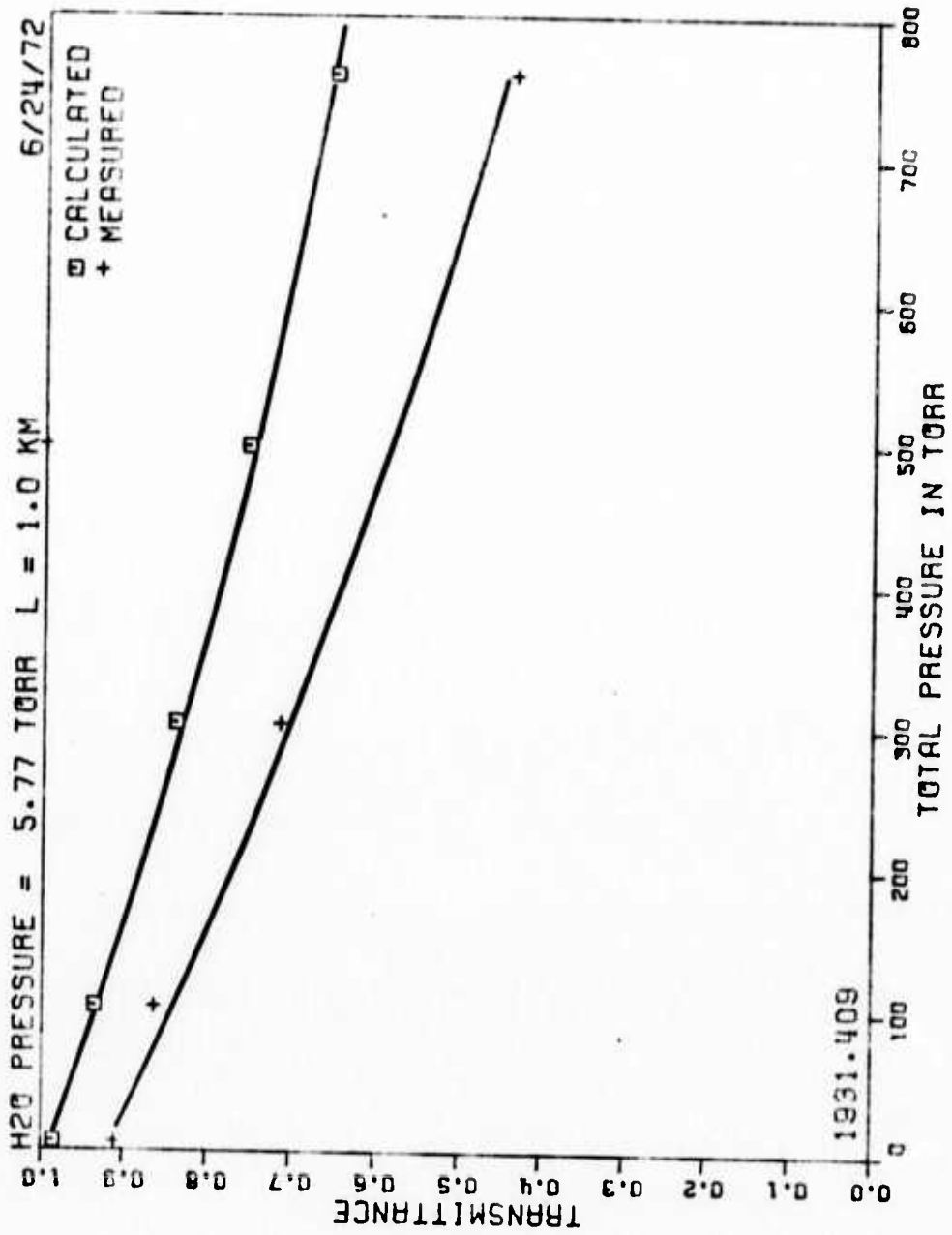

Fig. 21. Calculated and measured transmittance at 1931.409  $\text{cm}^{-1}$  for 5.77 torr water vapor.

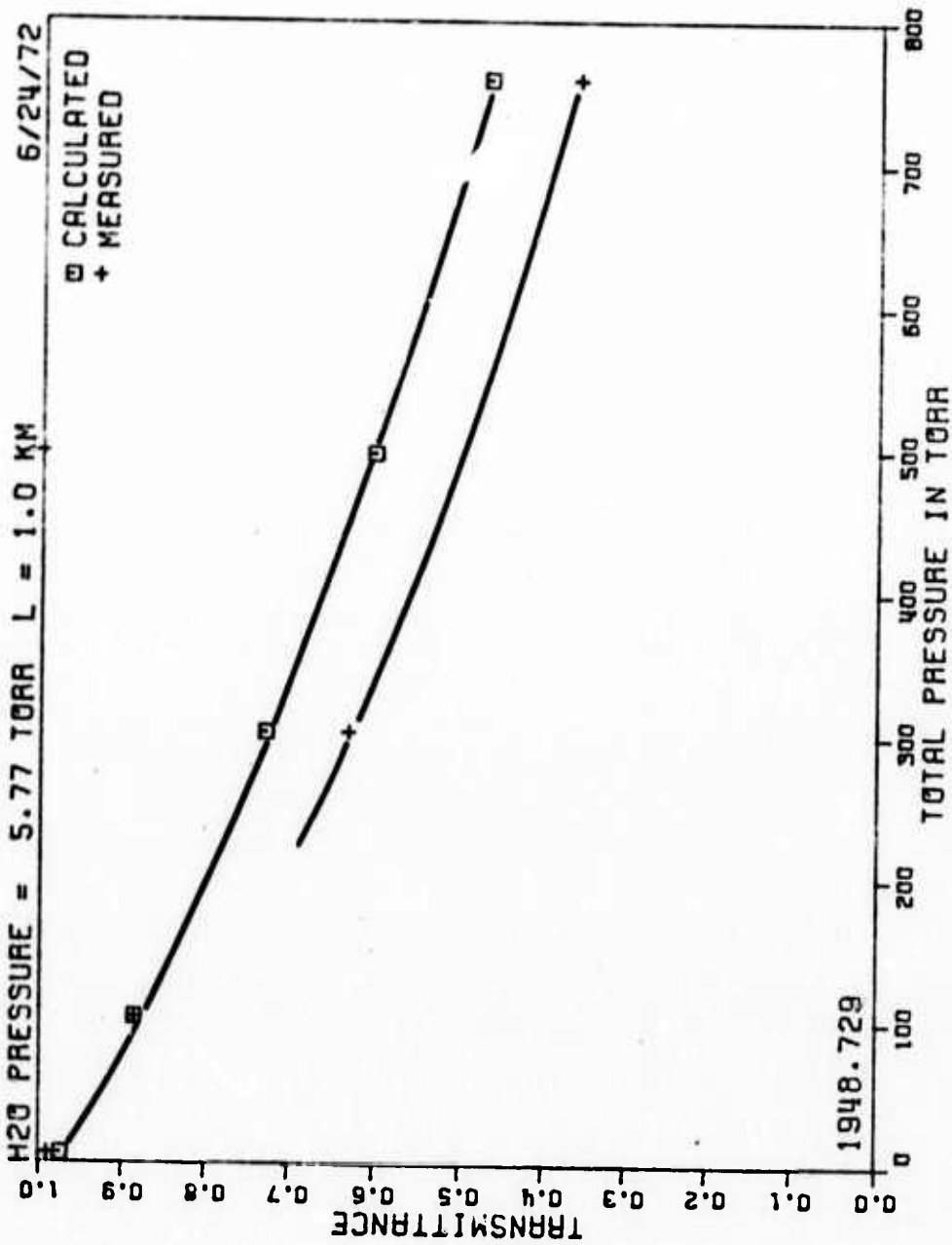

Fig. 22. Calculated and measured transmittance at 1948.729  $\text{cm}^{-1}$  for 5.77 torr water vapor.

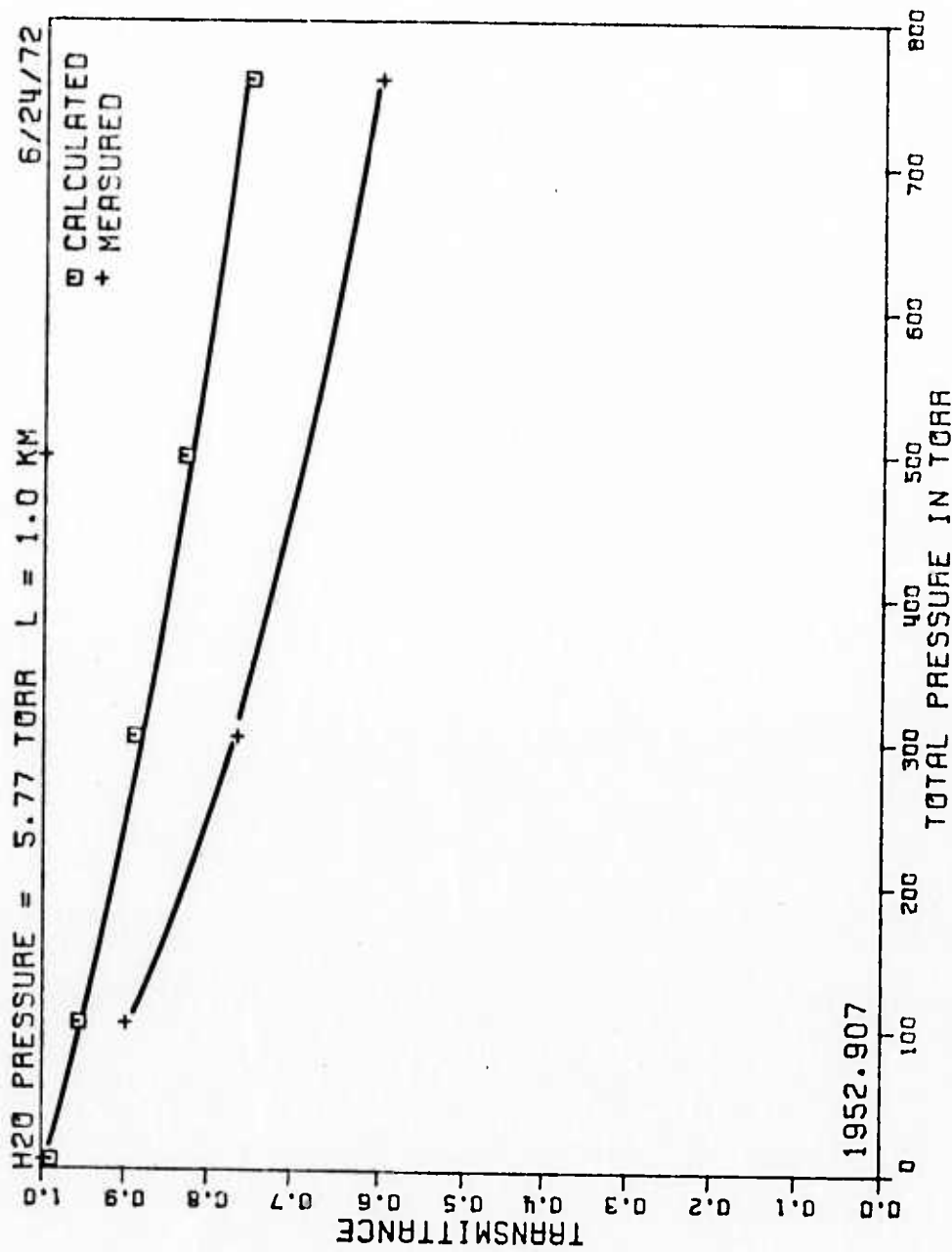

Fig. 23. Calculated and measured transmittance at 1952.907  $\text{cm}^{-1}$  for 5.77 torr water vapor.

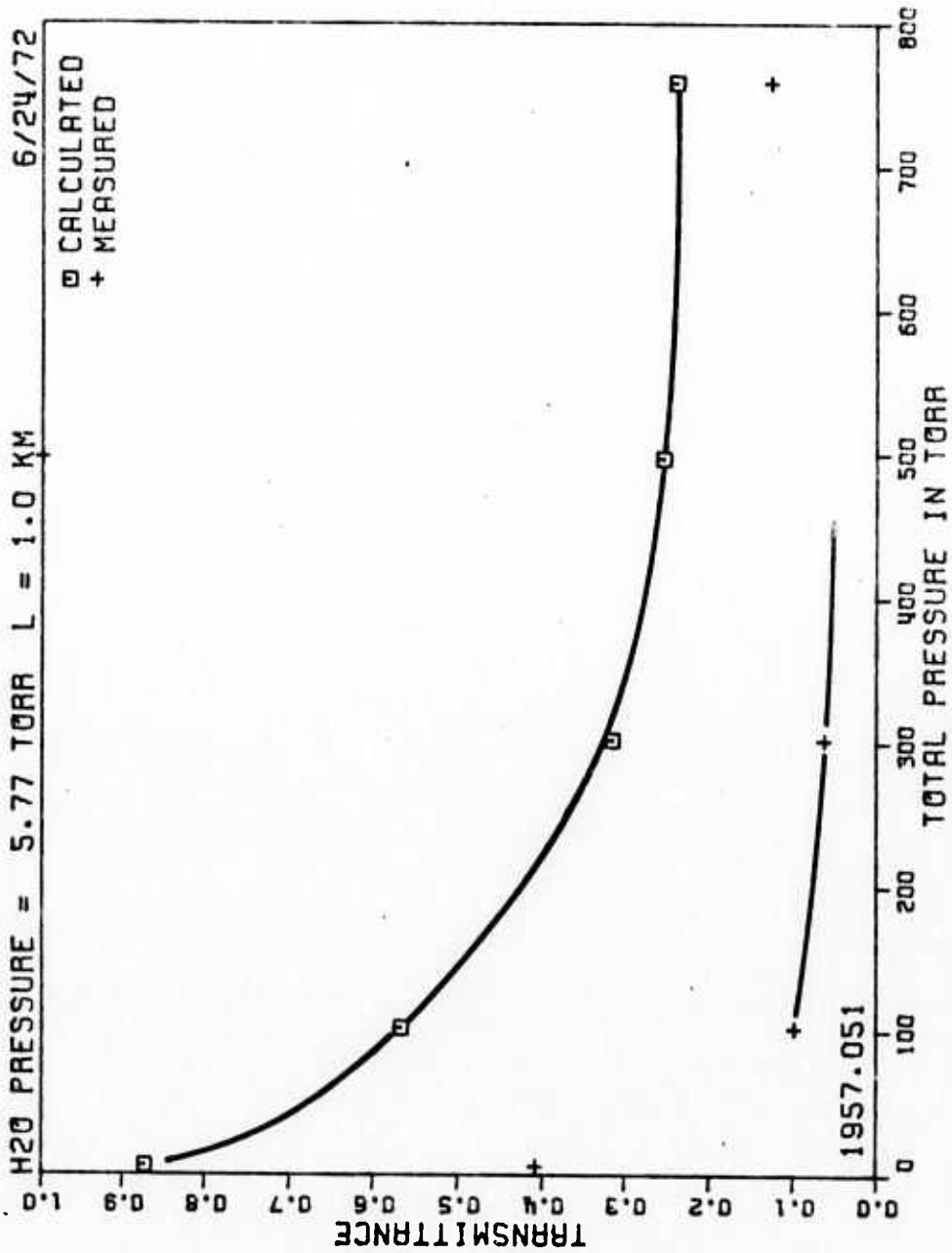

Fig. 24. Calculated and measured transmittance at 1957.051  $\text{cm}^{-1}$  for 5.77 torr water vapor.

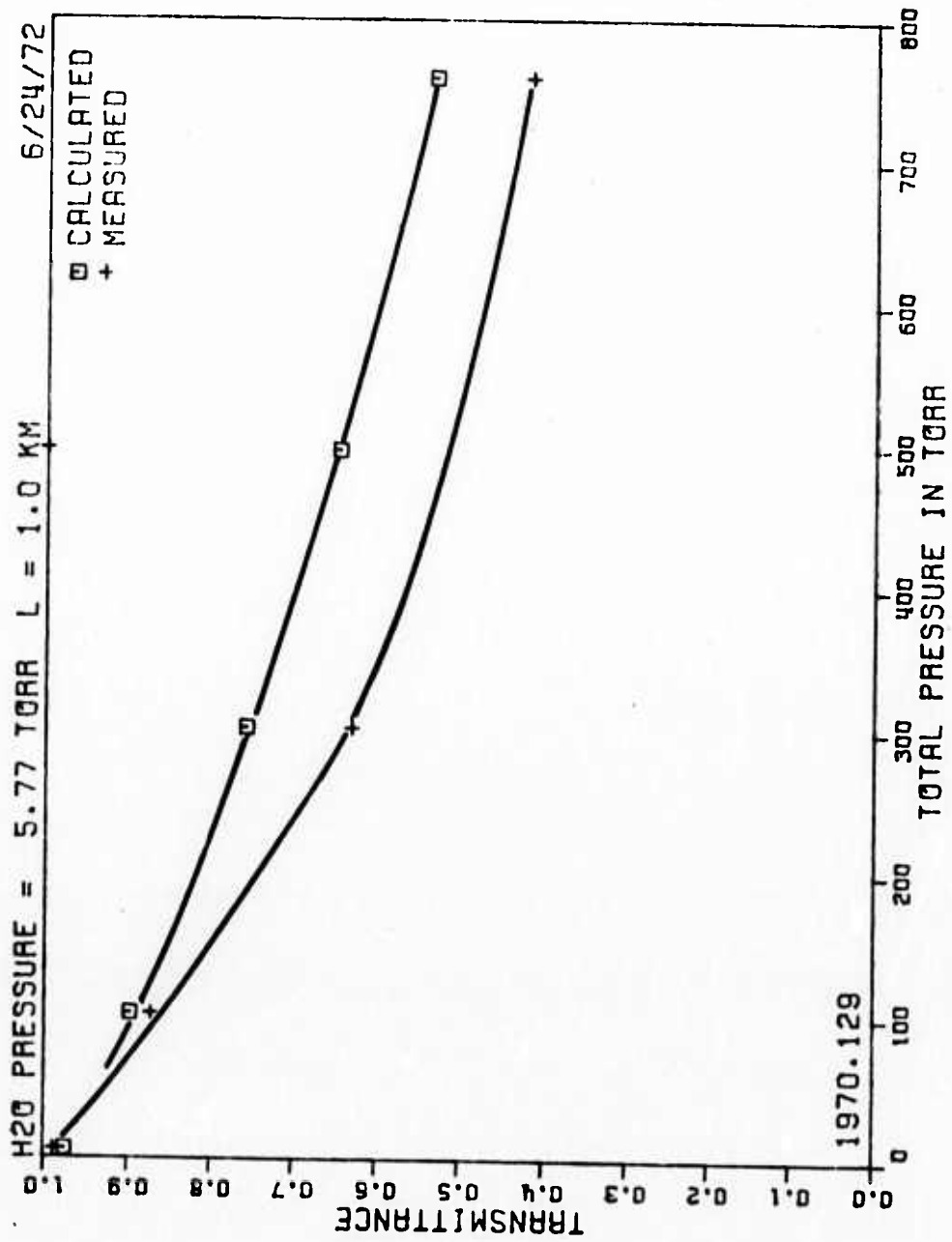

Fig. 25. Calculated and measured transmittance at 1970.129  $\text{cm}^{-1}$  for 5.77 torr water vapor.

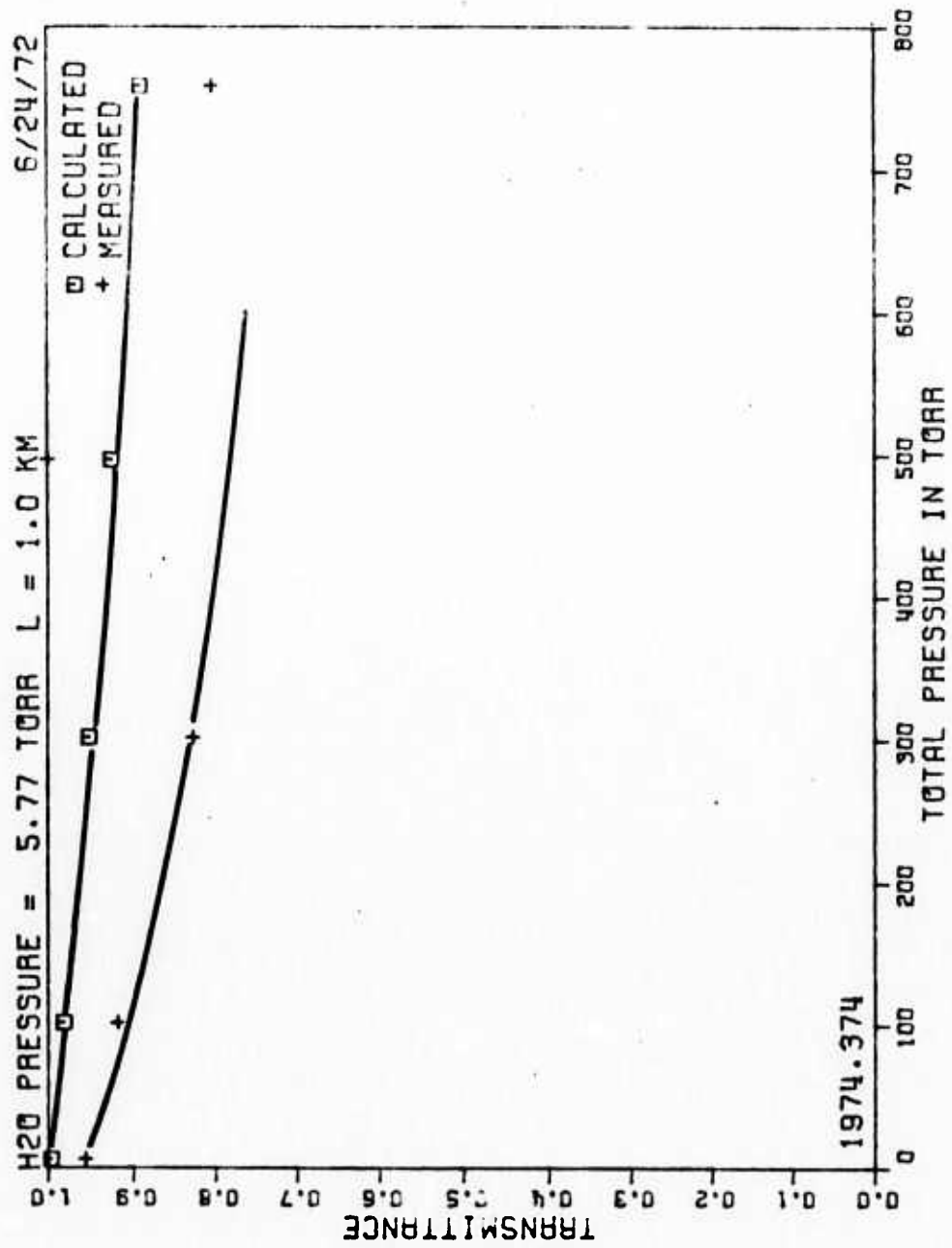

Fig. 26. Calculated and measured transmittance at 1974.374  $\text{cm}^{-1}$  for 5.77 torr water vapor.

#### D. Pure Water Vapor

One experiment was made using pure water vapor samples. In addition a pure sample was measured in each of the previous experiments. This data is presented in Table VI and column one of Tables III-V.

### V. INTERPRETATION OF RESULTS

#### A. Pure Water Vapor

All of the CO lines studied are located in window regions of the water vapor spectrum. If a Lorentz line shape is used and if the frequency is in the wings one has:

$$(1) \quad -\ln T = \sum_i \frac{C_i S_{oi} \alpha_{oi} p^2}{\pi[(v-v_{oi})^2]} = k p^2$$

so that the extinction coefficient should be proportional to the square of the water vapor pressure. The experimental data was used as input to a least square error curve fitting program of the form  $k = Ap^2$ . The results are presented in Table VII and Fig. 27. It can be seen that to a good approximation the pure water vapor extinction coefficients for these lines are proportional to the square of the pressure as predicted by simple theory.

#### B. Nitrogen Broadened Water Vapor

Figures 2-26 give the transmittance of a given laser line for fixed partial pressure of water vapor and variable total pressure. The calculated curve is based on the Calfee-Benedict[1] line data tables, a Lorentz line shape, a self broadening coefficient of 5 and a BOUND of  $25 \text{ cm}^{-1}$  as mentioned previously.

The predicted transmittances are considerably higher than those which were measured. This trend was confirmed in the more extensive measurements at 760 Torr total pressure which will be reported in the next quarterly report (3271-5). The form of the pressure dependence as depicted by the theory is confirmed by the measurements.

The nature of the difference led us to initially suspect a systematic error. However, extensive checking (described further in Report 3271-5) has only confirmed the basic accuracy of the experiments. It is possible that there is an important effect existing in the real world of water vapor mixtures which the theory does not

TABLE VI  
PURE WATER VAPOR MEASUREMENTS

1. Entries are transmittance  
on path length listed

DATE 6/21/72  
PATH LENGTH = .7317  
WATER VAPOR PRESS. = total pressure

| WAVENUMBER<br>$\text{cm}^{-1}$ | P = 2.9  |      | P = 5    |      | P = 7.45 |      | P = 11.08 |      | P = 13.23 |      | P = 15.65 |       |
|--------------------------------|----------|------|----------|------|----------|------|-----------|------|-----------|------|-----------|-------|
|                                | T<br>OBS | k    | T<br>OBS | k    | T<br>OBS | k    | T<br>OBS  | k    | T<br>OBS  | k    | T<br>OBS  | k     |
| 1854.933                       | .971     | .040 | .918     | .117 | .809     | .290 | .665      | .558 | .535      | .855 | .412      | 1.211 |
| 1880.348                       | .991     | .012 | .934     | .093 | .864     | .200 | .736      | .419 | .630      | .631 | .520      | .894  |
| 1927.299                       | .991     | .012 | .957     | .060 | .916     | .120 | .828      | .258 | .744      | .404 | .660      | .568  |
| 1948.729                       | .998     | .003 | .969     | .043 | .926     | .105 | .846      | .229 | .767      | .363 | .686      | .515  |
| 1952.907                       | .999     | .001 | .979     | .029 | .939     | .086 | .879      | .176 | .816      | .278 | .747      | .399  |
| 1970.129                       | .992     | .011 | .968     | .044 | .919     | .115 | .846      | .229 | .775      | .348 | .700      | .487  |
| 1974.374                       | .996     | .005 | .977     | .032 | .939     | .086 | .900      | .144 | .842      | .235 | .796      | .512  |



TABLE VII  
 MEASURED PURE WATER VAPOR EXTINCTION COEFFICIENTS FOR SEVEN  
 CO LASER LINES INCLUDING LEAST SQUARES FIT TO  $K = Ap^2$

| 1854.933<br>K=(.00487)P**2<br>RMS=(.0177) |           | 1880.348<br>K=(.00362)P**2<br>RMS=(.0146) |           | 1927.299<br>K=(.00226)P**2<br>RMS=(.0173)  |           | 1948.729<br>K=(.00204)P**2<br>RMS=(.0249) |           |
|---|-----------|---|-----------|--|-----------|---|-----------|
| PH20<br>TORR                              | K<br>1/KM | PH20<br>TORR                              | K<br>1/KM | PH20<br>TORR                               | K<br>1/KM | PH20<br>TORR                              | K<br>1/KM |
| 2.90                                      | .041      | 2.90                                      | .012      | 2.90                                       | .019      | 2.90                                      | .003      |
| 5.00                                      | .122      | 5.00                                      | .093      | 5.00                                       | .057      | 5.00                                      | .043      |
| 5.77                                      | .179      | 5.77                                      | .149      | 5.77                                       | .075      | 5.77                                      | .010      |
| 7.45                                      | .290      | 7.45                                      | .200      | 7.45                                       | .126      | 7.45                                      | .105      |
| 8.26                                      | .319      | 8.26                                      | .246      | 8.26                                       | .154      | 8.26                                      | .114      |
| 8.89                                      | .382      | 8.89                                      | .293      | 8.89                                       | .179      | 8.89                                      | .184      |
| 11.08                                     | .558      | 11.08                                     | .419      | 11.08                                      | .278      | 11.08                                     | .229      |
| 13.23                                     | .855      | 13.23                                     | .631      | 13.23                                      | .396      | 13.23                                     | .363      |
| 15.65                                     | 1.211     | 15.65                                     | .894      | 15.65                                      | .554      | 15.65                                     | .515      |
| 1952.907<br>K=(.00160)P**2<br>RMS=(.0135) |           | 1970.129<br>K=(.00198)P**2<br>RMS=(.0227) |           | 1974.374<br>K=(.00130)P**2<br>RMS=(.00945) |           | 1974.729<br>K=(.00204)P**2<br>RMS=(.0249) |           |
| PH20<br>TORR                              | K<br>1/KM | PH20<br>TORR                              | K<br>1/KM | PH20<br>TORR                               | K<br>1/KM | PH20<br>TORR                              | K<br>1/KM |
| 2.90                                      | .013      | 2.90                                      | .011      | 2.90                                       | .005      | 2.90                                      | .011      |
| 5.00                                      | .040      | 5.00                                      | .044      | 5.00                                       | .032      | 5.00                                      | .033      |
| 5.77                                      | .075      | 5.77                                      | .011      | 5.77                                       | .044      | 5.77                                      | .043      |
| 7.45                                      | .086      | 7.45                                      | .115      | 7.45                                       | .086      | 7.45                                      | .072      |
| 8.26                                      | .104      | 8.26                                      | .126      | 8.26                                       | .101      | 8.26                                      | .089      |
| 8.89                                      | .146      | 8.89                                      | .192      | 8.89                                       | .112      | 8.89                                      | .103      |
| 11.08                                     | .176      | 11.08                                     | .229      | 11.08                                      | .144      | 11.08                                     | .160      |
| 13.23                                     | .278      | 13.23                                     | .346      | 13.23                                      | .235      | 13.23                                     | .228      |
| 15.65                                     | .399      | 15.65                                     | .487      | 15.65                                      | .312      | 15.65                                     | .319      |

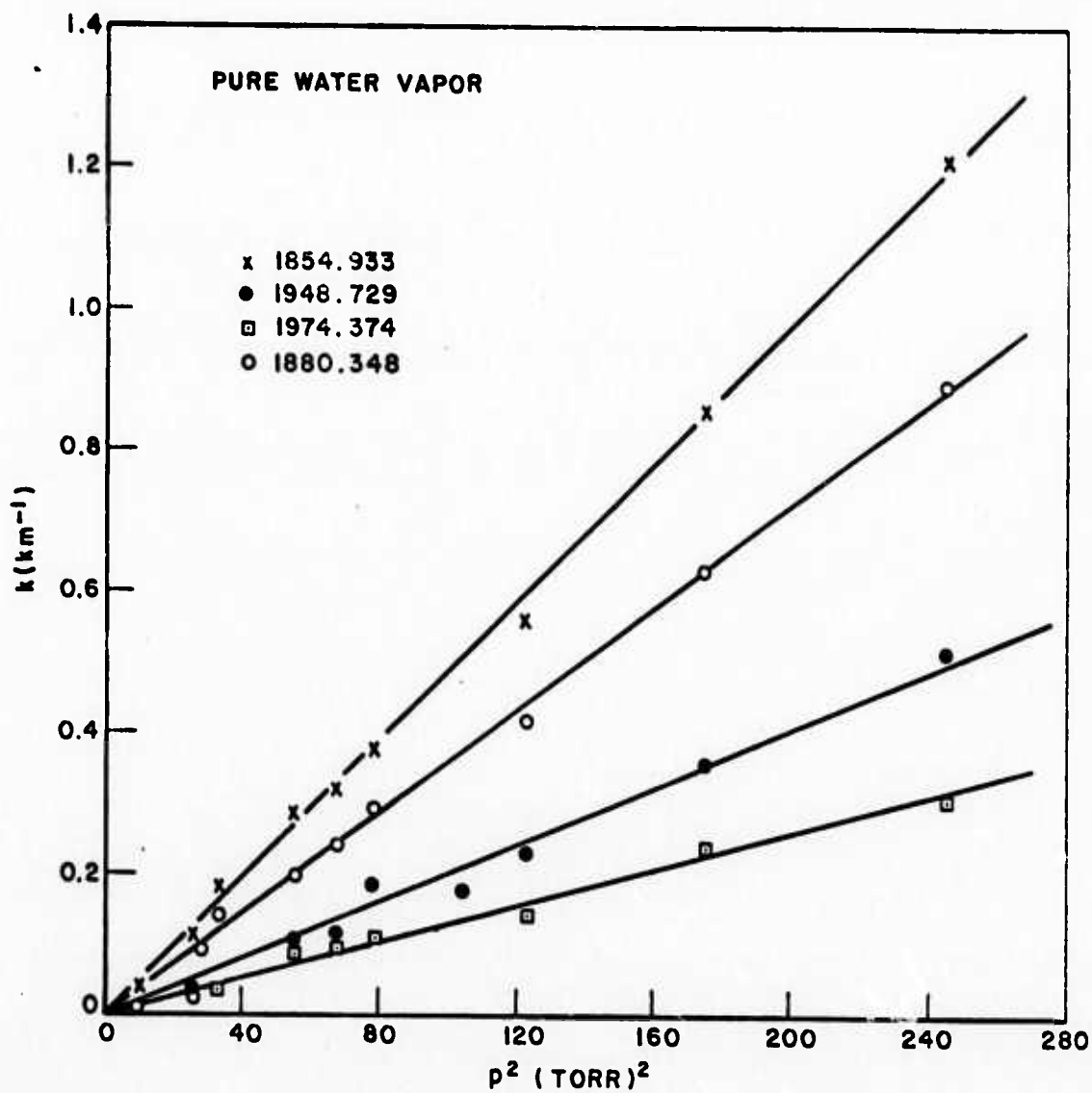

Fig. 27. Plot of the pure water vapor extinction coefficients for four CO laser lines versus square of the water vapor pressure.

take into account. Our current feeling, however, is that the basic problem is that the actual line shape is not Lorentzian. In 3271-5 we have suggested a "super Lorentzian" i.e., enhanced wing shape and have shown that using that shape it is possible in most cases to obtain excellent agreement with the measured results at all total pressures and all partial pressures in the range covered by the experiments. Further, the agreement between the 760 Torr total pressure results reported here and those reported in 3271-5 is excellent.

## VI. CONCLUSIONS

The measurements described in this report and its companion (3271-5) have shown that the absorption coefficients in water vapor-nitrogen mixtures at highly transmitting CO laser wavelengths are much higher than predicted by "synthetic spectra" type calculations when current practice (Lorentz line shape etc.) is followed.

The results present a discouraging picture for the application of the CO laser although the path length and the altitude of the proposed transmission path are most important due to the highly variable nature of atmospheric water vapor[3].

The best transmitting line studied was 1978.586 5-4 P(15). The 4-3 and lower bands of CO are interesting but were not available from our probe laser. A series of experiments using laser diode sources made by Ken Nill, MIT Lincoln Laboratory, are planned at Ohio State University in the spring of 1973. The diodes now available tune 2037-2108  $\text{cm}^{-1}$ .

## REFERENCES

1. Benedict, W.S. and Calfee, R.F., "Line Parameters for the 1.9 and 6.3 Micron Water-Vapor Bands," ESSA Professional Paper No. 2 (1967).
2. Ford, D.L., Mills, F.S., and Long, R.K., "Laser Absorption in the 5 Micron Band," Report 3271-3, July 1972, ElectroScience Laboratory, Department of Electrical Engineering, The Ohio State University; prepared under Contract F30602-72-C-0016 for Rome Air Development Center.
3. Nash, J.S. and Long, R.K., "Atmospheric Water Vapor Models Useful for Laser Propagation Calculations," Report 2819-3, April 1971, ElectroScience Laboratory, Department of Electrical Engineering, The Ohio State University; prepared under Contract F33615-69-C-1807 for Air Force Avionics Laboratory, Wright-Patterson Air Force Base. (AD 883 394).