

GVTDOC
D 211.
9:
3889

Ad 758644

NAVAL SHIP RESEARCH AND DEVELOPMENT CENTER

Bethesda, Md. 20034



A SUMMARY OF STRESS CONCENTRATIONS IN THE VICINITY OF OPENINGS IN SHIP STRUCTURES

by

J. P. Sikora

APPROVED FOR PUBLIC RELEASE: DISTRIBUTION UNLIMITED

STRUCTURES DEPARTMENT
RESEARCH AND DEVELOPMENT REPORT

20070122077

March 1973

Report 3889

A SUMMARY OF STRESS CONCENTRATIONS IN THE VICINITY OF OPENINGS IN SHIP STRUCTURES

The Naval Ship Research and Development Center is a U. S. Navy center for laboratory effort directed at achieving improved sea and air vehicles. It was formed in March 1967 by merging the David Taylor Model Basin at Carderock, Maryland with the Marine Engineering Laboratory at Annapolis, Maryland.

Naval Ship Research and Development Center
Bethesda, Md. 20034

MAJOR NSRDC ORGANIZATIONAL COMPONENTS

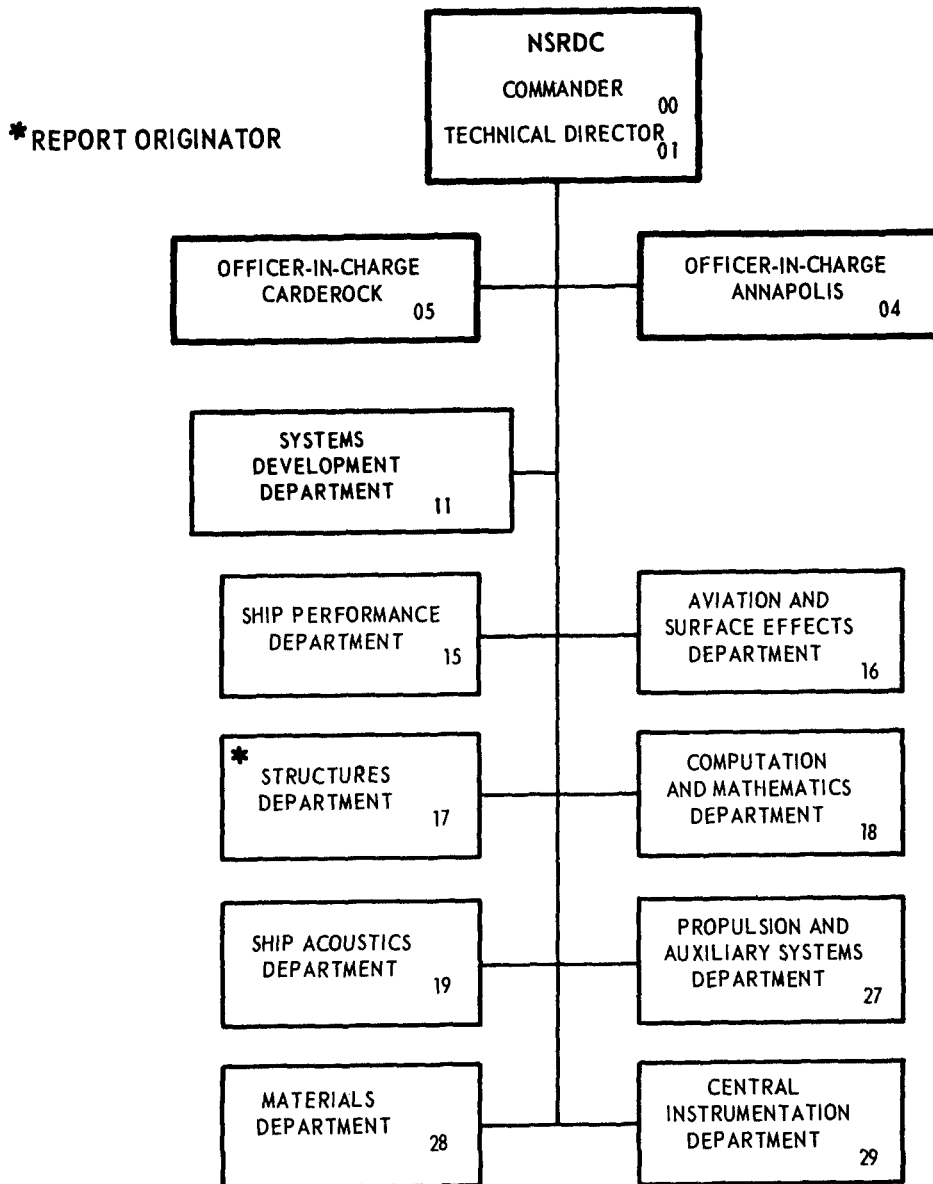

DEPARTMENT OF THE NAVY
NAVAL SHIP RESEARCH AND DEVELOPMENT CENTER

BETHESDA, MD. 20034

A SUMMARY OF STRESS CONCENTRATIONS IN THE VICINITY
OF OPENINGS IN SHIP STRUCTURES

by

J. P. Sikora



APPROVED FOR PUBLIC RELEASE: DISTRIBUTION UNLIMITED

March 1973

Report 3889

TABLE OF CONTENTS

	Page
ABSTRACT	1
ADMINISTRATIVE INFORMATION	1
INTRODUCTION	1
CURRENT DESIGN PRACTICE	2
RESULTS	2
SINGULAR OPENINGS	2
Unreinforced	2
Reinforced	3
PAIRS OF OPENINGS	3
Unreinforced	3
Reinforced	4
CLUSTERS OF OPENINGS	5
DISCUSSION	6
SUMMARY	7
RECOMMENDATIONS	7
APPENDIX A – PHOTOELASTIC STUDIES	35
REFERENCES	42

LIST OF FIGURES

	Page
Figure 1 – Stress Concentration Factor Around a Circular Hole in an . Infinite Plate	8
Figure 2 – Geometry and Notation of Rectangular Opening and Loading	9
Figure 3 – Location of Maximum Stress for Various Openings and Loadings; See Figure 2 for Notation	9
Figure 4 – Variation of Stress Concentration Factors with Radius Ratio Contours of Aspect Ratio; See Figure 2 for Notation	10
Figure 5 – Most Favorable Radius Ratio for Various Openings in Contours of Load Factor	11
Figure 6 – Most Favorable Radius Ratio for Various Loadings in Contours of Aspect Ratio; See Figure 2 for Notation	12

LIST OF FIGURES (Continued)

	Page
Figure 7 – Types of Reinforcements	12
Figure 8 – Maximum Stress Concentration Factor for Face-Bar Reinforced Square Openings with Rounded Corners	13
Figure 9 – Maximum Stress Concentration Factors versus Spacing of Two Equal Circular Holes	14
Figure 10 – Diagram Showing Pair of Unequal Holes	15
Figure 11 – Variation of Tangential Stress on Boundaries of Two Unequal Holes	15
Figure 12 – Variation of Maximum Tension and Compression on the Smaller of Two Unequal Holes as a Function of Hole Spacing; See Figure 10 for Notation	15
Figure 13 – Geometry of Two Unequal Circular Holes	16
Figure 14 – Maximum Stresses versus Pull Direction; See Figure 13 for Notation	17
Figure 15 – Maximum Stresses versus Ratio of Two Circular Holes; See Figure 13 for Notation	17
Figure 16 – Geometry of a Square and Circular Opening	18
Figure 17 – Maximum Stress Concentration Factor for a Square and Circular Opening as a Function of Separation; See Figure 16 for Notation	18
Figure 18 – Stress Concentration Factors for a Pair of Rectangles as a Function of Separation	19
Figure 19 – Stress Concentration Factors for a Pair of In-Line Rectangles with Equal Lengths	20
Figure 20 – Stress Concentration Factors for a Pair of In-Line Rectangles with Lengths in a Ratio of 2 to 3	20
Figure 21 – In-Line Rectangular Openings in a Plate Showing Areas of Reduced Stress	21
Figure 22 – Stress Concentration Factors for a Pair of Diagonally Adjacent Equal Square Openings	21
Figure 23 – Notation and Geometry of Two Equally Reinforced Circular Openings	22

	Page
Figure 24 – Maximum Stress Concentration Factors for Various Amounts of Reinforcing as a Function of Spacing of Two Equal Circular Openings; See Figure 23 for Notation	23
Figure 25 – Stress Distribution around Two Equal Circular Openings in Uniaxial Tension; See Figure 23 for Notation	24
Figure 26 – Stress Distribution around Two Equal Circular Openings in Biaxial Tension; See Figure 23 for Notation	25
Figure 27 – Comparison of Maximum Stress Concentration Factor from Theory and Experiment for Two Equal Circular Openings; See Figure 23 for Notation	25
Figure 28 – Notation and Geometry of Two Unequal Circular, Reinforced Openings	26
Figure 29 – Stress Concentration Factors for a Pair of Unequal, Circular Openings as a Function of Hole Size; See Figure 28 for Notation	26
Figure 30 – Stress Concentration Factors for a Pair of Unequal, Circular Openings as a Function of Load Direction; See Figure 28 for Notation	27
Figure 31 – Stress Concentration Factors for a Pair of Unequal, Circular Openings as a Function of Separation; See Figure 28 for Notation	27
Figure 32 – Stress Concentration Factors for a Pair of Diagonally Adjacent Equal Square Openings as a Function of Reinforcement	28
Figure 33 – Stress Concentration Factors for a Pair of Equal Rectangular Openings as a Function of Hole Separation	29
Figure 34 – Stress Distribution around an Infinite Row of Circular Holes	30
Figure 35 – Comparison of Stress Concentration Factors around a Cluster of Rectangular Openings on a Landing Craft	31
Figure 36 – Isochromatic Fringe Pattern around a Cluster of Openings on the AGEH PLAINVIEW	32
Figure 37 – Comparison of Stress Concentration Factors for Reinforced and Unreinforced Cluster of Openings on a Landing Craft	33
Figure 38 – Stress Concentration Factor for a Pair of Circular Openings as a Function of Separation	34

	Page
Figure 39 – Typical Test Setup for Photoelastic Experiments	37
Figure 40 – Isochromatic Fringe Pattern of a Pair of Rectangular Openings, Perpendicular Pull	38
Figure 41 – Isochromatic Fringe Pattern of a Pair of Rectangular Openings, Parallel Pull.....	39
Figure 42 – Isochromatic Fringe Pattern of a Pair of Diagonally Adjacent Square Openings	40
Figure 43 – Isochromatic Fringe Pattern of a Cluster of Openings	41

NOTATION

a, b	Biaxial load factors
d	Distance between the centers of two openings
h	Height of a rectangular opening
K	h/w
R	Radius of a circular opening
r	Radius of curvature of a corner on a square or rectangular opening
s	Distance between the boundaries of two openings
T	Tension load
w	Width of a rectangular opening
a	Reinforcement around an opening
β	Local coordinate system around an opening in degrees
θ	Load direction in degrees
λ	Ratio of applied biaxial loads a/b
ρ	r/w

ABSTRACT

A summary of stress concentration studies has been provided for the case of single and multiple openings in plate structures. This report summarizes some published theoretical studies as well as some previously unpublished photoelastic studies performed at the Center. Also included are comments for modifications of the design criteria currently used for openings on ships.

ADMINISTRATIVE INFORMATION

This work was authorized and funded by the Naval Ship Systems Command (SHIPS 0342) as part of Project S-F422 310, Task 15071.

INTRODUCTION

During recent years the Navy has been developing high-performance, weight-critical ships. These structurally complex ships have had to include numerous openings due to the increasing uses of electrical and hydraulic systems. These openings, clustered together with the more traditional openings due to hatches, ventilation ducts, passageways, etc., cause stress concentrations that the naval architect must consider in order to have a safe and efficient design.

Several papers have been written about stress concentrations around openings. Most of the work done has been devoted to the case of single, isolated openings of different shapes. There has also been theoretical and experimental work performed on pairs and select clusters of openings, such as circular openings arranged in rows and regular arrays. However, not much effort has been spent on the practical problem of reinforced openings in pairs and clusters. Zwenig¹ presents a review of the literature available through 1967.

This report presents a summary of theoretical and experimental published results concerning stress concentrations around openings in plates loaded under uniaxial and biaxial tension and compression. Several previously unpublished photoelastic studies of pairs and clusters of reinforced and unreinforced openings are also included. All of the results are combined under the following headings: single openings, pairs of openings, and clusters of openings. These groupings are also subdivided as to reinforced and unreinforced cases.

Recommendations are made for modifying the design procedures used for openings on ships. Appendix A contains the details of the previously unpublished photoelastic studies mentioned earlier.

¹Zwenig, E. A., "Bibliography of Stress Concentration with Emphasis on Structural Openings in Ship," NSRDC Report 2516 (Jun 1968). A complete list of references is given on page 42.

CURRENT DESIGN PRACTICE

The current procedures for designing openings in the structure of surface ships are outlined in Navy Design Data Sheets (DDS) 9110-1 and 9110-2. These design procedures consist of a few rules of thumb which consider the geometry of isolated openings and reinforcement based on standard plate thicknesses of conventional ships. In the nearly 20 years since these design procedures were first issued, new types of high-performance ships have been introduced to the fleet, having different service requirements than those for conventional ships. Since the service stresses in a ship are a function of its geometry and the magnitude and type of loads encountered, it is important to distinguish between types of ships when developing opening-design technology. The existing design methods, based on geometry, do not adequately consider the type and magnitude of loads. It is therefore possible that an opening may be overdesigned for the load conditions for one type of ship and yet be underdesigned for the load conditions for another type of ship. The current designs are also based on standard plate thicknesses for conventional ships and should be updated to include the new plate thicknesses and materials of weight-critical high-performance ships. The existing DDS's do not consider the mutual effects of openings in a cluster. However, so much work has been done, during recent years, on the important phenomena of mutual effects that it is now time to include these data in the design procedures.

RESULTS

SINGULAR OPENINGS

Unreinforced

Stress concentrations caused by an opening in a plate are presented as nondimensional numbers called stress concentration factors (SCF). An SCF is the ratio of the maximum stress to the nominal stress that would occur if the discontinuity of the opening were not present.

The stress distribution around an isolated, circular opening in an infinite plate is presented in Figure 1, taken from D'Arcangelo.² The maximum SCF of 3.0 is found on the boundary of the opening parallel to the applied uniaxial tension. Brock^{3,4} determines some SCF's for square holes with rounded corners by using the complex variable method of Muskhelishvili.⁵ Using this same method, Heller⁶ presents the SCF's for rectangular

²D'Arcangelo, A.M., "A Guide to Sound Ship Structures," Cornell Maritime Press, Cambridge, Md. (1964).

³Brock, J.S., "The Stresses Around Square Holes with Rounded Corners," *Journal of Ship Research* (Oct 1958).

⁴Brock, J.S., Analytical Determination of the Stresses Around Square Holes with Rounded Corners," David Taylor Model Basin Report 1149 (Nov 1957).

⁵Muskhelishvili, N.I., "Some Basic Problems of the Mathematical Theory of Elasticity," Third Revised Edition, Translated from the Russian by J.R.M. Radok, P. Noordhoff, Ltd., Groningen, Netherlands (1953).

⁶Heller, S.R., "Stress Concentration Factors for a Rectangular Opening with Rounded Corners in a Biaxially Loaded Plate," *Journal of Ship Research* (Sep 1969).

openings with rounded corners in biaxially loaded plates. Figures 2 through 4, taken from Heller⁶ are families of curves depicting the SCF's for rectangles of various aspect ratios and corner radii when loaded by combinations of uniaxial and biaxial tension and compression. Squares, circles, and ovaloids can also be found as special cases of the rectangles. Figures 5 and 6, taken from Heller,⁶ present curves for finding the most favorable corner-radius ratios in terms of load factors and aspect ratio. No SCF's for squares or rectangles with sharp corners are given because they have theoretical SCF's of infinity and induce failures in real structures.

Reinforced

Openings are often reinforced in order to lower the SCF's to acceptable levels. Figure 7, taken from Reference 2, shows the three kinds of reinforcements commonly used in welded structures, i.e.,

1. A doubler reinforcement
2. A face bar reinforcement and
3. An insert plate reinforcement.

Dhir and Brock⁷ present another method for reinforcing openings with large savings in structural weight.

The amount of reinforcement is often given as the ratio of cross-sectional area of the reinforcement to the cross-sectional area removed by the opening. Thus, an unreinforced opening would have a zero-percent ratio. Figure 8 taken from Reference 2, shows the optimum reinforcement and maximum SCF values for square openings with rounded corners. A circular opening would be the case of $r/h = 1/2$.

PAIRS OF OPENINGS

Unreinforced

It is frequently necessary to place an opening within the stress field of another opening. Depending upon the size, shape, and position of the two openings, their individual SCF's may experience an increase or even a decrease over the case of one of the same openings when it is isolated.

Out of all the possible combinations of circular, square, rectangular, and ovaloid openings let us begin with an examination of the case of two circular openings. Ling⁸ presents a theoretical study of two circular openings of equal size, loaded by uniaxial and biaxial tension. His results are summarized in Figure 9 by a family of curves plotting maximum

⁷Dhir, S.K. and J.S. Brock, "A New Method of Reinforcing a Hole Effecting Large Weight Savings," International Journal Solids Structures, Vol. 6 (1970).

⁸Ling, C.B., "On the Stresses in a Plate Containing Two Circular Holes," Journal of Applied Physics (Jan 1948).

SCF's against the separation of the two openings. Also included are some experimental points obtained from Borg's⁹ use of strain gages on steel plates. A reduction in the individual SCF's happens in the case of the two openings loaded in tension parallel to their centers.

The case of two unequal circular openings in uniaxial tension was studied by Haddon.¹⁰ Figure 10 shows the position of the openings and his notation. An example of the tangential boundary stresses is given in Figure 11. Figure 12 shows the maximum and minimum SCF's for a family of curves as a function of hole spacing. Dhir¹¹ presents the results of two unequal circular openings under biaxial loads. Figure 13 presents his notation and geometries. Figures 14 and 15 show the maximum SCF's as a function of pull direction and size ratio, respectively.

Another example is the common structural problem of a square opening near a circular opening. This case was theoretically studied by Dhir¹² whose notation and geometry can be found in Figure 16. A family of curves of relative opening sizes is presented in Figure 17 as the maximum SCF versus the hole separation. Some experimental photoelastic results conducted at the Center are also included.

A pair of rectangular openings with rounded corners represent another area of interest to the structural designer. The case of two rectangular openings loaded in uniaxial tension in a direction perpendicular to a line joining their centers was experimentally investigated by Phyllaier.* The results of his photoelastic analysis are presented in Figure 18, where the SCF's are plotted against the separation of two equal openings. The related case of two rectangular openings loaded in uniaxial tension in a direction parallel to the line joining their centers was experimentally investigated by Sikora.** The results of this photoelastic analysis are presented in Figures 19 and 20. The SCF's of each opening are given as functions of hole separation for the respective cases of rectangles with equal lengths and with unequal lengths. Figure 21 (Reference 2) shows the areas of reduced stress for the geometry of the preceding case. Another case consists of two equal square holes placed off center so that they possess a common diagonal direction. Figure 22** compares their SCF's as a function of corner radius.

Reinforced

The problem of reinforcing pairs of openings becomes important in weight-critical ships. Since openings may interact in either beneficial or detrimental manners, it is necessary to know how much, if any, reinforcing is sufficient to yield acceptable stress levels.

⁹Borg, M.F., "Maximum Stress Concentration Factors Caused by Two Equal Circular Holes in a Plate Subjected to Uniform Axial Loading," David Taylor Model Basin Report 907 (Sep 1957).

¹⁰Haddon, R.A., "Stresses in an Infinite Plate with Two Unequal Circular Holes," Quarterly Journal of Mechanics and Applied Mathematics (Aug 1967).

¹¹Dhir, S.K., "Stresses Around Two Adjacent Unequal Circular Holes Under Biaxial Loads," NSRDC Report 3367 (Jul 1970).

¹²Dhir, S.K., "Stresses Around Two Openings of General Shape," Journal of Ship Research (Dec 1970).

*W. Phyllaier of the Center conducted these studies in the spring of 1970; experimental details are in Appendix A.

**These studies, conducted in the spring of 1970, are described in Appendix A.

The stresses around two equal, reinforced, circular openings loaded by biaxial tension have been studied by Dhir.^{13,14} Figure 23 shows his notation and geometry for the openings. The maximum SCF's for various amounts of reinforcement are presented in Figure 24 as a function of hole separation. Figures 25 and 26 show the stress distribution around the openings. A comparison of Dhir's¹³ results and Brock's theory and some experimental points is presented in Figure 27. The stresses around two unequal, circular, reinforced openings have also been studied by Dhir.¹⁵ Figure 28 shows his notation and geometry. Figures 29 through 31 show the SCF as a function of the ratio of hole sizes, load direction, and separation, respectively.

The results of the previously described photoelastic analysis by Sikora, concerning the effect of reinforcing a pair of diagonally adjacent, equal, square openings is presented in Figure 32. A study of the stresses around two equal rectangular openings loaded in uniaxial tension in a direction perpendicular to a line joining their centers was also experimentally investigated by Sikora.* Figure 33 presents the SCF's for 0- and 40-percent reinforcement as a function of hole separation.

CLUSTERS OF OPENINGS

As with the case of pairs of openings, clusters are frequently encountered in ship hull structures. The number of hole parameters (such as shape, relative size, separation, and load direction) increases rapidly as the number of openings increases from a pair to three, four, and more. Therefore, it is not surprising to find that there has been little theoretical work done in this area. Most of the following cases consist of model studies related to individual ships.

The case of an infinite row of equal, circular holes was studied by Howland.¹⁶ His results for the cases of tension applied parallel to the line of centers and perpendicular to the line of centers can be found in Figure 34.

A photoelastic study of a cluster of openings in the deck of a landing craft was performed by Sikora.** The changes in stress distributions and intensities caused by adding

¹³Dhir, S.K., "Analytical Determination of the Stresses Around Two Equal Reinforced Circular Openings in a Thin Plate," NSRDC Report 2554 (Mar 1969).

¹⁴Dhir, S.K., "Stresses Around Two Equal Reinforced Circular Openings in a Thin Plate," International Journal Solids Structures, Vol. 4 (1968).

¹⁵Dhir, S.K., "Stresses Around Two Reinforced Openings of General Shape," NSRDC Report 3768 (Jan 1972).

¹⁶Howland, R.C.J., "Stresses in a Plate Containing an Infinite Row of Holes," Proceedings of Royal Society (London) (1935).

*These studies were conducted by the author and J. Collier of the Center during the fall of 1971; experimental details are in Appendix A.

**These studies were conducted by the author and J. Rodd of the Center during the fall of 1971; experimental details are in Appendix A.

a third and fourth hole to a pair of rectangular openings on this ship can be found in Figure 35. Reference 17 describes the openings in the deck of the hydrofoil AGEH PLAINVIEW. Figure 36 contains a photograph of the isochromatic fringe pattern around the openings as well as a list of their maximum SCF's. Brock¹⁸ used a steel model to determine the stresses around some openings in an aircraft carrier.

A typical example of a cluster of reinforced openings was included in the previous landing craft study by Sikora and Rodd. Figure 37 shows the effect of reinforcing a cluster of eight holes by 75 percent.

DISCUSSION

The magnitudes and distributions of the stresses around openings are governed by the geometry of the individual openings, the number and proximity of openings, their location on ships, and the kinds of loads they are subjected to. All of the results that have been presented have assumed nearly perfect workmanship in ideally isotropic materials. Good workmanship and materials are important since any notches or edge irregularities on the openings will cause additional stress concentrations.

Most of the results presented in this report are only valid for openings located in pure uniaxial tension. Although this idealized loading may not exist on ships, it is assumed that the major uniaxial loads encountered may often be significantly large enough to neglect the effects of minor tensions and compressions in other directions. Caution should, therefore, be exercised when the loads are unknown or when uniaxial tension is not approximated. In addition, these results are based on the assumption that the plates containing the openings are isotropic. Some of the effects of stiffeners on stress distributions and magnitudes are discussed in relation to a specific ship in Reference 17.

The results of several studies concerning the mutual interaction of a pair of openings has been presented and summarized in Figures 9 through 33. However, each of a pair of openings may be treated as isolated if they are sufficiently far apart. Figure 38 shows the maximum SCF for a pair of reinforced circular openings as a function of their separation. These curves, in contours of the ratio of hole sizes, are based on the information contained in Figures 24 and 31. There appears to be little significant interaction between the openings when their separation exceeds two diameters of the larger opening. This is also confirmed for the unreinforced case of equal openings as in Figure 9 as well as for the case of an unreinforced circular and square opening in Figure 17. Furthermore, when two circular openings are located between one diameter and two diameters apart and when the radius of

¹⁷Dhir, S.K. et al. "Stress Analysis of the Openings in the 0-1 Deck of AGEH Hydrofoil," NSRDC Report 3682 (Oct 1971).

¹⁸Brock, J.S., "The Stresses Around Small Openings in the Vicinity of the Large Side Openings of the CVA 59-Class Aircraft Carrier," NSRDC Report 2014 (Jun 1965).

the smaller is between one-fifth and one-tenth of the radius of the larger, the reinforcement should be increased to 45 percent of area replaced to area removed. This is based on allowing a maximum SCF of 1.7 which is produced by reinforcing an isolated circular opening by 40 percent. As the smaller opening in the pair increases in size greater than one-fifth of the larger, the material between the openings decreases. For example, equal openings located one diameter apart would be in contact. There are no data available for the case when the smaller opening is less than one-tenth of the larger.

Although it is frequently possible to consider a cluster of openings as groups of paired openings, care must be exercised that the cluster be not so dense that interactions between pairs of openings occur. Also, a cluster may be sufficiently isolated to be thought of as pairs and single openings under one kind of load condition but to be a dense cluster with severe interactions under another kind of load. Obviously much more work remains to be done before design criteria for clusters of openings can be recommended.

SUMMARY

1. The results of a collection of stress concentration studies of single and multiple openings has been provided. It was hoped that this compilation of results in the form of curves would provide the structural engineer and designer with a quick and easy method for determining the maximum stress concentration factor that could be expected from a given geometry and load condition. The material presented should be extensive enough to handle a wide variety of problems.

2. In spite of the significant work which has already been accomplished, there are still areas that require additional studies. One area is the case of an isolated opening of arbitrary shape with an arbitrary amount of reinforcing. This would be helpful in complementing the design data sheets. Another area requiring additional studies is the case of multiple openings. Since the existing DDS's 9110-1 and 9110-2 do not consider multiple openings, any work in this area would be of value to the designer.

3. The results from a series of photoelastic tests on the interaction of pairs of openings has been presented.

4. With the increasing use of new materials in high performance ships, it is necessary to study the effects of openings in orthotropic materials.

RECOMMENDATIONS

The recommendations are based upon the results presented in this report and are subject to the same assumptions and limitations which were described in the discussion. (The current design criteria of allowing a maximum SCF of 1.7 is also followed.)

1. The optimum corner radius for square and rectangular openings can be found in Figures 5 and 6 of Reference 6 as functions of load factors and geometries. For example, a square opening in uniaxial tension parallel to a side should have a corner radius to width ratio between one-fourth and three-eighths.

2. When multiple openings are required, they should be aligned in the same direction as the major component of the applied load, rather than in an arrangement perpendicular or askew to the load.

3. When the centers of two openings are located more than two diameters (of the larger openings) apart, consider each as an isolated opening.

4. When the centers of two circular openings are located between one diameter and two diameters (of the larger) apart and the smaller is between one-fifth and one-tenth the radius of the larger, the reinforcement of the smaller should be increased to 45 percent.

These recommendations are not intended to supplant the current Design Data Sheets DDS 9110-1 and DDS 9110-2 but are only intended to supplement them in two areas: (1) the optimization of the corner radius of square and rectangular openings, and (2) the placement and reinforcement of multiple openings. There still remains much work before an all encompassing DDS can be completed.

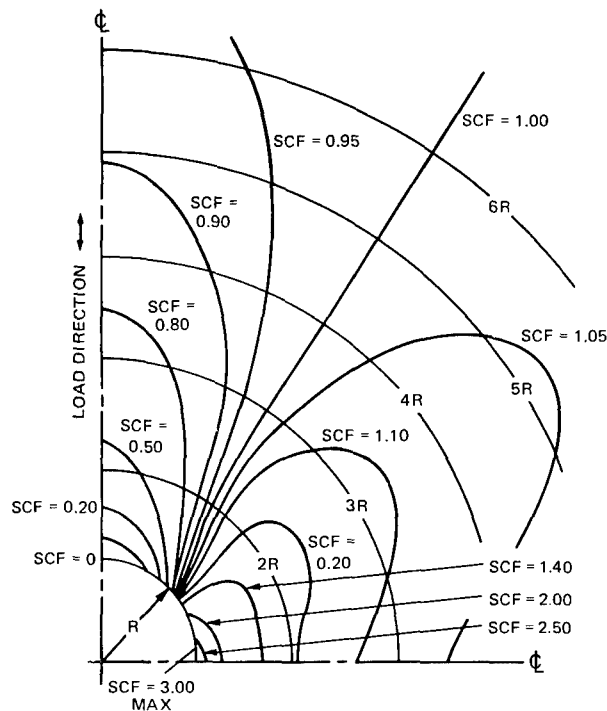

Figure 1 – Stress Concentration Factor around a Circular Hole in an Infinite Plate

Courtesy Reference 2.

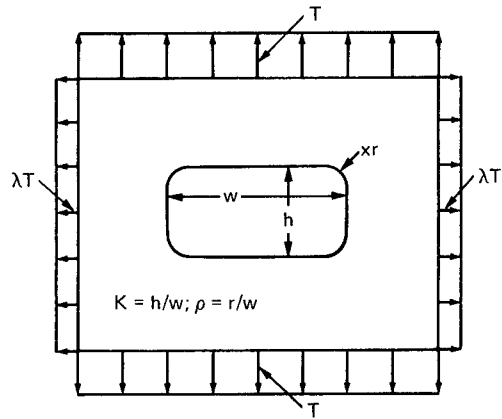

Figure 2 – Geometry and Notation of Rectangular Opening and Loading
Courtesy Reference 6.

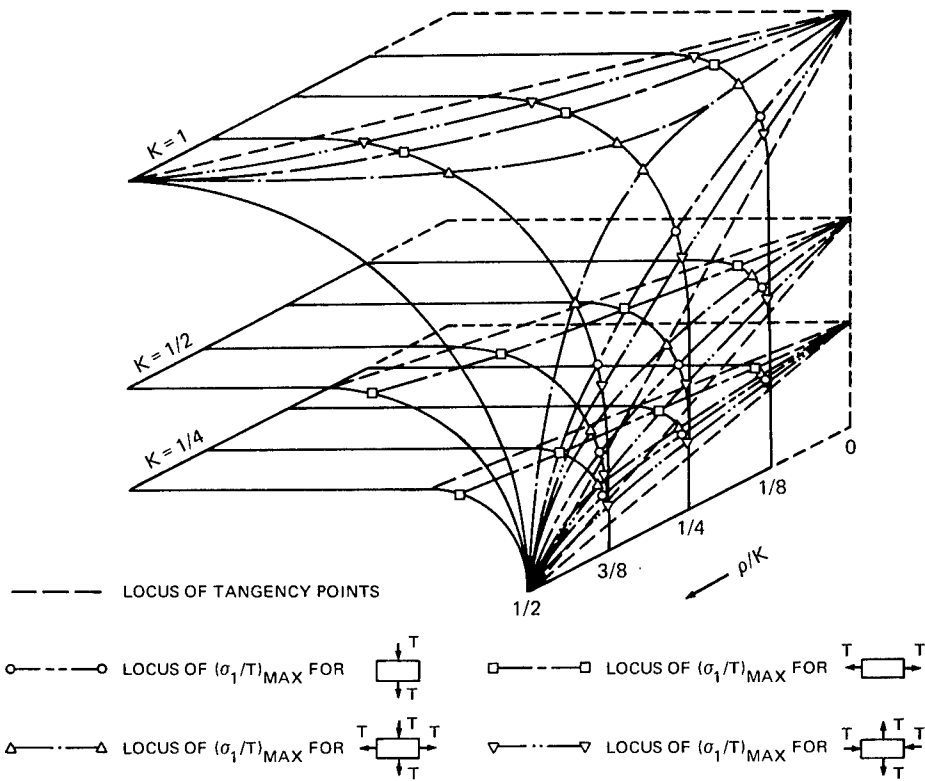

Figure 3 – Location of Maximum Stress for Various Openings and Loadings; See Figure 2 for Notation
Courtesy Reference 6.

Figure 4 — Variation of Stress Concentration Factors with Radius Ratio of Aspect Ratio; See Figure 2 for Notation
 Courtesy Reference 6.

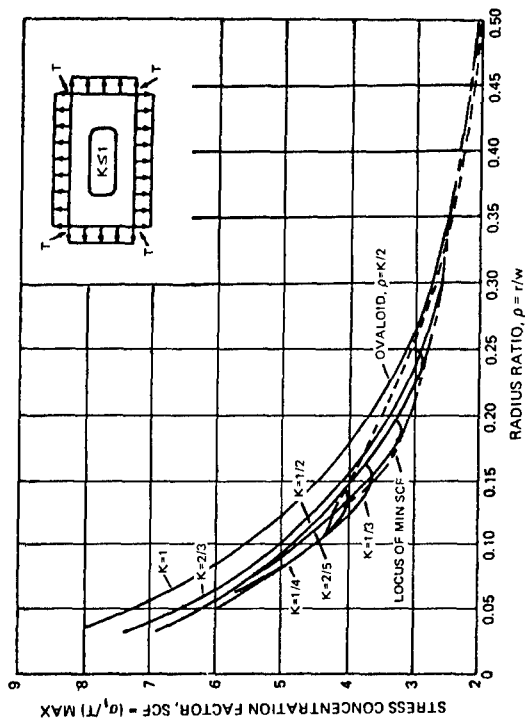

Figure 4a — $\lambda = +1$

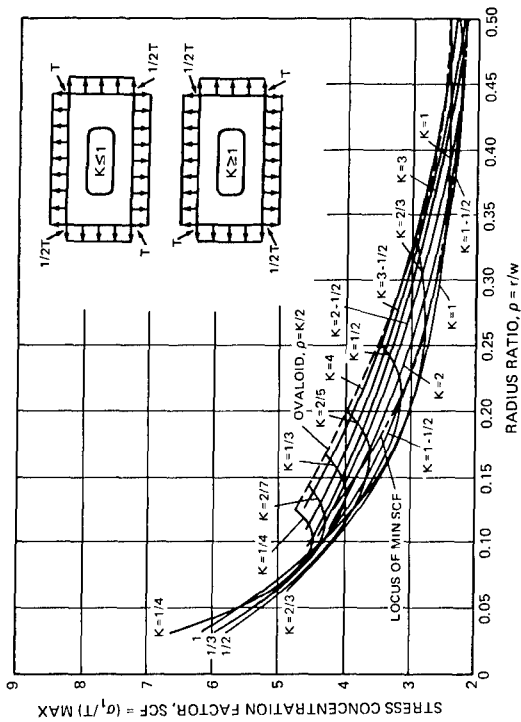

Figure 4b — $\lambda = +1/2$

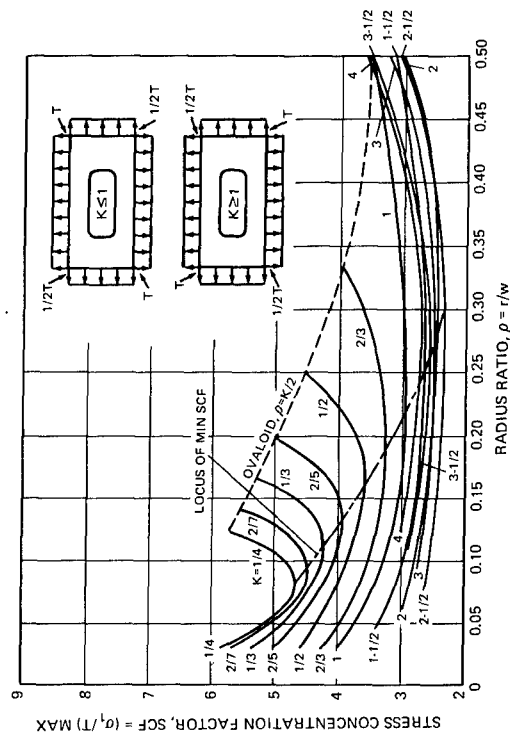

Figure 4c — $\lambda = -1/2$

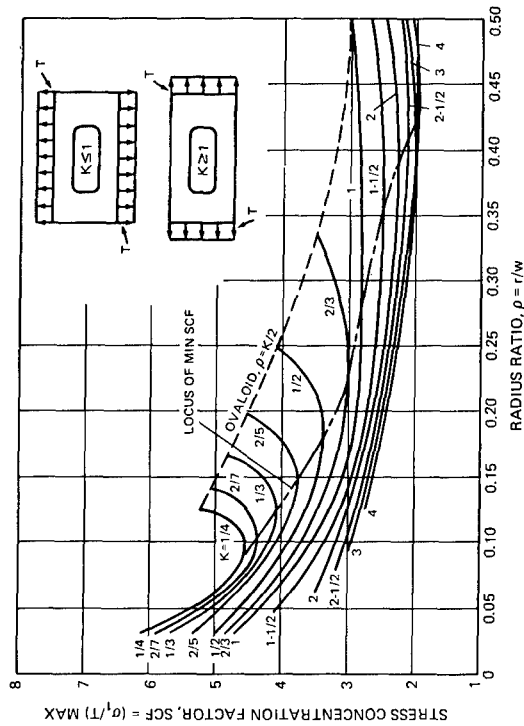

Figure 4d — $\lambda = 0$

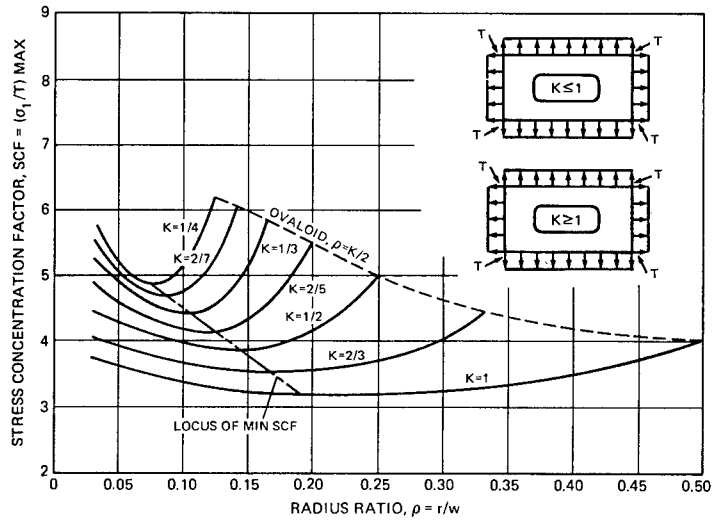

Figure 4e - $\lambda = -1$

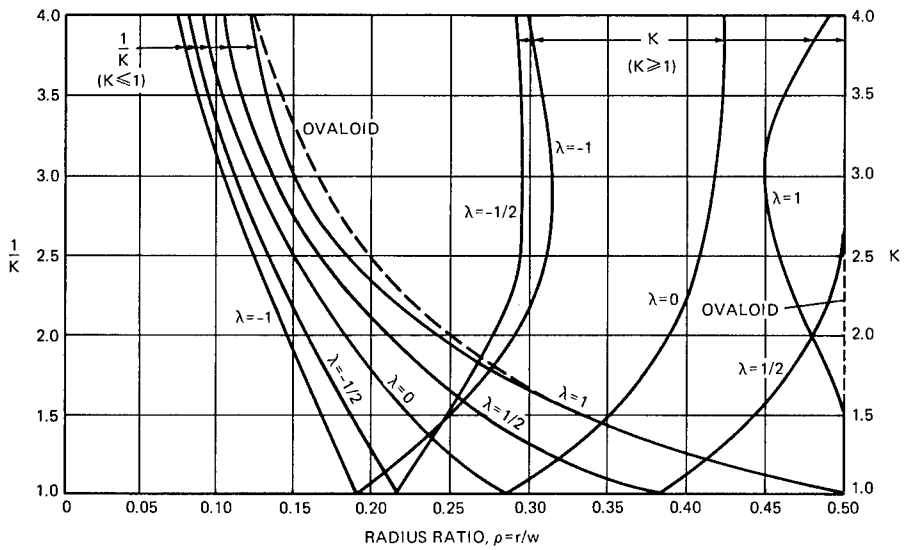

Figure 5 - Most Favorable Radius Ratio for Various Openings in Contours of Load Factor

Courtesy Reference 6.

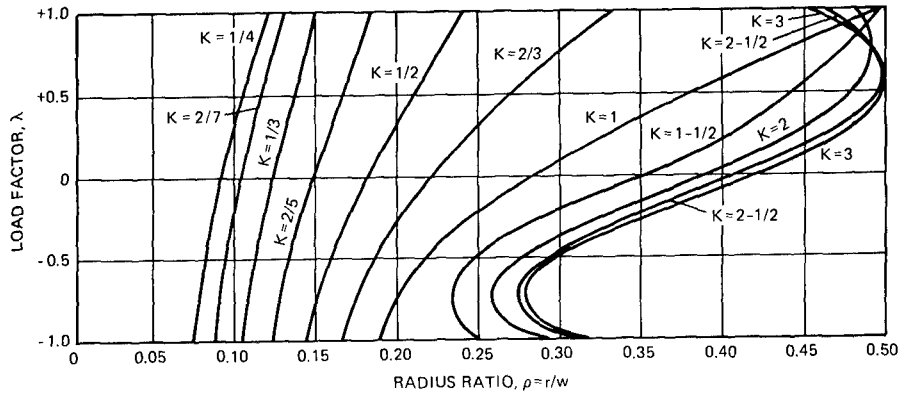

Figure 6 – Most Favorable Radius Ratio for Various Loadings in Contours of Aspect Ratio; See Figure 2 for Notation

Courtesy Reference 6.

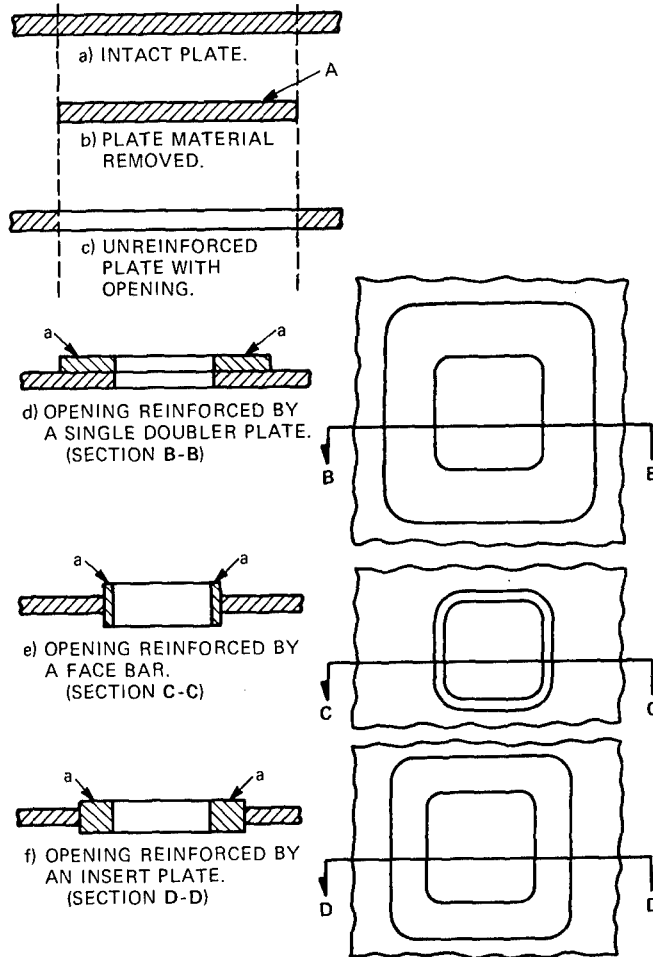

Figure 7 – Types of Reinforcements

Courtesy Reference 2.

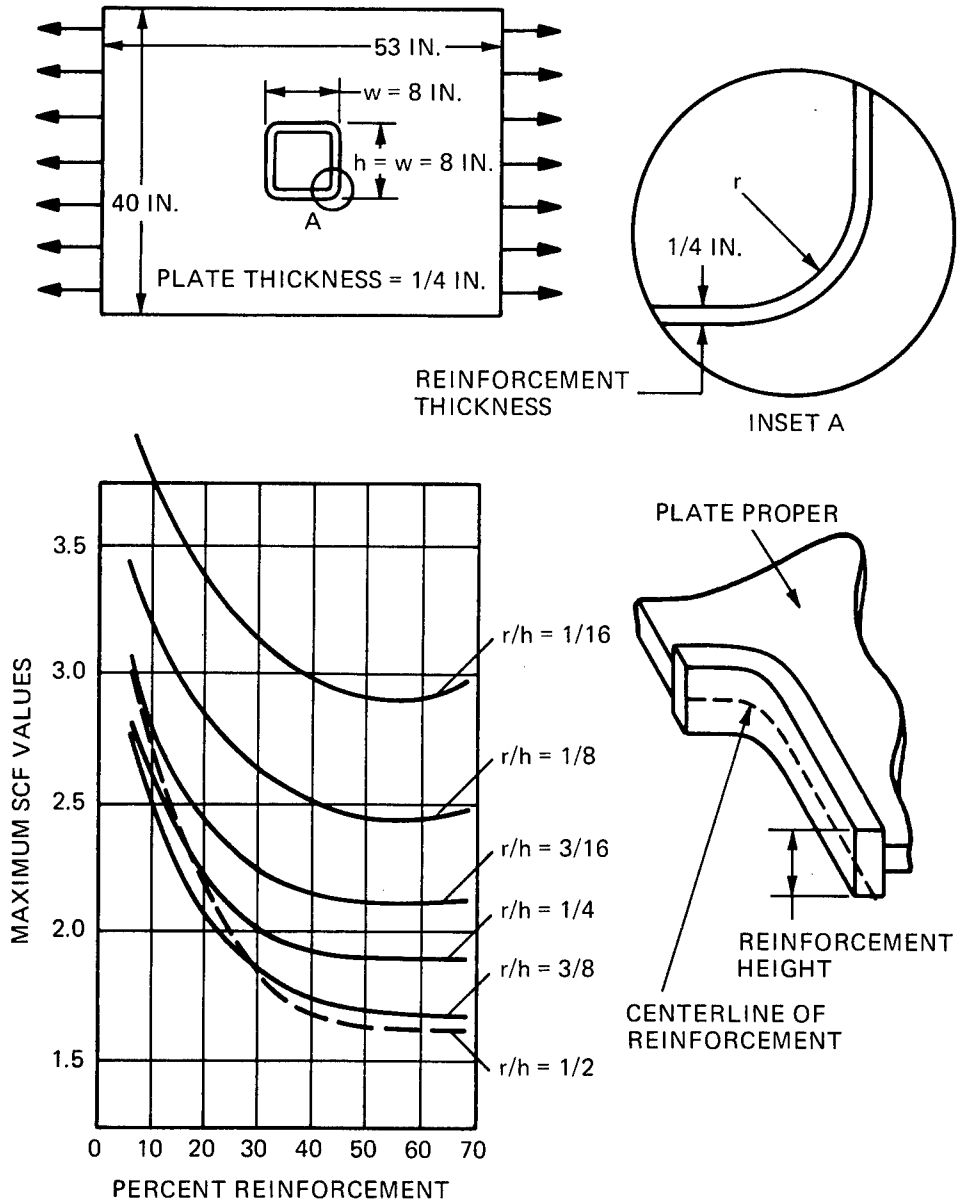

Figure 8 – Maximum Stress Concentration Factor for Face-Bar Reinforced Square Openings with Rounded Corners

Courtesy Reference 2

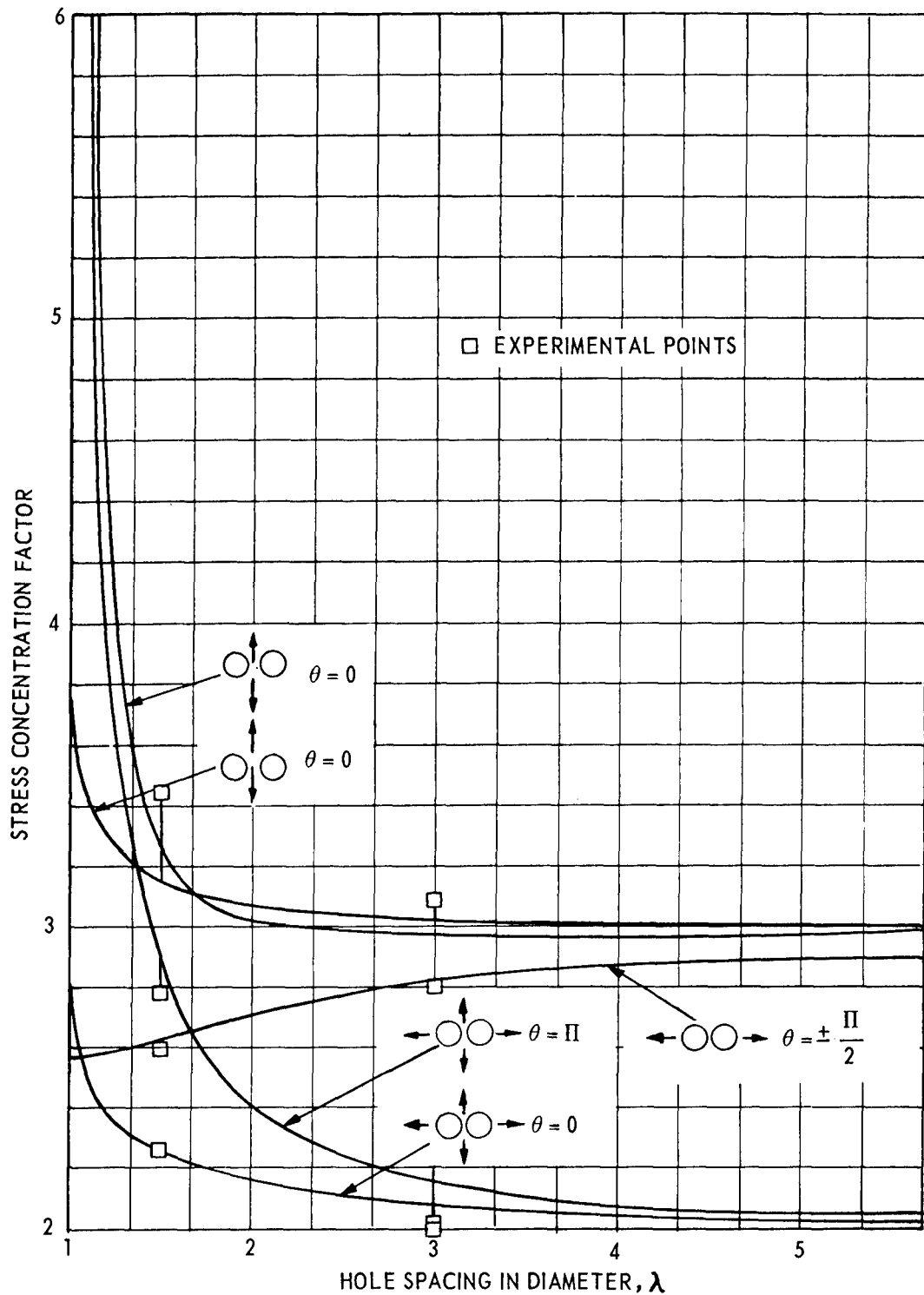

Figure 9 – Maximum Stress Concentration Factors versus Spacing of Two Equal Circular Holes

Courtesy References 8 (curves) and 9 (experimental points).

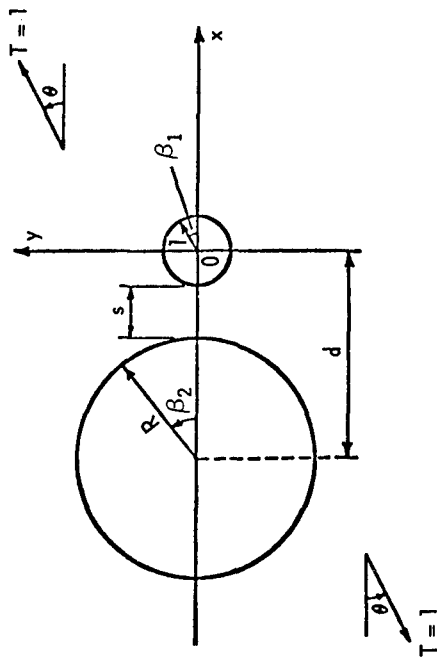

Figure 10 - Diagram Showing Pair of Unequal Holes
 Courtesy Reference 10.

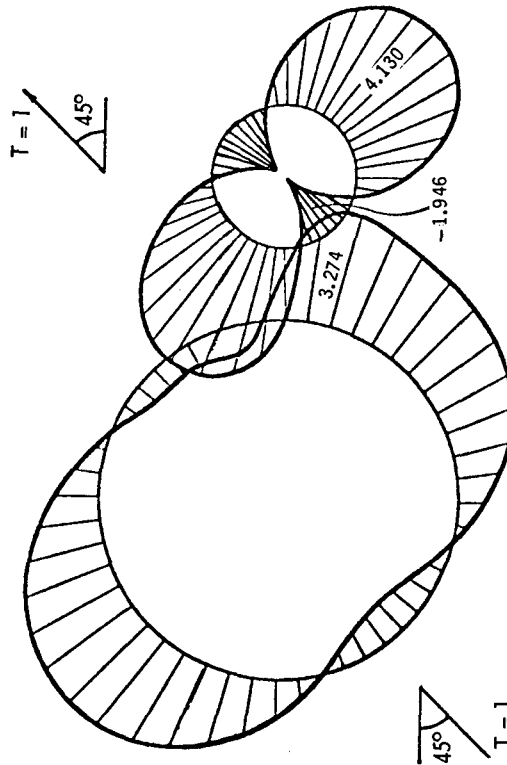

Figure 11 - Variation of Tangential Stress on Boundaries
 of Two Unequal Holes
 Courtesy Reference 10.

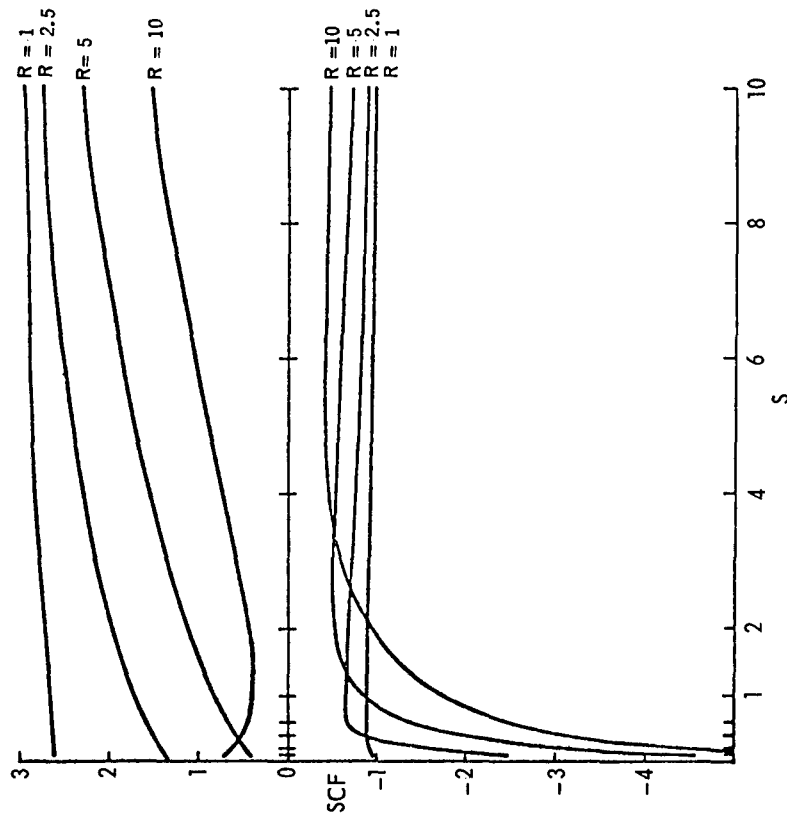

Figure 12 - Variation of Maximum Tension and Compression on
 the Smaller of Two Unequal Holes as a Function
 of Hole Spacing; See Figure 10 for Notation
 Courtesy Reference 10.

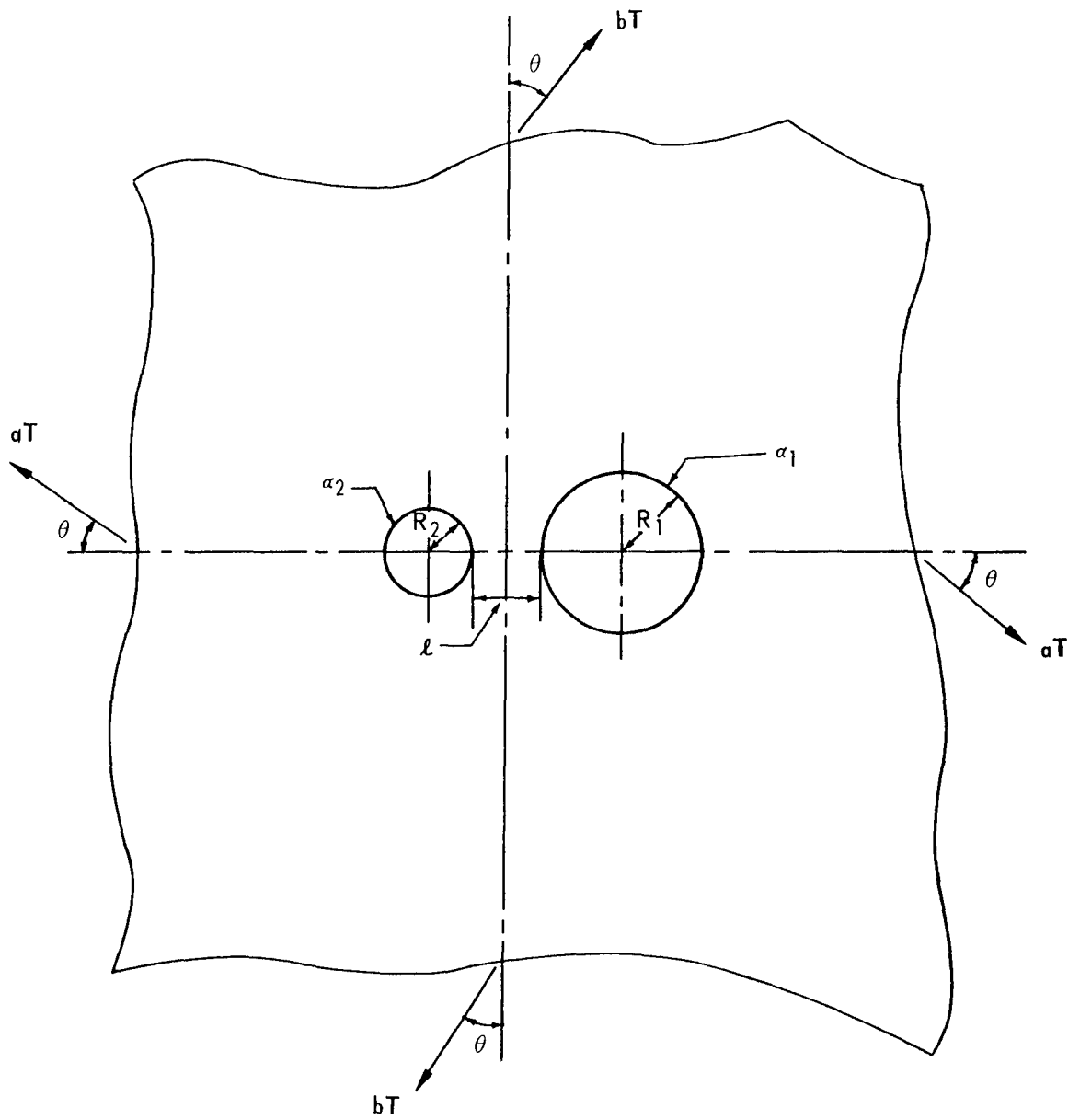

Figure 13 – Geometry of Two Unequal Circular Holes
 Courtesy Reference 11.

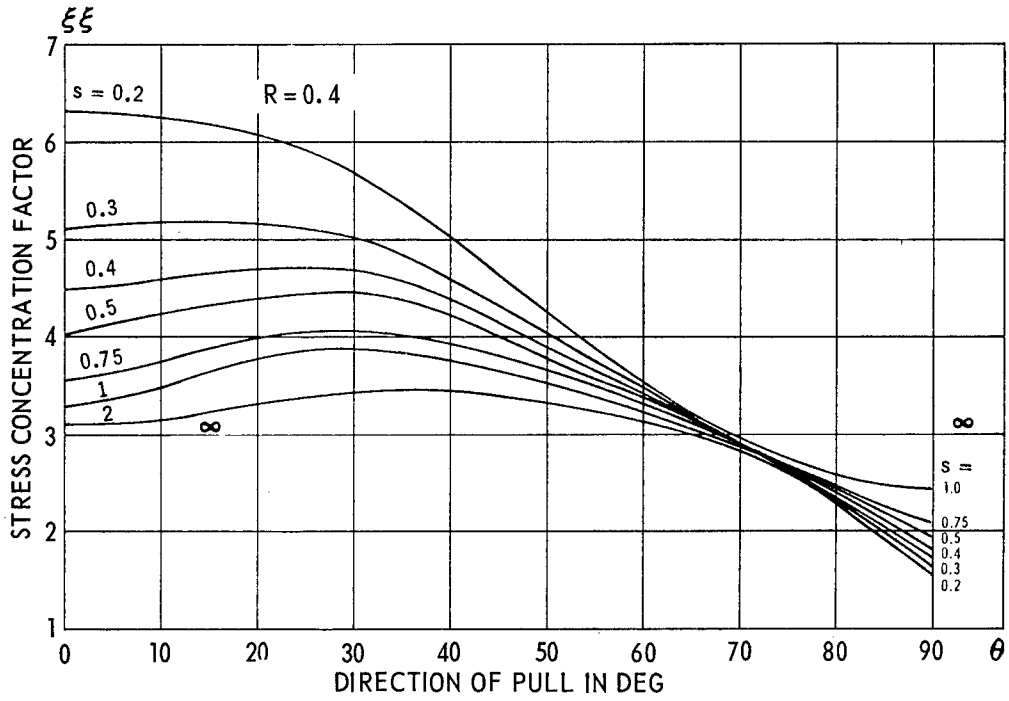

Figure 14 – Maximum Stresses versus Pull Direction; See Figure 13 for Notation
Courtesy Reference 11.

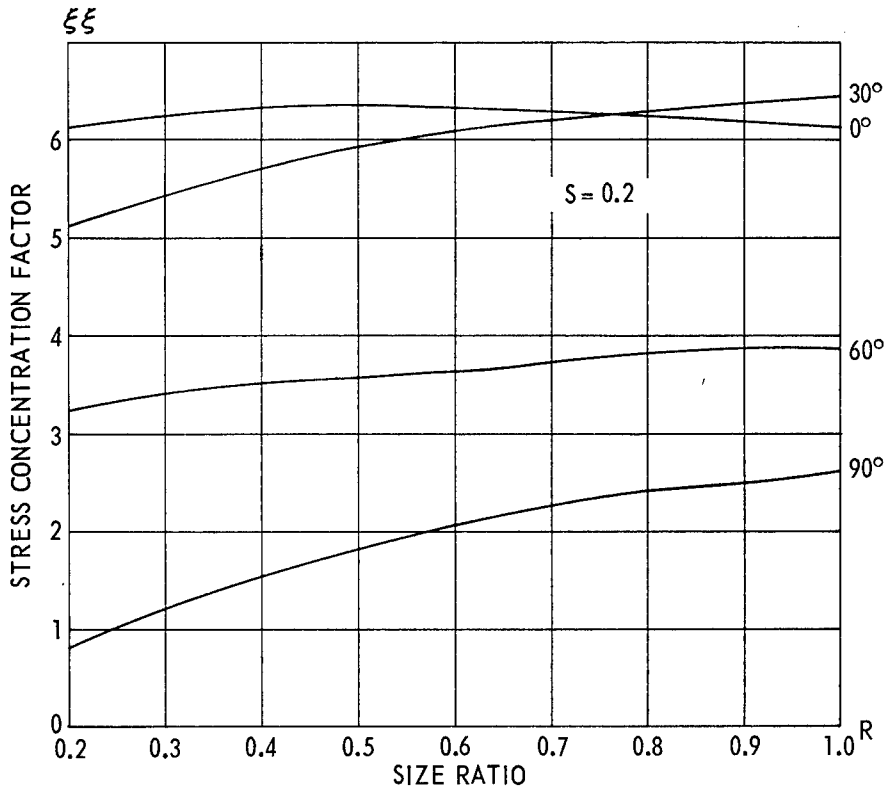

Figure 15 – Maximum Stresses versus Ratio of Two Circular Holes;
See Figure 13 for Notation
Courtesy Reference 11.

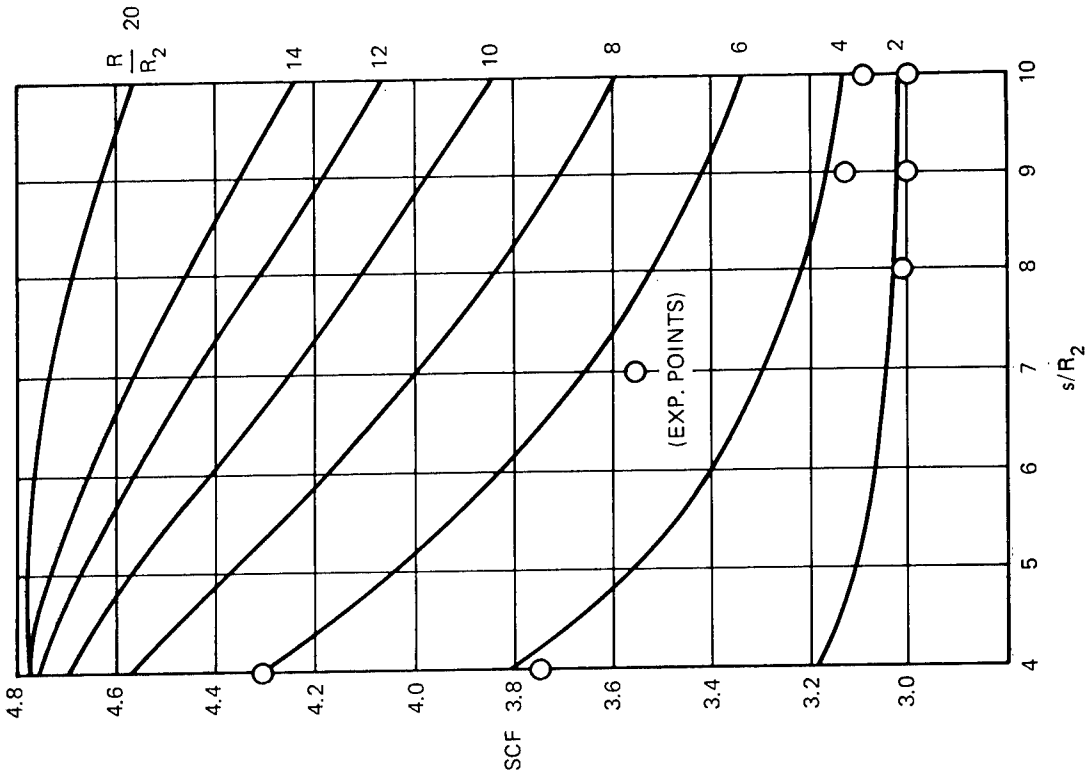

Figure 17 — Maximum Stress Concentration Factor for a Square and Circular Opening as a Function of Separation; See Figure 16 for Notation
Curves courtesy Reference 12.

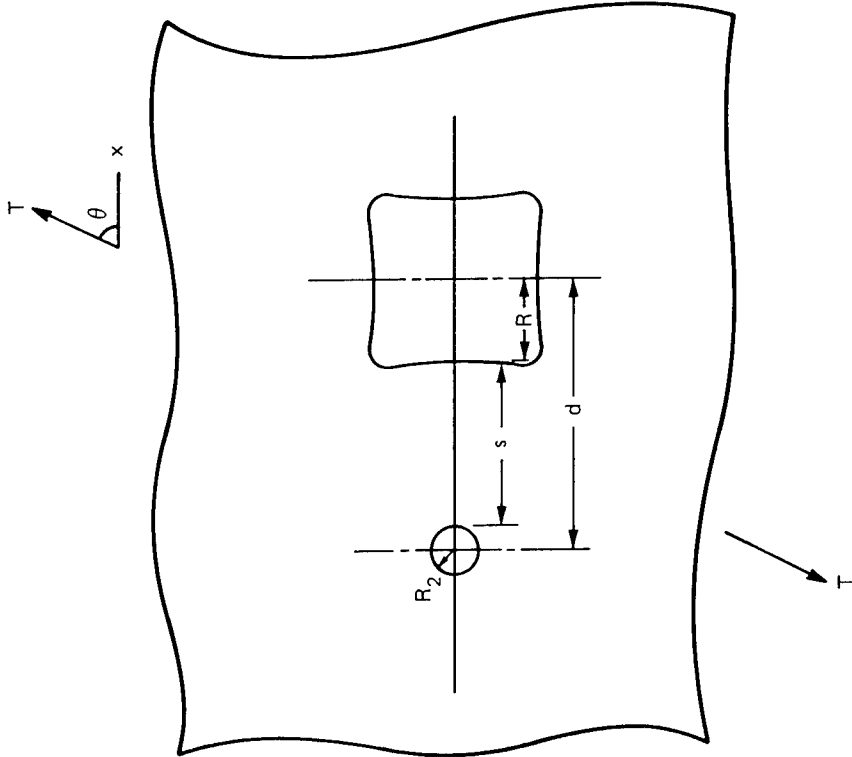
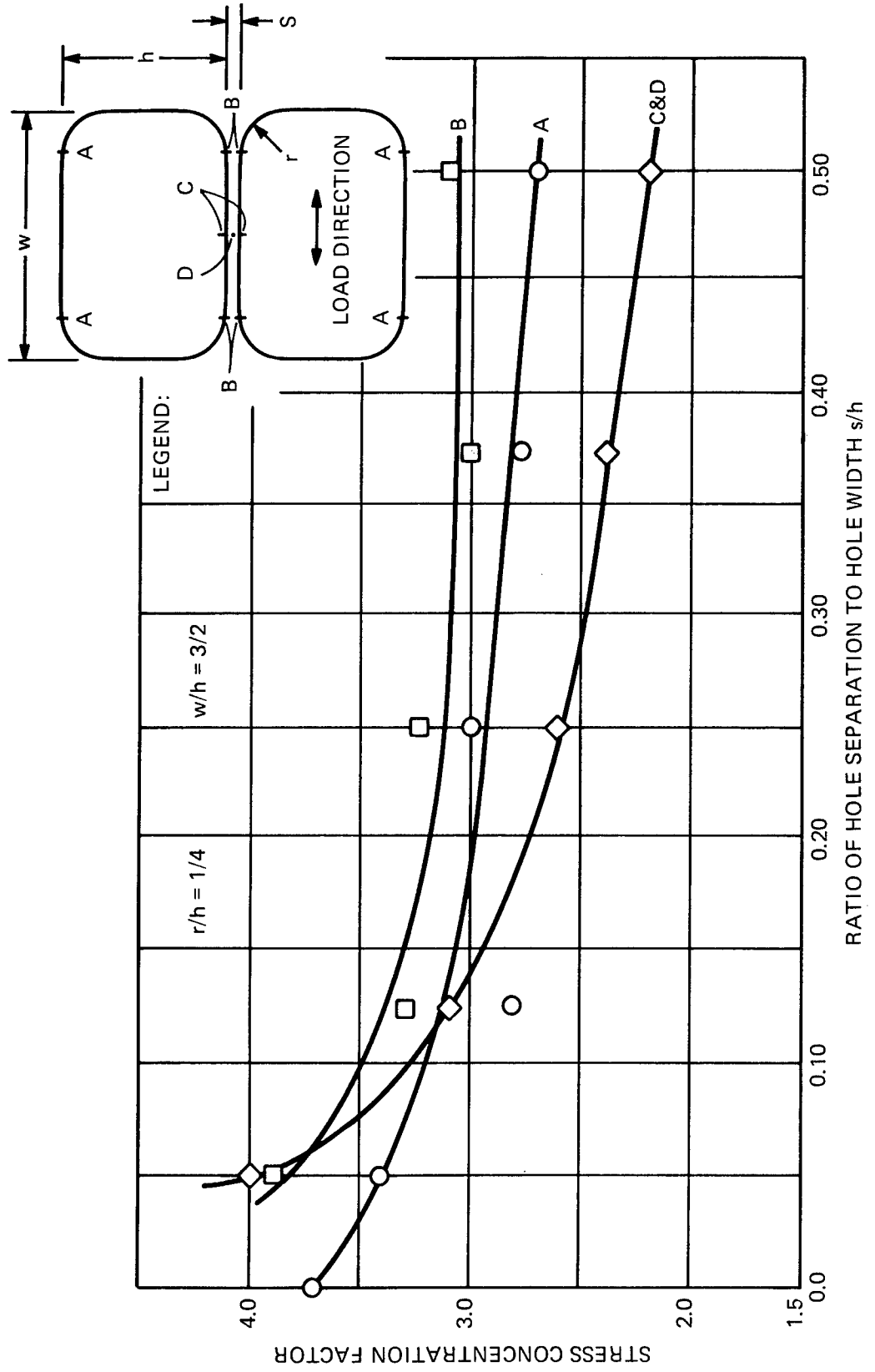

Figure 16 — Geometry of a Square and Circular Opening
Courtesy Reference 12.

Figure 18 - Stress Concentration Factors for a Pair of Rectangles as a Function of Separation



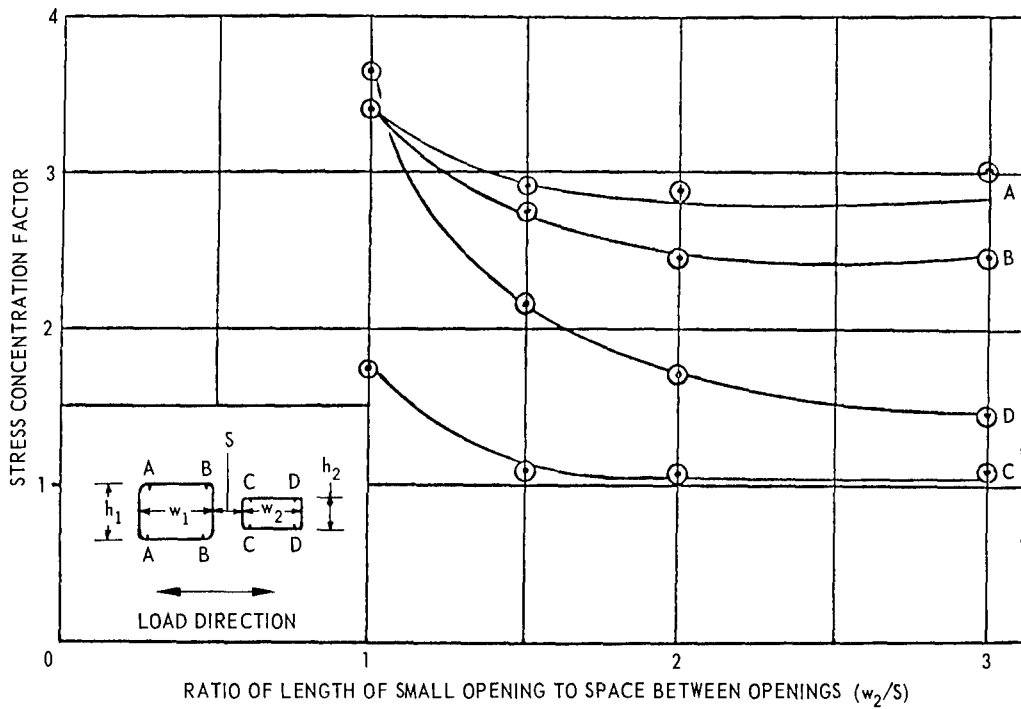

Figure 19 – Stress Concentration Factors for a Pair of In-Line Rectangles with Equal Lengths

The effect of lengthening two openings of Model 1 in the direction of the load. In all cases holes are of equal lengths ($w_1 = w_2$), the large hole has twice the breadth of the small opening ($h_1 = 2h_2$), and the breadth of the small hole equals the space between holes ($h_2 = S$).

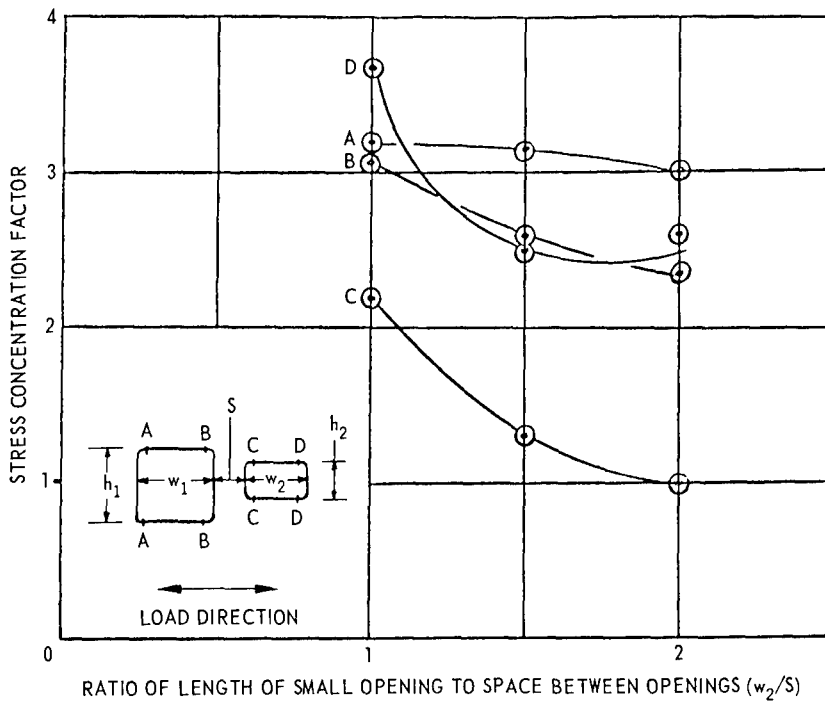

Figure 20 – Stress Concentration Factors for a Pair of In-Line Rectangles with Lengths in a Ratio of 2 to 3

The effect of lengthening two openings of Model 1 in the direction of the load. In all cases $w_1 = 1.5 w_2$, $h_1 = 2h_2$, $h_2 = S$.

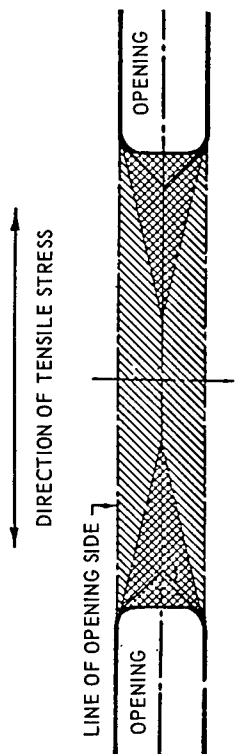

Figure 21a - Widely Spaced Openings

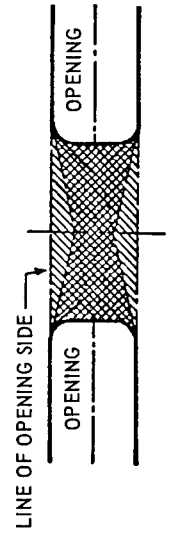

Figure 21b - Closely Spaced Openings

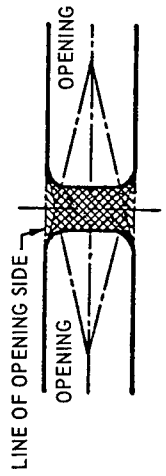

Figure 21c - Very Closely Spaced Openings

- NOTES:
- 1) INDICATES AREAS OF UNREDUCED STRESS
 - 2) INDICATES AREAS OF REDUCED STRESS
 - 3) THE BEST LOCATION FOR MINOR OPENINGS IN THE VICINITY OF THE LARGE OPENINGS SHOWN IN (a), (b) AND (c) IS WITHIN THE CROSS-HATCHED AREAS. HOWEVER, MINOR OPENINGS SHOULD BE PLACED WELL REMOVED FROM THE CORNERS OF THE LARGE OPENINGS.

Figure 21 - In-Line Rectangular Openings in a Plate Showing Areas of Reduced Stress
Courtesy Reference 2.

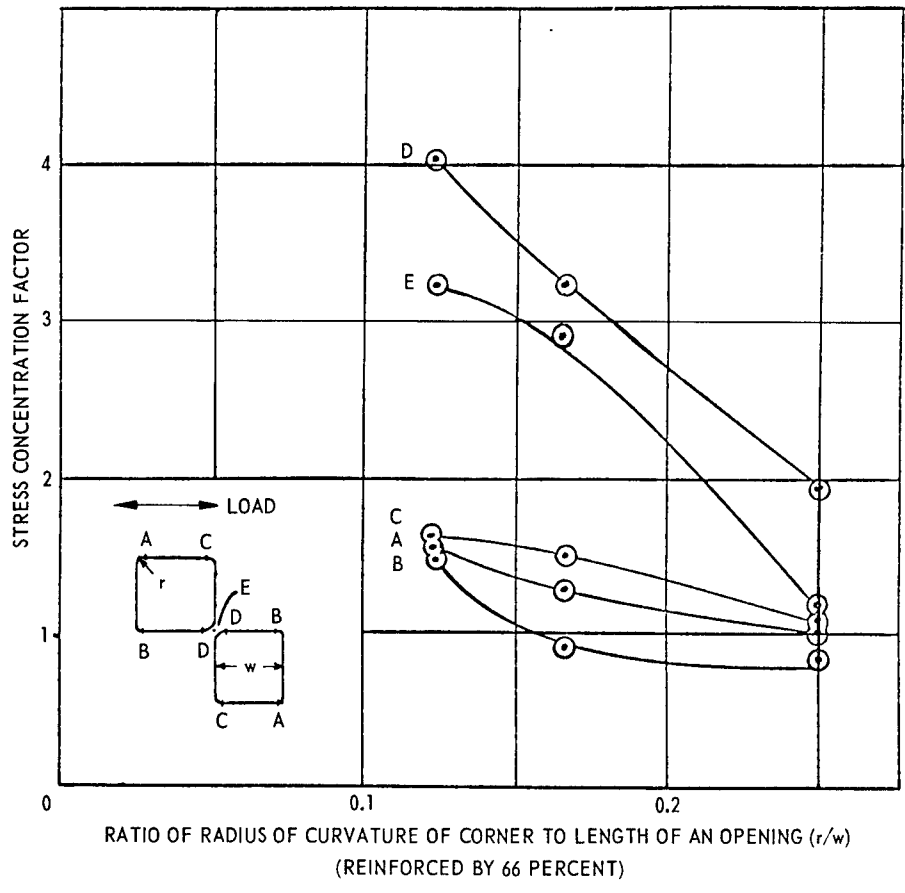

Figure 22 - Stress Concentration Factors for a Pair of Diagonally Adjacent Equal Square Openings

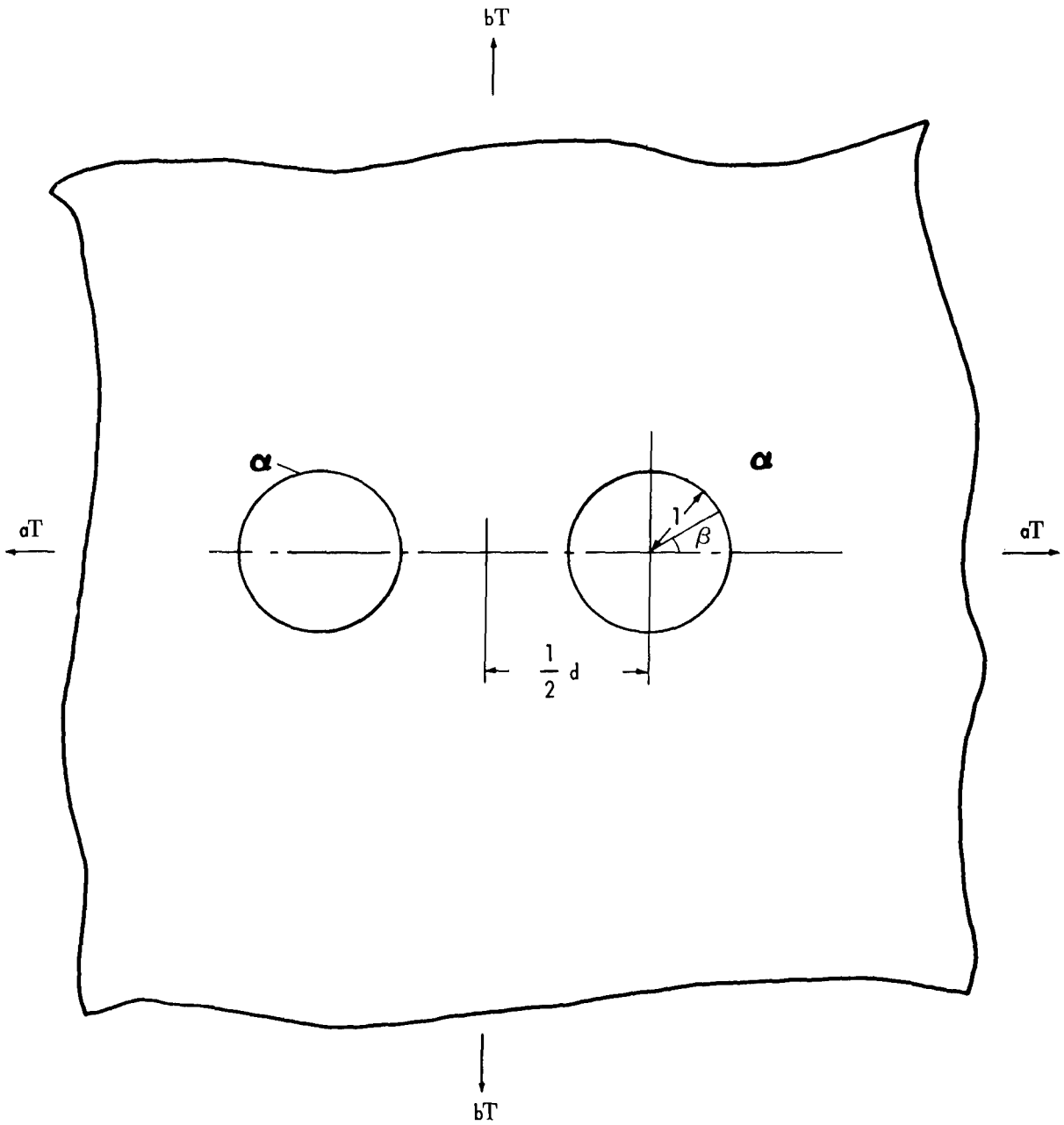

Figure 23 – Notation and Geometry of Two Equally Reinforced Circular Openings
 Courtesy Reference 13.

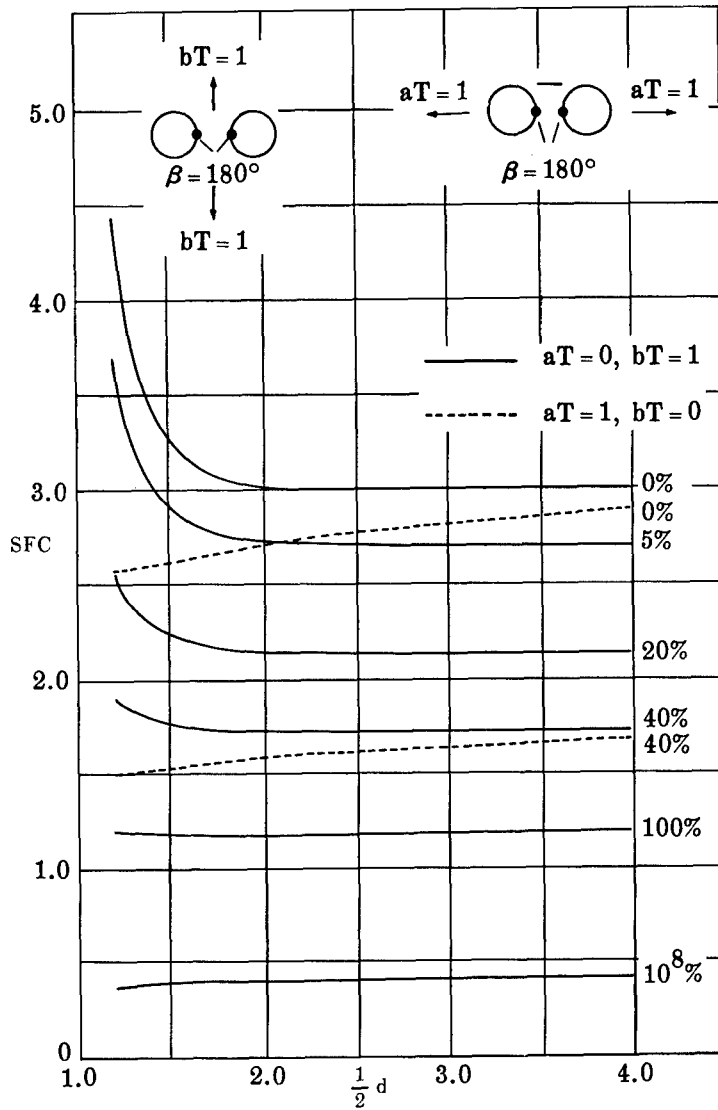

Figure 24 - Maximum Stress Concentration Factors for Various Amounts of Reinforcing as a Function of Spacing of Two Equal Circular Openings; See Figure 23 for Notation
 Courtesy Reference 13.

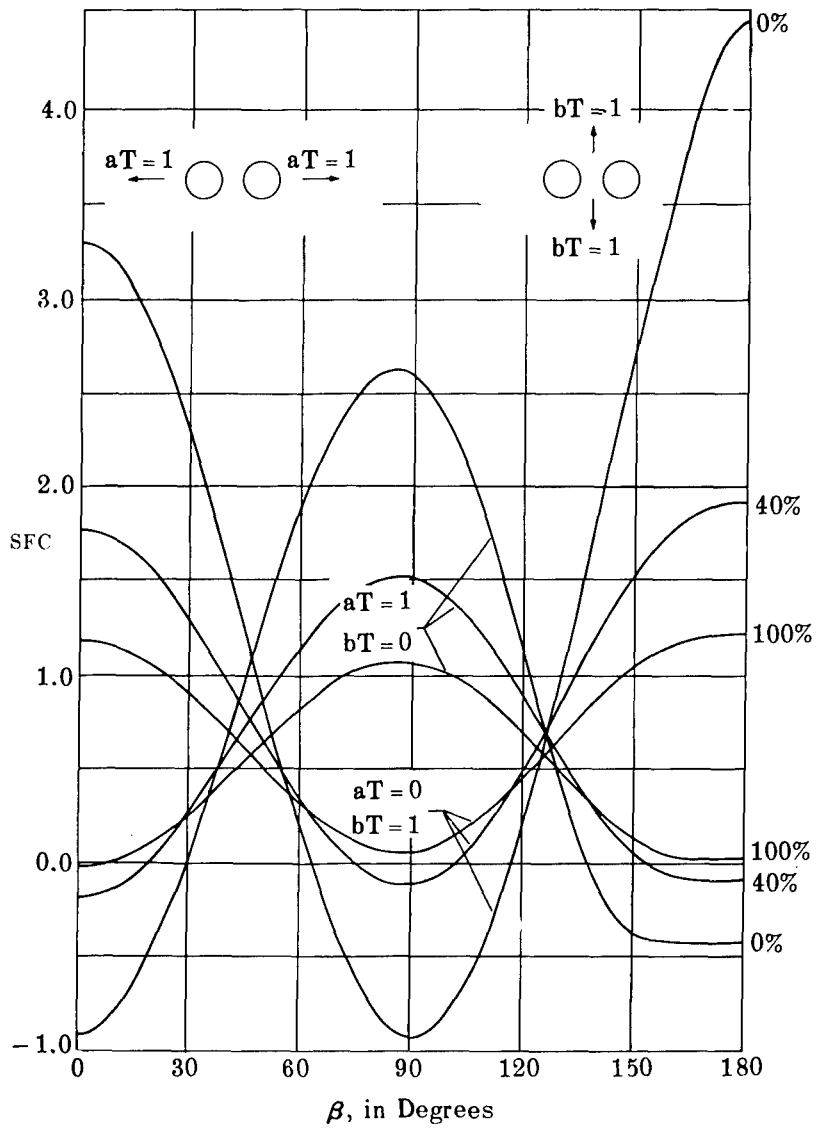

Figure 25 – Stress Distribution around Two Equal Circular Openings in Uniaxial Tension; See Figure 23 for Notation
 Courtesy Reference 13.

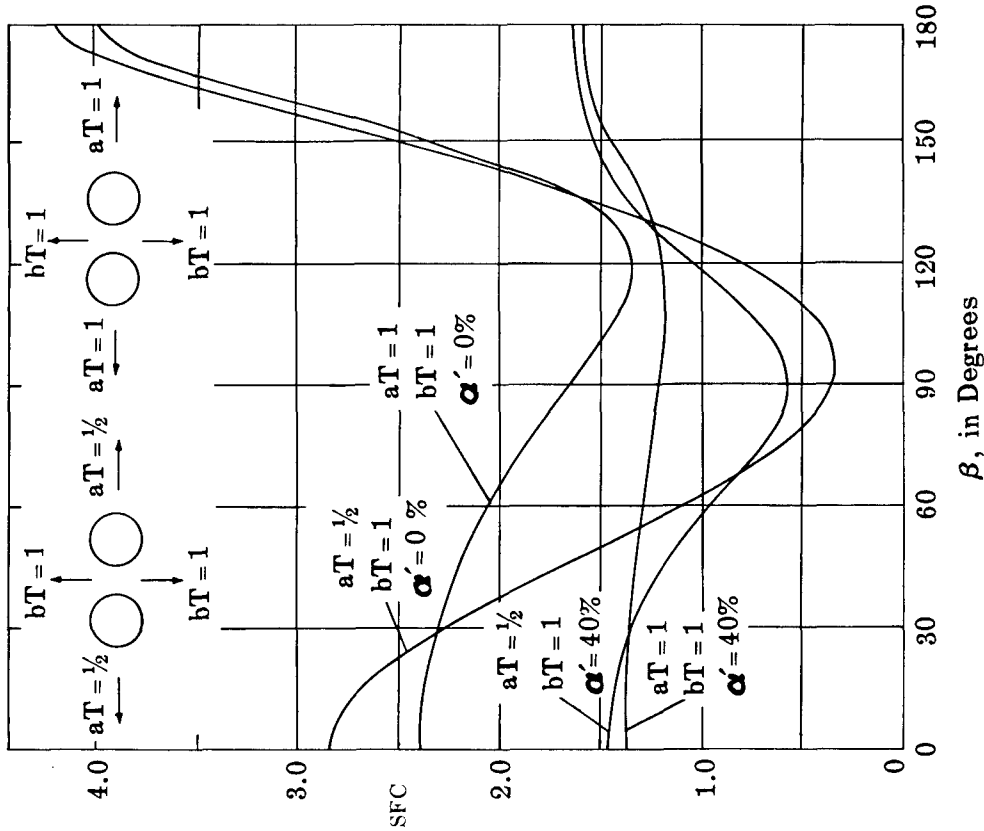

Figure 26 – Stress Distribution around Two Equal Circular Openings in Biaxial Tension; See Figure 23 for Notation

Courtesy Reference 13.

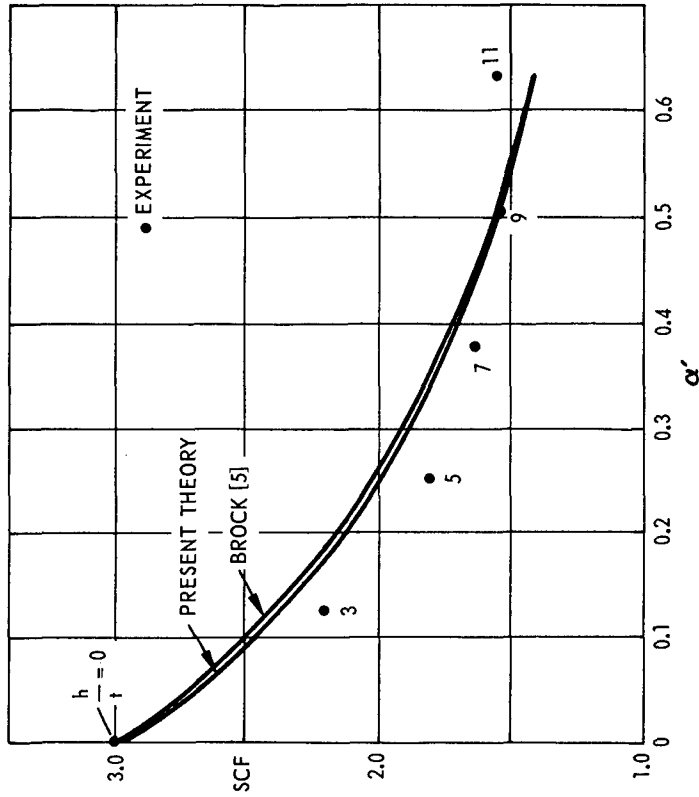

Figure 27 – Comparison of Maximum Stress Concentration Factor from Theory and Experiment for Two Equal Circular Openings; See Figure 23 for Notation

Courtesy Reference 13.

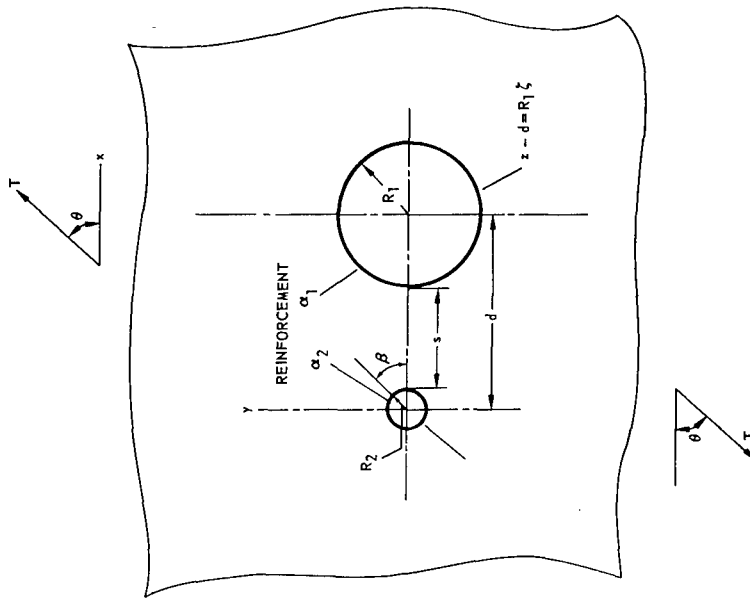

Figure 28 -- Notation and Geometry of Two Unequal Circular, Reinforced Openings

Courtesy Reference 15.

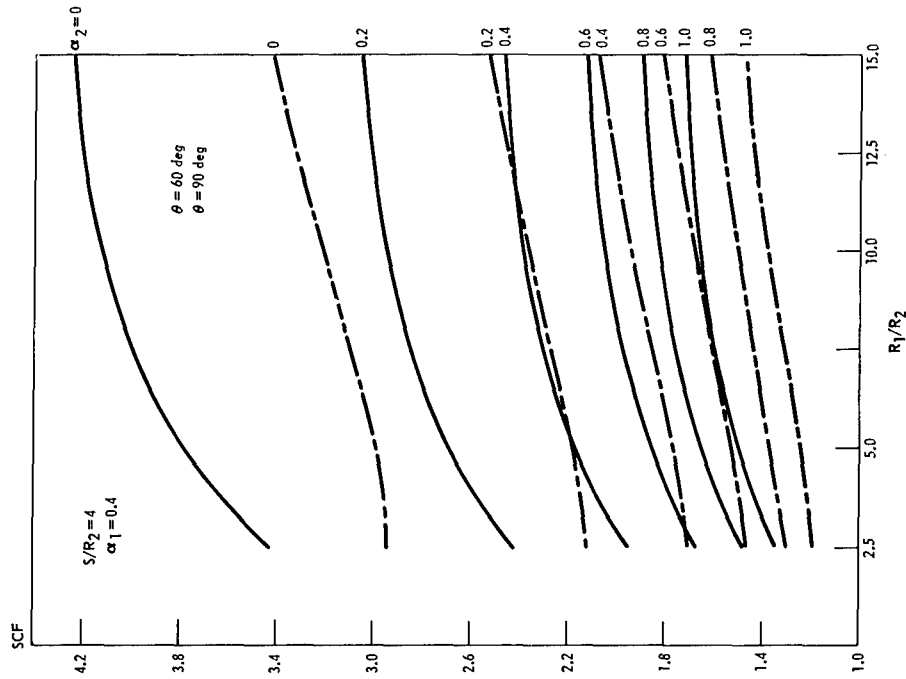

Figure 29 -- Stress Concentration Factors for a Pair of Unequal, Circular Openings as a Function of Hole Size; See Figure 28 for Notation

Courtesy Reference 15.

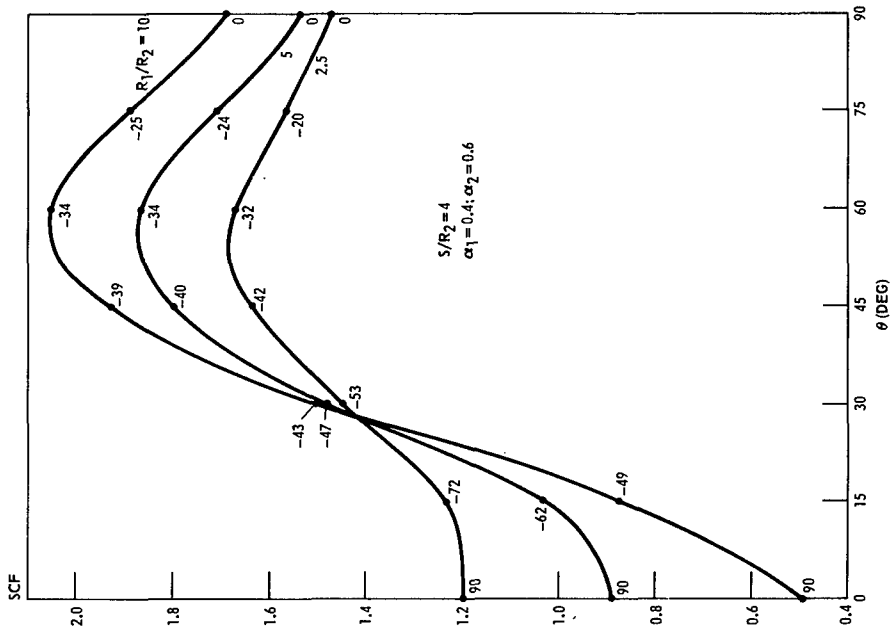

Figure 30 — Stress Concentration Factors for a Pair of Unequal, Circular Openings as a Function of Load Direction; See Figure 28 for Notation
Courtesy Reference 15.

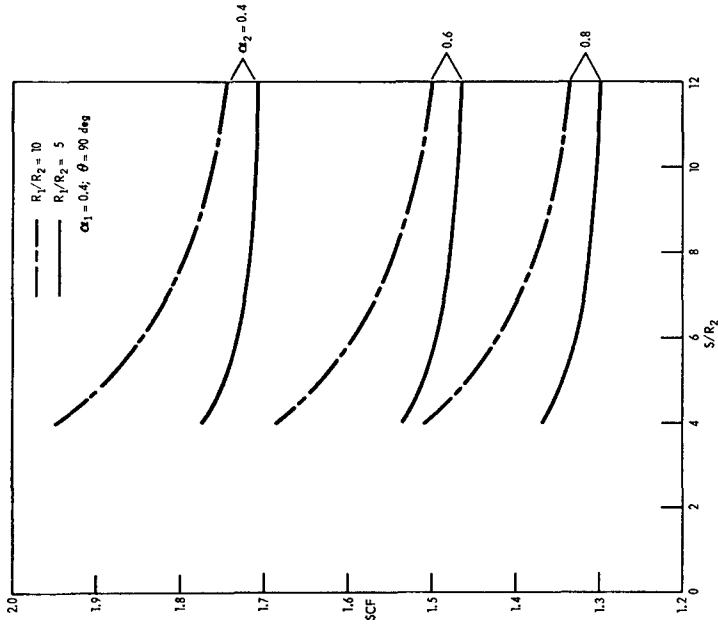

Figure 31 — Stress Concentration Factors for a Pair of Unequal, Circular Openings as a Function of Separation; See Figure 28 for Notation
Courtesy Reference 15.

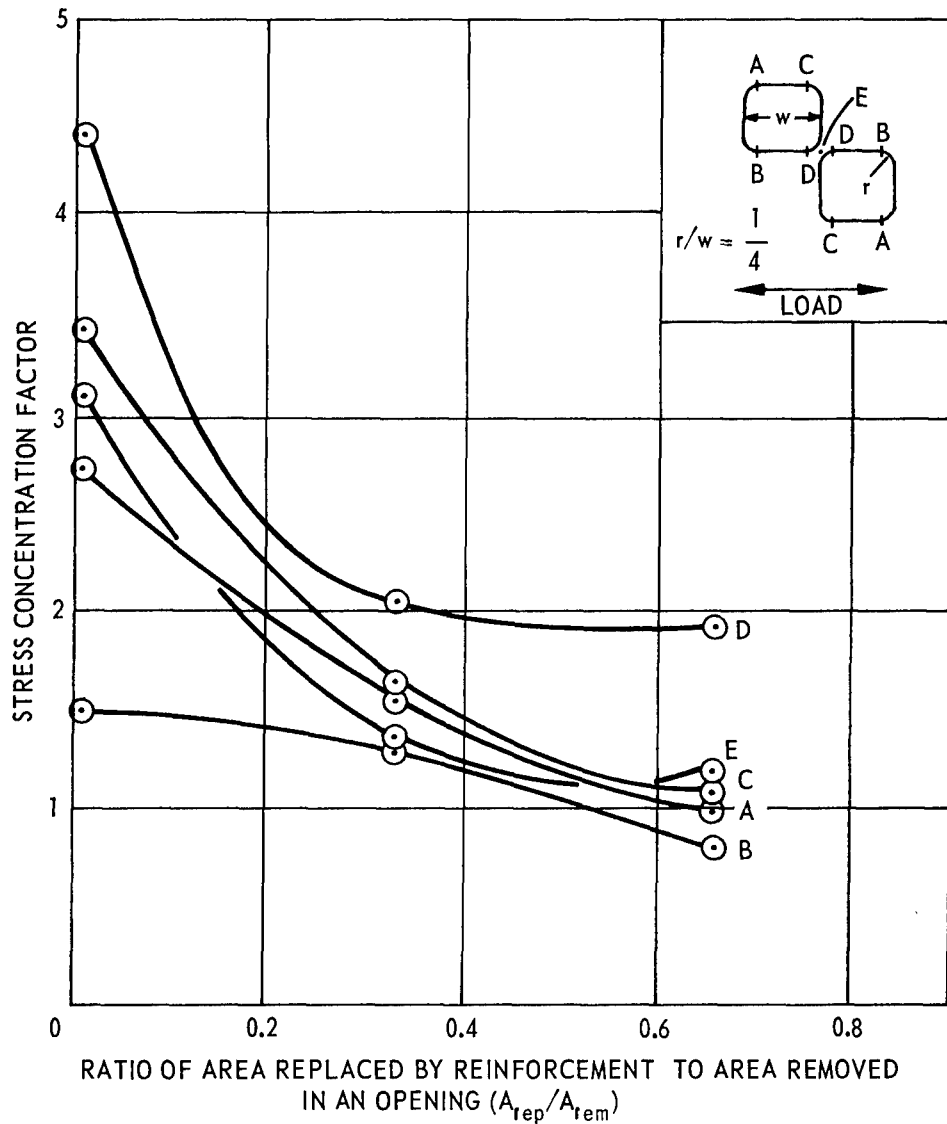

Figure 32 – Stress Concentration Factors for a Pair of Diagonally Adjacent Equal Square Openings as a Function of Reinforcement

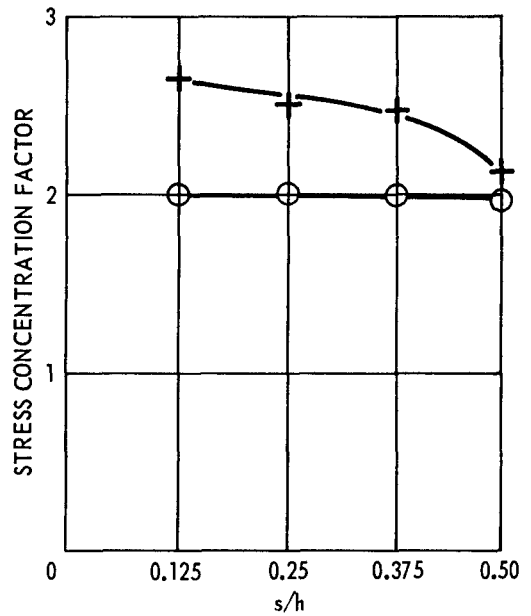
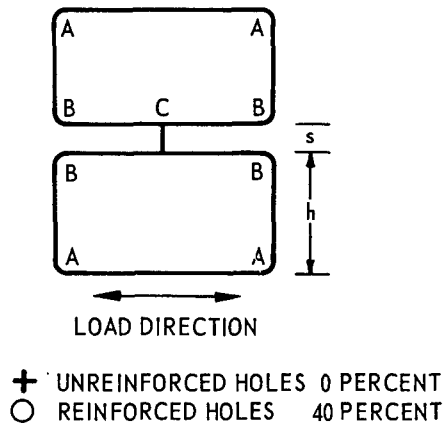

Figure 33a - Outside Corners

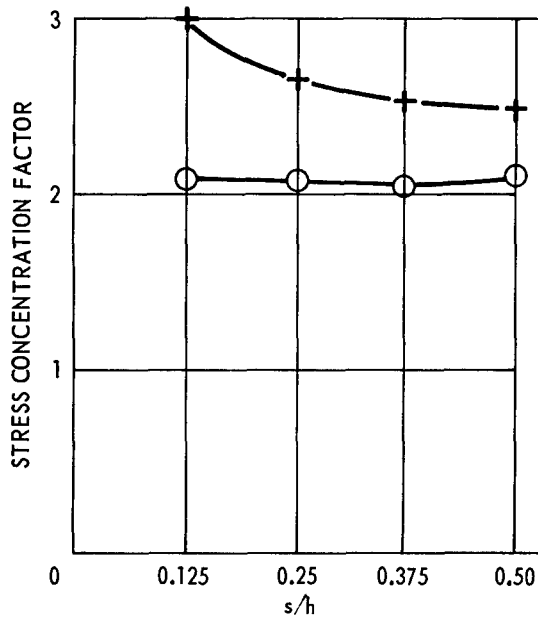

Figure 33b - Inside Corners

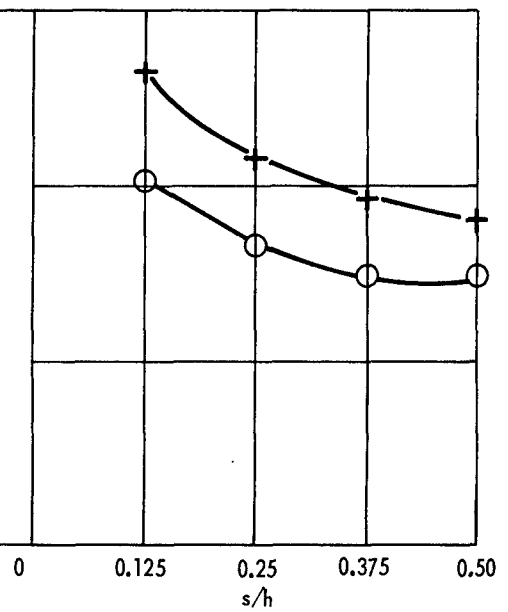

Figure 33c - Midpoints

Figure 33 - Stress Concentration Factors for a Pair of Equal Rectangular Openings as a Function of Hole Separation

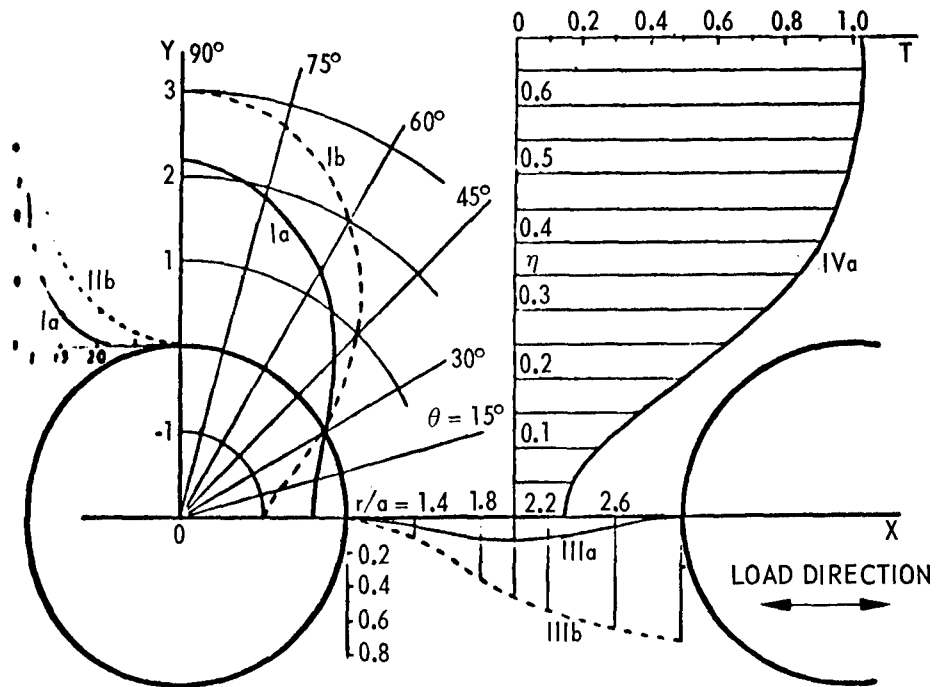

Figure 34a - Tension Parallel to Line of Centers

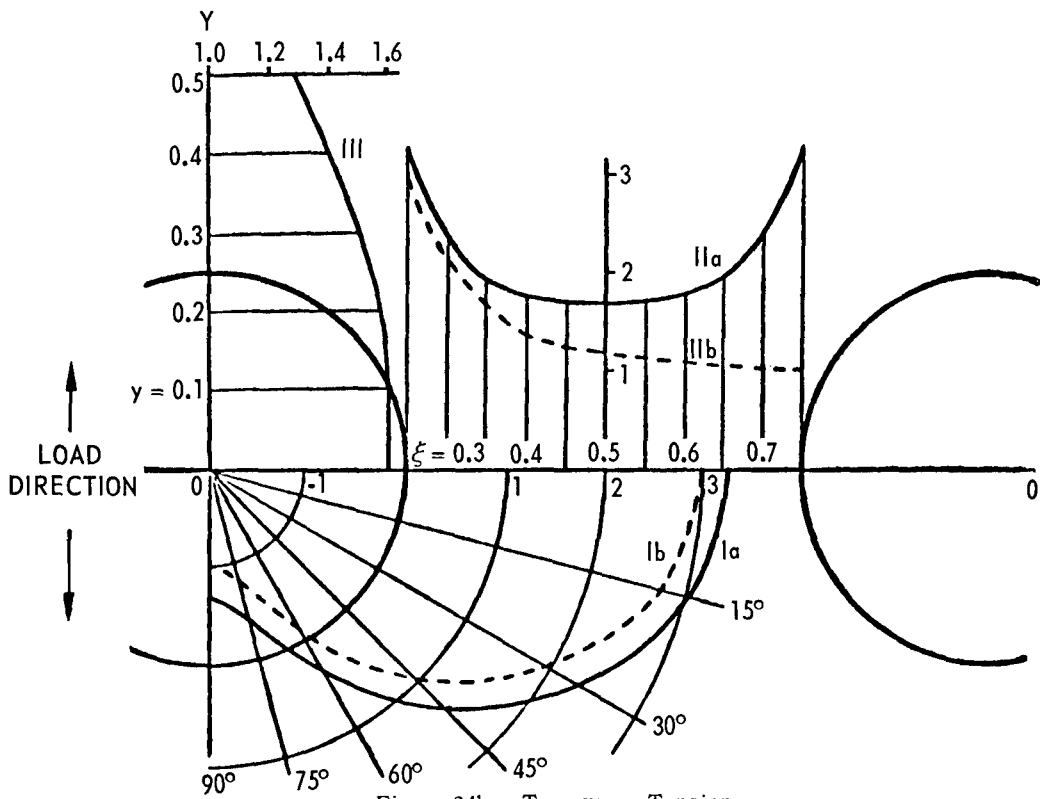
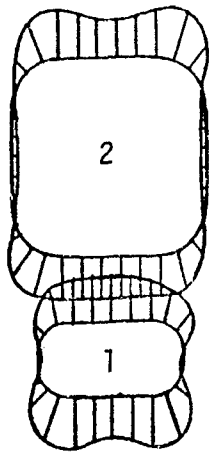

Figure 34b - Transverse Tension

Figure 34 - Stress Distribution around an Infinite Row of Circular Holes

Courtesy Reference 16.



TEST 1

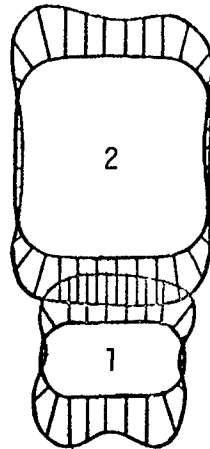

TEST 2

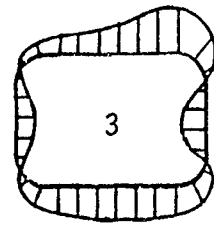

TEST 3

←→
LOAD DIRECTION

TENSION REPRESENTED BY SHADED
AREA OUTSIDE OF HOLE
COMPRESSION REPRESENTED BY
SHADED AREA WITHIN HOLE
SCALE: 0.1 INCH CORRESPONDS
TO SCF OF 1.0

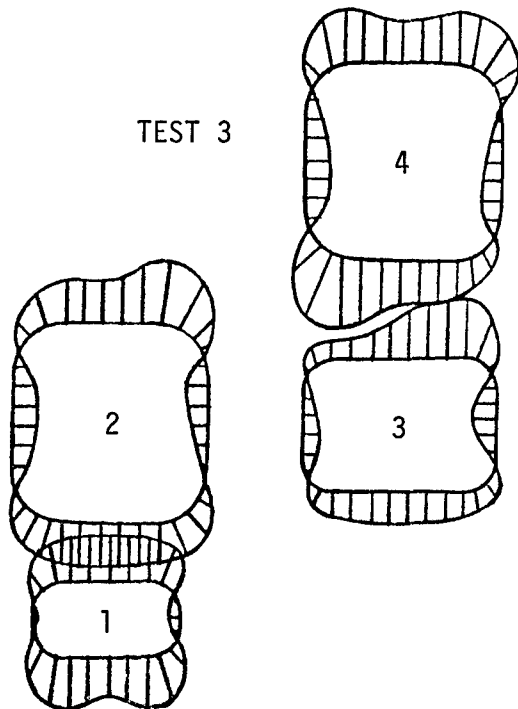

Figure 35 – Comparison of Stress Concentration Factors around a Cluster of Rectangular Openings on a Landing Craft

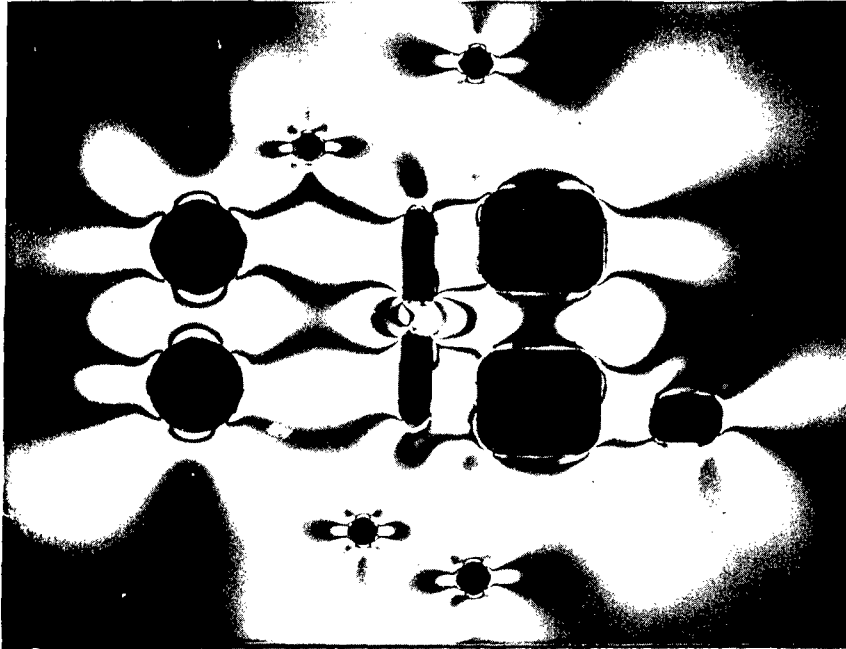

Figure 36a - Isochromatic Fringes

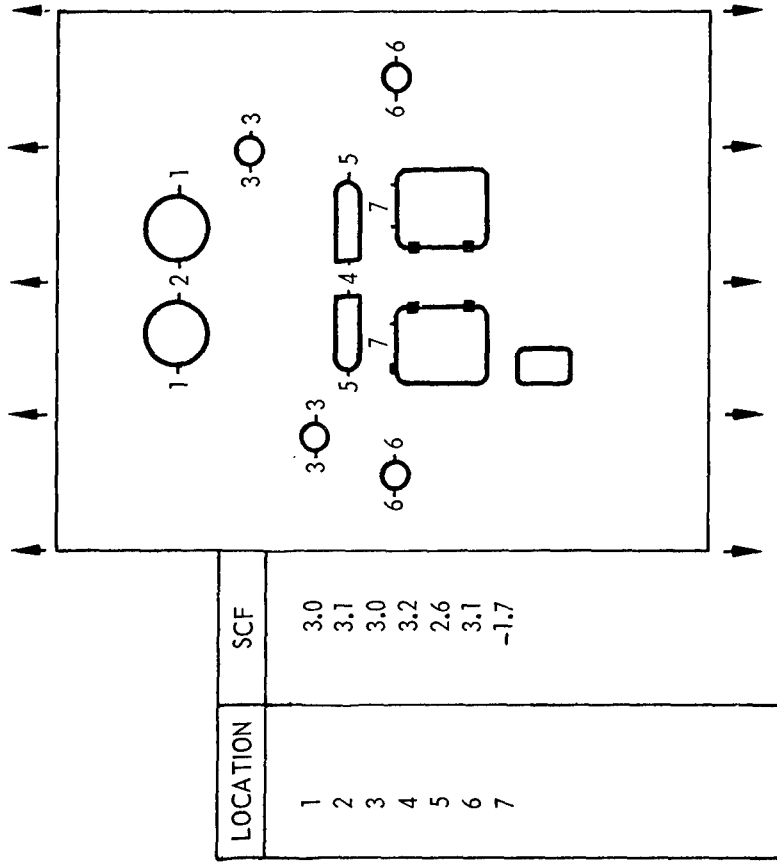

Figure 36b - Locations of Maximum Stress Concentration Factors

Figure 36 - Isochromatic Fringe Pattern around a Cluster of Openings on the AGEH PLAINVIEW
 Courtesy Reference 16.

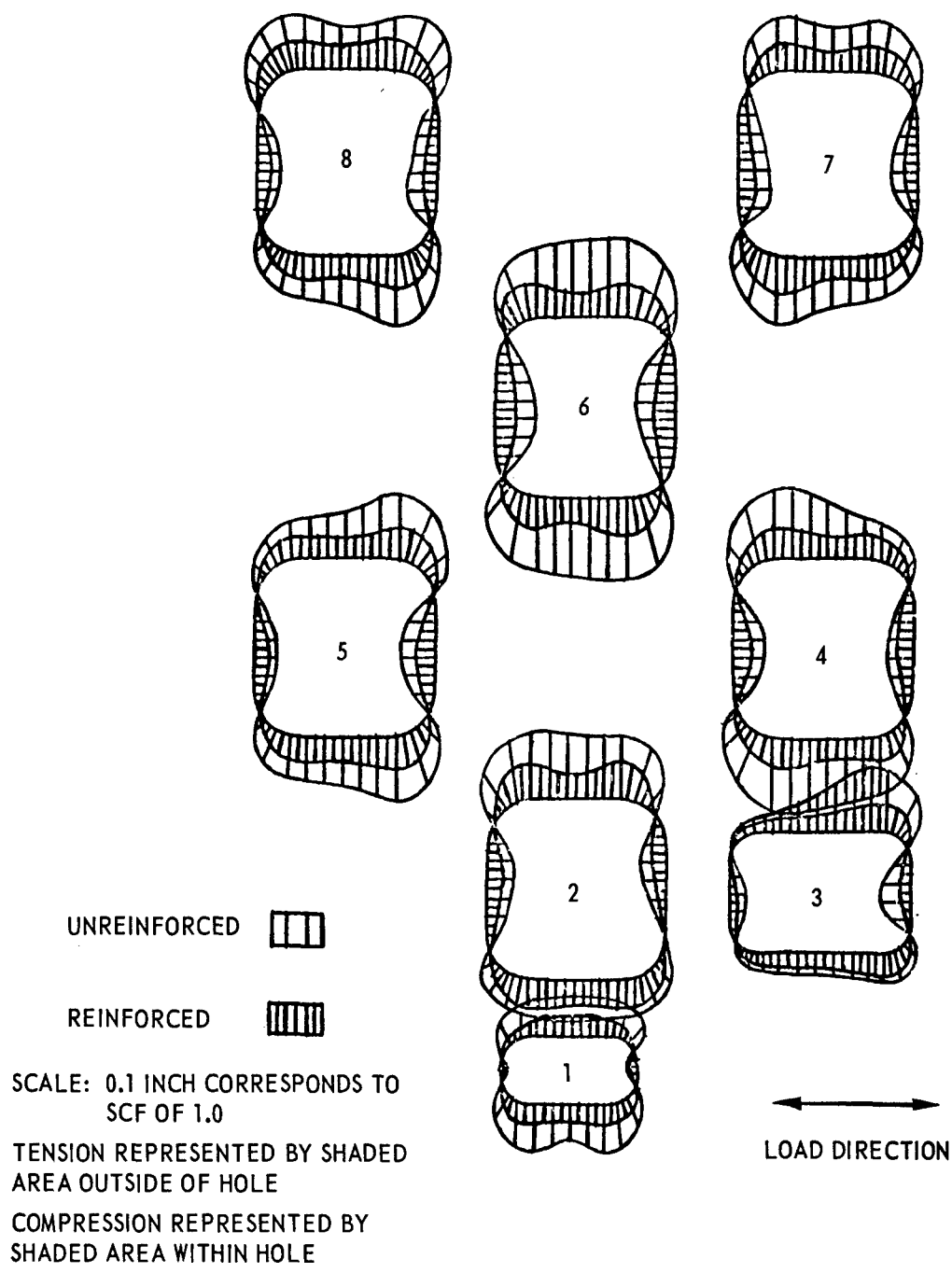

Figure 37 – Comparison of Stress Concentration Factors for Reinforced and Unreinforced Cluster of Openings on a Landing Craft

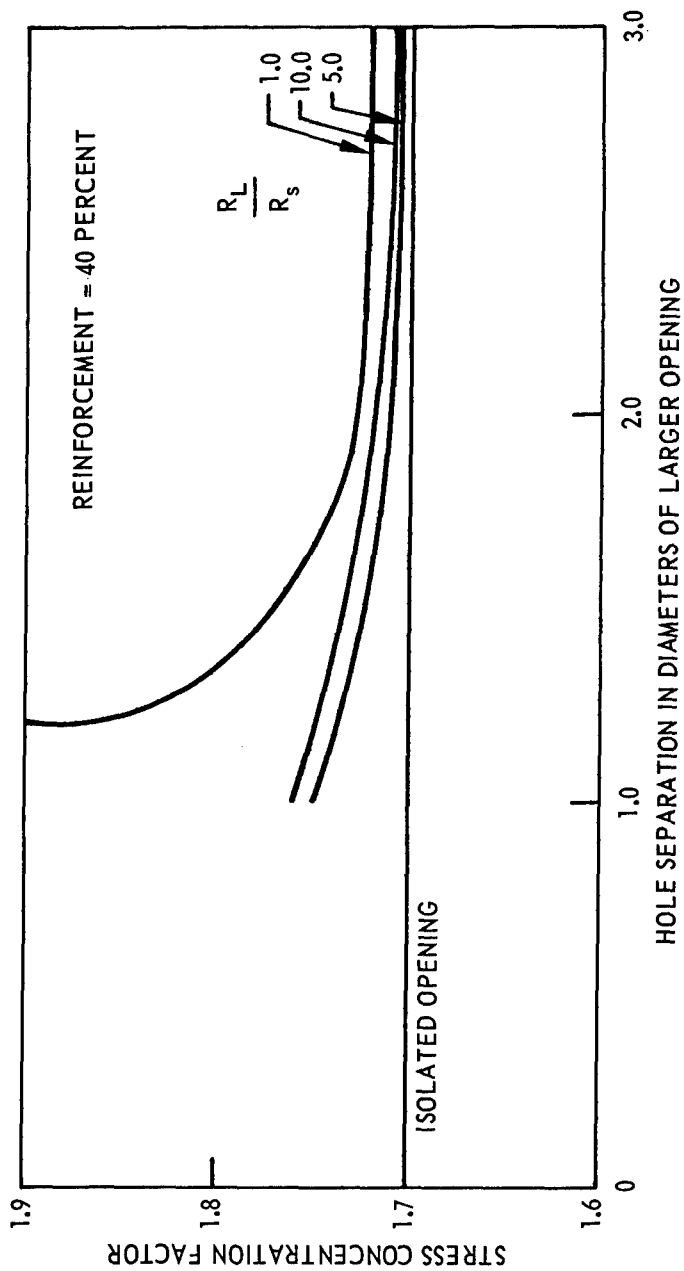

Figure 38 — Stress Concentration Factor for a Pair of Circular Openings as a Function of Separation

APPENDIX A

PHOTOELASTIC STUDIES

A series of photoelastic tests have been performed at the Naval Ship Research and Development Center to determine the stress concentrations around pairs and clusters of square and rectangular openings. Some of the details are presented in this appendix.

BACKGROUND

Photoelasticity is an optical method of stress analysis. Beams of polarized light produce colored fringe patterns in birefringent, transparent materials when subjected to various loads. These isochromatic fringes, contours of constant principal stress difference, are related to stress distribution by the stress optic law

$$\sigma_1 - \sigma_2 = \frac{NS}{t}$$

where σ_1 and σ_2 are principal stresses

N is the observed fringe order

S is a material constant and

t is the thickness of the material

Since the stress perpendicular to the boundary of an opening is zero at the boundary, the fringe order is directly related to the stress parallel to the boundary. Hence the stress optic law provides the maximum stress. The SCF is the ratio of the maximum stress in the model to the applied stress of the undisturbed region (that part of the model which is away from the openings). For unreinforced models the plate is of a uniform thickness, so the SCF = N/N_0 where N_0 is the fringe order in the undisturbed region. Due to the presence of reinforcing on the boundaries of openings, the SCF = $N/N_0 (t_0/t)$ where t_0 is the thickness of the undisturbed region and t is the thickness at the point of interest.

DESCRIPTION OF MODELS AND APPARATUS

All of the models consisted of 12- by 24-in. plates of CR-39 plastic in thicknesses of three-sixteenths and one-fourth inch. The openings were centered and kept small enough so that the plates could be considered infinite. A uniaxial tension load was applied to the models by means of loading trees which distributed 1000 lb of force over 16 pins at each end of the models. Figure 39 shows a typical model mounted in a load tree, supported in a frame, and placed in a transmission polariscope. The stress effects of the loading tree on the models were blended into a uniform fringe within 2 in. of the pins and thus presented no difficulties in the measurements. The CR-39 model material was a brittle material, which, even with careful machining, was subject to some edge chipping and residual machine stresses. Thus it was necessary to examine the unloaded models and to note the isochromatic fringes due to machining. These were subtracted from the test data so that all subsequent data would be free of machining stress errors.

RESULTS

An example of the isochromatic fringe pattern for the case of two rectangular openings loaded in uniaxial tension in a direction perpendicular to a line joining their centers is shown in Figure 40a. A reinforced version of this case is shown in Figure 40b. The results of these tests, in which the separation of the holes was varied, have been presented in Figures 18 and 33. Figure 41 shows the isochromatic fringes for a typical case of two rectangular openings loaded in a direction parallel to a line joining their centers. Figures 19 and 20 show the results of varying the hole separation for this series. The isochromatic fringe pattern for a typical case of two equal square holes with a common diagonal direction can be found in Figure 42a. A reinforced version of this case is shown in Figure 42b. The results of these tests have been presented in Figures 18 and 36. Examples of the isochromatic patterns for some clusters are presented in Figures 43a, 43b, and 43c. The case shown in Figure 43b of eight openings was produced by adding four openings to the case shown in Figure 43a. The case pictured in Figure 43c is a reinforced version of that shown in Figure 43b.

DISCUSSION

For the case pictured in Figure 40, it was found that as the separation between the holes decreased, the SCF's for the corners of the unreinforced models increased and the SCF's for the corners of the reinforced holes remained the same. The SCF's at the mid-points between the holes did increase as the separation decreased for both sets of models; however, they did not become higher than the SCF's at the corners for the hole separations studied. The addition of reinforcing rings, which replace 40 percent of the cross-sectional area of the material removed, reduces the maximum SCF's from 14 to 30 percent as the separation between the holes is decreased. Adjacent holes which are reinforced may be designed so that their separation is as little as 0.125 times the width of the holes without considering their interaction at the corners of the holes.

It is shown that the maximum stress concentrations around two rectangular adjacent openings (Figure 41) can be reduced by 20 percent when their aspect ratios are increased from one to one and a half. Little reductions in stress concentrations are obtained by further increasing the aspect ratios.

The maximum stresses around the two openings of Figure 42 were found to decrease by one-half when reinforced by 33 percent of the area of the opening. The stress concentrations were found to double when the radius of curvature of the corners was reduced from one-fourth to one-eighth of the length of the opening.

The following conclusions can be drawn from the cases shown in Figure 43. The maximum stress concentration in a cluster of small holes occurs at the near corners of two diagonally adjacent square holes when the load line is 45 deg from the common diagonal. The cluster of small reinforced holes (Figure 43c) exhibited approximately 25 percent less maximum stress than a single large rectangular opening of comparable area would have.

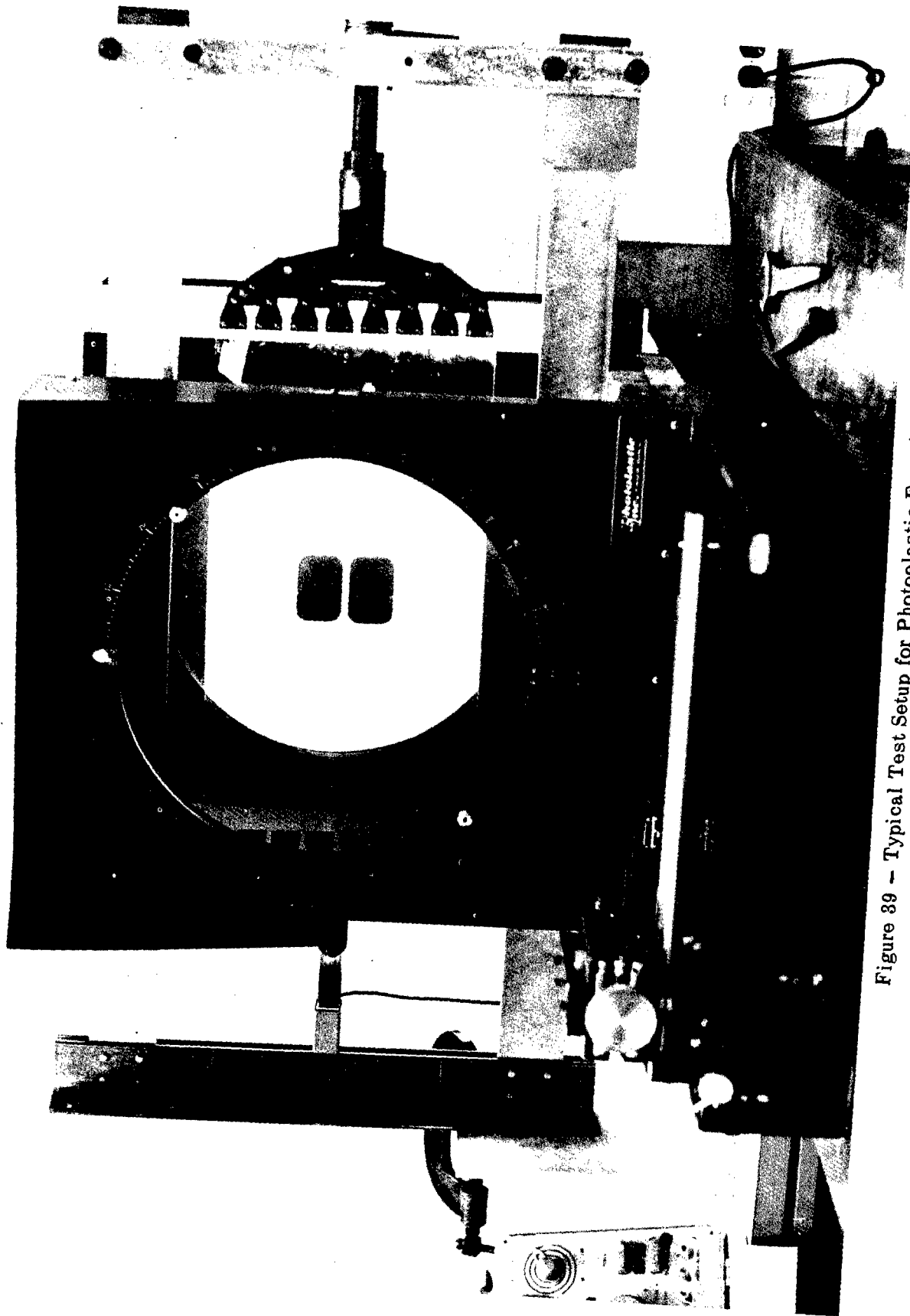

Figure 89 - Typical Test Setup for Photoelastic Experiments

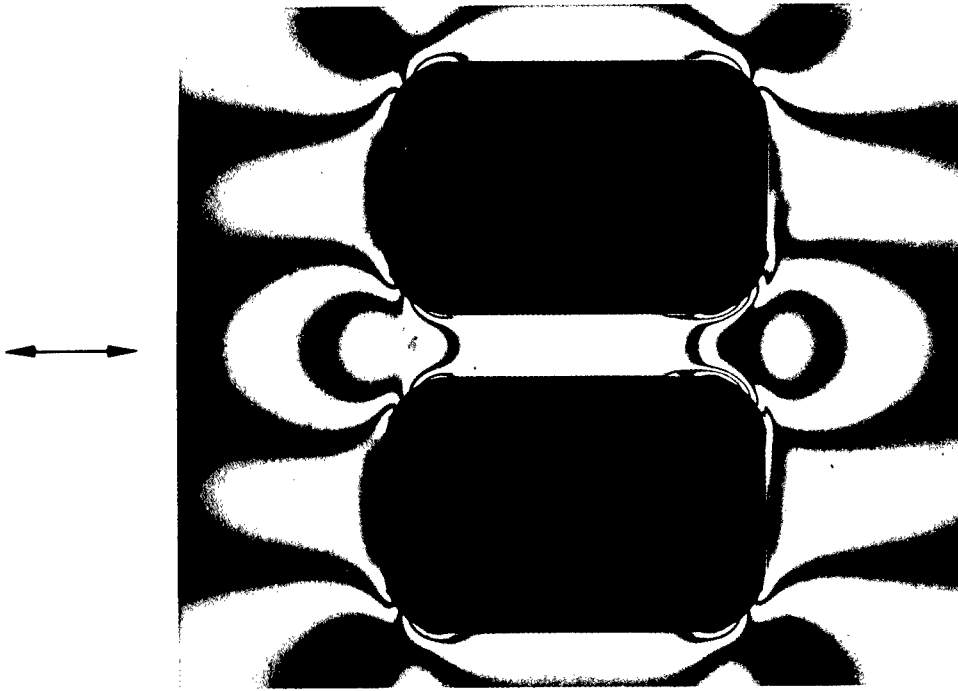

Figure 40a - Unreinforced

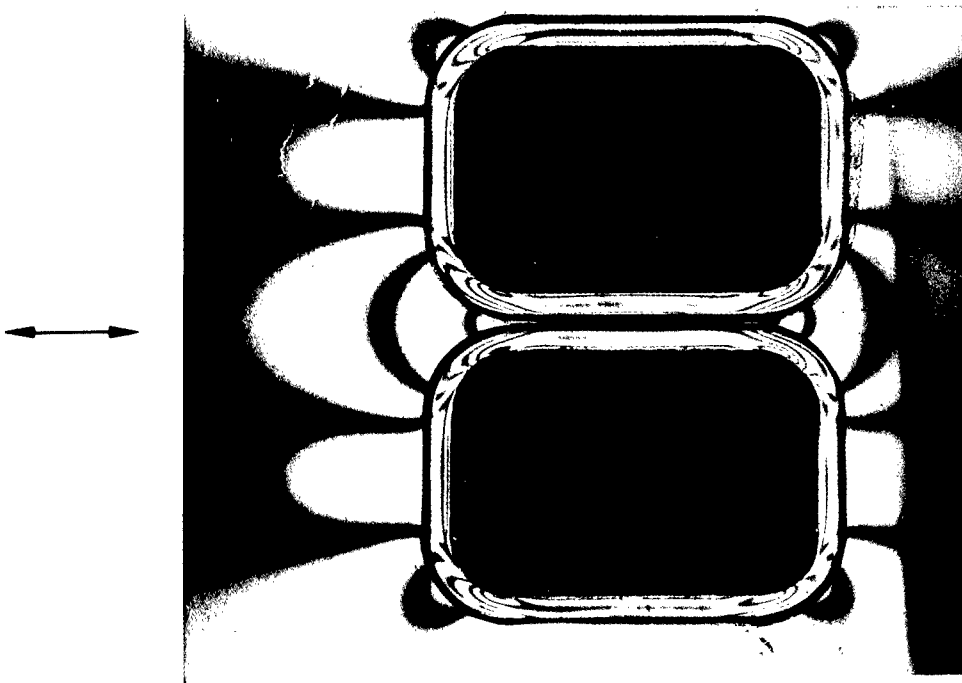

Figure 40b - Reinforced

Figure 40 - Isochromatic Fringe Pattern of a Pair of Rectangular Openings, Perpendicular Pull

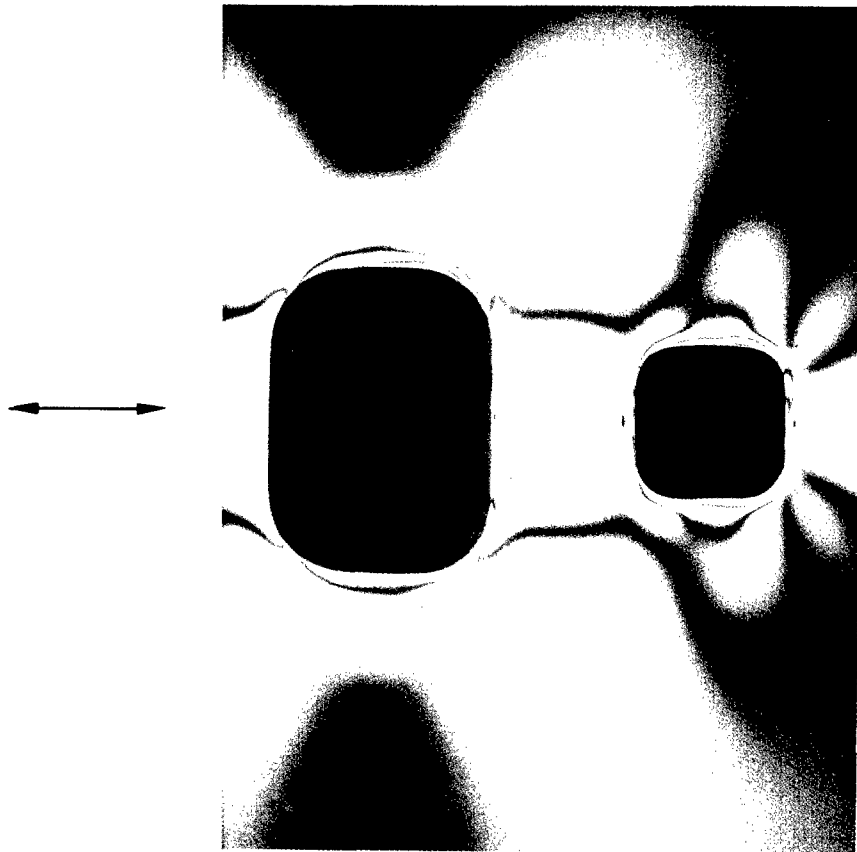

Figure 41 – Isochromatic Fringe Pattern of a Pair of Rectangular Openings, Parallel Pull

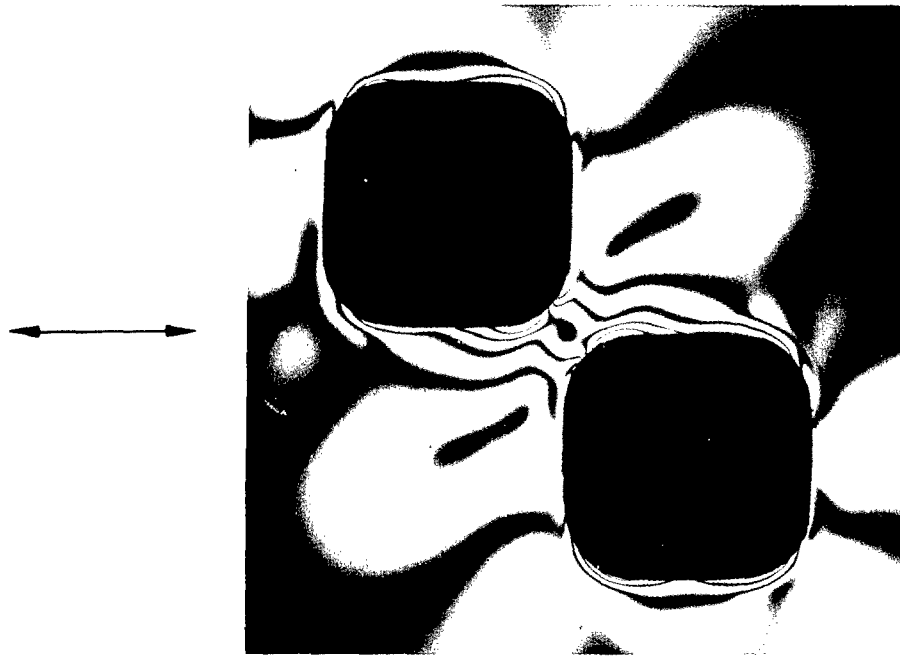

Figure 42a - Unreinforced



Figure 42b - Reinforced

Figure 42 - Isochromatic Fringe Pattern of a Pair of Diagonally Adjacent Square Openings

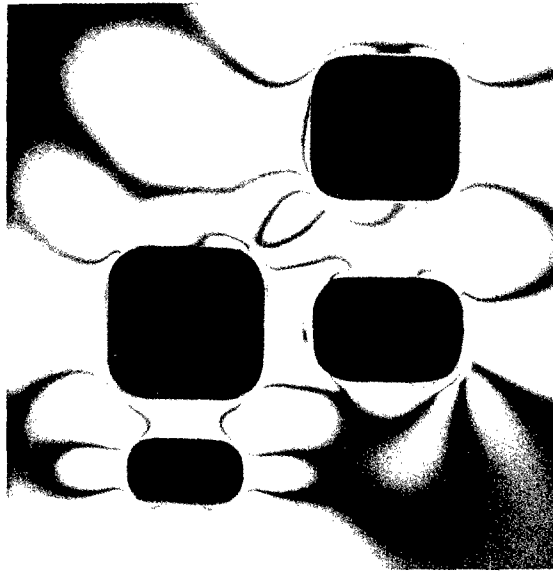

Figure 43a - Four Holes Unreinforced

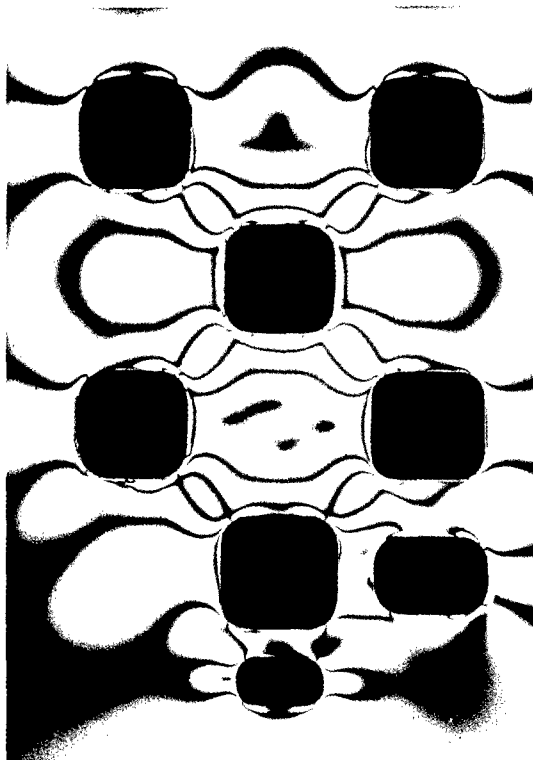

Figure 43b - Eight Holes Unreinforced

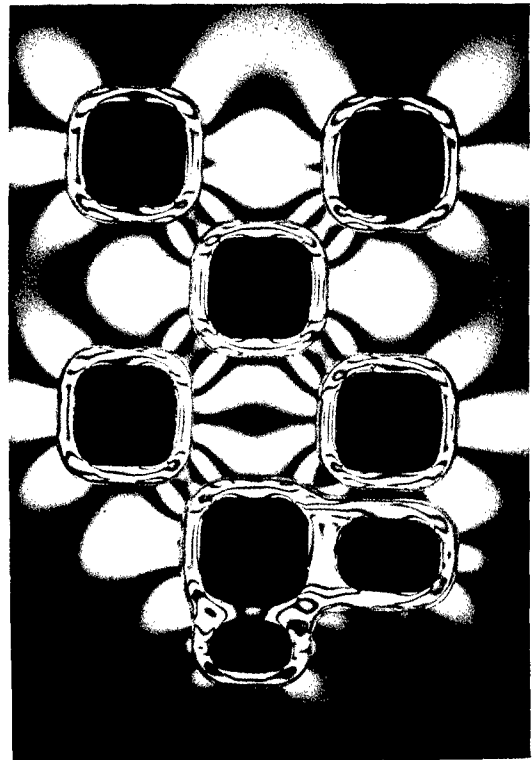

Figure 43c - Eight Holes Reinforced

Figure 43 - Isochromatic Fringe Pattern of a Cluster of Openings

REFERENCES

1. Zwenig, E.A., "Bibliography of Stress Concentration with Emphasis on Structural Openings in Ship," NSRDC Report 2516 (Jun 1968).
2. D'Arcangelo, A.M., "A Guide to Sound Ship Structures," Cornell Maritime Press, Cambridge, Md. (1964).
3. Brock, J.S., "The Stresses Around Square Holes with Rounded Corners," *Journal of Ship Research* (Oct 1958).
4. Brock, J.S., "Analytical Determination of the Stresses Around Square Holes with Rounded Corners," David Taylor Model Basin Report 1149 (Nov 1957).
5. Muskhelishvili, N. I., "Some Basic Problems of the Mathematical Theory of Elasticity," Third Revised Edition, Translated from the Russian by J.R.M. Radok, P. Noordhoff, Ltd., Groningen, Netherlands (1953).
6. Heller, S.R., "Stress Concentration Factors for a Rectangular Opening with Rounded Corners in a Biaxially Loaded Plate," *Journal of Ship Research* (Sep 1969).
7. Dhir, S.K. and J.S. Brock, "A New Method of Reinforcing a Hole Effecting Large Weight Savings," *International Journal Solids Structures*, Vol. 6 (1970).
8. Ling, C.B., "On the Stresses in a Plate Containing Two Circular Holes," *Journal of Applied Physics* (Jan 1948).
9. Borg, M.F., "Maximum Stress Concentration Factors Caused by Two Equal Circular Holes in a Plate Subjected to Uniform Axial Loading," David Taylor Model Basin Report 907 (Sep 1957).
10. Haddon, R.A., "Stresses in an Infinite Plate with Two Unequal Circular Holes," *Quarterly Journal of Mechanics and Applied Mathematics* (Aug 1967).
11. Dhir, S.K., "Stresses Around Two Adjacent Unequal Circular Holes Under Biaxial Loads," NSRDC Report 3367 (Jul 1970).
12. Dhir, S.K., "Stresses Around Two Openings of General Shape," *Journal of Ship Research* (Dec 1970).
13. Dhir, S.K., "Analytical Determination of the Stresses Around Two Equal Reinforced Circular Openings in a Thin Plate," NSRDC Report 2554 (Mar 1969).
14. Dhir, S.K., "Stresses Around Two Equal Reinforced Circular Openings in a Thin Plate," *International Journal Solids Structures*, Vol. 4 (1968).
15. Dhir, S.K., "Stresses Around Two Reinforced Openings of General Shape," NSRDC Report 3768 (Jan 1972).
16. Howland, R.C.J., "Stresses in a Plate Containing an Infinite Row of Holes," *Proceedings of Royal Society (London)* (1935).
17. Dhir, S.K. et al., "Stress Analysis of the Openings in the 0-1 Deck of AGEH Hydrofoil," NSRDC Report 3682 (Oct 1971).
18. Brock, J.S., "The Stresses Around Small Openings in the Vicinity of the Large Side Openings of the CVA 59-Class Aircraft Carrier," NSRDC Report 2014 (Jun 1965).

INITIAL DISTRIBUTION

Copies

1 DDR & E
Attn: Mr. Peterson

1 ARPA

3 CNO
1 OP 098T
1 OP 0983
1 OP 03

2 CHONR
1 Code 439
1 Code 459

1 DNL

2 CHNAVMAT
1 MAT 03T
1 MAT 034

1 NRL
Tech Lib

1 USNA
Attn: Lib

1 NAVPGSCOL
Attn: Lib

1 USNROTC & NAVADMINU, MIT

1 NAVWARCOL

7 NAVSHIPSYSKOM
2 SHIPS 2052
1 SHIPS 031
1 SHIPS 0342
1 SHIPS 034
2 SHIPS 034-12

3 NAVAIRSYSKOM
1 Aero & Hydro Br (Code 5301)
1 Str Br (Code 5302)
1 Eng Div (Code 520)

1 NAVORDSYSKOM
ORD 913

2 NAVAIRDEVCOM
1 Aero Str. Dept (Code ST)
1 Expl. Dev (Code STD)

1 NELC
Attn: Mr. D. Washburn

Copies

1 NAVUSEACEN
Attn: Mr. C. Miller (D602)

2 NAWPNSCEN
1 Code 556
1 Code 5056

1 NOL
Code 730

1 NLONLAB, NUSC

1 NAVSHIPYD BSN

1 NAVSHIPYD BREM

1 NAVSHIPYD CHASN

1 NAVSHIPYD LBEACH

1 NAVSHIPYD NORVA

1 NAVSHIPYD PEARL

1 NAVSHIPYD PTSMH

1 NAVSHIPYD SFRANBAY VJO

1 SUPSHIP 13th Nav Dis (Code 6233D)

12 NAVSEC
4 SEC 6110
1 SEC 6115
1 SEC 6120
1 SEC 6128
1 SEC 6132
1 SEC 6139
1 SEC 6137
1 SEC 6101
1 SEC 6114D

1 NAVAIRENGCEN

1 Commander
Mechanics Div
Air Force Office of Sci Research
Washington, D.C. 20333

1 Commander
Chief Applied Mechanics Grp Tech Lib
W-PAFB, Dayton, Ohio 45433

12 DDC

Copies

- 2 U.S. COGARD
1 Ch Testing & Dev Div
1 Ship Structures Comm
- 1 Lib of Congress
Science & Tech Div
- 2 MARAD
1 Ch Div of Ship Design
1 Off of Res & Dev
- 1 Nat'l Science Foundation
Engr Div
1951 Constitution Ave., N.W.
Washington, D.C. 20550
- 1 Director Dept of Naval Arch
College of Engr
Univ of Calif
Berkeley, Calif 94720
- 1 Catholic Univ
Washington, D.C.
Attn: Prof S.R. Heller, Jr.
- 1 Director
Iowa Inst of Hydraulic Res
Univ of Iowa
Iowa City, Iowa
- 1 Dept of Mechanics
Lehigh Univ
Bethlehem, Pa 18015
- 1 MIT, Dept of Ocean Eng
Cambridge, Mass 02139
- 1 The Univ of Michigan
Dept of NAME
Ann Arbor, Mich 48105
- 1 Univ of Minnesota
St. Anthony Falls Hydraulic Lab
Minneapolis, Minn 55414
- 1 SWRI
8500 Culebra Rd.
San Antonio, Texas 78228
- 1 Director, Davidson Lab SIT
711 Hudson St
Castle Pt. Station
Hoboken, N.J. 07030

Copies

- 1 Virginia Polytechnic Institute and
State University
Dept of Engineering Mechanics
Blacksburg, Virginia 24061
Attn: Prof. C.W. Smith
- 1 Ship Hull Research Committee
Nat'l Research Council
Nat'l Academy of Sciences
2101 Constitution Ave
Washington, D.C. 20418
- 1 Secretary SNAME
Slamming Panel
74 Trinity Place
New York, New York 10006
- 1 American Bureau of Shipping
45 Broad Street
New York, N.Y. 10004
Attn: S.G. Stiansen
- 1 The Boeing Co., Aerospace Grp
P.O. Box 3999
Seattle, Wash. 98124
- 1 Gibbs & Cox Inc.
21 West Street
New York, N.Y. 10006
- 1 Grumman Aerospace Corp
Bethpage, Long Island
New York 11714
- 1 President, Hydronautics Inc.
Pindel School Rd.
Laurel, Md. 20810

CENTER DISTRIBUTION

Copies	Code	Name	Copies	Code	Name
1	11	Mr. W. M. Ellsworth	1	1703	Mr. J. Bader
1	115	Dr. D. A. Jewell	1	172	Mr. M. Krenzke
1	1151	Mr. W. C. O'Neill	1	173	Mr. A. Stavovy
1	1153		1	1731	Mr. G. Thomas
1	1154	LCDR H. Schmidt	1	1735	
1	117	Mr. R. M. Stevens	1	174	Mr. R. Short
1	118	Mr. M. W. Brown	1	177	Dr. H. Schauer
1	1181	LTJG K. Wilson	1	178	Mr. L. Becker
1	1182	Mr. Z. G. Wachnik	1	18	Mr. G. H. Gleissner
1	15	Dr. W. E. Cummins	1	1844	Dr. S. Dhir
1	156	Mr. J. Hadler	1	19	Dr. M. M. Sevik
1	16	Dr. H. R. Chaplin	1	196	
1	161	Mr. R. L. Schaeffer	1	1962	Mr. A. Zaloumis
1	163	Mr. A. G. Ford	1	1966	Mr. S. E. Lee
1	17	Dr. W. W. Murray	1	27	Mr. H. V. Nutt
			1	28	Mr. D. H. Kallas

UNCLASSIFIED

Security Classification

DOCUMENT CONTROL DATA - R & D

(Security classification of title, body of abstract and indexing annotation must be entered when the overall report is classified)

1. ORIGINATING ACTIVITY (Corporate author) Naval Ship Research and Development Center Bethesda, Maryland 20034		2a. REPORT SECURITY CLASSIFICATION UNCLASSIFIED	
		2b. GROUP	
3. REPORT TITLE A SUMMARY OF STRESS CONCENTRATIONS IN THE VICINITY OF OPENINGS IN SHIP STRUCTURES			
4. DESCRIPTIVE NOTES (Type of report and inclusive dates)			
5. AUTHOR(S) (First name, middle initial, last name) Jerome P. Sikora			
6. REPORT DATE March 1973		7a. TOTAL NO. OF PAGES 51	7b. NO. OF REFS 18
8a. CONTRACT OR GRANT NO.		9a. ORIGINATOR'S REPORT NUMBER(S) 3889	
b. PROJECT NO. S-F422 310, Task 15071			
c.		9b. OTHER REPORT NO(S) (Any other numbers that may be assigned this report)	
d.			
10. DISTRIBUTION STATEMENT Approved for Public Release: Distribution Unlimited			
11. SUPPLEMENTARY NOTES		12. SPONSORING MILITARY ACTIVITY Naval Ship Systems Command (SHIPS 0342)	
13. ABSTRACT A summary of stress concentration studies has been provided for the case of single and multiple openings in plate structures. This report summarizes some published theoretical studies as well as some previously unpublished photoelastic studies performed at the Center. Also included are comments for modifications of the design criteria currently used for openings on ships.			

UNCLASSIFIED

Security Classification

UNCLASSIFIED

Security Classification

14. KEY WORDS	LINK A		LINK B		LINK C	
	ROLE	WT	ROLE	WT	ROLE	WT
Stress Concentrations Openings						