

AFFDL-TR-71-144

AD 745130

**FILAMENT COMPOSITE WHEEL
DEVELOPMENT FOR MILITARY AIRCRAFT**

A. L. PRICE

**WHITTAKER CORPORATION
RESEARCH AND DEVELOPMENT DIVISION**

TECHNICAL REPORT AFFDL-TR-71-144

OCTOBER 1971

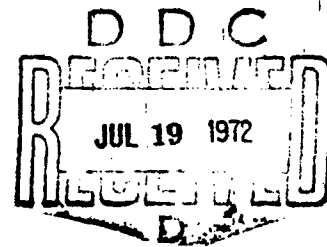

Approved for public release; distribution unlimited.

Reproduced by
**NATIONAL TECHNICAL
INFORMATION SERVICE**
U S Department of Commerce
Springfield VA 22151

**AIR FORCE FLIGHT DYNAMICS LABORATORY
AIR FORCE SYSTEMS COMMAND
WRIGHT-PATTERSON AIR FORCE BASE, OHIO 45433**

NOTICE

When Government drawings, specifications, or other data are used for any purpose other than in connection with a definitely related Government procurement operation, the United States Government thereby incurs no responsibility nor any obligation whatsoever; and the fact that the government may have formulated, furnished, or in any way supplied the said drawings, specifications, or other data, is not to be regarded by implication or otherwise as in any manner licensing the holder or any other person or corporation, or conveying any rights or permission to manufacture, use, or sell any patented invention that may in any way be related thereto.

REG. SECTION	<input checked="" type="checkbox"/>
DUPP SECTION	<input type="checkbox"/>
REG.	<input type="checkbox"/>
.....	
.....	
DISTRIBUTION/AVAILABILITY CODES	
DIST.	AVAIL. AND SPECIAL
A	

Copies of this report should not be returned unless return is required by security considerations, contractual obligations, or notice on a specific document.

Unclassified

Security Classification

DOCUMENT CONTROL DATA - R & D		
<i>(Security classification of title, body of abstract and indexing annotation must be entered when the overall report is classified)</i>		
1. ORIGINATING ACTIVITY (Corporate author) Whittaker Corporation Research and Development Division San Diego, California 92123		2a. REPORT SECURITY CLASSIFICATION Unclassified
		2b. GROUP
3. REPORT TITLE Filament Composite Wheel Development for Military Aircraft		
4. DESCRIPTIVE NOTES (Type of report and inclusive dates) Final Report (22 October 1970 - 13 August 1971)		
5. AUTHOR(S) (First name, middle initial, last name) Audie L. Price		
6. REPORT DATE October, 1971	7a. TOTAL NO. OF PAGES 19	7b. NO. OF REFS -
8a. CONTRACT OR GRANT NO.	9a. ORIGINATOR'S REPORT NUMBER(S) MJO 3025	
b. PROJECT NO.	9b. OTHER REPORT NO(S) (Any other numbers that may be assigned this report) AFFDL-TR-71-144	
c.		
d.		
10. DISTRIBUTION STATEMENT Approved for public release; distribution unlimited		
11. SUPPLEMENTARY NOTES -	12. SPONSORING MILITARY ACTIVITY Air Force Flight Dynamics Laboratory Air Force Systems Command Wright-Patterson AFB, Ohio	
13. ABSTRACT A program was conducted wherein a fibrous graphite/epoxy aircraft wheel was designed, fabricated and delivered to the Air Force for testing. The composite wheel was fabricated using continuous fibers laid up on a male mold with multiple autoclave staging. The material was applied in broadgood patterns by hand and in continuous forms by filament winding. The completed layup was machined to proper configuration.		

DD FORM 1 NOV 65 1473

1a

Unclassified

Security Classification

Unclassified
Security Classification

14. KEY WORDS	LINK A		LINK B		LINK C	
	ROLE	WT	ROLE	WT	ROLE	WT
Aircraft Wheel Design						
Fabrication Processes for Composite Materials						
Aircraft Wheels						
Composite Materials						
Graphite/Epoxy Fibers						
Filament Winding						

**FILAMENT COMPOSITE WHEEL
DEVELOPMENT FOR MILITARY AIRCRAFT**

BY

A. L. PRICE

**WHITTAKER CORPORATION
RESEARCH AND DEVELOPMENT DIVISION**

Approved for public release; distribution unlimited.

ie

FOREWORD

This record covers activities performed by Whittaker Corporation, Research and Development Division, San Diego, Calif., under Air Force contract No. AF33615-71-C-1089, "Filament Composite Wheel Development for Military Aircraft", in the period 22 October 1970 to 13 August 1971. The program was sponsored by the Air Force Flight Dynamics Laboratory (FFDL), Wright-Patterson Air Force Base, Ohio, and conducted under Project 1369, Task 11. Lt. G. Shumaker was the program manager.

This technical report has been reviewed and is approved.

K. H. Digges

KENNERLY H. DIGGES
Chief, Mechanical Branch
Vehicle Equipment Division

ABSTRACT

A program was conducted wherein a fibrous graphite/epoxy aircraft wheel was designed, fabricated and delivered to the Air Force for testing. The composite wheel was fabricated using continuous fibers laid up on a male mold with multiple autoclave staging. The material was applied in broadgood patterns by hand and in continuous forms by filament winding. The completed layup was machined to proper configuration.

TABLE OF CONTENTS

	<u>Page</u>
SECTION I - INTRODUCTION	1
SECTION II - TECHNICAL DISCUSSION	2
1. PROCESS DEVELOPMENT	2
2. QUALITY CONTROL PROVISIONS	3
3. FABRICATION OF GRAPHITE/EPOXY WHEEL	14
4. TOOLING	18
5. DESIGN	18
SECTION III - CONCLUSIONS AND RECOMMENDATIONS	20
Appendix A - Manufacturing Process	
Appendix B - Loads and Design Criteria for Composite Military Aircraft Wheel	

LIST OF FIGURES

<u>Page No.</u>		<u>Page</u>
1	Notation for Areas of the Wheel	4
2	Physical Analysis of Process Development Fiber Glass/Epoxy Wheel	5
3	Steel Mold with Fiber Patterns Demonstrated	6
4	Steel Mold and Dissected Fiber Glass Wheel Half	6
5	Steel Mold with Bolt Bosses with Circumferential Graphite Epoxy Fibers Applied to Mold	6
6	Cutting Prepreg Patterns for Bolt Bosses	7
7	Bolt Boss Patterns Applied to Mold	7
8	Preparing Patterns for Layup	8
9	Winding Fiber Annular Ring	8
10	Fiber Annuli Staged for Wheel Layup	9
11	Applying Radial/Axial Fibers to Layup	9
12	Circumferential Fiber Prepreg	10
13	Winding Circumferential Fibers	10
14	Dimensionally Inspecting Layup	11
15	Layup with Short Fibers Shown in Mating Face	11
16	Winding Circumferential Fiber Over Radial/Axial Fiber	11
17	Preparing to Vacuum Bag Layup	12
18	Vacuum Bagged Part in Autoclave Ready for Curing	12
19	Part After Autoclave Cure	13
20	Machining Laminated Wheel Half Section	13
21	Wheel Assembly - Graphite Composite	15
22	Area Requiring Additional Layup	16
23	O-Ring Delamination	17
24	Completed Wheel	19

SECTION I
INTRODUCTION

A program was conducted in which a composite wheel, the main landing gear wheel for the A-37B aircraft, was designed and fabricated utilizing epoxy and high modulus graphite fibers. Fiber reinforced plastic composite materials for aircraft wheel applications offer a number of potential advantages over metals. Composite materials have demonstrated their potential for weight reduction of numerous aircraft structural components. In the case of the composite wheel, an approximate 16% weight reduction over the same metal wheel was realized. In addition, composite materials offer the potential for increased corrosion resistance and greater fatigue life.

The objectives of this effort were to:

- Demonstrate the feasibility of constructing an aircraft wheel using graphite epoxy composite materials.

- Achieve lighter weight than is possible with present aluminum wheels.

Program tasks included:

- Select materials.

- Establish quality control procedures.

- Design wheel.

- Develop fabrication technology to build a prototype wheel.

- Fabricate prototype test wheel.

SECTION II

TECHNICAL DISCUSSION

1. PROCESS DEVELOPMENT

A process development effort was conducted to check out the fabrication process planned for the graphite/epoxy wheel and to establish prepreg material characteristics.

A wheel half was constructed on a steel mandrel using type E fiber glass and the 4617 resin system. E fiber glass was used in lieu of graphite to minimize costs, however, small samples of graphite were used to define the significant prepreg characteristics and these characteristics were translated to the fiber glass prepreg. Optimum characteristics of the graphite/epoxy prepreg were established as follows:

• Resin Content	37 ± 3%
• Volatile Content	5.5 ± 1.5% (nominal)
• Resin Solids/Volatile Ratio	0.19 ± 0.03
• Flow	17 ± 3%
• Drape	High
• Tack	Medium

The lamination sequence was established as follows:

- 6 compaction stages - 2 ± 1 hrs (depending on the degree of staging desired) @ 190°F ± 10°F and 50 ± 5 psig
- 1 final cure stage - 2 hrs @ 190°F ± 10°F and 50 ± 5 psig followed by 16 hrs @ 325°F ± 10°F and 50 ± 5 psig

Each layup consisted of (a) fibers oriented parallel to the wheel axis continuous through the wheel and radial in the face areas, (b) circumferential fibers perpendicular to the wheel axis, and (c) fibers ±45° to the wheel axis.

Both the ±45° and the parallel fibers were cut into approximately 1/2 inch width patterns from prepreg broadgoods sheets and applied to the layup by hand. Shorter patterns were placed in the extra thickness areas. The circumferential fibers were applied in the flange and cylindrical areas by winding single tow continuous filament prepreg directly onto the layup. The mandrel was placed in a lathe that had been modified for this operation. In the face areas of the wheel circumferential fiber annuli preforms were prepared by winding the single tow continuous

fiber into aluminum forms, cooling to a low temperature to rigidize them, and manually transferring the preform to the layup. In the conical area of the wheel, circumferential fibers were wound on an aluminum form; frozen, and placed on the layup. Figure 1 indicates the areas of the wheel.

Once the fiberglass process development part had been completely laid up, it was machined, using a tracer lathe to the approximate configuration of the actual wheel half. This part was then cut up and analyzed for specific gravity, resin and void content. The results are presented in Figure 2.

Based on the results obtained from the physical and visual analyses of the process development wheel, changes were made in the layup procedure toward applying more effective pressure to the high resin content areas, toward eliminating fiber wrinkling in the circumferential fiber layers, and toward establishing better thickness control of the individual layers.

A photographic sequence of the layup of the fiber glass process development wheel is presented in Figures 3 through 20. Figures 6 and 7 show the boss areas in the graphite wheel mold and the preparation of epoxy/graphite prepreg to fit the bosses. The photo sequence is typical of the fabrication processes used for both the graphite and glass epoxy wheels.

2. QUALITY CONTROL PROVISIONS

The following quality control provisions were developed and established for the fabrication of the graphite/epoxy wheel:

a. Raw Materials

- Resin - Manufacturer's Certification
- Graphite - Manufacturer's Certification and Test Report

b. Processed Materials

- Resin - Thermal Gravimetric Analysis (TGA)
- Prepreg
 - Volatile weight loss after 15 minutes @ 325°F
 - Resin content - by digestion process
 - Flow - by SPI Procedure III (15 psi x 15 minutes @ 325°F)
 - Tack and drape - by visual inspection

c. Lamination (in-process inspection)

- Sign-off of Part Processing (Traveler)
- Dimensional Inspection after Each Cure
- Monitor Cure Temperature and Pressure with Continuous Recording Charts

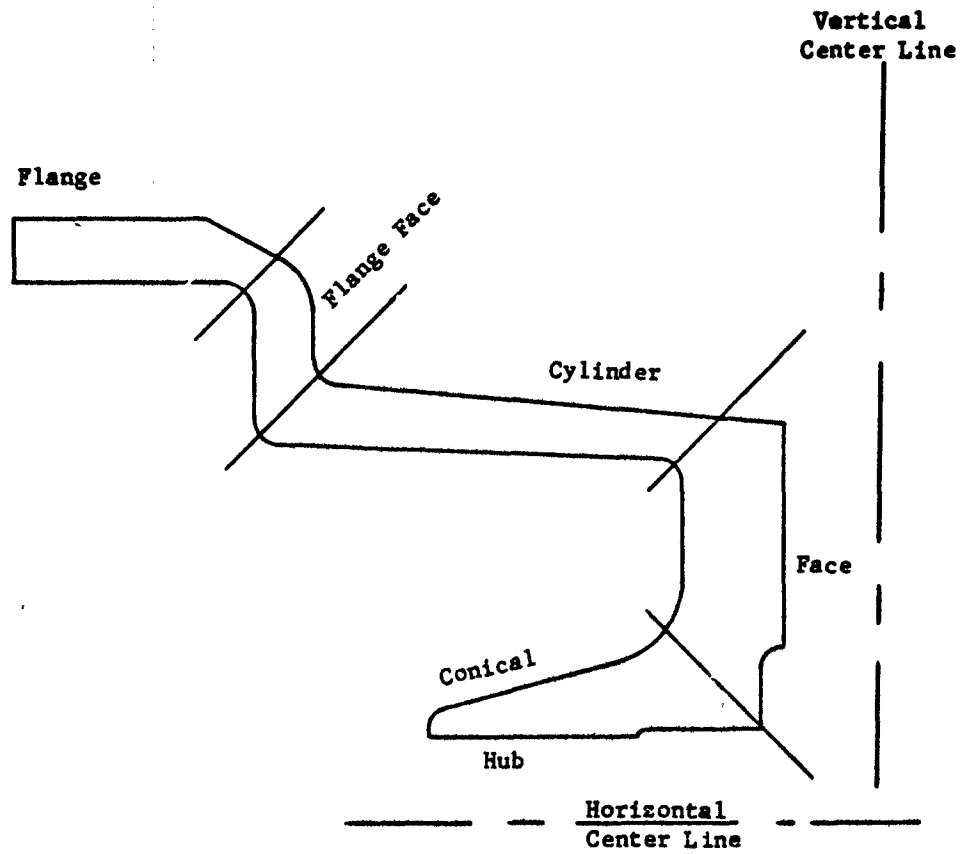

Figure 1. Notation used for Areas of the Wheel

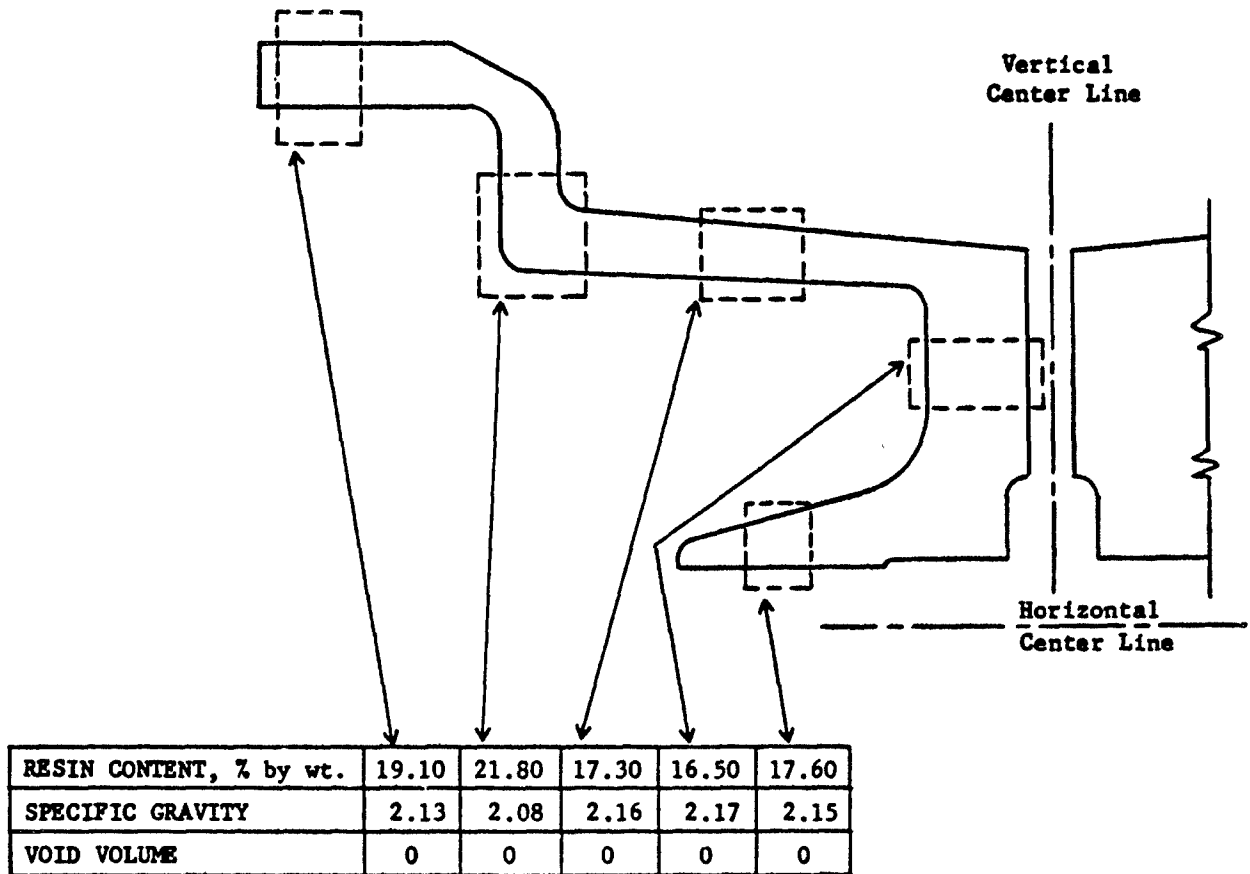

Figure 2. Results of the Physical Analysis of the Process Development Fiber Glass/Epoxy Wheel Half.



Figure 3.
Steel Mold with Fiber
Lay-Up Patterns Demonstrated.
Mold is Show Prior to
Modification for Graphite
Epoxy Wheel Bolt Bosses.



Reproduced from
best available copy.



Figure 4.
Steel Mold and Dissected
Fiberglass Wheel Half.



Figure 5.
Steel Mold Showing Bolt Bosses
with Circumferential Graphite
Epoxy Fibers Applied to Mold.



Figure 6
Cutting Prepreg
Patterns for
Bolt Bosses
(Graphite Epoxy)

Reproduced from
best available copy.



Figure 7
Bolt Boss Patterns
Applied to Mold
(Graphite Epoxy)

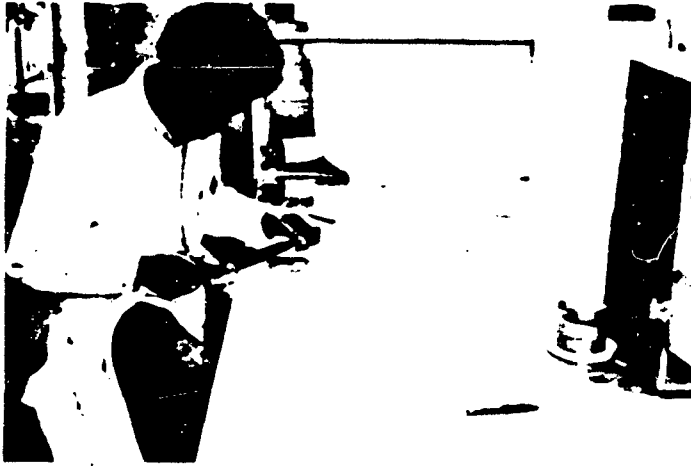

Figure 8.
Preparing Patterns
for Layup

reproduced from
best available copy.

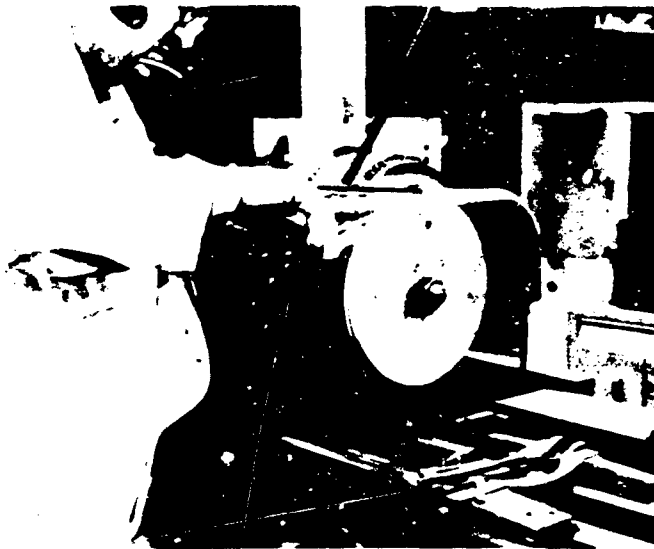

Figure 9.
Winding Fiber
Annular Ring

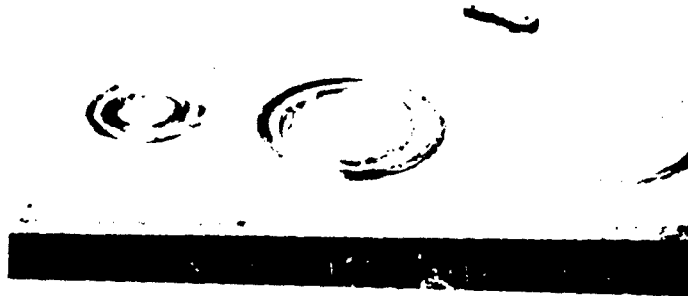

Figure 10.
Fiber Annuli Staged
For Wheel Layup

Reproduced from
best available copy.



Figure 11.
Applying Radial/Axial
Fibers to Layup



Figure 12.
Circumferential
Fiber Prepreg

Reproduced from
best available copy.

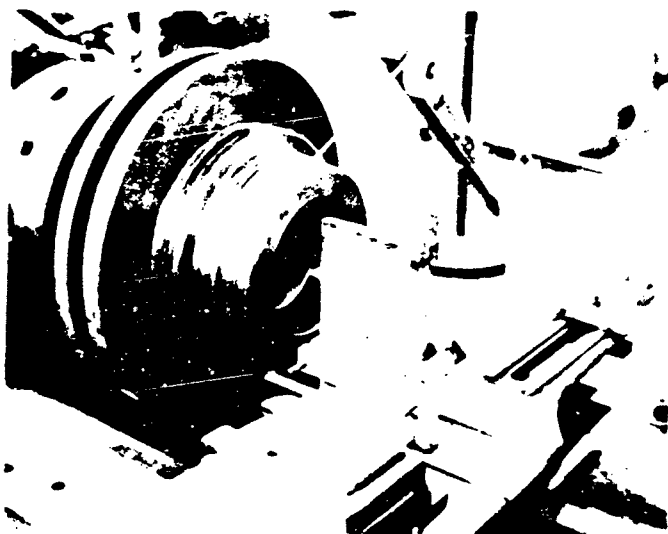

Figure 13.
Winding Circumferential
Fibers

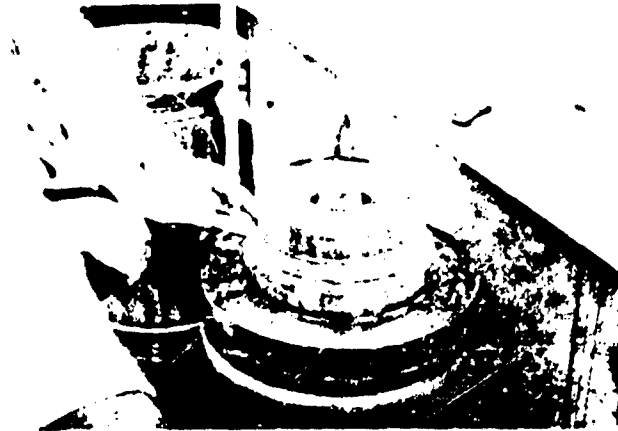

Figure 14.
Dimensionally Inspecting
Layup

Reproduced from
best available copy.

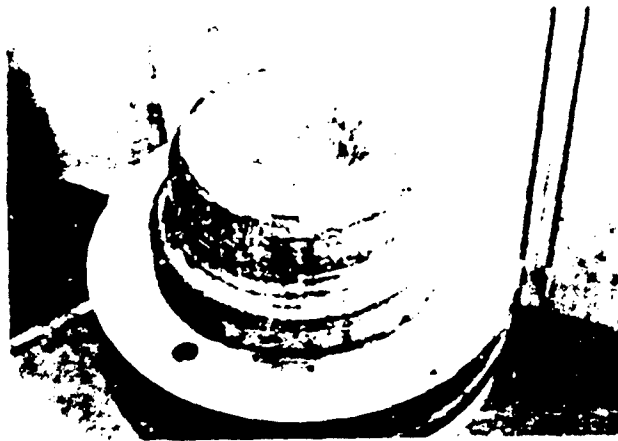

Figure 15.
Layup with Short Fibers
Shown in Mating Face

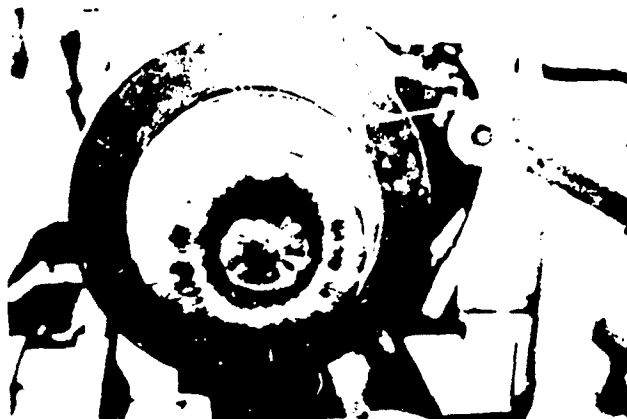

Figure 16.
Winding Circumferential
Fiber Over Radial/Axial
Fiber

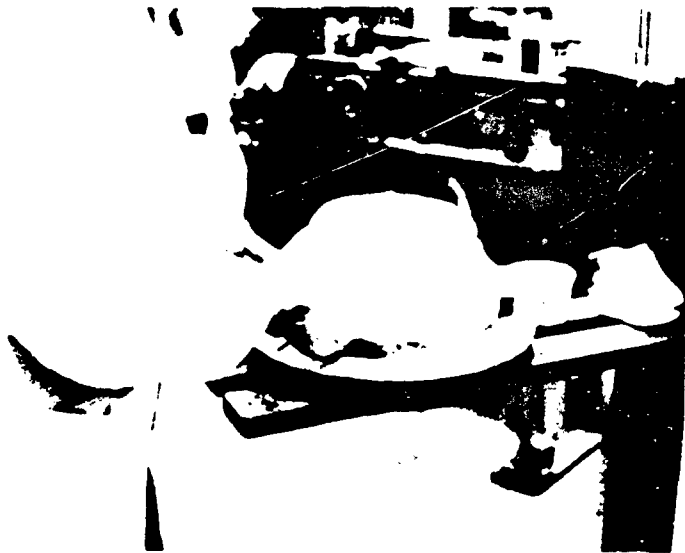

Figure 17.
Preparing to Vacuum
Bag Layup

Reproduced from
best available copy.

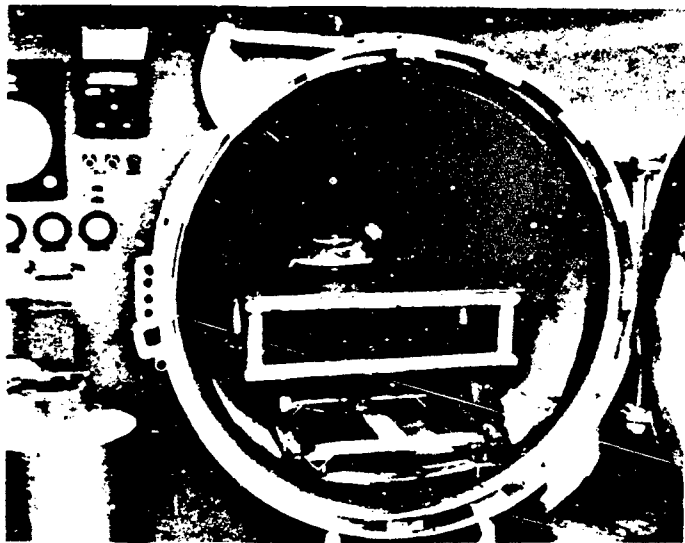

Figure 18.
Vacuum Bagged Part in
Autoclave Ready for
Curing

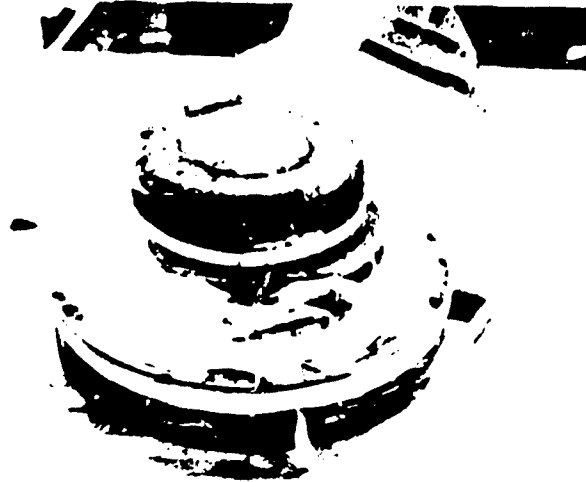

Figure 19.
Part After Autoclave Cure

Reproduced from
best available copy.

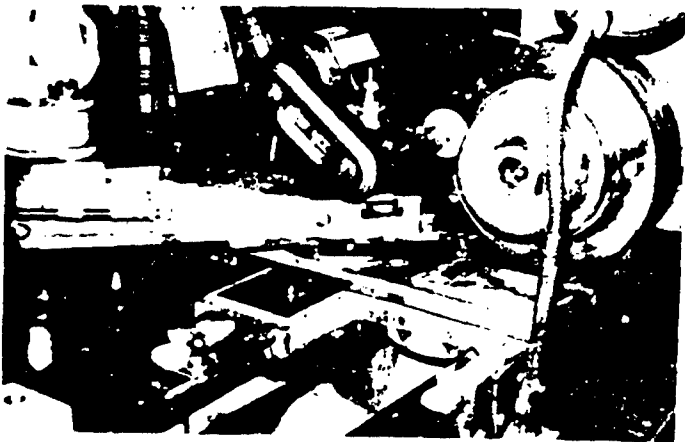

Figure 20.
Machining Laminated
Wheel Half Section

Visual Inspection, In-process, of Fiber Orientation and
Laminate Quality

3. FABRICATION OF GRAPHITE/EPOXY WHEEL

The wheel was laid up in accordance with the structural design and the fabrication process developed using glass fiber (Figure 21). No problems were encountered except that approximately 15% extra thickness buildup was experienced in the cylindrical section.

Upon final machining, which was accomplished on a tracer lathe using carbide cutter bits, it was noticed that insufficient material had been placed on the cylinder/mating face corner (see Figure 22) and it was necessary to add more plies on this area. Other difficulties were noted also in the final machining. The O-ring groove between the two half wheel specimens was a particular problem in that during the machining a rough surface was obtained which had to be repaired. It is suspected that the repair resin was not polished out completely, leaving some areas where the groove was not wide enough. Thus consequently, corner splitting occurred when the wheel halves were bolted together. A second problem involved drilling the bolt holes through the bosses. Some delamination occurred in the surface plies and a repair was necessary. A room temperature curing epoxy adhesive was used for the repair. Finally, in assembling the wheel with a tire in place, the side pressure exerted by the compressed O-ring created interlaminar shear stresses which failed the composite material (see Figure 23). This area was again repaired and modified by widening the O-ring groove from the low side of the tolerance to the high side of the tolerance. This resulted in less pressure being exerted by the O-ring and was a satisfactory solution to the problem. To eliminate this problem in the future the O-ring groove should be moved toward the center to a smaller diameter.

Offal rings from the wheel halves were analyzed for specific gravity and resin content, with the following results:

<u>Wheel Half</u>	<u>Resin Content</u>	<u>Specific Gravity</u>
#1	35.6%	1.53
#2	31.6%	1.52

With the aluminum hub, bearing cups and air valve installed, the wheel weighed 10.1 lbs, resulting in a weight-saving of 16% for the wheel

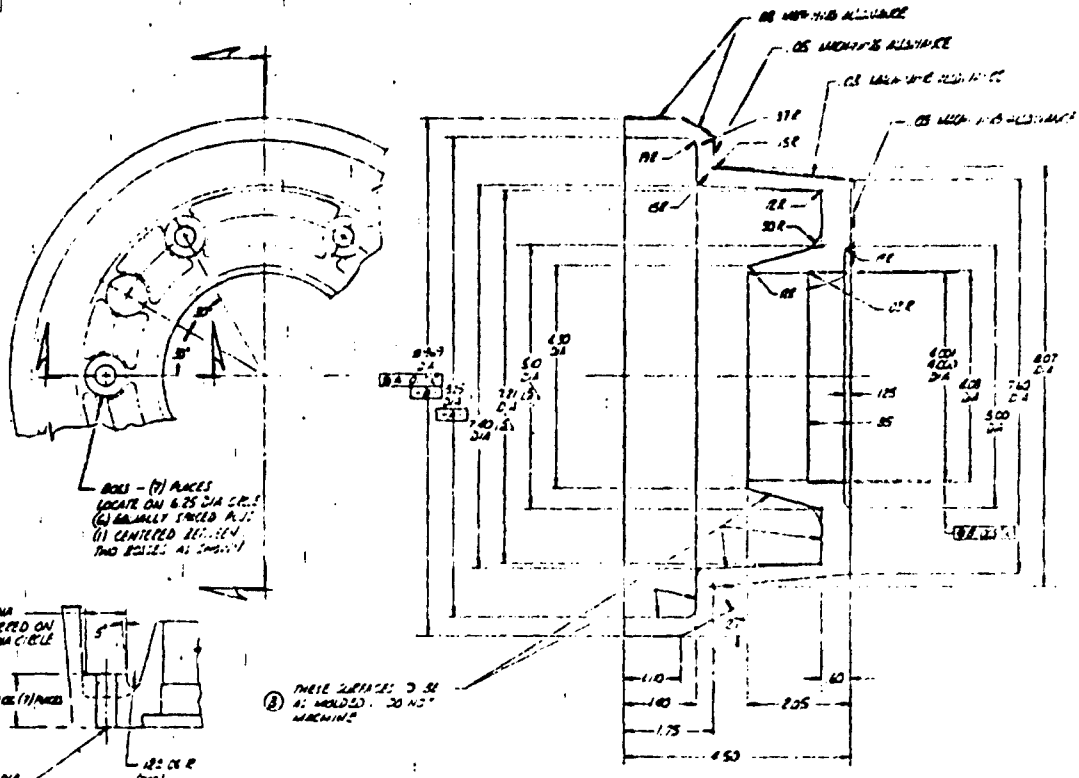

BOSS - (7) PAGES
 LOCATE ON 6.25 DIA CIRCLES
 (6) EQUALLY SPACED A.P.C.
 (1) CENTERED BETWEEN TWO BOSSSES AT CENTER

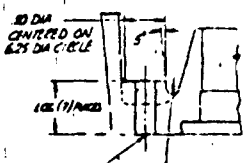

TYPICAL CROSS SECTION OF BOSS - (7) PAGES

- 1 DETAIL

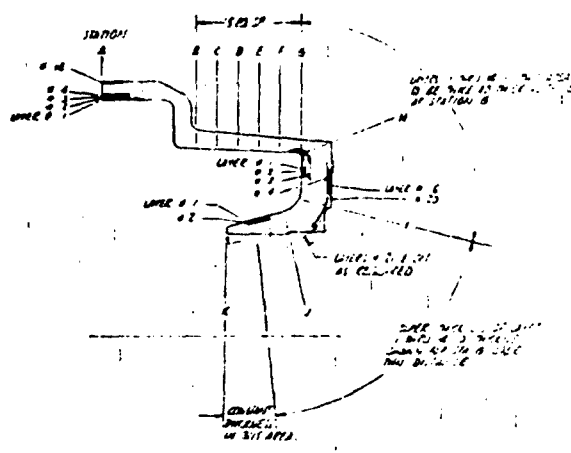

LAY-UP TABLE

LAYER	STAINLESS									
	A	B	C	D	E	F	G	H	I	J
1										
2										
3										
4										
5										
6										
7										
8										
9										
10										
11										
12										
13										
14										
15										
16										
17										
18										
19										
20										
21										
22										
23										
24										
25										
26										
27										
28										
29										
30										
31										
32										
33										
34										
35										
36										
37										
38										
39										
40										
41										
42										
43										
44										
45										
46										
47										
48										
49										
50										
51										
52										
53										
54										
55										
56										
57										
58										
59										
60										
61										
62										
63										
64										
65										
66										
67										
68										
69										
70										
71										
72										
73										
74										
75										
76										
77										
78										
79										
80										
81										
82										
83										
84										
85										
86										
87										
88										
89										
90										
91										
92										
93										
94										
95										
96										
97										
98										
99										
100										

LEGEND:
 CIRC - CIRCUMFERENTIAL REINFORCEMENT
 DIA - DIAGONAL REINFORCEMENT
 SPP - SPREADER PLATE TO ALL OF REINFORCEMENT
 R - NUMBER OF PILES

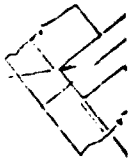

TYP. SLOT DIA
 (7) SLOT CIRC
 SPACED EQUALLY
 WITH 1/2 DIA DIA
 NOT IN SECTION

A

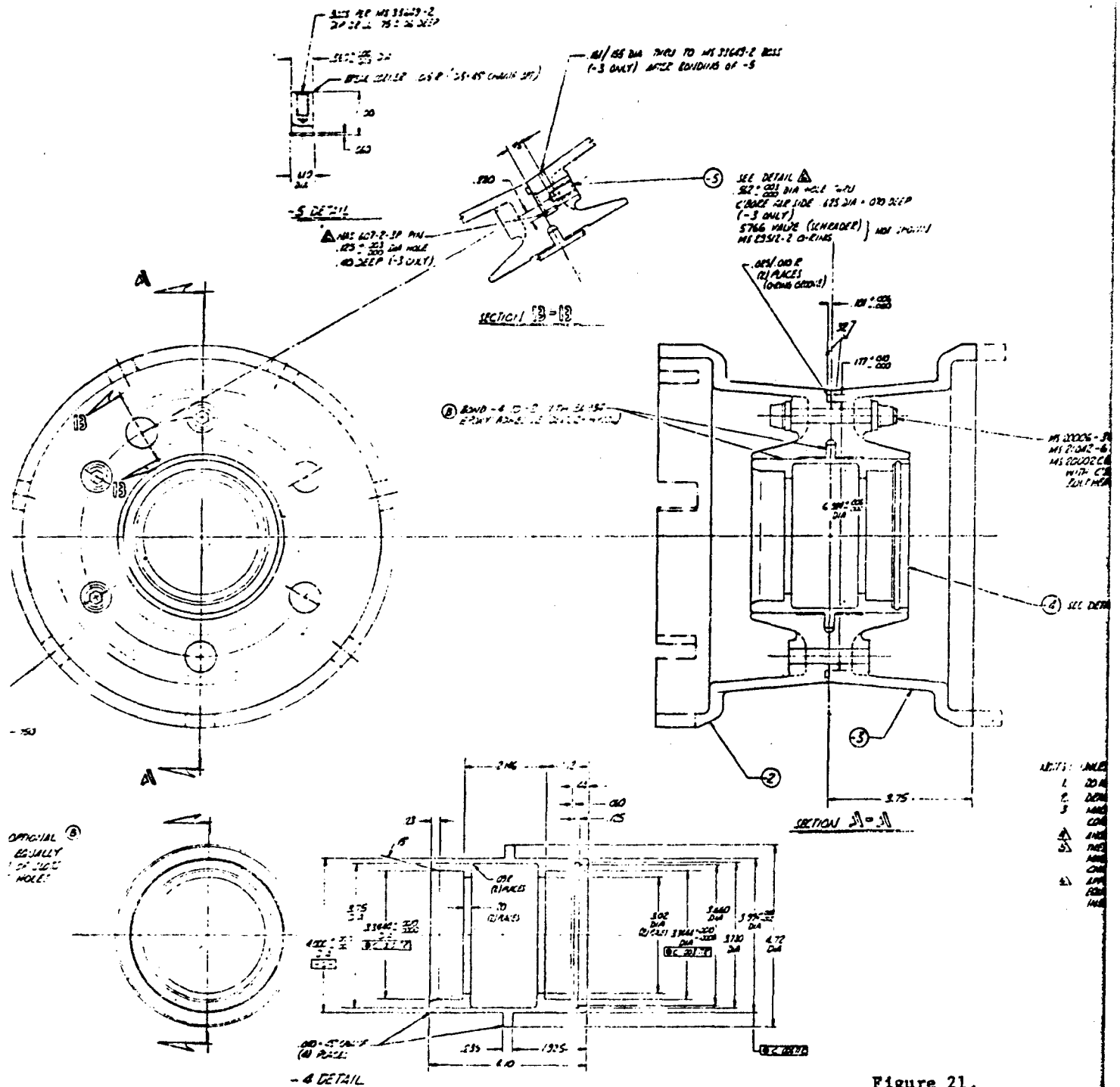
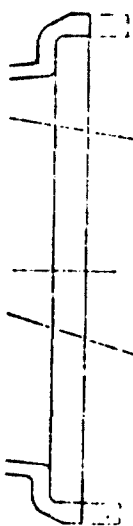

Figure 21.

B

1. 10/14/71
 2. 10/14/71
 3. 10/14/71



1. 10/14/71
 2. 10/14/71
 3. 10/14/71

- NOTES - UNLESS OTHERWISE SPECIFIED
1. DO NOT SCALE DRAWINGS. REFER TO DIMENSIONS GIVEN.
 2. DIMENSIONS ARE GIVEN IN INCHES UNLESS OTHERWISE SPECIFIED.
 3. DIMENSIONS ARE GIVEN IN MILLIMETERS UNLESS OTHERWISE SPECIFIED.
 4. DIMENSIONS ARE GIVEN IN METERS UNLESS OTHERWISE SPECIFIED.
 5. DIMENSIONS ARE GIVEN IN FEET UNLESS OTHERWISE SPECIFIED.
 6. DIMENSIONS ARE GIVEN IN KILOMETERS UNLESS OTHERWISE SPECIFIED.

REV	DATE	DESCRIPTION	BY	CHKD
1	10/14/71	INITIAL DESIGN		
2	10/14/71	REVISION		
3	10/14/71	REVISION		
4	10/14/71	REVISION		
5	10/14/71	REVISION		
6	10/14/71	REVISION		
7	10/14/71	REVISION		
8	10/14/71	REVISION		
9	10/14/71	REVISION		
10	10/14/71	REVISION		
11	10/14/71	REVISION		
12	10/14/71	REVISION		
13	10/14/71	REVISION		
14	10/14/71	REVISION		
15	10/14/71	REVISION		
16	10/14/71	REVISION		
17	10/14/71	REVISION		
18	10/14/71	REVISION		
19	10/14/71	REVISION		
20	10/14/71	REVISION		
21	10/14/71	REVISION		
22	10/14/71	REVISION		
23	10/14/71	REVISION		
24	10/14/71	REVISION		
25	10/14/71	REVISION		
26	10/14/71	REVISION		
27	10/14/71	REVISION		
28	10/14/71	REVISION		
29	10/14/71	REVISION		
30	10/14/71	REVISION		
31	10/14/71	REVISION		
32	10/14/71	REVISION		
33	10/14/71	REVISION		
34	10/14/71	REVISION		
35	10/14/71	REVISION		
36	10/14/71	REVISION		
37	10/14/71	REVISION		
38	10/14/71	REVISION		
39	10/14/71	REVISION		
40	10/14/71	REVISION		
41	10/14/71	REVISION		
42	10/14/71	REVISION		
43	10/14/71	REVISION		
44	10/14/71	REVISION		
45	10/14/71	REVISION		
46	10/14/71	REVISION		
47	10/14/71	REVISION		
48	10/14/71	REVISION		
49	10/14/71	REVISION		
50	10/14/71	REVISION		
51	10/14/71	REVISION		
52	10/14/71	REVISION		
53	10/14/71	REVISION		
54	10/14/71	REVISION		
55	10/14/71	REVISION		
56	10/14/71	REVISION		
57	10/14/71	REVISION		
58	10/14/71	REVISION		
59	10/14/71	REVISION		
60	10/14/71	REVISION		
61	10/14/71	REVISION		
62	10/14/71	REVISION		
63	10/14/71	REVISION		
64	10/14/71	REVISION		
65	10/14/71	REVISION		
66	10/14/71	REVISION		
67	10/14/71	REVISION		
68	10/14/71	REVISION		
69	10/14/71	REVISION		
70	10/14/71	REVISION		
71	10/14/71	REVISION		
72	10/14/71	REVISION		
73	10/14/71	REVISION		
74	10/14/71	REVISION		
75	10/14/71	REVISION		
76	10/14/71	REVISION		
77	10/14/71	REVISION		
78	10/14/71	REVISION		
79	10/14/71	REVISION		
80	10/14/71	REVISION		
81	10/14/71	REVISION		
82	10/14/71	REVISION		
83	10/14/71	REVISION		
84	10/14/71	REVISION		
85	10/14/71	REVISION		
86	10/14/71	REVISION		
87	10/14/71	REVISION		
88	10/14/71	REVISION		
89	10/14/71	REVISION		
90	10/14/71	REVISION		
91	10/14/71	REVISION		
92	10/14/71	REVISION		
93	10/14/71	REVISION		
94	10/14/71	REVISION		
95	10/14/71	REVISION		
96	10/14/71	REVISION		
97	10/14/71	REVISION		
98	10/14/71	REVISION		
99	10/14/71	REVISION		
100	10/14/71	REVISION		

ire 21.

C

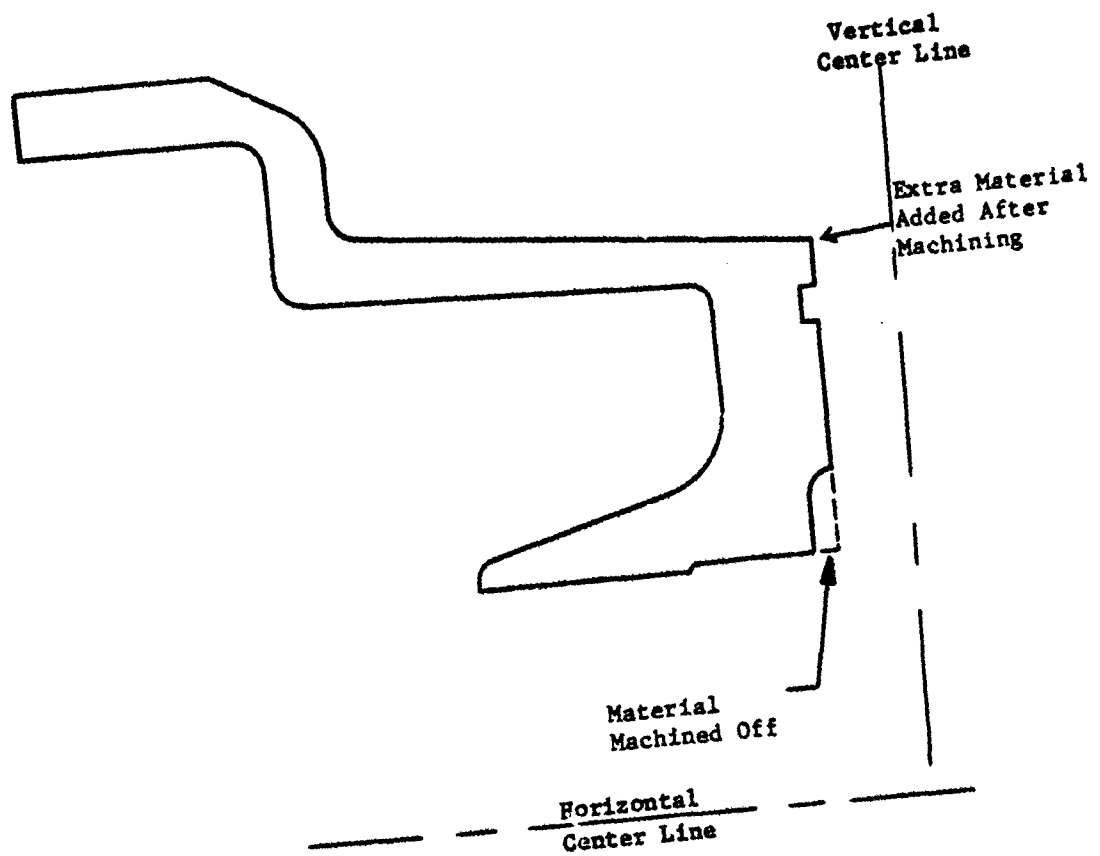

Figure 22. Area Requiring Additional Layup

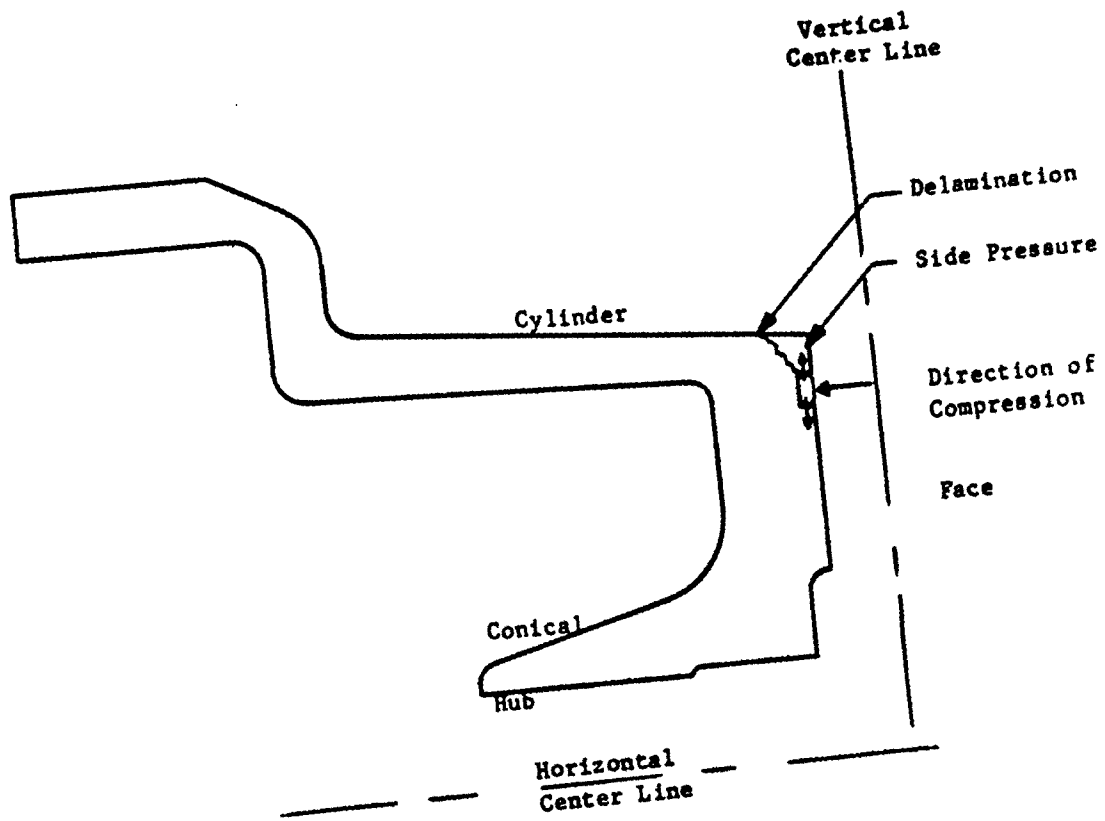

Figure 23. O-Ring Delamination

assembly. The completed wheel is depicted in Figure 24. The manufacturing process (job traveler) is included as Appendix A.

4. TOOLING

For the fabrication of the part, two (2) steel mandrels (one for each wheel half) defining the exposed wheel surface were utilized (Figure 3). One (1) of the molds was modified as required to accommodate the bosses for bolting the wheel together.

It was felt that the time savings realized in fabricating the two (2) wheel halves simultaneously more than offset the extra cost of the second mandrel.

5. DESIGN

The design philosophy in this effort was to replace the existing metal wheel with equivalent thickness of composite material. The wheel was not optimized for minimum weight. The wheel consisted of an aluminum hub fitted with the bearing cups which was bonded to the bore of one wheel half. Six (6) bolts were used to fasten the wheel halves together. The wheel was fitted with an air valve and an O-ring at the wheel mating faces to provide tubeless air retention. Braking requirements were not considered in the design, thus brake rotor slots were not included in the test article constructed. The prototype wheel was designed to the basic loads which appear in Appendix B.

6. STRESS ANALYSIS

The stress analysis associated with this effort will be published as AFFDL Technical Memorandum TM-72-02-FEM. Publication of this T.M. is forthcoming.

7. TEST RESULTS

Static and roll testing of this wheel has been conducted by the AFFDL (FEM) at WPAFB. The results of this test will be published as an AFFDL Technical Report (TR). Publication of this TR is forthcoming.



Reproduced from
best available copy.



Figure 24. Completed Wheel

SECTION III

CONCLUSIONS AND RECOMMENDATIONS

Graphite fiber composite material for aircraft wheel application offers potential for superiority over conventional metal wheels in the areas of weight and corrosion resistance.

A wheel is a complex structure subject to combined loading conditions which complicate the design and analysis problem. The use of a composite material having anisotropic properties further increases the difficulty of this problem. In order to obtain an optimized composite wheel, a series of test-failure analysis-redesign steps will be required.

This prototype wheel was designed to the approximate configuration and envelope of the metal wheel. In order to optimize the composite wheel, future efforts should study configurations which take better advantage of the properties and fabrication methods characteristic of composite materials. For example, eliminate sharp corners and rapid change of section thickness, etc. The hand layup fabrication process used for this prototype wheel results in a high per unit cost, therefore, more cost effective designs must be found. Designs which use some randomly oriented fiber and matched die molding techniques should be considered.

APPENDIX A
MANUFACTURING PROCESS

WHITTAKER CORPORATION APPENDIX A - MANUFACTURING PROCESS
 Research & Development Division

MASTER JOB TRAVELER WRD-002		MJO/WO No. 3025-002	Name of Item COMPOSITE WHEEL		
ROUTING INSTRUCTIONS: (Check One of Indicate Sequence by Numbers)				REQUESTED BY A. PRICE	EXT. 274
✓ No.	ROUTE TO	DATE SUBMITTED	DATE REQUIRED	EST. HRS.	ACT. HRS.
	Fabrication				
	Machine Shop				
	Test Lab.				

SPECIAL REQUIREMENTS, MATERIALS, INSTRUCTIONS:
 2 REQ'D/ASS'Y

TOOL CONTROL

Contract No. F33615-71-C-1089 Property of Tool No. MJO No.

COMPLETION INITIALS & DATE	OPERATION NO.	INSTRUCTIONS
		Note: Prefix the operation No. with F, M, T, or T.C. corresponding to the applicable department.
		MATERIALS: (1) Union Carbide 4617
		(2) Meter-Length Modmor II
		(3) Mid-Length Modmor II
		REF: WRD Dwg. 4618 Rev A
	5	Impregnate midlength Modmor II with 37 ±3% 4617 Resin using dip process. Apply heat to remove volatiles. Take 2-g sample at 0.75-lb intervals and submit to analytical lab for verification of resin content.
	6	Determine resin solids content on samples submitted.
	10	Lay up meter-length Modmor II in 1-lb quantities in 10 - 12 inch width sheets. Apply 37% ±3% resin solids. B-stage to 5.5 ±1% volatile. Achieve high drape and medium tack. Submit 3 samples from each lb for testing.
	11	Determine resin content and volatile content.
	15	Repeat operations 5 to 11 as required to furnish sufficient material to fabricate 1 wheel ass'y.

A-1 22

USE REVERSE SIDE FOR ADDITIONAL INSTRUCTIONS

COMPLETION INITIALS & DATE	OPERATION NO.	INSTRUCTIONS NOTE: Prefix the operation F, M, or T, corresponding to the applicable Dept
	20	Prepare mandrels by washing with solvent, inspecting for burrs or surface irregularities and coating with DC 20. Bake coating at 420°F - 500°F for 1 hr minimum.
	26	Inspect mold preparation.
	30	Set lathe at 5 TPI, set tensioner at 4 - 6 lbs. (Setting to be maintained for all subsequent circ operations.) Place mandrel in lathe. Wind 3 layers circumferential fibers (circs) Sta A to Sta G. Wind 1 additional circ Sta A to F.
	35	Place .028 spacer in flange annular mold and wind mold full. Freeze to rigidize and remove ring from mold. Place ring on layup. Trim to fit as required.
	40	Cut discs to fit wheel bosses. Position 5 plies in bosses. Randomly orient fiber direction of discs.
	45	Cut approx. 1" width patterns of radial/axial (R/A) fibers for layup from Sta A to Sta K.
	50	Lay up 1 ply R/A cut in previous operation.
	55	Cut discs to fit wheel bosses. Position 30 plies in bosses. Randomly orient fiber direction of discs.
	60	Lay up 1 ply R/A cut in operation 45.

WHITTAKER CORPORATION
Research & Development Division

MASTER JOB TRAVELER WRD-002		MJO/WO No. 3025-002	Name of Item COMPOSITE WHEEL		
ROUTING INSTRUCTIONS: (Check One of Indicate Sequence by Numbers)				REQUESTED BY	EXT.
✓ or No.	ROUTE TO	DATE SUBMITTED	DATE REQUIRED	EST. HRS.	ACT. HRS.
	Fabrication				
	Machine Shop				
	Test Lab.				

SPECIAL REQUIREMENTS, MATERIALS, INSTRUCTIONS:

TOOL CONTROL

Contract No. Property of Tool No. MJO No.

COMPLETION INITIALS & DATE	OPERATION NO.	INSTRUCTIONS
		Note: Prefix the operation No. with F, M, T, or T.C. corresponding to the applicable department.
	65	Cut discs to fit wheel bosses. Position 40 plies in bosses. Randomly orient fiber direction of discs.
	70	Cut patterns of R/A fibers Sta A to Sta F. Apply 1 ply to layup. Cut patterns of double thickness for Sta G to I. Apply to layup.
	75	Wind 3 circs Sta A to Sta G.
	80	Wind 1 circ Sta A to Sta F.
	85	Place .028 spacer in flange annular mold and wind mold full. Freeze to rigidize and remove ring from mold. Place ring on layup. Trim to fit as required.
	90	Place .042 spacer in web annular mold and wind mold full. Freeze to rigidize and remove ring from mold. Place ring on layup. Trim to fit as required.
	91	Inspect layup for cleanliness, fiber alignment, and conformance to drawing.

24
A-3

USE REVERSE SIDE FOR ADDITIONAL INSTRUCTIONS

COMPLETION INITIALS & DATE	OPERATION NO.	INSTRUCTIONS NOTE: Prefix the operation F, M, or T, corresponding to the applicable Dept
	95	Cover assembly with 1 ply 128-style unfinished peel/bleeder fiber glass. Bag in Capram vacuum bag. Place assembly in autoclave. Place 1 T/C on part, 1 T/C in air.
①	100	Precompact part at 50 ±5 psi x 190 ±10°F x 2 ⁺¹ ₋₀ hrs. Identify and store pressure and temperature recorder charts.
	105	When assembly is cool, strip bag and bleeder materials.
	106	Inspect precompaction cure records. Inspect part.
	110	Sand assembly. Prepare for next layup. Prime surface with 4617 resin.
	115	Cut discs for boss areas and place in any low areas remaining after cure. Maintain random orientation.
	120	Cut patterns and place double ply layer R/A on assembly Sta A to Sta K.
	125	Cut patterns and place 1 R/A on assembly Sta A to Sta E.
	130	Cut patterns and place double ply layer R/A on assembly Sta G to Sta K.
	135	Cut patterns for + and -45° fibers for layup Sta A to Sta K. Apply 1 layer + , 1 layer - .
		25

WHITTAKER CORPORATION
Research & Development Division

MASTER JOB TRAVELER MJO/WO No. 3025-002 Name of Item **COMPOSITE WHEEL**
 WRD-002

ROUTING INSTRUCTIONS: (Check One of Indicate Sequence by Numbers) REQUESTED BY A. PRICE EXT. 274

√ or No.	ROUTE TO	DATE SUBMITTED	DATE REQUIRED	EST. HRS.	ACT. HRS.	SPECIAL REQUIREMENTS, MATERIALS, INSTRUCTIONS:
	Fabrication					
	Machine Shop					
	Test Lab.					

TOOL CONTROL

Contract No. Property of Tool No. MJO No.

COMPLETION INITIALS & DATE	OPERATION NO.	INSTRUCTIONS
		Note: Prefix the operation No. with F, M, T, or T.C. corresponding to the applicable department.
	140	Cut patterns and apply 1 layer + , 1 layer - , Sta A to Sta E. Apply 2 layers + , 2 layers - , Sta G to Sta J.
	141	Inspect layup for cleanliness, fiber alignment, and conformance to drawing.
	145	Cover assembly with 1 ply 128-style unfinished peel/bleeder fiber glass. Bag in Capram vacuum bag. Place assembly in autoclave. Place 1 T/C on part, 1 T/C in air.
	150	Precompact part at 50 ±5 psi x 190 ±10°F x 2 ⁺¹ ₋₀ hrs. Identify and store pressure and temperature recorder charts.
	155	When assembly is cool, strip bag and bleeder materials.
	156	Inspect precompaction cure records. Inspect part.
	160	Sand assembly. Prepare for next layup. Prime surface with 4617 resin.
	165	Wind 3 circs Sta A to Sta G.

USE REVERSE SIDE FOR ADDITIONAL INSTRUCTIONS

COMPLETION INITIALS & DATE	OPERATION NO.	INSTRUCTIONS NOTE: Prefix the operation F, M, or T, corresponding to the applicable Dept
	170	Wind 1 circ Sta A to Sta E.
	175	Place 0.028 spacer in flange annular mold and wind mold full. Freeze to rigidize and remove ring from mold. Place ring on layup. Trim to fit as required.
	180	Place 0.042 spacer in web annular mold and wind mold full. Freeze to rigidize and remove ring from mold. Place ring on layup. Trim to fit as required.
	185	Wind 6 circs on cone mandrel. Freeze to rigidize and place on assembly Sta I to Sta K. Trim as required to fit.
	190	Cut patterns and place 1 ply R/A Sta A to Sta K. Place 1 ply additional Sta A to Sta D. Place 2 additional plies Sta G to Sta I.
	195	Cut $\pm 45^\circ$ patterns. Place 2 + , 2 - layers Sta A to Sta K.
	196	Inspect layup for cleanliness, fiber alignment, and conformance to drawing.
	200	Cover assembly with 1 ply 128-style unfinished peel/bleeder fiber glass. Bag in Capram vacuum bag. Place assembly in autoclave. Place 1 T/C on part, 1 T/C in air.
	205	Precompact part at 50 \pm 5 psi x 190 \pm 10 $^\circ$ F x 2 $^{+1}_0$ hrs. Identify and store pressure and temperature recorder charts.
	210	When assembly is cool, strip bag and bleeder materials.

WHITTAKER CORPORATION
Research & Development Division

MASTER JOB TRAVELER MJO/WO No. **MJO 3025** Name of Item **COMPOSITE WHEEL**
 WTD-002

ROUTING INSTRUCTIONS:
 (Check One of Indicate Sequence by Numbers)

REQUESTED BY **A. PRICE** EXT. **274**

✓ or No.	ROUTE TO	DATE SUBMITTED	DATE REQUIRED	EST. HRS.	ACT. HRS.	SPECIAL REQUIREMENTS, MATERIALS, INSTRUCTIONS:
	Fabrication					
	Machine Shop					
	Test Lab.					

TOOL CONTROL

Contract No. _____ Property of _____ Tool No. _____ MJO No. _____

COMPLETION INITIALS & DATE	OPERATION NO.	INSTRUCTIONS
		Note: Prefix the operation No. with F, M, T, or T.C. corresponding to the applicable department.
	211	Inspect precompaction cure records. Inspect part.
	215	Sand assembly. Prepare for next layup. Prime surface with 4617 resin.
	220	Wind 3 circs Sta A to Sta G.
	225	Wind 1 circ: Sta A to Sta D.
	230	Place .028 spacer in flange annular mold and wind mold full. Freeze to rigidize and remove ring from mold. Place ring on layup. Trim to fit as required.
	235	Place .042 spacer in web annular mold and wind mold full. Freeze to rigidize and remove ring from mold. Place ring on layup. Trim to fit as required.
	240	Wind 6 circs on cone mandrel. Freeze to rigidize and place on assembly Sta I to Sta K. Trim as required to fit.

USE REVERSE SIDE FOR ADDITIONAL INSTRUCTIONS

COMPLETION INITIALS & DATE	OPERATION NO.	INSTRUCTIONS NOTE: Prefix the operation F, M, or T, corresponding to the applicable Dept.
	245	Cut patterns and lay up 1 ply R/A Sta A to Sta C. Add 1 ply Sta A to Sta C. Add 3 plies Sta H to Sta J.
	250	Cut $\pm 45^\circ$ patterns. Lay up 1 ply +, 1 ply -, Sta A to Sta K. Lay up 1 ply +, 1 ply -, Sta A to Sta C. Lay up 2 plies +, 2 plies -, Sta H to Sta J.
	251	Inspect layup for cleanliness, fiber alignment, and conformance to drawing.
	255	Cover assembly with 1 ply 128-style unfinished peel/bleeder fiber glass. Bag in Capram vacuum bag. Place assembly in autoclave. Place 1 T/C on part, 1 T/C in air.
	260	Precompact part at 50 ± 5 psi x $190 \pm 10^\circ\text{F}$ x 2^{+1}_{-0} hrs. Identify and store pressure and temperature recorder charts.
	265	When assembly is cool, strip bag and bleeder materials.
	266	Inspect precompaction cure records. Inspect part.
	270	Sand assembly. Prepare for next layup. Prime surface with 4617 resin.
	275	Wind 3 circs Sta A to Sta G. Wind 1 circ Sta A to Sta C.
	280	Place Q028 spacer in flange annular mold and wind mold full. Freeze to rigidize and remove ring from mold. Place ring on layup. Trim to fit as required.

WHITTAKER CORPORATION
Research & Development Division

MASTER JOB TRAVELER HRD-002		MJO/WO No. 3025-002	Name of Item COMPOSITE WHEEL	
ROUTING INSTRUCTIONS: (Check One of Indicate Sequence by Numbers)			REQUESTED BY A. PRICE	EXT. 274
✓ or No.	ROUTE TO	DATE SUBMITTED	DATE REQUIRED	EST. ACT. HRS. HRS.
	Fabrication			
	Machine Shop			
	Test Lab.			

SPECIAL REQUIREMENTS, MATERIALS, INSTRUCTIONS:

TOOL CONTROL

Contract No.	Property of	Tool No.	MJO No.
COMPLETION INITIALS & DATE	OPERATION NO.	INSTRUCTIONS	
		Note: Prefix the operation No. with F, M, T, or T.C. corresponding to the applicable department.	
	285	Place 0.042 spacer in web annular mold and wind mold full.	
		Freeze to rigidize and remove ring from mold. Place ring	
		on layup. Trim to fit as required.	
	290	Wind 6 circs on cone mandrel. Freeze to rigidize and place on	
		assembly Sta I to Sta K Trim as required to fit.	
	295	Cut patterns and lay 2 R/A layers Sta A to Sta K. Place	
		1 additional layer Sta A to Sta B. Place 2 additional	
		layers Sta H to Sta J.	
	296	Inspect layup for cleanliness, fiber alignment, and conformance	
		to drawing.	
	300	Cover assembly with 1 ply 128-style unfinished peel/bleeder	
		fiber glass. Bag in Capram vacuum bag. Place assembly in	
		autoclave. Place 1 T/C on part, 1 T/C in air.	
	305	Precompact part at 50 ± 5 psi x 190 ± 10°F x 2 ⁺¹ ₋₀ hrs. Identify	
		and store pressure and temperature recorder charts.	

USE REVERSE SIDE FOR ADDITIONAL INSTRUCTIONS

COMPLETION INITIALS & DATE	OPERATION NO.	INSTRUCTIONS
		NOTE: Prefix the operation F, M, or T, corresponding to the applicable Dept
	310	When assembly is cool, strip bag and bleeder materials.
	311	Inspect precompaction cure records. Inspect part.
	315	Sand assembly. Prepare for next layup. Prime surface with 4617 resin.
	320	Wind 5 circo Sta A to Sta G.
	325	Place 0.028 spacer in flange annular mold and wind mold full. Freeze to rigidize and remove ring from mold. Place ring on layup. Trim to fit as required.
	330	Place 0.042 spacer in web annular mold and wind mold full. Freeze to rigidize and remove ring from mold. Place ring on layup. Trim to fit as required.
	335	Wind 6 circo on cone mandrel. Freeze to rigidize and place on assembly Sta I to Sta K. Trim as required to fit.
	340	Cut patterns and place 2 layers R/A Sta H to Sta J.
	345	Cut patterns and place 1 + , 1 -45° layer Sta H to Sta J.
	350	Place 0.042 spacer in web annular mold and wind mold full. Freeze to rigidize and remove ring from mold. Place ring on layup. Trim to fit as required.
	355	Cut patterns and place 2 layers R/A Sta H to Sta J.

WHITTAKER CORPORATION
Research & Development Division

MASTER JOB TRAVELER MJO/WO No. **3025-002** Name of Item **COMPOSITE WHEEL**
 RD-002

ROUTING INSTRUCTIONS:
 (Check One of Indicate Sequence by Numbers)

For No.	ROUTE TO	DATE SUBMITTED	DATE REQUIRED	EST. HRS.	ACT. HRS.
	Fabrication				
	Machine Shop				
	Test Lab.				

REQUESTED BY _____ EXT. _____

SPECIAL REQUIREMENTS, MATERIALS, INSTRUCTIONS:

TOOL CONTROL

Contract No. _____ Property of _____ Tool No. _____ MJO No. _____

COMPLETION INITIALS & DATE	OPERATION NO.	INSTRUCTIONS
	356	Inspect layup for cleanliness, fiber alignment, and conformance to drawing.
	360	Cover assembly with 1 ply 128-style unfinished peel/bleeder fiber glass. Bag in Capram vacuum bag. Place assembly in autoclave. Place 1 T/C on part, 1 T/C in air.
A	365	Precompact part at 50 ±5 psi x 190 ±10°F x 2 ⁺¹ ₋₀ hrs. Identify and store pressure and temperature recorder charts.
	370	When assembly is cool, strip bag and bleeder materials.
	371	Inspect precompaction cure records. Inspect part.
	375	Sand assembly. Prepare for next layup. Prime surface with 4617 resin.
	380	Cut patterns and place 1 layer R/A Sta H to Sta K.

A-11

32

USE REVERSE SIDE FOR ADDITIONAL INSTRUCTIONS

COMPLETION INITIALS & DATE	OPERATION NO.	INSTRUCTIONS NOTE: Prefix the operation F, M, or T, corresponding to the applicable Dept
	385	Cut patterns and place 1 + , 1 -45° layer Sta H to Sta J.
	390	Place 0.042 spacer in web annular mold and wind mold full. Freeze to rigidize and remove ring from mold. Place ring on layup. Trim to fit as required.
	395	Continue layup, alternating 4 plies R/A Sta I to Sta K and annular ring layup described in operation 90 to achieve proper thickness in accordance with drawing.
	396	Inspect layup for cleanliness, fiber alignment, and conformance to drawing.
	400	Cover assembly with 1 ply 128-style unfinished peel/bleeder fiber glass. Bag in Capram vacuum bag. Place assembly in autoclave. Place 1 T/C on part, 1 T/C in air.
	405	Final cure 2. ⁺¹ ₋₀ hrs x 190 ±10°F x 50 ±5 psig followed by 16 ±2 hrs x 325 ±10°F x 50 ±5 psig. Temperature changes at 1/2 °/min maximum.
	410	When assembly is cool, strip bag and bleeder materials.
	411	Inspect precompaction cure records. Inspect part.
	415	Machine wheel halves in accordance with drawing 4618.

WHITTAKER CORPORATION
Research & Development Division

MASTER JOB TRAVELER WRD-002	MJO/WO No. 3025-002	Name of Item COMPOSITE WHEEL
---------------------------------------	------------------------	--

ROUTING INSTRUCTIONS: (Check One of Indicate Sequence by Numbers)				REQUESTED BY A. PRICE	EXT. 274
✓ or No.	ROUTE TO	DATE SUBMITTED	DATE REQUIRED	EST. HRS.	ACT. HRS.
	Fabrication				
	Machine Shop				
	Test Lab.				

SPECIAL REQUIREMENTS, MATERIALS, INSTRUCTIONS:

TOOL CONTROL

Contract No.	Property of	Tool No.	MJO No.
--------------	-------------	----------	---------

COMPLETION INITIALS & DATE	OPERATION NO.	INSTRUCTIONS
		Note: Prefix the operation No. with F, M, T, or T.C. corresponding to the applicable department.
	416	Inspect wheel dimensionally, inspect for delamination, foreign material, etc. Assemble wheel, tighten bolts to 17 ft/lb, check for cracks, etc., around bolt bosses and in O-ring area.
	420	Install air valve insert. Bond using RTV silicone rubber adhesive. Drill hole in accordance with drawing.
	425	Install bearing cups, install aluminum hub in plastic wheel. Bond hub to inside wheel half, using EA 934 adhesive. Cure at R.T.
	426	Inspect metal components assembly.

USE REVERSE SIDE FOR ADDITIONAL INSTRUCTIONS

APPENDIX B

LOADS & DESIGN CRITERIA

INTRODUCTION

The composite military aircraft wheel will be designed to the loads and design criteria specified in this report. The loads are abstracted from Military Specification Mil-W-5013G, "Wheel and Brake Assemblies; Aircraft" and from U.S. Air Force Drawing No. 67J1951, "Wheel-Brake and Tire Assembly - Main Gear - Size 7.00-8/16 PR-Tubeless Type III". The numbers shown in parenthesis refer to paragraph numbers of Mil-W-5013G.

1.0 LOADS

1.1 STATIC LOADS

1.1.1 RADIAL LOAD (4.5.5)*

This load is less critical than combined loads and will not be used for design and analysis.

1.1.2 COMBINED LOADS (4.5.6)

LIMIT LOAD ~ SIDE LOAD = 5,933 LBS.

RADIAL LOAD = 14,832 LBS.

YIELD LOAD ~ SIDE LOAD = 6,823 LBS.

RADIAL LOAD = 17,057 LBS.

ULTIMATE LOAD ~ SIDE LOAD = 8,899 LBS.

RADIAL LOAD = 22,248 LBS.

1.1.3 PRESSURE

p OPERATING = 125 psi (MAX.)

p BURST = 440 psi

*PARAGRAPH NUMBERS IN M11-W-5013G

1.2 DYNAMIC LOADS

1.2.1 RADIAL LOAD ROLL TEST (4.5.8)

P
RADIAL = 6150 LBS }
L = 1400 MILES } WHEEL AT AMBIENT TEMPERATURE

1.2.2 COMBINED RADIAL - SIDE LOAD ROLL TEST

P
RADIAL = 6254 LBS

P
SIDE = 1564 LBS (ACTING INBOARD) WHEEL AT
AMBIENT TEMP.

L = 400 MILES

2.0 DESIGN CRITERIA

2.1 STATIC LOADS

The composite wheel will be designed to support the static loads listed in paragraph 1.1 above. Composite material allowable stresses will be established.