

ALUMINUM COMPANY OF AMERICA
P.O. BOX 2970 PITTSBURGH, PA. 15230
ALCOA TECHNICAL CENTER



AD 743518

May 8, 1972

NAVAL AIR SYSTEMS COMMAND
CONTRACT N00019-71-C-0131

FURTHER DEVELOPMENT OF ALUMINUM ALLOY X7050

Final Report

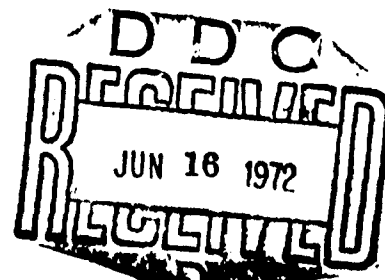

J. T. Staley
J. T. Staley
Project Engineer

5-9-72

J. P. Lyle, Jr.
J. P. Lyle, Jr.
Project Supervisor

5-16-72

H. Y. Hunsicker
H. Y. Hunsicker
Project Leader

5/17/72

APPROVED FOR PUBLIC RELEASE;
DISTRIBUTION UNLIMITED

THIS DOCUMENT IS SUBJECT TO SPECIAL EXPORT CONTROLS
AND EACH TRANSMITTAL TO FOREIGN GOVERNMENTS OR
FOREIGN NATIONALS MAY BE MADE ONLY WITH PRIOR
APPROVAL OF THE NAVAL AIR SYSTEMS COMMAND

FOREWORD

This report presents results of work sponsored by the U. S. Naval Air Systems Command under Contract N00019-71-C-0131. Mr. R. Schmidt administered the program. This report covers the period September 16, 1970 through February 15, 1972.

SYNOPSIS

Results of exposures of short-transverse specimens of X7050 plate in an inland industrial atmosphere and a seacoast atmosphere for up to 840 days were analyzed, and compared with results of similar exposures of 7075-T6 and 7079-T6 plate and with results of prior exposures in the 3.5% NaCl alternate immersion test. Alloy X7050 plate developed substantially higher resistance to stress-corrosion cracking than 7075-T6 and 7079-T6 plate of equal strength levels. A 30-day exposure in the 3.5% NaCl alternate immersion test appeared to be a conservative indication of atmospheric stress-corrosion resistance.

An X7050-T7352 hand forging and two X7050-T736 die forgings were fabricated, and properties were compared with those of 7075-T6 and 7079-T6 forgings. The X7050 forgings developed equal or higher strengths and fracture toughness, comparable fatigue strengths, and substantially higher resistance to stress-corrosion cracking.

Effects of isothermally aging X7050 plate at 300 F or 325 F and of preceding the age at 325 F by a pre-age at 250 F were determined. Aging conditions had no effect on the relationship between strength and notch-toughness, but preliminary results of atmospheric exposures suggest that isothermal aging at 325 F provided the best combination of strength and resistance to stress-corrosion cracking. Tests to verify the effects of isothermal aging were inconclusive because of the non-critical grain structure of the die forging used, so additional work is needed.

TABLE OF CONTENTS

	<u>Page</u>
FOREWORD	i
SYNOPSIS	ii
BACKGROUND AND OBJECTIVE	1
ANALYSIS OF ATMOSPHERIC EXPOSURE DATA.	2
Specimens Exposed During Contract N00019-69-C-0292.	2
Specimens Exposed During Contract N00019-70-C-0118.	6
FORGING EVALUATION	7
Hand Forging.	7
Alcoa Die 8457.	10
Alcoa Die 15093	12
PRECIPITATION HEAT TREATMENT INVESTIGATION	14
Plate	14
Alcoa Die 783	16
SUMMARY.	18
Specimens Exposed During Contract N00019-69-C-0292.	18
Specimens Exposed During Contract N00019-70-C-0118.	19
Forging Evaluation.	19
Precipitation Heat Treatment.	19
CONCLUSIONS.	20
RECOMMENDATIONS.	21
REFERENCES	22
TABLES	
FIGURES	
APPENDICES	
Appendix I, Percent Survival vs. Days in New Kensington NAVAIR Alloys	
Appendix II, Percent Survival vs. Days in A.I. Test NAVAIR Alloys	
Appendix III, Percent Survival vs. Days in A.I. and New Kensington, 7075 and 7079	
Appendix IV, Percent Survival vs. Short-Transverse Yield Strength	
Appendix V, Results of Grumman's Tests	

LIST OF TABLES

1. Results of Short-Transverse Stress-Corrosion Tests of Alloy NAVAIR 3 Exposed in the New Kensington Atmosphere
2. Results of Short-Transverse Stress-Corrosion Tests of Alloy NAVAIR 4 Exposed in the New Kensington Atmosphere
3. Results of Short-Transverse Stress-Corrosion Tests of Alloy NAVAIR 5 Exposed in the New Kensington Atmosphere
4. Results of Short-Transverse Stress-Corrosion Tests of Alloy NAVAIR 6 Exposed in the New Kensington Atmosphere
5. Results of Short-Transverse Stress-Corrosion Tests of Alloy NAVAIR 7 Exposed in the New Kensington Atmosphere
6. Results of Short-Transverse Stress-Corrosion Tests of Alloy NAVAIR 8 Exposed in the New Kensington Atmosphere
7. Results of Short-Transverse Stress-Corrosion Tests of Alloy NAVAIR 9 Exposed in the New Kensington Atmosphere
8. Results of Short-Transverse Stress-Corrosion Tests of Alloy NAVAIR 10 Exposed in the New Kensington Atmosphere
9. Results of Short-Transverse SCC Tests of Alloys Solution Heat Treated 24 Hours and Exposed in the New Kensington Atmosphere
10. Tensile Properties of X7050 Plate
11. Stress-Corrosion Test Schedule
12. Tensile Properties and Fracture Toughness of Six-Inch Thick Hand Forgings
13. Tensile Properties of X7050-T736, Alcoa Die 8457
14. Plane-Strain Fracture Toughness, K_{IC} , of X7050 and 7079 Forgings
15. Tensile Properties of Forging, Alcoa Die 15093
16. Average Tensile Properties of Forging, Alcoa Die 15093
17. Fracture Toughness of Forgings in Alcoa Die 15093
18. Stress-Corrosion Test Schedule for Forgings in Alcoa Die 15093

19. Stress-Corrosion Performance of 7075-T6 Forging in Alcoa Die 15093
20. Long-Transverse Tensile Properties and Electrical Conductivity of 2" Thick X7050 Plate
21. Short-Transverse Tensile Properties of 2" Thick X7050 Plate
22. Stress-Corrosion Performance 2" Plate (X7050) in 3.5% NaCl Alternate Immersion
23. Stress-Corrosion Performance 2" Plate (X7050) in 6% Boiling NaCl
24. Stress-Corrosion Performance 2" Plate (X7050) in Industrial Atmosphere
25. Chemical Analysis of X7050, Alcoa Die 783
26. Tensile Properties of X7050 Forging, Alcoa Die 783

LIST OF FIGURESFigure Number

- 1 Percent Survived vs. Days in New Kensington, 25 ksi Stress
- 2 Percent Survived vs. Days in New Kensington, 40 ksi Stress
- 3 Percent Survived vs. Days in New Kensington, 75% S-T Y.S. Stress
- 4 Percent Survived vs. Applied Stress, 840 Days New Kensington
- 5 Percent Survived in Accelerated and Natural Environments vs. Applied Stress
- 6 Percent Survived in Accelerated and Natural Environments vs. Applied Stress
- 7 Percent Survived After 840 Days in New Kensington Atmosphere
- 8 Percent Survived After 30 Days in 3.5% NaCl Alternate Immersion Test
- 9 Percent Survived vs Yield Strength of Plate
- 10 Compares Performances of Medium Thickness X7050 and 7075-T651 Plate
- 11 Compares Performances of Thick X7050 and 7079-T651 Plate
- 12 Relative SCC Performance in Seacoast Environment for 30 Months
- 13 Boeing Landing Gear Side Strut, Alcoa Die 8457
- 14 McDonnell-Douglas Nose Landing Gear Cylinder, Alcoa Die 15093
- 15 Orientation of Fracture Toughness Specimens
- 16 Fracture Toughness Specimen
- 17 Macrostructure of X7050-T736 Forging, Alcoa Die 8457
- 18 Smooth Fatigue Curve for X7050-T736

Figure Number

- 19 Notch Fatigue Curve for X7050-T736
- 20 Macrostructures of X7050-T736 Forging, Alcoa Die 15093
- 21 Macrostructures of 7075-T6 Forging, Alcoa Die 15093
- 22 Macrostructures of 7075-T73 Forging, Alcoa Die 15093
- 23 Die Bar Locations, Alcoa Die 15093
- 24 Bar Specimen
- 25 C-ring Used to Evaluate Stress-Corrosion of Die Forging 15093
- 26 Smooth Fatigue Curves for X7050-T736 Forging
- 27 Notch Fatigue Curves for X7050-T736 Forging
- 28 Smooth-Fatigue Data, X7050-T736 Die Forgings
- 29 Notch-Fatigue Data, X7050-T736 Die Forgings
- 30 Goodman Diagram for X7050-T7X Products, $K_t = 1$
- 31 Goodman Diagram for X7050-T736 Die Forgings, $K_t = 3$
- 32 Notch Tensile Specimen
- 33 Notch Toughness of X7050 Plate vs. Yield Strength
- 34 X7050 Forging, Alcoa Die 783
- 35 Aging Curves for X7050 Forging, Alcoa Die 783
- 36 Grain Structure of X7050 Forging, Alcoa Die 783

BACKGROUND AND OBJECTIVE

This investigation is an extension of work initiated under Contracts N00019-68-C-0146,¹ N00019-69-C-0292,² and N00019-70-C-0118.³ The object is to develop a high-strength aluminum alloy which has a high resistance to stress-corrosion cracking.

Results of work completed for Contract N00019-69-C-0292 indicated that alloys containing 5.8-7% Zn, 2.0-2.5% Mg, 2.1-2.5% Cu, 0.09-0.15% Zr, 0.12% max. Fe, and 0.10% max. Si developed an attractive combination of strength, resistance to stress-corrosion cracking based on 60-day 3.5% NaCl alternate immersion test results, hardenability in thick sections, and high short-transverse ductility. Results of work completed for Contract N00019-70-C-0118 confirmed that 1" to 6" thick plate of X7050 (previously MA15), an alloy within the composition range indicated above, demonstrated a better combination of strength, fracture toughness, and resistance to stress-corrosion cracking* than that possessed by established commercial aluminum alloy plate.

The object of this contract was threefold: (1) monitor and analyze performance of specimens exposed in the atmosphere during previous contracts, (2) produce forgings of X7050 for evaluation by Alcoa and by airframe manufacturers, and (3) investigate precipitation heat-treatment practice for X7050.

*Based on 84-day 3.5% NaCl alternate immersion test results and preliminary results of atmospheric exposure.

ANALYSIS OF ATMOSPHERIC EXPOSURE DATA

Specimens Exposed During
Contract N00019-69-C-0292

In this contract, alloys containing 5.8 to 7.4% Zn, 2.0 to 2.5% Mg, 2.1 to 2.7% Cu, with either separate or combined additions of Zr, Mn, and Cr were investigated as two-inch thick plate. Resistance to stress-corrosion cracking was evaluated using 1/8" diameter, short-transverse specimens exposed in the 3.5% NaCl alternate immersion test and in the industrial atmosphere at New Kensington, Pennsylvania. Because of the long exposure time needed to cause failure in a natural environment, results were analyzed on the basis of a 60-day exposure in the accelerated test.

Interpretation of these results was not straightforward because metallographic examination of many specimens which fractured during the 3.5% NaCl alternate immersion test revealed transgranular cracking emanating from sites of deep localized corrosion and did not reveal characteristic evidence of intergranular stress-corrosion cracking. Using results of metallographic examination and times to fracture as criteria, performances of stress specimens were categorized as follows:

1. Susceptible to Stress-Corrosion Cracking
2. Probably Resistant to Stress-Corrosion Cracking
3. Questionable Resistance to Stress-Corrosion Cracking

Based on this interpretation, Al-Zn-Mg-Cu-Zr alloys were selected for additional work which culminated in the development of alloy X7050. Alloys that contained Mn or Cr,

but did not contain Zr, were not investigated further because they appeared to develop a less attractive combination of properties.

Exposure time on the specimens exposed in the New Kensington atmosphere now exceeds two years, so the data were analyzed to determine if accelerated and natural environment tests ranked the alloys in the same manner.

Results of exposure in the New Kensington atmosphere of 1/8" diameter short-transverse orientation tensile specimens are presented in Table 1 through 9. Chemical analyses are also given in the tables.

Because of the large number of specimens exposed, over 700 in each environment, the data were conveniently analyzed using a "percent survival" basis. A computer was used to assist analysis of results as a function of test environment and duration, applied stress, yield strength, and heat treatment conditions. Specimens from plate aged 24 hours at 250 F were not included. Preliminary analysis of the data revealed that solution heat treatment practice had no effect on stress-corrosion performance. Consequently, results of material solution heat treated using different practices were combined.

Data from NAVAIR alloys 4, 6, 7, and 10 (X7050-type)* and NAVAIR alloys 3, 5, 8, and 9 (zirconium-free) were analyzed separately. Percent survival of specimens stressed to a given level was determined as a function of time in test

*Zr content of NAVAIR 10 exceeds limits of X7050 by 0.3% and Mn content of NAVAIR 7 exceeds limits of X7050 by 0.05%.

(Appendix I). Graphs relating survival percentage with time in the New Kensington atmosphere (Figures 1, 2, and 3) strongly indicate that performance of the X7050-type alloys exceeded performance of the NAVAIR alloys which did not contain zirconium.

The plot of percent survival versus applied stress in Figure 4 summarizes the data in Figures 1-3 after an exposure period of 840 days. This figure also reveals the superior performance of the X7050-type alloys.

Performance in the 3.5% NaCl alternate immersion test was also evaluated using a percent survival criterion (Appendix II). The plots in Figures 5 and 6 of applied stress versus percent survival after either 840 days in the New Kensington atmosphere or 30 days in the 3.5% NaCl alternate immersion test indicate that the accelerated test was more severe than the exposure in the natural environment.

Results of prior stress-corrosion tests on 1.75" to 3.0" thick 7075-T6 and T651 plate, 1.75" to 3.0" thick 7075-T73 and T7351 plate, and 2.0" to 5.0" thick 7079-T6 and 7079-T651 plate were analyzed for comparison (Appendix III). Percentages of specimens that survived either 30 days in the 3.5% NaCl alternate immersion test or 840 days in the New Kensington atmosphere were determined as a function of applied stress (Figures 7 and 8). Performance of the X7050-type alloy plate aged to short-transverse yield strengths comparable to strengths of 7075-T6 and 7079-T6 substantially exceeded performances of 7079-T6 and 7075-T6 plate in either environment. Performance of X7050-type plate at a

stress level of 25 ksi equaled that of 7075-T73 plate in both environments, but performance near 40 ksi was slightly lower in the natural environment and even lower in the accelerated test. Strength of the 7075-T73 plate, however, was about 7 ksi lower than strength of the 7075-T6 plate. These results confirm that X7050-type alloy plate develops a substantially more attractive combination of strength and resistance to stress-corrosion cracking than that available in commercial aluminum plate.

To enable comparisons of stress-corrosion performance at equal yield strengths, the following procedure was employed. Data were arranged in order of increasing short-transverse yield strength as in Appendix IV, Tables 1 and 2. Cumulative number of specimens that survived, S_{cum} , (starting at the highest strength) and cumulative number of specimens that failed, F_{cum} , (starting at the lowest strength) were determined. Cumulative percent survival, $S_{cum}/(S_{cum} + F_{cum}) \times 100$, was calculated and plotted on normal probability paper versus yield strength (Appendix IV, Figures 1 and 2), and a straight line which passed through the points was drawn.

Percent survival was calculated in this manner for NAVAIR 4, 6, 7, and 10 and NAVAIR 3, 5, 8, and 9 plate exposed for 840 days in the New Kensington atmosphere at stress levels of 25 ksi, 40 ksi, and 75% of yield strength. Results were compared with performances of 7075-T6, 7075-T73, and 7079-T6 plate. A summary of the data in Figure 9 illustrates the superior combination of strength and resistance to stress-corrosion cracking of the X7050-type alloy plate.

Specimens Exposed During
Contract N00019-70-C-0118

In this contract, 1", 2", 4", and 6" thick plate of an alloy subsequently registered as X7050 was fabricated and heat treated to three experimental tempers designated T6X1, T7X1, and T7X2. Tensile properties are repeated in Table 10 for easy reference. Specimens of this material along with specimens of 7075-T651 and 7079-T651 plate have been exposed in an inland industrial atmosphere and a seacoast atmosphere for between one and two years according to the schedule in Table 11.

Performances in the industrial atmosphere at New Kensington, Pennsylvania, are best illustrated by the graphs of applied stress versus failure time in Figures 10 and 11. The data in Figure 10 indicate that stress-corrosion performances of 1-2" thick X7050-T6X1 plate was the same as that of 0.8-2" thick 7075-T651 plate, while stress-corrosion performance of X7050-T7X1 plate exceeded that of 7075-T651 plate. No specimens of X7050-T7X2 plate failed. Figure 11 compares stress-corrosion behavior of 4-6" thick X7050 plate with behavior of 5" thick 7079-T6 plate. Performance of X7050-T6X1 plate exceeded that of 7079-T651 plate, and performance of X7050-T7X1 plate was even higher. No specimens of 4-6" thick X7050-T7X2 plate failed.

Because specimens are not monitored as regularly at our seacoast exposure station at Point Judith, R. I., as they are at New Kensington, Pennsylvania, stress-life curves are not an appropriate method of analysis. Performances can be

compared, however, by collating the percent survival versus applied stress. The data presented in Figure 12 indicate that the performance of X7050-T6X1 exceeded that of 7075-T651 (note that all 24 of the specimens of 7075-T651 had failed within 66 days). The performance of X7050-T7X2 approached that expected of 7075-T7351 from previous tests, and the performance of X7050-T7X1 was intermediate.

FORGING EVALUATION

Three forgings were selected:

1. Hand forging, 6" x 12" x 40"
2. Die forging. Boeing landing gear side strut. Alcoa die 8457 (Figure 13)
3. Die forging. McDonnell-Douglas nose landing gear cylinder. Alcoa die 15093 (Figure 14)

McDonnell-Douglas will evaluate the nose landing gear cylinder and will put some in service.

Grumman evaluated the hand forging and machined main landing gear uplock supports from 3-1/4" x 5-1/8" x 6-3/4" pieces sawed from the hand forging and installed them on eight A6 aircraft for service experience.

Alcoa evaluated the landing gear side strut and compared some properties of the hand forging and the other die forging with properties of standard alloy forgings.

Hand Forging

The 6" x 12" x 40" X7050 hand forging was heat treated to the T7352 temper at the Cleveland Forge Plant. It was solution heat treated at 890 F, quenched in water at 100 F maximum,

stress-relieved by compression in the 6" dimension, and aged 24 hours at 250 F followed by 8 hours at 350 F.

A 6" x 12" x 10" portion was removed for preliminary evaluation at the Alcoa Research Laboratories. Properties were compared with properties of a 6" x 12" x 36" 7079-T652 hand forging. Tensile properties were evaluated using duplicate longitudinal, long-transverse, and short-transverse specimens taken midway between forged surfaces. Fracture toughness in the transverse directions was evaluated using duplicate T-S and S-L compact fracture toughness specimens (Figures 15 and 16). Properties are presented in Table 12. Strength of the X7050-T7352 forging, especially the yield strength, exceeded that of the 7079-T652 forging, but elongation values in the transverse directions were lower than the elongation values for 7079-T652. Despite the lower elongation, K_{IC} values of X7050 in the transverse direction exceeded K_{IC} values of 7079-T652 by 10-25%.

Resistance to stress-corrosion cracking of the X7050 hand forging was evaluated using 1/8" diameter short-transverse specimens removed midway between forged surfaces and stressed as previously described.¹ Initially, duplicate specimens were stressed at 45, 40, 35, 30, and 25 ksi, and were exposed four days in a boiling aqueous solution of 6% NaCl. All specimens survived the test, so the forging was sent to Grumman.

Results of the evaluation by Grumman are presented in Appendix IV. Several differences between results of tests at Alcoa and at Grumman were observed. One difference was in the tensile properties. Strengths determined by Grumman were higher

than those determined by Alcoa, and test specimen location appears to be responsible. Whereas Alcoa removed specimens from the interior of the forging, Grumman removed specimens at various locations within the forging. Strengths of specimens taken from near the forged surfaces would probably be higher than strengths of specimens taken near the midplane of the forging because of the higher quench rate near the surface and because of differences in amount of work through the thickness.

Another difference is in fracture toughness. K_{IC} values determined at Alcoa were 3 to 4 ksi $\sqrt{\text{in.}}$ higher than those determined at Grumman. Specimen location may also have been responsible for this difference.

Stress-corrosion performances as determined at Alcoa and Grumman could not be compared initially because of difference in test procedures. Alcoa stressed specimens at 25 to 45 ksi and exposed them in a boiling 6% salt solution; Grumman stressed specimens at 51 and 57 ksi and exposed them in a 3.5% NaCl solution by alternate immersion. After results of Grumman's tests were reported, additional SCC tests were performed at Alcoa. Sets of duplicate 1/8" diameter specimens were stressed at 45 and 54 ksi and were exposed in a boiling 6% salt solution for 4 days. All specimens survived. In addition, sets of duplicate 1/8" diameter specimens were stressed at 35, 45, and 54 ksi and were exposed in the 3.5% NaCl alternate immersion test according to Federal Test Method 823. All specimens survived for 30 days, and the test is continuing. In comparison, specimens from the 7079-T652 forging that were stressed at 25 to 45 ksi failed in the alternate immersion test within two days.

Alcoa Die 8457

This forging was heat treated to the T736 temper by quenching into 150 F water from the solution heat treatment temperature of 890 F, followed by aging 24 hours at 250 F plus 12 hours at 350 F.

Tensile properties were evaluated using duplicate 1/2" diameter longitudinal specimens taken at the parting plane along the centerline of the forging at three locations and duplicate 1/8" diameter short-transverse specimens taken adjacent to the forged surface at the flange. Results (Table 13) reveal that properties were constant along the length of the forging. Strengths were comparable to strengths of 7079-T6 forgings.

Fracture toughness was determined using duplicate L-T and S-L orientation compact tension fracture toughness specimens taken midway between forged surfaces. Results are compared with results of previous tests of 7079-T6 forgings in Table 14. K_{IC} values exceeded those of 7079-T6 by 50%.

Resistance to stress-corrosion cracking was evaluated using 1/8" diameter tension specimens bisected by the parting plane and removed from the flange as closely as possible to the outer surface. Sets of duplicate specimens stressed at 25, 30, 35, 40, and 45 ksi survived the four-day exposure by continuous immersion in a boiling solution of 6% NaCl and 30-days exposure in the 3.5% NaCl alternate immersion test according to Federal Test Method 823. Grain configuration at the specimen location (Figure 17) is the type that usually provides a severe test of resistance to stress-corrosion cracking.

Fatigue performance was evaluated using smooth and notched ($K_t = 3$) longitudinal specimens axially stressed at a stress ratio (minimum stress/maximum stress) of 0.0. Stress-life curves are compared in Figures 18 and 19 with bands for alloy 7075 products. Fatigue strengths were comparable with those of 7075-T6 and 7075-T73.

Alcoa Die 15093

Properties of an X7050-T736 forging heat treated as previously described for the other X7050-T736 die forging were compared with properties of 7075-T6 and 7075-T73 forgings. Macrostructures of cross-sections of the barrel and a strut (Figures 20, 21, and 22) of the three forgings were comparable.

Results of tension tests of specimens taken from 26 locations (Figure 23) in the X7050-T736 die forging are compared in Table 15 with results of tests of specimens of the 7075-T6 and 7075-T73 forgings that were fabricated for comparison. Average properties are compared in Table 16. Average yield strength of the X7050-T736 forging equaled that of the 7075-T6 forging, while average tensile strength was 2 ksi lower. Average elongation values of the X7050-T736 forging exceeded average values of both 7075-T6 and 7075-T73 forgings.

The data were analyzed additionally by statistically comparing properties of the X7050-T736 forging with properties of a total of three 7075-T6 forgings. At the 95% confidence level, average yield strengths were not significantly different while the variance in yield strength of the X7050-T736 forging was

significantly lower than that of the 7075-T6 forgings. In addition, elongation values of the X7050-T736 forgings were significantly higher, while the variance in elongation was not significantly different from that of the 7075-T6 forgings.

Fracture toughnesses of the X7050-T736, 7075-T6, and 7075-T73 forgings were determined using duplicate L-T and T-L compact tension fracture toughness specimens and 0.10" thick tear specimens⁶ (Figure 24) from the barrel. Results (Table 17) indicate that X7050-T736 developed higher transverse toughness than 7075-T6 at comparable strength and developed transverse toughness equal to that of 7075-T73 at higher strength. Longitudinal toughness of X7050-T736 and 7075-T73 could not be determined because of specimen thickness limitation.

Stress-corrosion resistances of the X7050-T736, 7075-T6, and 7075-T73 forgings were determined using 1/8" diameter tension specimens taken across the parting plane of the forging in the barrel and in the struts and 5.4" diameter C-rings (Figure 25) stressed at the parting plane on the inside diameter (Table 18). Stress-corrosion performance in the 3.5% NaCl alternate immersion test according to Federal Test Method 823 (Table 19) confirms the low resistance to stress-corrosion cracking of the 7075-T6 forging. No specimens of either X7050-T736 or 7075-T73 have failed as of 32 days, and the test is continuing.

Axial fatigue characteristics were not determined on this forging because our standard specimen size could not be removed from the barrel. An X7050-T736 forging in Alcoa die

15093 that had not been bored prior to solution heat treatment was available, however, so fatigue tests were performed using specimens taken from the barrel. Stress-life curves for smooth and notched ($K_t = 3$) specimens tested at stress ratios of +0.5, 0.0, and -1.0 are presented in Figures 26 and 27, and data for the specimens tested at a stress ratio of 0.0 are presented in Figures 28 and 29 along with the data for die forging 8457. These data indicate that the smooth fatigue resistance is comparable with that of 7075-T6. Notch-fatigue resistance was at least as good as that of 7075-T6 and 7075-T73.

Fatigue performance of X7050 was initially surprising. Whereas current test results indicated that fatigue strengths of X7050 were no higher than fatigue strengths of 7075-T6, previous tests at the U. S. Navy Laboratory using 0.4 sq. in. cross-sectional area smooth specimens tested at a stress ratio of 0.25 indicated that fatigue strengths of X7050 plate substantially exceeded fatigue strengths of 7075-T651 and 7079-T651 plate.⁴

Results of the Navy's tests were compared with other tests to help resolve the apparent anomaly. Goodman diagrams were constructed (Figures 30 and 31) from Alcoa's tests on X7050-T736 in dies 8457 and 15093, from Grumman's tests on an X7050-T73 hand forging, and from the Navy's tests on X7050 plate. The data in Figure 30 strongly indicate that the performance of X7050 in all of the laboratories was comparable, regardless of specimen size. Results of similar analyses comparing fatigue performance of the 0.4 sq. in. cross-sectional area specimens of the 7075-T6

and 7079-T6 plate with prior Alcoa data, however, indicated that fatigue strengths determined by the Navy were lower than those determined at Alcoa.

Examination of other Navy tests⁵ on the same 7075-T651 and 7079-T651 plate indicates that relative sensitivity to fatigue specimen size may be the reason for the relative difference in performance of X7050 and the standard alloys. Although fatigue performances of the standard alloys in the 0.4 sq. in. area specimen size were below performances of the standard alloys in prior Alcoa tests (0.07 sq. in. area), fatigue performances of 0.04 sq. in. area specimens were comparable with prior Alcoa data. Moreover, fatigue strengths of 4.0 sq. in. area specimens were even lower than strengths of the 0.4 sq. in. area specimens. These Navy results strongly indicate that fatigue strengths of alloys 7075-T6 and 7079-T6 substantially decrease with increasing specimen size. Moreover, the work with X7050 indicates that this alloy is not sensitive to specimen size.

PRECIPITATION HEAT TREATMENT INVESTIGATION

Effects of isothermal precipitation heat treatment time at 300 F and 325 F and of second-step precipitation heat treatment time at 325 F after a first step of 24 hours at 250 F on tensile properties, notch toughness, and resistance to stress-corrosion of X7050 plate were determined. Effects of isothermal aging temperatures from 300 F to 360 F on tensile properties and resistance to stress-corrosion cracking of an X7050 die forging were also determined.

Plate

The 2" x 12" x 72" X7050 plate was solution heat treated at 890 F, quenched in water at room temperature, stretched 2%, then cut into 18 pieces 2" x 8" x 2-1/2". After 4 days at room temperature, 6 of these pieces were aged 24 hours at 250 F with no control on heating rate. Six days after quenching, five of these pieces along with six other pieces from the same plate were subsequently heated to 325 F at a constantly decreasing rate to simulate plant heating practices (5-1/2 hours to 315 F). Pieces were removed after periods ranging from 2 to 36 hours. The remaining pieces were heated to 300 F (6-1/2 hours to 290 F) five days after quenching and were removed after periods ranging from 4 to 128 hours.

Electrical conductivities were measured as previously described,¹ and long-transverse and short-transverse orientation tension and notch tension specimens (Figure 32) were removed from the mid-plane and tested. Tensile properties, notch toughness and electrical conductivities are presented in Tables 20 and 21, and notch-yield ratios are plotted versus yield strength in Figure 33. Toughness appeared to be related to the yield strength with relatively little dependence on difference in aging temperature or whether isothermal or stepped.

Resistance to stress-corrosion cracking of items having electrical conductivities of 35.6% I.A.C.S. or higher were determined. Sets of duplicate specimens were stressed at 25, 30, 35, 40, and 45 ksi and were exposed in the 3.5% NaCl alternate immersion test for 84 days, in a boiling 6% NaCl solution for 4 days, and in

the New Kensington atmosphere for 10 months where tests are continuing. New Kensington tap water and table grade salt were used in the accelerated tests. Results of the stress-corrosion tests are presented in Tables 22, 23, and 24.

Effects of precipitation heat treatment practice depended on test environment. Alternate immersion test data indicate that pre-aging at 250 F had no effect on resistance to stress-corrosion cracking of X7050 plate aged at 325 F; SCC performance of plate aged at 300 F was below that of plate aged to equal strength at 325 F. Results of the boiling salt solution test were inconclusive, but preliminary results of exposure in the atmosphere suggest that isothermal aging at 325 F provided the best combination of strength and resistance to SCC. Additional exposure time is needed to verify this indication.

Several specimens which fractured after 3 or more weeks exposure in the alternate immersion test were examined metallographically to determine if they exhibited the characteristic evidence of intergranular stress-corrosion cracking. Appearance appeared to be intermediate between the intergranular corrosion and intergranular cracking evident in fractured SCC specimens of 7075-T6 and the pitting corrosion and transgranular cracking evident in the infrequently observed fractures of 7075-T73 SCC specimens in aggressive accelerated tests.

Alcoa Die 783

A 9" diameter ingot was direct chill cast from a melt having the composition given in Table 25. After a 30-hour preheat

at 900 F, it was scalped to 8-1/2" in diameter, reheated to 825 F, and extruded to 2-5/8" diameter rod. Sections of the rod were reheated to 800 F and forged in Alcoa die 783 to the shape illustrated in Figure 34. These die forgings were solution heat treated 6 hours at 890 F and quenched in water at 80 F. The forgings were sawed in half in the transverse direction and were aged at 300 F to 360 F after 4 days at room temperature. Rate of heating to the precipitation heat treatment temperature was controlled at 50°F/hr.

Longitudinal tensile properties of all forgings were determined using duplicate 0.125" diameter specimens taken from the web. Short-transverse tensile properties of forgings having longitudinal yield strengths less than 85 ksi were subsequently determined using duplicate 0.125" diameter specimens from the flange centered on the parting plane and adjacent to the outer surface.

Results are presented in Table 26, and yield strengths are plotted versus log aging time in Figure 35. The aging reactions appeared to be isokinetic. The maximum yield strength developed after aging at any temperature was 88.25 ksi \pm 1.25 ksi, and the slopes of decreasing yield strength versus log aging time were the same for all aging temperatures.

Resistance to stress-corrosion cracking of those forgings which developed longitudinal yield strengths less than 85 ksi was subsequently determined. Ten 1/8" diameter short-transverse specimens were removed as closely as possible to the outer surface of the flange. Duplicate specimens were stressed at 25, 30, 35, 40, and 45 ksi and were exposed in the 3.5% NaCl alternate immersion test according to Federal Test Method 823. One specimen failed after 82 days at a stress level of 45 ksi, the remaining 143 specimens survived the 84-day exposure.

The SCC performance of this X7050 die forging was better than the performance of the X7050 plate examined in this investigation. This behavior was not anticipated because the grain flow in the rib-flange-type die forgings is usually more severe than the grain flow in plate. Cross sections of the die forging were examined metallographically to determine grain shape and orientation. This examination revealed that the grain flow at the SCC specimen location (Figure 36) was not typical of the grain flow in a similar location in a production rib-web-type forging, but was more like the grain flow in a thick hand forging. Consequently, the exceptional combination of strength and resistance to stress-corrosion cracking is attributed to this grain structure.

SUMMARY

Specimens Exposed During Contract N00019-69-C-C292

Initial work indicated that Al-Zn-Mg-Cu-Zr alloys containing at least 2% Cu developed an attractive combination of high strength, low quench sensitivity, and high fracture toughness. Resistance to stress-corrosion cracking, based on accelerated tests, was also indicated to be substantially higher than that of 7075-T6 and 7079-T6. Analysis during the current contract of results of stress-corrosion tests in a natural environment for periods greater than two years confirm that these alloys develop high resistance to stress-corrosion cracking when aged to the strength level of 7075-T6. This analysis also indicates that composition limits for Zn and Mn in

X7050 could be slightly increased without affecting resistance to stress-corrosion cracking. Previous work indicated, however, that increasing the amounts of these elements decreases toughness and increases quench sensitivity.²

Specimens Exposed During
Contract N00019-70-C-0118

Four thicknesses of X7050 plate were plant fabricated in three tempers. Stress-corrosion performances in an inland industrial atmosphere and a seacoast atmosphere for periods up to 640 days were compared with performances of 7075-T651 and 7079-T651 plate. Results confirm that X7050 developed a substantially better combination of strength and resistance to stress-corrosion cracking.

Forging Evaluation

An X7050-T7352 hand forging developed higher strength and substantially higher resistance to stress-corrosion cracking than 7079-T652 forgings and developed fracture toughness and fatigue strength comparable with the values for other high strength 7XXX aluminum alloys.

A heavy rib-web-type X7050-T736 forging developed strength equal to that of 7079-T6 forgings, substantially higher fracture toughness, and comparable fatigue strengths.

An X7050-T736 nose landing gear cylinder developed strength equal to that of 7075-T6, higher toughness, and comparable fatigue strengths.

Precipitation Heat Treatment

Based on preliminary results of atmospheric exposures,

X7050 plate isothermally aged at 325 F developed a more attractive combination of strength and resistance to stress-corrosion cracking than plate pre-aged at 250 F before the aging treatment at 325 F. Isothermal aging at 300 F provided a less attractive combination. Notch toughness was directly related to strength and was not affected by the aging conditions evaluated.

A laboratory-produced X7050 die forging developed an unusually attractive combination of high strength and resistance to stress-corrosion cracking. The high resistance to stress-corrosion cracking is attributed to the low directionality of the grain structure at the test specimen location.

CONCLUSIONS

1. Alloy X7050 plate aged to the strength levels of 7075-T6 and 7079-T6 plate developed substantially higher resistance to stress-corrosion cracking in accelerated and natural environments.
2. An X7050-T7352 hand forging and X7050-T736 die forgings having strengths equal to or higher than strengths of 7075-T6 and 7079-T6 forgings developed substantially higher resistance to stress-corrosion cracking in accelerated tests.
3. These X7050 forgings also developed fatigue strengths comparable to those of 7075-T6 and 7075-T73 and fracture toughness higher than that of 7079-T6 and 7075-T6.
4. Pre-aging X7050 plate at 250 F before aging at 325 F is not required, and may even be detrimental.

5. Fatigue performance of X7050 may not be as sensitive to specimen size as fatigue performance of 7075-T6 and 7079-T6.
6. A 30-day exposure in the alternate immersion test appears to be a conservative evaluation of resistance to stress-corrosion cracking of X7050 plate in the atmosphere.

RECOMMENDATIONS

1. Continue service trials of X7050.
2. Determine effects of aging conditions on X7050 using die forgings which have a high degree of grain directionality.
3. Develop heat treating practices for X7050 extrusions to develop optimum combination of strength and resistance to exfoliation corrosion and stress-corrosion cracking.
4. Continue surveillance of X7050 stress-corrosion specimens in natural environments.

REFERENCES

1. J. T. Staley. "Investigation to Improve the Stress-Corrosion Resistance of Aluminum Aircraft Alloys through Alloy Additions and Specialized Heat Treatment," Final Report under Naval Air Systems Command Contract N00019-68-C-0146, February 1969.
2. J. T. Staley, "Investigation to Develop a High-Strength, Stress-Corrosion Resistant Aluminum Aircraft Alloy," Final Report under Naval Air Systems Command Contract N00019-69-C-0292, January 1970.
3. J. T. Staley, "Investigation to Develop a High-Strength, Stress-Corrosion Resistant Naval Aircraft Alloy," Final Report under Naval Air Systems Command Contract N00019-70-C-0118, November 1970.
4. J. Viglione, "Fatigue Evaluation of X7050 Aluminum Alloy," Naval Air Development Center Report NADC-MA-7133, June 22, 1971.
5. J. Viglione, to be reported.
7. J. G. Kaufman and A. H. Knoll, "Tear Resistance of Aluminum Alloy Sheet as Determined from Kahn-Type Tear Tests." Materials Research and Standards, Vol. 4, No. 4, April 1964, p 151.

TABLE 1

**RESULTS OF SHORT-TRANSVERSE STRESS-CORROSION TESTS OF ALLOY
NAVAIR 3 EXPOSED IN THE NEW KENSINGTON ATMOSPHERE**

Code	Second Step Precipitation Heat Treatment	S-T Y.S. ksi	E.C. % IACS	Days to Fracture After Exposure at Indicated Stress Level		
				75% Y.S.	40 ksi	25 ksi
A	None	68.0	28.8	13,13	13,9	26,26
1E	3 hrs 350 F	74.2	34.8	19,26	49,49	125,112
1F	4 hrs 350 F	73.6	35.4	47,42	86,61	219,268
1G	6 hrs 350 F	70.6	36.6	335,211	294,384	OK,OK
1H	8 hrs 350 F	67.6	37.6	602,631	OK,OK	OK,OK
1I	10 hrs 350 F	63.9	38.1*	727,742	672,OK	OK,OK
1J	12 hrs 350 F	62.5	38.6*	OK,OK	OK,OK	OK,OK
2E	9 hrs 325 F	75.3	33.7	26,30	61,56	44,112
2F	12 hrs 325 F	74.9	34.5	26,30	42,86	56,278
2G	18 hrs 325 F	73.2	35.6	159,194	188,188	335,OK
2H	24 hrs 325 F	71.7	36.3	230,219	294,327	733,OK
2I	30 hrs 325 F	67.3	37.5*	700,OK	OK,OK	OK,OK
2J	36 hrs 325 F	66.9	37.8*	OK,OK	OK,OK	OK,OK

Specimen Number 367356

Solution treated 3 hrs at 890 F as two-inch thick plate and quenched in cold water.

Precipitation heat treated 24 hrs at 250 F after 4 days at room temperature.

Duplicate 1/8" diameter specimens exposed.

* = Estimated

OK = Specimen intact.

Exposure Date = 10/29/69

Exposure Time = 27 months

5.8 Zn, 2.4 Mg, 2.4 Cu, 0.3 Mn

TABLE 2

RESULTS OF SHORT-TRANSVERSE STRESS-CORROSION TESTS OF ALLOY
NAVAIR 4 EXPOSED IN THE NEW KENSINGTON ATMOSPHERE

Code	Second Step Precipitation Heat Treatment	S-T Y.S. ksi	E.C. % IACS	Days to Fracture After Exposure at Indicated Stress Level		
				75% Y.S.	40 ksi	25 ksi
A	None	68.3	30.3	13,30	26,30	82,72
1E	3 hrs 350 F	75.4	37.1	125,153	358,217	OK,OK
1F	4 hrs 350 F	75.8	37.8	201,224	273,730	OK,OK
1G	6 hrs 350 F	72.4	39.3	623,OK	OK,OK	OK,OK
1H	8 hrs 350 F	68.7	40.1	OK,OK	OK,OK	OK,OK
1I	10 hrs 350 F	64.6	40.7*	OK,OK	685,OK	OK,OK
1J	12 hrs 350 F	62.2	41.3*	OK,OK	OK,OK	OK,OK
2E	9 hrs 325 F	76.0	36.1	42,26	89,89	225,604
2F	12 hrs 325 F	75.4	36.9	79,42	117,226	327,OK
2G	18 hrs 325 F	72.6	38.3	259,273	631,OK	OK,OK
2H	24 hrs 325 F	71.2	39.1	335,376	659,OK	OK,OK
2I	30 hrs 325 F	68.5	39.9*	693,OK	OK,OK	OK,OK
2J	36 hrs 325 F	66.8	40.2*	OK,OK	OK,OK	OK,OK

Specimen Number 367357

Solution treated 3 hrs at 890 F as two-inch thick plate and quenched in cold water.

Precipitation heat treated 24 hrs at 250 F after 4 days at room temperature.

Duplicate 1/8" diameter specimens exposed.

* = Estimated

OK = Specimen intact

6.0 Zn, 2.5 Mg, 2.5 Cu, 0.1 Zr

Exposure Date = 10/29/69

Exposure Time = 27 months

TABLE 3

RESULTS OF SHORT-TRANSVERSE STRESS-CORROSION TESTS OF ALLOY
NAVAIR 5 EXPOSED IN THE NEW KENSINGTON ATMOSPHERE

Code	Second Step Precipitation Heat Treatment	S-T Y.S. ksi	E.C. % IACS	Days to Fracture After Exposure		
				At Indicated Stress Level	40 ksi	25 ksi
A	None	72.8	27.3	26,26	9,42	44,48
1E	3 hrs 350 F	79.7	33.5	72,44	100,121	659,790
1F	4 hrs 350 F	77.0	34.0	184,211	315,623	OK,OK
1G	6 hrs 350 F	72.0	35.6	609,287	OK,OK	OK,OK
1H	8 hrs 350 F	68.2	36.5	OK,OK	OK,OK	OK,OK
1I	10 hrs 350 F	63.2	37.4*	OK,OK	OK,OK	OK,OK
1J	12 hrs 350 F	60.7	38.0*	OK,OK	OK,OK	OK,OK
2E	9 hrs 325 F	76.9	33.5	47,42	14,91	659,659
2F	12 hrs 325 F	74.6	34.4	61,203	238,211	OK,OK
2G	18 hrs 325 F	68.8	35.8	586,OK	OK,OK	OK,OK
2H	24 hrs 325 F	67.3	36.6	OK,OK	OK,OK	OK,OK
2I	30 hrs 325 F	64.7	37.3*	OK,OK	685,OK	OK,OK
2J	36 hrs 325 F	62.4	37.9*	OK,OK	OK,OK	OK,OK

Specimen Number 367358

Solution treated 3 hrs at 890 F as two-inch thick plate and quenched in cold water.

Precipitation heat treated 24 hrs at 250 F after 4 days at room temperature.

Duplicate 1/8" diameter specimens exposed.

* = Estimated

OK = Specimen intact

Exposure Date = 10/29/69.

Exposure Time = 27 months

7.4 Zn, 2.2 Mg, 2.7 Cu, 0.35 Mn

TABLE 4

RESULTS OF SHORT-TRANSVERSE STRESS-CORROSION TESTS OF ALLOY
NAVAIR 6 EXPOSED IN THE NEW KENSINGTON ATMOSPHERE

Code	Second Step Precipitation Heat Treatment	S-T Y.S. ksi	E.C. % IACS	Days to Fracture After Exposure at Indicated Stress Level		
				75% Y.S.	40 ksi	25 ksi
A	None	65.1	30.5	26,26	42,42	49,117
1E	3 hrs 350 F	75.6	37.6	211,271	243,OK	OK,OK
1F	4 hrs 350 F	74.5	38.5	254,250	OK,OK	OK,OK
1G	6 hrs 350 F	69.3	40.1	OK,OK	OK,OK	OK,OK
1H	8 hrs 350 F	65.6	40.6	OK,OK	OK,OK	OK,OK
1I	10 hrs 350 F	59.8	41.3*	OK,OK	OK,OK	OK,OK
2E	9 hrs 325 F	75.8	37.6	198,254	278,637	OK,OK
2F	12 hrs 325 F	74.8	38.1	254,278	278,666	OK,OK
2G	18 hrs 325 F	71.9	39.5	OK,OK	OK,OK	OK,OK
2H	24 hrs 325 F	67.5	40.3	OK,OK	OK,OK	OK,OK
2I	30 hrs 325 F	63.4	40.9*	OK,OK	OK,OK	OK,OK

Specimen Number 367359

Solution treated 3 hrs at 890 F as two-inch thick plate and quenched in cold water.

Precipitation heat treated 24 hours at 250 F after 4 days at room temperature.

Duplicate 1/8" diameter specimen exposed.

* = Estimated.

OK = Specimen intact.

Exposure Date = 10/29/69

Exposure Time = 27 months

6.5 Zn, 2.1 Mg, 2.5 Cu, 0.1 Zr

TABLE 5

RESULTS OF SHORT-TRANSVERSE STRESS-CORROSION TESTS OF ALLOY
NAVAIR 7 EXPOSED IN THE NEW KENSINGTON ATMOSPHERE

Code	Second Step Precipitation Heat Treatment	S-T Y.S. ksi	E.C. % IACS	Days to Fracture After Exposure at Indicated Stress Level		
				75% Y.S.	40 ksi	25 ksi
A	None	70.0	28.5	42,42	42,26	91,91
1E	3 hrs 350 F	78.3	34.6	42,30	42,188	198,246
1F	4 hrs 350 F	77.4	35.3	112,61	91,173	252,637
1G	6 hrs 350 F	73.7	36.9	230,215	315,259	OK,OK
1H	8 hrs 350 F	70.4	37.5	671,623	671,698	OK,OK
1I	10 hrs 350 F	66.0	38.2*	OK,OK	OK,OK	OK,OK
1J	12 hrs 350 F	62.7	38.5*	OK,OK	OK,OK	OK,OK
2E	9 hrs 325 F	77.8	34.0	42,26	125,91	191,252
2F	12 hrs 325 F	76.6	34.7	42,42	194,252	340,OK
2G	18 hrs 325 F	73.8	36.5	233,213	238,595	OK,OK
2H	24 hrs 325 F	71.7	37.1	280,299	OK,OK	OK,OK
2I	30 hrs 325 F	68.3	37.8*	OK,OK	OK,OK	OK,OK
2J	36 hrs 325 F	67.6	38.3*	OK,OK	OK,OK	OK,OK

Specimen Number 367360

Solution treated 3 hrs at 890 F as two-inch thick plate and quenched in cold water.

Precipitation heat treated 24 hrs at 250 F after 4 days at room temperature.

Duplicate 1/8" diameter specimens exposed.

* = Estimated

OK = Specimen intact

6.7 Zn, 2.4 Mg, 2.4 Cu, 0.15 Mn, 0.1 Zr

Exposure Date = 10/29/69

Exposure Time = 27 months

TABLE 6

RESULTS OF SHORT-TRANSVERSE STRESS-CORROSION TESTS OF ALLOY
NAVAIR 8 EXPOSED IN THE NEW KENSINGTON ATMOSPHERE

Code	Second Step Precipitation Heat Treatment	S-T Y.S. ksi	E.C. % IACS	Days to Fracture After Exposure at Indicated Stress Level		
				75% Y.S.	40 ksi	25 ksi
A	None	58.2	30.1	9,9	13,26	26,47
1E	3 hrs 350 F	74.3	35.6	188,188	203,254	OK,OK
1F	4 hrs 350 F	71.7	36.5	243,254	275,OK	OK,OK
1G	6 hrs 350 F	65.8	37.6	OK,OK	OK,OK	OK,OK
1H	8 hrs 350 F	62.6	38.6	OK,OK	OK,OK	OK,OK
2E	9 hrs 325 F	73.9	35.1	30,215	177,502	OK,OK
2F	12 hrs 325 F	72.5	35.9	259,259	681,OK	OK,OK
2G	18 hrs 325 F	69.2	37.3	OK,OK	OK,OK	OK,OK
2H	24 hrs 325 F	67.2	38.1	OK,OK	OK,OK	OK,OK
2I	30 hrs 325 F	63.9	38.7*	OK,OK	OK,OK	OK,OK
2J	36 hrs 325 F	62.5	39.2*	OK,OK	OK,OK	OK,OK

Specimen Number 367361

Solution treated 3 hrs at 890 F as two-inch thick plate and quenched in cold water.

Precipitation heat treated 24 hrs at 250 F after 4 days at room temperature.

Duplicate 1/8" diameter specimens exposed.

* = Estimated

OK = Specimen intact

Exposure Date = 10/29/69

Exposure Time = 27 months

6.5 Zn, 2.1 Mg, 2.3 Cu, 0.15 Mn, 0.06 Cr

TABLE 7

RESULTS OF SHORT-TRANSVERSE STRESS-CORROSION TESTS OF ALLOY
NAVAIR 9 EXPOSED IN THE NEW KENSINGTON ATMOSPHERE

Code	Second Step Precipitation Heat Treatment	S-T Y.S. ksi	E.C. % IACS	Days to Fracture After Exposure at Indicated Stress Level		
				75% Y.S.	40 ksi	25 ksi
A	None	69.2	30.0	+26	44,26	61,44
1E	3 hrs 350 F	74.3	35.5	69,125	205,217	595,OK
1F	4 hrs 350 F	71.4	36.2	250,257	226,597	698,OK
1G	6 hrs 350 F	65.8	37.2	OK,OK	OK,OK	OK,OK
1H	8 hrs 350 F	63.2	37.9	730,OK	OK,OK	OK,OK
2E	9 hrs 325 F	77.0	33.7	42,42	121,56	180,243
2F	12 hrs 325 F	75.2	34.4	180,219	211,230	657,250
2G	18 hrs 325 F	70.8	35.8	257,580	OK,OK	OK,OK
2H	24 hrs 325 F	68.8	36.4	OK,324	OK,OK	OK,OK
2I	30 hrs 325 F	64.8	37.4*	OK,OK	OK,OK	OK,OK
2J	36 hrs 325 F	64.4	38.0*	OK,OK	OK,OK	OK,OK

Specimen Number 367362

Solution treated 3 hrs at 890 F as two-inch thick plate and quenched in cold water.

Precipitation heat treated 24 hours at 250 F after 4 days at room temperature.

Duplicate 1/8" diameter specimens exposed.

+ = Specimen broken before exposure began.

* = Estimated.

OK = Specimen intact.

Exposure Date = 10/29/59

Exposure Time = 27 months

6.8 Zn, 2.0 Mg, 2.1 Cu, 0.3 Mn

TABLE 8

RESULTS OF SHORT-TRANSVERSE STRESS-CORROSION TESTS OF ALLOY
NAVAIR 10 EXPOSED IN THE NEW KENSINGTON ATMOSPHERE

Code	Second Step Precipitation Heat Treatment	S-T Y.S. ksi	E.C. % IACS	Days to Fracture After Exposure at Indicated Stress Level		
				75% Y.S.	40 ksi	
A	None	71.7	29.7	19, 13	26, 42	51, 91
1E	3 hrs 350 F	77.7	37.0	93, 93	233, 254	OK, OK
1F	4 hrs 350 F	76.0	37.8	191, 250	522, 653	OK, OK
1G	6 hrs 350 F	72.2	39.3	618, 657	720, OK	OK, OK
1H	8 hrs 350 F	69.0	40.4	OK, OK	OK, OK	OK, OK
1I	10 hrs 350 F	64.6	41.0*	650, 714	OK, OK	OK, OK
1J	12 hrs 350 F	62.5	41.6*	OK, OK	OK, OK	OK, OK
2E	9 hrs 325 F	78.5	36.4	65, 93	105, 93	266, 631
2F	12 hrs 325 F	76.4	37.3	203, 121	211, 618	OK, OK
2G	18 hrs 325 F	73.6	39.0	215, 586	OK, OK	OK, OK
2H	24 hrs 325 F	72.0	39.9	701, 637	OK, OK	OK, OK
2I	30 hrs 325 F	68.4	40.6*	OK, OK	OK, OK	OK, OK
2J	35 hrs 325 F	67.1	41.2*	OK, OK	OK, OK	OK, OK

Specimen Number 367363
Solution treated 3 hrs at 890 F as two-inch thick plate and quenched in cold water.
Precipitation heat treated 24 hours at 250 F after 4 days at room temperature.
Duplicate 1/8" diameter specimens exposed.

* = Estimated

OK = Specimen intact.

Exposure Date = 10/29/69
Exposure Time = 27 months

7.0 Zn, 2.4 Mg, 2.3 Cu, 0.1 Zr

TABLE 9

RESULTS OF SHORT-TRANSVERSE S.C.C. TESTS OF ALLOYS SOLUTION HEAT TREATED 24 HRS AND EXPOSED IN THE NEW KENSINGTON ATMOSPHERE

Alloy	S. No.	Code	Second Step Precipitation Heat Treatment	S-T Y.S. ksi	E.C. % IACS	Days to Fracture After Exposure at Indicated Stress Level		
						75% Y.S.	40 ksi	25 ksi
NAVAIR 4	367357	24G	18 hrs 325 F	77.0	37.0	103,127	451,520	OK,OK
NAVAIR 4	367357	24I	30 hrs 325 F	71.6	37.7	298,565	OK,OK	OK,OK
NAVAIR 4	367357	24K	42 hrs 325 F	68.3	39.3	OK	OK,OK	OK,OK
NAVAIR 6	367359	24G	18 hrs 325 F	74.0	38.9	146,146	484,484	OK
NAVAIR 6	367359	24I	30 hrs 325 F	65.0	40.6	OK,OK	OK,OK	OK,OK
NAVAIR 6	367359	24K	42 hrs 325 F	62.3	41.3	OK,OK	OK,OK	OK,OK
NAVAIR 7	367360	24G	18 hrs 325 F	74.4	36.6	107,127	484,OK	571,OK
NAVAIR 7	367360	24I	30 hrs 325 F	70.4	37.0	383,OK	644,644	OK,OK
NAVAIR 7	367360	24K	42 hrs 325 F	65.8	38.2	741,OK	OK,OK	OK,OK
NAVAIR 8	367361	24G	18 hrs 325 F	71.3	36.9	248,300	484,OK	OK,OK
NAVAIR 8	367361	24I	30 hrs 325 F	66.1	37.9	OK,OK	OK,OK	OK,OK
NAVAIR 8	367361	24K	42 hrs 325 F	63.1	38.3	OK,OK	OK,OK	OK,OK
NAVAIR 9	367362	24G	18 hrs 325 F	71.9	35.8	55,59	101,148	591,OK
NAVAIR 9	367362	24I	30 hrs 325 F	66.1	37.1	707,741	OK,OK	OK,OK
NAVAIR 9	367362	24K	42 hrs 325 F	63.5	38.0	741	OK	OK,OK
NAVAIR 10	367363	24G	18 hrs 325 F	74.9	39.1	87,101	507,548	OK,OK
NAVAIR 10	367363	24I	30 hrs 325 F	69.2	40.2	600,OK	OK,OK	OK,OK
NAVAIR 10	367363	24K	42 hrs 325 F	66.4	40.8	OK,OK	OK,OK	OK,OK

Solution heat treated 24 hrs as two-inch thick plate and quenched in cold water.
Precipitation heat treated 24 hrs at 250 F after 4 days at room temperature.

Exposure Date = 12/5/69

Exposure Time = 26 months

TABLE 10
TENSILE PROPERTIES OF X7050 PLATE

Plate Thickness	Test Direction	T6X1			T7X1			T7X2					
		T.S. psi	Y.S. psi	% El. in 4D	R of A %	T.S. psi	Y.S. psi	% El. in 4D	R of A %	T.S. psi	Y.S. psi	% El. in 4D	R of A %
1"	L	89.4	84.1	11.8	28	83.0	75.0	14.5	38	78.5	69.0	15.0	42
	L-T	97.3	81.2	12.0	27	81.6	73.6	13.0	32	77.3	67.8	14.0	35
2"	L	87.7	82.4	12.0	23	81.0	74.3	13.0	28	76.2	67.0	14.0	24
	L-T	85.4	79.3	10.5	18	81.7	73.7	10.3	22	76.7	66.4	12.0	26
	S-T	85.0	73.3	7.2	N.D.	80.3	67.6	9.0	N.D.	75.2	61.5	9.0	N.D.
4"	L	81.7	78.8	12.0	24	77.6	71.8	12.0	30	73.5	65.4	14.0	34
	L-T	85.2	78.0	6.2	8	80.3	71.3	8.0	10	75.5	64.4	9.0	14
	S-T	82.7	72.9	5.0	4	77.7	67.0	4.9	7	73.1	61.4	7.1	8
6"	L	80.7	76.9	8.2	12	76.4	69.6	9.0	16	72.3	63.4	11.0	23
	L-T	82.1	74.3	3.0	4	78.0	67.7	5.0	5	73.6	61.2	8.0	12
	S-T	78.7	70.3	2.5	2	74.1	64.2	3.5	6	70.9	58.6	5.5	8

N.D. = not determined.

T6X1 temper = SHT, Quenched, Stretched, PHT 4 hrs. 250 F Plant, + PHT 4 hrs. 335 F lab.
T7X1 temper = SHT, Quenched, Stretched, PHT 4 hrs. 250 F + 9 hrs. 325-335 F Plant.
T7X2 temper = T7X1 temper plus 15 additional hours at 325 F in Lab.

Longitudinal and long-transverse direction properties are average of duplicate .505" dia. specimens taken from midplanes of 1" and 2" thick plate and from quarter-planes of 4" and 6" thick plate.

Short-transverse direction properties are average of duplicate .125" dia. specimens from 2" thick plate, .357" dia. specimens from 4" thick plate, and .505" dia. specimens from 6" thick plate.

TABLE 11

STRESS-CORROSION TEST SCHEDULE
NEW KENSINGTON, POINT JUDITH, AND 3.5% NaCl ALTERNATE IMMERSION

Material	Direction	Specimen Location†	Type	Number of Specimens Exposed in Each Environment at Indicated Stress Levels					
				Unst. ksi	25 ksi	30 ksi	40 ksi	50% Y.S.	
1" thick X7050 and .775" thick 7075-T651.	L & LT	M	1/8" dia.	2	0	0	0	3	0
	ST	M	"C" rings	0	0	3	3	3	0
2" thick X7050 and 2" thick 7075-T651	L	M	1/8" dia.	2	0	0	0	3	0
	L*	S	1/8" dia.	2	0	0	0	3	0
	LT	M	1/8" dia.	2	0	0	0	3	3*
	LT*	S	1/8" dia.	2	0	0	0	3	3
	ST	M	1/8" dia.	1-2**	0	3	3	3	0
4" and 6" thick X7050	L	M	1/8" dia.	2	0	0	0	3	0
	L*	S	1/8" dia.	2	0	0	0	3	0
	LT	M	1/8" dia.	2	0	0	0	3	3*
	LT*	S	1/8" dia.	2	0	0	0	3	3
	ST	M	1/8" dia.	1-2**	0	3	3	3	0
	ST*	M	1/4" dia.	2	0	3	3	3	0
5" thick 7079-T651††	L	M	1/8" dia.	0	0	0	0	3	3
	LT	M	1/8" dia.	0	0	0	0	3	3
	ST	M	1/8" dia.	2	3	3	0	3	0

† M = Midway between rolled surfaces, S = adjacent to rolled surface.

* X7050 in T6X1 and T7X1 tempers only to be tested.

All three tempers of X7050 to be tested identically if not otherwise indicated.

** Two specimens in A.I., one specimen in New Kensington and Point Judith.

†† 7079-T651 not exposed in Point Judith.

TABLE 12

TENSILE PROPERTIES AND FRACTURE TOUGHNESS OF
SIX-INCH THICK HAND FORGINGS

		950-T7352					7079-T652					
	Specimen Diameter	T.S. ksi	Y.S. ksi	% El In.	% R of	K _{IC} ksi/in.	Specimen Diameter	T.S. ksi	Y.S. ksi	% El in.	% R of A	K _{IC} ksi/in.
Longitudinal	0.500	74.2	66.0	13.5	34		0.500	73.5	62.2	14.2	23	
Long-Transverse	0.357	77.2	70.3	4.3	6		0.500	70.0	59.1	8.2	10	
Short-Transverse	0.501	74.1	62.4	4.2	4		0.500	72.0	58.5	8.7	10	
	0.357	75.6	65.3	4.0	4.5							
	0.125	74.8	62.4	9.0	N.D.							
T-S												23.3
S-L												18.0

TABLE 13

TENSILE PROPERTIES OF X7050 -T736
ALCOA DIE 8457

<u>Section Thickness</u>	<u>Specimen Orientation</u>	<u>T.S. ksi</u>	<u>Y.S. ksi</u>	<u>% El. in 4D</u>	<u>% R of A</u>
2"	L	69.9	61.7	14.5	35
4"	L	70.8	61.6	14.0	33
6"	L	71.2	62.4	13.3	32
Flange	ST	69.6	64.2	5.0	--

Results are average of duplicate specimens.

TABLE 14

PLANE-STRAIN FRACTURE TOUGHNESS, K_{Ic} , OF
X7050 AND 7079 FORGINGS

	L-T			S-L		
	Min.	Max.	Avg.	Min.	Max.	Avg.
X7050-T736†	43.1	44.1	43.6	26.2	26.8	26.5
7079-T652*	26.1	30.1	28	18.0	11.2	18

†Alcoa Die 8457.

*J. G. Kaufman, R. L. Moore, and P. E. Schilling,
"Fracture Toughness of Structural Aluminum Alloys,"
ASM Materials Engineering Congress, October 14, 1969.

5 lots of 7079 tested in L-T; 3 lots tested in S-L.

TABLE 15

TENSILE PROPERTIES OF DIE FORGING NO. 15093

Test Location	X7050-T736				7075-T6				7075-T73			
	T.S. ksi	Y.S. ksi	% El in 4D	% R of A	T.S. ksi	Y.S. ksi	% El in 4D	% R of A	T.S. ksi	Y.S. ksi	% El in 4D	% R of A
1	76.3	68.2	14.3	30	80.5	69.9	13.6	23	74.3	63.4	12.1	25
2	78.3	70.6	15.0	41	81.0	71.9	14.0	21	72.0	61.4	14.5	35
3	79.0	71.2	15.5	40	76.8	66.2	14.0	27	69.4	58.8	13.0	32
4	77.7	69.3	14.3	36								
5	75.0	66.0	14.0	12	74.0	66.9	6.0	9	71.1	62.1	9.0	15
6	76.7	67.6	13.0	19	81.3	72.8	13.0	20	71.6	62.1	10.5	18
7	75.9	67.6	15.0	36	77.6	66.2	12.9	22	69.8	58.1	12.9	29
8	76.4	67.8	14.3	36	80.3	69.4	10.0	15	72.5	60.6	13.6	33
9	76.8	68.0	17.1	43	81.9	70.4	12.1	19	69.6	57.6	13.6	34
10	77.2	68.9	13.6	32	76.2	63.9	17.1	32	71.3	59.8	13.6	32
11	75.8	66.6	9.0	9	76.1	66.4	7.5	9	72.5	63.1	7.0	6
12	76.2	66.6	9.0	12	78.1	68.7	7.0	8	68.5	58.6	8.0	11
13	74.0	66.7	10.7	26	78.1	65.7	14.3	21	69.7	57.9	13.6	28
14	75.8	66.0	13.0	24	76.9	65.4	12.0	18	71.6	60.6	14.0	29
15	76.8	67.5	12.0	20	75.0	63.8	12.0	17	71.6	60.6	12.5	29
16	77.9	69.7	14.3	35								
17	77.1	69.0	15.0	40	83.0	72.2	14.3	21	74.6	63.6	13.6	32
18	76.3	68.7	14.3	34	82.3	72.4	12.9	18	72.9	61.9	13.6	33
19	76.8	67.9	12.0	29	78.9	70.2	5.5	8	73.0	64.9	8.0	14
20	75.6	67.2	6.0	6	78.3	70.1	6.0	9	71.9	63.4	7.0	11
21	71.2	66.7	3.0	5								
22	72.8	66.5	4.0	4								
23	76.0	66.9	9.0	14	76.9	70.1	4.5	6	71.0	62.3	7.5	12
24	76.5	68.7	7.1	8	76.3	66.7	5.0	4	70.4	60.6	7.1	9
25	77.2	69.3	6.4	7	75.6	66.0	5.0	8	69.5	59.4	6.4	9
26	77.1	70.0	5.0	8	77.6	67.0	5.0	8	70.0	59.3	6.4	9

TABLE 16

AVERAGE TENSILE PROPERTIES OF DIE FORGING NO. 15093

	<u>X7050-T736</u>		<u>7075-T6</u>		<u>7075-T73</u>	
	<u>T.S.</u> <u>ksi</u>	<u>Y.S.</u> <u>ksi</u>	<u>T.S.</u> <u>ksi</u>	<u>Y.S.</u> <u>ksi</u>	<u>T.S.</u> <u>ksi</u>	<u>Y.S.</u> <u>ksi</u>
L*	76.6	68.2	78.4	67.3	71.2	59.9
T†	76.0	67.9	78.2	69.1	71.4	61.8
		14.0		13.2		13.3
		9.7		7.6		8.7

*L = Test bar locations 1,2,3,7,8,9,12,13,14,15

†T = Remaining test bar locations

TABLE 17

FRACTURE TOUGHNESS OF FORGINGS IN DIE 15093

<u>Alloy</u>	<u>Temper</u>	<u>S. No.</u>	<u>Specimen Orientation</u>	<u>K_{IC}</u>	<u>Tear Properties</u>		
					<u>Tear Str. ksi</u>	<u>Tear Str. T.Y.S. in.-lb/in.²</u>	<u>U.P.E. in.-lb/in.²</u>
X7050	T736	412850	L-T	*	77.9	1.15	†
			T-L	19.0	0.77	100	
7075	T6	405619	L-T	29.2	70.5	1.01	†
			T-L	17.5	38.1	0.56	55
7075	T73	405620	L-T	*	76.6	1.30	†
			T-L	19.0	45.2	0.74	70

<u>Alloy</u>	<u>Temper</u>	<u>S. No.</u>	<u>Specimen Orientation</u>	<u>Notch Toughness</u>		
				<u>NTS ksi</u>	<u>NTS/TYS</u>	<u>U.P.E.</u>
X7050	T736	412850	L	70.9	1.40	
			S-T	72.0	1.03	
7075	T6	405619	L	69.1	1.31	
			S-T	70.2	0.66	
7075	T73	405620	L	60.1	1.40	
			S-T	61.4	0.86	

*K_Q not valid K_{IC} because specimen was not thick enough.

U.P.E. = unit crack propagation energy.

†Diagonal fractures, U.P.E. could not be determined.

TABLE 18

STRESS-CORROSION TEST SCHEDULE FOR
FORGINGS IN ALCOA DIE 15093

Test Stress ksi	X7050-T736			7075-T6			7075-T73		
	Barrel C-rings	Barrel 1/8" bars	Strut 1/8" bars	Barrel C-rings	Barrel 1/8" bars	Strut 1/8" bars	Barrel C-rings	Barrel 1/8" bars	Strut 1/8" bars
5	0	0	0	1	0	1	0	0	0
10	0	0	0	0	1	1	0	0	0
15	0	0	0	1	1	1	0	0	0
20	0	0	1	0	1	1	0	0	0
25	2	2	1	1	1	1	2	0	0
30	0	2	1	0	0	1	0	0	0
35	1	2	1	0	0	0	2	0	0
40	0	2	1	0	0	0	0	0	0
42	0	0	0	0	0	0	0	0	3
45	1	2	1	0	0	0	2	0	0
75% YS	0	0	0	0	0	0	0	2	3

Indicated number of specimens exposed in the following environments:

- 1.) 3.5% NaCl alternate immersion test according to Federal Test Method 823
- 2.) Inland industrial atmosphere at New Kensington, Pennsylvania
- 3.) Seacoast environment at Point Judith, R. I.

TABLE 19

STRESS-CORROSION PERFORMANCE OF
7075-T6 FORGINGS, ALCOA DIE 15093

Stress ksi	Days to Fail		
	Barrel C-ring	Barrel 1/8" bars	Strut 1/8" bars
30	N.T.	N.T.	18
25	OK	2	32
20	N.T.	2	OK
15	OK	OK	OK
10	N.T.	OK	OK
5	OK	N.T.	OK

S.No. 405619

Single specimens exposed in the 3.5% NaCl alternate immersion test according to Federal Test Method 823

OK = Survived 32 days.

N.T. = No test.

TABLE 20

LONG-TRANSVERSE TENSILE PROPERTIES AND ELECTRICAL CONDUCTIVITY OF 2" THICK X7050 PLATE

S-No.	Aging Practice	Electrical Conductivity		Tensile Properties			Notch Toughness	
		% I.A.C.S.	ksi	T.S. ksi	Y.S. ksi	EL %	T.S.	N.T.S.
399177-1	4 Hrs 300F	32.0	81.6	70.0	13.0	97.0	1.39	
-2	8 Hrs 300F	32.2	82.8	74.4	10.5	95.4	1.28	
-3	16 Hrs 300F	34.9	84.1	74.8	10.0	97.8	1.31	
-4	32 Hrs 300F	36.6	80.3	71.2	10.5	98.8	1.39	
-5	64 Hrs 300F	39.3	78.8	69.1	10.0	96.6	1.40	
-6	128 Hrs 300F	41.0	75.8	65.7	12.0	97.0	1.48	
399178-1	2 Hrs 325F	53.4	81.2	70.6	15.5	96.1	1.36	
-2	4 Hrs 325F	34.9	83.6	75.2	12.0	98.4	1.31	
-3	8 Hrs 325F	36.5	83.6	74.7	10.0	92.4	1.24	
-4	18 Hrs 325F	40.0	83.3	75.2	10.5	94.8	1.26	
-5	24 Hrs 325F	40.5	80.2	71.2	11.0	96.5	1.36	
-6	36 Hrs 325F	41.6	76.9	67.3	13.0	96.3	1.43	
399179-1	24 Hrs 250F	31.4	82.3	74.3	12.0	99.6	1.34	
-2	24 Hrs 250F + 4 Hrs 325F	35.1	82.2	75.0	11.0	93.4	1.25	
-3	24 Hrs 250F + 8 Hrs 325F	37.0	82.2	74.9	11.5	97.2	1.30	
-4	24 Hrs 250F + 18 Hrs 325F	39.9	78.9	70.8	11.0	94.8	1.34	
-5	24 Hrs 250F + 24 Hrs 325F	40.5	77.7	69.0	11.0	96.2	1.39	
-6	24 Hrs 250F + 36 Hrs 325F	41.6	74.2	64.2	11.0	95.5	1.49	

Properties are average of duplicate long-transverse

TABLE 21
SHORT-TRANSVERSE TENSILE PROPERTIES OF
2" THICK X7050 PLATE

S-No.	Aging Practice	Tensile Properties			Notch Toughness	
		T.S. ksi	Y.S. ksi	EL %	Notched T.S., ksi	N.T.S. Y.S.
399177-4	32 Hrs 300F	85.4	73.2	8.0	82.0	1.12
-5	64 Hrs 300F	82.1	68.3	8.0	84.4	1.24
-6	128 Hrs 300F	77.0	64.6	9.0	88.2	1.36
399178-4	18 Hrs 325F	81.2	69.2	9.0	82.8	1.20
-5	24 Hrs 325F	79.7	67.3	8.0	86.6	1.29
-6	36 Hrs 325F	75.6	63.1	9.0	87.7	1.39
399179-3	24 Hrs 250F + 8 Hrs 325F	83.5	72.4	7.0	79.2	1.09
-4	24 Hrs 250F + 18 Hrs 325F	79.8	69.0	6.0	84.2	1.22
-5	24 Hrs 250F + 24 Hrs 325F	78.2	67.3	8.0	85.4	1.27
-6	24 Hrs 250F + 36 Hrs 325F	76.2	63.6	9.0	85.8	1.35

Properties are average of duplicate short-transverse specimens.

TABLE 22

STRESS-CORROSION PERFORMANCE 2" PLATE (X7050)
IN 3.5% NaCl ALTERNATE IMMERSION

S. No.	Aging Practice	S.T. Y.S. ksi	E.C. % IACS	Life in Days After Exposure at Indicated Stress Level									
				25 ksi	30 ksi	35 ksi	40 ksi	45 ksi					
399177-4	32 hrs 300 F	71.2	36.6	17	15	15	13	13	7	4			
399177-5	64 hrs 300 F	69.1	39.3	57	76	15	28	15	OK	13	26	8	3
399177-6	28 hrs 300 F	65.7	41.0	OK	OK	29	76	45	67	32	67	42	70
599178-4	18 hrs 325 F	75.2	40.0	OK	OK	17	18	12	17	18	39	17	84
399178-5	24 hrs 325 F	71.2	40.5	77	OK	OK	OK	73	65	26	28	18	26
399178-6	36 hrs 325 F	67.3	41.6	OK	OK	OK	OK	OK	OK	OK	OK	OK	OK
399179-3	24 hrs 250 F + 8 hrs 325 F	74.9	37.0	12	17	15	17	15	17	17	17	17	15
399179-4	24 hrs 250 F + 18 hrs 325 F	70.8	39.9	72	OK	67	OK	45	61	OK	67	31	41
399179-5	24 hrs 250 F + 24 hrs 325 F	69.0	40.5	OK	OK	OK	OK	OK	OK	OK	OK	76	65
399179-6	24 hrs 250 F + 36 hrs 325 F	64.2	41.6	OK	OK	OK	OK	OK	OK	OK	OK	OK	OK

Duplicate 1/8" diameter short-transverse specimens exposed at each stress level.

OK - Survived 84 days exposure.

TABLE 23

STRESS-CORROSION PERFORMANCE 2" PLATE (X7050)
IN 6% BOILING NaCl

S. No.	Aging Practice	S.T. Y.S. ksi	E.C. % IACS	Life in Days After Exposure at Indicated Stress Level					
				25 ksi	30 ksi	35 ksi	40 ksi	45 ksi	
399177-4	32 hrs 300 F	71.2	36.6	2	2	1	2	2	1
399177-5	64 hrs 300 F	69.1	39.3	4	2	3	2	1	3
399177-6	128 hrs 300 F	65.7	41.0	3	4	OK	3	OK	2
399178-4	18 hrs 325 F	75.2	40.0	OK	OK	OK	4	3	3
399178-5	24 hrs 325 F	71.2	40.5	OK	3	4	OK	1	3
399178-6	36 hrs 325 F	67.3	41.6	OK	OK	OK	1	OK	3
399179-3	24 hrs 250 F + 8 hrs 325 F	74.9	37.0	1	4	3	1	1	2
399179-4	24 hrs 250 F + 18 hrs 325 F	70.8	39.9	OK	OK	4	2	3	3
399179-5	24 hrs 250 F + 24 hrs 325 F	69.0	40.5	OK	OK	OK	4	OK	2
399179-6	24 hrs 250 F + 36 hrs 325 F	64.2	41.6	OK	OK	OK	2	3	OK

Duplicate 1/8" diameter short-transverse specimens exposed at each stress level.

OK - Survived 4-day exposure.

TABLE 24

STRESS-CORROSION PERFORMANCE 2" PLATE (X7050)
IN INDUSTRIAL ATMOSPHERE

S. No.	Aging Practice	S.T. Y.S. ksi	E.C. % IACS	Life in Days After Exposure at Indicated Stress Level				
				25 ksi	30 ksi	35 ksi	40 ksi	45 ksi
399177-4	32 hrs 300 F	71.2	36.6	OK, 264	175, 194	97, 145	127, 79	62, 105
399177-5	64 hrs 300 F	69.1	39.3	OK OK	OK OK	OK OK	OK OK	237, 252
399177-6	128 hrs 300 F	65.7	41.0	OK OK	OK OK	OK OK	OK OK	OK OK
399178-4	18 hrs 325 F	75.2	40.0	OK OK	OK OK	OK OK	OK OK	OK OK
399178-5	24 hrs 325 F	71.2	40.5	OK OK	OK OK	OK OK	OK OK	OK OK
399178-6	36 hrs 325 F	67.3	41.6	OK OK	OK OK	OK OK	OK OK	OK OK
399179-3	24 hrs 250 F + 8 hrs 325 F	74.9	37.0	OK OK	105 OK	OK OK	127, 83	78, 71
399179-4	24 hrs 250 F + 18 hrs 325 F	70.8	39.9	OK OK	OK OK	OK OK	OK OK	OK OK
399179-5	24 hrs 250 F + 24 hrs 325 F	69.0	40.5	OK OK	OK OK	OK OK	OK OK	OK OK
399179-6	24 hrs 250 F + 36 hrs 325 F	64.2	41.6	OK OK	OK OK	OK OK	OK OK	OK OK

Duplicate 1/8" diameter short-transverse specimens exposed at each stress level.

OK = Survived in New Kensington atmosphere for 10 months.

TABLE 25

CHEMICAL ANALYSIS OF X7050 FORGED IN
ALCOA DIE 783

<u>Zn</u>	<u>Mg</u>	<u>Cu</u>	<u>Zr</u>	<u>Cr</u>	<u>Mn</u>	<u>Fe</u>	<u>Si</u>	<u>Ti</u>	<u>B</u>
5.9	2.06	2.4	.12	.02	.00	.04	.05	.02	.003

TABLE 26

TENSILE PROPERTIES OF X7050 FORGING
ALCOA DIE 783

S. No.	Aging Time, hrs	Aging Temp., °F	Longitudinal		Short Transverse			
			T.S. ksi	Y.S. ksi	El., %	T.S. ksi	Y.S. ksi	El., %
404779-1	5.5	300	92.5	85.9	14.0			
	12	300	92.0	86.7	16.0			
	33	300	91.6	87.0	16.0			
	86	300	82.4	75.4	16.0	76.9	70.0	14.0
	140	300	80.0	72.2	16.0	75.1	67.0	12.0
	230	300	72.0	61.6	16.0	67.8	57.2	16.0
404780-1	1.5	320	95.4	87.9	16.0			
	4	320	94.9	89.5	16.0			
	10	320	93.6	88.6	14.0			
	27	320	88.7	83.0	16.0	81.2	75.0	8.0
	42	320	80.8	72.4	16.0	75.1	67.0	13.0
	34	320	73.8	63.4	16.0	69.2	58.8	14.0
404781-1	0.5	340	93.9	89.4	17.0			
	2	340	91.3	87.0	17.0			
	3.5	340	91.6	87.3	18.0			
	8	340	85.2	78.8	16.0	79.8	73.8	12.0
	14	340	78.8	70.8	16.0	72.0	63.9	12.0
	24	340	74.4	64.7	16.0	70.9	60.8	15.0
404782-1	0.5	360	92.8	88.8	17.0			
	1	360	91.0	87.2	16.0			
	2	360	89.8	85.0	16.0			
	3	360	87.4	81.7	16.0	80.4	74.0	15.0
	4.5	360	81.6	73.6	16.0	74.8	66.6	13.0
	7.5	360	76.6	67.1	16.0	71.8	62.4	14.0

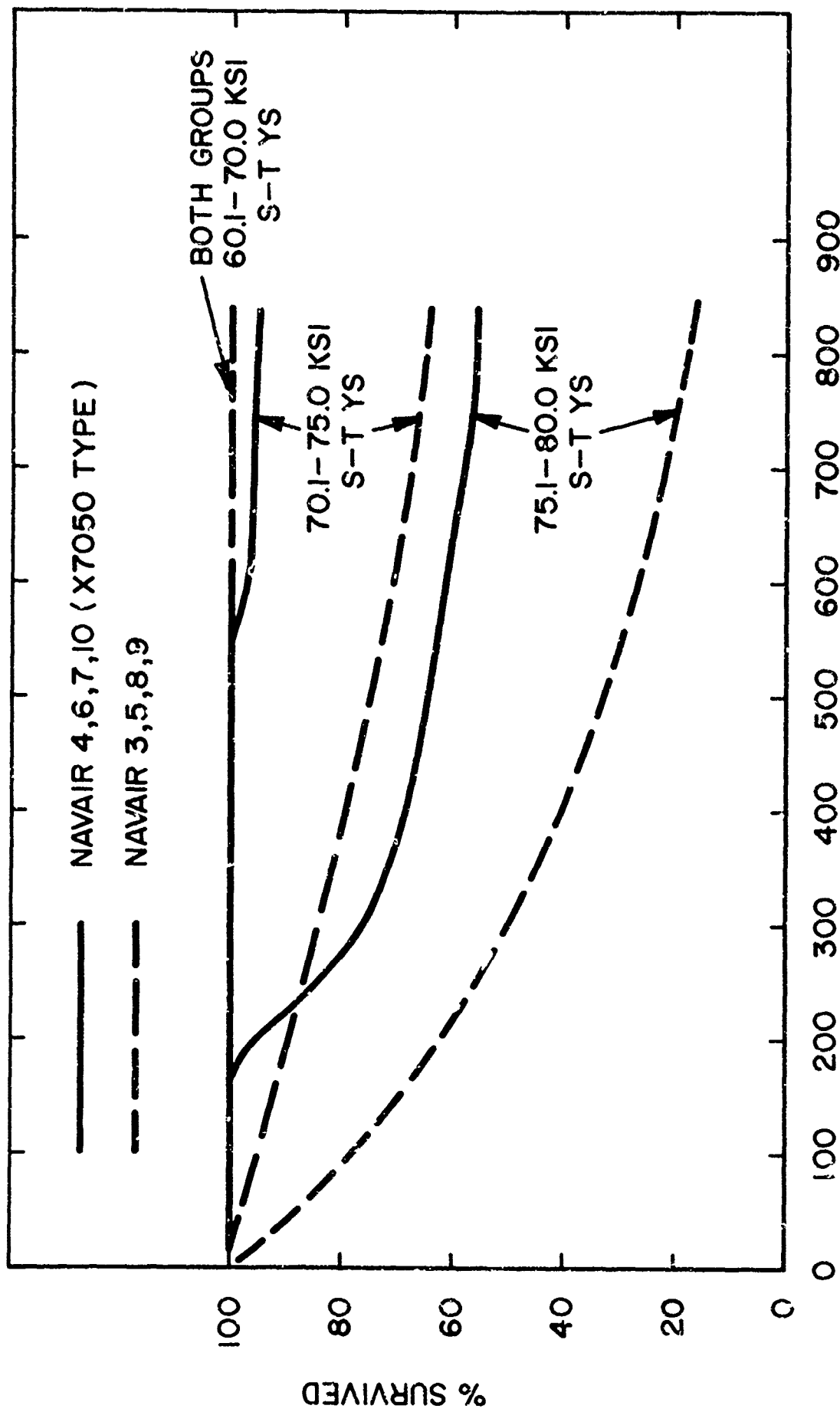

DAYS IN INDUSTRIAL ATMOSPHERE

FIG.1 % SURVIVED VS DAYS IN NEW KENSINGTON, 25 KSI STRESS

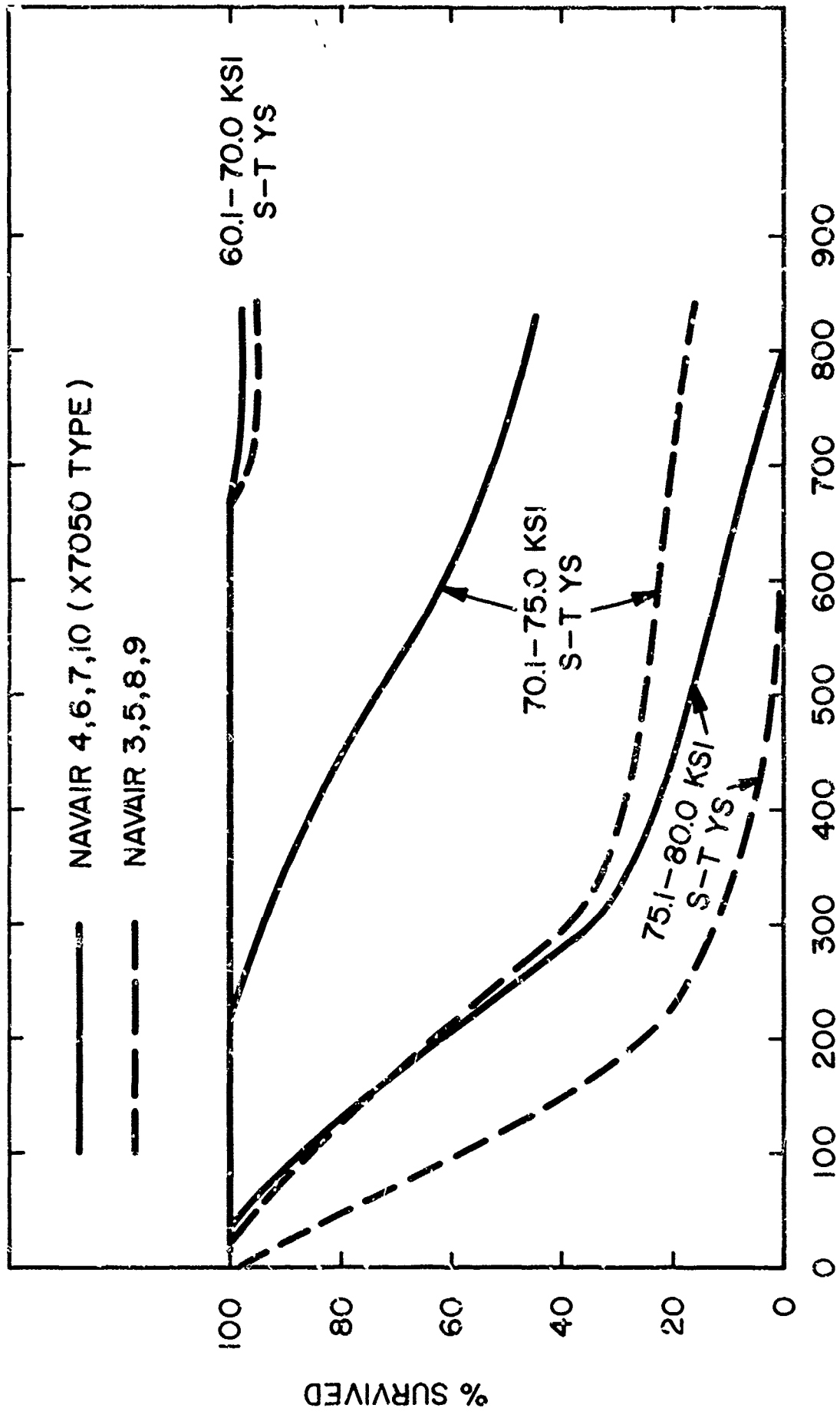

FIG. 2 % SURVIVED VS DAYS IN NEW KENSINGTON, 40 KSI STRESS

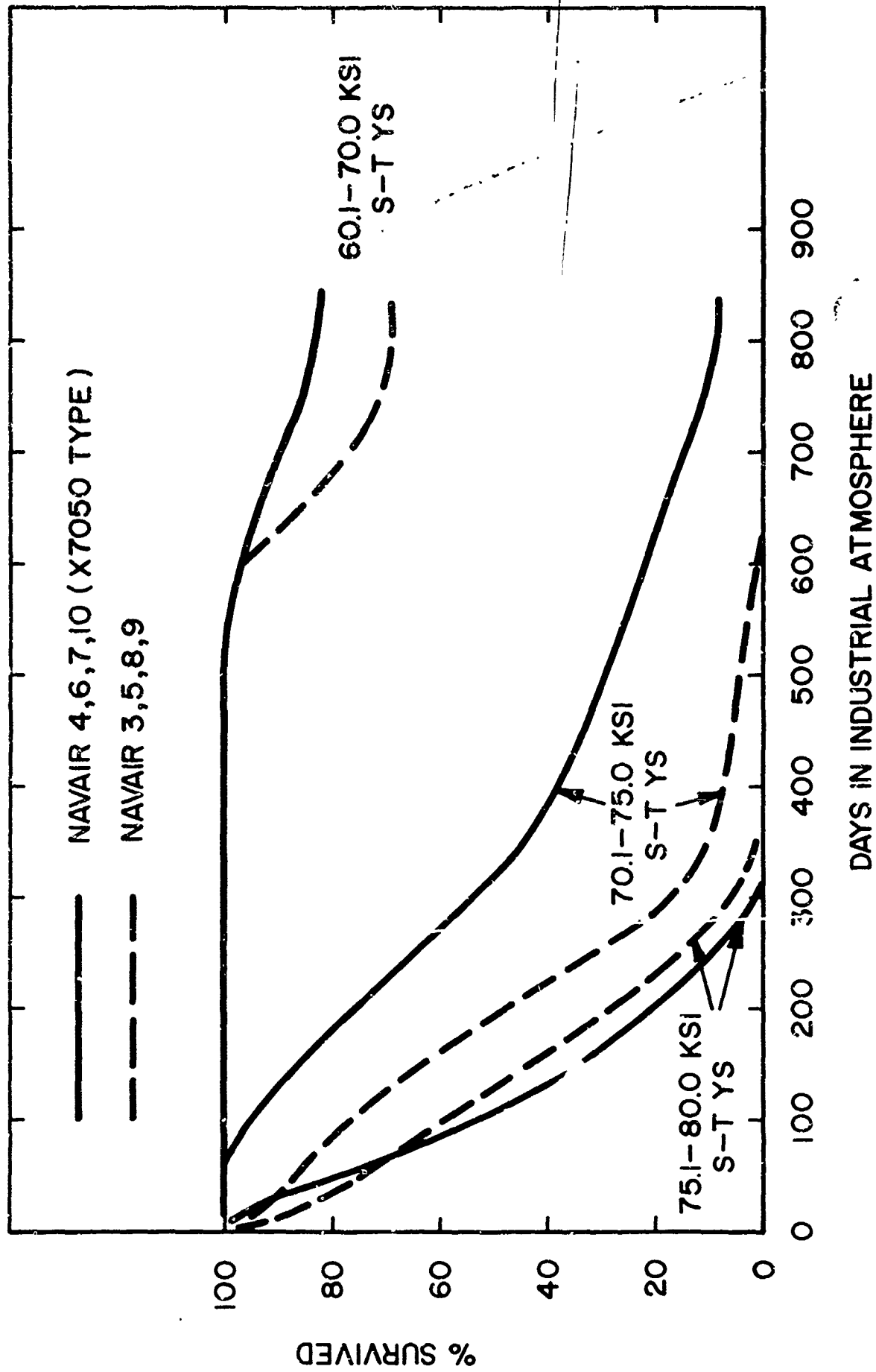

FIG. 3 % SURVIVED VS DAYS IN NEW KENSINGTON, 75% S-T YS STRESS

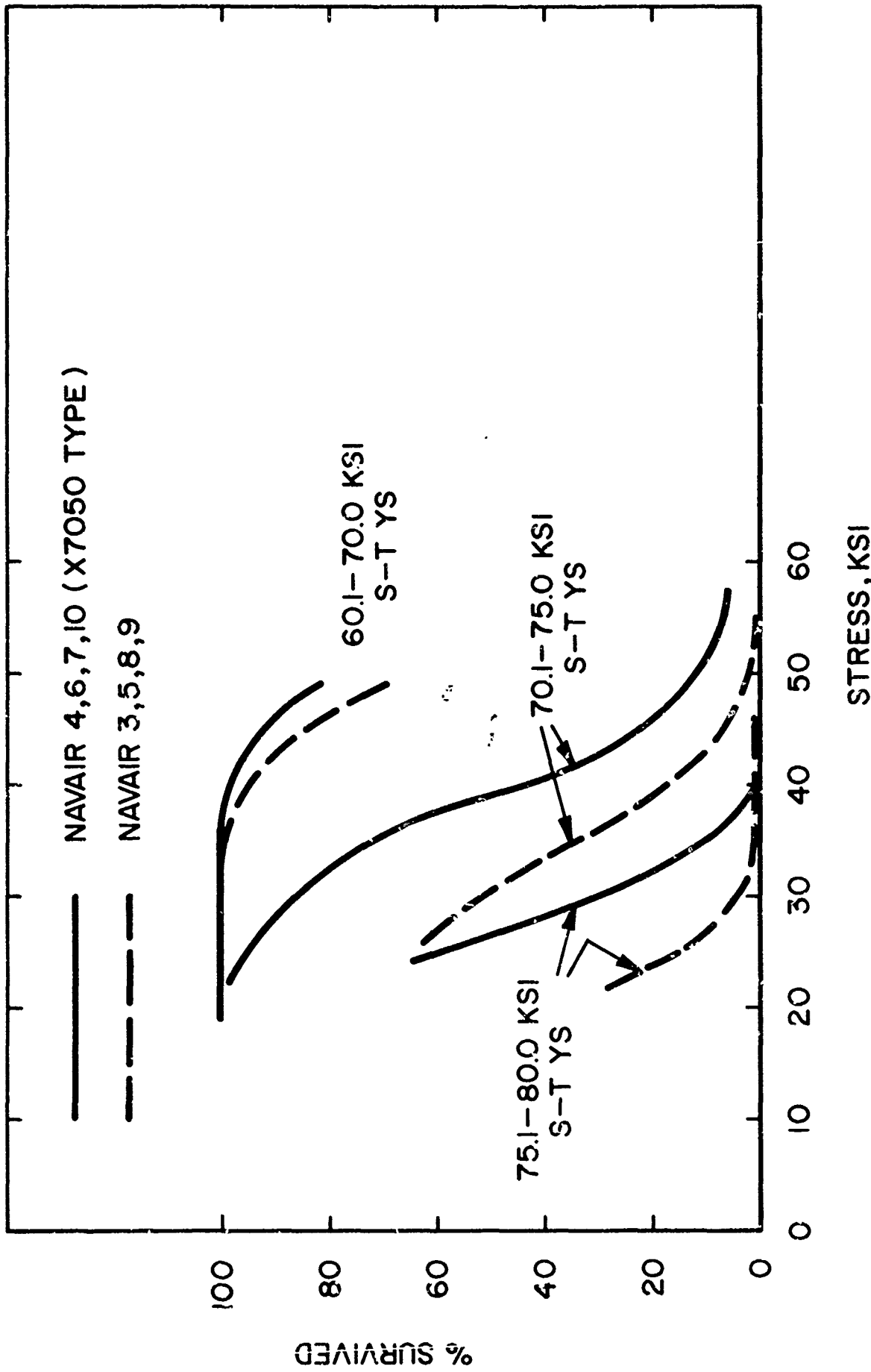

FIG. 4 % SURVIVED VS APPLIED STRESS, 840 DAYS NEW KENSINGTON

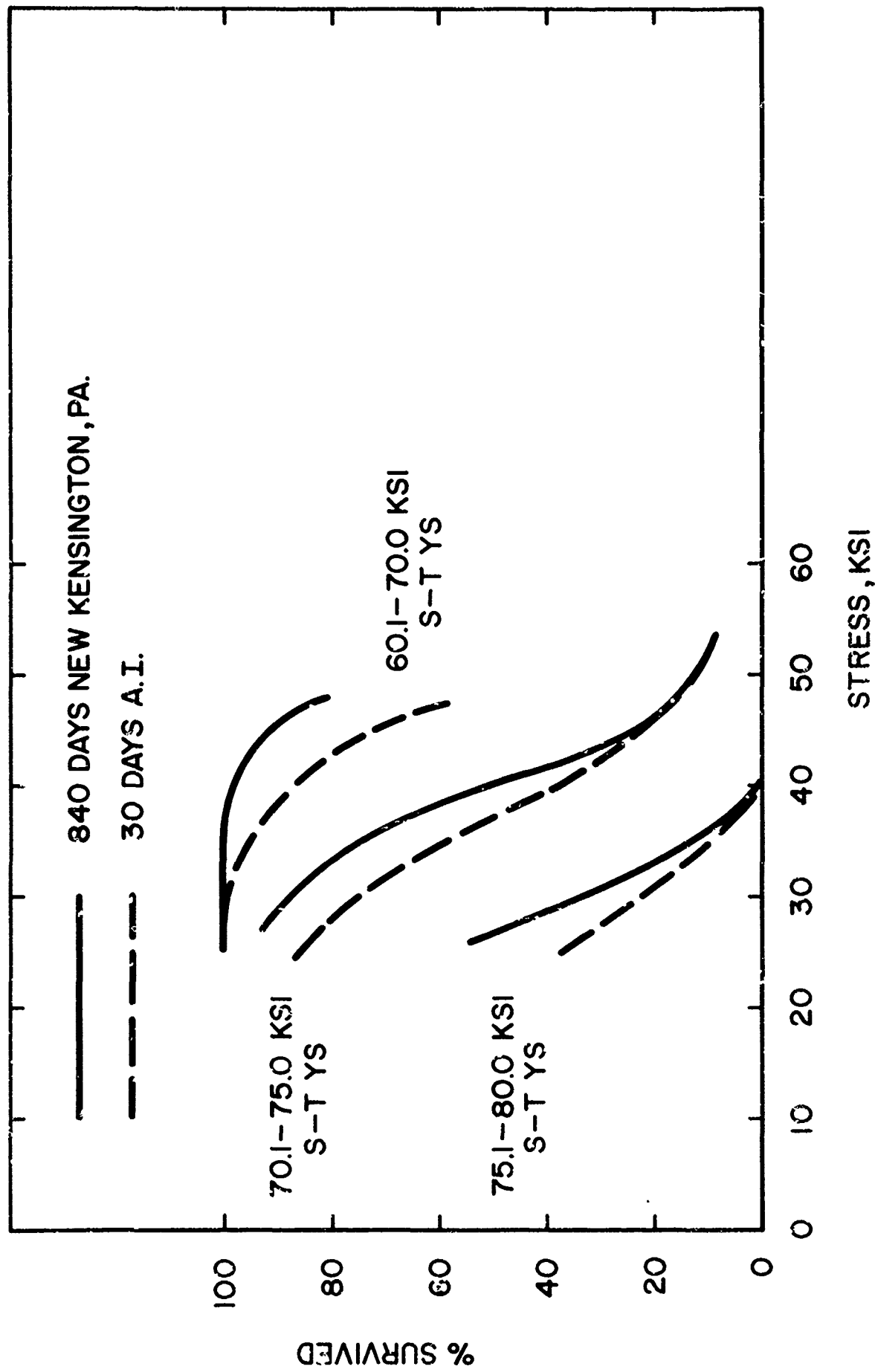

FIG. 5 % SURVIVED IN ACCELERATED AND NATURAL ENVIRONMENT VS APPLIED STRESS X7050 TYPE ALLOYS (NAVAIR 4,6,7,10)

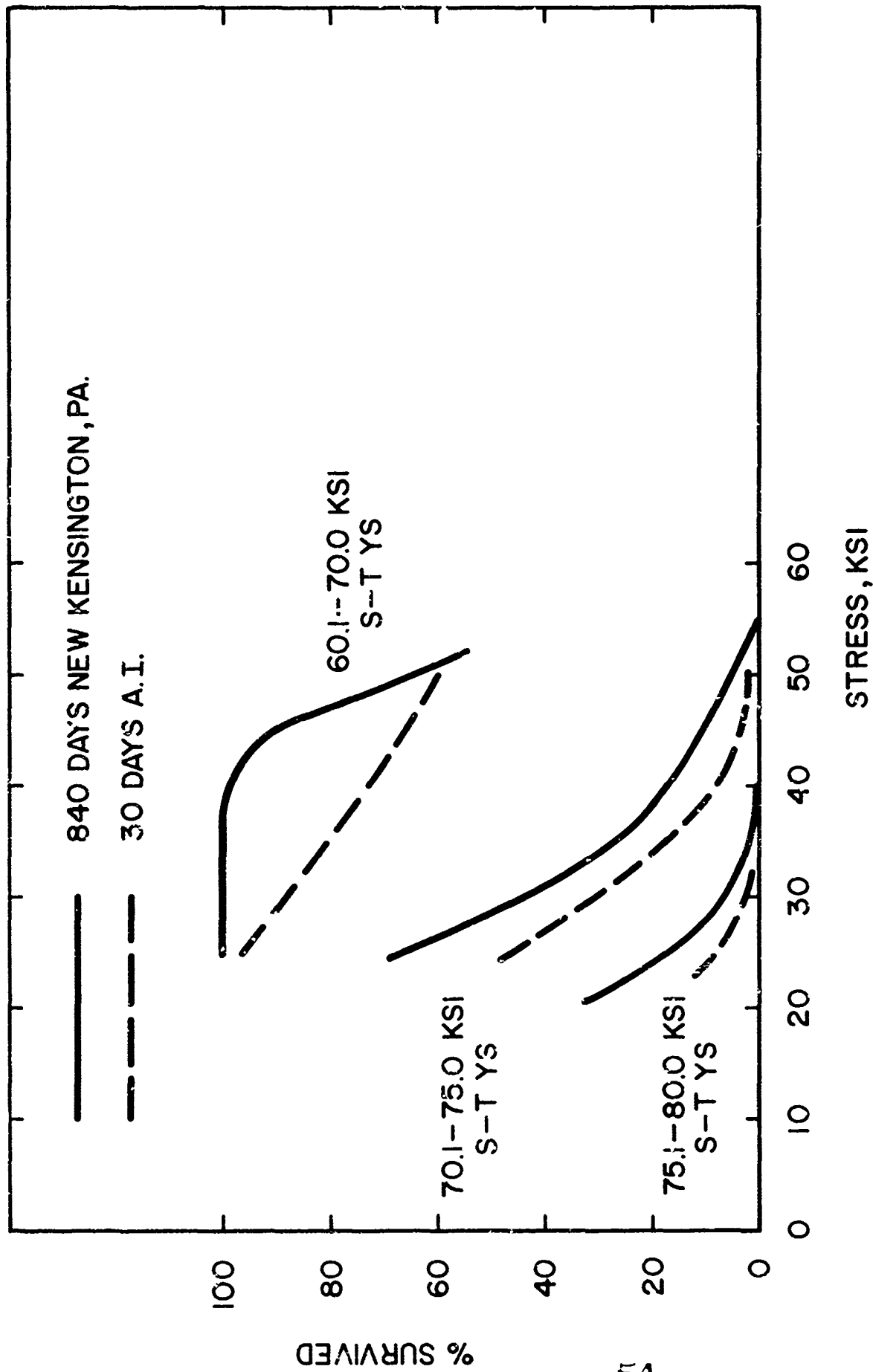
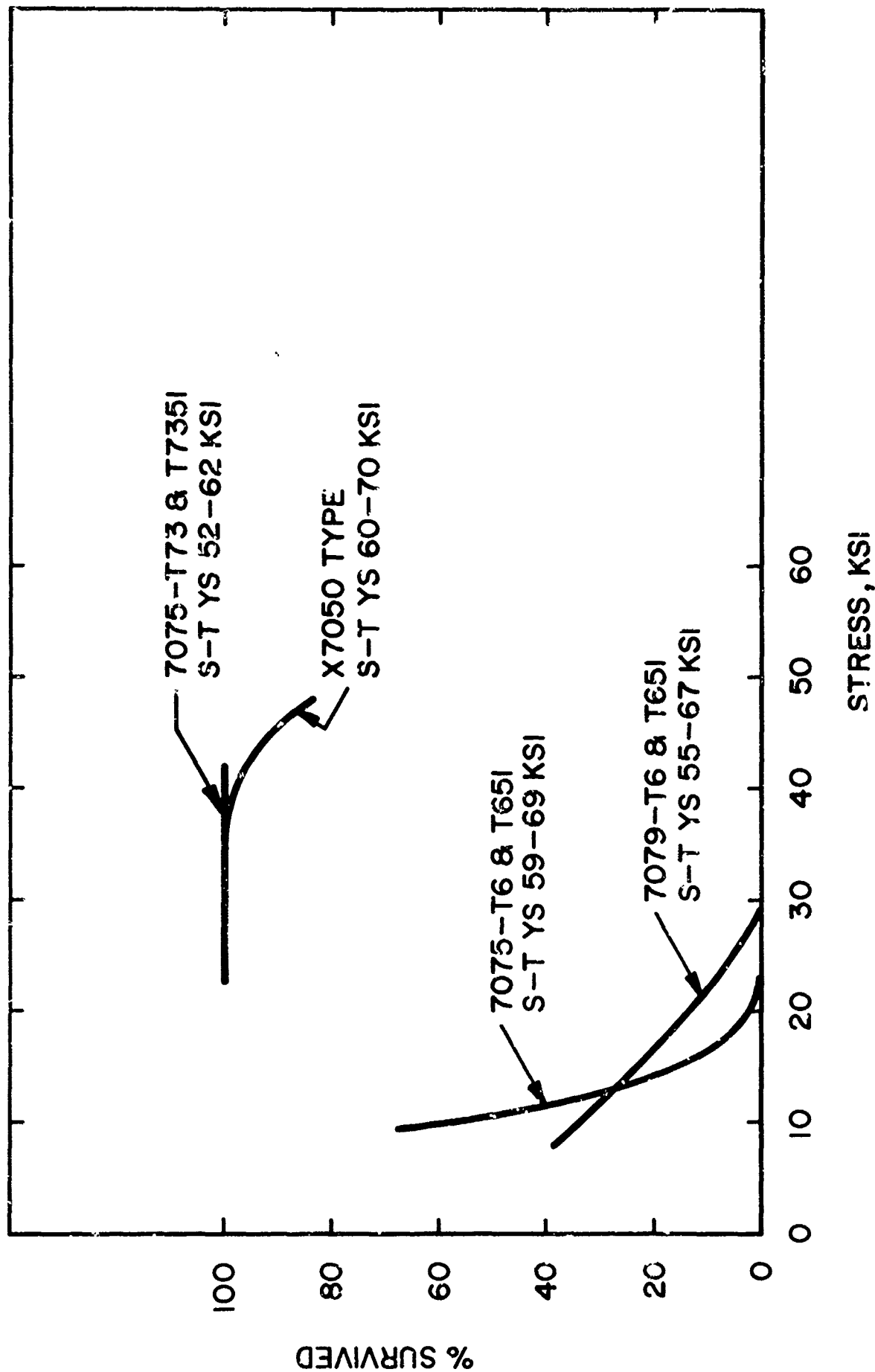

FIG. 6 % SURVIVED IN ACCELERATED AND NATURAL ENVIRONMENT VS APPLIED STRESS NAVAIR ALLOYS 3,5,8,9



**FIG. 7 % SURVIVED AFTER 840 DAYS IN NEW KENSINGTON ATMOSPHERE
X7050 TYPE AND STANDARD ALLOY PLATE**

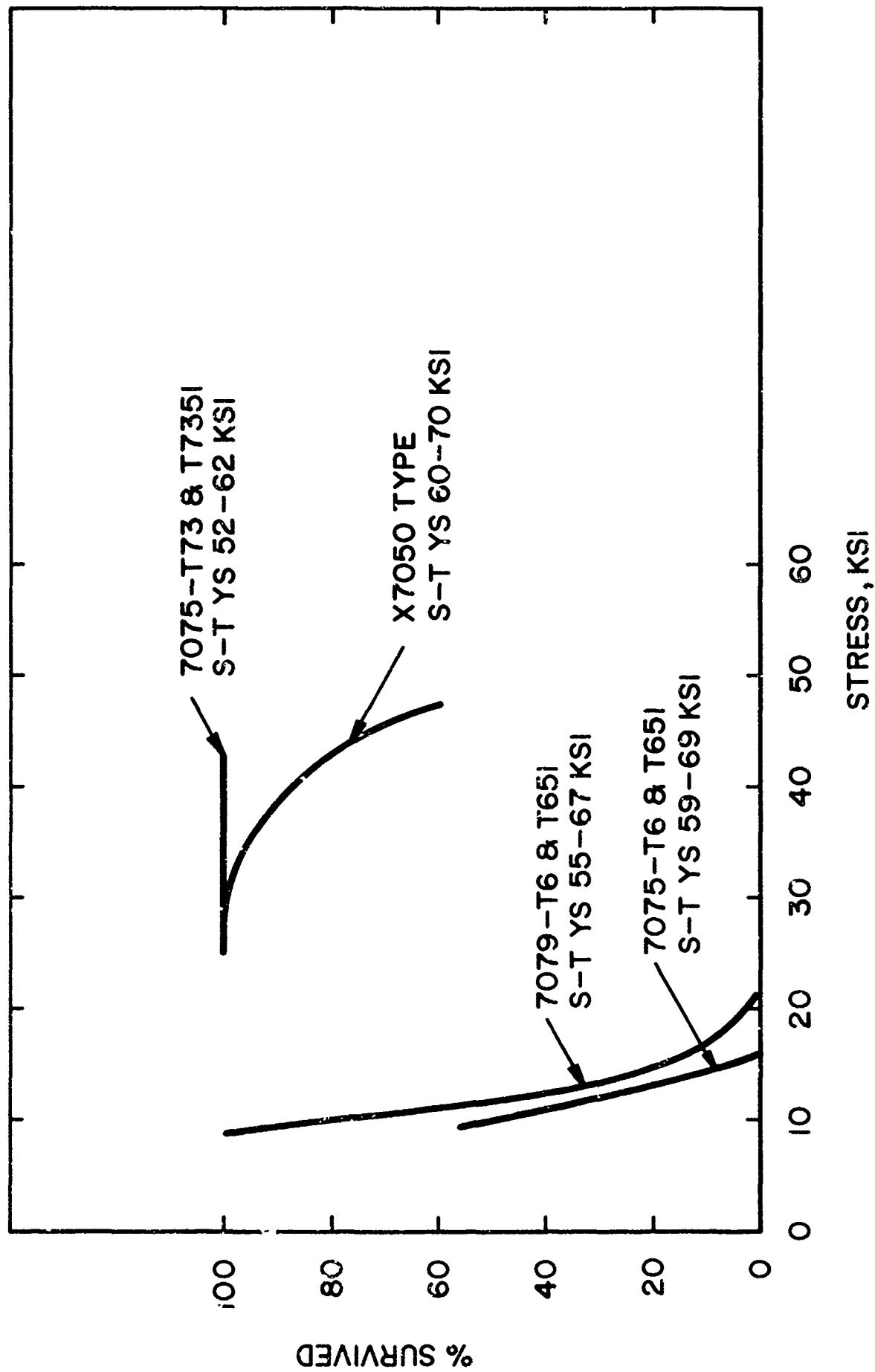
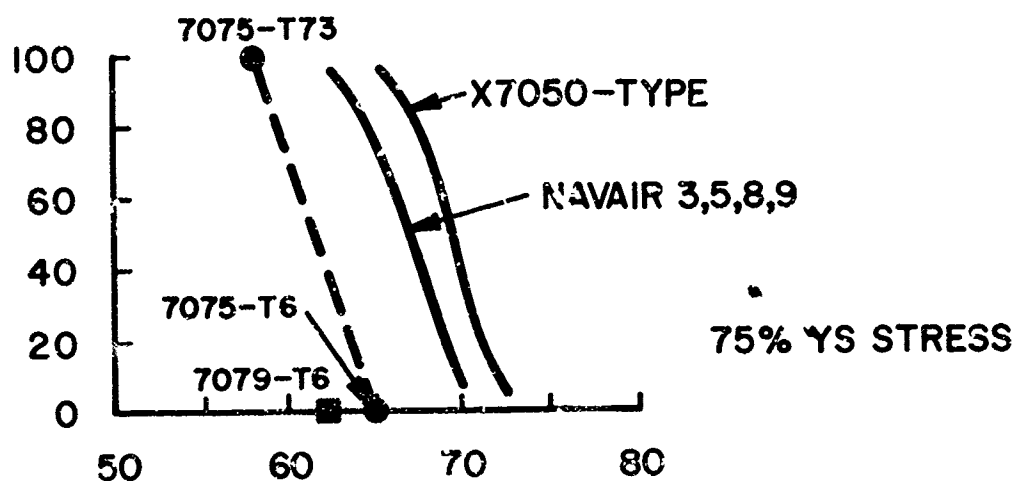
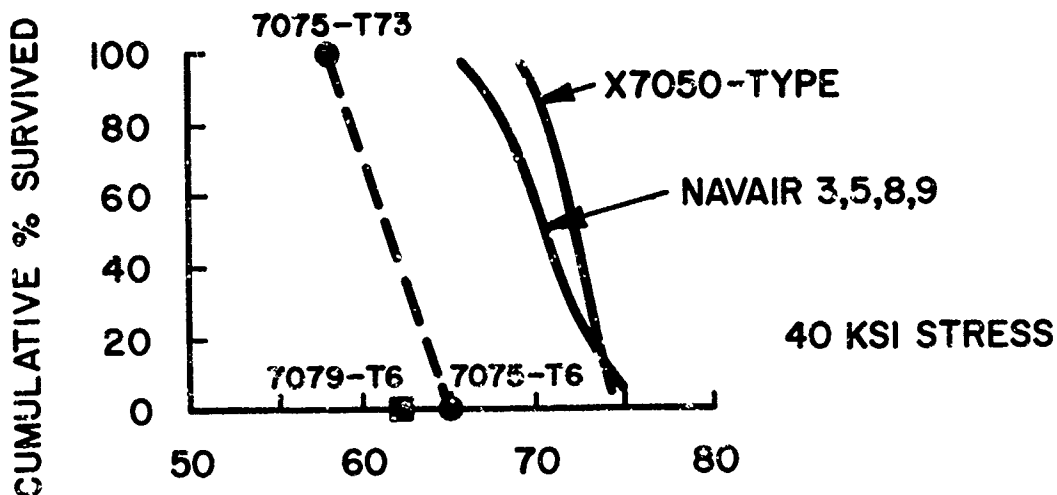
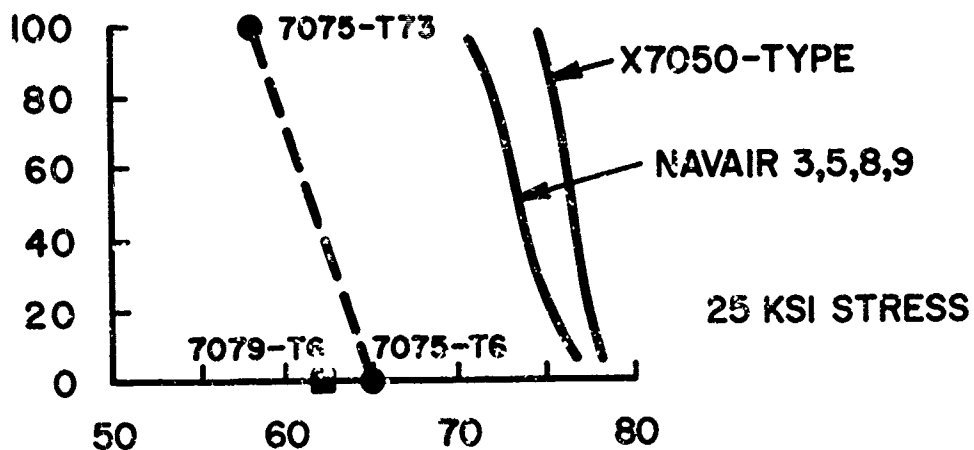

FIG. 8 % SURVIVED AFTER 30 DAYS IN 3.5% NaCl ALTERNATE IMMERSION TEST. X7050 TYPE AND STANDARD ALLOY PLATE

840 DAYS NEW KENSINGTON ATMOSPHERE



SHORT-TRANSVERSE YIELD STRENGTH, KSI

FIG. 9 % SURVIVED VERSUS YIELD STRENGTH OF PLATE

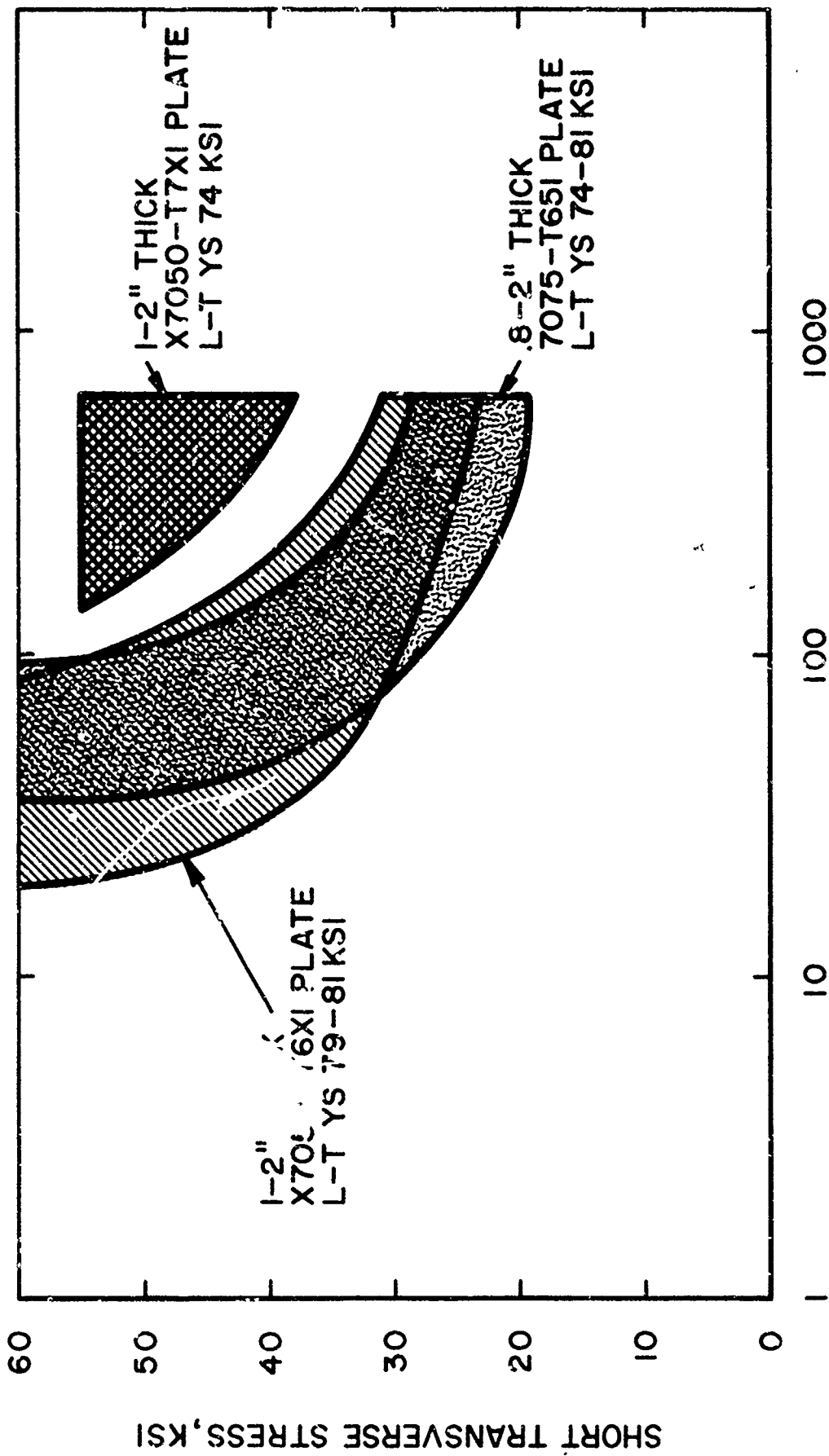

FAILURE TIME IN NEW KENSINGTON ATMOSPHERE, DAYS

FIG.10 COMPARES PERFORMANCES OF MEDIUM THICKNESS X7050 AND 7075-T651 PLATE

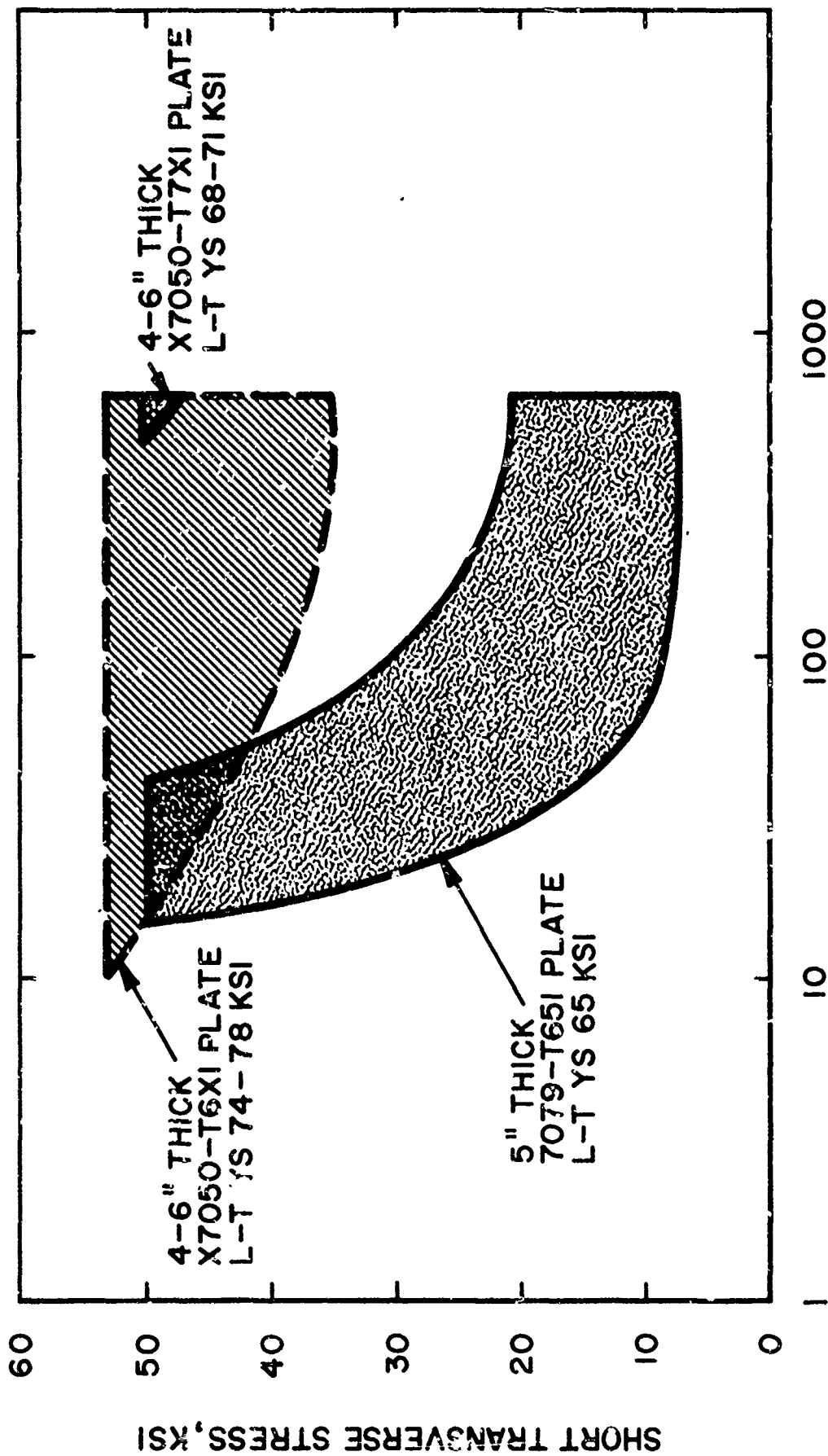

FIG.11 COMPARES PERFORMANCES OF THICK X7050 AND 7079-T65I PLATE

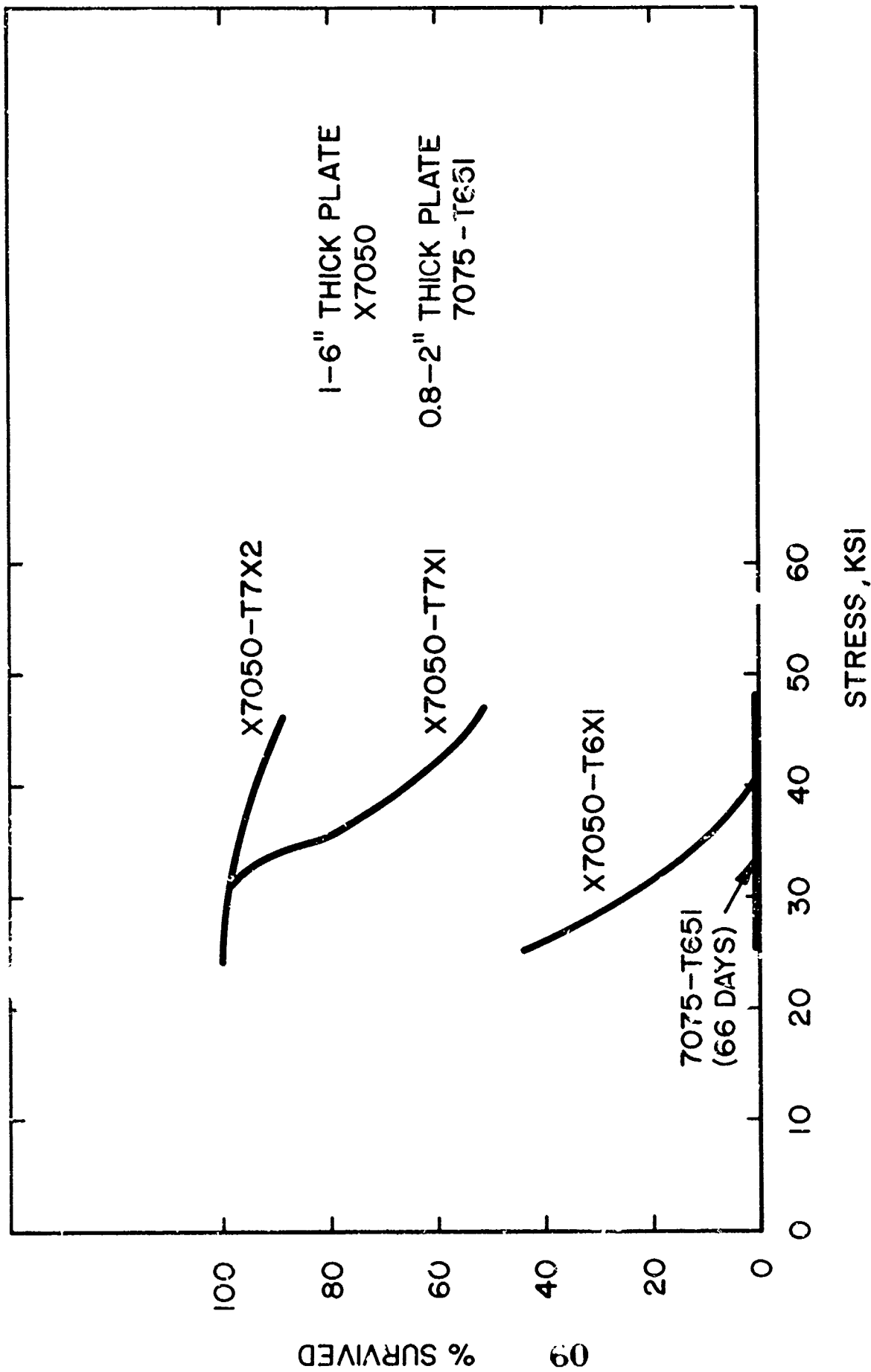
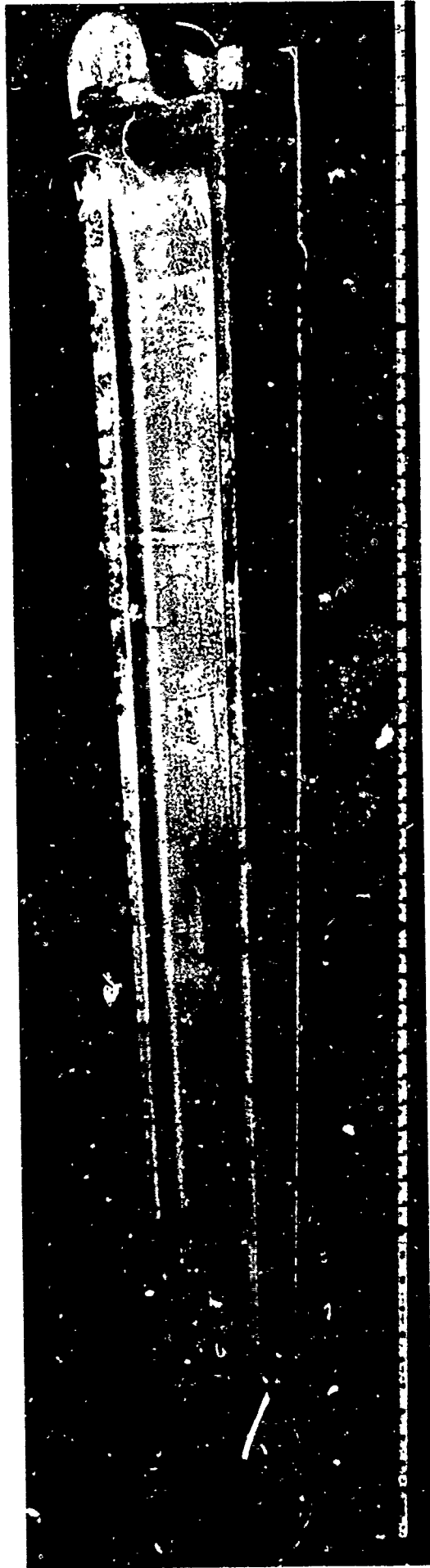

FIG.12 RELATIVE SCC PERFORMANCE IN SEA COAST ENVIRONMENT FOR 30 MONTHS



BOEING LANDING GEAR SIDE STRUT
ALCOA DIE 8457

FIG. 13



FIGURE 14 McDONNELL - DOUGLAS NOSE LANDING GEAR CYLINDER.
ALCOA DIE 15093

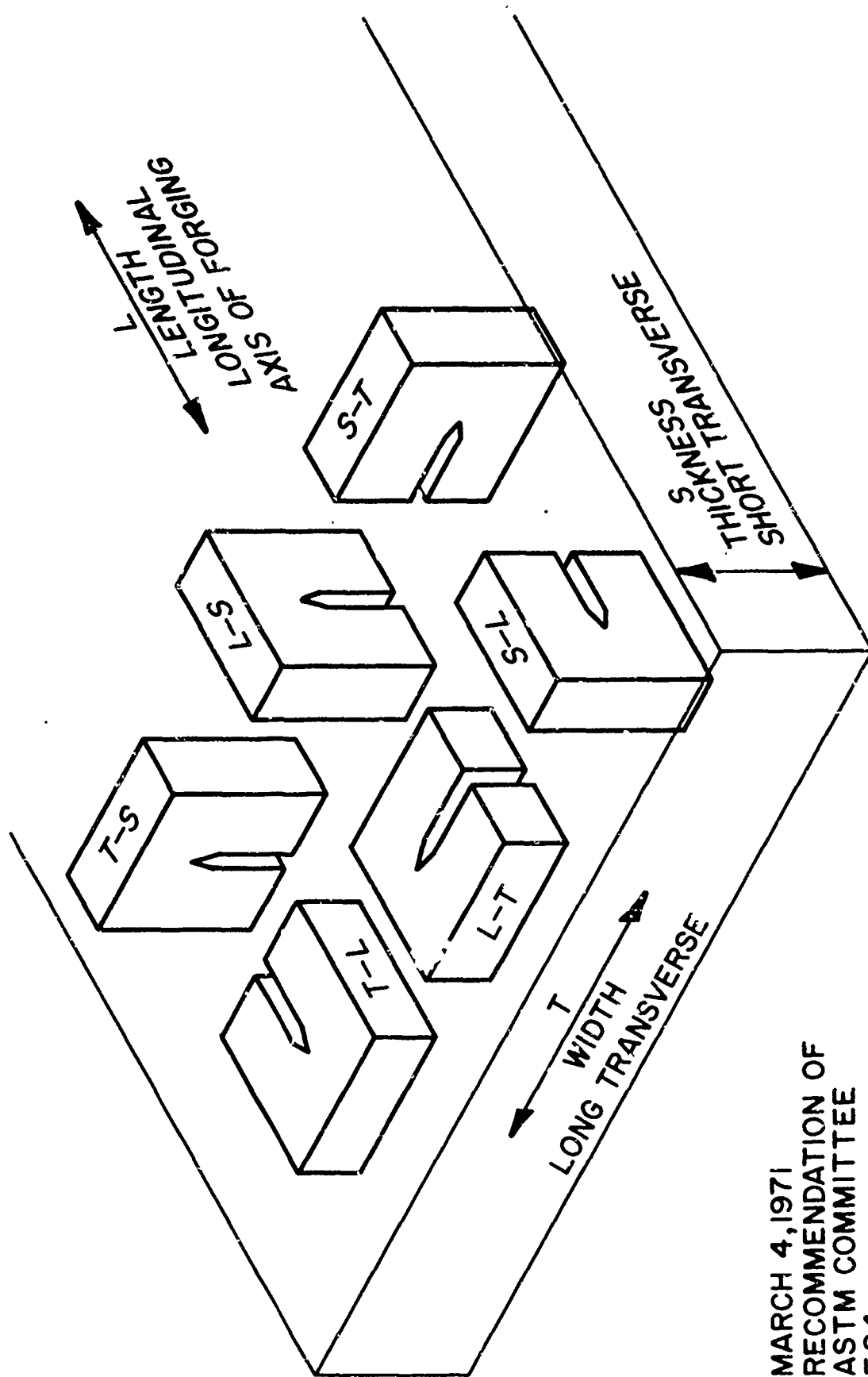

MARCH 4, 1971
 RECOMMENDATION OF
 ASTM COMMITTEE
 E24

FIG. 15 ORIENTATION OF FRACTURE TOUGHNESS SPECIMENS

D-C11832-RK

BILL OF MATERIAL	
REF. NO.	DESCRIPTION
QUAN.	

- NOTE 1. GRAIN IN THIS DIRECTION FOR LONGITUDINAL SPECIMENS
- NOTE 2. GRAIN IN THIS DIRECTION FOR TRANSVERSE SPECIMENS
- NOTE 3. MACHINING LAY IN THIS DIRECTION FOR ALL TYPES OF SPECIMENS.

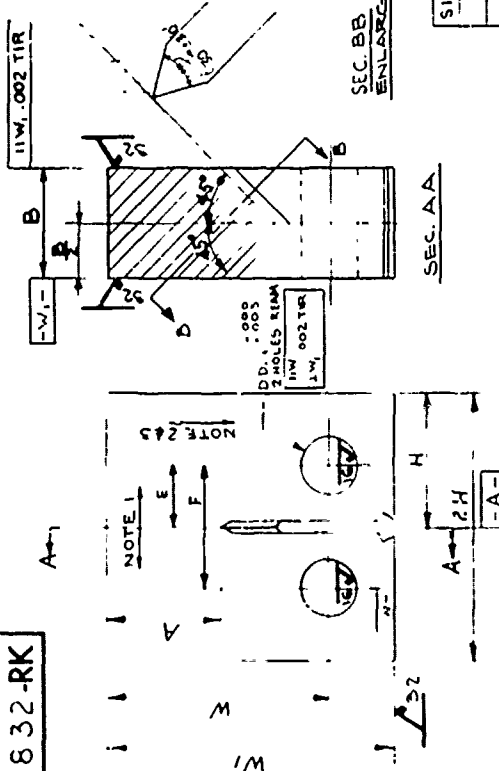

DIMENSION & TOLERANCE TABLE

SIZE	B	A	W	W1	#S	E	F	H	2H	D/2	D	G
1/2	0.50	0.20	1.00	1.25	1/2	0.275	0.52	0.50	1.20	0.250	0.250	0.075-0.100
3/4	0.75	0.32	1.50	1.875	3/4	0.412	0.82	0.90	1.80	0.375	0.375	0.075-0.100
1	1.00	1.10	2.00	2.50	1	0.550	1.10	1.20	2.40	0.500	0.500	0.075-0.100
1 1/2	1.50	1.65	3.00	3.75	1 1/2	0.825	1.65	1.80	3.60	0.750	0.750	0.125-0.200
2	2.00	2.20	4.00	5.00	2	1.100	2.20	2.40	4.80	1.000	1.000	0.125-0.200
3	3.00	3.30	6.00	7.50	3	1.650	3.30	3.60	7.20	1.500	1.500	0.125-0.200
4	4.00	4.40	8.00	10.00	4	2.200	4.40	4.80	9.60	2.000	2.000	0.125-0.200
1 1/4	1.25	1.37	2.50	3.125	1 1/4	0.687	1.37	1.50	3.00	0.625	0.625	0.075-0.100
OTHER SIZES	AS SHOWN	0.05W	W	1.25W	1/2	0.075W	0.55W	0.6W	1.2W	0.25W	0.25W	

NOTCH ROOT RADIUS .010 MAX
 FATIGUE CRACK TO EXTEND 0.1 BEYOND NOTCH TIP.

32/ ALL OVER (NOTCH)

±A 002 TIR
 ±W 002 TIR

KNIFE EDGES STRAIGHT & SQUARE TO FACES WITHIN .001 TIR

NOTCH ENLARGED VIEW

△ * S NOTCH DIMENSION SHOWN IS MAXIMUM IF NECESSARY NOTCH MAY BE NARROWER

REF SPECIAL SIZE SPECS		D-01532-RK
ALUMINUM COMPANY OF AMERICA ALCOA RESEARCH LABORATORIES NEW BRUNSWICK PA		
MECHANICAL TESTING DIV.		
COMPACT TENSION FRACTURE		
TOUGHNESS SPECIMEN (ASTM STD) A		
IN CHG OF SC. PUDNLESTON		DESIGN
SCALE N/A	DATE 5-14-68	DRAWN S. L. MALAK
D-011 8 32-RK		CHECK
		APPR. <i>[Signature]</i>

DECIMAL	REVISION RECORD
0.0001	12-23-71 11A WASTE ADDED
0.0002	11-3-71 3 ADDED. REF DWS / ASTM STD
0.0003	5-20-70 2 GENERAL EVALUATION
0.0004	11-18-68 1 ADDED. NOTES 1, 2, 3, 4
	DATE NO OR CK

FIG. 16 FRACTURE TOUGHNESS SPECIMEN



X7050-T736 FORGING

ALCOA DIE 8457

FIG. 17
.65

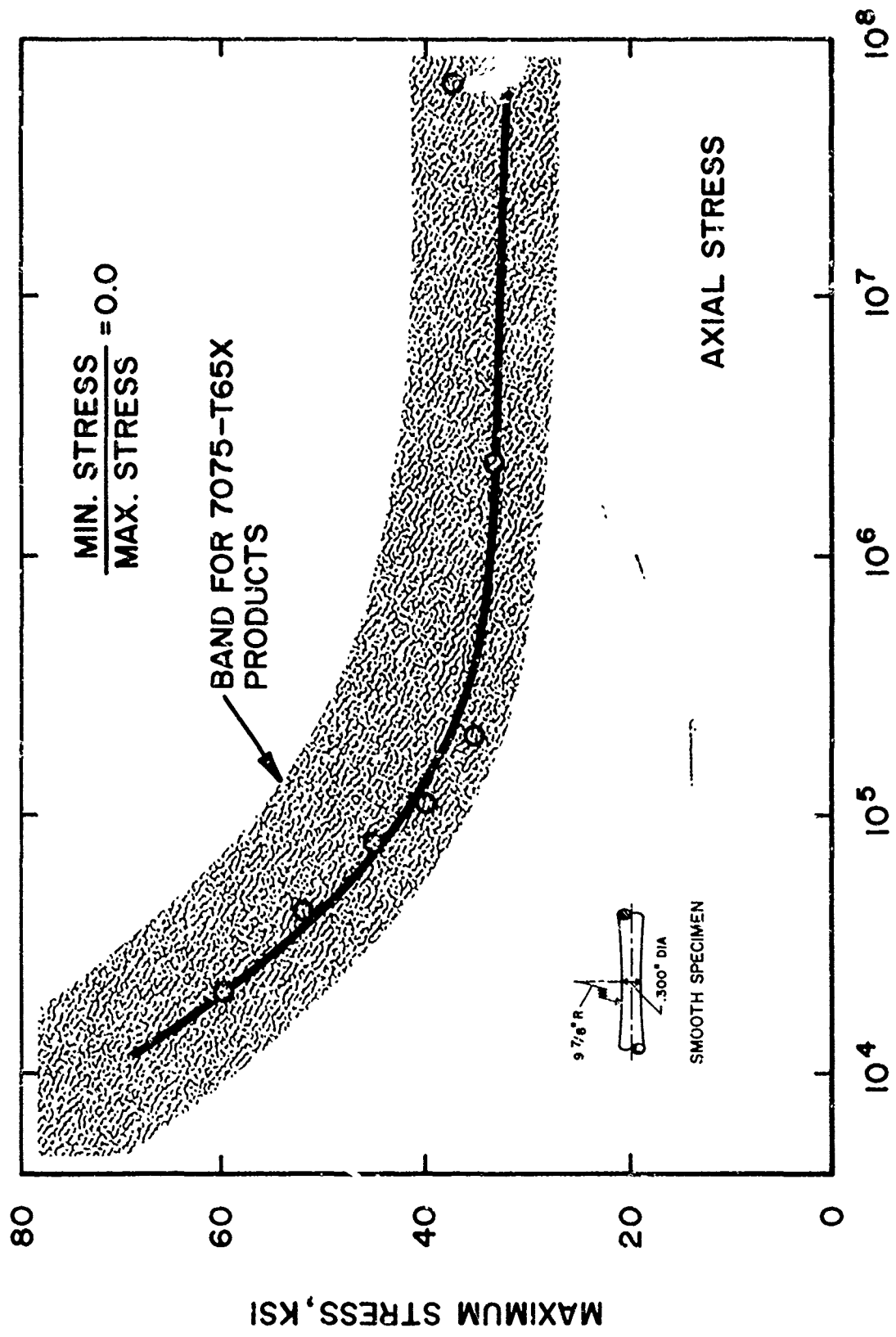

CYCLES TO FAILURE

FIG.18 SMOOTH FATIGUE CURVE FOR X7050-T736, ALCOA DIE 8457

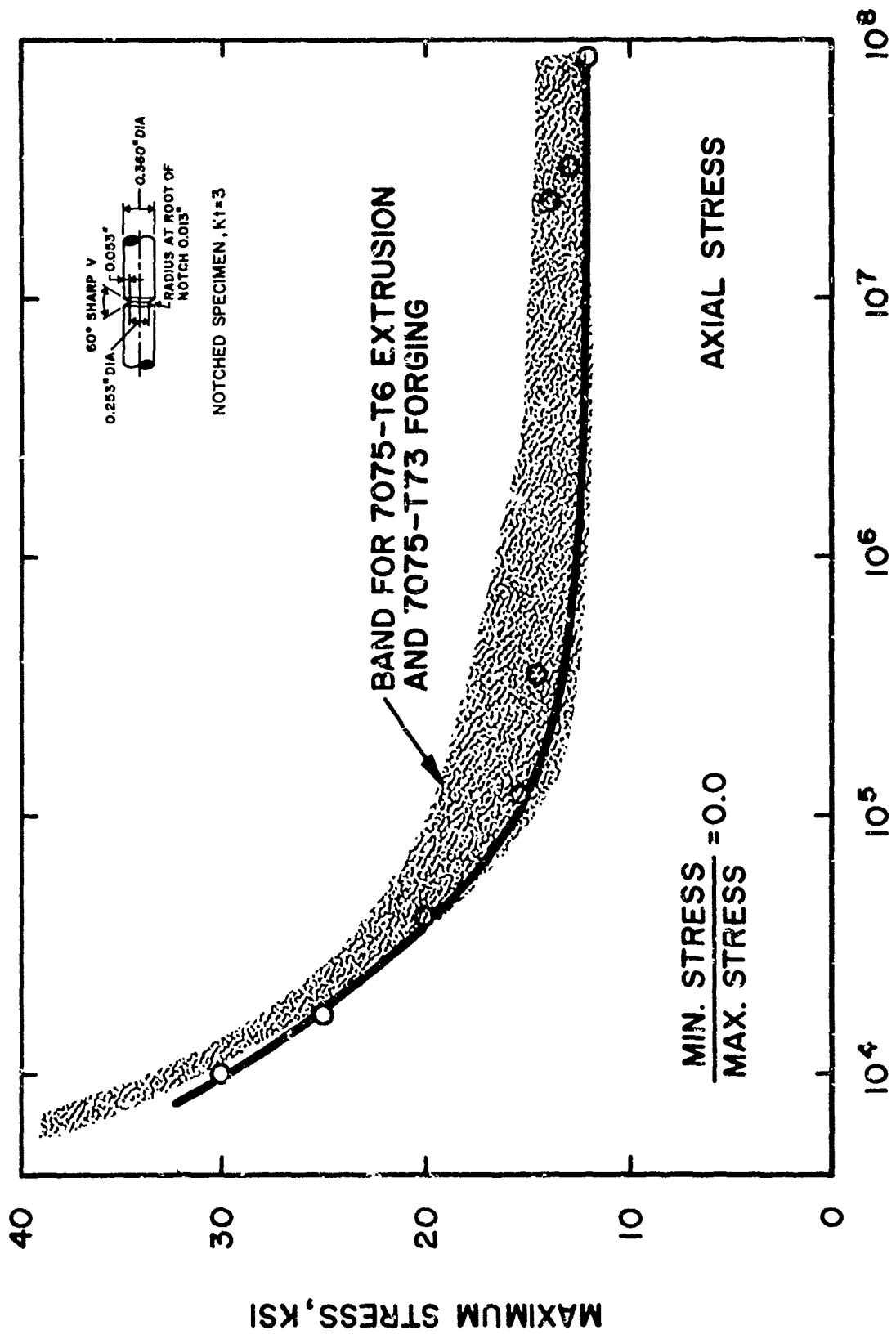

CYCLES TO FAILURE

FIG.19 NOTCH FATIGUE CURVE FOR X7050-T736, ALCOA DIE 8457

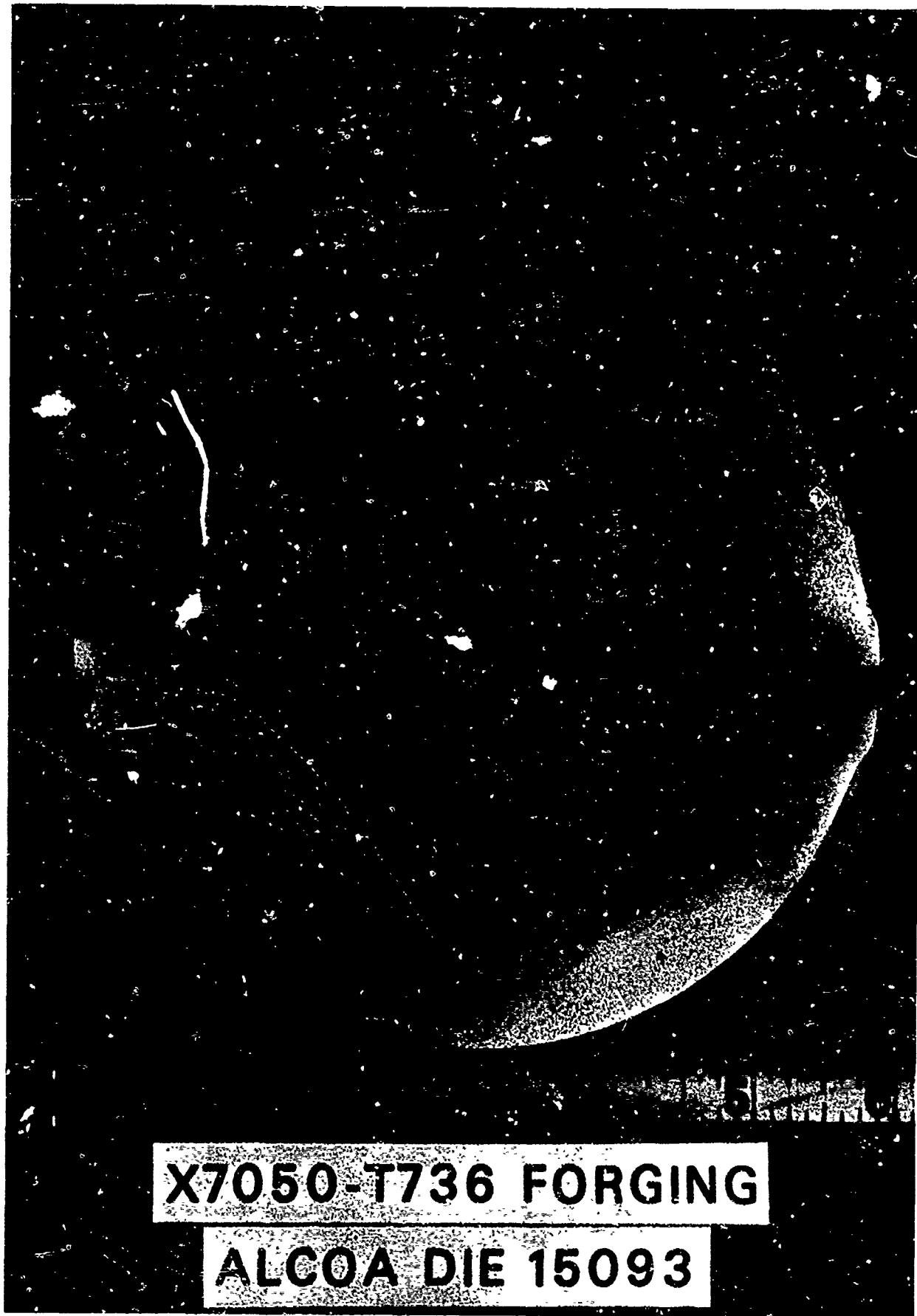

X7050-T736 FORGING

ALCOA DIE 15093

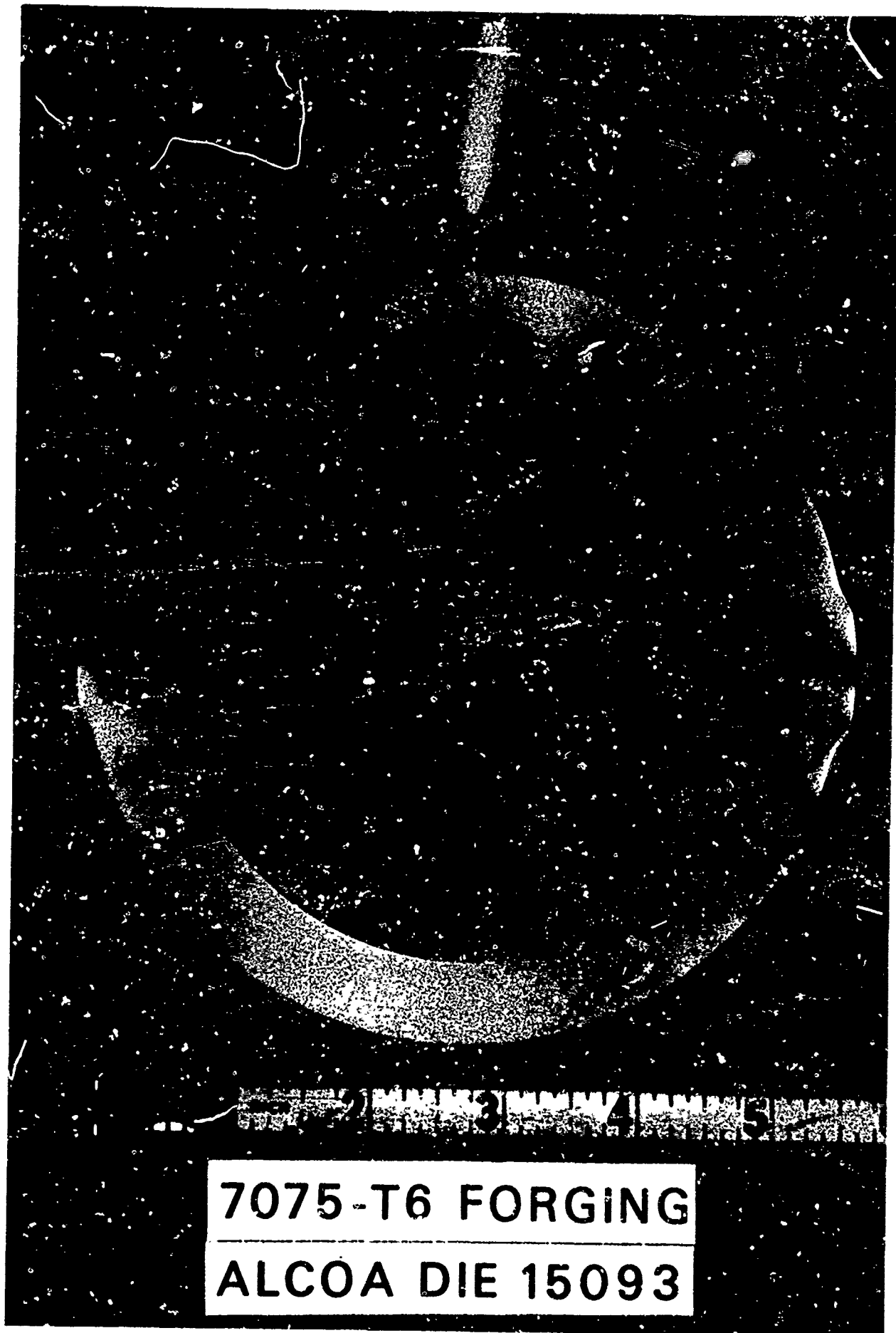

7075-T6 FORGING

ALCOA DIE 15093

FIG. 21

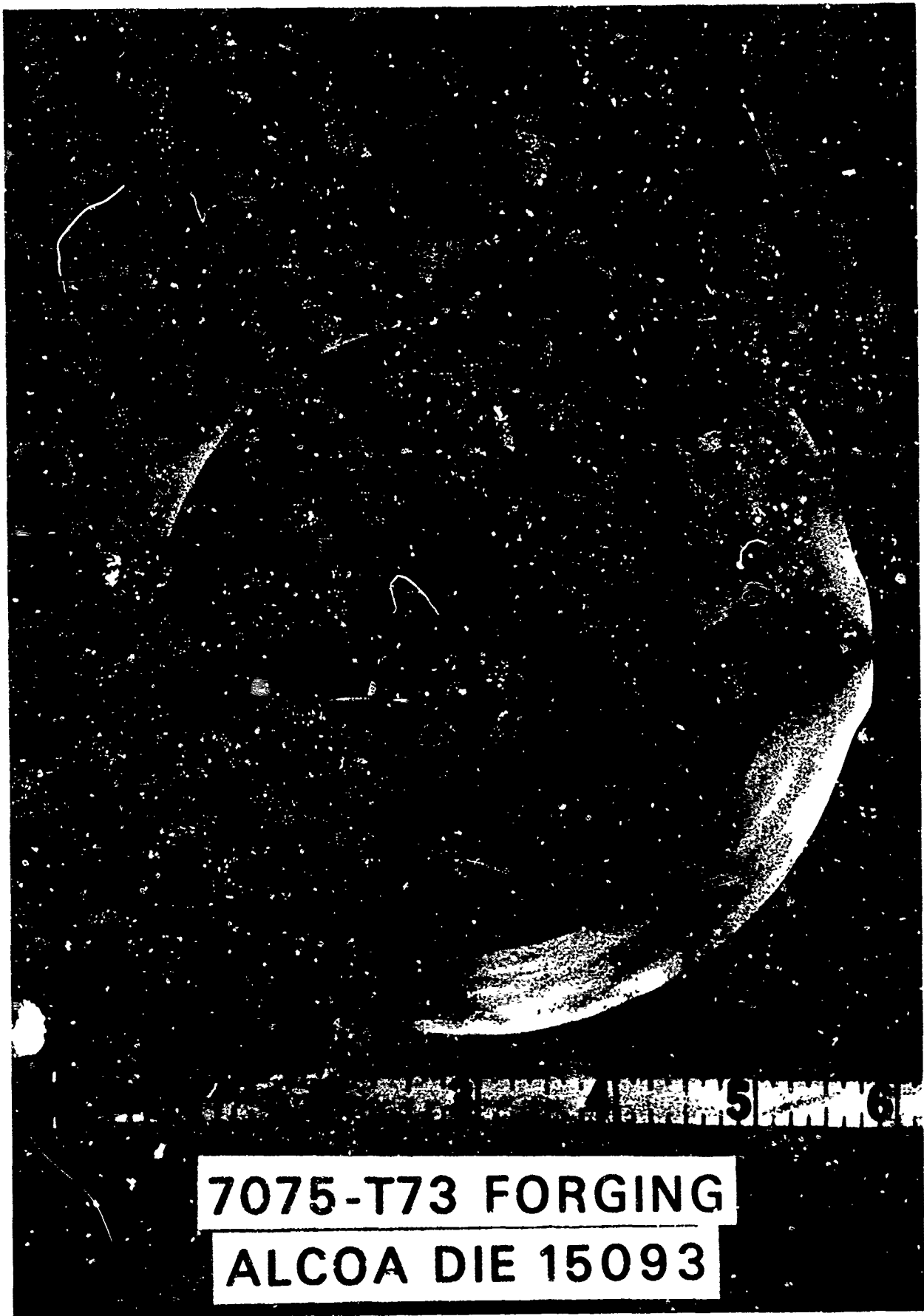

7075-T73 FORGING

ALCOA DIE 15093

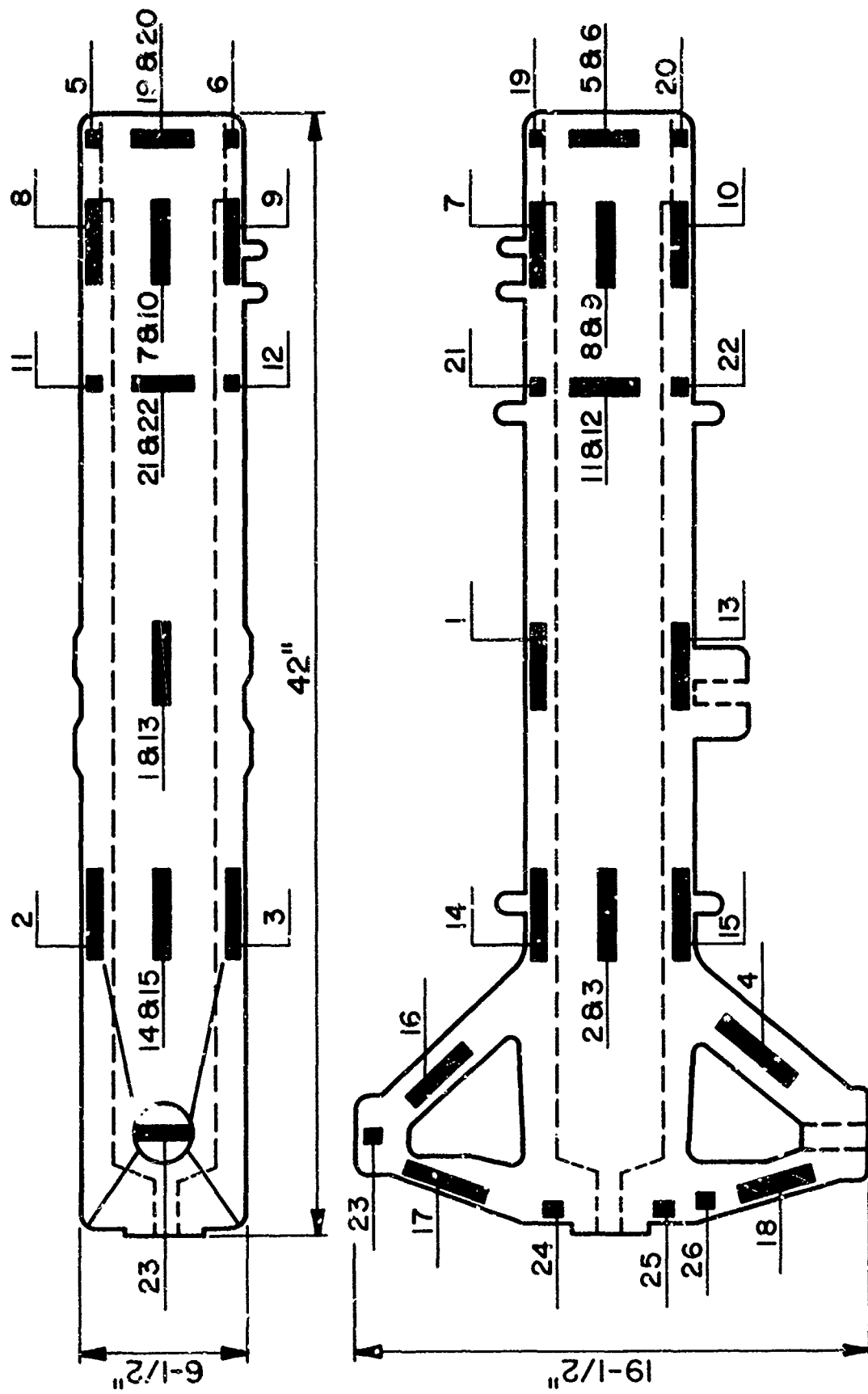

FIG. 23 TEST BAR LOCATIONS, ALCOA DIE I5093

$$\text{TEAR STRENGTH, PSI} = \frac{P}{A} + \frac{MC}{I} = \frac{P}{bt} + \frac{3P}{bt} = \frac{4P}{bt}$$

$$\text{UNIT PROPAGATION ENERGY, IN-LB PER SQ IN} = \frac{\text{ENERGY TO PROPAGATE A CRACK}}{bt}$$

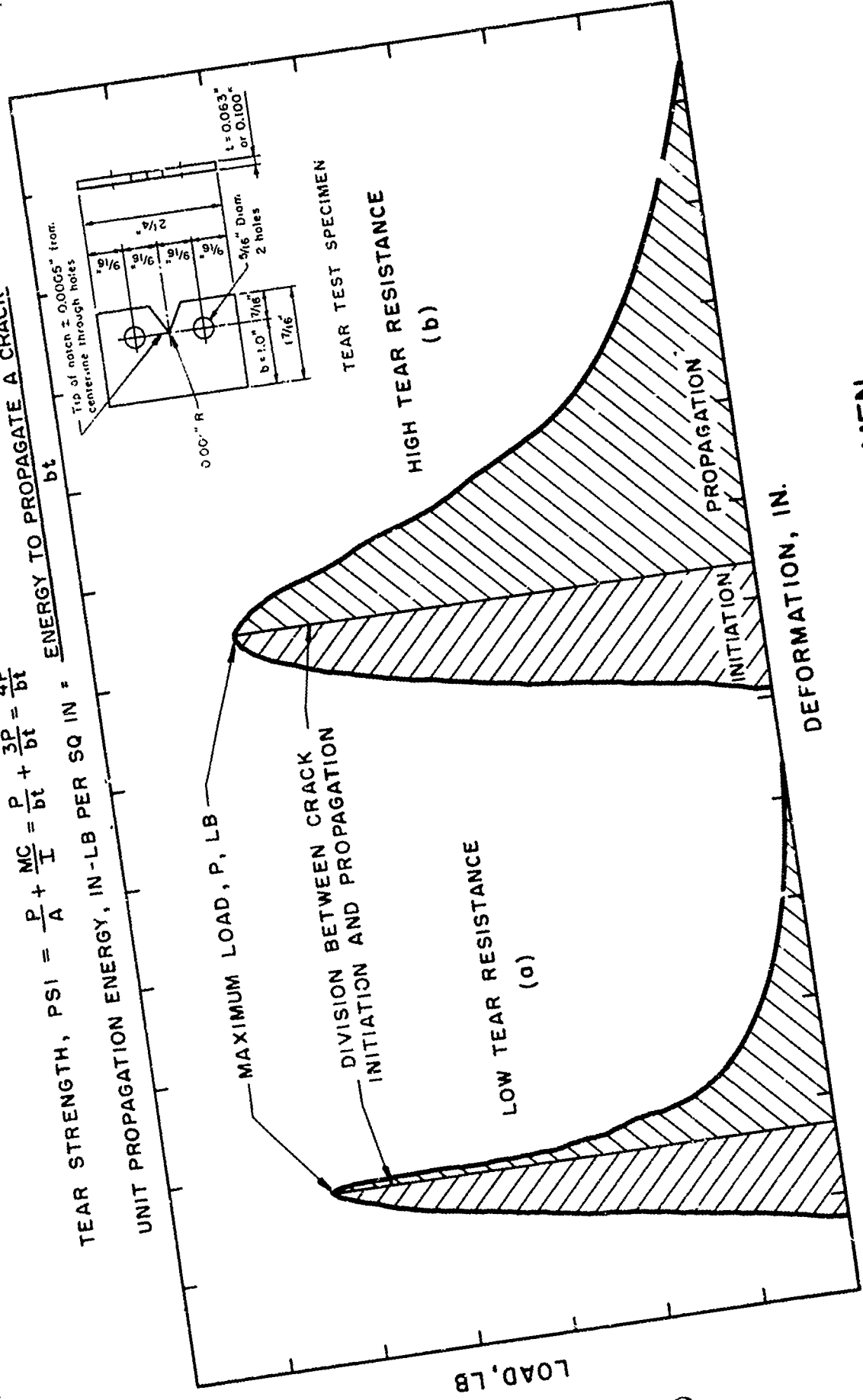
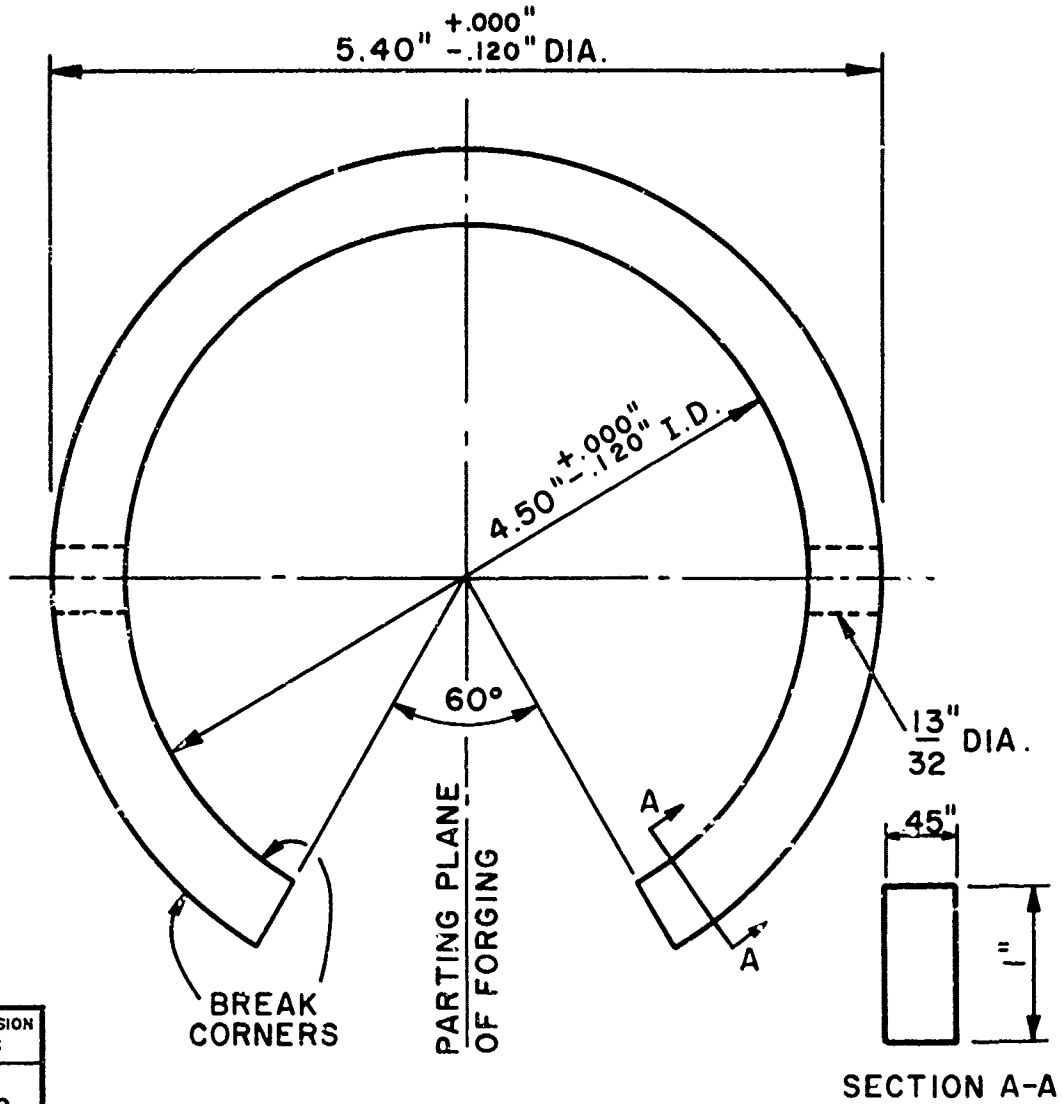

FIG. 24 TEAR TEST SPECIMEN

L-014889-RK



DECIMAL DIMENSION TOLERANCES	
.0	$\pm .020$
.00	$\pm .010$
.000	$\pm .005$

FINISH : 30 RMS OR BETTER,
ALL SURFACES

					ALUMINUM COMPANY OF AMERICA	
					ALCOA RESEARCH LABORATORIES	
					ENGINEERING DEPARTMENT	NEW KENSINGTON PA.
C-RING USED TO EVALUATE STRESS CORROSION OF DIE FORGING 15093.						
DATE	NO.	REVISION RECORD	DR.	CK.		
					IN CHG OF S. C. HUDDLESTON	DESIGN
					SCALE 12"=1'-0"	DATE 5-19-71
					L-014889-RK	DRAWN K. H. MAIER
						CHECK
						APPR

FIG. 25

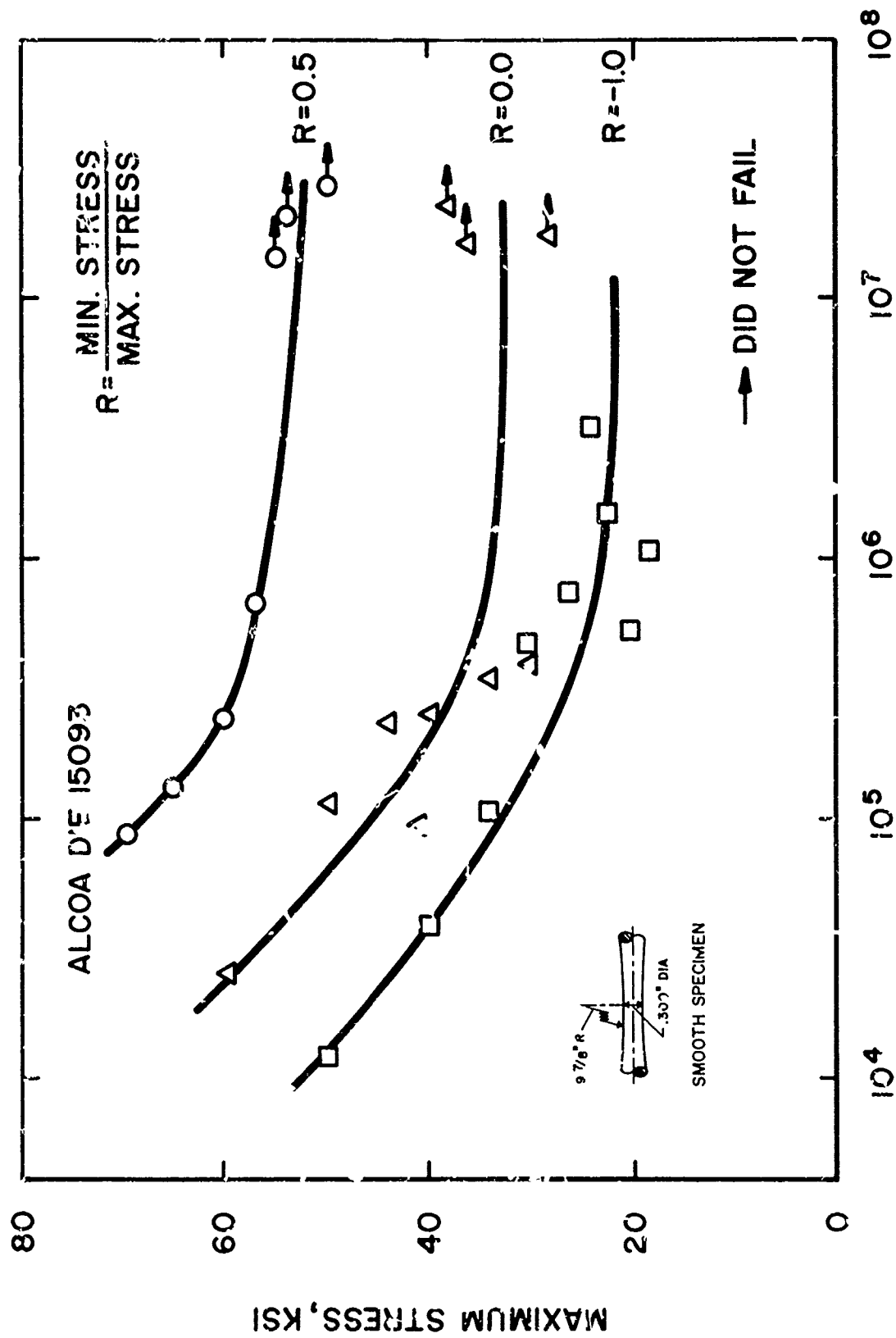
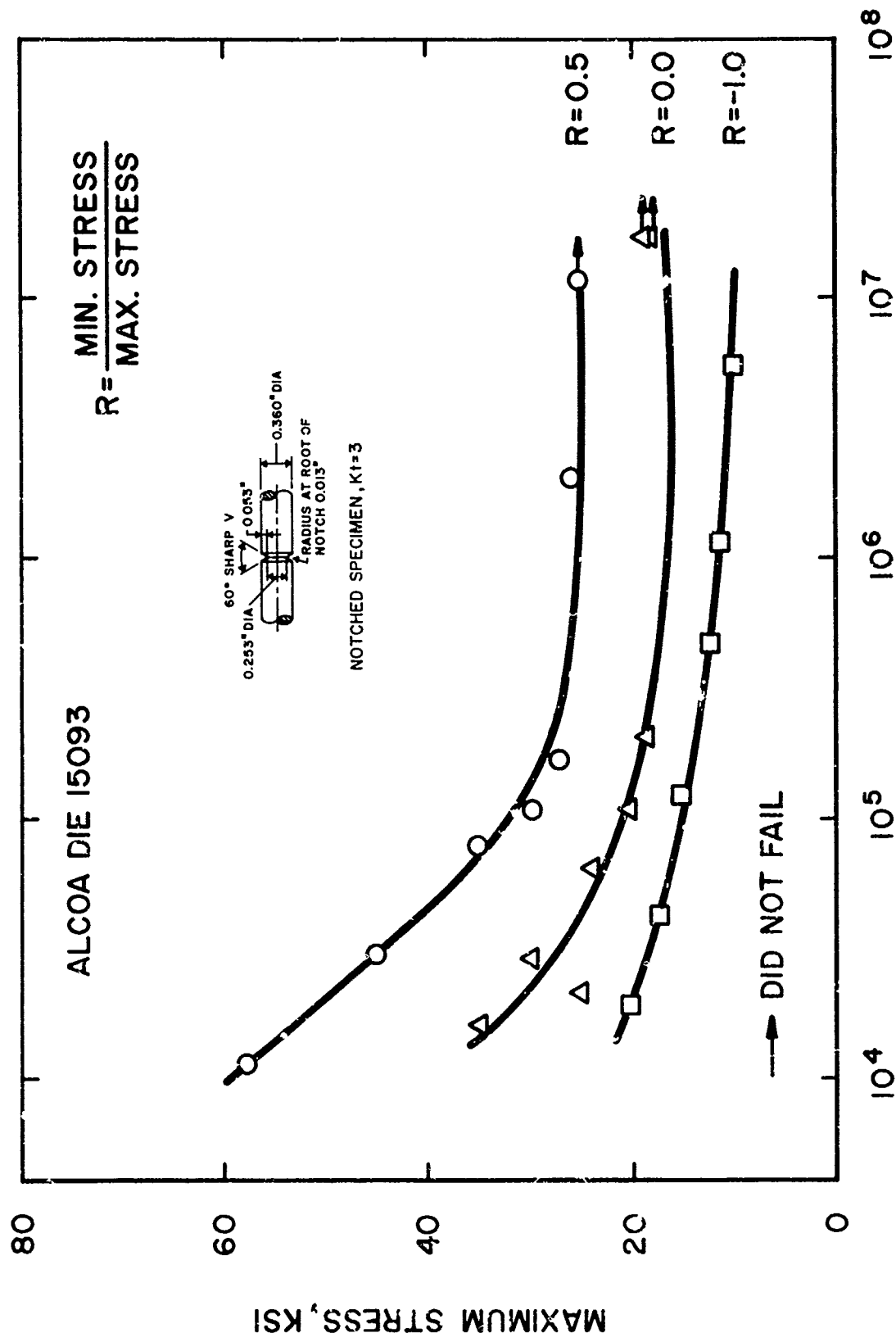

FIG. 2. SMOOTH FATIGUE CURVES FOR X7050-T736 FORGING



CYCLES TO FAILURE

FIG. 27 NOTCH FATIGUE CURVES FOR X7050-T736 FORGING

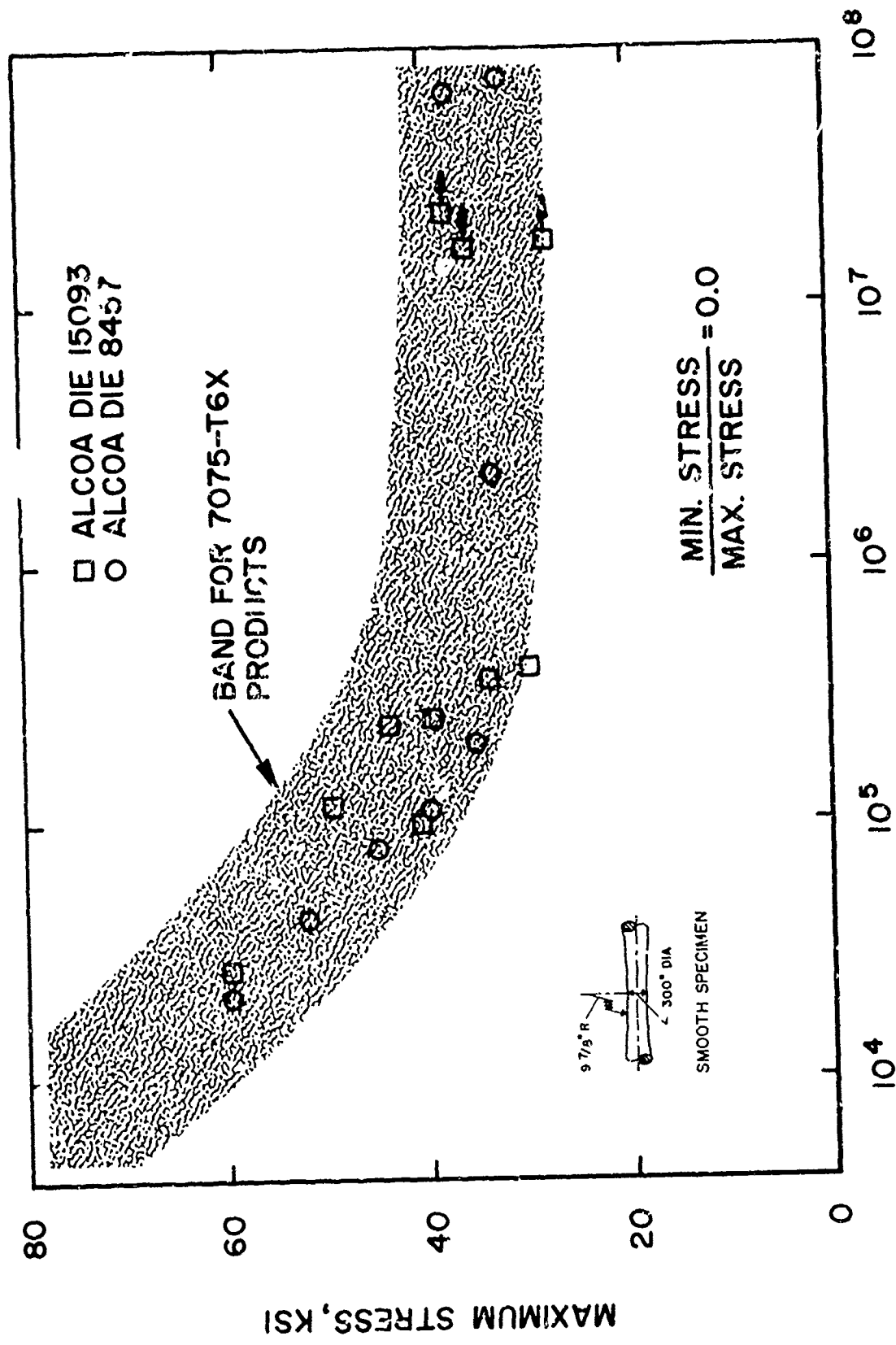

FIG. 28 SMOOTH FATIGUE DATA, X7050-T736 DIE FORGINGS

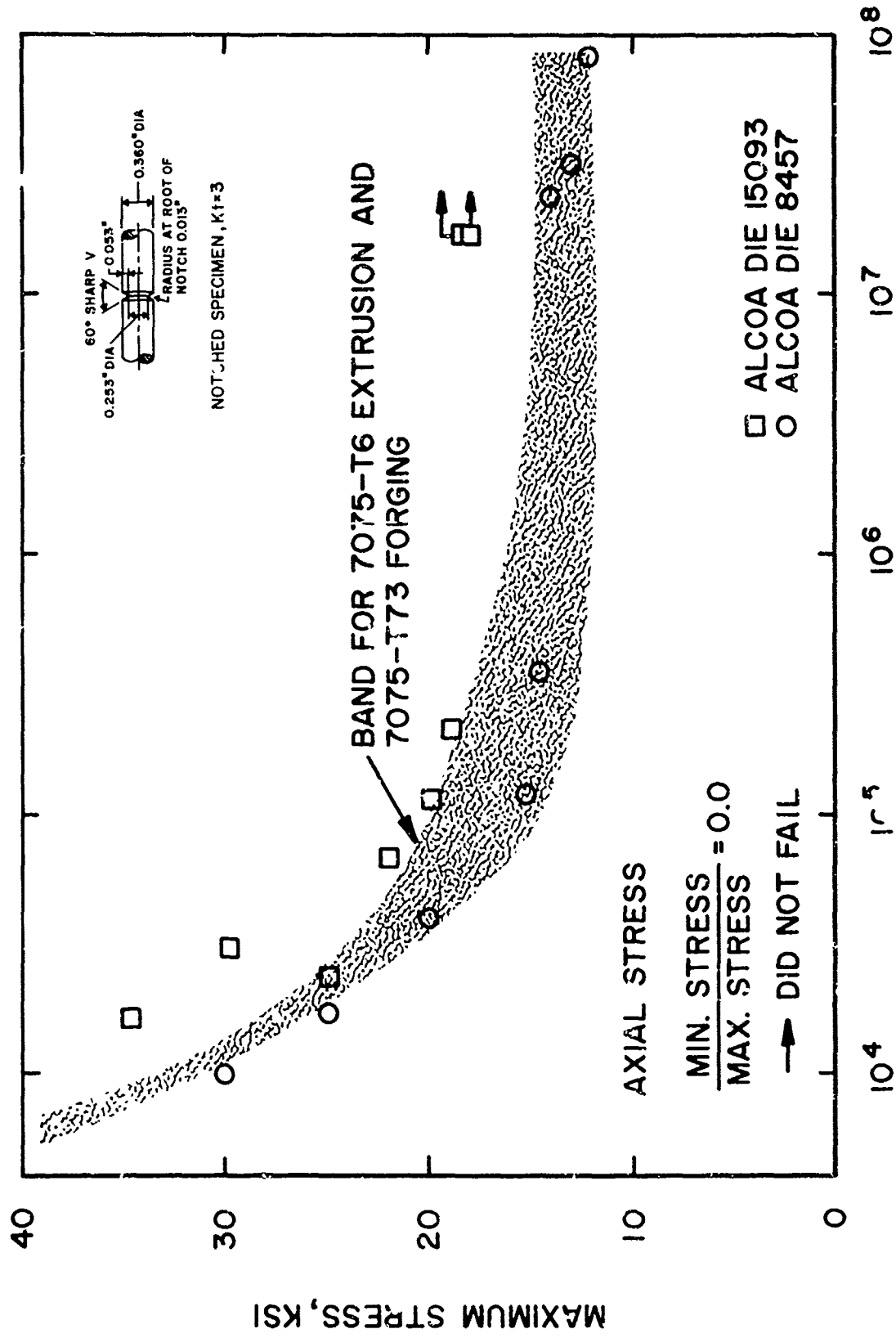

FIG. 29 NOTCH FATIGUE DATA, X7050-T736 DIE FORGINGS

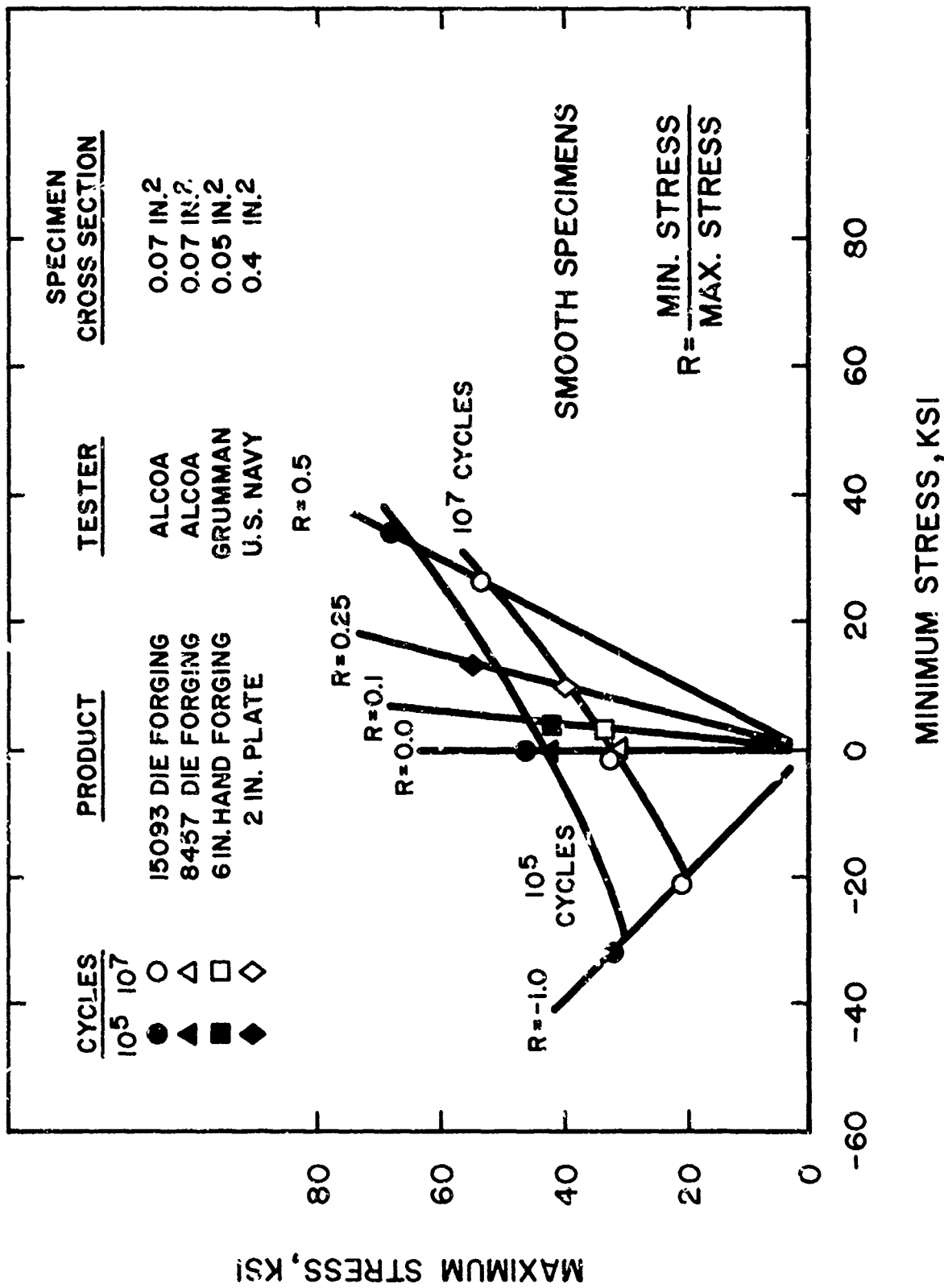

FIG. 30 GOODMAN DIAGRAM FOR X7050-T7X PRODUCTS, $K_t = 1$

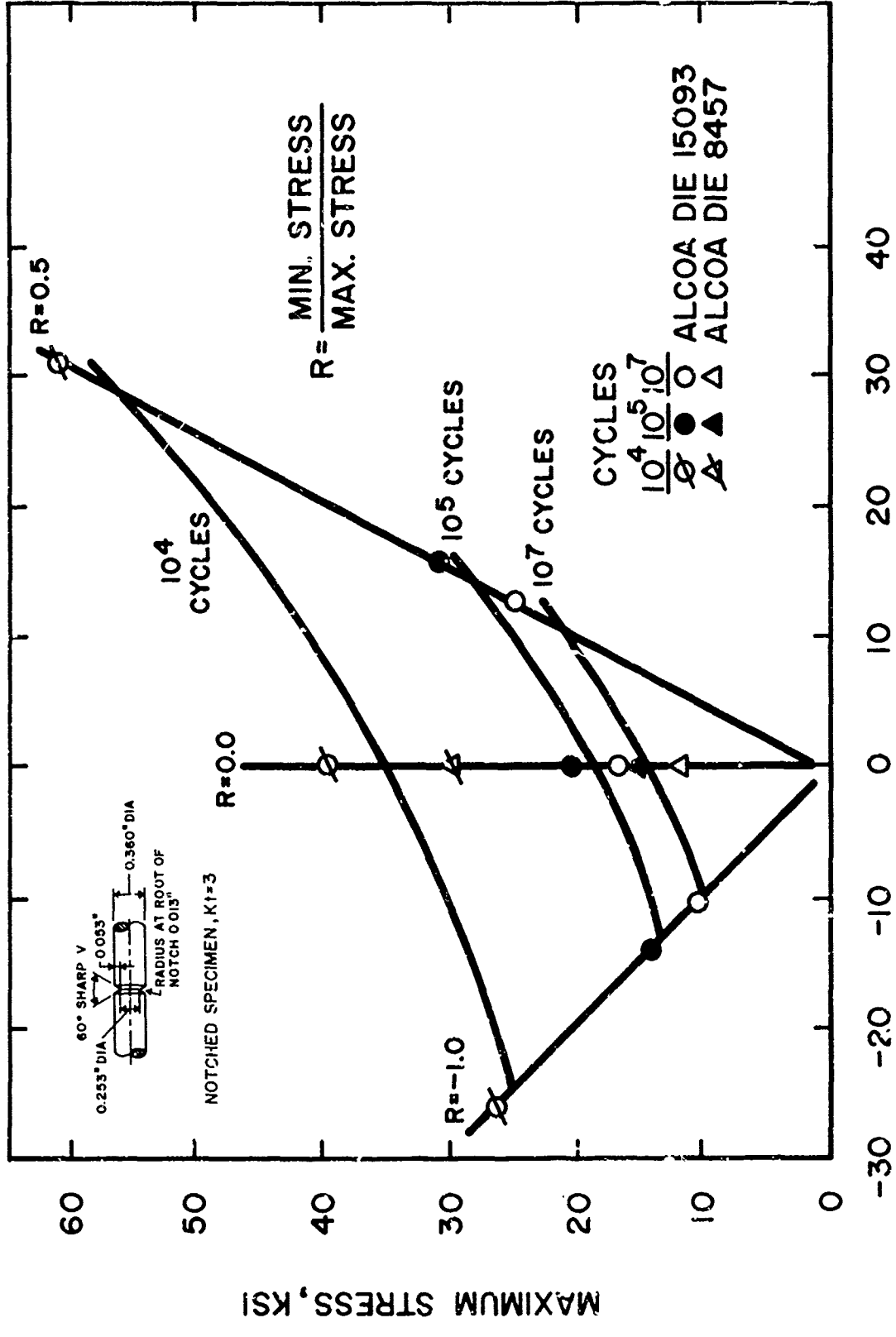
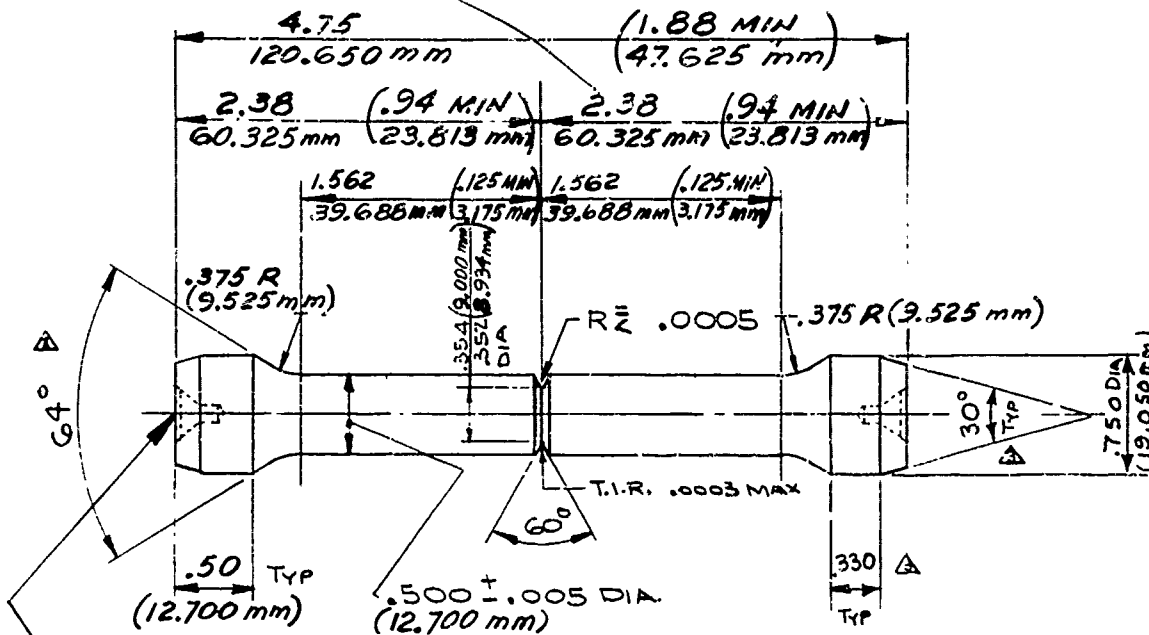

FIG. 31 GOODMAN DIAGRAM FOR X7050-T736 DIE FORGINGS, $K_t = 3$

L010817-RK



USE .875 DIA CUTTER N° 14
 CENTER. BOTH ENDS
 SEE D-7444

63 √ ALL OVER

NOTE: TO OBTAIN SHORT-TRANSVERSE SPECIMENS,
 THE OVERALL LENGTH MAY BE REDUCED BY
 SHORTENING THE REDUCED SECTION.

TOL		2
.XX	±.02	
.XXX	±.005	

DATE	NO	REVISION RECORD	DR	CK
11-24-71	3	ADDED 30° CHAM F.330, 64° WAS 62°	LM	
11-11-71	2	DEC DIMS-MM EQUIV & TOL ADDED	CM	
2-4-71	1	ADDED SPECIMEN WITH WELD REF	WF	

SPECIMEN WITH WELD		L-019634-RK
ALUMINUM COMPANY OF AMERICA		
ALCOA RESEARCH LABORATORIES		
ENGINEERING DEPARTMENT		NEW KENSINGTON, PA.
MECHANICAL TESTING DIV.		
.500 DIA. TAPERED SEAT		
TENSILE SPECIMEN		
IN CHG OF	S. C. H.	DESIGN
SCALE	12:1-0	DATE 9-20-66
DRAWN S. GLOZIK		CHECK
L-010817-RK		APPR

PR 7046-064

FIG. 32 NOTCH TENSILE SPECIMEN

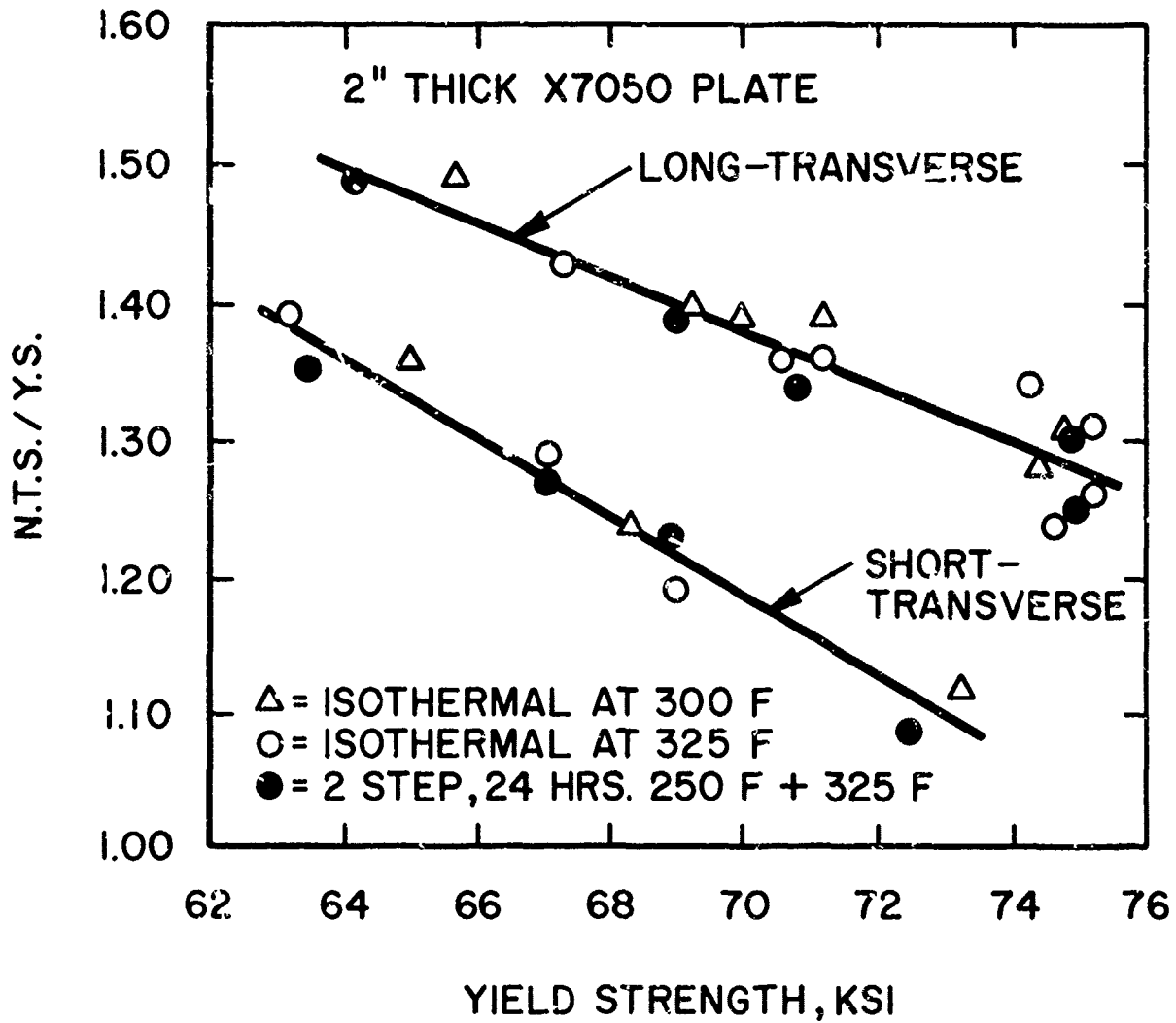

NOTCH-TOUGHNESS OF X7050 PLATE
VS YIELD STRENGTH

FIG.33

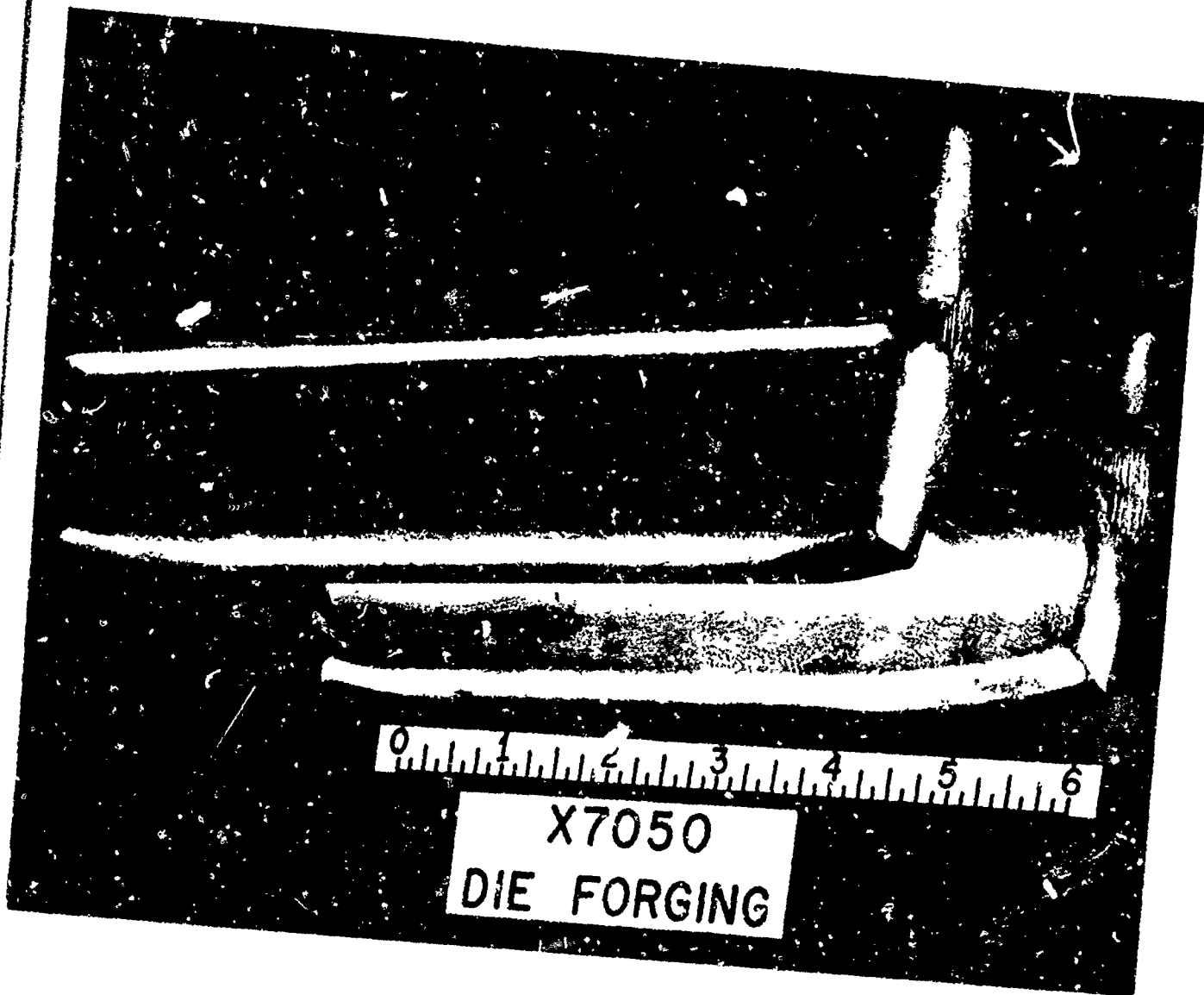

FIGURE 34
X7050 FORGING, ALCOA DIE 783

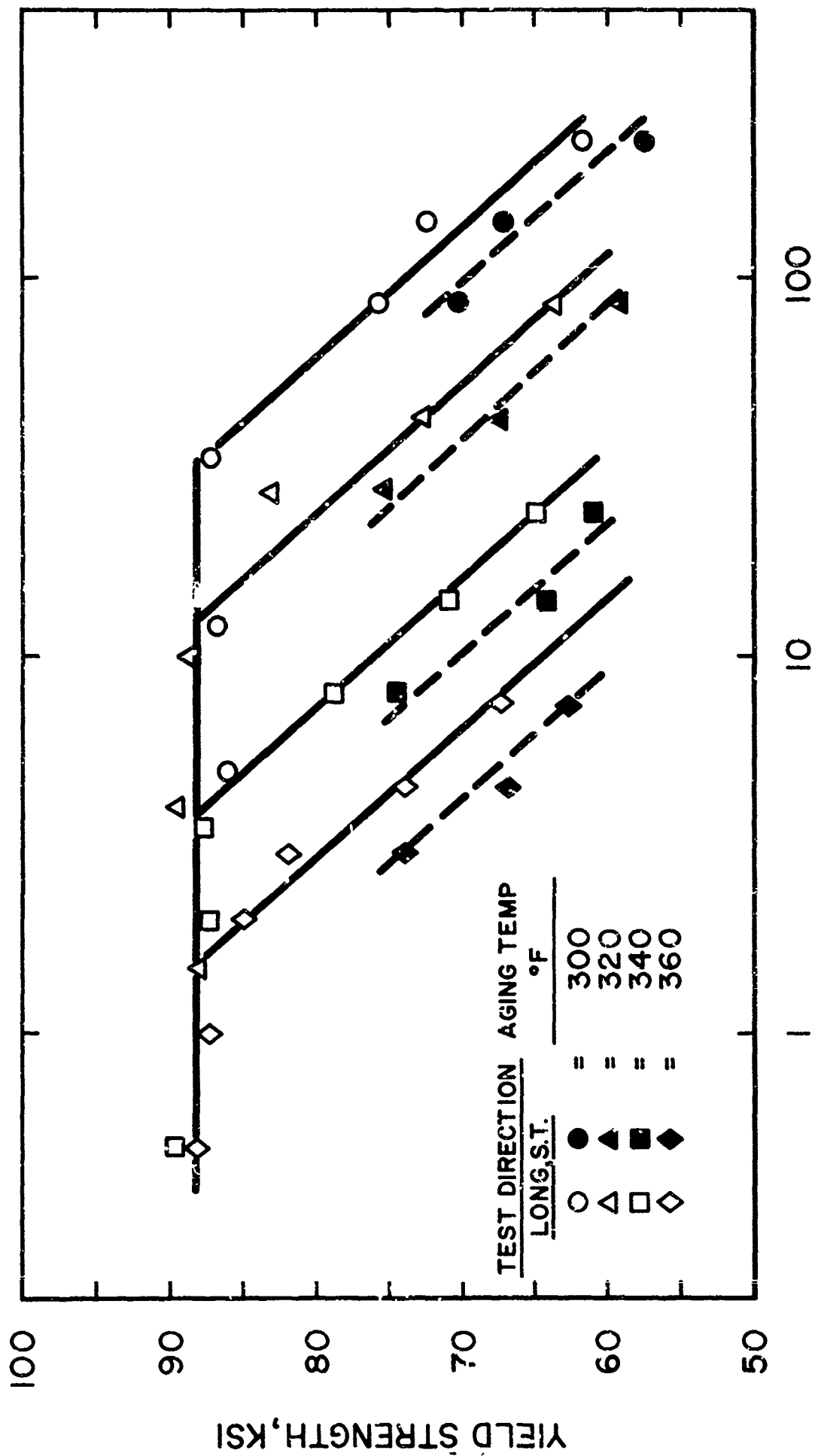

FIG. 35 AGING CURVE FOR X7050 FORGING, ALCOA DIE 783



X7050 FORGING

ALCOA DIE 783

FIG. 36
84

APPENDIX I

Percent Survived vs Days In
New Kensington Atmosphere

Short-Transverse Specimens from
Two-Inch Thick Plate of
NAVAIR Alloys 3 Through 10

Data Selected on Basis of Alloy
and Short-Transverse Yield Strength

Test Period = 840 Days

APPENDIX I

TABLE I
PERCENT SURVIVED VS. DAYS IN TEST

DAYS IN TEST	STRESSED 25-25 KSI		STRESSED 40-40 KSI		STRESSED 75-75 PCT	
	NO. TESTED	% PASSED	NO. TESTED	% PASSED	NO. TESTED	% PASSED
30	48	100.00	48	100.00	47	100.00
60	48	100.00	48	100.00	47	100.00
90	48	100.00	48	100.00	47	100.00
120	48	100.00	48	100.00	47	100.00
150	48	100.00	48	100.00	47	100.00
180	48	100.00	48	100.00	47	100.00
210	48	100.00	48	100.00	47	100.00
240	48	100.00	48	100.00	47	100.00
270	48	100.00	48	100.00	47	100.00
300	48	100.00	48	100.00	47	97.87
330	48	100.00	48	100.00	47	97.87
360	48	100.00	48	100.00	47	97.87
390	48	100.00	48	100.00	47	97.87
420	48	100.00	48	100.00	47	97.87
450	48	100.00	48	100.00	47	97.87
480	48	100.00	48	100.00	47	97.87
510	48	100.00	48	100.00	47	97.87
540	48	100.00	48	100.00	47	97.87
570	48	100.00	48	100.00	47	97.87
600	48	100.00	48	100.00	47	95.74
630	48	100.00	48	100.00	47	93.62
660	48	100.00	48	100.00	47	91.49
690	48	100.00	48	97.92	47	91.49
720	48	100.00	48	97.92	47	87.23
750	48	100.00	48	97.92	47	85.11
780	48	100.00	48	97.92	47	85.11
810	48	100.00	48	97.92	47	85.11
840	36	100.00	36	97.22	38	81.58

DATA SELECTED ON BASIS OF :

ALLOYS - NAVAIR 4, NAVAIR 6, NAVAIR 7, NAVAIR 10,
SHORT TRANSVERSE YIELD STRENGTH - 60.1 TO 70.0

THE ANALYSES WERE PERFORMED FOR NEW KENSINGTON ATMOSPHERE

APPENDIX I

TABLE 2

PERCENT SURVIVED VS. DAYS IN TEST

DAYS IN TEST	STRESSED 25-25 KSI		STRESSED 40-40 KSI		STRESSED 75-75 PCT	
	NO. TESTED	% PASSED	NO. TESTED	% PASSED	NO. TESTED	% PASSED
30	37	100.00	36	100.00	35	100.00
60	35	100.00	36	100.00	35	100.00
90	35	100.00	36	100.00	35	97.14
120	35	100.00	34	100.00	35	91.43
150	35	100.00	34	100.00	35	82.86
180	35	100.00	34	100.00	35	82.86
210	35	100.00	35	100.00	35	82.86
240	35	100.00	36	97.22	35	71.43
270	35	100.00	35	94.44	35	60.00
300	35	100.00	36	51.57	35	45.71
330	35	100.00	35	88.89	35	42.86
360	35	100.00	34	88.89	35	40.00
390	35	100.00	35	88.89	35	34.29
420	35	100.00	35	88.89	35	34.29
450	35	100.00	36	88.89	35	34.29
480	35	100.00	34	88.89	35	34.29
510	35	100.00	36	77.78	35	34.29
540	35	100.00	36	77.78	35	34.29
570	35	100.00	35	75.00	35	34.29
600	35	97.14	36	72.22	35	31.43
630	35	97.14	35	72.22	35	22.86
660	35	97.14	35	61.11	35	17.14
690	35	97.14	35	55.56	35	14.29
720	31	96.77	35	48.57	35	11.43
750	31	96.77	35	48.57	35	11.43
780	31	96.77	35	48.57	35	11.43
810	31	96.77	35	48.57	35	11.43
840	27	96.30	33	42.42	34	9.82

DATA SELECTED ON BASIS OF :

ALLOYS - NAVAIR 4, NAVAIR 6, NAVAIR 7, NAVAIR 10,
SHORT TRANSVERSE YIELD STRENGTH - 70.1 TO 75.0

THE ANALYSES WERE PERFORMED FOR THE KENSINGTON ATMOSPHERE

APPENDIX I

TABLE 3

PERCENT SURVIVED VS. DAYS IN TEST

DAYS IN TEST	STRESSED 25-25 KSI		STRESSED 40-40 KSI		STRESSED 75-75 PCT	
	NO. TESTED	% PASSED	NO. TESTED	% PASSED	NO. TESTED	% PASSED
30	30	100.00	30	100.00	30	90.00
60	30	100.00	30	96.67	30	70.00
90	30	100.00	30	90.00	30	60.00
120	30	100.00	30	73.33	30	43.33
150	30	100.00	30	70.00	30	33.33
180	30	100.00	30	65.67	30	30.00
210	30	93.33	30	60.00	30	16.67
240	30	93.33	30	50.00	30	10.00
270	30	80.00	30	40.00	30	3.33
300	30	76.67	30	33.33	30	0.0
330	30	73.33	30	30.00	30	0.0
360	30	70.00	30	26.67	30	0.0
390	30	70.00	30	26.67	30	0.0
420	30	70.00	30	26.67	30	0.0
450	30	70.00	30	26.67	30	0.0
480	30	70.00	30	23.33	30	0.0
510	30	70.00	30	23.33	30	0.0
540	30	70.00	30	16.67	30	0.0
570	30	70.00	30	16.67	30	0.0
600	30	70.00	30	16.67	30	0.0
630	30	66.67	30	13.33	30	0.0
660	30	60.00	30	6.67	30	0.0
690	30	60.00	30	6.67	30	0.0
720	28	57.14	30	6.67	30	0.0
750	28	57.14	30	3.33	30	0.0
780	28	57.14	30	0.0	30	0.0
810	28	57.14	30	0.0	30	0.0
840	28	57.14	30	0.0	30	0.0

DATA SELECTED ON BASIS OF

ALLOYS - NAVAIR 4, NAVAIR 5, NAVAIR 7, NAVAIR 10,
SHORT TRANSVERSE YIELD STRENGTH - 75.1 TO 80.0

THE ANALYSES WERE PERFORMED FOR NEW KENSINGTON ATMOSPHERE

APPENDIX I

TABLE 4

PERCENT SURVIVED VS. DAYS IN TEST

DAYS IN TEST	STRESSED 25-25 KSI		STRESSED 40-40 KSI		STRESSED 75-75 PCT	
	NO. TESTED	% PASSED	NO. TESTED	% PASSED	NO. TESTED	% PASSED
30	54	100.00	53	100.00	53	100.00
60	54	100.00	53	100.00	53	100.00
90	54	100.00	53	100.00	53	100.00
120	54	100.00	53	100.00	53	100.00
150	54	100.00	53	100.00	53	100.00
180	54	100.00	53	100.00	53	100.00
210	54	100.00	53	100.00	53	100.00
240	54	100.00	53	100.00	53	100.00
270	54	100.00	53	100.00	53	100.00
300	54	100.00	53	100.00	53	100.00
330	54	100.00	53	100.00	53	98.11
360	54	100.00	53	100.00	53	98.11
390	54	100.00	53	100.00	53	98.11
420	54	100.00	53	100.00	53	98.11
450	54	100.00	53	100.00	53	98.11
480	54	100.00	53	100.00	53	98.11
510	54	100.00	53	100.00	53	98.11
540	54	100.00	53	100.00	53	98.11
570	54	100.00	53	100.00	53	98.11
600	54	100.00	53	100.00	53	96.23
630	54	100.00	53	100.00	53	84.91
660	54	100.00	53	100.00	53	83.02
690	54	100.00	53	96.23	53	83.02
720	54	100.00	53	96.23	53	81.13
750	54	100.00	53	96.23	53	71.70
780	54	100.00	53	96.23	53	71.70
810	54	100.00	53	96.23	53	71.70
840	46	100.00	46	95.65	46	69.39

DATA SELECTED ON BASIS OF :

ALLOYS - NAVAIR 3, NAVAIR 5, NAVAIR 8, NAVAIR 9,
SHORT TRANSVERSE YIELD STRENGTH - 60.1 TO 70.0.

THE ANALYSES WERE PERFORMED FOR NEW KENSINGTON ATMOSPHERE

APPENDIX I

TABLE 5

STRESS vs. SURVIVAL vs. DAYS IN TEST

DAYS IN TEST	STRESSED 25-25 KSI		STRESSED 40-40 KSI		STRESSED 75-75 PCT	
	NO. TESTED	% PASSED	NO. TESTED	% PASSED	NO. TESTED	% PASSED
30	34	100.00	34	100.00	34	88.24
40	34	97.06	34	91.18	34	76.47
50	34	97.06	34	82.35	34	70.59
60	34	94.12	34	79.41	34	70.59
70	34	91.18	34	75.47	34	67.65
80	34	91.18	34	75.47	34	64.71
90	34	91.18	34	61.76	34	47.06
100	34	88.24	34	50.00	34	38.24
110	34	85.29	34	44.12	34	17.65
120	34	82.35	34	32.35	34	11.76
130	34	79.41	34	32.35	34	8.82
140	34	79.41	34	29.41	34	8.82
150	34	79.41	34	29.41	34	8.02
160	34	79.41	34	29.41	34	5.88
170	34	79.41	34	26.47	34	5.88
180	34	79.41	34	26.47	34	5.88
190	34	73.53	34	23.53	34	2.94
200	34	73.53	34	23.53	34	0.0
210	34	73.53	34	20.59	34	0.0
220	31	67.74	33	18.18	34	0.0
230	31	64.52	33	18.18	34	0.0
240	31	64.52	33	18.18	34	0.0
250	31	64.52	33	18.18	34	0.0
260	31	64.52	33	18.18	34	0.0

DATA SELECTED ON BASIS OF :

ALLOYS - NAVAIR 6, NAVAIR 5, NAVAIR 8, NAVAIR 9, SHORT TRANSVERSE YIELD STRENGTH - 70.1 TO 75.0

THE ANALYSES WERE PERFORMED FOR NEW KENSINGTON ATMOSPHERE

APPENDIX I

TABLE 6

PERCENT SURVIVED VS. DAYS IN TEST

DAYS IN TEST	STRESSED 20-25 KSI		STRESSED 40-40 KSI		STRESSED 75-75 PCT	
	NO. TESTED	% PASSED	NO. TESTED	% PASSED	NO. TESTED	% PASSED
30	12	100.00	12	100.00	12	83.33
60	12	83.33	12	75.00	12	58.33
90	12	83.33	12	66.67	12	50.00
120	12	75.00	12	50.00	12	50.00
150	12	75.00	12	33.33	12	50.00
180	12	66.67	12	33.33	12	41.67
210	12	66.67	12	33.33	12	33.33
240	12	66.67	12	16.67	12	16.67
270	12	50.00	12	16.67	12	16.67
300	12	50.00	12	16.67	12	16.67
330	12	50.00	12	8.33	12	16.67
360	12	50.00	12	8.33	12	16.67
390	12	50.00	12	8.33	12	16.67
420	12	50.00	12	8.33	12	16.67
450	12	50.00	12	8.33	12	0.0
480	12	50.00	12	8.33	12	0.0
510	12	50.00	12	8.33	12	0.0
540	12	50.00	12	8.33	12	0.0
570	12	50.00	12	8.33	12	0.0
600	12	50.00	12	8.33	12	0.0
630	12	50.00	12	0.0	12	0.0
660	12	25.00	12	0.0	12	0.0
690	12	25.00	12	0.0	12	0.0
720	12	25.00	12	0.0	12	0.0
750	12	25.00	12	0.0	12	0.0
780	12	25.00	12	0.0	12	0.0
810	12	16.67	12	0.0	12	0.0
840	12	16.67	12	0.0	12	0.0

DATA SELECTED ON BASIS OF :

ALL JOBS - NAVALIN 3, NAVALIN 7, NAVALIN 4, NAVALIN 9, SHORT TRANSVERSE YIELD STRENGTH - 75.1 TO 80.0

THE ANALYSES WERE PERFORMED FOR NEW KENSINGTON ATMOSPHERE

APPENDIX II

Percent Survived vs Days in
3.5% NaCl Alternate Immersion Test

Short-Transverse Specimens from
Two-Inch Thick Plate of
NAVAIR Alloys 3 Through 10

Data Selected on Basis of Alloy
and Short-Transverse Yield Strength

Test Period = 60 Days

APPENDIX II

TABLE I

PERCENT SURVIVED VS. DAYS IN TEST

DAYS IN TEST	STRESSED 25-25 KSI		STRESSED 40-40 KSI		STRESSED 75-75 PCT	
	NO. TESTED	% PASSED	NO. TESTED	% PASSED	NO. TESTED	% PASSED
2	44	100.00	44	100.00	44	100.00
4	44	100.00	44	100.00	44	100.00
6	44	100.00	44	97.92	44	100.00
8	44	100.00	44	97.92	44	97.92
10	44	100.00	44	95.43	44	91.67
12	44	100.00	44	95.43	44	87.50
14	44	100.00	44	95.43	44	87.50
16	44	100.00	44	93.75	44	81.25
18	44	100.00	44	93.75	44	81.25
20	44	100.00	44	93.75	44	81.25
22	44	100.00	44	91.67	44	75.00
24	44	100.00	44	91.67	44	70.83
26	44	100.00	44	91.67	44	66.67
28	44	100.00	44	87.50	44	58.33
30	44	100.00	44	85.42	44	56.25
32	44	100.00	44	85.42	44	56.25
34	44	100.00	44	79.17	44	56.25
36	44	100.00	44	72.92	44	56.25
38	44	100.00	44	70.43	44	47.92
40	44	100.00	44	68.75	44	45.83
42	44	100.00	44	68.75	44	45.83
44	44	100.00	44	64.75	44	45.83
46	44	100.00	44	64.75	44	43.75
48	44	100.00	44	64.75	44	43.75
50	44	100.00	44	66.67	44	39.58
52	44	100.00	44	66.67	44	39.58
54	44	100.00	44	66.67	44	37.50
56	44	97.92	44	64.54	44	37.50
58	44	97.92	44	62.50	44	37.50
60	44	91.67	44	45.43	44	31.25

DATA SELECTED ON BASIS OF :

ALLOYS - NAVAIR 4, NAVAIR 6, NAVAIR 7, NAVAIR 10.
SHORT TRANSVERSE YIELD STRENGTH - 60.1 TO 70.0

THE ANALYSES WERE PERFORMED FOR ALTERNATE IMMERSION

APPENDIX II

TABLE 2

PERCENT SURVIVED VS. DAYS IN TEST

DAYS IN TEST	STRESSED 25-25 KSI		STRESSED 40-40 KSI		STRESSED 75-75 PCT	
	NO. TESTED	% PASSED	NO. TESTED	% PASSED	NO. TESTED	% PASSED
2	36	100.00	36	100.00	36	94.44
4	36	100.00	36	97.22	36	80.56
6	36	100.00	36	94.44	36	75.00
8	36	100.00	36	86.11	36	66.67
10	36	100.00	36	80.56	36	61.11
12	36	100.00	36	72.22	36	50.00
14	36	100.00	36	69.44	36	38.89
16	36	100.00	36	69.44	36	33.33
18	36	100.00	36	66.67	36	30.56
20	36	100.00	36	66.67	36	25.00
22	36	97.22	36	61.11	36	13.89
24	36	97.22	36	61.11	36	9.33
26	36	94.44	36	52.78	36	8.33
28	36	86.11	36	36.11	36	5.56
30	36	83.33	36	36.11	36	5.56
32	36	83.33	36	33.33	36	5.56
34	36	83.33	36	33.33	36	5.56
36	36	83.33	36	33.33	36	5.56
38	36	77.78	36	30.56	36	5.56
40	36	77.78	36	22.22	36	5.56
42	36	77.78	36	22.22	36	2.78
44	36	75.00	36	22.22	36	2.78
46	36	75.00	36	19.44	36	2.78
48	36	72.22	36	19.44	36	2.78
50	36	69.44	36	19.44	36	0.00
52	36	69.44	36	19.44	36	0.00
54	36	69.44	36	16.67	36	0.00
56	36	66.67	36	16.67	36	0.00
58	36	66.67	36	13.89	36	0.00
60	36	55.56	36	4.33	36	0.00

DATA SELECTED ON BASIS OF :

ALLOYS - NAVAIR 4, NAVAIR 5, NAVAIR 7, NAVAIR 10,
SHORT TRANSVERSE YIELD STRENGTH - 70.1 TO 75.0

THE ANALYSES WERE PERFORMED FOR ALTERNATE IMPRESSION

APPENDIX II

TABLE 3

PERCENT SURVIVED VS. DAYS IN TEST

DAYS IN TEST	STRESSED 25-25, KSI		STRESSED 40-40 KSI		STRESSED 75-75 PCT	
	NO. TESTED	% PASSED	NO. TESTED	% PASSED	NO. TESTED	% PASSED
2	30	86.67	30	63.33	30	30.00
4	30	80.00	30	56.67	30	6.67
6	30	40.00	30	26.67	30	0.00
8	30	76.67	30	26.67	30	0.00
10	30	76.67	30	16.67	30	0.00
12	30	76.67	30	10.00	30	0.00
14	30	73.33	30	6.67	30	0.00
16	30	73.33	30	7.33	30	0.00
18	30	73.33	30	0.00	30	0.00
20	30	73.33	30	0.00	30	0.00
22	30	66.67	30	0.00	30	0.00
24	30	56.67	30	0.00	30	0.00
26	30	56.67	30	0.00	30	0.00
28	30	43.33	30	0.00	30	0.00
30	30	36.67	30	0.00	30	0.00
32	30	33.33	30	0.00	30	0.00
34	30	33.33	30	0.00	30	0.00
36	30	33.33	30	0.00	30	0.00
38	30	33.33	30	0.00	30	0.00
40	30	30.00	30	0.00	30	0.00
42	30	30.00	30	0.00	30	0.00
44	30	30.00	30	0.00	30	0.00
46	30	23.33	30	0.00	30	0.00
48	30	23.33	30	0.00	30	0.00
50	30	20.33	30	0.00	30	0.00
52	30	20.33	30	0.00	30	0.00
54	30	23.33	30	0.00	30	0.00
56	30	23.33	30	0.00	30	0.00
58	30	23.33	30	0.00	30	0.00
60	30	16.67	30	0.00	30	0.00

DATA SELECTED ON BASIS OF :

ALLOYS - NAVAIR 4, NAVAIR 5, NAVAIR 7, NAVAIR 10,
SHORT TRANSVERSE YIELD STRENGTH - 75.1 TO 80.0

THE ANALYSES WERE PERFORMED FOR ALTERNATE IMMERSION

APPENDIX II

TABLE 4

PERCENT SURVIVED VS. DAYS IN TEST

DAYS IN TEST	STRESSED 25-25 KSI		STRESSED 40-40 KSI		STRESSED 70-75 PCT	
	NO. TESTED	% PASSED	NO. TESTED	% PASSED	NO. TESTED	% PASSED
2	50	100.00	50	100.00	51	100.00
4	50	100.00	50	100.00	51	98.04
6	50	100.00	50	100.00	51	98.04
8	50	100.00	50	100.00	51	94.12
10	50	100.00	50	98.00	51	92.16
12	50	100.00	50	96.00	51	88.24
14	50	100.00	50	94.00	51	84.31
16	50	100.00	50	92.00	51	82.35
18	50	100.00	50	92.00	51	80.39
20	50	100.00	50	92.00	51	74.51
22	50	100.00	50	88.00	51	68.03
24	50	100.00	50	86.00	51	66.67
26	50	98.00	50	84.00	51	66.67
28	50	96.00	50	78.00	51	64.71
30	50	96.00	50	72.00	51	60.78
32	50	96.00	50	72.00	51	60.78
34	50	92.00	50	72.00	51	58.82
36	50	92.00	50	70.00	51	58.32
38	50	92.00	50	70.00	51	56.86
40	50	92.00	50	70.00	51	52.94
42	50	92.00	50	70.00	51	50.98
44	50	90.00	50	68.00	51	49.02
46	50	90.00	50	68.00	51	47.06
48	50	90.00	50	64.00	51	43.14
50	50	90.00	50	62.00	51	39.22
52	50	90.00	50	62.00	51	39.22
54	50	90.00	50	60.00	51	39.22
56	50	90.00	50	58.00	51	35.29
58	50	90.00	50	58.00	51	33.33
60	50	85.00	50	48.00	51	31.37

DATA SELECTED ON BASIS OF :

ALLOYS - NAVAIR 3, NAVAIR 5, NAVAIR 4, NAVAIR 9,
SHORT TRANSVERSE YIELD STRENGTH - 60.1 TO 70.0

THE ANALYSES WERE PERFORMED FOR ALTERNATE IMMERSION

APPENDIX II

TABLE 5

PERCENT SURVIVED VS. DAYS IN TEST

DAYS IN TEST	STRESSED 25-25 KSI		STRESSED 40-40 KSI		STRESSED 75-75 PCT	
	NO. TESTED	% PASSED	NO. TESTED	% PASSED	NO. TESTED	% PASSED
2	34	91.18	34	44.12	34	32.35
4	34	70.59	34	37.29	34	20.59
6	34	70.59	34	29.41	34	17.65
8	34	64.71	34	26.47	34	17.65
10	34	64.71	34	23.53	34	11.76
12	34	61.76	34	23.53	34	11.76
14	34	58.82	34	20.59	34	11.76
16	34	58.82	34	20.59	34	11.76
18	34	58.82	34	20.59	34	11.76
20	34	58.82	34	20.59	34	11.76
22	34	55.88	34	20.59	34	8.82
24	34	55.88	34	20.59	34	5.88
26	34	52.94	34	17.65	34	5.88
28	34	47.06	34	11.76	34	2.94
30	34	47.06	34	8.82	34	2.94
32	34	47.06	34	2.94	34	2.94
34	34	47.06	34	2.94	34	2.94
36	34	47.06	34	2.94	34	2.94
38	34	47.06	34	2.94	34	2.94
40	34	41.18	34	2.94	34	2.94
42	34	41.18	34	2.94	34	2.94
44	34	41.18	34	2.94	34	2.94
46	34	35.29	34	2.94	34	2.94
48	34	35.29	34	2.94	34	0.0
50	34	35.29	34	2.94	34	0.0
52	34	35.29	34	2.94	34	0.0
54	34	32.35	34	2.94	34	0.0
56	34	32.35	34	2.94	34	0.0
58	34	32.35	34	2.94	34	0.0
60	34	20.59	34	2.94	34	0.0

DATA SELECTED ON BASIS OF :

ALLOYS - NAVAIP 3, NAVAIP 5, NAVAIP 8, NAVAIP 9,
SHORT TRANSVERSE YIELD STRENGTH - 70.1 TO 75.0

THE ANALYSES WERE PERFORMED FOR ALTERNATE IMPERSON

APPENDIX II

TABLE 6
PERCENT SURVIVED VS. DAYS IN TEST

DAYS IN TEST	STRESSED 25-25 KSI		STRESSED 40-40 KSI		STRESSED 75-75 PCT	
	NO. TESTED	% PASSED	NO. TESTED	% PASSED	NO. TESTED	% PASSED
2	12	83.33	12	25.00	12	16.67
4	12	50.00	12	8.33	12	0.0
6	12	50.00	12	8.33	12	0.0
8	12	33.33	12	0.0	12	0.0
10	12	33.33	12	0.0	12	0.0
12	12	33.33	12	0.0	12	0.0
14	12	33.33	12	0.0	12	0.0
16	12	33.33	12	0.0	12	0.0
18	12	33.33	12	0.0	12	0.0
20	12	33.33	12	0.0	12	0.0
22	12	25.00	12	0.0	12	0.0
24	12	25.00	12	0.0	12	0.0
26	12	25.00	12	0.0	12	0.0
28	12	8.33	12	0.0	12	0.0
30	12	8.33	12	0.0	12	0.0
32	12	8.33	12	0.0	12	0.0
34	12	8.33	12	0.0	12	0.0
36	12	8.33	12	0.0	12	0.0
38	12	8.33	12	0.0	12	0.0
40	12	8.33	12	0.0	12	0.0
42	12	8.33	12	0.0	12	0.0
44	12	8.33	12	0.0	12	0.0
46	12	8.33	12	0.0	12	0.0
48	12	8.33	12	0.0	12	0.0
50	12	8.33	12	0.0	12	0.0
52	12	8.33	12	0.0	12	0.0
54	12	8.33	12	0.0	12	0.0
56	12	8.33	12	0.0	12	0.0
58	12	8.33	12	0.0	12	0.0
60	12	8.33	12	0.0	12	0.0

DATA SELECTED ON BASIS OF :

ALLOYS - NAVAIR 3, NAVAIR 5, NAVAIR 8, NAVAIR 9,
SHORT TRANSVERSE YIELD STRENGTH - 75.1 TO 80.0

THE ANALYSES WERE PERFORMED FOR ALTERNATE IMMERSION

APPENDIX III

Percent Survived vs Days in
New Kensington Atmosphere or
3.5% NaCl Alternate Immersion Test

Short-Transverse Specimens from
1.75 to 3.0" Thick 7075-T6 and
7075-T651 Plate and 2.0 to 5.0" Thick
7079-T6 and 7079-T651 Plate

Data Selected on Basis of Alloy,
Temper, Product, and Thickness

Test Period New Kensington Atmosphere = 840 days

Test Period Alternate Immersion Test = 60 days

APPENDIX III

TABLE 1

PERCENT SURVIVED VS. DAYS IN TEST

DAYS IN TEST	STRESSED 15-15 PCT		STRESSED 25-25 PCT		STRESSED 50-50 PCT		STRESSED 75-75 PCT	
	NO. TESTED	% PASSED	NO. TESTED	% PASSED	NO. TESTED	% PASSED	NO. TESTED	% PASSED
30	22	100.00	22	100.00	21	71.43	23	56.52
60	22	100.00	22	95.45	21	33.33	23	30.43
90	22	100.00	22	90.91	21	28.57	23	17.39
120	22	100.00	22	86.36	21	23.81	23	4.35
150	22	100.00	22	81.82	21	23.81	23	0.0
180	22	100.00	22	77.27	21	23.81	23	0.0
210	22	100.00	22	72.73	21	19.05	23	0.0
240	22	100.00	22	72.73	21	19.05	23	0.0
270	22	100.00	22	68.18	21	9.52	23	0.0
300	22	95.45	22	63.64	21	0.0	23	0.0
330	22	95.45	22	54.55	21	0.0	23	0.0
360	22	95.45	22	54.55	21	0.0	23	0.0
390	22	95.45	22	54.55	21	0.0	23	0.0
420	16	93.75	17	41.18	21	0.0	23	0.0
450	16	81.25	17	29.41	21	0.0	23	0.0
480	16	75.00	17	23.53	21	0.0	23	0.0
510	16	68.75	17	17.65	21	0.0	23	0.0
540	16	68.75	17	11.76	21	0.0	23	0.0
570	16	68.75	17	11.76	21	0.0	23	0.0
600	16	68.75	17	11.76	21	0.0	23	0.0
630	16	68.75	17	11.76	21	0.0	23	0.0
660	16	68.75	17	11.76	21	0.0	23	0.0
690	16	68.75	17	11.76	21	0.0	23	0.0
720	16	62.50	17	11.76	21	0.0	23	0.0
750	16	62.50	17	11.76	21	0.0	23	0.0
780	16	62.50	17	11.76	21	0.0	23	0.0
810	16	62.50	17	11.76	21	0.0	23	0.0
840	16	62.50	17	11.76	21	0.0	23	0.0

DATA SELECTED ON BASIS OF :

ALLOY - 7075; TEMPER - T651, T6; PRODUCTS - PLATE, PLATE SR; THICKNESS - 1.75 TO 3.0"

THE ANALYSES WERE PERFORMED FOR NEW KENSINGTON ATMOSPHERE

APPENDIX III

TABLE 2

PERCENT SURVIVED VS. DAYS IN TEST

DAYS IN TEST	STRESSED 15-15 PCT		STRESSED 25-25 PCT		STRESSED 50-50 PCT		STRESSED 75-75 PCT	
	NO. TESTED	% PASSED	NO. TESTED	% PASSED	NO. TESTED	% PASSED	NO. TESTED	% PASSED
30	20	100.00	20	100.00	20	70.00	15	20.00
60	20	100.00	20	95.00	20	40.00	15	0.0
90	20	100.00	20	95.00	20	25.00	15	0.0
120	20	100.00	20	90.00	20	15.00	15	0.0
150	20	100.00	20	85.00	20	15.00	15	0.0
180	20	100.00	20	85.00	20	15.00	15	0.0
210	20	100.00	20	85.00	20	10.00	15	0.0
240	20	100.00	20	80.00	20	0.0	15	0.0
270	20	80.00	20	80.00	20	0.0	15	0.0
300	20	75.00	20	35.00	20	0.0	15	0.0
330	20	70.00	20	35.00	20	0.0	15	0.0
360	20	55.00	20	35.00	20	0.0	15	0.0
390	20	55.00	20	35.00	20	0.0	15	0.0
420	17	47.06	19	31.58	20	0.0	15	0.0
450	17	41.18	19	31.58	20	0.0	15	0.0
480	17	41.18	19	31.58	20	0.0	15	0.0
510	17	41.18	19	26.32	20	0.0	15	0.0
540	17	41.18	19	26.32	20	0.0	15	0.0
570	17	41.18	19	21.05	20	0.0	15	0.0
600	17	41.18	19	21.05	20	0.0	15	0.0
630	17	41.18	19	21.05	20	0.0	15	0.0
660	17	35.29	19	21.05	20	0.0	15	0.0
690	17	35.29	19	21.05	20	0.0	15	0.0
720	17	35.29	19	21.05	20	0.0	15	0.0
750	17	35.29	19	21.05	20	0.0	15	0.0
780	17	35.29	19	21.05	20	0.0	15	0.0
810	17	35.29	19	21.05	20	0.0	15	0.0
840	17	35.29	19	21.05	20	0.0	15	0.0

DATA SELECTED ON BASIS OF :

ALLOY - 7079; TEMPER - T651, T6; PRODUCTS - PLATE, PLATE SR; THICKNESS - 2.0 TO 5.0"

THE ANALYSES WERE PERFORMED FOR NEW KENSINGTON ATMOSPHERE

APPENDIX III

TABLE 3

PERCENT SURVIVED VS. DAYS IN TEST

DAYS IN TEST	STRESSED 15-15 PCT		STRESSED 25-25 PCT		STRESSED 50-50 PCT		STRESSED 75-75 PCT	
	NO. TESTED	% PASSED	NO. TESTED	% PASSED	NO. TESTED	% PASSED	NO. TESTED	% PASSED
2	30	100.00	30	93.33	30	60.00	23	52.17
4	30	93.33	30	53.33	30	3.33	23	0.0
6	30	76.67	30	33.33	30	0.0	23	0.0
8	30	70.00	30	23.33	30	0.0	23	0.0
10	30	60.00	30	6.67	30	0.0	23	0.0
12	30	60.00	30	6.67	30	0.0	23	0.0
14	30	56.67	30	6.67	30	0.0	23	0.0
16	30	56.67	30	6.67	30	0.0	23	0.0
18	30	56.67	30	3.33	30	0.0	23	0.0
20	30	56.67	30	0.0	30	0.0	23	0.0
22	30	56.67	30	0.0	30	0.0	23	0.0
24	30	56.67	30	0.0	30	0.0	23	0.0
26	30	53.33	30	0.0	30	0.0	23	0.0
28	30	53.33	30	0.0	30	0.0	23	0.0
30	30	53.33	30	0.0	30	0.0	23	0.0
32	30	53.33	30	0.0	30	0.0	23	0.0
34	30	53.33	30	0.0	30	0.0	23	0.0
36	30	53.33	30	0.0	30	0.0	23	0.0
38	30	53.33	30	0.0	30	0.0	23	0.0
40	30	53.33	30	0.0	30	0.0	23	0.0
42	30	50.00	30	0.0	30	0.0	23	0.0
44	30	50.00	30	0.0	30	0.0	23	0.0
46	30	50.00	30	0.0	30	0.0	23	0.0
48	30	50.00	30	0.0	30	0.0	23	0.0
50	30	50.00	30	0.0	30	0.0	23	0.0
52	30	50.00	30	0.0	30	0.0	23	0.0
54	30	46.67	30	0.0	30	0.0	23	0.0
56	30	46.67	30	0.0	30	0.0	23	0.0
58	30	46.67	30	0.0	30	0.0	23	0.0
60	30	46.67	30	0.0	30	0.0	23	0.0

DATA SELECTED ON BASIS OF :

ALLOY - 7075; TEMPER - T651, T6; PRODUCT'S - PLATE, PLATE SR; THICKNESS - 1.75 TO 3.0"

THE ANALYSES WERE PERFORMED FOR ALTERNATE IMMERSION

APPENDIX III

TABLE 4

PERCENT SURVIVED VS. DAYS IN TEST

DAYS IN TEST	STRESSED 15-15 PCT		STRESSED 25-25 PCT		STRESSED 50-50 PCT		STRESSED 75-75 PCT	
	NO. TESTED	% PASSED	NO. TESTED	% PASSED	NO. TESTED	% PASSED	NO. TESTED	% PASSED
2	20	100.00	20	100.00	20	100.00	17	82.35
4	20	100.00	20	100.00	20	90.00	17	23.53
6	20	100.00	20	100.00	20	60.00	17	5.88
8	20	100.00	20	75.00	20	60.00	17	5.88
10	20	100.00	20	70.00	20	20.00	17	5.88
12	20	100.00	20	60.00	20	10.00	17	5.88
14	20	100.00	20	55.00	20	0.0	17	5.88
16	20	100.00	20	45.00	20	0.0	17	5.88
18	20	100.00	20	45.00	20	0.0	17	5.88
20	20	100.00	20	45.00	20	0.0	17	5.88
22	20	100.00	20	25.00	20	0.0	17	5.88
24	20	100.00	20	25.00	20	0.0	17	5.88
26	20	100.00	20	25.00	20	0.0	17	5.88
28	20	100.00	20	15.00	20	0.0	17	5.88
30	20	100.00	20	10.00	20	0.0	17	5.88
32	20	100.00	20	10.00	20	0.0	17	5.88
34	20	100.00	20	10.00	20	0.0	17	5.88
36	20	95.00	20	10.00	20	0.0	17	5.88
38	20	95.00	20	10.00	20	0.0	17	5.88
40	20	95.00	20	10.00	20	0.0	17	5.88
42	20	95.00	20	10.00	20	0.0	17	5.88
44	20	95.00	20	10.00	20	0.0	17	5.88
46	20	95.00	20	10.00	20	0.0	17	5.88
48	20	95.00	20	10.00	20	0.0	17	5.88
50	20	95.00	20	10.00	20	0.0	17	5.88
52	20	95.00	20	10.00	20	0.0	17	5.88
54	20	95.00	20	10.00	20	0.0	17	5.88
56	20	90.00	20	10.00	20	0.0	17	5.88
58	20	90.00	20	10.00	20	0.0	17	5.88
60	20	90.00	20	10.00	20	0.0	17	5.88

DATA SELECTED ON BASIS OF :

ALLOY - 7079; TEMPER - T651, T6; PRODUCTS - PLATE, PLATE SR; THICKNESS - 2.0 TO 5.0"

THE ANALYSES WERE PERFORMED FOR ALTERNATE IMMERSION

APPENDIX IV

Percent Survived vs Short-Transverse Y.S.

Short-Transverse Specimens from
Two-Inch Thick Plate of
NAVAIR Alloys 3 through 10

Data Selected on Basis of Alloy,
Exposure Time, and Test Environment

840 days New Kensington, Pennsylvania

APPENDIX IV

TABLE 1

PERCENT SURVIVED VS. SHORT TRANSVERSE YIELD STRENGTH

SHORT TRANSVERSE Y.S. (KSI)	STRESSED 25-25 KSI			STRESSED 40-40 KSI			STRESSED 75-75 PCT		
	NO. EXP	% PASSED ACT	CUM	NO. EXP	% PASSED ACT	CUM	NO. EXP	% PASSED ACT	CUM
60.7	2	100.0	100.0	2	100.0	100.0	2	100.0	100.0
62.4	2	100.0	100.0	2	100.0	100.0	2	100.0	100.0
62.5	4	100.0	100.0	4	100.0	100.0	4	100.0	100.0
62.6	2	100.0	100.0	2	100.0	100.0	2	50.0	96.3
63.2	4	100.0	100.0	4	100.0	100.0	4	75.0	92.6
63.5	0	*****	100.0	0	*****	100.0	1	0.0	88.0
63.9	4	100.0	100.0	4	75.0	97.3	4	50.0	81.5
64.4	2	100.0	100.0	2	100.0	97.1	2	100.0	80.0
64.7	2	100.0	100.0	2	50.0	93.9	2	100.0	78.3
64.8	2	100.0	100.0	2	100.0	93.8	2	100.0	76.2
65.8	4	100.0	100.0	4	100.0	93.3	4	50.0	66.7
66.1	0	*****	100.0	0	*****	92.3	2	0.0	57.1
66.9	2	100.0	100.0	2	100.0	92.3	2	100.0	57.1
67.2	2	100.0	100.0	2	100.0	91.7	2	50.0	50.0
67.3	4	100.0	100.0	4	100.0	90.9	4	100.0	47.4
67.6	2	100.0	100.0	2	100.0	88.9	2	0.0	29.4
68.2	2	100.0	100.0	2	100.0	87.5	2	100.0	29.4
68.8	4	100.0	100.0	4	100.0	85.7	4	50.0	17.6
69.2	2	100.0	100.0	2	100.0	80.0	2	50.0	6.3
70.6	2	100.0	100.0	2	0.0	60.0	2	0.0	0.0
70.8	2	100.0	100.0	2	100.0	60.0	2	0.0	0.0
71.3	0	*****	100.0	2	0.0	44.4	2	0.0	0.0
71.4	2	50.0	94.7	1	0.0	36.4	2	0.0	0.0
71.7	4	75.0	89.5	4	25.0	28.6	4	0.0	0.0
71.9	1	0.0	82.4	2	0.0	26.0	2	0.0	0.0
72.0	2	100.0	82.4	2	100.0	20.0	2	0.0	0.0
72.5	2	100.0	80.0	2	50.0	7.1	2	0.0	0.0
73.2	2	50.0	71.4	2	0.0	0.0	2	0.0	0.0
73.6	2	0.0	60.0	2	0.0	0.0	2	0.0	0.0
73.9	2	100.0	60.0	2	0.0	0.0	2	0.0	0.0

APPENDIX IV

TABLE 1 (Continued)

PERCENT SURVIVED VS. SHORT TRANSVERSE YIELD STRENGTH
(CONTINUED)

SHORT TRANSVERSE Y.S. (KSI)	STRESSED 25-25 KSI		STRESSED 40-40 KSI		STRESSED 75-75 PCT	
	NO. EXP	% PASSED ACT CUM	NO. EXP	% PASSED ACT CUM	NO. EXP	% PASSED ACT CUM
74.2	2	0.0 46.7	2	0.0 0.0	2	0.0 0.0
74.3	4	75.0 43.8	4	0.0 0.0	4	0.0 0.0
74.6	2	100.0 30.8	2	0.0 0.0	2	0.0 0.0
74.9	2	0.0 15.4	2	0.0 0.0	2	0.0 0.0
75.2	2	0.0 13.3	2	0.0 0.0	2	0.0 0.0
75.3	2	0.0 11.8	2	0.0 0.0	2	0.0 0.0
76.9	2	0.0 10.5	2	0.0 0.0	2	0.0 0.0
77.0	4	50.0 9.5	4	0.0 0.0	4	0.0 0.0
79.7	2	0.0 0.0	2	0.0 0.0	2	0.0 0.0

DATA SELECTED ON BASIS OF :

ALLOYS - NAVAIR 3, NAVAIR 5, NAVAIR 8, NAVAIR 9,
TEST ENVIRONMENT - NEW KENSINGTON ATMOSPHERE
TEST PERIOD - 840 DAYS

APPENDIX IV

TABLE 2

PERCENT SURVIVED VS. SHORT TRANSVERSE YIELD STRENGTH

SHORT TRANSVERSE Y.S. (KSI)	STRESSED 25-25 KSI		STRESSED 40-40 KSI		STRESSED 75-75 PCT	
	NO. EXP	% PASSED ACT CUM	NO. EXP	% PASSED ACT CUM	NO. EXP	% PASSED ACT CUM
59.8	2	100.0 100.0	2	100.0 100.0	2	100.0 100.0
62.2	2	100.0 100.0	2	100.0 100.0	2	100.0 100.0
62.5	2	100.0 100.0	2	100.0 100.0	2	100.0 100.0
62.7	2	100.0 100.0	2	100.0 100.0	2	100.0 100.0
63.4	2	100.0 100.0	2	100.0 100.0	2	100.0 100.0
64.6	4	100.0 100.0	4	75.0 97.6	4	50.0 92.9
65.6	2	100.0 100.0	2	100.0 97.4	2	100.0 92.3
65.8	0	**** 100.0	0	**** 97.3	1	0.0 83.0
66.0	2	100.0 100.0	2	100.0 97.3	2	100.0 88.0
66.8	2	100.0 100.0	2	100.0 97.1	2	100.0 87.0
67.1	2	100.0 100.0	2	100.0 97.0	2	100.0 85.7
67.5	2	100.0 100.0	2	100.0 96.8	2	100.0 84.2
67.6	2	100.0 100.0	2	100.0 96.6	2	100.0 82.4
68.3	2	100.0 100.0	2	100.0 96.3	3	66.7 75.0
68.4	2	100.0 100.0	2	100.0 96.0	1	100.0 71.4
68.5	2	100.0 100.0	2	100.0 95.7	2	50.0 64.3
68.7	2	100.0 100.0	2	100.0 95.2	2	100.0 61.5
69.0	2	100.0 100.0	2	100.0 94.7	2	50.0 50.0
69.2	0	**** 100.0	0	**** 94.1	1	0.0 41.7
69.3	2	100.0 100.0	2	100.0 94.1	2	100.0 41.7
70.4	2	100.0 100.0	4	0.0 73.7	3	0.0 23.1
71.2	2	100.0 100.0	2	50.0 70.0	2	0.0 20.0
71.4	0	**** 100.0	0	**** 68.4	2	0.0 17.6
71.7	2	100.0 100.0	2	100.0 68.4	2	0.0 15.8
71.9	2	100.0 100.0	2	100.0 64.7	2	100.0 15.8
72.0	2	100.0 100.0	2	100.0 60.0	2	0.0 5.3
72.2	2	100.0 100.0	2	50.0 50.0	2	0.0 4.8
72.4	2	100.0 100.0	2	100.0 46.2	2	50.0 4.5
72.6	2	100.0 100.0	2	50.0 33.3	2	0.0 0.0
73.6	2	100.0 100.0	2	100.0 27.3	2	0.0 0.0

APPENDIX IV

TABLE 2 (Continued)

PERCENT SURVIVED VS. SHORT TRANSVERSE YIELD STRENGTH
(CONTINUED)

SHORT TRANSVERSE Y.S. (KSI)	STRESSED 25-25 KSI		STRESSED 40-40 KSI		STRESSED 75-75 PCT	
	NO. EXP	% PASSED ACT CUM	NO. EXP	% PASSED ACT CUM	NO. EXP	% PASSED ACT CUM
73.7	2	100.0 100.0	2	0.0 9.1	2	0.0 0.0
73.8	2	100.0 100.0	2	0.0 7.7	2	0.0 0.0
74.0	0	***** 100.0	2	0.0 6.7	2	0.0 0.0
74.4	1	0.0 95.2	1	0.0 6.3	2	0.0 0.0
74.5	2	100.0 95.2	2	50.0 5.9	2	0.0 0.0
74.8	2	100.0 94.7	2	0.0 0.0	2	0.0 0.0
74.9	0	***** 94.1	2	0.0 0.0	2	0.0 0.0
75.4	4	75.0 88.9	4	0.0 0.0	4	0.0 0.0
75.6	2	100.0 86.7	2	0.0 0.0	2	0.0 0.0
75.8	4	100.0 84.6	4	0.0 0.0	4	0.0 0.0
76.0	4	50.0 63.6	4	0.0 -0.0	4	0.0 0.0
76.4	2	100.0 55.6	2	0.0 0.0	2	0.0 0.0
76.6	2	50.0 37.5	2	0.0 0.0	2	0.0 0.0
77.0	0	***** 28.6	2	0.0 0.0	2	0.0 0.0
77.4	2	0.0 22.2	2	0.0 0.0	2	0.0 0.0
77.7	2	100.0 22.2	2	0.0 0.0	2	0.0 0.0
77.8	2	0.0 0.0	2	0.0 0.0	2	0.0 0.0
78.3	2	0.0 0.0	2	0.0 0.0	2	0.0 0.0
78.5	2	0.0 0.0	2	0.0 0.0	2	0.0 0.0

DATA SELECTED ON BASIS OF :

ALLOYS - NAVAIR 4, NAVAIR 6, NAVAIR 7, NAVAIR 10.
TEST ENVIRONMENT - NEW KENSINGTON ATMOSPHERE
TEST PERIOD - 800 DAYS

APPENDIX IV

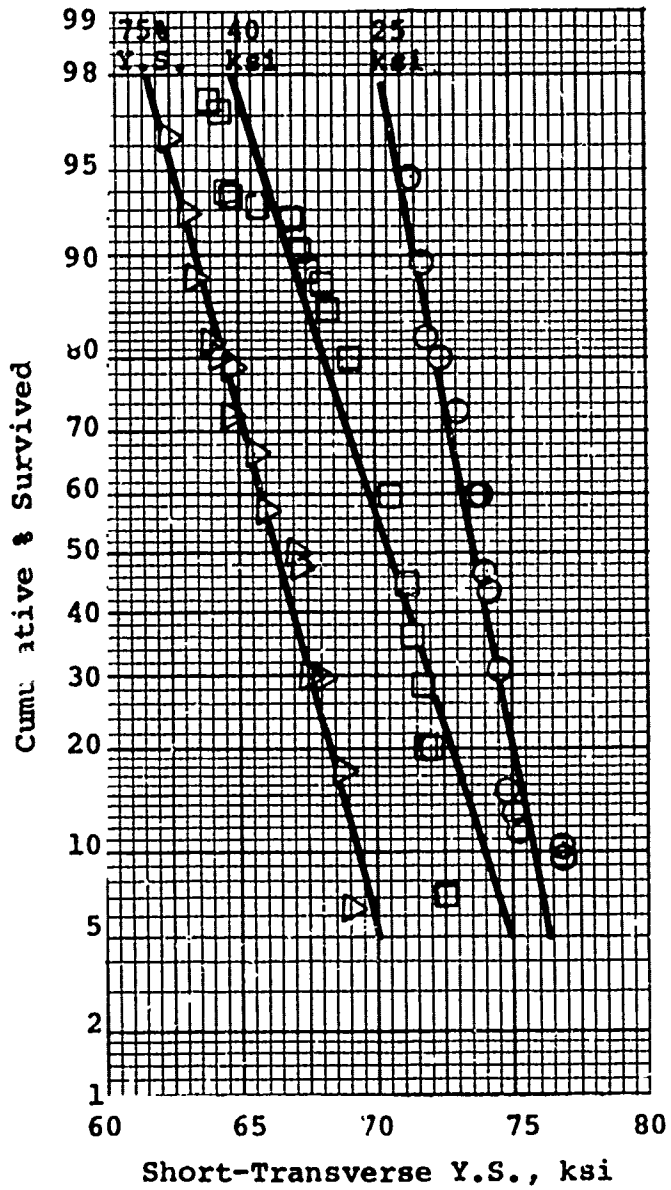

Figure 1 Percent Survived vs Short-Transverse Y.S. NAVAIR 3, 5, 8, 9. 840 Days New Kensington.

APPENDIX IV

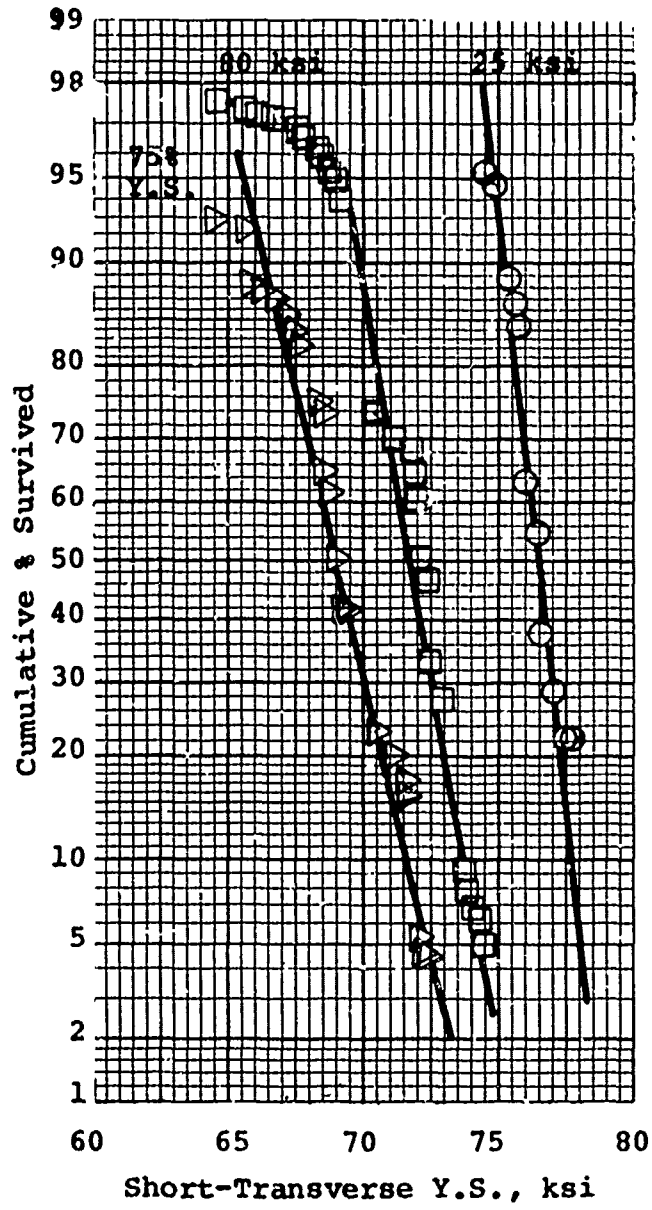

Figure 2 Percent Survived vs Short-Transverse Y.S. NAVAIR 4, 6, 7, 10. 840 Days New Kensington.

APPENDIX V
GRUMMAN INTER-OFFICE MEMORANDUM

FROM: G. Hilton ^{GAH} Metallurgy/Welding 12 7351 **DATE** 28 September 1971

TO: F. T. Main, Jr. **NO.** M&P/MWE-1-IM-71-102

SUBJECT: RESULTS OF MECHANICAL PROPERTY TESTS PERFORMED ON ALCOA ALLOY MA-15 (7050)

The mechanical property evaluation of a hand forged billet of MA-15 (7050) has been completed and the following properties have been measured in the directions indicated.

<u>Property</u>	<u>Direction</u>
Tensile	L, LT, ST
Toughness	TR, WT
Fatigue	LT
Stress Corrosion	ST

All coupons were machined from a 6" x 12" x 6" rectangular section removed approximately 3" from the end of a 6" x 12" x 28" hand forged billet. The material had been supplied by Alcoa solution heat treated and artificially aged to the -T7352 temper as part of an alloy data exchange program.

Tensile Property

Tensile properties were determined for all three orthogonal directions using a 1/4" round coupon with a 1/2" gage length (TGS 5307). The following data are the average of the values from three coupons from each direction.

<u>Direction</u>	<u>F_{ty}</u>	<u>F_{tu}</u>	<u>% Elong</u>	<u>% R.A.</u>
Longitudinal	74.2 ksi	79.7 ksi	12.7	13.0
Long Transverse	73.4 ksi	79.5 ksi	3.5	5.3
Short Transverse	71.6 ksi	79.0 ksi	4.1	3.8

All coupons were taken from random locations through the thickness dimension. The results appear to be higher than previously published tensile values for forgings with a corresponding decrease in elongation and reduction of cross section area values.

Toughness

The plane strain fracture toughness of the alloy was evaluated by means of six compact coupons (2 1/2" x 2 1/2" x 1" per TGS 1094-1). While

G. Hilton to F. T. Main, Jr.

M&P/MWE-1-IM-71-102

Toughness (Continued)

coupons taken from the WT direction yielded typical valid load-compliance traces, those from the TL direction displayed excessive non-linearity and the toughness values for them were based on maximum load. All fracture faces appeared flat with no appreciable shear lip formation.

<u>Direction</u>	<u>K_{1c}</u> (avg of three values)
WT	25.5 ksi \sqrt{in}
TL	18.1 * ksi \sqrt{in}

* K_Q value based on P max.

The toughness results from the WT direction are comparable to published data on 6" plate stock tested in the WL direction (crack propagation in the same plane but in the longitudinal direction rather than the thickness direction). The results from the TL direction while not precisely quantitative, indicate lower toughness properties in this direction which is typical. Published toughness values for 7075 and 7079 are approximately 25 and 20 ksi \sqrt{in} for the above directions.

Fatigue

Tension fatigue coupons (TGS 1052 1/4" dia. x 1" long cylindrical test section) were machined from the long transverse direction of the billet and tested at stress levels between 55 and 32 ksi at a stress ratio of 0.1. The results, shown in Figure 1, compare favorably with 7000 series alloys tested under similar conditions.

Stress Corrosion

The resistance to stress corrosion attack in an alternate immersion 3 1/2% sodium chloride solution was evaluated using a small rectangular stressing frame. Six coupons (TGS 1001 1/8" x 1/4" x 3/4" test section) whose axes were in the short transverse direction were loaded to 70% or 80% of their short transverse yield strength in the frame and placed in the test rig. The exposure cycle consisted of 10 minutes in the ASTM synthetic sea water solution and 50 minutes in laboratory air for drying. Although the coupons were checked daily for obvious sign of failure, the elastic coating applied to the ends of the coupon and the stressing frame would restrain any appreciable relaxation of a failed coupon. This condition would tend to mask the exact time of coupon failure.

<u>Sustained Load Level</u> (% of Short Trans. Fty)	<u>Time to Failure (Days)</u>
70%	38, 64, and 74
80%	21, 28, and 36

28 September 1971

-3-

G. Hilton to F. T. Main, Jr.

M&P/MWE-1-14-71-102

All coupons contained some evidence of intergranular attack associated with the fracture together with varying amounts of surface attack (pitting). The relative degree of pitting was proportional to the length of time in the bath rather than the stress level, thus the heaviest pitting was detected on the lower stress level coupons. Similar tests on 7075-T6 would have produced failures within one to seven days if stressed to similar levels.

The properties evaluated indicated that the alloy compares quite favorably to other 7000 series alloys with additional benefits of less tensile property sensitivity to section thickness and greater resistance to intergranular attack. The use of this alloy in field service will provide a realistic correlation with laboratory corrosion tests.

GH:jb

cc: J. Mainhardt
T. Wolfe *W*

P. Adler
J. Greenspan
A. McRac
J. Novak
J. Pellegrino
P. Shaw

K&E SEMI LOGARITHMIC 46 6213
 3 1/2 X 7 1/2 DIVISIONS
 SUFFEL & BROWN CO.

