

AD 729 401

HIGH-GAIN, LONG-PERIOD SEISMOGRAPH STATION

INSTALLATION REPORT

CHARTERS TOWERS, AUSTRALIA

by

John M. W. Rynn

Lamont-Doherty Geological Observatory

of

Columbia University

**Details of illustrations in
this document may be better
studied on microfiche**

31 March 1971

Sponsored By

Advanced Research Projects Agency

ARPA Order No. 1513

**BEST
AVAILABLE COPY**

DOCUMENT CONTROL DATA - R & D

Security classification of title, body of abstract and indexing annotation must be entered when the overall report is classified

1. ORIGINATING ACTIVITY (Corporate authority) Lamont-Doherty Geological Observatory of Columbia University Palisades, NY 10964	2a. REPORT SECURITY CLASSIFICATION Unclassified
	2b. GROUP

3. REPORT TITLE
 High-Gain, Long-Period Seismograph Station Installation,
 Charters Towers, Australia

4. DESCRIPTIVE NOTES (Type of report and inclusive dates)
 Scientific.....Interim

5. AUTHOR(S) (First name, middle initial, last name)
 John M. W. Rynn

6. REPORT DATE 31 March 1971	7a. TOTAL NO. OF PAGES 75	7b. NO. OF REFS 4
8a. CONTRACT OR GRANT NO. F44620-70-C-0038	9a. ORIGINATOR'S REPORT NUMBER(S) None	
8b. PROJECT NO. AO 1513 62701D	9b. OTHER REPORT NO(S) (Any other numbers that may be assigned this report) AFOSR - TR - 71 - 2368	

10. DISTRIBUTION STATEMENT
 Approved for public release;
 distribution unlimited.

11. SUPPLEMENTARY NOTES TECH, OTHER	12. SPONSORING MILITARY ACTIVITY AF Office of Scientific Research (NPG) 1400 Wilson Boulevard Arlington, VA
--	--

13. ABSTRACT

This report describes the installation of a high-gain, long-period seismograph system at Charters Towers, Australia. The station is located at 20°05'18" south latitude, 146°15'16" east longitude at an elevation of 356 m above sea level in the same tunnel as, and adjacent to, the World Wide Standardized Seismic Network (WWSSN) station CTA instrument vault. The system consists of three Geotech seismometers with natural periods of 30 sec (one vertical and two horizontal) each with two velocity transducers and one displacement transducer. One velocity transducer is coupled to a Kinometrics galvanometer with a natural period of 100 sec from which the signal is amplified by a photo-tube amplifier (P.T.A.) and recorded photographically and digitally (designated high-gain component). The signal from the second velocity transducer is coupled directly to a recording galvanometer and recorded photographically (designated standard component). The displacement transducer signal is recorded digitally. The system can operate with gains up to 500,000 at periods of 35 to 45 seconds. This high sensitivity has been achieved by isolating the seismometer from barometric changes, by electronically filtering out the 6 second microseisms and by shaping the instrument response to correlate with a natural low in the earth-noise spectrum. The dynamic range of the digital system is over 70db and is limited by the phototube amplifiers.

The seismometers and phototube amplifiers are housed in a chamber sealed from the environment by three ship-type bulkhead doors. The photographic drum recorders, recording galvanometers, control console and digital data acquisition system are located in a cement block building about 50 m from the seismometers.

ARPA Order Number: 1513
Program Code Number: OF10
Contractor: Columbia University
Effective date of Contract: 1 February 1970
Contract expiration date: 31 January 1971
Amount of Contract: \$942,578.00
Contract Number: F44620-70-C-0038
Principal Investigator: Lynn R. Sykes, 914-359-2900
Program Director: Peter L. Ward, 914-359-2900
Project Scientist: William J. Best, 202-0X4-5456
Title of Work: Long-period Seismological Research
Program

BLANK PAGE

TABLE OF CONTENTS

	<u>Page</u>
Station Personnel	1
I. Station Description	3
Station Location	3
Local Physiography	7
Climate	7
Local Geology	9
Station's Relation to Man-Made Structures	11
II. Station Construction and Installation	14
Seismometer - P.T.A. Chamber	14
Recording Building	23
Cables	29
III. Station Facilities	36
Available Commercial Power	36
Available Time Standards	38
Standard Temperature and Humidity	39
Background Noise	39
Other Instruments in Operation	42
IV. Instrument	44
Amendments to System Diagram	47
Instrument Characteristics - Vertical	48
North-South	52

Station Characteristics - East-West	55
Photographic Recorders	58
Displacement Transducers	58
Digital Data System	59
Acknowledgments	60
References	61
Appendix I--Photographs of Installation	63
Appendix II-Frequency Response Curves	71

LAMONT-DOHERTY GEOLOGICAL OBSERVATORY
OF COLUMBIA UNIVERSITY
IN THE CITY OF NEW YORK

HIGH-GAIN, LONG-PERIOD SEISMOGRAPH STATION

STATION: Charters Towers, Australia
WWSSN Abbreviation -- CTA

STATION DIRECTOR: Dr. J. P. Webb
Department of Geology and Mineralogy
University of Queensland
St. Lucia, Brisbane
Queensland, 4067, Australia
Telephone: University -- Brisbane 711377
ext. 676
Home -- Brisbane 782136
Cable: University
Brisbane
Telex: UNIVQLD
AA 40315

STATION SUPERVISOR: Mr. J. M. Millican
University of Queensland Seismograph Station
P. O. Box 6
Charters Towers
Queensland, 4820, Australia

Telephone: Station -- Charters Towers 339
Home -- Charters Towers 697

STATION INSTALLATION: Dates - 4 July 1970 to 25 September 1970

Personnel - George P. Hade Jr. (L.D.G.O.)

John M. W. Rynn (L.D.G.O.)

George Choy (L.D.G.O.)

John M. Millican (Univ. Qld.)

I: STATION DESCRIPTION

STATION LOCATION

Coordinates: Latitude 20° 05' 18" S

Longitude 146° 15' 16" E

Elevation above sea level:

High-Gain Seismometers: Z 356.56 m

N-S 356.72 m

E-W 356.71 m

Existing WSSN vault: 357.71 m

The city of Charters Towers is located in northeastern Australia about 1,050 km north-northwest of Brisbane and approximately 130 km inland from the Pacific Ocean (Figure I-1). The seismograph station is located on University of Queensland property on the western side of Towers Hill approximately 0.8 km south of the city (Figures I-2 and I-3). In 1957 the University of Queensland operated an I.G.Y. seismic station at a site on the north-east flank of Towers Hill. The World Wide Standardized Seismic Network (WSSN) station CTA was installed at the present site in 1963 and has been operating continuously since then. The high-gain station is in the same tunnel as, and adjacent to, the WSSN seismometer vault. The tunnel was originally a gold mine that, during World War II, was enlarged and reshored for use as a munitions storage area.

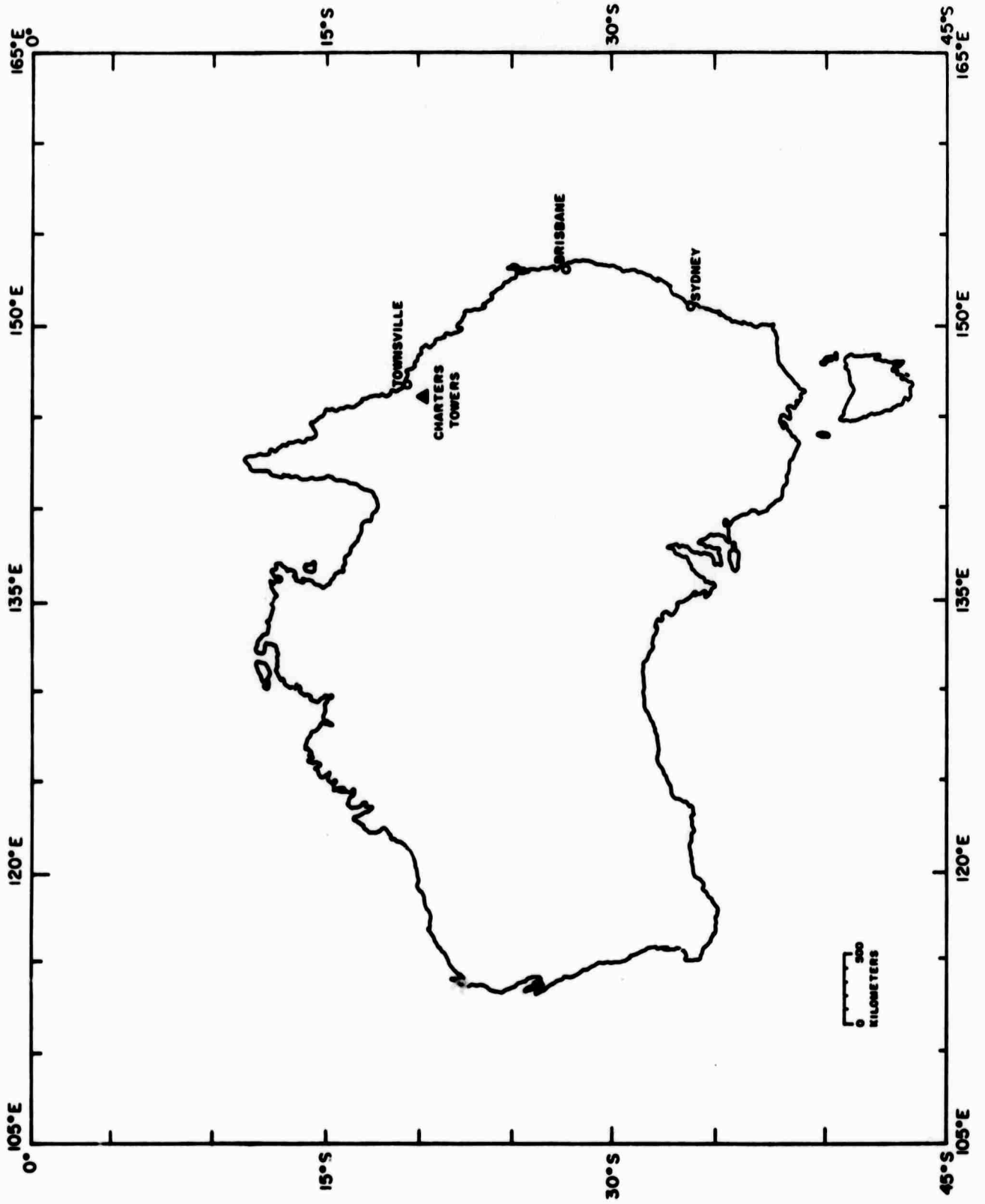

Figure I-1: Map of Australia showing location of Charters Towers.

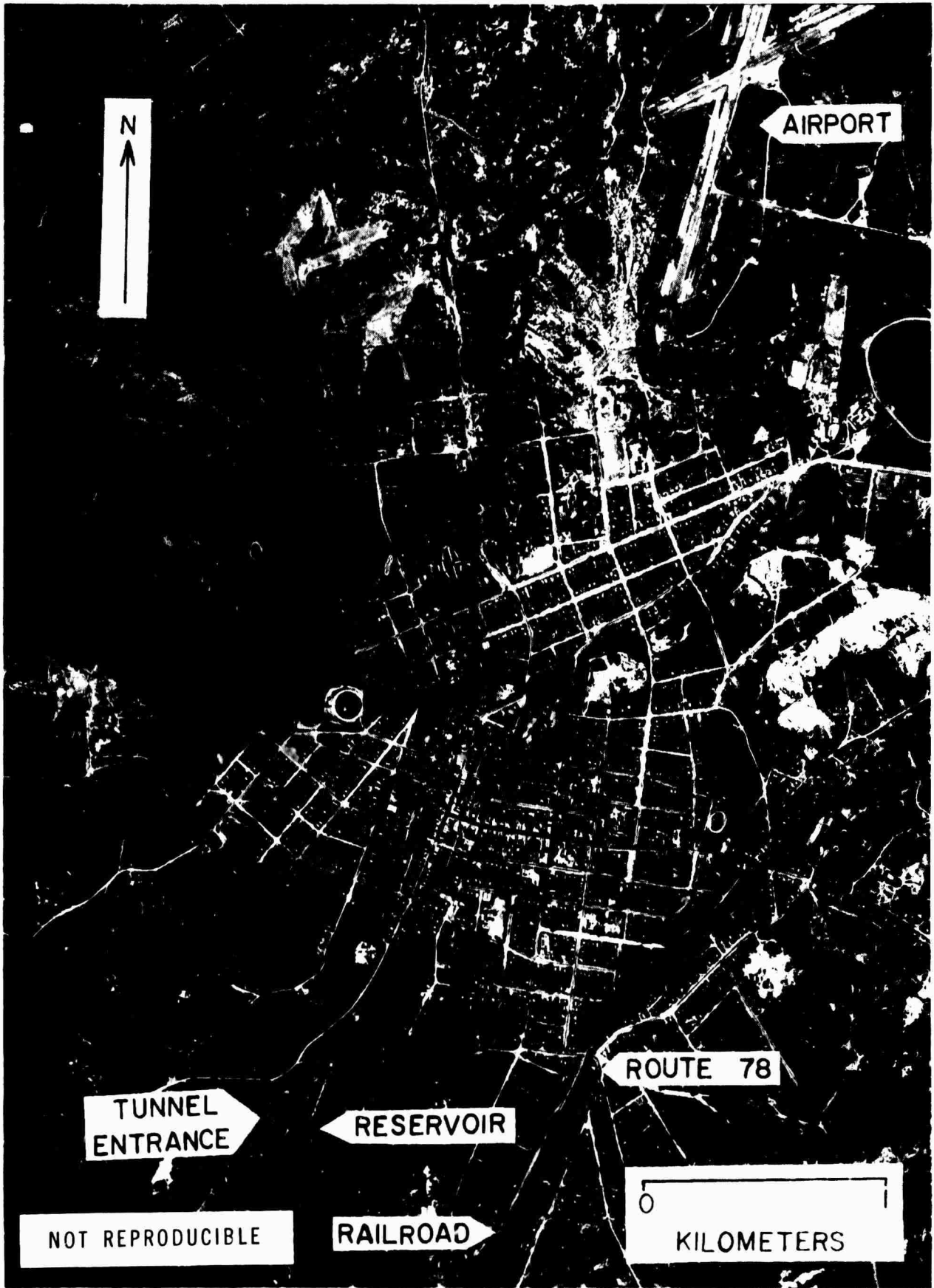

Figure 1-2: Aerial photograph of the city of Charters Towers showing the locations of the seismograph station tunnel entrance, the city reservoir, the railroad, Route 78, and the airport.

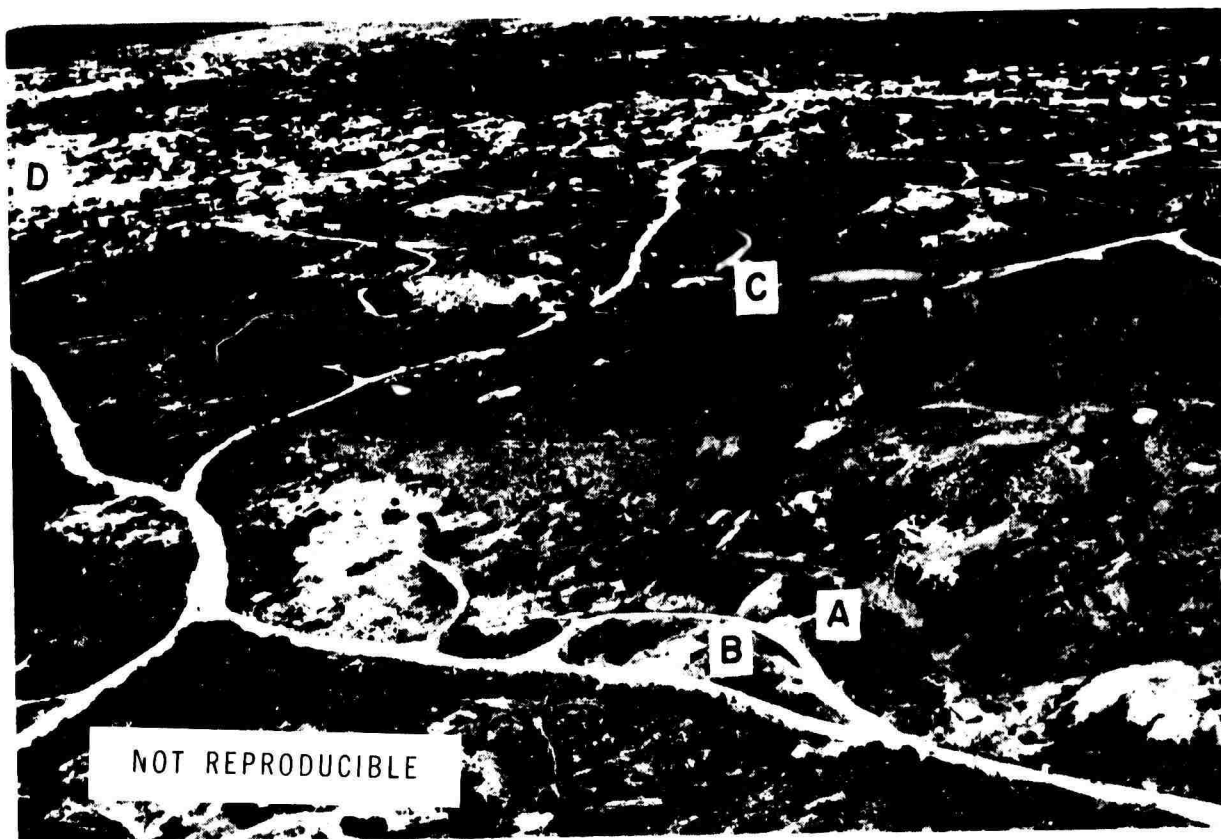

Figure 1-3: Photograph of the University of Queensland Seismograph Station property at Charters Towers: A - Tunnel Entrance; B - WSSN Standard Station CTA Recording Building; C - Reservoir; D - City of Charters Towers.

LOCAL PHYSIOGRAPHY

The Charters Towers district is part of a peneplain at an elevation of about 330 m above sea level and lies wholly within the dissected tableland that forms the eastern boundary of the Great Dividing Range. The topographic relief is characterized by a gently undulating surface traversed by sand-filled watercourses (Figure I-4). Several granodiorite monadnocks are prominent in the area. The seismograph station is located at the base of the largest of these monadnocks, Towers Hill, approximately 0.8 km south of the city of Charters Towers. Towers Hill is at an elevation of 420 m above sea level and 120 m above the peneplain level in the vicinity. The hill is most conspicuous in that it is covered with large boulders and is almost devoid of vegetation. The district is drained by the Burdekin River, one of the largest rivers on the eastern seaboard of Australia. Its closest approach to the station is about 16 km.

CLIMATE

The climate is tropical-continental with an average rainfall between 70 and 75 cm per year, most of which occurs during the wet season from December to April. The prevailing winds of the district come from the south-east during summer and from the west during the winter. Although wind strength is normally light, heavy winds accompany the early summer thunder storms (from October to December) and the dust storms at the end of winter. The temperature averages 35°C in the summer and 12°C in the winter.

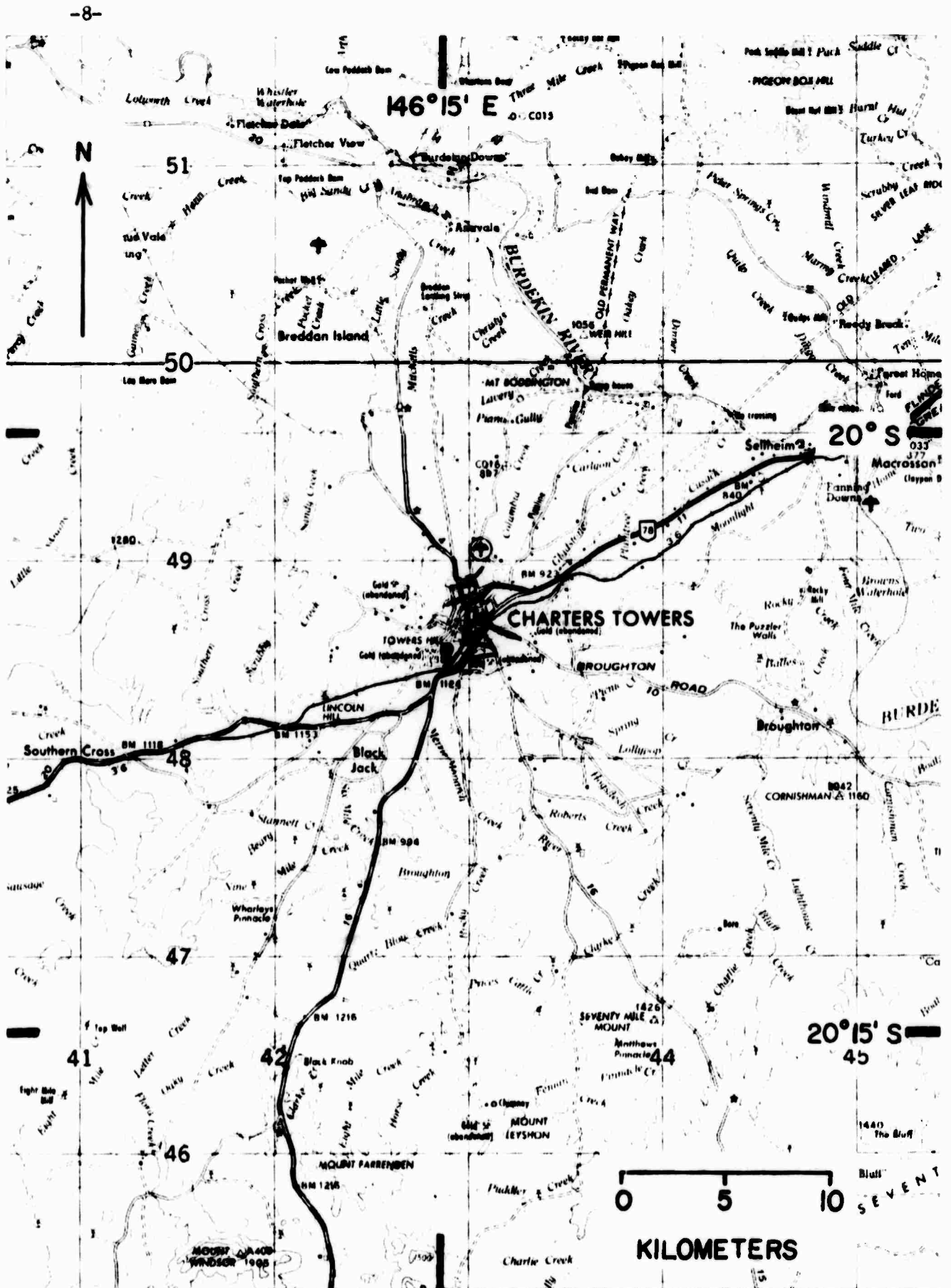

Figure I-4: Topographic map of the Charters Towers district. Seismograph station is indicated by solid circle at the base of Towers Hill.

NOT REPRODUCIBLE

Temperatures up to 45°C are known to occur during the summer. The average daily (day-night) temperature fluctuation is about 15°C in summer and less than 5°C in winter.

LOCAL GEOLOGY

Most geological studies within the Charters Towers district have been related to the gold mining activity. Reid (1917) gives a detailed description of the geology and structural history of the gold fields in and around the city of Charters Towers. A more recent geological survey giving a detailed account of the regional geology and tectonics of the district was completed by the Bureau of Mineral Resources and Queensland Department of Mines in 1967 (Figure I-5).

In the Charters Towers area, outcrops of mica-schists and quartzites of the Charters Towers Metamorphics, an early Paleozoic (pre-Devonian) metamorphic series, occur as roof-pendants in the Silurian to early Devonian Ravenswood Granodiorites. The former series constitute the oldest exposed rocks in the area. Both formations have been intruded by an extensive series of igneous dykes. In some parts of the area, Tertiary grits and sandstones lie conformably on the eroded granodiorite surface. Two series of faults of different ages developed within the granodiorite and formed the lode channels where gold was deposited.

The seismometer vault and recording building are located about 100 m inside an old gold mining tunnel at the base of Towers Hill. This hill is part of a large granodiorite batholith that

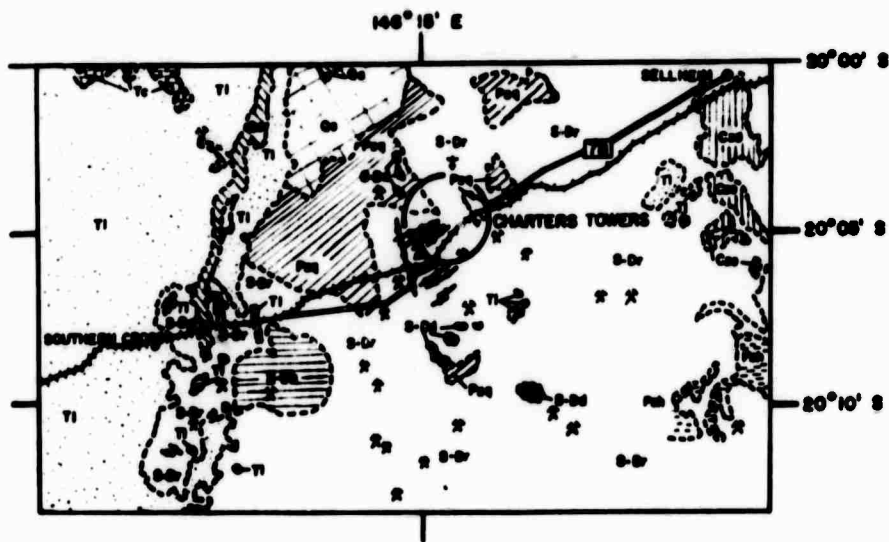

Figure I-5: Geological map of the Charters Towers district. Seismograph station is indicated by solid triangle.

QUATERNARY		ALLUVIUM
		SUPERFICIAL SAND
UNDIFFERENTIATED		ARGILLACEOUS SANDSTONE
		BUFF SANDSTONE
TERTIARY		FERRICRETE (incl. LATERITE)
		INTRUSIVE RHYOLITE
POST-LOWER CARBONIFEROUS		INTRUSIVE RHYOLITE
SILURIAN-LOWER DEVONIAN		RAVENSWOOD GRANODIORITE
		CHARTERS TOWERS METAMORPHICS
LOWER PALAEOZOIC		CHARTERS TOWERS METAMORPHICS

- ROUTE 78
- RAILROAD
- AIRPORT
- ABANDONED GOLD MINE
- DYKE
- SEISMOGRAPH STATION

intruded the Charters Towers Metamorphics. The exposed granodiorite in the seismometer vault is extensively fractured and faulted. The foliations strike north-west and dip steeply (from 40° to 90°) to the north-east. Extensive dendrite formations are observed along the foliation surfaces. It should be noted that the drift could easily be enlarged with a miner's pick or hand sledge and chisel, the rock slabs being easily removed from all surfaces of the drift.

STATION'S RELATION TO MAN-MADE STRUCTURES

There are no large structures near the vault. Several small concrete blockhouses are on the property (Figure I-3). One of these blockhouses is used for recording data from the WSSN station and several others are used as storage areas. However, the majority of the blockhouses are vacant.

The main highway (Route 78) and railroad to western North Queensland are approximately 1.4 km and 0.7 km, respectively, southeast of the station at their closest points (Figure I-2). A gravel road carrying only a few cars per day passes about 200 m west of the station. The city of Charters Towers, with a population of 8000, is primarily a farming center with no significant industrial works. The nearest dam is 16 km away. A microwave tower and repeater station have been constructed approximately 500 m SSE of the station.

One possible source of man-made noise is the city reservoir which is situated on top of Towers Hill ($20^{\circ} 05' 20.2''S$, $146^{\circ} 15' 12''E$) at an elevation of 390 m above sea level. The

reservoir has a diameter of 51.2 m, a depth of 4 m and a maximum capacity of 1.8 million gallons. The vertical and horizontal separations of the seismometer vault and the reservoir are 35 m and 13 m respectively. The water level is kept fairly constant by means of pumps that start automatically when the level drops by approximately 1 m. Water level readings are taken at 21:15 G.M.T. on weekdays. Figure I-6 shows the daily water levels for the months of October and November 1970. These measurements can be regarded as showing the typical condition of the reservoir.

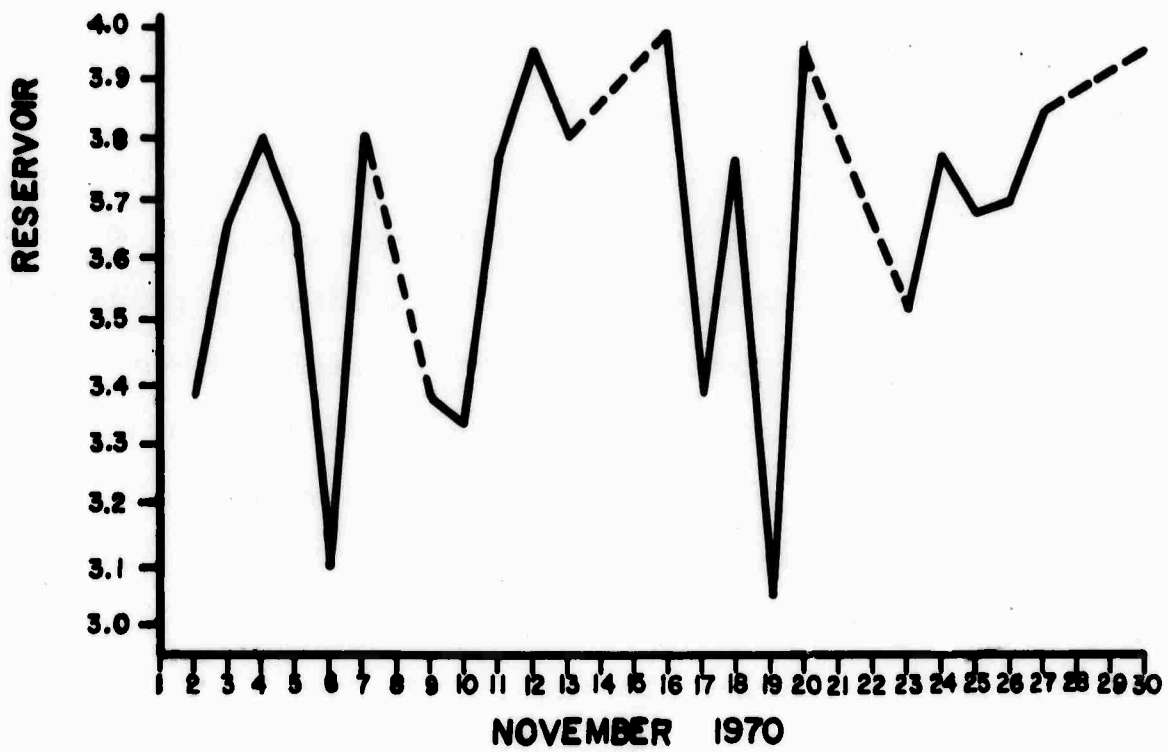
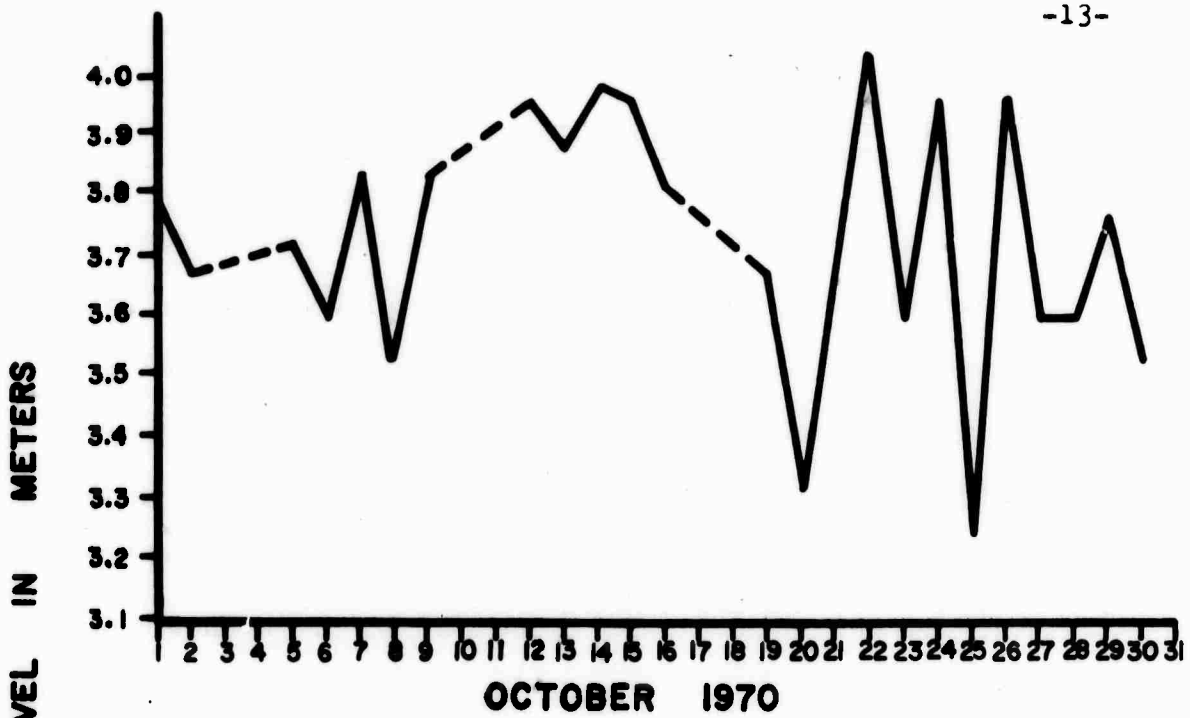

Figure I-6: Graph showing water levels for the Charters Towers city reservoir for September and October 1970. Dashed lines indicate interpolations for Saturdays and Sundays when readings were not taken.

II: STATION CONSTRUCTION AND INSTALLATION

The station is divided into two separate parts (Figure II-1):

- 1.) The seismometer vault and phototube amplifier (P.T.A.) room are located at the end of the main tunnel approximately 100 m from the entrance.
- 2.) The recording building, a three-room cement block structure, is located in a side tunnel about 30 m from the seismometer - P.T.A. chamber. This building is adjacent to the WSSN seismometer vault.

SEISMO METER - P.T.A. CHAMBER

The seismometer vault and P.T.A. room (Figure II-2) are located in an old drift originally 1.6 m by 1.3 m (5 feet by 4 feet) in cross-section but enlarged during installation to about 2.3 m by 2.3 m (7 feet by 7 feet) in cross-section. About 30 m of overburden exists above the vault. In an attempt to precisely control the environment, three ship-type bulkhead doors were installed. All exposed surfaces of the concrete bulkheads were coated with epoxy paint. A continuous flow of water from an unknown source was vented through the chamber via a 2 inch galvanized pipe with a pitch of 1 inch in 20 feet along the eastern footwall of the chamber. Two sumps, one in front of bulkhead door #1 and one behind bulkhead door #3, were constructed. The rate of flow is about 75 litres per day. No water was observed entering the seismometer vault, which is lower than the pipe and sumps. A 12V DC bilge pump (of capacity 7500 litres per hour) was installed in the sump in front of bulkhead door #1. This

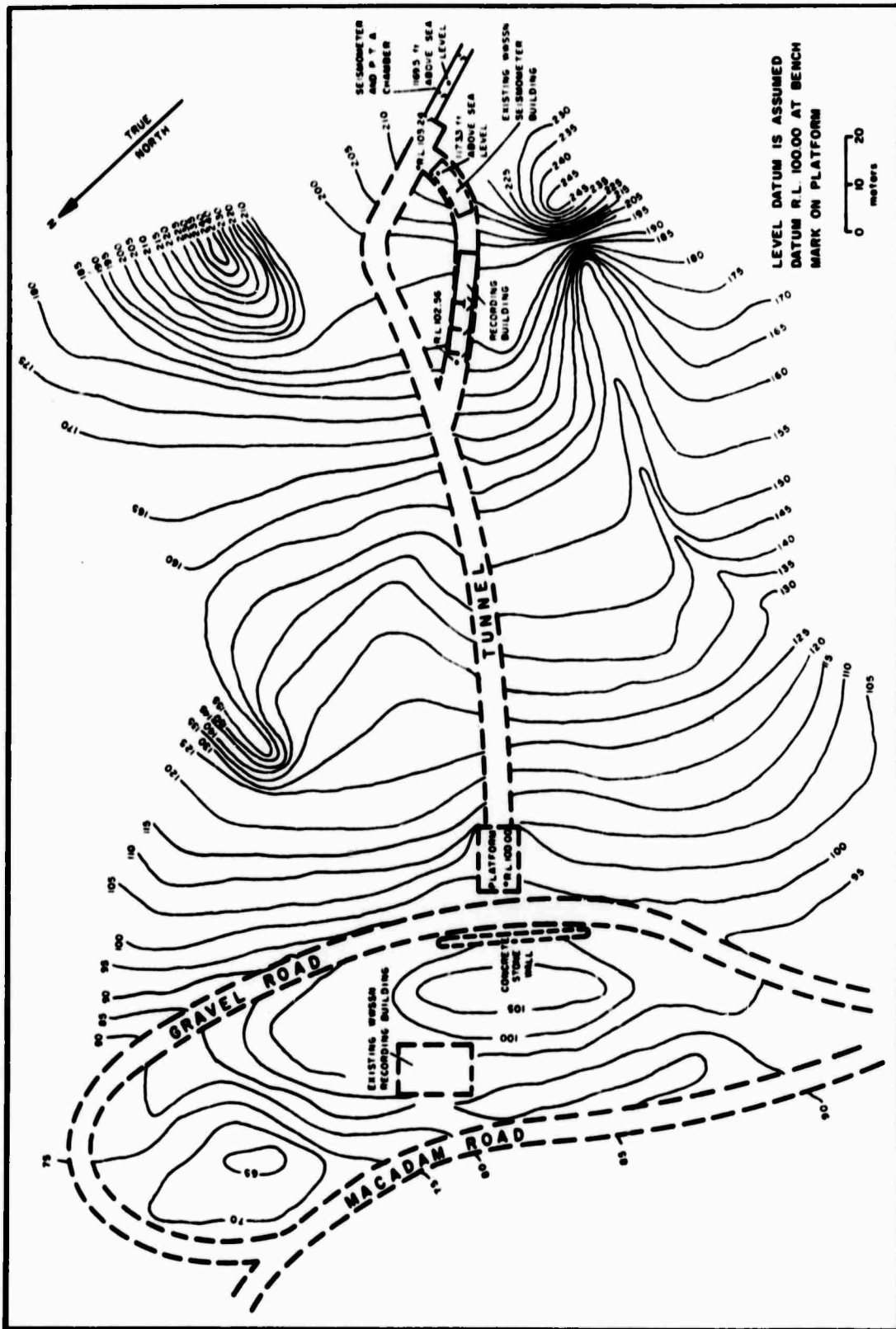

Figure II-1: Site contour plan of Charters Towers Seismograph Station. The WSSN seismometer vault and recording building and the L.D.G.O. seismometer-P.T.A. chamber and recording building are shown. The elevations of the WSSN and high-gain seismometers above mean sea level are indicated.

pump is operated for a short time interval once per day and does not create any observable noise on the records.

In preparing the seismometer vault floor for pouring concrete, all loose rock was removed by pick. The resulting solid bedrock surface was very irregular. Extreme care was taken in cleaning this surface by removing pebbles and sand grains and flushing with water and compressed air. A mixture of one part cement and two parts sand was carefully poured to obtain a dense seismometer pier. A firm bond to the bedrock was ensured by carefully trowelling the cement. No reinforcing devices were placed in the cement. Because of the uneven surface of the bedrock, the pier varies in thickness up to 35 cm and contains one step (Figure II-3). A 5 cm wide tar filler joint was placed at the P.T.A. room end of the vault.

The seismometer tanks were initially prestressed by distorting the base into a dome about 1 cm high at the center. Each tank was then anchored to the bedrock with 3/4 inch cadmium-plated steel rods and roofbolt anchors in holes drilled through the pier (Figure II-4). Holes were drilled at least 10 cm into the bedrock. The void under each tank was carefully filled with very fine grained "Sakrete" mortar mix.

The seismometer pier was surveyed for a north-south line to $\pm 0.5^\circ$ (Figure II-5) and permanently marked by points scribed at two opposite points on the flange of each tank bottom. Figure II-6 shows the alignment of the seismometers and the positions of the cable conduits in the tanks. All cables pass along steel and wooden-frame cable trellis attached to the eastern rib of the

A

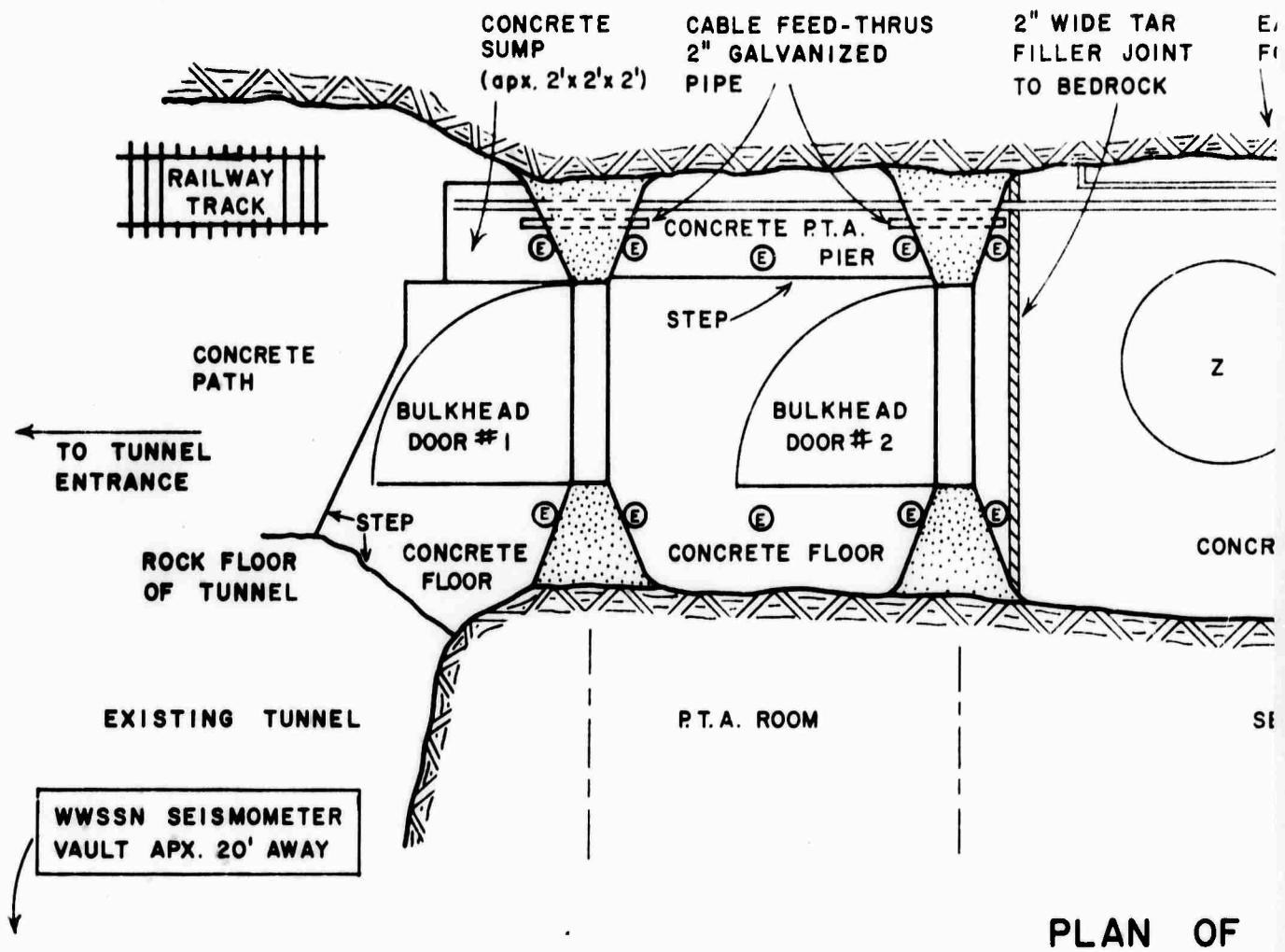
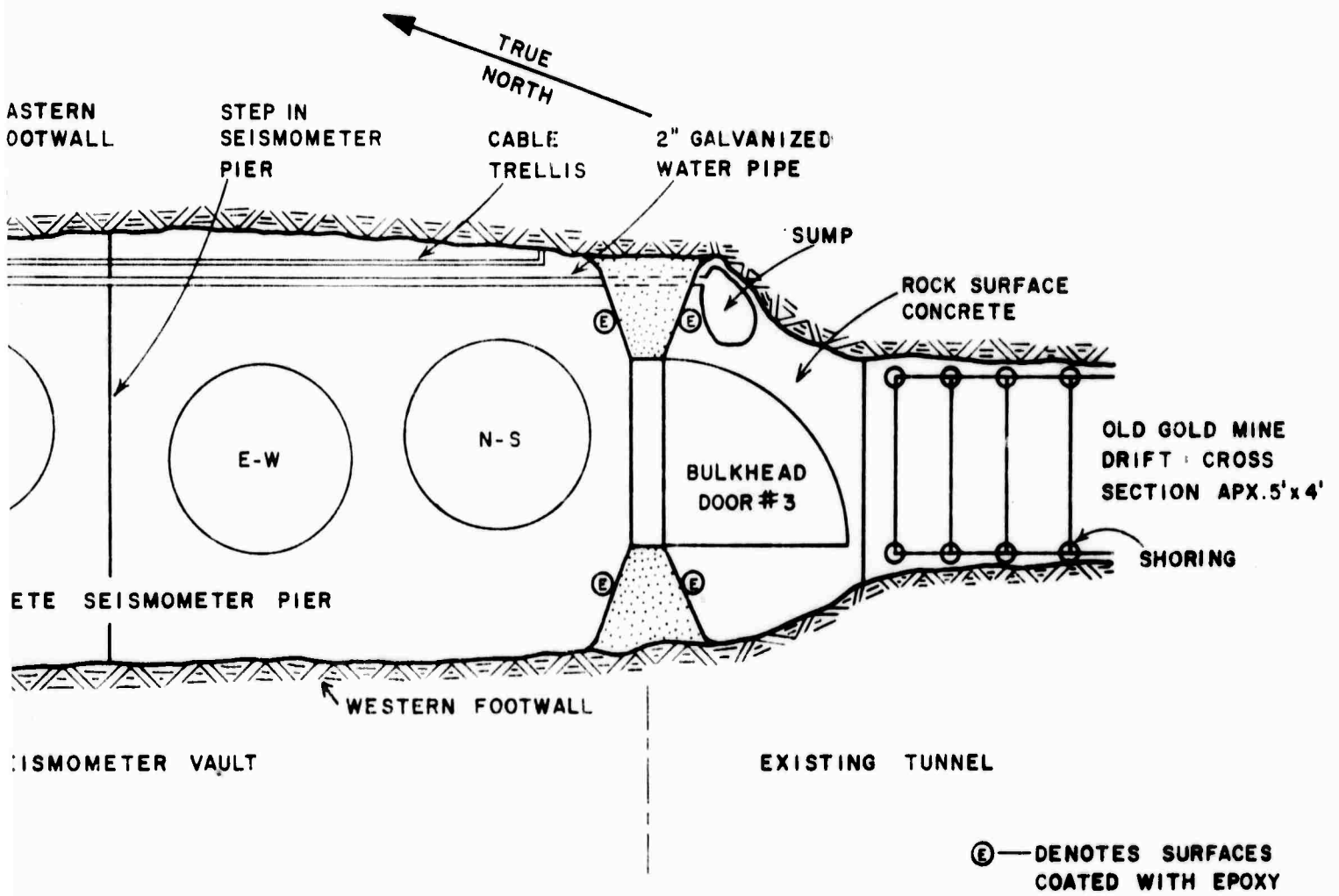
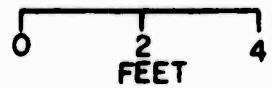

Figure II-2: Plan of seismometer-

B



ⓔ — DENOTES SURFACES COATED WITH EPOXY



SEISMOMETER - P.T.A. CHAMBER

P.T.A. chamber.

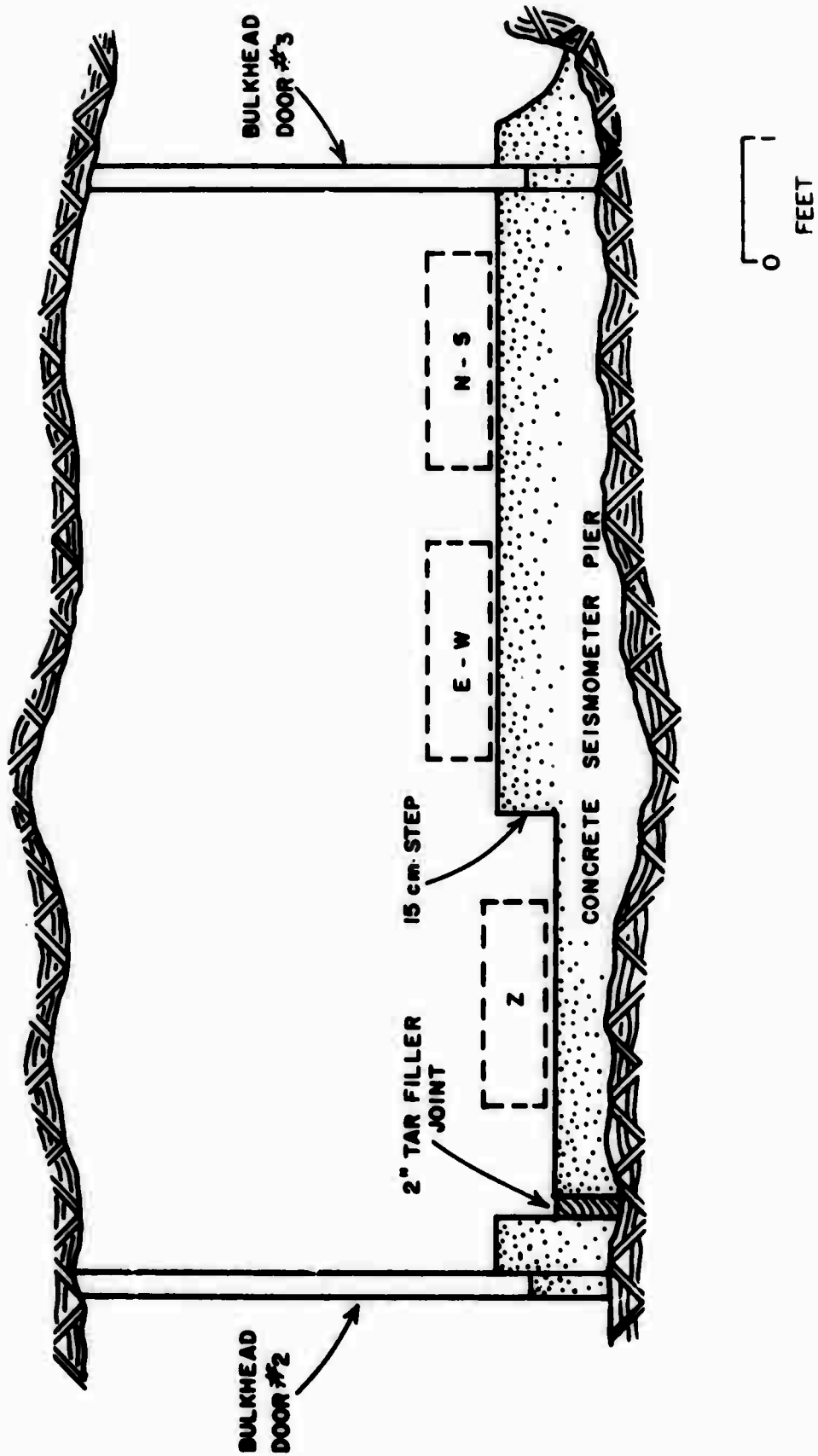
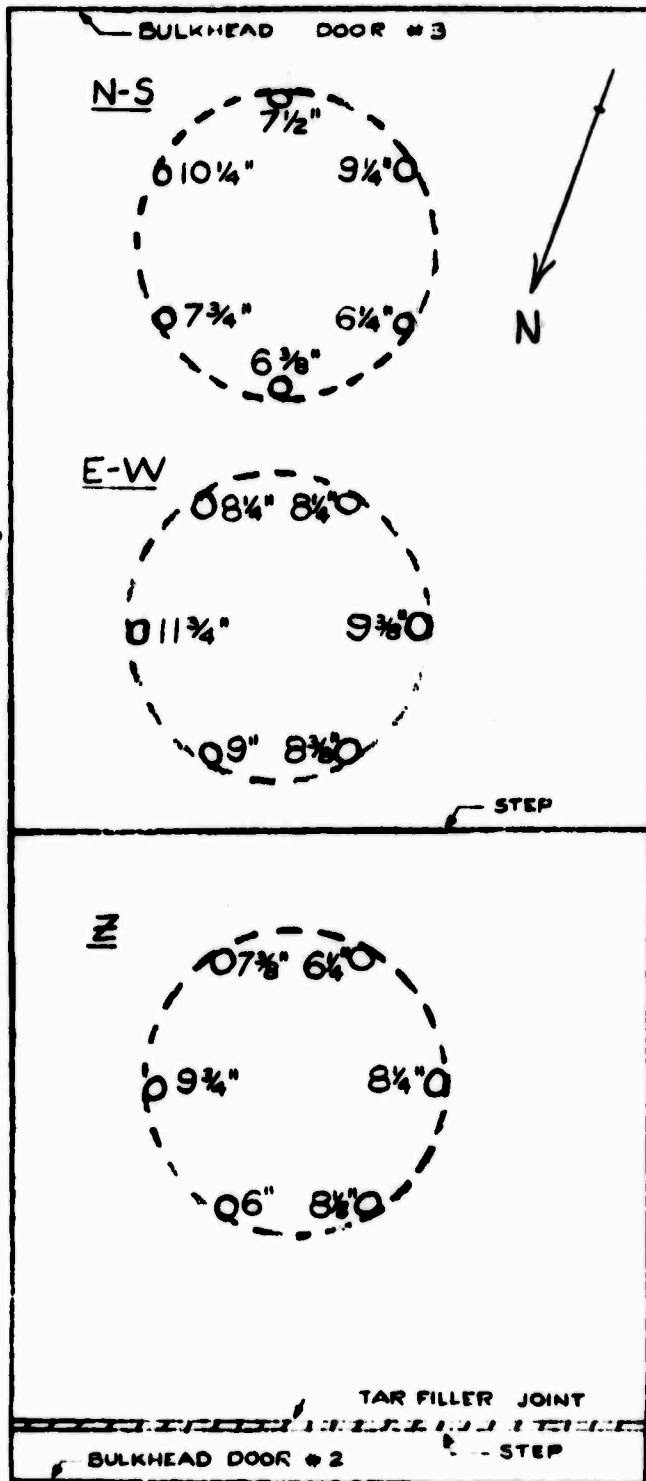

Figure II-3: Cross-section of the seismometer pier.



DIMENSIONS INDICATE DEPTH OF HOLES FOR SEISMOMETER TANK HOLD-DOWN STUDS.

ALL HOLES PENETRATED BEDROCK TO AT LEAST 4" AND ROOFBOLT ANCHORS BOTTOMED IN HOLES. DEPTH OF CEMENT FLOOR AT SEISMOMETER TANK POSITIONS CAN THUS BE CALCULATED.



Figure II-4: Plan of Seismometer Vault showing:
 (a) Position of seismometer pressure tanks
 (b) Position and depth of pressure tank hold-down rods.

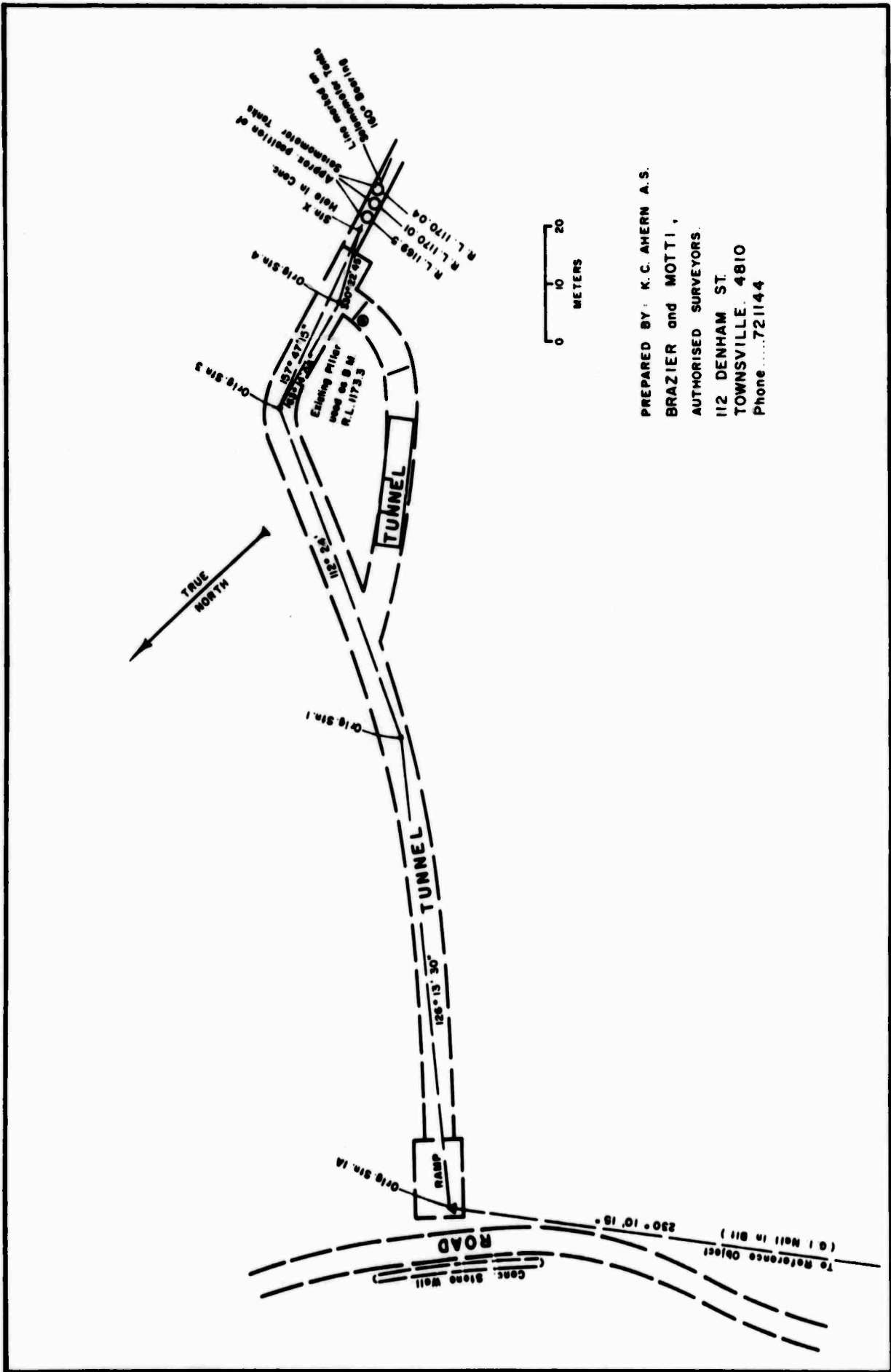

PREPARED BY: K. C. AMERN A. S.
 BRAZIER and MOTTI,
 AUTHORISED SURVEYORS.
 112 DENHAM ST.
 TOWNSVILLE 4810
 Phone.....721144

Figure II-5: Survey plan of tunnel showing true headings on L.D.G.O. seismograph station.

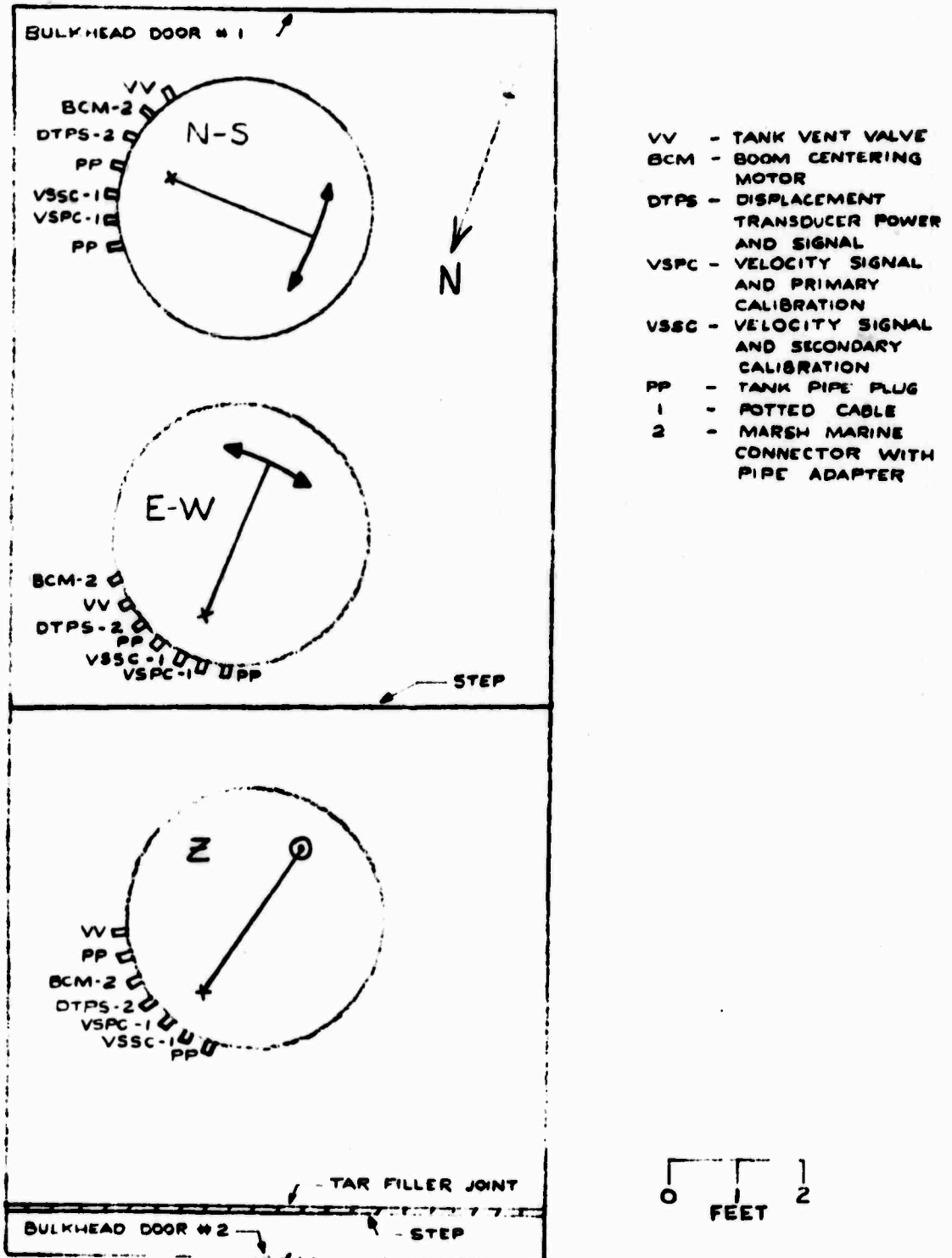

Figure II-6: Plan of Seismometer Vault showing:
 (a) Alignment of seismometers
 (b) Positions of cable conduits in pressure tanks.

seismometer vault, and then through cable conduits into the P.T.A. room.

The P.T.A. room houses the phototube amplifiers, their power supplies, and the power supply for the displacement transducers (Figure II-7). The P.T.A. pier and floor are concrete with the pier 8 cm above the floor (Figure II-8). All concrete surfaces in this room are covered with epoxy paint.

RECORDING BUILDING

The recording building is of cement block construction and divided into three rooms; recording room, control room, work-store room (Figure II-9).

The recording room (Figure II-10) has two separate concrete piers for the high-gain and standard (low-gain) recording galvanometers. Each pier is isolated from the floor by a 5 cm wide tar filler joint. Two three-drum photographic recorders are mounted on wooden-topped adjustable tubular steel benches. Cabling is routed in conduit on the ceiling adjacent to the eastern wall. All cable conduits were made light-tight. Double light-tight doors allow access to the recording room without interrupting the records.

The control room houses the power distribution panel, digital data acquisition system, control console, and two metal cabinets for spare parts.

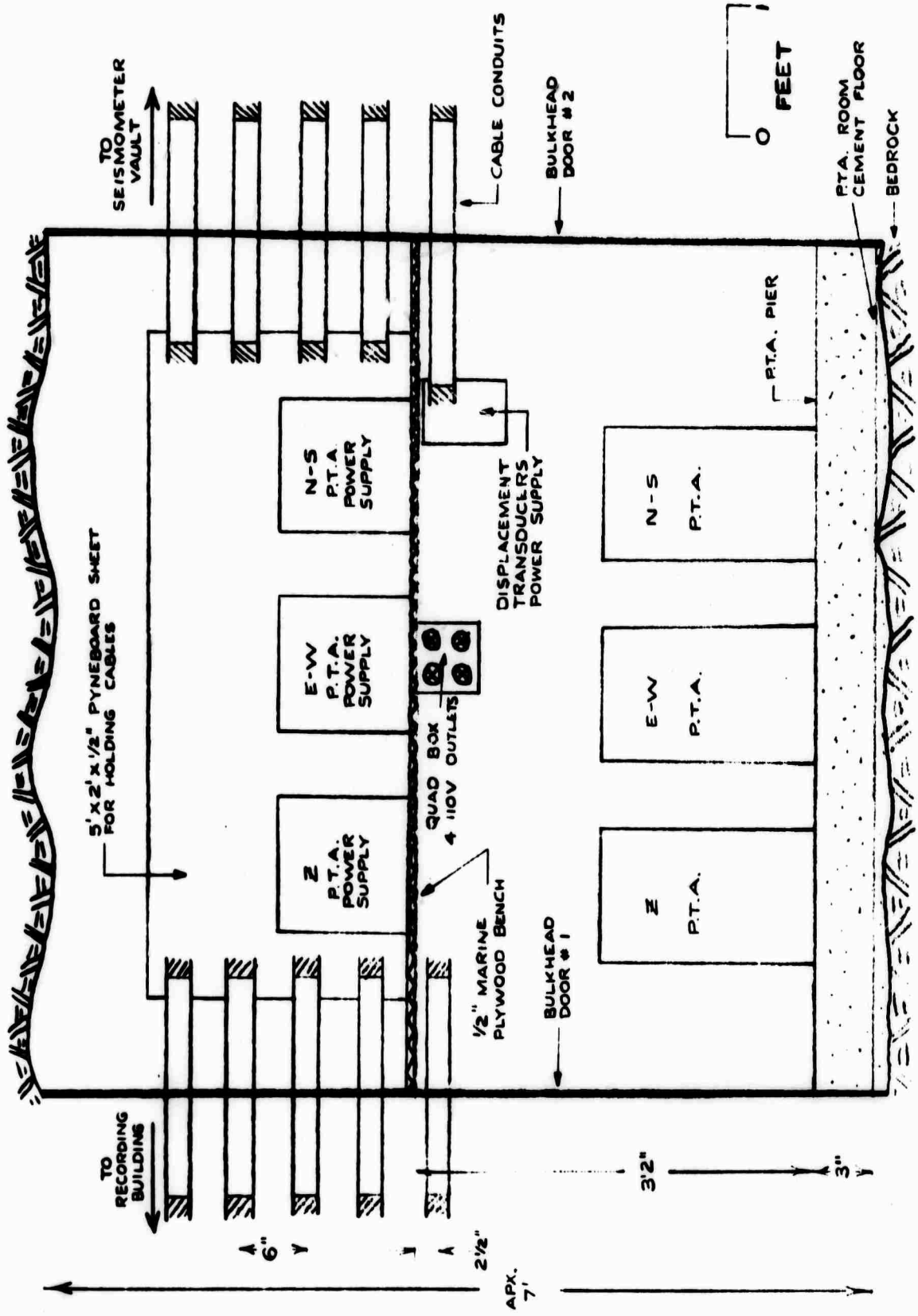

Figure II-7: Cross-sectional view of P.T.A. Room.

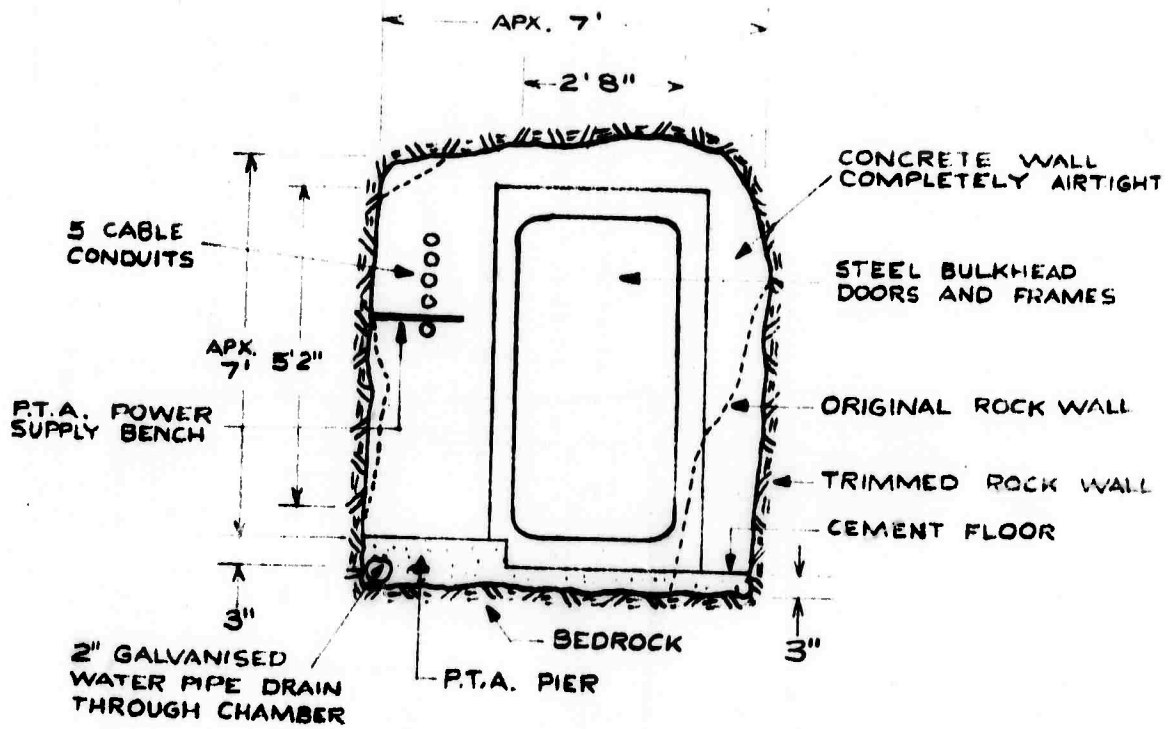

Figure II-8: Cross-sectional view of P.T.A. Room showing relative positions of bulkhead door, P.T.A. pier, cable conduits, and P.T.A. power supply bench.

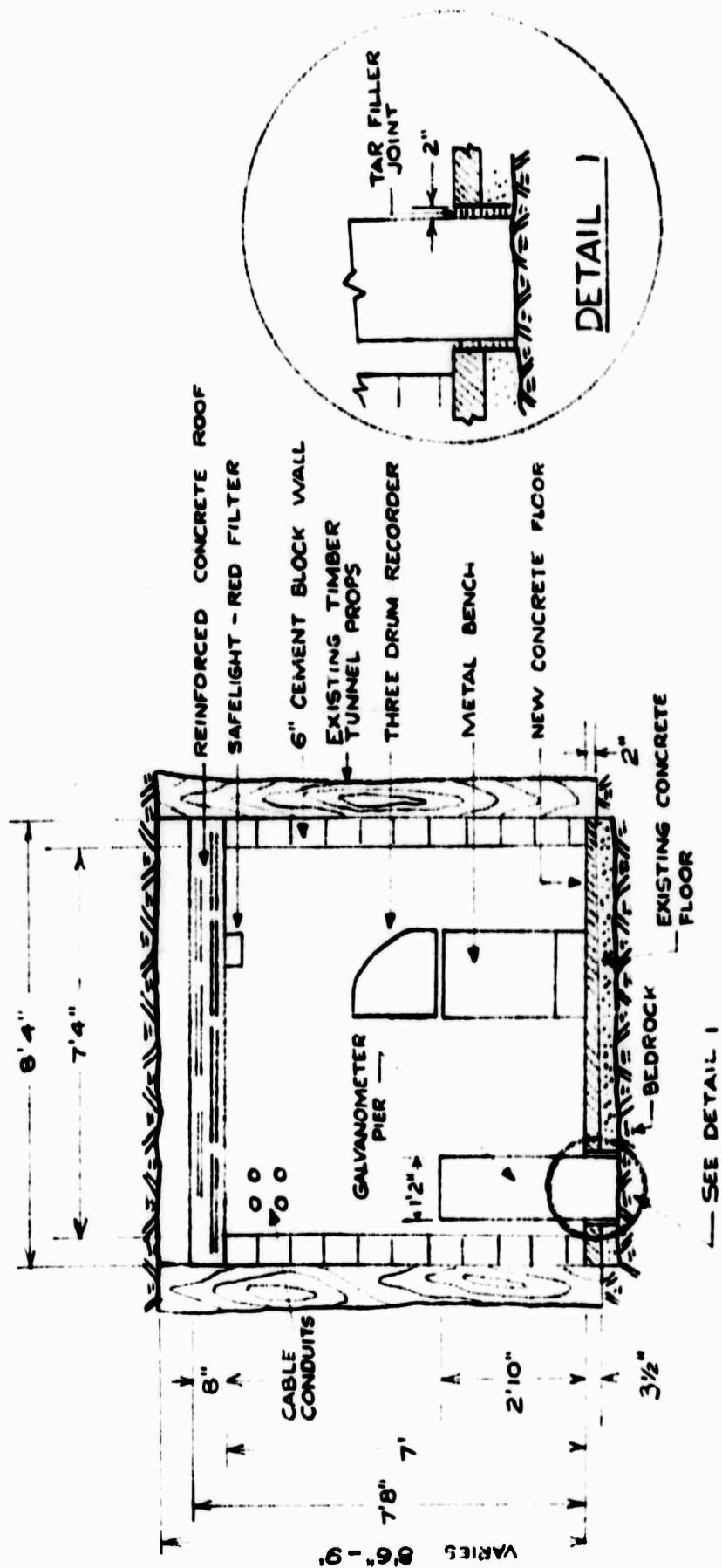
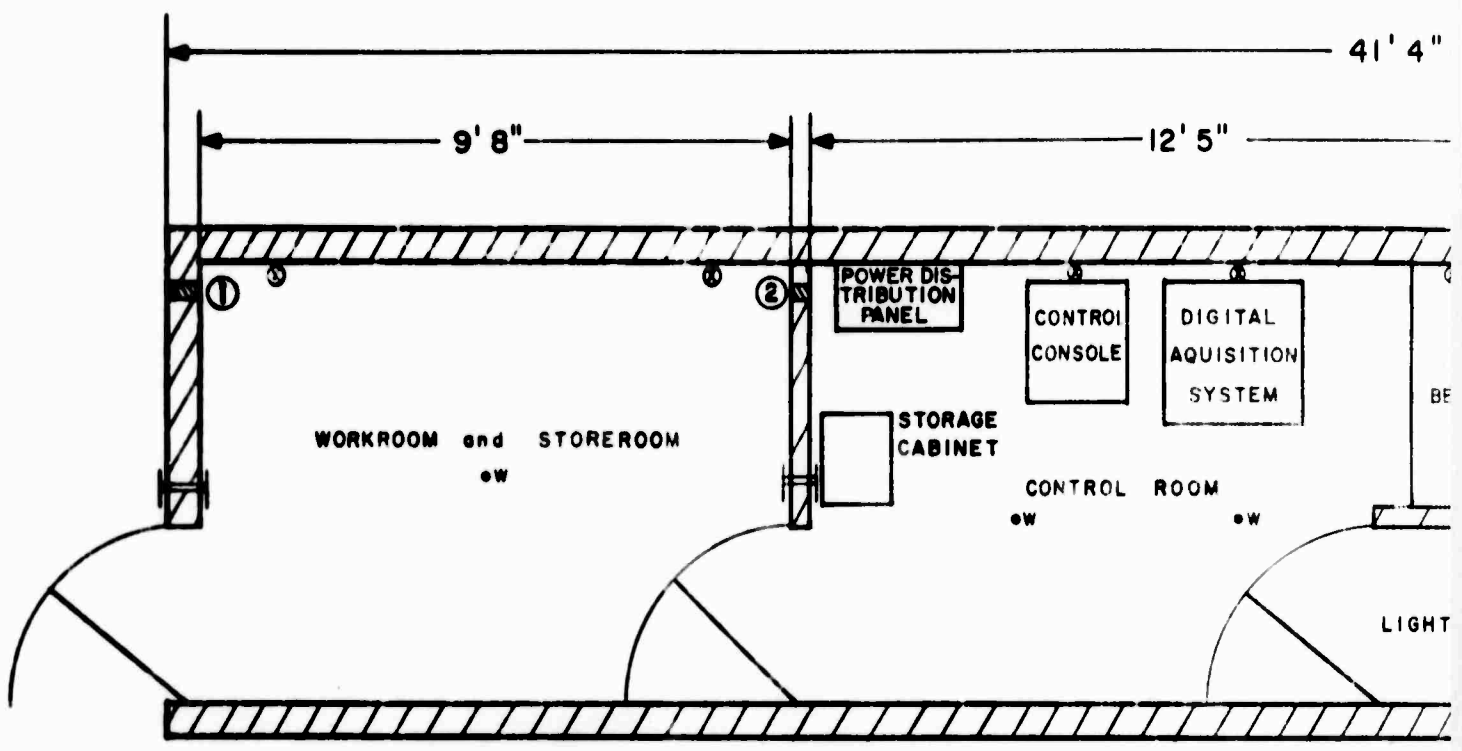

Figure II-10: Cross-sectional view of Recorder Room.

A



PLAN OF RECORDING

Figure II-9: Plan of Recording

B

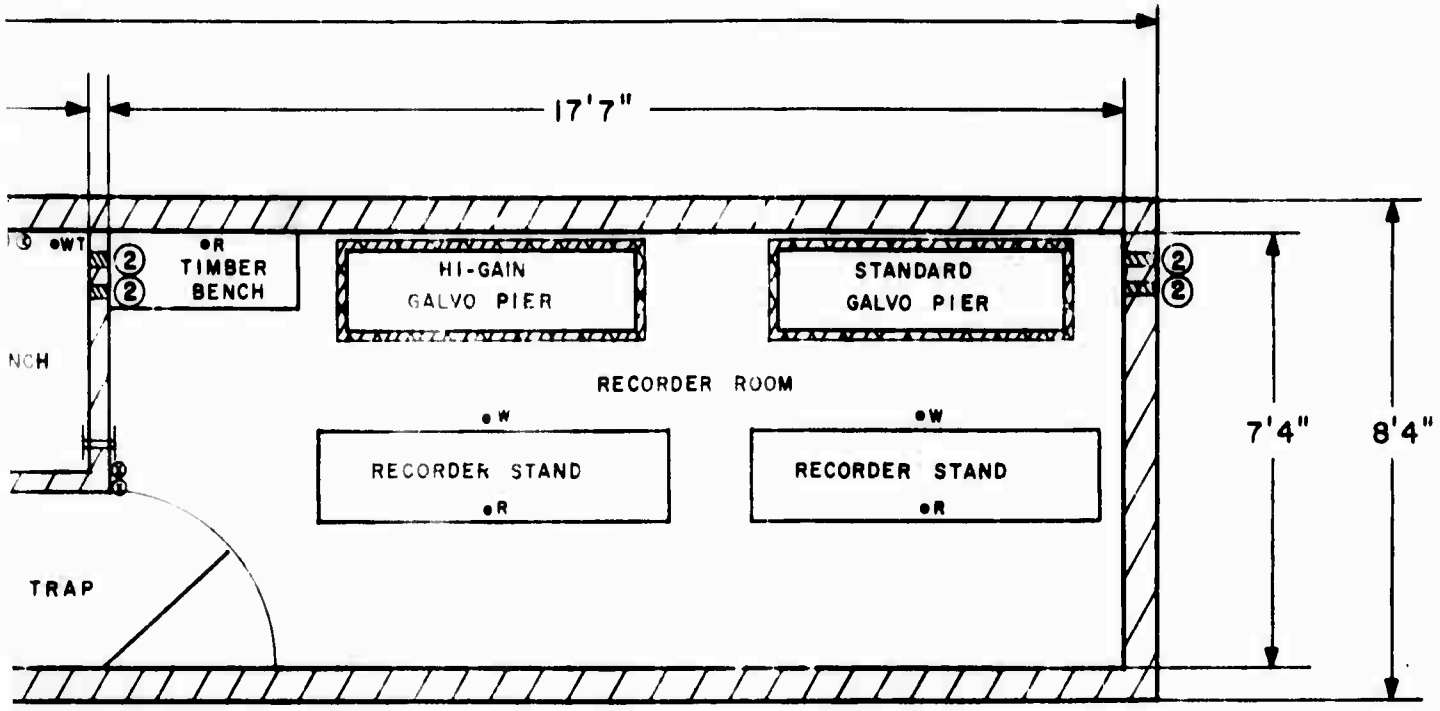

⊗	240 VOLT OUTLET	▨	CABLE CONDUIT
•R	RED SAFELIGHT	①	DENOTES NUMBER OF
•W	WHITE LIGHT	②	CABLE CONDUITS IN WALL
•WT	BENCH LAMP	▨	CEMENT BLOCK
⊔	LIGHT-PROOF VENT	▨	TAR FILLER JOINT

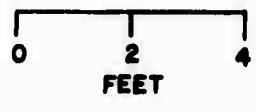

BUILDING

Building.

28

CABLES

Details of cables used for the installation are given in Table I. To preserve the pressure-seal conditions in the seismometer-P.T.A. chamber, all the cables are potted in "Scotchcast" resin and routed through 2 inch galvanized pipe conduits in the concrete bulkheads. In the recording building the cables pass through similar 2 inch pipe conduits (not potted) and through 2 inch U-section plastic conduit attached to the ceiling. The cable conduits at each end of the recorder room are sealed with "Duxseal" compound. The positions of cables in the cable conduits in the seismometer-P.T.A. chamber and recording building are shown in Figures II-11 and II-12 respectively.

TABLE I

CABLE DETAILS

<u>CABLE #</u>	<u>DESCRIPTION</u>		<u>CABLE TYPE</u>
1	N-S Velocity Low Gain Signal	Seismo to Photorec	2CS
2	E-W Velocity Low Gain Signal	Seismo to Photorec	2CS
3	Z Velocity Low Gain Signal	Seismo to Photorec	2CS
4	N-S Velocity High Gain Signal	Seismo to P.T.A.	2CS
5	E-W Velocity High Gain Signal	Seismo to P.T.A.	2CS
6	Z Velocity High Gain Signal	Seismo to P.T.A.	2CS
7	N-S Primary Calibration	Seismo to Console	2CS
8	E-W Primary Calibration	Seismo to Console	2CS
9	Z Primary Calibration	Seismo to Console	2CS
10	N-S Secondary Calibration	Seismo to Console	2CS
11	E-W Secondary Calibration	Seismo to Console	2CS
12	Z Secondary Calibration	Seismo to Console	2CS
13	N-S Velocity High Gain Signal	P.T.A. to Photorec	2CS
14	E-W Velocity High Gain Signal	P.T.A. to Photorec	2CS
15	Z Velocity High Gain Signal	P.T.A. to Photorec	2CS
16	N-S Velocity High Gain Signal	P.T.A. to Digital	2CST
17	E-W Velocity High Gain Signal	P.T.A. to Digital	2CST
18	Z Velocity High Gain Signal	P.T.A. to Digital	2CST
19	N-S Displacement Signal/ Boom Center Monitor	Seismo to Console	2CST

TABLE I (Continued)

CABLE #	DESCRIPTION		CABLE TYPE
20	E-W Displacement Signal/ Boom Center Monitor	Seismo to Console	2CST
21	Z Displacement Signal/ Boom Center Monitor	Seismo to Console	2CST
19C	N-S Displacement Signal	Console to Digital	2CST
20C	E-W Displacement Signal	Console to Digital	2CST
21C	Z Displacement Signal	Console to Digital	2CST
22	N-S P.T.A. Gal Centering Monitor	P.T.A. to Console	2CST
23	E-W P.T.A. Gal Centering Monitor	P.T.A. to Console	2CST
24	Z P.T.A. Gal Centering Monitor	P.T.A. to Console	2CST
25	N-S P.T.A. Gal Centering Motor	Console to P.T.A.	2CST
26	E-W P.T.A. Gal Centering Motor	Console to P.T.A.	2CST
27	Z P.T.A. Gal Centering Motor	Console to P.T.A.	2CST
28	N-S Boom Centering Motor	Console to Seismo	2CST
29	E-W Boom Centering Motor	Console to Seismo	2CST
30	Z Boom Centering Motor	Console to Seismo	2CST
31	N-S Displacement Transducer Power Supply	P.T.A. to Seismo	3CST

TABLE I (Continued)

CABLE #	DESCRIPTION		CABLE TYPE
32	E-W Displacement Transducer	P.T.A. to Seismo	3CST
	Power Supply		
33	Z Displacement Transducer	P.T.A. to Seismo	3CST
	Power Supply		
A	Spare	Seismo to Console	2CST
B	Spare	Seismo to Console	2CST
C	Spare	Seismo to Console	2CST
D	Spare	Seismo to Console	2CS
E	Spare	Seismo to Console	2CS
F	Spare	Seismo to Console	2CS
X	Spare	Seismo to P.T.A.	3CST
Y	Spare	Seismo to P.T.A.	3CST
Z	Spare	Seismo to P.T.A.	3CST

Notes: (1) Cable Type 2CS 2 Conductor Solid (#18 wire)
 2CST 2 Conductor Stranded (#16 wire)
 3CST 3 Conductor Stranded (#16 wire)

All cables with milar shield and separate earth conductor

(2) Cables 19C, 20C, 21C:

"C" denotes a cable connecting the displacement transducer output of the seismometer from the control console to the digital system enabling the displacement signal to be digitally recorded as well as the monitor for boom position.

TABLE I (Continued)

(3) Abbreviations for end positions of cable runs:

Seismo - Seismometer Vault

P.T.A. - P.T.A. Room

Photorec - Recording Room (Photographic recording)

Console - Control Console in Control Room

Digital - Digital Acquisition System in Control
Room

(4) All 110V cable is #10-3 wire plastic covered cable.

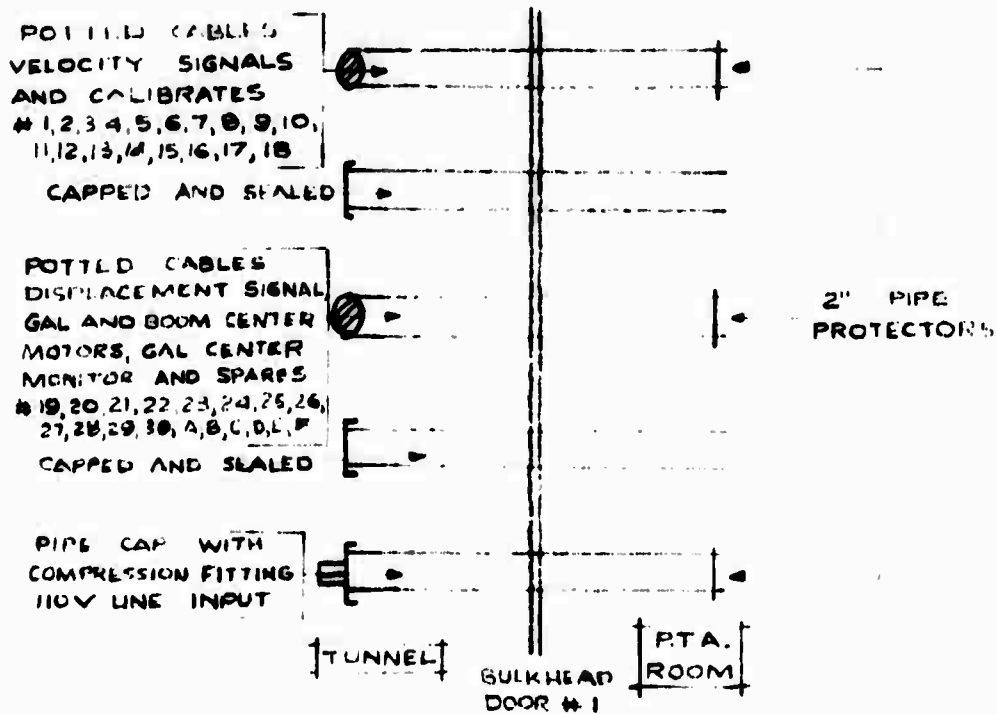
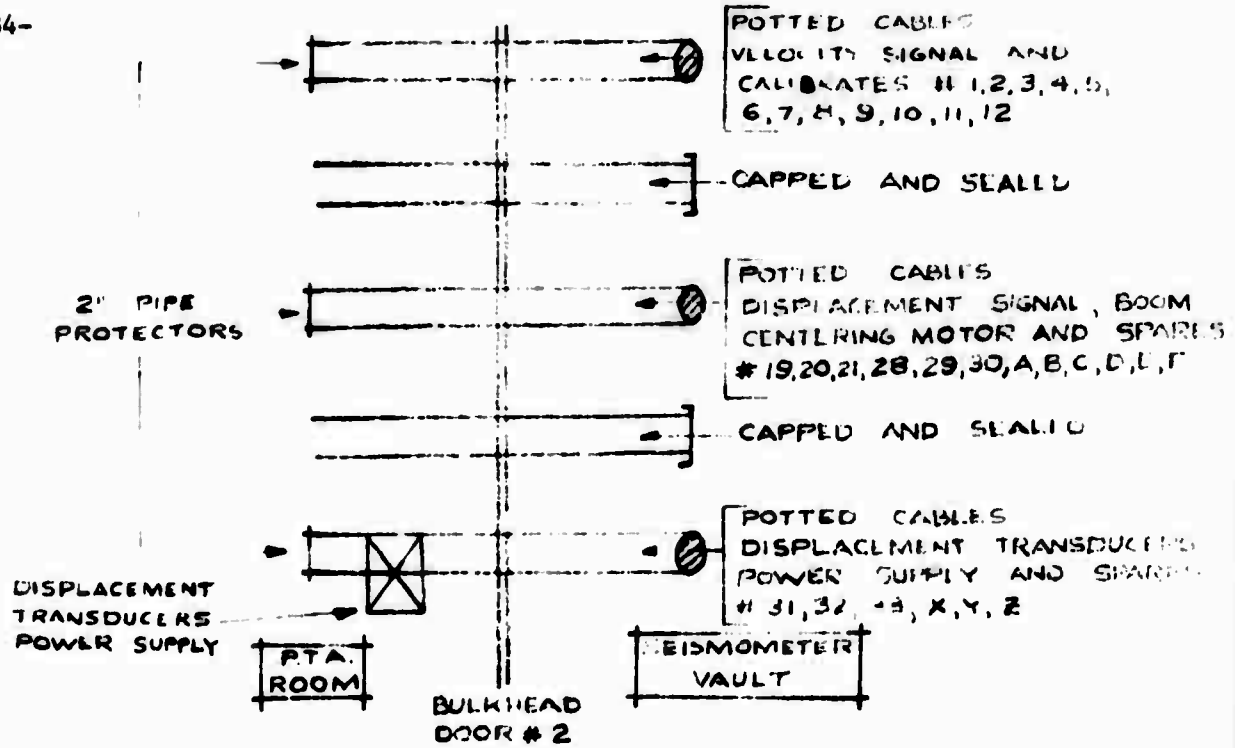
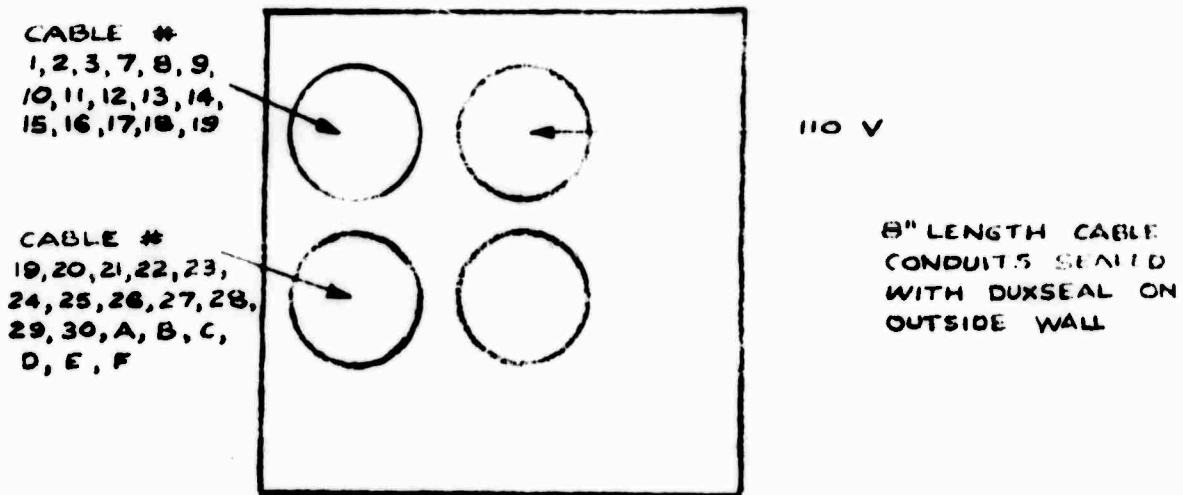
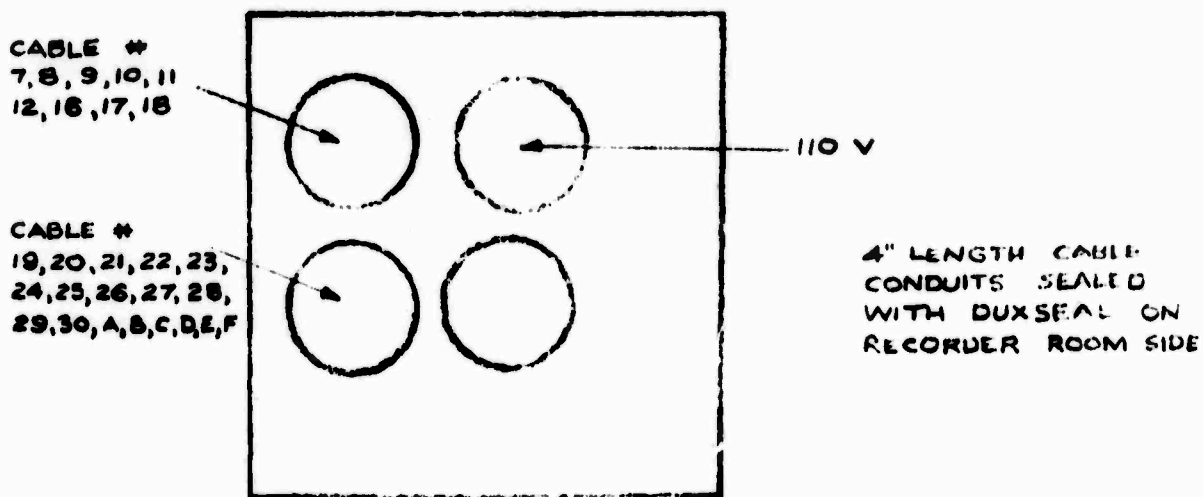

Figure II-11: Positions of cable conduits between Seismometer Vault and P.T.A. Room and between P.T.A. Room and tunnel.



(a) BACK WALL RECORDING ROOM



(b) WALL BETWEEN CONTROL AND RECORDING ROOMS

Figure II-12: Positions of cables in cable conduits entering and leaving Recording Room.

III: STATION FACILITIES

AVAILABLE COMMERCIAL POWER

Voltage: 240V

Frequency: 50 Hz

Reliability: High-gain, broad-band, long-period station voltage was observed to be lower than 240V. This voltage, which varies between 220V and 250V, is affected by fluctuating local district loads and by other voltage systems within the University of Queensland seismograph station. In particular, when the system of lights in the tunnel is on, the station voltage drops as low as 220V (Figure III-1). Consequently, the L.D.G.O. system 110V line is affected by these variations. For normal operation, the system voltage varies between 107V and 111V. However, when the tunnel lights are on, the voltage drops to about 104V and on some occasions was observed to fall below 100V.

Occasional power failures of varying duration are present. During a one month test period (15 August to 15 September 1970), six power failures of periods ranging from a few seconds to several minutes occurred. In the summer months, failures of up to one hour are known and are caused by severe electrical storms. When serious power breakdowns do occur, a secondary distribution system is used by the local authorities. Whereas

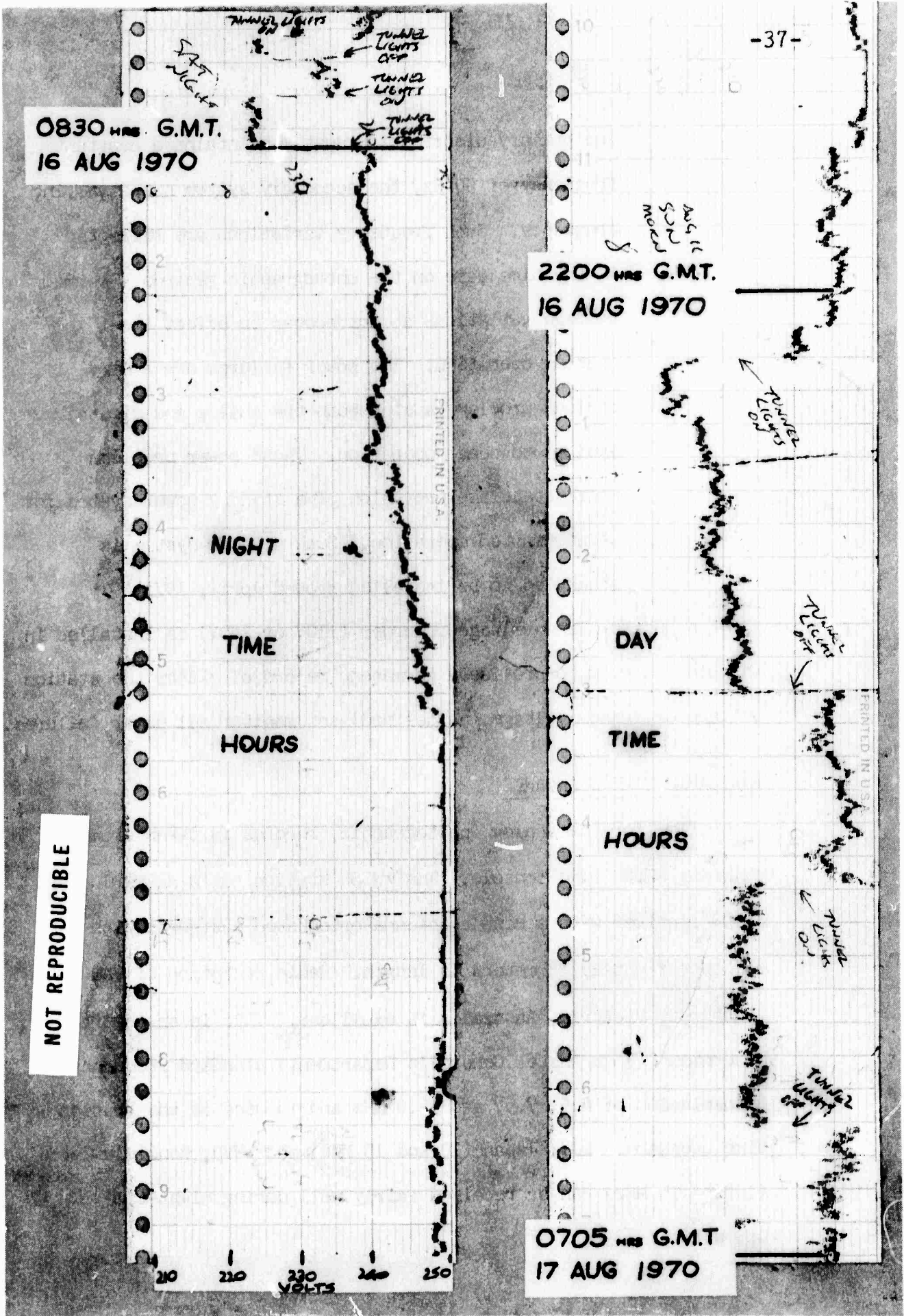

Figure III-1: Record of station voltage showing the effect of tunnel lights and voltage variations between day and night.

the primary distribution system maintains a constant frequency of 50 Hz, the secondary system has a varying frequency. Such frequency variations are reflected in the time base on the photographic records. Normal voltage variations do not appear to effect the station operation. The power failures are a very serious problem causing both the analog and digital systems to cease operation. These power problems necessitate the provision of a standby power system for uninterrupted operation. Such a power system is scheduled to be installed around April, 1971.

A Rustrak line-voltage recorder (110V or 240V) is installed in the control room to provide a permanent record of either the station voltage or system voltage (as desired) and monitor all power failures.

AVAILABLE TIME STANDARDS

Time for the analog (photographic) records is taken from the existing WWSSN time console. The WWSSN station has a Hammarlund SP600 receiver with a dipole antenna orientated east-west with each arm approximately 33 meters in length. Radio reception of VNG, Lyndhurst, Victoria, Australia is excellent. This is an Australian Government (Post Master General's Department) standard frequency transmission of 4.5, 7.5, and 12.0 MHz and is used as the station time standard. JJY, Japan (10 and 15 MHz) and WWVH, Honolulu (10 and 15 MHz) can be received fairly well during night-time hours.

The digital acquisition system has a crystal oscillator time standard. Its digital clock is checked daily and corrected, if necessary, to VNG time when tapes are changed every two weeks.

STANDARD TEMPERATURE AND HUMIDITY

No temperature control equipment or recording apparatus exist in the seismometer vault.

Temperature, humidity and barometric pressure records were obtained in the work room for the two-week period beginning 3 September 1970. Examples of the conditions are shown in Figures III-2 and III-3. These records indicate the relatively stable conditions that exist in the tunnel and recording building. Variations of a few degrees Centigrade in temperature and 10%-20% in humidity are expected. Microbarograph records indicate a maximum daily fluctuation of 0.2 inch Hg during a 24 hour period with a 6 to 7 hour cycle.

A Bendix hygro-thermograph and a Bendix micro-barograph are installed in the workroom to monitor the environmental temperature and barometric pressure changes. The effects of large meteorological phenomena can then be monitored.

BACKGROUND NOISE

The microseismic activity is associated with meteorological phenomena, particularly low pressure fronts and local storms, and is extremely variable in amplitudes. Predominant microseisms have periods of 2, 8 and 20 seconds. The greatest activity occurs from

ON 2245 GMT 11 SEPT 70
OFF 2240 GMT 12 SEPT 70

CHART NO. 207-D
HYDRO-THERMOGRAPH

THE BENDIX CORPORATION

INSTRUMENT NO. _____ DATE _____ STATION **CTA**

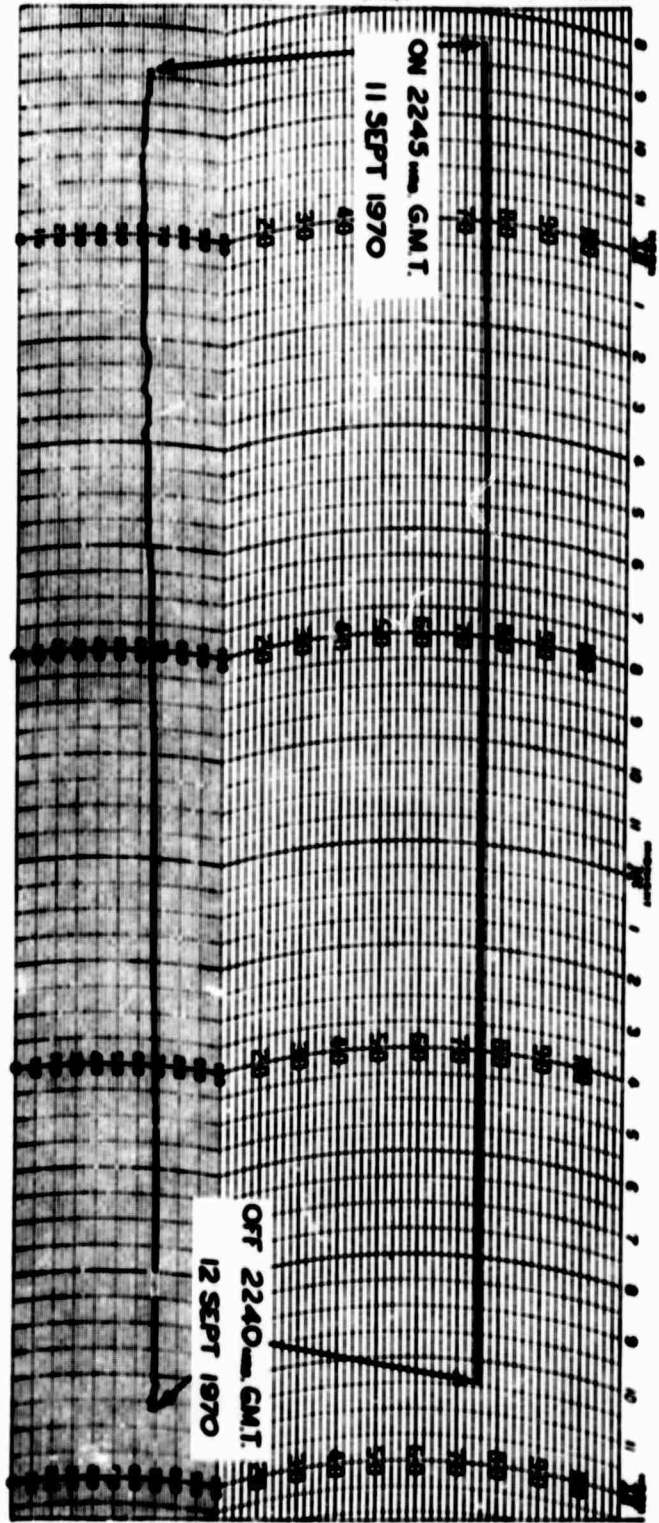

Figure III-2: Hygro-thermograph record for 12 September 1970. Instrument is located in the Workroom of the Recording Building and records temperature and humidity variations in the tunnel.

PRINTED IN U.S.A.
ON: 2245 GMT 11 SEPT 1970
OFF: 2240 GMT 12 SEPT 1970

WHEN ORDERING BINDS FOR
THIS CHART SPECIFY 503301

PART NO 500089

**MICRO-BAROGRAPH
CHART NO. 1071-SD, DAILY**

USE NO. 1 PEN
BENDIX AVIATION CORPORATION
PRICE INSTRUMENT DIVISION, BALTIMORE, MD., U.S.A.

INSTRUMENT NO. _____ DATE _____ STATION **CTA**
REMARKS **STORE ROOM NEW BUILDING**

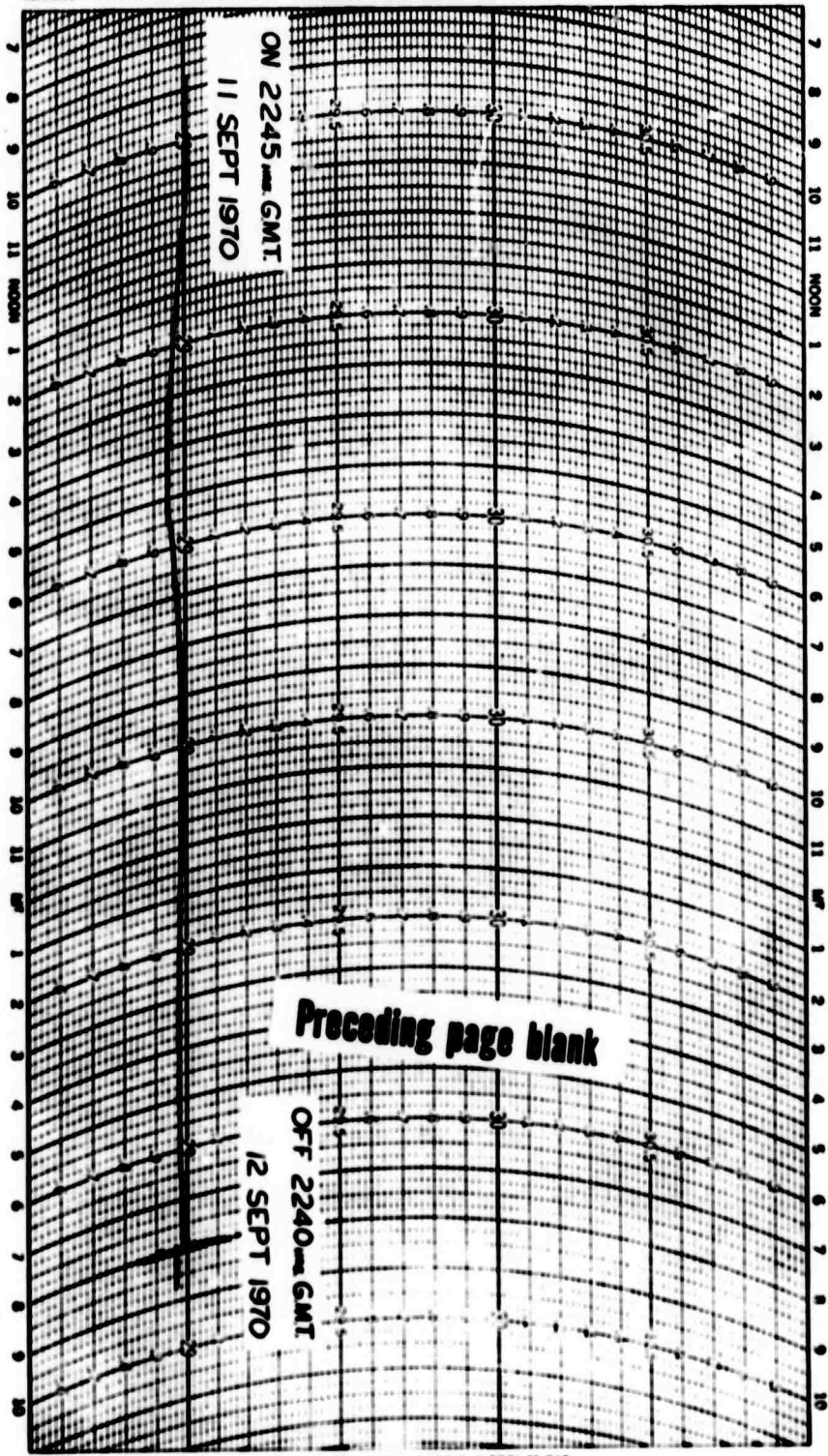

Figure III-3: Micro-barograph record for 12 September 1970. Instrument is located in the Workroom of the Recording Building next to the Hygro-thermograph and records atmospheric pressure in the tunnel.

November to March. During the dry season (April to October) the amplitudes are small (0.5μ). Storm microseism amplitudes may increase by a factor of five or more. The nature and effect of long period background noise is not known at present. Other natural seismic disturbances are not common.

OTHER INSTRUMENTS IN OPERATION

The WSSN standard station CIA has three short-period ($T_0 = 1$ sec) Benioff variable-reluctance seismometers and three long-period ($T_0 = 15$ sec) Press-Ewing seismometers the magnifications of the components are:

SP	Z	:	100,000
SP	N-S	:	100,000
SP	E-W	:	100,000
LP	Z	:	3,000
LP	N-S	:	3,000
LP	E-W	:	3,000

During the dry season (April to October) both systems can operate at increased magnifications.

A gravity station (Number 6491.2047) of the Australian National Gravity Network is located in the main tunnel of the seismograph station (Figure III-4). The value of gravity at this site is 978582.07 milligals.

CHARTERS TOWERS SEISMOGRAPH STATION
(QUEENSLAND UNIVERSITY)

PLATE

-43-

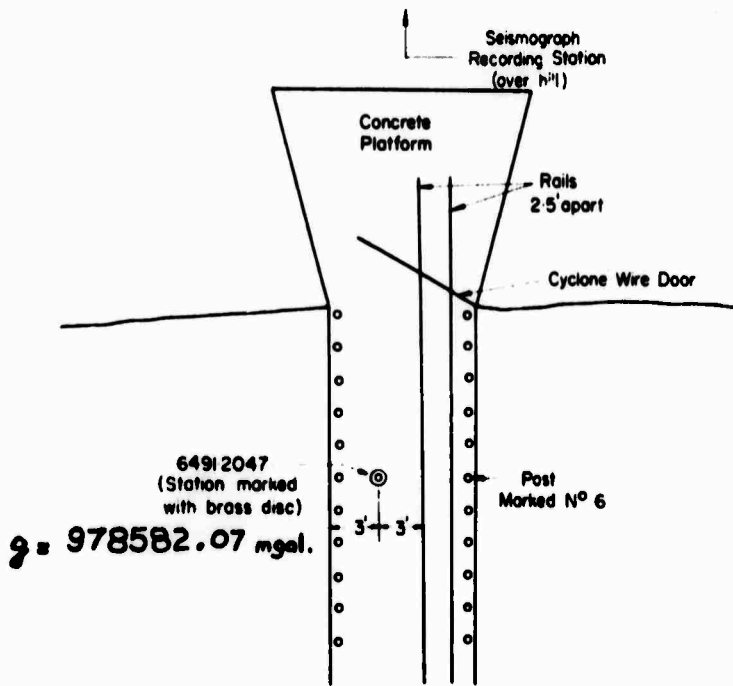
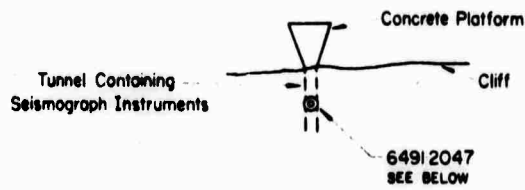
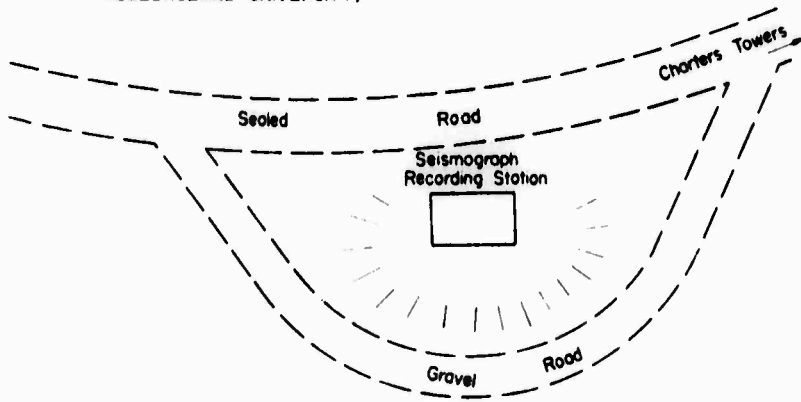

- ▲ Primary base
- △ Secondary base
- ⊙ Excentre

CHARTERS TOWERS QLD

Sheet 3 of 3

F55/B2-38-2

GRAVITY STATIONS
AUSTRALIAN NATIONAL GRAVITY NETWORK

Figure III-4: Location of Gravity Station in the tunnel at the University of Queensland Seismograph Station at Charters Towers, Australia.

IV: INSTRUMENTATION

The details of the system instrumentation are given in the Lamont-Doherty Geological Observatory Technical Report entitled "High-Gain, Long-Period Seismograph Station Instrumentation". The complete system is shown in Figures IV-1 and IV-2. Amendments to the system and specific details that pertain only to the Charters Towers installation are given below. All tests and calibrations were performed remotely from the Control Room. Photographs of the Charters Towers installation are given in Appendix 1.

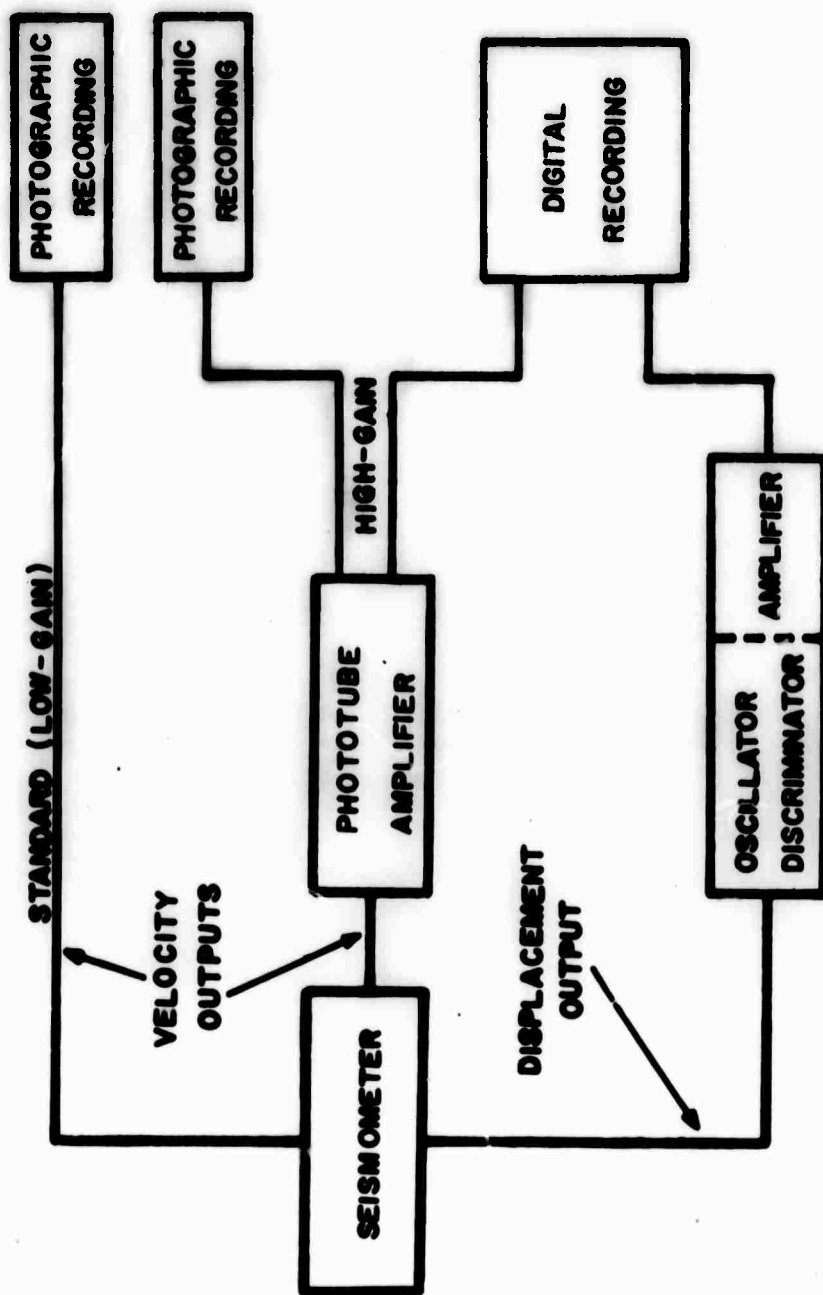

Figure IV-1: Schematic Block Diagram of the high-gain long-period seismograph system.

Figure IV-2: Detailed diagram of the high-gain, long-period seismograph system. The diagram is located at the end of this report.

AMENDMENTS TO SYSTEM DIAGRAM:

STATION: Charters Towers, Australia

1. The following parts are not at this station:
L.D.G.O. Part Numbers: 1114, 2104, 3218, 3219, 3276,
3277, 3410-1, 4101, 4102, 4301, 6005, 8001, 8002,
8005-8007, 8013-8020, 8023, 8027-8030, 8032, 8033,
8036, 8037, 8040, 8043, 8044, 8100, 8201-8208.
2. Voltage regulator (#3270) not in operation: AC
power from power distribution panel (#3424) to
specific components.
3. Dehumidifiers (#3600, #4400) not in operation.
4. Radio (#3218) not installed at station.
5. Antenna (#3219) not installed at station.
6. Time marks for Standard and High-Gain photographic
recorders (#4100) taken directly from existing WWSSN
time console and not via time relay closures from
digital clock (#3100).
7. Bulkhead door #3 (#5100) installed.
8. Filter galvanometers (#4350) were not installed.

VERTICAL

Seismometer:

Serial Number: 131

Free Period: 30 Seconds

Magnets: Lower - before attachment: 2,550 gauss
after attachment: 2,380 gauss
Upper - before attachment: 2,425 gauss
after attachment: 2,300 gauss

Coil Resistances: Standard signal: $r_3 = 590$ ohms
High-Gain signal: $r_6 = 590$ ohms
Primary Calibration: $r_9 = 1.9$ ohms
Secondary Calibration: $r_{12} = 1.9$ ohms

CDRX (Critical for one signal coil): 4,500 ohms

Electromechanical Constant, G:

Standard Signal Coil: $R^1 = 189,500$ ohms
 $V = 1.4$ volts
 $G = 126.1$ newtons amp⁻¹

High-Gain Signal Coil: $R^1 = 189,000$ ohms
 $V = 1.4$ volts
 $G = 125.4$ newtons amp⁻¹

Primary Calibration Coil: $R^1 = 23.8$ ohms
 $V = 1.4$ volts
 $G = 0.0359$ newtons amp⁻¹

Secondary Calibration Coil: $R^1 = 24.8$ ohms
 $V = 1.4$ volts
 $G = 0.0374$ newtons amp⁻¹

Cable Resistances:

Cable # 3 : 1.6 ohms
Cable # 9 : 1.7 ohms
Cable #12 : 1.5 ohms

Standard (Low-Gain) Recording Galvanometer:

Serial Number: 170
Free Period: 104 Seconds
Internal Resistance: 510 ohms
CDRX Set: 3,000 ohms
Damping: Critical
Current Sensitivity: 3.10×10^{-9} amp mm⁻¹ at 1 metre with
3000 ohms CDRX

P.T.A. Galvanometer:

Serial Number: 109
Free Period: 100 Seconds
Internal Resistance: 505 ohms
CDRX Set: 3,000 ohms
Damping: Critical
Current Sensitivity: 5.0×10^{-9} amp mm⁻¹ at 1 metre with
300 ohms CDRX

High-Gain Recording Galvanometer:

Serial Number:	3942
Free Period:	0.3 Seconds
Internal Resistance:	65 ohms
CDRX Set:	100 ohms
Damping:	Critical
Current Sensitivity:	1.49×10^{-8} amp mm ⁻¹ at 1 metre with 100 ohms CDRX
Gain Resistor:	300,000 ohms

Component Magnification (Peak):

Low-Gain:	5,000 at 28 Seconds
High-Gain:	140,000 at 44 Seconds

Remarks:

The final settings of the L-Pad attenuators are as follows:

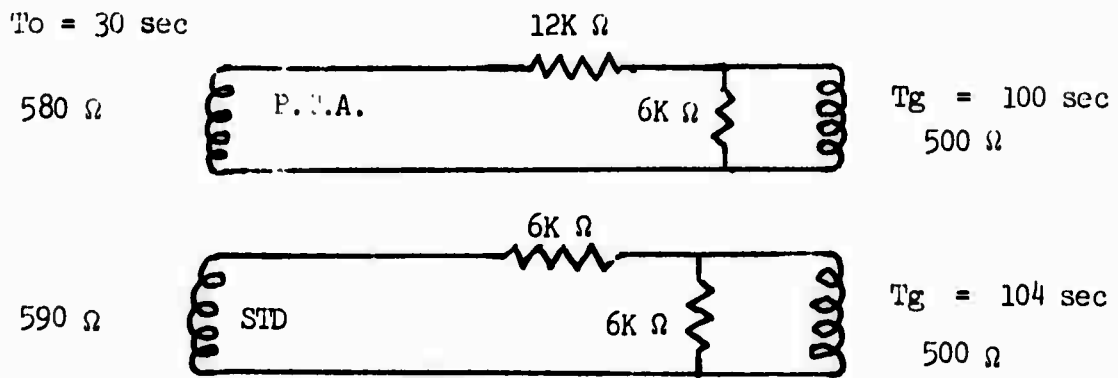

The seismometer is overdamped ($h \approx 1.1$).

The P.T.A. galvanometer is underdamped.

NORTH-SOUTH

Seismometer:

Serial Number: 234

Free Period: 31 Seconds

Magnets: Level Side: 2,520 gauss
Non-Level Side: 2,500 gauss

Coil Resistance: Standard signal: $r_1 = 600$ ohms
High-Gain signal: $r_4 = 600$ ohms
Primary Calibration: $r_7 = 2$ ohms
Secondary Calibration: $r_{10} = 2$ ohms

CDRX (Critical for one signal coil): 6,500 ohms

Electromechanical constant, G:

Standard signal coil: $R^1 = 196,300$ ohms
 $V = 1.43$ volts
 $G = 134.9$ newtons amp⁻¹

High-Gain signal coil: $R^1 = 196,700$ ohms
 $V = 1.43$ volts
 $G = 135.2$ newtons amp⁻¹

Primary Calibration: $R^1 = 59.2$ ohms
 $V = 1.41$ volts
 $G = 0.0426$ newtons amp⁻¹

Secondary Calibration: $R^1 = 58.3$ ohms
 $V = 1.41$ volts
 $G = 0.0419$ newtons amp⁻¹

Cable Resistances:

Cable # 1 : 1.4 ohms
Cable # 7 : 1.7 ohms
Cable # 10 : 1.6 ohms

Standard (Low-Gain) Recording Galvanometer:

Serial Number: 105
Free Period: 98 Seconds
Internal Resistance: 515 ohms
CDRX Set: 3,000 ohms
Damping: Critical
Current Sensitivity: 3.44×10^{-9} amp mm⁻¹ at 1 metre with
300 ohm CDRX

P.T.A. Galvanometer:

Serial Number: 125
Free Period: 100 Seconds
Internal Resistance: 505 ohms
CDRX Set: 3,000 ohms
Damping: Critical
Current Sensitivity: 5.0×10^{-9} amp mm⁻¹ at 1 metre with
300 ohms CDRX

High-Gain Recording Galvanometer:

Serial Number: 4194
Free Period: 0.3 Seconds
Internal Resistance: 65 ohms
CDRX Set: 100 ohms
Damping: Critical
Current Sensitivity: 3.1×10^{-8} amp mm⁻¹ at 1 metre
with 100 ohms CDRX
Gain Resistor: 300,000 ohms

Component Magnification (Peak):

Low-Gain: 4,900 at 34 Seconds
High-Gain: 72,000 at 50 Seconds

Remarks:

The final settings of the L-Pad attenuators are as follows:

To = 31 sec

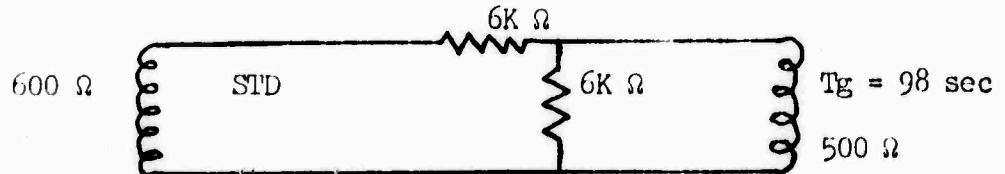
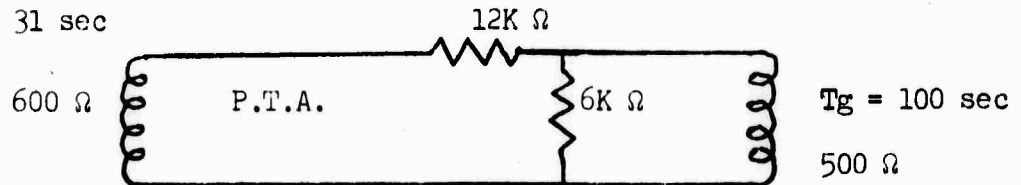

EAST-WEST

Seismometer:

Serial Number: 210
Free Period: 30 Seconds
Magnets: Level side: 2,520 gauss
Non-level side: 2,540 gauss
Coil Resistances: Standard signal: $r_2 = 580$ ohms
High-Gain signal: $r_5 = 600$ ohms
Primary Calibration: $r_8 = 2$ ohms
Secondary Calibration: $r_{11} = 1.9$ ohms
CDRX (Critical for one signal coil): 6,000 ohms

Electromechanical Constant, G:

Standard signal coil: $R^1 = 220,000$ ohms
 $V = 1.4$ volts
 $G = 152.4$ newtons amp⁻¹
High-Gain signal coil: $R^1 = 222,000$ ohms
 $V = 1.4$ volts
 $G = 155.8$ newtons amp⁻¹
Primary calibration: $R^1 = 65$ ohms
 $V = 1.4$ volts
 $G = 0.0467$ newtons amp⁻¹
Secondary calibration: $R^1 = 65.2$ ohms
 $V = 1.4$ volts
 $G = 0.0467$ newtons amp⁻¹

Cable Resistances:

Cable # 2 : 1.6 ohms
Cable # 8 : 1.7 ohms
Cable # 11 : 1.9 ohms

Standard (Low-Gain) Recording Galvanometer:

Serial Number: 107
Free Period: 100 Seconds
Internal Resistance: 505 ohms
CDRX Set: 3,000 ohms
Damping: Critical
Current Sensitivity: 3.36×10^{-9} amp mm⁻¹ at 1 metre with
3000 ohms CDRX

P.T.A. Galvanometer:

Serial Number: 149
Free Period: 100 Seconds
Internal Resistance: 510 ohms
CDRX Set: 3,000 ohms
Damping: Critical
Current Sensitivity: 5.0×10^{-9} amp mm⁻¹ at 1 metre with
3000 ohms CDRX

High-Gain Recording Galvanometer:

Serial Number: 4185
Free Period: 0.3 Seconds
Internal Resistance: 65 ohms

CDRX Set: 100 ohms
Damping: Critical
Current Sensitivity: 1.36×10^{-8} amp mm⁻¹ at 1 metre with
100 ohms CDRX

Component Magnification:

Low-Gain: 4,700 at 29 Seconds
High-Gain: 97,000 at 50 Seconds

Remarks:

The final settings of the L-Pad attenuators are as follows:

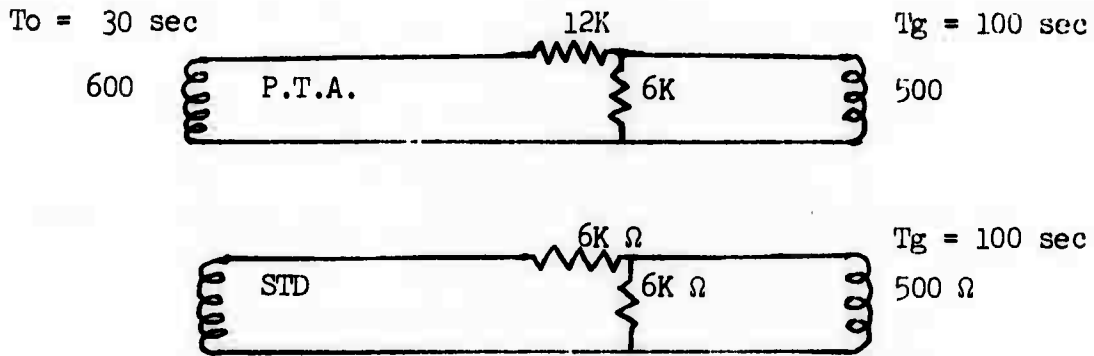

PHOTOGRAPHIC RECORDERS:

Low-Gain:	Rotation Speed:	15 mm/minute
	Translation Speed:	10 mm/revolution
High-Gain:	Rotation Speed:	15 mm/minute
	Translation Speed:	10 mm/revolution

DISPLACEMENT TRANSDUCERS:

Vertical:	Serial Number:	3876
	Sensitivity:	4.2 mV/ μ
	Range of Linearity ($\pm 0.1\%$):	3.8 mm peak to peak about center of oscillation
North-South:	Serial Number:	3888
	Sensitivity:	4.3 mV/ μ
	Range of Linearity ($\pm 0.1\%$):	3.6 mm peak to peak about center of oscillation
East-West:	Serial Number:	3884
	Sensitivity:	5.3 mV/ μ
	Range of Linearity ($\pm 0.1\%$):	3.7 mm peak to peak about center of oscillation

DIGITAL DATA ACQUISITION SYSTEM:

Station I.D.: 01

Input Channels	Written on Tape	Sampling Rate Samples per Second	Instrument
1	Yes	One Sample per Second	Z Velocity
2	Yes	One Sample per Second	N-S Velocity
3	Yes	One Sample per Second	E-W Velocity
4	No		
5	No		
6	No		
7	No		
8	No		
9	No		
10	No		Test Channel
11	Yes	One Sample per 5 Seconds	Z Displacement
12	Yes	One Sample per 5 Seconds	N-S Displacement
13	Yes	One Sample per 5 Seconds	E-W Displacement
14	No		
15	No		
16	No		

ACKNOWLEDGMENTS

The author wishes to thank the University of Queensland, Brisbane, Australia for making available the site at Charters Towers for the installation of this seismograph system. Particular thanks are due to Dr. John P. Webb and Mr. Paul Gaffy of the Department of Geology and Mineralogy, University of Queensland for their help and advice with the logistics of the project and to Mr. John M. Millican of the University of Queensland Seismograph Station at Charters Towers for his unending services during the installation. The author also wishes to thank Drs. Bryan Isacks, and Peter L. Ward, Mr. George P. Hade Jr., and Dr. J. P. Webb for their advise and criticism during the preparation of this report.

REFERENCES

- Lamont-Doherty Geological Observatory of Columbia University
(1971): Technical Report "High-Gain Long-Period
Seismograph Station Instrumentation".
- Reid, J. H. (1917): The Charters Towers Goldfield. Geol.
Survey, Queensland, Pub. No. 256.
- World-Wide Standard Seismograph Network Handbook (1966):
University of Michigan.
- Wyatt, D. H. A., G. L. Paine, D. E. Clark, C. M. Gregory, and
R. R. Hending (1967): The Geology of Charters Towers
1 : 250,000 Sheet Area. Bureau of Mineral Resources,
Record No. 1967/104.

Preceding page blank

-63-

APPENDIX I

PHOTOGRAPHS OF INSTALLATION



Plate 1: Seismometer vault floor before cementing.

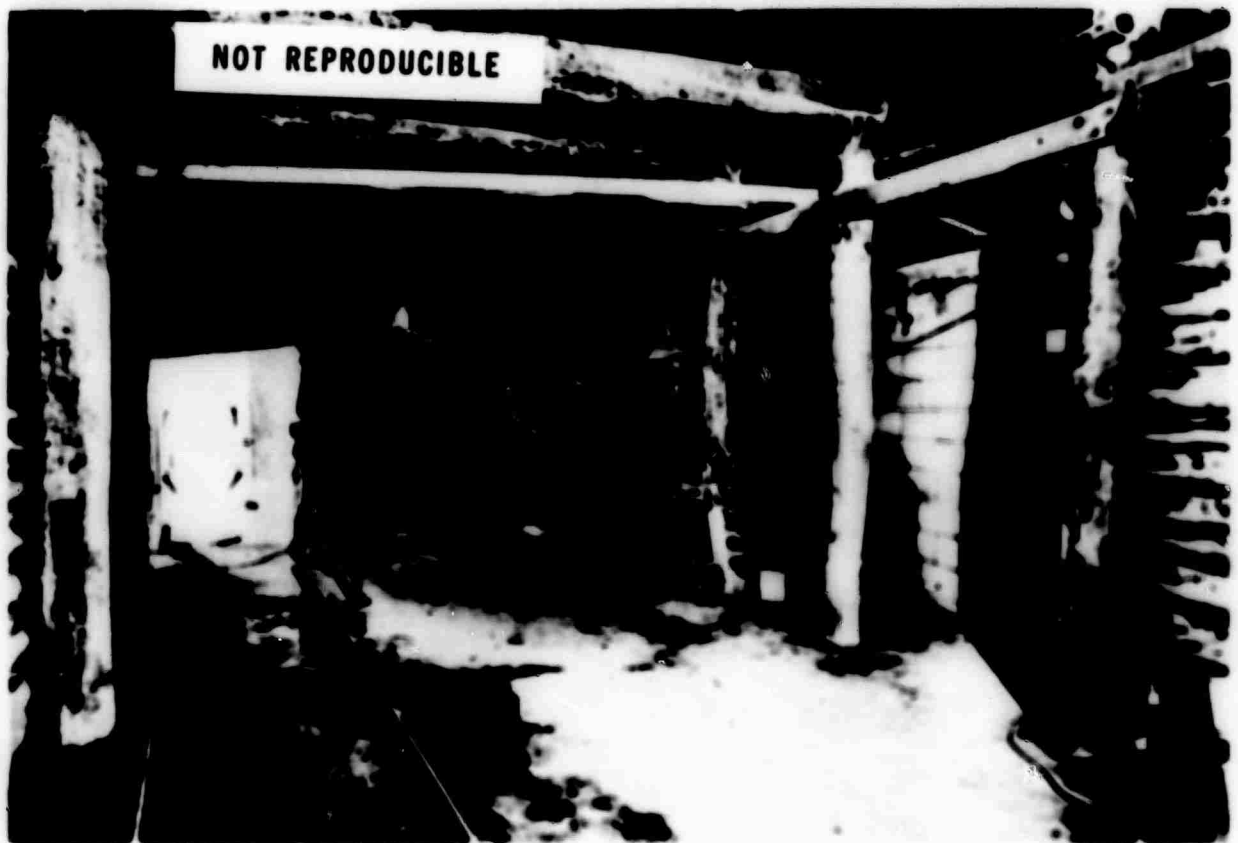

Plate 2: Entrance to Seismometer-Phototube Amplifier Chamber looking from inside of tunnel. WSSN seismometer instrumentation building is the cement-block structure on the right.



Plate 3: Scintimeter Vault and Phototube Amplifier Room.



NOT REPRODUCIBLE

Plate 4: Phototube-Amplifier Room.



Plate 5: Recording Room.

Preceding page blank

-71-

APPENDIX II

FREQUENCY RESPONSE CURVES

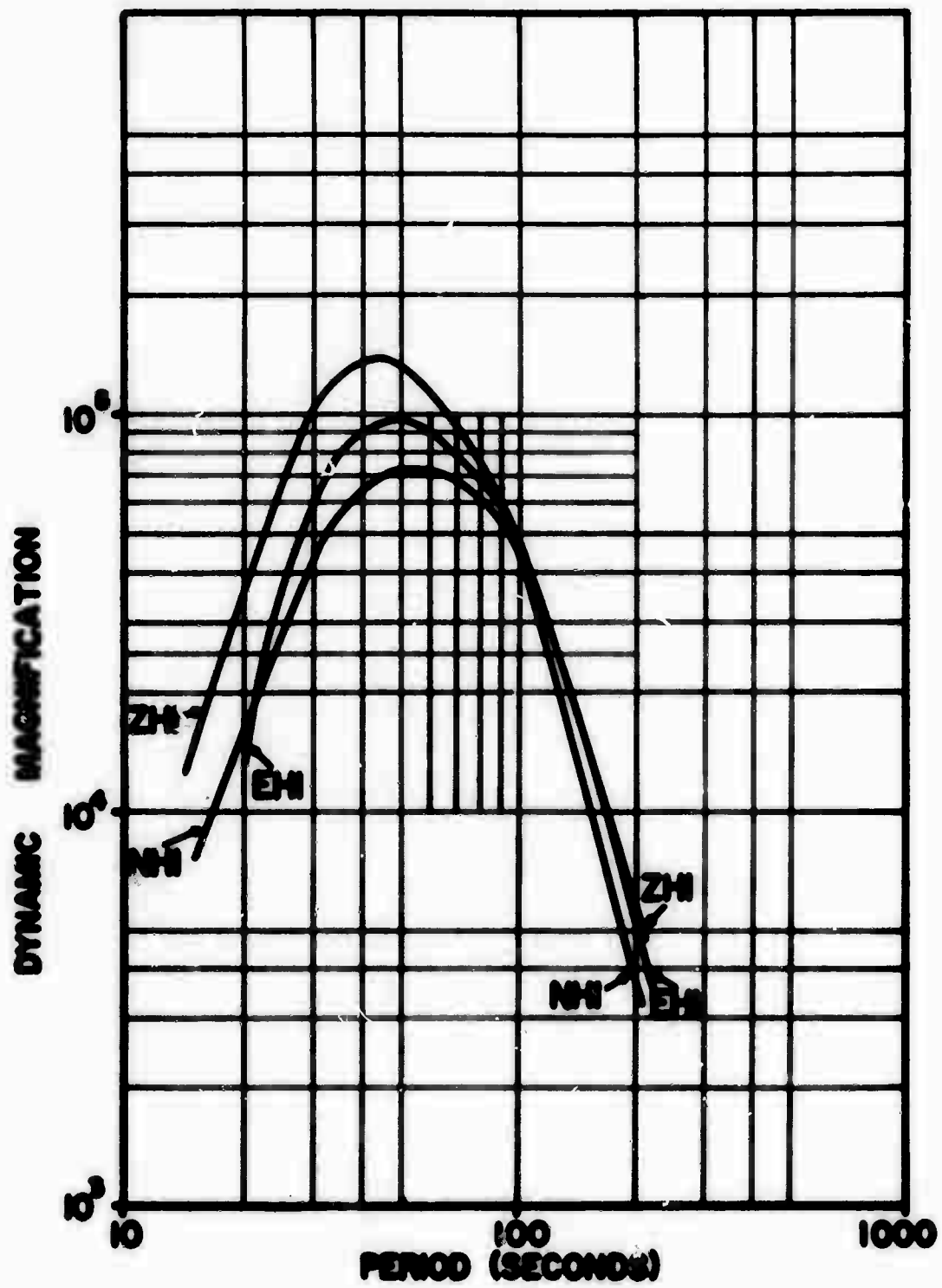

FREQUENCY RESPONSE OF HIGH-GAIN
LONG-PERIOD SEISMOGRAPH SYSTEM
AT
CHARTERS TOMERS AUSTRALIA

HIGH-GAIN COMPONENTS

PEAK MAGNIFICATIONS	Z	140,000	AT	44 Sec
	N-S	72,000	AT	50 Sec
	E-W	97,000	AT	50 Sec

FREQUENCY RESPONSE OF HIGH-GAIN
LONG-PERIOD SEISMOGRAPH SYSTEM
AT
CHARTERS TOWERS AUSTRALIA

STANDARD GAIN COMPONENTS

PEAK MAGNIFICATIONS	Z	5,100	AT	28	Sec
	N-S	4,900	AT	34	Sec
	E-W	4,700	AT	29	Sec

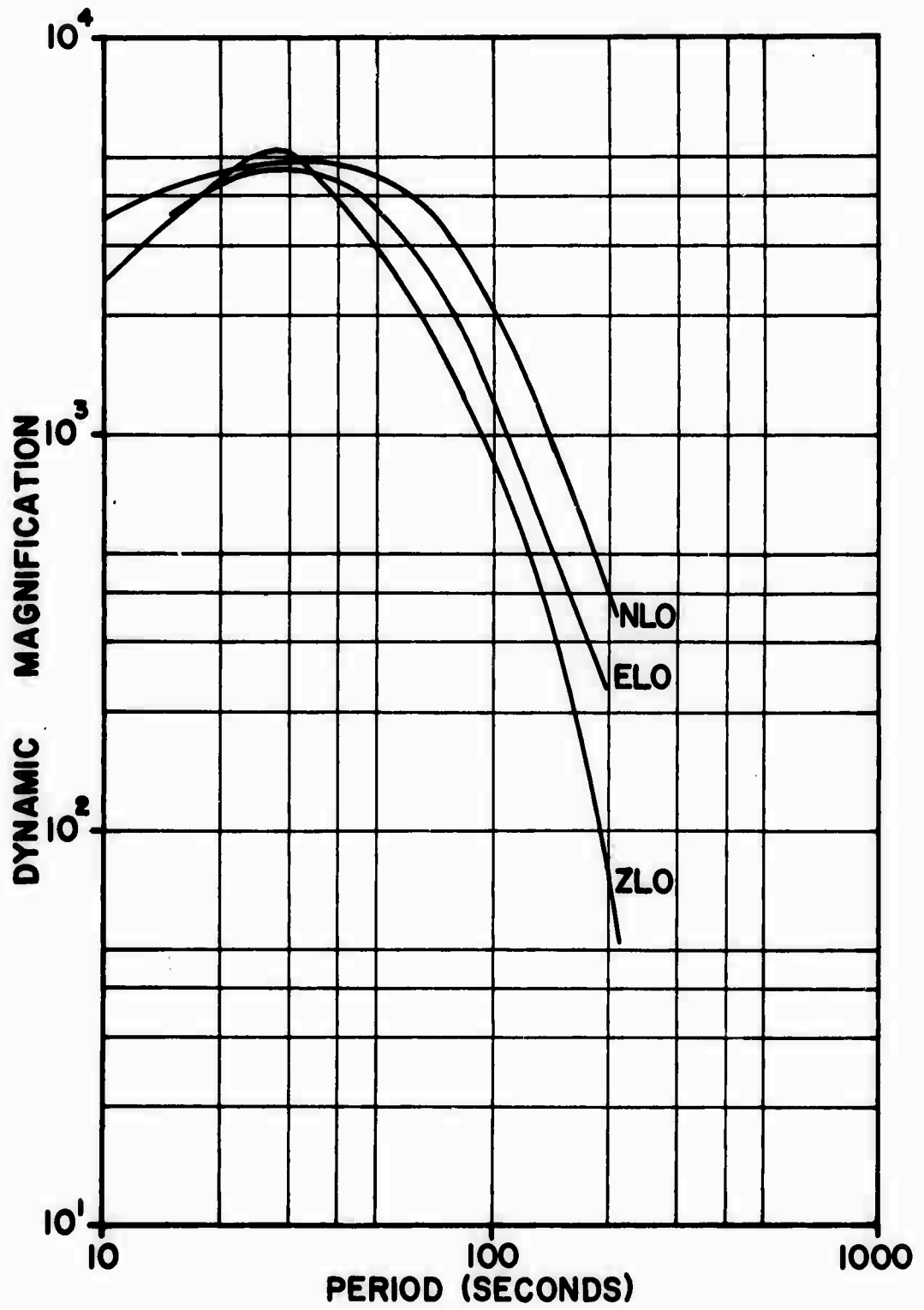

A

SEISMOMETER VAULT

P.T.A. ROOM

RECORDER ROOM

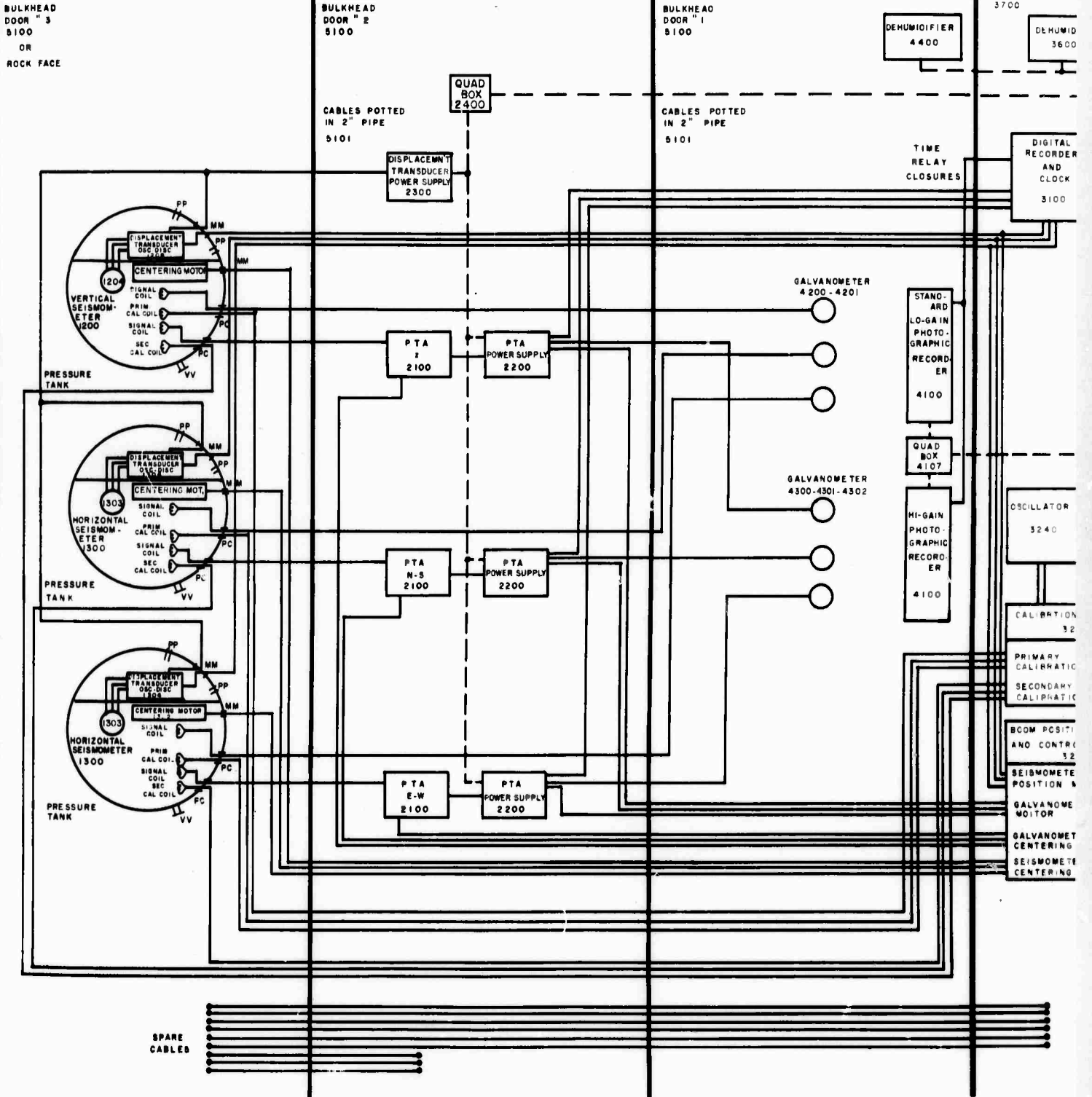

B

CONTROL ROOM

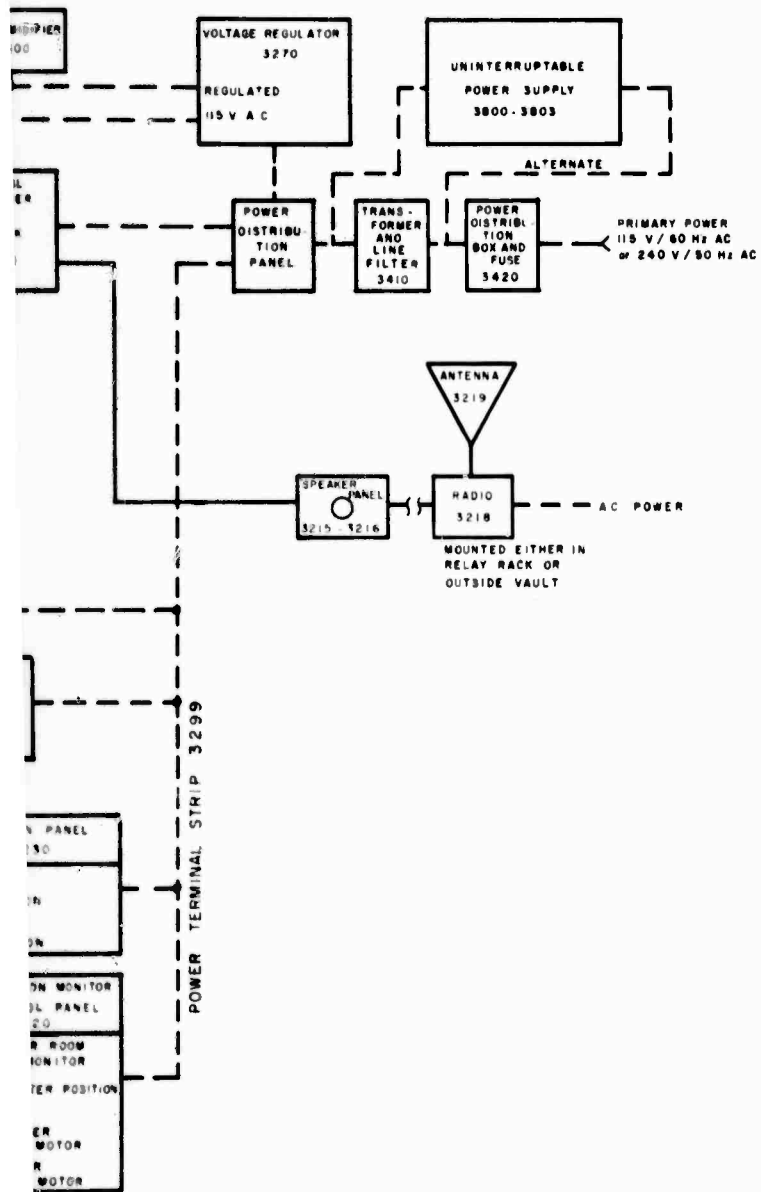

CASEMENT
DOOR
3700

**SYMBOLS USED ON
PRESSURE TANK**

VV	PRESSURE TANK VENT VALVE	1102
PC	POTTED CABLES	8208
MM	MARSH - MARINE CONNECTORS	1101 1103
PP	PIPE PLUG	1104

LAMONT - DOHERTY GEOLOGICAL
OBSERVATORY OF COLUMBIA UNIVERSITY

HIGH - GAIN BROAD - BAND
LONG - PERIOD
SEISMIC SYSTEM