

Report 2976B

COMPUTER PROGRAMS FOR PLATE VIBRATION INCLUDING THE EFFECTS OF CLAMPED AND ROTATIONAL BOUNDARIES AND CYLINDRICAL CURVATURE - OPTION 2

AD 724642

# NAVAL SHIP RESEARCH AND DEVELOPMENT CENTER

Washington, D. C. 20034



## COMPUTER PROGRAMS FOR PLATE VIBRATION INCLUDING THE EFFECTS OF CLAMPED AND ROTATIONAL BOUNDARIES AND CYLINDRICAL CURVATURE - OPTION 2

by

Ralph C. Leibowitz  
and  
Dolores R. Wallace

APPROVED FOR public release;  
distribution unlimited

~~... U.S. Government agencies only  
... evaluation, December 1970. Other...  
... for this... to Naval Ship Systems~~

SHIP ACOUSTIC DEPARTMENT  
AND  
COMPUTATION AND MATHEMATICS DEPARTMENT  
RESEARCH AND DEVELOPMENT REPORT

January 1971

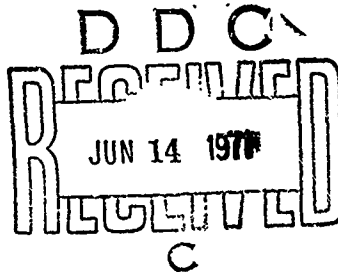

Report 2976B

Reproduced by  
NATIONAL TECHNICAL  
INFORMATION SERVICE  
Springfield, Va. 22151

164

DEPARTMENT OF THE NAVY  
NAVAL SHIP RESEARCH AND DEVELOPMENT CENTER  
WASHINGTON, D. C. 20034

COMPUTER PROGRAMS FOR PLATE VIBRATION INCLUDING  
THE EFFECTS OF CLAMPED AND ROTATIONAL  
BOUNDARIES AND CYLINDRICAL CURVATURE  
- OPTION 2

by

Ralph C. Leibowitz  
and  
Dolores R. Wallace

*MMMM*  
Distribution limited to U.S. Government agencies only;  
resale and further distribution prohibited after 1976. Other requests  
for this document must be referred to Naval Ship Systems  
Command, SHS PS 0311.

January 1971

Report 2976B

## TABLE OF CONTENTS

|   | Page |
|---|------|
| ABSTRACT .....                                    | 1    |
| ADMINISTRATIVE INFORMATION .....                  | 1    |
| INTRODUCTION.....                                 | 1    |
| DISCUSSION .....                                  | 3    |
| CALCULATION AND RESULTS .....                     | 5    |
| EVALUATION.....                                   | 5    |
| CONCLUSIONS AND RECOMMENDATIONS.....              | 13   |
| ACKNOWLEDGMENTS.....                              | 13   |
| APPENDIX A – THE WARBURTON METHOD .....           | 15   |
| APPENDIX B – THE YOUNG METHOD.....                | 21   |
| APPENDIX C – THE BALLENTINE-PLUMBLEE METHOD ..... | 29   |
| APPENDIX D – THE GREENSPON METHOD.....            | 43   |
| APPENDIX E – THE WHITE METHOD .....               | 49   |
| APPENDIX F – THE CROCKER METHOD.....              | 69   |
| APPENDIX G – THE SUN METHOD.....                  | 85   |
| APPENDIX H – THE CLAASSEN-THORNE METHOD .....     | 91   |
| APPENDIX I – COMPUTER PROGRAMS .....              | 95   |
| REFERENCES .....                                  | 149  |
| BIBLIOGRAPHY.....                                 | 152  |

## LIST OF FIGURES

|   | Page |
|---|------|
| Figure 1 – Examples of Mode Shapes .....  | 4    |
| Figure 2 – Comparison of Theoretical and Experimental<br>Natural Frequencies.....                               | 8    |
| Figure 3 – Modal Mean Square Plate Displacement for Clamped-Clamped<br>and Simply Supported Aluminum Plate..... | 10   |
| Figure 4 – Curved Panel Coordinate System .....   | 32   |
| Figure 5 – Nondimensional Frequency Solutions, Clamped Edges,<br>$A = 0.50$ .....                               | 36   |
| Figure 6 – Nondimensional Frequency Solutions, Clamped Edges,<br>$A = 0.67$ .....                               | 37   |
| Figure 7 – Nondimensional Frequency Solutions, Clamped Edges,<br>$A = 1.00$ .....                               | 38   |
| Figure 8 – Nondimensional Frequency Solutions, Clamped Edges,<br>$A = 1.50$ .....                               | 39   |
| Figure 9 – Nondimensional Frequency Solutions, Clamped Edges,<br>$A = 2.00$ .....                               | 40   |
| Figure 10 – Nomogram for Converting Nondimensional Frequency to<br>Actual Frequency .....                       | 41   |
| Figure 11 – Parameter $\psi_1$ versus $\alpha_{10}$ and $\alpha_{1L}$ , First Mode .....                        | 56   |
| Figure 12 – Parameter $\psi_2$ versus $\alpha_{20}$ and $\alpha_{2L}$ , Second Mode .....                       | 56   |
| Figure 13 – Parameter $\psi_3$ versus $\alpha_{30}$ and $\alpha_{3L}$ , Third Mode .....                        | 57   |
| Figure 14 – Frequency Parameter $\alpha_1$ versus $\alpha_{10}$ and $\alpha_{1L}$ , First Mode .....            | 57   |
| Figure 15 – Frequency Parameter $\alpha_2$ versus $\alpha_{20}$ and $\alpha_{2L}$ , Second Mode .....           | 58   |
| Figure 16 – Frequency Parameter $\alpha_3$ versus $\alpha_{30}$ and $\alpha_{3L}$ , Third Mode.....             | 58   |
| Figure 17 – Nomograph for Plate Nondimensional Frequency Parameters .....                                       | 60   |
| Figure 18 – Program to Calculate and Plot Clamped-Clamped Mode Shapes .....                                     | 78   |
| Figure 19 – Mode Shapes for a Clamped-Clamped Beam, First and Second<br>Modes .....                             | 79   |
| Figure 20 – Mode Shapes for a Clamped-Clamped Beam, Third and Fourth<br>Modes .....                             | 79   |

|   | Page |
|---|------|
| Figure 21 – Mode Shapes for a Clamped-Clamped Beam, Fifth and Sixth Modes .....   | 50   |
| Figure 22 – Mode Shapes for a Clamped-Clamped Beam, Seventh and Eighth Modes .....  | 80   |
| Figure 23 – Mode Shapes for a Clamped-Clamped Beam, Ninth and Tenth Modes .....   | 81   |
| Figure 24 – Flow Chart for WCGFRE, Computer Program for Computing Natural Frequencies of a Plate by Warburton, Crocker, and Greenspon Methods ..... | 102  |
| Figure 25 – Flow Chart for White Computer Program for Converting Nomograph Frequency Parameters $\alpha_{m, n}$ to Frequencies $f_{m, n}$ .....     | 105  |
| Figure 26 – Flow Chart for PLFREQ, Computer Program for Computing Natural Frequencies of a Plate by Ballentine-Plumlee Method .....                 | 115  |
| Figure 27 – Flow Chart for SUNFRE, Computer Program for Computing Natural Frequencies of a Plate by Sun Method .....                                | 127  |
| Figure 28 – Procedure for Determining Plate Mode Numbers for a Particular Frequency .....   | 137  |
| Figure 29 – Flow Chart for YNGFRE, Computer Program for Computing Natural Frequencies of a Plate by Young Method .....                              | 142  |

#### LIST OF TABLES

|   |    |
|---|----|
| Table 1 – Comparison of Natural Frequencies Computed by Various Methods for a Clamped-Clamped Steel Plate ..... | 6  |
| Table 2 – Summary of Key Features of Basic References.....  | 11 |
| Table 3 – Values of $\alpha_r$ and $\epsilon_r$ .....   | 26 |
| Table 4 – Integrals of Characteristic Functions of Clamped-Clamped Beam .....                                   | 26 |
| Table 5 – Natural Frequencies for Sample Problem .....  | 42 |
| Table 6 – Function Values for a Clamped-Clamped Beam.....   | 47 |
| Table 7 – Parameters for a Clamped-Clamped Mode Shape .....   | 74 |
| Table 8 – Program Listing for WCGFRE Computer Program .....   | 98 |

|   | Page |
|---|------|
| Table 9 – Program Listing for WHITE Computer Program .....      | 104  |
| Table 10 – Program Listing for PLFREQ Computer Program .....    | 107  |
| Table 11 – Program Listing for SUNFRE Computer Program .....    | 117  |
| Table 12 – Program Listing for YNGFRE Computer Program .....    | 138  |
| Table 13 – Sample Output Data for Each Eigenvalue of YEIGN..... | 147  |

## ABSTRACT

A comparative study is made of various methods for computing the free vibration modes and natural frequencies of thin plates with clamped and rotational supports and cylindrical curvature. The methods include closed form analytical, digital computer, nomographic, and graphical computations. Based on the results, preferred methods of computation are recommended. These methods—Option 2—are of particular value in extending previously formulated digital computer programs for obtaining the vibroacoustic response to turbulence excitation of a plate. Computer results for a particular case provide a comparison of the effect of clamped-clamped and simply supported boundaries on the vibratory response of a plate subject to turbulence excitation.

## ADMINISTRATIVE INFORMATION

This study was conducted at the Naval Ship Research and Development Center (NSRDC) and supported by the Naval Ships Systems Command (NAVSHIPS) Code 0311. Funding was provided by NAVSHIPS 0311 under Subprojects S-F1453 21 06 and R00303, Task 15326.

## INTRODUCTION

Reference 1\* documents four available computer programs for determining the vibratory response and associated acoustic radiation of a finite rectangular plate to fully developed turbulence excitation. Reference 2 treats a modification of these computations to include the effects of pressure pickup dimensions and boundary layer thickness (Option 1). These programs include the response of simple and clamped plates in air and in water. Several computational frameworks are provided which can be modified and extended through additional research to furnish more accurate programs capable of meeting naval needs in an increasingly realistic manner. The chief objective of the original study was to furnish a base for future development.

Reference 1 contains vibroacoustic solutions for all programs using simply supported plate boundaries and for the following programs using clamped plate boundaries:

1. Boeing Program I (Maestrello)
2. Boeing Program II – Finite Element (Jacobs and Lagerquist)
3. Electric Boat Program (Izzo et al.)

Boeing Program I uses the Warburton method for computing the modes and natural frequencies; it may not be adequately accurate for square plates or preferable with respect to accuracy, computer running time, computer cost, and ease of computation etc. compared to

---

\*References are listed on page 149.

other methods of computation. The finite element method of Boeing Program II yields results whose accuracy decreases with mode number. Finally, the particular aspect of the Electric Boat Program which deals with the normal modes and frequencies of clamped plates is considered proprietary by General Dynamics Corporation; hence although their numerical results for a particular clamped plate computation are accessible, the associated program is not available to NSRDC. Nor are other programs for obtaining the response of clamped-clamped plates presently available at NSRDC. Thus, there is a need for evaluating methods for obtaining the normal modes and natural frequencies of clamped plates in order (1) to select a method or methods which are relatively accurate, simple to apply, and inexpensive to run on a computer (if necessary) and (2) to extend the applicability of those programs in Reference 1 which are presently limited to the case of simply supported boundaries.

Accordingly, the present report presents a modification (Option 2) of any of the programs of Reference 1 for continuous thin plates. The modification is an attempt to incorporate into the programs accurate methods for computing the normal modes and natural frequencies of plates with clamped and rotational supports. A method is also presented for including the effects of clamped thin plates with cylindrical curvature in the modified programs. The selected methods for the clamped-clamped finite rectangular plate are based on a comparison of experimental results to results of closed form analytical, digital computer, nomographic, and graphical computations.

The following titles identify the methods treated in the comparative study and their location in the report; notations relevant to each method are also included in the Appendixes.

- Appendix A - Warburton Method
- Appendix B - Young Method
- Appendix C - Ballentine-Plumlee Method
- Appendix D - Greenspon Method
- Appendix E - White Method
- Appendix F - Crocker Method
- Appendix G - Sun Method
- Appendix H - Claassen-Thorne Method

The corresponding computer programs and flow charts are given in Appendix I.

For the convenience of the reader, the Appendixes include an adequate amount of mathematical development underlying these methods. An understanding of the development will assist the reader to appreciate the merits and shortcomings of a particular method and to compare and apply the various methods. Relevant figures and tables are adapted from the basic references.

In addition to the references, a bibliography of other pertinent published papers is given for background information.



## DISCUSSION

All of the computer programs in Reference 1 include a treatment for determining the vibroacoustic response for *simply* supported plates subject to turbulence excitation. However, both theory and experiment suggest that when properly interpreted, these programs can also be used directly to obtain the response for *clamped* plates. The interpretation is based on the following considerations.

As discussed in Appendix C of Reference 1, Izzo compared the computed sound pressure level for a clamped-clamped plate with that of a simply supported plate. The comparison suggests that a simplified and realistic approach to the investigation of plates with nonsimple supports would be to calculate the modal frequencies considering the true (clamped-clamped) end conditions but to use the mode shapes considering the end conditions to be simple supports. This approach requires much less computation and its results are in very good agreement with those of the exact approach (clamped-clamped frequencies and mode shapes).

Snowdon<sup>3</sup> lends further theoretical confirmation to these findings. He discusses the first few modes of a clamped-clamped beam\* harmonically driven at its midpoint. When this beam vibrates in its first four resonant and first four antiresonant modes, its displacement curves are closely similar in appearance to those of a simply supported beam. At the ends of the clamped-clamped beam, however, the slope as well as the displacement of the beam is constrained to zero. The results for the simply supported and clamped-clamped beams differ principally in the frequencies at which the resonant and antiresonant modes of beam vibration occur.

Other investigators have found that nodal lines on plates may be equivalent to simple supports, i.e., a plate with any boundary conditions oscillating in one of its higher modes thus behaves virtually like a slightly smaller plate on simple supports. Moreover, the effect of boundary conditions on the natural frequencies of a plate diminishes with increasing frequency (or mode number); see Figure 1.

Recent measurements made by Smith et al.<sup>4</sup> on the fundamental and higher modes of vibration of clamped stiffened plates show that the different clamp arrangements used did not affect the mode shapes but did affect the frequencies.

Thus to obtain a reasonable approximation to the vibroacoustic response for a clamped plate, we need merely determine the frequencies for the freely vibrating clamped plate and insert these predetermined eigenvalues as input data to the appropriate programs of Reference 1.

In view of the above, we seek to devise optional methods (including programs) for determining the frequencies of freely vibrating clamped plates. The establishment of accurate methods of calculation of the frequencies for all modes requires comparing the theoretical frequencies as computed by various methods to the experimental frequencies and using the

---

\*The modes for a plate are usually treated in terms of products of the modes for a beam (see Appendixes A-G).

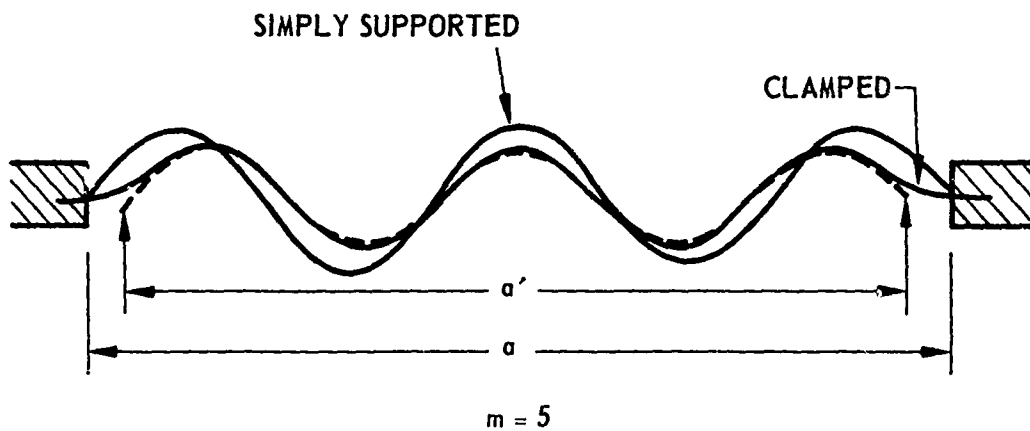
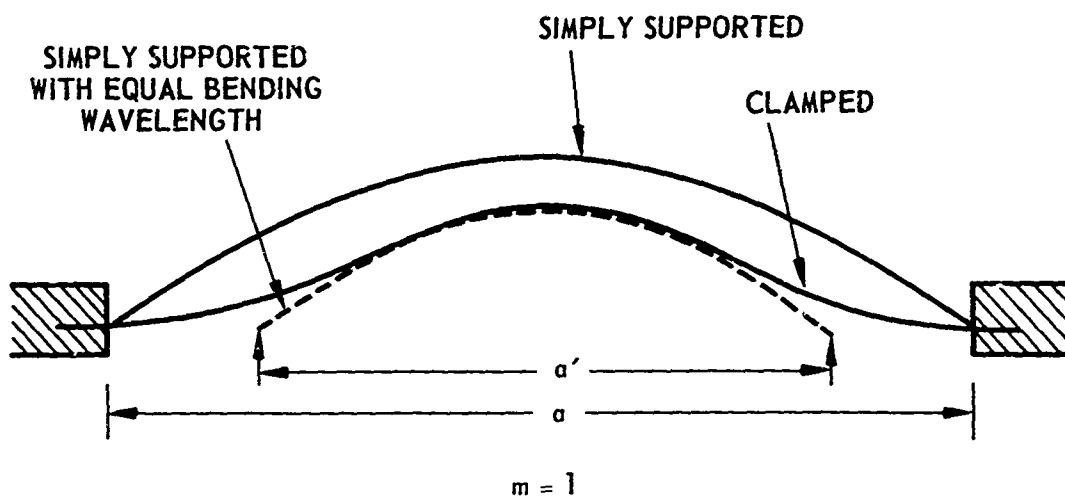

Figure 1 - Examples of Mode Shapes

NOTE. The analysis in Reference 5 suggests that a clamped edge panel has approximately the same transverse vibrational behavior as a simply supported panel whose orthogonal dimensions and bending wavelengths are smaller by the ratios  $\xi_m = \frac{1.05}{1 + 0.5m}$  and  $\xi_n = \frac{1.05}{1 + 0.5n}$  respectively;  $m, n$  are node numbers (number of half wavelengths in the plate in the  $x$ - and  $y$ -coordinate directions). Here,  $m = n$ . Thus,  $\xi_m$  and  $\xi_n$  can be termed, "bending wavelength equivalency factors." The physical significance of these ratios is clear from the figure where  $\frac{a'}{a} = \xi_m$ .

results of this comparison to select the best methods. The modes which are intrinsically associated with the frequencies can also be computed using the methods or programs recommended; the modes may be of value to users interested in making modal comparisons and in applying the results presented here to other problems.

## CALCULATION AND RESULTS

Table 1 compares computed and experimental results obtained for the natural frequencies of a clamped-clamped steel plate. The methods and programs used in the computations are respectively described in Appendixes A-H and Appendix I.

The frequencies versus mode numbers given in Table 1a for each method are plotted as Figure 2a. The frequencies versus method given in Table 1b for each mode number are plotted as Figure 2b. Experimental results cited by Izzo are also included in Table 1a.

Figure 3 compares the effect of clamped-clamped and simply supported boundaries on the vibratory response of a plate subject to turbulence excitation. The results were obtained by using the Warburton method for computing the natural frequencies of clamped-clamped plates (see Appendixes A and I) and the average of the natural frequencies obtained from the simple frequency expression  $\omega_{mn} = \kappa c_f \left[ \left( \frac{m\pi}{a} \right)^2 + \left( \frac{n\pi}{b} \right)^2 \right]$  and from Warburton's method for simply supported plates in the Maestrello program for vibratory response. Note that the computer program for the Warburton method given in Appendix I, yields results for both the clamped-clamped and the simply supported plates (see pages 97 and 103).

Table 2 summarizes key features associated with the basic references. Some of these features exceed those investigated in this paper. They may, however, be of interest to users and investigators who wish to extend the work of the present study.

## EVALUATION

A comparison of the *computed* natural frequencies obtained by several methods (see Table 1 and Figures 2a and 2b) shows that all of these methods yield frequency results which are in good agreement with each other. Hence on purely theoretical grounds, any method can be used if the percentage deviation (obtained from the results of Table 1) between the minimum (or maximum)\* frequency value and the value computed by the specific method is acceptable for a particular mode.

However, a comparison of the *computed* and *experimental* natural frequencies given in Table 1a and Figures 2a and 2b as well as an appreciation of the significant features involved in carrying out a computation lead to a preference for the Warburton method. Using Izzo's experimental results as a standard the data in the table and figures show that for the modes treated, the maximum error attributable to the Warburton method is less than 3.0 percent for

---

\*The deviation from the minimum or maximum is taken according to which one produces the greater deviation for a particular modal frequency.

TABLE 1  
Comparison of Natural Frequencies Computed by Various Methods for a Clamped-Clamped Steel Plate

| m, n | Izzo*       |              | Woburn | Young | Ballentine-<br>Plumlee | Greenspan** | White† | Crocker | Sun   | Cloassen-††<br>Thorne |
|------|-------------|--------------|--------|-------|------------------------|-------------|--------|---------|-------|-----------------------|
|      | Theoretical | Experimental |        |       |                        |             |        |         |       |                       |
| 1, 1 | 200         | 204          | 203.6  | 203.3 | 202.9                  | 203.4       | 203.3  | 212.4   | 203.3 | 203.2                 |
| 1, 2 | 368         | 372          | 375.7  | 375.2 | 374.1                  | 375.6       | 374.4  | 392.2   | 375.4 | 375.0                 |
| 1, 3 | 639         | 637          | 651.2  | 650.8 | 648.5                  | 651.3       | 613.2  | 672.4   | 651.4 | 650.2                 |
| 1, 4 | 1002        | 1002         | 1024   | 1024  | 1020                   | -           | -      | 1048    | 1025  | 1023                  |
| 1, 5 | 1447        | 1465         | 1491   | 1492  | 1487                   | -           | -      | 1518    | 1519  | -                     |
| 1, 6 | 2015        | -            | 2054   | 2056  | 2048                   | -           | -      | 2083    | 2108  | -                     |
| 1, 7 | 2660        | -            | 2709   | 2713  | -                      | -           | -      | 2739    | 2754  | -                     |
| 2, 1 | 443         | 450          | 452.2  | 451.0 | 450.5                  | 452.1       | 450.5  | 460.9   | 451.2 | 450.9                 |
| 2, 2 | 598         | 596          | 611.2  | 609.7 | 608.5                  | 611.4       | 619.6  | 629.1   | 610.3 | 609.3                 |
| 2, 3 | 858         | 864          | 875.1  | 872.1 | 872.1                  | 875.3       | 881.0  | 902.2   | 876.0 | 873.0                 |
| 2, 4 | 1215        | -            | 1241   | 1239  | 1235                   | -           | -      | 1274    | 1243  | -                     |
| 2, 5 | 1670        | -            | 1705   | 1703  | 1698                   | -           | -      | 1747    | 1751  | -                     |
| 2, 6 | 2220        | -            | 2265   | 2263  | 2256                   | -           | -      | 2316    | 2348  | -                     |
| 2, 7 | 2860        | -            | -      | 2918  | -                      | -           | -      | 2739    | -     | -                     |
| 3, 1 | 816         | 830          | 833.6  | 831.8 | 831.5                  | 933.5       | 833.3  | 841.1   | 832.4 | 831.6                 |
| 3, 2 | 965         | 967          | 986.4  | 983.6 | 992.9                  | 986.6       | 986.9  | 1002    | 985.0 | 983.0                 |
| 3, 3 | 1217        | 1206         | 1240   | 1239  | 1238                   | 1240        | 1213   | 1266    | 1268  | -                     |
| 3, 4 | 1567        | -            | 1596   | 1596  | 1594                   | -           | -      | 1632    | 1646  | -                     |
| 3, 5 | 2015        | -            | 2053   | 2054  | 2053                   | -           | -      | 2103    | -     | -                     |

Table 1a - Computed Natural Frequencies for Plate 1 (Izzo-Electric Boat) with Dimensions  $2.0 \times 2.33 \times 0.0313$  Feet (see Appendix I)

A

Preceding page blank

|      | 985          | 986.4 | 986.6 | 986.9 | 987.9 | 988.6 | 988.9 | 1002 | 983.0 |
|------|--------------|-------|-------|-------|-------|-------|-------|------|-------|
| 3, 2 | 1217<br>967  | 1240  | 1239  | 1238  | 1238  | 1240  | 1213  | 1266 | 1268  |
| 3, 3 | 1567<br>1206 | 1596  | 1596  | 1594  | 1594  | 1596  | -     | 1632 | 1646  |
| 3, 4 | 2015         | 2053  | 2054  | 2053  | 2053  | 2054  | -     | 2103 | -     |
| 3, 5 | 2560         | 2608  | 2610  | 2606  | 2606  | 2610  | -     | 2675 | -     |
| 4, 1 | 1319<br>1337 | 1343  | 1341  | 1340  | 1340  | 1341  | -     | 1350 | 1343  |
| 4, 2 | 1465         | 1494  | 1490  | 1489  | 1489  | 1490  | -     | 1507 | 1495  |
| 4, 3 | 1710         | 1741  | 1740  | 1739  | 1739  | 1740  | -     | 1766 | 1791  |
| 4, 4 | 2050         | 2099  | 2091  | 2089  | 2089  | 2091  | -     | 2125 | 2172  |
| 4, 5 | 2480         | 2538  | 2543  | 2542  | 2542  | 2543  | -     | 2593 | -     |
| 4, 6 | 3030         | 3087  | 3093  | 3090  | 3090  | 3093  | -     | 3167 | -     |
| 5, 1 | 1945         | 1981  | 1979  | 1978  | 1978  | 1979  | -     | 1986 | 2009  |
| 5, 2 | 2090         | 2132  | 2126  | 2125  | 2125  | 2126  | -     | 2142 | 2179  |
| 5, 3 | 2330         | 2375  | 2374  | 2374  | 2374  | 2374  | -     | 2397 | 2409  |
| 5, 4 | 2670         | 2718  | 2720  | 2701  | 2701  | 2720  | -     | 2750 | -     |
| 5, 5 | 3110         | 3160  | 3169  | 3172  | 3172  | 3169  | -     | 3216 | -     |
| 6, 1 | 2700         | 2746  | 2745  | 2743  | 2743  | 2745  | -     | 2751 | 2805  |
| 6, 2 | 2840         | 2896  | 2891  | 2889  | 2889  | 2891  | -     | 2903 | 2984  |
| 6, 3 | 3080         | 3139  | 3137  | 3137  | 3137  | 3137  | -     | 3153 | -     |
|      | -            | -     | -     | -     | -     | -     | -     | 3167 | -     |

\*Data obtained from Table 2 of Reference 6 (and duplicated in Reference 1).  
 \*\*Computation limited to values of data given in Reference 7 (see Appendix D of present report). However, additional data given in References 8 and 9 permit extension of computation to higher values of  $m, n$ .  
 †Computation limited to nine modes corresponding to Whites nomographic data.  
 †† Tables in Reference 10 do not yield all modal frequencies given by Izzo but do yield additional modal frequencies corresponding to values of  $m, n$  not considered by Izzo or shown here.

B

| m, n | Wilby*<br>(Experimental) | Hearmon* | Warburton | Young** | Ballentine-<br>Plumlee | Greenspon | White† | Crocker | Sun** | Cloassen-††<br>Thorne |
|------|--------------------------|----------|-----------|---------|------------------------|-----------|--------|---------|-------|-----------------------|
| 1, 1 | 541                      | 586      | 577.9     | -       | 581.0                  | 577.4     | 581.1  | 598.6   | -     | 577.0                 |
| 1, 2 | 1307                     | 1439     | 1402      | -       | 1394                   | 1402      | 1395   | 1433    | -     | 1398                  |
| 1, 3 | 2498                     | 2726     | 2647      | -       | 2636                   | 2647      | 2646   | 2484    | -     | 2638                  |
| 2, 1 | 833                      | 904      | 912.8     | -       | 907.2                  | 912.3     | 902.1  | 941.0   | -     | 923.3                 |
| 2, 2 | 1567                     | 1730     | 1714      | -       | 1703                   | 1714      | 1741   | 1758    | -     | 1717                  |
| 2, 3 | 2747                     | 3010     | 2954      | -       | 2937                   | 2954      | 2962   | 3009    | -     | 2948                  |
| 3, 1 | 1351                     | 1443     | 1474      | -       | 1465                   | 1473      | 1500   | 1502    | -     | 1499                  |
| 3, 2 | 2068                     | 2228     | 2241      | -       | 2229                   | 2240      | 2276   | 2287    | -     | 2259                  |
| 3, 3 | -                        | 3488     | 3461      | -       | 3449                   | 3460      | 3462   | 3525    | -     | -                     |
| 4, 1 | 2047                     | 2186     | 2247      | -       | 2237                   | 2245      | -      | 2273    | -     | 2290                  |
| 4, 2 | 2646                     | 2939     | 2986      | -       | 2969                   | 2985      | -      | 3030    | -     | 3022                  |

\*Results obtained from Reference 11. Wilby's experimental results were found to lie between the simply supported and fully fixed edge conditions in this reference. Hence, comparison between theory and experiment is of limited value.

\*\*Not computed for this plate but computed for plate in Table 1a.

† See third footnote to Table 1a.

†† See last footnote to Table 1a (Izzo-Wilby).

Table 1b -- Computed Natural Frequencies for Plate 2 (Wilby) with Dimensions 4.0 x 2.75 x 0.015 Inches (see Appendix I)

| m, n | Wilby*<br>(Experimental) | Hearmon* | Warburton | Young** | Ballentine-<br>Plumlee | Greenspon | White† | Crocker | Sun** | Cloassen-††<br>Thorne |
|------|--------------------------|----------|-----------|---------|------------------------|-----------|--------|---------|-------|-----------------------|
| 1, 1 | 1058                     | 925      | 935.1     | -       | 935.2                  | 934.6     | 935.8  | 954.9   | -     | 935                   |
| 1, 2 | 2495                     | 2409     | 2433      | -       | 2439                   | 2432      | 2435   | 2464    | -     | 2434                  |
| 2, 1 | 1265                     | 1215     | 1214      | -       | 1211                   | 1214      | 1236   | 1249    | -     | 1211                  |
| 2, 2 | 2742                     | 2689     | 2708      | -       | 2706                   | 2709      | 2781   | 2756    | -     | 2704                  |
| 3, 1 | 1723                     | 1727     | 1711      | -       | 1704                   | 1711      | 1731   | 1751    | -     | 1703                  |
| 3, 2 | 3140                     | 3165     | 3174      | -       | 3173                   | 3175      | 3332   | 3230    | -     | 3168                  |
| 4, 1 | 2403                     | 2456     | 2423      | -       | 2411                   | 2423      | -      | 2465    | -     | 2409                  |
| 5, 1 | 3321                     | 3392     | 3341      | -       | 3322                   | 3341      | -      | 3382    | -     | -                     |

\*See first footnote to Table 1b.

\*\*Not computed for this plate but computed for plate in Table 1a.

† See third footnote to Table 1a.

†† See last footnote to Table 1a (Izzo-Wilby)

Table 1c -- Computed Natural Frequencies for Plate 3 (Wilby) with Dimensions 4.0 x 2.0 x 0.015 Inches (see Appendix I)

Figure 2 - Comparison of Theoretical and Experimental Natural Frequencies

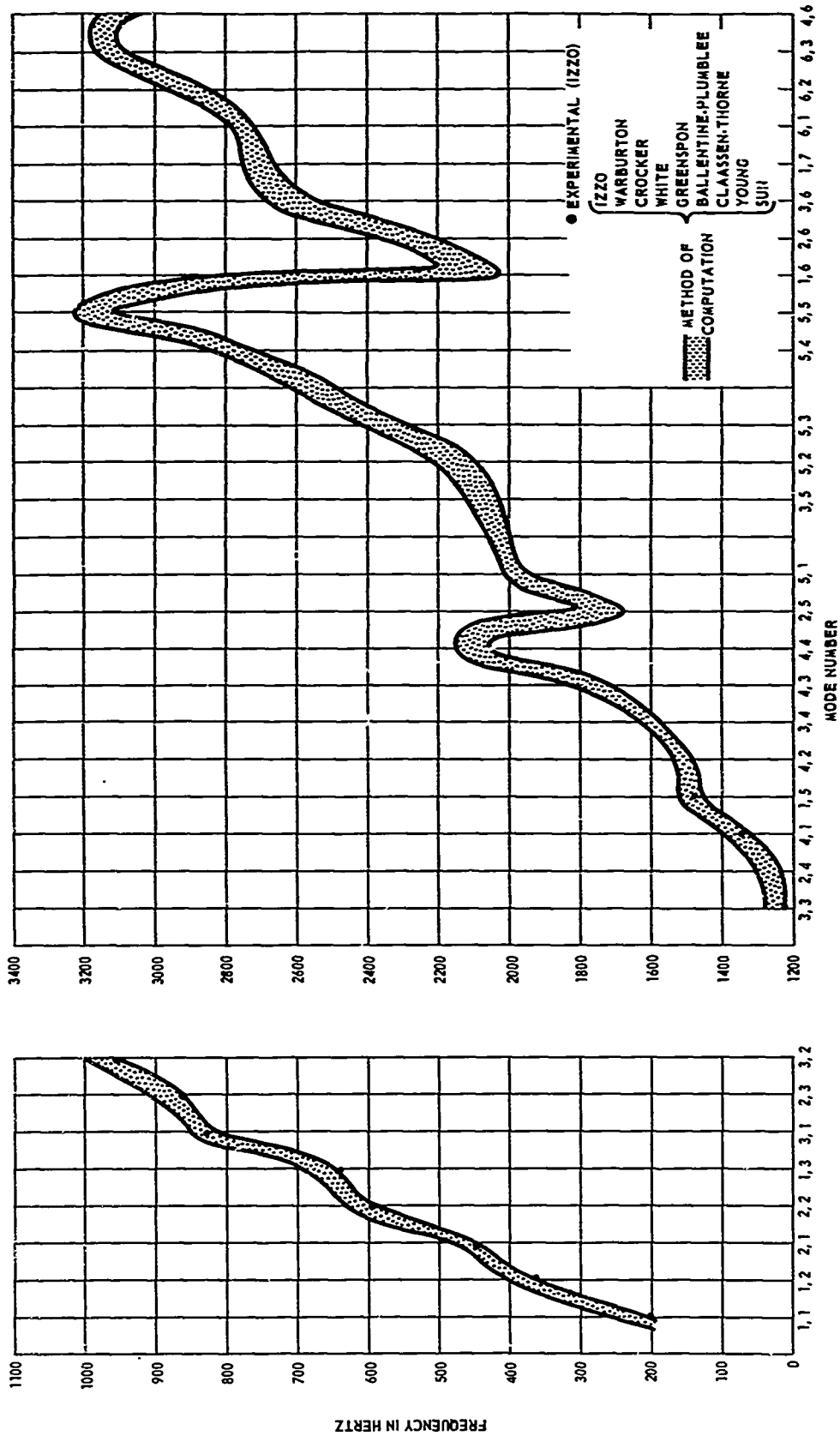

Figure 2a - Computed and Experimental Natural Frequency versus Mode Number for Each Method of Computation  
All methods of computation yield results lying within the upper and lower bounds indicated by the solid lines; see Table 1a.

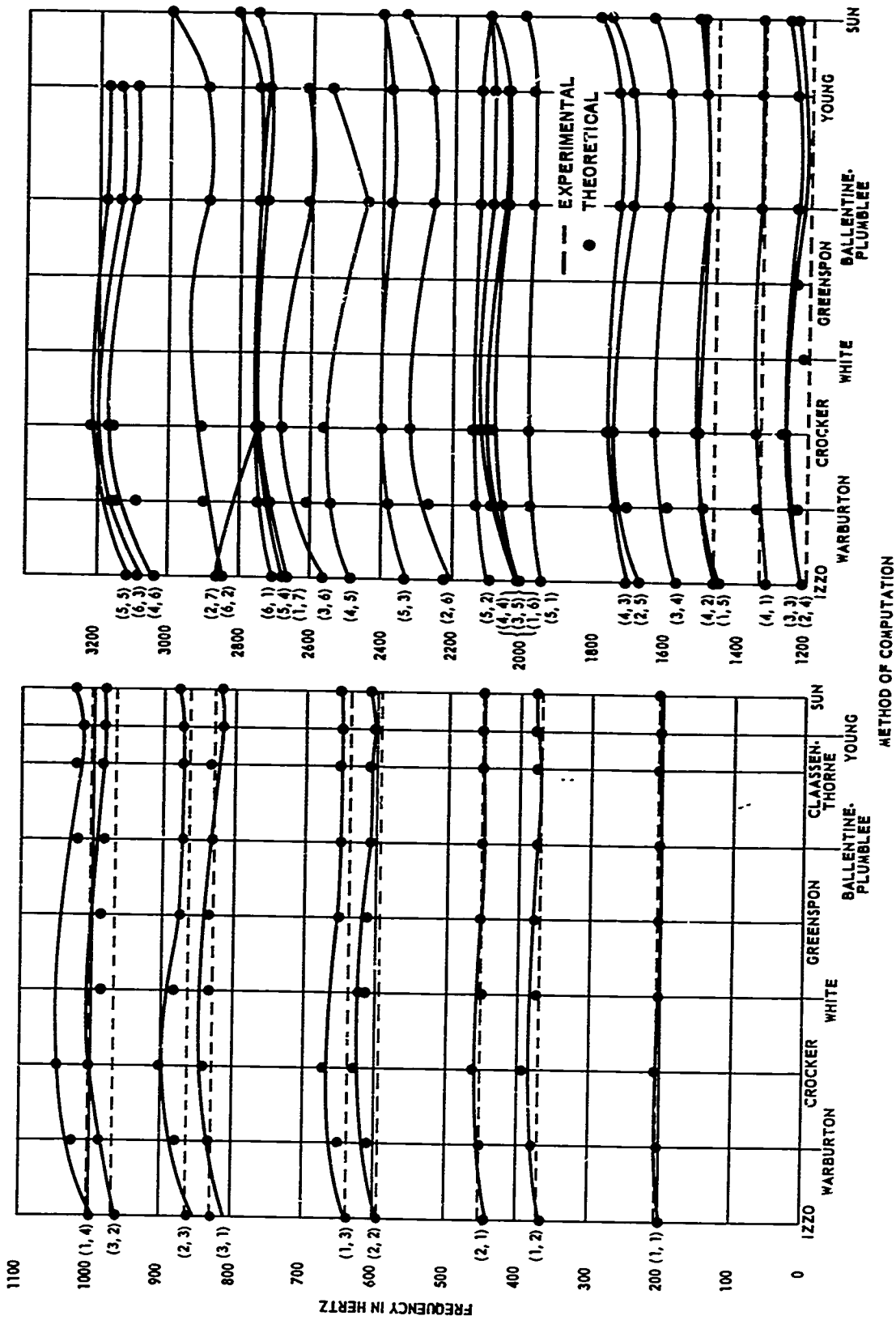
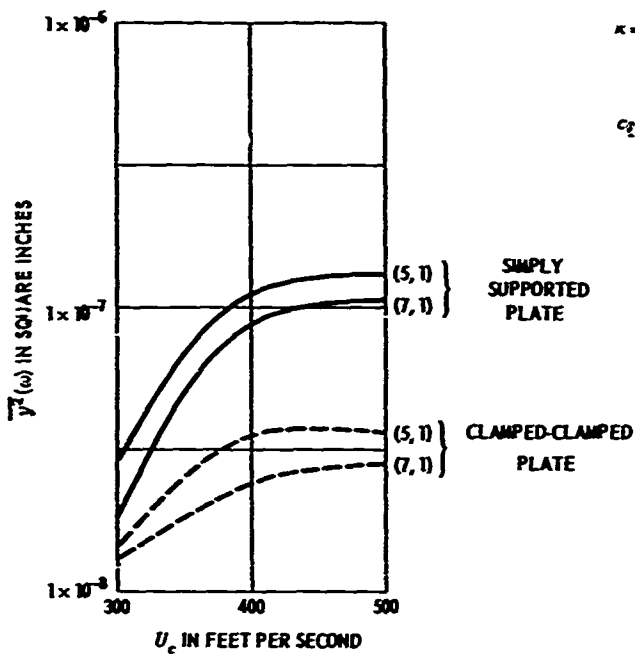

Figure 2b - Computed and Experimental Natural Frequency versus Method of Computation for Each Mode





$$\kappa = \frac{k}{2\sqrt{3}} = 1.157 \times 10^{-2} \text{ IN.}$$

$$= 9.64 \times 10^{-4} \text{ FT}$$

$$c_2 = 17,000 \text{ FT/SEC}$$

$$a = 3.0 \text{ FT}$$

$$b = 0.541666 \text{ FT}$$

$$h = 0.04 \text{ IN.}$$

$$x = x' = 1.5 \text{ FT}$$

$$y = y' = 0.270833 \text{ FT}$$

$$\left(\frac{\text{Weight}}{\text{Area}}\right)^2 = 0.36 \left(\frac{\text{LB}}{\text{FT}^2}\right)^2$$

$$\bar{p}^2 = 10.8686 \left(\frac{\text{LB}}{\text{FT}^2}\right)^2$$

$$\sigma = 0.33$$

$$E = 10 \times 10^6 \text{ LB/IN.}^2$$

$$\rho = 0.1075 \text{ LB/IN.}^3$$

$$g = 384.6 \text{ IN/SEC}^2$$

| $i$ | $A_i$ | $K_i$ |
|-----|-------|-------|
| 1   | 1.6   | 0.47  |
| 2   | 7.2   | 3.0   |
| 3   | 12.0  | 14.0  |

| $U_c$ (FT/SEC) | $\theta$ (SEC)        |
|----------------|-----------------------|
| 300            | $1.45 \times 10^{-3}$ |
| 400            | $1.0 \times 10^{-3}$  |
| 500            | $0.7 \times 10^{-3}$  |

| $m, n$ | $\omega_{S.S.}$ (RAD/SEC) | $\omega_{C-C}$ (RAD/SEC) | $a_{mn}$ |
|--------|---------------------------|--------------------------|----------|
| 5, 1   | 991                       | 1560                     | 34       |
| 7, 1   | 1418                      | 1930                     | 17       |

Figure 3 - Modal Mean Square Plate Displacement for Clamped-Clamped and Simply Supported Aluminum Plate

The computer program converts  $\left(\frac{\text{Weight}}{\text{Area}}\right)^2$  to  $\left(\frac{\text{Mass}}{\text{Area}}\right)^2$

$$\text{i.e. } M^2 = \frac{0.36}{g^2} \left(\frac{\text{lb-sec}^2}{\text{ft}^3}\right)^2$$

**TABLE 2**  
**Summary of Key Features of Basic References**

| Program Organization    | Location in Report | Ref. No.  | Theoretical Approach  | Basic Assumptions and Limitations   | Plate Geometry                              | Plate Boundary Conditions Treated in the Reference   | Timing*  | Nodes Usually Available                          | Method of Solution  |
|-------------------------|--------------------|-----------|---|---|---|--|--|--|---|
| Roberts Method          | Appendix A         | 12        | Rayleigh-Ritz Method  | <ol style="list-style-type: none"> <li>For clamped plates, with nodes as approximated on the product of the characteristic functions of two beams with fixed ends, i.e., functions of a-bending plates and beams are considered nodes.</li> <li>Not of bending supported. Each node represented as a single product of two beam functions corresponding to their nodes rather than as a double summation of products of beam functions corresponding to different nodes from Rayleigh-Ritz Method.</li> <li>Small vibration theory applied to the plate.</li> <li>Isotropic plate.</li> <li>Plate of uniform thickness.</li> <li>Thickness small compared to wavelength.</li> </ol>   | Rectangle, Square                           | <ol style="list-style-type: none"> <li>Free boundary conditions - all four edges free, freely supported, or fixed and traction stress on which some of the edges have one condition and the rest another.</li> <li>Fixed boundary conditions which include various combinations of free, freely supported or fixed boundary conditions e.g. two free, one freely supported and one fixed edge.</li> <li>Edges with support and part of moment.</li> </ol>  | 20 seconds for 25 nodes on IBM 7090.   | Combinations of (W - 1, 2, 3, 4 - 1, 2)          | Classical beam functions consisting of several terms of engineering functions, dependent on plate length, width, R, and $\nu$ , defined easily by computer. |
| Young Method            | Appendix B         | 18        | Ritz Method   | <ol style="list-style-type: none"> <li>Plate deflection represented as a linear combination of an infinite set of products of characteristic uniform beam functions.</li> <li>As the boundaries and products of the beam functions meet satisfy prescribed values for the deflection and slope but not the boundary conditions regarding the normal and shear directions.</li> <li>Small vibration theory applied to the plate.</li> <li>Homogeneous plate.</li> <li>Beam mode functions are orthogonal, their normal directions are also orthogonal.</li> </ol>  | Rectangle, Square                           | <ol style="list-style-type: none"> <li>Any combination of clamped and free edges.</li> </ol>   | 7 minutes to compute C(24, 24) matrix on IBM 7090, 6.3 minutes to compute 64 equations from three matrices on CDC 6600.                      | Combinations of (W - 1, 2, 3, 4 - 1, 2)          | Comma defined from classical beam functions defining plate, equations solved by matrix solution, with error bounds.   |
| Bellevue-Plankin Method | Appendix C         | 19        | Rayleigh-Ritz Method  | <ol style="list-style-type: none"> <li>Plate deflection represented as an infinite summation of products of beam functions corresponding to different nodes.</li> <li>Small vibration theory applied to the plate.</li> <li>Method of orthogonality in general.</li> <li>Plate thickness much less than major panel dimensions, i.e., thin shell.</li> <li>Integrals of mode shapes are orthogonal for simply supported edges but not for clamped edges. Although, for clamped plates, the analysis does not satisfy the desired orthogonality between the modes a numerical analysis for one row panel with and without the assumption of orthogonality shows little difference in the results.</li> </ol>   | Cylindrical Curvature, Flat Rectangular     | <ol style="list-style-type: none"> <li>Simply supported edges.</li> <li>Clamped edges.</li> </ol>  | 20 seconds for 24 nodes on IBM 360/57.   | 24 nodes Combinations of (W - 1, 2, 3, 4 - 1, 2) | Large matrix transformations and operations solutions needed to obtain final results.   |
| Greenough Method        | Appendix D         | 7, 12, 20 | Classical beam frequency solutions for plate and Ritz Method      | <ol style="list-style-type: none"> <li>For constant plate the plate equation is solved for the frequency assuming the deflection to be represented by an infinite sum of the normal modes. The resultant classical beam frequency equation is a function of the plate width and frequency numbers for the modes. The equations for the modes and values for the frequency numbers are identical to those used by Young.</li> <li>A similar procedure yields a frequency equation for a cross-hatched plate, i.e., orthotropic plate with rotational restraints. In this analysis the effects of fixed loading are included.</li> <li>Small vibration theory applied to the plate.</li> <li>Beam mode functions are orthogonal.</li> </ol>                         | Rectangle, Square                           | <ol style="list-style-type: none"> <li>Simply supported edges.</li> <li>Clamped edges.</li> <li>Rotational restraints at the edges.</li> </ol>   | 15 seconds for 25 nodes on IBM 7090.   | 25 beam modes.                                   | Classical beam solutions based on values given by Greenough.  |
| Wirtz Method            | Appendix E         | 21        | Rayleigh-Ritz Method  | <ol style="list-style-type: none"> <li>Plate deflection is expressed as a double infinite series of products of normalized uniform beam modes with <math>\beta</math> factors which are the same as the corresponding edges of the plate.</li> <li>Small vibration theory applied to the plate.</li> <li>Isotropic plate.</li> <li>Plate of uniform thickness.</li> </ol>   | Rectangle, Square                           | <ol style="list-style-type: none"> <li>Uniform distribution of elastic and inertial properties. These factors are equivalent to a uniform distribution of independent masses, translational springs and rotational springs along each edge of the plate, the various edges of the plate can have equal or different elastic components and inertial loadings. In particular, each edge can have a freely supported, a fixed and a clamped support. The only coupling between the individual masses along an edge is the coupling provided by the deflection of the plate.</li> <li>Edge deflections. In general the four edge deflections may have different boundary and rotational conditions and different masses so that the plate can be asymmetrically or unsymmetrically constrained, the four corners of the rectangular plate are translationally fixed.</li> </ol> | Manual computation for frequency parameters, 30 seconds on IBM 7090 for conversion to Wirtz (7 modes).                                       | 7 beam modes.                                    | Manual computations from matrix graphs derived by Wirtz, conversion to Wirtz by computer.   |
| Cocher Method           | Appendix F         | 23        | Approximate solution of plate frequency equations                 | <ol style="list-style-type: none"> <li>Plate mode is expressed on the product of normalized uniform beam modes with <math>\beta</math> factors which are the same as the corresponding edges of the plate.</li> <li>Small vibration theory applied to the plate.</li> <li>Isotropic plate.</li> <li>Plate of uniform thickness.</li> </ol>  | Rectangle, Square                           | <ol style="list-style-type: none"> <li>Simply supported edges.</li> <li>Clamped-clamped edges.</li> </ol>  | 15 seconds for 25 nodes on IBM 7090.   | Combinations of (W - 1, 2, 3, 4 - 1, 2)          | Different engineering approximations, but same type solution as Wirtz.  |
| Soo Method              | Appendix G         | 24        | Rayleigh-Ritz (using polynomial rather than normal mode analysis) | <ol style="list-style-type: none"> <li>Using the Rayleigh-Ritz procedure the plate deflection is represented by a series of polynomial's (higher than the product of beam normal mode functions).</li> <li>The plate deflection representation includes a term which satisfies the specific boundary condition. This terminal condition is treated as a function of the plate geometry which is considered to be approximated by the equation<br/> <math display="block">\left  \frac{x}{a} \right ^m + \left  \frac{y}{b} \right ^n - 1</math> or its equivalent<br/> <math display="block">x^m + y^n - 1</math> for all plates.</li> <li>Small vibration theory applied to the plate.</li> <li>Isotropic plate.</li> <li>Plate of uniform thickness.</li> </ol> | Rectangle, Square, Rhombus, Ellipse, Circle | <ol style="list-style-type: none"> <li>Simply supported edges.</li> <li>Clamped edges.</li> <li>Free edges.</li> </ol>   | 25 seconds for 8 nodes on IBM 360/57 or 30 min. on IBM 7090 for 22-order Gaussian quadrature, 45 sec. on the 360 for 44-order or, otherwise. | Combinations of (W - 1, 2, 3, 4 - 1, 2)          | Energy equation expressed as 22-term polynomial with integrals solved by Gaussian quadrature, operations found by method of reduction.                      |
| Chen-Tseng Method       | Appendix H         | 10        | Fourier Series Method   | <ol style="list-style-type: none"> <li>Plate deflection is assumed to be in the form of a doubly infinite Fourier series.</li> <li>The determination of the frequencies or <math>\beta</math> modes are approximated by using a finite number of <math>m</math>'s and <math>n</math>'s, assuming this number and examining the convergence of the procedure, i.e., of the sequence of <math>K</math> values. Calculations show that the values of <math>K</math> converge. No general theoretical investigations of convergence has been undertaken.</li> </ol>   | Rectangle                                   | <ol style="list-style-type: none"> <li>Clamped edges.</li> <li>Free edges.</li> <li>Clamped on two edges, free on two edges.</li> </ol>  |  |  | 1. For mode   |

\*An accurate timing ratio between the IBM 7090 and IBM 360/57 is difficult to establish. In general, the IBM 360 ranges from 3 to 15 times as fast as the IBM 7090, depending on the input/output and types of equations. The hourly cost of the IBM 360 is about 5 times that of the IBM 7090.

A

References

| Boundary Conditions Treated in the References   | Timing*   | Tables Ready Available  | Method of Solution  | Remarks or Restrictions   |  |
|---|---|---|---|---|--|
| <p>all conditions - all four edges free, freely supported, or cases in which some of the edges have one or more surfaces.</p> <p>conditions which include various combinations of fixed or free boundary conditions e.g. two free, fixed and one fixed edge.</p> <p>or and partial supports.</p>  | <p>20 seconds for 25 modes on IBM 709C.</p>   | <p>Combinations of <math>0F - 1, 2, 3, 4 - 1, 2, 3</math></p>   | <p>Closed form formulas consisting of several terms of trigonometric functions, dependent on plate length, width, <math>\nu</math>, and <math>\rho</math>, which can be computed.</p> | <ol style="list-style-type: none"> <li>1. Closed form frequency and mode shape expressions are obtained in their computation by the method as simple.</li> <li>2. The frequencies of natural vibrations of rectangular plates are derived for two boundary conditions (a) all edges free, supported and (b) two parallel sides fixed and two free supported.</li> </ol>   |  |
| <p>all clamped and free edges.</p>  | <p>2 seconds to compute C, D, E, G, and H on IBM 709C, 6.8 seconds to compute G, H, I, J, K, L, M, N, O, P, Q, R, S, T, U, V, W, X, Y, Z, AA, AB, AC, AD, AE, AF, AG, AH, AI, AJ, AK, AL, AM, AN, AO, AP, AQ, AR, AS, AT, AU, AV, AW, AX, AY, AZ, BA, BB, BC, BD, BE, BF, BG, BH, BI, BJ, BK, BL, BM, BN, BO, BP, BQ, BR, BS, BT, BU, BV, BW, BX, BY, BZ, CA, CB, CC, CD, CE, CF, CG, CH, CI, CJ, CK, CL, CM, CN, CO, CP, CQ, CR, CS, CT, CU, CV, CW, CX, CY, CZ, DA, DB, DC, DD, DE, DF, DG, DH, DI, DJ, DK, DL, DM, DN, DO, DP, DQ, DR, DS, DT, DU, DV, DW, DX, DY, DZ, EA, EB, EC, ED, EE, EF, EG, EH, EI, EJ, EK, EL, EM, EN, EO, EP, EQ, ER, ES, ET, EU, EV, EW, EX, EY, EZ, FA, FB, FC, FD, FE, FF, FG, FH, FI, FJ, FK, FL, FM, FN, FO, FP, FQ, FR, FS, FT, FU, FV, FW, FX, FY, FZ, GA, GB, GC, GD, GE, GF, GG, GH, GI, GJ, GK, GL, GM, GN, GO, GP, GQ, GR, GS, GT, GU, GV, GW, GX, GY, GZ, HA, HB, HC, HD, HE, HF, HG, HH, HI, HJ, HK, HL, HM, HN, HO, HP, HQ, HR, HS, HT, HU, HV, HW, HX, HY, HZ, IA, IB, IC, ID, IE, IF, IG, IH, II, IJ, IK, IL, IM, IN, IO, IP, IQ, IR, IS, IT, IU, IV, IW, IX, IY, IZ, JA, JB, JC, JD, JE, JF, JG, JH, JI, JJ, JK, JL, JM, JN, JO, JP, JQ, JR, JS, JT, JU, JV, JW, JX, JY, JZ, KA, KB, KC, KD, KE, KF, KG, KH, KI, KJ, KK, KL, KM, KN, KO, KP, KQ, KR, KS, KT, KU, KV, KW, KX, KY, KZ, LA, LB, LC, LD, LE, LF, LG, LH, LI, LJ, LK, LL, LM, LN, LO, LP, LQ, LR, LS, LT, LU, LV, LW, LX, LY, LZ, MA, MB, MC, MD, ME, MF, MG, MH, MI, MJ, MK, ML, MM, MN, MO, MP, MQ, MR, MS, MT, MU, MV, MW, MX, MY, MZ, NA, NB, NC, ND, NE, NF, NG, NH, NI, NJ, NK, NL, NM, NN, NO, NP, NQ, NR, NS, NT, NU, NV, NW, NX, NY, NZ, OA, OB, OC, OD, OE, OF, OG, OH, OI, OJ, OK, OL, OM, ON, OO, OP, OQ, OR, OS, OT, OU, OV, OW, OX, OY, OZ, PA, PB, PC, PD, PE, PF, PG, PH, PI, PJ, PK, PL, PM, PN, PO, PP, PQ, PR, PS, PT, PU, PV, PW, PX, PY, PZ, QA, QB, QC, QD, QE, QF, QG, QH, QI, QJ, QK, QL, QM, QN, QO, QP, QQ, QR, QS, QT, QU, QV, QW, QX, QY, QZ, RA, RB, RC, RD, RE, RF, RG, RH, RI, RJ, RK, RL, RM, RN, RO, RP, RQ, RR, RS, RT, RU, RV, RW, RX, RY, RZ, SA, SB, SC, SD, SE, SF, SG, SH, SI, SJ, SK, SL, SM, SN, SO, SP, SQ, SR, SS, ST, SU, SV, SW, SX, SY, SZ, TA, TB, TC, TD, TE, TF, TG, TH, TI, TJ, TK, TL, TM, TN, TO, TP, TQ, TR, TS, TT, TU, TV, TW, TX, TY, TZ, UA, UB, UC, UD, UE, UF, UG, UH, UI, UJ, UK, UL, UM, UN, UO, UP, UQ, UR, US, UT, UV, UW, UX, UY, UZ, VA, VB, VC, VD, VE, VF, VG, VH, VI, VJ, VK, VL, VM, VN, VO, VP, VQ, VR, VS, VT, VU, VV, VW, VX, VY, VZ, WA, WB, WC, WD, WE, WF, WG, WH, WI, WJ, WK, WL, WM, WN, WO, WP, WQ, WR, WS, WT, WU, WV, WW, WX, WY, WZ, XA, XB, XC, XD, XE, XF, XG, XH, XI, XJ, XK, XL, XM, XN, XO, XP, XQ, XR, XS, XT, XU, XV, XW, XX, XY, XZ, YA, YB, YC, YD, YE, YF, YG, YH, YI, YJ, YK, YL, YM, YN, YO, YP, YQ, YR, YS, YT, YU, YV, YW, YX, YY, YZ, ZA, ZB, ZC, ZD, ZE, ZF, ZG, ZH, ZI, ZJ, ZK, ZL, ZM, ZN, ZO, ZP, ZQ, ZR, ZS, ZT, ZU, ZV, ZW, ZX, ZY, ZZ.</p> | <p>2 seconds to compute C, D, E, G, and H on IBM 709C, 6.8 seconds to compute G, H, I, J, K, L, M, N, O, P, Q, R, S, T, U, V, W, X, Y, Z, AA, AB, AC, AD, AE, AF, AG, AH, AI, AJ, AK, AL, AM, AN, AO, AP, AQ, AR, AS, AT, AU, AV, AW, AX, AY, AZ, BA, BB, BC, BD, BE, BF, BG, BH, BI, BJ, BK, BL, BM, BN, BO, BP, BQ, BR, BS, BT, BU, BV, BW, BX, BY, BZ, CA, CB, CC, CD, CE, CF, CG, CH, CI, CJ, CK, CL, CM, CN, CO, CP, CQ, CR, CS, CT, CU, CV, CW, CX, CY, CZ, DA, DB, DC, DD, DE, DF, DG, DH, DI, DJ, DK, DL, DM, DN, DO, DP, DQ, DR, DS, DT, DU, DV, DW, DX, DY, DZ, EA, EB, EC, ED, EE, EF, EG, EH, EI, EJ, EK, EL, EM, EN, EO, EP, EQ, ER, ES, ET, EU, EV, EW, EX, EY, EZ, FA, FB, FC, FD, FE, FF, FG, FH, FI, FJ, FK, FL, FM, FN, FO, FP, FQ, FR, FS, FT, FU, FV, FW, FX, FY, FZ, GA, GB, GC, GD, GE, GF, GG, GH, GI, GJ, GK, GL, GM, GN, GO, GP, GQ, GR, GS, GT, GU, GV, GW, GX, GY, GZ, HA, HB, HC, HD, HE, HF, HG, HH, HI, HJ, HK, HL, HM, HN, HO, HP, HQ, HR, HS, HT, HU, HV, HW, HX, HY, HZ, IA, IB, IC, ID, IE, IF, IG, IH, II, IJ, IK, IL, IM, IN, IO, IP, IQ, IR, IS, IT, IU, IV, IW, IX, IY, IZ, JA, JB, JC, JD, JE, JF, JG, JH, JI, JJ, JK, JL, JM, JN, JO, JP, JQ, JR, JS, JT, JU, JV, JW, JX, JY, JZ, KA, KB, KC, KD, KE, KF, KG, KH, KI, KJ, KK, KL, KM, KN, KO, KP, KQ, KR, KS, KT, KU, KV, KW, KX, KY, KZ, LA, LB, LC, LD, LE, LF, LG, LH, LI, LJ, LK, LL, LM, LN, LO, LP, LQ, LR, LS, LT, LU, LV, LW, LX, LY, LZ, MA, MB, MC, MD, ME, MF, MG, MH, MI, MJ, MK, ML, MM, MN, MO, MP, MQ, MR, MS, MT, MU, MV, MW, MX, MY, MZ, NA, NB, NC, ND, NE, NF, NG, NH, NI, NJ, NK, NL, NM, NN, NO, NP, NQ, NR, NS, NT, NU, NV, NW, NX, NY, NZ, OA, OB, OC, OD, OE, OF, OG, OH, OI, OJ, OK, OL, OM, ON, OO, OP, OQ, OR, OS, OT, OU, OV, OW, OX, OY, OZ, PA, PB, PC, PD, PE, PF, PG, PH, PI, PJ, PK, PL, PM, PN, PO, PP, PQ, PR, PS, PT, PU, PV, PW, PX, PY, PZ, QA, QB, QC, QD, QE, QF, QG, QH, QI, QJ, QK, QL, QM, QN, QO, QP, QQ, QR, QS, QT, QU, QV, QW, QX, QY, QZ, RA, RB, RC, RD, RE, RF, RG, RH, RI, RJ, RK, RL, RM, RN, RO, RP, RQ, RR, RS, RT, RU, RV, RW, RX, RY, RZ, SA, SB, SC, SD, SE, SF, SG, SH, SI, SJ, SK, SL, SM, SN, SO, SP, SQ, SR, SS, ST, SU, SV, SW, SX, SY, SZ, TA, TB, TC, TD, TE, TF, TG, TH, TI, TJ, TK, TL, TM, TN, TO, TP, TQ, TR, TS, TT, TU, TV, TW, TX, TY, TZ, UA, UB, UC, UD, UE, UF, UG, UH, UI, UJ, UK, UL, UM, UN, UO, UP, UQ, UR, US, UT, UV, UW, UX, UY, UZ, VA, VB, VC, VD, VE, VF, VG, VH, VI, VJ, VK, VL, VM, VN, VO, VP, VQ, VR, VS, VT, VU, VV, VW, VX, VY, VZ, WA, WB, WC, WD, WE, WF, WG, WH, WI, WJ, WK, WL, WM, WN, WO, WP, WQ, WR, WS, WT, WU, WV, WW, WX, WY, WZ, XA, XB, XC, XD, XE, XF, XG, XH, XI, XJ, XK, XL, XM, XN, XO, XP, XQ, XR, XS, XT, XU, XV, XW, XX, XY, XZ, YA, YB, YC, YD, YE, YF, YG, YH, YI, YJ, YK, YL, YM, YN, YO, YP, YQ, YR, YS, YT, YU, YV, YW, YX, YY, YZ, ZA, ZB, ZC, ZD, ZE, ZF, ZG, ZH, ZI, ZJ, ZK, ZL, ZM, ZN, ZO, ZP, ZQ, ZR, ZS, ZT, ZU, ZV, ZW, ZX, ZY, ZZ.</p> | <p>Combinations of <math>0F - 1, 2, 3, 4 - 1, 2, 3</math></p>   | <p>Closed form solutions based on tables given by Gressman.</p>   | <ol style="list-style-type: none"> <li>1. The solutions are obtained by solving a system of equations. For four or less equations the system may be solved not only by expanding the determinant and solving by the rule of the submatrix. For more than four equations an iterative procedure can be used for manual computation. For large numbers of equations a computer method of solution is desirable.</li> </ol> |
| <p>edges.</p>   | <p>20 seconds for 25 modes on IBM 709C.</p>   | <p>25 modes. Combinations of <math>0F - 1, 2, 3, 4 - 1, 2, 3, 4</math></p>  | <p>Large matrix transformations and eigenvalue solutions are needed to obtain final results.</p>  | <ol style="list-style-type: none"> <li>1. A simplified eigenvalue problem (3 - 3 matrix) occurs when the mode shapes are taken to be orthogonal to the natural vibration and <math>(\omega^2 - \omega_n^2) = 0</math>. For this case the modes become uncoupled. Cases and eigenvalues determine the digital computer results for the case, for a range of variables of <math>\delta, \nu, \rho, \sigma</math>.</li> <li>2. If <math>\delta = 0</math> (free plate, <math>\delta = 0</math>) then the 3 - 3 matrix reduces to a 2 - 2 matrix and one equation in terms of <math>\omega^2</math> in the 2, 3 position. The 2 - 2 matrix gives the <math>\omega_n^2</math> for longitudinal vibration modes, whereas the equation resulting from <math>\omega^2 = 0</math> of interest for the free plate free end modes.</li> <li>3. For a clamped panel and for <math>\delta = 0.2</math> reduces a single algebraic equation is obtained for determining the approximate frequency of forced vibration.</li> </ol> |  |
| <p>edges.</p> <p>corners of the edges.</p>  | <p>25 seconds for 25 modes on IBM 709C.</p>   | <p>25 lower modes.</p>  | <p>Closed form solutions based on tables given by Gressman.</p>   | <ol style="list-style-type: none"> <li>1. Closed form frequency expression is obtained by this method. For the rectangular plate computation in a table. For the orthotropic for cross stiffened plate including fixed loading and natural constraints computations are more difficult.</li> <li>2. Exact solutions, for the frequencies, of a set of simultaneous algebraic equations can be obtained by solution of the 3rd type using standard digital computer techniques.</li> <li>3. Reasonably accurate estimates of the plate resonance frequencies can be obtained by using a single term from the approximate equation in the set. The resulting approximate frequency equation is given as well as an example for each computation of these frequencies for one mode.</li> </ol>   |  |
| <p>free all elastic and inertial end fixtures. These fixtures are a uniform distribution of independent springs and rotational springs along each edge of the plate can have equal or different and inertial loadings. In particular, each edge vibrates between a pinned and clamped support. Between the individual masses along an edge is fixed by the deflection of the plate.</p> <p>In general the four edge stiffeners may have different inertial stiffness and different masses so that symmetrically or unsymmetrically constrained, C or clamped plate are translationally fixed.</p> | <p>Manual computation for frequency parameters, 20 seconds on IBM 709C for combinations of 10 modes.</p>  | <p>9 lower modes.</p>   | <p>Manual computations from computer, derived by White, corrections in parts by computer.</p>   | <ol style="list-style-type: none"> <li>1. A method of analysis is developed, using the Rayleigh-Ritz method for computing the resonance frequencies and deflections of a rectangular plate with stiffeners. The loading and torsional deformations of the four edge stiffeners are accounted except through the coupling action of the plate.</li> <li>2. Approximate mode shapes, locations of peak deflections, locations of fixed lines, rotational mass, mass acceptance, and stress for the stiffeners of the plate are obtained. Data presented as curves.</li> <li>3. Beams with various conditions (including edge stiffeners) are also analyzed and results graphically presented.</li> </ol>  |  |
| <p>edges.</p> <p>edges.</p>   | <p>15 seconds for 25 modes on IBM 709C.</p>   | <p>Combinations of <math>0F - 1, 2, 3, 4 - 1, 2, 3, 4</math></p>  | <p>Differential equations approximated, but same type solution as Roberts.</p>  | <ol style="list-style-type: none"> <li>1. The frequency equations for a fully clamped plate are solved directly using various approximations to yield a closed form solution for the frequency.</li> <li>2. The modes for a fully clamped plate are then solved either manually or by use of a digital computer program.</li> <li>3. For the fully clamped plate approximate closed form and digital computer solutions yield the value and position of the maximum displacement of each mode.</li> <li>4. The generalized mass for the <math>n</math>-th clamped plate mode is evaluated.</li> <li>5. Frequency parameters, modal constants and generalized mass factors for a fully clamped plate are tabulated for the first ten modes. Mode shapes are also presented for the first ten modes.</li> <li>6. The free vibrations of a simply supported beam, fully fixed beam and tunnel wall as well as the response of a simply supported or clamped-clamped panel are also treated.</li> </ol>                 |  |
| <p>edges.</p>   | <p>25 seconds for 8 modes on IBM 709C, 91 or 20 min. on IBM 7090 for 33-order Gaussian quadrature, 45 sec. on the 300 for 64-order quadrature.</p>  | <p>Combinations of <math>0F - 1, 2, 3, 4 - 1, 2, 3, 4</math></p>  | <p>Energy equation expressed in 71-term polynomial with integrals solved by Gaussian quadrature, eigenvalues found by method of reduction.</p>  | <ol style="list-style-type: none"> <li>1. Inversion is used to find eigenvalues and eigenvectors. Computational methods include both a Beta function evaluation and a Gaussian quadrature numerical integration technique.</li> </ol>   |  |
| <p>edges, free on two edges.</p>  |   |   |   | <ol style="list-style-type: none"> <li>1. For a clamped-clamped plate curves and tables are given for the determination of the first ten frequencies and modes as a function of the ratio of the sides (aspect ratio).</li> </ol>   |  |

\* IBM 7090, depending on the input/output and types of equations.

B

all modes. Thus it is acceptably accurate for many (probably most) applications. In addition, the Warburton program is relatively easy to run on a computer and requires little running time per mode (1.1 minutes for 50 modal frequencies on the IBM 7090); this makes for a relatively inexpensive computation for each frequency.

The error of 3 percent may be exceeded for *square* plates (see Appendix A), and hence an alternative method of computation may be desirable for this case.

If a computer is not available, calculation of the natural frequencies for a finite rectangular clamped-clamped plate can be performed manually by any of several methods presented, using closed form analytical or nomographic or graphical computations (see Appendixes A-F, Appendix H, and Table 2).

The frequencies of clamped-clamped thin plates with cylindrical curvature can be obtained by use of the Ballentine-Plumlee method.

The frequencies of thin plates with clamped and rotational supports can be obtained by use of the White method (Appendix E) or by an extension of the Greenspon method (Appendix D) given in Reference 12.

Figure 3 shows that at the convection velocities considered, the value of the modal mean square displacement for any mode of clamped plates subject to turbulence excitation is less than the corresponding value for simply supported plates. The difference in the plate response corresponding to the two boundary conditions increases with convection velocity for any mode, but the difference is relatively constant at higher convection velocities in the region of maximum response.

The nature of the curves in Figure 3 suggests that at low convection velocities ( $U_c \leq 300$  ft/sec), the difference between the response of a clamped-clamped and a simply supported plate is significantly greater for the lower mode ( $m, n = 5, 1$ ) than for the higher mode ( $m, n = 7, 1$ ). It appears from this result that the statement previously made, namely, that the effect of the boundary conditions on the *natural frequencies* of a plate diminishes with increasing frequency (or mode number), can be extended to include a diminishing influence of boundaries on the *higher mode response* to turbulence at low convection velocities. For very low convection velocities, the trend of the curves suggests that the concept is also applicable to the lowest modes.

The magnitude of the curves indicates that the contribution of the higher mode to the total response is not negligible for either boundary condition, i.e., the contribution of the (7, 1) mode to the total response is of the same order of magnitude as that of the (5, 1) mode for a given boundary condition. Thus, determination of the total response requires that the computations include the contribution of the several modes of vibration deemed to be significant.

## CONCLUSIONS AND RECOMMENDATIONS

The following conclusions and recommendations are based on the results of the present investigation.

1. For computing the vibroacoustic response<sup>1</sup> of thin clamped-clamped rectangular plates, the modes and natural frequencies are adequately represented when the modal frequencies are calculated by considering the true (clamped-clamped) end conditions but using the mode shapes considering the end conditions to be simple supports.
2. For a thin, finite, rectangular clamped-clamped plate, the Warburton method of computation (including computer program) of the natural frequencies is acceptably accurate. For this reason as well as for its relative simplicity, short running time, and inexpensiveness in computer application, it is preferred to the other computer methods.
3. If a computer is unavailable, any of the manual methods of computation presented in Appendixes A-F and H can be used. The results shown in Table 1a indicate the degree of accuracy to be expected from a particular method. Moreover, as shown in the tables and discussed in the Appendixes, because of the limited data available, certain methods are applicable for only a limited range of mode numbers.
4. For clamped thin plates with cylindrical curvature, the Ballentine-Plumlee method (Appendix C) should be used to obtain the natural frequencies.
5. For thin rectangular plates with clamped and rotational supports, the White method (Appendix E) or the extension of the Greenspon method (Appendix D) given in Reference 12 should be used to obtain the natural frequencies.
6. The effect of the boundary conditions on the natural frequencies of a plate and on the response of a plate subject to turbulence excitation at low convection velocities diminishes with increasing frequency (or mode number).

## ACKNOWLEDGMENTS

The authors acknowledge the assistance of various individuals who contributed to the successful completion of this project: Mr. G. J. Franz, Mr. G. Gleissner, and Dr. E. Cuthill for supervisory aid and encouragement; Mr. D. Gignac for mathematical assistance on the Young program; Dr. H. E. Plumlee, Jr. of Lockheed-Georgia Company, Dr. R. W. White of Wyle Labs, and Dr. B. C. S. Sun of the University of Illinois and Mr. N. DeCapua of the Newark College of Engineering, for assistance with their respective programs. Dr. Sun and Mr. DeCapua also performed some computations for the authors on their computer using the Sun program.

## APPENDIX A

### THE WARBURTON METHOD

#### NOTATION

|                    |   |
|--------------------|---|
| $A$                | Amplitude   |
| $a, b$             | Length and width of sides of rectangular plate along $x$ - and $y$ -directions respectively |
| $c, k$             | Ratios in expression for displacement   |
| $E$                | Young's modulus   |
| $f, f_{mn}$        | Frequency, modal frequency  |
| $G_x, H_x, J_x$    | Functions of $m$ in frequency expression  |
| $G_y, H_y, J_y$    | Functions of $n$ in frequency expression  |
| $g$                | Acceleration due to gravity   |
| $h$                | Thickness of plate  |
| $m, n$             | Mode numbers in $x$ - and $y$ -directions, respectively                                     |
| $T$                | Kinetic energy  |
| $t$                | Time  |
| $U$                | Potential or strain energy  |
| $W$                | Waveform defined by Equation (A2) or amplitude of displacement $w$ , i.e., $w = W \sin wt$  |
| $w$                | Transverse displacement of a point on the plate   |
| $x, y$             | Coordinate distances in plane of plate  |
| $\gamma, \epsilon$ | Factors in amplitude expression defining modal pattern                                      |
| $\theta, \phi$     | Functions of $x$ and $y$ , respectively, defining waveform                                  |
| $\lambda$          | Nondimensional frequency factor defined by Equation (A8)                                    |
| $\rho$             | Weight per unit volume of plate   |
| $\sigma$           | Poisson's ratio   |
| $\omega$           | Circular frequency, equal to $2\pi f$   |

## DESCRIPTION

Using thin plate theory, Warburton<sup>13</sup> derived an approximate frequency formulation for all modes of vibration by applying the Rayleigh method and by assuming that the waveforms of transversely vibrating rectangular plates and beams are similar. For a fully clamped plate, the waveform is assumed to be the product of the characteristic functions (discussed below) for two beams with fixed ends. The plates are assumed to be isotropic, elastic, free from applied loads, and with a thickness that is both uniform and small compared to the wavelength. The frequency is expressed in terms of boundary conditions, the modal pattern, the dimensions of the plate, and the constants of the material. Because of the imposition of additional constraints on the system required by the Rayleigh method, the resulting frequencies are higher than those given by an exact analysis. To use this method, the modal patterns must consist of lines approximately parallel to the sides of the plate. This requirement is satisfied for clamped rectangular plates, and the errors are small. The exceptions and their effect on frequency associated with some modes of square plates are discussed in Reference 13.

## DERIVATION

The homogeneous equation for a freely vibrating thin plate is<sup>14</sup>

$$\frac{\partial^4 w}{\partial x^4} + 2 \frac{\partial^4 w}{\partial x^2 \partial y^2} + \frac{\partial^4 w}{\partial y^4} + \frac{i2\rho(1-\sigma^2)}{Egh^2} \frac{\partial^2 w}{\partial t^2} = 0 \quad (A1)$$

The solution of Equation (A1) is assumed to have the form of a product of separable solutions.

$$w(x, y, t) = W \sin \omega t = A \theta(x) \phi(y) \sin \omega t \quad (A2)$$

(The motion in each mode is  $w_{mn}(x, y, t) = W_{mn} \sin \omega_{mn} t = A_{mn} \theta_m(x) \phi_n(y) \sin \omega_{mn} t$  where the actual  $A_{mn}$  may be obtained from measurements.) Here  $\theta(x)$ ,  $\phi(y)$ , the characteristic beam functions or mode shapes which satisfy the boundary conditions for plates with fixed edges ( $w = \frac{\partial w}{\partial x} = 0$  at  $x = 0, a$  and  $w = \frac{\partial w}{\partial y} = 0$  at  $y = 0, b$ ) are assumed as follows ( $m$  and  $n$  are mode numbers and correspond to  $m-1$  and  $n-1$  modes respectively; see footnote at end of this Appendix).

$$\theta(x) = \cos \gamma \left( \frac{x}{a} - \frac{1}{2} \right) + k \cosh \gamma \left( \frac{x}{a} - \frac{1}{2} \right); m = 2, 4, 6 \quad (A3a)$$

$$\theta(x) = \sin \gamma' \left( \frac{x}{a} - \frac{1}{2} \right) + k' \sinh \gamma' \left( \frac{x}{a} - \frac{1}{2} \right); m = 3, 5, 7 \quad (A3b)$$

where\*  $k = \frac{\sin \frac{\gamma}{2}}{\sinh \frac{\gamma}{2}}$  and  $\tan \frac{\gamma}{2} + \tanh \frac{\gamma}{2} = 0$  in Equation (A3a)

and  $k' = -\frac{\sin \frac{\gamma'}{2}}{\sinh \frac{\gamma'}{2}}$  and  $\tan \frac{\gamma'}{2} - \tanh \frac{\gamma'}{2} = 0$  in Equation (A3b).

The corresponding expressions for  $\phi(y)$  are obtained by substituting  $y$ ,  $b$ ,  $\epsilon$ , and  $c$  for  $x$ ,  $a$ ,  $\gamma$ , and  $k$ , respectively.

For a rectangular plate, the potential and kinetic energies are respectively given by<sup>15</sup>

$$U = \int_0^a \int_0^b \frac{Eh^3}{12(1-\sigma^2)} \left[ \left( \frac{\partial^2 w}{\partial x^2} \right)^2 + \left( \frac{\partial^2 w}{\partial y^2} \right)^2 + 2\sigma \frac{\partial^2 w}{\partial x^2} \frac{\partial^2 w}{\partial y^2} + 2(1-\sigma) \left( \frac{\partial^2 w}{\partial x \partial y} \right)^2 \right] dx dy \quad (A3c)$$

$$T = \int_0^a \int_0^b \frac{1}{2} \frac{\rho h}{g} \left( \frac{\partial w}{\partial t} \right)^2 dx dy \quad (A4)$$

and the maximum values of these quantities are

$$U_{\max} = \frac{1}{2} \cdot \frac{Eh^3}{12(1-\sigma^2)} \int_0^a \int_0^b \left[ \left( \frac{\partial^2 W}{\partial x^2} \right)^2 + \left( \frac{\partial^2 W}{\partial y^2} \right)^2 + 2\sigma \frac{\partial^2 W}{\partial x^2} \frac{\partial^2 W}{\partial y^2} + 2(1-\sigma) \left( \frac{\partial^2 W}{\partial x \partial y} \right)^2 \right] dx dy \quad (A5)$$

$$T_{\max} = \frac{1}{2} \frac{\rho h \omega^2}{g} \int_0^a \int_0^b W^2 dx dy \quad (A6)$$

\*The equation  $\tan \frac{\gamma}{2} + \tanh \frac{\gamma}{2} = 0$  is transcendental and may be solved by plotting  $-\tanh \frac{\gamma}{2}$  and  $\tan \frac{\gamma}{2}$  and looking for the series of intersections. Then  $m = 1$  corresponds to the value of  $\gamma$  for the first intersection,  $m = 3$  for the second, etc.



Equating  $T_{\max}$  and  $U_{\max}$  as required by the Rayleigh method, we have

$$\omega^2 = \frac{U_{\max}}{\frac{\rho h}{2g} \int_0^a \int_0^b W^2 dx dy} \quad (A7)$$

By the Rayleigh principle, if a suitable waveform  $W = A \theta(x) \phi(y)$  is assumed and approximately satisfies the boundary conditions, the resulting frequency value is slightly higher than the true value because the assumption of an incorrect waveform is equivalent to the introduction of constraints in the system.

Substituting the expressions for the characteristic beam functions  $\theta_x$  and  $\phi_y$  given by Equations (A3a) and (A3b) which satisfy the boundary conditions for the clamped plate, into Equations (A2) and (A7), the following expression for the approximate frequency is obtained

$$f = \sqrt{\frac{\pi^4 E h^2 g}{4 \pi^2 \rho a^4 12 (1 - \sigma^2)}} \quad (A8)$$

where

$$\lambda^2 = G_x^4 + G_y^4 \frac{a^4}{b^4} + \frac{2a^2}{b^2} [\sigma H_x H_y + (1 - \sigma) J_x J_y] \quad (A9)$$

Here coefficients  $G_x$ ,  $G_y$ ,  $H_x$ ,  $H_y$ , and  $J_x$  depend on the modal pattern and boundary conditions.\* Values of these coefficients are

$$G_x = \begin{cases} 1.056 & \text{for } m = 1 \\ m - 1/2 & \text{for } m = 2, 3, 4 \dots \end{cases}$$

$$G_y = \begin{cases} 1.056 & \text{for } n = 1 \\ n - 1/2 & \text{for } n = 2, 3, 4 \dots \end{cases}$$

$$H_x = J_x = \begin{cases} 1.248 & \text{for } m = 1 \\ (m - 1/2)^2 \left[ 1 - \frac{2}{(m - 1/2)\pi} \right] & \text{for } m = 2, 3, 4, \dots \end{cases}$$

$$H_y = J_y = \begin{cases} 1.248 & \text{for } n = 1 \\ (n - 1/2)^2 \left[ 1 - \frac{2}{(n - 1/2)\pi} \right] & \text{for } n = 2, 3, 4, \dots \end{cases}$$

\*In Reference 13,  $m$  refers to the number of nodes along the plate length and hence to  $m - 1$  modes. In the present paper, however,  $m$  refers to the mode number. The latter notation is more common and is consistent with the notation used by Maestrello and other investigators. This definition for  $m$  is now reflected in the numerical values of  $m$  used in computing the coefficients  $G_x$ ,  $H_x$ ,  $J_x$  whereas the values for  $m$  used previously (Equations (A3a) and (A3b)) correspond to the Warburton definition in Reference 13. A similar situation holds for  $n$ .

Hence for a given  $m, n$  mode and  $\frac{a}{b}$  ratio, we obtain the appropriate value of the coefficients for use in determining  $\lambda^2$  from Equation (A9). For a given ratio  $a/b$ , the corresponding approximate frequency is found from Equation (A8) to be

$$f = \frac{\lambda h \pi}{a^2} \left[ \frac{Eg}{48\rho(1-\sigma^2)} \right]^{1/2} \quad (\text{A10})$$

For mode numbers  $mn$ ,  $\lambda \equiv \lambda_{mn}$  and  $f \equiv f_{mn}$  and  $\omega \equiv \omega_{mn} \equiv 2\pi f_{mn}$ . The corresponding mode shape is then  $W_{mn} = A_{mn} \theta_m(x) \phi_n(y)$ .

## APPENDIX B

### THE YOUNG METHOD

#### NOTATION

|  |   |
|--|---|
| $A_{mn}$   | Coefficient used in series representation of deflection                 |
| $a, b$   | Length and width of plate along $x$ - and $y$ -directions, respectively |
| $c_{mn}^{(ik)}$  | Coefficients  |
| $D$  | Bending stiffness of a plate equal to $Eh^3/12(1 - \mu^2)$              |
| $E$  | Modulus of elasticity   |
| $\left. \begin{matrix} E_{mi}, F_{kn} \\ H_{im}, K_{kn} \end{matrix} \right\}$ | Definite integrals  |
| $f$  | Frequency   |
| $H$  | Poisson's ratio   |
| $h$  | Thickness of plate  |
| $i, k$<br>$m, n$<br>$p, q$<br>$r, s$   | Positive integers   |
| $l$  | Length of beam  |
| $V$  | Elastic strain energy of bending of a plate                             |
| $w$  | Lateral deflection of plate   |
| $X_m$  | Function of $x$ alone   |
| $x, y$   | Rectangular coordinates   |
| $Y_n$  | Function of $y$ alone   |
| $\alpha_r$   | Parameter in expressions for $\phi_r$                                   |
| $\delta_{mn}$  | Kronecker delta   |
| $\epsilon_r$   | Parameter in expressions for $\phi_r$                                   |

|           |   |
|-----------|---|
| $\lambda$ | Characteristic value equal to $\frac{\omega^2 \rho h a^3 b}{D}$ |
| $\mu$     | Poisson's ratio   |
| $\rho$    | Mass density of plate material                                  |
| $\phi_r$  | Characteristic function of a vibrating beam                     |
| $\omega$  | Angular frequency equal to $2\pi f$                             |

## DESCRIPTION

Young<sup>16</sup> uses the Ritz method to obtain approximate solutions for the frequencies and modes of vibration of thin, homogeneous plates of uniform thickness; the frequencies calculated by the Ritz procedure are always higher than the exact values. To represent the plate deflection, Young treats combinations of the characteristic functions which define the normal modes of vibration for a uniform beam. He computes and tabulates values of these functions as well as associated integrals and derivatives of the functions. With the aid of these tables, the user can set up and solve the necessary equations with reasonable effort. A simple iteration procedure is used to solve the equations.

## DERIVATION

The maximum potential and kinetic energies for a harmonically vibrating uniform plate are, respectively (see Appendix A),

$$V = \frac{D}{2} \iint \left[ \left( \frac{\partial^2 w}{\partial x^2} \right)^2 + \left( \frac{\partial^2 w}{\partial y^2} \right)^2 + 2\mu \frac{\partial^2 w}{\partial x^2} \frac{\partial^2 w}{\partial y^2} + 2(1 - \mu) \left( \frac{\partial^2 w}{\partial x \partial y} \right)^2 \right] dx dy \quad (\text{B1a})$$

$$T = \frac{\rho h \omega^2}{2} \iint w^2 dx dy \quad (\text{B1b})$$

Equating these expressions, we obtain

$$\omega^2 = \frac{2}{\rho h} \frac{V}{\iint w^2 dx dy} \quad (\text{B2})$$

The Ritz method consists of assuming the deflection  $w(x, y)$  as a linear series of "admissible" functions and adjusting the coefficients in the series so as to minimize Equation (B2). For rectangular plates with edges parallel to the  $x$ - and  $y$ -axes, Young represents  $w$  by the following approximate series:

$$w(x, y) = \sum_{m=1}^p \sum_{n=1}^q A_{mn} X_m^{(x)} Y_n^{(y)} \quad (\text{B3})$$

Each function  $X_m Y_n$  must be admissible, i.e., it must satisfy the so-called *artificial* boundary conditions which are the prescribed values for the deflection and for the slope. It need

not satisfy any *natural* boundary conditions which require that second or third derivatives or combinations thereof vanish at the boundary. Satisfaction of these latter conditions, if possible, is desirable however in accordance with practical consideration of the rate of convergence.

Substituting for  $w(x, y)$  in Equation (B2) using Equation (B3) and minimizing the right-hand side by taking the partial derivative with respect to each coefficient  $A_{mn}$  and equating to zero, we obtain a set of linear homogeneous equations in the unknown  $A_{mn}$  each of which has the form

$$\frac{\partial V}{\partial A_{ik}} - \frac{\omega^2 \rho h}{2} \frac{\partial}{\partial A_{ik}} \iint w^2 dx dy = 0 \quad (B4)$$

where  $A_{ik}$  is any one of the coefficients  $A_{mn}$ . The natural frequencies  $\omega_1, \omega_2$  are determined from the condition that the determinant of the system must vanish.

For a *clamped-clamped beam*, the infinite set of characteristic functions is given by

$$\phi_r = \cosh \frac{\epsilon_r x}{\ell} - \cos \frac{\alpha_r x}{\ell} - \alpha_r \left( \sinh \frac{\epsilon_r x}{\ell} - \sin \frac{\alpha_r x}{\ell} \right) \dots r = 1, 2, 3 \dots \quad (B5)$$

$0 \leq x \leq \ell$

(The method for determining the set of characteristic functions which define the normal modes is given in References 15 and 17.)

The numerical values of  $\alpha_r$  and  $\epsilon_r$  for each set of functions is given in Table 3. Reference 8 tabulates values of these functions to five decimal places at intervals of the argument  $\frac{x}{\ell} = 0.02$ .

The function  $\phi_r$  given by Equation (B5) satisfies both the boundary (i.e., end) conditions for the clamped-clamped beam  $\phi_r = \frac{d\phi_r}{dx} = 0$  at  $x = 0, \ell$  and the differential equation for the beam  $\frac{d^4 \phi_r}{dx^4} = \frac{\epsilon_r \phi_r}{\ell^4}$ . Also any set of functions  $\phi_r$  and  $\phi_s$  are orthogonal for  $0 \leq x \leq \ell$ , i.e.,

$$\int_0^\ell \phi_r \phi_s dx = \begin{cases} \ell & (\text{for } r = s) \\ 0 & (\text{for } r \neq s) \end{cases} \quad (B6)$$

The second derivatives of the functions of the set are also orthogonal and satisfy the relations

$$\left. \begin{aligned} \int_0^{\ell} \frac{d^2 \phi_r}{dx^2} \frac{d^2 \phi_s}{dx^2} dx &= \frac{\epsilon_r^4}{\ell^3} & (\text{for } r = s) \\ &= 0 & (\text{for } r \neq s) \end{aligned} \right\} \quad (\text{B7})$$

Numerical values of  $\epsilon_r^4$  are given in Table 3. In addition to the integrals defined by Equations (B6) and (B7), the Ritz method also requires evaluation of the integrals

$$\int_0^{\ell} \phi_r \frac{d^2 \phi_s}{dx^2} dx \quad \text{and} \quad \int_0^{\ell} \frac{d\phi_r}{dx} \frac{d\phi_s}{dx} dx$$

Table 4 gives the values of these integrals computed by Young.

The characteristic functions are those that are used for  $X_m$  and  $Y_n$  in Equation (B3). Consider a rectangular plate bounded by the lines  $x = 0$ ,  $x = a$ ,  $y = 0$ ,  $y = b$ . When the function is used for  $X_m$ , we take  $\ell = a$ ; if used for  $Y_n$ , we take  $\ell = b$  and replace  $x$  by  $y$ . Appropriate changes of the subscripts  $r$  and  $s$  to either  $m$  and  $i$  or to  $n$  and  $k$  are to be made in the set of functions.

It is convenient to introduce the following notation:

$$E_{im} = a \int_0^a X_i \frac{d^2 X_m}{dx^2} dx, \quad E_{mi} = a \int_0^a X_m \frac{d^2 X_i}{dx^2} dx \quad (\text{B8})$$

$$F_{kn} = b \int_0^b Y_k \frac{d^2 Y_n}{dy^2} dy, \quad F_{nk} = b \int_0^b Y_n \frac{d^2 Y_k}{dy^2} dy \quad (\text{B9})$$

$$H_{im} = a \int_0^b \frac{dX_i}{dx} \frac{dX_m}{dx} dx, \quad K_{kn} = b \int_0^b \frac{dY_k}{dy} \frac{dY_n}{dy} dy \quad (\text{B10})$$

Since the appropriate  $\phi$ -functions are to be used for  $X_m$  and  $Y_n$ , the numerical value of these integrals can be obtained directly from the data given in Table 4.

From Equations (B1a) and (B3) and the orthogonality relations (Equations (B6) and (B7)), the set of Equations (B4) can be reduced to the form

$$\sum_{m=1}^p \sum_{n=1}^q [C_{mn}^{(ik)} - \lambda \delta_{mn}] A_{mn} = 0 \quad (\text{B11})$$

TABLE 3

Values of  $\alpha_r$  and  $\epsilon_r$

| Type of Beam    | r     | $\alpha_r$  | $\epsilon_r$ | $\epsilon_r^4$ |
|-----------------|-------|-------------|--------------|----------------|
| Clamped-Clamped | 1     | 0.9825 0222 | 4.7300 408   | 500.564        |
|                 | 2     | 1.0007 7731 | 7.8532 046   | 3 803.537      |
|                 | 3     | 0.9999 6645 | 10.9956 078  | 14 617.630     |
|                 | 4     | 1.0000 0145 | 14.1371 655  | 39 943.799     |
|                 | 5     | 0.9999 9994 | 17.2787 596  | 89 135.407     |
|                 | 6     | 1.0000 0000 | 20.4203 522  | 173 881.316    |
|                 | r > 6 | 1.0         | (2r + 1)π/2  |                |

TABLE 4

Integrals of Characteristic Functions of Clamped-Clamped Beam

Values of  $\int_0^l \frac{d\phi_r}{dx} \frac{d\phi_a}{dx} dx$

| r \ a | 1         | 2         | 3         | 4          | 5          | 6          |
|-------|-----------|-----------|-----------|------------|------------|------------|
| 1     | 12.30262  | 0         | - 9.73079 | 0          | - 7.61544  | 0          |
| 2     | 0         | 46.05012  | 0         | - 17.12892 | 0          | - 15.19457 |
| 3     | - 9.73079 | 0         | 98.90480  | 0          | - 24.34987 | 0          |
| 4     | 0         | -17.12892 | 0         | 171.58566  | 0          | - 31.27645 |
| 5     | - 7.61544 | 0         | -24.34987 | 0          | 263.99798  | 0          |
| 6     | 0         | -15.19457 | 0         | - 31.27645 | 0          | 376.15008  |

NOTE:  $\int_0^l \phi_r \frac{d^2 \phi_a}{dx^2} dx = - \int_0^l \frac{d\phi_r}{dx} \frac{d\phi_a}{dx} dx$



where

$$\lambda = \frac{\omega^2 \rho h a^3 b}{D} \quad (\text{B12})$$

$$\left. \begin{aligned} \delta_{mn} &= 1 \text{ for } mn = ik \\ &= 0 \text{ for } mn \neq ik \end{aligned} \right\}$$

and

$$C_{mn}^{(ik)} = \mu \frac{a}{b} [E_{mi} F_{kn} + E_{im} F_{nk}] + 2(1 - \mu) \frac{a}{b} H_{im} K_{kn} \quad (\text{B13})$$

which is valid for  $mn \neq ik$ . For  $mn = ik$ , the coefficient is

$$C_{ik}^{(ik)} = \frac{b}{a} \epsilon_i^4 + \frac{a^3}{b^3} \epsilon_k^4 + 2\mu \frac{a}{b} E_{ii} F_{kk} + 2(1 - \mu) \frac{a}{b} H_{ii} K_{kk} \quad (\text{B14})$$

In Equation (B14),  $\epsilon_i$  is to be taken from the data in Table 3 corresponding to the  $\phi$ -function that represents  $X_m$ , whereas  $\epsilon_k$  is to be taken from data for the  $\phi$ -function that represents  $Y_n$ .

There will be one equation of the type (B11) for each of the  $p \cdot q$  combinations of  $ik$ . In general,\* an iterative procedure<sup>18</sup> is used to find the characteristic values of  $\lambda$  from the condition that the determinant of this system of equations must vanish. Results for a clamped square plate are given in Reference 16.

---

\*A manual computation can be performed for systems with no more than three or four equations.

## APPENDIX C

### THE BALLENTINE-PLUMBLEE METHOD

#### NOTATION

|            |  |
|------------|--|
| $A$        | Simple panel aspect ratio; ratio of arc length to straight edge length |
| $a$        | Midplane radius of simple panel  |
| $b$        | Panel arc length   |
| $E$        | Young's modulus for isotropic material                                 |
| $h$        | Simple panel thickness   |
| $\ell$     | Panel length (for simple and sandwich panel)                           |
| $q_r$      | Generalized coordinate   |
| $T$        | Kinetic energy   |
| $t$        | Length to thickness ratio for simple panel                             |
| $U$        | Strain energy  |
| $U_{mn}$   | Generalized coordinate   |
| $U_0$      | Strain energy density  |
| $u$        | Midplane displacement in $x$ -direction                                |
| $V_{mn}$   | Generalized coordinate   |
| $v$        | Midplane displacement in $y$ -direction                                |
| $w$        | Midplane displacement in radial, $z$ -direction                        |
| $X_m(x)$   | Mode shape for $x$ -coordinate   |
| $x$        | Shell midplane coordinate  |
| $Y_n(y)$   | Mode shape for $y$ -coordinate   |
| $y$        | Shell midplane coordinate, $y = a\phi$                                 |
| $z$        | Shell midplane coordinate through thickness                            |
| $\alpha_m$ | Constant appearing in clamped mode function                            |

|              |  |
|--------------|--|
| $\beta_m$    | Constant appearing in mode function  |
| $\gamma_m$   | Constant appearing in mode function  |
| $\epsilon_i$ | Strain   |
| $\theta_m$   | Constant appearing in clamped mode function                                |
| $\lambda$    | Nondimensional frequency   |
| $\nu$        | Poisson's ratio for isotropic material                                     |
| $\rho$       | Mass density   |
| $\sigma_i$   | Stress   |
| $\phi$       | Angle which defines cylindrical coordinate $y$<br>(generalized coordinate) |
| $\omega$     | Circular frequency   |
| [ ]          | Row matrix   |
| { }          | Column matrix  |
| [ ]          | Rectangular matrix   |
| { }          | Diagonal matrix  |

## DESCRIPTION

Ballentine<sup>19</sup> uses the Rayleigh-Ritz energy method for finding the frequencies and normal modes of a cylindrically curved panel with clamped edge conditions\*; the results include those for the flat plate. For clamped edges, inexact mode functions which satisfy only the geometric boundary but not the differential equations are used. The analysis assumes that the material is linearly elastic and orthotropic and that the panel thickness is much less than the major panel dimensions, i.e., the elasticity theory of thin shells is applicable. Only the main analytical steps and chief results are discussed here. The reader interested in studying the associated details of matrix manipulation is referred to Reference 19.

## DERIVATION

The total strain energy  $U$  of the curved plate (Figure 4) obtained by integrating the strain energy density  $U_0$  over the volume of the plate is

$$U = \int_0^b \int_0^{\ell} \int_{-\frac{h}{2}}^{+\frac{h}{2}} U_0 dz dx dy \quad (C1)$$

where

$$U_0 = \frac{1}{2} [\sigma_i] \{ \epsilon_i \} \quad (C2)$$

$\sigma_i$  is expressed in terms of strain  $\epsilon_i$  and then the strain in terms of displacements which are represented by

$$\left. \begin{aligned} u &= \sum \sum \frac{1}{\beta_m} U_{mn} X'_m(x) Y_n(y) \\ v &= \sum \sum \frac{1}{\gamma_n} V_{mn} X_m(x) Y'_n(y) \\ w &= \sum \sum W_{mn} X_m(x) Y_n(y) \end{aligned} \right\} \quad (C3)$$

\*Results for simply supported conditions are also presented in this reference.

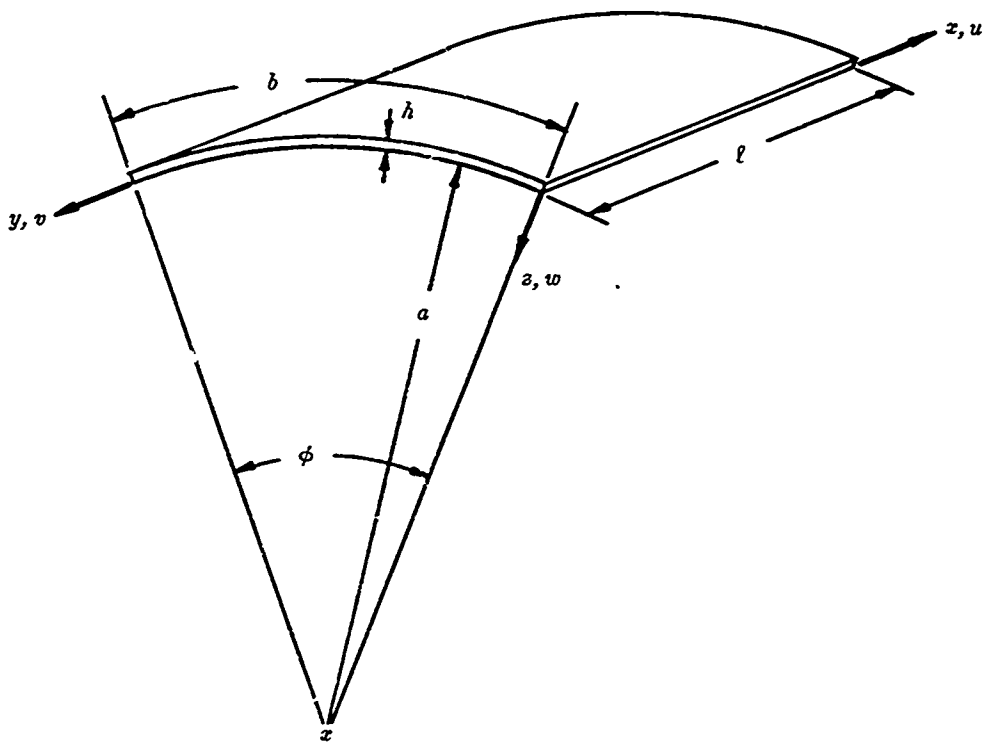

Figure 4 - Curved Panel Coordinate System

which can be expressed in matrix form. The boundary conditions for a curved plate with clamped edges are

$$\left. \begin{aligned} w(0, y) = w(l, y) = w(x, 0) = w(x, b) = 0 \\ w_x(0, y) = w_x(l, y) = w_y(x, 0) = w_y(x, b) = 0 \\ v(0, y) = v(l, y) = v(x, 0) = v(x, b) = 0 \\ u(0, y) = u(l, y) = u(x, 0) = u(x, b) = 0 \end{aligned} \right\} \quad (C4)$$

The assumed mode shapes for a plate with clamped edges are

$$\left. \begin{aligned} X_m(x) &= \text{Cosh } \beta_m x - \text{Cos } \beta_m x - \alpha_m (\text{Sinh } \beta_m x - \sin \beta_m x) \\ Y_n(y) &= \text{Cosh } \gamma_n y - \text{Cos } \gamma_n y - \theta_n (\text{Sinh } \gamma_n y - \sin \gamma_n y) \end{aligned} \right\} \quad (C5)$$

where

$$\alpha_m = \frac{\text{Cosh } \beta_m l - \cos \beta_m l}{\text{Sinh } \beta_m l - \sin \beta_m l}$$

$$\theta_n = \frac{\text{Cosh } \gamma_n b - \cos \gamma_n b}{\text{Sinh } \gamma_n b - \sin \gamma_n b}$$

and  $\beta_m$  and  $\gamma_n$  are determined from

$$\left. \begin{aligned} \text{Cosh } \beta_m l \cos \beta_m l = 1 \\ \text{Cosh } \gamma_n b \cos \gamma_n b = 1 \end{aligned} \right\} \quad (C6)$$

The kinetic energy of the vibrating plate obtained by integrating the product of mass and one-half velocity squared over the volume of the plate is

$$T = \frac{\rho}{2} \int_0^b \int_0^l \int_{-\frac{h}{2}}^{\frac{h}{2}} (\dot{u}^2 + \dot{v}^2 + \dot{w}^2) dz dy dx \quad (C7)$$

where  $\dot{u}$ ,  $\dot{v}$ ,  $\dot{w}$  can be expressed in matrix form using Equation (C3).

$U$  and  $T$  are now substituted in the Lagrange equation of motion to obtain an equation for the natural modes of vibration which can be written in the form

$$[K] - \omega^2 \rho h [J] \{q_r\} = 0 \quad (C8)$$

where the terms in the  $[K]$  and  $[J]$  matrices are given in Reference 19. This equation can be solved for the modal frequencies.

Reference 19 indicates that inasmuch as the integrals of  $X_p' X_m'$ ,  $X_p'' X_m''$  and  $X_p X_m''$  (which were used in deriving the terms in  $[K]$   $[J]$ ) for clamped edge conditions are nonzero when  $p \neq m$  then the analysis does not display the desired orthogonality between the modes. However, a numerical analysis for one of the test panels used in the reference program showed insignificant differences when compared to a numerical analysis which assumed orthogonality. A complete investigation of the effects of including this nonorthogonality relationship has not been evaluated because of computer time requirements. Finally a simplification of considerable interest to the orthotropic curved panel frequency analysis occurs, provided the modal integrations are taken to be *orthogonal* and the material is *isotropic*. In this case the modes are uncoupled, and assuming that

$$\frac{h^2}{a^2} \ll 1 \quad (C9)$$

we find that the determinant of the coefficients is

$$\left. \begin{aligned} [G] - \lambda^2 [L] &= 0 \\ [K] &= \frac{E h^3}{\ell^2 (1 - \nu^2)} [G] \\ [J] &= \ell b [L] \\ \lambda^2 &= \frac{\rho \ell^3 b (1 - \nu^2)}{E h^2} \omega^2 \end{aligned} \right\} \quad (C10)$$

and

where the terms in  $[G]$  and  $[L]$  are given in Reference 19. Equation (C10) can be solved for the modal frequencies.

If  $a = \infty$  (flat plate,  $\phi = \frac{b}{a} = 0$ ), then the  $3 \times 3$  matrix is reduced to a  $2 \times 2$  matrix and one equation in terms of  $\lambda^2$  in the 3, 3 position. The equation resulting from the 3, 3 element yields the flat plate flexural modes, whereas the  $2 \times 2$  matrix gives the in-plane or longitudinal vibration modes.

Some important simplifications can be made in the frequency theory if the angle which the panel subtends is small. For angles  $\phi$  less than 0.2 radians, the frequency of flexural vibration can be approximated by the following equation when all edges are *clamped*:

$$\lambda^2 = 41.7 A + \frac{25.2}{A} + \frac{41.7}{A^3} + \frac{t^2 \phi^2}{A} ; \phi < 0.2 \text{ radians} \quad (C11)$$

where  $A = \frac{b}{\ell}$ ,  $\phi = \frac{b}{a}$ , and  $t = \frac{\ell}{h}$ .

It follows from the foregoing equations that the ratio of the curved panel frequency to that of the infinite panel for the 1, 1 mode of vibration is

$$\left( \frac{\omega_{11c}}{\omega_{11\infty}} \right)^2 = 1 + \frac{C (At\phi)^2}{A^4 + 0.61 A^2 + 1}$$

where the theoretical value of  $C$  is 0.024 for clamped edges.

The frequency analysis for *isotropic* curved panels with *no coupled modes*, Equation (C10), has been programmed in Fortran language for solution on the IBM 360/91 at the Applied Physics Laboratory of Johns Hopkins University. The equations are nondimensionalized in terms of three independent variables  $A$ ,  $\phi$ ,  $t$  and the dependent variable which is nondimensional frequency. Calculation of the frequency for clamped plates was made over the following range of variables:

$$0 \leq \frac{b}{a} = \phi \leq 3.14$$

$$20 \leq \frac{\ell}{h} = t \leq 1000$$

$$0.5 \leq \frac{b}{\ell} = A \leq 2.0$$

For particular values of aspect ratio  $A$ , nondimensional frequency is plotted for six modes and six values of length-to-thickness ratio. Figures 5 to 9 give clamped edge frequencies.\* Once nondimensional frequency is found, the actual frequency can be determined from the nomogram shown in Figure 10.

As an example, the natural frequencies of a clamped, curved panel calculated in Reference 19 are presented. The panel dimensions are

Radius  $a$  = 100 in.

Arc length  $b$  = 10 in.

Length,  $\ell$  = 20 in.

Thickness  $h$  = 0.05 in.

The nondimensional ratios are:

$$A = 0.5$$

$$\phi = 0.1$$

$$t = 400$$

---

\*Similar results are presented in Reference 19 for simply supported edges.



| Code | Mode Number      |                | Code | Subtended Angle, $\phi$ |
|------|------------------|----------------|------|-------------------------|
|      | Straight Edge, m | Curved Edge, n |      |                         |
| c    | 1                | 1              | 1    | 0                       |
| d    | 1                | 2              | 2    | 0.05                    |
| e    | 1                | 3              | 3    | 0.1                     |
| f    | 2                | 1              | 4    | 0.2                     |
| g    | 2                | 2              | 5    | 1.0                     |
| h    | 3                | 1              | 6    | 3.14                    |

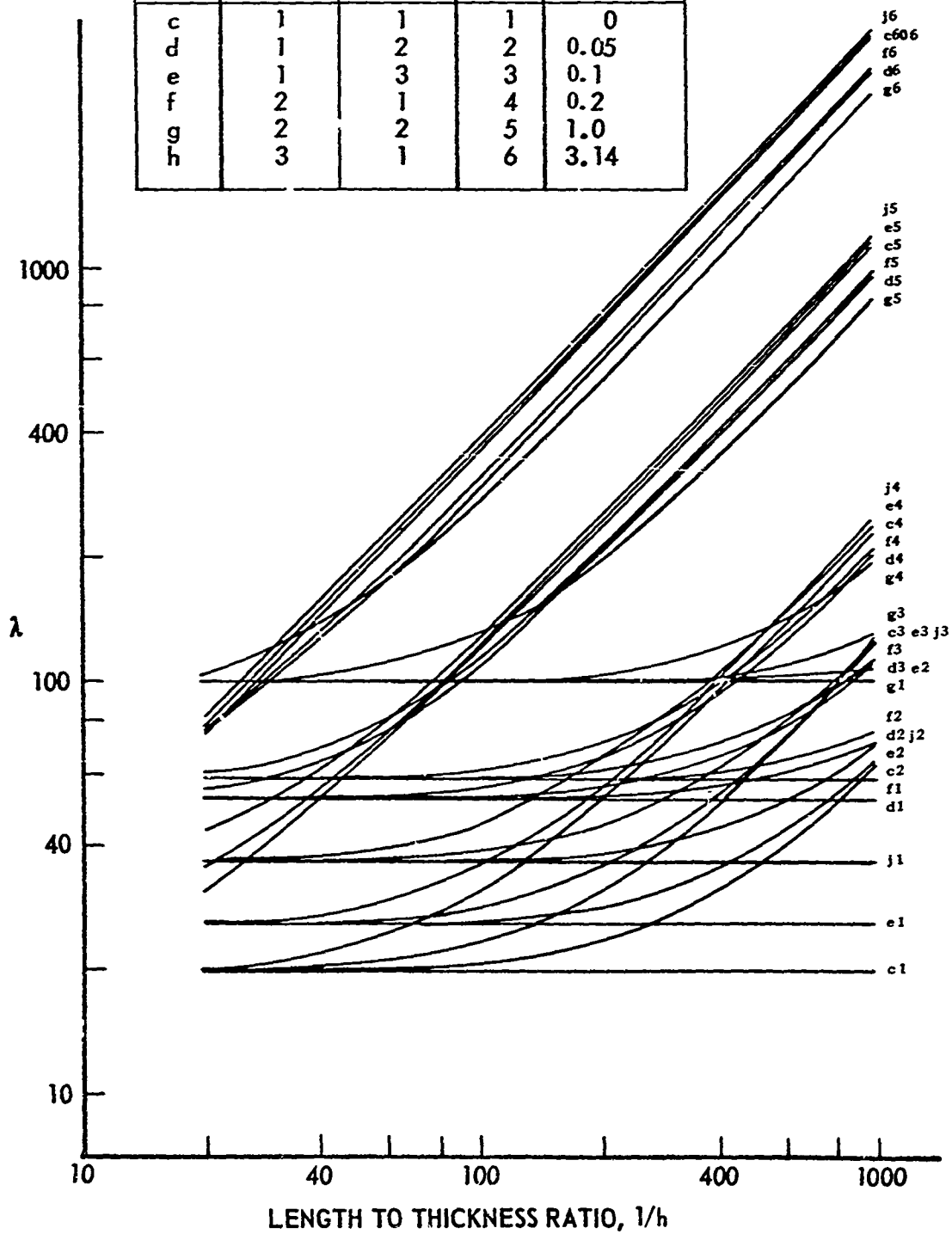

Figure 5 - Nondimensional Frequency Solutions, Clamped Edges,  $A = 0.50$

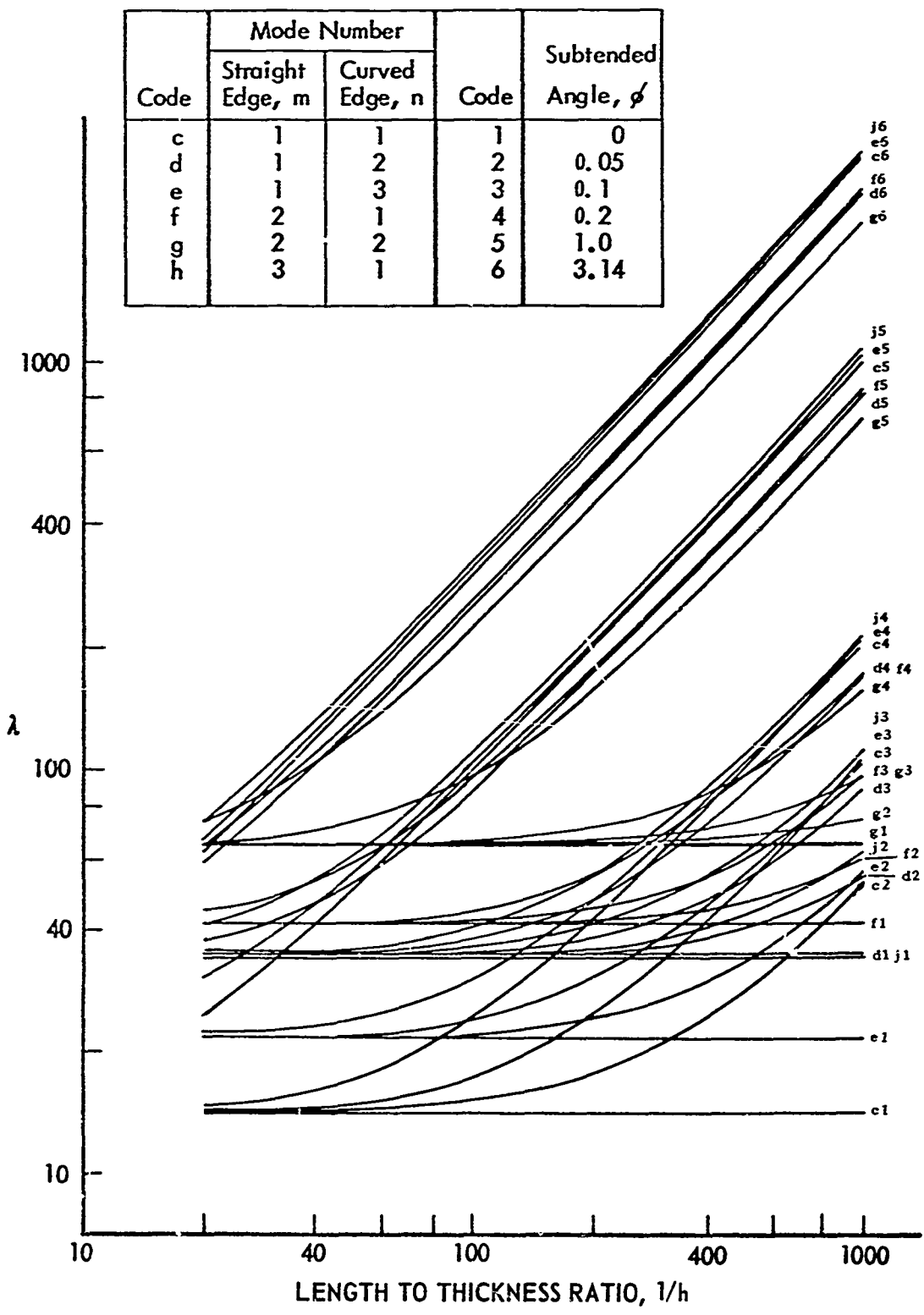

Figure 6 - Nondimensional Frequency Solutions, Clamped Edges,  $A = 0.67$

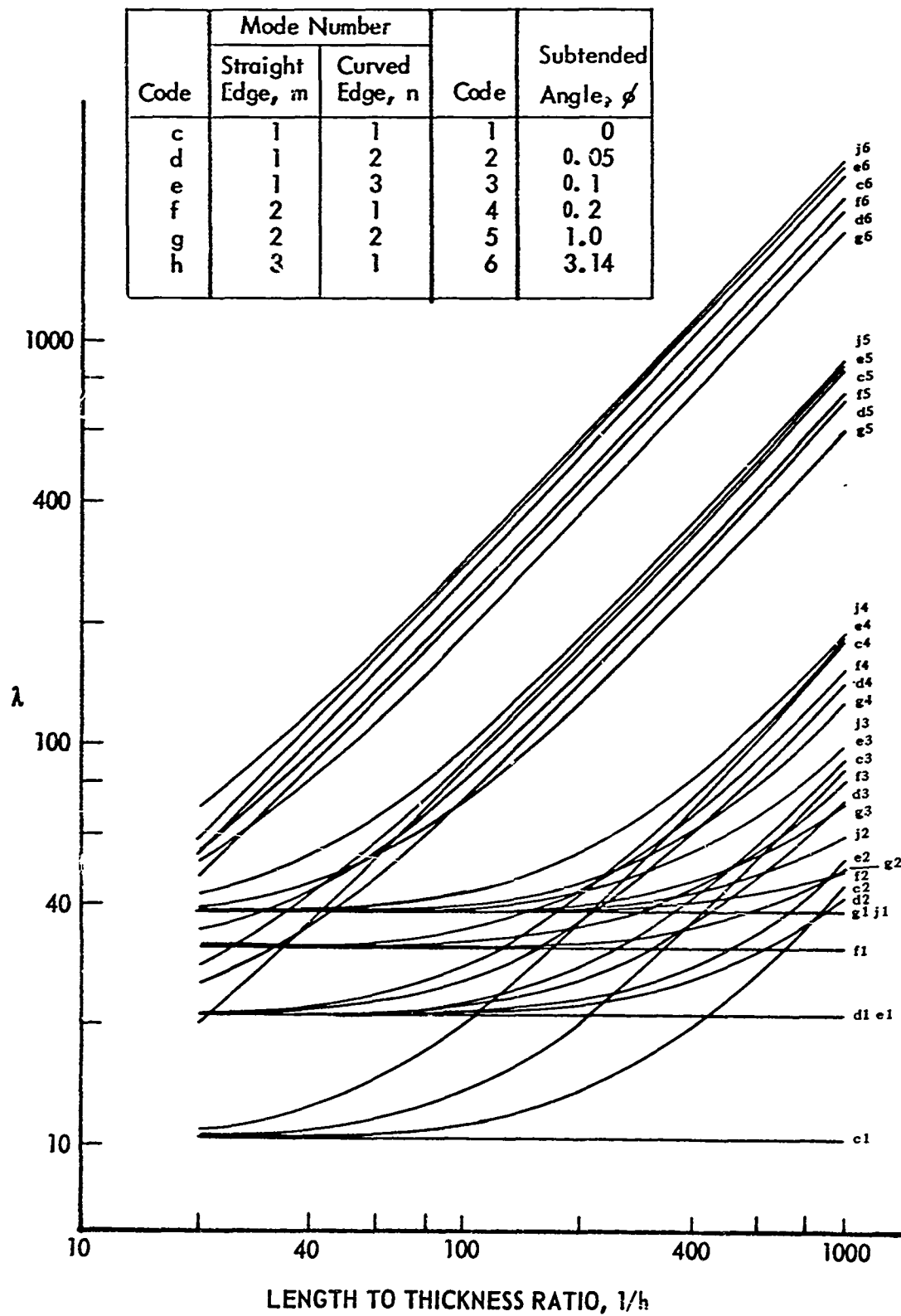

Figure 7 - Nondimensional Frequency Solutions, Clamped Edges,  $A = 1.00$

| Code | Mode Number      |                | Code | Subtended Angle, $\phi$ |
|------|------------------|----------------|------|-------------------------|
|      | Straight Edge, m | Curved Edge, n |      |                         |
| c    | 1                | 1              | 1    | 0                       |
| d    | 1                | 2              | 2    | 0.05                    |
| e    | 1                | 3              | 3    | 0.1                     |
| f    | 2                | 1              | 4    | 0.2                     |
| g    | 2                | 2              | 5    | 1.0                     |
| h    | 3                | 1              | 6    | 3.14                    |

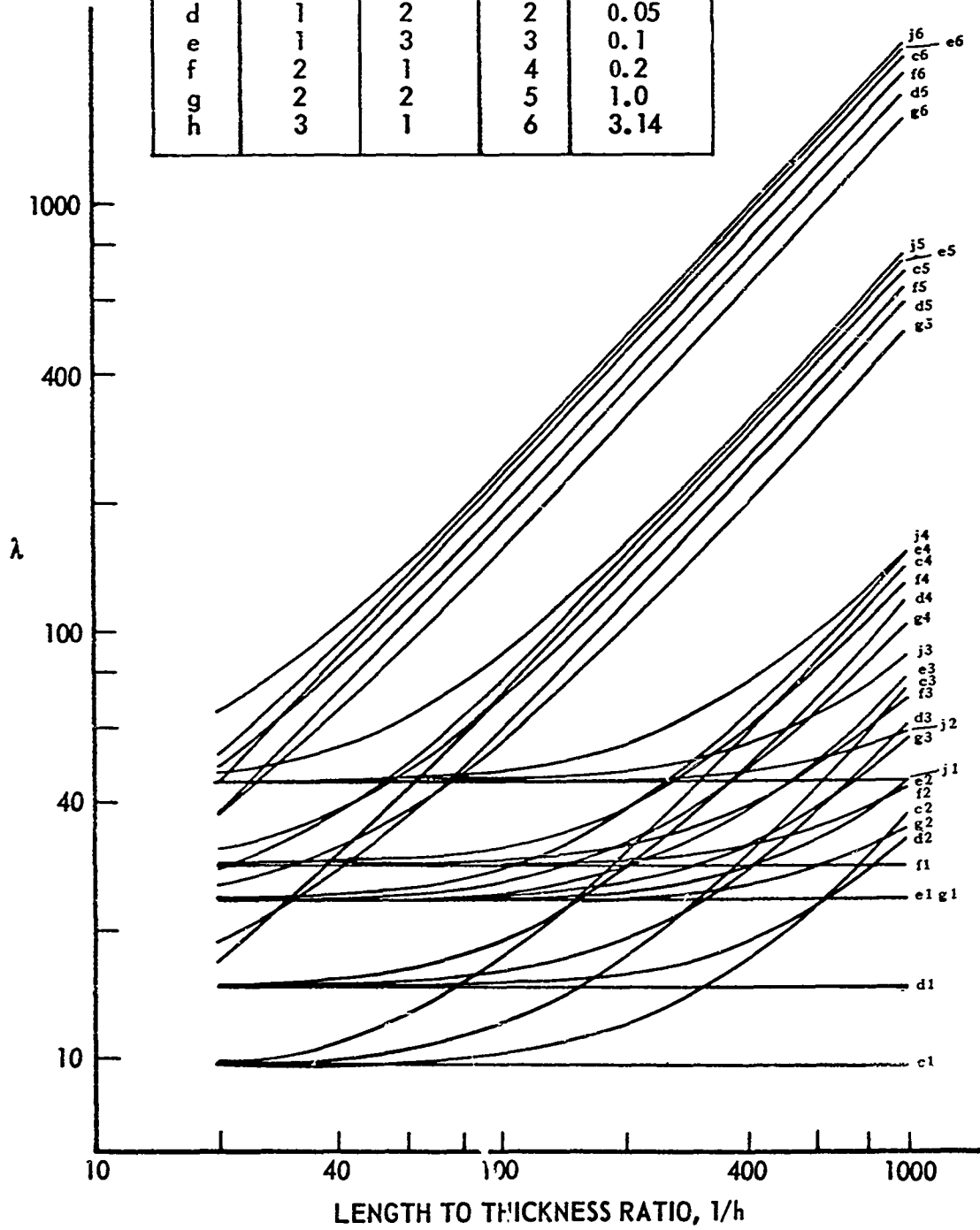

Figure 8 - Nondimensional Frequency Solutions, Clamped Edges,  $A = 1.50$

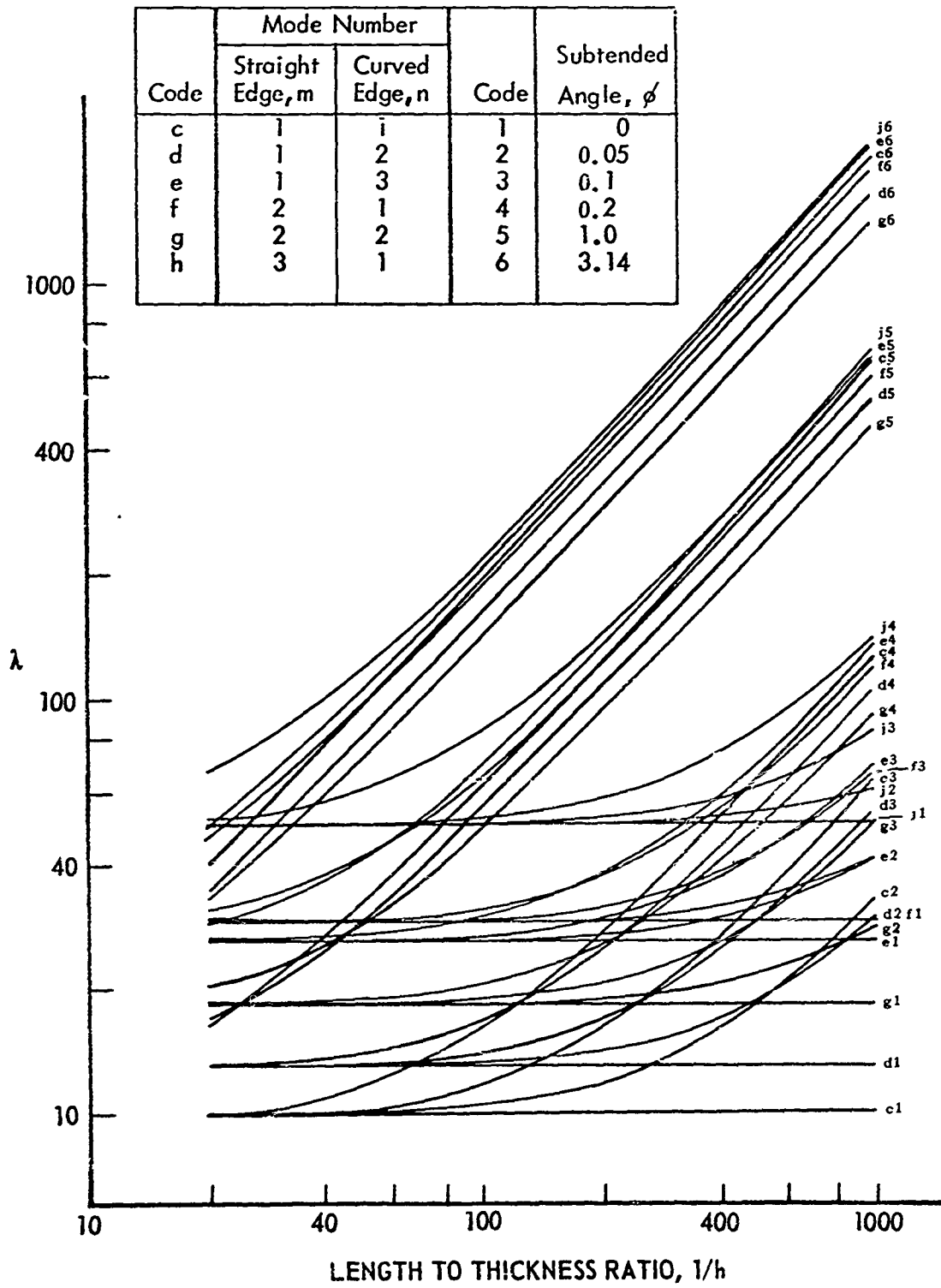

Figure 9 - Nondimensional Frequency Solutions, Clamped Edges,  $A = 2.00$

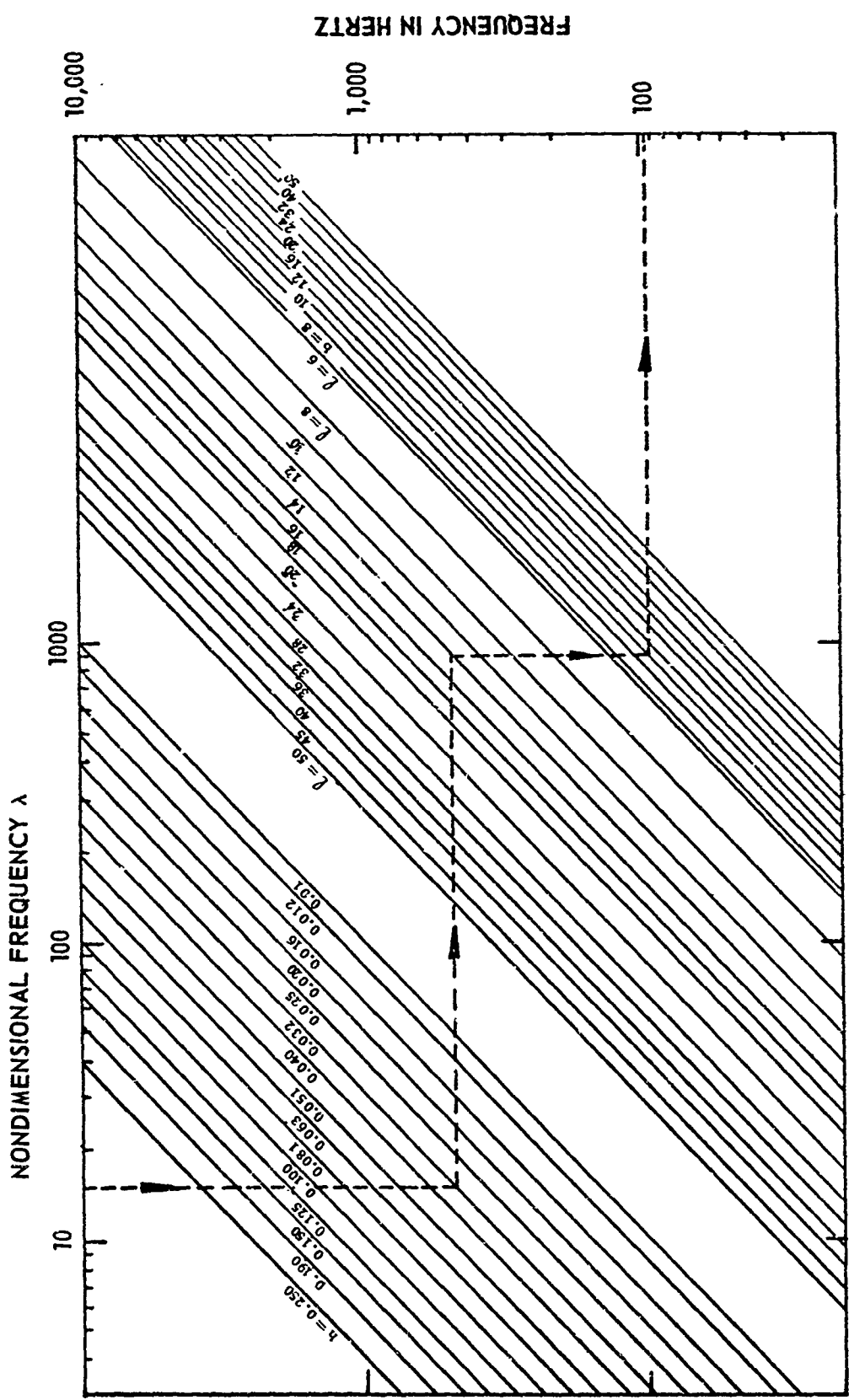

Figure 10 — Nomogram for Converting Nondimensional Frequency to Actual Frequency

Table 5 shows values of  $\lambda$  for the different combinations of mode number. These values were taken from Figure 5 for  $A = 0.50$ . The frequencies converted through the use of the nomogram are also displayed in Table 5.

TABLE 5  
Natural Frequencies for Sample Problem

| $m$ | $n$ | $\lambda$ | $f$ |
|-----|-----|-----------|-----|
| 1   | 1   | 51        | 300 |
| 1   | 2   | 65        | 382 |
| 1   | 3   | 101       | 594 |
| 2   | 1   | 54        | 318 |
| 2   | 2   | 71        | 418 |
| 3   | 1   | 61        | 359 |

## APPENDIX D

### THE GREENSPON METHOD

#### NOTATION

|                      |  |
|----------------------|--|
| $A_p$                | Area of plate  |
| $a$                  | Width of plate   |
| $b$                  | Length of plate  |
| $b/a$                | Aspect ratio   |
| $D$                  | Plate modulus = $\frac{Eh^3}{12(1-\nu^2)}$   |
| $dA$                 | Differential element of area   |
| $E$                  | Modulus of elasticity of plate material  |
| $h$                  | Thickness of plate   |
| $n$                  | Distance in direction normal to boundary of a flat plate of arbitrary shape (has dimensions of length); $n$ lies in plane of plate               |
| $p_r$                | Circular frequency of $r$ th mode of vibration   |
| $p_{ij}$             | Circular frequency of $ij$ th mode of vibration  |
| $q_m$                | A function of time such that $w = w_m q_m$ satisfies the homogeneous plate equation $D\nabla^4 w + \rho h \frac{\partial^2 w}{\partial t^2} = 0$ |
| $s$                  | Distance in direction of boundary of a flat plate of arbitrary shape (has dimensions of length)  |
| $t$                  | Time variable  |
| $w$                  | Lateral deflection   |
| $w_r$                | Deflection function in $r$ th mode of vibration  |
| $X_i, Y_j$           | Normal mode functions for the modes of vibration of a beam   |
| $\alpha_i, \alpha_j$ | Factors defining modes of vibration of a beam  |
| $\beta_i, \beta_j$   | Frequency numbers of the modes of vibration of a beam  |



- $\nu$  Poisson's ratio
- $\rho$  Mass per unit volume of plate material
- $\nabla^4$  Differential operator  $\left( \frac{\partial^4}{\partial x^4} + 2 \frac{\partial^4}{\partial x^2 \partial y^2} + \frac{\partial^4}{\partial y^4} \right)$  in rectangular coordinates
- $\frac{\partial w}{\partial x}$  Slope of plate boundary

## DESCRIPTION

Using the general theory of small vibrations of plates, Greenspon<sup>7, 12, 20</sup> presents a method for calculating the frequency and deflection response of a clamped rectangular plate.\* The calculation is based on a knowledge of the normal modes of vibrations which are approximated by the product of two beam functions (or characteristic functions) identical to that used by Young (see Appendix B).

## DERIVATION

The homogeneous equation for a freely vibrating thin plate is given by<sup>7, 12, 20</sup>

$$D \nabla^4 w + \rho h \frac{\partial^2 w}{\partial t^2} = 0 \quad (D1)$$

For a clamped boundary

$$\begin{aligned} w &= 0 \text{ along } s \\ \frac{\partial w}{\partial n} &= 0 \text{ along } s \end{aligned} \quad (D2)$$

The deflection of the plate is taken to be the sum of the normal modes.

$$w(x, y, t) = \sum_{r=1}^{\infty} w_r(x, y) q_r(t) \quad (D3)$$

Substitution of Equation (D2) into Equation (D1) yields

$$\frac{D}{\rho h} \nabla^4 \sum_{r=1}^{\infty} w_r q_r + \sum_{r=1}^{\infty} w_r \frac{d^2 q_r}{dt^2} = 0 \quad (D4)$$

Integration of the product of Equation (A3) and one of the normal mode functions  $w_m$  over the plate area  $A$  gives

$$\frac{D}{\rho h} \int_{A_p} w_m \left[ \nabla^4 \sum_{r=1}^{\infty} w_r q_r \right] dA + \int_{A_p} w_m \left[ \sum_{r=1}^{\infty} w_r \frac{d^2 q_r}{dt^2} \right] dA = 0 \quad (D5)$$

\*Results for isotropic plates are given in Reference 7 and for orthotropic (i.e., stiffened) plates in References 12 and 20.

As shown in Reference 12, the first term in this equation which contains integrals of the form  $\int w_m \nabla^4 w_r dA$  is zero if  $r \neq m$  and the second term in this equation which contains integrals of the form  $\int_{A_p} w_m w_r dA$  is also zero if  $r \neq m$  and the plate is clamped. Thus if the plate is vibrating freely in one of its modes  $w = w_r \sin p_r t$ , Equation (D5) can be written

$$\frac{D}{\rho h} \int_{A_p} w_m \nabla^4 w_r dA = p_r^2 \int_{A_p} w_m w_r dA \quad (D6)$$

and since the integrals have a value only for  $r=m$ , the circular frequency of the  $m$ th mode of vibration is

$$p_m = \sqrt{\frac{D}{\rho h}} \left[ \sqrt{\frac{\int_{A_p} w_m \nabla^4 w_m dA}{\int_{A_p} w_m^2 dA}} \right] \quad (D7)$$

To calculate the frequency and deflection response, the normal modes of the clamped plate are approximated by the product of two beam (or characteristic) functions, i.e.,  $w_m = X_i Y_j$ , which depend on the boundary conditions of the plate.\* (For the first mode  $i = 1, j = 1$ ; for the second mode  $i = 1, j = 2$ , etc.) (For the clamped plate, the values of  $X_i$  and  $Y_j$  used by Greenspon are identical to those used by Young; see Appendix B.)

$$\begin{aligned} X_i &= \cosh \frac{\beta_i x}{a} - \cos \frac{\beta_i x}{a} - \alpha_i \left( \sinh \frac{\beta_i x}{a} - \sin \frac{\beta_i x}{a} \right) \\ Y_j &= \cosh \frac{\beta_j y}{b} - \cos \frac{\beta_j y}{b} - \alpha_j \left( \sinh \frac{\beta_j y}{b} - \sin \frac{\beta_j y}{b} \right) \end{aligned} \quad (D8)$$

Substituting the value of  $w_m = X_i Y_j$  into Equation (D7) using Equation (D8), we find (see page 30 of Reference 12 for details).

$$p_{ij} = \sqrt{\frac{D}{\rho h}} \cdot \sqrt{\frac{(\beta_i)^4}{a^4} + \frac{(\beta_j)^4}{b^4} + \frac{2 \int_0^a \int_0^b X_i X_i'' Y_j Y_j'' dx dy}{\int_0^a \int_0^b X_i^2 Y_j^2 dx dy}} \quad (D9)$$

where  $X_i'' = \frac{d^2 X_i}{dx^2}$  and  $Y_j'' = \frac{d^2 Y_j}{dy^2}$ .

\*The product of the beam functions is not an exact expression for the modes of a clamped plate because it generally does not satisfy the plate equation.

The values of  $\beta$  and  $\alpha$  as well as the integrals  $\int_0^a X_i X_i'' dx$ ,  $\int_0^a X_i^2 dx$  and the values of  $X_i$  and  $X_i''$  which are contained in References 8, 9, and 16 were used by Greenspon<sup>7</sup> to compute Table 6.

For purposes of the present report, the final expression for the deflection response derived in References 7, 12, and 20) is omitted here.

Following a similar procedure, Reference 12 presents a frequency equation for a fluid-loaded, cross-stiffened plate, i.e., orthotropic plate. It also gives the procedure for determining the orthotropic constants and other data. The beam functions  $X_i, Y_j$  are written for a beam with rotational constraint which includes simply supported and clamped constraints. Thus Equation (D9) is a special case of the more general frequency equation given in this reference.

TABLE 6

Function Values for a Clamped-Clamped Beam

(Here  $a$  or  $b$  is the length of the beam, and the origin  $x = 0$  is located at one end.

The tabulations will remain valid if  $X_i$  is replaced by  $Y_j$ .)

| $i$ or $j$ | $\alpha_i, \alpha_j$ | $\beta_i, \beta_j$ | $b \int_0^b Y_j Y_j'' dy =$<br>or<br>$a \int_0^a X_i X_i'' dx$ | $\frac{\int_0^b Y_j^2 dy}{b}$ or<br>$\frac{\int_0^a X_i^2 dx}{a}$ | Value of<br>$X_i$ | Point at Which<br>this Value of<br>$X_i$ Occurs | Value of<br>$\frac{a^2}{\beta_i^2} X_i''$ | Point at Which<br>this Value of<br>$\frac{a^2}{\beta_i^2} X_i''$<br>Occurs | $\frac{\int_0^b Y_j dy}{b}$ or<br>$\frac{\int_0^a X_i dx}{a}$ |
|------------|----------------------|--------------------|--|---|-------------------|---|---|--|---|
| 1          | 0.9825               | 4.7300             | - 12.3026  | 1   | 1.5882            | $x = 0.5 a$                                     | 2   | $x = 0$  | 0.8309  |
| 2          | 1.0008               | 7.8532             | - 46.0501  | 1   | 0                 | $x = 0.5 a$                                     | 2   | $x = 0$  | 0   |
| 3          | 1.0000               | 10.9956            | - 98.9048  | 1   | -1.4060           | $x = 0.5 a$                                     | 2   | $x = 0$  | 0.3638  |
| 5          | 1.0000               | 17.2788            | -263.9980  | 1   | 1.4146            | $x = 0.5 a$                                     | 2   | $x = 0$  | 0.2315  |

## APPENDIX E

### THE WHITE METHOD

#### NOTATION

|                   |  |
|-------------------|--|
| $a$               | Beam width   |
| $a_{mn}, a_{rs}$  | Coefficients used in series representation of deflection   |
| $a_m, a_n$        | A constant which determines the amplitude of response for the $m$ th and $n$ th modes respectively of a beam; beam nondimensional frequency parameters |
| $b$               | Beam length  |
| $C_i$             | Rotational spring stiffness per unit length along the $i$ th edge  |
| $C_{mn}^{rs}$     | Quantity defined by Equation (E16)   |
| $D$               | Plate bending stiffness equal to $EI = \frac{Eh^3}{12(1-\nu^2)}$   |
| $E$               | Young's modulus of elasticity  |
| $g$               | Gravity acceleration   |
| $h$               | Plate thickness  |
| $I$               | Moment of inertia of cross section of the beam about the neutral axis  |
| $J_i$             | Mass moment of inertia per unit length along the $i$ th edge   |
| $M_p$             | Plate mass   |
| $m, n$ and $r, s$ | Mode numbers, i.e., number of elastic half-waves parallel to the $x$ - and $y$ -axes, respectively   |
| $m_i$             | Edge mass per unit of length along the $i$ th edge   |
| $T$               | Kinetic energy   |
| $\bar{T}$         | Equal to $\frac{2T}{\omega^2 M_p}$ ; defined by Equation (E7)  |
| $V$               | Potential energy   |

|  |   |
|--|---|
| $\bar{V}$  | Equal to $\frac{2Vb^3}{Da}$ ; defined by Equation (E11)   |
| $W(x, y)$  | Plate deflection  |
| $x, y$   | Rectangular coordinates   |
| $\alpha_m, \alpha_n$                             | Beam nondimensional frequency parameters  |
| $\alpha_{mn}$                                    | Plate nondimensional frequency parameters   |
| $\alpha_{n0}, \alpha_{nL}$                       | Nondimensional frequency parameters for the $n$ th mode of a symmetrically constrained beam which has springs of stiffness $C_0$ and $C_L$ , respectively, at both ends of the beam |
| $\delta_{mn}^{rs}$                               | Defined by Equation (E17)   |
| $\theta_n^{(y)}, \theta_s^{(y)}$                 | Beam mode shapes (functions of $y$ only)  |
| $\lambda, \lambda_{mn}$                          | Nondimensional plate frequency parameters defined by Equations (E13) and (E19), respectively  |
| $\mu$  | Plate mass per unit of area   |
| $\nu$  | Poisson's ratio   |
| $\xi_i$  | Nondimensional rotational stiffness parameter   |
| $\rho$   | Mass density  |
| $\phi_m(x), \phi_r(x), \theta_n(y), \theta_s(y)$ | Beam mode shapes (functions of $x$ or $y$ only)   |
| $\phi_{mn}(x, y)$                                | Plate mode shape, approximately equal to $\phi_m(x) \theta_n(y)$  |
| $\psi_m, \psi_n$                                 | Beam functions defined by Equation (E19)  |
| $\omega, \omega_{mn}$                            | Circular frequency and circular resonance frequency of plate, respectively  |
| —  | Designates a nondimensional integral  |

## DESCRIPTION

Using the Rayleigh-Ritz technique, White<sup>21</sup> derives a set of simultaneous algebraic equations for computing the resonance frequencies and modes of a rectangular flat plate having a uniform distribution of elastic and inertial edge fixities. These fixities are equivalent to a uniform distribution of independent masses, translational springs, and rotational springs along each edge of the plate; the various edges of the plate can have equal or different elastic constraints and inertial loadings. The only coupling between the individual masses along an edge is the coupling provided by the deflection of the plate. Certain integrals of products of beam mode shapes and derivatives of these mode shapes are expanded in terms of modal displacements and derivatives of these displacements at the ends of the beam. These integrals are used to develop expressions for plate frequencies. All effects of rotary inertia and shear deformation of the beam are neglected.

Once the masses and springs along the four edges of the plate are known, the frequencies and modes can be numerically evaluated. Solutions of the simultaneous set of algebraic equations can be obtained by iteration using standard digital computer techniques.

Reference 21 treats the special case in which the edges of the plate are translationally fixed, elastically constrained in rotation by a uniform distribution of rotational springs, and not loaded by edge masses. In this special case, each edge of the plate can have a fixity arbitrarily between a pinned and *clamped* support and the four edges can have different elastic constraints. The special case is further specialized in the present report to treat only the completely clamped case. Although exact solutions of the corresponding set of simultaneous frequency equations require an iteration of the Ritz type, it was found that reasonably accurate estimates of the plate resonance frequencies can be obtained by using a single term from the appropriate equation in the set. The resulting approximate frequency equation is given as well as nomographs for quick computation of these frequencies.\* The White method as applied to the completely clamped plate follows.

## DERIVATION

The partial differential equation which defines the undamped resonant vibration of a thin, uniform rectangular plate is

$$\left[ \frac{\partial^4}{\partial x^4} + 2 \frac{\partial^4}{\partial x^2 \partial y^2} + \frac{\partial^4}{\partial y^4} - \omega^2 \frac{\rho h}{D} \right] W(x, y) = 0 \quad (\text{E1})$$

Using the Rayleigh-Ritz technique, the approximate solution  $W(x, y)$  of Equation (E1) is expressed as a doubly infinite series of products of normalized uniform beam modes.

---

\*The nomographs yield results for the special case cited above which includes the clamped plate.

$$W(x, y) = \sum_{m=1}^{\infty} \sum_{n=1}^{\infty} A_{mn} \phi_m(x) \theta_n(y) \quad (\text{E2})$$

where the mode shapes  $\phi_m(x)$  and  $\theta_n(y)$  are associated with the mode shapes of uniform beams having end fixities which are the same as the corresponding edges of the plate; the particular form of these beam modes for particular boundary conditions can be obtained from Reference 21. These forms are not required for the present analysis.

The kinetic energy  $T$  of the clamped plate is\*

$$T = \frac{\omega^2}{2} \rho h \int_0^a \int_0^b W^2(x, y) dx dy \quad (\text{E3})$$

Substituting Equation (E2) into Equation (E3), we obtain

$$T = \frac{1}{2} \omega^2 \sum_{m,n,r,s} a_{mn} a_{rs} M_p \overline{\phi_m \phi_r} \overline{\theta_n \theta_s} \quad (\text{E4})$$

From the condition of orthogonality of beam modes

$$\begin{aligned} \overline{\theta_n \theta_s} &= 0 \quad \text{if } n \neq s \\ \overline{\phi_m \phi_r} &= 0 \quad \text{if } m \neq r \end{aligned} \quad (\text{E5})$$

writing

$$T = \frac{1}{2} \omega^2 M_p \bar{T} \quad (\text{E6})$$

we have

$$\bar{T} = \sum_{m,n,r,s} a_{mn} a_{rs} \overline{\phi_m \phi_r} \overline{\theta_n \theta_s} \quad (\text{E7})$$

The integral expression for the potential energy  $V$  of a flat rectangular clamped plate is\*\*

\*Assuming no edge masses, all  $M_i = 0$  in Reference 21. With no mass moments of inertia at the boundaries, all  $J_i = 0$  in Reference 21.

\*\*For the clamped plate, we assume infinite stiffness in the translational and rotational springs along the edges of the plate so that no potential energy is associated with these springs. The spring energies are, however, included in the potential energy term in Reference 21.



$$V = \frac{D}{2} \int_0^a \int_0^b [W_{xx}^2 + W_{yy}^2 + 2\nu W_{xx} W_{yy} + 2(1-\nu) W_{xy}^2] dx dy$$

(E8)

or

$$V = \frac{D}{2} \int_0^a \int_0^b [W_{xx} + W_{yy}]^2 dx dy + (1-\nu) D \int_0^a \int_0^b [W_{xy}^2 - W_{xx} W_{yy}] dx dy$$

Substituting Equation (E2) in Equation (E8), we get

$$V = \frac{D}{2} \frac{a}{b^3} \sum_{mnr s} a_{mn} a_{rs} \left[ \left(\frac{b}{a}\right)^4 \overline{\phi_m'' \phi_r''} \overline{\theta_n \theta_s} + \overline{\phi_m \phi_r} \overline{\theta_n'' \theta_s''} \right. \\ \left. + \left(\frac{b}{a}\right)^2 \{ \overline{\phi_m'' \phi_r} \overline{\theta_n \theta_s''} + \overline{\phi_m \phi_r''} \overline{\theta_n'' \theta_s} \} \right] \quad (E9) \\ + \frac{D}{ab} (1-\nu) \sum_{mnr s} a_{mn} a_{rs} [\overline{\phi_m' \phi_r' \theta_n' \theta_s'} - \overline{\phi_m'' \phi_r} \overline{\theta_n \theta_s''}]$$

This equation can be simplified by use of the integral relationships between  $\overline{\phi_m \phi_r}$ ,  $\overline{\phi_m'' \phi_r''}$ ,  $\overline{\phi_m' \phi_r'}$  and  $\overline{\theta_n \theta_s}$ ,  $\overline{\theta_n'' \theta_s''}$ ,  $\overline{\theta_n' \theta_s'}$  given by Equation (42) of Reference 21. The steps involve a lengthy integration by parts. The resulting expression for the potential energy becomes.

$$V = \frac{D}{2} \frac{a}{b^3} \bar{V} \quad (E10)$$

where

$$\bar{V} = \sum_{mnr s} a_{mn} a_{rs} \left[ \alpha_m^4 \left(\frac{b}{a}\right)^4 \overline{\phi_m \phi_r} \overline{\theta_n \theta_s} + \alpha_n^4 \overline{\theta_n \theta_s} \overline{\phi_m \phi_r} \right] \\ + \sum_{mnr s} a_{mn} a_{rs} \left(\frac{b}{a}\right)^2 [\overline{\phi_m'' \phi_r} \overline{\theta_n \theta_s''} + \overline{\phi_m \phi_r''} \overline{\theta_n'' \theta_s}] \\ + \sum_{mnr s} a_{mn} a_{rs} \{2(1-\nu)\} \left(\frac{b}{a}\right)^2 [(\phi_m' \phi_r')_0^a (\theta_n \theta_s')_0^b \\ - (\phi_m' \phi_r')_0^a \overline{\theta_n \theta_s''} - (\theta_n \theta_s')_0^b \overline{\phi_m'' \phi_r}] \quad (E11)$$

Applying the Rayleigh-Ritz method, we set  $T = V$  and minimize the plate frequency  $\omega$  with respect to each of the coefficients  $a_{rs}$ . It follows from Equations (E6), (E7), (E10), and (E11) that

$$\lambda \bar{T} = \bar{V} \quad (\text{E12})$$

where the resonance frequency and  $\lambda$  are related by the equation

$$\omega = \sqrt{\lambda} \sqrt{\frac{D}{\rho h b^4}} \quad (\text{E13})$$

Minimizing the frequency  $\omega$  with respect to  $a_{rs}$  implies that  $\frac{\partial \lambda}{\partial a_{rs}} = 0$  and hence

$$\lambda \frac{\partial \bar{T}}{\partial a_{rs}} = \frac{\partial \bar{V}}{\partial a_{rs}} \quad (\text{E14})$$

Performing this operation gives the final result

$$\sum_{m=1}^{\infty} \sum_{n=1}^{\infty} [C_{mn}^{rs} - \lambda \delta_{mn}^{rs}] a_{mn} = 0 \quad (\text{E15})$$

where, noting that the beam modes  $\phi_m$ ,  $\phi_r$ ,  $\theta_n$ , and  $\theta_s$  are equal to zero at the plate boundaries,

$$\begin{aligned} C_{mn}^{rs} = & \left[ \left( \frac{b}{a} \right)^4 \alpha_m^4 + \alpha_n^4 \right] \overline{\phi_m \phi_r \theta_n \theta_s} \\ & + \left( \frac{b}{a} \right)^2 [ \overline{\phi_m'' \phi_r \theta_n \theta_s''} + \overline{\phi_m \phi_r'' \theta_n'' \theta_s} ] \end{aligned} \quad (\text{E16})$$

and

$$\delta_{mn}^{rs} = \overline{\phi_m \phi_r \theta_n \theta_s} \quad (\text{E17})$$

and where (see Equation 42 of Reference 17)

$$\begin{aligned} \overline{\phi_m \phi_r} &= 0 \quad \text{if } m \neq r \\ \overline{\theta_n \theta_s} &= 0 \quad \text{if } n \neq s \end{aligned} \quad (\text{E18})$$

Equation (E15) represents a set of linear simultaneous equations in  $a_{mn}$  where there is one equation for each combination of  $r$  and  $s$ .

All the expressions necessary to evaluate the derivatives and integrals of mode shape appearing in Equations (E7), (E11), (E16), and (E17) have been developed in Reference 21 and are also used in Appendix F. Hence the quantities  $C_{mn}^{rs}$  and  $\delta_{mn}^{rs}$  can be numerically evaluated for a clamped plate. Solution of the set of Equations (E15) can be obtained by iteration using standard digital techniques. These methods are briefly discussed in References 16, 21, and 22 for certain special cases.

In Reference 21 numerical evaluation of Equation (E15) showed that accurate estimates of the plate frequencies can be obtained by using a single term from the appropriate equation out of the set of Equations (E15). To obtain the approximate frequency equation, set  $rs = mn$  in Equation (E15) and equate to zero the coefficient of  $a_{mn}$  giving

$$\omega_{mn} = (\lambda_{mn})^2 \left[ D / (\rho h b^4) \right]^{\frac{1}{2}}$$

where

$$\lambda_{mn} = (b/a)^4 \alpha_m^4 + \alpha_n^4 + 2(b/a)^2 \psi_m \psi_n$$

$$\psi_m = \frac{\overline{\phi_m'' \phi_m}}{\overline{\phi_m^2}}$$

$$\psi_n = \frac{\overline{\theta_n'' \theta_n}}{\overline{\theta_n^2}}$$

(E19)

Actually Equation (E19) and the quantity  $\psi_m$  (or  $\psi_n$ ) was numerically evaluated for the beam having translationally fixed ends and rotational spring ends. Thus Equation (E19) is the approximate solution to an equation somewhat more comprehensive than Equation (E15), given by Equations (66) in Reference 21. For a clamped plate, the rotational spring has infinite stiffness. The results are presented in Figures 11-13 for the first three beam modes. Thus approximate frequencies can be obtained for the *first nine modes* of the plate for any aspect ratio  $b/a$  by using the above equation and the data presented in Figures 11-13 for  $\psi_m$  (and  $\psi_n$ ) and Figures 14-16 for  $\alpha_m$  (and  $\alpha_n$ ). For symmetric edge fixity in which opposite edges are equally constrained, the numerical results obtained agree within 2 or 3 percent with those computed in Reference 22 using a 36-term series. The approximation is increasingly more accurate the smaller the plate aspect ratio and has the greatest error for the square plate, particularly in the fourth and fifth modes when equally constrained on all four edges. Approximate mode shapes  $\phi_{mn}(x, y) \approx \phi_m(x) \theta_n(y)$ , locations of peak deflections, locations of node lines, etc. can be obtained from the data presented in Figures 19-53 of Reference 21. A nomograph constructed by White is presented in the present report to aid in evaluating the approximate resonance frequencies of the plate, Equation (E19), corresponding to the *first nine modes* for any aspect ratio  $b/a$ . The opposite edges can have equal or different elastic constraints. Note that graphical techniques can account for only the most significant term or terms in a mathematical solution which may involve a large number of terms.

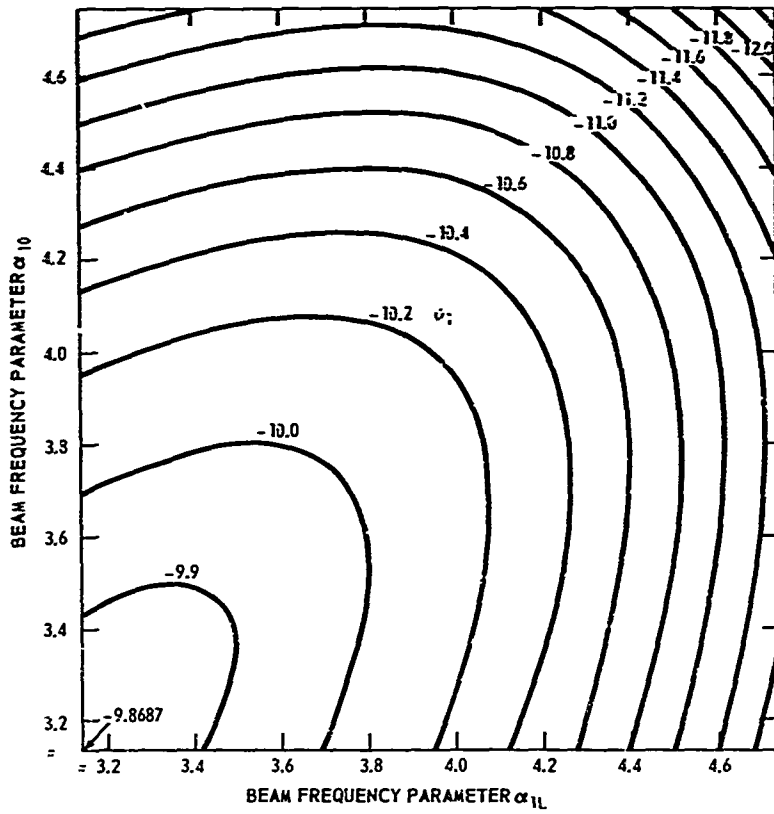

Figure 11 - Parameter  $\psi_1$  versus  $\alpha_{10}$  and  $\alpha_{1L}$ . First Mode

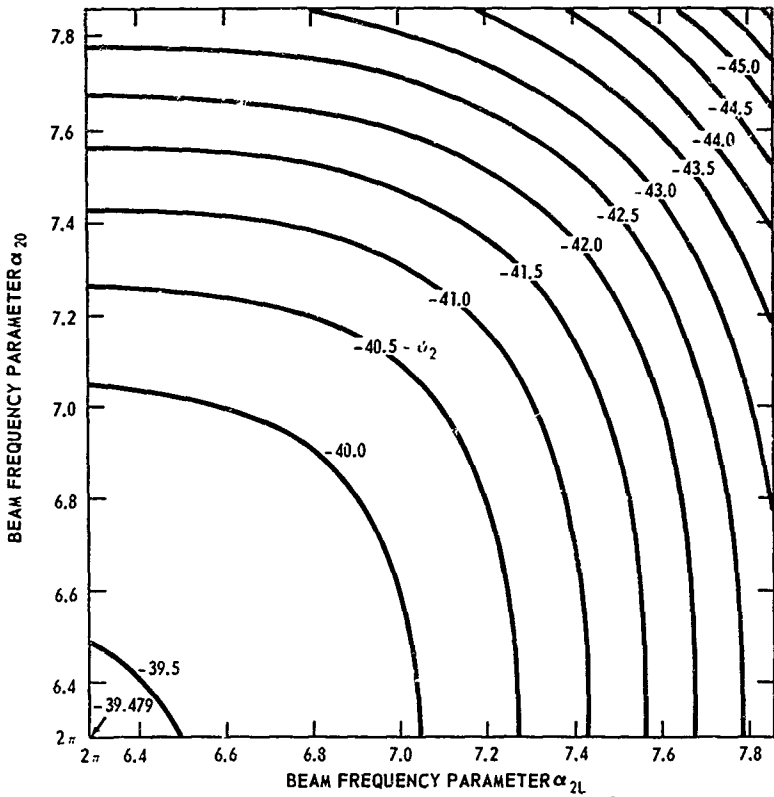

Figure 12 - Parameter  $\psi_2$  versus  $\alpha_{20}$  and  $\alpha_{2L}$ . Second Mode

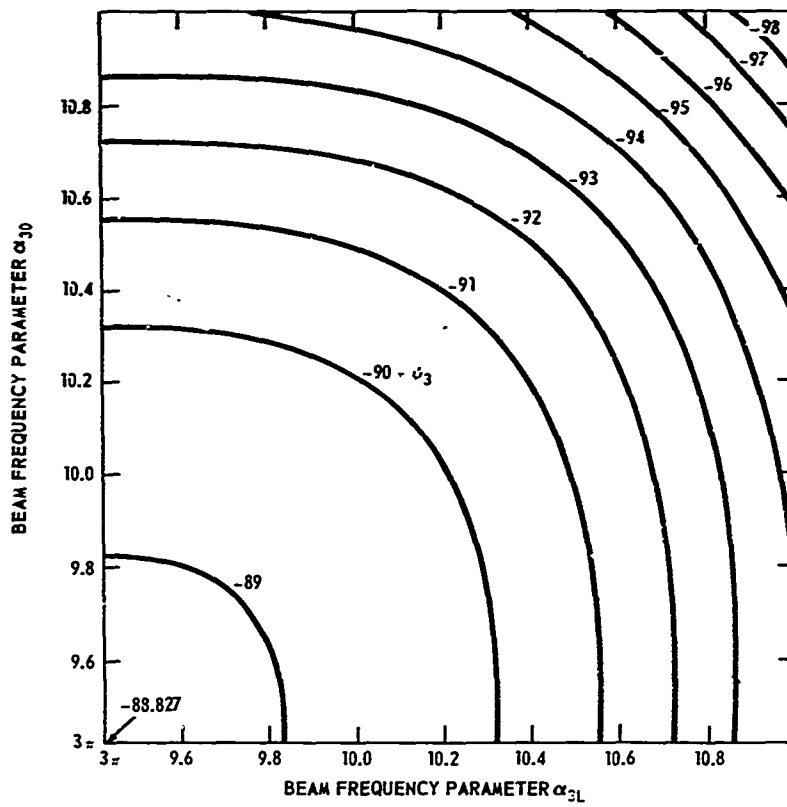

Figure 13 - Parameter  $\psi_3$  versus  $\alpha_{30}$  and  $\alpha_{3L}$ . Third Mode

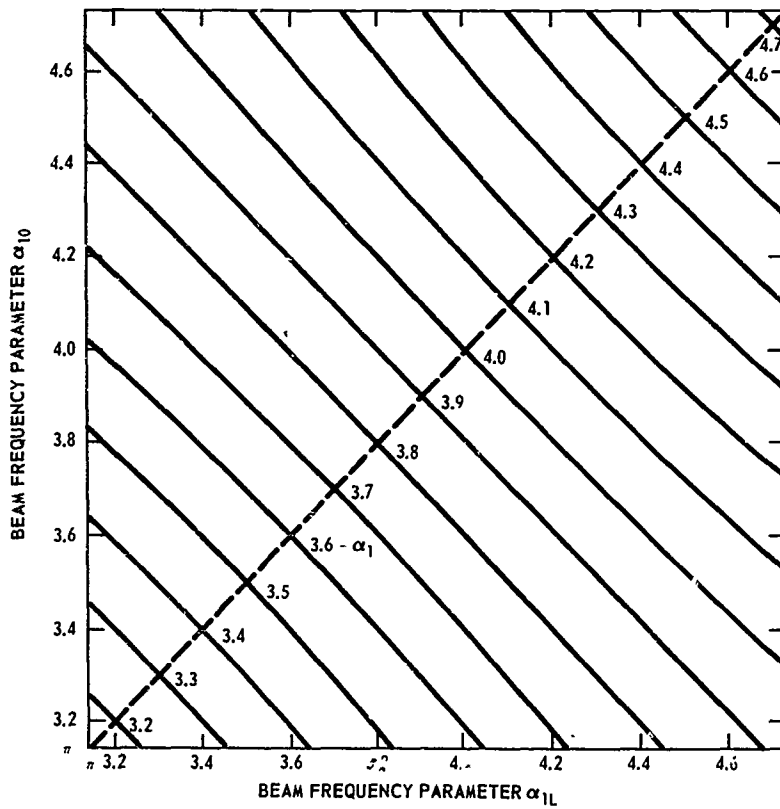

Figure 14 - Frequency Parameter  $\alpha_1$  versus  $\alpha_{10}$  and  $\alpha_{1L}$ . First Mode

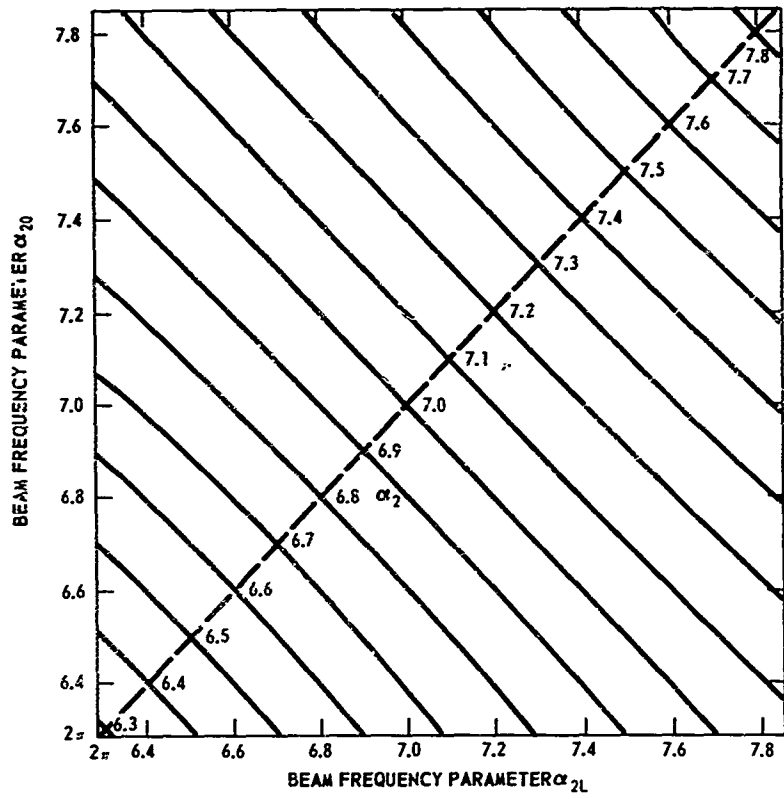

Figure 15 – Frequency Parameter  $\alpha_2$  versus  $\alpha_{20}$  and  $\alpha_{2L}$ , Second Mode

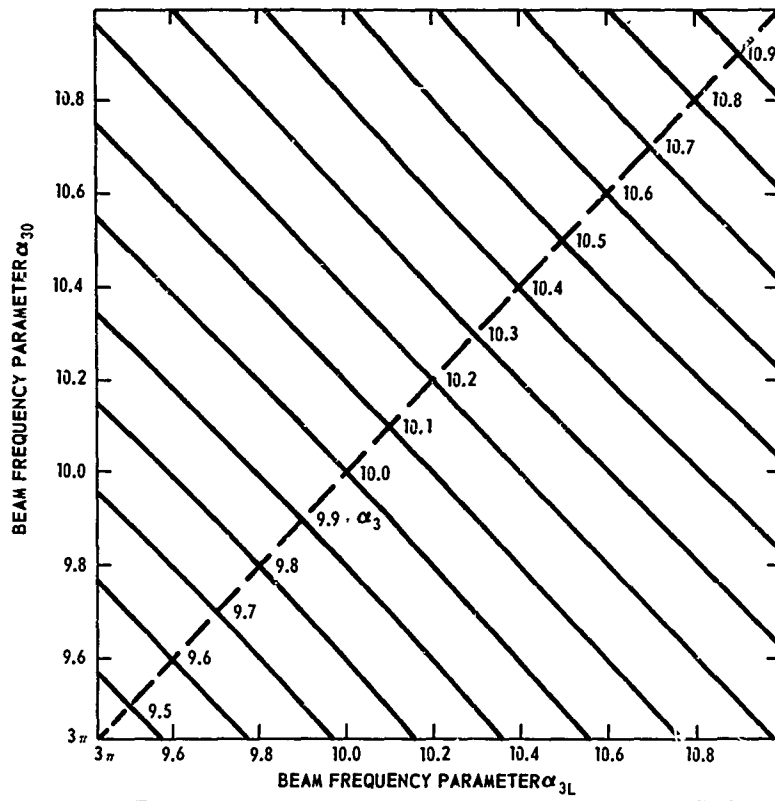

Figure 16 – Frequency Parameter  $\alpha_3$  versus  $\alpha_{30}$  and  $\alpha_{3L}$ , Third Mode

Figure 17 presents nomographs developed by Dr. White for nine modes of a rectangular plate. These permit the graphical computation of resonance frequencies of a plate of arbitrary aspect ratio when the four edges of the plate are translationally fixed but elastically restrained against rotation. The compliances of the rotational supports are assumed to be uniform along each edge, but the compliances may be different for all four edges. The clamped plate is represented by rotational springs of infinite stiffness along all edges. Each nomograph contains a sample calculation which is indicated by arrows and which is tabulated on the nomograph. Note that it is necessary to transfer numerical values from certain scales to other scales; these transfers are indicated by arrows at the bottom of each nomograph. If opposite edges of the plate have different rotational elastic constraints, the  $\psi_1$  and  $\alpha_1$  scales should be used instead of the  $\xi$  scales. Values of  $\alpha_1$  are obtained from Figure 14 for unsymmetric edge fixities. In the nomographs  $\sqrt{\lambda_{mn}}$  is replaced by  $\alpha_{mn}$ . Symbols used in the nomographs correspond to those used in Reference 21.

Figure 17 - Nomograph for Plate Nondimensional Frequency Parameters

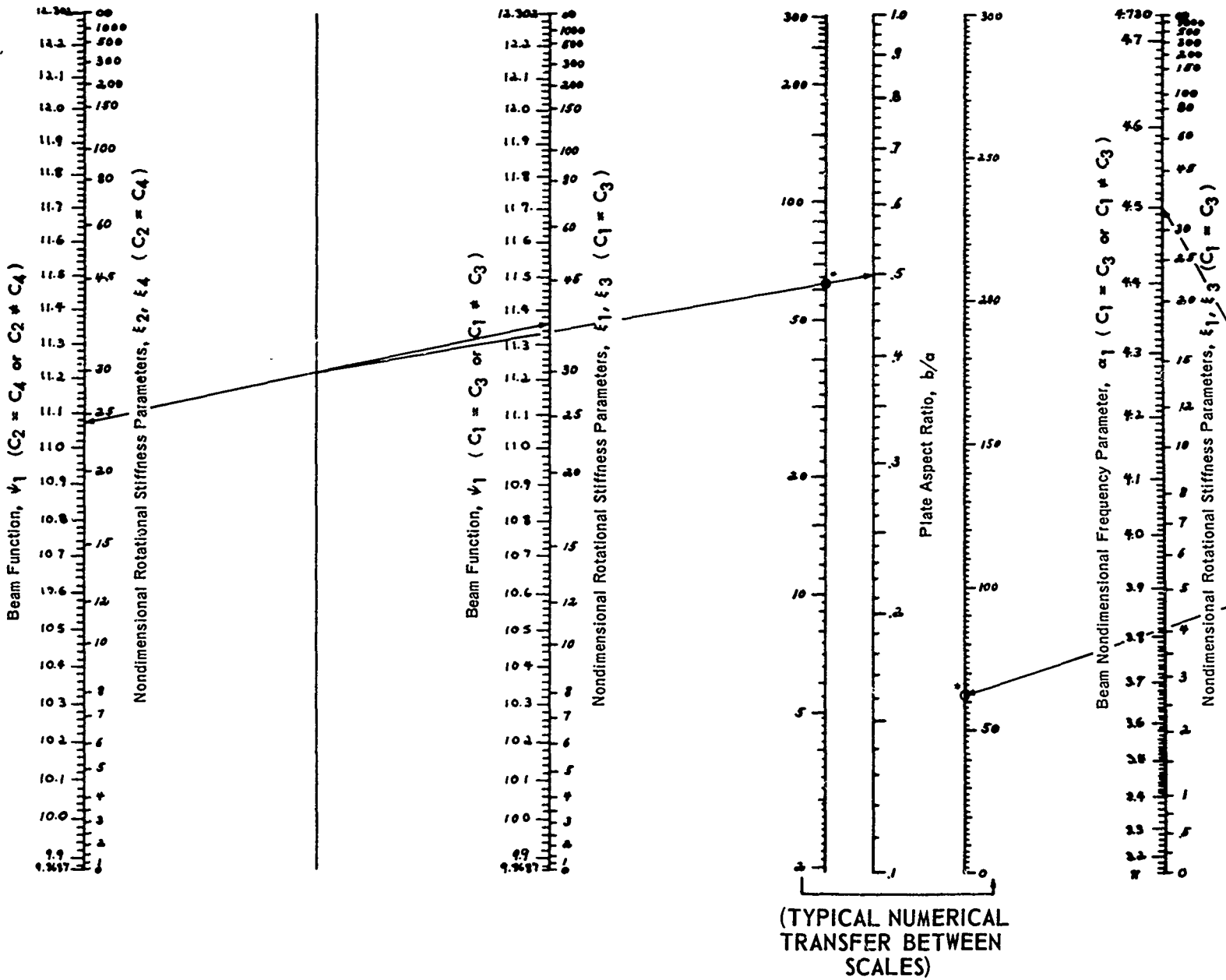
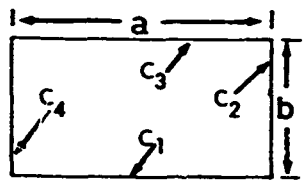
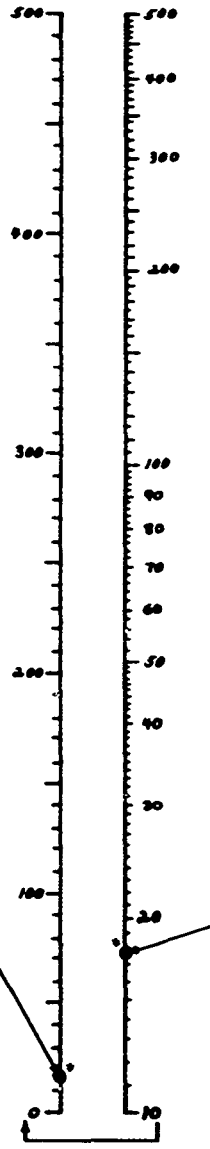
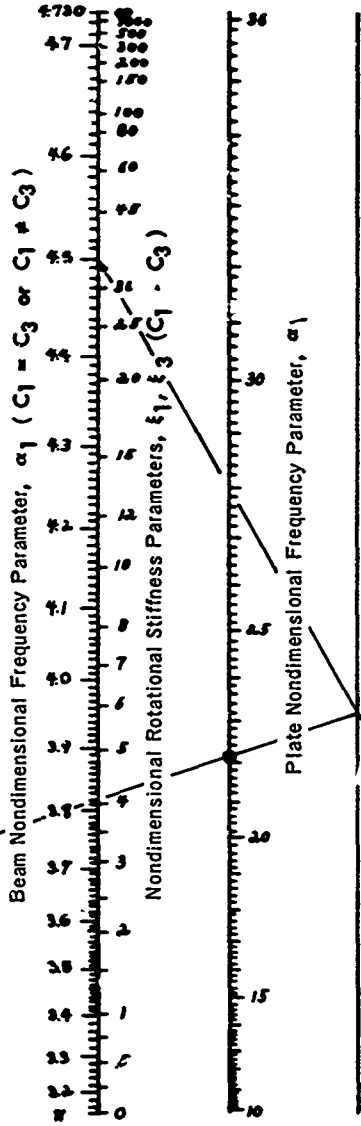

Figure 17a - Nomograph for Plate Nondimensional Frequency Parameter  $\alpha_{11}$

A





$$\xi_1 = \frac{C_1 b}{EI}$$

$$\xi_2 = \frac{C_2 a}{EI}$$

$$\xi_3 = \frac{C_3 b}{EI}$$

$$\xi_4 = \frac{C_4 a}{EI}$$

$$\alpha_{11} = \alpha_{11} \sqrt{\frac{Dg}{\mu b^4}}$$

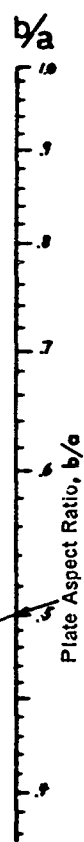

|                       |                      |
|-----------------------|----------------------|
| Example: $\xi_1 = 20$ | $\alpha_{10} = 4.38$ |
| $\xi_3 = 80$          | $\alpha_{1L} = 4.62$ |
| $\alpha_1 = 4.50$     | $\psi_1 = 11.36$     |
| $\xi_2 = 2$           | $\alpha_{10} = 3.58$ |
| $\xi_4 = 100$         | $\alpha_{1L} = 4.63$ |
| $\alpha_1 = 4.09$     | $\psi_1 = 11.07$     |
| $b/a = .5$            |                      |
| $\alpha_{11} = 22.1$  |                      |

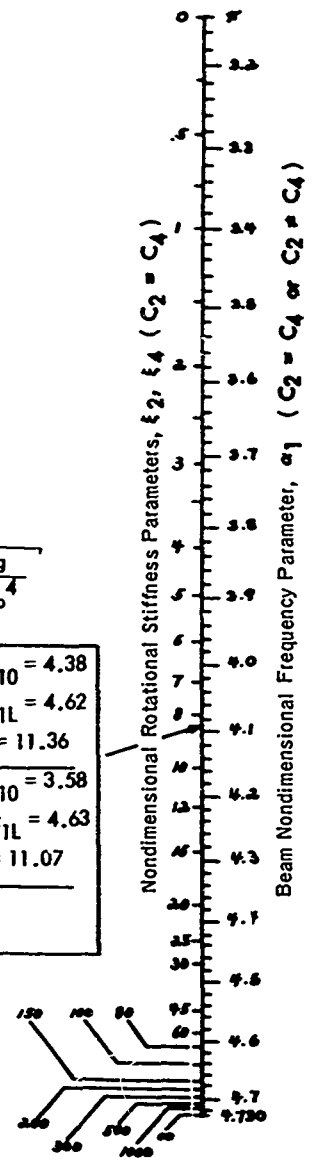

B

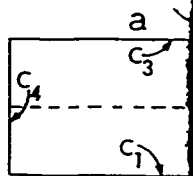
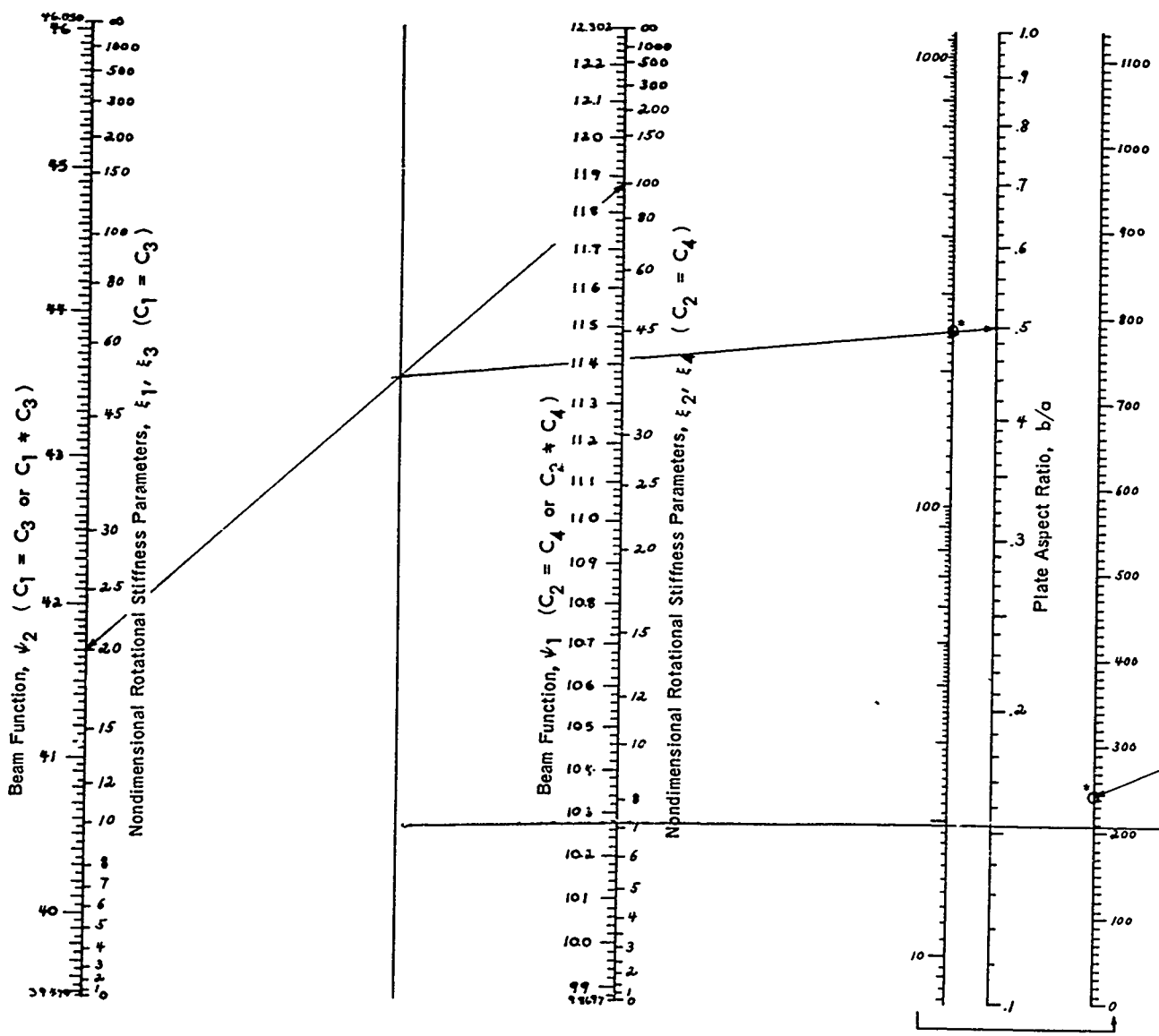

$$\xi_1 = \frac{C_1 b}{EI}$$

$$\xi_2 = \frac{C_2 a}{EI}$$

$$\xi_3 = \frac{C_3 b}{EI}$$

$$\xi_4 = \frac{C_4 a}{EI}$$

$$\alpha_{12} = \alpha_{12} \sqrt{\dots}$$

Example:  $\xi_1 = \xi_3$   
 $\xi_2 = \xi_4$   
 $b/a$   
 $\alpha_{12}$

Figure 17b - Nomograph for Plate Nondimensional Frequency Parameter  $\alpha_{12}$

A

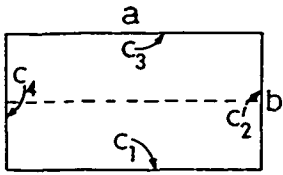

$$\xi_1 = \frac{C_1 b}{EI}$$

$$\xi_2 = \frac{C_2 a}{EI}$$

$$\xi_3 = \frac{C_3 b}{EI}$$

$$\xi_4 = \frac{C_4 a}{EI}$$

$$\alpha_{12} = \alpha_{12} \sqrt{\frac{Dg}{\mu b^4}}$$

Example:  $\xi_1 = \xi_3 = 20$   
 $\xi_2 = \xi_4 = 100$   
 $b/a = .5$   
 $\alpha_{12} = 21.4$

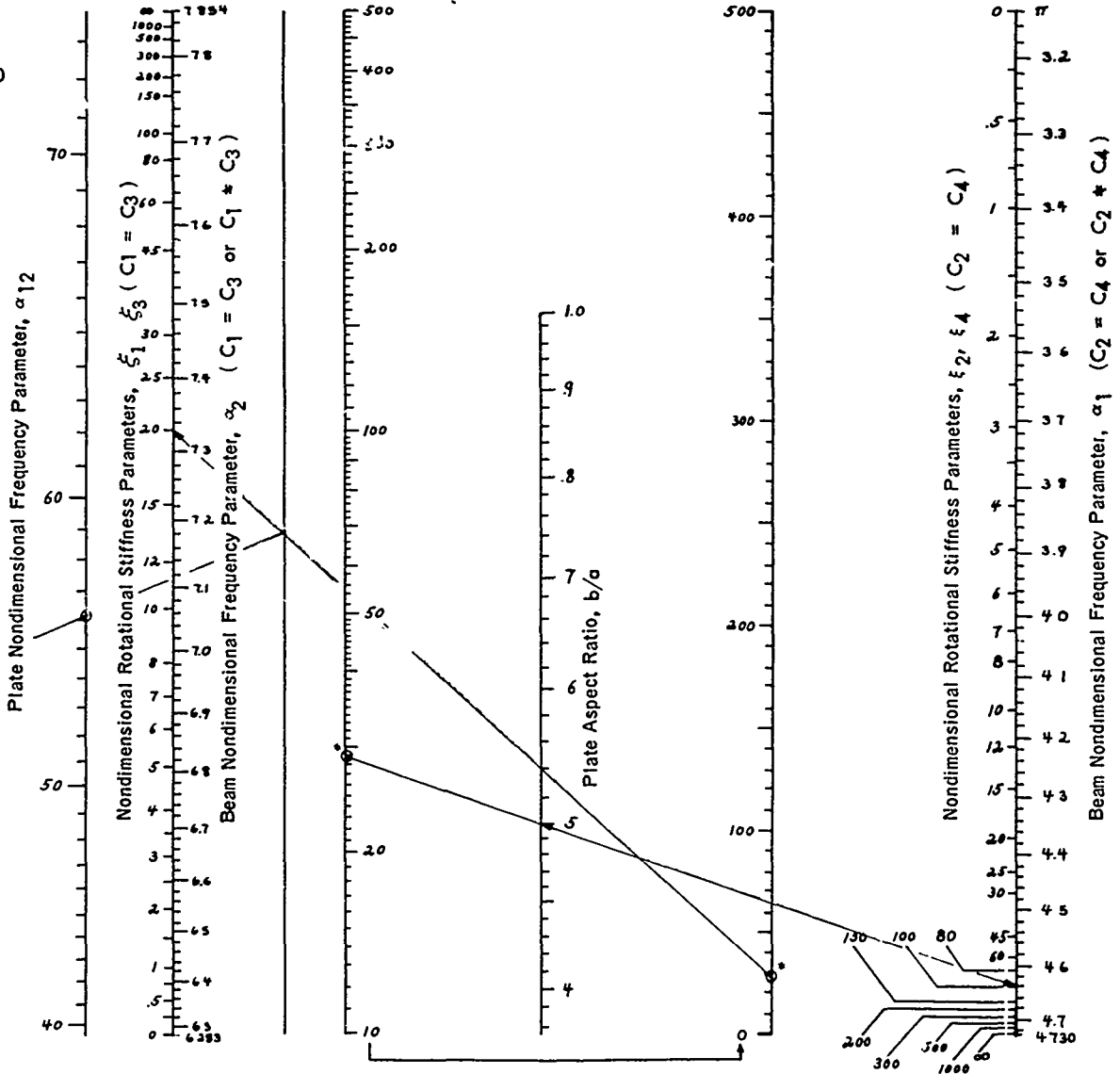

B

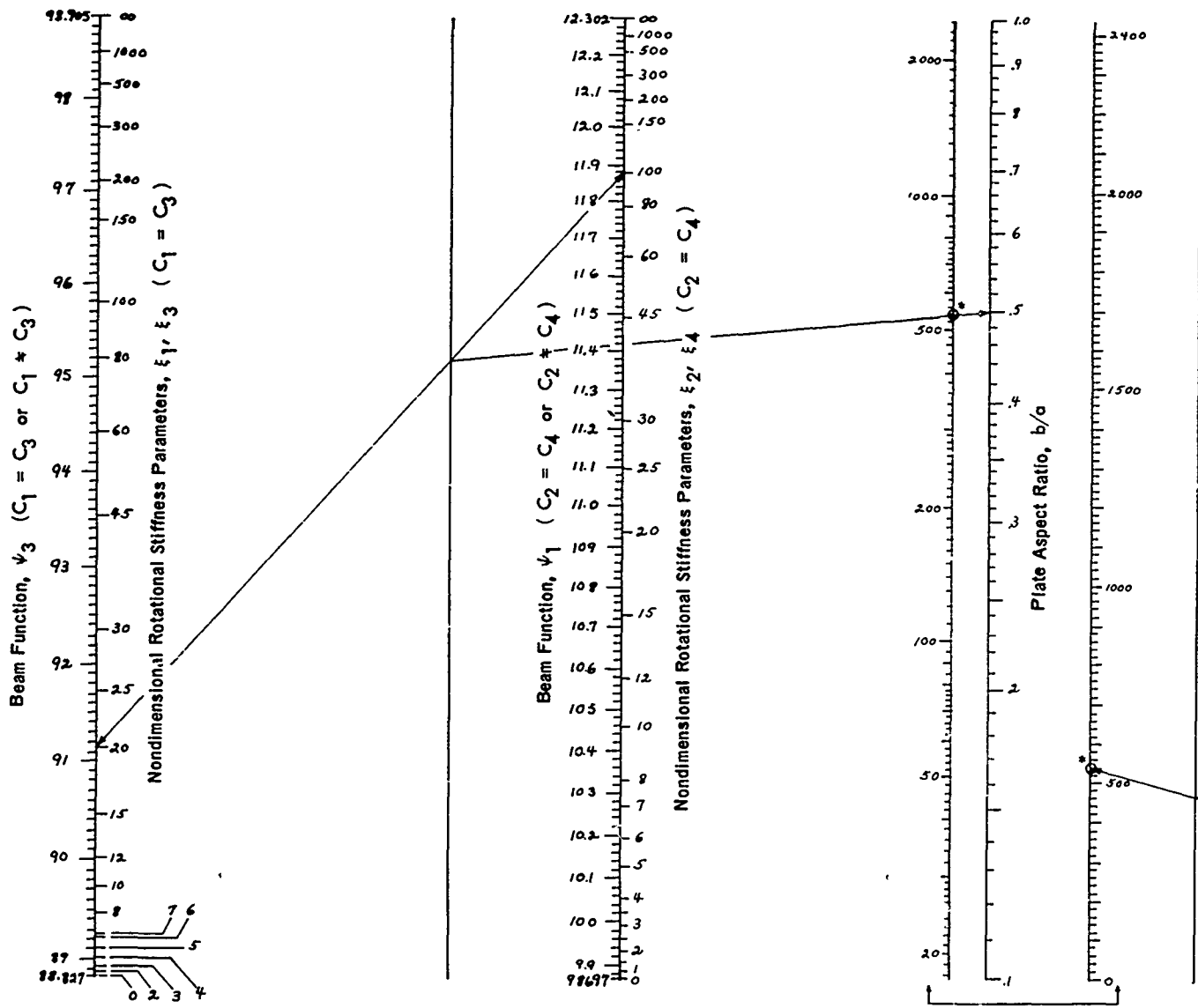
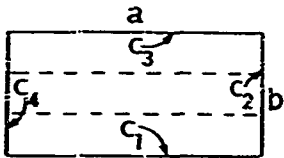

Figure 17c - Nomograph for Plate Nondimensional Frequency Parameter  $\alpha_{13}$

A

L

L



$$\xi_1 = \frac{C_1 b}{EI}$$

$$\xi_2 = \frac{C_2 a}{EI}$$

$$\xi_3 = \frac{C_3 b}{EI}$$

$$\xi_4 = \frac{C_4 a}{EI}$$

$$\alpha_B = \alpha_B \sqrt{\frac{D_B}{b^4}}$$

Example:  $\xi_1 = \xi_3 = 20$   
 $\xi_2 = \xi_4 = 100$   
 $b/a = .5$   
 $\alpha_B = 21.4$

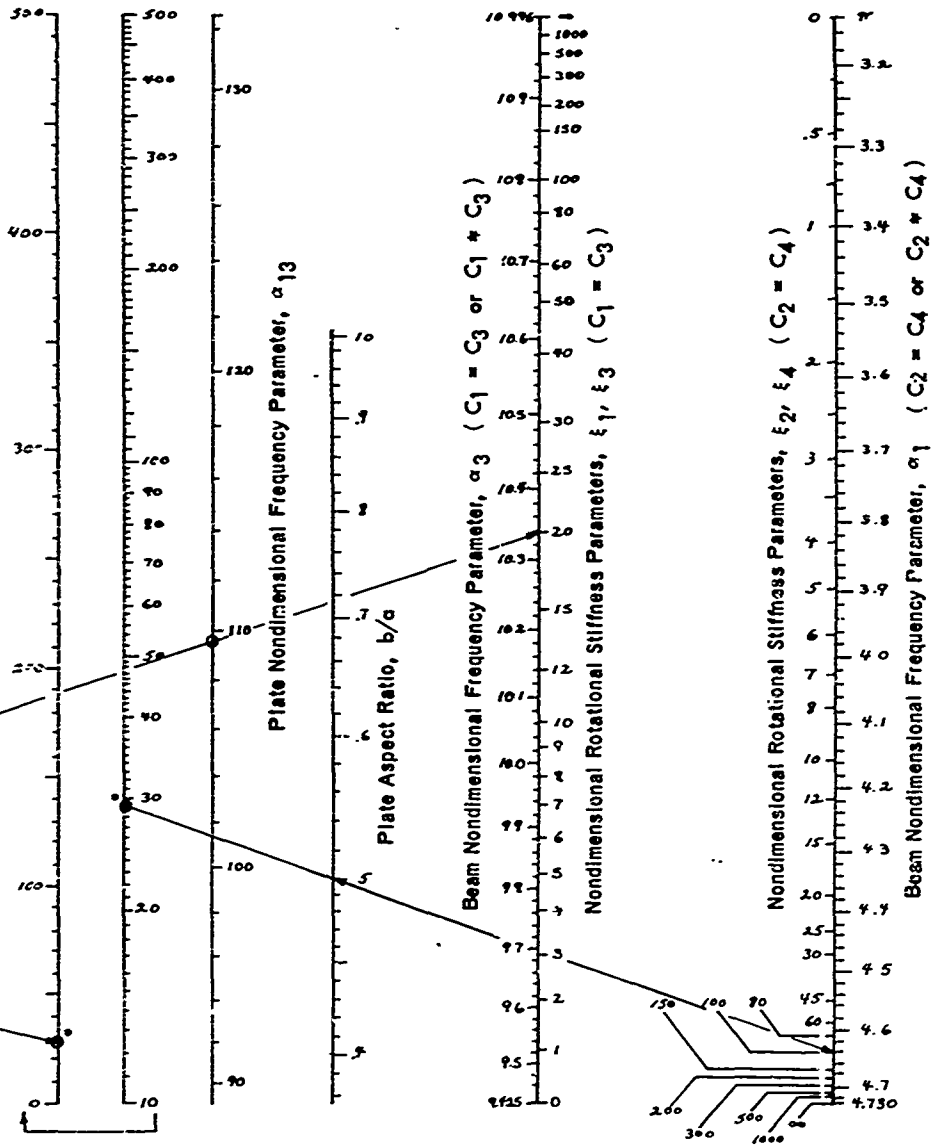

B

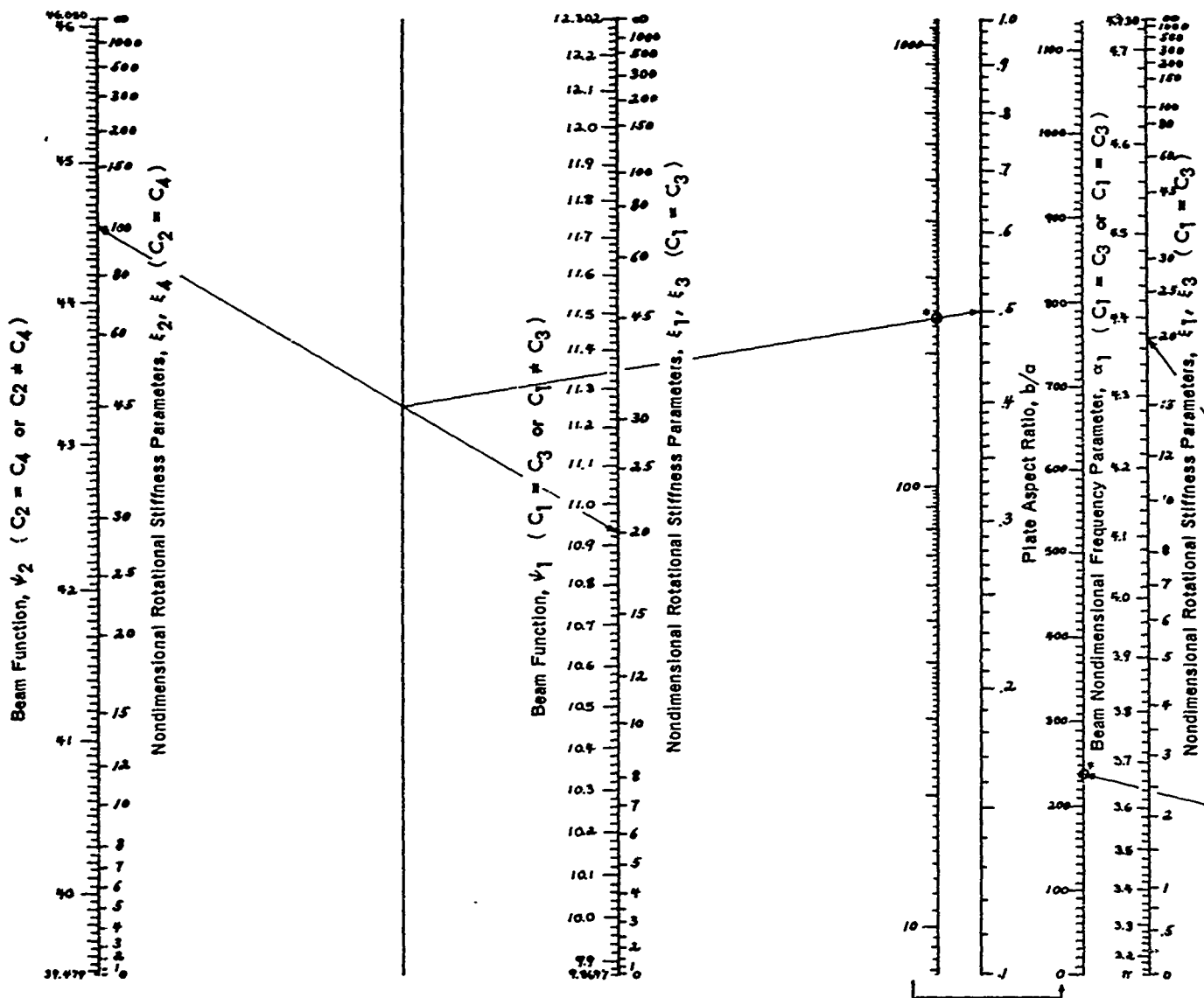
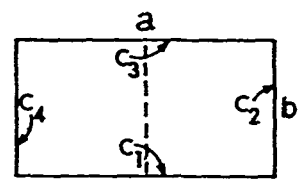
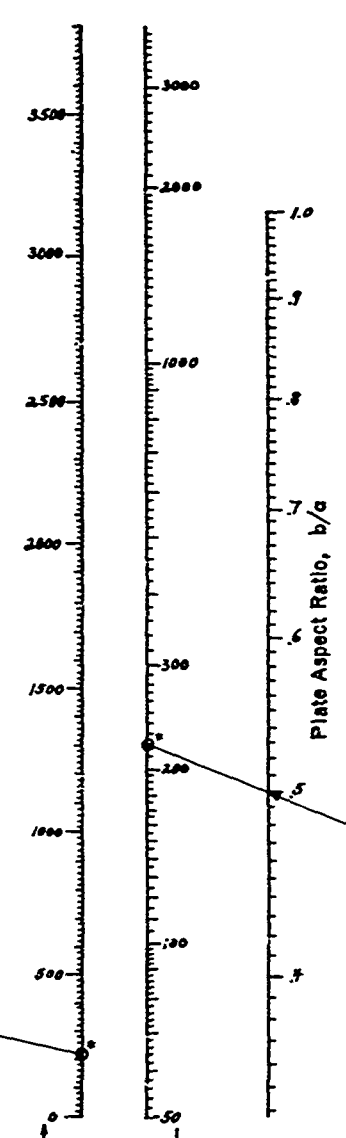
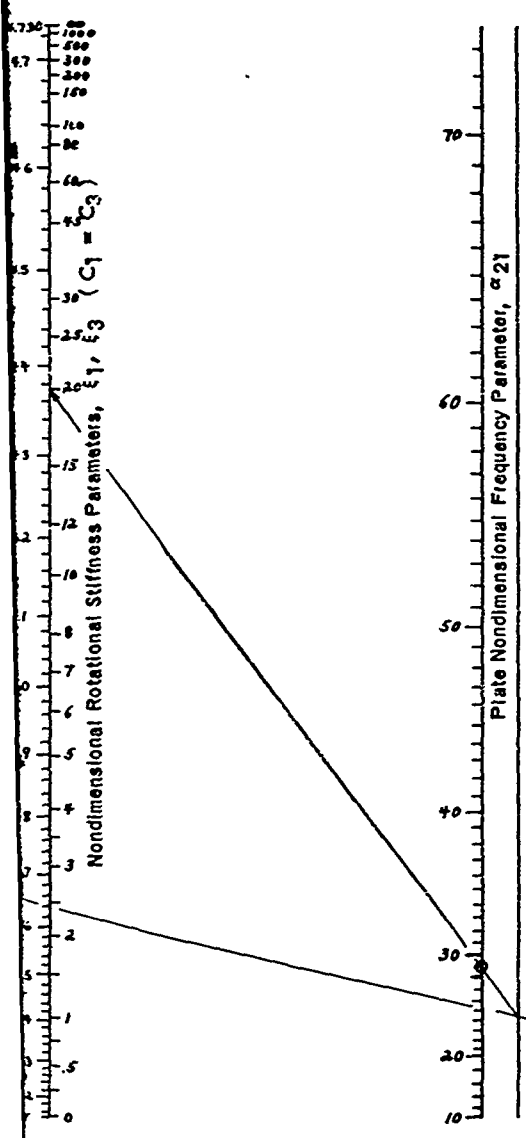

Figure 17d - Nomograph for Plate Nondimensional Frequency Parameter  $\alpha_{21}$

A



$$\xi_1 = \frac{C_1 b}{EI}$$

$$\xi_2 = \frac{C_2 a}{EI}$$

$$\xi_3 = \frac{C_3 b}{EI}$$

$$\xi_4 = \frac{C_4 a}{EI}$$

$$\alpha_{21} = \alpha_{21} \sqrt{\frac{Dg}{b^4}}$$

Example:  $\xi_1 = \xi_3 = 20$   
 $\xi_2 = \xi_4 = 100$   
 $b/a = .5$   
 $\alpha_{21} = 21.4$

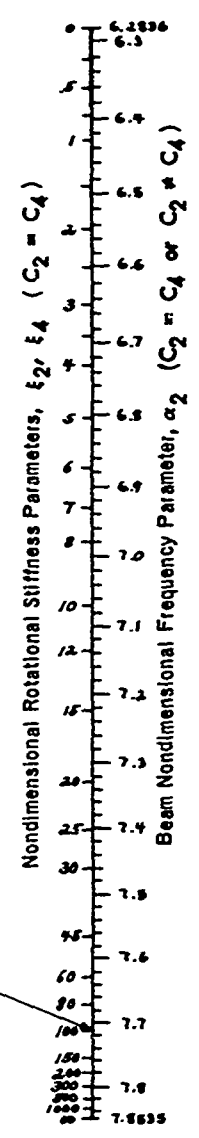

B

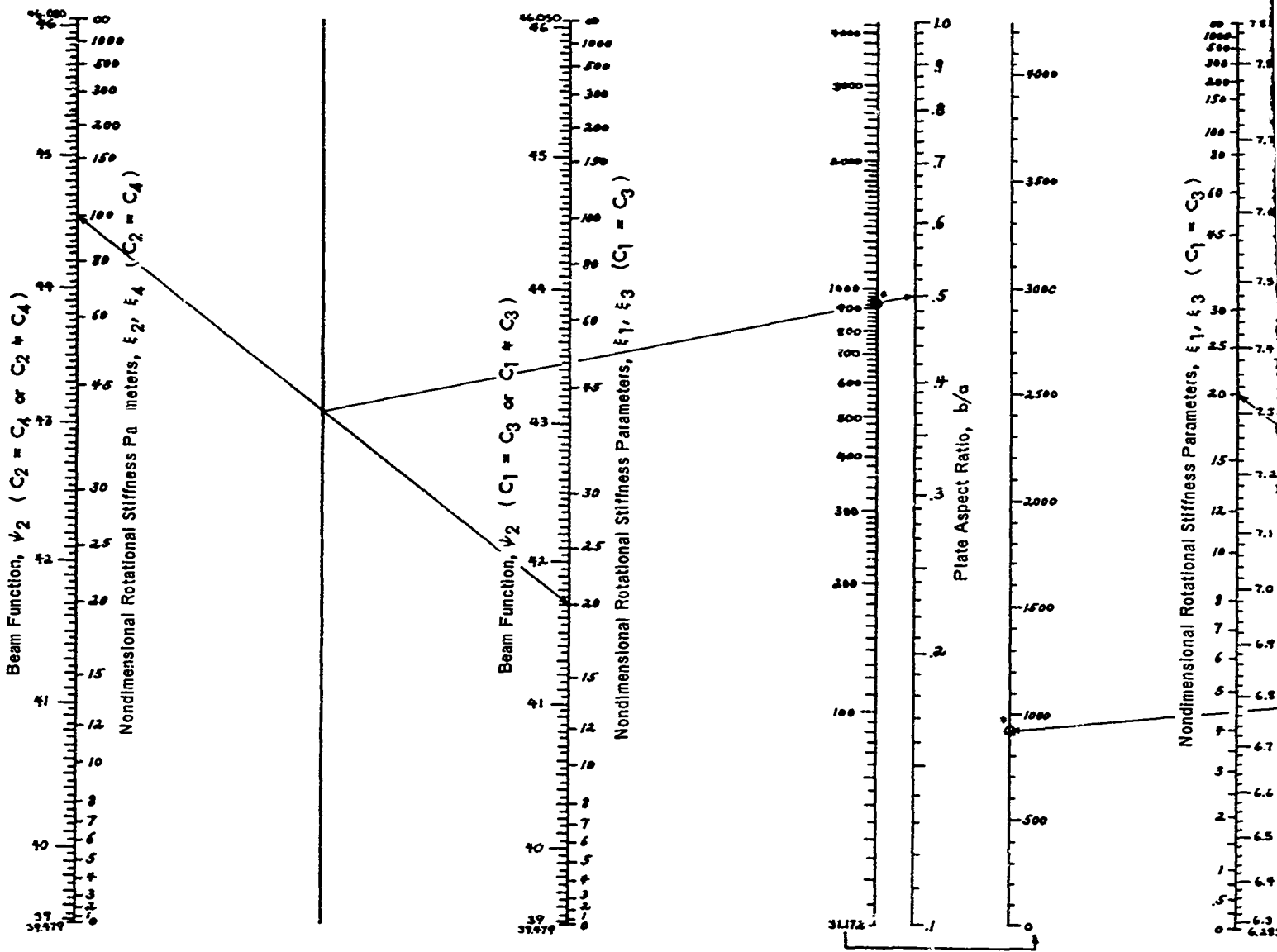
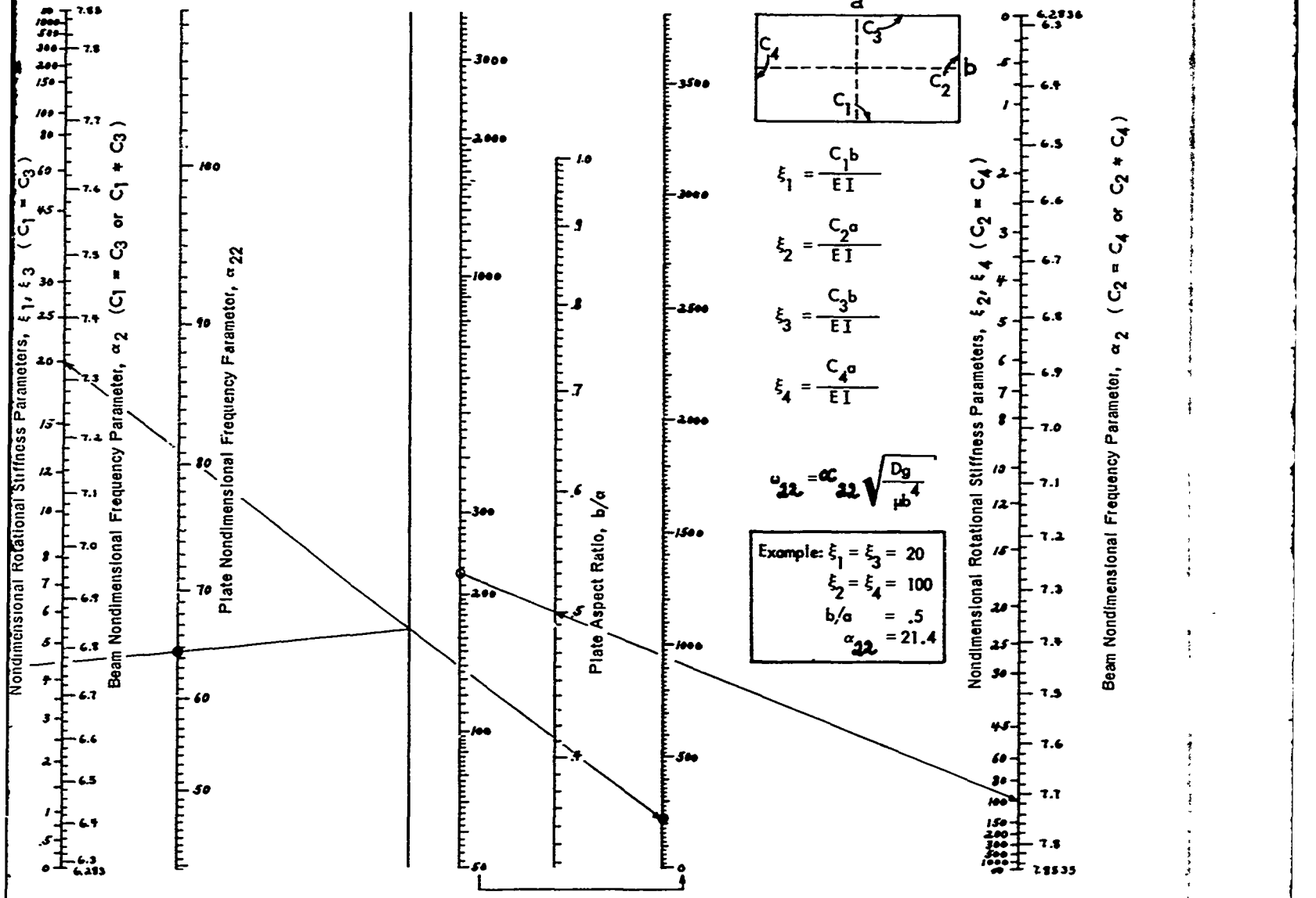

Figure 17e - Nomograph for Plate Nondimensional Frequency Parameter  $\alpha_{22}$

A





B

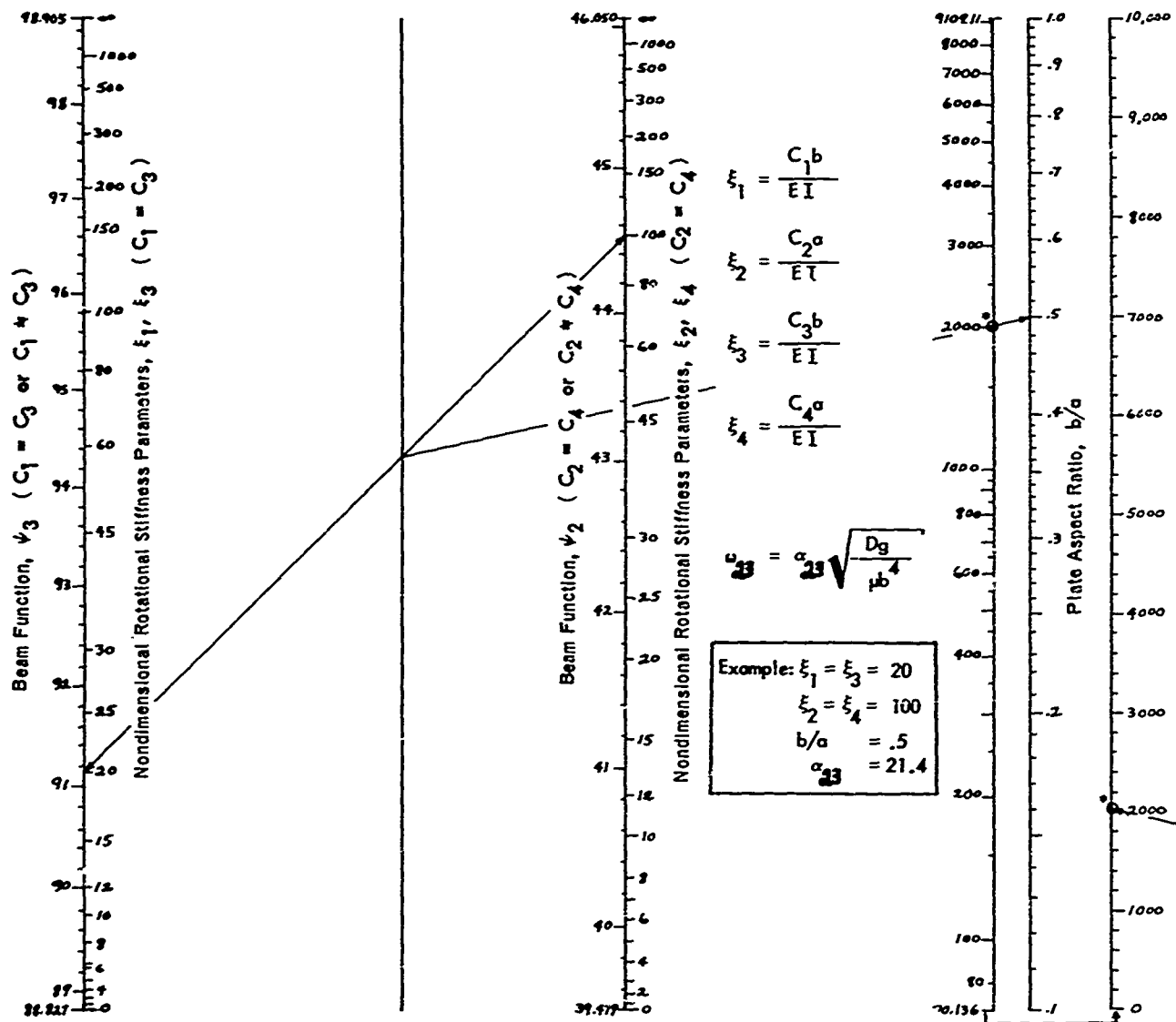

Figure 17f — Nomograph for Plate Nondimensional Frequency Parameter  $\alpha_{22}$

A

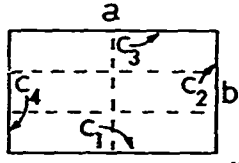

Plate Nondimensional Frequency Parameter,  $\alpha_{23}$

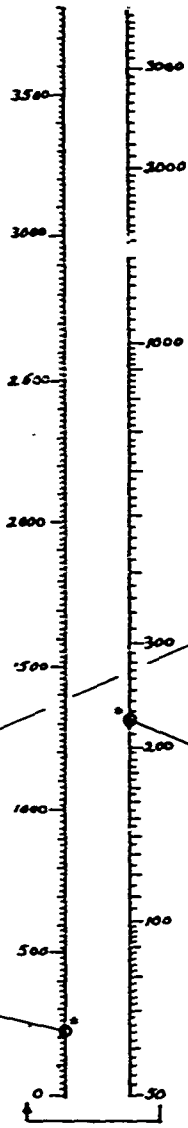
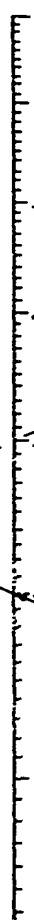
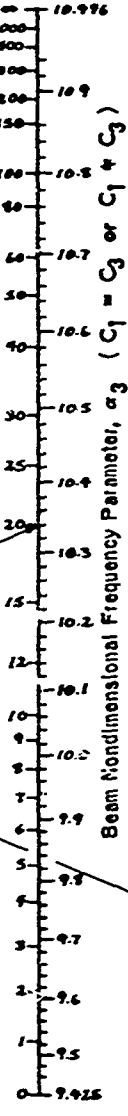

Plate Aspect Ratio,  $b/a$



Nondimensional Rotational Stiffness Parameters,  $\xi_1, \xi_3$  ( $C_1 = C_3$ )



Beam Nondimensional Frequency Parameter,  $\alpha_3$  ( $C_1 = C_3$  or  $C_1 \neq C_3$ )



Nondimensional Rotational Stiffness Parameters,  $\xi_2, \xi_4$  ( $C_2 = C_4$ )

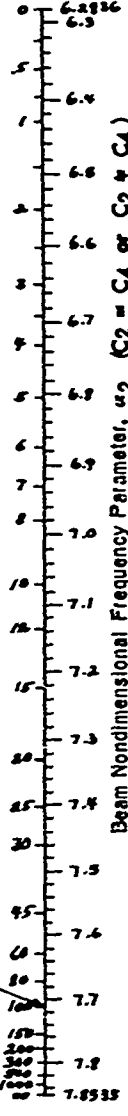

Beam Nondimensional Frequency Parameter,  $\alpha_2$  ( $C_2 = C_4$  or  $C_2 \neq C_4$ )



B

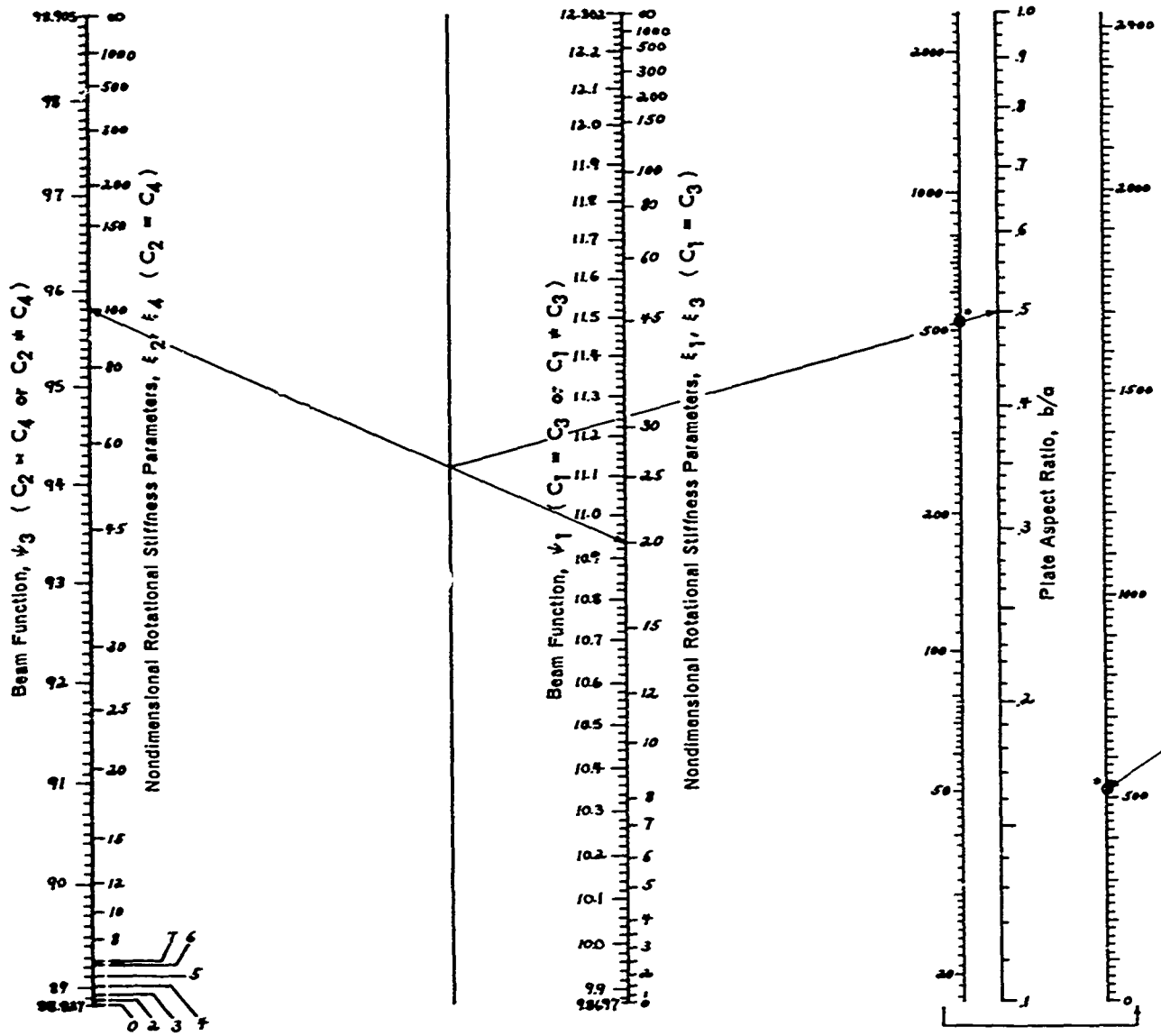
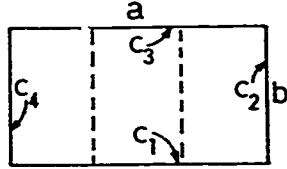
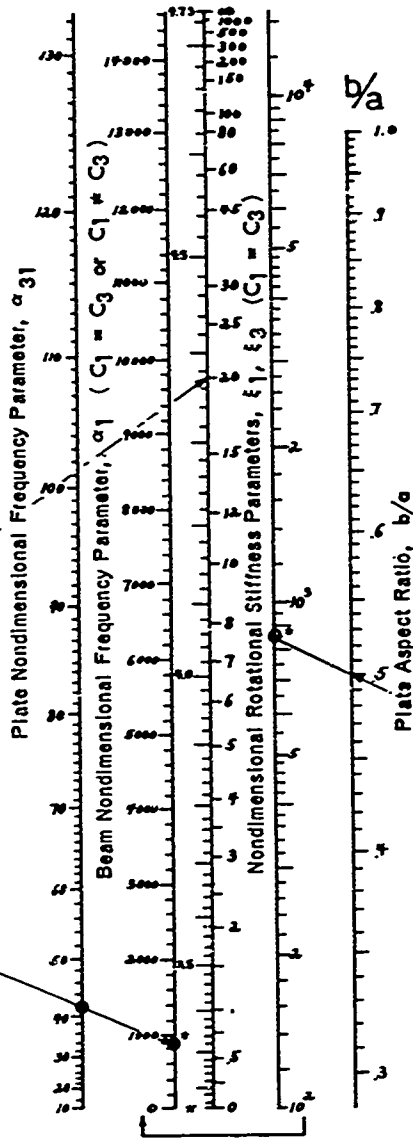

Figure 17g - Nomograph for Plate Nondimensional Frequency Parameter  $\alpha_{31}$

A



$$\xi_1 = \frac{C_1 b}{EI}$$

$$\xi_2 = \frac{C_2 a}{EI}$$

$$\xi_3 = \frac{C_3 b}{EI}$$

$$\xi_4 = \frac{C_4 a}{EI}$$

$$\alpha_{31} = \alpha_{31} \sqrt{\frac{Dg}{b^4}}$$

Example:  $\xi_1 = \xi_3 = 20$   
 $\xi_2 = \xi_4 = 100$   
 $b/a = .5$   
 $\alpha_{31} = 21.4$

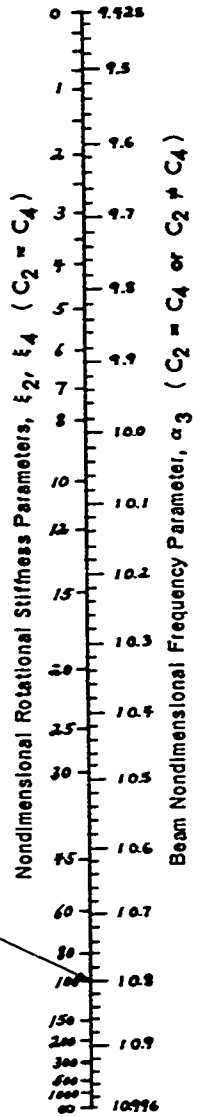

B

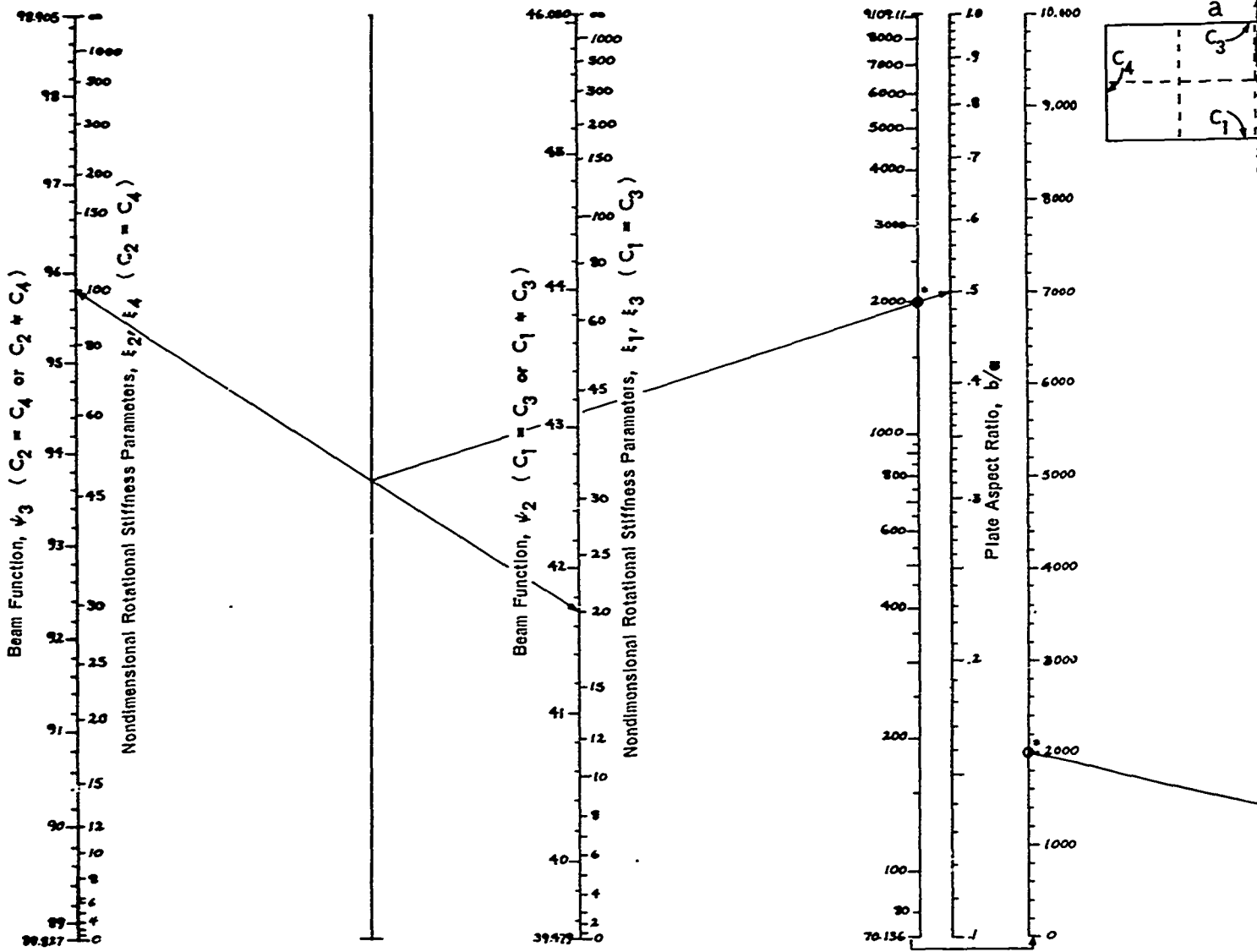
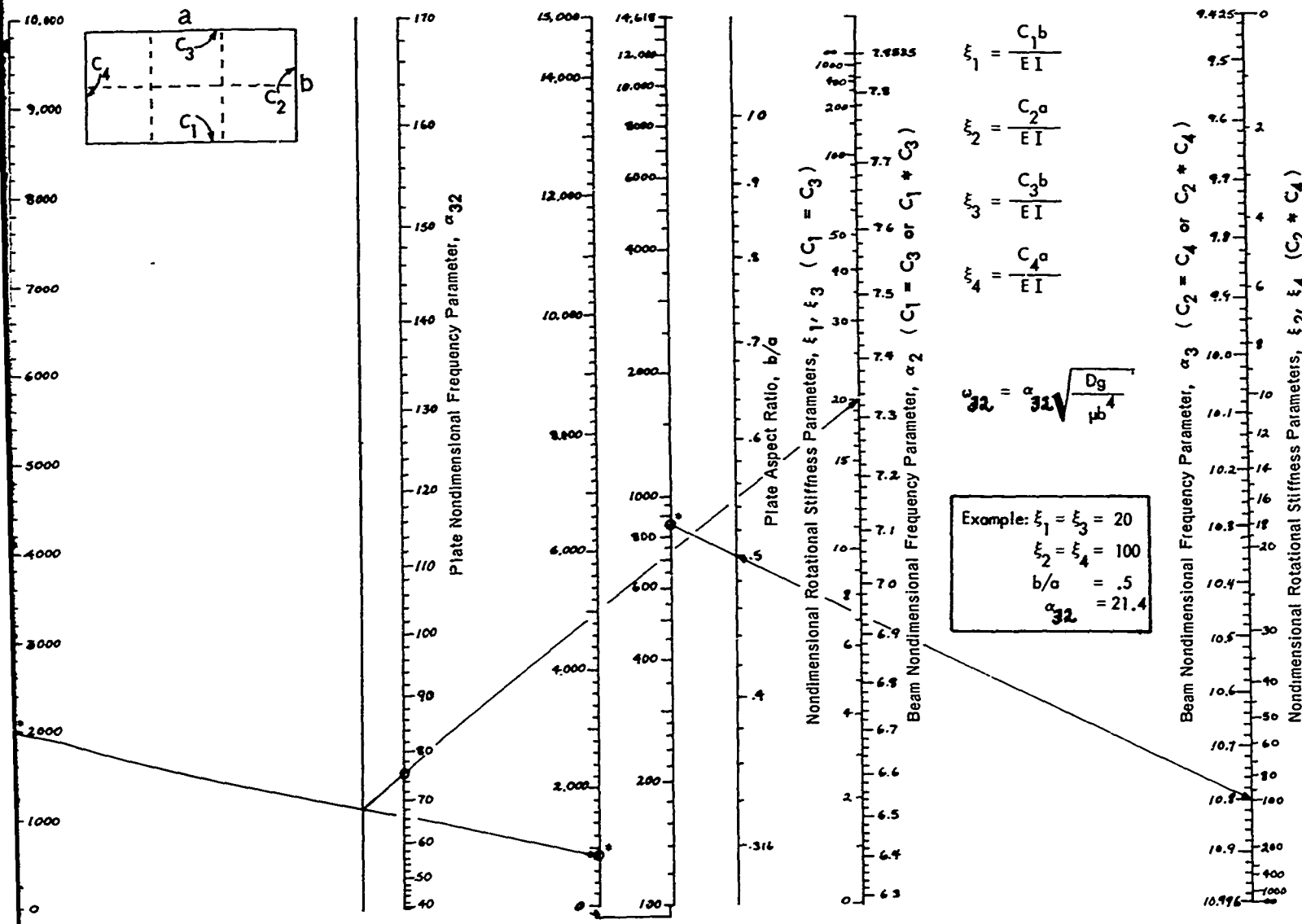

Figure 17h - Nomograph for Plate Nondimensional Frequency Parameter  $\alpha_{32}$

A



Example:  $\xi_1 = \xi_3 = 20$   
 $\xi_2 = \xi_4 = 100$   
 $b/a = .5$   
 $\alpha_{32} = 21.4$

B

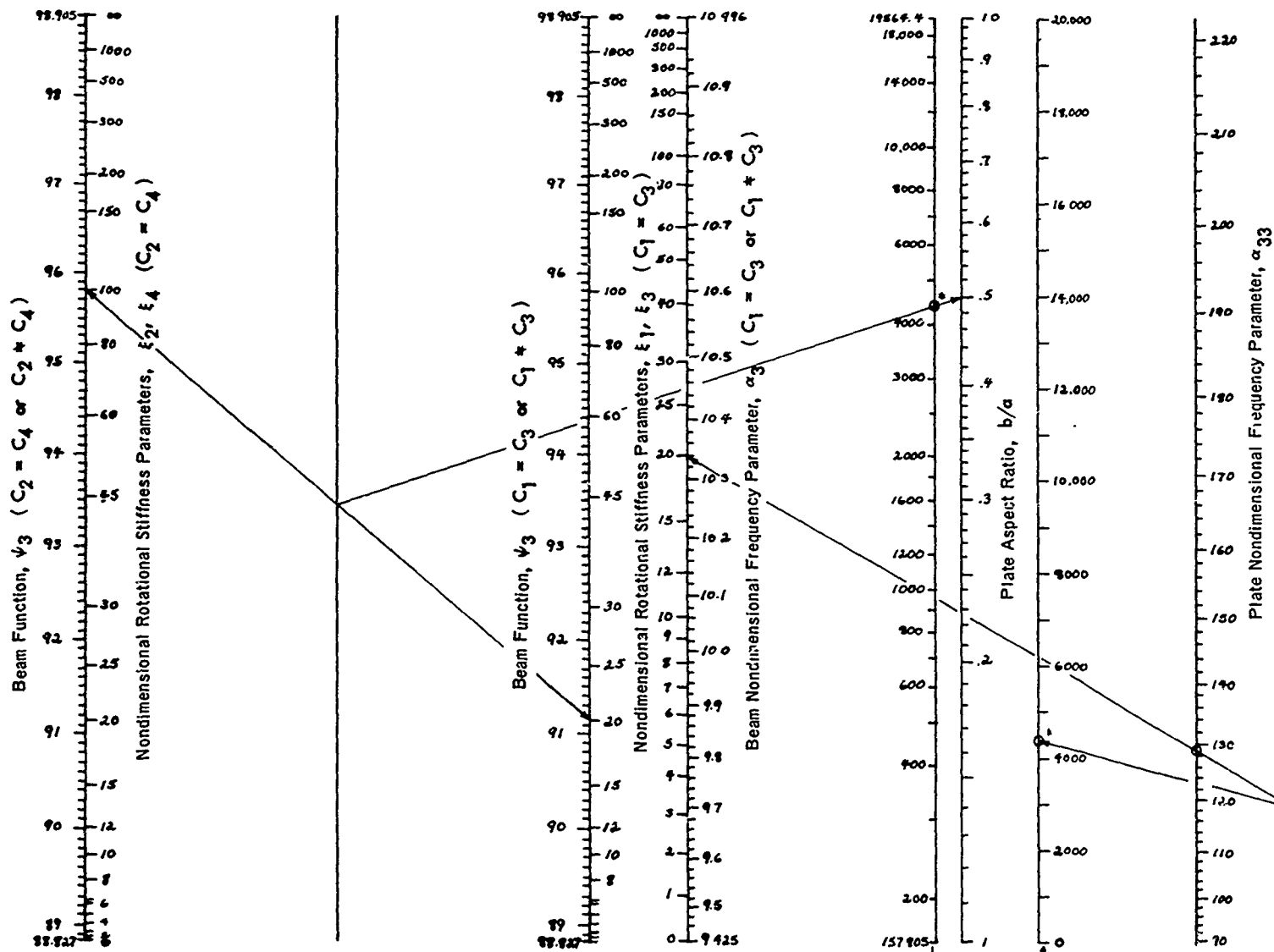
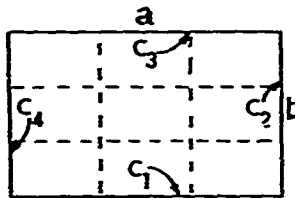
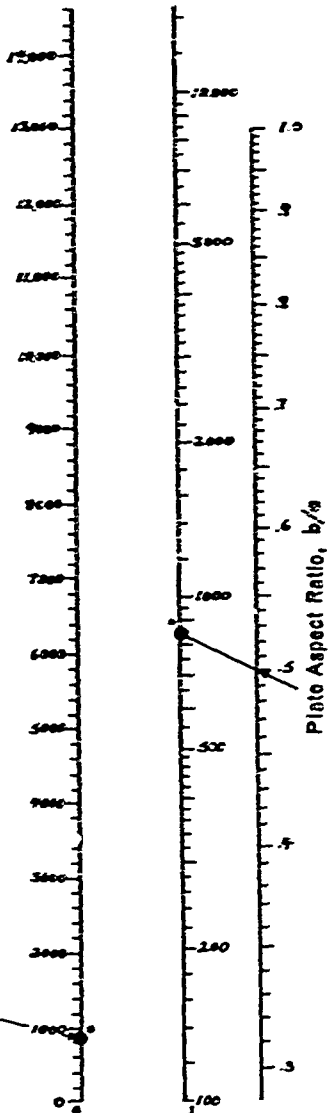
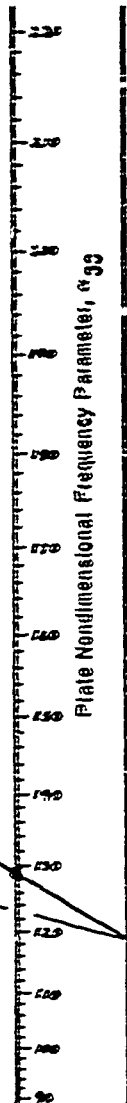

Figure 171 - Nomograph for Plate Nondimensional Frequency Parameter  $\alpha_{33}$

A





$$\xi_1 = \frac{C_1 b}{EI}$$

$$\xi_2 = \frac{C_2 a}{EI}$$

$$\xi_3 = \frac{C_3 b}{EI}$$

$$\xi_4 = \frac{C_4 a}{EI}$$

$$\alpha_{33} = \frac{R}{33} \sqrt{\frac{D_0}{b^4}}$$

Example:  $\xi_1 = \xi_3 = 20$   
 $\xi_2 = \xi_4 = 100$   
 $a/b = .5$   
 $\alpha_{33} = 21.4$

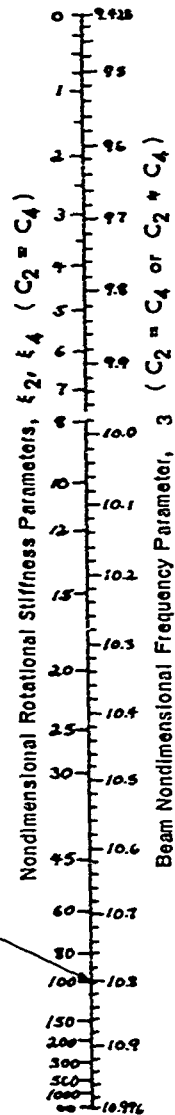

B

## APPENDIX F

### THE CROCKER METHOD

#### NOTATION

|                  |  |
|------------------|--|
| $A$              | Modal constant   |
| $a$              | Panel length in $x$ -direction   |
| $B$              | Modal constant   |
| $b$              | Panel width in $y$ -direction  |
| $C$              | Modal constant   |
| $D$              | Modal constant; also equal to $EI = \frac{Eh^3}{12(1-\nu^2)}$                              |
| $E$              | Young's modulus  |
| $e$              | Base of natural logarithms = 2.716   |
| $f_r$            | Normalized $r$ th mode shape of panel  |
| $h$              | Panel thickness  |
| $I$              | Second moment of area of cross section about neutral axis through its centroid             |
| $\ell$           | Length of equivalent beam  |
| $m$              | Mode number in $x$ -direction  |
| $n$              | Mode number in $y$ -direction  |
| $R$              | Frequency parameter  |
| $X$              | Modal function of $x$ or $y$   |
| $ X $            | Maximum value of $X$   |
| $x, y$           | Distance measured along and perpendicular to the undeflected equivalent beam, respectively |
| $\alpha$         | Frequency parameter  |
| $\Delta, \delta$ | Small quantities   |
| $\lambda$        | Frequency parameter  |

|          |                              |
|----------|------------------------------|
| $\rho$   | Density of material          |
| $\sigma$ | Poisson's ratio              |
| $\phi$   | Normalized mode shape        |
| $\psi$   | Resonant frequency parameter |
| $\omega$ | Circular frequency           |

**Subscripts**

|        |   |
|--------|---|
| $m, n$ | Refer to $m$ th and $n$ th modes, respectively  |
| $n$    | Refers to direction normal to certain direction |
| $r$    | Refers to $r$ th mode                           |
| $x$    | Refers to $x$ -direction                        |
| $y$    | Refers to $y$ -direction                        |

## DESCRIPTION

Crocker<sup>23</sup> presents an analysis for computing the normal modes and frequencies of a uniform flat panel with fully fixed edge conditions. The method involves an approximate solution of the frequency equations.

## DERIVATION

The mode shapes of a clamped-clamped panel are approximately

$$f_i(x, y) = \frac{X_m(x) X_n(y)}{|X_m(x)| |X_n(y)|} = \frac{1}{|X_m| |X_n|} \left[ A_m \cosh \alpha_m \frac{x}{a} + B_m \sinh \alpha_m \frac{x}{a} + C_m \cos \alpha_m \frac{x}{a} + D_m \sin \alpha_m \frac{x}{a} \right] \cdot \left[ A_n \cosh \alpha_n \frac{y}{b} + B_n \sinh \alpha_n \frac{y}{b} + C_n \cos \alpha_n \frac{y}{b} + D_n \sin \alpha_n \frac{y}{b} \right] \quad (\text{F1})$$

where the quantities in brackets or  $X_m$ ,  $X_n$  represent the mode shapes of vibrating uniform beams lying along the  $x$ - and  $y$ -axes, respectively, and  $|X_m|$  and  $|X_n|$  are their respective values. Applying the boundary conditions for a clamped-clamped plate, i.e., for either

$$X_m \text{ or } X_n, X = \frac{\partial X}{\partial x} = 0 \text{ at } \begin{cases} x=0, & y=0 \\ x=a, & y=b \end{cases}$$

Then

$$A = -C$$

$$B = -D$$

and

$$0 = A \cosh \alpha + B \sinh \alpha + C \cos \alpha + D \sin \alpha \quad (\text{F2})$$

$$0 = A \sinh \alpha + B \cosh \alpha - C \sin \alpha + D \cos \alpha$$

Equations (F2) may be solved in order to obtain the frequency equations for a clamped-clamped plate:

$$\begin{aligned} \cosh \alpha_m \cos \alpha_m &= 1 \\ \cosh \alpha_n \cos \alpha_n &= 1 \end{aligned} \quad (\text{F3})$$

### Solution of Frequency Equations

The solution of Equations (F3) may be shown to be of the form:

$$\alpha_m = (2m + 1) \cdot \frac{\pi}{2} + \Delta; \quad m = 1, 2, 3 \dots, \infty \quad (\text{F4})$$

where  $\Delta \rightarrow 0$  as  $m \rightarrow \infty$ . Now

$$\begin{aligned} \cosh \alpha_m &= \left[ \cosh (2m + 1) \cdot \frac{\pi}{2} \right] \cosh \Delta + \left[ \sinh (2m + 1) \cdot \frac{\pi}{2} \right] \sinh \Delta \\ &= \left[ \sinh (2m + 1) \cdot \frac{\pi}{2} \right] [\cosh \Delta + \sinh \Delta] \end{aligned} \quad (\text{F5})$$

and from Equation (F4)

$$\begin{aligned} \cos \alpha_m &= - \left[ \sin (2m + 1) \cdot \frac{\pi}{2} \right] \sin \Delta, \quad \left[ \text{since } \cos (2m + 1) \cdot \frac{\pi}{2} = 0 \right] \\ &= -(-1)^m \sin \Delta \end{aligned} \quad (\text{F6})$$

Thus from Equations (F3), (F5), and (F6):

$$(\cosh \Delta + \sinh \Delta) \sin \Delta = \frac{-(-1)^m}{\sinh (2m + 1) \cdot \frac{\pi}{2}} \quad (\text{F7})$$

But  $\Delta \approx 0$ . Thus for small values of  $\Delta$ ,

$$\cosh \Delta = \frac{1}{2} [e^\Delta + e^{-\Delta}] \approx \frac{1}{2} \left[ 1 + \Delta + \frac{\Delta^2}{2} + 1 - \Delta + \frac{\Delta^2}{2} \right] = \left[ 1 + \frac{\Delta^2}{2} \right] \quad (\text{F8})$$

$$\sinh \Delta = \frac{1}{2} [e^\Delta - e^{-\Delta}] \approx \frac{1}{2} \left[ 1 + \Delta + \frac{\Delta^2}{2} - 1 + \Delta + \frac{\Delta^2}{2} \right] = \Delta \quad (\text{F9})$$

$$\sin \Delta \approx \Delta \quad (\text{F10})$$

Thus substituting Equations (F8), (F9), and (F10) into Equation (F7) gives:

$$\left( 1 + \Delta + \frac{\Delta^2}{2} \right) \Delta = \frac{(-1)^m}{\sinh (2m + 1) \cdot \frac{\pi}{2}} \approx 2(-1)^m e^{-2(m+1) \frac{\pi}{2}} \quad (\text{F11})$$

and neglecting terms of order greater than  $\Delta$ , then:

$$\Delta = 2(-1)^{m+1} \cdot e^{-(2m+1) \cdot \frac{\pi}{2}} \quad (\text{F12})$$

Using Equations (F4) and (F12), values of  $\alpha_1$  to  $\alpha_{10}$  were calculated in Reference 23 and are presented in Table 7. It was found that for the higher frequency parameters, the value of  $\Delta$  became negligible and Equation (F4) was sufficiently accurate. For example,  $\Delta_6 = -1.436 \times 10^{-10}$  and was thus negligible. Equations (F3) may also be solved by assuming a solution such as Equation (F4) with  $\Delta = 0$  and using the Newton method to refine the original approximate solution.

#### Determination of the Modal Constants

Arbitrarily putting one of the modal constants  $D_m = 1$ , the other modal constants may be determined from Equations (F2).

Thus  $B = -D = -1$  and  $A_m \sinh \alpha_m - \cosh \alpha_m + A_m \sin \alpha_m + \cos \alpha = 0$ .

$$A_m = \frac{\cosh \alpha_m - \cos \alpha_m}{\sinh \alpha_m + \sin \alpha_m} \quad (\text{F13})$$

But using Equations (F5) and (F9),

$$\cosh \alpha_m = \frac{e^{(2m+1) \frac{\pi}{2}}}{2} = \sinh \alpha_m$$

Thus:

$$A_m = \frac{\sinh \alpha_m - \cos \alpha_m}{\sinh \alpha_m + \sin \alpha_m} = \frac{1 - \frac{\cos \alpha_m}{\sinh \alpha_m}}{1 + \frac{\sin \alpha_m}{\sinh \alpha_m}}$$

$$A_m = \left(1 - \frac{\cos \alpha_m}{\sinh \alpha_m}\right) \cdot \left(1 - \frac{\sin \alpha_m}{\sinh \alpha_m}\right)$$

$$A_m \approx 1 - \frac{(\sin \alpha_m + \cos \alpha_m)}{\sinh \alpha_m}$$

TABLE 7

Parameters for a Clamped-Clamped Mode Shape

| $m$ or $n$ | Frequency Parameter<br>$\alpha_m$ or $\alpha_n$ | Resonant<br>Frequency Parameter<br>$\psi_m$ or $\psi_n$ | Maximum<br>Displacement<br>$X_m$ or $X_n$ | Modal Coefficient<br>$A_m$ or $A_n$ |
|------------|---|---|---|-------------------------------------|
| 1          | 4.73004   | 12.302  | 1.61628                                   | 1.017804                            |
| 2          | 7.85320   | 46.050  | 1.50605                                   | 0.999224                            |
| 3          | 10.99560  | 98.905  | 1.51259                                   | 1.000034                            |
| 4          | 14.13720  | 171.590   | 1.51228                                   | 0.999998552                         |
| 5          | 17.27880  | 264.1376  | 1.5125                                    | 1.000000627                         |
| 6          | 20.420352                                       | 376.1092  | 1.5125                                    | 0.9999999729                        |
| 7          | 23.561945                                       | 506.8633  | 1.5125                                    | 1.00000001175                       |
| 8          | 26.703537                                       | 659.4048  | 1.5125                                    | 0.999999999491                      |
| 9          | 29.845130                                       | 830.7431  | 1.5125                                    | 1.0000000000220                     |
| 10         | 32.986722                                       | -   | 1.5125                                    | 0.999999999999046                   |

Note: The modal coefficients  $C_m = -A_m$  and  $B_m = -D_m = -1$ . More significant figures are given where they are required for accurate calculations.

But from Equation (F6)

$$\cos \alpha_m = -(-1)^m \sin \Delta$$

and from Equation (F4)

$$\sin \alpha_m = \left[ \sin (2m + 1) \cdot \frac{\pi}{2} \right] \cos \Delta; \quad \left[ \text{since } \cos (2m + 1) \cdot \frac{\pi}{2} = 0 \right] = (-1)^m \cos \Delta$$

Thus

$$A_m = 1 - \frac{[(-1)^m \cdot \cos \Delta - (-1)^m \cdot \sin \Delta]}{\sin \alpha_m}$$

$$A_m = 1 - \frac{(-1)^m \cdot [\cos \Delta - \sin \Delta]}{\sinh \alpha_m}$$

$$A_m = -C_m = 1 - (-1)^m \cdot [1 - \Delta] \cdot 2e^{-\alpha_m} \cdot 2e^{-\frac{\pi}{2}} \quad (\text{F14})$$

Thus using Equation (F14), values of  $A_m$  and  $C_m$  were calculated for  $m=1$  through 10; see Table 7

#### Determination of Resonant Frequency Parameters

From Equations (E19) of Appendix E with  $\lambda_{mn} = R_{mn}$  and  $D = EI = \frac{Eh^3}{12(1 - \sigma^2)}$ , the undamped resonant circular frequency of the  $mn$ th mode of the plate is:

$$\omega_{mn} = \sqrt{R_{mn}} \frac{h}{b^2} \sqrt{\frac{E}{12\rho(1 - \sigma^2)}} \quad (\text{F15})$$

where

$$R_{mn} = \left(\frac{b}{a}\right)^4 \cdot \alpha_m^4 + \alpha_n^4 + 2\left(\frac{b}{a}\right)^2 \cdot \psi_m \psi_n \quad (\text{F16})$$

$\alpha_m$  was derived above in this appendix and values are given in Table 7. Also the following relations were derived in Reference 21 and used in Appendix E.

$$\psi_m = \frac{\overline{\phi_m''} \cdot \phi_m}{\phi_m^2} \quad (\text{F17})$$



where

$$\begin{aligned}\phi_m &= \frac{1}{|X_m|} \left[ (A_m + B_m) \sinh \alpha_m \cdot \frac{z}{l} + A_m \left( e^{-\alpha_m \frac{z}{l}} - \cos \alpha_m \cdot \frac{z}{l} \right) + \sin \alpha_m \cdot \frac{z}{l} \right] \\ \phi_m' &= \frac{\alpha_m}{|X_m|} \left[ (A_m + B_m) \cosh \alpha_m \cdot \frac{z}{l} + A_m \left( -e^{-\alpha_m \frac{z}{l}} + \sin \alpha_m \cdot \frac{z}{l} \right) + \cos \alpha_m \cdot \frac{z}{l} \right] \\ \phi_m'' &= \frac{\alpha_m^2}{|X_m|} \left[ (A_m + B_m) \sinh \alpha_m \cdot \frac{z}{l} + A_m \left( e^{-\alpha_m \frac{z}{l}} + \cos \alpha_m \cdot \frac{z}{l} \right) - \sin \alpha_m \cdot \frac{z}{l} \right] \\ \phi_m''' &= \frac{\alpha_m^3}{|X_m|} \left[ (A_m + B_m) \cosh \alpha_m \cdot \frac{z}{l} + A_m \left( -e^{-\alpha_m \frac{z}{l}} + \sin \alpha_m \cdot \frac{z}{l} \right) - \cos \alpha_m \cdot \frac{z}{l} \right]\end{aligned}\tag{F18}$$

and where

$$\overline{\phi_m'' \phi_m} = \frac{1}{4\alpha_m^4} \left[ \phi_m''' \phi_m'' \right]_0^l + \frac{1}{4} \left[ \phi_m \phi_m' \right]_0^l \overset{\text{zero}}{\cancel{}} - \frac{\alpha_m^2}{2|X_m|^2} [B_m^2 - A_m^2 + C_m^2 + D_m^2]\tag{F19}$$

$$\overline{\phi_m'^2} = \frac{3}{4\alpha_m^4} \left[ \phi_m \phi_m''' \right]_0^l \overset{\text{zero}}{\cancel{}} + \frac{1}{4\alpha_m^4} \left[ \phi_m' \phi_m'' \right]_0^l \overset{\text{zero}}{\cancel{}} + \frac{1}{2|X_m|^2} [A_m^2 - B_m^2 + C_m^2 + D_m^2]\tag{F20}$$

The terms shown zero in Equations (F19) and (F20) are zero due to the boundary conditions  $\phi_m = \phi_m' = 0$  at  $x = 0$  and  $x = l$  for a clamped-clamped mode.

Substituting Equations (F19) and (F20) into Equation (F17) and utilizing Equations (F18) gives, after simplification,

$$\begin{aligned}\psi_m &= \left\{ \frac{\alpha_m}{2} \{ [(A_m + B_m) \cosh \alpha_m + A (-e^{-\alpha_m} - \sin \alpha_m) - \cos \alpha_m] [(A_m + B_m) \sinh \alpha_m \right. \\ &\quad \left. + A_m (e^{-\alpha_m} + \cos \alpha_m) - \sin \alpha_m] + 2A_m (1 - B_m) \} - \alpha_m^2 [B_m^2 - A_m^2 + C_m^2 + D_m^2] \right\} / \\ &\quad [A_m^2 - B_m^2 + C_m^2 + D_m^2]\end{aligned}\tag{F21}$$

Equation (F21) was evaluated for  $m = 1$  through 9; the values are presented in Table 7.

### Value of Position of Maximum Displacement for Each Mode

In order to simplify the computer program for the response of a clamped-clamped panel, it was necessary to determine the maximum value  $X_m$ , denoted  $|X_m|$ , for each mode. In fact, the simplest and most accurate method found was to calculate the mode shape:

$$X_m(x) = \left[ A_m \cosh \alpha_m \cdot \frac{x}{a} + B_m \sinh \alpha_m \cdot \frac{x}{a} + C_m \cos \alpha_m \cdot \frac{x}{a} + D_m \sin \alpha_m \cdot \frac{x}{a} \right] \quad (\text{F22})$$

by means of a computer. The computer program written by Crocker is given in Figure 18. Both numerical values and computer plots were obtained for  $m = 1$  through 10, and the computer plots are given in Figures 19-23. In this manner, both values of  $|X_m|$  and  $X_m$  for  $x = a/2$  were obtained. Since the whole mode shape was calculated, the response of any point of the panel could be computed by using the appropriate values of  $X_m(x)$  and  $X_n(y)$ . It is interesting to notice that Figures 19-23 indicate that the maximum displacement  $|X_m|$  does not occur at the center of the span except for the first mode, but two maxima  $|X_m|$  occur for the higher modes, one nearest to each support. The other maxima are found to be slightly smaller, to be of approximately constant value for the higher modes, and to lie between positions of the maxima  $|X_m|$ .

An approximate method is given below for determining the value and position of the maximum displacement  $|X_m|$  for the higher modes. Although approximate,  $|X_m|$  calculated by this method is seen to be only 0.66 percent smaller than when calculated by the more exact computer program.

The mode shape as given by Equation (F22) may be rewritten:

$$X_m = (A_m + B_m) \sinh \alpha_m \cdot \frac{x}{a} + A_m \left( e^{-\alpha_m x/a} - \cos \frac{\alpha_m x}{a} \right) + \sin \frac{\alpha_m x}{a} \quad (\text{F23})$$

but for a maximum or minimum value of  $X_m$ :

$$\frac{\alpha_m}{a} \left( \frac{dX_m}{dx} \right) = 0 = (A_m + B_m) \cosh \frac{\alpha_m x}{a} + A_m \left( -e^{-\alpha_m x/a} + \sin \frac{\alpha_m x}{a} \right) + \cos \frac{\alpha_m x}{a} \quad (\text{F24})$$

Since for the *higher modes*:

$$\left. \begin{aligned} A_m + B_m &= 0 \\ A_m &= 1 \end{aligned} \right\} \quad (\text{F25})$$

```

PROGRAM CROCKER
COMMON BLOCK
C CLAMPED-CLAMPED PLATE MODE SHAPES
DIMENSION ALPHA(10),PHAI(10),PHI(10)
HEAD(60)200 MODES(1)101010)
200 FORMAT(10A4)
C SM, OR FOR PLOTTING OFF FOR PRINTING
AL1=0.017804
AL2=0.099228
AL3=1.000036
AL4=0.99991552
AL5=1.0000000627
AL6=0.9999999373
AL7=1.0000000001
AL8=1.0
AL9=1.0
AL10=1.0
ALPHA1=0.71804
ALPHA2=0.745320
ALPHA3=0.79956
ALPHA4=0.841372
ALPHA5=0.8772788
ALPHA6=0.90420352
ALPHA7=0.923561385
ALPHA8=0.93703537
ALPHA9=0.945885130
ALPHA10=0.94986722
PHI1=0.71804E-02
PHI2=-7.76E-04
PHI3=0.340E-05
PHI4=-1.846E-06
PHI5=0.6270E-08
PHI6=-2.710E-09
PHI7=0.175E-10
PHI8=-5.090E-12
PHI9=0.220E-13
PHI10=-9.54E-15
N=1
10 X=0.
DO 10 (30)301,302,303,304,305
C GET NEW ORIGIN
300 CALL PLOT(0,10,3)
C DRAW X-AXIS
CALL PLOT(0,10,2)
DRAW TIC MARKS ON X-AXIS
TWO=
Y2=.125
WRITE
DO 502 I=1,10
CALL PLOT(X,Y1)
CALL PLOT(X,Y2)
C WRITE LABELS ON X-AXIS
CALL SYMBL(1,-.25,.14,ACX1)0.2)
302 X=X+1.
C WRITE N= AND ITS VALUE
CALL SYMBL(1,7.65,1.75,.14,ACX1)0.2)
C DRAW Y-AXIS
CALL PLOT(0,2,3)
CALL PLOT(0,2,2)
C DRAW TIC MARKS ON Y-AXIS
Y1=0.
Y2=.125
Y=.2.
DO 503 I=1,9
CALL PLOT(X,Y+3)
CALL PLOT(X2,Y+2)
503 Y=Y+.5
C WRITE LABELS ON Y-AXIS
CALL SYMBL(1,-.85,2.0,.14,ACX1)2.0)0.2)
CALL SYMBL(1,-.83,1.5,.14,ACX1)1.5)0.2)0.2)
CALL SYMBL(1,-.81,1.0,.14,ACX1)1.0)0.2)0.2)
CALL SYMBL(1,-.79,0.5,.14,ACX1)0.5)0.2)0.2)
CALL SYMBL(1,-.77,0.0,.14,ACX1)0.0)0.2)0.2)
CALL SYMBL(1,-.75,-0.5,.14,ACX1)-0.5)0.2)0.2)
CALL SYMBL(1,-.73,-1.0,.14,ACX1)-1.0)0.2)0.2)
CALL SYMBL(1,-.71,-1.5,.14,ACX1)-1.5)0.2)0.2)
CALL SYMBL(1,-.69,-2.0,.14,ACX1)-2.0)0.2)0.2)
C WRITE G AND X ON GRID
CALL SYMBL(1,6.7,1.4,ACX1)3)0.2)
CALL SYMBL(1,5.0,-.75,.14,ACX1)0.2)
C RETURN TO ORIGIN
CALL PLOT(0,0,3)
501 CONTINUE
1 CUB(N)=EXP(ALPHA(N)*X)-EXP(-ALPHA(N)*X)/2.
D=ALPHA(N)*X
E=ALPHA(N)*COS(ALPHA(N)*X)
F=SIN(ALPHA(N)*X)
G=C*D+E*F
DO 10 (30)301,302,303,304,305
504 CONTINUE
C PLOT POINTS
XP=10.*X
CALL PLOT(XP,Y2)
GO TO 506
505 CONTINUE
WRITE(6)2)X,X+C,D,E,F,G
2 FORMAT(1X)3)F6E14.3)
506 CONTINUE
3 X=X+.0025
IF(X-1.0)1,3)
CONTINUE
4 N=N+1
IF(N-10)1,5)5
5 STOP
END

```

Figure 18 - Program to Calculate and Plot Clamped-Clamped Mode Shapes

This program is not the one used at NSRDC to obtain the frequencies.  
The NSRDC program is given in Appendix I.

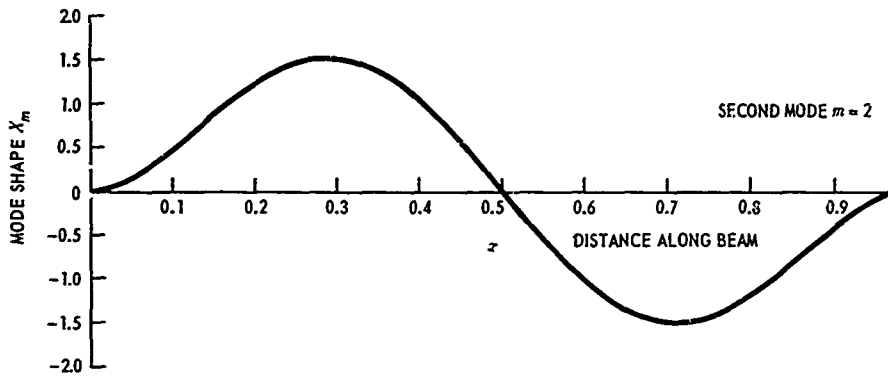
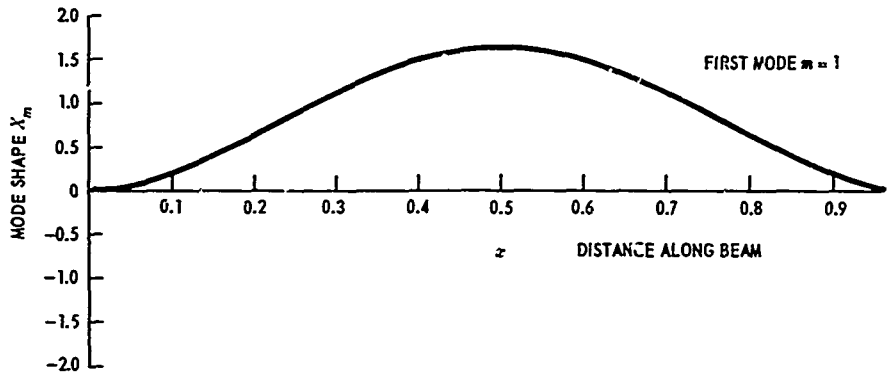

Figure 19 – Mode Shapes for a Clamped-Clamped Beam, First and Second Modes

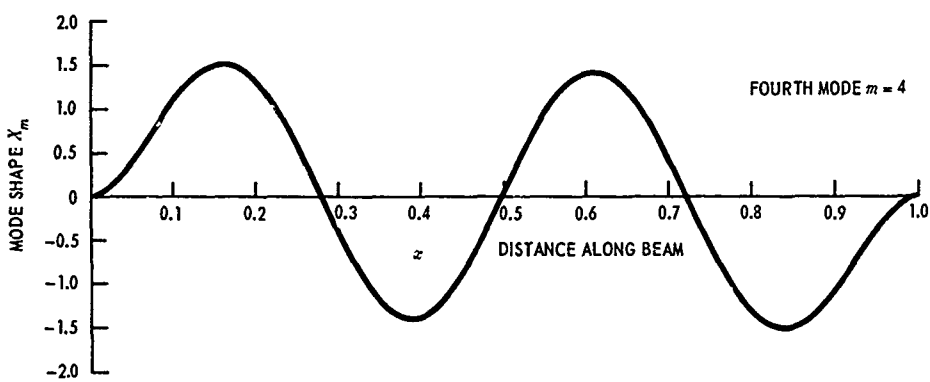
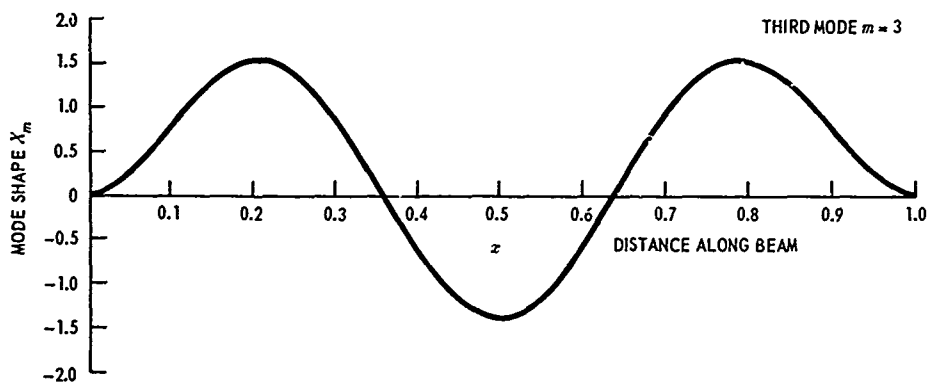

Figure 20 – Mode Shapes for a Clamped-Clamped Beam, Third and Fourth Modes

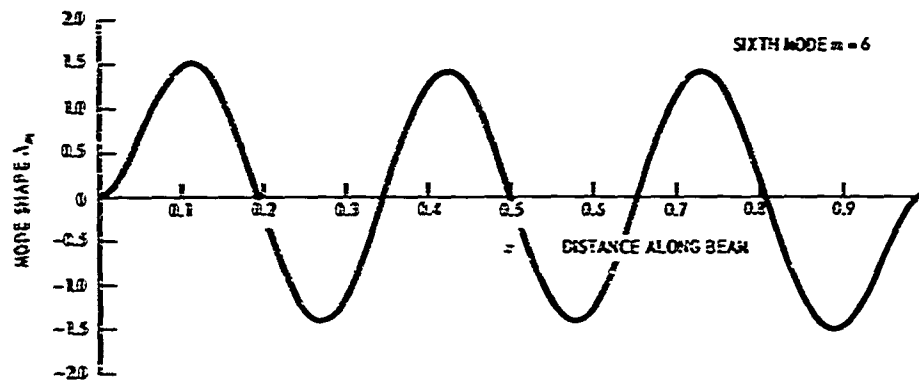
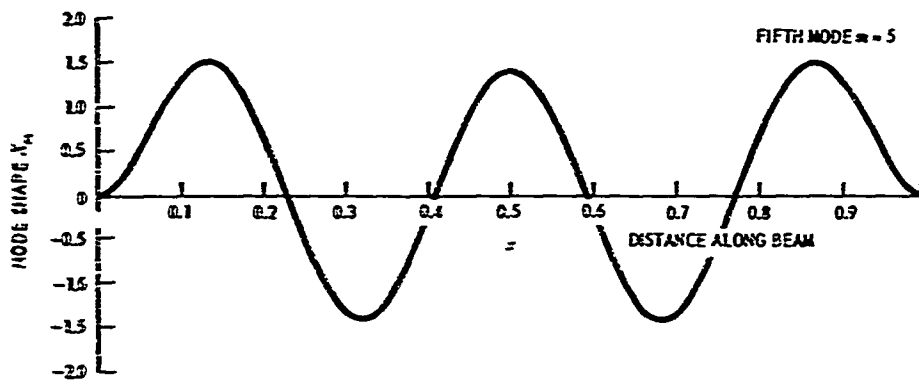

Figure 21 - Mode Shapes for a Clamped-Clamped Beam, Fifth and Sixth Modes

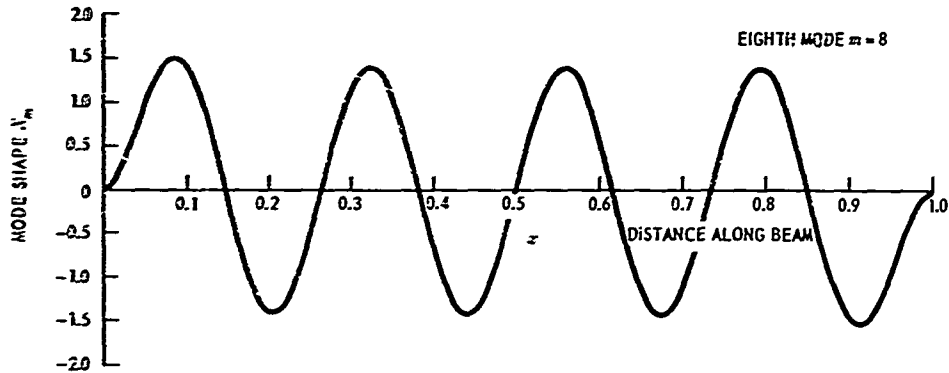
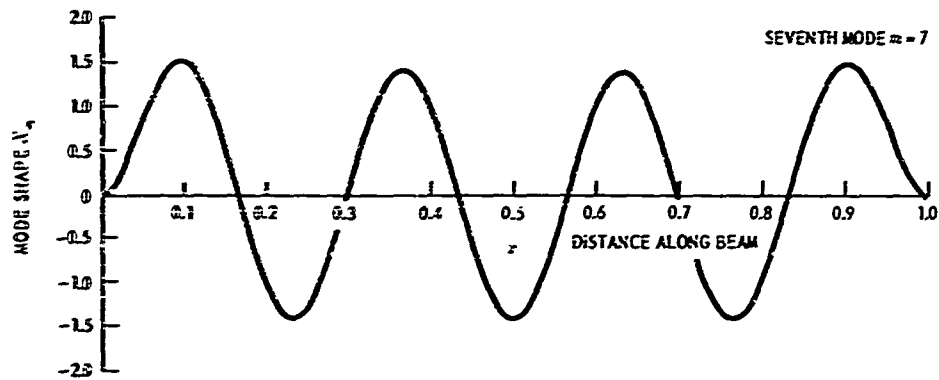

Figure 22 - Mode Shapes for a Clamped-Clamped Beam, Seventh and Eighth Modes

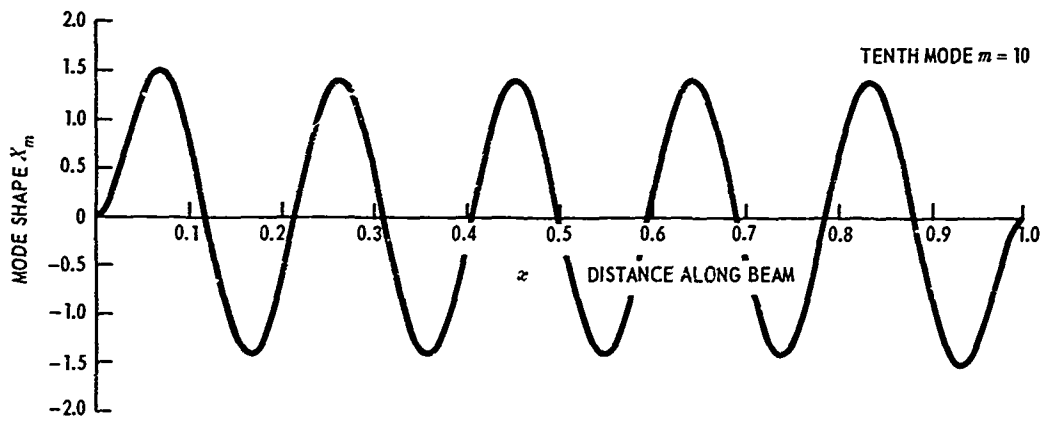
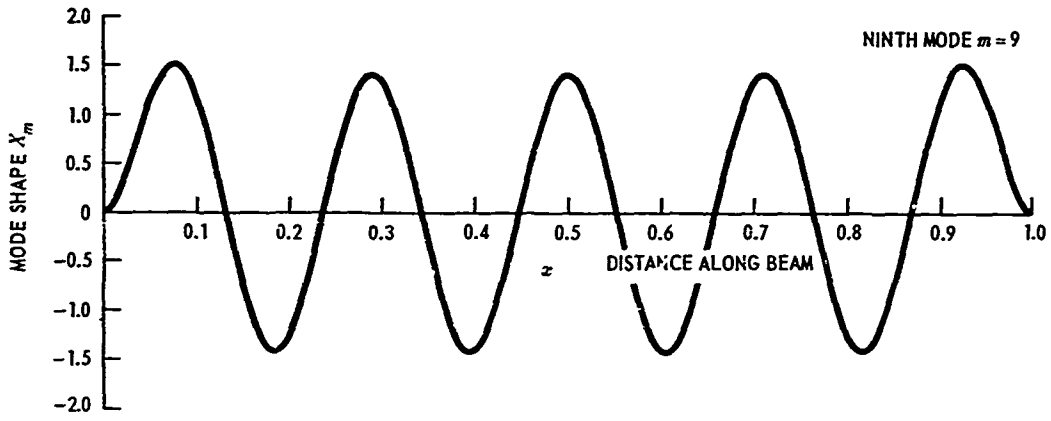

Figure 23 – Mode Shapes for a Clamped-Clamped Beam, Ninth and Tenth Modes

it is seen by inspection of Equation (F24) that the first maximum will occur at:

$$\alpha_m \cdot \frac{x}{a} = \frac{3}{4} \pi + \delta \quad (\text{F26})$$

where  $\delta$  is a small number.

Thus making the approximations then  $\cosh \delta \approx 1$  and  $\cos \delta \approx 1$ ,

$$\cosh \alpha_m \cdot \frac{x}{a} \approx \cosh \frac{3\pi}{4} + \delta \sinh \frac{3\pi}{4}$$

$$e^{-\alpha_m \frac{x}{a}} \approx (1 - \delta) e^{-\frac{3\pi}{4}} \quad (\text{F27})$$

$$\sin \alpha_m \cdot \frac{x}{a} \approx \frac{-1}{\sqrt{2}} (1 - \delta)$$

$$\cos \alpha_m \cdot \frac{x}{a} \approx \frac{-1}{\sqrt{2}} (1 + \delta)$$

Then substituting Equations (F27) into Equation (F24):

$$(A_m + B_m) \cosh \frac{3\pi}{4} + \delta (A_m + B_m) \sinh \frac{3\pi}{4} - (1 - \delta) A_m e^{-\frac{3\pi}{4}} + \frac{A_m}{\sqrt{2}} (1 - \delta) - \frac{1}{\sqrt{2}} (1 + \delta) = C$$

and thus

$$\delta = \frac{-(A_m + B_m) \cosh \frac{3\pi}{4} + A_m e^{-\frac{3\pi}{4}} + (1 - A_m)/\sqrt{2}}{(A_m + B_m) \sinh \frac{3\pi}{4} + A_m e^{-\frac{3\pi}{4}} - (1 + A_m)/\sqrt{2}} \quad (\text{F28})$$

Using the approximations in Equations (F25), Equation (F28) reduces to:

$$\delta \approx \frac{e^{-3\pi/4}}{e^{-3\pi/4} - \sqrt{2}} = \frac{0.0948}{0.0948 - 1.4142}$$

$$\delta \approx \frac{0.0948}{1.3194} = 0.0719$$

Again using the approximations of Equations (F25) and (F27), Equation (F23) reduces to:

$$\begin{aligned} |X_m| &= e^{-\alpha_m \cdot \frac{x}{a}} - \cos \alpha_m \cdot \frac{x}{a} + \sin \alpha_m \cdot \frac{x}{a} \\ &= (1 - \delta) e^{\frac{-3\pi}{4}} + \frac{1}{\sqrt{2}}(1 + \delta) + \frac{1}{\sqrt{2}}(1 - \delta) \\ &= (0.9281)(0.0948) + \sqrt{2} \\ &= 0.688 + 1.414 \\ |X_m| &= 1.502 \end{aligned} \tag{F29}$$

The position of this first maximum will be located at:

$$\frac{x}{a} = \alpha_m \left( \frac{3\pi}{4} + 0.0719 \right) \tag{F30}$$

The value of  $|X_m|$  obtained by the above approximate method and presented in Equation (F29) compares well with the computed values (presented in Figures 19-23) and, in fact, is only about 0.66 percent smaller. The position of the maximum displacement as given by Equation (F30) is also in good agreement.



## APPENDIX G

### THE SUN METHOD

#### NOTATION

|            |   |
|------------|---|
| $[A]$      | Symmetric square matrix of order $n$ whose elements are defined by Equation (G14b)  |
| $A_i$      | Coefficient in equation for displacement surface function   |
| $A_{mn}$   | Coefficient in equation for displacement surface function   |
| $a$        | Length of rectangular plate   |
| $[B]$      | Symmetric real matrix defined by Equation (B15)   |
| $b$        | Width of rectangular plate  |
| $[C]$      | Symmetric square matrices of order $n$ whose elements are defined by Equation (G14a)  |
| $D$        | Flexural rigidity of plate equal to $\frac{Eh^3}{12(1-\sigma^2)}$   |
| $F$        | Function satisfying the boundary condition for clamped plate  |
| $G^i, G^l$ | Polynomial in equation for displacement surface function  |
| $g$        | Acceleration due to gravity   |
| $h$        | Plate thickness   |
| $L, L'$    | Defined by Equations (G15a) and (G18), respectively   |
| $m, n$     | Mode numbers  |
| $R$        | Equal to $R^{-\beta} = \left(\frac{b}{a}\right)^{-\beta}$   |
| $p, p_i$   | Circular natural frequency; $p_i = \frac{1}{\lambda_i} \sqrt{\frac{gD}{yh}} = \omega_i \sqrt{\frac{gD}{yh}}$ where $i = 1, 2, \dots, n$ |
| $R$        | Equal to $\frac{b}{a}$  |
| $T$        | Kinetic energy  |
| $t$        | Time  |

|                       |   |
|-----------------------|---|
| $V$                   | Potential energy  |
| $W, W_t$              | Surface displacement function of plate in direction perpendicular to plate; subscript $t$ indicates a time derivative   |
| $X, Y$                | Equal to $\frac{x}{a}$ and $\frac{y}{a}$ , respectively   |
| $\{X\}$               | Column matrix containing elements of $X$ where $X = L'\psi$   |
| $x, y$                | Variables in cartesian coordinate system  |
| $\alpha$              | Exponent  |
| $\beta$               | Exponent  |
| $\frac{\gamma h}{g}$  | Plate mass per unit of surface area where $\gamma$ is the weight per unit volume of plate   |
| $\nabla^2$            | Equal to $\frac{\partial^2}{\partial x^2} + \frac{\partial^2}{\partial y^2}$  |
| $\delta_{ij}$         | Kronecker delta   |
| $\lambda$             | Equal to $\frac{1}{\omega^2}$   |
| $\sigma$              | Poisson's ratio   |
| $\Phi, \Phi_t$        | Transverse displacement of plate in free vibration; subscript $t$ signified a time derivative   |
| $\{\psi\} \{\psi_i\}$ | Column matrix of $A_1, A_2, \dots, A_i, \dots, A_n$ defining the eigenvector of the specific natural mode concerned, i.e., nodal pattern of $i$ th vibration mode |
| $\omega$              | Eigenvalue defined by $\omega = p \sqrt{\frac{\gamma h}{gD}}$   |

## DESCRIPTION

Sun<sup>24</sup> presents a method for computing the normal modes and frequencies for a clamped thin rectangular plate undergoing transverse vibrations. Vertical shear and rotary inertia effects are ignored. The method uses the Rayleigh-Ritz procedure, but the deflection of the plate is represented by a series of polynomials rather than the product of beam normal mode functions.

## DERIVATION

The transverse displacement for a freely vibrating thin plate is

$$\Phi(x, y, t) = W(x, y) \cos pt \quad (G1)$$

The potential energy of the plate is

$$V = \iiint dV = \frac{D}{2} \iint (\Phi_{xx}^2 + \Phi_{yy}^2 + 2\sigma \Phi_{xx} \Phi_{yy} + 2(1-\sigma) \Phi_{xy}^2) dx dy \quad (G2)$$

The kinetic energy of the plate is

$$T = \frac{\gamma h}{2g} \iint \dot{\Phi}_t^2 dx dy \quad (G3)$$

Substituting Equation (G1) into (G2) and (G3) and setting cosine and sine values equal to 1 in Equations (G2) and (G3), respectively, the maximum potential and kinetic energies are

$$V_{\max} = \frac{D}{2} \iint \{ (\nabla^2 W)^2 - 2(1-\sigma) [W_{xx} W_{yy} - W_{xy}^2] \} dx dy \quad (G4)$$

$$T_{\max} = \frac{\gamma h}{2g} p^2 \iint W^2 dx dy \quad (G5)$$

Equating Equations (G4) and (G5) as required by the Rayleigh principle

$$p^2 = \frac{2g}{\gamma h} \frac{V_{\max}}{\iint W^2 dx dy} \quad (G6)$$

Now there is a class of plate geometries governed by the equation

$$\left| \frac{x}{a} \right|^\alpha + \left| \frac{y}{b} \right|^\beta = 1 \quad (G7)$$

Equation (G7) includes the approximated rectangle. Dividing through Equation (G7) by  $a$  and letting  $X = z/a$ ,  $Y = y/a$ ,  $B = b/a$ ,  $P = B^{-\beta}$ , the resultant normalized equation replacing Equation (G7) is

$$X^\alpha + PY^\beta = 1 \quad (G8)$$

Then to determine the natural frequency  $p$  of the clamped rectangular plate in terms of  $\alpha$ ,  $\beta$ , and  $P$ , let the displacement surface function be expressed as

$$\begin{aligned} \bar{W}(X, Y, P, \alpha, \beta) &= F(X, Y, P, \alpha, \beta) \sum_{n=0}^{\infty} \sum_{m=0}^{\infty} A_{nm} X^n Y^m \\ &= F(X, Y, P, \alpha, \beta) (A_{00} + A_{10}X + A_{01}Y + A_{11}XY + \dots) \quad (G9) \\ &= F \sum_{i=1}^{\infty} A_i G^i \end{aligned}$$

where for a clamped plate

$$F = (1 - X^\alpha - PY^\beta)^2 \quad (G10)$$

satisfies the requirement  $\frac{\partial \bar{W}}{\partial X} = \frac{\partial \bar{W}}{\partial Y} = 0$ ,  $\bar{W} = 0$  along the boundaries.

Following the Rayleigh-Ritz procedure, the  $A_i$ 's in Equation (G9) have values obtained from a minimization of Equation (G4).

$$\frac{\partial}{\partial A_i} \left[ \iiint \left\{ (\nabla^2 W)^2 - 2(1-\sigma) [W_{zz}W_{yy} - W_{zy}^2] - \frac{p^2 y h}{gD} W^2 \right\} dXdY \right] \quad (G11)$$

$$i = 1, 2, \dots, n$$

For the clamped plate, satisfaction of the natural boundary conditions<sup>25\*</sup> (also see Appendix B) reduces Equation (G11) to the simpler form

$$\frac{\partial}{\partial A_i} \left[ \iiint \left\{ (\nabla^2 W)^2 - \frac{p^2 y h}{gD} W^2 \right\} dXdY \right] = 0 \quad (G12)$$

$$i = 1, 2, \dots, n$$

\*There are no *natural* boundary conditions for the clamped plate and therefore they need not be satisfied. However, as discussed in Appendix B, practical consideration of the rate of convergence makes such satisfaction desirable.

Substituting Equation (G9) with  $F = (1 - X^\alpha - PY\beta)^2$  into the above equation, a matrix equation results as

$$[C] \{\psi\} - \omega^2 [A] \{\psi\} = 0 \quad (G13)$$

where  $[A]$  and  $[C]$  are square matrices of order  $n$  whose elements are respectively defined as

$$C(I, J) = \int_0^1 \int_0^1 \frac{R(1-X^\alpha)^{\frac{1}{\beta}}}{V^2} (FG^I) \frac{1}{V^2} (FG^J) dXdY \quad (G14a)$$

$$A(I, J) = \int_0^1 \int_0^1 \frac{R(1-X^\alpha)^{\frac{1}{\beta}}}{V} (FG^I) (FG^J) dXdY \quad (G14b)$$

where  $F = (1 - X^\alpha - PY\beta)^2$ .

Matrices  $[C]$  and  $[A]$  are therefore symmetric square matrices with all real number elements.

The column matrix  $\{\psi\}$  of  $A_1, A_2, \dots, A_i, \dots, A_n$  defines the eigenvector of the specific natural mode concerned and, in turn, yields the modal patterns of the corresponding vibration mode.

The eigenvalues of Equation (G13) are  $\omega^2 = p^2 (yh/gD)$  where  $p$  is the natural frequency.

In order to reduce Equation (G13) to standard matrix pencil,<sup>26</sup> let  $C = LL'$ ,  $\lambda = 1/\omega^2$ , and  $X = L'\psi$ . Equation (G13) then becomes

$$L^{-1} A (L')^{-1} X = \lambda X \quad (G15a)$$

$$\text{or } [B] \{X\} = \lambda \{X\} \quad (G15b)$$

where  $[B]$  is symmetric and real and thus  $\{X\}$  is orthogonal with respect to each natural mode, that is<sup>27</sup>

$$X_i' X_j = \delta_{ij} \quad (G16)$$

where  $\delta_{ij}$  is Kronecker delta. The natural frequencies can then be expressed as

$$p_i = \sqrt{\frac{1}{\lambda_i}} \sqrt{\frac{gD}{yh}}, \quad i = 1, 2, \dots, n \quad (G17)$$

and the corresponding eigenvectors  $\{\psi_i\}$  can then be obtained through the following transformation:

$$\{\psi_i\} = (L')^{-1} \{X_i\} \quad (G18)$$

The modal pattern of the  $i$ th vibration mode is given by  $\{\psi_i\}$ .

To achieve a good approximation to the fundamental and higher mode frequencies, Sun used an  $xy$  (or  $XY$ ) polynomial consisting of 21 terms. The computational methods include both a beta function evaluation and a Gaussian quadrature integration technique.\* The latter has no restriction as to the values of  $\alpha$  and  $\beta$  but requires approximately twice the computational time of the former. The method of reduction (i.e., iteration) is used to find the eigenvalues and the corresponding eigenvectors are obtained from Equation (G15b). Polynomial expressions for the fundamental and higher modes as well as other details relevant to the computational methods are given in Reference 24. The reference also includes computed results which were carried out on an IBM 7094.

---

\*When  $\alpha$  and  $\beta$  values are less than or equal to 1.5, the beta function is not properly defined. Hence, a numerical integration using the Gaussian quadrature rule of order 64 was used in the range below  $\alpha = \beta = 1.6$ . A Gaussian quadrature double integration formula is given in Appendix B of Reference 24.

## APPENDIX H

### THE CLAASSEN-THORNE METHOD

#### NOTATION

|   |   |
|---|---|
| $a$   | Plate length lying along $x$ -axis  |
| $a_{mn}$  | Coefficient of doubly-infinite Fourier series defined by Equation (H6)            |
| $b$   | Plate width lying along $y$ -axis   |
| $b_m, f_n,$<br>$d_m, h_n,$<br>$c_m, g_n,$<br>$e_m, i_n$ | Coefficients of Fourier series defined by Equation (H4)                           |
| $E$   | Young's modulus   |
| $f$   | Frequency   |
| $h$   | Half-thickness  |
| $K$   | Equal to $\frac{a^2}{\pi^2} K_1$  |
| $K'$  | Equal to $\frac{K}{k^2}$  |
| $K_1$   | Equal to $\sqrt{\frac{3\rho(1-\nu^2)(2\pi f)^2}{Ek^2}}$                           |
| $k$   | Equal to $\frac{a}{b}$  |
| $k'$  | Equal to $\frac{1}{k}$  |
| $m, n$  | Harmonic order for sine waves along $x$ and $y$ , respectively; see Equation (H5) |
| $t$   | Time  |
| $W(X, Y)$   | Amplitude   |
| $X, Y$  | Rectangular coordinates   |
| $x, y$  | Equal to $\frac{\pi}{a} X$ and $\frac{\pi}{b} Y$ , respectively                   |

$\nu, \sigma$

Poisson's ratio

$\rho$

Mass density of plate

$\phi$

Phase angle



## DESCRIPTION

Classen-Thorne<sup>10</sup> present a Fourier series method for computing the frequencies and modes of free transverse vibrations of thin, rectangular, isotropic, fully clamped plates.\* Curves are given for determining the first ten frequencies and their modal patterns as a function of the aspect ratio.

## DERIVATION

The governing differential equation for sinusoidal free vibrations of a thin rectangular isotropic plate is

$$\frac{\partial^4 w}{\partial X^4} + 2 \frac{\partial^4 w}{\partial X^2 \partial Y^2} + \frac{\partial^4 w}{\partial Y^4} = - \frac{3\rho(1-\nu^2)}{Eh^2} \frac{\partial^2 w}{\partial t^2} \quad (\text{H1})$$

For sinusoidal vibrations,  $w(X, Y, t) = W(X, Y) \sin(2\pi ft + \phi)$  Equation (H1) becomes

$$\frac{\partial^4 W}{\partial X^4} + 2 \frac{\partial^4 W}{\partial X^2 \partial Y^2} + \frac{\partial^4 W}{\partial Y^4} = K_1^2 W \quad (\text{H2})$$

where  $K_1^2 = \frac{3\rho(1-\nu^2)(2\pi f)^2}{Eh^2}$ .

For a clamped plate the boundary conditions are

$$\left. \begin{aligned} W(X, Y) &= 0 \\ W_n(X, Y) &= 0 \end{aligned} \right\} \quad (\text{H3})$$

where the subscript  $n$  denotes the normal derivative.

The origin of the rectangular coordinate system is taken at one corner of the plate, with one side of length  $a$  lying along the  $X$ -axis and the other of width  $b$  along the  $Y$ -axis. Thus, Equation (H1) is valid for  $0 < X < a$  and  $0 < Y < b$ .

It is useful to transform the coordinate system. Let  $x = \frac{\pi}{a} X$ ,  $y = \frac{\pi}{b} Y$ ,  $k = \frac{a}{b}$ , and  $K = \frac{a^2}{\pi^2} K_1$ . Then Equation (H1) becomes

$$\frac{\partial^4 W}{\partial x^4} + 2k^2 \frac{\partial^4 W}{\partial x^2 \partial y^2} + \frac{\partial^4 W}{\partial y^4} = K^2 W, \quad \begin{aligned} 0 < x < \pi \\ 0 < y < \pi \end{aligned} \quad (\text{H4})$$

\*The frequencies and modes are also computed for plates with two edges clamped and two edges free.

A solution for  $W$  is assumed to be in the form of a doubly infinite Fourier series

$$W(x, y) = \sum_m \sum_n a_{mn} \sin nx \sin my, \quad \begin{array}{l} 0 < x < \pi \\ 0 < y < \pi \end{array} \quad (\text{H5})$$

where  $\sum_m$  denotes  $\sum_{m=1}^{\infty}$  and  $\sum_n$  denotes  $\sum_{n=1}^{\infty}$ .

Further Fourier series that are assumed to exist for  $0 < x < \pi$  or  $0 < y < \pi$  (i.e., the boundary conditions) are:

$$\begin{array}{ll} W(\pi, y) = \sum_m b_m \sin my & W(0, y) = \sum_m c_m \sin my \\ W(x, \pi) = \sum_n f_n \sin nx & W(x, 0) = \sum_n g_n \sin nx \\ W_{xx}(\pi, y) = \sum_m d_m \sin my & W_{xx}(0, y) = \sum_m e_m \sin my \\ W_{yy}(x, \pi) = \sum_n h_n \sin nx & W_{yy}(x, 0) = \sum_n i_n \sin nx \end{array} \quad (\text{H6})$$

where  $W_{xx} = \frac{\partial^2 W}{\partial x^2}$ , etc.

The authors apply an available technique to Equations (H5) and (H6) to obtain formulas for the higher derivatives and cross derivatives of the Fourier series. These results are then used to obtain a solution for each  $a_{mn}$  of Equation (H5) in terms of the coefficients in Equation (H6). Higher derivatives and cross derivatives required by Equation (H4) are then obtained from Equation (H5) using the solution obtained for each  $a_{mn}$ . Moreover, since the deflection on all edges and corners is zero for the case of a clamped-clamped plate,  $b_m = c_m = f_n = g_n = W(0, 0) = W(\pi, 0) = W(0, \pi) = W(\pi, \pi) = 0$ . Also the normal derivatives at all four edges are zero so that  $W_y(x, 0) = W_y(x, \pi) = W_x(0, y) = W_x(\pi, y) = 0$ . Finally, applying to Equation (H4) these boundary conditions as well as the higher derivatives and cross derivatives previously obtained, an infinite set of homogeneous equations is obtained. The authors then present a method for the approximate determination of  $K$  satisfying these equations.

For the completely clamped plate,  $K$ 's are graphed only for  $0 < k < 1$ . Setting  $k' = \frac{1}{k}$  and  $K' = \frac{K}{k^2}$ , a value of  $K$  can be found for  $k > 1$  by locating the value of  $K$  for  $\frac{1}{k}$  and multiplying by  $k^2$ . Appendix I gives the method for determining the frequency from these quantities as well as a sample computation.

The frequency and mode data computed in Reference 10 are presented there in both tabular and graphical form. Interpretation of the results are given as well as computer times involved in obtaining the results. A copy of this reference is available in the computer files associated with this investigation at the Computation and Mathematics Department.

## APPENDIX I

### COMPUTER PROGRAMS

Appendixes A–H have presented several methods for computing the natural frequencies of vibration of clamped-clamped plates. The corresponding computer programs including flow charts are given here; computer program decks are now available at the Computation and Mathematics Department of NSRDC. Table 1 gives the results of these programs for particular plate input data representing the plate geometry and mass-elastic properties. Figures 2 and 3 are plots of the data in Table 1a only. Thus, the first set of results shown in Table 1a contains the computed frequencies for a plate with geometry and properties identical to those used by Izzo (Electric Boat)<sup>1</sup>; experimental results cited by Izzo are also included. The second and third sets of results shown in Tables 1b and 1c, respectively, are the computed and experimentally\* obtained frequencies for two plates used by Wilby.<sup>11</sup> The corresponding input data for the three sets of results are:

| Data                        | Plate 1<br>(Izzo-Electric Boat)        |                     | Plate 2<br>(Wilby)                     |                      | Plate 3<br>(Wilby)                     |                      |
|-----------------------------|--|---------------------|--|----------------------|--|----------------------|
| Dimension in $x$ -direction | 2.0                                    | ft                  | 4.0                                    | in.                  | 4.0                                    | in.                  |
| Dimension in $y$ -direction | 2.33                                   | ft                  | 2.75                                   | in.                  | 2.0                                    | in.                  |
| Plate thickness $h$         | 0.0313                                 | ft                  | 0.015                                  | in.                  | 0.015                                  | in.                  |
| Young's modulus $E$         | $4.175 \times 10^9$ lb/ft <sup>2</sup> |                     | $33.7 \times 10^6$ lb/in. <sup>2</sup> |                      | $31.0 \times 10^6$ lb/in. <sup>2</sup> |                      |
| Poisson's ratio $\sigma$    | 0.33                                   |                     | 0.3                                    |                      | 0.3                                    |                      |
| Weight density $\rho_w$     | 466.56                                 | lb/ft <sup>3</sup>  | 0.27                                   | lb/in. <sup>3</sup>  | 0.27                                   | lb/in. <sup>3</sup>  |
| Gravitational constant $g$  | 32.2                                   | ft/sec <sup>2</sup> | 386.4                                  | in./sec <sup>2</sup> | 386.4                                  | in./sec <sup>2</sup> |

Five sets of computer programs and one manual method of computation are presented. Their designations and the computers used in making the calculation are:

1. WCGFRE on the IBM 7090 of NSRDC: This program includes the methods of Warburton (Appendix A), Crocker (Appendix F), and Greenspon (Appendix D). Figure 24 presents a flow chart of this program.

2. WHITE on the IBM 7090: This program treats the conversion of the White nomographic values (Appendix E) to dimensional frequencies. Figure 25 presents a flow chart of this program.

\*The measured frequencies were obtained by Wilby in Reference 11.

3. PLFREQ on the IBM 360/91 of the Applied Physics Laboratory, Johns Hopkins University: This program treats the Baillentine-Plumlee method (Appendix C). Figure 26 presents a flow chart of the program.

4. SUNFRE on the IBM 360/91: This program treats the Sun method (Appendix G). Figure 27 presents a flow chart of this program.

5. YNGFRE on the IBM 360/91: This program treats the Young method (Appendix B). Figure 29 presents a flow chart of this program.

6. Claassen-Thorne manual method of computation.

In all computations, the frequency  $f$  (in hertz) is obtained as the product of the frequency parameter  $\lambda_{m,n}$  (or  $\alpha_{m,n}$ ) and a factor. For particular computations, the factors are:

$$\begin{aligned} \text{Warburton:} & \quad \frac{h\pi}{a^2} \sqrt{\frac{E}{48\rho_m(1-\sigma^2)}} \\ \text{Crocker:} & \quad \frac{h}{2\pi b^2} \sqrt{\frac{E}{12\rho_m(1-\sigma^2)}} \\ \text{Greenspon:} & \quad h \sqrt{\frac{E}{12\rho_m(1-\sigma^2)}} \\ \text{Plumlee:} & \quad \sqrt{\frac{E}{\rho_m \ell^3 b (1-\sigma^2)}} \quad \left( \begin{array}{l} \ell = a \\ \rho_2 = \rho_m \end{array} \right) \\ \text{Young:} & \quad \frac{h}{2\pi} \sqrt{\frac{E}{12\rho_m b^3 a (1-\sigma^2)}} \\ \text{White:} & \quad \frac{h}{2\pi a^2} \sqrt{\frac{E}{12\rho_m(1-\sigma^2)}} \\ \text{Sun:} & \quad \frac{h}{2\pi a^2} \sqrt{\frac{E}{12\gamma(1-\sigma^2)}} \\ \text{Claassen-Thorne:} & \quad \frac{k^2 h\pi}{2a^2} \sqrt{\frac{E}{3\rho_m(1-\sigma^2)}} \end{aligned}$$

NOTE: The user submits weight density  $\rho_w$  which is converted by the program to mass density  $\rho_m$  where  $\rho_m = \frac{\rho_w}{g}$ .

## WCGFRE (see Table 8 and Figure 24)

This combined program yields separate solutions corresponding to the Warburton, Crocker, and Greenspon methods. The program card IOPT contains data input to the program which permit the user to compute the natural frequency for either one or all of these methods, i.e., IOPT = 1 → Warburton method, IOPT = 2 → Crocker method, IOPT = 3 → Greenspon method, IOPT = 4 → all of these methods.

Warburton<sup>13</sup> treats the frequency parameter subscripts  $m, n$  as the number of *nodal points* along the plate length and width, respectively; see Appendix A. However, most other authors treat  $m, n$  as the *mode numbers* along these dimensions (or define it for the opposite dimensions). Thus  $(m=2, n=3)_{\text{Warburton}}$  means the 1, 2 mode containing 2 nodes along  $x$  and 3 along  $y$  whereas  $(m=2, n=3)_{\text{Others}}$  means the 2, 3 mode containing either 3 nodes along  $x$  and 4 along  $y$  or 4 nodes along  $x$  and 3 along  $y$  depending on the definition of  $m, n$  with respect to the  $x, y$  coordinates. To avoid confusion and for compatibility with most investigators, the program assigns the *modal (not nodal) meaning* to  $m, n$  for all computations.

### WCGFRE Restrictions

For IOPT = 3,  $M \leq 5$ ,  $N \leq 5$ . That is, the Greenspon option computes the frequencies for  $M \leq 5$  and  $N \leq 5$ . However, for this option, if the user requires higher modes he may change the Greenspon subroutine to read in the values of the integrals discussed in Appendix D. The integrals are given in References 7, 8, and 9.

The simply-supported frequencies may be computed by the Warburton method. In this case, the value of SPEC must be 1.0. Clamped frequencies are computed with any value of SPEC not equal to 1.0.

### Units

All length units are shown in feet. However, if *all* length data are converted to inches, this is acceptable to the program, and is actually preferable in the case of a very small plate because of simpler handling and greater accuracy.

TABLE 8

## Program Listing for WCGFRE Computer Program

```

COMMENT **** PROGRAM WCGFRE *****
COMMON M,N,A,B,H,F,SIGMA,RHO,PI,G
*****
C M - MODES IN X DIRECTION
C N - MODES IN Y DIRECTION
C A - LENGTH IN X DIRECTION
C B - LENGTH IN Y DIRECTION
C H - PLATE THICKNESS
C E - YOUNGS MODULUS
C SIGMA - POISSONS RATIO
C RHO - PLATE DENSITY
C G - ACCELERATION DUE TO GRAVITY
C *****
PI=3.1415927
READ(5,2) IOPT, NCASE
DO 500 L=1,NCASE
READ(5,2) M,N
READ(5,3) A,B,H
READ(5,4) E,SIGMA,RHO,G
2 FORMAT(2I5)
3 FORMAT(3F12.6)
4 FORMAT(E16.8,3F12.6)
RHO=RHO/G
GO TO (10,20,30,10), IOPT
10 CALL WARB
IF(IOPT.LE.1) GO TO 500
20 CALL CROCK
IF(IOPT.LE.2) GO TO 500
30 CALL GREEN
500 CONTINUE
STOP
END

SIBFTC WARB
SUBROUTINE WARB
REAL LAMBDA,JX,JY,K,KP
DIMENSION OMEGA(20,10)
DIMENSION FREQ(25,10), GX(100),HX(100),JX(100),GY(100),HY(100)
1 JY(100)
COMMON M,N,A,B,H,E,SIGMA,RHO,PI,G
READ(5,9979) SPEC
9979 FORMAT(F10.0)
A2=A*A
B2=B*B
A4=A2*A2
B4=B2*B2
MP1=M+1
NP1=N+1
IF(SPEC.EQ. 1.0) GO TO 510
GX(1)=1.
HX(1)=1.
JX(1)=1.
GY(1)=1.
HY(1)=1.
JY(1)=1.
GX(2)=1.506
HX(2)=1.248
JX(2)=1.248
GY(2)=1.506
HY(2)=1.248
JY(2)=1.248

```

TABLE 8 (Continued)

```

DO 100 M1=3,MP1
GX(M1)=FLOAT(M1)-.5
HX(M1)=((FLOAT(M1)-.5)**2)*(1.-2./((FLOAT(M1)-.5)*PI))
JX(M1)=HX(M1)
100 CONTINUE
DO 150 N1=3,MP1
GY(N1)=FLOAT(N1)-.5
HY(N1)=((FLOAT(N1)-.5)**2)*(1.-2./((FLOAT(N1)-.5)*PI))
JY(N1)=HY(N1)
150 CONTINUE
GO TO 590
510 DO 500 M1 = 1,MP1
GX(M1) = FLOAT(M1) - 1.0
HX(M1) = GX(M1) **2
500 JX(M1) = HX(M1)
DO 550 N1 = 1,MP1
GY(N1) = FLOAT(N1)-1.0
HY(N1) = GY(N1)**2
550 JY(N1) = HY(N1)
590 WRITE(6,20)A,B,H,E,SIGMA,RHO
20 FORMAT(1H1,3H A=,F7.2,3H B=,F7.2,3H H=,F7.4,3H E=,E11.4,7H SIGMA=,
1 F7.2,5H RHO=,E11.4)
WRITE(6,19)
19 FORMAT(/23X, 22H WARBURTON FREQUENCIES)
IW = 1
DO 400 N2=2,MP1
N21=N2-1
WRITE(6,21)N21
21 FORMAT(3H N=,I2)
WRITE(6,22)
22 FORMAT(9X,1HM,15X,6HLAMBDA,16X,5H FREQ)
DO 300 M2=2,MP1
M21=M2-1
XLAMSO=GX(M2)*GX(M2)*GX(M2)*GX(M2)+(GY(N2)*GY(N2)*GY(N2)*GY(N2)
1 *A4)/B4+(2.*A2/B2)*(SIGMA*HX(M2)*HY(N2)+(1.-SIGMA)*JX(M2)*JY(N2))
LAMBDA=SQRT(XLAMSO)
FREQ(M2,N2)=((LAMBDA*H*PI)/A2)*SQRT(F / (48.*RHO*(1.-SIGMA**2)))
WRITE(6,23)M21,LAMBDA,FREQ(M2,N2)
23 FORMAT(5X,I5,5X,E15.8,5X,E15.8)
OMEGA(M2,N2) = 2. * PI * FREQ(M2,N2)
WRITE(6,30) OMEGA(M2,N2), IW
WRITE(8,30) OMEGA(M2,N2), IW
30 FORMAT(F10.4,65X,I5)
IW = IW + 1
300 CONTINUE
400 CONTINUE
RETURN
END

```

TABLE 8 (Continued)

```

$IBFTC CRCKER
SUBROUTINE CROCK
DIMENSION FREQ(20,10)
COMMON M,N,A,B,H,E,SIGMA,RHO,PI,G
REAL LAMBDA
WRITE(6,4)A,B,H,E,SIGMA,RHO
4 FORMAT(1H1,3H A=,F7.2,3H B=,F7.2,3H H=,F7.4,3H E=,E11.4,7H SIGMA=,
1 F7.2,5H RHO=,F7.2)
WRITE(6,19)
19 FORMAT(/23X,20H CROCKER FREQUENCIES)
DO 40 J=1,N
GAMN=(2.*FLOAT(J)+1.)*PI/2.
AN=(COSH(GAMN)-COS(GAMN))/(SINH(GAMN)+SIN(GAMN))
WRITE(6,13)J
13 FORMAT(3H N=,I2)
WRITE(6,14)
14 FORMAT(9X,1HM,15X,6HLAMBDA,16X,5H FREQ)
ZIN=(GAMN/2.*(((AN-1.)*COSH(GAMN)+AN*(-EXP(-GAMN)-SIN(GAMN))
1 -COS(GAMN))*((AN-1.)*SINH(GAMN)+AN*(EXP(-GAMN)+COS(GAMN))-
2 SIN(GAMN))+4.*AN)-2.*GAMN**2)/2.*AN*AN
DO 30 I=1,M
GAMM=(2.*FLOAT(I)+1.)*PI/2.
AM=(COSH(GAMM)-COS(GAMM))/(SINH(GAMM)-SIN(GAMM))
ZIM=(GAMM/2.*(((AM-1.)*COSH(GAMM)+AM*(-EXP(-GAMM)-SIN(GAMM))
1 -COS(GAMM))*((AM-1.)*SINH(GAMM)+AM*(EXP(-GAMM)+COS(GAMM))-
2 SIN(GAMM))+4.*AM)-2.*GAMM**2)/2.*AM*AM
LAMBDA=(B*GAMM/A)**4+GAMN**4+2.*ZIM*ZIN*(B/A)**2
FREQ(I,J)=SQRT(LAMBDA*E/(12.*RHO*(1.-SIGMA**2)))*H/B**2
FREQ(I,J)=FREQ(I,J)/(2.*PI)
WRITE(6,7)I,LAMBDA,FREQ(I,J)
7 FORMAT(5X,I5,5X,E15.8,5X,E15.8)
30 CONTINUE
40 CONTINUE
50 CONTINUE
RETURN
END
$IBFTC GRNSP
SUBROUTINE GREEN
DIMENSION FREQ(5,5),P(5),X(5),Y(5),XSQ(5),YSQ(5)
COMMON M,N,A,B,H,E,SIGMA,RHO,PI,G
P(1)=4.73
P(2)=7.8532
P(3)=10.9956
P(4)=14.1372
P(5)=17.2788
X(1)=-12.3026/A
X(2)=-46.0501/A
X(3)=-98.9048/A

```



TABLE 8 (Continued)

```

X(4)=-171.2560/A
X(5)=-263.9980/A
Y(1)=-12.3026/B
Y(2)=-46.0501/B
Y(3)=-98.9048/B
Y(4)=-171.2560/B
Y(5)=-263.9980/B
DO 1 I=1,5
  XSQ(I)=A
  YSQ(I)=B
1 CONTINUE
  A4=A**4
  B4=B**4
  H3=H**3
  WRITE(6,8)A,B,H,E,SIGMA,RHO
8  FORMAT(1H1,3H A=,F7.2,3H B=,F7.2,3H H=,F7.4,3H E=,E11.4,7H SIGMA=,
1  F7.2,5H RHO=,F7.2)
  D=E*H3/(12.*(1.-SIGMA**2))
  F=SQRT(D/(RHO*H))
  IF (M .GT. 5) M=5
  IF(N .GT. 5) N=5
  WRITE(6,19)
19 FORMAT(//23X,22H GREENSPON FREQUENCIES)
  DO 20 J=1,N
  WRITE(6,4) J
4  FORMAT(///3H N=,I2)
  WRITE(6,5)
5  FORMAT(9X,1HM,15X,5H FREQ)
  DO 10 I=1,M
  FREQ(I,J)=F*SQR((P(I)**4/A4)+(P(J)**4/B4)+(2.*X(I)*Y(J))/
1  (XSQ(I)*YSQ(J)))
  FREQ(I,J)=FREQ(I,J)/(2.*PI)
  WRITE(6,6) I,FREQ(I,J)
6  FORMAT(5X,I5,5X,E15.8)
10 CONTINUE
20 CONTINUE
30 CONTINUE
  RETURN
  END

```

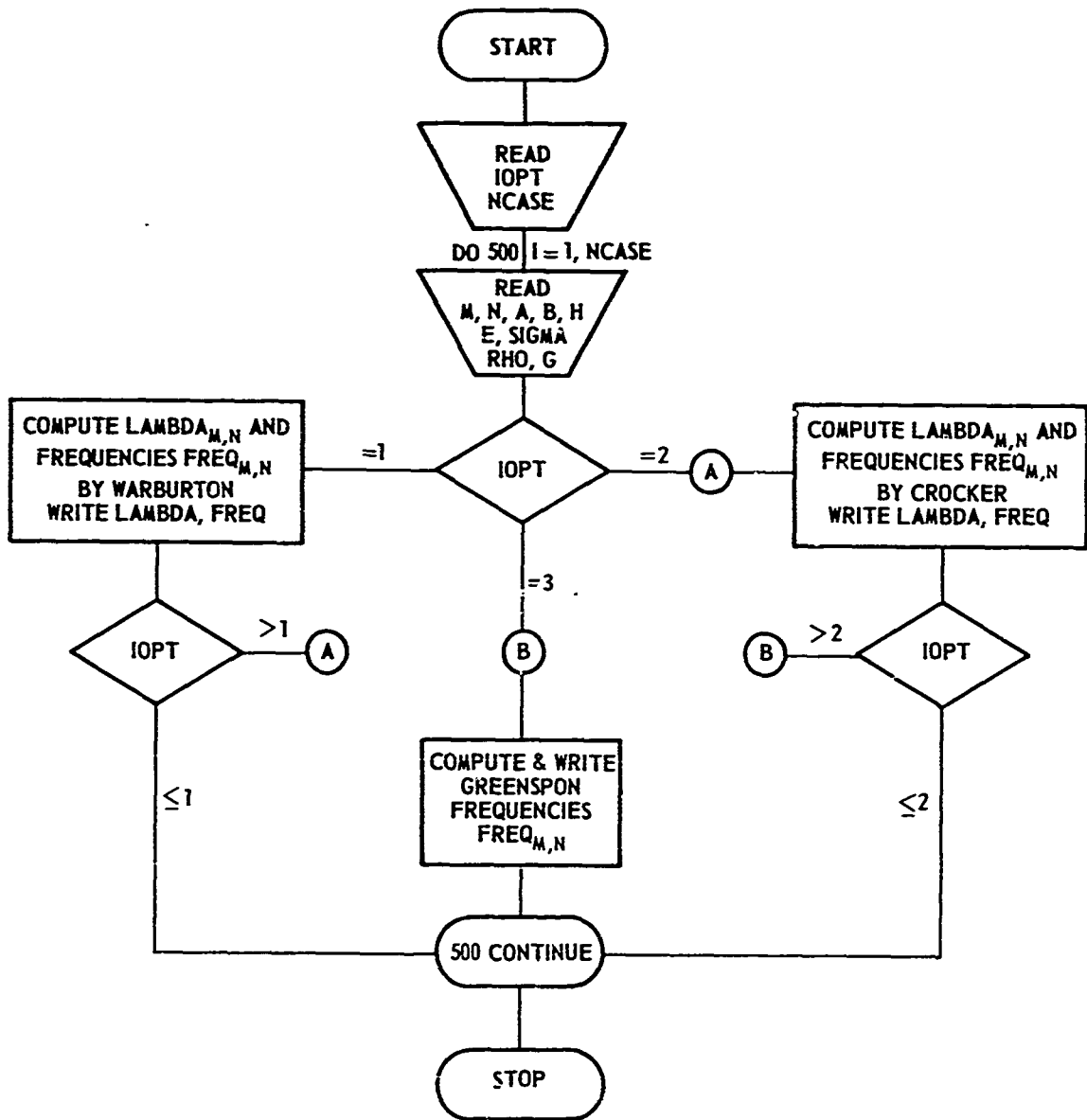

Figure 24 - Flow Chart for WCGFRE, Computer Program for Computing Natural Frequencies of a Plate by Warburton, Crocker, and Greenspon Methods

The printed output of the program contains  $FREQ(M, N)$ . However the value  $FREQ(M, N) \times 2\pi$  may be used as the input  $OMEGA(M, N)$  to Subprogram A in Appendix B of Reference 1.

## Input Description

The input description is as follows.

| Card No. | Program Symbol | Theory Symbol     | Description   | Units               | Format |
|----------|----------------|-------------------|---|---------------------|--------|
| 1        | IOPT           |                   | OPTION for methods:<br>1 - Warburton only;<br>2 - Crocker only;<br>3 - Greenspon only;<br>4 - all methods                   |                     | I5     |
| 1        | NCASE          |                   | Number of plates to compute frequencies for   |                     | I5     |
| 2        | M              | $m$               | Number of modes in $x$ -direction   |                     | I5     |
| 2        | N              | $n$               | Number of modes in $y$ -direction   |                     | I5     |
| 3        | A              | $a$               | Plate dimensions, $x$ -direction  | ft                  | F12.6  |
| 3        | B              | $b$               | Plate dimensions, $y$ -direction  | ft                  | F12.6  |
| 3        | H              | $h$               | Plate thickness   | ft                  | F12.6  |
| 4        | E              | $E$               | Young's modulus   | lb/ft <sup>2</sup>  | E16.8  |
| 4        | SIGMA          | $\sigma$ or $\nu$ | Poisson's ratio   |                     | F12.6  |
| 4        | RHO            | $\rho_w$          | Weight density of plate   | lb/ft <sup>3</sup>  | F12.6  |
| 4        | G              | $g$               | Gravitational constant  | ft/sec <sup>2</sup> | F12.6  |
| 5        | SPEC           |                   | OPTION for Warburton simply-supported frequencies.<br>Used : if IOPT = 1 or = 4;<br>SPEC = 1.0 means simply-supported case. |                     | F10.0  |

Cards 2-4 are repeated NCASE number of times.

## Output Description

The input data and results are labelled and printed out for each plate (or each value of NCASE). The first printout is Warburton, followed by Crocker, and finally Greenspon. The mode numbers ( $m, n$ ), nondimensional frequency  $\lambda$ , and final frequency  $f$  (in hertz) are given.

A sample problem using all subroutines to compute 25 modes each for two plates took a total of 1.1 minutes on the 7090.

## WHITE (see Table 9 and Figure 25)

White has provided a set of nomographs that permit manual computation of the frequency parameters  $\alpha_{m,n} = \sqrt{\lambda_{m,n}}$  for the first nine modes. A short subroutine handles the conversion

TABLE 9

## Program Listing for WHITE Computer Program

```

DIMENSION FREQ(20,7),ALPHA(20,7)
PI=3.1415927
WRITE(6,1)
1 FORMAT(1H1,18H WHITE FREQUENCIES)
  READ(5,2) NCASE
2 FORMAT(I5)
4 FORMAT(2I5)
5 FORMAT(4F12,6)
6 FORMAT(E16,8,2F12,6)
7 FORMAT(/3H A=,F8,3,3H B=,F8,3,3H H=,F8,3,3H E=,E11,4,7H SIGMA=,
1 F7,2,5H RHO=,F8,3)
9 FORMAT(9X,1HM,15X,6HALPHA ,16X,5H FREQ)
8 FORMAT(3H N=,I2)
10 FORMAT(5X,I5,5X,E15,8,5X,E15,8)
  M = 3
  N = 3
  DO 40 L=1,NCASE
    READ(5,3) ((ALPHA(I,J),I=1,3),J=1,3)
3 FORMAT(3F12,6)
    READ(5,5) A,R,H,G
    READ(5,6) F,SIGMA,RHO
    WRITE(6,7) A,R,H,E,SIGMA,RHO
    A4 = A**4
    R4=R**4
    H3=H**3
    D=E*H3/(12.*(1.-SIGMA**2))
    F=SQRT((D*G)/(RHO*H*A4))
    DO 30 N2=1,N
      WRITE(6,8) N2
      WRITE(6,9)
    DO 20 M2=1,M
      FREQ(M2,N2)=ALPHA(M2,N2)*F/(2.*PI)
      WRITE(6,10) M2,ALPHA ,FREQ(M2,N2)
20 CONTINUE
30 CONTINUE
40 CONTINUE
  STOP
  END

```

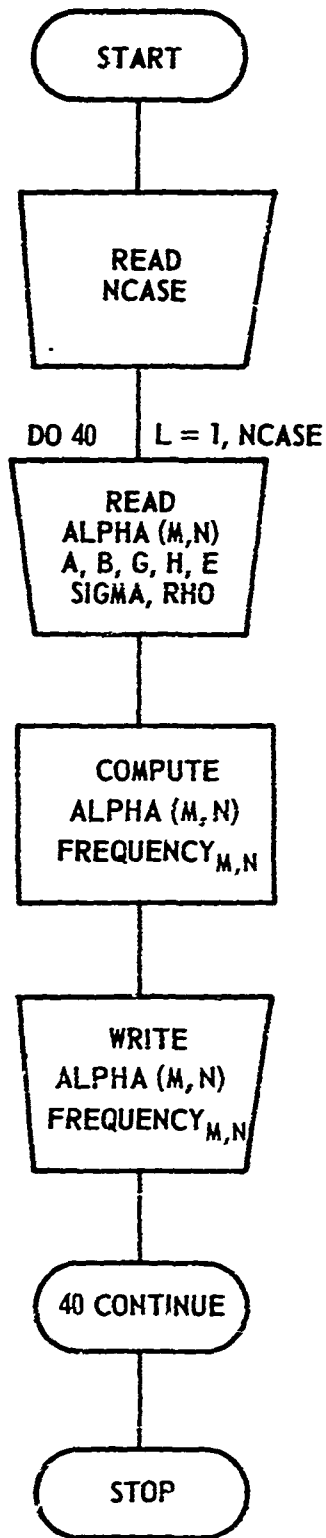

Figure 25 - Flow Chart for WHITE. Computer Program for Converting Nomograph Frequency Parameters  $\alpha_{m,n}$  to Frequencies  $f_{m,n}$

The printed output includes  $FREQ(M,N)$ . However, the value  $2\pi \times FREQ(M,N)$  may be used as the input  $OMEGA(M,N)$  to Subprogram A in Appendix B of Reference 1.

of these frequency parameters to hertz using a formula given by White (Appendix E). The nomographs are read for various aspect ratios  $\frac{b}{a} < 1$ . Thus the user must make adjustments for the case  $\frac{b}{a} > 1$ , e.g., interchanging  $m$  and  $n$ . The nomographs are applicable to nine combinations of  $m = 1, 2, 3$  and  $n = 1, 2, 3$ .

### Input Description

The input description is as follows.

| Card No.                                   | Program Symbol                               | Theory Symbol  | Description                                      | Units               | Format |
|--|--|----------------|--|---------------------|--------|
| 1  | NCASE  |                | Number of plates                                 |                     | I5     |
| (There are NCASE sets of remaining cards.) |  |                |  |                     |        |
| 2-4  | (ALPHA) (I, J),<br>(I = 1, 3),<br>(J = 1, 3) | $\alpha_{m,n}$ | Modal frequency parameter, found from nomographs |                     | 3F12.6 |
| 5  | A  | $a$            | Dimension, $x$ -direction                        | ft                  | F12.6  |
| 5  | B  | $b$            | Dimension, $y$ -direction                        | ft                  | F12.6  |
| 5  | H  | $h$            | Plate thickness                                  | ft                  | F12.6  |
| 5  | G  | $g$            | Gravitational constant                           | ft/sec <sup>2</sup> | F12.6  |
| 6  | E  | $\bar{E}$      | Young's modulus                                  | lb/ft <sup>2</sup>  | E16.8  |
| 6  | SIGMA  | $\sigma$       | Poisson's ratio                                  |                     | F12.6  |
| 6  | RHO  | $\rho_w$       | Plate weight density                             | lb/ft <sup>3</sup>  | F12.6  |

### Output Description

Both ALPHA and FREQ ( $f_{m,n}$ ) are given according to mode. The 7090 computer time is about 30 seconds.

### PLFREQ (see Table 10 and Figure 26)

PLFREQ is a computer program developed by Plumblee<sup>28</sup> and Ballentine<sup>19</sup> to yield the natural frequencies of vibration of either a simply supported or clamped thin plate, flat or curved. The original program was in nondimensional form. However, for the comparison purposes of this report, the program was modified so that additional input in units permitted the frequency to also be computed in hertz.

The mathematical subroutines needed from the IBM SHARE library are EIGEN, LOC, and MINV. The sample problems for 36 modes were run on the IBM 360/91 and took 18 seconds per plate.

TABLE 10

## Program Listing for PLFREQ Computer Program

```

REAL BETAL(20),M1(20,20),M2(20,20),R(27),ML,NU
DOUBLE PRECISION L(378),VECTOR(729),VEC(27),XX
DOUBLE PRECISION FR(5)
INTEGER LR(45),LM(45),P,Q,PP,QQ,QQQ,S,T,PQ,QI
415 READ(5,415) RHO,AL,B,G,E
415 FORMAT(4F12.6,E16.8)
3 READ(5,1)THETA,TL,A,NU
READ(5,2)MM,NN,MV,LL,LBOUND
1 FORMAT(4E10.4)
2 FORMAT(5I2)
WRITE(6,15)THETA,TL,A,NU
15 FORMAT(4X,'THETA=',F10.4,'TL=',F10.4,'A=',F10.4,'NU=',F10.4)
WRITE(6,16)MM,NN,MV,LL,LBOUND
16 FORMAT(4X,'MM=',I2,'NN=',I2,'MV=',I2,'LL=',I2,'LBOUND=',I2)
R(1)=LBOUND
CALL BETA(MM,NN,R,BETAL,M2,M1)
IF(MM-NN) 41,41,42
41 KK=2*NN
GO TO 43
42 KK=2*MM
43 WRITE(6,46)
DO 44 I=1,KK
WRITE(6,48) (M1(I,J),J=1,KK)
44 CONTINUE
WRITE(6,47)
DO 45 I=1,KK
WRITE(6,48) (M2(I,J),J=1,KK)
45 CONTINUE
46 FORMAT(1H1,4X,'MATRIX M1(I,J)',//)
47 FORMAT(1H1,4X,'MATRIX M2(I,J)',//)
48 FORMAT(5X,9E12.5)
MN=MM*NN
MN5=3*MN
P=1
GO TO 11

```

TABLE 10 (Continued)

```

10 P=P+1
11 CALL SUBSCP(P,MN,NN,LL,PP,S,T)
   Q=P
   GO TO 13
12 Q=Q+1
13 CALL SUBSCP(Q,MN,NN,LL,QQ,M,N)
   CALL LOC(P,Q,PQ,MN5,MN5,1)
   GO TO (101,102,103),PQ
101 GO TO (1011,1012,1013),QQ
1011 L(PQ)=A*BETAL(M)**3*M1(S,M)*M1(T,N)/BETAL(S)+(1.-NU)*M2(S,M)
   1*M2(T,N)/(BETAL(M)*BETAL(S)**2.*A)
   IF(P-Q) 12,10111,12
10111 R(P)=M2(S,M)*M1(T,N)/(BETAL(S)*BETAL(M))
   GO TO 12
1012 L(PQ)=(1.+NU)*M2(S,M)*M2(T,N)/(BETAL(S)*BETAL(N)**2.0)
   GO TO 12
1013 L(PQ) = -NU*THETA*M2(S,M)*M1(T,N)/BETAL(S)
   IF(3*MM*NN-Q)10,10,12
102 QQ=QQ-1
   GO TO (1022,1023),QQ
1022 L(PQ)=M1(S,M)*M1(T,N)*BETAL(N)**3*(1.+THETA**2/(12.*(TL*A)**2))
   1/(A*BETAL(T))+{1.-NU}*A*M2(S,M)*M2(T,N)*(1.+((THETA/A/TL)**2/3.0)
   2)/(2.*BETAL(T)*BETAL(N))
   IF(P-Q)12,10222,12
10222 R(P)=M1(S,M)*M2(T,N)/(BETAL(T)*BETAL(N))
   GO TO 12
1023 L(PQ)=THETA*M1(S,M)*M2(T,N)/(A*BETAL(T))+THETA*M2(S,M)*M2(T,N)
   1*NU/(12.*A*TL*TL*BETAL(N))+THETA*M1(S,M)*M1(T,N)*BETAL(N)**4/12.
   2/(TL*TL*A**3*BETAL(T))+{1.-NU}*THETA*M2(S,M)*M2(T,N)/(6.*A*TL*TL)
   3/BETAL(T)
   IF(MN5-Q)10,10,12
103 L(PQ)=THETA**2*M1(S,M)*M1(T,N)/A+A*M1(S,M)*BETAL(M)**4*M1(T,N)
   1/(12.*TL*TL)+M1(S,M)*M1(T,N)*BETAL(N)**4/(12.*TL*TL*A**3)+
   2M2(S,M)*M2(T,N)/(6.*TL*TL*A)
   IF(P-Q)1033,10333,1033

```



TABLE 10 (Continued)

```

10333 R(P)=M1(S,M)*M1(T,N)
1033 IF(MN5-Q) 1034,1034,12
1034 IF(MN5-P)100,100,10
100 DO 110 I=1,MN5
110 R(I)=SQRT(R(I))
    DO 120 I=1,MN5
    DO 120 J=I,MN5
    CALL LOC(I,J,IJ,MN5,MN5,1)
    L(IJ)=L(IJ)/(R(I)*R(J))
120 CONTINUE
    DFACT=1.
140 DNORM=1.
    DO 150 I=1,MN5
    CALL LOC(I,I,II,MN5,MN5,1)
    DNORM=DNORM*L(II)/DFACT
    IF(DNORM-1.D+70)145,155,155
145 IF(DNORM-1.D-70)160,160,150
150 CONTINUE
    GO TO 165
155 DFACT=10.*DFACT
    GO TO 140
160 DFACT =0.1*DFACT
    GO TO 140
165 DNORM=(ABS(DNORM))**(1/MN5)
    DO 170 I=1,MN5
    DO 170 J=I,MN5
    CALL LOC(I,J,IJ,MN5,MN5,1)
170 L(IJ)=L(IJ)/(DNORM*DFACT)
    DO 125 I=1,MN5
    DO 125 J=1,MN5
    CALL LOC(I,J,IK,MN5,MN5,0)
    CALL LOC(I,J,IJ,MN5,MN5,1)
125 VECTOR( IK)=L(IJ)
    MN52=MN5*MN5
    CALL MINV(VECTOR,MN5,XX,LM,LR)

```

TABLE 10 (Continued)

```

WRITE(6,130) XX
130 FORMAT('0','THE DETERMINANT IS', E12.5)
DO 135 I=1,MN5
DO 135 J=1,MN5
CALL LOC(I,J,IJ,MN5,MN5,1)
CALL LOC(I,J,IK,MN5,MN5,0)
135 L(IJ)=VECTOR(IK)
CALL EIGEN(L,VECTOR,MN5,MV)
20 FORMAT('1',8X,'DIMENSIONLESS FREQUENCIES ARE NORMALIZED',
1 2X,'EIGENVECTORS')
WRITE(6,20)
21 FORMAT(33X,'FOR')
WRITE(6,21)
22 FORMAT(21X,'A CYLINDRICALLY CURVED PANEL')
WRITE(6,22)
23 FORMAT(32X,'WITH')
WRITE(6,23)
GO TO (241,242),LBOUND
241 WRITE(6,24)
24 FORMAT(28X,'CLAMPED EDGES')
GO TO 251
242 WRITE(6,245)
245 FORMAT(23X,'SIMPLY SUPPORTED EDGES')
251 WRITE(6,25)
25 FORMAT('0',29X,'*****')
26 FORMAT('0',19X,'NONDIMENSIONAL INPUT PARAMETERS')
WRITE(6,26)
27 FORMAT('0','SUBTENDED ANGLE=' F7.4,10X,'ASPECT RATIO=',F7.4)
WRITE(6,27)THETA,A
28 FORMAT('0','LENGTH/SKIN THICKNESS=',F7.2)
WRITE(6,28) TL
WRITE(6,29) NU
29 FORMAT('0','POISSONS RATIO=',F4.3)
32 FORMAT('0','NUMBER OF SERIES TERMS ALONG STRAIGHT EDGE=',I1,
1',ALONG CURVED EDGE=',I1)

```

TABLE 10 (Continued)

```

WRITE(6,32)MM,NN
33 FORMAT('0',29X,'*****'//,17X'COMPUTED FREQUENCIES AND',
1'MODE SHAPES')
WRITE(6,33)
DO 180 I=1,MN5
CALL LOC(I,I,II,MN5,MN5,1)
IF(L(II))180,180,179
179 L(I)=0.159154*SQRT(DNORM*DFACT)/DSQRT(L(II))
180 CONTINUE
II=1
GO TO 51
50 II=II+1
51 MI=5*(II-1)+1
NI=5*II
IF(MN-4)520,520,523
520 GO TO (521,521,522,523),MN
522 GO TO (521,531,521),II
523 IF(II-1)521,521,533
532 FORMAT('1'//////////)
533 WRITE(6,532)
GO TO 521
53 FORMAT('1')
531 WRITE(6,53)
52 FORMAT('0','FREQUENCY=',5(1X,E11.4))
521 WRITE(6,52) (L(I),I=MI,NI)
J = 1
DO 5521 I = MI,NI
FR(J) = L(I)* SQRT((E*G)/(RHO*AL*B*(1.-NU**2)))
5521 J = J + 1
WRITE(6,5522) (FR(I),I = 1,5)
5522 FORMAT(10X,5(1X,E11.4))
54 FORMAT('0','GEN COORD',3X,5(2X,'MODE SHAPE'))
WRITE(6,54)
Q=1
GO TO 61

```

TABLE 10 (Continued)

```

60 Q=Q+1
61 CALL SUBSCP(Q,MN,NN,LL,QQ,M,N)
   GO TO (7110,7210,7310),QQ
7110 DO 711 I=MI,NI
      CALL LOC(Q,I,QI,MN5,MN5,0)
711 VEC(I)=VECTOR(QI)
      WRITE(6,71)M,N,(VEC(I),I=MI,NI)
      GO TO 60
7210 DO 721 I=MI,NI
      CALL LOC(Q,I,QI,MN5,MN5,0)
721 VEC(I)=VECTOR(QI)
      WRITE(6,72)M,N,(VEC(I),I=MI,NI)
      GO TO 60
7310 DO 731 I=MI,NI
      CALL LOC(Q,I,QI,MN5,MN5,0)
731 VEC(I)=VECTOR(QI)
      WRITE(6,73)M,N,(VEC(I),I=MI,NI)
      IF(MN5-Q)76,76,60
76 IF(MN5-NI)77,77,50
77 WRITE(6,53)
80 CONTINUE
   IF(LL-4) 3,74,74
71 FORMAT(2X,'U(',I1,',',',I1,')',4X,5(1X,E11.4))
72 FORMAT(2X,'V(',I1,',',',I1,')',4X,5(1X,E11.4))
73 FORMAT(2X,'W(',I1,',',',I1,')',4X,5(1X,E11.4))
74 CONTINUE
   APL=SQRT(41.7*A+25.2/A+41.7/A**3+(TL*THETA)**2/A)
   WRITE(6,78) APL
78 FORMAT(E11.4)
   STOP
   END
   SUBROUTINE BETA(M,N,A,B,G,H)
   DIMENSION A(1),B(1),G(20,20),H(20,20)
   IF(M-N)1,1,20
1 KK=2*N

```

TABLE 10 (Continued)

```

GO TO 2
20 KK=2*M
2 IF(A(1)-1.5)9,9,10
9 DO 5 I=5, KK
  IF(I-5)4,4,3
3 A(I)=1.0
  B(I)=(2*I+1)*1.5707963
  GO TO 5
4 A(1)=.9825022158
  A(2)=1.000777311
  A(3)=.9999664501
  A(4)=1.00000145
  A(5)=.9999999373
  B(1)=4.7300408
  B(2)=7.8532046
  B(3)=10.9956078
  B(4)=14.1371655
  B(5)=17.2787596
5 CONTINUE
  DO 8 I=1, KK
  DO 8 J=1, KK
  IF(I-J)7,6,7
6 G(I,J)=A(I)*B(I)*(A(I)*B(I)-2.0)
  H(I,J)=1.0
  GO TO 8
7 G(I,J)=-4.*B(I)**2*B(J)**2*(A(I)*B(I)-A(J)*B(J))*
  1 (1.+(-1.)*(I+J))/(B(I)**4-B(J)**4)
  H(I,J)=0.0
8 CONTINUE
  RETURN
10 DO 11 I=1, KK
  B(I)=I*3.1415927
  DO 11 J=1, KK
  IF(I-J)12,13,12
12 G(I,J)=0.0

```

TABLE 10 (Continued)

```
H(I,J)=0.0
GO TO 11
13 G(I,J)=B(I)**2
H(I,J)=1.0
11 CONTINUE
RETURN
END
SUBROUTINE SUBSCP(NR,MN,NN,KK,NP,J,K)
NP=(NR-1)/MN+1
I=NR-(NP-1)*MN
II=(I-1)/NN
GO TO (1,2,3,4),KK
1 J=2*II+1
K=2*I-2*II*NN-1
RETURN
2 J=2*II+2
K=2*I-2*II*NN-1
RETURN
3 J=2*II+1
K=2*I-2*II*NN
RETURN
4 J=2*II+2
K=2*I-2*II*NN
RETURN
END
```

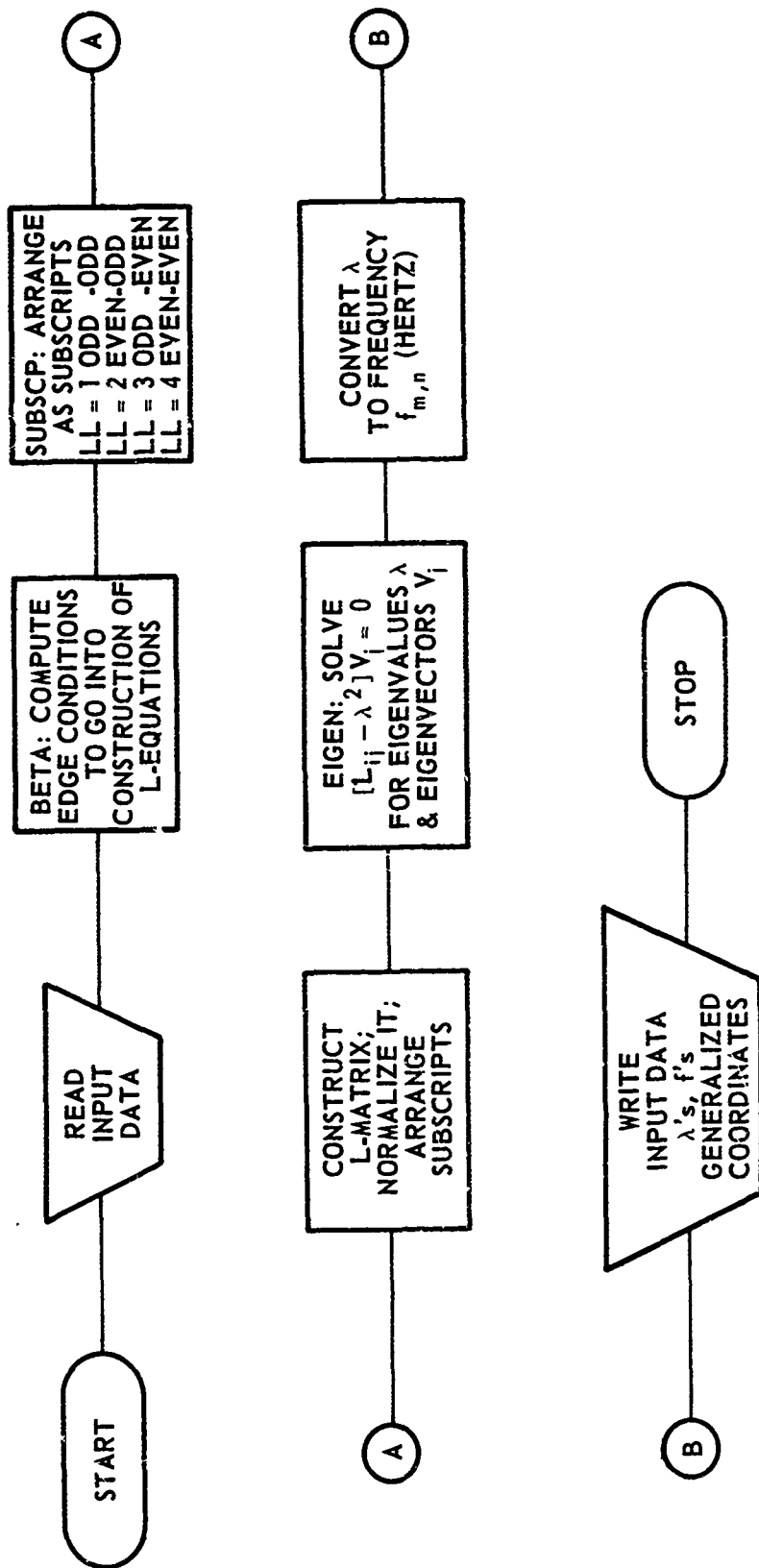

Figure 26 - Flow Chart for PLFREQ, Computer Program for Computing Natural Frequencies of a Plate by Ballentine-Plumlee Method

The printed output contains FREQ (M,N) which may be multiplied by  $2\pi$  to give the values OMEGA (M,N) which may be used as input to Subprogram A in Appendix B of Reference 1.

### Input Description

The input description is as follows.

| Card No.   | Program Symbol | Theory Symbol     | Description  | Units               | Format |
|--|----------------|-------------------|--|---------------------|--------|
| 1  | RHO            | $\rho_w$          | Plate weight density   |                     | F12.6  |
| 1  | AL             | $a \text{ or } l$ | Panel length   | ft                  | F12.6  |
| 1  | B              | $b$               | Panel arc length   | ft                  | F12.6  |
| 1  | G              | $g$               | Gravitational constant   | ft/sec <sup>2</sup> | F12.6  |
| 1  | E              | $E$               | Young's modulus  | lb/ft <sup>2</sup>  | E16.8  |
| For each value of LL, there is a set of the following cards: |                |                   |  |                     |        |
| 2  | THETA          | $\theta$          | Subtended angle $\frac{b}{R}$ (0 for flat plate)                                 |                     | E10.4  |
| 2  | TL             | $\frac{l}{h}$     | If curved panel, $R$ = panel midplane radius, ratio of panel length to thickness |                     | E10.4  |
| 2  | A              | $\frac{b}{l}$     | Aspect ratio   |                     | E10.4  |
| 2  | NU             | $\nu$             | Poisson's ratio  |                     | E10.4  |
| 3  | MM             | $m$               | Modes, $x$ -direction  |                     | I2     |
| 3  | NN             | $n$               | Modes, $y$ -direction  |                     | I2     |
| 3  | MV             |                   | 0 eigenvalues and eigenvectors<br>1 eigenvalue only                              |                     | I2     |
| 3  | LL             |                   | 1 odd-odd modes<br>2 even-odd<br>3 odd-even<br>4 even-even                       |                     | I2     |
| 3  | LBOUND         |                   | 1 clamped edges<br>2 simply supported edges                                      |                     | I2     |

### Output Description

The frequencies are printed out in ascending order for each set of subscripts (odd-odd, even-odd, odd-even, even-even). The nondimensional frequency is given first, with frequency in hertz on the next line. The generalized coordinates and mode shapes are also given in the same column as the frequencies they represent.

### SUNFRE (see Table 11 and Figure 27)

SUNFRE is a computer program developed by Sun<sup>24</sup> to obtain the natural frequencies of vibration of a class of thin plates, including such special cases as the circle, square, and rectangle.



TABLE 11

## Program Listing for SUNFRE Computer Program

```

C   FREQUENCIES OF GENERAL PLATE BY RITZ METHOD
DOUBLE PRECISION XMA(21,21),XMB(21,21),XMC(21,21),XI(48),YI(48)      0010
DOUBLE PRECISION WI(48),HOR(21),VER(21),AREA(462),AREAU(462)        0020
DOUBLE PRECISION AREAV(462),XWW(462)                                30
DIMENSION XP(21),YP(21)                                           40
DOUBLE PRECISION XU(21,21),XMD(21,21),A(21),B(21),C(21)           0050
DOUBLE PRECISION VAL,DSIG,ASD,P,CONV,AMPLTD,EIGENS                 0060
DOUBLE PRECISION VXP(21),VYP(21)                                   70
COMMON XMA, XMB, XMC, XI, YI, WI, HOR, VER, AREA, AREAU, AREAV,    0080
1   XWW,P,B,ALPHA,BETA,RATIO,NK,NROW,XP,YP,AM1,BM1,                0090
2   SWITCH, VXP, VYP                                              100
READ (5, 999 ) NK, (XI(I), I = 1, NK ), (WI(I), I = 1, NK )      0110
999 FORMAT(I10 / (4E20,10))                                        120
DO 2 I = 1, NK                                                    130
2   YI(I) = XI(I)                                                140
SWITCH = 0.                                                       150
10  READ (5, 1000) ALPHA, BETA, RATIO, MODE, NOIT, NP, LIMIT, CONV 0160
1000 FORMAT ( 3F5.2, 4I5, F10.7 )                                0170
LAST = 0                                                           180
C   MODE = 1 X, Y TAKE EVEN POWER                                  0190
C   MODE = 2 X, Y TAKE ODD POWER                                  0200
C   MODE = 3 X TAKE EVEN POWER, Y TAKE ODD POWER                 0210
C   MODE = 4 Y TAKE EVEN POWER, X TAKE ODD POWER                 0220
C   NOIT = NUMBER OF EIGENVALUES DESIRED                          0230
C   NP = 0 NO POINTS FOR NODAL LINES                              0240
C   NP = 20 20 POINTS FOR NODAL LINES PLOT                       0250
C   LIMIT = 800 (RECOMMENDED) CYCLES OF ITERATION                0260
C   CONV = 0.00001 IS RECOMMENDED                                 0270
CALL XPYP (XP,YP,NROW,MODE)                                        0280
WRITE (6,1050) ALPHA, BETA, RATIO, NROW, MODE                     0290
1050 FORMAT(/ 2X, 7HALPHA =, F6.2,8H BETA =, F6.2,9H RATIO =, F6.2, 0300
1   4X, 25HNO. OF TERMS IN X AND Y =, I4, 8H MODE =, I3 )        0310
WRITE (6,1052) ((XP(I), YP(I)), I = 1, NROW )                     0320
1052 FORMAT ( 7(2H (, F3.0, F3.0, 2H) ) )                          0330
P = 1. / (RATIO ** BETA )                                         0340
AM1 = ALPHA - 1.                                                  350
BM1 = BETA - 1.                                                  360
CALL DUBINT                                                        370
ICCT = 1                                                           380
DO 12 I = 1, NROW                                                 390
DO 12 J = I, NROW                                                 400
XMC(I,J) = AREA(ICCT)                                             410
XMC(J,I) = AREA(ICCT)                                             420
12 ICCT = ICCT + 1                                               430
DO 13 I = 1, NROW                                                 440
13 WRITE (6, 1054) (XMC(I,J), J = 1, NROW )                       0450
1054 FORMAT (//(1X, 5D25.16 ))                                    460
DO 14 I = 1, NROW                                                 470
DO 14 J = I, NROW                                                 480
XMA(I,J) = AREA(ICCT)                                             490
XMA(J,I) = AREA(ICCT)                                             500
14 ICCT = ICCT + 1                                               510
DO 15 I = 1, NROW                                                 520
15 WRITE (6, 1054) (XMA(I,J), J = 1, NROW )                       0530
IF ( NROW - 1 ) 16, 16, 18                                        540
16 AMPLTD = XMC(1,1) / XMA(1,1)                                    550
EIGENS = DSQRT( AMPLTD)                                           560
WRITE (6, 1060) EIGENS                                             570
1060 FORMAT (// 3X, 15HEIGEN VALUE = , D25.16 //)                0580
GO TO 10                                                            590

```

TABLE 11 (Continued)

|      |  |          |
|------|--|----------|
| 18   | CALL SMTRX ( XMC, XMA, NROW, XMB, XU )                             | 0590     |
|      | WRITE (6, 1070) ((XMB(I,J), J = 1, NROW ), I = 1, NROW )           | 0600     |
|      | DO 20 I = 1, NROW  | 610      |
|      | DO 20 J = I, NROW  | 620      |
|      | XMB(I,J) = (XMB(I,J) + XMB(J,I))/2.                                | 0630     |
| 20   | XMB(J,I) = XMB(I,J)  | 640      |
|      | WRITE (6, 1070) ((XMB(I,J), J = 1, NROW), I = 1, NROW )            | 0650     |
| 1070 | FORMAT (1X, 5D25.16 )  | 660      |
|      | CALL EIGEN ( XMB, NROW, NOIT, A, XMD, LIMIT, CONV, TELL, NUMCYC )  | 0670     |
| C    | A - COLUMN MATRIX OF EIGENVALUES                                   | 0680     |
| C    | XMD - SQUARE MATRIX OF CALCULATED EIGENVECTORS FOR MATRIX PENCIL   | 0690     |
|      | WRITE (6, 1072) TELL, CONV, LIMIT, NUMCYC                          | 0700     |
| 1072 | FORMAT(/ 2X, 6HTELL = , F5.2, 3X, 20HCONVERGENCE FACTOR = , F10.8, | 0710     |
|      | 1 3X, 15HLIMITED CYCLE = , I5 / 3X, 19HNUMBER OF CYCLE =           | 0720     |
|      | 2 , I6 )   | 730      |
|      | IF ( TELL ) 10, 10, 30   | 740      |
| 30   | CONTINUE   | 750      |
|      | DO 40 I = 1, NOIT  | 760      |
| 40   | A(I) = DSQRT ( 1. / A(I) ) * 4.0                                   | 0770     |
|      | WRITE (6, 1076) (A(I), I = 1, NOIT )                               | 0780     |
| 1076 | FORMAT (1X, 16HEIGENVALUES ARE , / (5D25.16) )                     | 0790     |
|      | DO 44 I = 1, NOIT  | 800      |
| 44   | WRITE (6, 1078) I, (XMD(I,L), L = 1, NROW )                        | 0810     |
| 1078 | FORMAT (3X, I3, 31HTH EIGENVECTORS FROM ITERATION / ( 5D25.16 ))   | 0820     |
|      | NM1 = NOIT - 1   | 830      |
|      | DO 48 I = 1, NM1   | 840      |
|      | IP1 = I + 1  | 850      |
|      | DO 48 J = IP1, NOIT  | 860      |
|      | VAL = 0.   | 870      |
|      | DO 46 K = 1, NROW  | 880      |
| 46   | VAL = VAL + XMD(I,K) * XMD(J,K)                                    | 0890     |
| 48   | WRITE (6, 1080) I, J, VAL  | 900      |
| 1080 | FORMAT ( 3X, I4 , 25HTH EIGENVECTORS MULTIPY , I4, 25HTH EIGEN V   | 0910     |
|      | 1ECTORS EQUAL TO , D25.16 )  | 0920     |
|      | DO 70 I = 1, NOIT  | 930      |
| 52   | DO 53 J = 1, NROW  | 940      |
| 53   | C(J) = XMD(I,J)  | 950      |
|      | CALL TRAVEC ( XU, C, B, NROW )                                     | 960      |
| C    | B - ORIGINAL COLUMN MATRIX   | 970      |
|      | BIG = 0.   | 980      |
|      | DO 56 J = 1, NROW  | 990      |
|      | ABSB = DABS(B(J) )   | 100C     |
|      | IF ( BIG - ABSB ) 54, 56, 56                                       | 1010     |
| 54   | BIG = ABSB   | 1020     |
| 56   | CONTINUE   | 1030     |
|      | DO 60 J = 1, NROW  | 1040     |
| 60   | B(J) = B(J) / BIG  | 1050     |
|      | WRITE (6, 1090) I, A(I), (B(J), J = 1, NROW )                      | 1060     |
| 1090 | FORMAT ( 2X, I2, 15HTH EIGEN VALUE , D25.16 / ( /5D25.16 ))        | 1070     |
|      | IF ( NP ) 66, 70, 66   | 1080     |
| 66   | CALL PLNODE ( NP )   | 1090     |
| 70   | CONTINUE   | 1100     |
|      | LAST = LAST + 1  | 1110     |
| 100  | IF ( LAST - 1 ) 10, 300, 300                                       | 1120     |
| 300  | CONTINUE   | 1130     |
|      | STOP   | 1140     |
|      | END  | 1150     |
|      | <br>SUBROUTINE XPYP (XP, YP, NROW, MODE )                          | <br>1160 |

TABLE 11 (Continued)

|      |   |      |
|------|---|------|
|      | DIMENSION XP(21),YP(21)   | 1170 |
|      | READ(5,1000) NROW   | 1180 |
| 1000 | FORMAT (I10)  | 1190 |
|      | DO 1110 II= 1,MODE  | 1200 |
| 1110 | READ(5,1100) ((XP(I),YP(I)), I = 1,NROW)                        | 1210 |
| 1100 | FORMAT (16F5.2)   | 1220 |
|      | RETURN  | 1230 |
|      | END   | 1240 |
|      |   |      |
|      | SUBROUTINE DUBINT   | 1250 |
|      | DOUBLE PRECISION XMA(21,21),XMB(21,21),XMC(21,21),XI(48),YI(48) | 1260 |
|      | DOUBLE PRECISION WI(48),HOR(21),VER(21),AREA(462),AREAU(462)    | 1270 |
|      | DOUBLE PRECISION AREAV(462),XWW(462)                            | 1280 |
|      | DIMENSION XP(21), YP(21)  | 1290 |
|      | DOUBLE PRECISION HXX(21),HYY(21),HXY(21),B(21)*                 | 1300 |
|      | DOUBLE PRECISION BOQ,WII,UI,VI,DU,DV, #IJ,YPS,YMS,YUP,YUM,YVP   | 1310 |
|      | DOUBLE PRECISION YVM,XWIJ,P                                     | 1320 |
|      | COMMON XMA, XMB, XMC, XI, YI, WI, HOR, VER, AREA, AREAU, AREAV, | 1330 |
| 1    | XWB,P,B,ALPHA,BETA,RATIO,NK,NROW,XP,YP,AM1,BM1                  | 1340 |
|      | SM1 = .667  | 1350 |
|      | NO = NROW*(NROW + 1)  | 1360 |
|      | BOQ = 1. / BETA   | 1370 |
|      | DO 1 K=1,NROW   | 1380 |
|      | AREAU(K) = 0.   | 1390 |
|      | AREAV(K) = 0.   | 1400 |
| 1    | AREA(K) = 0.  | 1410 |
|      | DO 20 I=1,NK  | 1420 |
|      | WRITE ( 6, 1000) I  | 1430 |
| 1000 | FORMAT ( 3X, 3HI =, I3 )  | 1440 |
|      | WII = WI(I)   | 1450 |
|      | UI = 0.5*(1.+XI(I))   | 1460 |
|      | VI = 0.5*(1.-XI(I))   | 1470 |
|      | DU = RATIO*((1.-UI**ALPHA)**BOQ)                                | 1480 |
|      | DV = RATIO*((1.-VI**ALPHA)**BOQ)                                | 1490 |
|      | DO 14 J=1,NK  | 1500 |
|      | WIJ = WI(J)   | 1510 |
|      | YPS = 0.5*(1.+YI(J))  | 1520 |
|      | YMS = 0.5*(1.-YI(J))  | 1530 |
|      | YUP = DU*YPS  | 1540 |
|      | YUM = DU*YMS  | 1550 |
|      | YVP = DV*YPS  | 1560 |
|      | YVM = DV*YMS  | 1570 |
|      | CALL ALL (UI,YUP, HXX, HYY, HXY )                               | 1580 |
|      | IC = 1  | 1590 |
|      | DO 4 KJ=1,NROW  | 1600 |
|      | DO 4 KI=KJ,NROW   | 1610 |
|      | XWW(IC) = HOR(KJ) * HOR(KI) - SM1 * (HYY(KI) * HXX(KJ)          | 1620 |
| 1    | + HXX(KI) * HYY(KJ) - 2. * HXY(KI) * HXY(KJ) )                  | 1630 |
| 4    | IC = IC+1   | 1640 |
|      | DO 5 KJ = 1, NROW   | 1650 |
|      | DO 5 KI = KJ,NROW   | 1660 |
|      | XWW(IC) = VER(KJ) * VER(KI)                                     | 1670 |
| 5    | IC = IC+1   | 1680 |
|      | CALL ALL ( UI, YUM, HXX, HYY, HXY )                             | 1690 |
|      | IC = 1  | 1700 |
|      | DO 6 KJ=1,NROW  | 1710 |
|      | DO 6 KI=KJ,NROW   | 1720 |
|      | XWIJ = WIJ * (XWW(IC) + HOR(KI) * HOR(KJ) -                     | 1730 |
| 1    | SM1 * ( HYY(KJ) * HXX(KI) + HXX(KJ) * HYY(KI) - 2. * HXY(KI) *  | 1740 |

TABLE 11 (Continued)

|    |   |      |
|----|---|------|
| 2  | HXY(KJ) ) )   | 1750 |
|    | AREAU(IC) = AREAU(IC)+XWIJ                                      | 1760 |
| 6  | IC = IC+1   | 1770 |
|    | DO 7 KJ = 1, NROW   | 1780 |
|    | DO 7 KI = KJ, NROW  | 1790 |
|    | XWIJ = WIJ * (XWW(IC) + VER(KI)*VER(KJ))                        | 1800 |
|    | AREAU(IC) = AREAU(IC)+XWIJ                                      | 1810 |
| 7  | IC = IC+1   | 1820 |
|    | CALL ALL ( VI, YVP, HXX, HY, HXY )                              | 1830 |
|    | IC = 1  | 1840 |
|    | DO 8 KJ=1,NROW  | 1850 |
|    | DO 8 KI=KJ,NROW   | 1860 |
|    | XWW(IC) = HOR(KJ) * HOR(KI) - SM1 * (HYY(KJ) * HXX(KI)          | 1870 |
| 1  | + HXX(KJ) * HYY(KI) - 2. * HXY(KI) * HXY(KJ) )                  | 1880 |
| 8  | IC = IC+1   | 1890 |
|    | DO 9 KJ = 1, NROW   | 1900 |
|    | DO 9 KI = KJ, NROW  | 1910 |
|    | XWW(IC) = VER(KI) * VER(KJ)                                     | 1920 |
| 9  | IC = IC+1   | 1930 |
|    | CALL ALL ( VI, YVM, HXX, HYY, HXY )                             | 1940 |
|    | IC = 1  | 1950 |
|    | DO 10 KJ=1,NROW   | 1960 |
|    | DO 10 KI=KJ,NROW  | 1970 |
|    | XWIJ = WIJ * (XWW(IC) + HOR(KI) * HCR(KJ) -                     | 1980 |
| 1  | SM1 * ( HYY(KJ) * HXX(KI) + HXX(KJ) * HYY(KI) - 2. * HXY(KI) *  | 1990 |
| 2  | HXY(KJ) ) )   | 2000 |
|    | AREAV(IC) = AREAV(IC)+XWIJ                                      | 2010 |
| 10 | IC = IC+1   | 2020 |
|    | DO 11 KJ = 1, NROW  | 2030 |
|    | DO 11 KI = KJ, NROW   | 2040 |
|    | XWIJ = WIJ * ( XWW(IC) + VER(KI)*VER(KJ))                       | 2050 |
|    | AREAV(IC) = AREAV(IC)+XWIJ                                      | 2060 |
| 11 | IC = IC+1   | 2070 |
| 14 | CONTINUE  | 2080 |
|    | DO 16 K=1,NO  | 2090 |
|    | AREA(K) = AREA(K)+WII*(DU*AREAU(K)+DV*AREAV(K))/2.              | 2100 |
|    | AREAU(K) = 0.   | 2110 |
| 16 | AREAV(K) = 0.   | 2120 |
| 20 | CONTINUE  | 2130 |
|    | DO 30 K=1,NO  | 2140 |
| 30 | AREA(K) = .5*AREA(K)  | 2150 |
|    | RETURN  | 2160 |
|    | END   | 2170 |
|    | <br>  |      |
|    | SUBROUTINE ALL ( X, Y, HXX, HYY, HXY )                          | 2180 |
|    | DOUBLE PRECISION XMA(21,21),XMB(21,21),XMC(21,21),XI(48),YI(48) | 2190 |
|    | DOUBLE PRECISION WI(48),HOR(21),VER(21),AREA(462),AREAU(462)    | 2200 |
|    | DOUBLE PRECISION AREAV(462),XWW(462)                            | 2210 |
|    | DIMENSION XP(21), YP(21)  | 2220 |
|    | DIMENSION NXP(21), NYP(21)                                      | 2230 |
|    | DOUBLE PRECISION HXX(21),HYY(21),HXY(21),B)21*                  | 2240 |
|    | DOUBLE PRECISION X,Y,F,FX,FY,FXX,FYY,FXI                        | 2250 |
|    | DOUBLE PRECISION DF,XIP,YJP,G,GX,GY,GXX,GYY,GXY,DG,P,AI,AJ      | 2260 |
|    | COMMON XMA, XMB, XMC, XI, YI, WI, HOR, VER, AREA, AREAU, AREAV, | 2270 |
| 1  | XWW,P,B,ALPHA,BETA,RATIO,NK,NROW,XP,YP,AM1,BM1                  | 2280 |
| C  | *****   | 2290 |
|    | CALL VECTOR (X,Y,F,FX,FY,FXX,FYY,FXI,ALPHA,BETA,P,AM1,BM1 )     | 2300 |
| C  | *****   | 2310 |
|    | DF = FXX + FYY  | 2320 |

TABLE 11 (Continued)

|  |      |
|--|------|
| DO 20 KK = 1, NROW   | 2330 |
| NXP(KK) = XP(KK)   | 2340 |
| NYP(KK) = YP(KK)   | 2350 |
| XIP = X **NXP(KK)  | 2360 |
| YJP = Y **NYP(KK)  | 2370 |
| AI = XP(KK)  | 2380 |
| AJ = YP(KK)  | 2390 |
| G = XIP * YJP  | 2400 |
| GX = AI * G / X  | 2410 |
| GY = AJ * G / Y  | 2420 |
| GXX = (AI - 1.) * GX / X   | 2430 |
| GYG = (AJ - 1.) * GY / Y   | 2440 |
| GXY = AJ * GX / Y  | 2450 |
| DG = GXX + GYG   | 2460 |
| HOR(KK) = G * DF + F * DG + 2.*(FX*GX + FY*GY)                   | 2470 |
| HOR(KK) = HOR(KK)*1000000000.                                    | 2480 |
| VER(KK) = F * G  | 2490 |
| VER(KK) = VER(KK)*1000000000.                                    | 2500 |
| HXX(KK) = FXX*G + F*GXX + 2.*FX*GX                               | 2510 |
| HXX(KK) = HXX(KK)*1000000000.                                    | 2520 |
| HYY(KK) = FYY*G + F*GYG + 2.*FY*GY                               | 2530 |
| HYY(KK) = HYY(KK)*1000000000.                                    | 2540 |
| HXY(KK) = FXY*G + F*GXY + FX*GY + FY*GX                          | 2550 |
| HXY(KK) = HXY(KK)*1000000000.                                    | 2560 |
| 20 CONTINUE  | 2570 |
| RETURN   | 2580 |
| END  | 2590 |
| <br>   |      |
| SUBROUTINE VECTOR(X,Y,F,FX,FY,FXX,FYY,FGY,ALPHA,BETA, P,AM1,BM1) | 2600 |
| DOUBLE PRECISION X,Y,F,FX,FY,FXX,FYY,FGY                         | 2610 |
| DOUBLE PRECISION XA,PYC,FR1,FR2,DX,DY,P                          | 2620 |
| NALPH = IFIX(ALPHA)  | 2630 |
| NBETA = IFIX(BETA)   | 2640 |
| XA = X**NALPH  | 2650 |
| PYB = P * Y**NBETA   | 2660 |
| FR1 = 1. - XA - PYB  | 2670 |
| FR2 = FR1 * FR1  | 2680 |
| F = FR2  | 2690 |
| DX = - ALPHA * XA / X  | 2700 |
| DY = - BETA * PYB / Y  | 2710 |
| FX = 2. * FR1 * DX   | 2720 |
| FY = 2. * FR1 * DY   | 2730 |
| FGY = 2. * DX * DY   | 2740 |
| FXX = 2. * FR1 * DX * AM1 / X + 2.* DX * DX                      | 2750 |
| FYY = 2. * FR1 * DY * BM1 / Y + 2. * DY * DY                     | 2760 |
| RETURN   | 2770 |
| END  | 2780 |
| <br>   |      |
| C SUBROUTINE SMTRX( A, C, N, E, XU )                             | 2790 |
| TO TRANSFORM (C-W2A)X = C INTO BX=W2X                            | 2800 |
| DOUBLE PRECISION A(21,21),C(21,21),XL(21,21),XU(21,21),D(21,21)  | 2810 |
| DOUBLE PRECISION E(21,21)  | 2820 |
| CALL SMTRX1(A, XL, XU, N)  | 2830 |
| CALL SMTRX2 ( XL,C, D, N )                                       | 2840 |
| CALL SMTRX3 ( XU, D, E, N )                                      | 2850 |
| RETURN   | 2860 |
| END  | 2870 |
| SUBROUTINE SMTRX1( A, XL, XU, N )                                | 2880 |

TABLE 11 (Continued)

|     |   |      |
|-----|---|------|
| C   | TO FIND L AND L', TO STORE IN XL AND XU       | 2890 |
|     | DOUBLE PRECISION A(21,21),XL(21,21),XU(21,21) | 2900 |
|     | DOUBLE PRECISION S                            | 2910 |
|     | DO 5 I = 1, N                                 | 2920 |
|     | DO 5 J = 1, N                                 | 2930 |
|     | XU(I,J) = 0.                                  | 2940 |
|     | XL(I,J) = 0.                                  | 2950 |
|     | XU(1,1) = DSQRT(A(1,1))                       | 2960 |
|     | XL(1,1) = XU(1,1)                             | 2970 |
|     | DO 15 IC = 2, N                               | 2980 |
|     | XU(1, IC) = A(1, IC) / XU(1,1)                | 2990 |
| 15  | XL(IC,1) = XU(1,IC)                           | 3000 |
|     | DO 100 I = 2, N                               | 3010 |
|     | IP1 = I + 1                                   | 3020 |
|     | IM1 = I - 1                                   | 3030 |
|     | S = 0.  | 3040 |
|     | DO 20 K = 1, IM1                              | 3050 |
| 20  | S = S + XU(K,I) * XU(K,I)                     | 3060 |
|     | XU(I,I) = DSQRT(A(I,I) - S)                   | 3070 |
|     | XL(I,I) = XU(I,I)                             | 3080 |
|     | IF ( I - N ) 23, 100, 100                     | 3090 |
| 23  | DO 30 J = IP1, N                              | 3100 |
|     | S = 0.  | 3110 |
|     | DO 25 K = 1, IM1                              | 3120 |
| 25  | S = S + XU(K,I) * XU(K,J)                     | 3130 |
|     | XU(I,J) = (A(I,J) - S) / XU(I,I)              | 3140 |
| 30  | XL(J,I) = XU(I,J)                             | 3150 |
| 100 | CONTINUE                                      | 3160 |
|     | RETURN  | 3170 |
|     | END   | 3180 |
|     | SUBROUTINE SMTRX2 (XL, C, D, N)               | 3190 |
| C   | TRANSFORM TO (L)-1C AND STORE IN D            | 3200 |
|     | DOUBLE PRECISION XL(21,21),C(21,21),D(21,21)  | 3210 |
|     | DOUBLE PRECISION S                            | 3220 |
|     | DO 5 I = 1, N                                 | 3230 |
|     | D(I,1) = C(I,1) / XL(I,1)                     | 3240 |
|     | DO 100 J = 2, N                               | 3250 |
|     | IM1 = J - 1                                   | 3260 |
|     | DO 100 J = 1, N                               | 3270 |
|     | S = 0.  | 3280 |
|     | DO 10 K = 1, IM1                              | 3290 |
| 10  | S = S + XL(I,K) * D(K,J)                      | 3300 |
| 100 | D(I,J) = (C(I,J) - S) / XL(I,I)               | 3310 |
|     | RETURN  | 3320 |
|     | END   | 3330 |
|     | SUBROUTINE SMTRX3 (XU, D, E, N)               | 3340 |
| C   | TRANSFORM TO (L)-1C(L')-1 AND STORE IN E      | 3350 |
|     | DOUBLE PRECISION XU(21,21),D(21,21),E(21,21)  | 3360 |
|     | DOUBLE PRECISION S                            | 3370 |
|     | DO 5 I = 1, N                                 | 3380 |
| 5   | E(I,1) = D(I,1) / XU(I,1)                     | 3390 |
|     | DO 100 J = 2, N                               | 3400 |
|     | JM1 = J - 1                                   | 3410 |
|     | DO 100 I = 1, N                               | 3420 |
|     | S = 0.  | 3430 |
|     | DO 10 K = 1, JM1                              | 3440 |
| 10  | S = S + E(I,K) * XU(K,J)                      | 3450 |
| 100 | E(I,J) = (D(I,J) - S) / XU(J,J)               | 3460 |

TABLE 11 (Continued)

|  |      |
|--|------|
| RETURN   | 3470 |
| END  | 3480 |
|  |      |
| SUBROUTINE EIGEN(A,NRANK,NROOT,ANSWER,VECTOR,LIMIT,CONVER,TELL,            | 3490 |
| 1 NUMCYC )   | 3500 |
| C THIS SUBROUTINE FINDS THE EIGENVALUES AND EIGENVECTORS BY AN ITERATIVE S | 3510 |
| C USING THE METHOD OF REDUCTION.   | 3520 |
| DOUBLE PRECISION A(21,21),ANSWER(21),VECTOR(21,21),Z(21),Y(21,21)          | 3530 |
| DOUBLE PRECISION GREAT,TRY,R,DIFF,CONVER                                   | 3540 |
| DIFF = 0.  | 3550 |
| DO 24 I=1,NROOT  | 3560 |
| WRITE (6, 200) I   | 3570 |
| 200 FORMAT (2H , I3 )  | 3580 |
| J=I,NRANK  | 3590 |
| 1 Y(I,J)=1.  | 3600 |
| NUMCYC=0   | 3610 |
| 2 NUMCYC=NUMCYC+1  | 3620 |
| WRITE (6, 300) NUMCYC, DIFF  | 3630 |
| 300 FORMAT ( 4X, I4, 5X, D25.16 , 3X)                                      | 3640 |
| IF(NUMCYC-LIMIT)3,3,25   | 3650 |
| 3 DO 4 J=I,NRANK   | 3660 |
| Z(J)=0.  | 3670 |
| DO 4 K=I,NRANK   | 3680 |
| 4 Z(J)=Z(J)+A(J,K)*Y(I,K)  | 3690 |
| GREAT = DABS(Z(I))   | 3700 |
| INDEX=I  | 3710 |
| IF(I-NRANK)5,8,8   | 3720 |
| 5 K=I+1  | 3730 |
| DO 7 J=K,NRANK   | 3740 |
| TRY = DABS(Z(J))   | 3750 |
| IF(GREAT-TRY)6,7,7   | 3760 |
| 6 GREAT=TRY  | 3770 |
| INDEX=J  | 3780 |
| 7 CONTINUE   | 3790 |
| 8 DIFF=0.  | 3800 |
| GREAT=Z(INDEX)   | 3810 |
| DO 9 J=I,NRANK   | 3820 |
| Z(J)=Z(J)/GREAT  | 3830 |
| 9 DIFF = DIFF + DABS(Z(J) - Y(I,J))  | 3840 |
| DO 10 J=I,NRANK  | 3850 |
| 10 Y(I,J)=Z(J)   | 3860 |
| IF(DIFF-CONVER)11,11,2   | 3870 |
| 11 ANSWER(I)=GREAT   | 3880 |
| GREAT=Z(I)   | 3890 |
| DO 12 J=I,NRANK  | 3900 |
| Z(J)=Z(J)/GREAT  | 3910 |
| 12 Y(I,J)=Z(J)   | 3920 |
| IF(I-NROOT)13,15,15  | 3930 |
| 13 L=I+1   | 3940 |
| DO 14 J=L,NRANK  | 3950 |
| DO 14 K=L,NRANK  | 3960 |
| 14 A(J,K)=A(J,K)-Z(J)*A(I,K)   | 3970 |
| 15 IF(I-1)20,20,16   | 3980 |
| 16 DO 19 J=2,I   | 3990 |
| L=I-J+1  | 4000 |
| M=L+1  | 4010 |
| R=0.   | 4020 |
| DO 17 K=M,NRANK  | 4030 |
| 17 R=R+A(L,K)*Z(K)   | 4040 |

TABLE 11 (Continued)

|   |      |
|---|------|
| R=R/(ANSWER(I)-ANSWER(L))                                       | 4050 |
| Z(L)=1.   | 4060 |
| DO 18 K=M,NRANK   | 4070 |
| 18 Z(K)=Y(L,K)+Z(K)/R   | 4080 |
| 19 CONTINUE   | 4090 |
| 20 GREAT = DABS(Z(1))   | 4100 |
| INDEX=1   | 4110 |
| DO 22 J=2,NRANK   | 4120 |
| TRY = DABS(Z(J))  | 4130 |
| IF(GREAT-TRY)21,22,22   | 4140 |
| 21 GREAT=TRY  | 4150 |
| INDEX=J   | 4160 |
| 22 CONTINUE   | 4170 |
| GREAT=Z(INDEX)  | 4180 |
| DO 23 J=1,NRANK   | 4190 |
| 23 VECTOR(I,J)=Z(J)/GREAT                                       | 4200 |
| 24 CONTINUE   | 4210 |
| TELL=1.   | 4220 |
| RETURN  | 4230 |
| 25 TELL=-1.   | 4240 |
| RETURN  | 4250 |
| END   | 4260 |
| <br>  |      |
| SUBROUTINE TRAVEC (XU, X, PHI, NROW)                            | 4270 |
| DOUBLE PRECISION XU(21,21),X(21),PHI(21)                        | 4280 |
| DOUBLE PRECISION SUM  | 4290 |
| N = NROW  | 4300 |
| NM1 = N - 1   | 4310 |
| PHI(N) = X(N) / XU(N,N)   | 4320 |
| DO 100 I = 1, NM1   | 4330 |
| J = N - I   | 4340 |
| SUM = 0.  | 4350 |
| DO 80 K = J, NM1  | 4360 |
| KP1 = K + 1   | 4370 |
| 80 SUM = SUM + XU(J, KP1) * PHI(KP1)                            | 4380 |
| 100 PHI(J) = (X(J) - SUM) / XU(J,J)                             | 4390 |
| RETURN  | 4400 |
| END   | 4410 |
| <br>  |      |
| SUBROUTINE PLNODE (NP)  | 4420 |
| DOUBLE PRECISION XMA(21,21),XME(21,21),XMC(21,21),XI(48),YI(48) | 4430 |
| DOUBLE PRECISION WI(48),HOR(21),VER(21),AREA(462),AREAU(462)    | 4440 |
| DOUBLE PRECISION AREAV(462),XWW(462)                            | 4450 |
| DIMENSION XP(21), YP(21)  | 4460 |
| DOUBLE PRECISION B(21),VXP(21),VYP(21),R(50)                    | 4470 |
| DOUBLE PRECISION V,XNP,ERROR,STEP,P                             | 4480 |
| COMMON XMA, XMB, XMC, XI, YI, WI, HOR, VER, AREA, AREAU, AREAV, | 4490 |
| 1 XWW,P,B,ALPHA,BETA,RATIO,NK,NROW,XP,YP,AM1,BM1,               | 4500 |
| 2 SWITCH, VXP, VYP  | 4510 |
| ERROR = 0.0001  | 4520 |
| STEP = 0.05   | 4530 |
| SWITCH = 1.   | 4540 |
| XNP = NP  | 4550 |
| DO 50 I = 1, NP   | 4560 |
| AI = I - 1  | 4570 |
| V = AI / XNP  | 4580 |
| IF ( V ) 20, 10, 20   | 4590 |
| 10 DO 18 IX = 1, NROW   | 4600 |



TABLE 11 (Continued)

|  |      |
|--|------|
| IF ( XP(IX) ) 16, 14, 16   | 4610 |
| 14 VXP(IX) = 1.  | 4620 |
| GO TO 18   | 4630 |
| 16 VXP(IX) = 0.  | 4640 |
| 18 CONTINUE  | 4650 |
| GO TO 28   | 4660 |
| 20 DO 26 IX = 1, NROW  | 4670 |
| IF ( XP(IX) ) 24, 22, 24   | 4680 |
| 22 VXP(IX) = 1.  | 4690 |
| GO TO 26   | 4700 |
| 24 VXP(IX) = V ** XP(IX)   | 4710 |
| 26 CONTINUE  | 4720 |
| 28 CALL REGSUN ( 0., 1., STEP, R, NR, ERROR )                      | 4730 |
| IF ( NR ) 50, 50, 44   | 4740 |
| 44 WRITE (6, 1400) V, (R(J), J = 1, NR )                           | 4750 |
| 1400 FORMAT ( 1X, 3HX =, F6.3, 2X, 3i:Y =, 19F6.3 / (13X,19F6.3) ) | 4760 |
| 50 CONTINUE  | 4770 |
| SWITCH = 3.  | 4780 |
| DO 80 I = 1, NP  | 4790 |
| AI = I - 1   | 4800 |
| V = AI / XNP   | 4810 |
| IF ( V ) 60, 52, 60  | 4820 |
| 52 DO 58 IY = 1, NROW  | 4830 |
| IF ( YP(IY) ) 56, 54, 56   | 4840 |
| 54 VYP(IY) = 1.  | 4850 |
| GO TO 58   | 4860 |
| 56 VYP(IY) = 0.  | 4870 |
| 58 CONTINUE  | 4880 |
| GO TO 68   | 4890 |
| 60 DO 66 IY = 1, NROW  | 4900 |
| IF ( YP(IY) ) 64, 62, 64   | 4910 |
| 62 VYP(IY) = 1.  | 4920 |
| GO TO 66   | 4930 |
| 64 VYP(IY) = V ** YP(IY)   | 4940 |
| 66 CONTINUE  | 4950 |
| 68 CALL REGSUN ( 0., 1., STEP, R, NR, ERROR )                      | 4960 |
| IF ( NR ) 80, 80, 74   | 4970 |
| 74 WRITE (6, 1600) V, (R(J), J = 1, NR )                           | 4980 |
| 1600 FORMAT ( 1X, 3HY =, F6.3, 2X, 3HX =, 19F6.3 / (13X,19F6.3) )  | 4990 |
| 80 CONTINUE  | 5000 |
| RETURN   | 5010 |
| END  | 5020 |
|  |      |
| C SUBROUTINE REGSUN ( A, B, H, R, N, ERROR )                       | 5030 |
| TO FIND ALL ROOTS OF EIGENVECTOR                                   | 5040 |
| DOUBLE PRECISION R(50),ERROR,XL,XR,YL,YR,XI,H,YI                   | 5050 |
| N = 0  | 5060 |
| XL = A   | 5070 |
| 4 YL = FUNCT(XL)   | 5080 |
| IF ( DABS(YL) - 0.1D-10 ) 10, 10, 20                               | 5090 |
| 10 N = N + 1   | 5100 |
| R(N) = XL  | 5110 |
| XL = XL + H  | 5120 |
| IF ( XL - B ) 4, 4, 16   | 5130 |
| 16 RETURN  | 5140 |
| 20 XR = XL + H   | 5150 |
| IF ( XR - B ) 22, 22, 16   | 5160 |
| 22 YR = FUNCT(XR)  | 5170 |
| IF ( DABS(YR) - 0.1D-10 ) 30, 30, 24                               | 5180 |

TABLE 11 (Continued)

|     |   |      |
|-----|---|------|
| 24  | IF ( YR*YL ) 40, 30, 60   | 5190 |
| 30  | N = N + 1   | 5200 |
|     | R(N) = XR   | 5210 |
|     | XL = XR + H   | 5220 |
|     | IF ( XL - B ) 4, 4, 16  | 5230 |
| 40  | XI = ( XR + XL ) / 2.   | 5240 |
|     | IF ( XI - XL - ERROR ) 46, 46, 48                               | 5250 |
| 46  | N = N + 1   | 5260 |
|     | R(N) = XI   | 5270 |
|     | XL = XI + H   | 5280 |
|     | GO TO 4   | 5290 |
| 48  | YI = FUNCT(XI)  | 5300 |
|     | IF ( DABS(YI) - 0.1D=10 ) 46, 46, 50                            | 5310 |
| 50  | IF ( YL*YI ) 52, 46, 54   | 5320 |
| 52  | XR = XI   | 5330 |
|     | GO TO 40  | 5340 |
| 54  | XL = XI   | 5350 |
|     | GO TO 40  | 5360 |
| 60  | XL = XR   | 5370 |
|     | YL = YR   | 5380 |
|     | GO TO 20  | 5390 |
|     | END   | 5400 |
|     | <br>FUNCTION FUNCT(Q)   | 5410 |
|     | DOUBLE PRECISION XMA(21,21),XMB(21,21),XMC(21,21),XI(48),YI(48) | 5420 |
|     | DOUBLE PRECISION WI(48),HOR(21),VER(21),AREA(462),AREAU(462)    | 5430 |
|     | DOUBLE PRECISION AREAV(462),XW(462)                             | 5440 |
|     | DIMENSION XP(21), YP(21)  | 5450 |
|     | DIMENSION NXP(21),NYP(21)                                       | 5460 |
|     | DOUBLE PRECISION B(21),VXP(21),VYP(21)                          | 5470 |
|     | DOUBLE PRECISION Q, SUM,QYP,QXP,FUNCT,P                         | 5480 |
|     | COMMON XMA, XMB, XMC, XI, YI, WI, HOR, VER, AREA, AREAU, AREAV, | 5490 |
|     | 1 XW,P,B,ALPHA,BETA,RATIO,NK,NROW,XP,YP,A1,B1                   | 5500 |
|     | 2 SWITCH, VXP, VYP  | 5510 |
|     | DO 500 I = 1,NROW   |      |
|     | NYP(I) = YP(I)  | 5520 |
|     | NXP(I) = XP(I)  | 5530 |
| 500 | CONTINUE  |      |
|     | IF ( SWITCH - 2. ) 2, 20, 20                                    | 5540 |
| 2   | SUM = 0.  | 5550 |
|     | DO 10 I = 1, NROW   | 5560 |
|     | IF ( YP(I) ) 4, 3, 4  | 5570 |
| 3   | QYP = 1.  | 5580 |
|     | GO TO 10  | 5590 |
| 4   | IF (Q) 6, 5, 6  | 5600 |
| 5   | QYP = 0.  | 5610 |
|     | GO TO 10  | 5620 |
| 6   | QYP = Q **NYP(I)  | 5630 |
| 10  | SUM = SUM + B(I) * VXP(I) * QYP                                 | 5640 |
|     | FUNCT = SUM   | 5650 |
|     | RETURN  | 5660 |
| 20  | SUM = 0.  | 5670 |
|     | DO 30 I = 1, NROW   | 5680 |
|     | IF ( XP(I) ) 24, 23, 24   | 5690 |
| 23  | QXP = 1.  | 5700 |
|     | GO TO 30  | 5710 |
| 24  | IF (Q) 26, 25, 26   | 5720 |
| 25  | QXP = 0.  | 5730 |
|     | GO TO 30  | 5740 |
|     | <br>26 QXP = Q **NXP(I)   | 5750 |
| 30  | SUM = SUM + B(I) * QXP * VYP(I)                                 | 5760 |
|     | FUNCT = SUM   | 5770 |
|     | RETURN  | 5780 |
|     | END   | 5790 |

Figure 27 - Flow Chart for SUNFRE, Computer Program for Computing Natural Frequencies of a Plate by Sun Method

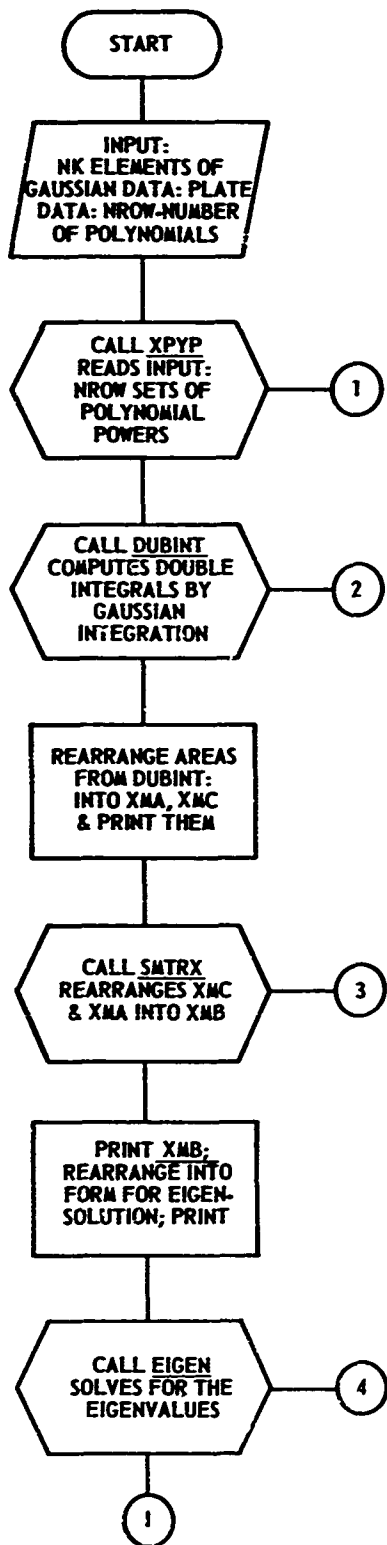

Figure 27a

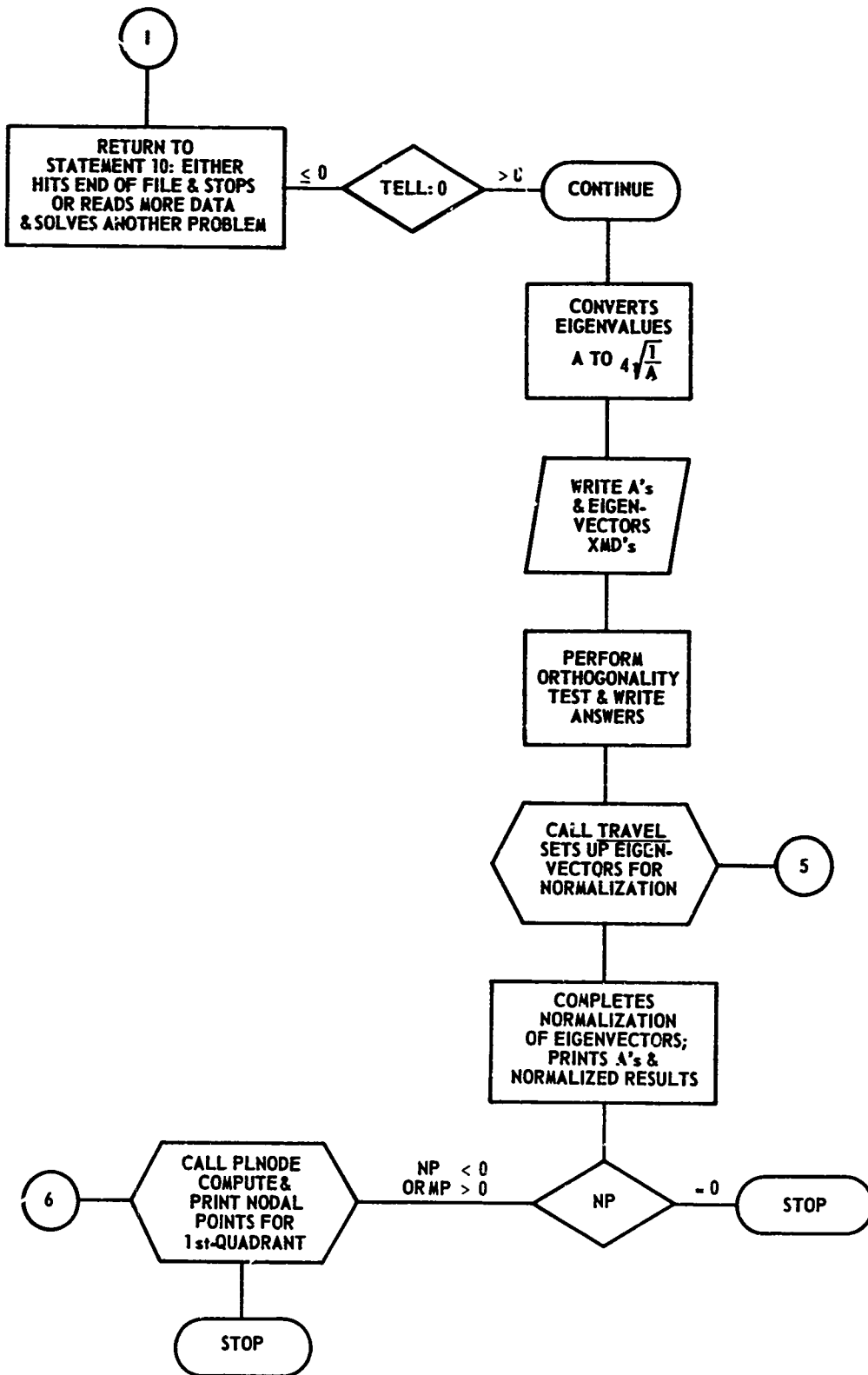

Figure 27b

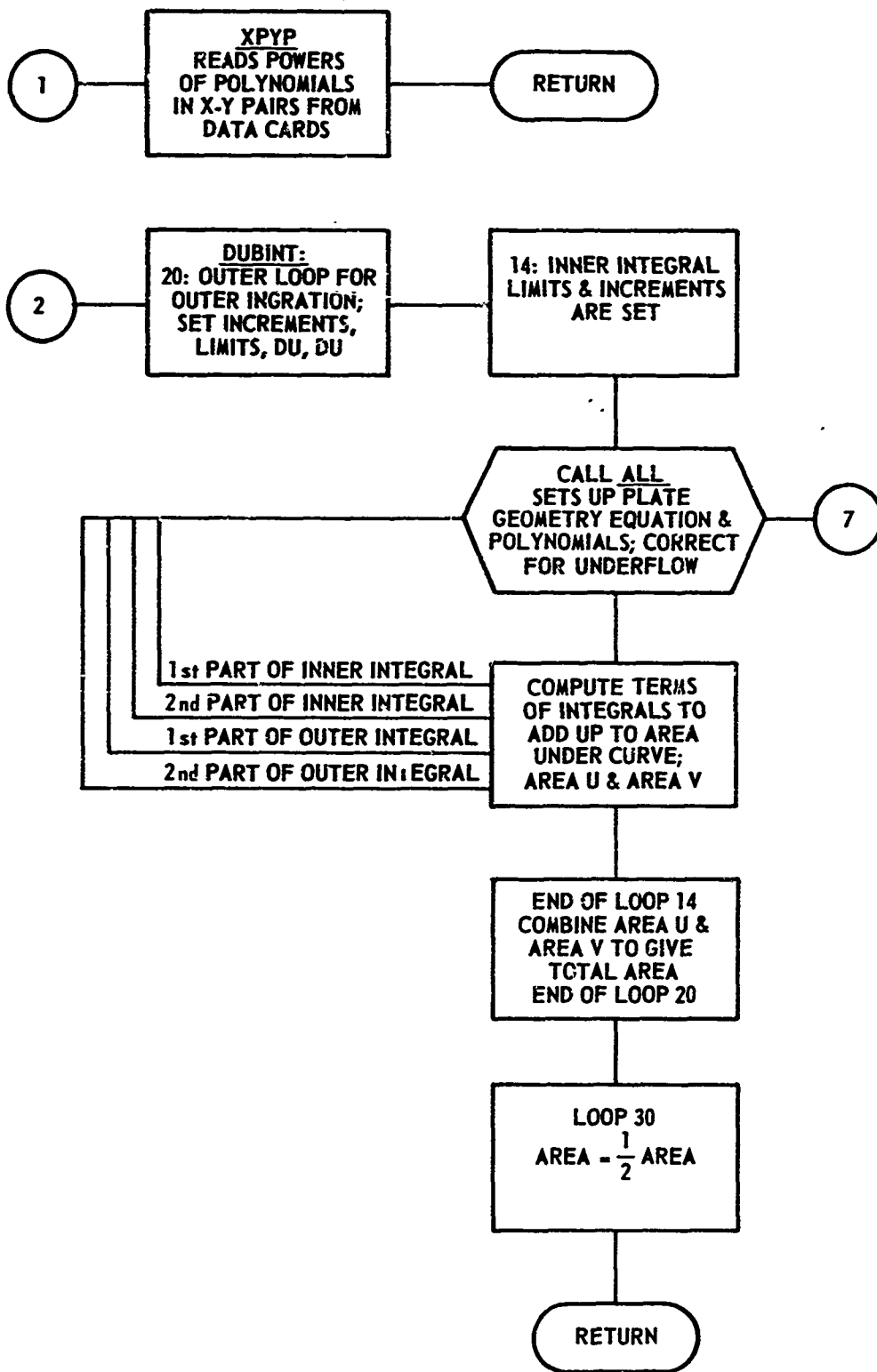

Figure 27c

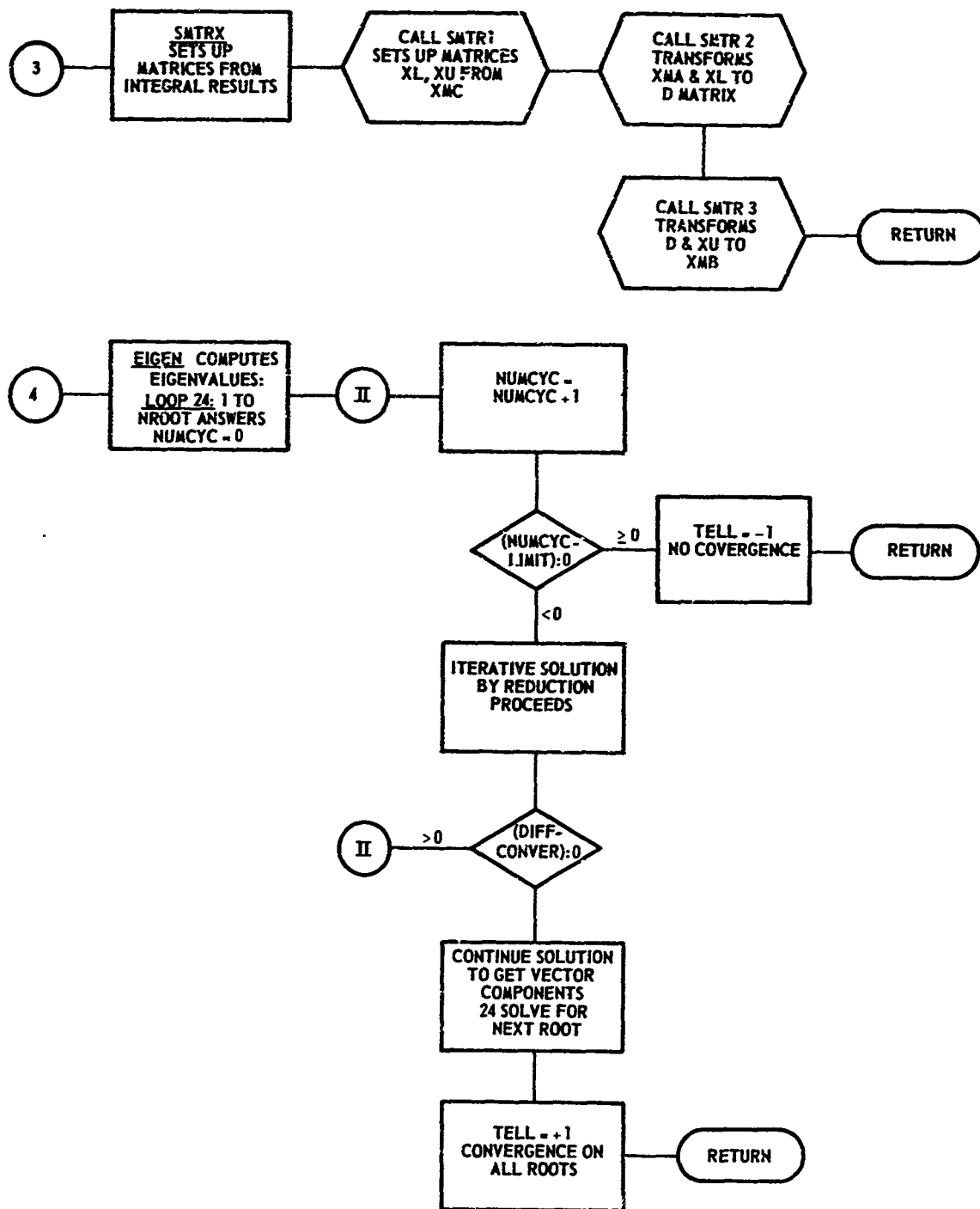

Figure 27d

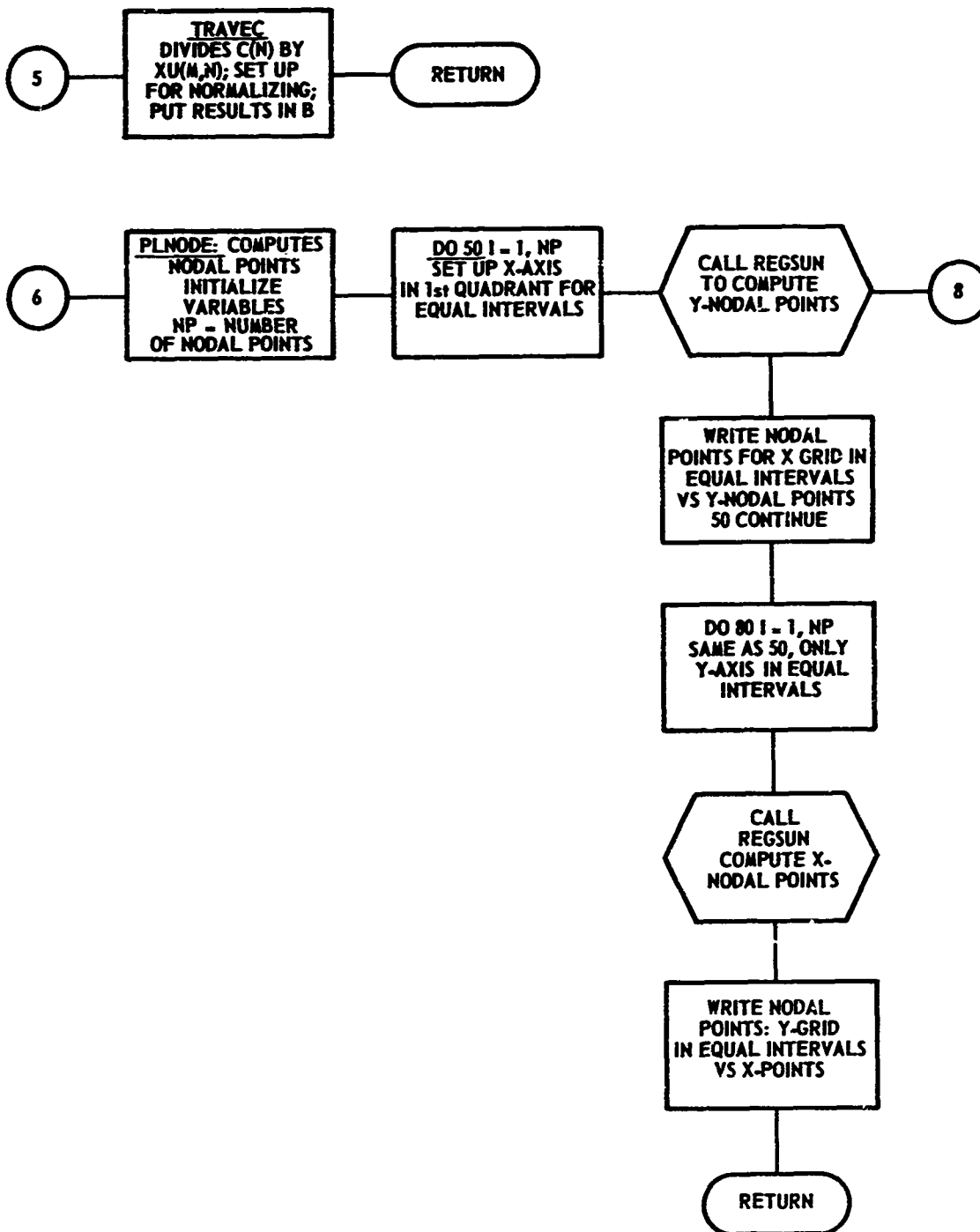

Figure 27e

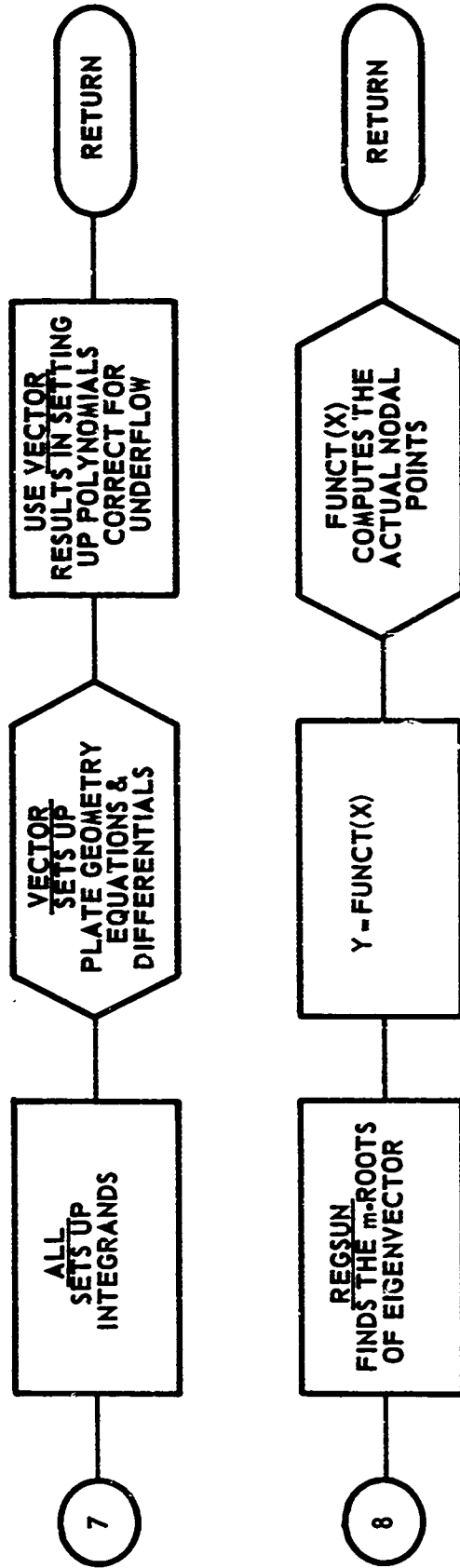

Figure 27f



The principle used to solve for the natural frequencies is the Rayleigh-Ritz method. The plate geometry is defined by

$$F(X, Y, P, \alpha, \beta) = (1 - X^\alpha - PY^\beta)^2$$

where  $X = \frac{x}{a}$ ,

$$Y = \frac{y}{b},$$

$$R = \frac{b}{a},$$

$$P = R^{-\beta},$$

$$\alpha = \beta = 10,$$

$a$  is the dimension in  $x$ -direction, and

$b$  is the dimension in  $y$ -direction for a rectangle with clamped boundaries.

In the computer program, the Rayleigh-Ritz procedure uses a 21-term polynomial in  $X$  and  $Y$  to express the displacement  $W$  (Equation (G9)). The integrals of the Rayleigh-Ritz equations are then solved by a 64-order Gaussian quadrature technique. Finally, the eigenvalues of Equation (G13) are solved by an iterative method of reduction.

The computer program solves for one set of frequencies at a time. Four sets of polynomials completely define the plate: even-even, odd-odd, even-odd, odd-even. Manual plotting of the nodal points for the first quadrant yields the modes shapes from which the modal numbers may be assigned to the frequencies.

The eigenvalues resulting from the computer program are actually the dimensionless frequencies (note:  $\omega \neq 2\pi f$  in this program)

$$\omega_{m,n} = a^2 \sqrt{p_{m,n}^2 \left( \frac{\gamma h}{gD} \right)} \quad (11)$$

where the  $p_{m,n}$  represent the natural frequencies. Thus, the program eigenvalues must be modified manually to yield frequencies in hertz. Letting  $p_{mn} = 2\pi f_{mn}$  and  $D = \frac{Eh^3}{12(1-\sigma^2)}$ , Equation (11) becomes

$$f_{m,n} = \frac{\omega_{m,n} h}{2\pi a^2} \sqrt{\frac{E}{12\gamma(1-\sigma^2)}} \quad (12)$$

In addition to the eigenvalues, the program computes the points for the nodal lines to be plotted to give the mode shapes.

A sample problem for eight modes with 32-order Gaussian quadrature required 30 minutes on the IBM 7090.

## Input Description

The input data are in dimensionless form. Their description is as follows.

| Program Symbol   | Theory Symbol | Description  | Format  |
|--|---------------|--|---------|
| NK (card 1)  |               | The value $\frac{N}{2}$ where N is the order of Gaussian quadrature  | I10     |
| Beginning on card 2, start the XI array and end with WI array; last card of this set is card $\left(1 + \frac{NK}{2}\right)$ |               |  |         |
| XI   |               | Gaussian arguments; NK elements; 4 to a card   | 4D20.10 |
| WI   |               | Gaussian weights; NK elements; 4 to a card   | 4D20.10 |
| Next 8 elements are on the $\left(2 + \frac{NK}{2}\right)$ card  |               |  |         |
| ALPHA  | $\alpha$      | Exponent of plate geometry equation:<br>ALPHA = 10 for rectangle   | F5.2    |
| BETA   | $\beta$       | Exponent of plate geometry equation:<br>BETA = 10 for rectangle  | F5.2    |
| RATIO  | $R$           | Aspect ratio $b/a$ , where $b$ is dimension in $y$ -direction and $a$ is dimension in $x$ -direction   | F5.2    |
| MODE   |               | The number of sets of modes desired.<br>If MODE =<br>1 X, Y are even powered: odd-odd modes<br>2 X, Y are odd powered: even-even modes<br>3 X even, Y odd: odd-even modes<br>4 X odd, Y even: even-odd modes | I5      |
| NOIT   |               | Number of eigenvalues desired  | I5      |
| NP   |               | Number of nodal points desired:<br>NP = 0 means no points<br>NP = 20 means 20 points<br>for nodal line plot  | I5      |
| LIMIT  |               | Number of iterations in eigenvalue solution;<br>suggested limit is 800   | I5      |
| CONV   |               | Convergence criterion: suggested value<br>0.00001  | F10.7   |
| NROW $\left(\text{card } 3 + \frac{NK}{2}\right)$  |               | Number of polynomials in X and Y   | I10     |
| XP (I), YP (I)<br>$\left(\text{next } \frac{NROW * 2}{16} \text{ cards for MODE number of times}\right)$                     |               | Powers of terms of X · Y polynomial;<br>note that there must be as many sets as the value of MODE indicates but that the program solves for only one set at a time   | 16F5.2  |

Sample input data corresponding to the above description are shown below:

```

16
0.9972638618494815600.9856115115452683300.9647622555875064300.934906075937739580
0.8963211557660521200.8493676137325699700.7944837959679424000.732182118740289630
0.6630442669302152000.5877157572407623200.5062999089322293950.421351276130635340
0.3318686022221276400.2392873622521370700.1444719615827964930.048397665687738310
0.0070186100094700900.0162743947309056700.0253920653092620500.034273862913021430
0.0428358980222266800.0509980592623761700.0586840934785355400.06522222776561840
0.0723457941088485000.0761938957870703000.0833119242269457500.087652093004403910
0.0911738786957638800.0938443990808045600.0956387200792748500.096540088514727300
10.0 10.0 1.167 4 8 20 200 0.000001

21
0.0 0.0 2.0 0.0 4.0 0.0 6.0 0.0 8.0 0.0 10.0 0.0 0.0 2.0 2.0 2.0 }
4.0 2.0 6.0 2.0 8.0 2.0 0.0 4.0 2.0 4.0 4.0 4.0 6.0 4.0 0.0 6.0 }
2.0 6.0 4.0 6.0 0.0 8.0 2.0 8.0 0.0 10.0
1. 1. 3. 1. 5. 1. 7. 1. 9. 1. 11. 1. 1. 3. 3. 3. }
5. 3. 7. 3. 9. 3. 1. 5. 3. 5. 5. 5. 7. 5. 1. 7. }
3. 7. 5. 7. 1. 9. 3. 9. 1. 11.
0. 1. 2. 1. 4. 1. 6. 1. 8. 1. 10. 1. 0. 3. 2. 3. }
4. 3. 6. 3. 8. 3. 0. 5. 2. 5. 4. 5. 6. 5. 0. 7. }
2. 7. 4. 7. 0. 9. 2. 9. 0. 11.
1.0 0.0 1.0 2.0 1.0 4.0 1.0 6.0 1.0 8.0 1.0 10.0 3.0 0.0 3.0 2.0 }
3.0 4.0 3.0 6.0 3.0 8.0 5.0 0.0 5.0 2.0 5.0 4.0 5.0 6.0 7.0 0.0 }
7.0 2.0 7.0 4.0 9.0 0.0 9.0 2.0 11.0 0.0 }

```

### Output Description

The program yields the eigenvalues and eigenvectors, with nodal points for the first quadrant and many intermediate results. Unless the user is particularly interested in a programming analysis, he will use the first page of output and then skip to the eigenvalue section.

On the first page are some of the input data, such as  $\alpha$ ,  $\beta$ , RATIO, MODE, which are labelled accordingly. The index I is printed to indicate the step of Gaussian quadrature. An underflow message from the system may occur; the program corrects for small numbers in the underflow in subroutine ALL.

The next several pages have five elements to a row and are the following matrices:

1. C-matrix of Equation (G14a)
2. A-matrix of Equation (G14b)
3. B-matrix of Equation (G15b)

The output then indicates which eigenvalue is being solved for and the number of iterations needed. The variable TELL indicates convergence: TELL = 1 means convergence but TELL = - 1 means no convergence. The convergence limit and the number of times the iterations are performed are also printed. The eigenvalues are printed in ascending order, followed by the eigenvectors. The results of the orthogonality check are shown.

Finally for a given eigenvalue the nodal points for the first quadrant are printed out. Figure 28 shows, by way of a particular example, how the mode shapes and corresponding frequencies are matched. The eigenvalues (called EIGENVALUE in the output data) obtained directly as output from the computer program are multiplied by the frequency factor for SUNFRE given in Appendix I. This process yields the natural frequencies which are tabulated in Table 1.

Thus for a particular eigenvalue (e.g., EIGENVALUE = 337.0694), a corresponding natural frequency can be computed ( $f = 2179.078$  for this case). The corresponding mode number can be determined by plotting wave shape data available from the computer program. These data are plotted in the first quadrant (Figure 28a) and then projected into all four quadrants (Figure 28b). From the latter figure, the mode number is evidently  $(m, n) = (5, 2)$ .

#### YNGFRE (see Table 12 and Figure 29)

Two steps are needed to find the natural frequencies of vibrations by the Young method. The first, YOUNG, provides preliminary data. The second, YEIGN, computes the eigenvalues and converts them to the natural frequencies. Since the results of YOUNG could be used as input for other eigenvalue programs, YOUNG was made more general than YEIGN.

#### YOUNG

YOUNG is a computer program which calculates the members of the  $C$ -array of the eigensystem, Equation (B11):

$$\sum_{m=1}^p \sum_{n=1}^q (C_{mn}^{ik} - \lambda \delta_{mn}) A_{mn} = 0 ,$$

$$\delta_{mn} = 1 \text{ for } m = i \text{ and } n = k$$

$$\delta_{mn} = 0 \text{ for } m \neq i \text{ or } n \neq k$$

For the computer program,  $i = 1, p; k = 1, q;$  and  $p, q \leq 10$ .

The program YOUNG uses its subroutine YINTGR to compute numerical results of Young's closed form solutions of the Rayleigh-Ritz integrals of a clamped beam. Next YINTGR constructs the arrays necessary for the computation of the  $C$ -matrix:

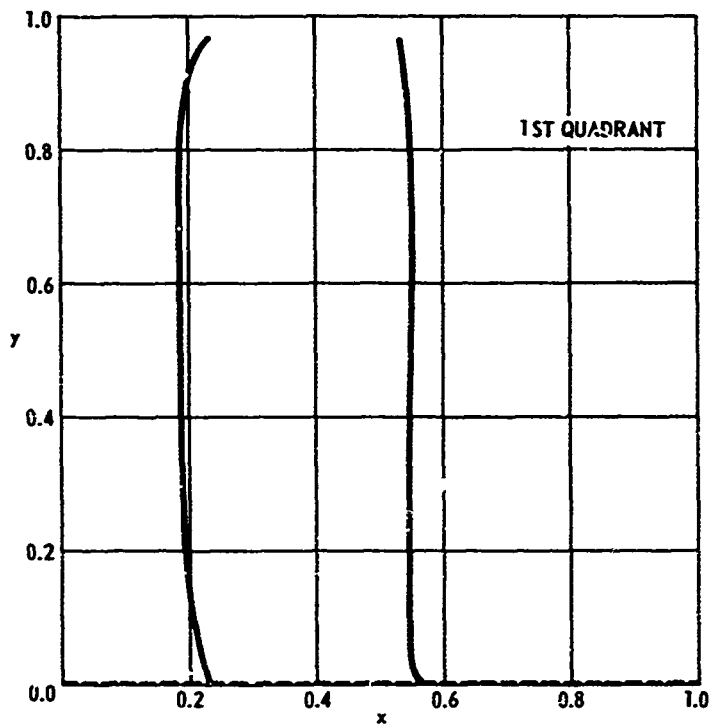

Figure 28a

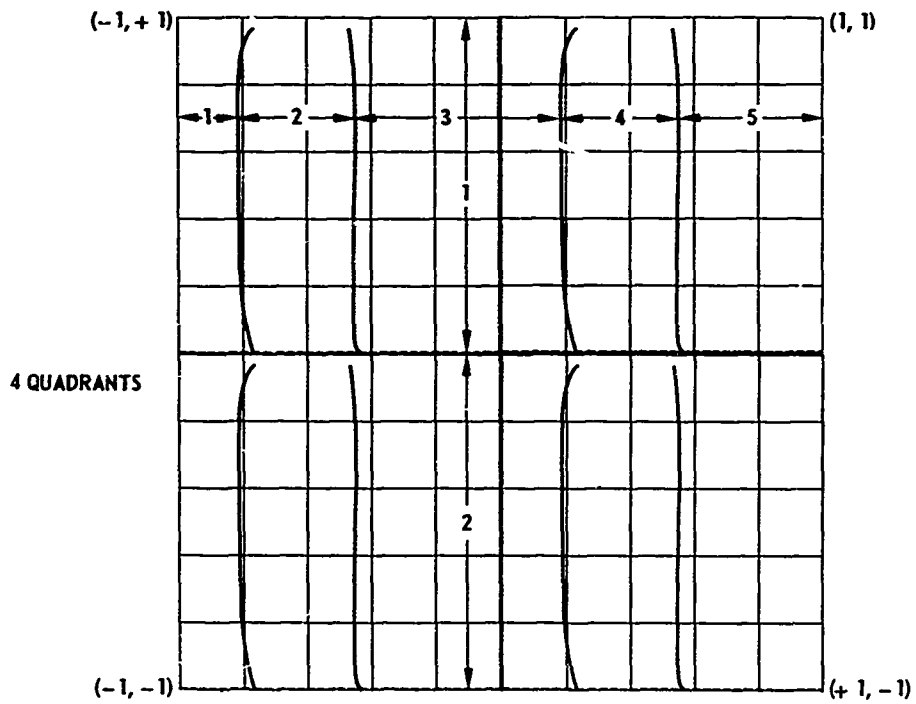

Figure 28b

Figure 28 - Procedure for Determining Plate Mode Numbers for a Particular Frequency

The sample illustrates a modal plot for the (5, 2) mode corresponding to  $f = 2179.078$ .

TABLE 12

## Program Listing for YNGFRE Computer Program

Table 12a - YOUNG

```

SIBFTC YOUNG
  DIMENSION E(10,10),F(10,10),H(10,10),K(10,10),EPS(10),C(10,10)
  REAL K
  RFAD(5,1) M,N
  1 FORMAT(2I5)
  READ(5,1) A,B
  11 FORMAT(2F12,6)
  PI = 3.14159
  CALL YINTGR(M,N,EPS,E)
  WRITE(6,5) (EPS(I),I = 1,M)
  5 FORMAT(6X,5F16,8)
  SIGMA = .33
  A3=A**3
  B3=B**3
  WRITE(6,310) A,C
  310 FORMAT(5X,2F12,6)
  WRITE(6,320) M,N
  320 FORMAT(5X,2I5)
  NY1 = N/2
  NY2 = N/2 + 1
  DO 4 I=1,M
  DO 3 J=1,N
  H(I,J) = E(I,J)
  K(I,J) = E(I,J)
  E(I,J) = -E(I,J)
  F(I,J) = E(I,J)
  3 CONTINUE
  4 CONTINUE
  KOUNT=0
  DO 400 I=1,M
  DO 300 J=1,N
  DO 200 MX=1,M
  DO 100 NY=1,N
  IF(MX.NE.I) GO TO 8
  IF(NY.EQ.J) GO TO 6
  8 C(MX,NY)=SIGMA*A/B*(E(MX,I)*F(J,NY)+F(I,MX)*F(NY,J))
  1+2.*(1.-SIGMA)*A/B*H(I,MX)*K(J,NY)
  GO TO 7
  6 CONTINUE
  C(MX,NY)=B/A*EPS(I)**A+A3/B3*EPS(J)**A+2.*SIGMA*A/B*E(I,I)*F(J,J)
  1+2.*(1.-SIGMA)*A/B*H(I,I)*K(J,J)
  7 CONTINUE
  100 CONTINUE
  KOUNT=KOUNT+1
  COMMENT KOUNT WAS USED FOR ENDPUNCHING**** NOW IT USED ONLY
  C*****IN THE CASE N IS A MULTIPLE OF 2. *****
  IF(M-(M/5*5)) 200,250,240
  240 IF(M-(M/3*3)) 200,210,220
  220 IF(M-(M/2*2)) 200,222,230
  210 WRITE(6,20) ( C(MX,NY), NY =1,N)
  WRITE(8,20) ( C(MX,NY), NY =1,N)
  GO TO 200
  222 WRITE(6,22) ( C(MX,NY), NY =1,NY1), KOUNT
  WRITE(6,22) ( C(MX,NY), NY =NY2,N), KOUNT
  WRITE(8,22) ( C(MX,NY), NY =1,NY1), KOUNT
  WRITE(8,22) ( C(MX,NY), NY =NY2,N), KOUNT
  GO TO 200
  250 WRITE(6,24) ( C(MX,NY), NY =1,NY1)
  WRITE(6,24) ( C(MX,NY), NY =NY2,N)
  WRITE(8,24) ( C(MX,NY), NY =1,NY1)

```

TABLE 12a (Continued)

```

WRITE(8,24) ( C(MX,NY), NY =NY2,N)
200 CONTINUE
300 CONTINUE
400 CONTINUE
ENDFILE 8
20 FORMAT(3E16.8)
22 FORMAT(4E16.8,12X,I4)
24 FORMAT(5E16.8)
230 STOP
END
SIRFTC YINTER
SUBROUTINE YINTGR(M,N,EPS,A)
DIMENSION ALP(10),EPS(10),A(10,10)
PI = 3.14159
ALP(1) = 0.98250726
ALP(2) = 1.00077731
ALP(3) = 0.99996645
ALP(4) = 1.00000145
ALP(5) = 0.99999994
ALP(6) = 1.0
EPS(1) = 4.73004080
EPS(2) = 7.85320460
EPS(3) = 10.99560780
EPS(4) = 14.13716550
EPS(5) = 17.27875960
EPS(6) = 20.423552
DO 10 J = 7,M
ALP(J) = 1.0
AJ = J
10 EPS(J) = ((2.0*AJ + 1.0)*PI)/2.0
DO 25 K = 1,M
DO 35 L = 1,N
KL = K + L
IF(K.NE.L) GO TO 40
A(K,L) = ALP(K)*EPS(K)*(ALP(K)*EPS(K)-2.0)
GO TO 35
40 A(K,L) = ((4.0*EPS(L)**2*EPS(K)**2)*(ALP(L)*EPS(L)
1 -ALP(K)*EPS(K)
2 *(1.+(-1)**(KL))) / (EPS(K)**4 - EPS(L)**4)
35 CONTINUE
25 CONTINUE
WRITE(6,50) ((A(KM,KN),KM = 1,M),KN = 1,N)
50 FORMAT(2X,5E16.8)
RETURN
END

```

Table 12b - YEIGN

```

PROGRAM YEIGN(INPUT,OUTPUT,TAPES=INPUT,TAPE6=OUTPUT)
DIMENSION B(64,64),RTR(64),RTI(64),U(64,64),IX1(64),IX2(64),
A      X1(64),X2(64),X3(64),X4(64),XX1(64,64),XX2(64,64),
B      XX3(64,64),EVLRAD(64),EVTRAD(64,64),X5(64),X6(64),
C      X7(64),X8(64),X9(64),X10(64),X11(64)
DOUBLE PRECISION BDP(64,64),RTRIMP(64),RTIIMP(64),XIMP(64,64),
A      DPX1(64),DPX2(64)
COMMENT AS OF 11/20/70 LIM MUST BE A MULTIPLE OF 3,4, OR 5
READ(5,110) LIM,LUP
110 FORMAT(2I10)
N = LIM ** 2
READ(5,115) CONST
115 FORMAT(E16.8)
DCONS = DBLE(CONST)
WRITE(6,3)
3 FORMAT(1H1)
WRITE(6,1)LIM,N
1 FORMAT(2I10)
IF(MOD(LIM,3).EQ.0) GO TO 410
IF(MOD(LIM,5).EQ.0) GO TO 420
READ(5,91)((B(IA,JA),JA=1,N),IA=1,N)
91 FORMAT(4E16.8)
GO TO 99
410 READ(5,94)((B(IA,JA),JA=1,N),IA=1,N)
94 FORMAT(3E16.8)
GO TO 99
420 READ(5,430)((B(IA,JA),JA=1,N),IA=1,N)
430 FORMAT(5E16.8)
99 WRITE(6,4)((B(IA,JA),JA=1,N),IA=1,N)
DO 10 I=1,N
DO 10 J=1,N
10 BDP(I,J)=B(I,J)
4 FORMAT(1X,6E18.8)
CALL VARAH1(B,N,RTR,RTI,U,64,IX1,IX2,X1,X2,X3,X4,XX1,XX2,XX3)
WRITE(6,3)
WRITE(6,5)(I,RTR(I),RTI(I),I=1,N)
5 FORMAT(15,2E17.8)
WRITE(6,3)
DO 9 J=1,N
WRITE(6,6),U(I,J),I=1,N)
6 FORMAT(/15/(6E20.8))
9 CONTINUE
DO 11 K = 1,LUP
CALL VARAH2(BDP,N,2.0**(-95),RTR,RTI,U,RTRIMP,RTIIMP,EVLRAD,XIMP,
1      EVTRAD,.TRUE., 64,IX1,X1,X2,X3,X4,X5,X6,X7,X8,X9,
2      X10,X11,DPX1,DPX2,XX1,XX2,XX3),
3      RETURNS(97)
DO 12 I=1,N
RTR(I)=RTRIMP(I)
RTI(I)=RTIIMP(I)
DO 12 J=1,N
12 U(I,J)=XIMP(I,J)
11 CONTINUE
WRITE(6,3)
92 DO 14 I=1,N
IF (RTRIMP(I).GE.1.0 D-12) GO TO 13
DPX1(I)=-1.0 DO
GO TO 14
13 DPX1(I) = DCONS * DSQRT(RTRIMP(I))
14 CONTINUE

```



TABLE 12b (Continued)

```

WRITE(6,250)
250 FORMAT(1H1,5X,*THE FOLLOWING IS INTENDED AS A GUIDE IN INTERPRETIN
1G THE OUTPUT,* / 5X,* THE SUBSCRIPT PRINTED WITH THE EIGENVALUES AN
2D FREQUENCIES ON THE LAST PAGE*/5X,*IS THE SUBSCRIPT OF ABS LAMBDA
3( ) IN THE MAIN SECTION OF OUTPUT-- EACH EIGENVALUE IS PRINTED,* /
45X,*FOLLOWED IMMEDIATELY BY ITS EIGENVECTOR.THE SECOND SUBSCRIPT
5 OF THE EIGENVECTOR COMPONENTS AGREE*/5X,*WITH THE SUBSCRIPT OF
6LAMBDA*)
WRITE(6,240)
240 FORMAT(5X,*WHEN READING EIGENVECTORS,LOOK FOR THAT COMPONENT*/
1*WHOSE VALUE = 1.0 .THE FIRST SUBSCRIPT OF THIS COMPONENT*/
2 5X,*INDICATES THE MODE NUMBER OF THE FREQUENCY,* /
3 5X,*INTERPRETATION SCHEME BELOW WITH M,N BEING THE MODE NUMBER*/
4 6X,*JA*,12X,*M*,7X,*N*)
KOUNT = 1
DO 210 KM = 1,LIM
DO 202 KN = 1,LIM
WRITE(6,310) KOUNT,KM,KN
310 FORMAT(5X,I4,10X,I4,5X,I4)
KOUNT = KOUNT + 1
202 CONTINUE
210 CONTINUE
WRITE(6,260)
260 FORMAT(5X,*THUS BY LOOKING AT THE EIGENVECTOR OF EACH LAMBDA*/5X,
1*USER MAY ASSIGN MODAL NUMBERS TO THE FREQUENCIES BELOW*)
WRITE(6,120)
120 FORMAT(6X, *EIGENVALUES AND CORRESPONDING FREQUENCIES * )
WRITE(6,15) (I,RTRIMP(I),DPX1(I),I = 1,N)
15 FORMAT(16,D25.16,5X,D25.16)
STOP
97 WRITE(6,98)
98 FORMAT(5X,* PROGRAM ABORTS UNNATURALLY * )
RTRIMP(I)=RTR(I)
RTIIMP(I)=RTI(I)
GO TO 92
END

```

Figure 29 – Flow Chart for YNGFRE, Computer Program for Computing Natural Frequencies of a Plate by Young Method

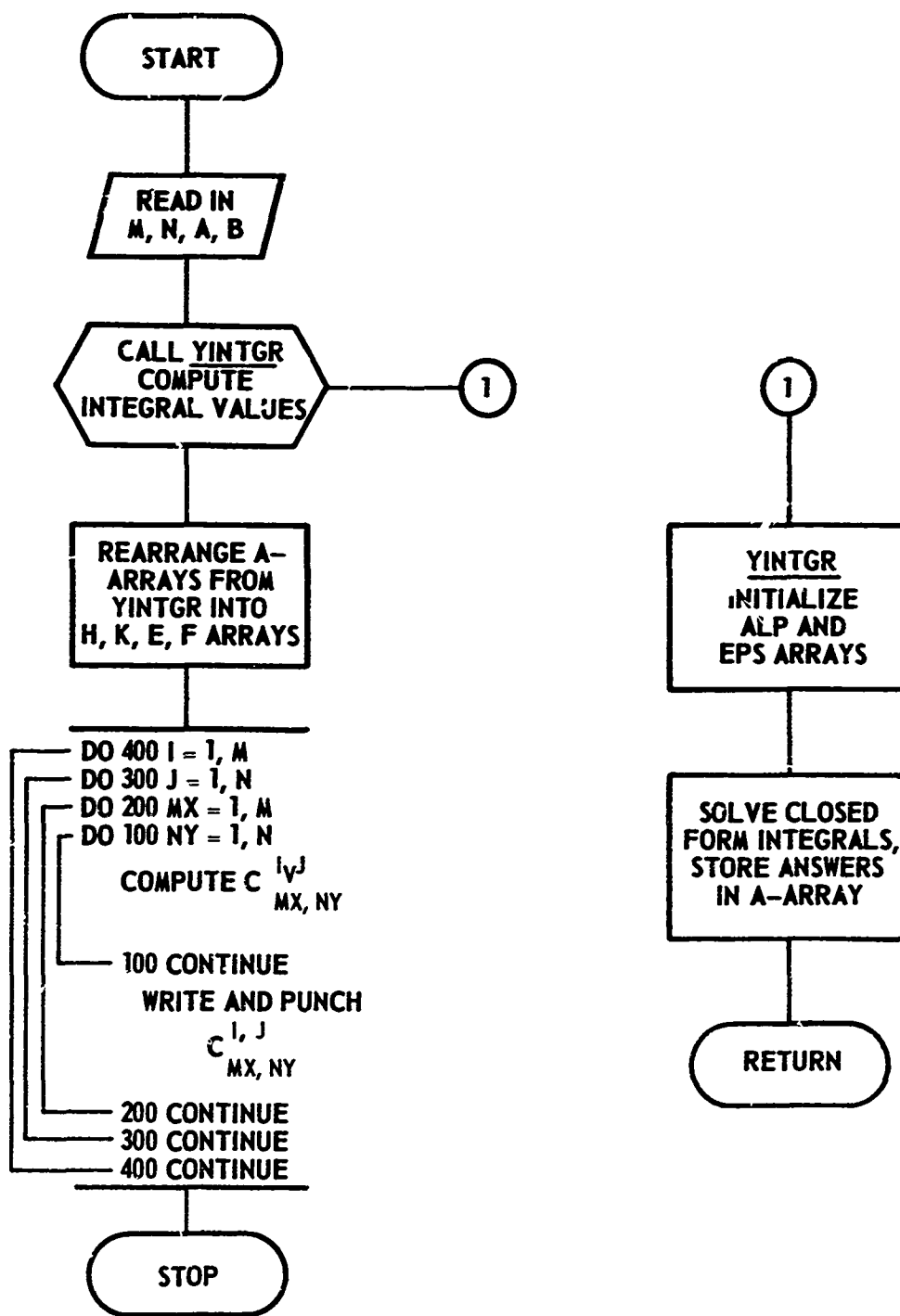

Figure 29a – YOUNG

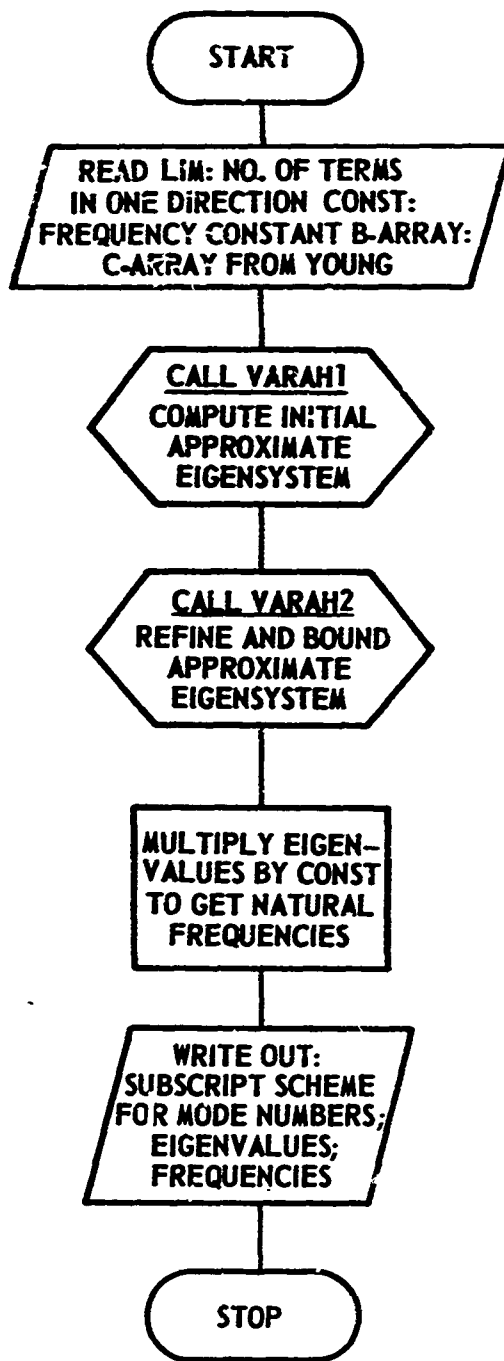

Figure 29b - YEIGN

$$C_{\pi\pi}^{(ik)} = \mu \frac{a}{b} [E_{\pi i} F_{k\pi} + E_{i\pi} F_{\pi k}] + 2(1-\mu) \frac{a}{b} H_{i\pi} K_{k\pi} \quad \text{Same as (B13)}$$

for  $\pi \neq i$  or  $\pi \neq k$

$$C^{(ik)}_{ik} = \frac{b}{a} \epsilon_i^4 + \frac{a^3}{b^3} \epsilon_k^4 + 2\mu \frac{a}{b} E_{ii} F_{\pi k} + 2(1-\mu) \frac{a}{b} H_{ii} K_{kk} \quad \text{Same as (B14)}$$

for  $\pi = i$  and  $\pi = k$

Finally the main program computes the  $C$ -matrix. These data are punched out on cards for use in a program for solving the eigensystem.

Only two cards are needed for YOUNG:

| Card | Symbol | Description  | Format |
|------|--------|--|--------|
| 1    | M      | Number of terms in $x$ -direction, $M \leq 10$   | 215    |
|      | N      | Number of terms in $y$ -direction, $N \leq 10$ ;<br>If output of YOUNG is to be used with YEIGN, $M=N$ |        |
| 2    | A      | Length in $x$ -direction   | 2F12.6 |
|      | B      | Length in $y$ -direction   |        |

The printed output consists of the array of integral values  $E(I, J)$ , five elements to a row. Then comes the  $EPS$ -array (values of  $\epsilon_i$ ), again five elements to a row.  $A, B, M, N$  are printed next. Finally the array  $C_{MX, NY}^{I, J}$  is both printed and punched on cards. There are  $N/2$  elements per card, (or  $N/3$  if  $N$  is a multiple of three) with the order cycling first through  $NY = 1, N$ , then  $MX = 1, M$ , next  $J = 1, N$ , and finally  $I = 1, M$ .

For  $C_{8,8}^{8,8}$ , YOUNG required 2 minutes on the IBM 7090.

### YEIGN Step

YEIGN is a computer program for the CDC 6600 which uses the eigensystem programs VARAH1 and VARAH2. The latter two NSRDC programs are FORTRAN IV adaptations of algorithms of J. M. Varah.<sup>29</sup>

VARAH1 computes an initial approximate eigensystem. The eigenvalues are computed using the  $QR$  method of Francis<sup>30</sup> after the system is reduced to Hessenberg form.\* The eigenvectors are found by the inverse iteration method of Wielandt.\* Finally VARAH2 refines

\*See Reference 33.

and bounds the approximate eigensystem as suggested by Wilkinson.<sup>31, 32</sup> For further information about both the mathematical processes and the programs, complete with listings, see Reference 33.

Because the CDC 6600 has a 60-bit word, the high degree of accuracy needed in the inverse iteration might not be achieved on smaller word computers. Also, the largest problem tested was a  $64 \times 64$  matrix, which took 6.85 minutes.

The problem to be solved is Equation (B11). However, the double summation is treated as a single summation for use in YEIGEN. The problem becomes

$$\sum_{JA=1}^N (B(IA, JA) - \lambda I) A_{JA} = 0, \quad JA = 1, N$$

where  $N = (LIM)^2$  ( $LIM$  is the number of terms  $p$  of Equation (B11);  $p$  must equal  $q$  for YEIGN);

$I$  is the identity matrix to which the Kronecker delta reduces;

$A$  is the single dimensional matrix replacing  $A_{mn}$ ;

$B$  is the matrix of two dimensions replacing the  $C$ -matrix;

$JA$  is the subscript replacing  $m$  and  $n$ , cycling through  $n$  first, then  $m$ ; and

$IA$  is the subscript replacing  $i$  and  $k$ , cycling through  $k$  first, then  $i$ .

An example of the transition from  $C_{mn}^{ik}$  to  $B(IA, JA)$  is shown below, with  $LIM = 3$ ;

$$\begin{array}{llll} C_{11}^{11} = B(1, 1) & C_{11}^{12} = B(2, 1) & C_{11}^{22} = B(5, 1) & C_{11}^{33} = B(9, 1) \\ C_{12}^{11} = B(1, 2) & C_{12}^{12} = B(2, 2) & \vdots & \vdots \\ C_{13}^{11} = B(1, 3) & \vdots & C_{23}^{22} = B(5, 9) & C_{33}^{33} = B(9, 9) \\ C_{21}^{11} = B(1, 4) & C_{33}^{12} = B(2, 9) & C_{11}^{23} = B(6, 9) & \\ C_{22}^{11} = B(1, 5) & C_{11}^{13} = B(3, 1) & \vdots & \\ C_{23}^{11} = B(1, 6) & \vdots & C_{11}^{31} = B(7, 1) & \\ C_{31}^{11} = B(1, 7) & C_{33}^{13} = B(3, 9) & \vdots & \\ C_{32}^{11} = B(1, 8) & C_{11}^{21} = B(4, 1) & C_{11}^{32} = B(8, 1) & \\ & \vdots & \vdots & \\ C_{33}^{11} = B(1, 9) & C_{33}^{21} = B(4, 9) & C_{11}^{32} = B(8, 1) & \end{array}$$

$A(JA)$  associates with  $m, n$  in a similar manner. The vector  $A$  does have two subscripts for computer storage purposes; however, the printed output of the eigenvectors has two subscripts with the first of these referring to  $JA$ . The eigenvector yields the frequency modal number  $(m, n)$  from the  $JA$ -value of the eigenvector component whose amplitude is equal to 1.0. The subscripts  $JA$  are related to their respective  $(m, n)$  values in the final section of the printout.

YEIGN produces many pages of output. The user should look first at the last few pages of the output for the eigenvalues and corresponding natural frequencies and for the eigenvector subscript scheme. Then the user should go to the main body of the output to locate each eigenvalue, followed immediately by its eigenvector. Now, from the component with the value of 1.0, he can assign the frequency a modal number, as directed above.

A sample output for each eigenvalue of YEIGN is given in Table 13. The eigenvalue and vector components are given with their error bounds. In the given case, the frequency has modal number (3, 4).

The data cards needed for YEIGN are as follows:

| Card | Symbol         | Description   | Format |
|------|----------------|---|--------|
| 1    | LIM<br><br>LUP | Limit on summation of Equation (B11)<br>Note: $N = (\text{LIM})^2$ is number of eigenvalues<br><br>Number of iterations for refining eigen-system. For engineering purposes LUP = 1 yields adequate frequencies | 2I10   |
| 2    | CONST          | Value of $\frac{h}{2\pi a^2} \sqrt{\frac{E}{12\gamma(1-\sigma^2)}}$<br><br>FREQUENCY = CONST * $\sqrt{\text{EIGENVALUE}}$   | E16.8  |
| 3    | B(IA, JA)      | C-array of Equations (B13) and (B14), with JA changing most rapidly; that is (JA = 1, N) for each IA value, (IA = 1, N)   | 4E16.8 |

TABLE 13

Sample Output Data for Each Eigenvalue of YEIGN

| ABS  | (LAMBDA(4)-(7D4133401370142D+09) ) | .LE  | .17061900E-16 |
|--|------------------------------------|------|---------------|
| ABS( X( 1° 4) - ( 0. ) )                     |                                    | .LE. | .92924537E-20 |
| ABS( X( 2° 4) - ( .5995n72403005593D-02) )   |                                    | .LE. | .77884ca0F-20 |
| ABS( X( 3° 4) - ( 0. ) )                     |                                    | .LE. | .907404n5E-20 |
| ABS( X( 4° 4) - ( -.7218449637816229D-01) )  |                                    | .LE. | .76914313E-20 |
| ABS( X( 5° 4) - ( 0. ) )                     |                                    | .LE. | .23765565E-19 |
| ABS( X( 6° 4) - ( -.6693040078781831D-02) )  |                                    | .LE. | .51119409E-20 |
| ABS( X( 7° 4) - ( 0. ) )                     |                                    | .LE. | .60568449E-20 |
| ABS( X( 8° 4) - ( -.1724742043731114D-02) )  |                                    | .LE. | .17499727E-20 |
| ABS( X( 9° 4) - ( 0. ) )                     |                                    | .LE. | .39850989E-20 |
| ABS( X( 10° 4) - ( 0. ) )                    |                                    | .LE. | .90119974E-21 |
| ABS( X( 11° 4) - ( 0. ) )                    |                                    | .LE. | .42278382E-20 |
| ABS( X( 12° 4) - ( 0. ) )                    |                                    | .LE. | .14420883E-20 |
| ABS( X( 13° 4) - ( 0. ) )                    |                                    | .LE. | .86487961E-20 |
| ABS( X( 14° 4) - ( 0. ) )                    |                                    | .LE. | .10814287E-20 |
| ABS( X( 15° 4) - ( 0. ) )                    |                                    | .LE. | .10334147E-20 |
| ABS( X( 16° 4) - ( 0. ) )                    |                                    | .LE. | .29353291E-21 |
| ABS( X( 17° 4) - ( 0. ) )                    |                                    | .LE. | .70895791E-20 |
| ABS( X( 18° 4) - ( -.6874537660978476D-01) ) |                                    | .LE. | .52992614E-20 |
| ABS( X( 19° 4) - ( 0. ) )                    |                                    | .LE. | .11693165E-19 |
| ABS( X( 20° 4) - ( .1000000000000000D+01) )  |                                    | .LE. | .11653756E-20 |
| ABS( X( 21° 4) - ( 0. ) )                    |                                    | .LE. | .58801661E-20 |
| ABS( X( 22° 4) - ( .42945351707250n20-01) )  |                                    | .LE. | .24154938E-20 |
| ABS( X( 23° 4) - ( 0. ) )                    |                                    | .LE. | .26464114E-20 |
| ABS( X( 24° 4) - ( .1391268514668272D-01) )  |                                    | .LE. | .10856934E-20 |
| ABS( X( 25° 4) - ( 0. ) )                    |                                    | .LE. | .97955310E-20 |
| ABS( X( 26° 4) - ( 0. ) )                    |                                    | .LE. | .77354137E-20 |
| ABS( X( 27° 4) - ( 0. ) )                    |                                    | .LE. | .10844866E-19 |
| ABS( X( 28° 4) - ( 0. ) )                    |                                    | .LE. | .17627156E-20 |
| ABS( X( 29° 4) - ( 0. ) )                    |                                    | .LE. | .30234793E-20 |
| ABS( X( 30° 4) - ( 0. ) )                    |                                    | .LE. | .67036259E-21 |
| ABS( X( 31° 4) - ( 0. ) )                    |                                    | .LE. | .77401143E-21 |
| ABS( X( 32° 4) - ( 0. ) )                    |                                    | .LE. | .29003447E-21 |
| ABS( X( 33° 4) - ( 0. ) )                    |                                    | .LE. | .34095718E-20 |
| ABS( X( 34° 4) - ( -.8585515983982192D-02) ) |                                    | .LE. | .97511100E-20 |
| ABS( X( 35° 4) - ( 0. ) )                    |                                    | .LE. | .52494042E-20 |
| ABS( X( 36° 4) - ( .5222242782532450D-01) )  |                                    | .LE. | .46230181E-20 |
| ABS( X( 37° 4) - ( 0. ) )                    |                                    | .LE. | .30222952E-20 |
| ABS( X( 38° 4) - ( .5034686043160675D-04) )  |                                    | .LE. | .17174838E-20 |
| ABS( X( 39° 4) - ( 0. ) )                    |                                    | .LE. | .11097536E-20 |
| ABS( X( 40° 4) - ( -.4542548099141130D-03) ) |                                    | .LE. | .86786923E-21 |
| ABS( X( 41° 4) - ( 0. ) )                    |                                    | .LE. | .15290011E-20 |
| ABS( X( 42° 4) - ( 0. ) )                    |                                    | .LE. | .62553825E-21 |
| ABS( X( 43° 4) - ( 0. ) )                    |                                    | .LE. | .17786800E-20 |
| ABS( X( 44° 4) - ( 0. ) )                    |                                    | .LE. | .58734800E-21 |
| ABS( X( 45° 4) - ( 0. ) )                    |                                    | .LE. | .12221567E-20 |
| ABS( X( 46° 4) - ( 0. ) )                    |                                    | .LE. | .32236593E-21 |
| ABS( X( 47° 4) - ( 0. ) )                    |                                    | .LE. | .50079662E-21 |
| ABS( X( 48° 4) - ( 0. ) )                    |                                    | .LE. | .12632940E-21 |
| ABS( X( 49° 4) - ( 0. ) )                    |                                    | .LE. | .93935974E-21 |
| ABS( X( 50° 4) - ( -.2059776941314566D-02) ) |                                    | .LE. | .70007703E-21 |
| ABS( X( 51° 4) - ( 0. ) )                    |                                    | .LE. | .14363692E-20 |
| ABS( X( 52° 4) - ( .15462806868010n10-01) )  |                                    | .LE. | .97950883E-21 |
| ABS( X( 53° 4) - ( 0. ) )                    |                                    | .LE. | .86913384E-21 |
| ABS( X( 54° 4) - ( -.4185638609633713D-03) ) |                                    | .LE. | .64457120E-21 |
| ABS( X( 55° 4) - ( 0. ) )                    |                                    | .LE. | .31352843E-21 |
| ABS( X( 56° 4) - ( -.5190904464922058D-03) ) |                                    | .LE. | .24050771E-21 |
| ABS( X( 57° 4) - ( 0. ) )                    |                                    | .LE. | .25239636E-21 |
| ABS( X( 58° 4) - ( 0. ) )                    |                                    | .LE. | .21729957E-21 |
| ABS( X( 59° 4) - ( 0. ) )                    |                                    | .LE. | .39280608E-21 |
| ABS( X( 60° 4) - ( 0. ) )                    |                                    | .LE. | .10845599E-21 |
| ABS( X( 61° 4) - ( 0. ) )                    |                                    | .LE. | .34350941E-21 |
| ABS( X( 62° 4) - ( 0. ) )                    |                                    | .LE. | .72577677E-22 |
| ABS( X( 63° 4) - ( 0. ) )                    |                                    | .LE. | .26340496E-21 |
| ABS( X( 64° 4) - ( 0. ) )                    |                                    | .LE. | .61120439E-22 |

In this table, the eigenvalue represents the frequency with modal number (3, 4).

Notice that the vector component ABS (X(20, 4)) has bounded value of 1.0.

### Claassen-Thorne Manual Method of Computation

Claassen and Thorne<sup>10</sup> give an exact analysis of the problem of sinusoidal free vibrations of a thin rectangular isotropic plate. For comparison with the results of the present report, the frequency parameter  $K_1$  was modified *manually* to frequency  $f$  using the formulas shown below. The results are shown in Table 1.

For  $\frac{a}{b} = k \leq 1$ , the corresponding value  $K_1$  is obtained from a table in Reference 10. Then:\*

$$f = K_1 \frac{\pi h}{2a^2} \sqrt{\frac{E}{3\rho_m(1-\sigma^2)}}$$

$$\text{For } \frac{a}{b} > 1, k' = \frac{1}{k} < 1, \text{ and } K_1' = K_1/k^2 \text{ so that } f = K_1 \frac{k^2 h \pi}{2a^2} \sqrt{\frac{E}{3\rho_m(1-\sigma^2)}}.$$

#### Sample Problem

Given:

$$a = 2 \text{ ft}; b = 2.33 \text{ ft}, h \text{ (half thickness)} = \frac{0.0313}{2} \text{ ft},$$

$$E = 4175 \times 10^6 \text{ lb/ft}^2, \rho_w = 466.56 \text{ lb/ft}^2, \sigma = 0.33,$$

$$1 - \sigma^2 = 0.8911, g = 32.2 \text{ ft/sec}^2$$

Then:

$$k = \frac{a}{b} = 0.858$$

The corresponding value of  $K_1$  is obtained from Table II of Reference 10 by interpolation of values of  $K_1$  (designated  $K$  in the reference) corresponding to  $k = 0.84$  and  $k = 0.86$  given in the table. The result for the 1, 1 mode\* is  $K_1 = 3.184789$ . Then

$$f_{11} = K_1 \left[ \frac{h\pi}{2a^2} \sqrt{\frac{E}{3\rho_m(1-\sigma^2)}} \right] = (3.184789)(63.8047) = 203.204$$

\*The table and therefore interpolation of tabulated values yield different values of  $K_1$  for different modes, i.e.,  $K_1$  is unique for a particular mode.



## REFERENCES

1. Leibowitz, R. C. and Wallace, D. R., "Engineering Guide and Computer Programs for Determining Turbulence-Induced Vibration and Radiation of Plates," NSRDC Report 2976 (Jan 1970).
2. Leibowitz, R. C. and Wallace, D. R., "Computer Program for Correction of Boundary Layer Pressure Fluctuations for Hydrophone Size and Boundary Layer Thickness Effects - Option 1," NSRDC Report 2976A (Sep 1970).
3. Snowdon, J. C., "Vibration and Shock in Damped Mechanical Systems," John Wiley and Sons, Inc., Chapter 8 (1968).
4. Smith, G. A. et al., "Experimental and Analytical Study of Vibrating, Stiffened, Rectangular Plates Subjected to In-Plane Loading," JASA, Vol. 48, No. 3, Part 2 (1970).
5. Szechenyi, Edmond, "An Approximate Method for the Determination of the Natural Frequencies of Single and Stiffened Panel Structures," Sound and Vib. Technical Report 23 (Mar 1970).
6. Izzo, A. J. et al., "Sound Radiated from Turbulence-Excited Finite Plates with Arbitrary Boundary Conditions," General Dynamics/Electric Boat Division Report U411-67-045 (22 Aug 1967); also Underwater Acoustics, Vol. 18, No. 1 (Jan 1968).
7. Greenspon, J. E., "Stresses and Deflections in Flat Rectangular Plates under Dynamic Lateral Loads Based on Linear Theory," David Taylor Model Basin Report 774 (Apr 1955).
8. Young, D. and Felgar, R. P., "Table of Characteristic Functions Representing the Normal Modes of Vibration of a Beam," Engineering Research Series, No. 44, University of Texas, Austin, Texas, (1 Jul 1949).
9. Felgar, R. P., "Formulas for Integrals Containing Characteristic Functions of a Vibrating Beam," University of Texas Circular 14 (1950).
10. Claassen, R. and Thorne, C., "Transverse Vibrations of Thin Rectangular Isotropic Plates," NAVWEFS Report 7016, NOTSTP 2379 (1960).
11. Wilby, John F., "The Response of Simple Panels to Turbulent Boundary Excitation," Technical Report AFFDL-TR-67-70 (Oct 1967).
12. Leibowitz, R. C. and Greenspon, J. E., "A Method for Predicting the Plate-Hull Girder Response of a Ship Incident to Slam," David Taylor Model Basin Report 1706 (Oct 1964).
13. Warburton, G. B., "The Vibration of Rectangular Plates," Proc. Instn. of Mech. Engrs, London, Vol. 168, p. 271 (1954).

14. Love, A. E. H., "Mathematical Theory of Elasticity," Fourth Edition, Cambridge University Press (1927).
15. Timoshenko, S., "Vibration Problems in Engineering," Third Edition, D. Van Nostrand Co., Inc. (1955).
16. Young, D., "Vibration of Rectangular Plates by the Ritz Method," J. Appl. Mech., p. 448 (Dec 1950).
17. Lord Rayleigh, "Theory of Sound," Second American Edition, Dover Publications, New York, N. Y. (1945).
18. Ritz, W., "Theorie der Transversalschwingungeneiner quadratischen Platten mit freien Randern," Annalen der Physik, Vierte Folge, Vol. 28, pp. 737-786 (1909)
19. Ballentine, J. R. et al., "Sonic Fatigue in Combined Environment," Wright-Patterson Air Force Base Technical Report AFFDL-TR-66-7 (May 1967).
20. Greenspon, J. E., "An Approximate Method for Obtaining the Frequencies, Deflections and Stresses in Sandwich and Cross-Stiffened Rectangular Plates," J. G. Engineering Research Associates Technical Report 1 for David Taylor Model Basin Contract Nonr-3123(00) X (Jul 1960).
21. White, R. W., "Vibration Characteristics of Beams and Plates Mounted on Elastic and Inertial Supports," Wyle Labs Report 64-2 (11 Aug 1964).
22. Carmichael, T. E., "The Vibration of Rectangular Plate with Edges Elastically Restrained against Rotation," Quart. J. Mech. and Appl. Math., Vol. XII, Part 1 (1959).
23. Crocker, M. J., "Theoretical and Experimental Response of Panels to Traveling Sonic Boom and Blast Waves," Wyle Labs - Research Staff, Report WR 66-2 under Contract NAS8-5384 (Mar 1966).
24. Sun, B. C., "Transverse Vibration of a Class of Plates with Clamped, Simply Supported or Free Boundary," PhD Thesis, Department of Theoretical and Applied Mechanics, University of Illinois (Aug 1967).
25. Langhaar, H. L., "Energy Methods in Applied Mechanics," John Wiley and Sons, Inc., New York, pp. 92-100 and 159-170 (1962).
26. Bishop, R. E. D. et al., "The Matrix Analysis of Vibration," Cambridge University Press, London, Chapter 8 (1965).
27. Frazer, R. A. et al., "Elementary Matrices," Cambridge University Press, pp. 70, 259, and 299-300 (1963).
28. Plumblee, Harry E., Jr., "Transverse Vibration Analysis of a Curved Sandwich Panel," Lockheed-Georgia Company ER-9208 (May 1960).

29. Varah, J. M., "The Computation of Bounds for the Invariant Subspaces of a General Matrix Operator," Computer Science Department, Stanford University Technical Report CS66 (26 May 1967); also available through the Clearinghouse for Federal Scientific and Technical Information, Department of Commerce, as Document AD652921.

30. Francis, J. G. F., "The QR Transformation, A Unitary Analogue to the LR Transformation, I, II," The Computer Journal Vol. 4, pp. 265-271 and 332-345 (1961-2).

31. Wilkinson, J. H., "The Algebraic Eigenvalue Problem," Clarendon Press, Oxford, England (1965).

32. Wilkinson, J. H., "Calculation of Eigensystems of Matrices," Chapter 3 of "Numerical Analysis: An Introduction," J. Walsh, editor, Thompson Book Company, Washington, D. C. (1967).

33. Gignac, D., "VARAH1 and VARAH2: Two Eigensystem Programs for General Real Matrices," NSRDC Report 3549 (in preparation).

## BIBLIOGRAPHY

1. Leissa, A. W., "Vibration of Plates," NASA SP-160 (1969).
2. Egle, D. M., "The Influence of Changing End Conditions on the Resonant Response of Beams and Plates," School of Aerospace and Mechanical Engineering, The University of Oklahoma, prepared for NASA under NASA Research Grant NG37-003-041 (Feb 1970).
3. Henry, F. D. and Egle, D. M., "The Effect of an Elastic Edge Restraint on the Forced Vibration of a Rectangular Plate," presented at the Fifth Southeastern Conference on Theoretical and Applied Mechanics, Rayleigh-Durham, N. C. (16-17 Apr 1970).
4. Ungar, E. E., "Free Oscillations of Edge Connected Simply Supported Plate Systems: Transactions of the ASME, pp. 434-440 (Nov 1961); also Bolt Beranek and Newman Report 721 (11 Jan 1960).
5. Fahy, F. J., "Vibration of Containing Structures by Sound in the Contained Fluid," ISVR Technical Report 11, University of Southampton (Nov 1968).
6. Maddox, N. R., "Curved Panel Frequency Analysis with Elastic Boundaries," Aerospace Sciences Lab, Lockheed-Georgia Company ER-9872 (Jul 1968).
7. Maddox, N. R. et al., "Frequency Analysis of Cylindrically Curved Panel with Clamped and Elastic Boundaries," J. Sound Vib., Vol. 12, No. 2, pp. 225-249 (Jun 1970).
8. Worley, W. J. and Wang, H-C., "Geometrical and Inertial Properties of a Class of Thin Shells of Revolution," prepared for NASA under Grant NsG-434 by Department of Theoretical and Applied Mechanics, University of Illinois (Sep 1964).
9. Worley, W. J. and Wang, H-C., "Geometrical and Inertial Properties of a Class of Thin Shells of a General Type," prepared for NASA under Grant NsG-434 by Department of Theoretical and Applied Mechanics, University of Illinois (Aug 1965).
10. Stern et al., "A Method for Determining an Optimum Shape of a Class of Thin Shells of Revolution," prepared for NASA under Grant NGR 14-005-011 by Department of Theoretical and Applied Mechanics, University of Illinois (Jan 1966).
11. Wang, H-C. and Worley, W. J., "Tables of Natural Frequencies and Nodes for Transverse Vibration of Tapered Beams," prepared for NASA under Grant NsG 434/14-05-010 by Department of Theoretical and Applied Mechanics, University of Illinois (Apr 1966).
12. Moriarty, T. F. and Worley, W. J., "Conformal Mapping of the Interior of a Unit Circle onto the Interior of a Class of Smooth Curves," prepared for NASA under Grant NsG 434/14-005-010 by Department of Theoretical and Applied Mechanics, University of Illinois (May 1969).
13. Petit, M. and Nath, J. M. Deb., "Vibration Analysis of Singly Curved Rectangular Plates," J. Sound Vib., Vol. 13, No. 4, pp. 485-497 (1971).

UNCLASSIFIED

Security Classification

| DOCUMENT CONTROL DATA - R & D  |   |   |
|--|---|---|
| <i>(Security classification of title, body of abstract and indexing annotation must be entered when the overall report is classified)</i>  |   |   |
| 1. ORIGINATING ACTIVITY (Corporate author)<br>Naval Ship Research And Development Center<br>Washington, D. C. 20034  |   | 2a. REPORT SECURITY CLASSIFICATION<br><b>UNCLASSIFIED</b> |
|  |   | 2b. GROUP   |
| 3. REPORT TITLE<br><b>COMPUTER PROGRAMS FOR PLATE VIBRATION INCLUDING THE EFFECTS OF CLAMPED AND ROTATIONAL BOUNDARIES AND CYLINDRICAL CURVATURE - OPTION 2</b>  |   |   |
| 4. DESCRIPTIVE NOTES (Type of report and inclusive dates)<br><b>Final Report</b>   |   |   |
| 5. AUTHOR(S) (First name, middle initial, last name)<br><b>Ralph C. Leibowitz and Dolores R. Wallace</b>   |   |   |
| 6. REPORT DATE<br><b>January 1971</b>  | 7a. TOTAL NO. OF PAGES<br><b>160</b>  | 7b. NO. OF REFS<br><b>33</b>                              |
| 8a. CONTRACT OR GRANT NO.  | 9a. ORIGINATOR'S REPORT NUMBER(S)<br><b>2976B</b>                                   |   |
| b. PROJECT NO. <b>S-F1453 21 06 and R00303</b><br>Task 15326   | 9b. OTHER REPORT NO(S) (Any other numbers that may be assigned this report)         |   |
| c.   |   |   |
| d.   |   |   |
| 10. DISTRIBUTION STATEMENT<br>Distribution limited to U.S. Government agencies only; Test and Evaluation December 1970<br>Other requests for this document must be referred to Naval Ship Systems Command SHIPS 037.   |   |   |
| 11. SUPPLEMENTARY NOTES  | 12. SPONSORING MILITARY ACTIVITY<br><b>Naval Ship Systems Command<br/>SHIPS 037</b> |   |
| 13. ABSTRACT<br><p>A comparative study is made of various methods for computing the free vibration modes and natural frequencies of thin plates with clamped and rotational supports and cylindrical curvature. The methods include closed form analytical, digital computer, nomographic, and graphical computations. Based on the results, preferred methods of computation are recommended. These methods—Option 2—are of particular value in extending previously formulated digital computer programs for obtaining the vibroacoustic response to turbulence excitation of a plate. Computer results for a particular case provide a comparison of the effect of clamped-clamped and simply supported boundaries on the vibratory response of a plate subject to turbulence excitation.</p> |   |   |

**UNCLASSIFIED**

Security Classification

| 14. KEY WORDS  | LINK A |    | LINK B |    | LINK C |    |
|--|--------|----|--------|----|--------|----|
|  | ROLE   | WT | ROLE   | WT | ROLE   | WT |
| Turbulence-Induced Vibration and Radiation of Plates<br>Simply Supported, Clamped and Rotational Boundaries<br>Flat Plates and Plates with Cylindrical Curvature<br>Mathematical Analysis<br>Manual Computations<br>Nomographic Computation<br>Digital Computer Computations<br>Digital Computer Programs<br>Recommendations |        |    |        |    |        |    |