

AFAPL-TR-70-80

AD724145

**PERFORMANCE AND ACOUSTIC TESTING OF A  
VARIABLE CAMBER PROPELLER**

*DONALD P. McERLEAN, 1ST LIEUTENANT, USAF  
DONALD E. EDWARDS*

TECHNICAL REPORT AFAPL-TR-70-80

FEBRUARY 1971

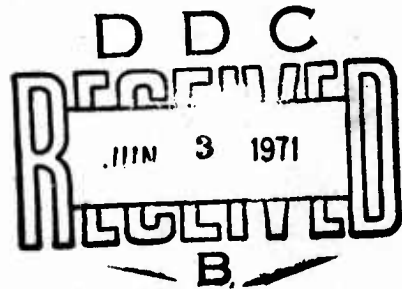

This document has been approved for public release  
and sale; its distribution is unlimited.

AIR FORCE AERO PROPULSION LABORATORY  
AIR FORCE SYSTEMS COMMAND  
WRIGHT-PATTERSON AIR FORCE BASE, OHIO

Reproduced by  
NATIONAL TECHNICAL  
INFORMATION SERVICE  
Springfield, Va. 22151

99

UNCLASSIFIED

Security Classification

DOCUMENT CONTROL DATA - R & D		
<i>(Security classification of title, body of abstract and indexing annotation must be entered when the overall report is classified)</i>		
1. ORIGINATING ACTIVITY (Corporate author) Air Force Aero Propulsion Laboratory Wright-Patterson AFB, Ohio		2a. REPORT SECURITY CLASSIFICATION UNCLASSIFIED
		2b. GROUP
3. REPORT TITLE PERFORMANCE AND ACOUSTIC TESTING OF A VARIABLE CAMBER PROPELLER		
4. DESCRIPTIVE NOTES (Type of report and inclusive dates) Work period from March 1970 through July 1970		
5. AUTHOR(S) (First name, middle initial, last name) Donald P. McErlean, 1st Lieutenant, USAF Donald E. Edwards		
6. REPORT DATE February 1971	7a. TOTAL NO. OF PAGES 98	7b. NO. OF REFS 3
8a. CONTRACT OR GRANT NO.	9a. ORIGINATOR'S REPORT NUMBER(S) AFAPL-TR-70-80	
b. PROJECT NO. 3066 c. Task No. 306612 d.	9b. OTHER REPORT NO(S) (Any other numbers that may be assigned this report)	
10. DISTRIBUTION STATEMENT This document has been approved for public release and sale; its distribution is unlimited.		
11. SUPPLEMENTARY NOTES	12. SPONSORING MILITARY ACTIVITY Air Force Aero Propulsion Laboratory Wright-Patterson AFB, Ohio	
13. ABSTRACT This report presents the test results obtained from a series of performance and acoustic near-field measurements on a propeller fitted with a variable camber feature. The subject propeller, manufactured by the Detroit Diesel Allison Division of General Motors under a prior Contributing Engineering Program Contract, effects a change in camber by deflecting a flap positioned along the 72% chordal line of each blade.  The tests were conducted on the 10,000 horsepower electric whirl rig located at Wright-Patterson Air Force Base. In comparison with the same blade with fixed camber, the variable camber feature increased the static thrust by approximately 11% with a horsepower input of 3500 SHP at 1020 RPM. The overall sound pressure level and the 1/3 octave band frequency spectra did not appear to be appreciably influenced by increasing the camber on this propeller.  These tests represent the only test data available on this unique propeller configuration which has good potential for V/STOL applications.		

DD FORM 1473  
1 NOV 65

UNCLASSIFIED

Security Classification

UNCLASSIFIED

Security Classification

14. KEY WORDS	LINK A		LINK B		LINK C	
	ROLE	WT	ROLE	WT	ROLE	WT
Propellers for Aircraft Variable Camber V/STOL Aircraft Static Performance Acoustic Performance Testing						

UNCLASSIFIED

Security Classification

**AFAPL-TR-70-80**

**PERFORMANCE AND ACOUSTIC TESTING OF A  
VARIABLE CAMBER PROPELLER**

*DONALD P. McERLEAN, 1ST LIEUTENANT, USAF  
DONALD E. EDWARDS*

**This document has been approved for public release  
and sale; its distribution is unlimited.**

FOREWORD

This report summarizes the variable camber propeller test program work accomplished during the period from March 1970 through July 1970 under Project 3066, Task 306612, "Propeller Technology," Lt McErlean, AFAPL/TBC, project engineer. This report was submitted by the authors November 1970.

In-house technical support for the test program and report preparation was provided by members of the Components Branch, Turbine Engine Division of the Air Force Aero Propulsion Laboratory. The performance testing was conducted by Dr. Donald P. McErlean and the acoustic testing was conducted by Mr. Donald E. Edwards. Test facilities were under the direction of Mr. S. W. Blosser of the Experimental Test Branch, Technical Facilities Division of the Air Force Aero Propulsion Laboratory; Mr. George Medisch of the same Branch was the Chief of the Propeller Test Crew.

Special appreciation is extended to Mr. M. P. Wannemacher of the Components Branch, Turbine Engine Division of the Air Force Aero Propulsion Laboratory for acting as associate investigator during the course of this program, and to the members of the propeller test crew for their assistance and cooperation.

Technical support was provided by the manufacturer of the propeller, Detroit Diesel Allison Division of General Motors Corporation, Indianapolis, Indiana.

This technical report has been reviewed and is approved.

  
ERNEST C. SIMPSON  
Director, Turbine Engine Division  
AF Aero Propulsion Laboratory

ABSTRACT

This report presents the test results obtained from a series of performance and acoustic near-field measurements on a propeller fitted with a variable camber feature. The subject propeller, manufactured by the Detroit Diesel Allison Division of General Motors under a prior Contributing Engineering Program Contract, effects a change in camber by deflecting a flap positioned along the 72% chordal line of each blade.

The tests were conducted on the 10,000 horsepower electric whirl rig located at Wright-Patterson Air Force Base. In comparison with the same blade with fixed camber, the variable camber feature increased the static thrust by approximately 11% with a horsepower input of 3500 SHP at 1020 RPM. The overall sound pressure level and the 1/3 octave band frequency spectra did not appear to be appreciably influenced by increasing the camber on this propeller.

These tests represent the only test data available on this unique propeller configuration which has good potential for V/STOL applications.

**BLANK PAGE**

## TABLE OF CONTENTS

SECTION	PAGE
I INTRODUCTION	1
II TEST AND FACILITIES	2
1. Test Vehicle	2
2. Test Plan	3
a. Test Data Recorded	3
b. Propeller Configurations Tested	3
3. Test Facilities	4
a. Horsepower	4
b. Thrust	5
c. RPM	5
d. Acoustic Data Acquisition System	5
III DATA ANALYSIS AND REDUCTION	7
1. Aerodynamic Data	7
2. Acoustic Data	7
IV TEST RESULTS	9
1. Aerodynamic Performance Results	9
a. Thrust vs RPM	9
b. Horsepower vs RPM	9
c. $C_T/C_p$ vs $C_p$	9
d. Figure of Merit	9
e. Thrust vs Blade Angle	10



TABLE OF CONTENTS (CONT)

SECTION	PAGE
2. Acoustic Data	10
a. Graphical Frequency Spectra	10
b. Overall Sound Pressure Level	11
c. Tabular Frequency Spectra	11
d. Comparison of Measured Sound Pressure Levels With Predicted Values	11
V CONCLUSIONS AND RECOMMENDATIONS	12
1. Conclusions	12
2. Recommendations	12
APPENDIX RAW TEST DATA	51
1. Whirl Rig Performance Data	54
2. Tabular Frequency Spectra	70
REFERENCES	90

ILLUSTRATIONS

FIGURE	PAGE
1. End View of Variable Camber Blade	13
2. Variable Camber Propeller Installed on Whirl Rig No. 1	14
3. Blade Flap Actuation Mechanism	15
4. Microphone Positions for Acoustic Data Acquisition System	16
5. Pounds Thrust vs Propeller Speed at Various Blade Angles - Zero Blade Flap Deflection	17
6. Pounds Thrust vs Propeller Speed at Various Blade Angles - Full Blade Flap Deflection	18
7. Horsepower vs Propeller Speed at Various Blade Angles - Zero Blade Flap Deflection	19
8. Horsepower vs Propeller Speed at Various Blade Angles - Full Blade Flap Deflection	20
9. Thrust/Horsepower vs Power Coefficient	21
10. Figure of Merit vs Power Coefficient	22
11. Pounds of Thrust vs Blade Angle at 1000 RPM	23
12. Pounds of Thrust vs Blade Angle at 1020 RPM	24
13-28. Graphical Frequency Spectra	26-41
29-34. Overall Sound Pressure Level Diagrams	44-49

## SYMBOLS

D	propeller diameter, ft
AF	activity factor = $\frac{100,000}{16} \int_{0.2}^{1.0} \frac{b}{D} \left(\frac{r}{R}\right)^3 d\left(\frac{r}{R}\right)$
$\beta$	blade angle
r	radius along blade, ft
R	total blade radius, ft
$C_{Li}$	integrated design lift coefficient = $4 \int_{0.2}^{1.0} C_{li} \left(\frac{r}{R}\right)^3 d\left(\frac{r}{R}\right)$
$C_{li}$	blade section design lift coefficient
M	tip Mach number = $\frac{\pi ND}{60a}$
N	propeller speed, RPM
a	speed of sound, ft/sec
$\sigma$	density ratio, $\rho / \rho_0$
$\rho$	local density, lb-sec <sup>2</sup> /ft <sup>4</sup>
$\rho_0$	sea level standard density, lb-sec <sup>2</sup> /ft <sup>4</sup>
HP	corrected rig horsepower $\frac{\text{test horsepower}}{\sigma}$
$C_p$	power coefficient $\frac{5 \times 10^{10} \text{ HP}}{N^3 D^5}$
$C_T$	thrust coefficient $\frac{1.514 \times 10^6 \text{ Th}}{N^2 D^4}$
F. M.	figure of merit = $0.798 \frac{C_T^{1.5}}{C_p}$
Th	corrected rig thrust, pounds $\frac{\text{test thrust}}{\sigma}$

SECTION I  
INTRODUCTION

A serious problem with the propellers which are currently used for V/STOL and STOL applications is that the need for high static thrust has caused the blade to be designed for takeoff conditions and therefore the performance at cruise speed is hampered. The development of a high speed V/STOL or STOL turbo-prop requires that the propeller give good performance in both the static and flight regimes. An excellent way of accomplishing this high performance throughout the flight envelope is to utilize a propeller which incorporates variable geometry.

Although the above discussion centers around performance, it is recognized that the planned application of STOL and V/STOL aircraft for short-haul transportation in and around a civilian environment has caused the noise generated by these aircraft to become of major importance. Therefore, it was decided that, to evaluate the performance of propellers for this type of aircraft, it would be necessary to measure not only thrust, horsepower, and RPM but also the near-field acoustic signature.

This report presents the results of the performance testing of a variable camber propeller manufactured by the Detroit Diesel Allison Division of General Motors. This propeller incorporates a flap, similar to the aileron of a wing, located along the trailing edge of each blade. When activated, this flap effectively changes the camber of the blade.

In view of the current interest in improving STOL and V/STOL aircraft performance and in the noise pollution aspects of such aircraft, the findings of this report are believed to be of significant value. They represent the only test data available on this unique propulsor configuration and, hopefully, may provide a basis for further research into the area of variable geometry propellers.

SECTION II  
TEST AND FACILITIES

1. TEST VEHICLE

The tests described in this report were performed on a variable camber propeller developed by the Detroit Diesel Allison Division of General Motors. This propeller, which is basically a standard Aero products A6441FN-606 (Lockheed Electra) blade, was modified by the addition of a flap positioned along the 72% chordal line of each blade. This flap, similar to the aileron of a wing, effectively changes the camber of the blade when deflected. This can be seen quite clearly in Figures 1 and 2.

The blade flap actuation mechanism, which can be seen in Figure 3, is basically a two-position cam which deflects the flap after the blade has progressed through a specified blade angle. This mechanism operates in the following manner: When the blades are moved into the takeoff position, the cam rotates the flap toward the blade thrust face to produce the high camber required for maximum takeoff thrust. As the blade angle is increased into the cruise range, the flap moves to its low camber position where it completes the design airfoil section for high cruise efficiency.

The present configuration deflects the flap at all blade angles of 40° or less. However, this mechanism was modified slightly for this experiment in order to allow the flap angle to be varied independently of the blade angle so that a base line could be drawn for performance/ acoustic measurements.

The following are the major characteristics of the propeller:

Diameter	13 feet, 6 inches
Activity Factor	177
Design RPM	1020
Takeoff Horsepower	4200
Integrated Design Lift Coefficient	0.25

AFAPL-TR-70-80

Equivalent Design Lift Coefficient (Flap Deflected)	0.75
Number of Blades	4
Material	SAE 4350 steel, hollow-ribbed construction

## 2. TEST PLAN

The tests described in this report are standard whirl rig calibration tests during which both performance and acoustic near-field data were obtained.

### a. Test Data Recorded

The following data were recorded, where applicable, through the total RPM range of the test:

Test Run Number	Barometric Pressure
Time of Day	Ambient Temperature
Total Test Time	Corrected Horsepower
Blade Angle, Degrees	Corrected Thrust
Propeller Speed, RPM	Acoustic Near-Field Signature

### b. Propeller Configurations Tested

The following test runs were made with both zero and full-blade flap deflection:

+25° blade angle, 500 to 1000 RPM in 100 RPM increments plus 1020 and 1050 RPM

\*+32.2° blade angle, 500 to 1000 RPM in 100 RPM increments plus 1020 and 1050 RPM

\*+39.2° blade angle, 500 to 1000 RPM in 100 RPM increments plus 1020 and 1050 RPM

\*+42.8° blade angle, 500 to 1000 RPM in 100 RPM increments plus 1020 and 1050 RPM.

+50.1° blade angle, 500 to 1000 RPM in 100 RPM increments plus 1020 and 1050 RPM.

\*Acoustic near-field signature was recorded for these configurations.

All blade and flap angles were measured at the 42-inch blade station and 4200 SHP and 1050 RPM were employed as operating limits.

For all the configurations tested, full blade flap deflection consisted of moving the blade flap 5.4° in the increasing camber direction from the design airfoil position. The measurement of both blade and flap angle was accomplished by using a protractor and a special template designed according to the manufacturer's blade drawings.

### 3. TEST FACILITIES

All testing described in this report was done on the 10,000 horsepower electric whirl rig No. 1 located at Wright-Patterson AFB. In general, this rig consists of a large concrete pier which houses the electric drive motor, thrust and RPM measuring equipment, and various accessory drives. The pier rises about 25 feet off the floor of a large open building. The control room is located under the pier and the propeller may be observed via a periscope and strobe light arrangement. The following paragraphs give a brief description of the horsepower, thrust, and RPM measuring systems.

#### a. Horsepower

The input power to the propeller is calculated from measuring the armature voltage and amperage at the electric drive motor. Predetermined correction factors are then applied to allow for the copper and field winding losses. The resultant watts are then converted to horsepower and an atmospheric correction factor is used to adjust the data to standard day conditions. These calculations are made with an electronic desk calculator during the course of the test so that field curves can be drawn to check for obvious data discrepancies.

The system is calibrated against a well documented test propeller whose blades have been accurately set and locked into place. No load losses are determined by motoring the rig at various RPM settings.

b. Thrust

The thrust is measured by converting the movement of the propeller shaft to hydraulic pressure via a hydraulic diaphragm. The pressure signal is then directly converted to pounds thrust with a precalibrated Emery-Tate load indicator and then corrected to standard day conditions. The thrust system is calibrated statically by applying a known load (lead weights) to the propeller shaft.

c. RPM

Accurate shaft RPM was obtained from a magnetic pickup which receives impulses from the drive motor shaft. These impulses are then presented on a digital display in the control room as propeller RPM.

d. Acoustic Data Acquisition System

The acoustic data acquisition system consisted of six channels. Each channel employed a one-half inch Bruel and Kjaer microphone and cathode follower. The microphones were clamped to microphone stands which gave them the same elevation as the propeller hub and were positioned as shown in Figure 4. A preamplifier was used to drive the signal through 250 feet of four-conductor shielded cable. The cable connected the microphone assembly to the instrumentation in the control room where the signal was monitored by an oscilloscope and a Bruel and Kjaer voltmeter which was built into a third-octave spectrum analyzer. An Ampex FR-1300 tape unit was used to record the signal and a junction box with variable attenuators was used for system calibration. Power supplies for the microphones and amplifiers were also located in the control room.



A complete list of the data acquisition system instrumentation follows:

- Microphone - half-inch Bruel and Kjaer condenser type 4133
- Cathode  
Follower - Bruel and Kjaer type 2619
- Preamplifier - general purpose line drive amplifier,  
Fairchild ADO-24
- Cable - 20 gage, 4-conductor, shielded
- Tape  
Recorder - Ampex FR1300, 30 IPS, extended mode,  
54 KHz center frequency

SECTION III  
DATA ANALYSIS AND REDUCTION

1. AERODYNAMIC DATA

As was previously stated, the performance data was taken directly from the instrumentation in the control room. This data is then corrected for the various loss and atmospheric effects by employing predetermined correction factors. The data in this form is then delivered to the Project Engineer for reduction. This is accomplished by using a computer program written for the IBM 7094 Digital Computer at Wright-Patterson Air Force Base. This program is entitled "Computer Program for Reducing Static Propeller Test Data" and is contained in Reference 1. The explanation of the program contained here generally follows that of Chopin (Reference 2).

The program accepts whirl rig test data in precisely the format in which it is taken from the rig by the test crew. This is then reduced by the computer into power coefficient ( $C_p$ ), thrust coefficient ( $C_T$ ),  $C_T/C_p$ , figure of merit (F.M.), thrust/horsepower (Th/HP), and propeller tip Mach number.

The computer then fits a second-degree polynomial, employing the method of least squares, through six consecutive test data points which are distributed on either side of a selected tip Mach number value. This routine continues until smoothed horsepower and thrust curves are created for the entire range of tip Mach numbers. The reduced data is then presented in two forms: coefficients computed from the raw test data, and coefficients computed from the fitted curves at preselected tip Mach number increments.

For this series of tests, a tip Mach number increment of 0.025 from  $M = 0.300$  to the last data point was employed. The computer printouts of the reduced data are contained in the Appendix.

2. ACOUSTIC DATA

The acoustic data, which was recorded on magnetic tape, was reduced by utilizing the data analysis capability of the Air Force Flight Dynamics Laboratory, Wright-Patterson AFB, Ohio.

AFAPL-TR-70-80

The magnetic recording tape was run on a Honeywell 7600 tape transport from which the signal was analyzed by a General Radio, type 1921, third-octave, real-time, spectrum analyzer. The frequency spectra from the analyzer were then printed in tabular form on paper tape.

Selected frequency spectra were then programmed into an IBM 1800 computer for graphical presentation by a Calcomp plotter. The spectrum analyzer center frequencies and filter numbers are shown in the tabular acoustic data contained in the Appendix.

SECTION IV

TEST RESULTS

1. AERODYNAMIC PERFORMANCE RESULTS

a. Thrust vs RPM

Figures 5 and 6 show the thrust generated by the propeller at various blade angles with increasing RPM. Comparison of the curve for the zero flap angle blade with the curve for the flap-deflected blade shows a much more marked drop in thrust for the flap-deflected case when the blade angle is increased past the stall point. This behavior is not unusual as it exhibits the basic difference between the effective camber of the two blades.

b. Horsepower vs RPM

Figures 7 and 8 display the increase in the power absorbed by the propeller at various blade angles with increasing RPM. Comparison of the two curves shows that, at each blade angle-RPM combination, the blade absorbed (or required) more horsepower with the flap deflected than it did without the flap deflected.

c.  $C_T/C_p$  vs  $C_p$

Figure 9 is essentially a curve of thrust/horsepower at various power settings. As can be seen from the figure, the effect of RPM (as reflected in tip Mach number) was negligible, except at low power settings. What was most interesting was the fact that the curve for the high cambered blade (flap deflected) was always above the curve for the low cambered blade. Thus, the blade with the flap deflected always has the advantage in thrust production per horsepower, although this advantage is slight at high power coefficients.

d. Figure of Merit

The Figure of Merit is essentially a measure of the static efficiency of a propeller or helicopter rotor. Figure 10 shows that the deflection of the blade

flap caused an average increase in the Figure of Merit of approximately 5 points. It is also interesting to note that again there was only a very slight effect due to changing the propeller speed at a fixed blade angle.

e. Thrust vs Blade Angle

Probably the most significant conclusions can be drawn from Figures 11 and 12. These figures illustrate the variation in thrust with blade angle for a given propeller RPM. Also shown on these plots are some representative cross-plot lines of constant horsepower. Therefore, assuming a constant speed propeller (which is the actual operational design of the tested configuration) and a horsepower which is fixed by the turbomachinery involved, these curves show the actual gain in static thrust due to the variable camber feature.

Figure 12, at 1020 RPM, showed that the increase in the blade camber caused by deflecting the flap resulted in about an 11% thrust increase at the 3500 SHP level and about a 7% increase at the 4200 SHP level.

It should be noted, however, that it was not possible to determine from the data whether this was an optimum configuration. A much more extensive test program would have to be carried out to study the effects of flap chord, deflection angle, basic blade shape, etc. Testing of this scope was simply not possible within the confines of the present effort.

2. ACOUSTIC DATA

The microphone positions utilized to obtain the acoustic data are shown in Figure 4.

a. Graphical Frequency Spectra

Selected frequency spectra as plotted by the Calcomp plotter are illustrated in Figures 13 through 28. The values selected are representative of a high and low blade angle both with and without the flap deflected.

An interesting observation which may be obtained from the graphical spectra of microphone positions 5 and 6 is that the broadband vortex noise propagated forward from the plane of rotation does not seem to be affected by the deflection of the blade flap.

b. Overall Sound Pressure Level

Figures 29 through 34 present the overall sound pressure level for each microphone position at three selected RPM values for each configuration tested. Except for microphone position 4, which is along the axis of expected maximum sound pressure level, the flap caused no consistent increase in sound pressure level.

c. Tabular Frequency Spectra

Included in the Appendix with the performance data are tables of the measured sound pressure level for each center frequency in the 1/3 octave band analysis. This data may then be plotted to obtain graphs similar to Figure 13 for any propeller test configuration desired.

d. Comparison of Measured Sound Pressure Levels With Predicted Values

A detailed comparison of the measured near-field noise levels with existing prediction methods (Reference 3) has indicated maximum deviations of +13 db and -7 db. The average deviation between measured and predicted data is +5 db to -3 db. Inaccuracies in the prediction methods do not fully account for the discrepancies between measured and predicted data. Additional studies are currently under way to determine the acoustic characteristics of the whirl rig facility in detail. The effect of reverberation on the accuracy of measured near-field data will be investigated.

## SECTION V

### CONCLUSIONS AND RECOMMENDATIONS

#### 1. CONCLUSIONS

The variable camber propeller with blade flaps deflected showed approximately 11% gain in static thrust at 3500 SHP and 1020 RPM. This is reflected in a gain of 1-1/2 to 3 points in the Figure of Merit at all power coefficients tested.

The overall sound pressure level was practically unaffected by deflecting the blade flaps. This result was somewhat unexpected, especially for the broadband vortex noise.

#### 2. RECOMMENDATIONS

The manufacturer of the propeller felt that a 10° flap angle should have been the maximum deflection angle. However, despite repeated attempts on the rig and in the assembly shop, only an 8° deflection angle was obtained and of that only 5.4° was in the positive (increasing camber) direction. Therefore, one recommendation would be to take the present configuration and, with some delicate machining, attempt to obtain the 10° deflection angle.

Additionally, since this concept has certainly shown that it is feasible, further work is warranted to try and optimize the flapped blade configuration.

Hopefully, different variable geometry concepts will be tested on a continuing basis and will allow direct comparison of the results for each configuration. Since the static thrust of V/STOL machines has been considered a high risk area of V/STOL propulsion, this work should have considerable application.

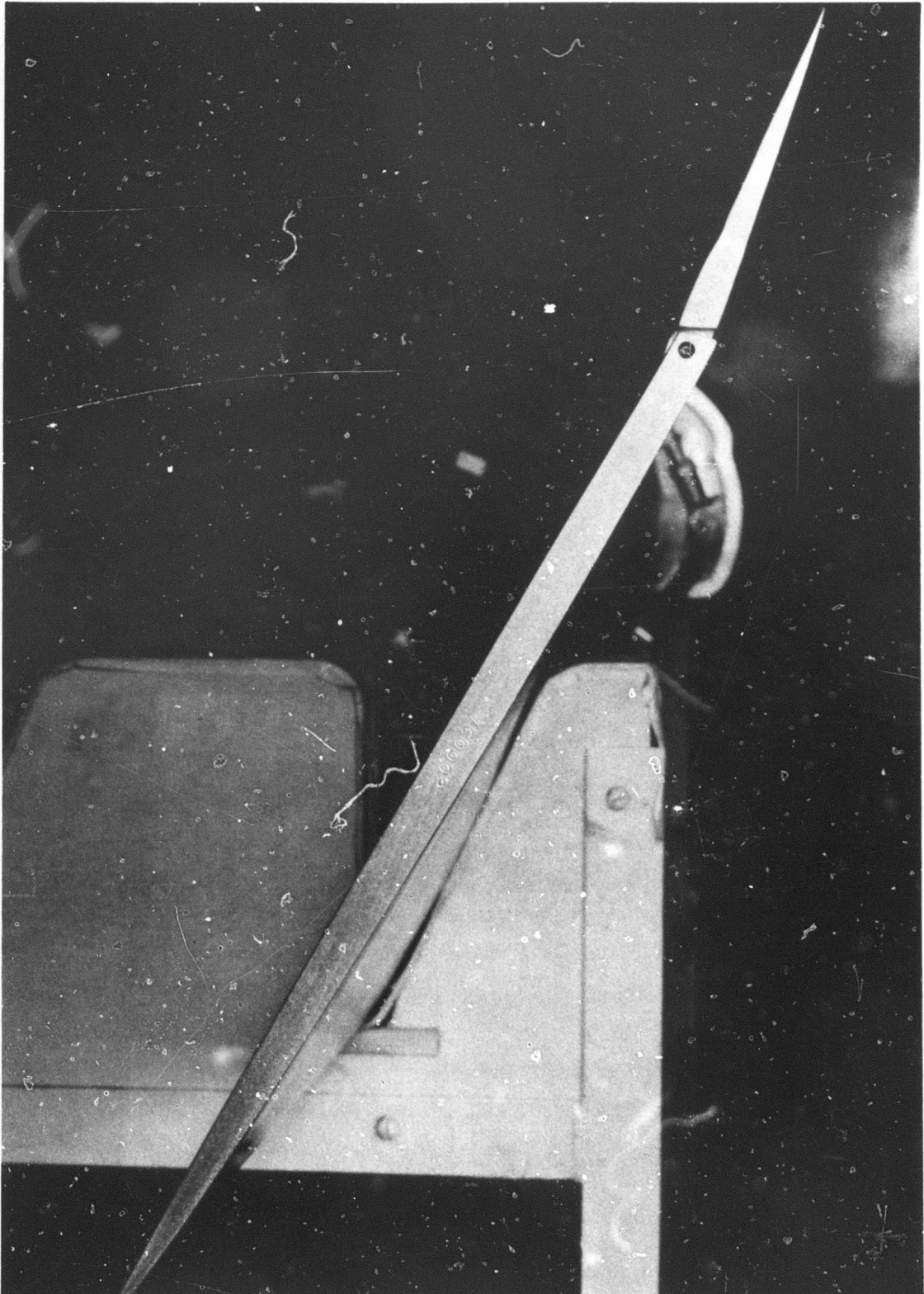

Figure 1. End View of Variable Camber Blade



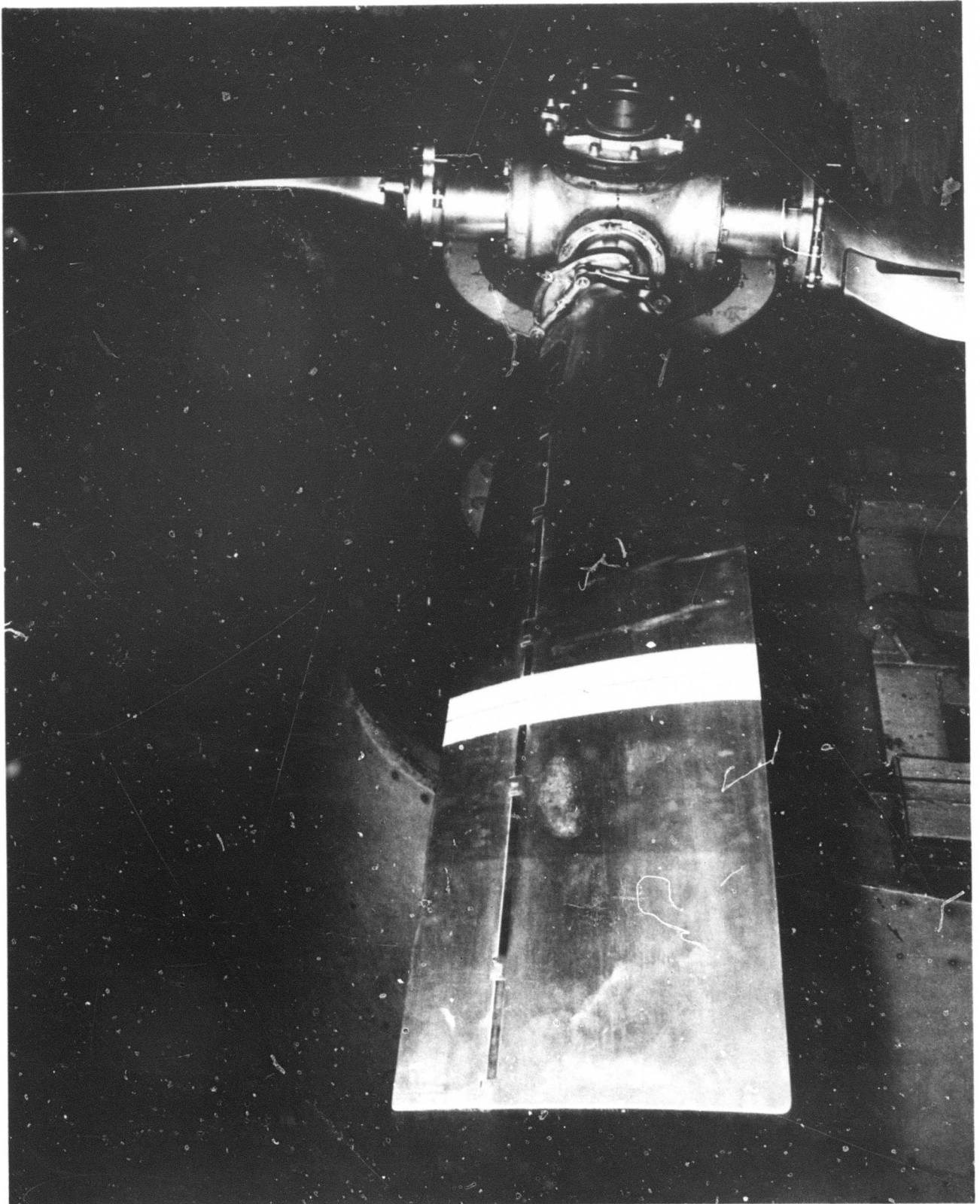

Figure 2. Variable Camber Propeller Installed on Whirl Rig No. 1

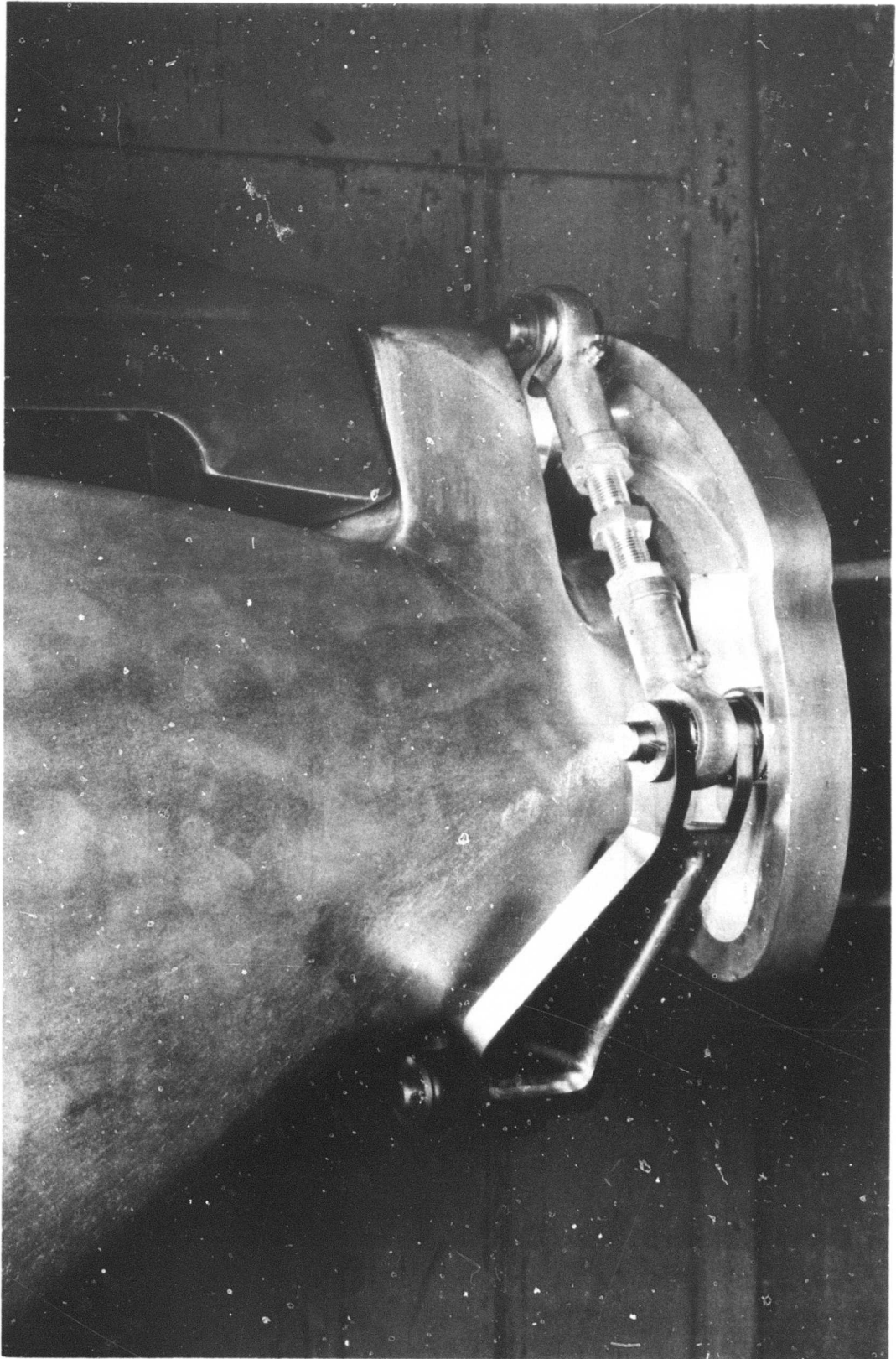

Figure 3. Blade Flap Actuation Mechanism

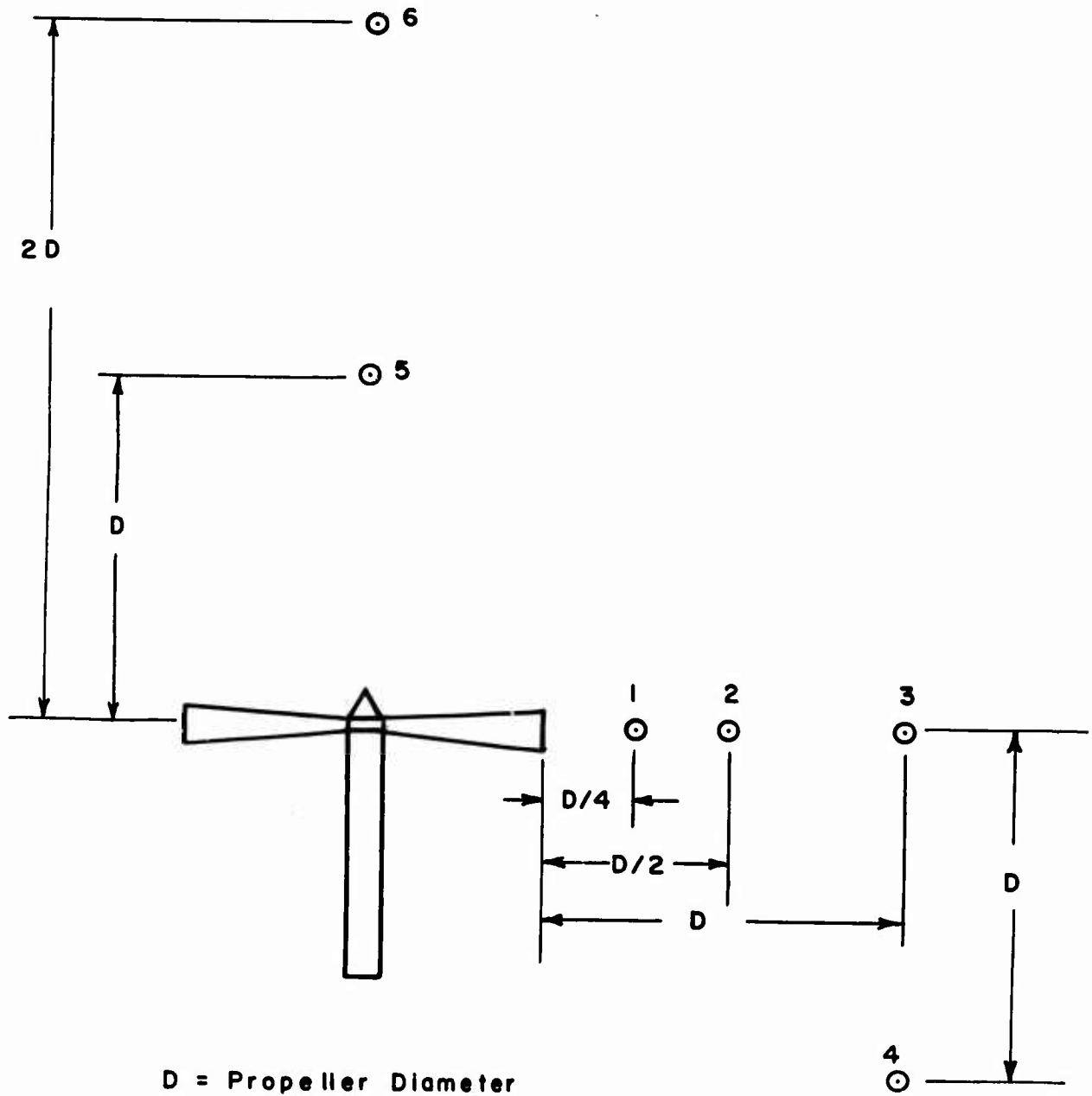

Figure 4. Microphone Positions for Acoustic Data Acquisition System

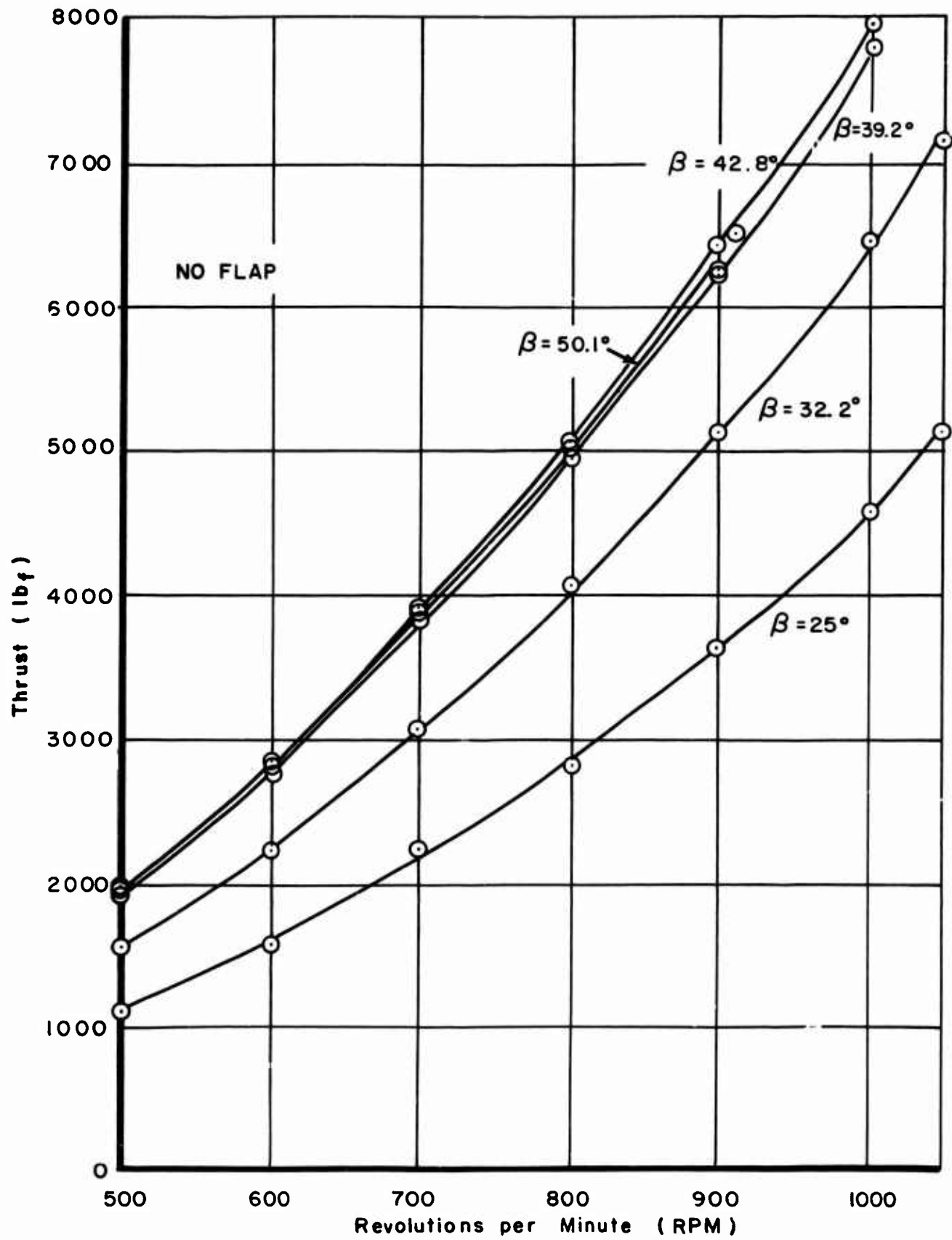

Figure 5. Pounds Thrust vs Propeller Speed at Various Blade Angles - Zero Blade Flap Deflection

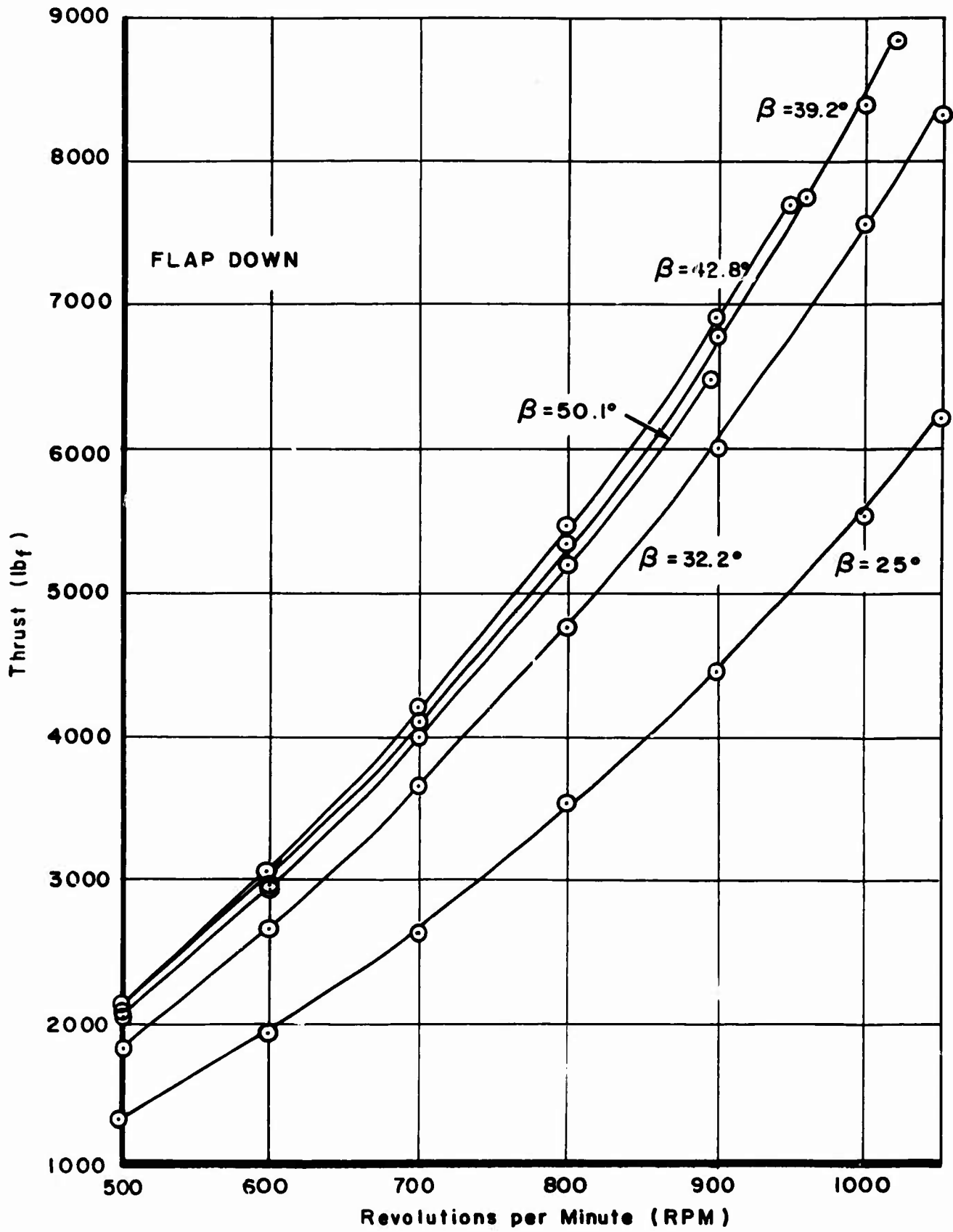

Figure 6. Pounds Thrust vs Propeller Speed at Various Blade Angles - Full Blade Flap Deflection

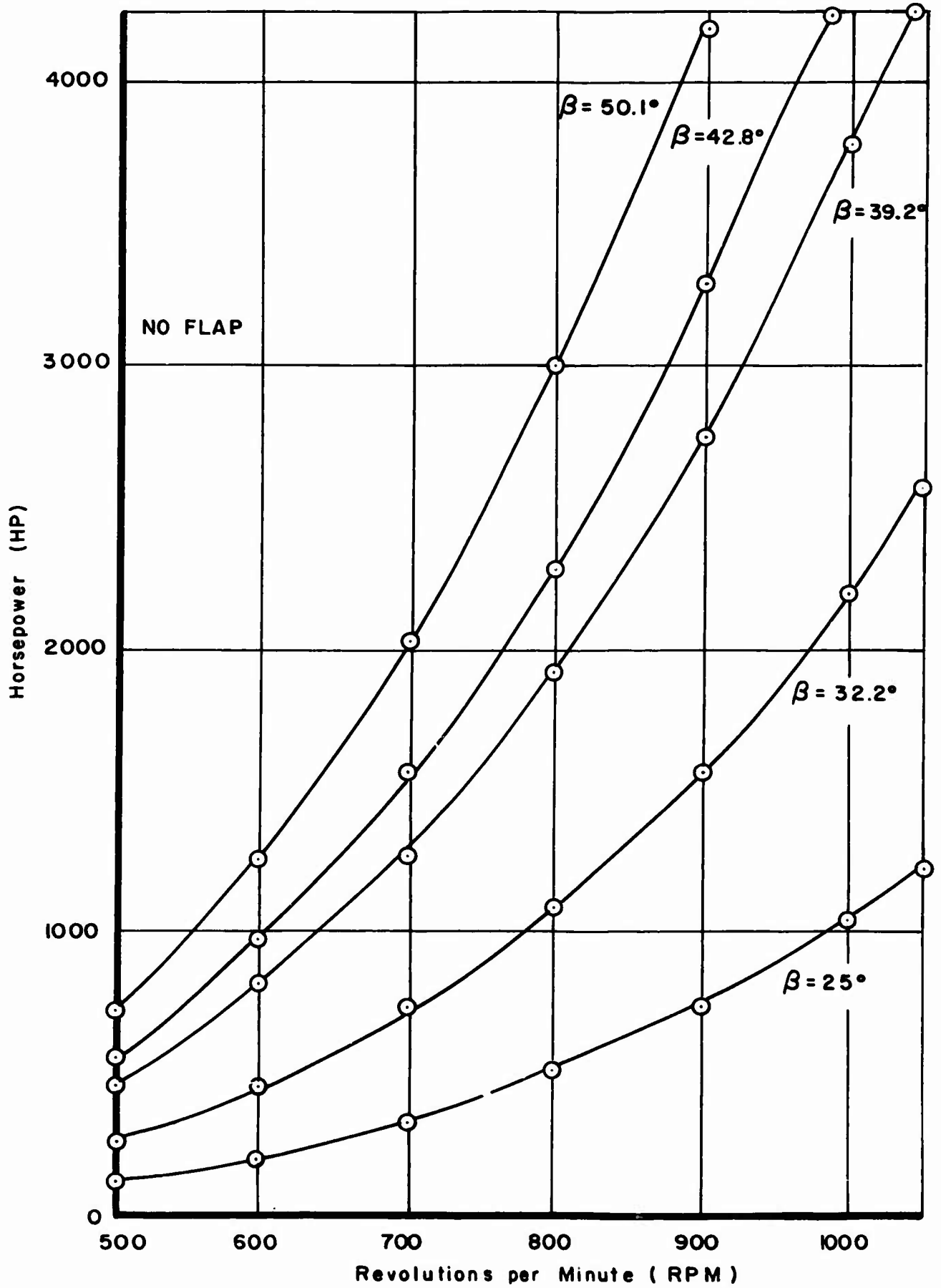

Figure 7. Horsepower vs Propeller Speed at Various Blade Angles - Zero Blade Flap Deflection

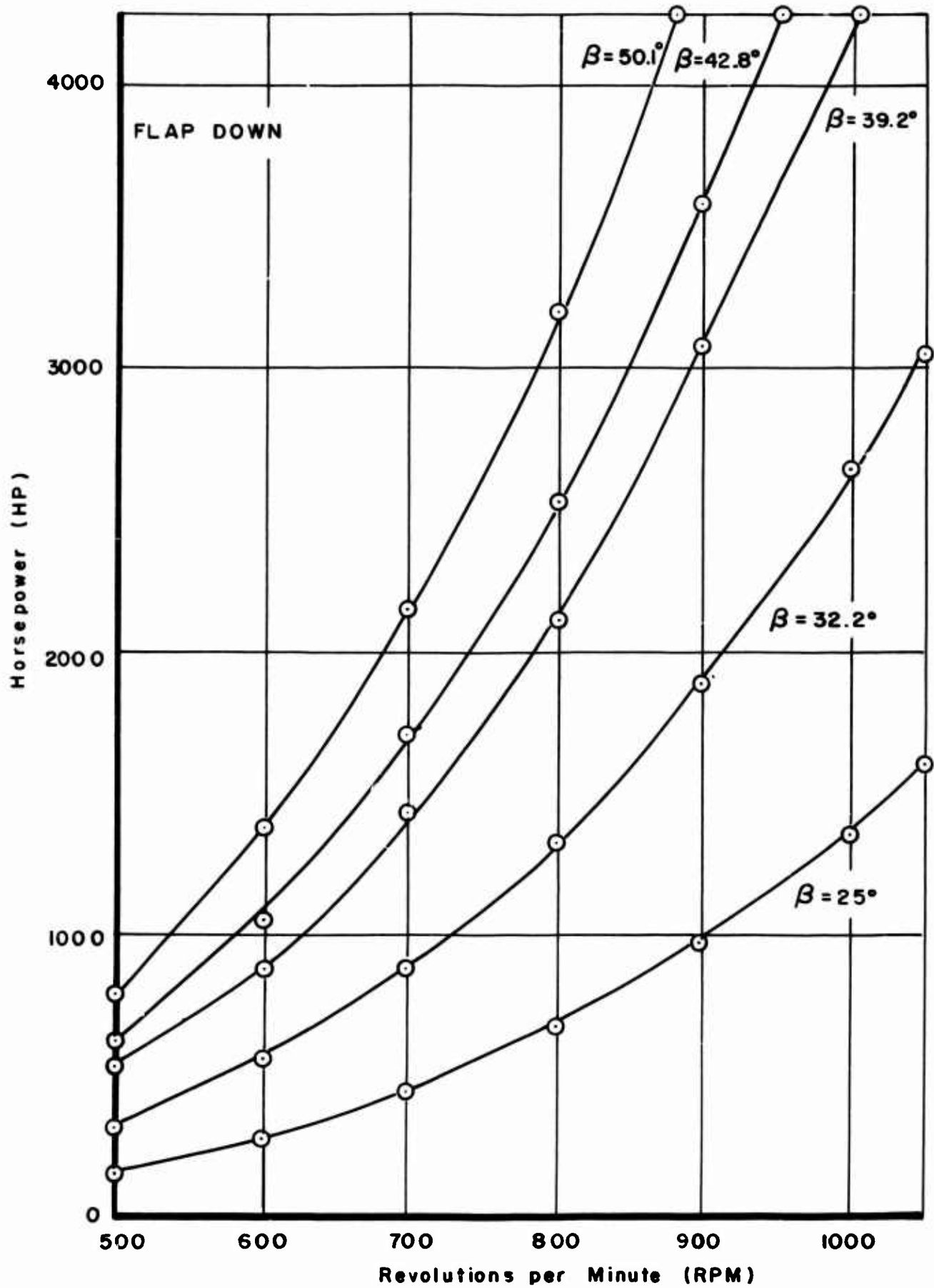

Figure 8. Horsepower vs Propeller Speed at Various Blade Angles - Full Blade Flap Deflection

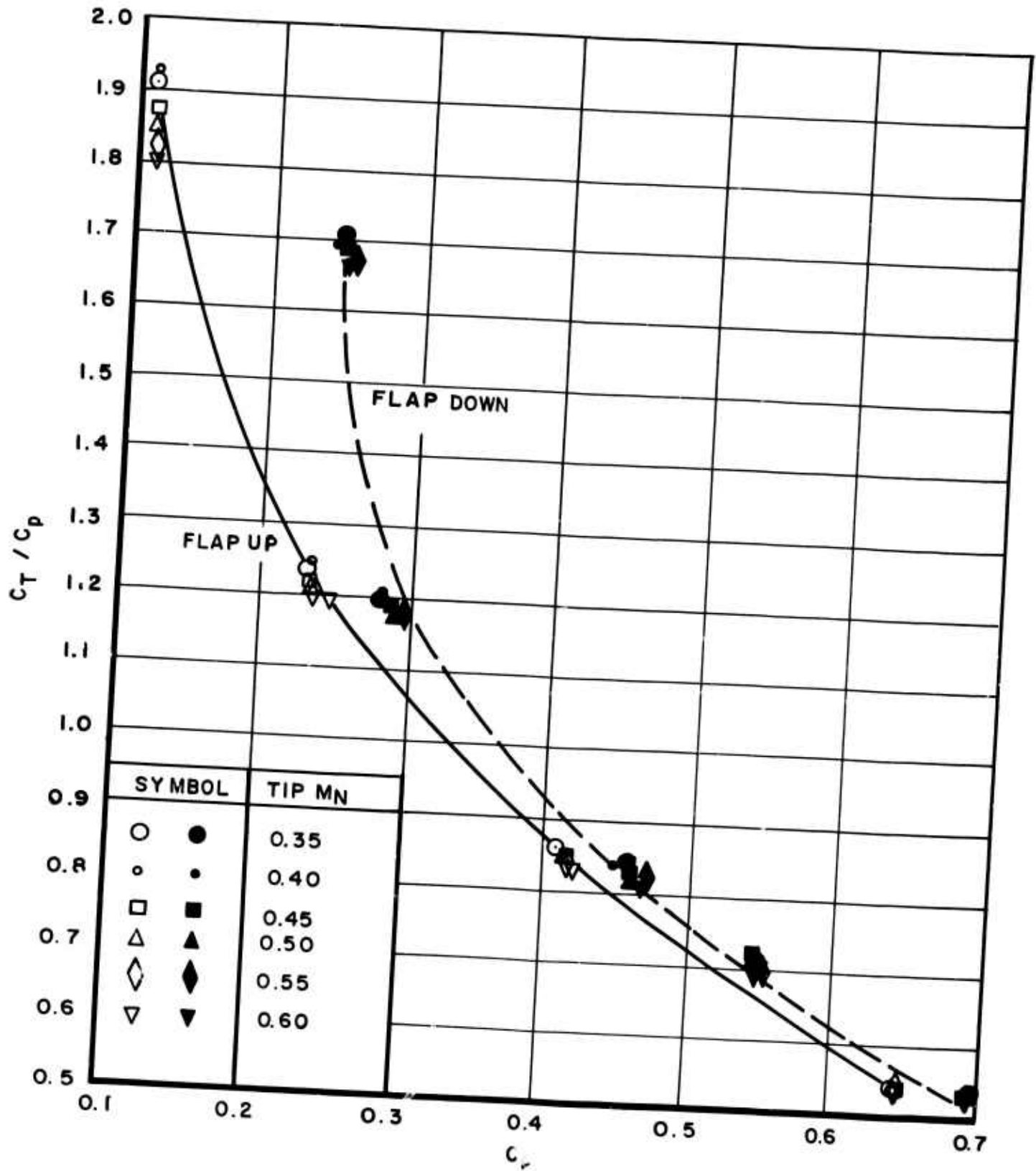

Figure 9. Thrust/Horsepower vs Power Coefficient



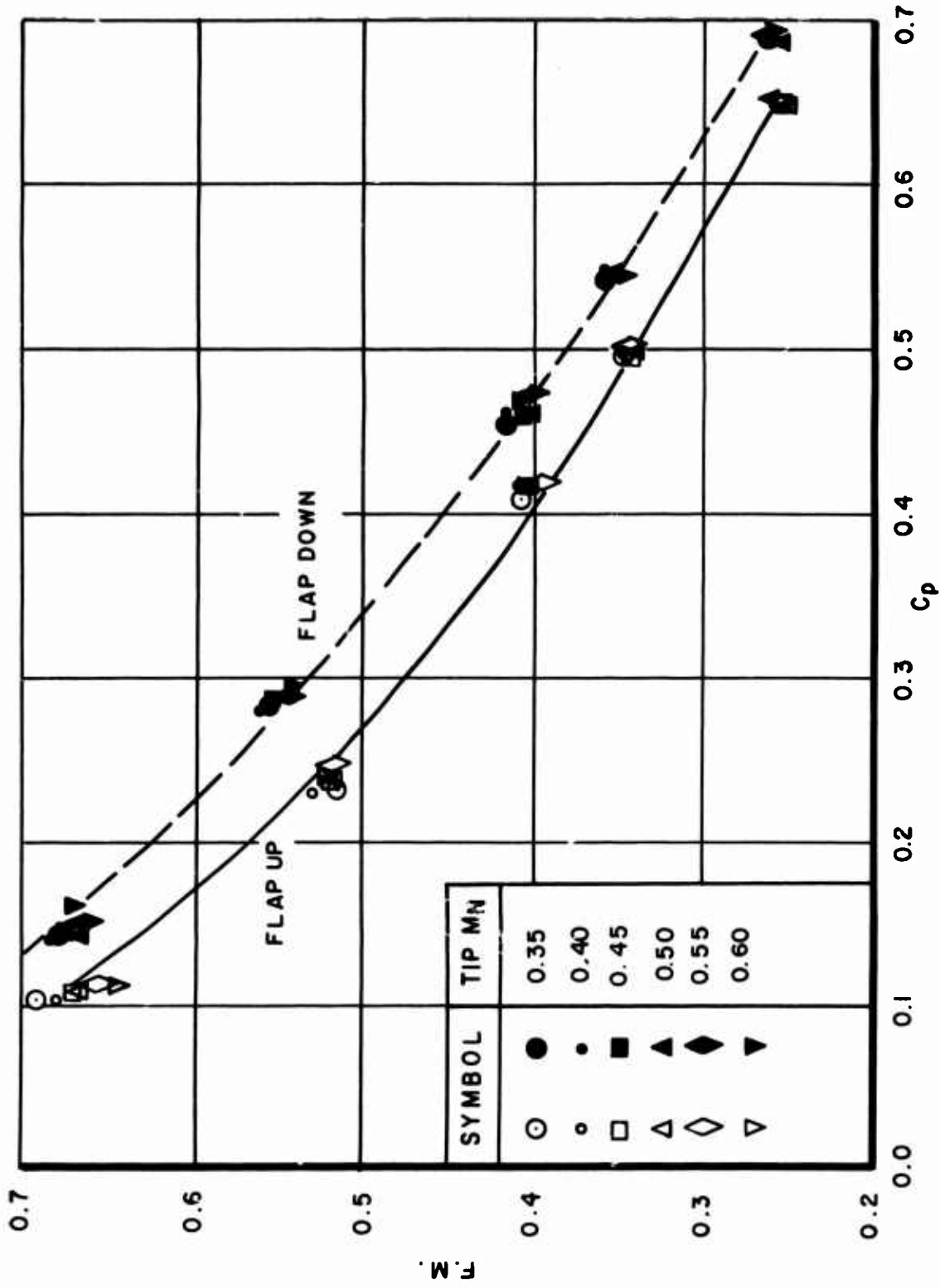

Figure 10. Figure of Merit vs Power Coefficient

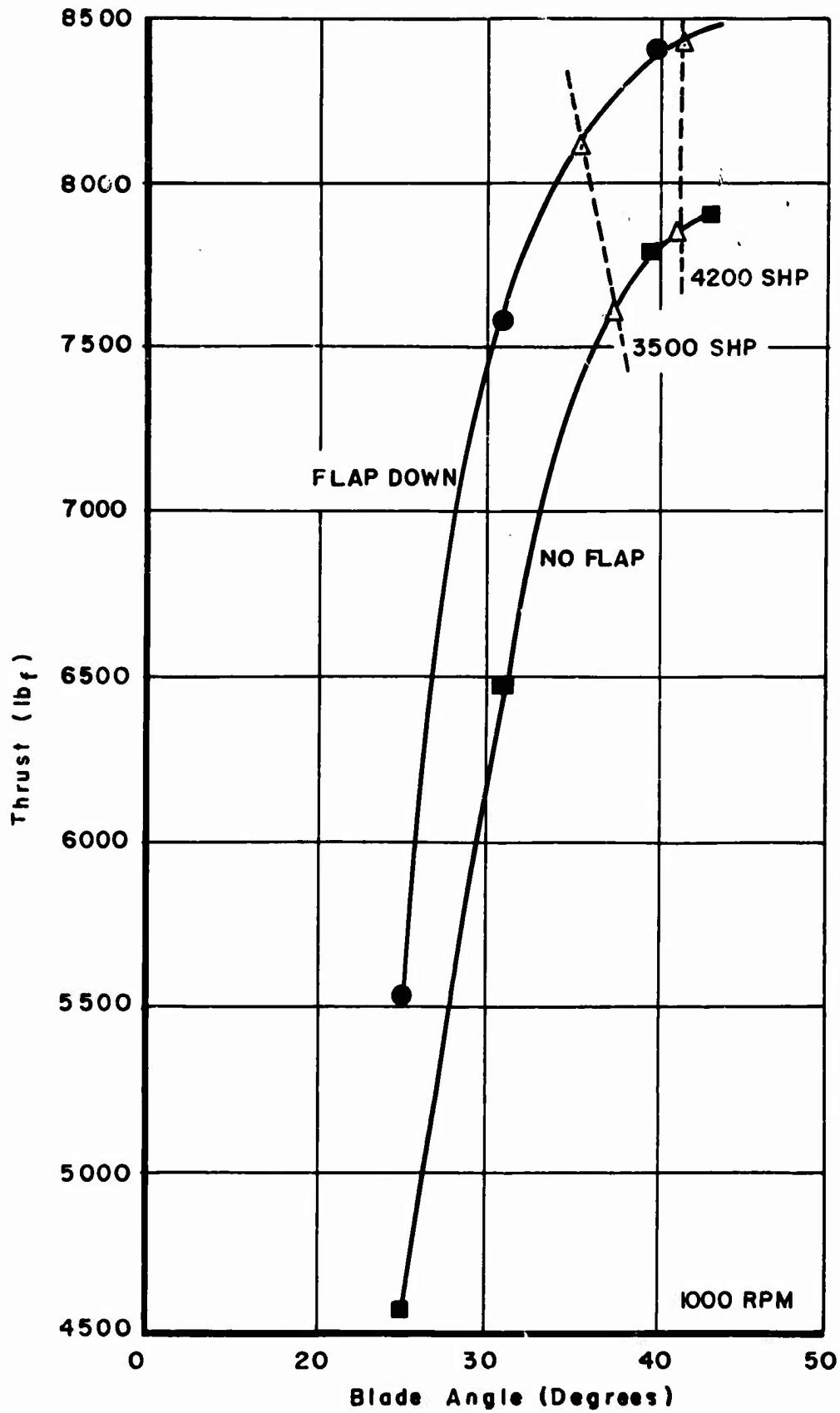

Figure 11. Pounds of Thrust vs Blade Angle at 1000 RPM

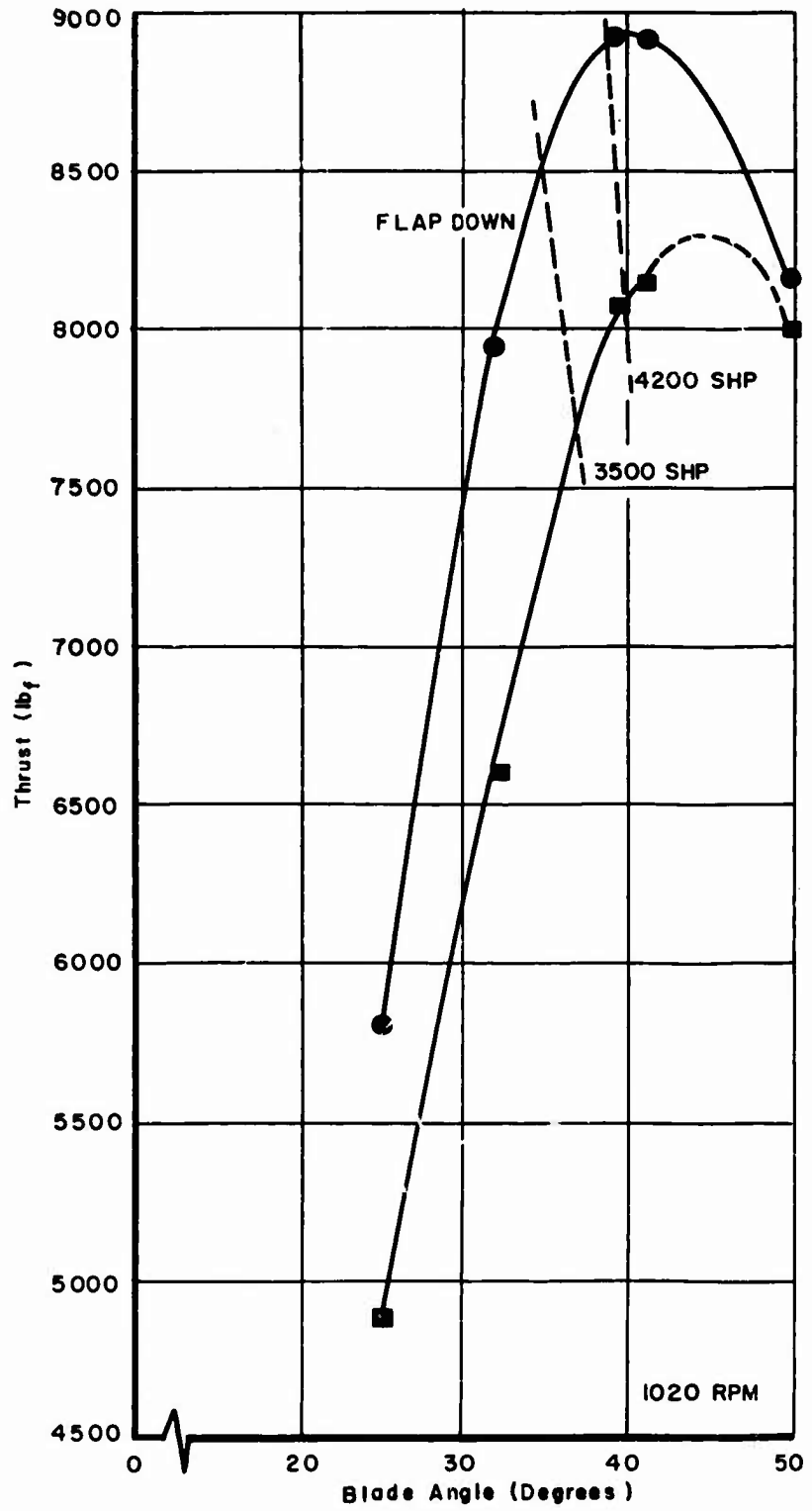

Figure 12. Pounds of Thrust vs Blade Angle at 1020 RPM

AFAPL-TR-70-80

GRAPHICAL FREQUENCY SPECTRA

Figures 13 through 28

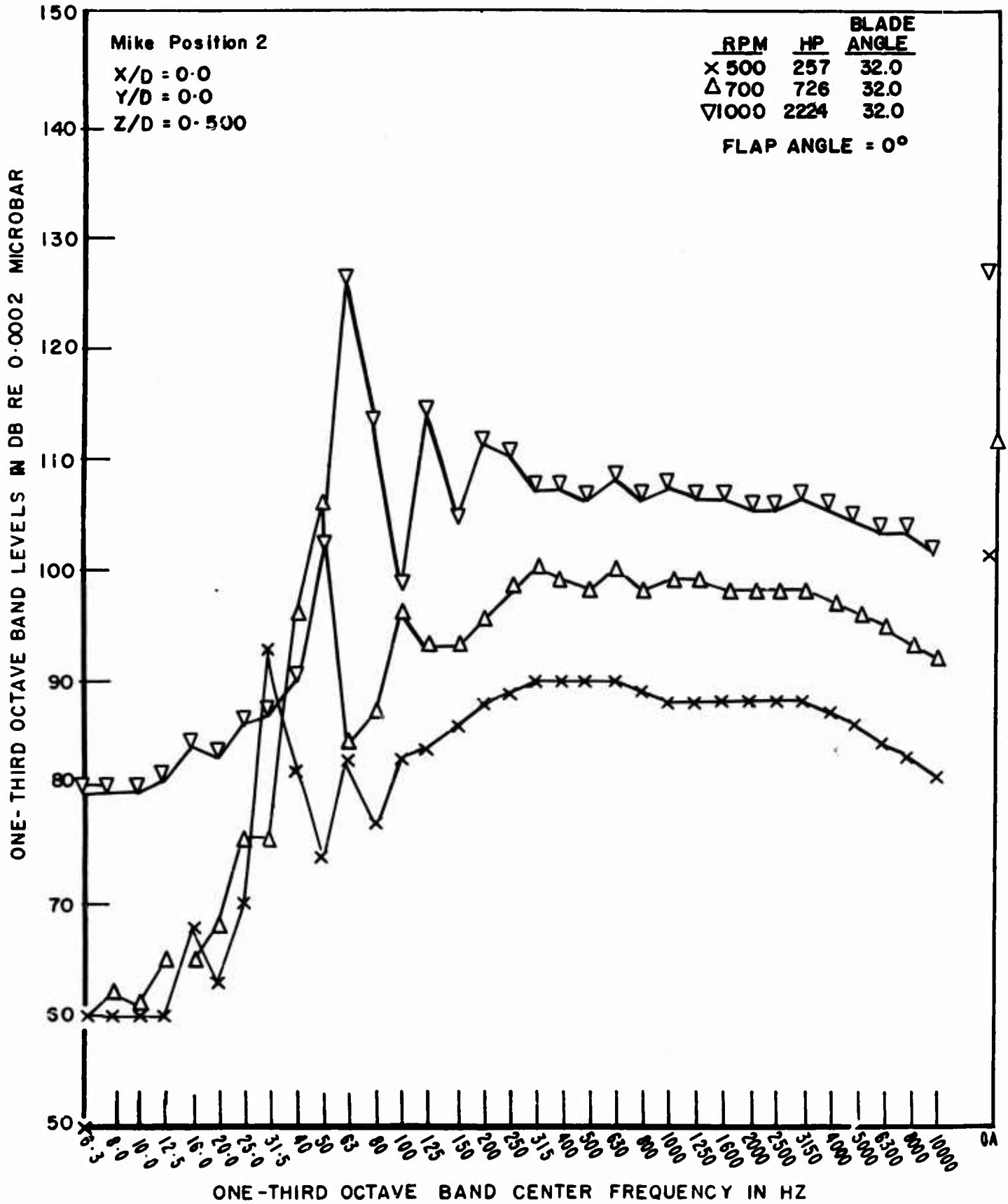

Figure 13

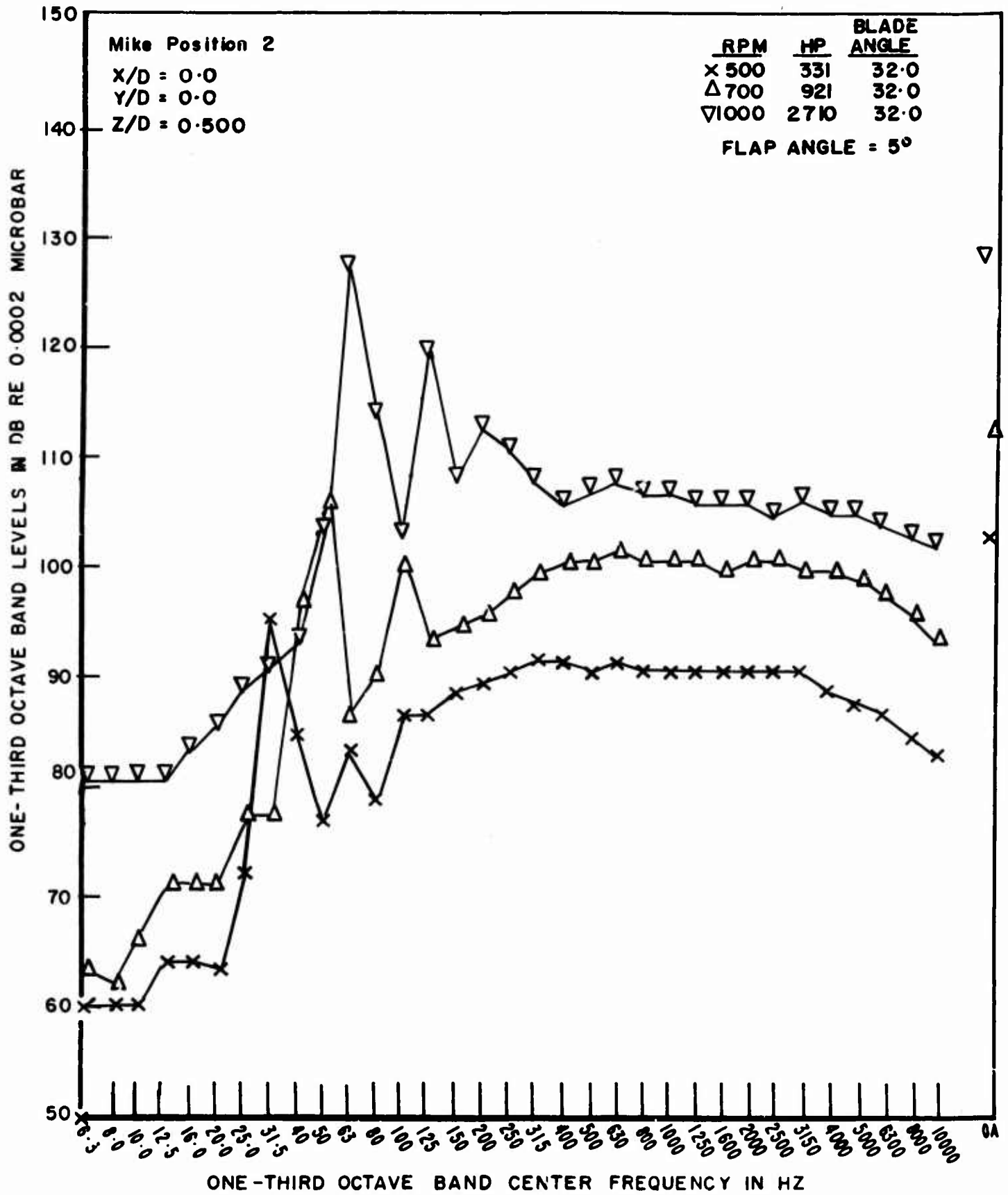

Figure 14

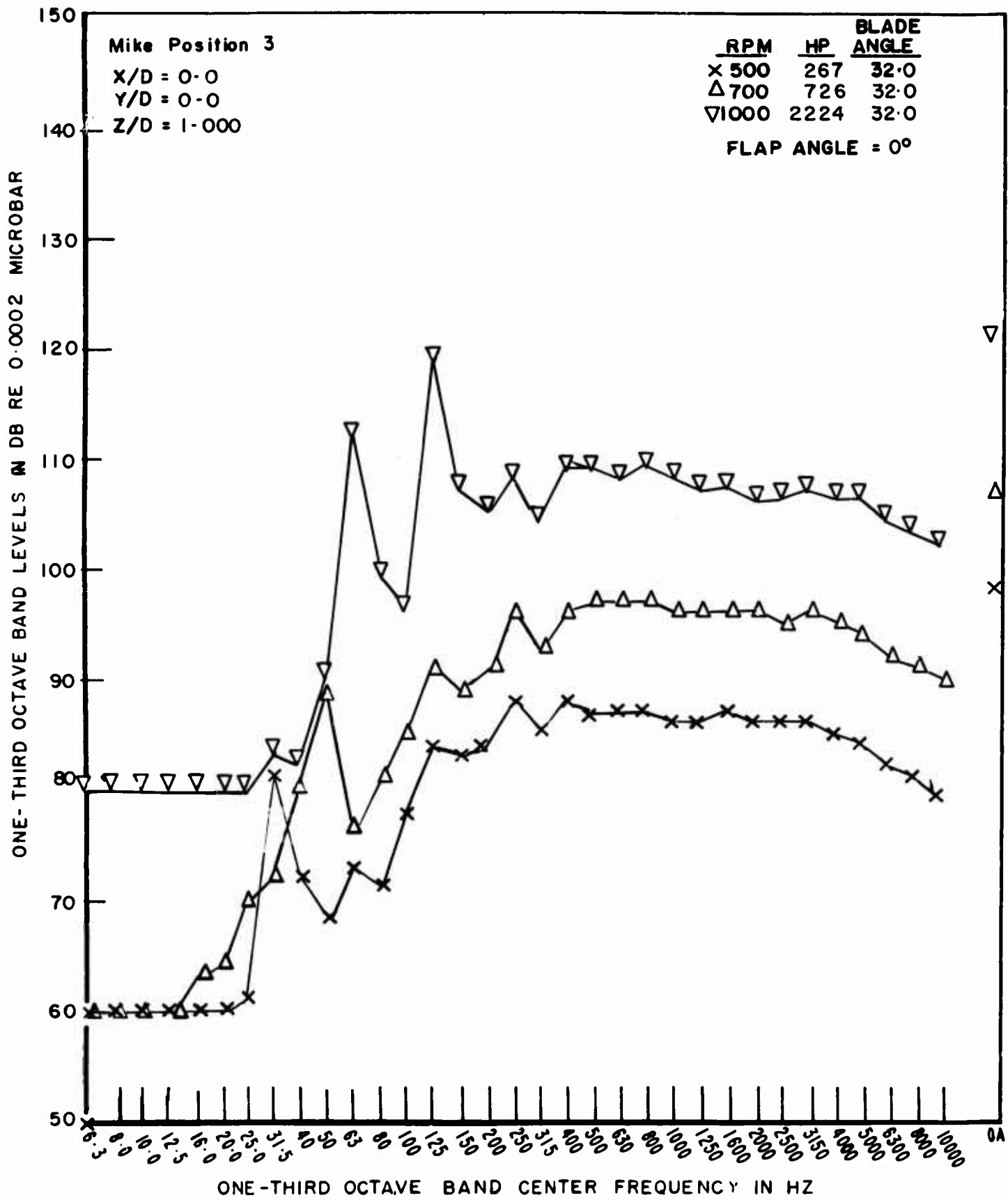

Figure 15

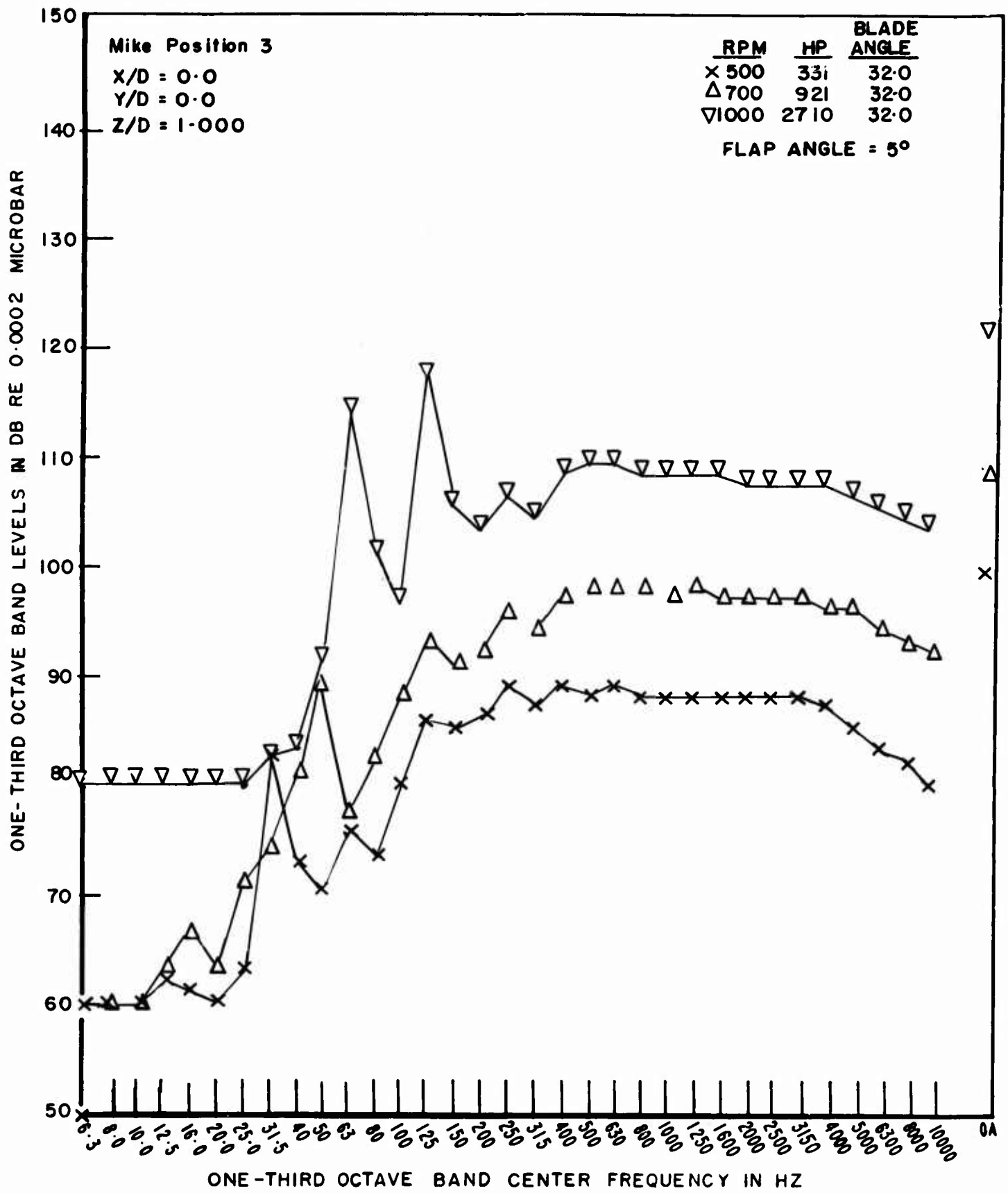

Figure 16



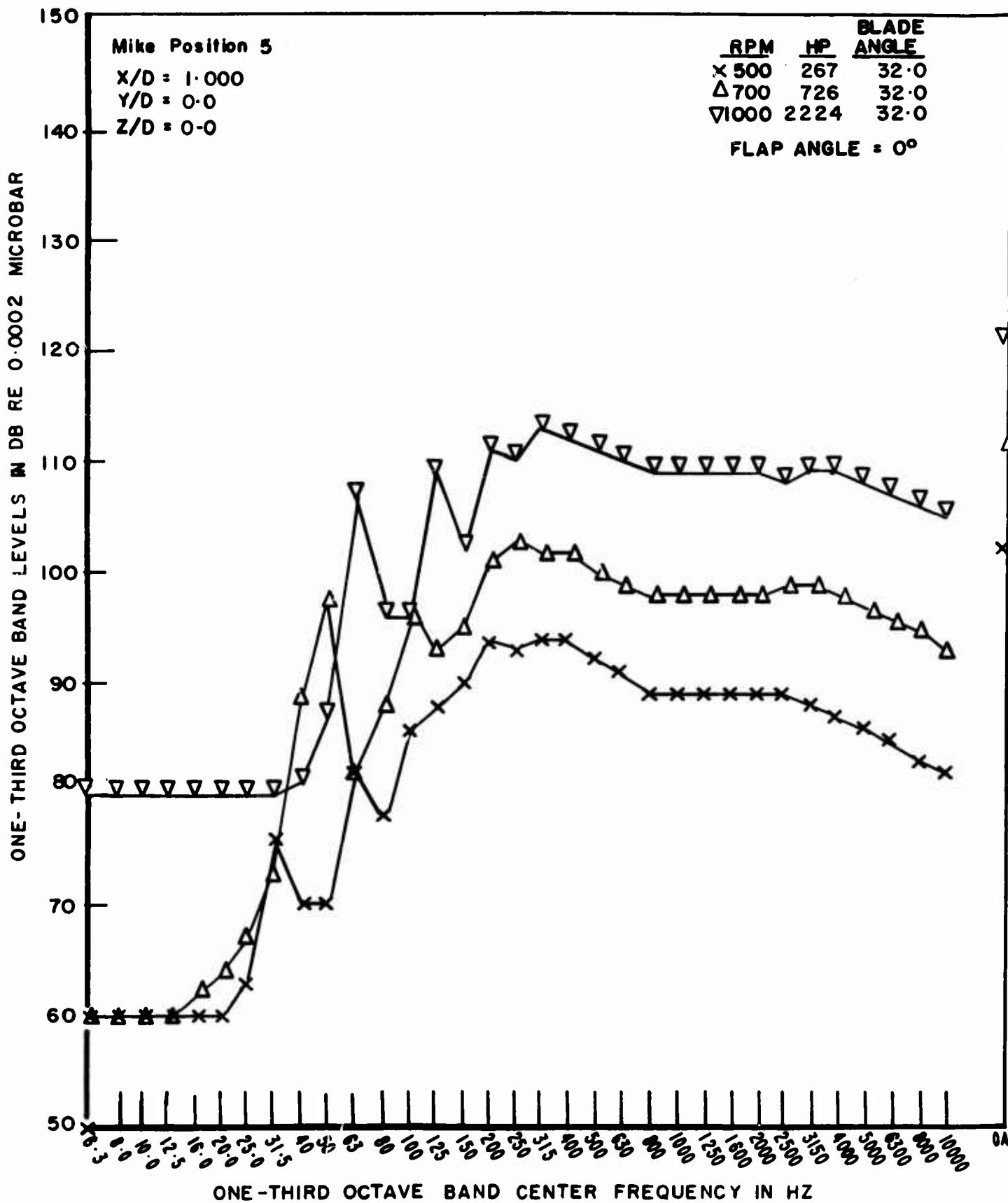

Figure 17

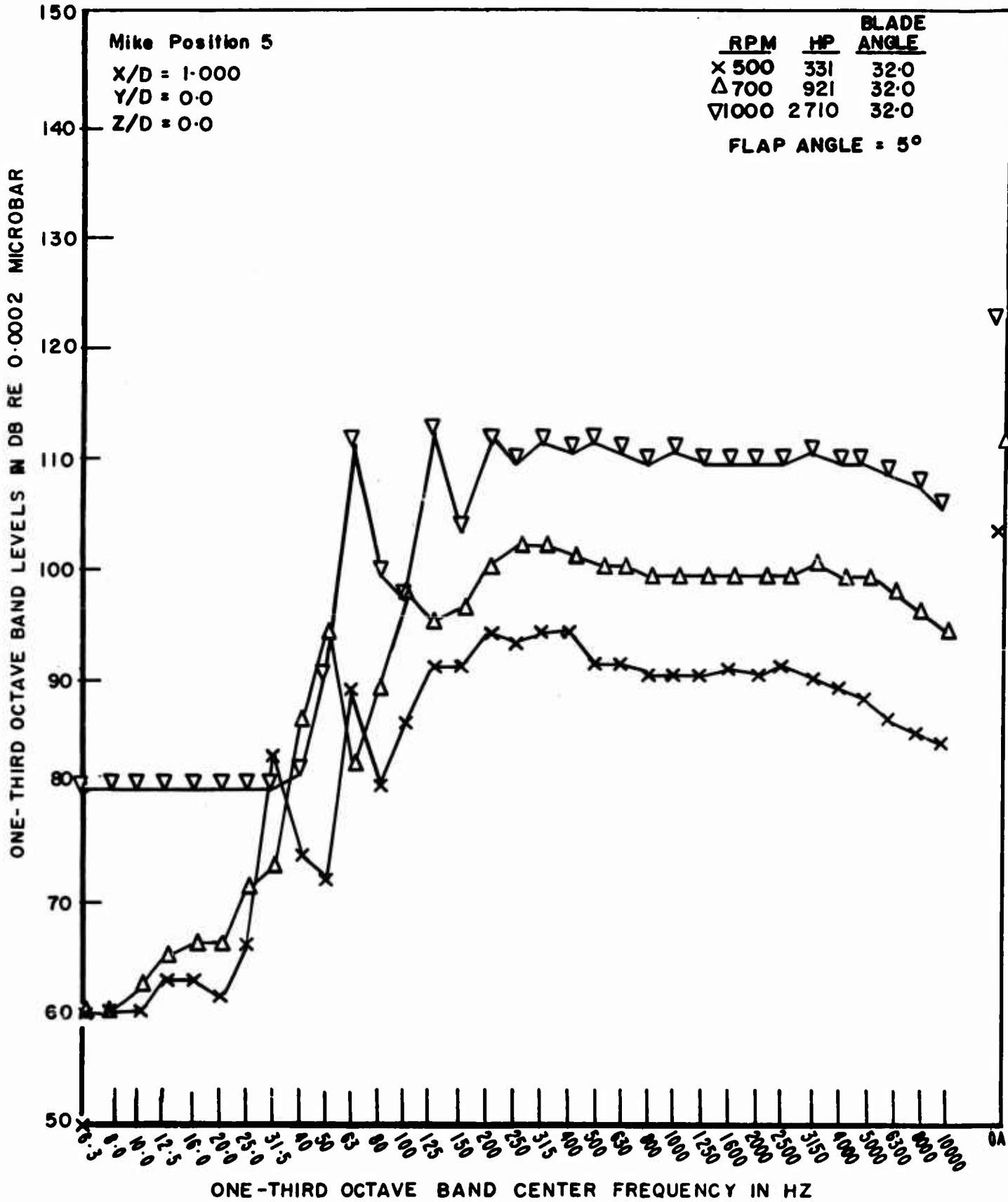

Figure 18

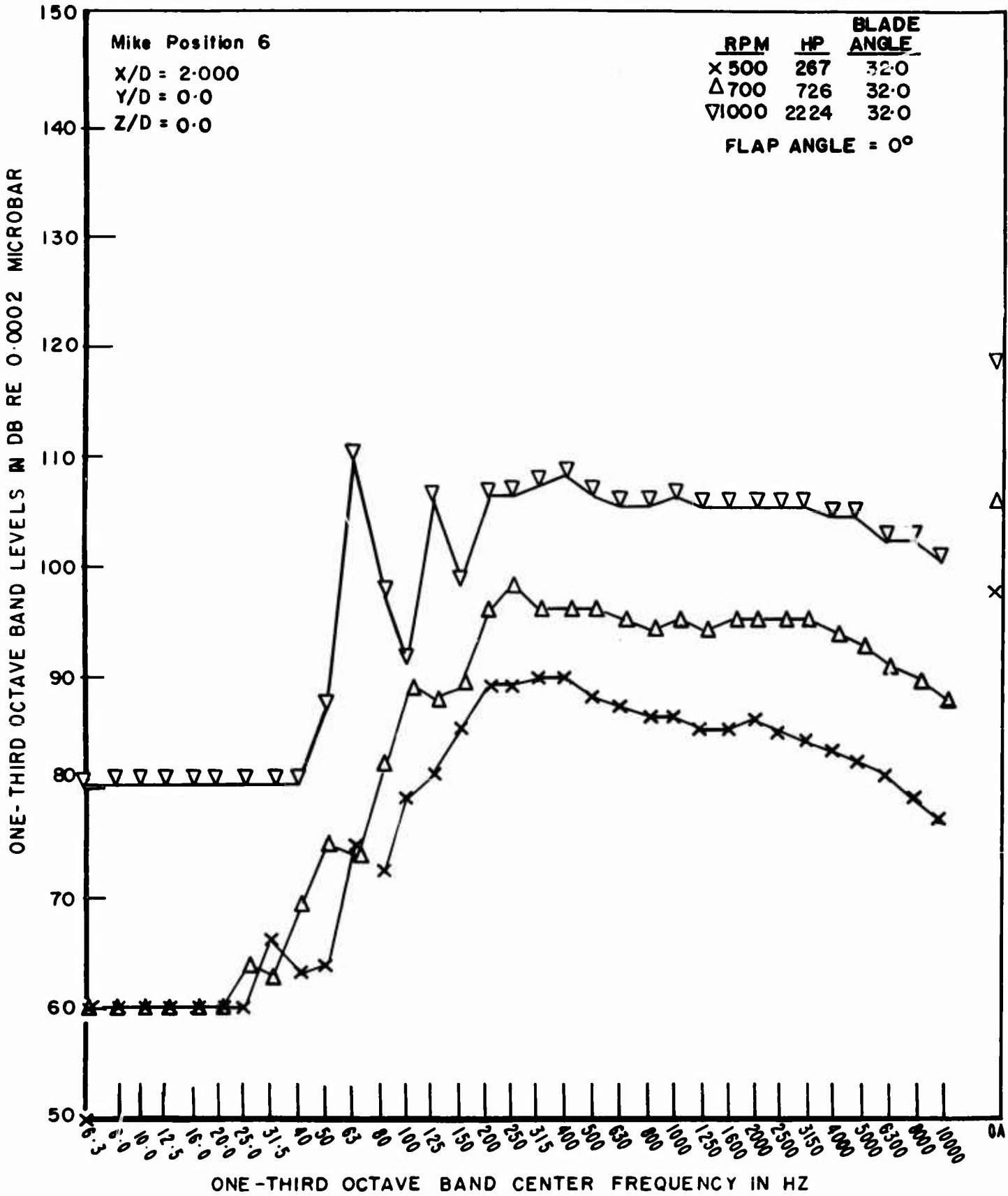

Figure 19

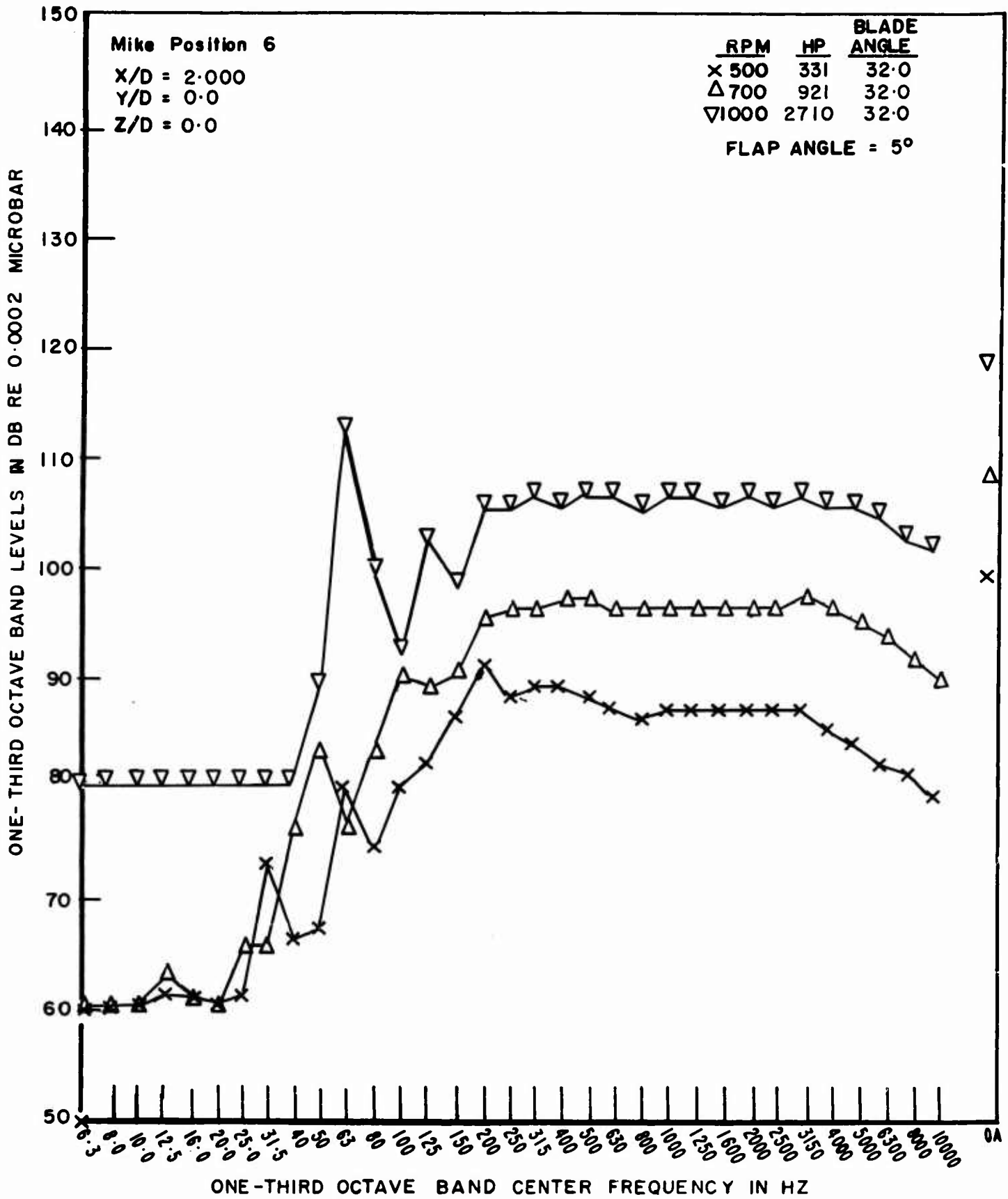

Figure 20

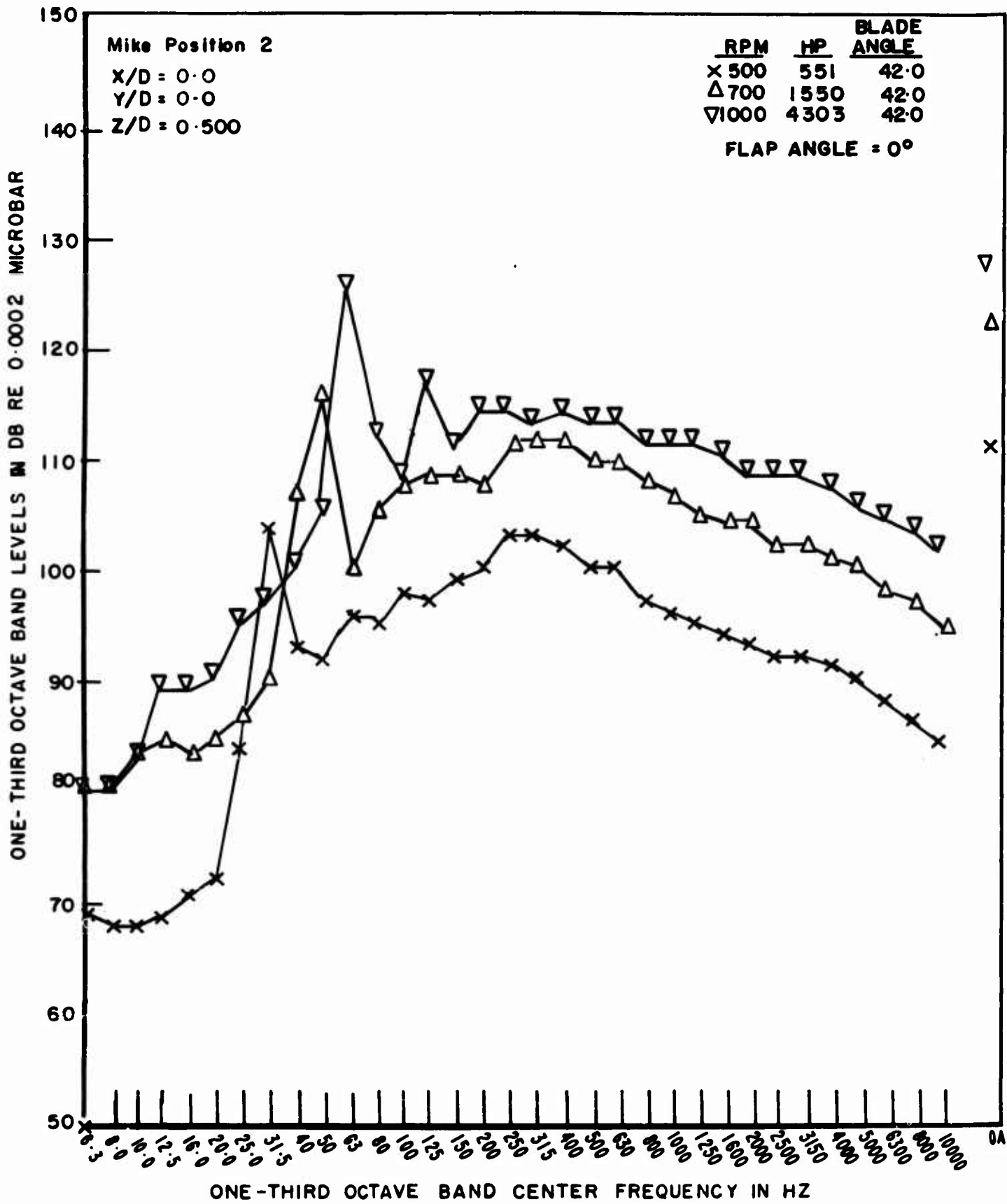

Figure 21

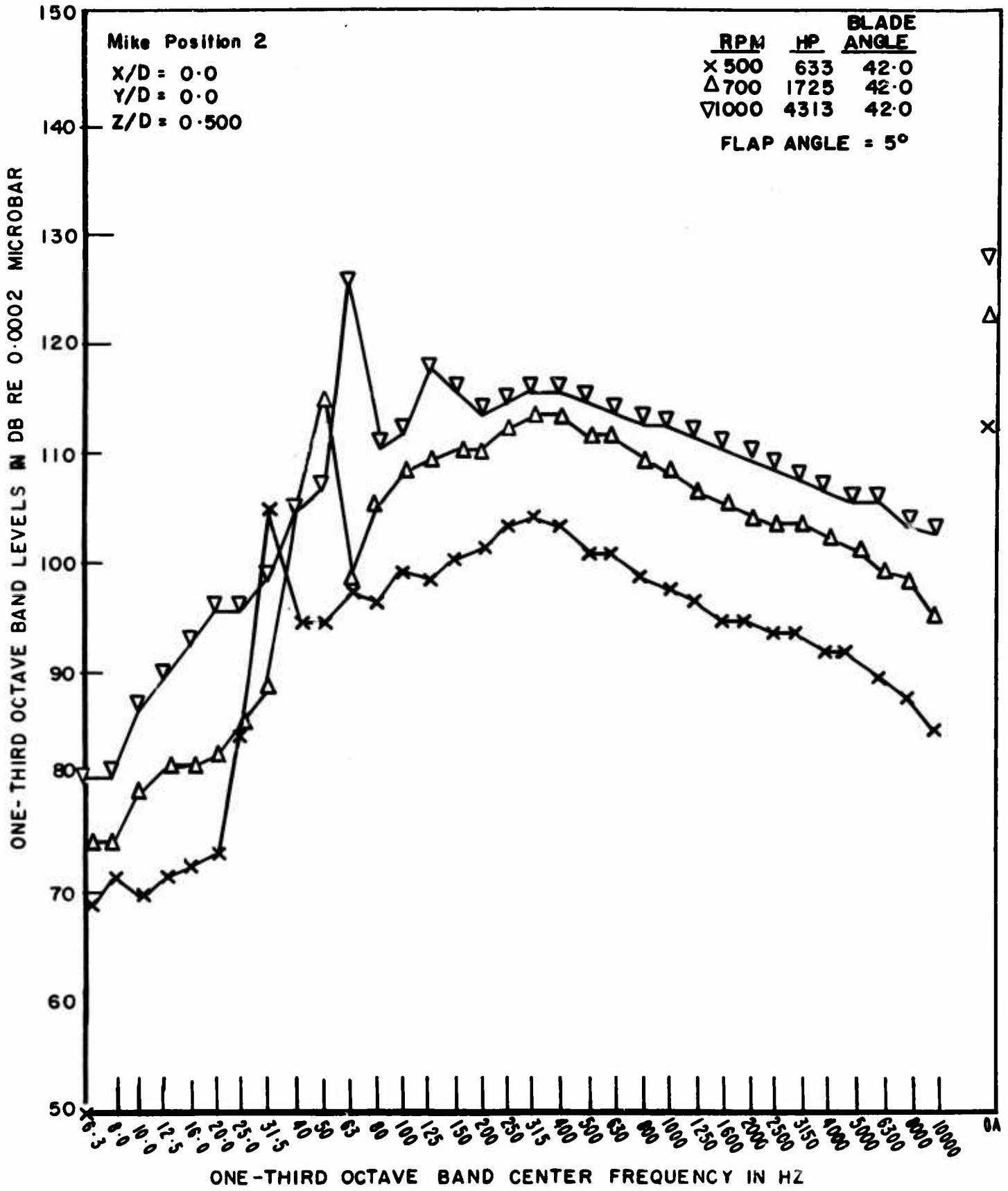

Figure 22

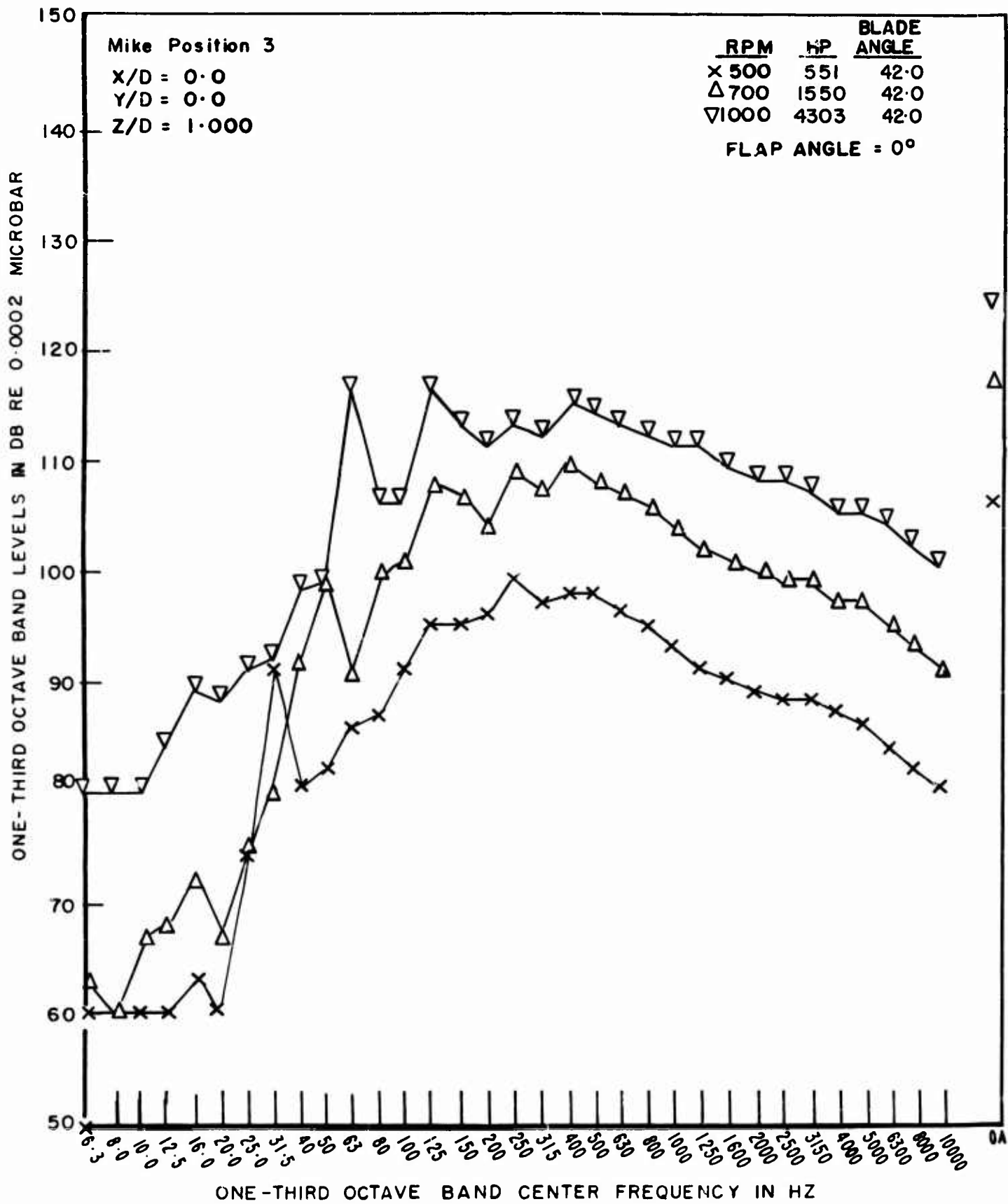

Figure 23

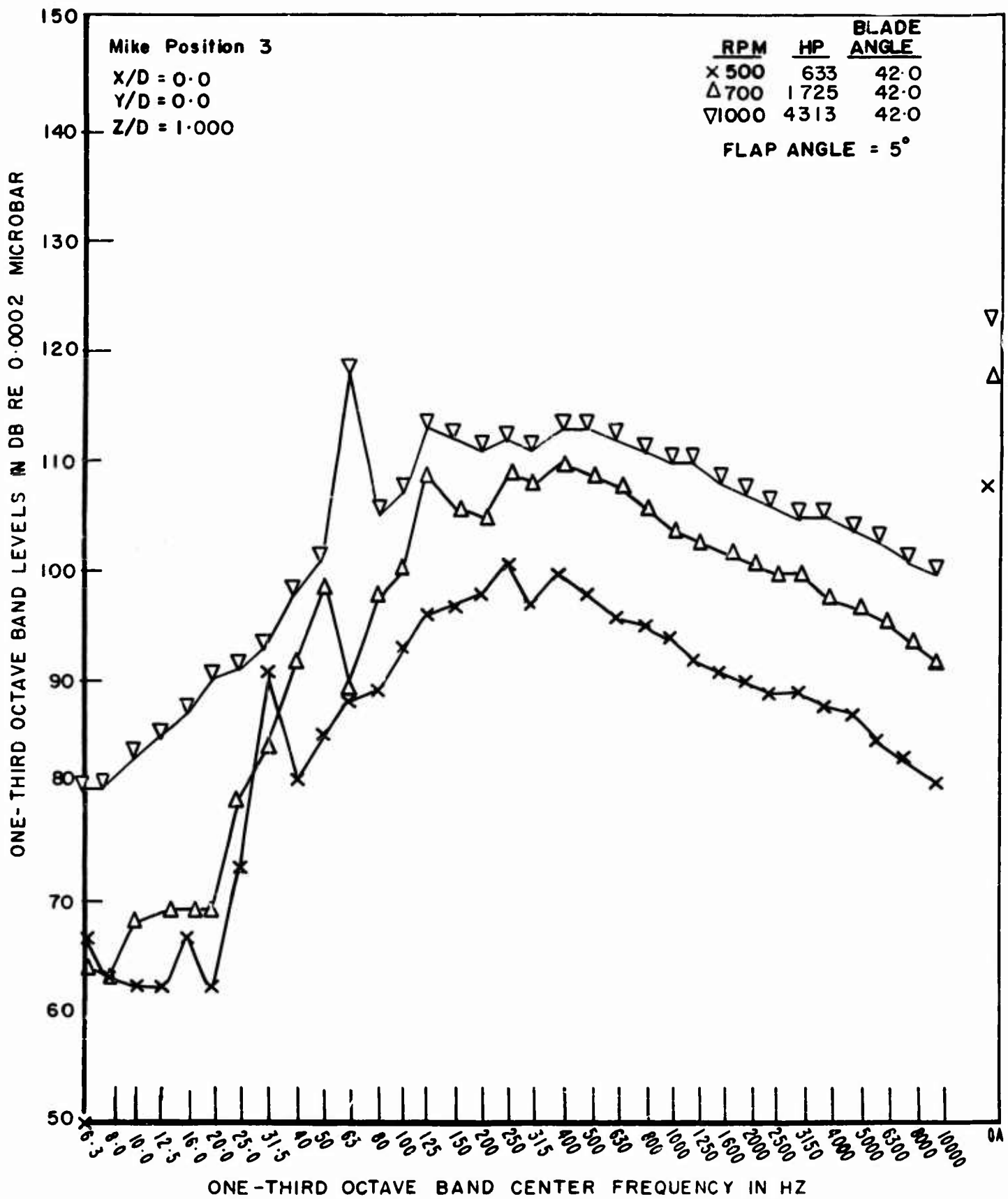

Figure 24



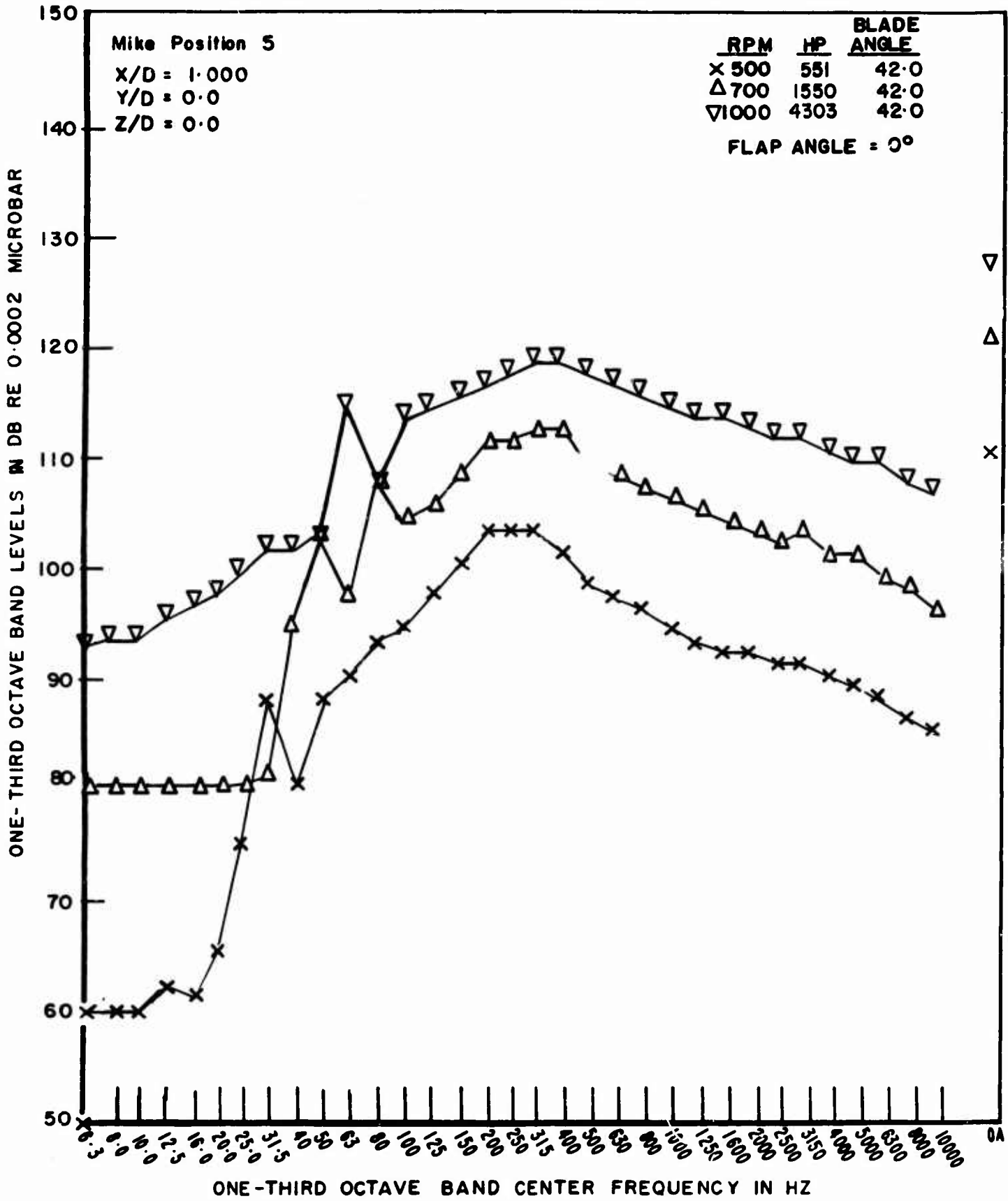

Figure 25

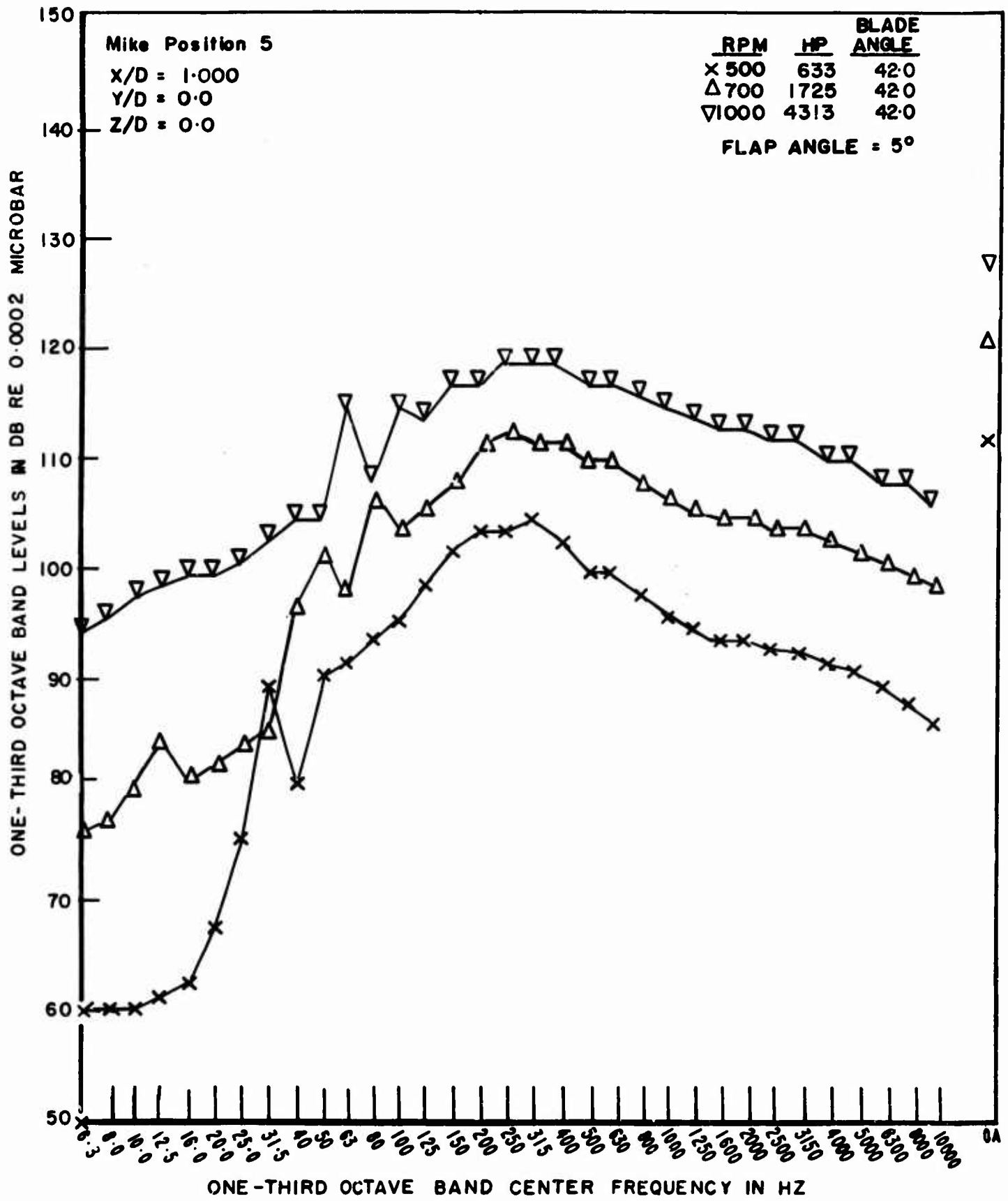

Figure 26

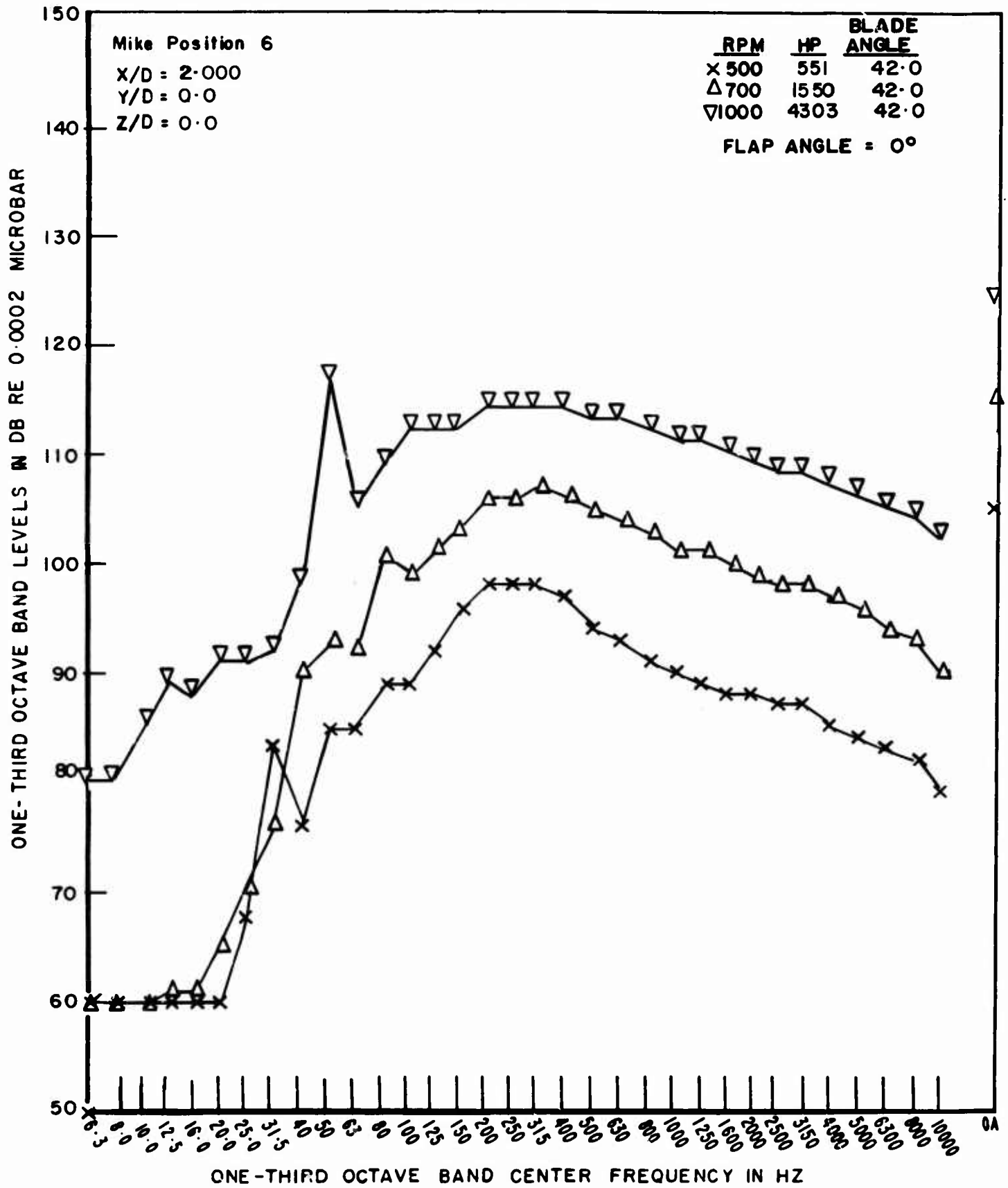

Figure 27

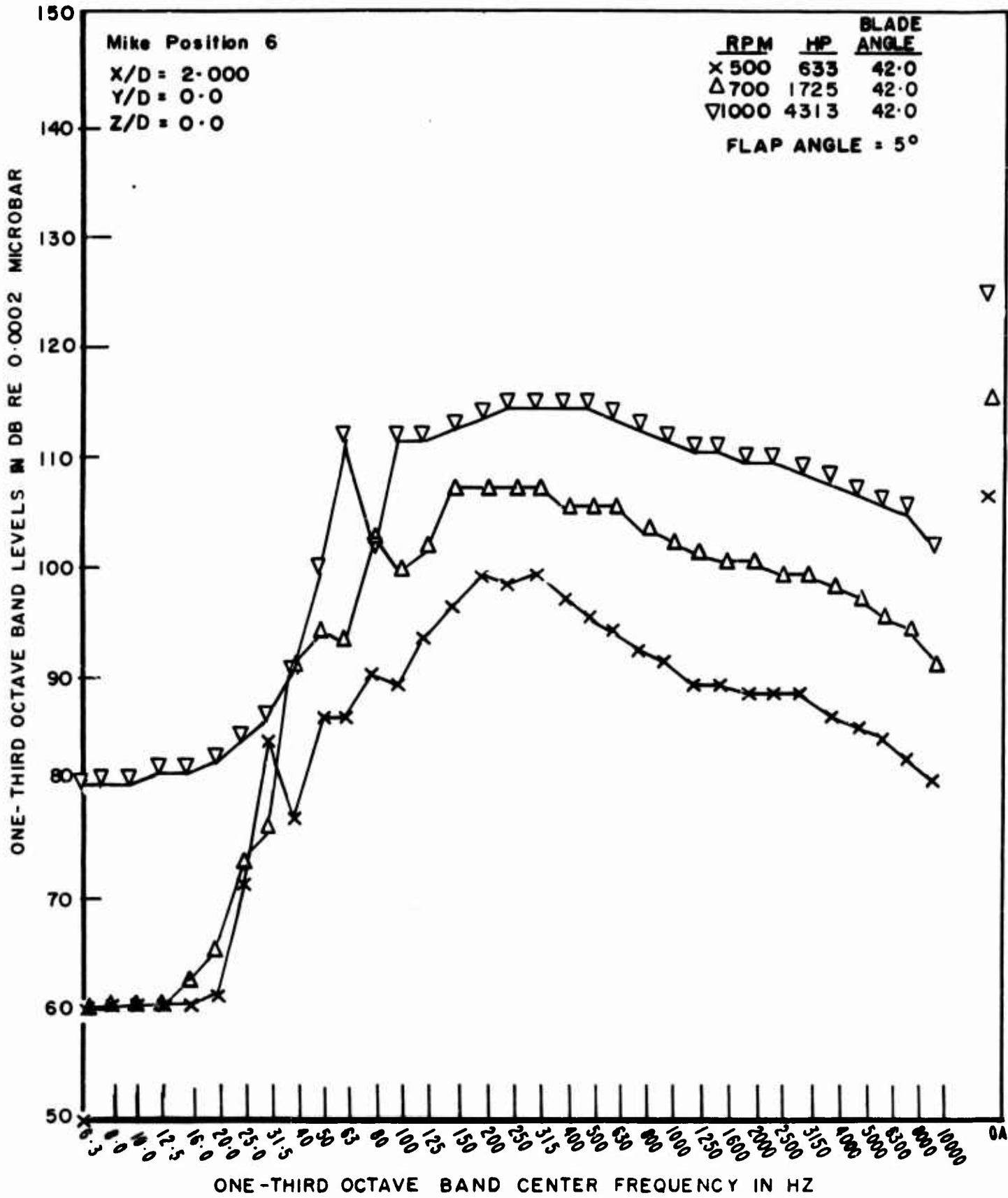

Figure 28

BLADE ANGLE = 32.2  
 FLAP ANGLE = 0.0

6  
 ○ Overall Sound Pressure Level, db\* | RPM

98	500
106	700
118	1000

5  
 ○ Overall Sound Pressure Level, db | RPM

102	500
112	700
121	1000

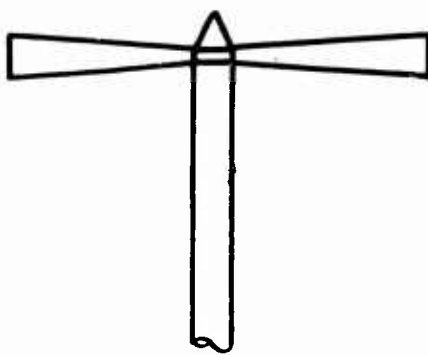

1      2      3  
 ○      ○      ○

Overall Sound Pressure Level, db			RPM
103	101	98	500
114	111	107	700
126	126	121	1000

4  
 ○ Overall Sound Pressure Level, db | RPM

99	500
106	700
120	1000

\*decibel reference 0.0002 microbar

Figure 29

BLADE ANGLE = 32.2

FLAP ANGLE = 5.0

6

Overall Sound Pressure Level, db*	RPM
99	500
108	700
118	1000

5

Overall Sound Pressure Level, db	RPM
103	500
112	700
122	1000

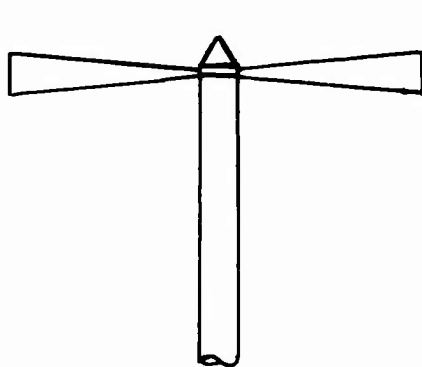

1	2	3	
Overall Sound Pressure Level, db	Overall Sound Pressure Level, db	Overall Sound Pressure Level, db	RPM
105	102	98	500
115	112	108	700
128	127	121	1000

4

Overall Sound Pressure Level, db	RPM
99	500
108	700
120	1000

\*decibel reference 0.0002 microbar

Figure 30

BLADE ANGLE = 39.2

FLAP ANGLE = 0.0

6

Overall Sound Pressure Level, db *	RPM
103	500
111	700
122	1000

5

Overall Sound Pressure Level, db	RPM
108	500
116	700
126	1000

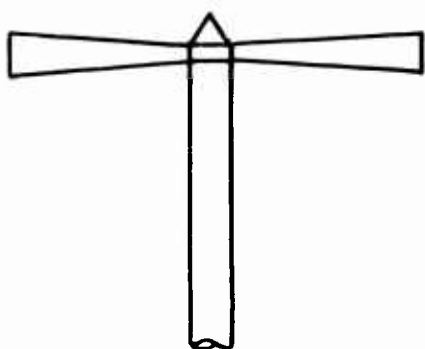

1	2	3	RPM
110	108	103	500
121	119	113	700
127	128	123	1000

4

Overall Sound Pressure Level, db	RPM
103	500
113	700
122	1000

\*decibel reference 0.0002 microbar

Figure 31

BLADE ANGLE = 39.2

FLAP ANGLE = 5.0

6

Overall Sound Pressure Level, db*	RPM
102	500
112	700
123	1000

5

Overall Sound Pressure Level, db	RPM
107	500
117	700
126	1000

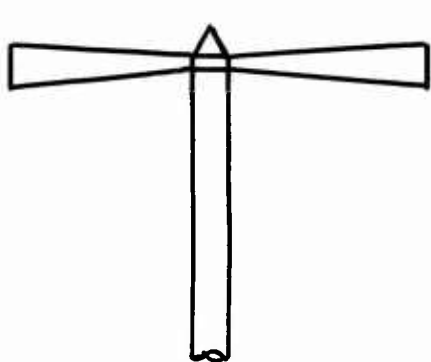

Overall Sound Pressure Level, db			RPM
110	109	104	500
122	120	114	700
127	127	124	1000

Overall Sound Pressure Level, db	RPM
104	500
114	700
123	1000

\*decibel reference 0.0002 microbar

Figure 32



BLADE ANGLE = 42.8  
 FLAP ANGLE = 0.0

6

Overall Sound Pressure Level, db*	RPM
105	500
115	700
124	1000

5

Overall Sound Pressure Level, db	RPM
110	500
120	700
127	1000

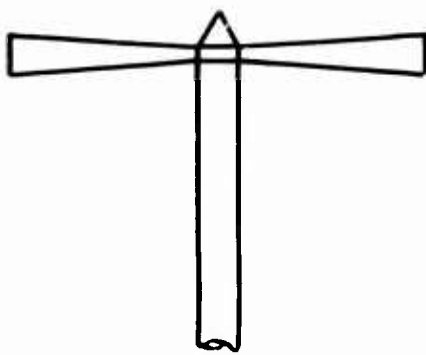

Overall Sound Pressure Level, db			RPM
113	111	106	500
123	122	117	700
127	127	124	1000

Overall Sound Pressure Level, db	RPM
107	500
117	700
124	1000

\*decibel reference 0.0002 microbar

Figure 33

BLADE ANGLE = 42.8

FLAP ANGLE = 5.0

6

Overall Sound Pressure Level, db*	RPM
106	500
115	700
124	1000

5

Overall Sound Pressure Level, db	RPM
111	500
120	700
127	1000

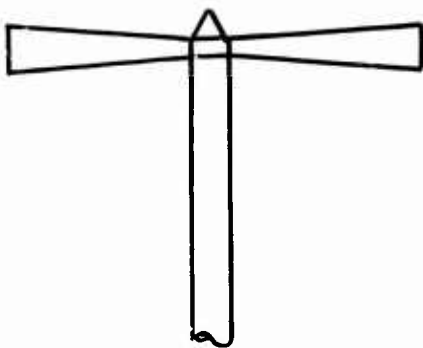

Overall Sound Pressure Level, db			RPM
113	112	108	500
121	122	118	700
127	127	123	1000

\*decibel reference 0.0002 microbar

4

Overall Sound Pressure Level, db	RPM
108	500
118	700
124	1000

Figure 34

BLADE ANGLE = 42.8

FLAP ANGLE = 5.0

6

Overall Sound Pressure Level, db*	RPM
106	500
115	700
124	1000

5

Overall Sound Pressure Level, db	RPM
111	500
120	700
127	1000

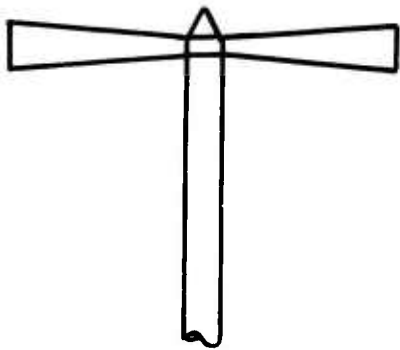

Overall Sound Pressure Level, db			RPM
113	112	108	500
121	122	118	700
127	127	123	1000

\*decibel reference 0.0002 microbar

4

Overall Sound Pressure Level, db	RPM
108	500
118	700
124	1000

Figure 34

AFAPL-TR-70-80

APPENDIX

RAW TEST DATA

COMPUTER PRINTOUT

Line 3

- BETA - Test blade angle (reference only)
- AF - Blade activity factor (reference only)
- DIA - Propeller diameter in feet
- NBL - Number of blades in hub (reference only)
- TEMPC - Ambient temperature in degrees Centigrade
- TEMPR - Ambient temperature in degrees Rankine
- SIGMA - Density ratio (reference only)

RAW DATA POINTS \* \* \* \* \*

- RPM - Propeller rpm
- HP - Corrected horsepower
- TH - Corrected thrust
- TMACH - Propeller tip Mach number
- RCT - Raw thrust coefficient
- RCP - Raw power coefficient
- RCT/CP - Ratio of raw thrust to raw power coefficient
- RFM - Raw figure of merit
- RTH/HP - Ratio of raw corrected thrust to corrected horsepower

AFAPL-TR-70-80

FITTED CURVE DATA FOR CONSTANT MACH  
NUMBER INCREMENTS \* \* \* \* \*

- MACH - Selected Mach number increment
- HP - Horsepower at Mach increment
- TH - Thrust at Mach increment
- TIPS - Propeller tip speed in ft/sec corresponding to Mach increment
- RPM - Propeller rpm at Mach increment
- CT - Thrust coefficient at Mach increment
- CP - Power coefficient at Mach increment
- CT/CP - Ratio of thrust coefficient to power coefficient at Mach increment
- FM - Figure of merit at Mach increment
- TH/HP - Ratio of thrust to horsepower at Mach increment

1. WHIRL RIG PERFORMANCE DATA

STATIC PRCP PERFORMANCE

RUN 1 ALLISON VARIABLE CAMBER 0 DEG FLAP

BETA=25.0 AF=177.0 DIA=13.500 NBL=4 TEMPC= 25.0 TEMPR= 536.69 SIGMA=0.9458

\*\*\*\* RAW DATA PCINTS \*\*\*\*

RPM	H-P	TH	TMACH	RCT	RCP	RCT/CP	RFM	RTH/HP
500.	125.	1102.	0.311	0.2015	0.1115	1.8067	0.6471	8.8160
600.	210.	1570.	0.373	0.1992	0.1084	1.8385	0.6550	7.4752
708.	322.	2227.	0.441	0.2030	0.1043	1.9465	0.6999	6.7078
800.	509.	2842.	0.498	0.2029	0.1109	1.8308	0.6582	5.5835
900.	745.	3648.	0.560	0.2058	0.1140	1.8062	0.6539	4.8966
1000.	1040.	4581.	0.622	0.2094	0.1160	1.6054	0.6592	4.4048
1020.	1101.	4783.	0.635	0.2101	0.1157	1.8161	0.6643	4.3442
1050.	1220.	5149.	0.653	0.2124	0.1175	1.8162	0.6696	4.2205

\*\*\*\* FITTED CURVE DATA FOR CONSTANT MACH NUMBER INCREMENTS \*\*\*\* (HP, 6 PCINT 2ND ORDER.

MACH	HP	TH	TIPS	RPM	CT	CP	CT/CP	FM	TH/HP
0.325	140.	1199.	369.	522.	0.2008	0.1097	1.831	0.655	8.554
0.350	167.	1385.	398.	562.	0.2000	0.1046	1.913	0.683	8.297
0.375	203.	1589.	426.	603.	0.1999	0.1032	1.937	0.691	7.841
0.400	247.	1811.	454.	643.	0.2002	0.1038	1.929	0.689	7.321
0.425	301.	2051.	493.	693.	0.2009	0.1053	1.907	0.682	6.813
0.450	364.	2309.	511.	723.	0.2017	0.1072	1.882	0.674	6.348
0.475	425.	2585.	540.	753.	0.2027	0.1091	1.858	0.667	5.939
0.500	513.	2877.	568.	804.	0.2036	0.1103	1.846	0.665	5.605
0.525	602.	3189.	596.	844.	0.2047	0.1118	1.831	0.661	5.295
0.550	701.	3520.	625.	884.	0.2059	0.1131	1.820	0.659	5.023
0.575	811.	3856.	652.	924.	0.2064	0.1146	1.800	0.653	4.752
0.600	920.	4236.	682.	964.	0.2082	0.1156	1.801	0.656	4.557
0.625	1057.	4640.	710.	1005.	0.2102	0.1163	1.807	0.661	4.390
0.650	1154.	5069.	738.	1045.	0.2122	0.1167	1.818	0.668	4.246

STATIC PRCP PERFORMANCE

RUN 2 ALLISON VARIABLE CAMPER 5 DEG. FLAP

BETA=25.0 AF=177.0 DIA=13.500 NPL=4 TEMPC= 24.0 TEMPR= 534.89 SIGMA=0.9477

\*\*\*\* RAW DATA PCINTS \*\*\*\*

RPM	FP	TH	TMACH	RCT	RCP	RCT/CP	RFM	RTH/HP
500.	164.	1333.	0.312	0.2437	0.1463	1.6657	0.6562	8.1250
599.	286.	1926.	0.273	0.2453	0.1464	1.6533	0.6535	6.7343
700.	433.	2634.	0.416	0.2457	0.1473	1.6682	0.6558	5.8146
800.	679.	3518.	0.499	0.2512	0.1479	1.6988	0.6755	5.1811
900.	979.	4422.	0.581	0.2495	0.1497	1.6661	0.6641	4.5169
999.	1362.	5544.	0.623	0.2539	0.1523	1.6667	0.6701	4.0705
1019.	1444.	5798.	0.635	0.2552	0.1522	1.6770	0.6760	4.0152
1050.	1503.	6210.	0.654	0.2574	0.1544	1.6672	0.6750	3.8740

51

\*\*\*\* FITTED CURVE DATA FOR CONSTANT MACH NUMBER INCREMENTS \*\*\*\* (HP) 6 PCINT 2ND ORDER.

MACH	HP	TH	TIPS	RPM	CT	CP	CT/CP	FM	TH/HP
0.325	189.	1452.	369.	521.	0.2440	0.1482	1.646	0.645	7.702
0.350	228.	1686.	397.	562.	0.2443	0.1438	1.699	0.670	7.382
0.375	279.	1939.	425.	602.	0.2448	0.1427	1.715	0.677	6.956
0.400	340.	2213.	454.	642.	0.2456	0.1434	1.712	0.677	6.510
0.425	412.	2507.	482.	682.	0.2464	0.1448	1.702	0.674	6.089
0.450	494.	2821.	510.	722.	0.2473	0.1464	1.689	0.670	5.707
0.475	587.	3155.	539.	762.	0.2482	0.1480	1.677	0.667	5.370
0.500	685.	3504.	567.	802.	0.2488	0.1480	1.682	0.665	5.114
0.525	799.	3879.	595.	842.	0.2499	0.1491	1.675	0.668	4.853
0.550	926.	4276.	624.	882.	0.2509	0.1502	1.671	0.668	4.620
0.575	1060.	4689.	652.	923.	0.2518	0.1504	1.674	0.670	4.426
0.600	1213.	5136.	681.	963.	0.2532	0.1516	1.670	0.671	4.233
0.625	1381.	5606.	709.	1003.	0.2548	0.1527	1.669	0.672	4.060
0.650	1562.	6100.	737.	1043.	0.2563	0.1535	1.670	0.675	3.906



STATIC PRCP PERFORMANCE

RUN 3 ALLISON VARIABLE CAMFER 0 DEG FLAP

BETA=32.2 AF=177.0 DIA=13.500 NBL=4 TEMPC= 24.0 TEMPR= 534.89 SIGMA=0.9486

\*\*\*\* RAW DATA POINTS \*\*\*\*

RPM	FP	TH	TMACH	RCT	RCP	RCT/CP	RFM	RTH/HP
500.	266.	1570.	0.312	0.2870	0.2373	1.2095	0.5171	5.9023
600.	452.	2245.	0.274	0.2851	0.2333	1.2220	0.5207	4.9690
700.	734.	3086.	0.436	0.2878	0.2386	1.2062	0.5164	4.2044
800.	1056.	4080.	0.499	0.2914	0.2387	1.2206	0.5258	3.7226
899.	1575.	5158.	0.560	0.2917	0.2417	1.2067	0.5201	3.2749
1000.	2204.	6469.	0.623	0.2956	0.2458	1.2030	0.5220	2.9351
1020.	2351.	6744.	0.616	0.2962	0.2470	1.1992	0.5209	2.8686
1050.	2588.	7166.	0.654	0.2971	0.2493	1.1916	0.5183	2.7689

55

\*\*\*\* FITTED CURVE DATA FOR CONSTANT MACH NUMBER INCREMENTS \*\*\*\* (HP) 6 PCINT 2ND ORDER.

MACH	HP	TH	TIPS	RPM	CT	CP	CT/CP	FM	TH/HP
0.325	301.	1703.	359.	521.	0.2861	0.2371	1.207	0.515	5.648
0.350	366.	1972.	397.	562.	0.2858	0.2304	1.241	0.529	5.390
0.375	448.	2255.	425.	502.	0.2860	0.2291	1.248	0.533	5.062
0.400	547.	2583.	454.	642.	0.2866	0.2305	1.243	0.531	4.726
0.425	653.	2923.	482.	682.	0.2873	0.2330	1.233	0.527	4.411
0.450	795.	3288.	510.	722.	0.2882	0.2358	1.222	0.524	4.130
0.475	947.	3676.	539.	762.	0.2892	0.2384	1.213	0.521	3.883
0.500	1107.	4088.	567.	802.	0.2903	0.2390	1.215	0.522	3.694
0.525	1292.	4524.	595.	842.	0.2914	0.2411	1.209	0.521	3.501
0.550	1497.	4984.	624.	882.	0.2925	0.2429	1.204	0.520	3.329
0.575	1711.	5463.	652.	923.	0.2933	0.2430	1.207	0.522	3.192
0.600	1960.	5972.	681.	963.	0.2945	0.2450	1.202	0.520	3.046
0.625	2222.	6506.	709.	1003.	0.2956	0.2468	1.198	0.520	2.915
0.650	2526.	7065.	737.	1043.	0.2968	0.2482	1.196	0.520	2.797

STATIC PRCP PERFORMANCE

RUN 4 ALLISON VARIABLE CAMBER 5 DEG FLAP

BETA=32.2 AF=177.0 DIA=13.500 NBL=4 TEMPC= 25.0 TEMPR= 536.69 SIGMA=0.9448

\*\*\*\*\* RAW DATA POINTS \*\*\*\*\*

RPM	FP	TH	TMACH	RCT	RCP	RCT/CP	RFM	RTH/HP
500.	520.	1830.	0.311	0.3345	0.2855	1.1719	0.5409	5.7188
602.	568.	2691.	0.375	0.3394	0.2903	1.1690	0.5434	4.7377
700.	629.	3661.	0.436	0.3415	0.2890	1.1815	0.5509	4.1181
800.	1329.	4754.	0.498	0.3395	0.2894	1.1729	0.5453	3.5771
900.	1693.	6011.	0.560	0.3392	0.2880	1.1775	0.5472	3.1922
1000.	2650.	7581.	0.622	0.3465	0.2955	1.1725	0.5507	2.8608
1020.	2759.	7776.	0.635	0.3416	0.2899	1.1783	0.5495	2.8184
1050.	3048.	9307.	0.653	0.3444	0.2936	1.1729	0.5492	2.7254

\*\*\*\*\* FITTED CURVE DATA FOR CONSTANT MACH NUMBER INCREMENTS \*\*\*\*\* (HP & PCINT 2ND ORDER.)

MACH	HP	TH	TIPS	RPM	CT	CP	CT/CP	FM	TH/HP
0.325	371.	2016.	369.	522.	0.3377	0.2903	1.163	0.539	5.434
0.350	450.	2534.	398.	563.	0.3370	0.2820	1.195	0.554	5.184
0.375	550.	2978.	426.	603.	0.3369	0.2799	1.204	0.558	4.872
0.400	669.	3090.	454.	643.	0.3372	0.2809	1.200	0.556	4.555
0.425	810.	3449.	483.	682.	0.3378	0.2853	1.192	0.553	4.259
0.450	970.	3875.	511.	723.	0.3385	0.2860	1.184	0.550	3.993
0.475	1151.	4328.	540.	763.	0.3393	0.2895	1.176	0.547	3.759
0.500	1343.	4799.	569.	804.	0.3397	0.2886	1.177	0.547	3.574
0.525	1562.	5300.	596.	844.	0.3402	0.2899	1.174	0.546	3.394
0.550	1802.	5829.	625.	884.	0.3409	0.2909	1.172	0.546	3.234
0.575	2058.	6373.	653.	924.	0.3410	0.2907	1.173	0.547	3.097
0.600	2345.	6960.	682.	964.	0.3420	0.2918	1.172	0.547	2.966
0.625	2659.	7578.	710.	1005.	0.3432	0.2925	1.173	0.549	2.850
0.650	2996.	8226.	738.	1045.	0.3445	0.2930	1.176	0.551	2.746

STATIC PRCP PERFORMANCE

RUN 5 ALLISON VARIABLE CAMPER 0 DEG FLAP

BETA=59.2 AF=177.0 DIA=13.500 NBL=4 TEMPC= 26.0 TEMPR= 538.49 SIGMA=0.9417

\*\*\*\* RAW DATA POINTS \*\*\*\*

RPM	HP	TH	TMACH	RCT	RCP	RCT/CP	RFM	RTH/HP
500.	469.	1922.	0.311	0.3514	0.4184	0.8398	0.3973	4.0981
600.	811.	2796.	0.373	0.3550	0.4187	0.8476	0.4031	3.4476
700.	1290.	3834.	0.435	0.3576	0.4194	0.8527	0.4069	2.9721
802.	1924.	4963.	0.498	0.3526	0.4159	0.8475	0.4018	2.5795
900.	2761.	6284.	0.559	0.3545	0.4223	0.8396	0.3989	2.2760
1005.	3817.	7796.	0.624	0.3528	0.4193	0.8413	0.3987	2.0424
1020.	3944.	7988.	0.634	0.3509	0.4144	0.8457	0.4002	2.0254
1050.	4326.	8499.	0.652	0.3523	0.4167	0.8455	0.4005	1.9646

\*\*\*\* FITTED CURVE DATA FOR CONSTANT MACH NUMBER INCREMENTS \*\*\*\* (HP, 6 PCINT 2ND ORDER.

MACH	HP	TH	TIPS	RPM	CT	CP	CT/CP	FM	TH/HP
0.325	528.	2115.	370.	523.	0.3531	0.4189	0.843	0.400	3.931
0.350	650.	2452.	398.	563.	0.3543	0.4111	0.862	0.409	3.732
0.375	809.	2931.	427.	604.	0.3550	0.4098	0.866	0.412	3.501
0.400	986.	3224.	455.	644.	0.3554	0.4115	0.863	0.411	3.272
0.425	1190.	3641.	484.	684.	0.3554	0.4143	0.858	0.408	3.059
0.450	1423.	4051.	512.	724.	0.3553	0.4172	0.852	0.405	2.869
0.475	1683.	4544.	541.	765.	0.3551	0.4195	0.846	0.403	2.701
0.500	1954.	5031.	569.	803.	0.3548	0.4200	0.845	0.402	2.561
0.525	2277.	5538.	597.	843.	0.3543	0.4205	0.843	0.400	2.432
0.550	2619.	6069.	626.	885.	0.3537	0.4205	0.841	0.399	2.318
0.575	2985.	6615.	654.	925.	0.3529	0.4198	0.841	0.398	2.216
0.600	3387.	7197.	683.	966.	0.3525	0.4190	0.841	0.395	2.125
0.625	3817.	7803.	711.	1006.	0.3522	0.4178	0.843	0.395	2.044
0.650	4276.	8434.	740.	1046.	0.3520	0.4161	0.846	0.401	1.972

STATIC PROP PERFORMANCE

RUN 5 ALLISON VARIABLE CAMPER 5 DEG FLAP

BETA=39.2 AF=177.0 DIA=13.500 NBL=4 TEMPC= 26.0 TEMPR= 538.49 SIGMA=0.9417

\*\*\*\* RAW DATA POINTS \*\*\*\*

RPM	FP	TH	TMACH	RCT	RCP	RCT/CP	RFM	RTH/HP
500.	537.	2157.	0.311	0.3943	0.4790	0.8232	0.4125	4.0168
600.	827.	2993.	0.373	0.3800	0.4579	0.8298	0.4082	3.3742
700.	1428.	4111.	0.405	0.3834	0.4642	0.8255	0.4081	2.8789
801.	2123.	5357.	0.498	0.3916	0.4606	0.8284	0.4084	2.5233
902.	3086.	6848.	0.560	0.3847	0.4689	0.8204	0.4060	2.2191
1002.	4203.	8414.	0.622	0.3830	0.4659	0.8221	0.4060	2.0019
1016.	4455.	8733.	0.611	0.3866	0.4737	0.8163	0.4050	1.9602

\*\*\*\* FITTED CURVE DATA FOR CONSTANT MACH NUMBER INCREMENTS \*\*\*\* (HP, 6 PCINT 2ND ORDER.

MACH	HP	TH	TIPS	RPM	CT	CP	CT/CP	FM	TH/HP
0.325	604.	2329.	370.	522.	0.2887	0.4704	0.826	0.411	3.854
0.350	735.	2562.	398.	563.	0.3861	0.4579	0.843	0.418	3.651
0.375	857.	3065.	427.	604.	0.3844	0.4544	0.846	0.419	3.419
0.400	1050.	3478.	455.	644.	0.3833	0.4552	0.842	0.416	3.190
0.425	1315.	3919.	484.	684.	0.3826	0.4578	0.836	0.412	2.980
0.450	1572.	4390.	512.	724.	0.3823	0.4610	0.829	0.409	2.793
0.475	1860.	4890.	541.	765.	0.3822	0.4638	0.824	0.406	2.629
0.500	2159.	5429.	559.	805.	0.3829	0.4637	0.826	0.408	2.503
0.525	2524.	5992.	597.	845.	0.3833	0.4662	0.822	0.406	2.374
0.550	2915.	6584.	626.	885.	0.3838	0.4681	0.820	0.405	2.259
0.575	3340.	7204.	654.	926.	0.3842	0.4694	0.818	0.405	2.157
0.600	3759.	7852.	693.	966.	0.3846	0.4700	0.818	0.405	2.067
0.625	4254.	8528.	711.	1006.	0.3850	0.4700	0.819	0.406	1.986

STATIC PROCP PERFORMANCE

RUN 7 ALLISON VARIABLE CAMPER 0 DEG FLAP

BETA=50.1 AF=177.0 DIA=13.500 NPL=4 TEMPC= 27.0 TEMPR= 540.29 SIGMA=0.9350

\*\*\*\* RAW DATA PCINTS \*\*\*\*

RPM	HP	TH	IMACH	RCT	RCP	RCT/CP	RFM	RTH/HP
500.	736.	1909.	0.310	0.3600	0.6566	0.5482	0.2625	2.0753
601.	1269.	2300.	0.373	0.3550	0.6518	0.5447	0.2590	2.2112
701.	2027.	2909.	0.425	0.3542	0.6561	0.5395	0.2564	1.9791
800.	3001.	4966.	0.496	0.3348	0.6536	0.5423	0.2580	1.6554
900.	4204.	6245.	0.558	0.3524	0.6430	0.5480	0.2596	1.4855
921.	4519.	6518.	0.571	0.3512	0.6450	0.5443	0.2575	1.4424

\*\*\*\* FITTED CURVE DATA FOR CONSTANT MACH NUMBER INCREMENTS \*\*\*\* (HP) 6 PCINT 2ND ORDER.

MACH	HP	TH	TIPS	RPM	CT	CP	CT/CP	FM	TH/HP
0.325	642.	2152.	370.	524.	0.3581	0.6526	0.549	0.262	2.554
0.350	1048.	2491.	399.	564.	0.3573	0.6500	0.550	0.262	2.376
0.375	1291.	2353.	427.	605.	0.3566	0.6511	0.548	0.261	2.210
0.400	1572.	3240.	456.	645.	0.3559	0.6532	0.545	0.259	2.061
0.425	1891.	3651.	484.	685.	0.3552	0.6549	0.542	0.258	1.931
0.450	2247.	4085.	513.	726.	0.3545	0.6556	0.541	0.257	1.818
0.475	2641.	4544.	541.	766.	0.3539	0.6551	0.540	0.256	1.721
0.500	3072.	5026.	570.	806.	0.3533	0.6535	0.541	0.256	1.636
0.525	3541.	5553.	598.	847.	0.3528	0.6507	0.542	0.257	1.562
0.550	4049.	6063.	627.	887.	0.3522	0.6469	0.545	0.258	1.498

STATIC PRCP PERFORMANCE

RUN 8 ALLISON VARIABLE CAMPER 5 DEG FLAP

BETA=50.1 AF=177.0 DIA=13.500 NBL=4 TEMPC= 28.0 TEMPR= 542.09 SIGMA=0.9319

\*\*\*\*\* RAW DATA POINTS \*\*\*\*\*

RPM	FP	TH	TMACH	RCT	RCP	RCT/CP	RFM	RTH/HP
500.	750.	2087.	0.210	0.3815	0.7047	0.5414	0.2668	2.6418
604.	1378.	2970.	0.374	0.3721	0.6973	0.5336	0.2557	2.1553
700.	2149.	3992.	0.453	0.3723	0.6986	0.5330	0.2595	1.8576
802.	3203.	5176.	0.497	0.3578	0.6924	0.5312	0.2571	1.6160
895.	4471.	6473.	0.556	0.3671	0.6885	0.5333	0.2578	1.4439

\*\*\*\*\* FITTED CURVE DATA FOR CONSTANT MACH NUMBER INCREMENTS \*\*\*\*\* (HP 6 PCINT 2ND ORDER.

MACH	HP	TH	TIPS	RPM	CT	CP	CT/CP	FM	TH/HP
0.325	508.	2264.	371.	525.	0.3787	0.6996	0.541	0.266	2.515
0.350	1125.	2650.	400.	553.	0.3760	0.6944	0.542	0.265	2.337
0.375	1362.	3002.	428.	606.	0.3740	0.6940	0.539	0.263	2.171
0.400	1682.	3401.	437.	646.	0.3723	0.6953	0.535	0.261	2.022
0.425	2021.	3826.	435.	687.	0.3710	0.6956	0.533	0.259	1.893
0.450	2402.	4277.	514.	727.	0.3699	0.6973	0.531	0.257	1.781
0.475	2822.	4753.	542.	767.	0.3690	0.6968	0.530	0.257	1.684
0.500	3284.	5257.	571.	808.	0.3683	0.6951	0.530	0.257	1.601
0.525	3737.	5736.	599.	843.	0.3677	0.6923	0.531	0.257	1.528
0.550	4230.	6341.	628.	886.	0.3672	0.6885	0.533	0.258	1.465

STATIC PRCP PERFORMANCE

RUN 9 ALLISON VARIABLE CAMPER 0 DEG FLAP

BETA=42.8 AF=177.0 DIA=13.500 NBL=4 TEMPC= 20.0 TEMPR= 527.69 SIGMA=0.9606

\*\*\*\* RAW DATA POINTS \*\*\*\*

RPM	FP	TH	TMACH	RCT	RCP	RCT/CP	RFM	RTH/HP
500.	563.	1984.	0.314	0.3627	0.5040	0.7196	0.3458	3.5115
600.	972.	2840.	0.376	0.3605	0.5018	0.7185	0.3443	2.9218
704.	1568.	3915.	0.442	0.3610	0.5011	0.7204	0.3454	2.4968
800.	2297.	5053.	0.502	0.3615	0.5003	0.7227	0.3468	2.2042
903.	3289.	6400.	0.567	0.3587	0.4981	0.7202	0.3442	1.9459
995.	4396.	7809.	0.625	0.3598	0.4961	0.7252	0.3471	1.7764

\*\*\*\* FITTED CURVE DATA FOR CONSTANT MACH NUMBER INCREMENTS \*\*\*\* (HP) 6 PCINT 2ND ORDER.

MACH	HP	TH	TIPS	RPM	CT	CP	CT/CP	FM	TH/HP
0.325	520.	2125.	366.	518.	0.3621	0.5052	0.717	0.344	3.376
0.350	772.	2463.	394.	558.	0.3618	0.4960	0.729	0.350	3.191
0.375	945.	2826.	422.	598.	0.3516	0.4939	0.732	0.351	2.989
0.400	1150.	3213.	451.	637.	0.3613	0.4950	0.730	0.350	2.794
0.425	1385.	3624.	479.	677.	0.3511	0.4972	0.726	0.348	2.616
0.450	1652.	4061.	507.	717.	0.3608	0.4994	0.723	0.346	2.458
0.475	1949.	4521.	535.	757.	0.3606	0.5011	0.720	0.345	2.319
0.500	2278.	5007.	563.	797.	0.3604	0.5020	0.718	0.344	2.198
0.525	2637.	5517.	591.	837.	0.3602	0.5021	0.717	0.344	2.092
0.550	3028.	6051.	620.	877.	0.3600	0.5013	0.718	0.344	1.999
0.575	3449.	6611.	648.	916.	0.3598	0.4992	0.720	0.345	1.916
0.600	3902.	7194.	676.	956.	0.3596	0.4976	0.723	0.346	1.844

STATIC PRCP PERFORMANCE

RUN 10 ALLISON VARIABLE CAMBER 5 DEG FLAP

BETA=42.8 AF=177.0 DIA=12.500 NBL=4 TEMPC= 21.0 TEMPR= 529.49 SIGMA=0.9573

\*\*\*\* RAW DATA POINTS \*\*\*\*

RPM	HP	TH	TMACH	RCT	RCP	RCT/CP	RFM	RTH/HP
501.	631.	2159.	0.314	0.3931	0.5595	0.7026	0.3515	3.4216
601.	1060.	3050.	0.376	0.3859	0.5445	0.7088	0.3514	2.8774
700.	1696.	4192.	0.438	0.3910	0.5514	0.7091	0.3538	2.4717
800.	2537.	5460.	0.501	0.3899	0.5525	0.7057	0.3516	2.1521
901.	3589.	6833.	0.564	0.3847	0.5471	0.7031	0.3480	1.9039
963.	4342.	7776.	0.603	0.3832	0.5421	0.7069	0.3452	1.7909

\*\*\*\* FITTED CURVE DATA FOR CONSTANT MACH NUMBER INCREMENTS \*\*\*\* (HP, 5 PCINT 2ND ORDER.

MACH	HP	TH	TIPS	RPM	CT	CP	CT/CP	FM	TH/HP
0.325	692.	2298.	367.	519.	0.3901	0.5524	0.706	0.352	3.221
0.350	855.	2672.	395.	559.	0.3911	0.5457	0.715	0.357	3.124
0.375	1031.	3069.	423.	599.	0.3914	0.5463	0.716	0.358	2.920
0.400	1280.	3490.	451.	639.	0.3912	0.5480	0.714	0.356	2.728
0.425	1540.	3935.	480.	678.	0.3906	0.5500	0.710	0.354	2.554
0.450	1824.	4402.	508.	718.	0.3899	0.5515	0.707	0.352	2.401
0.475	2160.	4894.	536.	758.	0.3889	0.5523	0.704	0.350	2.266
0.500	2518.	5408.	564.	798.	0.3879	0.5521	0.703	0.349	2.148
0.525	2909.	5946.	592.	838.	0.3869	0.5509	0.702	0.349	2.044
0.550	3332.	6508.	621.	878.	0.3858	0.5489	0.703	0.348	1.953
0.575	3788.	7092.	649.	918.	0.3847	0.5461	0.704	0.349	1.872
0.600	4276.	7701.	677.	958.	0.3836	0.5426	0.707	0.349	1.801



STATIC PROP PERFORMANCE

RUN 1A ALLISON VARIABLE CAMBER 505G FLAP

PETA=42.8 AF=177.0 DIA=13.500 NRL=4 TEMPC= 19.0 TEMPR= 525.89 SIGMA=0.9635

\*\*\*\* FAN DATA POINTS \*\*\*\*

RPM	HP	TH	TMACH	RCT	RCP	RCT/CP	RFM	RTH/HP
500.	632.	2197.	0.214	0.4016	0.5647	0.7113	0.2597	3.4705
600.	1025.	3113.	0.377	0.3952	0.5617	0.7036	0.3530	2.8612
700.	1725.	4210.	0.440	0.3932	0.5508	0.7012	0.3509	2.4441
800.	2547.	5463.	0.503	0.3903	0.5547	0.7035	0.3507	2.1457
900.	3555.	6908.	0.515	0.3841	0.5489	0.6995	0.3452	1.8974
957.	4313.	7703.	0.602	0.3844	0.5487	0.7003	0.3466	1.7860

\*\*\*\* FITTED CURVE DATA FOR CONSTANT MACH NUMBER INCREMENTS \*\*\*\* (HP, 6 PCINT 2ND ORDER.

MACH	HP	TH	TIPS	RPM	CT	CP	CT/CP	FM	TH/HP
0.325	702.	2341.	355.	517.	0.4001	0.5659	0.707	0.357	3.356
0.350	864.	2705.	394.	557.	0.3986	0.5577	0.715	0.360	3.122
0.375	1059.	3092.	422.	597.	0.3970	0.5555	0.715	0.359	2.923
0.400	1285.	3504.	450.	636.	0.3954	0.5559	0.711	0.357	2.728
0.425	1544.	3939.	478.	676.	0.3938	0.5569	0.707	0.354	2.552
0.450	1835.	4393.	505.	716.	0.3922	0.5577	0.702	0.351	2.396
0.475	2150.	4881.	534.	756.	0.3906	0.5579	0.700	0.349	2.261
0.500	2516.	5398.	562.	795.	0.3892	0.5573	0.698	0.348	2.142
0.525	2905.	5919.	590.	835.	0.3877	0.5558	0.698	0.347	2.033
0.550	3326.	6473.	619.	875.	0.3864	0.5555	0.698	0.346	1.946
0.575	3780.	7052.	647.	915.	0.3851	0.5505	0.700	0.346	1.866
0.600	4266.	7654.	675.	955.	0.3839	0.5468	0.702	0.347	1.794

STATIC PROP PERFORMANCE

RUN 2A ALLISON VARIABLE CAMBER 0 DEG FLAP

BETA=42.8 AF=177.0 DIA=13.500 NBL=4 TEMPC= 20.0 TEMPR= 527.69 SIGMA=0.9642

\*\*\*\* RAW DATA POINTS \*\*\*\*

RPM	FP	TH	TMACH	RCT	RCP	RCT/CP	RFM	RTH/HP
500.	551.	1981.	0.314	0.3521	0.4915	0.7368	0.3538	3.5953
600.	957.	2829.	0.376	0.3591	0.4940	0.7270	0.3477	2.9561
704.	1550.	3884.	0.452	0.3562	0.4954	0.7230	0.3453	2.5058
800.	2250.	4992.	0.502	0.3565	0.4900	0.7275	0.3466	2.2187
900.	3228.	6313.	0.565	0.3562	0.4938	0.7214	0.3436	1.9557
992.	4303.	7675.	0.622	0.3564	0.4915	0.7252	0.3455	1.7836

\*\*\*\* FITTED CURVE DATA FOR CONSTANT MACH NUMBER INCREMENTS \*\*\*\* (HP) 6 PCINT 2ND ORDER.

MACH	HP	TH	TIPS	RPM	CT	CP	CT/CP	FM	TH/HP
0.325	617.	2123.	300.	518.	0.3516	0.4951	0.730	0.351	3.441
0.350	735.	2452.	394.	555.	0.3502	0.4851	0.741	0.355	3.242
0.375	927.	2807.	422.	598.	0.3592	0.4843	0.742	0.355	3.028
0.400	1129.	3187.	451.	637.	0.3534	0.4859	0.732	0.352	2.823
0.425	1352.	3592.	479.	677.	0.3578	0.4836	0.732	0.350	2.638
0.450	1625.	4022.	507.	717.	0.3574	0.4914	0.727	0.347	2.474
0.475	1920.	4477.	535.	757.	0.3571	0.4936	0.726	0.345	2.351
0.500	2247.	4957.	562.	797.	0.3568	0.4951	0.721	0.344	2.207
0.525	2504.	5453.	591.	837.	0.3566	0.4957	0.719	0.343	2.093
0.550	2992.	5993.	620.	877.	0.3565	0.4934	0.720	0.343	2.003
0.575	3411.	6548.	648.	916.	0.3564	0.4942	0.721	0.343	1.920
0.600	3852.	7129.	675.	956.	0.3563	0.4925	0.723	0.345	1.846

STATIC PRCP PERFORMANCE

RUN 3A ALLISON VARIABLE CAMBER 5 DEG FLAP

BETA=39.2 AF=177.0 DIA=13.500 NBL=4 TEMPC= 24.0 TEMPR= 534.89 SIGMA=0.9512

\*\*\*\* RAW DATA POINTS \*\*\*\*

RPM	FP	TH	TMACH	RCT	RCP	RCT/CP	RFM	RTH/HP
500.	533.	2152.	0.312	0.3934	0.4755	0.8274	0.4141	4.0375
600.	930.	3107.	0.374	0.3944	0.4801	0.8216	0.4118	3.3409
700.	1476.	4225.	0.416	0.3941	0.4758	0.8212	0.4114	2.8625
800.	2211.	5333.	0.499	0.3951	0.4815	0.8205	0.4116	2.5025
900.	3123.	6389.	0.581	0.3887	0.4777	0.8137	0.4048	2.2059
1000.	4264.	8567.	0.623	0.3915	0.4777	0.8196	0.4053	1.9998
1011.	4405.	8683.	0.630	0.3852	0.4754	0.8166	0.4060	1.9707

\*\*\*\* FITTED CURVE DATA FOR CONSTANT MACH NUMBER INCREMENTS \*\*\*\* (HP, 6 PCINT 2ND ORDER.

MACH	HP	TH	TIPS	RPM	CT	CP	CT/CP	FM	TH/HP
0.325	608.	2346.	369.	521.	0.3943	0.4783	0.824	0.413	3.857
0.350	749.	2723.	397.	562.	0.3945	0.4717	0.836	0.415	3.634
0.375	921.	3125.	425.	602.	0.3945	0.4712	0.837	0.420	3.395
0.400	1122.	3554.	454.	642.	0.3943	0.4733	0.833	0.417	3.167
0.425	1334.	4009.	482.	682.	0.3940	0.4762	0.827	0.414	2.960
0.450	1617.	4490.	510.	722.	0.3936	0.4789	0.822	0.411	2.777
0.475	1910.	4998.	539.	762.	0.3932	0.4810	0.818	0.409	2.617
0.500	2225.	5532.	567.	802.	0.3928	0.4801	0.818	0.409	2.488
0.525	2576.	6089.	595.	842.	0.3921	0.4805	0.816	0.408	2.364
0.550	2961.	6671.	624.	882.	0.3915	0.4804	0.815	0.407	2.253
0.575	3378.	7279.	652.	922.	0.3908	0.4796	0.815	0.407	2.155
0.600	3827.	7912.	681.	963.	0.3902	0.4782	0.816	0.407	2.068
0.625	4308.	8571.	709.	1003.	0.3895	0.4763	0.818	0.407	1.990

STATIC PRCP PERFORMANCE

RUN 4A ALLISON VARIABLE CAMBER 0 DEG FLAP

BETA=39.2 AF=177.0 DIA=13.500 NBL=4 TEMPC= 23.0 TEMPR= 533.09 SIGMA=0.9545

\*\*\*\* RAW DATA POINTS \*\*\*\*

RPM	HP	TH	TMACH	RCT	RCP	RCT/CP	RFM	RTH/HP
500.	475.	1950.	0.312	0.3565	0.4237	0.8413	0.4008	4.1053
600.	624.	2817.	0.275	0.3576	0.4254	0.8407	0.4012	3.4187
700.	1276.	3784.	0.437	0.3529	0.4148	0.8508	0.4034	2.9655
800.	1950.	5034.	0.499	0.3595	0.4247	0.8465	0.4050	2.5815
902.	2761.	6295.	0.563	0.3536	0.4195	0.8425	0.4060	2.2800
999.	3731.	7593.	0.624	0.3523	0.4173	0.8443	0.3999	2.0619
1021.	4033.	8156.	0.637	0.3576	0.4227	0.8459	0.4036	2.0213
1045.	4273.	8566.	0.652	0.3585	0.4175	0.8586	0.4102	2.0047

\*\*\*\* FITTED CURVE DATA FOR CONSTANT MACH NUMBER INCREMENTS \*\*\*\* (HP; S PCINT 2ND ORDER.

MACH	HP	TH	TIPS	RPM	CT	CP	CT/CP	FM	TH/HP
0.325	536.	2111.	368.	521.	0.3559	0.4237	0.840	0.400	3.937
0.350	638.	2455.	396.	551.	0.3570	0.4157	0.857	0.409	3.729
0.375	807.	2822.	425.	601.	0.3574	0.4153	0.861	0.411	3.496
0.400	932.	3211.	453.	641.	0.3575	0.4165	0.858	0.410	3.269
0.425	1184.	3623.	481.	681.	0.3573	0.4185	0.854	0.407	3.060
0.450	1412.	4058.	510.	721.	0.3569	0.4204	0.849	0.405	2.874
0.475	1666.	4515.	538.	761.	0.3564	0.4219	0.845	0.403	2.709
0.500	1934.	4988.	566.	801.	0.3554	0.4198	0.847	0.403	2.579
0.525	2245.	5497.	594.	841.	0.3553	0.4209	0.844	0.402	2.449
0.550	2585.	6032.	623.	881.	0.3552	0.4215	0.843	0.401	2.334
0.575	2955.	6594.	651.	921.	0.3552	0.4216	0.842	0.401	2.232
0.600	3352.	7188.	679.	961.	0.3556	0.4211	0.845	0.402	2.144
0.625	3779.	7810.	708.	1001.	0.3561	0.4200	0.848	0.404	2.067
0.650	4235.	8460.	736.	1041.	0.3567	0.4154	0.852	0.406	1.998

STATIC PRCP PERFORMANCE

RUN 5A ALLISON VARIABLE CAMBER 5 DEG FLAP

BETA=32.2 AF=177.0 DIA=13.500 NBL=4 TEMPC= 23.0 TEMPR= 533.09 SIGMA=0.9473

\*\*\*\* RAW DATA PCINTS \*\*\*\*

RPM	FP	TH	TMACH	RCT	RCP	CT	CP	CT/CP	RFM	RTH/HP
500.	331.	1853.	0.212	0.3227	0.2953	0.3420	0.3010	1.136	0.5328	5.5982
600.	578.	2700.	0.275	0.3428	0.2984	0.3398	0.2914	1.166	0.5367	4.6713
700.	921.	3664.	0.427	0.3417	0.2994	0.3387	0.2885	1.174	0.5325	3.9783
800.	1333.	4739.	0.499	0.3324	0.2947	0.3383	0.2890	1.171	0.5331	3.5026
900.	1931.	6035.	0.582	0.3406	0.2954	0.3384	0.2909	1.163	0.5370	3.1258
1000.	2710.	7593.	0.624	0.3470	0.3022	0.3388	0.2934	1.153	0.5398	2.8018
1020.	2881.	7879.	0.637	0.3461	0.3027	0.3395	0.2957	1.149	0.5367	2.7348
1050.	3170.	8393.	0.655	0.3431	0.3053	0.3391	0.2944	1.152	0.5368	2.6492

\*\*\*\* FITTED CURVE DATA FCP CONSTANT MACH NUMBER INCREMENTS \*\*\*\* (HP) 6 PCINT 2ND ORDER.

MACH	HP	TH	TIPS	RPM	CT	CP	CT/CP	FM	TH/HP
0.325	381.	2028.	368.	521.	0.3420	0.3010	1.136	0.530	5.325
0.350	460.	2357.	396.	561.	0.3398	0.2914	1.166	0.542	5.075
0.375	561.	2674.	425.	601.	0.3387	0.2885	1.174	0.545	4.768
0.400	682.	3039.	453.	641.	0.3383	0.2890	1.171	0.543	4.457
0.425	823.	3432.	481.	681.	0.3384	0.2909	1.163	0.540	4.168
0.450	935.	3852.	510.	721.	0.3388	0.2934	1.153	0.537	3.910
0.475	1168.	4301.	538.	761.	0.3395	0.2957	1.149	0.534	3.682
0.500	1357.	4759.	566.	801.	0.3391	0.2944	1.152	0.535	3.508
0.525	1581.	5231.	594.	841.	0.3400	0.2964	1.147	0.534	3.328
0.550	1829.	5795.	623.	881.	0.3412	0.2982	1.144	0.533	3.169
0.575	2086.	6345.	651.	921.	0.3418	0.2976	1.148	0.536	3.042
0.600	2389.	6946.	679.	961.	0.3437	0.3000	1.145	0.556	2.908
0.625	2720.	7582.	708.	1001.	0.3457	0.3023	1.144	0.537	2.787
0.650	3081.	8253.	736.	1041.	0.3479	0.3043	1.143	0.538	2.679

STATIC PRCP PERFORMANCE

RUN 6A ALLISON VARIABLE CAMBER 0 DEG FLAP

BETA=32.2 AF=177.0 DIA=13.500 NBL=4 TEMPC= 24.0 TENPR= 534.89 SIGMA=0.9422

\*\*\*\*\* RAW DATA POINTS \*\*\*\*\*

RPM	FP	TH	TMACH	RCT	RCP	RCT/CP	RFM	RTH/HP
501.	267.	1576.	0.312	0.2870	0.2368	1.2120	0.5181	5.9026
601.	460.	2258.	0.375	0.2857	0.2363	1.2091	0.5157	4.9087
700.	460.	3083.	0.436	0.2876	0.1455	1.9229	0.8228	6.7022
800.	1109.	4031.	0.499	0.2879	0.2415	1.1918	0.5103	3.6348
902.	1603.	5176.	0.562	0.2907	0.2426	1.1937	0.5136	3.2289
1002.	2224.	6497.	0.624	0.2957	0.2465	1.1997	0.5206	2.9213
1020.	2384.	6810.	0.636	0.2994	0.2505	1.1952	0.5219	2.8591
1051.	2556.	7210.	0.655	0.2982	0.2493	1.1964	0.5214	2.7773

68

\*\*\*\*\* FITTED CURVE DATA FCP CONSTANT MACH NUMBER INCREMENTS \*\*\*\*\* (HP) 6 PCINT 2ND ORDER.

MACH	HP	TH	TIPS	RPM	CT	CP	CT/CP	FM	TH/HP
0.325	284.	1703.	369.	521.	0.2871	0.2232	1.285	0.550	6.018
0.350	221.	1970.	397.	562.	0.2855	0.2019	1.414	0.603	6.144
0.375	381.	2257.	425.	602.	0.2849	0.1949	1.462	0.623	5.927
0.400	464.	2568.	454.	542.	0.2850	0.1957	1.456	0.620	5.535
0.425	571.	2905.	432.	622.	0.2855	0.2007	1.423	0.607	5.091
0.450	700.	3257.	510.	722.	0.2864	0.2075	1.320	0.589	4.663
0.475	954.	3653.	539.	752.	0.2874	0.2150	1.337	0.572	4.280
0.500	1026.	4051.	557.	802.	0.2877	0.2215	1.299	0.556	3.950
0.525	1224.	4491.	595.	842.	0.2893	0.2284	1.267	0.544	3.669
0.550	1447.	4950.	624.	882.	0.2911	0.2347	1.240	0.534	3.429
0.575	1759.	5444.	652.	922.	0.2923	0.2510	1.164	0.502	3.079
0.500	2014.	5969.	681.	953.	0.2942	0.2517	1.169	0.506	2.964
0.625	2264.	6525.	709.	1003.	0.2955	0.2504	1.184	0.515	2.881
0.650	2519.	7111.	737.	1043.	0.2988	0.2476	1.207	0.526	2.822

2. TABULAR FREQUENCY SPECTRA

AMBIENT

Filter Number	Center Frequency	Microphone Numbers					
		1	2	3	4	5	6
		db*	db	db	db	db	db
40	Overall	070	073	070	071	071	072
39	20,000.	060	060	060	060	060	060
38	16,000.	060	060	060	060	060	060
37	12,500.	060	060	060	060	060	060
36	10,000.	063	062	062	061	062	062
35	8,000.	060	060	060	060	060	060
34	6,300.	060	060	060	060	060	060
33	5,000.	060	060	060	060	060	060
32	4,000.	060	060	060	060	060	060
31	3,150.	060	060	060	060	060	060
30	2,500.	060	060	060	060	060	060
29	2,000.	060	060	060	060	060	060
28	1,600.	060	060	060	060	060	060
27	1,250.	060	060	060	060	060	060
26	1,000.	060	060	060	060	060	060
25	800.	060	060	060	060	060	060
24	630.	060	060	060	060	060	060
23	500.0	060	060	060	060	060	060
22	400.0	060	065	060	064	060	064
21	315.0	060	061	060	060	060	061
20	250.0	060	060	060	060	060	060
19	200.0	060	060	060	060	060	060
18	160.0	060	060	060	060	060	060
17	125.0	060	060	060	060	060	060
16	100.0	060	060	060	060	060	060
15	80.0	060	060	060	060	060	060
14	63.0	067	070	067	067	070	070
13	50.0	060	060	060	060	060	060
12	40.0	060	060	060	060	060	060
11	31.5	060	060	060	060	060	060
10	25.0	060	060	060	060	060	060
9	20.0	060	060	060	060	060	060
8	16.0	060	060	060	060	060	060
7	12.5	060	060	060	060	060	060
6	10.0	060	060	060	060	060	060
5	8.0	060	060	060	060	060	060
4	6.3	060	060	060	060	060	060
3	5.0	060	060	060	060	060	060
2	4.0	060	060	060	060	060	060
1	3.15	060	060	060	060	060	060

\*Decibel reference .0002 microbar

AFAPL-TR-70-80

Blade Angle 32°

Flap Angle 0°

RPM 500

Filter Number	Center Frequency	Microphone Numbers					
		1	2	3	4	5	6
		db*	db	db	db	db	db
40	Overall	103	101	098	099	102	098
39	20,000.	060	060	060	060	060	060
38	16,000.	064	062	060	060	063	060
37	12,500.	077	074	072	068	075	070
36	10,000.	083	081	078	076	082	077
35	8,000.	086	083	080	078	083	079
34	6,300.	087	084	082	079	084	081
33	5,000.	088	086	083	081	086	082
32	4,000.	089	087	085	082	086	083
31	3,150.	090	087	085	084	088	084
30	2,500.	090	088	086	084	088	085
29	2,000.	090	088	086	085	089	085
28	1,600.	090	088	086	085	089	085
27	1,250.	090	088	086	086	089	085
26	1,000.	090	088	086	086	089	086
25	800.	091	088	087	086	089	085
24	630.	091	090	087	088	091	087
23	500.0	090	089	087	088	091	088
22	400.0	090	090	088	090	094	089
21	315.0	090	090	085	088	094	090
20	250.0	091	089	088	089	093	089
19	200.0	087	088	084	088	094	089
18	160.0	084	086	083	087	090	085
17	125.0	084	084	084	087	087	081
16	100.0	083	083	077	080	086	079
15	80.0	081	076	071	081	078	072
14	63.0	091	083	072	080	082	075
13	50.0	076	073	068	079	069	064
12	40.0	087	082	071	079	070	063
11	31.5	098	093	082	080	075	066
10	25.0	075	070	061	077	063	060
9	20.0	065	062	060	075	060	060
8	16.0	070	067	060	074	060	060
7	12.5	062	060	060	073	060	060
6	10.0	060	060	060	072	060	060
5	8.0	060	060	060	071	060	060
4	6.3	060	060	060	069	060	060
3	5.0	060	060	060	066	060	060
2	4.0	060	060	060	061	060	060
1	3.15	060	060	060	060	060	060

\*Decibel reference .0002 microbar



Blade Angle 32°

Flap Angle 0°

RPM 700

Filter Number	Center Frequency	Microphone Numbers					
		1	2	3	4	5	6
		db*	db	db	db	db	db
40	Overall	113	111	107	106	111	106
39	20,000.	064	061	060	060	062	060
38	16,000.	075	072	069	066	074	069
37	12,500.	087	085	083	078	086	081
36	10,000.	094	092	090	086	093	088
35	8,000.	096	093	091	088	095	090
34	6,300.	097	095	092	090	096	091
33	5,000.	098	096	094	091	097	093
32	4,000.	100	097	095	092	098	094
31	3,150.	100	098	096	093	098	095
30	2,500.	100	098	095	093	098	095
29	2,000.	100	098	096	094	098	094
28	1,600.	100	098	096	094	098	094
27	1,250.	100	098	096	095	098	094
26	1,000.	100	099	096	095	098	094
25	800.	100	098	097	095	098	094
24	630.	100	100	097	096	099	095
23	500.0	099	098	097	097	100	095
22	400.0	099	099	096	096	102	096
21	315.0	098	100	093	096	102	095
20	250.0	098	098	096	095	103	097
19	200.0	094	094	091	091	101	096
18	160.0	092	093	089	089	095	089
17	125.0	093	093	091	089	093	088
16	100.0	102	096	085	088	096	089
15	80.0	092	087	081	081	088	082
14	63.0	085	084	076	076	081	074
13	50.0	109	105	088	087	098	074
12	40.0	100	096	080	078	088	069
11	31.5	079	075	072	068	073	062
10	25.0	077	076	069	067	067	063
9	20.0	069	067	064	062	064	060
8	16.0	067	065	063	061	061	060
7	12.5	071	065	060	060	060	060
6	10.0	064	061	060	060	060	060
5	8.0	060	062	060	060	060	060
4	6.3	060	060	060	060	060	060
3	5.0	060	060	060	060	060	060
2	4.0	060	060	060	060	060	060
1	3.15	060	061	060	060	060	060

\*Decibel reference .0002 microbar

AFAPL-TR-70-80

Blade Angle 32°

Flap Angle 0°

RPM 1000

Filter Number	Center Frequency	Microphone Numbers					
		1	2	3	4	5	6
		db*	db	db	db	db	db
40	Overall	126	126	121	120	121	118
39	20,000.	080	080	080	080	080	080
38	16,000.	087	083	082	080	086	082
37	12,500.	099	094	094	090	097	098
36	10,000.	106	101	102	098	105	100
35	8,000.	106	102	103	100	106	102
34	6,300.	107	103	104	101	107	102
33	5,000.	108	104	105	103	108	104
32	4,000.	109	105	106	103	108	104
31	3,150.	109	105	106	105	108	105
30	2,500.	109	105	106	104	108	105
29	2,000.	109	105	106	105	108	105
28	1,600.	109	106	107	106	108	105
27	1,250.	110	106	107	107	109	105
26	1,000.	111	107	108	106	109	105
25	800.	110	106	109	106	109	105
24	630.	110	108	108	107	110	105
23	500.0	109	106	108	109	111	106
22	400.0	108	107	108	110	111	108
21	315.0	108	106	104	105	113	107
20	250.0	108	109	107	105	110	105
19	200.0	110	111	104	105	111	106
18	160.0	106	103	106	099	102	098
17	125.0	118	114	118	108	109	106
16	100.0	097	098	096	092	096	091
15	80.0	112	113	099	104	096	097
14	63.0	125	126	112	117	107	110
13	50.0	101	102	090	093	087	086
12	40.0	090	090	082	082	081	080
11	31.5	088	087	082	081	080	080
10	25.0	086	086	080	080	080	080
9	20.0	084	083	080	080	080	080
8	16.0	087	083	080	080	080	080
7	12.5	083	081	080	080	080	080
6	10.0	081	080	080	080	080	080
5	8.0	080	080	080	080	080	080
4	6.3	080	080	080	080	080	080
3	5.0	080	080	080	080	080	080
2	4.0	080	080	080	080	080	080
1	3.15	080	080	080	080	082	080

\*Decibel reference .0002 microbar

AFAPL-TR-70-80

Blade Angle 32°

Flap Angle 5°

RPM 500

Filter Number	Center Frequency	Microphone Numbers					
		1	2	3	4	5	6
		db*	db	db	db	db	db
40	Overall	105	102	099	099	103	099
39	20,000.	060	060	060	060	060	060
38	16,000.	067	063	061	060	064	060
37	12,500.	078	075	073	069	076	072
36	10,000.	085	082	080	077	083	079
35	8,000.	087	084	081	079	085	081
34	6,300.	088	085	083	081	086	082
33	5,000.	089	087	085	082	087	083
32	4,000.	090	088	086	084	088	085
31	3,150.	092	089	087	086	090	086
30	2,500.	092	090	087	086	090	087
29	2,000.	092	089	088	086	090	087
28	1,600.	092	090	088	087	090	086
27	1,250.	092	090	088	087	090	086
26	1,000.	092	089	088	087	089	086
25	800.	092	090	088	088	089	086
24	630.	093	091	088	088	090	087
23	500.0	092	090	088	089	091	088
22	400.0	091	091	089	091	093	089
21	315.0	091	091	086	089	094	088
20	250.0	092	090	089	088	093	088
19	200.0	090	088	086	088	094	091
18	160.0	087	088	084	088	091	085
17	125.0	085	086	086	084	091	082
16	100.0	081	086	080	083	086	079
15	80.0	081	078	073	074	080	073
14	63.0	090	083	076	083	089	080
13	50.0	075	076	070	068	072	067
12	40.0	088	083	073	070	074	066
11	31.5	100	095	083	080	083	073
10	25.0	076	071	063	061	066	060
9	20.0	064	062	060	060	061	060
8	16.0	067	064	061	060	063	061
7	12.5	063	063	062	060	062	061
6	10.0	060	060	060	060	060	060
5	8.0	061	060	060	060	060	060
4	6.3	060	060	060	060	060	060
3	5.0	060	060	060	060	060	060
2	4.0	060	060	060	060	060	060
1	3.15	060	060	060	060	060	060

\*Decibel reference .0002 microbar

AFAPL-TR-70-80

Blade Angle 32°

Flap Angle 5°

RPM 700

Filter Number	Center Frequency	Microphone Numbers					
		1	2	3	4	5	6
		db*	db	db	db	db	db
40	Overall	115	112	108	108	111	108
39	20,000.	065	062	060	060	063	060
38	16,000.	077	073	070	067	075	070
37	12,500.	089	086	084	080	087	082
36	10,000.	096	093	091	088	094	090
35	8,000.	097	095	093	090	096	092
34	6,300.	098	096	094	092	097	093
33	5,000.	100	098	095	093	098	094
32	4,000.	101	098	096	094	099	095
31	3,150.	102	099	097	096	100	097
30	2,500.	102	100	097	095	099	096
29	2,000.	102	100	097	096	099	096
28	1,600.	102	099	097	096	099	095
27	1,250.	102	099	097	096	099	095
26	1,000.	102	099	097	097	099	096
25	800.	102	099	098	097	099	095
24	630.	102	101	098	098	100	096
23	500.0	101	100	098	099	100	096
22	400.0	101	100	097	100	101	097
21	315.0	100	099	094	099	102	096
20	250.0	099	097	096	097	102	096
19	200.0	097	095	092	093	100	095
18	160.0	094	093	091	092	096	090
17	125.0	095	093	092	092	095	088
16	100.0	102	099	088	093	097	090
15	80.0	092	090	082	083	088	083
14	63.0	086	086	077	077	082	076
13	50.0	111	106	089	093	094	084
12	40.0	101	097	081	084	085	075
11	31.5	080	077	073	071	073	065
10	25.0	079	077	070	068	071	065
9	20.0	075	071	063	063	066	060
8	16.0	072	071	067	065	066	061
7	12.5	071	070	063	063	065	063
6	10.0	069	066	060	061	061	060
5	8.0	064	062	060	060	060	060
4	6.3	063	063	060	061	060	060
3	5.0	062	060	060	061	060	060
2	4.0	060	060	060	060	060	060
1	3.15	060	060	060	060	060	060

\*Decibel reference .0002 microbar

AFAPL-TR-70-80

Blade Angle 32°

Flop Angle 5°

RPM 1000

Filter Number	Center Frequency	Microphone Numbers					
		1	2	3	4	5	6
		db*	db	db	db	db	db
40	Overall	128	126	121	120	121	118
39	20,000.	080	080	080	080	080	080
38	16,000.	087	083	083	080	087	082
37	12,500.	098	093	096	091	098	094
36	10,000.	106	100	102	099	105	100
35	8,000.	107	101	104	101	107	102
34	6,300.	107	102	105	102	107	103
33	5,000.	109	103	106	103	109	105
32	4,000.	109	104	106	104	109	105
31	3,150.	109	104	107	105	109	105
30	2,500.	109	104	106	105	109	105
29	2,000.	109	105	107	105	109	105
28	1,600.	109	105	107	105	108	105
27	1,250.	110	105	108	107	109	106
26	1,000.	110	106	108	106	109	105
25	800.	110	106	108	107	109	105
24	630.	111	107	109	107	109	105
23	500.0	112	105	109	109	110	106
22	400.0	113	105	108	108	109	105
21	315.0	113	106	104	106	110	106
20	250.0	113	109	106	105	108	105
19	200.0	113	112	103	101	111	105
18	160.0	109	107	104	100	103	098
17	125.0	120	119	116	105	111	101
16	100.0	105	101	096	093	096	091
15	80.0	113	113	100	104	098	099
14	63.0	126	126	114	117	111	111
13	50.0	105	102	091	093	090	088
12	40.0	101	092	083	083	081	080
11	31.5	099	090	081	082	080	080
10	25.0	099	087	080	080	080	080
9	20.0	098	084	080	080	080	080
8	16.0	098	082	080	080	080	080
7	12.5	096	080	080	080	080	080
6	10.0	094	080	080	080	080	080
5	8.0	093	080	080	080	080	080
4	6.3	092	080	080	080	080	080
3	5.0	091	080	080	080	080	080
2	4.0	090	080	080	080	080	080
1	3.15	088	080	080	080	080	080

\*Decibel reference .0002 microbar

AFAPL-TR-70-80

Blade Angle 39°

Flap Angle 0°

RPM 500

Filter Number	Center Frequency	Microphone Numbers					
		1	2	3	4	5	6
		db*	db	db	db	db	db
40	Overall	110	108	103	103	107	102
39	20,000.	060	060	060	060	060	060
38	16,000.	064	063	060	060	064	060
37	12,500.	076	076	072	068	076	071
36	10,000.	084	083	079	076	084	078
35	8,000.	086	085	082	078	085	080
34	6,300.	088	087	083	080	087	082
33	5,000.	089	089	085	082	088	083
32	4,000.	091	090	086	083	089	084
31	3,150.	091	091	087	085	090	086
30	2,500.	092	092	087	085	090	086
29	2,000.	093	092	088	086	091	087
28	1,600.	093	093	089	088	091	087
27	1,250.	094	093	090	089	092	088
26	1,000.	095	094	090	090	093	088
25	800.	095	095	093	092	094	090
24	630.	099	098	094	094	096	092
23	500.0	097	097	095	095	097	093
22	400.0	099	099	095	096	099	094
21	315.0	099	099	093	095	101	095
20	250.0	099	098	094	094	099	095
19	200.0	096	095	092	093	099	093
18	160.0	091	094	090	092	096	091
17	125.0	091	092	091	089	093	087
16	100.0	090	093	087	083	090	085
15	80.0	089	089	083	080	087	084
14	63.0	095	091	080	081	087	083
13	50.0	083	086	077	078	082	077
12	40.0	095	091	078	075	078	073
11	31.5	106	102	089	083	086	082
10	25.0	083	079	068	066	070	065
9	20.0	073	070	060	061	066	060
8	16.0	075	070	062	060	061	060
7	12.5	070	066	060	060	060	060
6	10.0	067	065	060	060	060	060
5	8.0	066	066	060	060	060	060
4	6.3	060	061	060	060	060	060
3	5.0	061	061	060	060	060	060
2	4.0	060	061	060	060	060	060
1	3.15	063	060	060	060	060	060

\*Decibel reference .0002 microbar

Blade Angle 39°

Flap Angle 0°

RPM 700

Filter Number	Center Frequency	Microphone Numbers					
		1	2	3	4	5	6
		db*	db	db	db	db	db
40	Overall	121	118	113	113	116	111
39	20,000.	080	080	060	060	063	060
38	16,000.	080	080	068	066	075	069
37	12,500.	088	087	083	078	088	082
36	10,000.	095	094	091	087	095	089
35	8,000.	097	096	092	090	097	092
34	6,300.	098	097	094	091	098	093
33	5,000.	100	099	096	093	099	095
32	4,000.	100	100	096	094	100	096
31	3,150.	101	101	097	096	101	097
30	2,500.	102	102	098	096	101	097
29	2,000.	102	102	099	097	102	098
28	1,600.	103	102	100	099	102	098
27	1,250.	104	104	101	100	103	099
26	1,000.	105	105	102	101	103	099
25	800.	105	105	103	102	104	101
24	630.	108	107	104	104	105	101
23	500.0	106	106	104	105	106	102
22	400.0	106	107	104	104	107	103
21	315.0	107	107	102	103	107	101
20	250.0	106	105	104	102	107	102
19	200.0	103	102	098	100	106	101
18	160.0	101	102	099	099	102	097
17	125.0	103	102	101	098	100	095
16	100.0	108	106	094	094	097	095
15	80.0	101	100	092	092	098	094
14	63.0	096	095	084	084	089	084
13	50.0	119	115	094	092	099	087
12	40.0	109	106	086	085	091	082
11	31.5	089	086	078	075	077	072
10	25.0	086	083	071	070	072	067
9	20.0	080	080	068	068	068	062
8	16.0	080	080	065	064	063	060
7	12.5	090	080	065	065	062	060
6	10.0	081	080	064	062	060	060
5	8.0	080	080	061	064	060	060
4	6.3	080	080	060	065	060	060
3	5.0	080	080	060	064	060	060
2	4.0	080	080	060	062	060	060
1	3.15	080	080	065	062	060	060

\*Decibel reference .0002 microbar

AFAPL-TR-70-80

Blade Angle 39°

Flop Angle 0°

RPM 1000

Filter Number	Center Frequency	Microphone Numbers					
		1	2	3	4	5	6
		db*	db	db	db	db	db
40	Overall	127	127	123	122	126	122
39	20,000.	080	080	080	080	080	080
38	16,000.	083	083	082	081	087	083
37	12,500.	094	094	092	091	099	095
36	10,000.	101	101	100	098	106	101
35	8,000.	103	101	102	100	108	104
34	6,300.	104	103	103	101	109	105
33	5,000.	104	104	104	103	110	106
32	4,000.	105	105	105	104	110	107
31	3,150.	106	106	106	105	111	107
30	2,500.	107	107	107	105	111	108
29	2,000.	107	107	107	106	112	108
28	1,600.	108	108	108	107	112	108
27	1,250.	109	109	109	109	113	109
26	1,000.	109	109	109	109	114	110
25	800.	109	110	110	110	114	110
24	630.	110	111	111	111	115	111
23	500.0	110	111	111	111	115	110
22	400.0	111	111	112	110	116	111
21	315.0	111	110	110	108	115	110
20	250.0	112	112	111	107	114	110
19	200.0	110	112	108	109	114	110
18	160.0	110	110	109	106	111	106
17	125.0	120	118	118	107	115	110
16	100.0	105	105	103	102	107	102
15	80.0	112	113	105	106	102	103
14	63.0	125	126	117	119	112	115
13	50.0	102	103	099	099	097	094
12	40.0	096	096	097	095	094	085
11	31.5	093	094	093	090	093	081
10	25.0	090	092	092	089	089	080
9	20.0	089	088	088	088	089	080
8	16.0	084	085	087	086	088	080
7	12.5	084	083	082	083	087	080
6	10.0	083	082	082	081	087	080
5	8.0	081	080	080	080	083	080
4	6.3	080	080	080	080	083	080
3	5.0	080	080	080	080	080	080
2	4.0	080	080	080	080	080	080
1	3.15	082	080	080	080	080	080

\*Decibel reference .0002 microbar



AFAPL-TR-70-80

Blade Angle 39°

Flap Angle 5°

RPM 500

Filter Number	Center Frequency	Microphone Numbers					
		1	2	3	4	5	6
		db*	db	db	db	db	db
40	Overall	110	109	104	103	107	102
39	20,000.	060	060	060	060	060	060
38	16,000.	064	064	060	060	065	060
37	12,500.	077	077	072	069	076	071
36	10,000.	084	084	080	077	084	079
35	8,000.	087	086	082	079	086	081
34	6,300.	088	088	084	081	087	082
33	5,000.	090	090	085	082	089	084
32	4,000.	091	090	086	083	089	085
31	3,150.	092	092	088	085	091	086
30	2,500.	092	092	088	086	090	086
29	2,000.	093	092	088	087	091	087
28	1,600.	094	093	089	088	092	087
27	1,250.	095	094	090	089	092	088
26	1,000.	096	095	091	091	093	088
25	800.	096	096	093	092	094	090
24	630.	098	098	094	094	095	091
23	500.0	096	097	095	095	097	093
22	400.0	099	100	096	096	099	094
21	315.0	098	099	092	095	099	094
20	250.0	098	098	095	094	099	094
19	200.0	095	096	092	092	098	094
18	160.0	093	095	092	092	095	091
17	125.0	093	093	092	090	092	087
16	100.0	091	092	086	085	091	085
15	80.0	090	088	083	082	087	083
14	63.0	097	091	082	081	086	082
13	50.0	086	087	079	080	082	079
12	40.0	095	091	078	075	079	075
11	31.5	107	103	088	082	099	084
10	25.0	083	079	068	068	070	067
9	20.0	072	069	063	060	064	060
8	16.0	073	071	064	062	061	060
7	12.5	070	066	060	061	060	060
6	10.0	067	065	062	062	060	060
5	8.0	068	063	060	060	060	060
4	6.3	064	062	060	060	060	060
3	5.0	061	060	060	060	060	060
2	4.0	063	060	060	060	060	060
1	3.15	060	060	060	060	060	060

\*Decibel reference .0002 microbar

AFAPL-TR-70-80

Blade Angle 39°

Flap Angle 5°

RPM 700

Filter Number	Center Frequency	Microphone Numbers					
		1	2	3	4	5	6
		db*	db	db	db	db	db
40	Overall	122	120	113	113	117	112
39	20,000.	080	080	060	061	064	060
38	16,000.	080	080	069	069	075	070
37	12,500.	088	087	083	079	088	083
36	10,000.	095	094	091	087	096	090
35	8,000.	097	096	093	090	097	092
34	6,300.	099	098	095	092	099	094
33	5,000.	100	100	096	094	100	095
32	4,000.	100	101	097	095	101	096
31	3,150.	102	101	098	096	102	097
30	2,500.	102	102	099	097	101	097
29	2,000.	102	103	099	098	102	098
28	1,600.	103	104	101	099	102	098
27	1,250.	104	104	101	101	103	099
26	1,000.	106	105	102	102	104	099
25	800.	105	106	104	103	105	101
24	630.	107	108	105	105	106	102
23	500.0	106	107	105	106	107	102
22	400.0	108	109	105	106	108	101
21	315.0	108	108	102	105	108	102
20	250.0	106	106	104	103	107	103
19	200.0	103	103	100	100	106	101
18	160.0	101	104	100	100	102	098
17	125.0	104	104	102	100	100	096
16	100.0	109	107	096	094	099	094
15	80.0	102	100	091	094	099	094
14	63.0	098	097	085	084	090	085
13	50.0	120	117	093	094	098	089
12	40.0	111	108	085	088	091	084
11	31.5	091	089	079	078	079	072
10	25.0	087	086	073	072	073	067
9	20.0	082	081	069	068	070	061
8	16.0	083	081	069	067	066	060
7	12.5	084	081	066	064	065	060
6	10.0	080	080	063	067	062	060
5	8.0	080	080	061	067	060	060
4	6.3	080	080	060	067	060	060
3	5.0	080	080	060	066	060	060
2	4.0	080	080	060	063	060	060
1	3.15	080	080	060	060	060	060

\*Decibel reference .0002 microbar

AFAPL-TR-70-80

Blade Angle 39°

Flap Angle 5°

RPM 1000

Filter Number	Center Frequency	Microphone Numbers					
		1	2	3	4	5	6
		db*	db	db	db	db	db
40	Overall	127	127	124	122	128	122
39	20,000.	080	080	080	080	080	080
38	16,000.	084	083	082	082	087	083
37	12,500.	095	093	093	092	099	094
36	10,000.	101	101	100	098	106	101
35	8,000.	103	101	102	100	108	103
34	6,300.	105	103	103	101	109	105
33	5,000.	106	104	105	103	110	106
32	4,000.	106	105	105	104	111	107
31	3,150.	107	107	106	105	112	108
30	2,500.	107	106	107	105	111	108
29	2,000.	108	107	107	106	112	109
28	1,600.	109	108	108	107	113	108
27	1,250.	109	109	109	108	113	109
26	1,000.	110	110	110	109	114	110
25	800.	110	110	111	110	114	111
24	630.	111	111	112	111	115	112
23	500.0	110	110	112	111	115	112
22	400.0	112	112	112	110	115	112
21	315.0	112	111	110	109	115	110
20	250.0	112	113	110	108	114	110
19	200.0	111	112	110	109	114	109
18	160.0	110	109	110	106	110	107
17	125.0	119	119	119	107	115	111
16	100.0	105	105	104	102	107	102
15	80.0	113	113	105	107	102	104
14	63.0	126	126	116	120	112	117
13	50.0	102	103	098	098	096	094
12	40.0	096	096	097	094	094	086
11	31.5	094	094	094	091	092	082
10	25.0	091	092	092	087	092	082
9	20.0	087	089	089	086	089	080
8	16.0	088	087	087	085	092	082
7	12.5	083	084	084	083	088	081
6	10.0	081	080	080	080	087	080
5	8.0	080	081	081	080	085	080
4	6.3	080	080	080	080	082	080
3	5.0	080	080	080	080	080	080
2	4.0	080	080	080	080	080	080
1	3.15	080	080	080	080	080	080

\*Decibel reference .0002 microbar

AFAPL-TR-70-80

Blade Angle 42°

Flap Angle 0°

RPM 500

Filter Number	Center Frequency	Microphone Numbers					
		1	2	3	4	5	6
		db*	db	db	db	db	db
40	Overall	113	111	106	107	110	105
39	20,000.	060	060	060	060	060	060
38	16,000.	064	063	060	060	065	060
37	12,500.	077	076	073	070	077	072
36	10,000.	084	083	080	077	085	079
35	8,000.	087	086	082	079	086	082
34	6,300.	088	087	084	081	087	083
33	5,000.	090	090	086	083	089	084
32	4,000.	091	091	086	084	090	085
31	3,150.	092	092	088	086	091	086
30	2,500.	093	092	088	087	091	087
29	2,000.	093	093	089	088	092	088
28	1,600.	094	094	090	089	092	088
27	1,250.	095	095	091	090	093	089
26	1,000.	096	096	092	092	094	090
25	800.	097	097	095	093	096	091
24	630.	099	100	096	096	097	092
23	500.0	099	100	097	098	098	094
22	400.0	102	102	097	099	101	097
21	315.0	103	103	097	099	103	098
20	250.0	103	103	099	099	103	098
19	200.0	101	100	096	097	102	098
18	160.0	099	099	095	096	100	096
17	125.0	096	097	095	093	097	092
16	100.0	096	098	091	088	094	089
15	80.0	096	094	087	088	093	089
14	63.0	098	096	086	086	090	085
13	50.0	092	092	082	084	088	085
12	40.0	097	093	080	078	080	075
11	31.5	108	104	091	083	088	083
10	25.0	086	084	074	071	074	068
9	20.0	078	072	060	063	065	060
8	16.0	077	071	063	063	061	060
7	12.5	073	069	060	060	062	060
6	10.0	071	068	060	060	060	060
5	8.0	072	068	060	060	060	060
4	6.3	068	069	060	060	060	060
3	5.0	066	067	060	060	060	060
2	4.0	067	063	060	060	060	060
1	3.15	060	064	060	060	060	060

\*Decibel reference .0002 microbar

AFAPL-TR-70-80

Blade Angle 42°

Flap Angle 0°

RPM 700

Filter Number	Center Frequency	Microphone Numbers					
		1	2	3	4	5	6
		db*	db	db	db	db	db
40	Overall	123	121	117	117	120	115
39	20,000.	080	080	061	060	080	060
38	16,000.	080	080	070	069	080	070
37	12,500.	088	088	084	082	088	083
36	10,000.	095	094	091	090	096	090
35	8,000.	097	096	093	091	098	093
34	6,300.	098	098	095	093	099	094
33	5,000.	099	100	096	094	101	096
32	4,000.	101	101	097	096	101	097
31	3,150.	102	102	099	097	102	098
30	2,500.	102	102	099	098	102	098
29	2,000.	103	103	100	099	103	099
28	1,600.	104	104	101	100	103	100
27	1,250.	104	105	102	102	104	100
26	1,000.	106	107	104	104	106	101
25	800.	107	107	106	104	107	103
24	630.	109	110	107	107	108	104
23	500.0	107	110	108	108	109	105
22	400.0	110	112	110	109	111	106
21	315.0	111	112	107	108	112	106
20	250.0	112	111	109	107	111	106
19	200.0	107	108	104	104	111	106
18	160.0	107	108	106	105	107	103
17	125.0	107	108	108	104	105	101
16	100.0	109	108	101	099	103	099
15	80.0	106	106	100	100	106	101
14	63.0	101	100	089	089	097	091
13	50.0	120	117	100	088	102	093
12	40.0	111	107	092	087	095	090
11	31.5	095	090	079	080	081	076
10	25.0	094	087	075	074	080	071
9	20.0	091	085	067	069	080	065
8	16.0	090	084	071	071	080	061
7	12.5	085	084	068	068	080	061
6	10.0	087	084	067	067	080	060
5	8.0	081	080	060	068	080	060
4	6.3	080	080	062	068	080	060
3	5.0	080	080	061	069	080	060
2	4.0	080	080	060	068	080	060
1	3.15	080	080	060	070	080	060

\*Decibel reference .0002 microbar

AFAPL-TR-70-80

Blade Angle 42°

Flap Angle 0°

RPM 992

Filter Number	Center Frequency	Microphone Numbers					
		1	2	3	4	5	6
		db*	db	db	db	db	db
40	Overall	127	127	124	124	126	123
39	20,000.	080	080	080	080	080	080
38	16,000.	084	084	082	083	087	083
37	12,500.	096	094	093	094	098	094
36	10,000.	102	101	100	100	106	102
35	8,000.	104	103	102	101	107	103
34	6,300.	104	104	104	103	108	104
33	5,000.	106	105	105	104	109	106
32	4,000.	106	106	105	105	110	106
31	3,150.	107	107	107	106	111	108
30	2,500.	108	108	107	107	111	108
29	2,000.	109	108	108	108	111	108
28	1,600.	110	109	109	109	113	109
27	1,250.	110	110	110	110	113	110
26	1,000.	111	111	111	111	114	111
25	800.	112	111	112	112	115	112
24	630.	114	113	113	113	116	113
23	500.0	114	113	114	114	116	113
22	400.0	115	114	115	115	118	114
21	315.0	113	113	112	112	118	113
20	250.0	114	114	113	112	117	114
19	200.0	112	113	111	111	116	112
18	160.0	112	111	113	110	115	112
17	125.0	119	117	116	111	114	112
16	100.0	108	108	106	106	113	109
15	80.0	112	112	105	106	107	104
14	63.0	125	126	117	118	114	117
13	50.0	105	105	099	100	103	098
12	40.0	100	100	098	098	101	092
11	31.5	094	096	092	096	101	090
10	25.0	093	094	091	092	099	090
9	20.0	092	090	088	091	097	088
8	16.0	091	089	089	088	095	089
7	12.5	087	089	084	086	095	085
6	10.0	084	083	080	083	093	081
5	8.0	080	080	080	081	093	080
4	6.3	080	080	080	080	092	080
3	5.0	080	080	080	080	089	080
2	4.0	080	080	080	080	087	080
1	3.15	080	080	080	080	083	080

\*Decibel reference .0002 microbar

AFAPL-TR-70-80

Blade Angle 42°

Flap Angle 5°

RPM 500

Filter Number	Center Frequency	Microphone Numbers					
		1	2	3	4	5	6
		db*	db	db	db	db	db
40	Overall	113	112	107	108	111	106
39	20,000.	060	060	060	060	060	060
38	16,000.	066	064	061	060	065	061
37	12,500.	078	077	074	071	078	073
36	10,000.	085	084	081	078	085	080
35	8,000.	088	087	083	080	087	082
34	6,300.	089	089	085	082	089	083
33	5,000.	091	090	086	084	090	085
32	4,000.	092	091	088	085	091	086
31	3,150.	093	092	089	087	092	088
30	2,500.	093	093	089	087	092	088
29	2,000.	095	094	090	089	093	088
28	1,600.	095	094	091	090	093	088
27	1,250.	096	095	092	092	094	089
26	1,000.	097	097	093	093	095	090
25	800.	098	098	094	094	097	092
24	630.	100	100	096	096	098	094
23	500.0	100	100	097	098	099	095
22	400.0	103	103	099	100	102	097
21	315.0	104	104	096	100	104	098
20	250.0	104	103	101	100	103	098
19	200.0	101	101	097	097	103	098
18	160.0	098	100	097	098	101	096
17	125.0	098	098	096	094	098	093
16	100.0	097	099	093	089	094	089
15	80.0	097	096	089	089	093	090
14	63.0	100	097	088	087	091	085
13	50.0	092	094	085	085	090	086
12	40.0	098	094	081	078	080	077
11	31.5	109	105	091	085	089	084
10	25.0	087	084	073	074	075	070
9	20.0	078	073	062	063	067	061
8	16.0	076	072	067	064	061	060
7	12.5	073	071	062	061	061	060
6	10.0	074	069	061	060	060	060
5	8.0	076	071	062	060	060	060
4	6.3	072	067	067	060	060	060
3	5.0	073	064	065	060	060	060
2	4.0	071	065	061	060	060	060
1	3.15	068	061	067	060	060	060

\*Decibel reference .0002 microbar

AFAPL-TR-70-80

Blade Angle 42°

Flap Angle 5°

RPM 700

Filter Number	Center Frequency	Microphone Numbers					
		1	2	3	4	5	6
		db*	db	db	db	db	db
40	Overall	921	922	117	118	120	115
39	20,000.	070	068	061	063	069	060
38	16,000.	079	079	070	069	080	071
37	12,500.	089	089	084	082	091	084
36	10,000.	095	095	091	089	098	091
35	8,000.	097	097	094	092	099	094
34	6,300.	097	099	096	094	100	095
33	5,000.	099	101	097	095	101	096
32	4,000.	100	102	098	096	102	098
31	3,150.	101	103	099	098	103	099
30	2,500.	102	103	100	099	103	099
29	2,000.	103	104	101	100	104	100
28	1,600.	103	105	102	101	104	100
27	1,250.	105	106	103	103	105	101
26	1,000.	106	108	104	104	106	102
25	800.	106	109	106	106	107	102
24	630.	108	111	107	108	108	104
23	500.0	107	111	109	110	109	105
22	400.0	109	113	110	110	111	107
21	315.0	110	113	108	110	111	107
20	250.0	110	112	109	109	112	107
19	200.0	107	109	105	105	111	107
18	160.0	104	110	106	106	107	104
17	125.0	107	109	109	105	105	100
16	100.0	107	107	100	099	103	098
15	80.0	106	105	098	101	105	102
14	63.0	098	098	089	090	097	093
13	50.0	118	115	099	092	101	094
12	40.0	109	106	092	089	096	091
11	31.5	092	088	084	081	085	076
10	25.0	091	085	078	075	084	072
9	20.0	089	082	069	068	081	065
8	16.0	089	081	069	069	080	062
7	12.5	086	080	069	067	084	060
6	10.0	084	079	067	068	079	060
5	8.0	080	074	063	064	077	060
4	6.3	079	074	064	066	076	060
3	5.0	074	073	060	067	078	060
2	4.0	071	068	063	069	074	060
1	3.15	067	071	063	063	073	060

\*Decibel reference .0002 microbar



Blade Angle 42°  
 Flap Angle 5°  
 RPM 957

Filler Number	Center Frequency	Microphone Numbers					
		1	2	3	4	5	6
		db*	db	db	db	db	db
40	Overall	127	127	123	124	127	124
39	20,000.	080	080	080	080	080	080
38	16,000.	084	084	082	082	087	082
37	12,500.	095	095	093	093	098	094
36	10,000.	101	101	100	100	105	101
35	8,000.	102	103	101	102	106	103
34	6,300.	103	104	103	103	107	105
33	5,000.	105	105	104	104	108	106
32	4,000.	105	106	104	105	109	107
31	3,150.	107	107	105	106	111	108
30	2,500.	108	108	106	107	111	108
29	2,000.	108	109	107	108	111	109
28	1,600.	109	109	108	109	112	109
27	1,250.	110	111	109	111	113	110
26	1,000.	111	112	110	112	114	111
25	800.	111	112	111	112	114	112
24	630.	113	113	112	114	116	113
23	500.0	113	113	113	115	116	114
22	400.0	114	114	113	115	118	114
21	315.0	114	114	110	114	118	114
20	250.0	112	114	111	112	117	114
19	200.0	112	113	110	110	116	113
18	160.0	112	115	112	113	115	112
17	125.0	118	117	113	111	113	111
16	100.0	107	111	107	110	114	111
15	80.0	108	109	105	103	107	101
14	63.0	125	125	118	114	114	111
13	50.0	106	106	101	101	104	099
12	40.0	101	103	097	098	104	089
11	31.5	099	097	093	095	102	085
10	25.0	094	095	091	095	100	083
9	20.0	091	095	090	092	099	082
8	16.0	087	091	087	089	099	081
7	12.5	085	088	085	086	097	081
6	10.0	083	086	083	083	096	080
5	8.0	080	080	080	080	095	080
4	6.3	080	080	080	080	094	080
3	5.0	080	080	080	080	092	080
2	4.0	080	080	080	080	091	080
1	3.15	080	080	080	080	090	080

\*Decibel reference .0002 microbar

## AMBIENT

Filter Number	Center Frequency	Microphone Numbers					
		1	2	3	4	5	6
		db*	db	db	db	db	db
40	Overall	072	073	073	073	073	072
39	20,000.	060	060	060	060	060	060
38	16,000.	060	060	060	060	060	060
37	12,500.	060	060	060	060	060	060
36	10,000.	064	062	064	062	063	062
35	8,000.	060	060	061	060	060	060
34	6,300.	060	060	060	060	060	060
33	5,000.	060	060	060	060	060	060
32	4,000.	060	060	060	060	060	060
31	3,150.	060	060	060	060	060	060
30	2,500.	060	060	060	060	060	060
29	2,000.	060	060	060	060	060	060
28	1,600.	060	060	060	060	060	060
27	1,250.	060	060	060	060	060	060
26	1,000.	060	060	060	060	060	060
25	800.	060	060	060	060	060	060
24	630.	060	060	060	060	060	060
23	500.0	060	060	060	060	060	060
22	400.0	060	062	060	063	060	063
21	315.0	060	060	060	062	061	061
20	250.0	060	060	060	061	060	060
19	200.0	060	060	060	060	060	060
18	160.0	060	060	060	060	060	060
17	125.0	060	060	060	060	060	060
16	100.0	060	060	060	060	060	060
15	80.0	060	060	060	060	060	060
14	63.0	069	069	070	070	070	070
13	50.0	060	060	060	060	060	060
12	40.0	060	060	060	060	060	060
11	31.5	060	060	060	060	060	060
10	25.0	060	060	060	060	060	060
9	20.0	060	060	060	060	060	060
8	16.0	061	060	061	060	062	060
7	12.5	062	061	062	061	062	061
6	10.0	060	060	060	060	060	060
5	8.0	060	060	060	060	060	060
4	6.3	060	060	060	060	060	060
3	5.0	060	060	060	060	060	060
2	4.0	060	060	060	060	060	060
1	3.15	060	060	060	060	060	060

\*Decibel reference .0002 microbar

REFERENCES

1. Gerald T. Cafarelli and Matthew H. Chopin, Computer Program for Reducing Static Propeller Test Data, ASD Technical Report 68-19, Aeronautical Systems Division, Wright-Patterson Air Force Base, Ohio, June 1968.
2. Matthew H. Chopin, Propeller Static Performance Tests for V/STOL Aircraft, Part I - Summary Report, ASD Technical Report 69-15, Aeronautical Systems Division, Wright-Patterson Air Force Base, Ohio, January 1970.
3. Peter A. Franken and Edward M. Kerwin, Methods of Flight Vehicle Noise Prediction, WADC Technical Report 58-343, Wright Air Development Center, Wright-Patterson Air Force Base, Ohio, November 1958.