

AD 722 690

NUMERICAL CALCULATION OF THE ADDED MASS AND
DAMPING COEFFICIENTS OF CYLINDERS OSCILLATING
IN OR BELOW A FREE SURFACE

J. W. Bedel, et al

Naval Ship Research and Development Center
Washington, D. C.

March 1971

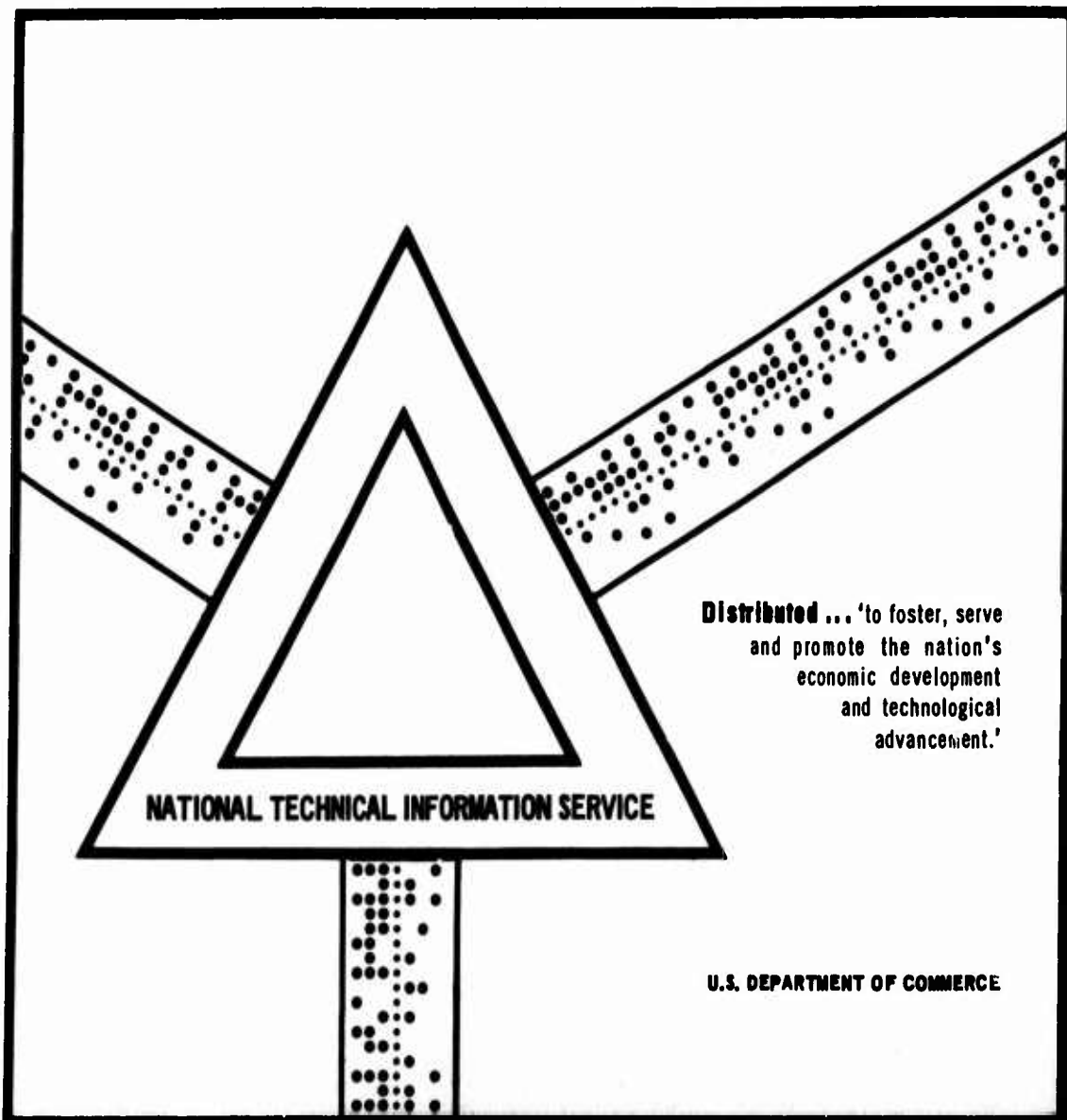

This document has been approved for public release and sale.

**Best
Available
Copy**

Report 3551

NUMERICAL CALCULATION OF THE ADDED MASS AND DAMPING COEFFICIENTS OF CYLINDERS OSCILLATING IN OR BELOW A FREE SURFACE

AD 722690

NAVAL SHIP RESEARCH AND DEVELOPMENT CENTER

Washington, D.C. 20034



NUMERICAL CALCULATION OF THE ADDED MASS AND DAMPING
COEFFICIENTS OF CYLINDERS OSCILLATING IN OR BELOW
A FREE SURFACE

by

J.W. Bedel and C.M. Lee

Approved for Public Release:
Distribution Unlimited.

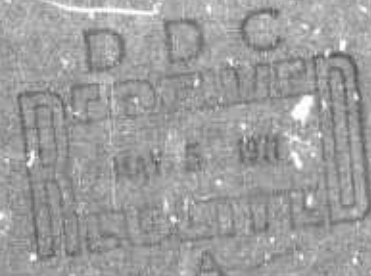

SHIP PERFORMANCE DEPARTMENT
RESEARCH AND DEVELOPMENT REPORT

March 1971

Report 3551

NATIONAL TECHNICAL
INFORMATION SERVICE

4

The Naval Ship Research and Development Center is a U.S. Navy center for laboratory effort directed at achieving improved sea and air vehicles. It was formed in March 1967 by merging the David Taylor Model Basin at Carderock, Maryland and the Marine Engineering Laboratory (now Naval Ship R & D Laboratory) at Annapolis, Maryland. The Mine Defense Laboratory (now Naval Ship R & D Laboratory) Panama City, Florida became part of the Center in November 1967.

Naval Ship Research and Development Center
Washington, D.C. 20034

MAJOR NSRDC ORGANIZATIONAL COMPONENTS

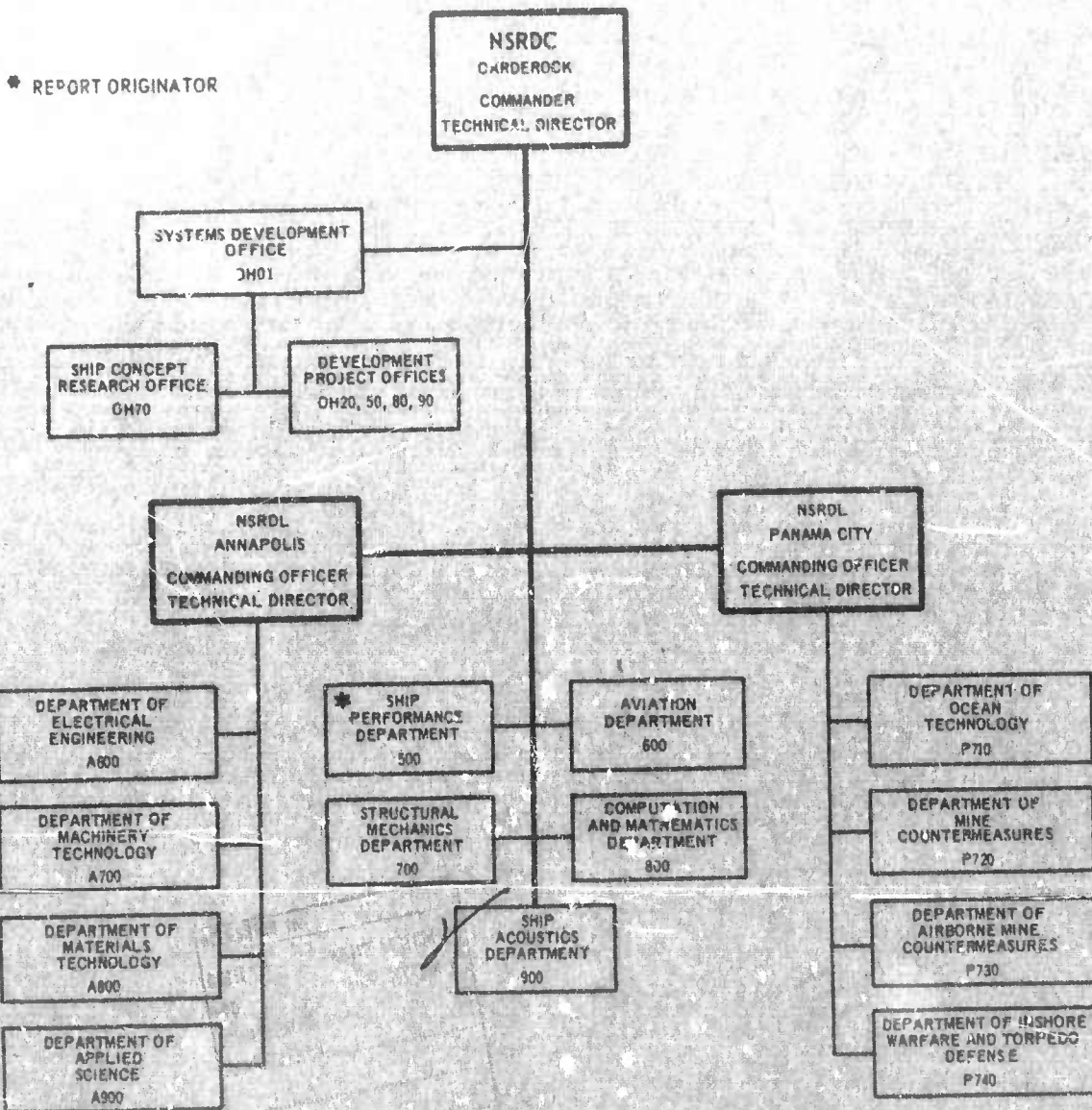

UNCLASSIFIED

Security Classification

DOCUMENT CONTROL DATA - R & D		
<i>(Security classification of title, body of abstract and indexing annotation must be entered when the overall report is classified)</i>		
1. ORIGINATING ACTIVITY (Corporate author) Naval Ship Research and Development Center Washington, D.C. 20034		2a. REPORT SECURITY CLASSIFICATION UNCLASSIFIED
		2b. GROUP
3. REPORT TITLE NUMERICAL CALCULATION OF THE ADDED MASS AND DAMPING COEFFICIENTS OF CYLINDERS OSCILLATING IN OR BELOW A FREE SURFACE		
4. DESCRIPTIVE NOTES (Type of report and inclusive dates) Final Report		
5. AUTHOR(S) (First name, middle initial, last name) J.W. Bedel and C.M. Lee		
6. REPORT DATE March 1971	7a. TOTAL NO. OF PAGES 43	7b. NO. OF REFS 1
8a. CONTRACT OR GRANT NO	9a. ORIGINATOR'S REPORT NUMBER(S) 3551	
b. PROJECT NO. R 01101 c. Subproject Task ZR011.01.01 d.	9b. OTHER REPORT NO(S) (Any other numbers that may be assigned this report)	
10. DISTRIBUTION STATEMENT Approved for public release: distribution unlimited.		
11. SUPPLEMENTARY NOTES	12. SPONSORING MILITARY ACTIVITY NSRDC in-house IR/IED program	
13. ABSTRACT The computer program presented herein provides values of the added mass and damping coefficients of infinitely long horizontal cylinders oscillating in or below a free surface. The report includes the theoretical background, the general structure, the details of the input and output schemes, and the program listing. <		

UNCLASSIFIED

Security Classification

14 KEY WORDS	LINK A		LINK B		LINK C	
	ROLE	WT	ROLE	WT	ROLE	WT
Pressures and Forces on Oscillating Cylinders Added Mass Coefficient of Cylinders Damping Coefficient of Cylinders Two-Dimensional Water Wave Problem Numerical Calculations						

DEPARTMENT OF THE NAVY
NAVAL SHIP RESEARCH AND DEVELOPMENT CENTER
WASHINGTON, D. C. 20034

NUMERICAL CALCULATION OF THE ADDED MASS AND DAMPING
COEFFICIENTS OF CYLINDERS OSCILLATING IN OR BELOW
A FREE SURFACE

by

J.W. Bedel and C.M. Lee

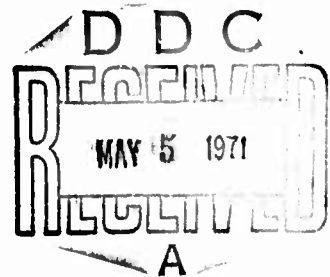

Approved for Public Release:
Distribution Unlimited.

March 1971

Report 3551

TABLE OF CONTENTS

	Page
ABSTRACT	1
ADMINISTRATIVE INFORMATION	1
INTRODUCTION	1
TERMINOLOGY	3
PROGRAM DESCRIPTION	4
PROGRAM INPUT	6
PROGRAM OUTPUT	14
REMARKS	18
CORRECTIONS TO REPORT 2375	18
LIMITATIONS OF THE PROGRAM	20
DETERMINATION OF NUMBER OF BODY SEGMENTS	22
ESTIMATED COMPUTER TIME	22
ACKNOWLEDGMENTS	24
APPENDIX - PROGRAM LISTING	25

LIST OF FIGURES

	Page
Figure 1 - Floating Cylinder	4
Figure 2 - Submerged Cylinder	4
Figure 3 - Order of Cycling Process	5
Figure 4 - Program Organization	7
Figure 5 - Input Setup for YFA4	8
Figure 6 - Listing of Sample Data Cards	9
Figure 7 - Description of Coordinates	13
Figure 8 - Geometric Output	16
Figure 9 - Hydrodynamic Output	17

	Page
Figure 10 - Alteration for Upper Horizontal Contour	23
Figure 11 - Alteration for Lower Horizontal Contour	23
Figure 12 - Cylinder Forms Unsuitable for Program YFA4	23

ABSTRACT

The computer program presented herein provides values of the added mass and damping coefficients of infinitely long horizontal cylinders oscillating in or below a free surface. The report includes the theoretical background, the general structure, the details of the input and output schemes, and the program listing.

ADMINISTRATIVE INFORMATION

This study was conducted under the in-house independent research/independent exploratory development program of the Naval Ship Research and Development Center (NSRDC). Funding was provided under Project R01101, Subproject ZR011.01.01.

INTRODUCTION

The main objective of this report is to provide sufficient information to enable the user to properly run computer program YFA4. This program was originally developed by W. Frank and is based on his theory.* It provides the pressures, added mass, and damping of a horizontal cylinder oscillating in heave, sway, or roll while located in or below the free surface.

A brief explanation of the analysis contained in the reference is presented in order to provide the understanding necessary for the most effective usage of the program. The theory deals with a velocity potential problem for an oscillating, horizontal cylinder of infinite length. The

*Frank, W., "Oscillation of Cylinders in or below the Free Surface of Deep Fluids," NSRDC Report 2375 (Oct 1967). Hereafter Report 2375 will be indicated simply as "the reference."

cylinder is symmetric about its vertical centerplane and is either in or below the free surface.* It undergoes forced simple harmonic oscillation of small amplitude in heave, sway, or roll.

The solution to this problem was obtained by the integral-equation method utilizing the Green function which was represented by a pulsating source below the free surface. The sources which satisfy the linearized free-surface condition were distributed along the contour of the cross section of the cylinder. The unknown strengths of the distributed sources were obtained by satisfying the kinematic boundary condition on the cylinder. To solve the integral equation, Frank employed an approximation by replacing the continuous source distribution with a finite number of sources. This approximation amounts to replacing the cylinder contour by a finite number of small straight-line segments along each of which the source density is assumed to be constant. The accuracy of this solution therefore depends on the number of source points on the cylindrical contour.

The program is written in Fortran IV and consists of five subroutines and one function supporting the main program. The program can handle in one run any desired number of cylinders for various depths of submergence and various frequencies of oscillation in heave, sway, or roll. This report provides detailed instructions for preparing the input data to the program and a description of the output generated by the program. The

* Hereinafter, "in" or "below" the free surface will be referred to as "floating" or "submerged," respectively.

limitations of the program and some necessary precautions in using it are also given. The user is strongly advised to read the Remarks section carefully before using the program.

TERMINOLOGY

In order to facilitate reader comprehension of the precise meaning of the terms used in the text, the following definitions are given below:

1. Added mass and damping - for bodies in water undergoing oscillations due to an external force $F_0 \sin \omega t$ in the x-direction, the equation of motion can be given by:

$$(M + m) \ddot{x} + b\dot{x} + kx = F_0 \sin \omega t$$

where M is the body mass,

k is the spring constant (or restoring force coefficient),

x is the displacement of the body from its mean position, and

ω is the radian frequency of oscillation.

As used in this equation, m is called "added mass" and b is called "damping." These quantities are used here for the case of two-dimensional cylindrical cross sections and therefore represent the added mass and damping per unit length of the cylinder.

2. Beam - the beam of a floating cylinder is the width of its cross section at the mean waterline when the cylinder is at its mean position (see Figure 1). The beam of a submerged cylinder is the maximum width of its cross section (see Figure 2).

3. Draft - the draft of a floating cylinder is the vertical distance from the keel to the mean waterline (see Figure 1). The draft of a submerged cylinder is the maximum height of the cross section (see Figure 2).

4. Floating cylinder - this is a cylinder located in the free surface as shown in Figure 1. As far as the computation of hydrodynamic quantities are concerned, the shape of the cylinder above the waterline can be arbitrary.

5. Submerged cylinder - this is a cylinder below the free surface as shown in Figure 2.

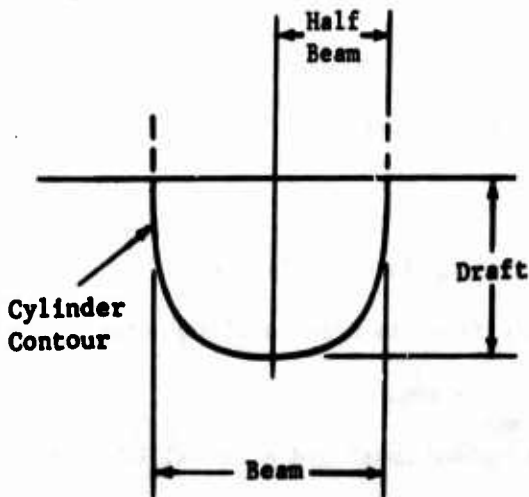

Figure 1 - Floating Cylinder

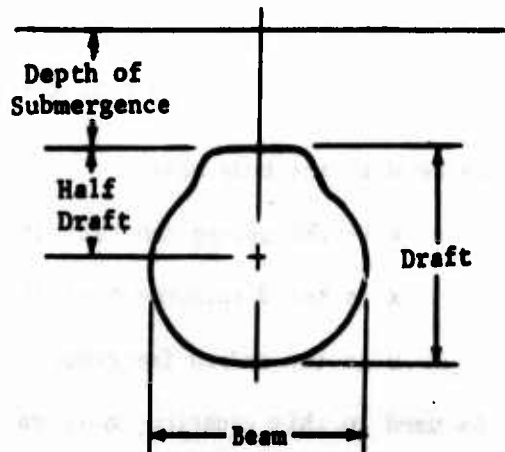

Figure 2 - Submerged Cylinder

PROGRAM DESCRIPTION

The program is written in Fortran IV. The program has four major cycling loops. The order of the cycling process is as shown in Figure 3.

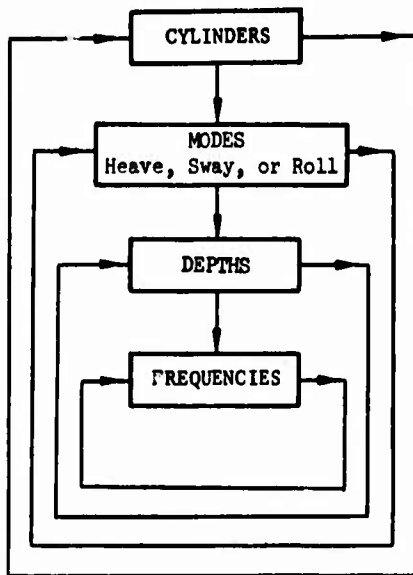

Figure 3 - Order of Cycling Process

The program consists of the following subroutines and functions:

MAIN - This program reads in input data and prints out output results. It serves as a control center to interrelate the supporting subroutines.

SHAPED - This subroutine computes the geometric quantities, such as the length and tangent angle for each segment of the cylinder contour, which are transmitted to Subroutines FIND and FREQ through common statements.

The length quantities are nondimensionalized by the half-beam for a floating cylinder and by the half-draft for a submerged cylinder.

SING - This function assigns the positive sign to heave motion and the negative sign to sway and roll motions. This distinction of signs for different modes of motion stems from the symmetric or asymmetric property of the flow about the cylinder.

FIND - This subroutine computes the normal derivatives of the logarithmic singularities on the cylinder contour (see Equations (35) and (42) in the reference).

FREQ - This subroutine computes the source strengths on the contour segments, the pressure in phase with the acceleration of the motion, the pressure in phase with the velocity of the motion, the added mass, and the damping.

DAVID - This subroutine calculates the principal-value integral of the type

$$\text{p.v.} \int_0^{\infty} \frac{e^{-ik(z-\bar{\zeta})}}{v-k} dk$$

as shown in Appendix A of the reference.

MATNIV - This subroutine solves for X in the linear algebraic equation AX = B by means of a matrix inversion.

Figure 4 is a block diagram showing the interconnection between and the process order of the foregoing main program and subprograms.

PROGRAM INPUT

The input setup is shown in Figure 5 and an example is given in Figure 6. The explanation of each card is as follows:

Cards 1-4 - TITO; TITD; TITA; TITV; (12A6 each):

These are titles that are printed out just before the computed output of the program. They may be used to describe the subject investigated by the program (see the section on Program Output). These four cards provide a space for a maximum of 288 letters or characters. Blank cards should be provided if no titles are desired.

Card 5 - NOK, MAXB, NH; (3I6):

NOK is the number of frequencies at which the hydrodynamic quantities will be computed. A maximum of 50 frequencies may be provided. MAXB is

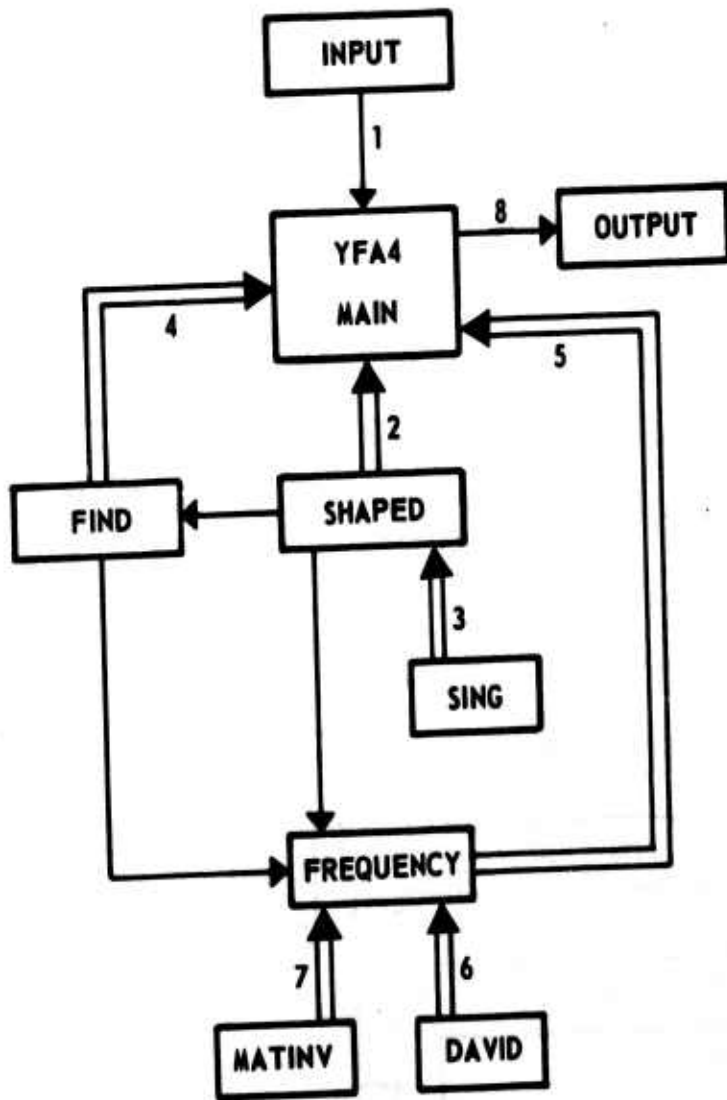

THE NUMBERS IN THE ABOVE INDICATE THE PROCESS ORDER

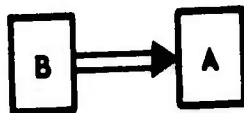

B IS CALLED BY A

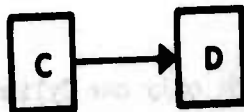

INFORMATION FROM C
IS GIVEN TO D VIA
COMMON VARIABLES

Figure 4 - Program Organization

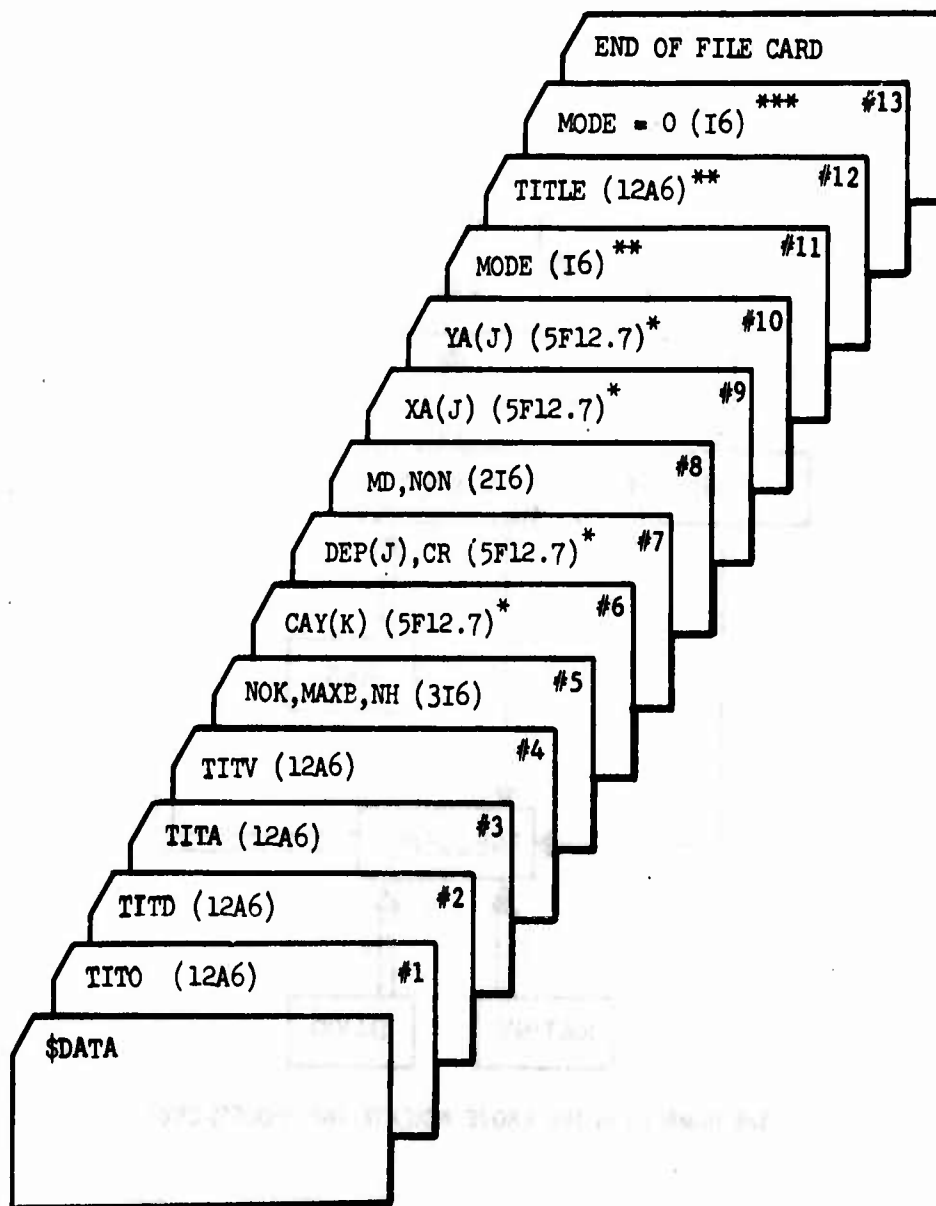

* More than one card may be needed.

** This setup indicates a case in which only one mode is being calculated.

*** This setup indicates a case in which only one Cylinder is being handled.

Figure 5 - Input Setup for YFA4

Column No. →	6	12	18	24	36	48	60
Card No.							
↓							
1	TESTING OF W. FRANK 2-D CYLINDER PROBLEM						
2							
3	EXAMINATION OF ADDED MASS FOR TRIANGULAR CYLINDER						
4							
5	2	9	1				
6	.15	0.25					
7	.50	0.0					
8	1	13					
9	0.0	0.19635	0.39270	0.58905	0.78540		
	0.98175	1.17810	1.37445	1.57080	1.37445		
	1.17810	0.78540	0.39270	0.0			
10	-2.0	-1.75	-1.5	-1.25	-1.0		
	-0.75	-0.50	-0.25	-0.000010	-0.000008		
	-0.000006	-0.000004	-0.000002	-0.0			
11	1						
12	SUBMERGED TRIANGULAR CYLINDER - HEAVE						
13	0						

Figure 6 - Listing of Sample Data Cards
 (Cards are set up for the output shown
 in Figures 9 and 10.)

an integer number which is an argument of the variable XA so that XA (MAXB) corresponds to the half-beam of the cylinder. (See Card 9 for the definition of XA.) The input for MAXB is used only for the purpose of obtaining the half-beam and the sectional area coefficient of the cylinder. These data have no effect on the hydrodynamic quantities. NH is the number of different depths of submergence of the cylinder to be studied. If only a floating cylinder is to be considered, then NH = 1. A maximum of ten depths may be provided.

Card 6 - (CAY(K), K = 1, NOK); (5F12.7):

CAY(K) are the nondimensionalized frequencies to be run and are defined by

$$CAY = \frac{\omega^2 a}{g}$$

where ω is the radian frequency,

a is the half-beam for a floating cylinder,
 a is the half-draft for a submerged cylinder, and

g is the gravitational acceleration.

The quantities used to determine CAY can be in any consistent dimensional units. The program can handle zero- and infinite-frequency cases by letting the values of CAY be zero and a negative number, respectively. More than one card will be necessary if NOK > 5.

Card 7 - (DEP(J), J = 1, NH), CR; (5F12.7):

DEP(J) are the values of the depths of submergence for the submerged cylinder. (For the floating cylinder, NH=1 and DEP(1) = 0.0). They are measured from the free surface to the top of the submerged cylinder (see Figure 2) in the same scale unit as used for the cylinder dimensions. The data for DEP(J) may require more than one card if NH > 5. CR is the

negative vertical distance from the center of rotation to the free surface for a floating cylinder or to the intersection of the vertical line of symmetry and the upper contour of the cylinder for a submerged body. CR is needed only when roll motion is considered. If a roll motion is not considered, the user should provide a zero value for CR.

Card 8 - MD, NON; (2I6):

MD is a control integer whose value depends on whether the cylinder is floating or submerged. MD = 1 for a submerged body and MD = 2 for a floating body. NON is the number of segments to be taken on the right-half of the body contour. To determine the number of segments, see Section III of the Remarks. The maximum number of segments is 45.

Card 9 - (XA(J), J = 1, NUT); (5F12.7):

These are the horizontal offsets of the end points of the line segments located on the cylinder contour. These are measured from the vertical line of symmetry. The scale unit of these data can be arbitrary, provided all other length scales involved for the input data are consistent. The value of NUT is internally defined as $NUT = NON + 1$ where NON, the number of segments on the half-cylinder contour, was read in on Card 8. Since the present program is capable of treating only symmetrical cylinders, the X-coordinates of the points on the body contour are given only for the right-hand side of the cylinder contour. These values should be given as positive numbers. The first input point XA(1) must be that of the intersection of the vertical line of symmetry with the bottom contour of the cylinder and should always be given by $XA(1) = 0.$ The remaining points are read in the counterclockwise direction around the contour. The last point should be the intersecting point of the calm waterline and the

cylinder contour for a floating cylinder or the intersection point of the vertical line of symmetry and the upper contour for a submerged body. The foregoing description is shown in Figure 7. Several cards may be needed to provide the input data for XA(J).

Card 10 - (YA(J), J = 1, NUT); (5F12.7):

These are the vertical offsets of the end points of the segments on the cylinder contour. They form ordered pairs of offsets with the XA(J) values. As shown in Figure 7, the YA points for a floating cylinder are measured from the free surface, and the YA points for a submerged body are measured from the intersection of the vertical line of symmetry and the upper contour of the cylinder. Note that for either case they will be entered into the program as negative numbers or zero.

Card 11 - MODE; I(6):

MODE is a control variable whose value depends on the type of oscillation. MODE = 1 for heave, MODE = 2 for sway, and MODE = 3 for roll.

Card 12 - TITLE; (12A6):

The information contained on this card is printed out as a title on the program output. Its primary purpose is to describe the specific geometric shape that the input represents. It may also be used to emphasize the mode that is being considered (see the section on Program Output).

If more than one mode of motion is to be considered, the user should provide additional sets of MODE and TITLE cards just after Card 12. For example, if the user wants to consider sway and roll motions in addition to heave motion, he has to provide four more cards after Card 12. The first extra card should give 2 for MD, the second should describe the mode for sway condition, the third should give 3 for MD, and the fourth should describe the mode for roll condition.

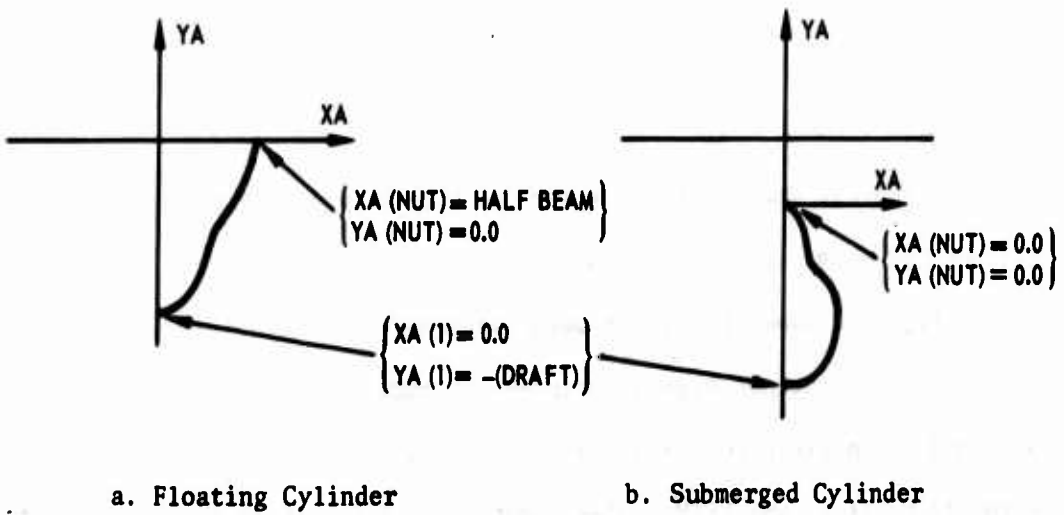

Figure 7 - Description of Coordinates

Card 13 - MODE; (I6):

This is the entry point for a new cylinder. The variable MODE is used not only for designating the different modes of the oscillation but also for transferring to a new cylinder, if any, after all the desired results have been obtained for the preceding cylinder. This transfer is accomplished by assigning MODE equal to a negative integer to indicate that there is another set of data cards for a new cylinder. The new geometry would be read in starting with Card 5. If MODE = 0, it means that the desired computations have been completed and thus the program should call STOP.

PROGRAM OUTPUT

A typical sample printout for the case of a submerged triangular cylinder is shown in Figures 8 and 9.

Figure 8 shows the input data and geometric characteristics of the cylinder. This output page is printed out each time a new geometry is provided. The first two lines are the printout of the input title data TITO, TITD, TITA, and TITV. (See Input Cards 1-4), where TITD and TITV were inputted as blank cards.

The third and fourth lines are the internally executed printout. Under the heading of INPUT VALUES is the printout of the input values. The variables MD, NON, NOK, CR, CAY, and DEPTHS (DEP) have already been defined in the program input. Below these input values are the coordinates XA(J) and YA(J), where XA and YA are as explained under program input. AREA COEFFICIENT is defined by the cross-sectional area divided by the area of a rectangle with the same beam and draft as the inputted cylinder.

Figure 9 is a typical example of the output of the hydrodynamic quantities. The first line is the printout of the input data of the TITLE card (see Card 12 of program input). This line plus the second line giving the depth ratio H/D (H is the depth of submergence as shown in Figure 2 and D is the half-draft of the body) is printed out for each depth. After these lines come the sets of output data for each frequency of oscillation. The CAY value is the same as described in the program input (see Card 6). NONWL is the nondimensional wave length which represents the ratio of the oscillation generated outgoing wave length to the half-beam (half-draft) for a floating (submerged) cylinder. This value provides the general idea of the magnitude of the oscillation frequency. The nondimensional added mass coefficient AMC is defined as the added mass (or added roll moment of inertia) per unit length of the cylinder divided by ρA . The nondimensional damping coefficient DFC is defined as the damping per unit length of the cylinder divided by $\rho \omega A$. The quantities in the divisor are defined as:

ρ = density of fluid,

ω = radian frequency of oscillation,

$$A = \begin{cases} \frac{\pi}{2} (\text{half-beam})^2 & \text{for a floating cylinder in heave or sway.} \\ \pi (\text{half-draft})^2 & \text{for a submerged cylinder in heave or sway.} \\ \frac{\pi}{4} (\text{half-beam})^4 & \text{for a floating cylinder in roll.} \\ \frac{\pi}{2} (\text{half-draft})^4 & \text{for a submerged cylinder in roll} \end{cases}$$

WVH is the ratio of the outgoing wave amplitude to the motion amplitude.

TESTING OF W. FRANK 2-D CYLINDER PROBLEM
EXAMINATION OF ADDED MASS FOR TRIANGULAR CYLINDER

SURMERGED CYLINDERS OSCILLATING UNDER THE FREE SURFACE

H/D = DEPTH TO TOP OF BODY / HALF DRAFT

INPUT VALUES

MD = 1 NON = 13 NOK = 2 CR = 0.

CAY VALUES

0.1500000 0.2500000

DEPTHS

0.5000000

ABSCISSAS OF CYLINDRICAL CROSS SECTION

0.	0.19635	0.39270	0.58905	0.78540
0.98175	1.17810	1.37445	1.57080	1.37445
1.17810	0.78540	0.39270	0.	

ORDINATES OF CYLINDRICAL CROSS SECTION

-2.00000	-1.75000	-1.50000	-1.25000	-1.00000
-0.75000	-0.50000	-0.25000	-0.00001	-0.00001
-0.00001	-0.00000	-0.00000	0.	

HALF BEAM =	1.57080
DRAFT =	2.00000
AREA COEFFICIENT =	0.50000

Figure 8 - Geometric Output

SUBMERGED TRIANGULAR CYLINDER - HEAVE

HEAVING OSCILLATIONS, H/D = 0.50000

CAY = 0.1500 NONWL = 41.8879

AMC = 5.73358 DFC = 3.53881 W VH = 0.50014

PRESSURES IN PHASE WITH ACCELERATION

0.33350	0.33592	0.32991	0.31565	0.29184
0.25516	0.19750	0.08275	-0.22434	-0.38084
-0.55365	-0.71550	-0.79729		

PRESSURES IN PHASE WITH VELOCITY

-0.24004	-0.25312	-0.26985	-0.29061	-0.31642
-0.34937	-0.39421	-0.47112	-0.64755	-0.73502
-0.83210	-0.92313	-0.96914		

DETERMINANT = 0.85849593E-18

CAY = 0.2500 NONWL = 25.1327

AMC = 2.01477 DFC = 5.19088 W VH = 1.00957

PRESSURES IN PHASE WITH ACCELERATION

0.71930	0.74604	0.76539	0.77850	0.78522
0.78395	0.76987	0.71910	0.52156	0.41059
0.28514	0.16480	0.10291		

PRESSURES IN PHASE WITH VELOCITY

0.05588	0.03895	0.01639	-0.01347	-0.05354
-0.10926	-0.19286	-0.35562	-0.79080	-1.03027
-1.30621	-1.57200	-1.70890		

DETERMINANT = 0.12779346E-17

Figure 9 - Hydrodynamic Output

The pressures in phase with the motion acceleration and velocity shown in the output are the pressures on each segment of the half-contour of the cylinder cross section starting from the bottom segment and proceeding in a counterclockwise direction. The values are the pressures divided by $\rho g h_0$ (where h_0 is the amplitude of the oscillation) and are to be read row by row. The value of DETERMINANT is a scaled value of the determinant of the matrix coefficient used in determining the source strengths on the cylinder contour (see Equation (23) of the reference). The significance of the value of DETERMINANT is explained in Section II of REMARKS.

REMARKS

CORRECTIONS TO REPORT 2375

The following changes are corrections to typographical errors and do not affect the numerical results. The corrections are indicated by asterisks.

Page	Equation No.	Correction
8	(26)	$\sum_{i=1}^N p_a^{(m)}(x_i, y_i; \omega) n_i^{(m)} S_i^* $
8	(27)	$\sum_{i=1}^N p_v^{(m)}(x_i, y_i; \omega) n_i^{(m)} S_i^* $
9		$\psi_k = B_k \sin(k\pi x/B) \sinh(k\pi y/B)$
14		$\text{P.V.} \int_0^\infty \frac{e^{-ik(z-\xi)}}{v-k} dk$
14	(31)	$-i\pi e^{-iv(z-\xi)}$

Page Equation No. Correction

14 (32) On second and fourth lines the right side of the equation add:

$$+ \begin{cases} 2\pi i & \text{for } x - \xi > 0 \\ 0 & \text{for } x - \xi < 0 \end{cases}$$

15 (33)
$$i \left[\sum_{n=1}^{\infty} \frac{r^n \sin(n\theta)}{n \cdot n!} + \begin{cases} \theta & \text{for } x - \xi > 0 \\ \theta - 2\pi & \text{for } x - \xi < 0 \end{cases} \right]$$

15
$$S(r, \theta) = \sum_{n=1}^{\infty} \frac{r^n \sin(n\theta)}{n \cdot n!} + \begin{cases} \theta & \text{for } x - \xi > 0 \\ \theta - 2\pi & \text{for } x - \xi < 0 \end{cases}$$

16 (35)
$$\int_{s_j} \left[\frac{1}{2\pi} (\log(z - \zeta) \dots \right]$$

20 (42) If we rewrite Eq. (42) in the form of

$$\phi(m) = \frac{1}{2\pi} \sum_{j=1}^N Q_j R_e \{G_1\} \cos \omega t - \sum_{j=1}^N Q_{N+j} R_e \{G_2\} \sin \omega t, \text{ then the}$$

corrected form should be

$$\phi(m) = \left[\frac{1}{2\pi} \sum_{j=1}^N Q_j R_e \{G_1\} - \sum_{j=1}^N Q_{N+j} R_e \{G_2\} \right] \cos \omega t + \left[\frac{1}{2\pi} \sum_{j=1}^N Q_{N+j} R_e \{G_1\} + \sum_{j=1}^N Q_j R_e \{G_2\} \right] \sin \omega t$$

LIMITATIONS OF THE PROGRAM

Irregular Frequencies

As described on page 9 of the reference, there exists for a given floating cylinder a set of discrete frequencies at which the described theory fails to give a correct solution. Such frequencies are called "irregular frequencies." An approximate formula to find these frequencies is given by

$$\omega_j = g \sqrt{\frac{j\pi}{B} \cot h(j\pi d/B)}, \quad j = 1, 2, \dots$$

where g is the gravitational acceleration,
 B is the beam of the cylinder, and
 d is the draft of the cylinder.

If the value of either DETERMINANT or some other computed value shows sudden discontinuities when plotted versus frequency, the user should regard this as due to the irregular frequency problem and thus should discard all results of these discontinuities.

Unsuitable Cylinder Forms

The present program cannot handle certain cylindrical forms primarily because of the limitation of the built-in function for the arc tangent which is called ATAN2 (X,Y). The range of the angle defined by this function is $-\pi < \theta \leq \pi$. When $X < 0$ and Y approaches zero, the value of the ATAN2 function can either approach π or $-\pi$ depending on the direction of the approach. This sensitivity of ATAN2 coupled with roundoff error can cause a large error in the computed results of the present program. The following case provides an example:

$$X < 0$$

$$Y = A - \left(\frac{A+A}{2} \right)$$

If A is a floating number, the value of Y could be either $Y \geq 1.E-38$ or $Y \leq -1.E-38$ depending on computer facilities (referring to IBM 7090). The former case $ATAN2(X,Y) = \pi$, and the later case $ATAN2(X,Y) = -\pi$.

In the following two cases, the program may produce wrong results:

1. The cylinder has horizontal lines as part of its top contour (see e.g., Figure 10) and the user's computer yields

$$Y = \left(\frac{A+A}{2} \right) - A \leq -1.E-38$$

where A is a floating number.

2. The cylinder has horizontal lines as part of its bottom contour (see e.g., Figure 11) and the user's computer yields

$$Y = \left(\frac{A+A}{2} \right) - A \geq 1.E-38$$

The following remedies are suggested whenever the user encounters the above two cases:

Case 1 - Replace the horizontal lines on the top contour by the dotted lines as shown in Figure 10 and provide the coordinate data for XA and YA (see Input Cards 9 and 10) based on the modified shape.

Case 2 - Replace the horizontal lines on the bottom contour by the dotted lines as shown in Figure 11 and provide the coordinate data for XA and YA based on the modified shape.

The present program cannot treat cylinders which have two or more points on their half-section boundaries having identical vertical coordinates. Some examples of such cylinders are shown in Figure 12.

DETERMINATION OF NUMBER OF BODY SEGMENTS

There is no definite rule to determine how many segments are required to obtain results that are sufficiently accurate. As more segments are provided, the results become more accurate. A trial-and-error method must be used by the user to determine how many segments will yield the desired accuracy. The use of a large number of segments should be avoided as the time, and thus the cost, increases roughly with the square of the increase in segment numbers.

Nine segments of equal circumferential length have been found to yield satisfactory results for a floating semicircular cylinder. Twelve segments have proved satisfactory for a submerged rectangle. Because the source strengths are averaged over each segment, it should be noted that for extreme cases, such as rectangular bodies, the segment lengths should be smaller near the sharp corners. The user should never use less than six segments for a floating cylinder or less than ten for a submerged cylinder.

ESTIMATED COMPUTER TIME

It is always a difficult task to provide an accurate estimate of the running time of a computer program. The present program is no exception and the difficulty is increased because of independent variables involved. These include the number of segments on the body, frequencies, depths of submergence, modes of motion, and cylinder shapes. Under such

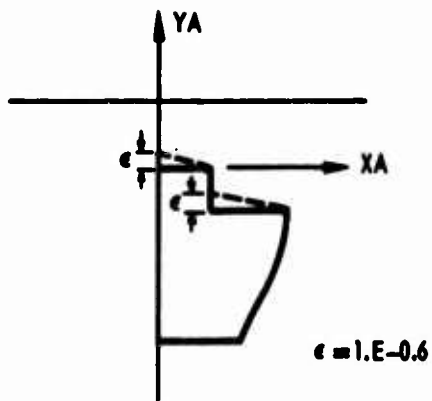

Figure 10 - Alteration for
Upper Horizontal Contour

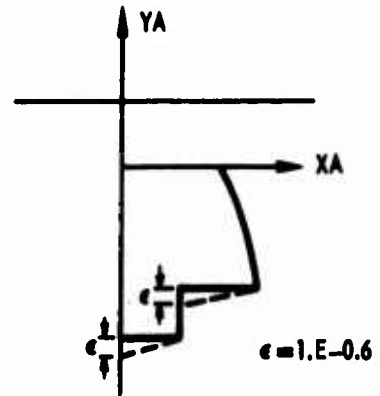

Figure 11 - Alteration for
Lower Horizontal Contour

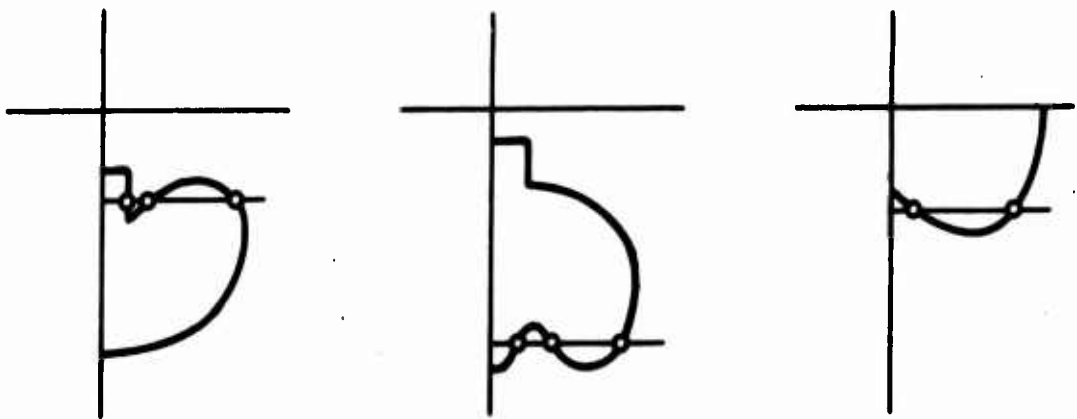

Figure 12 - Cylinder Forms Unsuitable for
Program YFA4

circumstances, the best rough estimates that can be provided are based on experience with the IBM 7090 computer at NSRDC. The suggested formula for the IBM 7090 which gives the computer time in minutes for a given cylinder is:

$$0.1 (A \times B \times C) \left(\frac{N}{12}\right)^2 + 1.5$$

where A is the number of frequencies,

B is the number of depths of submergence,

C is the number of modes of motion, and

N is the number of segments on the half-contour of the cylinder cross section.

ACKNOWLEDGMENTS

The authors acknowledge the significant achievements of the late Mr. W. Frank who developed the program and express their thanks to Mr. V.J. Monacella for his helpful comments and careful review of the manuscript.

**APPENDIX
PROGRAM LISTING**

C MAIN PROGRAM -- YFA4

DIMENSION XA(46),YA(46)

COMMON PI,HPI,QPI,TPI,MD,MODE,DPH,CR,RAT,SUR,DEG,JERK,DRT,HBM,SG,N
1OE,PDM,VOL,DEW,UN,OMEGA,CP,WVH,ID,DOG,IG,SEN(46),CES(46),XX(45),YY
2(45),DEL(45),SNE(45),CSE(45),FR(45),BLOG(45,45),YLOG(45,45),CON(90
3,1),CT(90,90),PSI1(45,45),PSI2(45,45),PRA(45),PRV(45),DEP(10)

COMMON/GR/NOK,NUT,NON,TITLE(12),TITO(12),CAY(50),AMC(50),DFC(50),X
1(46),Y(46)

COMMON/FQ/K

COMMON/TT/TEST

COMMON/GRPH/TITD(12),DET(50),LAD,LDT,TITA(12),TITV(12),PAK(50),PVK
1(50),PAS(50),PVS(50),LPV

COMMON/SHP/MAXB,DUL(45)

COMMON/MOD/F(5),D(5)

1 FORMAT(12I6)

2 FORMAT(5F12.7)

3 FORMAT(12A6)

4 FORMAT(////60H SUBMERGED CYLINDERS OSCILLATING UNDER THE FREE

1 SURFACE//6X,40H H/D = DEPTH TO TOP OF BODY / HALF DRAFT)

5 FORMAT(39HO TRANSFORMATION NOT DEFINED - STOP)

6 FORMAT(24HO MATRIX IS SINGULAR)

7 FORMAT(34HO HEAVING OSCILLATIONS, H/D = F10.5)

8 FORMAT(34HO SWAYING OSCILLATIONS, H/D = F10.5)

9 FORMAT(33HO ROLLING OSCILLATIONS ABOUT F10.5,8H H/D = F10.5)

10 FORMAT(12HO CAY = F8.4,13H NONWL = F8.4)

11 FGMAT(12HO AMC = F10.5,9H DFC = F10.5,9H WVH = F10.5)

12 FORMAT(42HO PRESSURES IN PHASE WITH ACCELERATION//)

13 FORMAT(5F12.5)

14 FORMAT(38HO PRESSURES IN PHASE WITH VELOCITY//)

29 FORMAT(20HO DETERMINANT = E15.8)

34 FORMAT(6X,14HSTRUT DEPTH = F4.2,10H, ARC = F8.4,8H DEGREES/6X,20
1HDFC = 0.0 FOR CAY = F4.2)

35 FORMAT(1HO,12X,12H HALF BEAM = F10.5/17X,8HDRAFT = F10.5/6X,19H AREA
1 COEFFICIENT = F10.5)

36 FORMAT(1HO,5X,38H ABSCISSAS OF CYLINDRICAL CROSS SECTION//)

37 FORMAT(1HO,5X,38H ORDINATES OF CYLINDRICAL CROSS SECTION//)

42 FORMAT(1HO,5X,42H IMPULSIVE SURFACE CONDITION, NU VERY LARGE)

52 FORMAT(////61H SEMISUBMERGED CYLINDERS OSCILLATING IN THE FRE
1E SURFACE)

54 FORMAT(5H MD = ,I3,4X,

6H NON = ,I3,4X,6H NOK = ,I3,4X

1,5H CR = ,F9.4)

65 FORMAT(2H1 ,12A6)

66 FORMAT(///2X,11H CAY VALUES//(5F12.7))

67 FORMAT(/// 2X,13H INPUT VALUES//)

68 FORMAT(//2X,7H DEPTHS//(5F12.7))

69 FORMAT(2H1 ,12A6//)

70 FORMAT(2X,////)

71 FORMAT(2H1)

PI=3.1415927

HPI=.5*PI

QPI=.5*HPI

TPI=2.*PI

F(1)=0.52175561

F(2)=0.39866681

```

F(3)=0.075942450
F(4)=0.003611758
F(5)=0.000023369972
D(1)=0.26356032
D(2)=1.4134031
D(3)=3.5964258
D(4)=7.0858100
D(5)=12.640801
READ(5,3)(TITO(J),J=1,12)
READ(5,3)(TITD(J),J=1,12)
READ(5,3)(TITA(J),J=1,12)
READ(5,3)(TITV(J),J=1,12)
WRITE(6,65) (TITO(J),J=1,12)
WRITE(6,3) (TITD(J),J=1,12)
WRITE(6,3) (TITA(J),J=1,12)
WRITE(6,3) (TITV(J),J=1,12)
55 READ(5,1) NOK,MAXB,NH
READ(5,2) (CAY(K),K=1,NOK)
READ(5,2) (DEP(J),J=1,NH),CR
READ(5,1) MD,NON
NUT=NON+1
READ(5,2) (XA(J),J=1,NUT)
READ(5,2) (YA(J),J=1,NUT)
GO TO (61,62),MD
62 HBEAM=XA(NUT)
GO TO 63
61 HBEAM=XA(MAXB)-XA(1)
63 AREA=0.0
DO 64 J=1,NON
XX(J)=.5*(XA(J)+XA(J+1))
XINT=XA(J+1)-XA(J)
YINT=YA(J+1)-YA(J)
DA=YINT*XX(J)
AREA=AREA+DA
DUL(J)=SQRT(XINT**2+YINT**2)
SNE(J)=YINT/DUL(J)
64 CSE(J)=XINT/DUL(J)
DRAFT=YA(NUT)-YA(1)
AREA=AREA/(HBEAM*DRAFT)
GO TO (50,51),MD
51 WRITE(6,52)
GO TO 53
50 WRITE(6,4)
53 WRITE(6,67)
WRITE(6,54) MD,NON,NOK,CR
WRITE(6,66) (CAY(K),K=1,NOK)
WRITE(6,68) (DEP(J),J=1,NH)
WRITE(6,36)
WRITE(6,13) (XA(J),J=1,NUT)
WRITE(6,37)
WRITE(6,13) (YA(J),J=1,NUT)
WRITE(6,35) HBEAM,DRAFT,AREA
38 READ(5,1) MODE
IF(MODE) 40,40,41
41 READ(5,3)(TITLE(J),J=1,12)
DO 20 I5=1,NH

```

NOT REPRODUCIBLE

NOT REPRODUCIBLE

```
WRITE(6,69) (TITLE(J),J=1,12)
DPH=DEP(I5)
DO 78 J=1,NUT
X(J)=XA(J)
78 Y(J)=YA(J)
17 CALL SHAPED
18 CALL FIND
32 GO TO(21,22,23),MODE
21 WRITE(6,7)DPH
GO TO 24
22 WRITE(6,8)DPH
GO TO 24
23 WRITE(6,9)CR,DPH
24 WRITE(6,70)
DO 20 K=1,NOK
UN=CAY(K)/PDM
OMEGA=SQRT(ABS(UN))
WLN=2.*PI/ABS(CAY(K))
WN=CAY(K)/DRT
IF(UN)43,44,44
43 WRITE(6,42)
GO TO 45
44 WRITE(6,10) CAY(K),WLN
45 CALL FREQ
ID=ID
GO TO(25,28),ID
28 WRITE(6,6)
GO TO 48
25 WRITE(6,11)AMC(K),DFC(K),WVH
WRITE(6,12)
WRITE(6,13)(PRA(J),J=1,NON)
WRITE(6,14)
WRITE(6,13)(PRV(J),J=1,NON)
WRITE(6,29)DOG
PAK(K)=PRA(1)
PVK(K)=PRV(1)
PAS(K)=PRA(NON)
PVS(K)=PRV(NON)
IF(UN)46,46,47
46 DET(K)=0.0
GO TO 48
47 DET(K)=DOG
48 WRITE(6,70)
20 CONTINUE
27 GO TO 38
40 WRITE(6,71)
IF(MODE.LT.0) GO TO 55
STOP
END
```

SUBROUTINE SHAPED

```

COMMON PI,HPI,QPI,TPI,MD,MODE,DPH,CR,RAT,SUR,DEG,JERK,DRT,HBM,SG,N
10E,PDM,VOL,DEW,UN,OMEGA,CP,WVH,ID,DOG,IG,SEN(46),CES(46),XX(45),YY
2(45),DEL(45),SNE(45),CSE(45),FR(45),BLOG(45,45),YLOG(45,45),CON(90
3,1),CT(90,90),PSI1(45,45),PSI2(45,45),PRA(45),PRV(45)
COMMON/GR/NOK,NUT,NON,TITLE(12),TITO(12),CAY(50),AMC(50),DFC(50),X
1(46),Y(46)
COMMON/SHP/MAXB,DUL(45)
JERK=1
KAB=MAXB
GO TO (10,15),MD
15 D=X(NUT)
DPH=0.0
GO TO 53
10 D=.5*(Y(NUT)-Y(1))
53 DO 54 J=1,NUT
X(J)=X(J)/D
54 Y(J)=Y(J)/D
DRT=D
HBM=X(KAB)
CP=CR/D
IF(DPH) 24,24,21
21 DPH=DPH/D
DO 22 J=1,NUT
22 Y(J)=Y(J)-DPH
NUT=NON+1
24 DO 25 J=1,NON
XX(J)=.5*(X(J)+X(J+1))
YY(J)=.5*(Y(J)+Y(J+1))
25 DEL(J)=DUL(J)/D
SG=SING(MODE)
NOE=2*NON
GO TO(26,27,28),MODE
26 DO 29 J=1,NON
29 FR(J)=CSE(J)
33 PDM=1.0
DEW=1.0
GO TO (31,30),MD
30 VOL=HPI
GO TO 37
31 VOL=PI
GO TO 37
27 DO 32 J=1,NON
32 FR(J)=-SNE(J)
GO TO 33
28 DO 34 J=1,NON
34 FR(J)=(YY(J)-CP)*SNE(J)+XX(J)*CSE(J)
DEW=HBM
PDM=1.0
GO TO (36,35),MD
35 VOL=QPI
GO TO 37
36 VOL=HPI
37 RETURN
END

```

NOT REPRODUCIBLE

```
FUNCTION SING(N)
  IF(1-N)2,1,1
  1 SING=1.
  GO TO 77
  2 SING=-1.
  77 RETURN
  END
```

SUBROUTINE FIND

COMMON PI,HPI,QPI,TPI,MD,MODE,DPH,CR,RAT,SUR,DEG,JERK,DRT,HBM,SG,N
 10E,PDM,VOL,DEW,UN,OMEGA,CP,WVH,ID,DOG,IG,SEN(46),CES(46),XX(45),YY
 2(45),DEL(45),SNE(45),CSE(45),FR(45),BLOG(45,45),YLOG(45,45),CON(90
 3,1),CT(90,90),PSI1(45,45),PSI2(45,45),PRA(45),PRV(45)

COMMON/GR/NOK,NUT,NON,TITLE(12),TITO(12),CAY(50),AMC(50),DFC(50),X
 1(46),Y(46)

DO 1 I=1,NON

XM1=XX(I)-X(1)

YM1=YY(I)-Y(1)

XP1=XX(I)+X(1)

YP1=YY(I)+Y(1)

FPR1=.5*ALOG(XM1**2+YM1**2)

FPL1=.5*ALOG(XP1**2+YM1**2)

FCR1=.5*ALOG(XM1**2+YP1**2)

FCL1=.5*ALOG(XP1**2+YP1**2)

APR1=ATAN2(YM1,XM1)

APL1=ATAN2(YM1,XP1)

ACR1=ATAN2(YP1,XM1)

ACL1=ATAN2(YP1,XP1)

DO 1 J=1,NON

XM2=XX(I)-X(J+1)

YM2=YY(I)-Y(J+1)

XP2=XX(I)+X(J+1)

YP2=YY(I)+Y(J+1)

FPR2=.5*ALOG(XM2**2+YM2**2)

FPL2=.5*ALOG(XP2**2+YM2**2)

FCR2=.5*ALOG(XM2**2+YP2**2)

FCL2=.5*ALOG(XP2**2+YP2**2)

APR2=ATAN2(YM2,XM2)

APL2=ATAN2(YM2,XP2)

ACR2=ATAN2(YP2,XM2)

ACL2=ATAN2(YP2,XP2)

SIMJ=SNE(I)*CSE(J)-SNE(J)*CSE(I)

CIMJ=CSE(I)*CSE(J)+SNE(I)*SNE(J)

SIPJ=SNE(I)*CSE(J)+SNE(J)*CSE(I)

CIPJ=CSE(I)*CSE(J)-SNE(I)*SNE(J)

DPNR=SIMJ*(FPR1-FPR2)+CIMJ*(APR1-APR2)

99 PPR=CSE(J)*(XM1*FPR1-YM1*APR1-XM1-XM2*FPR2+YM2*APR2+XM2)+SNE(J)*(Y
 1M1*FPR1+XM1*APR1-YM1-YM2*FPR2-XM2*APR2+YM2)

DPNL=SIPJ*(FPL2-FPL1)+CIPJ*(APL2-APL1)

PPL=CSE(J)*(XP2*FPL2-YM2*APL2-XP2-XP1*FPL1+YM1*APL1+XP1)+SNE(J)*(Y
 1M1*FPL1+XP1*APL1+YM2-YM2*FPL2-XP2*APL2-YM1)

DCNR=SIPJ*(FCR1-FCR2)+CIPJ*(ACR1-ACR2)

PCR=CSE(J)*(XM1*FCR1-YP1*ACR1-XM1-XM2*FCR2+YP2*ACR2+XM2)+SNE(J)*(Y
 1P2*FCR2+XM2*ACR2+YP1-YP1*FCR1-XM1*ACR1-YP2)

DCNL=SIMJ*(FCL2-FCL1)+CIMJ*(ACL2-ACL1)

PCL=CSE(J)*(XP2*FCL2-YP2*ACL2-XP2-XP1*FCL1+YP1*ACL1+XP1)+SNE(J)*(Y
 1P2*FCL2+XP2*ACL2-YP2-YP1*FCL1-XP1*ACL1+YP1)

BLOG(I,J)=DPNR+SG*DPNL-DCNR-SG*DCNL

YLOG(I,J)=PPR+SG*PPL-PCR-SG*PCL

IF(J-NON)2,1,1

2 XM1=XM2

NOT REPRODUCIBLE

YM1=YM2
XP1=XP2
YP1=YP2
FPR1=FPR2
FPL1=FPL2
FCR1=FCR2
FCL1=FCL2
APR1=APR2
APL1=APL2
ACR1=ACR2
ACL1=ACL2
1 CONTINUE
RETURN
END

SUBROUTINE FREQ

COMMON PI,HPI,QPI,TPI,MD,MODE,DPH,CR,RAT,SUR,DEG,JERK,DRT,HBM,SG,N
 IOE,PDM,VOL,DEW,UN,OMEGA,CP,WVH,ID,DOG,IG,SEN(46),CES(46),XX(45),YY
 2(45),DEL(45),SNE(45),CSE(45),FR(45),BLOG(45,45),YLOG(45,45),CON(90
 3,1),CT(90,90),PSI1(45,45),PSI2(45,45),PRA(45),PRV(45)

COMMON/GR/NOK,NUT,NON,TITLE(12),TITO(12),CAY(50),AMC(50),DFC(50),X
 1(46),Y(46)

COMMON/FQ/K

COMMON/TT/TEST

IF(UN)8,9,10

8 DO 11 I=1,NON

DO 11 J=1,NON

NOT REPRODUCIBLE

CT(I,J)=BLOG(I,J)

11 PSI1(I,J)=YLOG(I,J)

GO TO 14

9 DO 12 I=1,NON

XM1=XX(I)-X(1)

XP1=XX(I)+X(1)

YP1=YY(I)+Y(1)

FCR1=.5*ALOG(XM1**2+YP1**2)

FCL1=.5*ALOG(XP1**2+YP1**2)

ACR1=ATAN2(YP1, XM1)

ACL1=ATAN2(YP1, XP1)

DO 12 J=1,NON

XM2=XX(I)-X(J+1)

XP2=XX(I)+X(J+1)

YP2=YY(I)+Y(J+1)

FCR2=.5*ALOG(XM2**2+YP2**2)

FCL2=.5*ALOG(XP2**2+YP2**2)

ACR2=ATAN2(YP2, XM2)

ACL2=ATAN2(YP2, XP2)

SIMJ=SNE(I)*CSE(J)-SNE(J)*CSE(I)

CIMJ=CSE(I)*CSE(J)+SNE(I)*SNE(J)

SIPJ=SNE(I)*CSE(J)+SNE(J)*CSE(I)

CIPJ=CSE(I)*CSE(J)-SNE(I)*SNE(J)

DCNR=SIPJ*(FCR1-FCR2)+CIPJ*(ACR1-ACR2)

PCR=CSE(J)*(XM1*FCR1-YP1*ACR1-XM1-XM2*FCR2+YP2*ACR2+XM2)+SNE(J)*(Y
 1P2*FCR2+XM2*ACR2+YP1-YP1*FCR1-XM1*ACR1-YP2)

DCNL=SIMJ*(FCL2-FCL1)+CIMJ*(ACL2-ACL1)

PCL=CSE(J)*(XP2*FCL2-YP2*ACL2-XP2-XP1*FCL1+YP1*ACL1+XP1)+SNE(J)*(Y
 1P2*FCL2+XP2*ACL2-YP2-YP1*FCL1-XP1*ACL1+YP1)

CT(I,J)=BLOG(I,J)+2.0*(DCNR+SG*DCNL)

PSI1(I,J)=YLOG(I,J)+2.0*(PCR+SG*PCL)

IF(J-NON)13,12,12

13 XM1=XM2

XP1=XP2

YP1=YP2

FCR1=FCR2

FCL1=FCL2

ACR1=ACR2

ACL1=ACL2

12 CONTINUE

14 DO 15 I=1,NON

15 CON(I,1)=FR(I)

CALL MATINV(CT,NON,CON,1,DOG, ID)

```

GO TO(16,6),ID
16 DO 17 I=1,NON
PRA(I)=0.0
PRV(I)=0.0
DO 17 J=1,NON
17 PRA(I)=PRA(I)-CON(J,1)*PSI1(I,J)
AMC(K)=0.0
DFC(K)=0.0
WVH=0.0
DO 18 I=1,NON
18 AMC(K)=AMC(K)+PRA(I)*DEL(I)*FR(I)
AMC(K)=2.0*AMC(K)/VOL
GO TO 6
10 DO 1 I=1,NON
NI=NON+I
CON(I,1)=0.
CON(NI,1)=OMEGA*FR(I)
XR1=UN*(XX(I)-X(1))
YR1=-UN*(YY(I)+Y(1))
XL1=UN*(XX(I)+X(1))
YL1=YR1
CALL DAVID(XR1,YR1,EJ1,CXR1,SXR1,RAR1,RBR1,CR1,SR1)
CALL DAVID(XL1,YL1,EJ1,CXL1,SXL1,RAL1,RBL1,CL1,SL1)
DO 1 J=1,NON
NJ=NON+J
XR2=UN*(XX(I)-X(J+1))
YR2=-UN*(YY(I)+Y(J+1))
XL2=UN*(XX(I)+X(J+1))
YL2=YR2
CALL DAVID(XR2,YR2,EJ2,CXR2,SXR2,RAR2,RBR2,CR2,SR2)
CALL DAVID(XL2,YL2,EJ2,CXL2,SXL2,RAL2,RBL2,CL2,SL2)
SIPJ=SNE(I)*CSE(J)+SNE(J)*CSE(I)
CIPJ=CSE(I)*CSE(J)-SNE(I)*SNE(J)
SIMJ=SNE(I)*CSE(J)-SNE(J)*CSE(I)
CIMJ=CSE(I)*CSE(J)+SNE(I)*SNE(J)
CT(I,J)=BLOG(I,J)+2.0*(SIPJ*(CR1-CR2)-CIPJ*(SR1-SR2)-SG*(SIMJ*(CL1-
1CL2)-CIMJ*(SL1-SL2)))
PSI1(I,J)=YLOG(I,J)+2.0/UN*(SNE(J)*(RAR1-RAR2)+CSE(J)*(RBR1-RBR2)+S
1G*(SNE(J)*(RAL1-RAL2)+CSE(J)*(RBL2-RBL1)))
CT(NI,NJ)=CT(I,J)
CT(I,NJ)=TPI*(EJ2*(SXR2*CIPJ-CXR2*SIPJ)-EJ1*(SXR1*CIPJ-CXR1*SIPJ)-
1SG*(EJ2*(SXL2*CIMJ-CXL2*SIMJ)-EJ1*(SXL1*CIMJ-CXL1*SIMJ)))
PSI2(I,J)=TPI/UN*(EJ1*(SXR1*CSE(J)-CXR1*SNE(J))-EJ2*(SXR2*CSE(J)-C
1XR2*SNE(J))-SG*(EJ1*(SXL1*CSE(J)+CXL1*SNE(J))-EJ2*(SXL2*CSE(J)+CXL
22*SNE(J)))
CT(NI,J)=-CT(I,NJ)
IF(J-NON)7,1,1
7 XR1=XR2
YR1=YR2
XL1=XL2
YL1=YL2
EJ1=EJ2
CR1=CR2
SR1=SR2
CL1=CL2

```

NOT REPRODUCIBLE

```

SL1=SL2
RAR1=RAR2
RBR1=RBR2
RAL1=RAL2
RBL1=RBL2
CXR1=CXR2
SXR1=SXR2
CXL1=CXL2
SXL1=SXL2
1 CONTINUE
CALL MATINV(CT,NOE,CON,1,DOG, ID)
GO TO(2,6),ID
2 DO 3 I=1,NON
PRA(I)=0.
PRV(I)=0.
DO 4 J=1,NON
NJ=NON+J
PRA(I)=PRA(I)+CON(J,1)*PSI2(I,J)-CON(NJ,1)*PSI1(I,J)
4 PRV(I)=PRV(I)+CON(J,1)*PSI1(I,J)+CON(NJ,1)*PSI2(I,J)
PRA(I)=OMEGA*PRA(I)
3 PRV(I)=OMEGA*PRV(I)
AMC(K)=0.0
DFC(K)=0.0
DO 5 I=1,NON
AMC(K)=AMC(K)+PRA(I)*DEL(I)*FR(I)
5 DFC(K)=DFC(K)+PRV(I)*DEL(I)*FR(I)
AMC(K)=2.0*AMC(K)
DFC(K)=2.0*DFC(K)
WVH=OMEGA*SQRT(ABS(DFC(K)))/DEW
AMC(K)=AMC(K)/(UN*VOL)
DFC(K)=DFC(K)/(UN*VOL)
6 RETURN
END

```

SUBROUTINE DAVID(X,Y,E,C,S,RA,RB,CIN,SON)

C COMPUTATION OF EXPONENTIAL INTEGRAL WITH COMPLEX ARGUMENT

COMMON/MOD/F(5),D(5)

Q=3.1415927

AT=ATAN2(X,Y)

ARG=AT-.5*Q

E=EXP(-Y)

C=COS(X)

S=SIN(X)

R=X**2+Y**2

AL=0.5*ALOG(R)

A=-Y

B=-X

IF(A.GE.0.0) GO TO 78

IF(B.EQ.0.0) GO TO 79

78 IF(R.GE.100.) GO TO 10

79 TEST=0.00001

IF(R.LT.1.0) GO TO 5

TEST=0.1*TEST

IF(R.LT.2.0) GO TO 5

TEST=0.1*TEST

IF(R.LT.4.0) GO TO 5

TEST=0.1*TEST

5 CONTINUE

SUMC=0.57721566+AL+Y

SUMS=AT+X

TC=Y

TS=X

DO 1 K=1,500

TO=TC

COX=K

CAY=K+1

FACT=COX/CAY**2

TC=FACT*(Y*TC-X*TS)

TS=FACT*(Y*TS+X*TO)

SUMC=SUMC+TC

SUMS=SUMS+TS

IF(K.GE.500) GO TO 3

IF((ABS(TC)+ABS(TS)).GT.TEST) GO TO 1

3 CIN=E*(C*SUMC+S*SUMS)

SON=E*(S*SUMC-C*SUMS)

GO TO 4

1 CONTINUE

10 G1=0.

G2=0.

DO 20 I=1,5

DEN=(-Y+D(I))**2+X**2

GA=F(I)*(-Y+D(I))/DEN

GB=F(I)*(-X)/DEN

G1=G1+GA

20 G2=G2+GB

CIN=E*Q*S-G1

SON=-E*Q*C+G2

4 RA=AL-CIN

RB=ARG+SON

RETURN

END

```

SUBROUTINE MATINV(A,N1,B,M1,DETERM,IO)
C   PIVOT METHOD
C   MATRIX INVERSION WITH ACCOMPANYING SOLUTION OF SIMUL. EQ.
C   PIVOT METHOD
C   FORTRAN IV SINGLE PRECISION WITH ADJUSTABLE DIMENSION
C   FEBRUARY 1966 S GOOD DAVID TAYLOR MODEL BASIN AM MAT4
C   WHERE CALLING PROGRAM MUST INCLUDE
C   DIMENSION A( ), B( ), INDEX( )
C   N IS THE ORDER OF A
C   M IS THE NUMBER OF COLUMN VECTORS IN B(MAY BE 0)
C   DETERM WILL CONTAIN DETERMINANT ON EXIT
C   IO WILL BE SET BY ROUTINE TO 2 IF MATRIX A IS SINGULAR
C   1 IF INVERSION WAS SUCCESSFUL
C   A THE INPUT MATRIX WILL BE REPLACED BY A INVERSE
C   B THE COLUMN VECTORS WILL BE REPLACED BY CORRESPONDING
C   SOLUTION VECTORS
C   INDEX WORKING STORAGE ARRAY
C   IF IT IS DESIRED TO SCALE THE DETERMINANT CARD MAY BE
C   DELETED AND DETERM PRESET BEFORE ENTERING THE ROUTINE

```

```

C   DIMENSION A(90,90),B(90,1),INDEX(90,3)
C   EQUIVALENCE (IROW,JROW), (ICOLUMN,JCOLUMN), (AMAX, T, SWAP)
C   INITIALIZATION

```

```

C   N=N1
C   M=M1
C   DETERM = 1.0
C   DO 20 J=1,N
20 INDEX(J,3) = 0
C   DO 550 I=1,N

```

NOT REPRODUCIBLE

```

C   SEARCH FOR PIVOT ELEMENT

```

```

C   AMAX = 0.0
C   DO 105 J=1,N
C   IF(INDEX(J,3)-1) 60, 105, 60
60 DO 100 K=1,N
C   IF(INDEX(K,3)-1) 80, 100, 715
80 IF ( AMAX -ABS (A(J,K))) 85, 100, 100
85 IROW=J
C   ICOLUMN =K
C   AMAX = ABS (A(J,K))
100 CONTINUE
105 CONTINUE
C   INDEX(ICOLUMN,3) = INDEX(ICOLUMN,3) +1
C   INDEX(I,1)=IROW
C   INDEX(I,2)=ICOLUMN

```

```

C   INTERCHANGE ROWS TO PUT PIVOT ELEMENT ON DIAGONAL

```

```

C   IF (IROW-ICOLUMN) 140, 310, 140
140 DETERM=-DETERM
C   DO 200 L=1,N
C   SWAP=A(IROW,L)

```

```

      A(IROW,L)=A(ICOLUM,L)
200 A(ICOLUM,L)=SWAP
      IF(M) 310, 310, 210
210 DO 250 L=1, M
      SWAP=A(IROW,L)
      B(IROW,L)=B(ICOLUM,L)
250 B(ICOLUM,L)=SWAP
C
C   DIVIDE PIVOT ROW BY PIVOT ELEMENT
C
310 PIVOT  =A(ICOLUM,ICOLUM)
      DETERM=DETERM*PIVOT
330 A(ICOLUM,ICOLUM)=1.0
      DO 350 L=1,N
350 A(ICOLUM,L)=A(ICOLUM,L)/PIVOT
      IF(M) 380, 380, 360
360 DO 370 L=1,M
370 B(ICOLUM,L)=B(ICOLUM,L)/PIVOT
C
C   REDUCE NON-PIVOT ROWS
C
380 DO 550 L1=1,N
      IF(L1-ICOLUM) 400, 550, 400
400 T=A(L1,ICOLUM)
      A(L1,ICOLUM)=0.0
      DO 450 L=1,N
450 A(L1,L)=A(L1,L)-A(ICOLUM,L)*T
      IF(M) 550, 550, 460
460 DO 500 L=1,M
500 B(L1,L)=B(L1,L)-B(ICOLUM,L)*T
550 CONTINUE
C
C   INTERCHANGE COLUMNS
C
      DO 710 I=1,N
      L=N+1-I
      IF (INDEX(L,1)-INDEX(L,2)) 630, 710, 630
630 JROW=INDEX(L,1)
      JCOLUM=INDEX(L,2)
      DO 705 K=1,N
      SWAP=A(K,JROW)
      A(K,JROW)=A(K,JCOLUM)
      A(K,JCOLUM)=SWAP
705 CONTINUE
710 CONTINUE
      DO 730 K = 1,N
      IF(INDEX(K,3) -1) 715,720,715
720 CONTINUE
730 CONTINUE
      ID = 1
810 RETURN
715 ID = 2
      GO TO 810
      END

```

NOT REPRODUCIBLE

INITIAL DISTRIBUTION

Copies		Copies	
1	NAVMAT (Code 0331)	1	DIR, APL, JHU, Silver Spring
9	NAVSEC	1	DIR, Fluid Mech Lab, Columbia Univ
	1 SEC 6110	1	DIR, Fluid Mech Lab, Univ of Calif, Berkeley
	1 SEC 6114D		
	3 SEC 6114H	1	Prof E.V. Laitone
	2 SEC 6136		Aero Sci Div
	2 SEC 6111B		Univ of Calif
5	NAVSHIPS		Berkeley, Calif 94720
	3 SHIPS 2052	2	DIR, DL, SIT
	1 SHIPS 034		1 Dr. H.C. Kim
	1 SHIPS 525	3	McDonald-Douglas Aircraft, Aircraft Div, Long Beach, Calif 90801
3	NAVORDSYSCOM		1 Mr. A.M.O. Smith
	1 Aero & Hydro Br (Code RAAD-3)		1 Mr. J.L. Hess
	1 Ship Instal & Des (Code SP-26)		1 Mr. J.P. Giesing
	1 Loads & Dyn Sec (Code RADD-22)		
4	CHONR	1	DIR, Scripps Inst of Oceano, Univ of Calif
	1 Nav Analysis (Code 405)	1	DIR, Penn St Univ, Univ Pk
	1 Math Br (Code 432)	1	DIR, WHOI
	2 Fluid Dyn (Code 438)	1	Prof L. Ward
1	ONR, New York		Webb Inst of Nav Arch
1	ONR, Pasadena	2	DIR, Iowa Inst of Hydraul Research
1	ONR, Chicago		1 Prof L. Landweber
1	ONR, Boston	2	DIR, St. Anthony Falls Hydraul Lab
1	ONR, London		1 Prof C.S. Song
1	CDR, USNOL, White Oak	5	Head, NAME, MIT, Cambridge
2	DIR, USNRL (Code 5520)		1 Prof Abkowitz
	1 Mr. Faires		1 Prof Kerwin
1	CDR, USNWC, China Lake		1 Prof Newman
1	CDR, NUREDC, Pasadena		1 Prof Lewis
1	CDR, USNAVMISCEN, Point Mugu		
1	DIR, Natl BuStand		
	Attn: Dr. Schubauer		
12	DDC		

Copies

- 2 Inst of Mathematical Sci, NYU,
New York
1 Dr. Stoker
- 1 Hydronautics, Inc., Pindell School Rd
Laurel, Md
- 2 Dept of Nav Architecture, Univ
of Calif, Berkeley, Calif 94720
1 Prof J.V. Wehausen
1 Prof W.C. Webster
- 1 Prof Finn Michelsen, Dept of Nav Arch,
Univ of Mich, Ann Arbor
- 2 Prof T.F. Ogilvie
Dept of Nav Arch, Univ of Mich,
Ann Arbor
- 1 Prof Richard MacCamy, Carnegie Tech
Pittsburgh 13
- 2 Hydro Lab, CIT, Pasadena
1 Prof T.Y. Wu
- 1 Dr. Hartley Pond, 14 Elliot Dr
New London, Conn
- 1 Prof M. Van Dyke, Dept of Aero & Astro
Stanford Univ, Palo Alto, Calif
- 1 Prof B.V. Korvin-Kourkovsky, East Randolph
Vt
- 2 Dept of Aero & Astro, MIT
1 Prof Widnall
- 1 DIR, Inst for Fluid Dyn & Appl Math
Univ of Md
- 1 DIR, Hydraul Lab, Univ of Colorado
- 1 Pres, Oceanics, Inc
Technical Industrial Park
Plainview, N.Y.