

AD719919

1

015-3d
4 copy wife
12 Aug 69 Jph

AN ATLAS OF AIR ABSORPTIONS IN THE INFRARED

by

D. J. Lovell

INTERIM REPORT

June 1969

Supported By

U. S. Office of Naval Research
Washington, D. C. 20360

Principal Investigator: John Strong

*Reproduction in whole or in part is permitted
for any purpose of the United States Government.*

DEPARTMENT OF PHYSICS AND ASTRONOMY
ASTRONOMY RESEARCH FACILITY
UNIVERSITY OF MASSACHUSETTS, AMHERST
and
THE FOUR COLLEGE OBSERVATORIES

D D C
RECEIVED
MAR 15 1969
ACCEPTED
A

Reproduced by
NATIONAL TECHNICAL
INFORMATION SERVICE
Springfield, Va. 22151

Contract No. N00014-67-A-0230-0002

NR No. 015-301

Contribution # 49/243

CLASSIFICATION STATEMENT A
Approved for public release;
Distribution Unlimited

84

AN ATLAS OF AIR ABSORPTIONS IN THE INFRARED

by D. J. Lovell

June 1969

Department of Physics and Astronomy
University of Massachusetts
Amherst, Mass. 01002

**Best
Available
Copy**

ABSTRACT

An atlas of the spectral absorption characteristic of air is presented in the spectral region from 4000 to 250 cm^{-1} . Spectra were observed over a 92 meter path under two conditions: in a near vacuum and at ambient pressure and temperature.

AN ATLAS OF AIR ABSORPTIONS IN THE INFRARED

D. J. Lovell

Introduction

Interest in the absorption characteristics of the atmosphere dates back nearly to the discovery of infrared radiation itself. It was soon found that the principal atmospheric absorber is water vapor. Because the determination of the concentration of this component is variable and difficult to assess, precise computations of atmospheric attenuations have only been undertaken in comparatively recent years.

The accurate determination of atmospheric attenuation has been attacked by three empirical methods. First, using artificial sources, the spectral transmissions of atmospheric paths have been directly measured. These generally have been made over approximately horizontal paths in which the temperature, pressure, and component concentrations are assumed not to vary appreciably. A second empirical technique has been to use the sun as a source. Here, the path through the atmosphere is nearly vertical, and some model atmosphere must be assumed if the resulting attenuation is to be compared to the constituent concentrations. A third empirical approach has been to study, under laboratory conditions, the

absorptions produced by the specific constituent gases of the atmosphere.

The data developed from these techniques have permitted reasonable predictions of atmospheric attenuation to be made. However, some uncertainties still exist. The work presented here is intended to provide additional insights into the problem by providing an atlas of the relative spectral absorption characteristics of a homogeneous path of atmosphere. The atlas permits one to observe and compare the constituent features that spectrally attenuate radiation in the atmosphere. By using "normal" air, the absorbing characteristics due to all constituents of the atmosphere except ozone, of course, are properly superimposed. It is hoped that the spectral coverage (approximately 4000 to 250 cm^{-1}) and the spectral resolution (usually better than 1 cm^{-1}) will enable meteorologists, astronomers, and others interested in atmospheric attenuation to improve their ability to predict this characteristic.

Atlas Preparation

The atlas, presented here, covers the spectral region from about 4000 cm^{-1} (2.5μ) to 250 cm^{-1} (40μ). It has been prepared over a 92-meter (300 ft.) homogeneous path under both ambient pressure conditions and at a pressure of a few millimeters of mercury.

Measurements were made using the long path absorption cell described by Lovell and Strong (1). This cell is shown in the drawing (Fig. 1) and is indicated schematically in Fig. 2. Note that the distance between the two large mirrors in Fig. 2 has been foreshortened. A globar source was used, and the radiation was reflected to the spectrometer by four gold-coated mirrors. The signal was synchronously detected and amplified by a Brower Model 131 lock-in amplifier.

The spectra at ambient atmosphere and vacuum conditions were obtained under identical spectrometer settings in a specified spectral region. Experience has indicated that results obtained in this way are generally reproducible to better than 10%, but that larger errors do sometimes occur. The near-vacuum spectra were recorded to indicate the approximate envelope of the radiation source. The air at ambient pressure was at a temperature of approximately 22°C and a relative humidity of about 40%.

Although the spectrometer is flushed with dry air, the absorption due to the approximately one meter path within the spectrometer can overwhelm that in the evacuated cell under some circumstances. This is particularly true of the 15 μ band of CO₂ and care must be taken not to attribute these absorptions to the partial pressure within the

cell. It is reemphasized that the vacuum spectra are obtained to provide an irradiance envelope for comparison in addition to providing better spectral resolution where bands are nearly opaque under ambient conditions.

Identification of the lines presented here has been done primarily by comparison of the results presented by various authors. The specific data used are indicated on the tables presented. Where no wavenumber identification was available, it was determined by interpolation and is indicated by the designation \underline{x} . This interpolation is not more accurate than 0.5 cm^{-1} .

The wavenumbers presented are for vacuum conditions. Reported values have been rounded off to the nearest 0.1 cm^{-1} since, although values are often reported to an order of magnitude greater accuracy, disagreements among the values reported to nearly 1 cm^{-1} sometimes arise.

The spectra were all obtained with a Perkin-Elmer Model 210 grating monochromator. Four separate gratings were used to cover the spectral region. Spectra were recorded in the first order; cut-on interference filters were used to reject higher orders of shorter wavelengths. The grating, slit widths used and the calculated spectral slit widths are given in Table 1.

Acknowledgment

This work was supported by the Office of Naval Research
under Contract #N00014-67-A-0230-0002.

References

1. D. J. Lovell, and John Strong, "Long-Path Study of Infrared Absorption and Emission," Appl. Opt., to be published.
2. Orren C. Mohler, A. Keith Pierce, Robert R. McMath, and Leo Goldberg, Photometric Atlas of the Near Infra-Red Solar Spectrum. (Univ. of Michigan Press, Ann Arbor, 1950).
3. International Union of Pure and Applied Chemistry Commission on Molecular Structure and Spectroscopy, Tables of Wavenumbers for the Calibration of Infra-Red Spectrometers. (Bitterworths, Washington, 1961).
 - 3a. H₂O, 3400-4000 cm⁻¹, pp. 596-597.
 - 3b. H₂O, 3900-4000 cm⁻¹, pp. 608-609.
 - 3c. H₂O, 3800-3900 cm⁻¹, pp. 610-611.
 - 3d. H₂O, CO₂; 3700-3800 cm⁻¹, pp. 612-613.
 - 3e. CO₂, 2300-2400 cm⁻¹, pp. 576-577.
 - 3f. ¹³CO₂, 2250-2700 cm⁻¹, pp. 578-579.
 - 3g. CO₂, CO; 2200-2300 cm⁻¹, pp. 642-643.
 - 3h. CO, 2040-2240 cm⁻¹, pp. 580-581.
 - 3i. H₂O, 1350-1900 cm⁻¹, pp. 598-599.
 - 3j. H₂O, 1800-1900 cm⁻¹, pp. 650-651.
 - 3k. H₂O, 1700-1800 cm⁻¹, pp. 652-653.
 - 3m. H₂O, 1600-1700 cm⁻¹, pp. 654-655.
 - 3n. H₂O, 1500-1600 cm⁻¹, pp. 656-657.
 - 3p. H₂O, 1400-1500 cm⁻¹, pp. 658-659.
 - 3q. H₂O, 1300-1400 cm⁻¹, pp. 660-661.
 - 3r. CO₂, 630-710 cm⁻¹, pp. 592-593.
4. M. Migeotte, L. Neven, and J. Swensson, "The Solar Spectrum from 2.8 to 23.7 Microns," Mémoires de la Société Royale des Sciences de Liège. Special Volume No. 1, (1956).

5. S. R. Drayson, and C. Young, The Frequencies and Intensities of Carbon Dioxide Absorption Lines Between 12 and 18 Microns. (Univ. of Michigan Report ORA 08183-1-T, Nov. 1967).
6. C. B. Farmer, and P. J. Key, "A Study of the Solar Spectrum from 7 μ to 400 μ ," Appl. Opt. 4, 1051, (1956).
7. W. S. Benedict, H. H. Claassen, and J. H. Shaw, "Absorption Spectrum of Water Vapor Between 4.5 and 13 Microns," J. of Res. N.B.S. 49, 91, (Aug. 1952).

NOT REPRODUCIBLE

Fig. 1. The experimental set-up used in the preparation of the atlas.

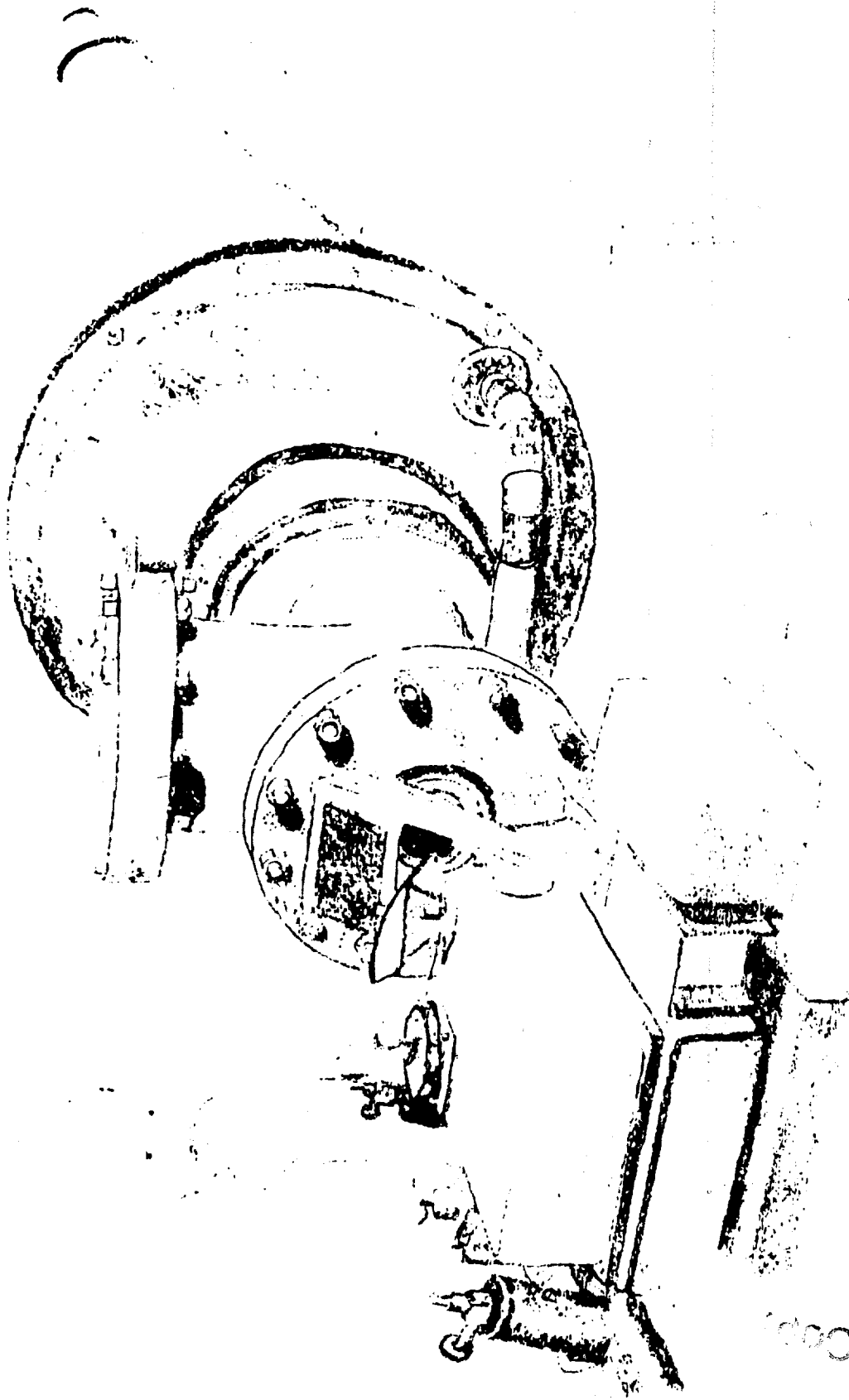

Best Available Copy

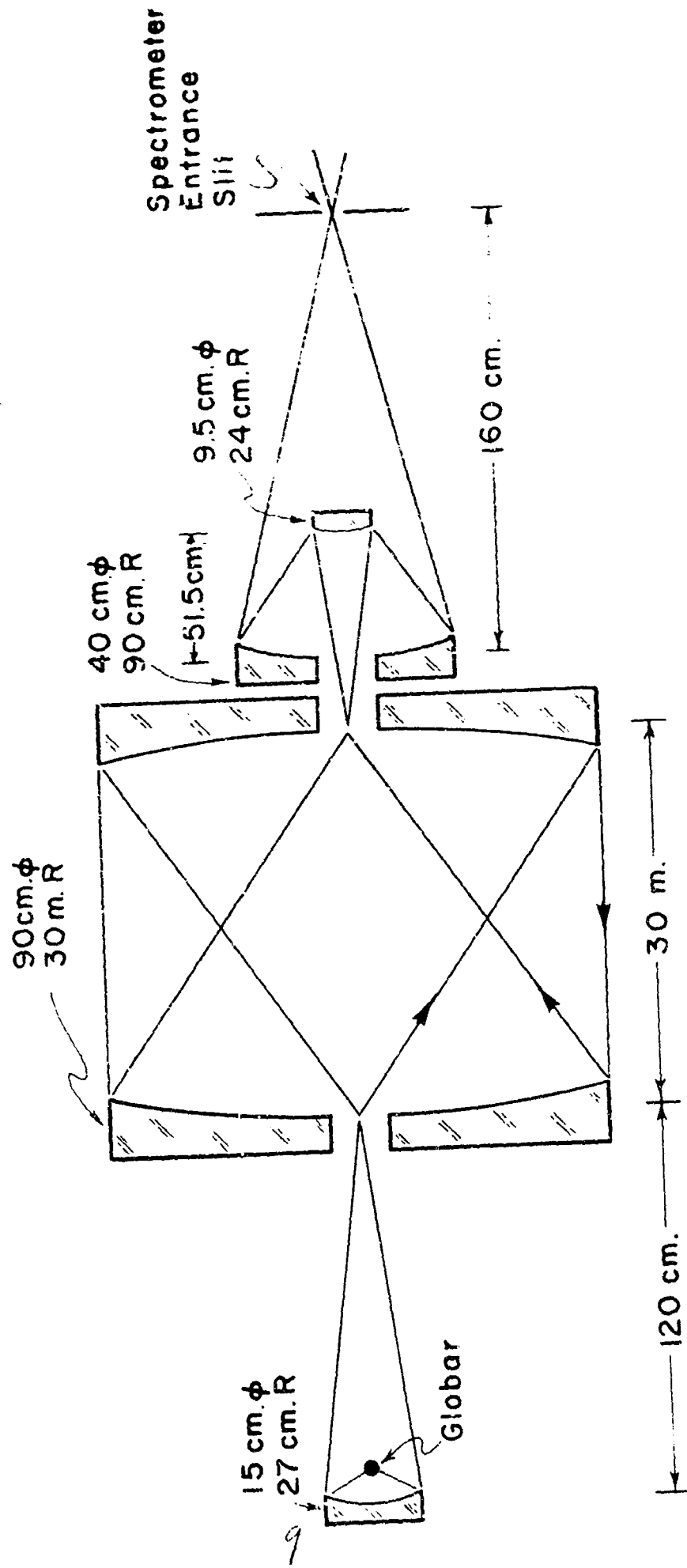

Fig. 2. A schematic drawing of the optical path used.

TABLE 1

Plate	Grating (1/mm)	Spectral Region (cm^{-1})		Slit Width (mm)	Spectral Slit Width (cm^{-1})
1	240	4100	3700	0.06	1.35
2	240	3700	3300	0.06	1.1
3	240	3300	2900	0.065	0.9
4	240	2900	2550	0.065	0.65
5	240	2550	2200	0.078	0.55
6	240	2200	1800	0.09	0.45
7	240	1800	1550	0.125	0.4
8a	101	1575	1460	0.120	0.95
8b	101	1460	1425	0.100	0.75
9	101	1425	1300	0.100	0.7
10a	101	1300	1175	0.115	0.6
10b	101	1175	1150	0.150	0.7
11a	101	1150	1070	0.150	0.6
11b	101	1070	1025	0.200	0.7
12a	101	1025	925	0.240	0.7
12b	101	925	875	0.275	0.7
13a	101	875	780	0.300	0.6
13b	101	785	730	0.440	0.7
14	101	730	600	0.475	0.55

Plate	Grating (1/mm)	Spectral Region (cm^{-1})		Slit Width (mm)	Spectral Slit Width (cm^{-1})
15	40	670	600	0.225	0.8
16	40	600	540	0.285	0.8
17a	40	540	490	0.330	0.7
17b	40	500	470	0.425	0.8
18	40	470	400	0.540	0.9
19	30	450	390	0.500	1.0
20a	30	390	350	0.610	0.95
20b	30	360	330	0.850	1.0
21a	30	330	300	1.00	1.1
21b	30	305	290	1.35	1.2
22	30	290	240	1.8	1.8

PLATE 1

Line	Wavenumber (cm^{-1})	Molecule	Reference
1	4085.8	H_2O	2
2	4076	H_2O	x
3	4071	H_2O (?)	x
4	4058.8	H_2O	2
5	4050	H_2O (?)	x
6	4044	H_2O	x
7	4030	H_2O	x
8	4024	H_2O (?)	x
9	4019	H_2O	x
10	4011	H_2O (?)	x
11	4008	H_2O	x
12	3995	H_2O	x
13	3991	H_2O	x
14	3986	H_2O	2
15	3981.8	H_2O	2
16	3980.8	H_2O	2
17	3976	H_2O	2
18	3975	H_2O	2
19	3973	H_2O	2
20	3968.5	H_2O	2

PLATE 1

Line	Wavenumber (cm^{-1})	Molecule	Reference
21	3964	H_2O	x
22	3961.7	H_2O	2
23	3957	H_2O (?)	x
24	3952	H_2O (?)	x
25	3950	H_2O	3a
26	3947	H_2O	x
27	3942.9	H_2O	3a
28	3938	H_2O	x
29	3932.5	H_2O	x
30	3930	H_2O	x
31	3925.2	H_2O	3a
32	3920.1	H_2O	3a
33	3918	H_2O	x
34	3904.2	H_2O	3b
35	3903.5	H_2O	x
36	3899.4	H_2O	3a
37	3894.5	H_2O	x
38	3891.3	H_2O	3b
39	3885.9	H_2O	3c
40	3883.3	H_2O	3a

PLATE 1

Line	Wavenumber (cm^{-1})	Molecule	Reference
41	3879	H_2O	x
42	3874	H_2O	x
43	3869.5	H_2O	x
44	3865.2	H_2O	3a
45	3861.5	H_2O	x
46	3858	H_2O	x
47	3854	H_2O	x
48	3852.1	H_2O	3a
49	3842.8	H_2O	3c
50	3840	H_2O	x
51	3837.9	H_2O	3c
52	3835.1	H_2O	3e
53	3831.7	H_2O	3c
54	3826	H_2O	x
55	3819.5	H_2O	x
56	3816.1	H_2O	3a
57	3807	H_2O	3a
58	3801.4	H_2O	3c
59	3796	H_2O	x
60	3790	H_2O	x

PLATE 1

Line	Wavenumber (cm^{-1})	Molecule	Reference
61	3785	H_2O	x
62	3779.4	H_2O	3a
63	3769.8	H_2O	3d
64	3765.8	H_2O	3d
65	3759.8	H_2O	3a
66	3756	H_2O	x
67	3752.2	H_2O	3a
68	3749.3	H_2O	3d
69	3744.5	H_2O	3d
70	3741	H_2O	3d
71	3736	H_2O	x
72	3732	H_2O	x
73	3737	H_2O	x
74	3733	H_2O	x
75	3730	H_2O	x
76	3714.8	H_2O	3a
77	3713	H_2O	x
78	3710	H_2O	x
79	3701.9	H_2O	3a
80	3691	H_2O	x
81	3688	H_2O	x

PLATE 2

Line	Wavenumber (cm^{-1})	Molecule	Reference
1	3713	H ₂ O	x
2	3710	H ₂ O	x
3	3701.9	H ₂ O	3a
4	3691	H ₂ O	x
5	3688	H ₂ O	x
6	3680	H ₂ O	x
7	3676	H ₂ O	x
8	3671	H ₂ O	x
9	3659.9	H ₂ O	3a
10	3656.3	H ₂ O	3a
11	3652	H ₂ O	x
12	3651	H ₂ O	x
13	3648	H ₂ O	x
14	3642.5	H ₂ O	x
15	3638.2	H ₂ O	3a
16	3634	H ₂ O	x
17	3629	H ₂ O	x
18	3626	H ₂ O	x
19	3619	H ₂ O	x
20	3617.5	H ₂ O	x

PLATE 2

Line	Wavenumber (cm^{-1})	Molecule	Reference
21	3615	H ₂ O	x
22	3613	H ₂ O	x
23	3609	H ₂ O	x
24	3607	H ₂ O	x
25	3601	H ₂ O	x
26	3598	H ₂ O	x
27	3596	H ₂ O	x
28	3593	H ₂ O	x
29	3589	H ₂ O	x
30	3586	H ₂ O	x
31	3581	H ₂ O	x
32	3577	H ₂ O	x
33	3575	H ₂ O	x
34	3572.5	H ₂ O	x
35	3570.5	H ₂ O	3a
36	3568	(?)	x
37	3566	(?)	x
38	3557.0	H ₂ O	4
39	3554.7	CO ₂	4
40	3552.4	H ₂ O	3a

PLATE 2

Line	Wavenumber (cm^{-1})	Molecule	Reference
41	3544.6	H ₂ O	4
42	3543.0	H ₂ O	4
43	3540	¹³ CO ₂ (?)	4
44	3536.4	H ₂ O	3a
45	3530.7	H ₂ O	4
46	3518	H ₂ O	4
47	3528.0	H ₂ O	4
48	3518.9	H ₂ O	4
49	3509.5	H ₂ O	3a
50	3504.7/3503.0	H ₂ O	4
51	3496.6	H ₂ O	3a
52	3490.8	H ₂ O	4
53	3488.1	H ₂ O	3a
54	3485	H ₂ O	x
55	3482.3	H ₂ O	3a
56	3474.8	H ₂ O	4
57	3470.5	H ₂ O	4
58	3467.2	H ₂ O	4
59	3462.7/3461.4	H ₂ O	4
60	3458.6/3457.5	H ₂ O	4

PLATE 2

Line	Wavenumber (cm^{-1})	Molecule	Reference
61	3455.7	H ₂ O	4
62	3447.2	H ₂ O	3a
63	3442.2	H ₂ O	4
64	3436.1	H ₂ O	4
65	3430.9	H ₂ O	4
66	3420.4	H ₂ O	4
67	3413.0	H ₂ O	4
68	3408.8	H ₂ O	4
69	3406.6	H ₂ O	4
70	3403.6	H ₂ O	4
71	3403.5	H ₂ O	4
72	3402.1	H ₂ O	4
73	3397.2	H ₂ O	4
74	3392.6	H ₂ O	4
75	3385.6/3384.2	H ₂ O	4
76	3380.4	H ₂ O	4
77	3374.7	H ₂ O	4
78	3371.8	H ₂ O	4
79	3367.5	H ₂ O	4
80	3365.7	H ₂ O	4

PLATE 2

Line	Wavenumber (cm^{-1})	Molecule	Reference
81	3361.6	H ₂ O	4
82	3360	H ₂ O	x
83	3355.6	H ₂ O	4
84	3351.2	H ₂ O	4
85	3348.4	H ₂ O	4
86	3346.0	H ₂ O	4
87	3342.3	H ₂ O	4
88	3340.1	H ₂ O	4
89	3336.7	H ₂ O	4
90	3334.5	H ₂ O	4
91	3329.5	H ₂ O	4
92	3327.4/3326.4	H ₂ O	4
93	3324.6	H ₂ O	4
94	3323	H ₂ O	4
95	3318.5/3317.3	H ₂ O	4
96	3213.0	H ₂ O	4
97	3211	H ₂ O	x
98	3308.5	H ₂ O	4

PLATE 3

Line	Wavenumber (cm^{-1})	Molecule	Reference
1	3327.4/3326.4	H ₂ O	4
2	3324.6	H ₂ O	4
3	3323.0	H ₂ O	4
4	3318.3/3317.3	H ₂ O	4
5	3313.0	H ₂ O	4
6	3308.5	H ₂ O	4
7	3303.2	H ₂ O	4
8	3297.4	H ₂ O	4
9	3292.6	H ₂ O	4
10	3288.5	H ₂ O	4
11	3282.9	H ₂ O	4
12	3280.0	H ₂ O	4
13	3276.3	H ₂ O	4
14	3273.6	H ₂ O	4
15	3265.0	H ₂ O	4
16	3260.4	H ₂ O	4
17	3257.1	H ₂ O	4
18	3254.0	H ₂ O	4
19	3245.1	H ₂ O	4
20	3240.0	H ₂ O	4

21

PLATE 3

Line	Wavenumber (cm^{-1})	Molecule	Reference
21	3236.6	H ₂ O	4
22	3232.9	H ₂ O	4
23	3230.0	H ₂ O	4
24	3227.5	H ₂ O	4
25	3219.3	H ₂ O	4
26	3214.1	H ₂ O	4
27	3209.8	H ₂ O	4
28	3199.8	H ₂ O	4
29	3197.9	H ₂ O	4
30	3196.2	H ₂ O	4
31	3185.2	H ₂ O	4
32	3178.2	H ₂ O	4
33	3169.7	H ₂ O	4
34	3167.9	H ₂ O	4
35	3151.4	H ₂ O	4
36	3142.8	H ₂ O	4
37	3133.1	H ₂ O	4
38	3126.8	H ₂ O	4
39	3122.3	H ₂ O	4
40	3119.1	H ₂ O	4

22

PLATE 3

Line	Wavenumber (cm^{-1})	Molecule	Reference
41	3115.9	H ₂ O	4
42	3112.1	H ₂ O	4
43	3110.2	H ₂ O	4
44	3107.3	H ₂ O	4
45	3103.1	H ₂ O	4
46	3101.2	H ₂ O	4
47	3099.6	H ₂ O	4
48	3095.8	H ₂ O	4
49	3087.2	H ₂ O	4
50	3081.3	H ₂ O	4
51	3079.6	H ₂ O	4
52	3077.9	H ₂ O	4
53	3067.2	H ₂ O	4
54	3064.3	H ₂ O	4
55	3059.9	H ₂ O	4
56	3056.4	H ₂ O	4
57	3049.0	H ₂ O	4
58	3034.4	H ₂ O	4
59	3031.9/3030.8	H ₂ O	4
60	3025.8	H ₂ O	4

PLATE 3

Line	Wavenumber (cm^{-1})	Molecule	Reference
61	3022.4	H ₂ O	4
62	3017.3	CH ₄	4
63	3015.5	H ₂ O	4
64	3010.3	H ₂ O	4
65	3003.7	H ₂ O	4
66	2994.4	H ₂ O	4
67	2991.8	H ₂ O	4
68	2987.5	H ₂ O	4
69	2984.2	H ₂ O	4
70	2980.3	H ₂ O	4
71	2978.0	H ₂ O	4
72	2975.2	H ₂ O	4
73	2973.2	H ₂ O	4
74	2967.9	H ₂ O	4
75	2965	H ₂ O	4
76	2958.3	CH ₄	4
77	2955.7	H ₂ O	4
78	2953	CH ₄ (?)	4
79	2947.9	CH ₄	4
80	2920.8	CH ₄	4

29

PLATE 5

Line	Wavenumber (cm^{-1})	Molecule	Reference
1	2371.5	CO_2	3e
2	2370.3	CO_2	3e
3	2369.1	CO_2	3e
4	2367.9	CO_2	3e
5	2365.7	CO_2	3e
6	2365.4	CO_2	3e
7	2364.2	CO_2	3e
8	2362.8	CO_2	3e
9	2361.5	CO_2	3e
10	2360.2	CO_2	3e
11	2358.8	CO_2	3e
12	2357.4	CO_2	3e
13	2355.9	CO_2	3e
14	2354.5	CO_2	3e
15	2353.0	CO_2	3e
16	2351.5	CO_2	3e
17	2350.0	CO_2	3e
18	2347.6	CO_2	3e
19	2346.0	CO_2	3e
20	2344.4	CO_2	3e

PLATE 5

Line	Wavenumber (cm^{-1})	Molecule	Reference
21	2342.8	CO_2	3e
22	2341.1	CO_2	3e
23	2339.4	CO_2	3e
24	2337.7	CO_2	3e
25	2336.0	CO_2	3e
26	2334.2	CO_2	3e
27	2332.4	CO_2	3e
28	2330.6	CO_2	3e
29	2328.8	CO_2	3e
30	2326.9	CO_2	3e
31	2325.0	CO_2	3e
32	2323.1	CO_2	3e
33	2321.2	CO_2	3e
34	2319.2	CO_2	3e
35	2317.2	CO_2	3e
36	2315.2	CO_2	3e
37	2313.2	CO_2	3e
38	2311.1	CO_2	3e
39	2309.0	CO_2	3e
40	2307.0	CO_2	3e

PLATE 5

Line	Wavenumber (cm^{-1})	Molecule	Reference
41	2304.8	CO_2	3e
42	2302.7	CO_2	3e
43	2300.5	CO_2	3e
44	2294.4	$^{13}\text{CO}_2$	3f
45	2293.1	$^{13}\text{CO}_2$	3f
46	2291.6	$^{13}\text{CO}_2$	3f
47	2290.2	$^{13}\text{CO}_2$	3f
48	2288.8	$^{13}\text{CO}_2$	3f
49	2287.3	$^{13}\text{CO}_2$	3f
50	2285.8	$^{13}\text{CO}_2$	3f
51	2283.9	$^{13}\text{CO}_2$	3f
52	2281.9	$^{13}\text{CO}_2$	3f
53	2280.3	$^{13}\text{CO}_2$	3f
54	2278.7	$^{13}\text{CO}_2$	3f
55	2271.1	$^{13}\text{CO}_2$	3f
56	2275.4	$^{13}\text{CO}_2$	3f
57	2273.7	$^{13}\text{CO}_2$	3f
58	2272.0	$^{13}\text{CO}_2$	3f
59	2270.3	$^{13}\text{CO}_2$	3f
60	2268.6	$^{13}\text{CO}_2$	3f

PLATE 5

Line	Wavenumber (cm^{-1})	Molecule	Reference
61	2266.8	$^{13}\text{CO}_2$	3t
62	2265.0	$^{13}\text{CO}_2$	3t
63	2263.1	$^{13}\text{CO}_2$	3t
64	2261.3	$^{13}\text{CO}_2$	3t
65	2259.4	$^{13}\text{CO}_2$	3t
66	2257.5	$^{13}\text{CO}_2$	3t
67	2255.6	$^{13}\text{CO}_2$	3t
68	2253.7	$^{13}\text{CO}_2$	3t
69	2251.7	$^{13}\text{CO}_2$	3t
70	2249.7	$^{13}\text{CO}_2$	3t
71	2247.7	$^{13}\text{CO}_2$	3t
72	2245.6	$^{13}\text{CO}_2$	3g
73	2243.6	$^{13}\text{CO}_2$	3g
74	2241.4	$^{13}\text{CO}_2$	3g
75	2239.4	$^{13}\text{CO}_2$	3g
76	2237.2	$^{13}\text{CO}_2$	3g
77	2235	$^{13}\text{CO}_2$	x
78	2203.2	CO	3h
79	2199.9	CO	3h
80	2196.7	CO	3h

PLATE 5

Line	Wavenumber (cm^{-1})	Molecule	Reference
81	2193.4	CO	3h
82	2190.0	CO	3h
83	2186.6	CO	3h
84	2183.2	CO	3h
85	2179.8	CO	3h
86	2176.3	CO	3h
87	2172.8	CO	3h
88	2169.2	CO	3h
89	2165.6	CO	3h
90	2162.0	CO	3h

PLATE 6

1	2193.4	CO	3h
2	2190.0	CO	3h
3	2186.6	CO	3h
4	2183.2	CO	3h
5	2179.8	CO	3h
6	2176.3	CO	3h
7	2172.8	CO	3h
8	2169.2	CO	3h
9	2165.6	CO	3h
10	2162.0	CO	3h

PLATE 6

Line	Wavenumber (cm^{-1})	Molecule	Reference
11	2158.3	CO	3h
12	2154.6	CO	3h
13	2150.9	CO	3h
14	2147.1	CO	3h
15	2139.4	CO	3h
16	2135.6	CO	3h
17	2131.6	CO	3h
18	2127.7	CO	3h
19	2123.7	CO	3h
20	2119.7	CO	3h
21	2115.6	CO	3h
22	2111.6	CO	3h
23	2107.4	CO	3h
24	2103.3	CO	3h
25	2094.9	CO	3h
26	2090.6	CO	3h
27	2086.3	CO	3h
28	2082.0	CO	3h
29	2077.7	CO	3h
30	2073.3	CO	3h

PLATE 6

Line	Wavenumber (cm^{-1})	Molecule	Reference
31	2058.8	CO	3h
32	2064.4	CO/H ₂ O	4
33	2059.9	CO	3h
34	2050.9	CO	3h
35	2046.3	CO	3h
36	2043.9	H ₂ O	4
37	2041.3	H ₂ O	4
38	2037.4	H ₂ O	4
39	2034.0	H ₂ O	4
40	2032.4	CO	3h
41	2026.6	H ₂ O	4
42	2023.0	H ₂ O	4
43	2018.2	H ₂ O	4
44	2016.8	H ₂ O	4
45	2013.4	CO	3h
46	2009.3	H ₂ O	4
47	2007.6	H ₂ O	4
48	2004	?	x
49	1998.9	H ₂ O	4
50	1993.2	H ₂ O	4

PLATE 6

Line	Wavenumber (cm^{-1})	Molecule	Reference
51	1992.2	H ₂ O	4
52	1988.6	H ₂ O	4
53	1976.2	H ₂ O	4
54	1967.4	H ₂ O	4
55	1966.2	H ₂ O	4
56	1960.7	H ₂ O	4
57	1955.0	H ₂ O	4
58	1946.4/1945.4	H ₂ O	4
59	1932.6/1931.8	H ₂ O	4
60	1933.2	H ₂ O	4
61	1923.4/1922.4	H ₂ O	4
62	1917.9	H ₂ O	4
63	1913.0	H ₂ O	4
64	1908.0	H ₂ O	4
65	1904.4	H ₂ O	4
66	1901.8	H ₂ O	4
67	1897.1	H ₂ O	4
68	1893.4	H ₂ O	4
69	1889.5	H ₂ O	4
70	1884.6	H ₂ O	4

11

PLATE 6

Line	Wavenumber (cm^{-1})	Molecule	Reference
71	1879.3	H_2O	4
72	1876.6	H_2O	4
73	1870.8	H_2O	4
74	1868.6	H_2O	4
75	1866.4	H_2O	4
76	1861.5	H_2O	4
77	1851.5	H_2O	4
78	1856.3	H_2O	4
79	1852.4	H_2O	4
80	1847.7	H_2O	4
81	1842.2	H_2O	4
82	1837.2	H_2O	4
83	1829.9	H_2O	4
84	1825.2	H_2O	31
85	1817.5	H_2O	4
86	1810.6	H_2O	31
87	1807.7	H_2O	4
88	1805.2	H_2O	4
89	1799.6	H_2O	31

PLATE 7

Line	Wavenumber (cm^{-1})	Molecule	Reference
1	1825.4	H ₂ O	31
2	1817.5	H ₂ O	7
3	1810.6	H ₂ O	31
4	1808.6	H ₂ O	7
5	1805.2	H ₂ O	7
6	1802.4	H ₂ O	7
7	1799.6	H ₂ O	31
8	1796.9	H ₂ O	7
9	1792.6	H ₂ O	3j
10	1791.0	H ₂ O	3j
11	1785.0	H ₂ O	31
12	1782.0	H ₂ O	7
13	1775.6	H ₂ O	7
14	1772.6	H ₂ O	3k
15	1771.4	H ₂ O	7
16	1768.2	H ₂ O	31
17	1761.9	H ₂ O	3e
18	1756.8	H ₂ O	31
19	1751.4	H ₂ O	3k
20	1748	H ₂ O	r

PLATE 7

Line	Wavenumber (cm^{-1})	Molecule	Reference
21	1746	H ₂ O	x
22	1744	H ₂ O	x
23	1742	H ₂ O	x
24	1739.8	H ₂ O	3k
25	1734.6	H ₂ O	3k
26	1733.4	H ₂ O	3k
27	1731	H ₂ O	x
28	1723.5	H ₂ O	31
29	1718.6	H ₂ O	31
30	1717.4	H ₂ O	31
31	1715.2	H ₂ O	3k
32	1710.2	H ₂ O	31
33	1706.4	H ₂ O	3k
34	1704.5	H ₂ O	3k
35	1700	H ₂ O	x
36	1696	H ₂ O	3k
37	1690.5	H ₂ O	x
38	1688	H ₂ O	x
39	1684.9	H ₂ O	3m
40	1680	H ₂ O	x

35

PLATE 7

Line	Wavenumber (cm^{-1})	Molecule	Reference
41	1675	H ₂ O	x
42	1672	H ₂ O	x
43	1669.4	H ₂ O	3m
44	1662.8	H ₂ O	3m
45	1655	H ₂ O	x
46	1653.4/1652.4	H ₂ O	3m
47	1648	H ₂ O	x
48	1646.0	H ₂ O	3m
49	1637.6	H ₂ O	3m
50	1635.6	H ₂ O	3m
51	1627.8	H ₂ O	3m
52	1624	H ₂ O	x
53	1616.7	H ₂ O	3n
54	1576.2	H ₂ O	3n
55	1569.8	H ₂ O	3n
56	1564.8	H ₂ O	3n
57	1560.5	H ₂ O	x
58	1558.6	H ₂ O	3n
59	1557.6	H ₂ O	3n
60	1554.4	H ₂ O	3n

PLATE 7

Line	Wavenumber (cm^{-1})	Molecule	Reference
61	1550	H_2O	x
62	1545.2	H_2O	3n
63	1542	H_2O	x
64	1540.3	H_2O	3n
65	1539.0	H_2O	3n

PLATE 8

1	1576.2	H_2O	3n
2	1569.8	H_2O	3n
3	1564.8	H_2O	3n
4	1560.5	H_2O	x
5	1558.6	H_2O	3n
6	1557.5	H_2O	3n
7	1554.4	H_2O	3n
8	1550	H_2O	x
9	1545.2	H_2O	3n
10	1542	H_2O	x
11	1540.3	H_2O	3n
12	1539.0	H_2O	3n
13	1534	H_2O	x
14	1531.7	H_2O	?
15	1528.7	H_2O	?

PLATE 8

Line	Wavenumber (cm^{-1})	Molecule	Reference
16	1527.4	H ₂ O	7
17	1525.5	H ₂ O	3n
18	1522.7	H ₂ O	7
19	1521.4	H ₂ O	3n
20	1520.4	H ₂ O	7
21	1517.5	H ₂ O	3n
22	1515.0	H ₂ O	3n
23	1512.3	H ₂ O	3n
24	1509.8	H ₂ O	7
25	1508.6	H ₂ O	3n
26	1507.1	H ₂ O	3n
27	1505.6	H ₂ O	3n
28	1507.1	H ₂ O	7
29	1498.8	H ₂ O	3n
30	1496.2	H ₂ O	3n
31	1490.8	H ₂ O	3n
32	1489.8	H ₂ O	3p
33	1487.3	H ₂ O	3p
34	1480.4	H ₂ O	7
35	1476.3	H ₂ O	?

PLATE 8

Line	Wavenumber (cm^{-1})	Molecule	Reference
36	1473.5	H ₂ O	3p
37	1472.0	H ₂ O	3p
38	1464.9	H ₂ O	3p
39	1459.3	H ₂ O	3p
40	1458.2	H ₂ O	3p
41	1456.8	H ₂ O	3p
42	1455.3	H ₂ O	7
43	1452.0	H ₂ O	7
44	1447.9	H ₂ O	3p
45	1436.7	H ₂ O	3p
46	1430.0	H ₂ O	3p

PLATE 9

1	1436.7	H ₂ O	3p
2	1430.0	H ₂ O	3p
3	1423.9	H ₂ O	7
4	1419.3	H ₂ O	3p
5	1417.4	H ₂ O	3p

PLATE 9

Line	Wavenumber (cm^{-1})	Molecule	Reference
6	1416.1	H ₂ O	7
7	1411.8	H ₂ O	4
8	1410.0	H ₂ O	4
9	1408.5	H ₂ O	4
10	1405.0	H ₂ O	3p
11	1399.2	H ₂ O	3p
12	1397.7	H ₂ O	7
13	1395.8	H ₂ O	3p
14	1394.4	H ₂ O	3p
15	1390.6/1391.0	H ₂ O	4
16	1387.5	H ₂ O	3q
17	1384	HDO	4
18	1382.2	H ₂ O	4
19	1380.2/1380	H ₂ O	4
20	1378/1378.4	H ₂ O	4
21	1375.1	H ₂ O	3q
22	1373.7	H ₂ O	3q
23	1368.6	H ₂ O	3q
24	1362.5	H ₂ O	4
25	1361.1	H ₂ O	3i

40

PLATE 9

Line	Wavenumber (cm^{-1})	Molecule	Reference
26	1358.2/1358.7	H_2O	4
27	1354.9	H_2O	4
28	1352.4	H_2O	4
29	1349.4	H_2O	4
30	1341.1	H_2O	4
31	1339.0	H_2O	4
32	1336.6	H_2O	31
33	1332.5	H_2O	4
34	1329.9	H_2O	4
35	1323.4	H_2O	4
36	1318.7	H_2O	4
37	1316.3	H_2O	4
38	1314.9	H_2O	4
39	1313.5	H_2O	4
40	1312.5	H_2O	4
41	1308.3	H_2O	4
42	1305.4	H_2O	4
43	1296.6	H_2O	4

41

PLATE 10

Line	Wavenumber (cm^{-1})	Molecule	Reference
1	1308.3	H_2O	4
2	1305.4	H_2O	4
3	1296.6	H_2O	4
4	1290.5	H_2O	4
5	1288.2	H_2O	4
6	1287.4	H_2O	4
7	1284.3	H_2O	4
8	1280.0	H_2O	4
9	1271.9	H_2O	4
10	1270.0	H_2O	4
11	1268.3	H_2O	4
12	1266.1	H_2O	4
13	1264.0	H_2O	4
14	1260.7	H_2O	4
15	1258.6	H_2O	4
16	1244.2	H_2O	4
17	1225.6/1225.2	H_2O	4
18	1218.5	H_2O	4
19	1212.4	H_2O	4
20	1211.3	H_2O	4

42

PLATE 10

Line	Wavenumber (cm^{-1})	Molecule	Reference
21	1198.2	H ₂ O	4
22	1187.1	H ₂ O	4
23	1180.9	H ₂ O	4
24	1174.5	H ₂ O	4
25	1165.5	H ₂ O	4

PLATE 11

1	1165.5	H ₂ O	4
2	1152.4	H ₂ O	4
3	1149.5	H ₂ O	4
4	1137.4	H ₂ O	4
5	1135.8	H ₂ O	4
6	1121.2	H ₂ O	4
7	1111.5	H ₂ O	4
8	1106.7	H ₂ O	4

PLATE 12

1	948.3	H ₂ O	4
---	-------	------------------	---

43

PLATE 13

Line	Wavenumber (cm^{-1})	Molecule	Reference
1	854.6	H ₂ O	4
2	852.5	H ₂ O	4
3	849.6	H ₂ O	4
4	814.6/813.9	H ₂ O	4
5	803.6	H ₂ O	4
6	798.7	H ₂ O	4
7	796.0	H ₂ O	4
8	784.5	H ₂ O	4
9	777.0	H ₂ O	4
10	775.7	H ₂ O	4
11	754.5	H ₂ O	4
12	748.3	CO ₂	4
13	746.8	CO ₂	4
14	745.3	CO ₂	4
15	744.8	H ₂ O	4
16	741.5	CO ₂	4
17	740.8	CO ₂ /H ₂ O	4
18	739.3	CO ₂	5
19	737.8	CO ₂	5
20	736.2	CO ₂	5
21	734.7	CO ₂	5
22	733.0	CO ₂	5

44

PLATE 14

Line	Wavenumber (cm^{-1})	Molecule	Reference
1	740.8	H ₂ O/CO ₂	4
2	739.3	CO ₂	5
3	737.8	CO ₂	5
4	736.2	CO ₂	5
5	734.7	CO ₂	5
6	733.0	CO ₂	5
7	731.4	CO ₂	5
8	729.7	CO ₂	5
9	728.0	CO ₂	5
10	727.0	CO ₂	5
11	725.5	CO ₂	5
12	724.0	CO ₂	5
13	720.0	CO ₂	5
14	714.8	CO ₂	5
15	713.2	CO ₂	5
16	712.2	CO ₂	5
17	711.5	CO ₂	5
18	710.6	CO ₂	5
19	709.9	CO ₂	5
20	709.0	CO ₂	4

4/5

PLATE 14

Line	Wavenumber (cm^{-1})	Molecule	Reference
21	708.2	CO_2	5
22	706.6	CO_2	5
23	705.0	CO_2	5
24	703.3	CO_2	5
25	701.7	CO_2	3r
26	700.1	CO_2	3r
27	698.4	CO_2	3r
28	696.8	CO_2	3r
29	695.2	CO_2	3r
30	693.6	CO_2	3r
31	692.0	CO_2	3r
32	690.4	CO_2	3r
33	688.8	CO_2	3r
34	687.2	CO_2	3r
35	685.6	CO_2	3r
36	684	CO_2	3r
37	682.4	CO_2	3r
38	680.8	CO_2	3r
39	679.2	CO_2	3r
40	677.6	CO_2	3r

46

PLATE 14

Line	Wavenumber (cm^{-1})	Molecule	Reference
41	676.0	CO ₂	3r
42	674.4	CO ₂	3r
43	672.9	CO ₂	3r
44	667.4	CO ₂	5
45	665.8	CO ₂	3r
46	664.3	CO ₂	3r
47	662.7	CO ₂	3r
48	661.2	CO ₂	3r
49	659.6	CO ₂	3r
50	658.1	CO ₂	3r
51	656.5	CO ₂	3r
52	655.0	CO ₂	3r
53	653.5	CO ₂	3r
54	651.9	CO ₂	3r
55	650.4	CO ₂	3r
56	648.9	CO ₂	3r
57	647.4	CO ₂	3r
58	645.9	CO ₂	3r
59	644.4	CO ₂	3r
60	642.9	CO ₂	3r

47

PLATE 14

Line	Wavenumber (cm^{-1})	Molecule	Reference
61	641.4	CO_2	3r
62	639.8	CO_2	3r
63	638.3	CO_2	3r
64	636.9	CO_2	3r
65	635.4	CO_2	3r
66	633.9	CO_2	3r
67	632.4	CO_2	3r
68	630.9	CO_2	3r
69	629.5	CO_2	3r
70	625.6	$^{13}\text{CO}_2/\text{H}_2\text{O}$	4
71	620.8	$^{13}\text{CO}_2/\text{CO}_2$	4
72	617.7	CO_2	6
73	616.0	H_2O	4
74	612.8	CO_2	4
75	611.0	CO_2	4
76	609.4	CO_2	4
77	607.8	CO_2	4
78	606.3	CO_2	4
79	604.6	CO_2	4
80	603.2	CO_2	4

48

PLATE 14

Line	Wavenumber (cm^{-1})	Molecule	Reference
81	601.5	CO_2	4
82	600.1	CO_2	4
83	595.0	$\text{CO}_2/\text{H}_2\text{O}$	4
84	591.9	H_2O	4
85	584.7	H_2O	4
86	580.9	H_2O	4

PLATE 15

1	667.4	CO_2	5
2	664.3	CO_2	3r
3	662.7	CO_2	3r
4	661.2	CO_2	3r
5	659.6	CO_2	3r
6	658.1	CO_2	3r
7	656.5	CO_2	3r
8	655.0	CO_2	3r
9	653.5	CO_2	3r
10	651.9	CO_2	3r

49

PLATE 15

Line	Wavenumber (cm^{-1})	Molecule	Reference
11	650.4	CO_2	3r
12	648.9	CO_2	3r
13	647.4	CO_2	3r
14	645.9	CO_2	3r
15	644.4	CO_2	3r
16	642.9	CO_2	3r
17	641.4	CO_2	3r
18	639.8	CO_2	3r
19	638.3	CO_2	3r
20	636.9	CO_2	3r
21	635.4	CO_2	3r
22	633.9/632.4	CO_2	3r
23	630.9	CO_2	3r
24	629.5	CO_2	3r
25	626.9	CO_2	3r
26	625.6	$^{13}\text{CO}_2/\text{H}_2\text{O}$	4
27	622.5	$^{13}\text{CO}_2/\text{CO}_2$	4
28	620.8	$^{13}\text{CO}_2/\text{CO}_2$	4
29	617.7	CO_2	5
30	616.0	H_2O	4

50

PLATE 15

Line	Wavenumber (cm^{-1})	Molecule	Reference
31	612.8	CO_2	4
32	610.9	CO_2	4
33	609.4	CO_2	4
34	607.8	CO_2	4
35	606.2	CO_2	4
36	604.6	CO_2	4
37	603.2	CO_2	4
38	601.5	CO_2	4
39	600.1	CO_2	4

PLATE 16

1	604.6	CO_2	4
2	600.1	CO_2	4
3	596.9	CO_2	4
4	595.1	$\text{CO}_2/\text{H}_2\text{O}$	4
5	591.9	H_2O	4

51

PLATE 16

Line	Wavenumber (cm^{-1})	Molecule	Reference
6	584.7	H_2O	4
7	580.9	H_2O	4
8	576.1	H_2O	4
9	571.2	H_2O	4
10	569.2	H_2O	4
11	567.2	H_2O	4
12	563.2	H_2O	4
13	557.2	H_2O	4
14	554.7	H_2O	4
15	552.3	H_2O	4
16	550.1	H_2O	4
17	547.8	H_2O	4
18	546.3	H_2O	4
19	545.3	H_2O	4
20	541.0	H_2O	4
21	539.6	H_2O	4
22	536.3	H_2O	4
23	534.3	H_2O	4

52

PLATE 17

Line	Wavenumber (cm^{-1})	Molecule	Reference
1	536.3	H_2O	4
2	534.3	H_2O	4
3	526.0	H_2O	4
4	519.7	H_2O	4
5	517.7/516.9	H_2O	4
6	515.1	H_2O	4
7	512.0	H_2O	4
8	510.5	H_2O	4
9	507.0	H_2O	4
10	504.4	H_2O	4
11	502.2	H_2O	4
12	494.2	H_2O	4
13	492.0	H_2O	4
14	489.5	H_2O	4
15	486.1	H_2O	4
16	484.0	H_2O	4
17	481.0	H_2O	4
18	476.4	H_2O	4
19	472.6	H_2O	4

53

PLATE 15

Line	Wavenumber (cm^{-1})	Molecule	Reference
1	472.6	H_2O	4
2	468.8/467.9	H_2O	4
3	461.5	H_2O	4
4	457.7	H_2O	4
5	452.8	H_2O	4
6	448.9	H_2O	4
7	443.7	H_2O	4
8	442.0	H_2O	4
9	436.4	H_2O	4
10	434.8	H_2O	4
11	431.2	H_2O	4
12	428.8	H_2O	4
13	426.3/425.3	H_2O	4
14	423.1	H_2O	4
15	419	H_2O	6
16	415	H_2O	6
17	406	H_2O	6

54

PLATE 19

Line	Wavenumber (cm^{-1})	Molecule	Reference
1	447	H_2O	6
2	444	H_2O	6
3	442.5	H_2O	6
4	437	H_2O	6
5	435	H_2O	6
6	432	H_2O	6
7	429	H_2O	6
8	426	H_2O	6
9	423	H_2O	6
10	419	H_2O	6
11	415	H_2O	6
12	406	H_2O	6
13	400	H_2O	x
14	399	H_2O	x
15	397	H_2O	x
16	393	H_2O	x
17	390	H_2O	6

55

PLATE 20

Line	Wavenumber (cm^{-1})	Molecule	Reference
1	390	H_2O	6
2	385	H_2O	6
3	381	H_2O	6
4	378	H_2O	6
5	376	H_2O	6
6	374	H_2O	6
7	370	H_2O	6
8	352	H_2O	6
9	359	H_2O	6
10	358	H_2O	6
11	355	H_2O	x
12	352.5	H_2O	x
13	350	H_2O	x
14	344	H_2O	x
15	341	H_2O	x
16	336	H_2O	x
17	328	H_2O	x

56

PLATE 21

Line	Wavenumber (cm^{-1})	Molecule	Reference
1	328	H_2O	6
2	324	H_2O	6
3	315	H_2O	6
4	302	H_2O	5
5	298	H_2O	6
6	289	H_2O	6

PLATE 22

1	289	H_2O	6
2	282	H_2O	6
3	280	H_2O	6
4	278	H_2O	6
5	276	H_2O	6
6	267	H_2O	6
7	255	H_2O	x
8	249	H_2O	x
9	247	H_2O	x

57

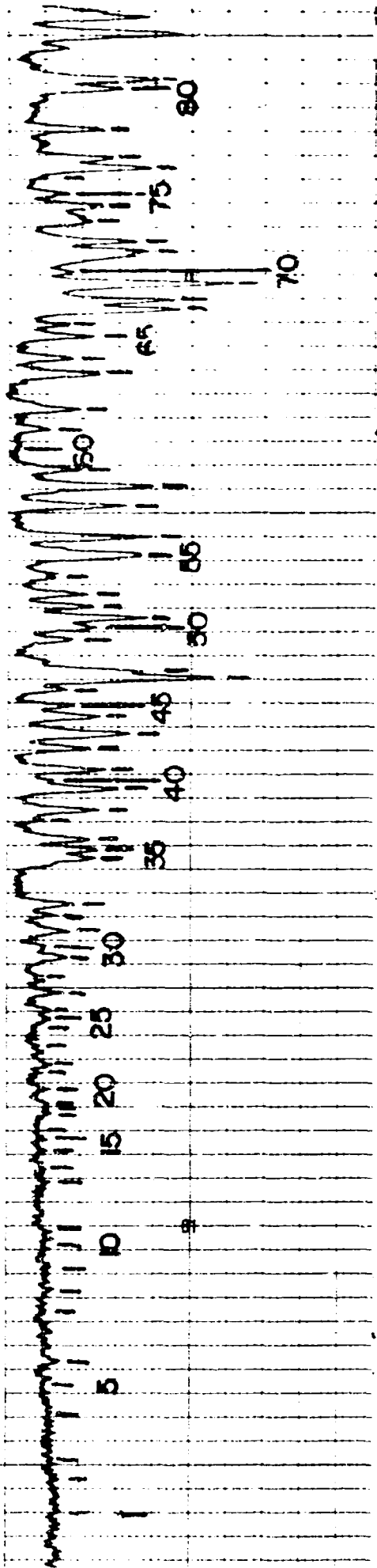

59

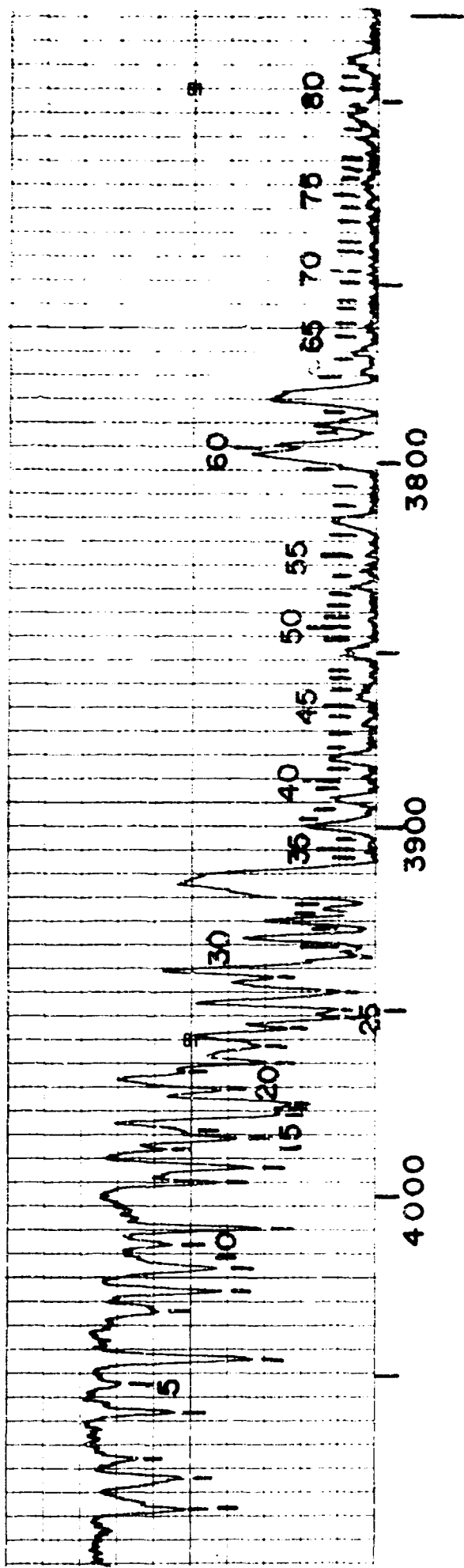

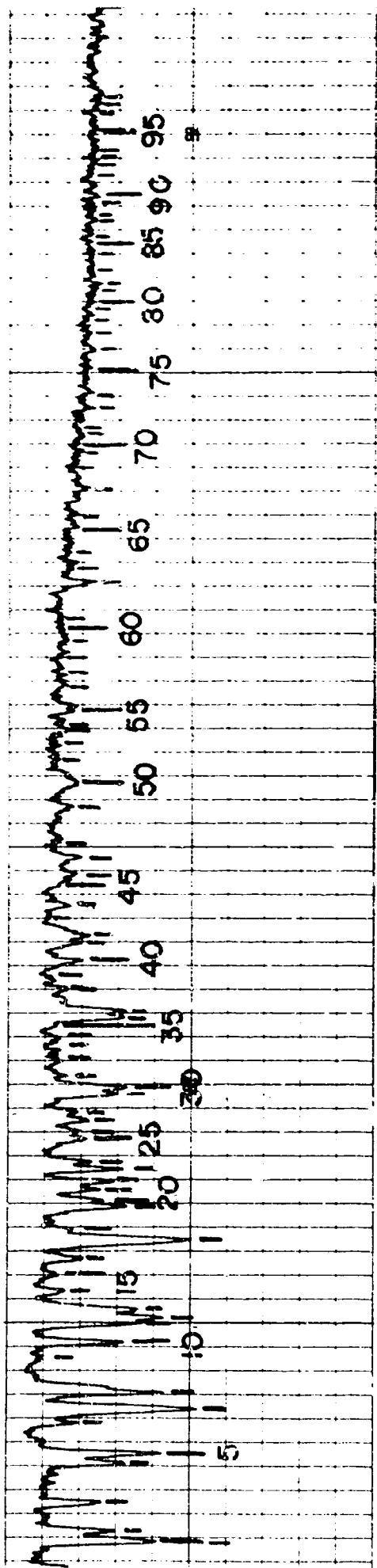

509

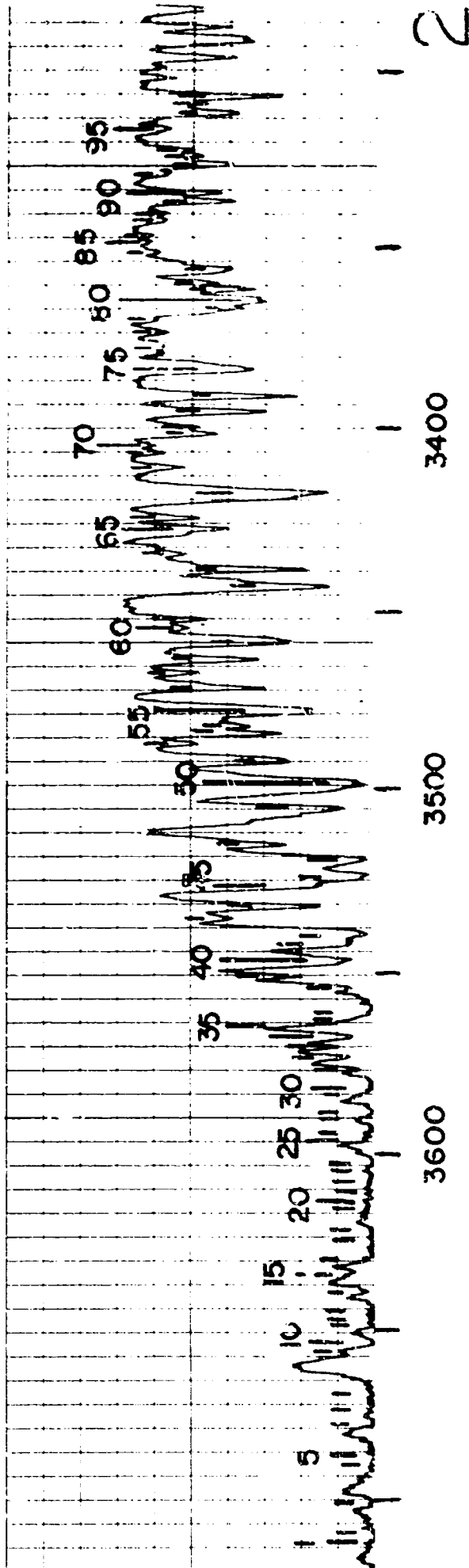

2

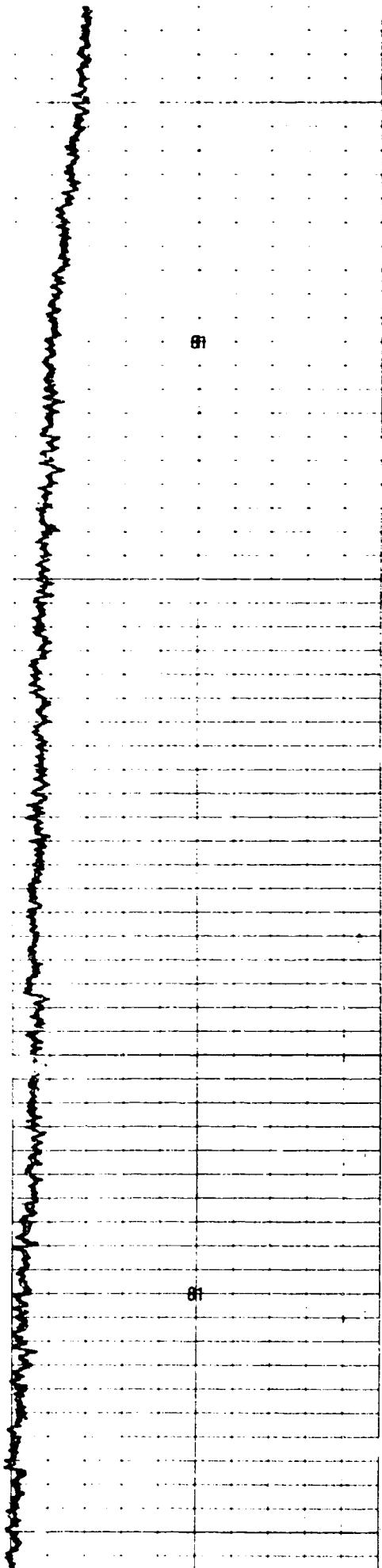

9

9

60

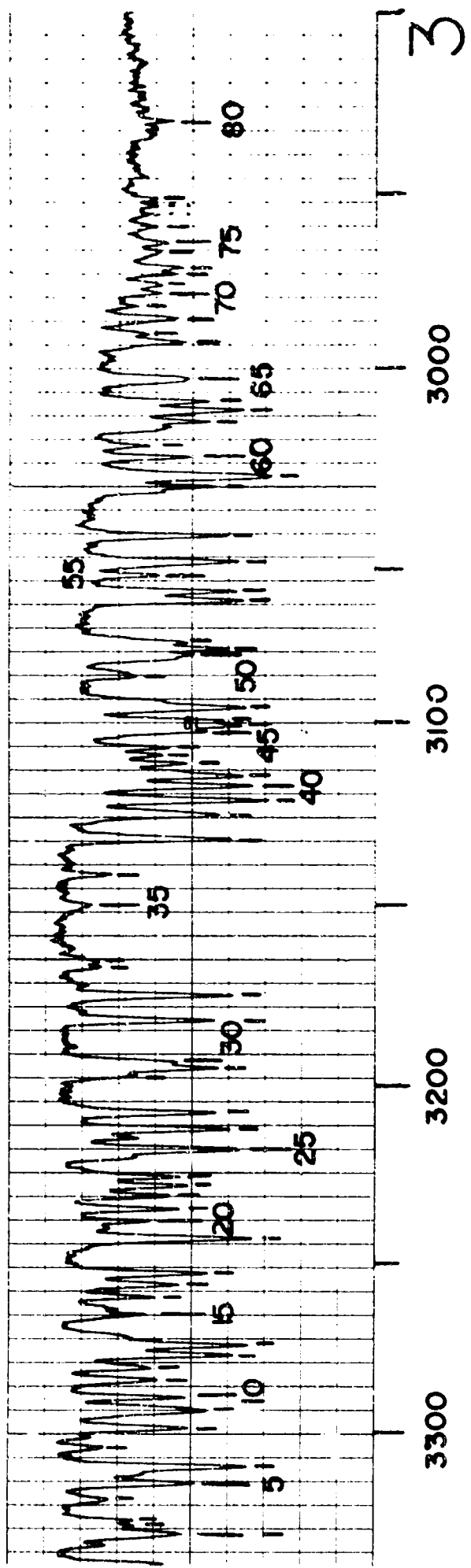

3

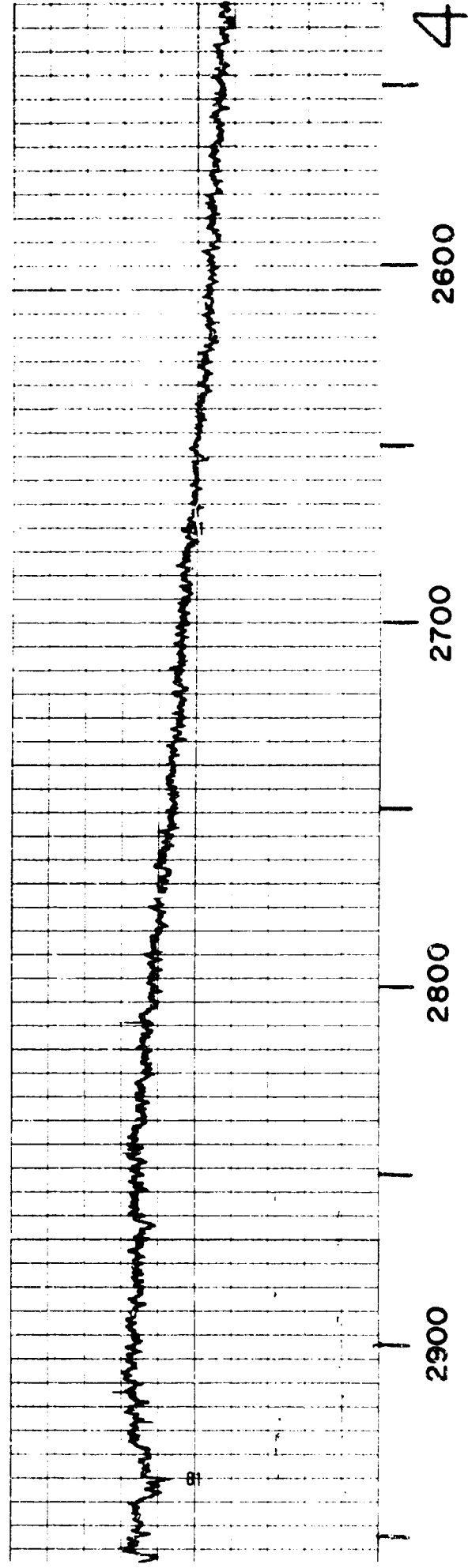
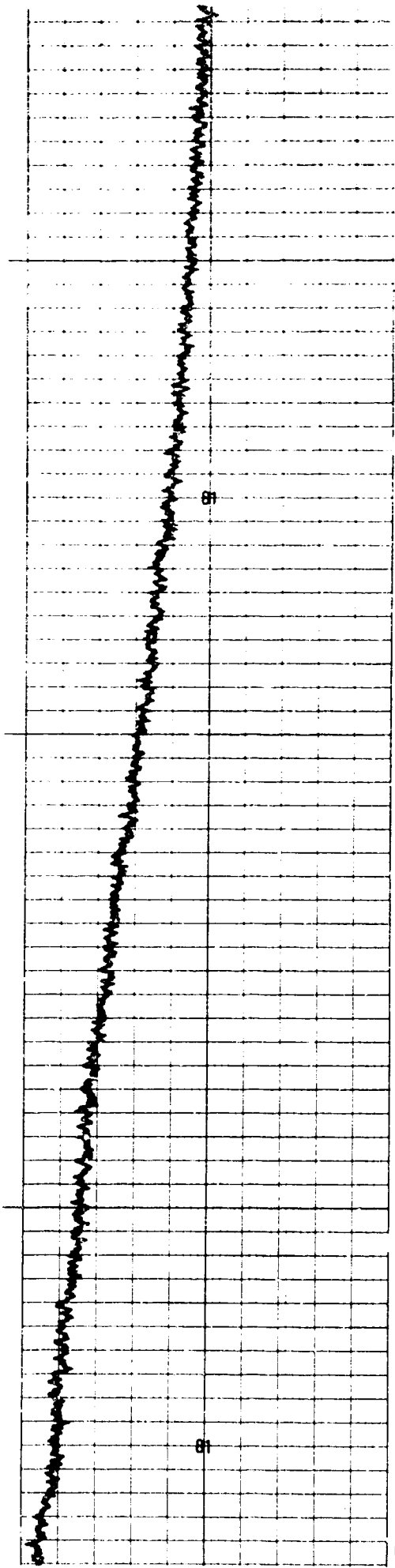

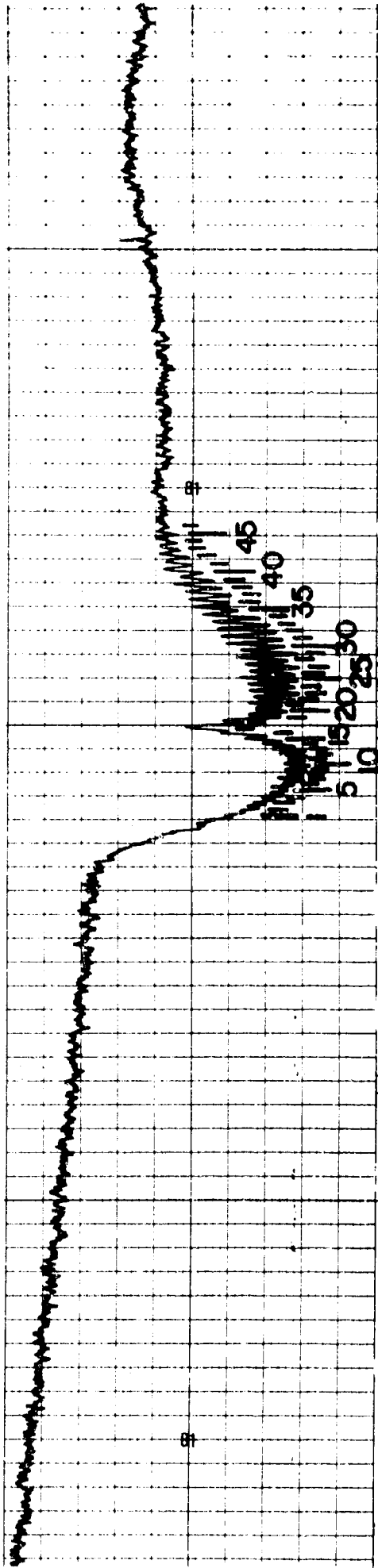

62

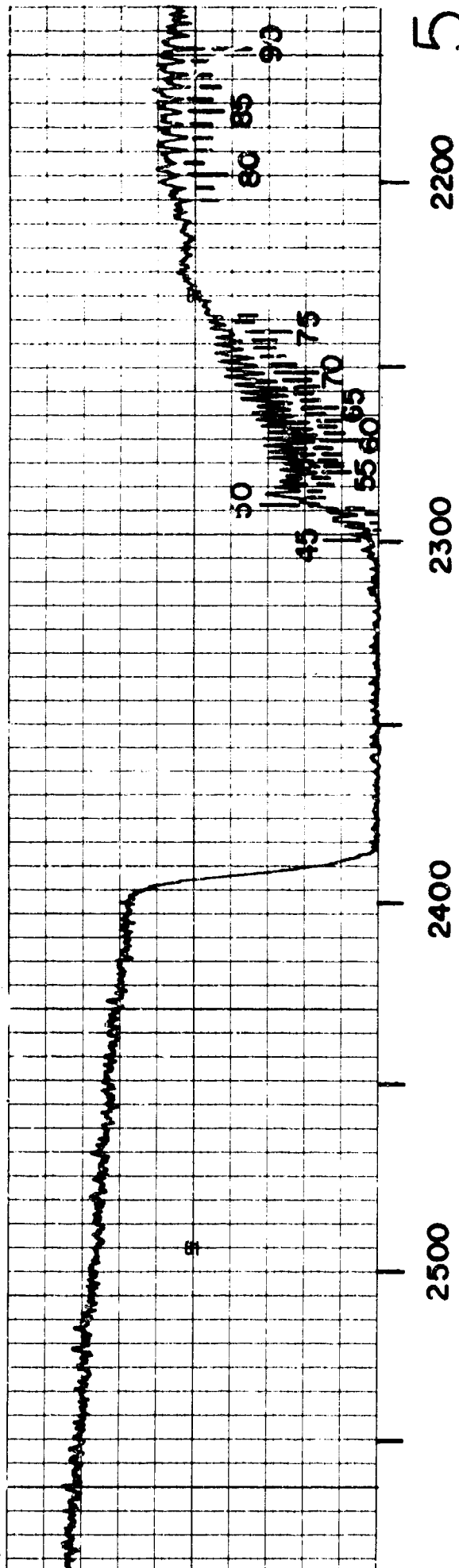

5

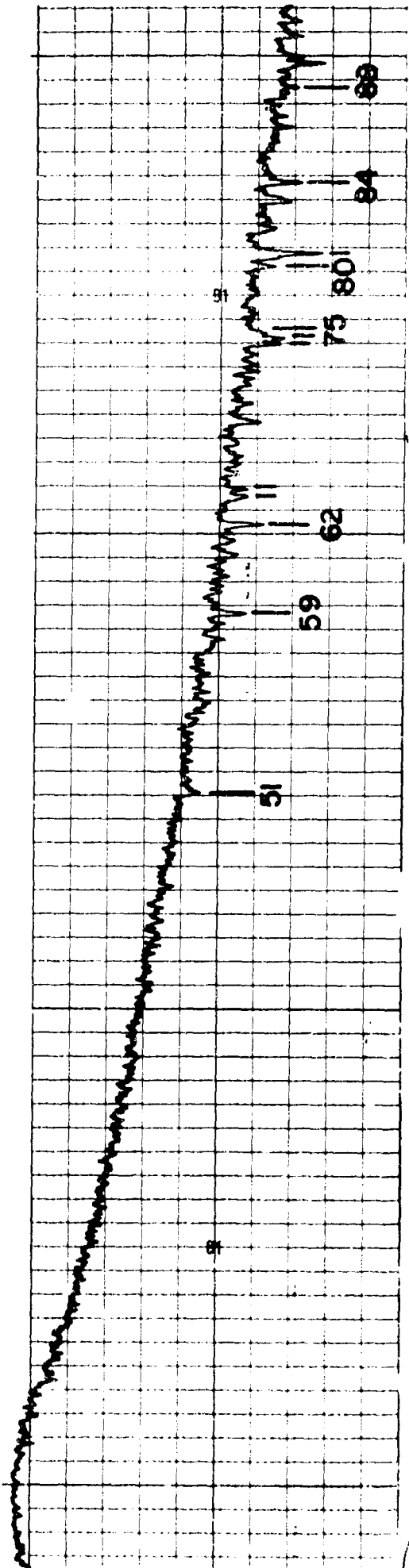

63

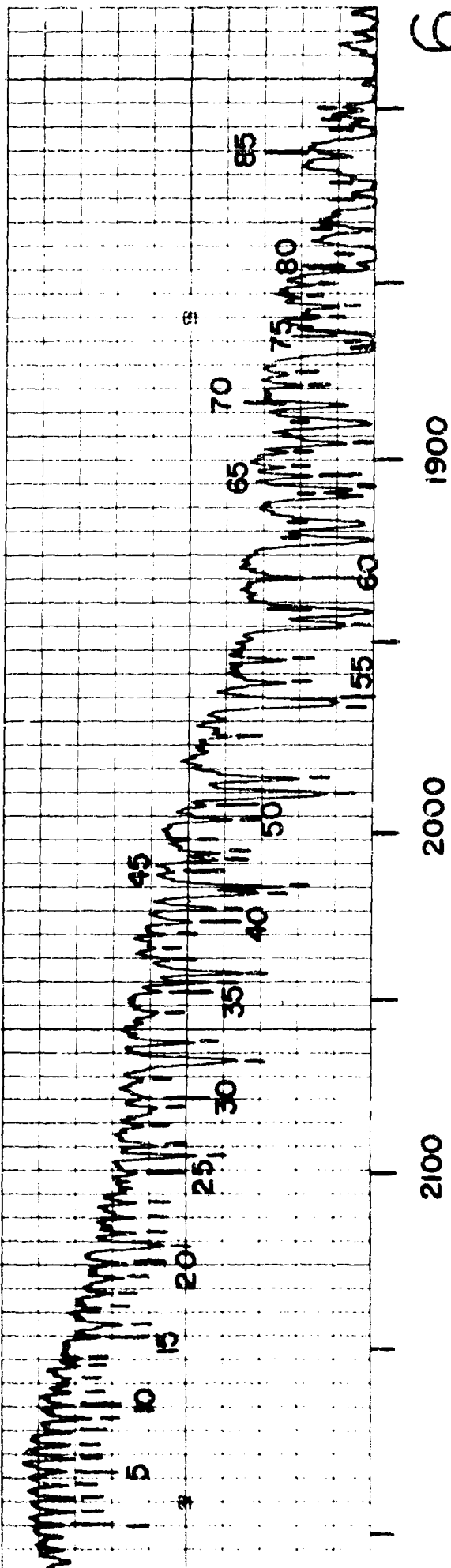

6

1900

2000

2100

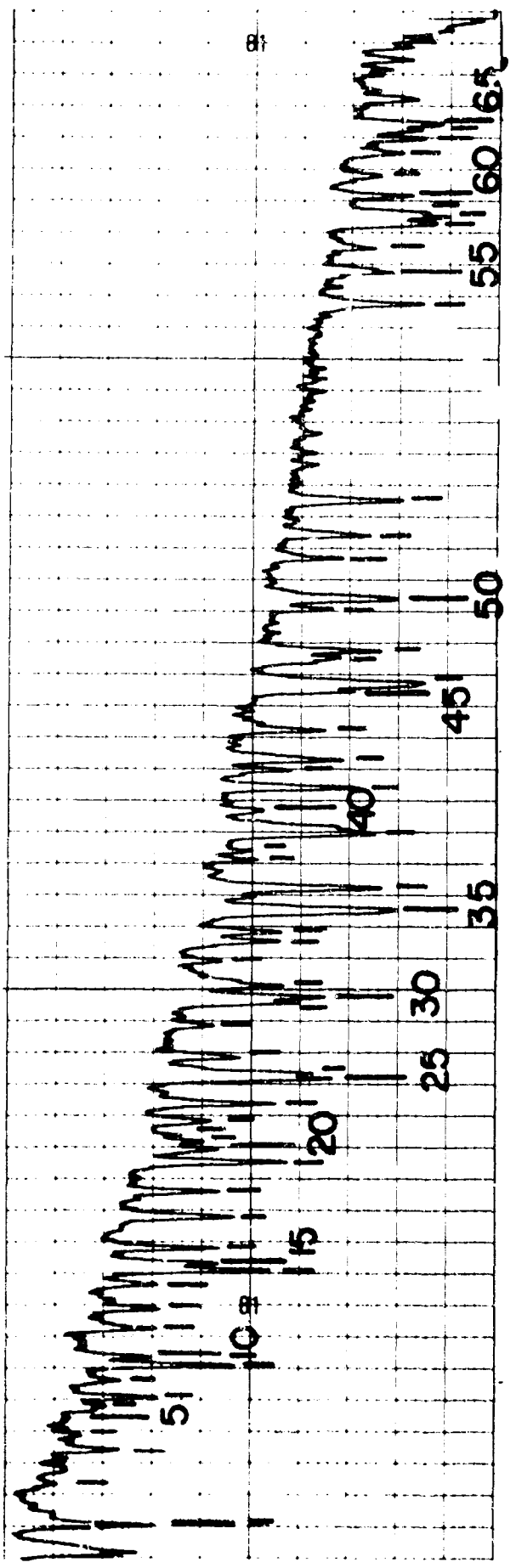

624

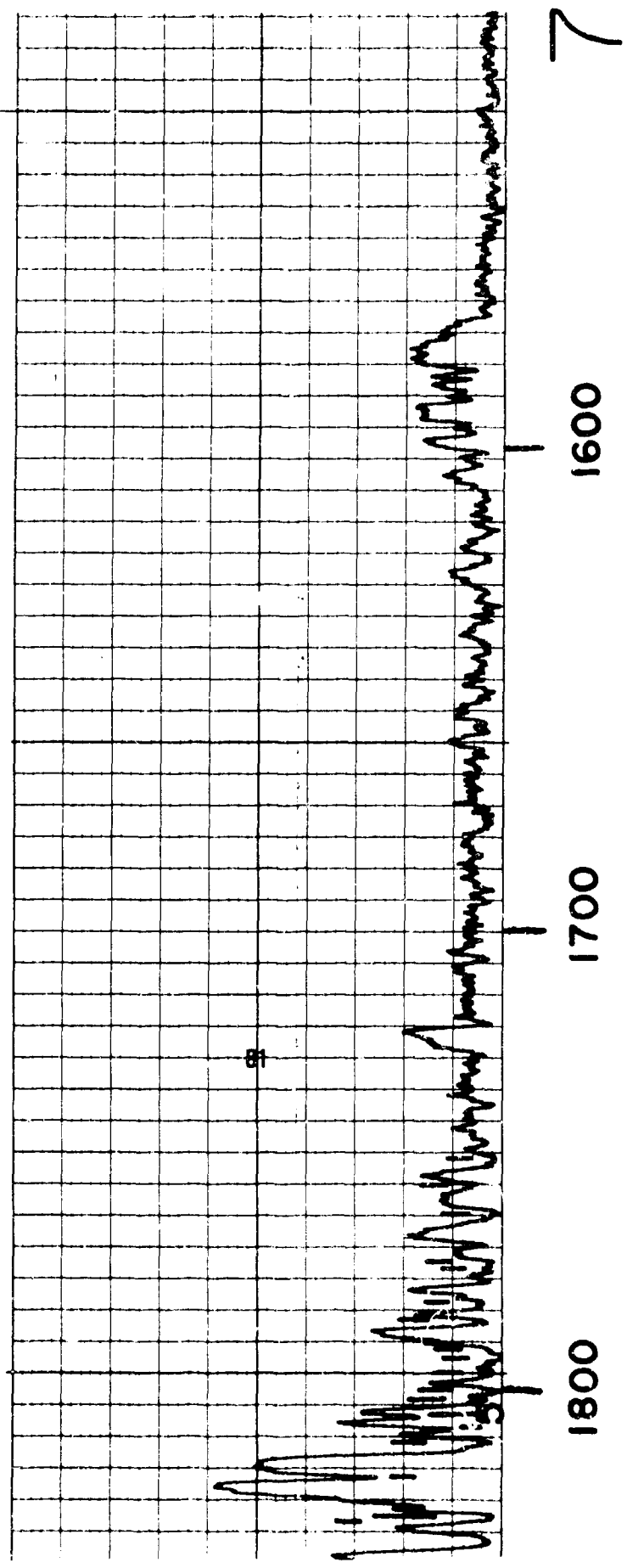

7

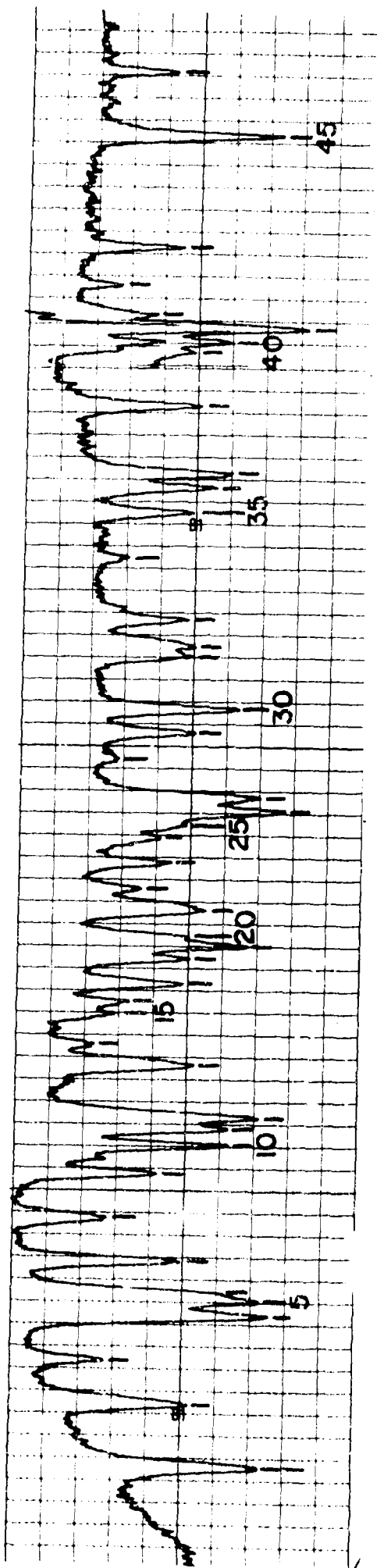

65

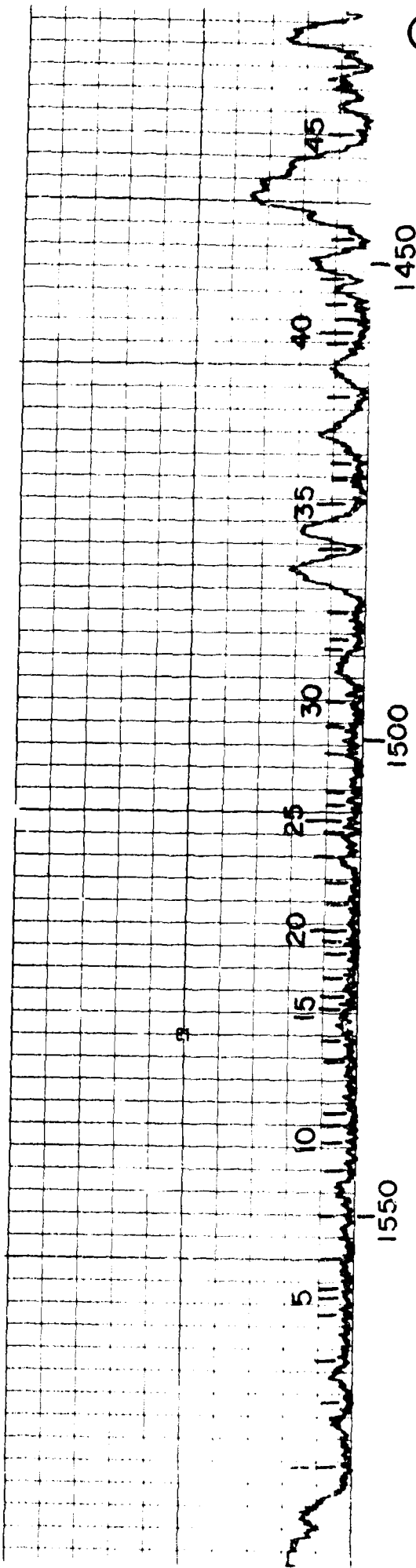

1550

1500

1450

8

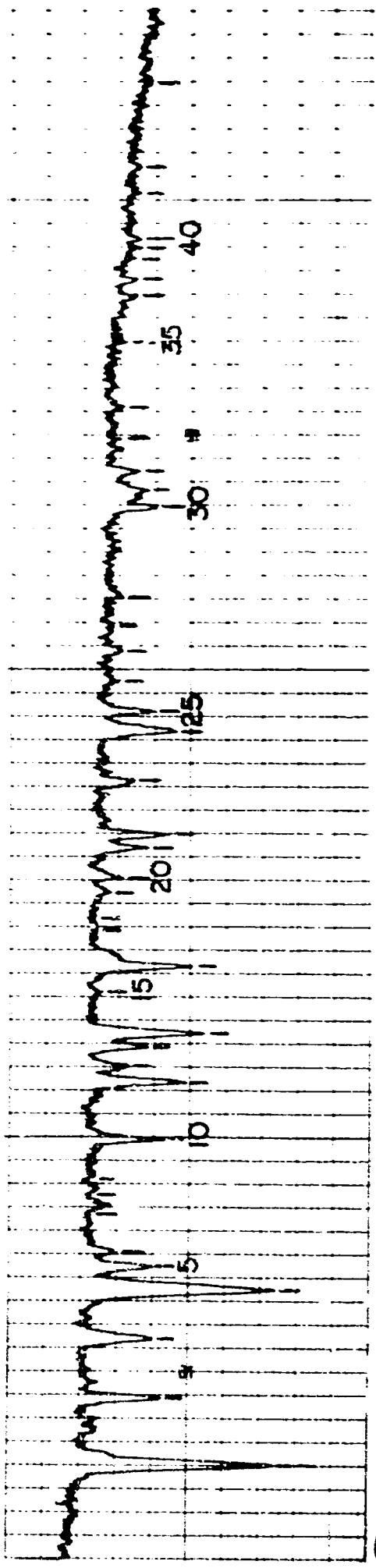

66

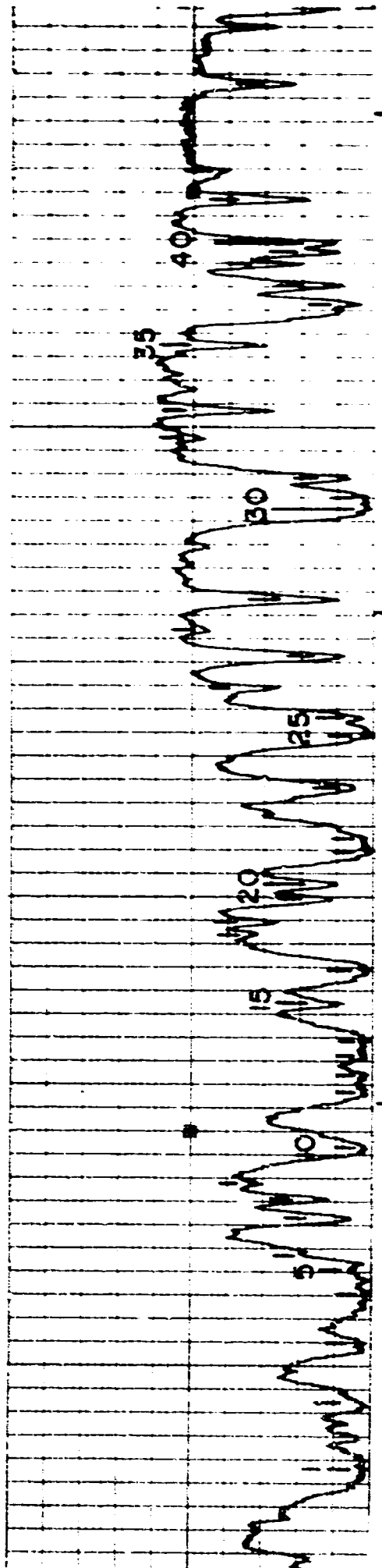

1400

1350

1300

9

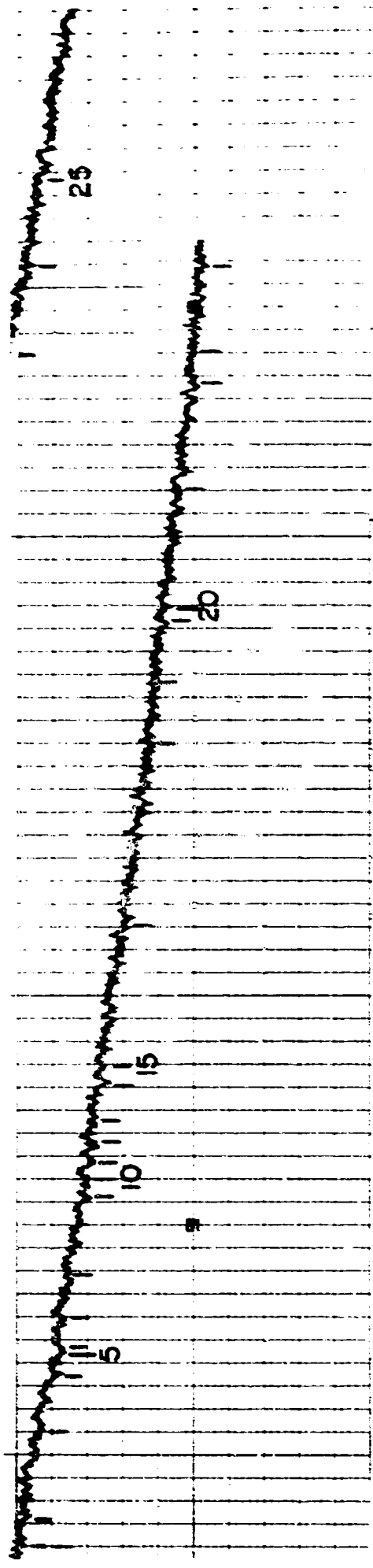

67

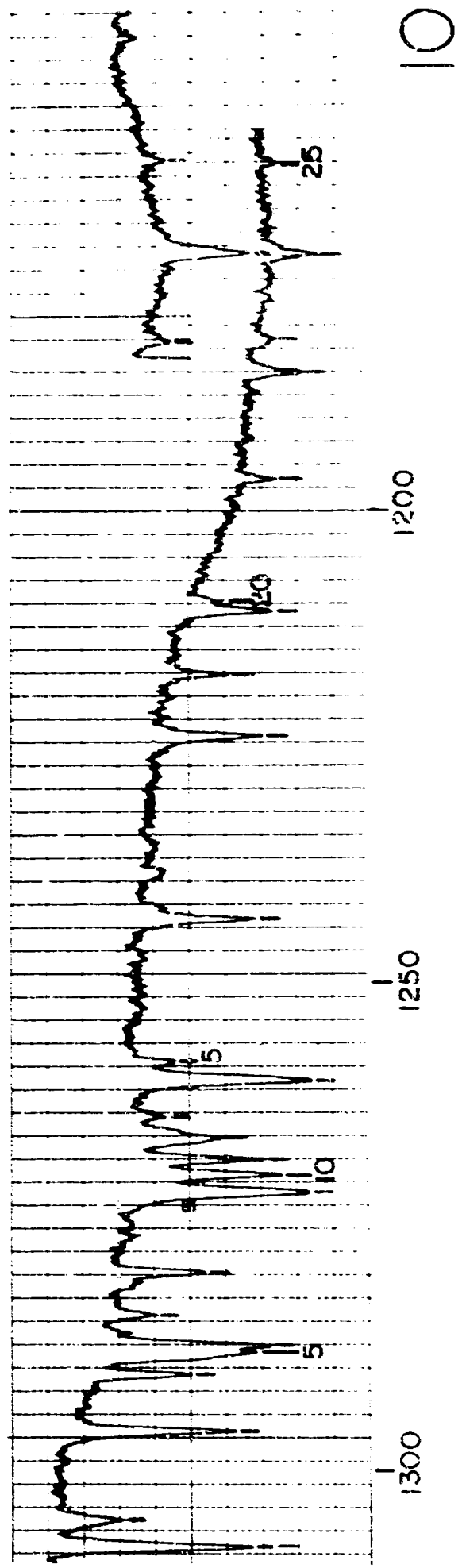

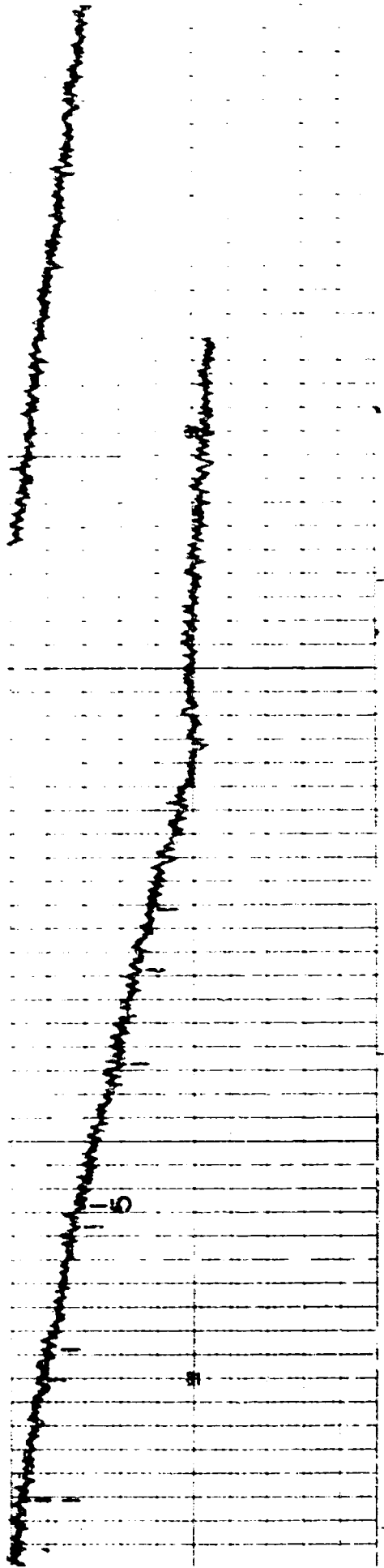

68

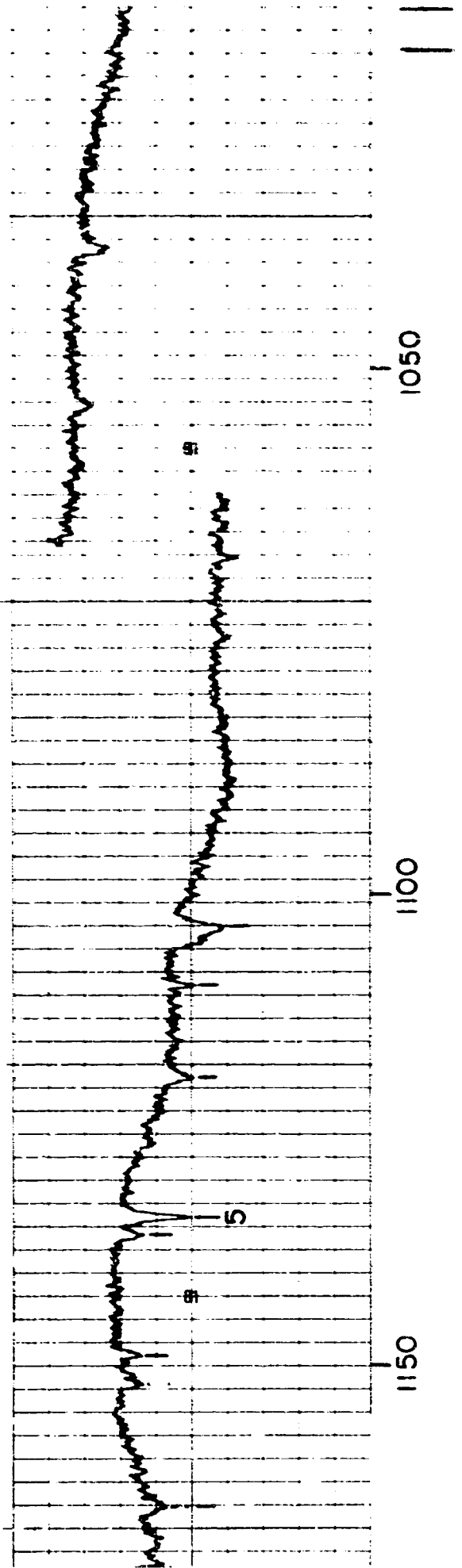

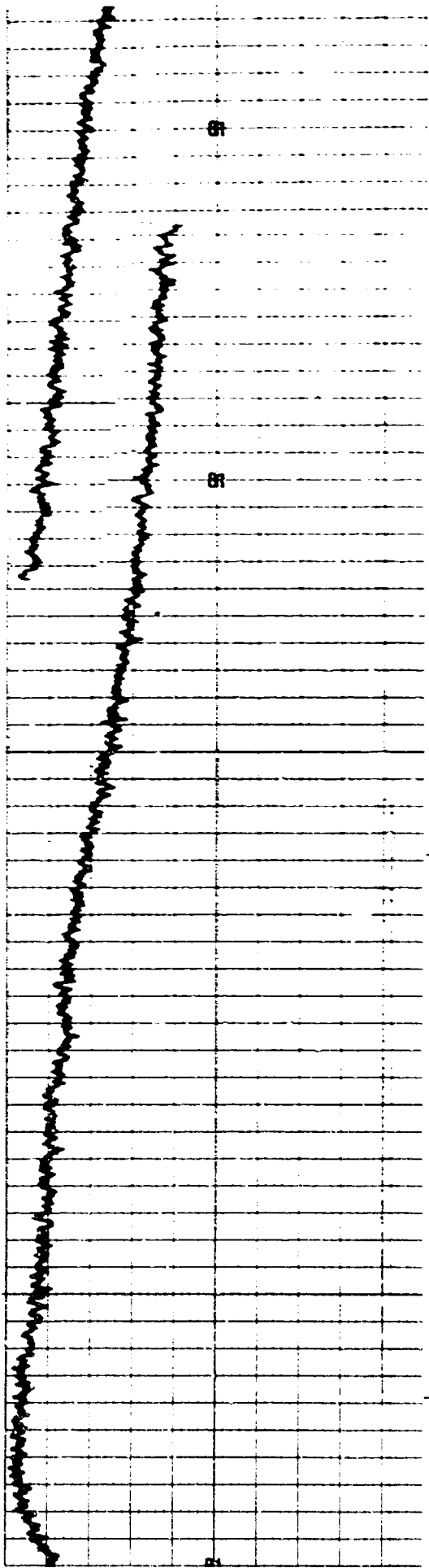

6/9

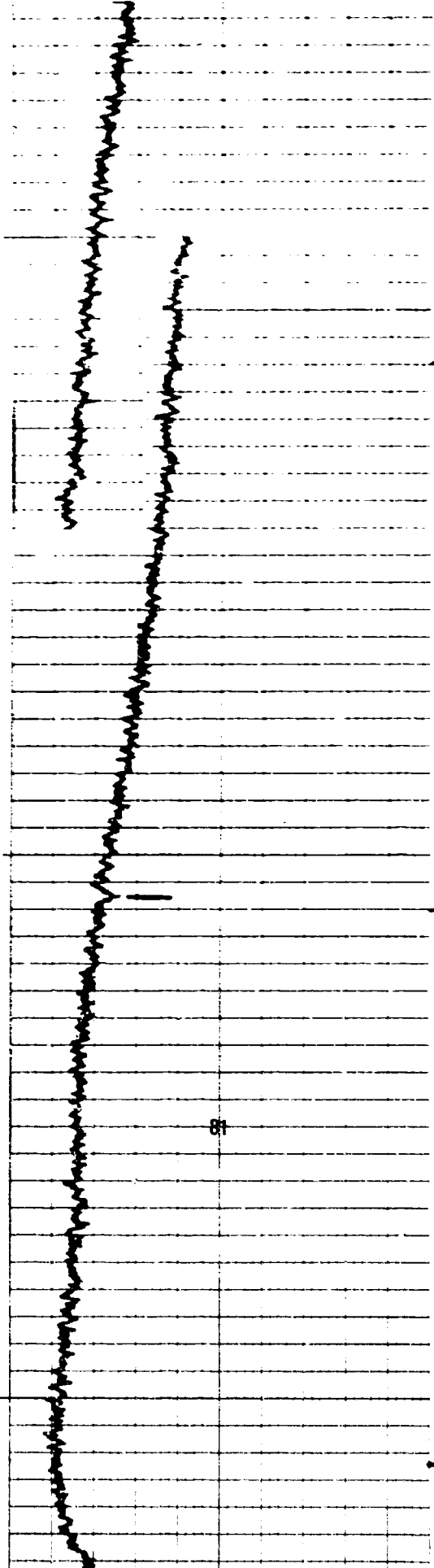

1000

950

900

12

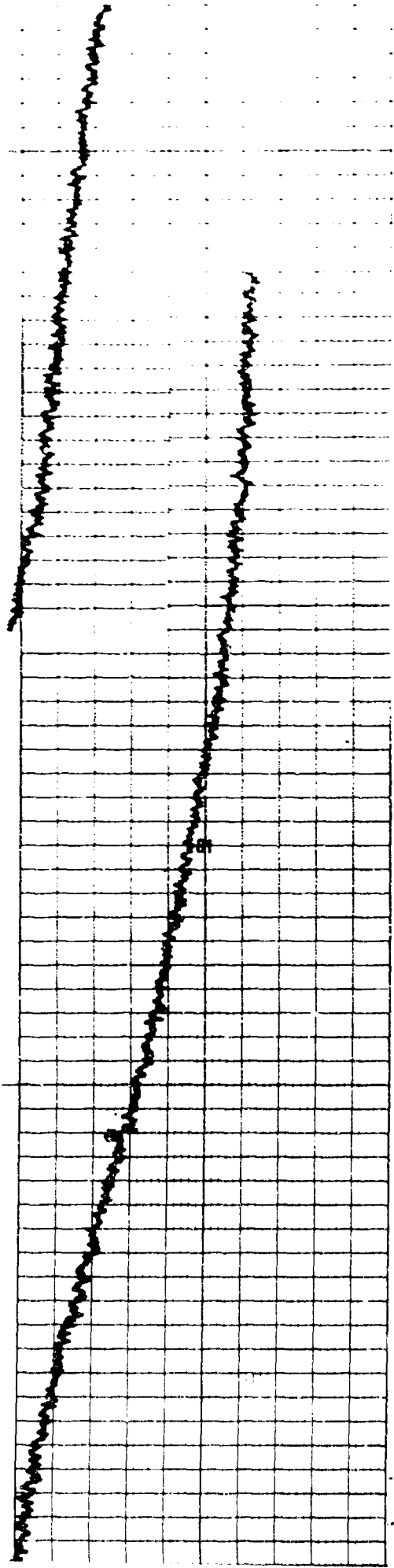

70

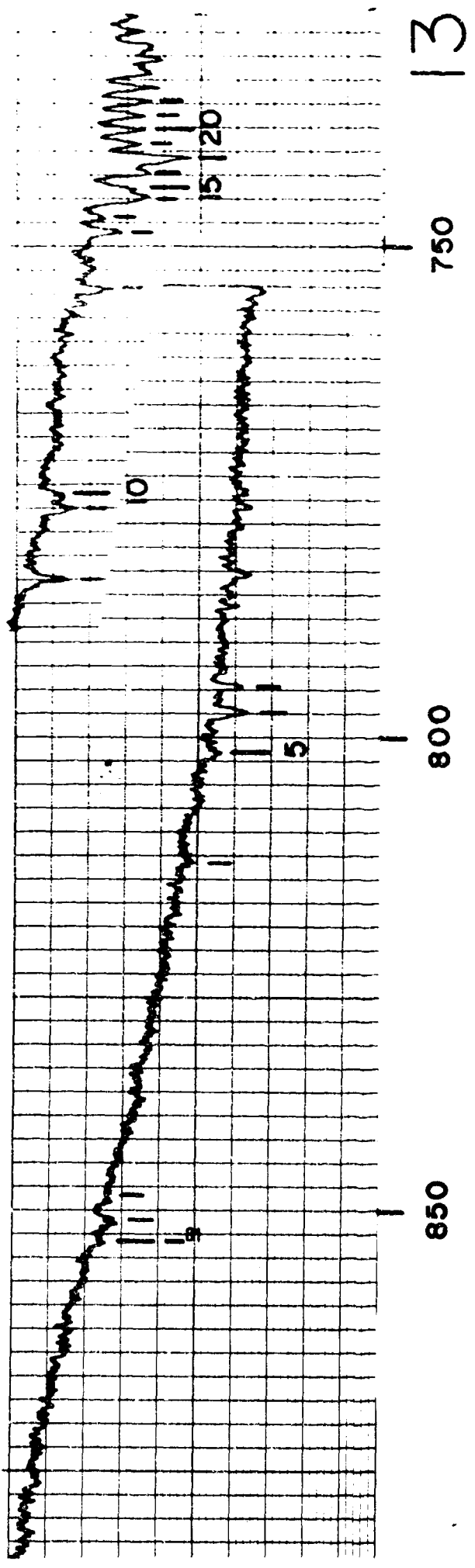

130

750

800

850

10

15 20

5

5

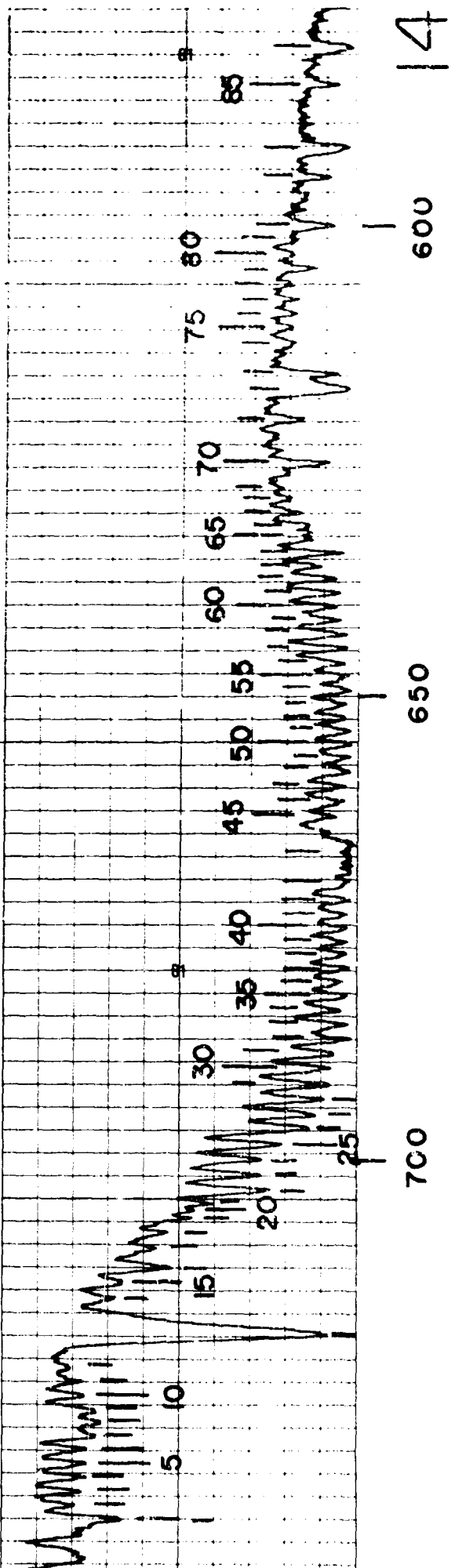
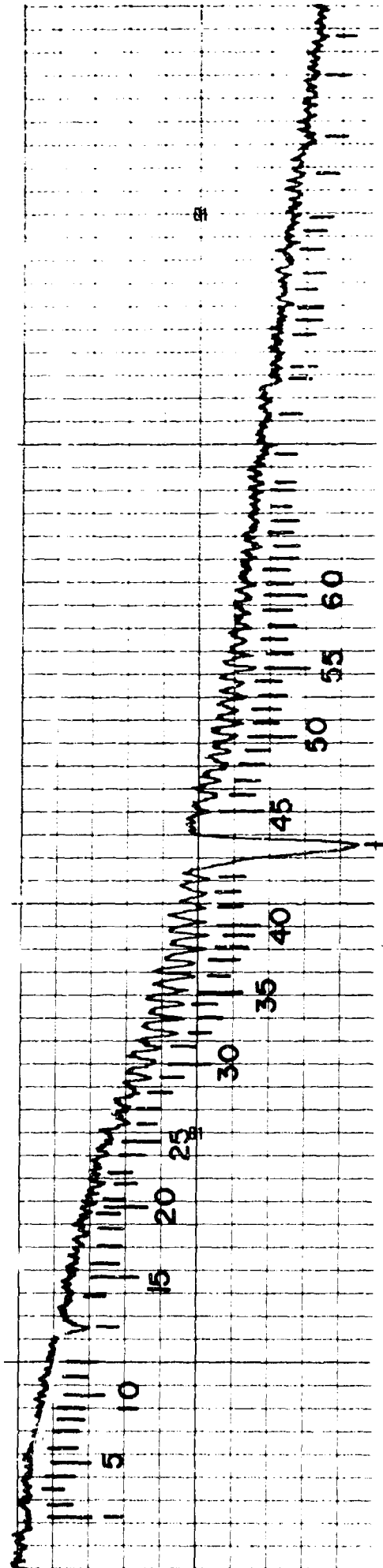

14

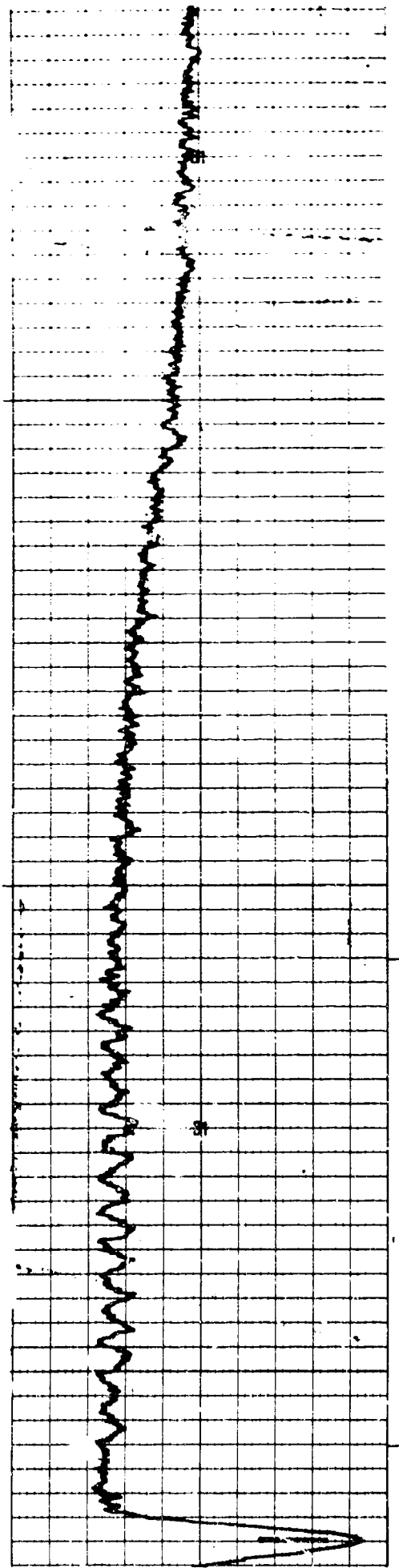

92

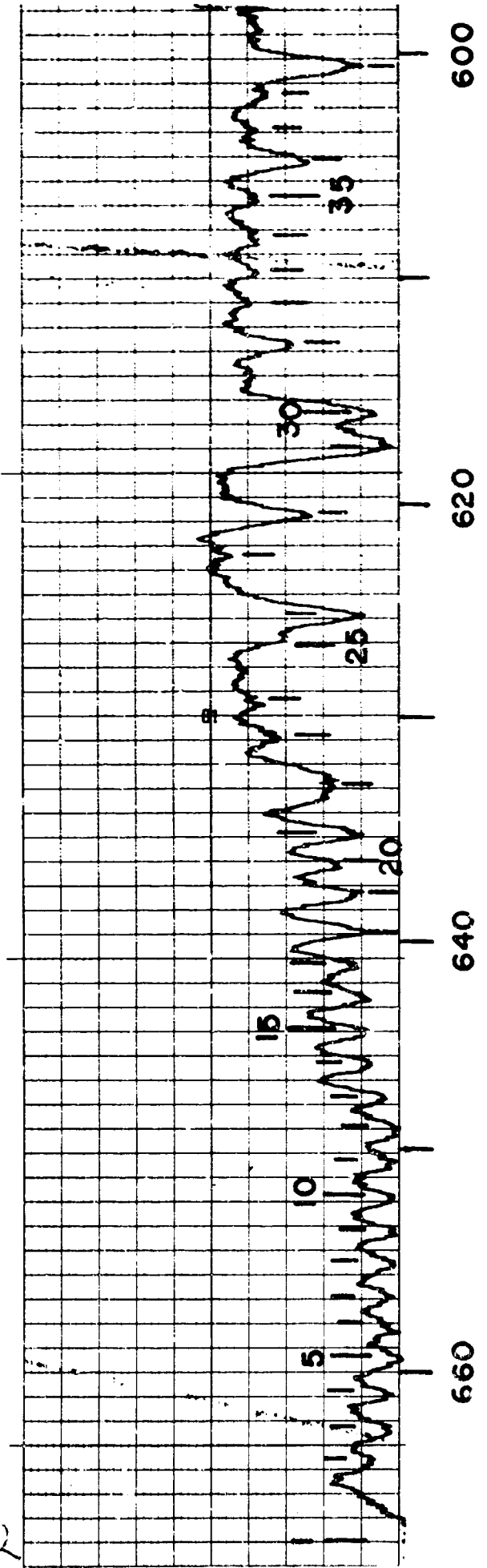

5

660

640

620

600

5

10

15

20

25

30

35

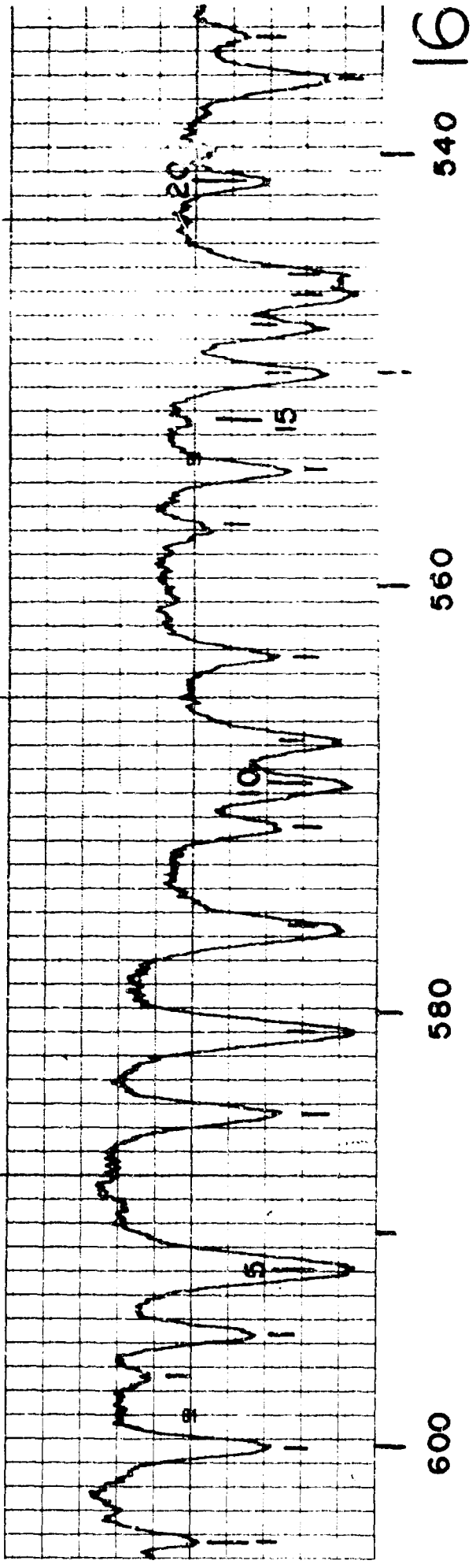
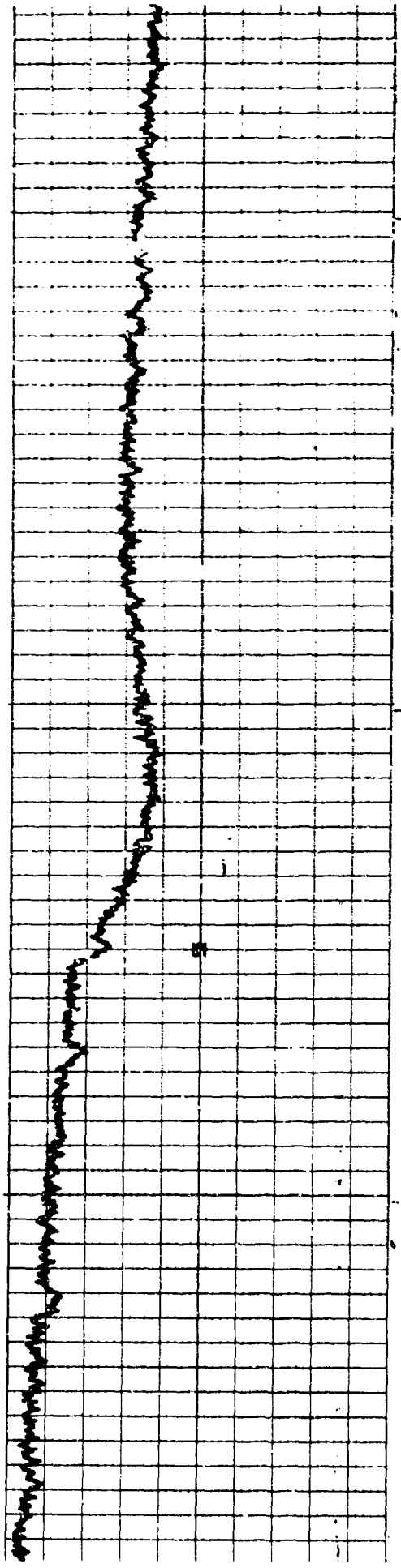

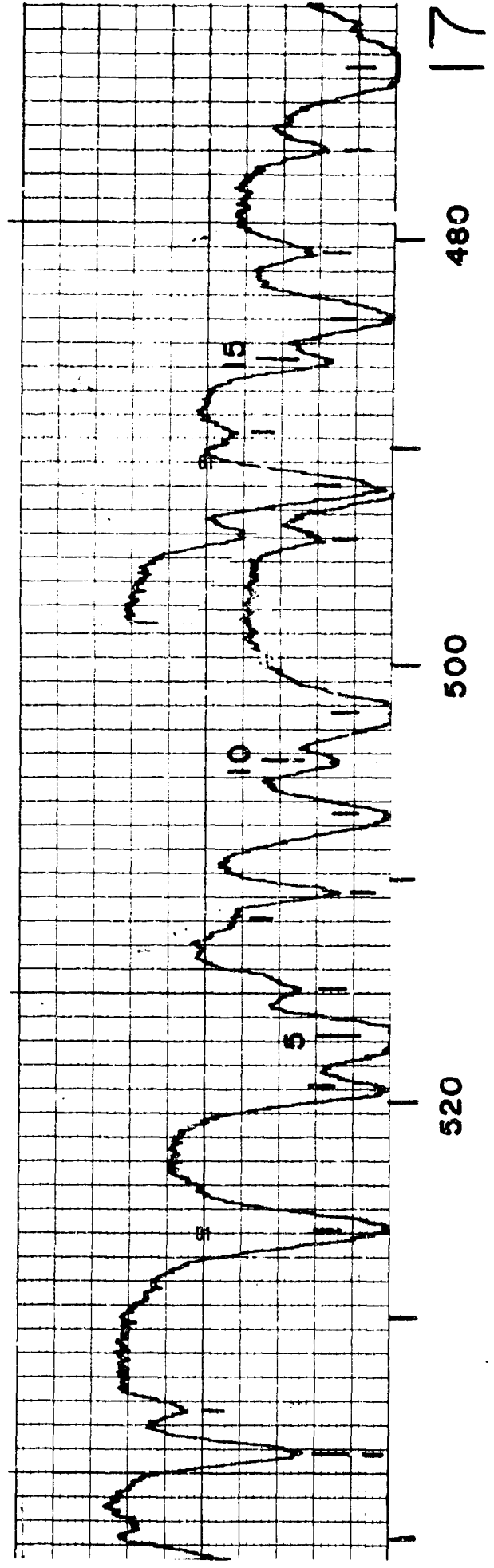
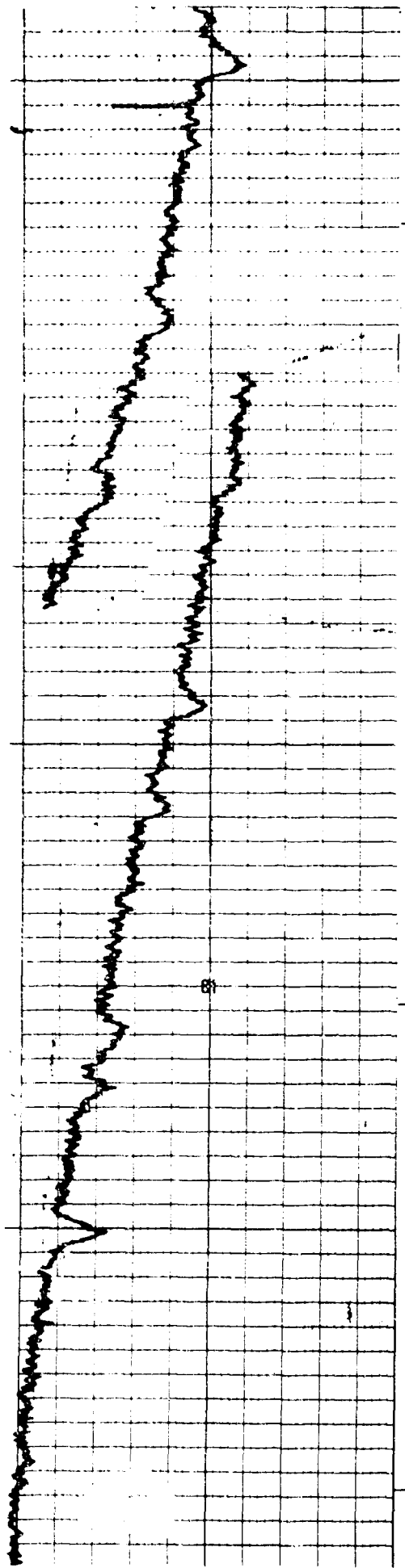

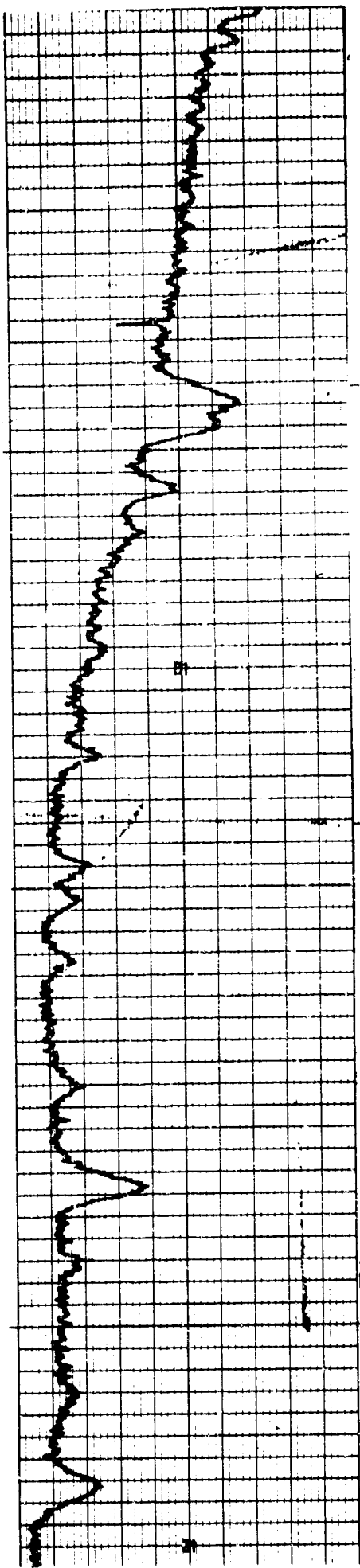

75.

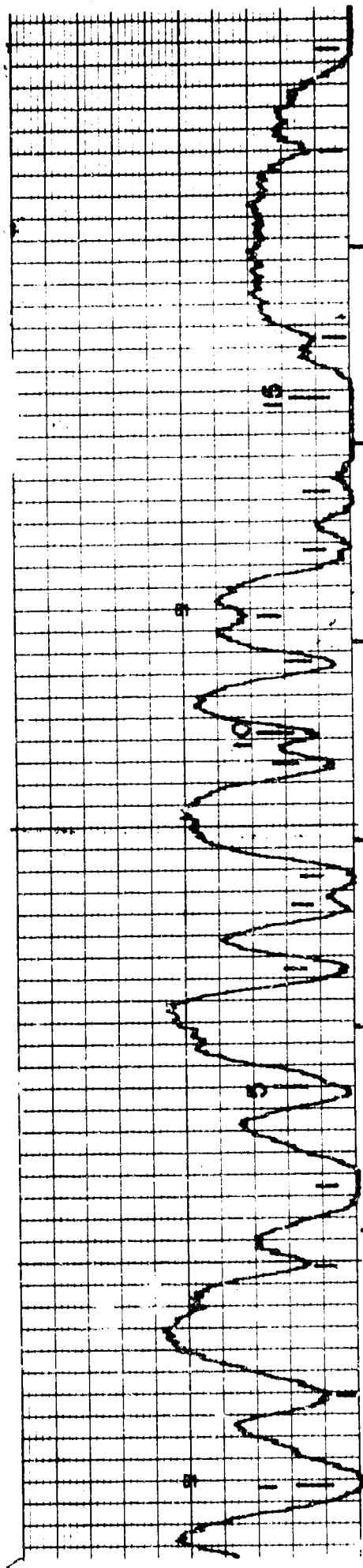

18

420

440

460

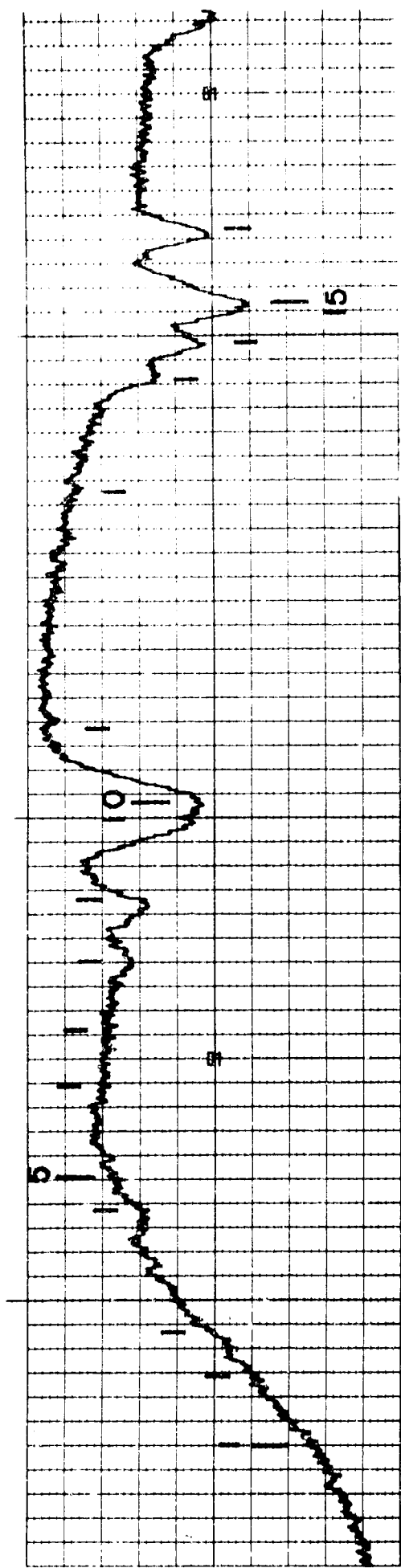

76

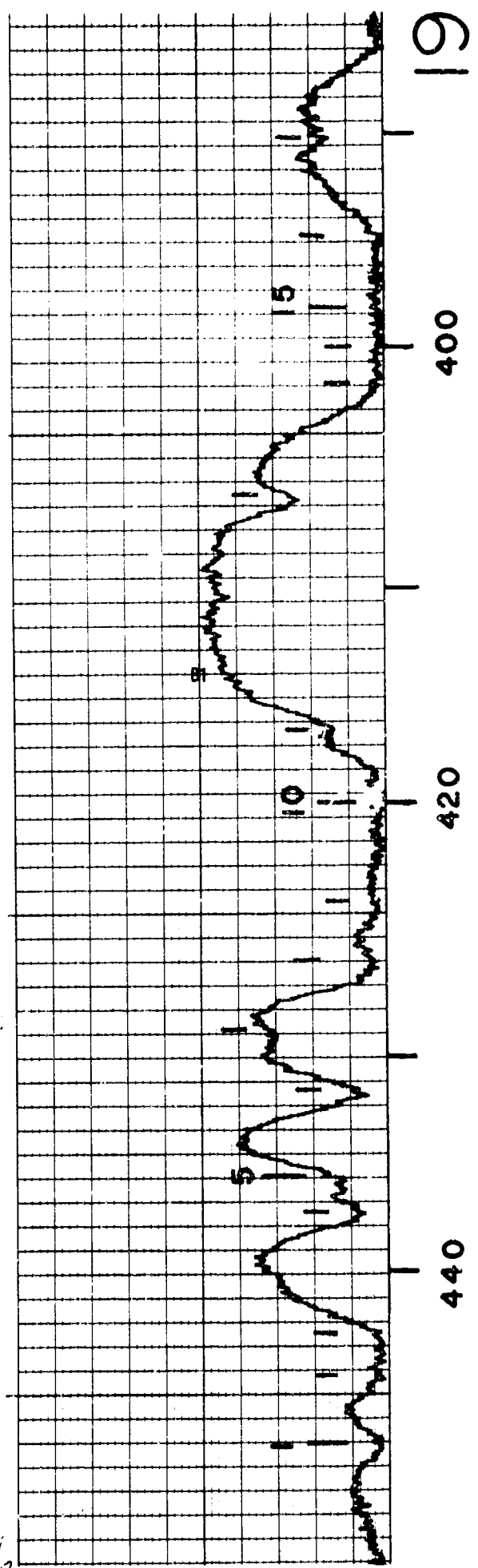

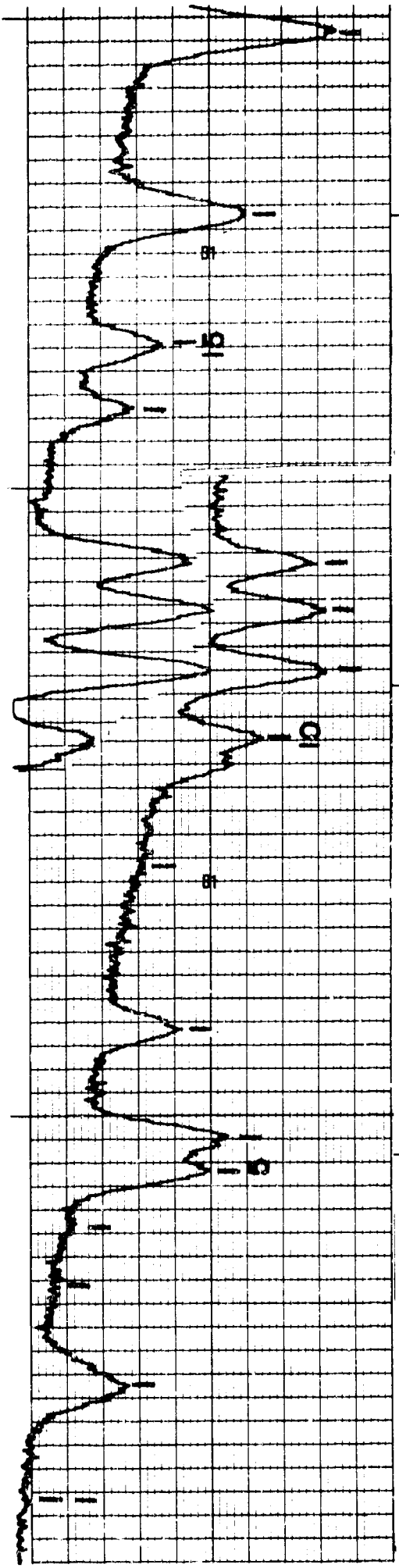

71

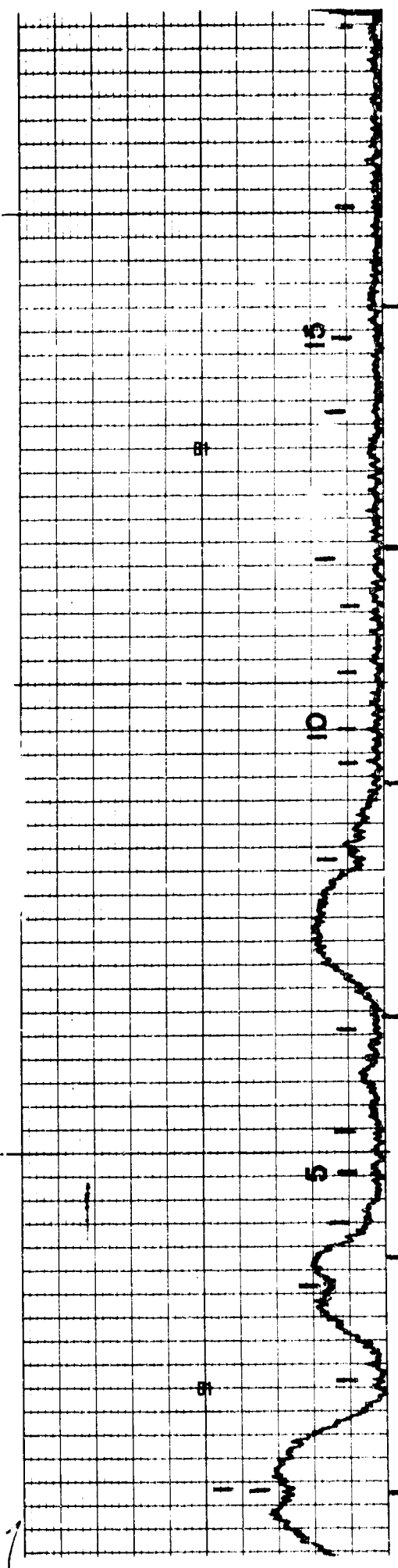

20

340

360

380

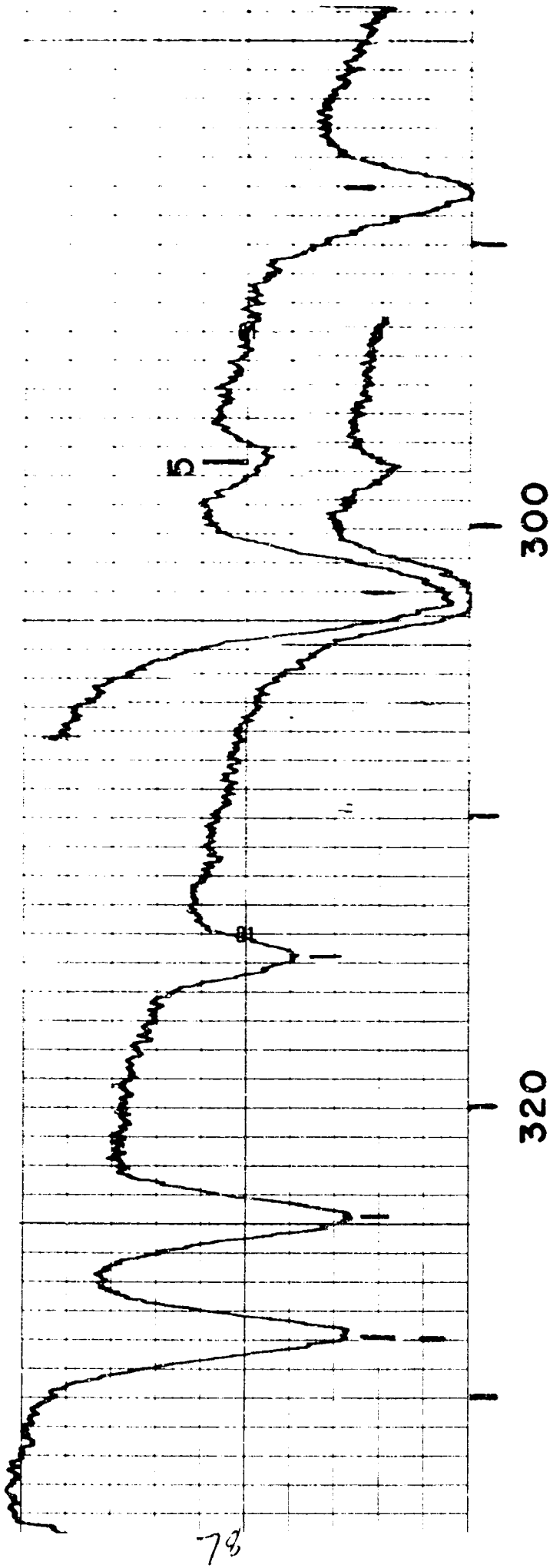

21

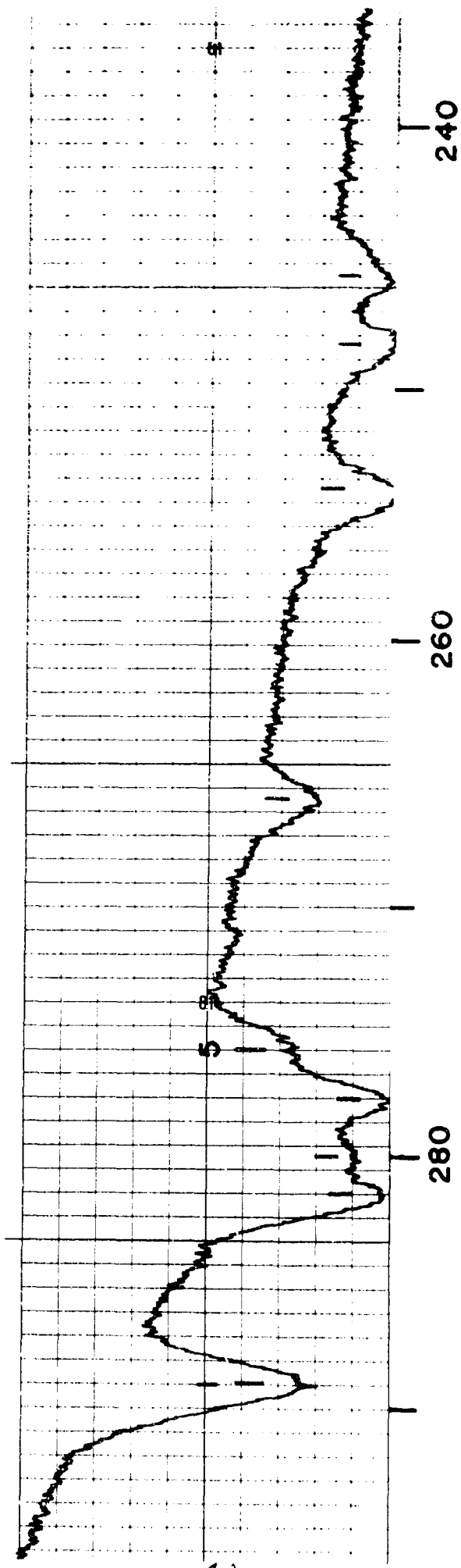

22

UNCLASSIFIED

Security Classification

DOCUMENT CONTROL DATA - R & D

(Security classification of title, body of abstract and indexing annotation must be entered when the overall report is classified)

1. ORIGINATING ACTIVITY (Corporate author) University of Massachusetts Department of Physics and Astronomy Amherst, Massachusetts 01002		2a. REPORT SECURITY CLASSIFICATION UNCLASSIFIED	
		2b. GROUP	
3. REPORT TITLE AN ATLAS OF AIR ABSORPTIONS IN THE INFRARED			
4. DESCRIPTIVE NOTES (Type of report and inclusive dates) Scientific.-----Interim.			
5. AUTHOR(S) (First name, middle initial, last name) D. J. Lovell			
6. REPORT DATE June 1969	7a. TOTAL NO. OF PAGES 82	7b. NO. OF REFS 7	
8a. CONTRACT OR GRANT NO. N00014-67-A-0230-0002	9a. ORIGINATOR'S REPORT NUMBER(S) 243		
b. PROJECT NO. NR 015-301	9b. OTHER REPORT NO(S) (Any other numbers that may be assigned this report) Four-College Contribution No. 49		
c.			
d.			
10. DISTRIBUTION STATEMENT Distribution of this document is unlimited.			
11. SUPPLEMENTARY NOTES		12. SPONSORING MILITARY ACTIVITY Office of Naval Research Washington, D.C. 20360	
13. ABSTRACT An atlas of the spectral absorption characteristic of air is presented in the spectral region from 4000 to 250/cm ⁴⁹⁷ . Spectra were observed over a 92-meter path under two conditions: in a near vacuum and at ambient pressure and temperature.			

DD FORM 1473
1 NOV 65

UNCLASSIFIED

Security Classification

UNCLASSIFIED

Security Classification

14. KEY WORDS	LINK A		LINK B		LINK C	
	ROLE	WT	ROLE	WT	ROLE	WT
Absorption						
Air						
Atlas						
Infrared						

Best Available Copy

UNCLASSIFIED

Security Classification