

AD 711838

(1)

THE UNIVERSITY OF MICHIGAN



Memorandum 28

CONCOMP

June 1970

CAMA: DEFINE PROBLEM COMMAND

Suzanne D. Goodrich

This document has been approved
for public release and sale; its
distribution is unlimited

U.S. GOVERNMENT
CLEARINGHOUSE
505 LINDSEY BLDG. WASHINGTON, D.C. 20540
Ordering Office: GPO: 1970-271-511

DDC
RECEIVED
SEP 24 1970
REGULATED

C

T H E U N I V E R S I T Y O F M I C H I G A N

Memorandum 28

CAMA: DEFINE PROBLEM COMMAND

Suzanne D. Goodrich

CONCOMP: Research in Conversational Use of Computers
 F.H. Westervelt, Project Director
 ORA Project 07449

supported by:

ADVANCED RESEARCH PROJECTS AGENCY
DEPARTMENT OF DEFENSE
WASHINGTON, D.C.

CONTRACT NO. DA-49-083 OSA-3050
ARPA ORDER NO. 716

administered through:

OFFICE OF RESEARCH ADMINISTRATION ANN ARBOR

June 1970

TABLE OF CONTENTS

1. Introduction 1

2. User's Guide for Command DPROB 1

 2.1. Data Structure 2

 2.1.1. Master Directory Entries 2

 2.1.2. Data Packs 4

 2.2. General Execution Structure. 5

 2.3. Subroutines Used in DPROB Command. . . . 22

3. References 31

1. INTRODUCTION

The Computer-Aided Mathematical Analysis system (CAMA) permits construction of symbols and expressions, manipulation of expressions, and solution of equations. CAMA operates under MTS in the IBM 360/67 and RAMP in the PDP-8/338 terminal. CAMA operations are divided into tasks which may be inserted into the queue via commands.

2. USER'S GUIDE FOR COMMAND DPRØB

The command DPRØB is used to define a problem. Execution of this command causes a flag to be set so that a second specification of the command is ignored until the first request is completed. The command has four branches: (1) construct symbols, (2) select symbols for a problem, (3) define expressions for a problem, (4) escape to return to the CAMA system.

(1) Construct symbols.

The user specifies the menu into which the generated symbol will be placed. He constructs and names the symbol. Options exist during construction for erasing the existing symbol and starting again or rejecting the entire stage. If the user duplicates a symbol name, he may rename the symbol or destroy the old definition as he wishes.

(2) Select Symbols for Problem.

The user specified a problem. If the problem

exists and contains symbols, the symbols are displayed. The user selects entire menus or particular symbols from menus to be included in his problem. He may remove one or all symbols from his problem. A maximum of 63 symbols may be included in one problem.

(3) Define Expressions for a Problem.

The user specifies a problem and the problem symbols are displayed. He may display, modify, and save or destroy an existing expression of the problem, or create and save a new expression.

2.1 DATA STRUCTURE

2.1.1. Master Directory Entries

The command DPRØB uses entries MSYMTBL, MPROB, NAMEFLAG, and PRØBLEM (see Fig. 1) in the master directory and the corresponding packs. MSYMTBL is a name-list containing the names of all menus, both system menus and user-named menus containing user-created symbols, and pointers to the menu packs. The menu packs are lists of symbols in the menu and pointers to the data pack which contains the display file for the symbol.

MPRØB is a list of problems and corresponding pack pointers. A problem pack is an association table identifying the symbols in a problem. The association object is the symbol name, and the value is the name of the menu

Entries in
Master Directory

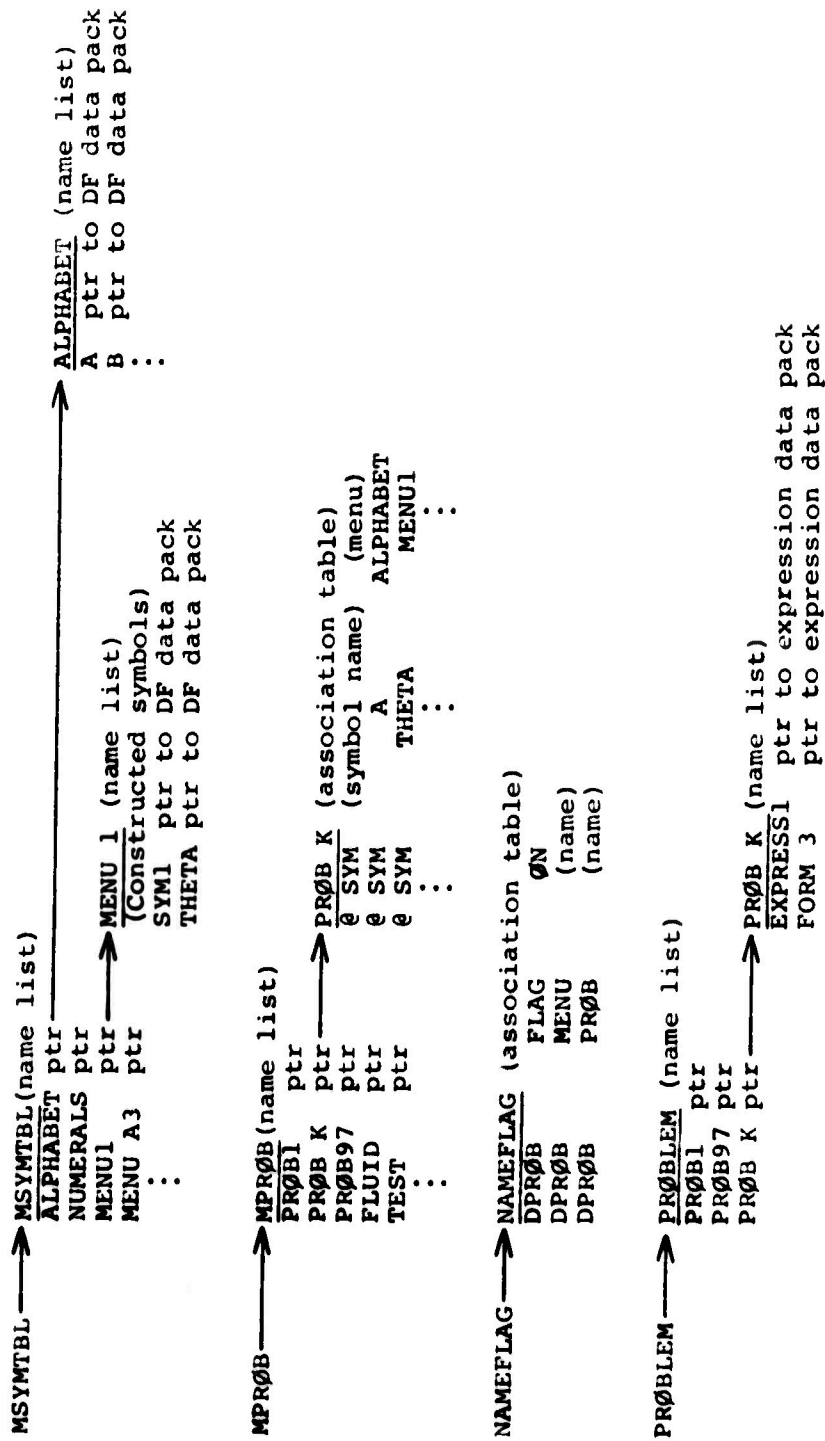

Figure 1. Entries in Master Directory

containing the symbol.

The NAMEFLAG entry in the master directory points to an association table which identifies the current problem and menu, and indicates the availability of this command.

PROBLEM is a name-list of problems and the corresponding pointers. The problem packs are name-lists of expressions in the specific problem and pointers to the data packs defining the expressions.

2.1.2. Data Packs

The first ten words of the symbol display file data pack are the display file header (PSECT2 of the DF routines¹). Byte 1 of word 1 and words 6, the buffer location pointer, 7, the PDP-8 word count, and 9, the first location of the actual buffer, must be set to appropriate values before the display file is transmitted. Switch 1 which is byte 1 of word 1 should be set to 40_{16} so the DF routines will not modify the last location of the display file. The remainder of the data pack contains the display file with one 338 word stored in two bytes using six bits in each byte, as described and illustrated in Appendix C of The DF Routines User's Guide¹.

Data packs are also used to define the expression with one 20-byte entry for each symbol of the expression (see Fig. 2).

X	Y	symbol name	scale	(free)	entity no.	(free)
2	2	8 bytes	2	2	2	2

Figure 2.

The entry contains the X and Y coordinates of the symbol in raster points, the symbol name, the scale for the symbol in range 1-3, and the entity number. (The entity number is not used in command DPRØB and will be discussed in greater detail when relevant.)

2.2 GENERAL EXECUTION STRUCTURE

The general sequence of execution of command DPROB is illustrated in Fig. 3. Successive tasks are executed in the central computer in response to light button requests until the user chooses to exit from the command.

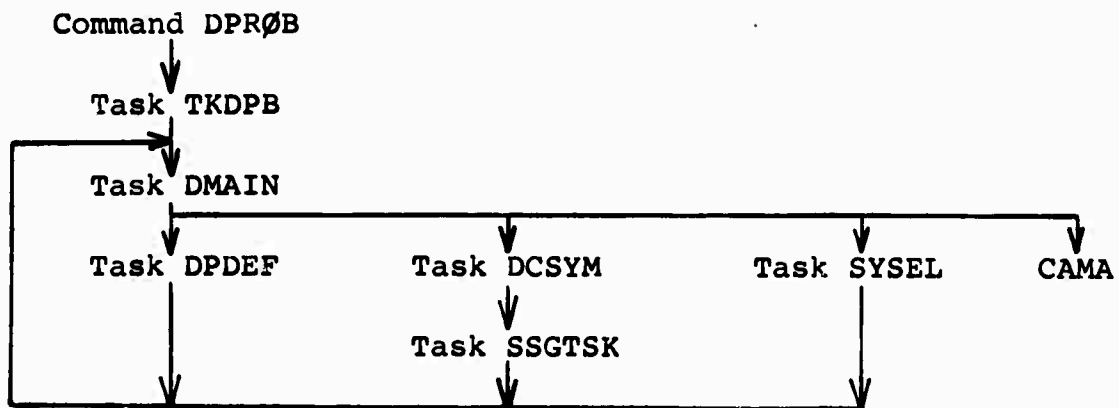

Figure 3.

Task TKDPB

Task TKDPB examines the NAMEFLAG association table.

If the association

DPRØB FLAG ØN

is present, a comment

TASK IN CURRENT USE ... NEW REQUEST IGNORED.

is printed and a return is made to the CAMA system. If the flag association is not present, the task DMAIN is executed.

Task DMAIN

The DMAIN task is the main branching stage. The light buttons

ESCAPE

PRØBLEM DEFINITIØN

CONSTRUCT SYMBØLS

SELECT SYMBØLS FØR PRØBLEM

are displayed. The user indicates the desired option with the Grafacon. If the user chooses to exit command DPRØB via the ESCAPE button, all DPRØB entries in the NAMEFLAG table are erased and a return is made to the CAMA system.

Task DPDEF

Task DPDEF is the response to the PROBLEM DEFINITION light button of task DMAIN. The execution of DPDEF is outlined in Fig. 4. The display screen is illustrated in

Fig. 5.

Task DCSYM

Task DCSYM is the response to the CONSTRUCT SYMBOLS light button. The 360 program which generates and transmits the display files is outlined in Fig. 6. The PDP-8 programs, specifically the actual symbol construction program, will be discussed in a subsequent memo². The display screen is illustrated in Fig. 7.

Task SSGTSK

The SSGTSK task moves the display file for the constructed symbol from a line directory to a data pack as described in Section 2.1.2. Execution of the task will be discussed in another memo².

Task SYSEL

Task SYSEL is executed as the response to the SELECT SYMBOLS FOR PROBLEM light button. The subroutine is outlined in Fig. 8. A maximum of 63 symbols may be selected for a problem. The display screen is illustrated in Fig. 9.

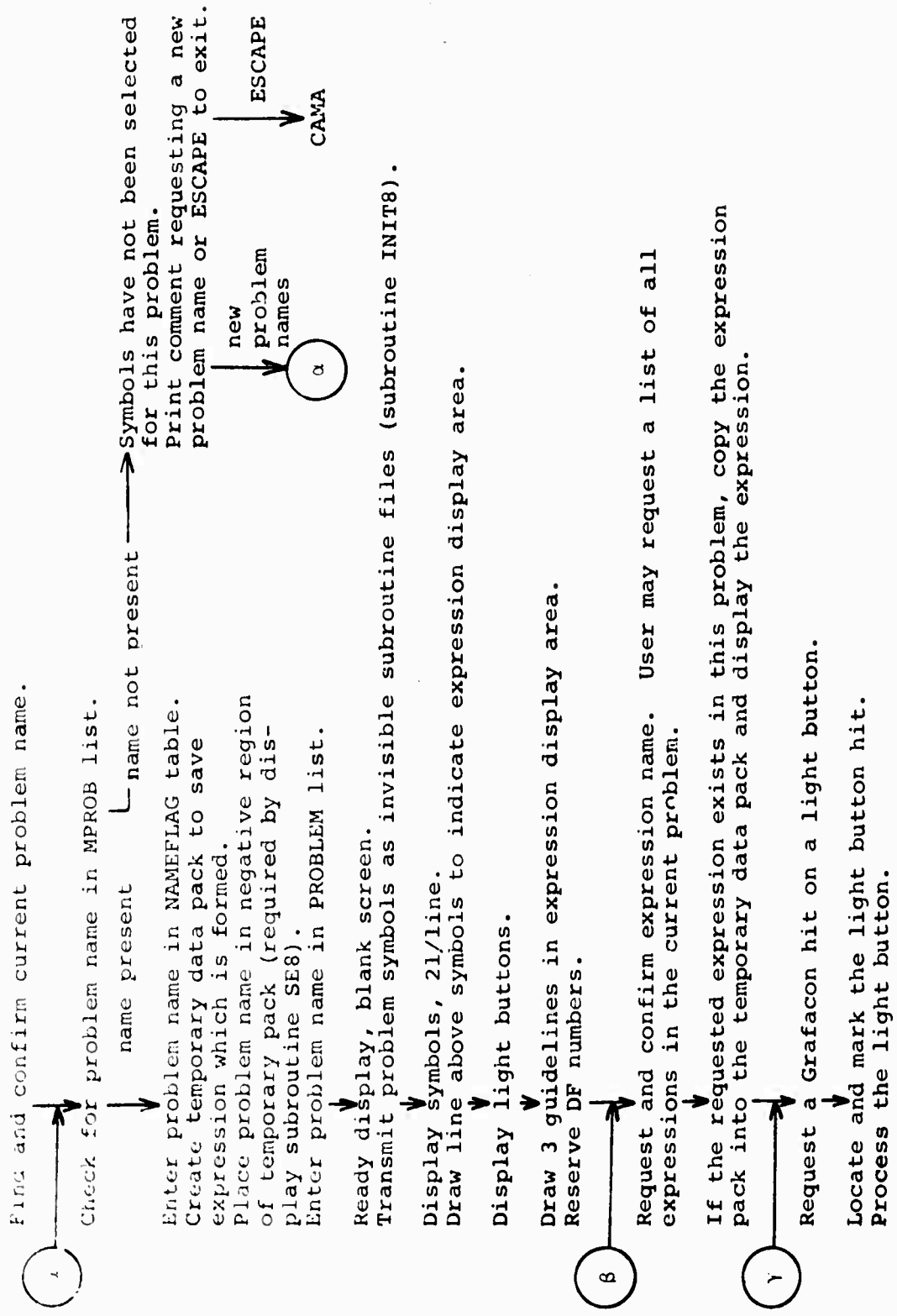

Figure 4. Subroutine DPDEF

LIGHT BUTTONS

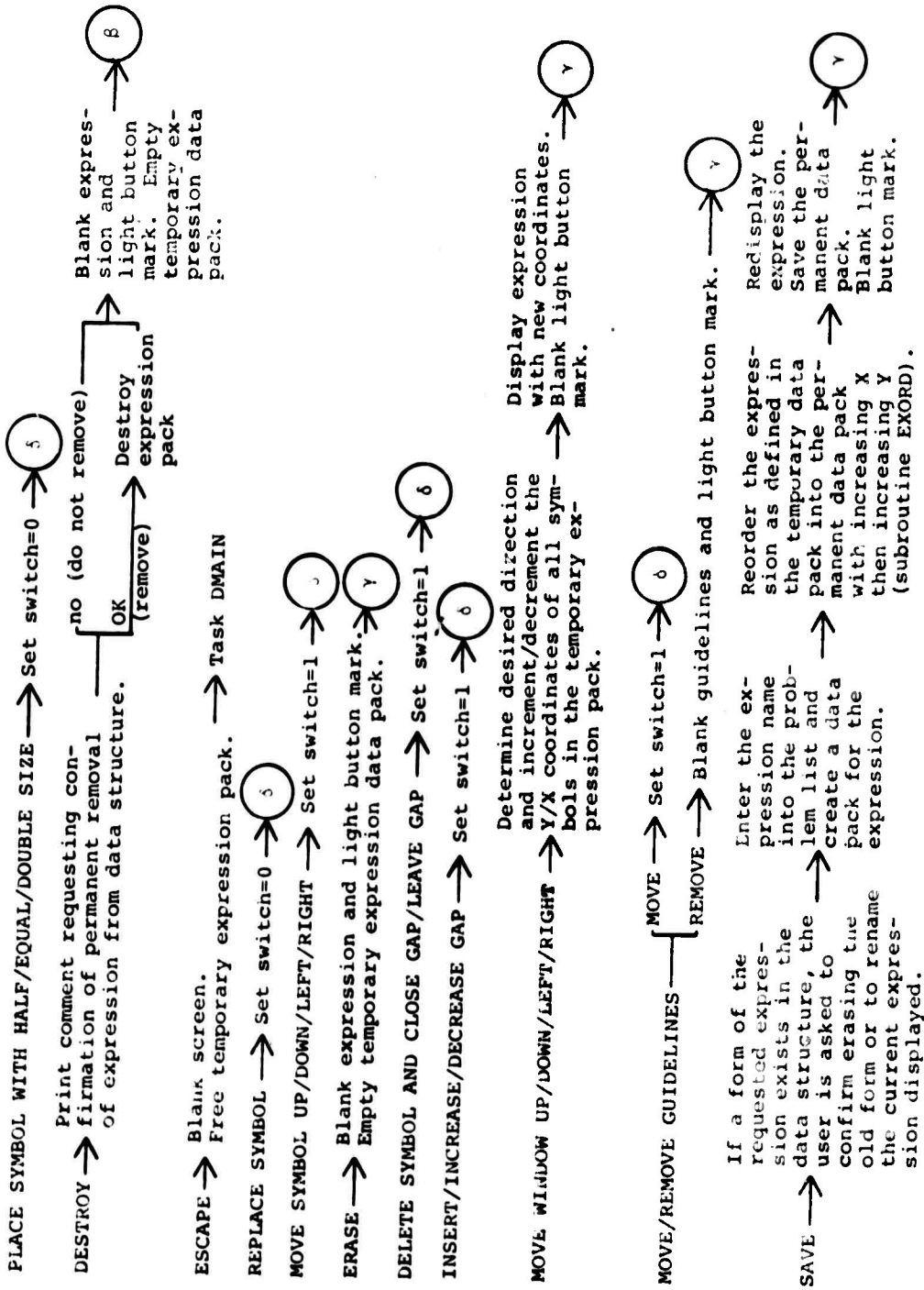
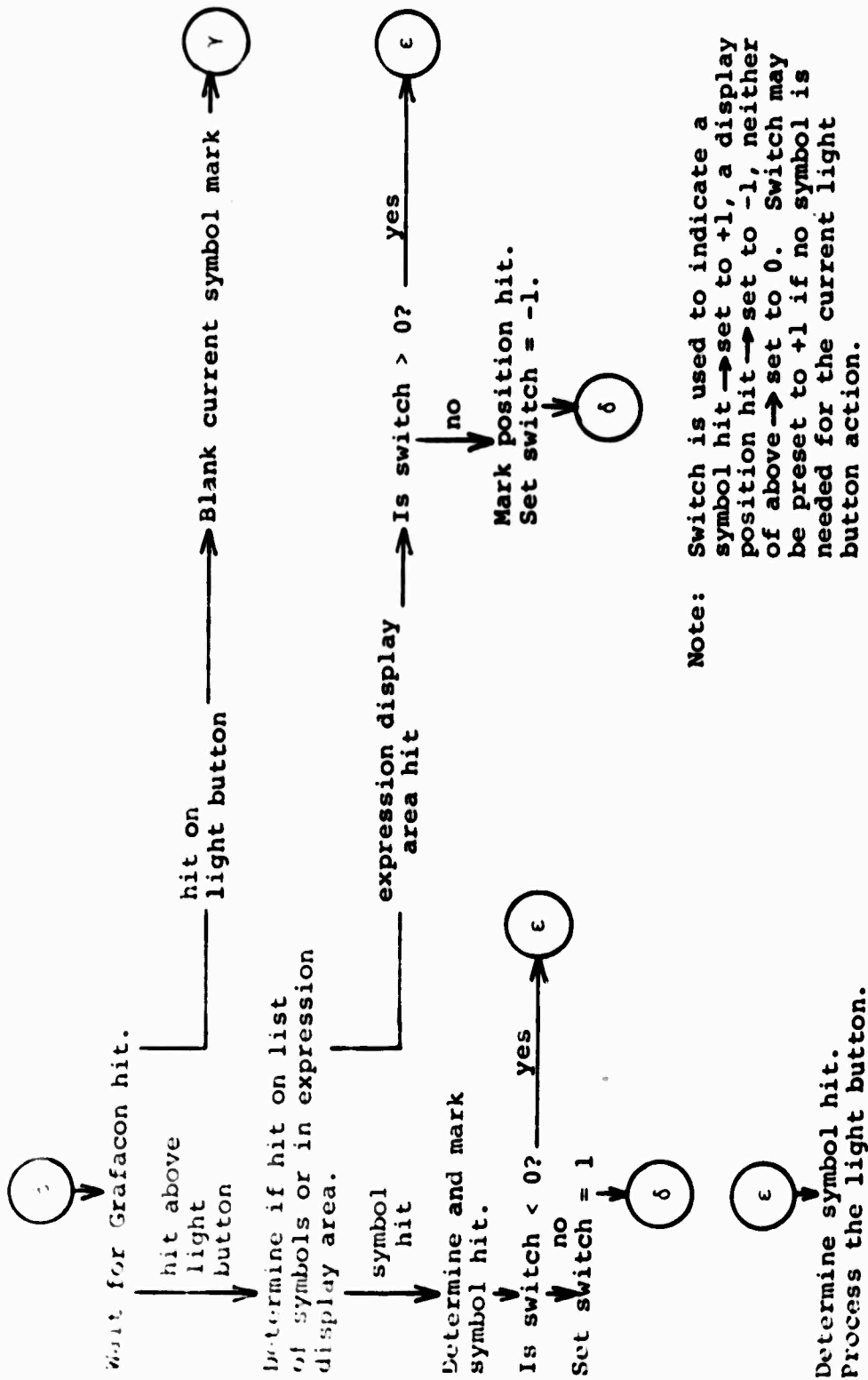

Figure 4. Subroutine DPDEF, continued



Note: Switch is used to indicate a symbol hit → set to +1, a display position hit → set to -1, neither of above → set to 0. Switch may be preset to +1 if no symbol is needed for the current light button action.

Figure 4. Subroutine DPDEF, continued

LIGHT BUTTONS

PLACE SYMBOL WITH HALF/EQUAL/DOUBLE SIZE → Determine size desired.
 Set scale value for expression pack entry.
 Calculate X and Y coordinates.
 Enter in temporary expression pack.
 Display expression. → Set switch=1 → 6

DESTROY → 5 → Print error comment.
 (This light button should have been processed above.) → EXIT

ESCAPE → 5

REPLACE SYMBOL → Identify symbol of expression indicated (subroutine EXLOC).
 Replace symbol name in temporary expression pack with symbol name from list. → Blank symbol mark.
 Display expression. → Set switch=0 → 6

MOVE SYMBOL UP/DOWN/LEFT/RIGHT → Identify symbol of expression hit.
 Calculate new X/Y coordinate.
 Replace current coordinate with new value. → Display expression.
 Set switch=1 → 6

ERASE → 5

Figure 4. Subroutine DPDEF, continued

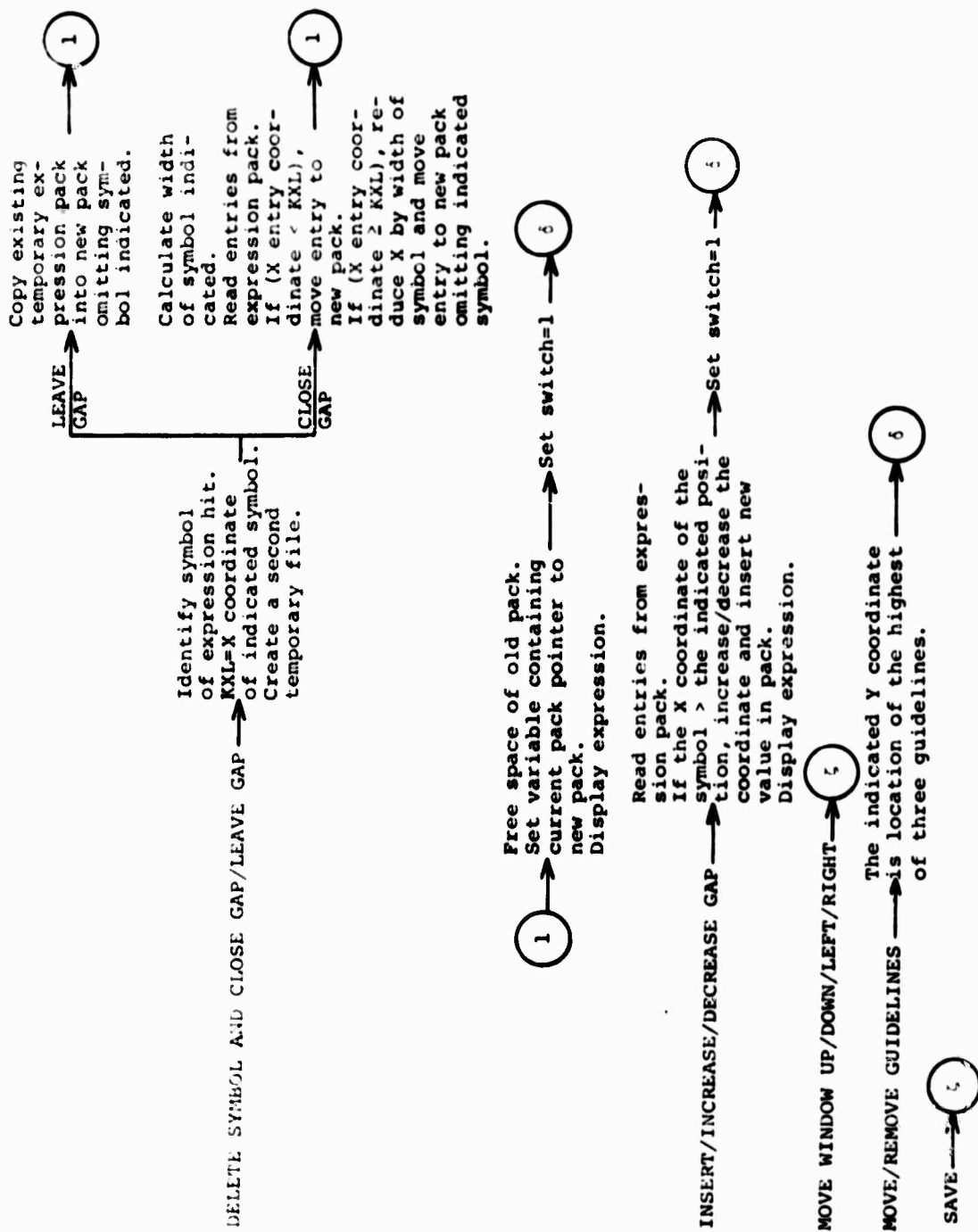

Figure 4. Subroutine DPDEF, concluded

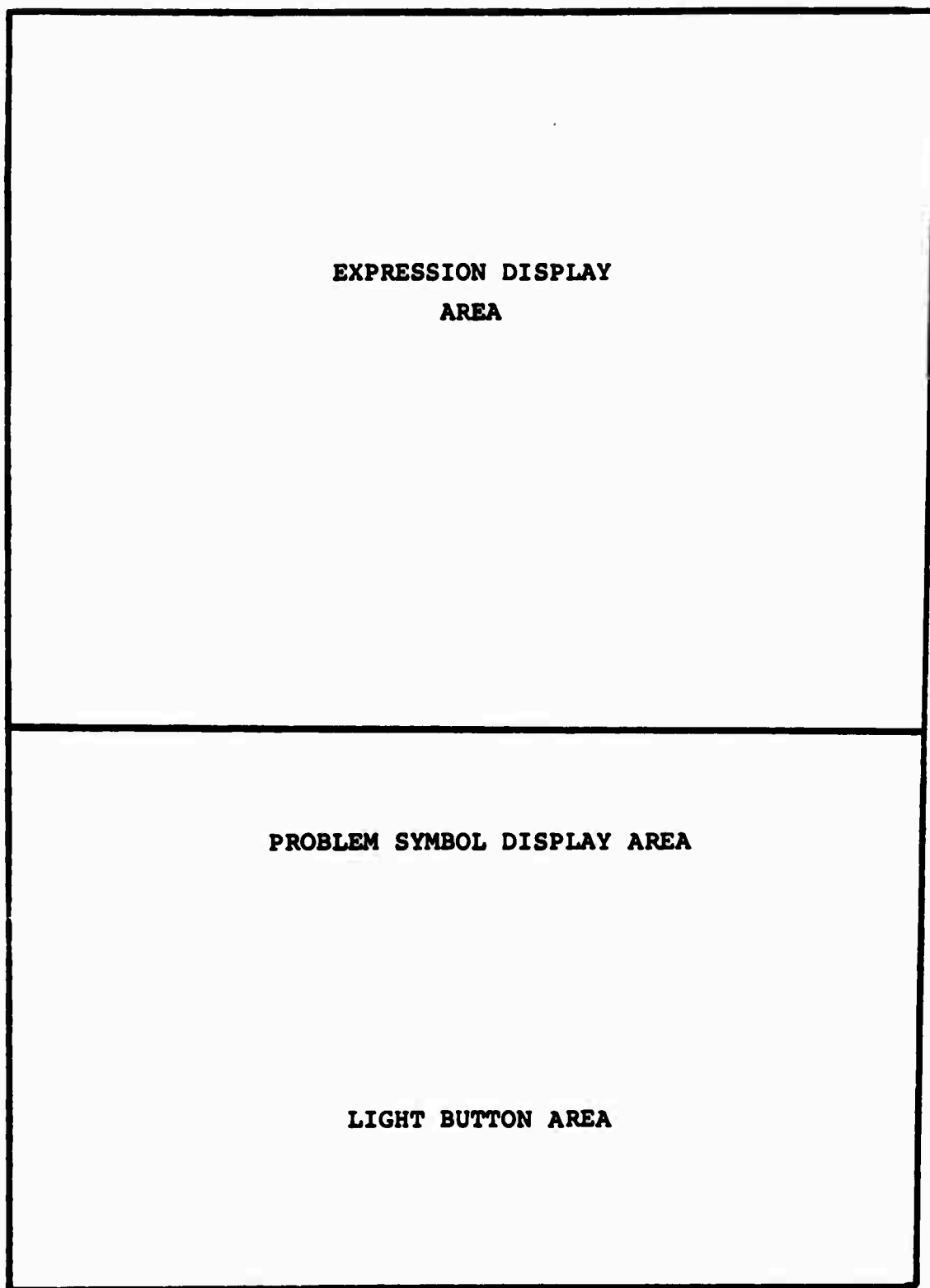

Figure 5. Display Screen for DFDEF

Ready display, blank screen.



Find and confirm current menu name.
Enter menu name in MSYMTBL list and create menu list or obtain pointer to existing menu list.



Call CAMSET which executes PDP-8 code to save main display file locations.



Transmit a square as a subroutine display file.
Transmit a small square as a main display file. This will later be used to indicate the Grafacon location by altering the end point of the first invisible vector.
Transmit the light buttons, each as a main display file containing a push-jump to the subroutine box, the text of the label, and a stop blink code.
Transmit the grid of endpoints by first generating and transmitting as a subroutine file a line of eight points. The grid is displayed as two main display files each containing four push-jumps to this subroutine file.
Transmit a box to contain the symbol. The user generates the symbol on a large scale for convenience. The symbol in the box shows the actual transmitted size.



Call CAMSET to stop saving main display file locations.



Find the data pack containing the PDP-8 symbol generation program.
Call PRØG to transmit the program to the PDP-8. PROG executes a PDP-8 task which reads the transmitted program, stores it, and transfers to the starting location of the transmitted code.

Figure 6. Subroutine DCSYM.

N A M E	<input type="checkbox"/>							
D E S T R O Y	<input type="checkbox"/>							
E S C A P E	<input type="checkbox"/>							
				<input type="checkbox"/>				
<input type="checkbox"/>					I N V I S I B L E			
<input type="checkbox"/>	<input type="checkbox"/>		<input type="checkbox"/>			<input type="checkbox"/>		
D R A W	E R A S E		R E F E R E N C E			S E C O N D A R Y		

Figure 7. Display Screen for DCSYM

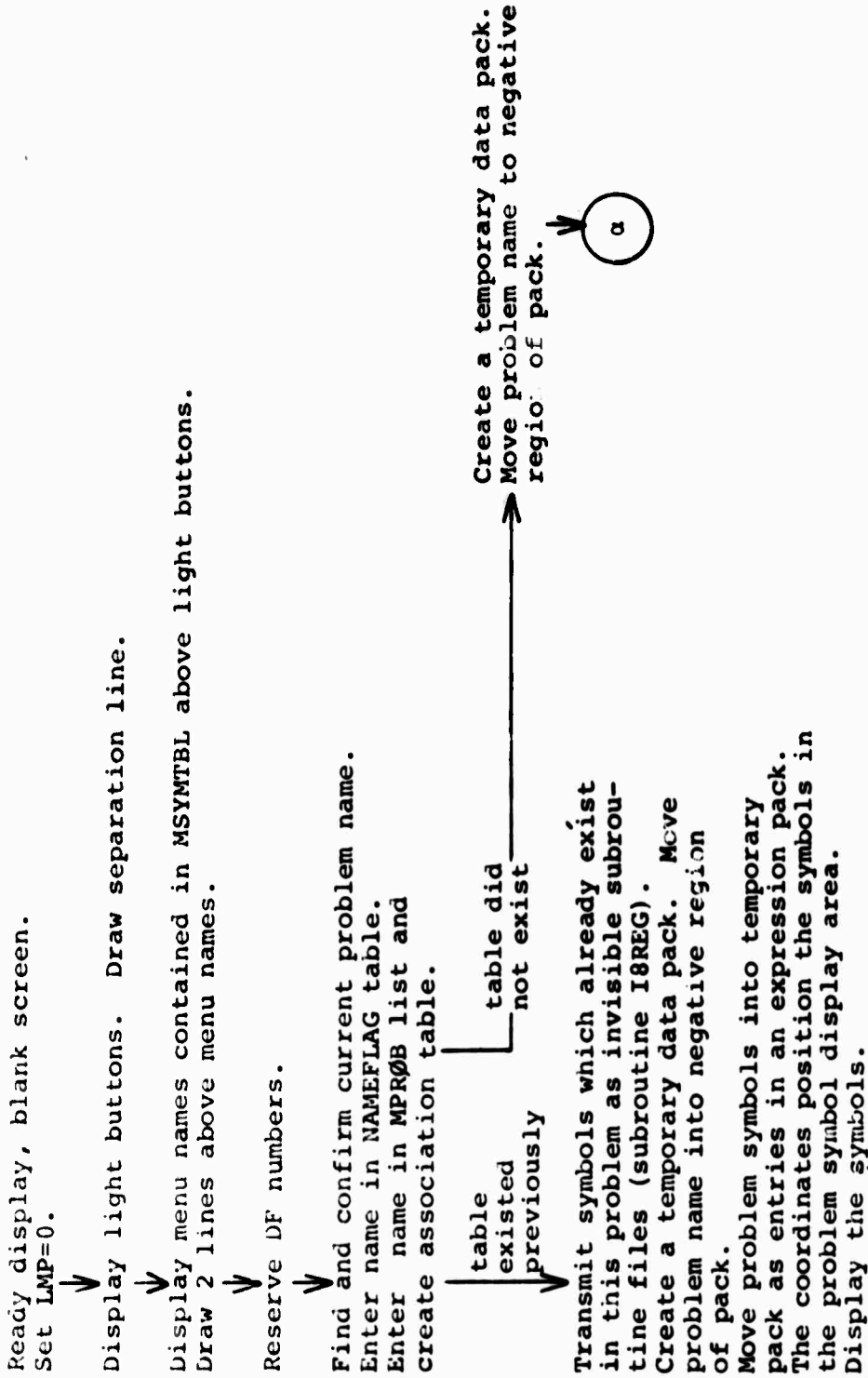

Figure 8. Subroutine DSYSEL

Page 6x9

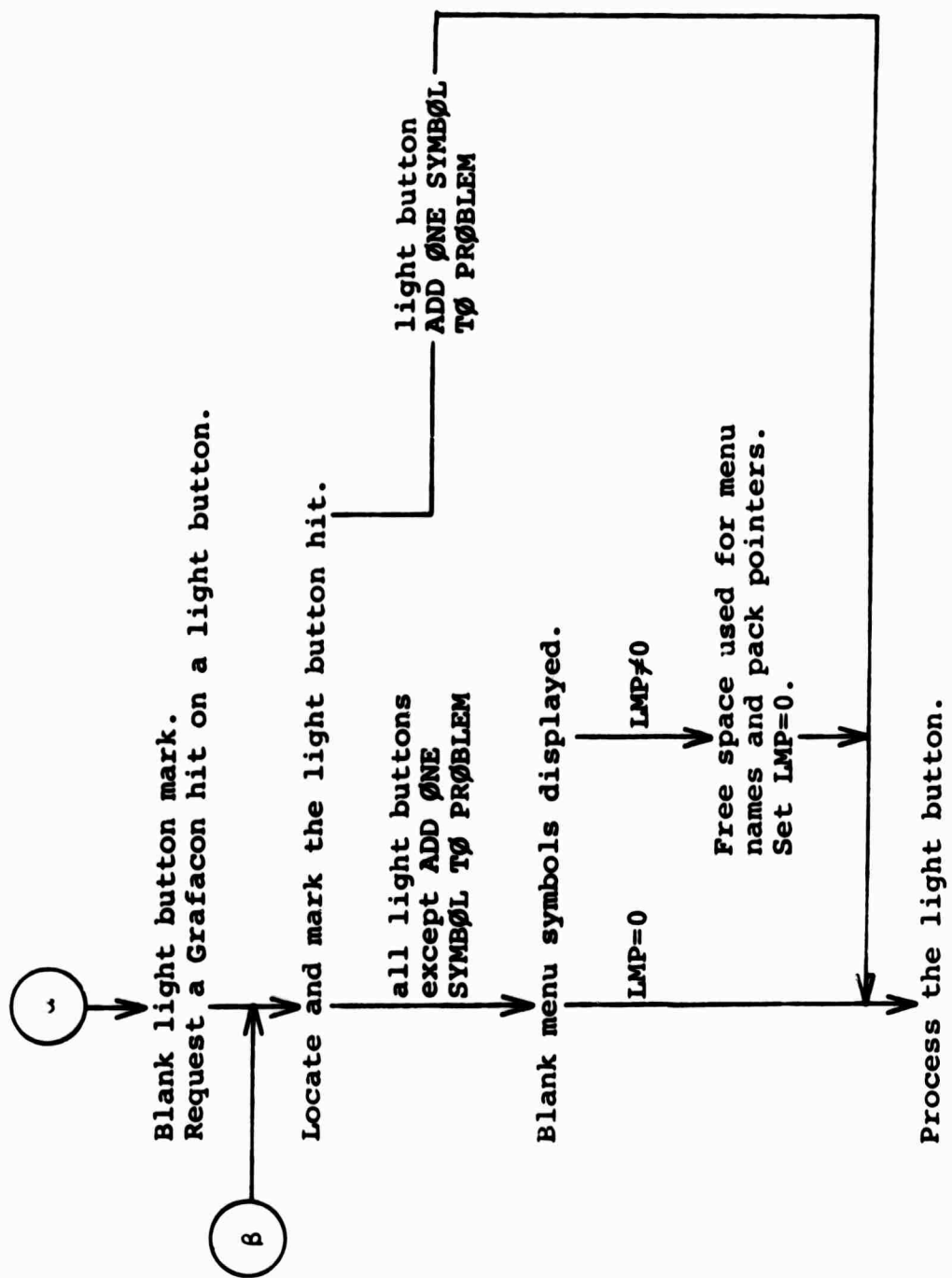

Figure 8. Subroutine DSYSEL, continued.

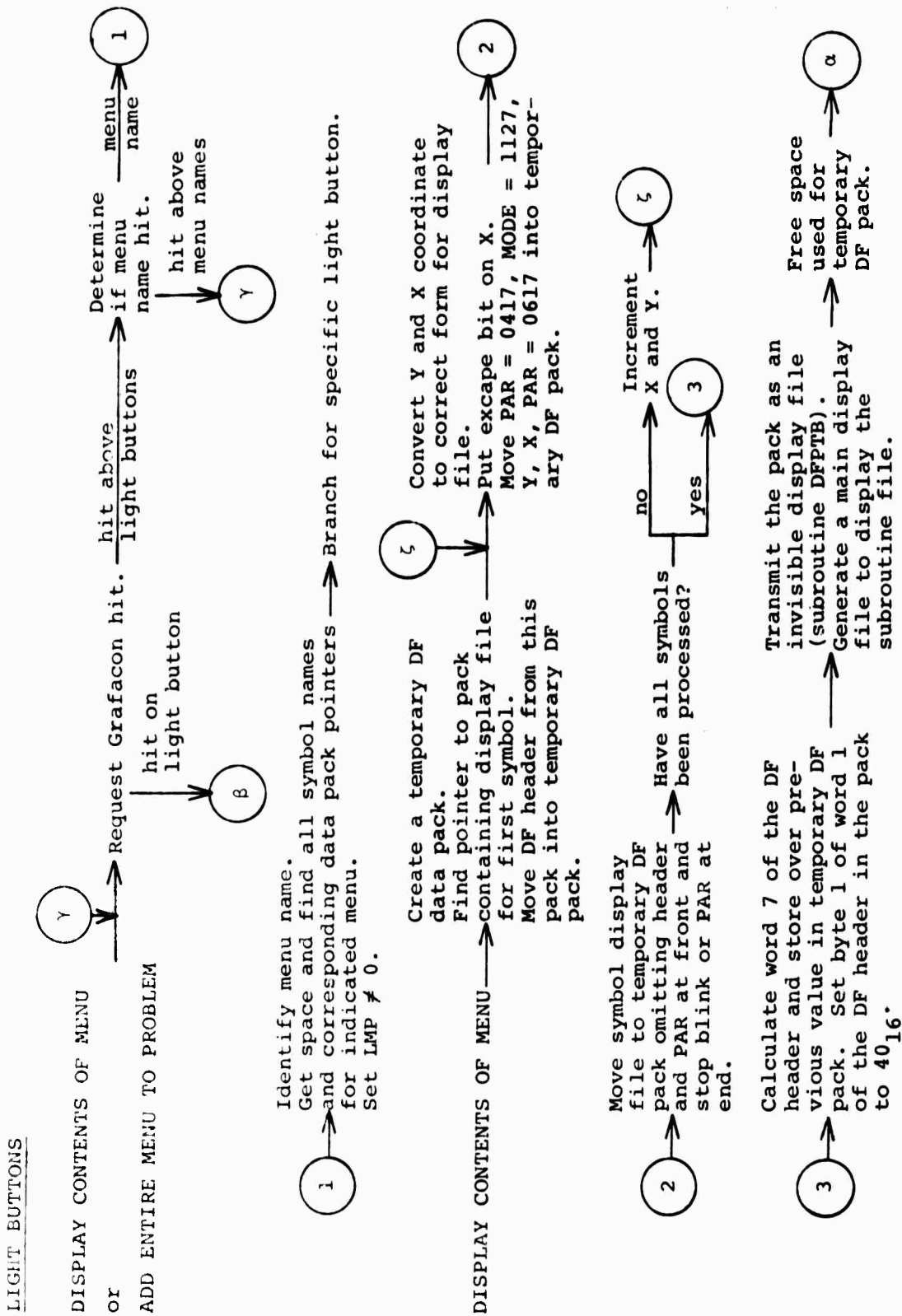

Figure 8. Subroutine DSYSEL, continued

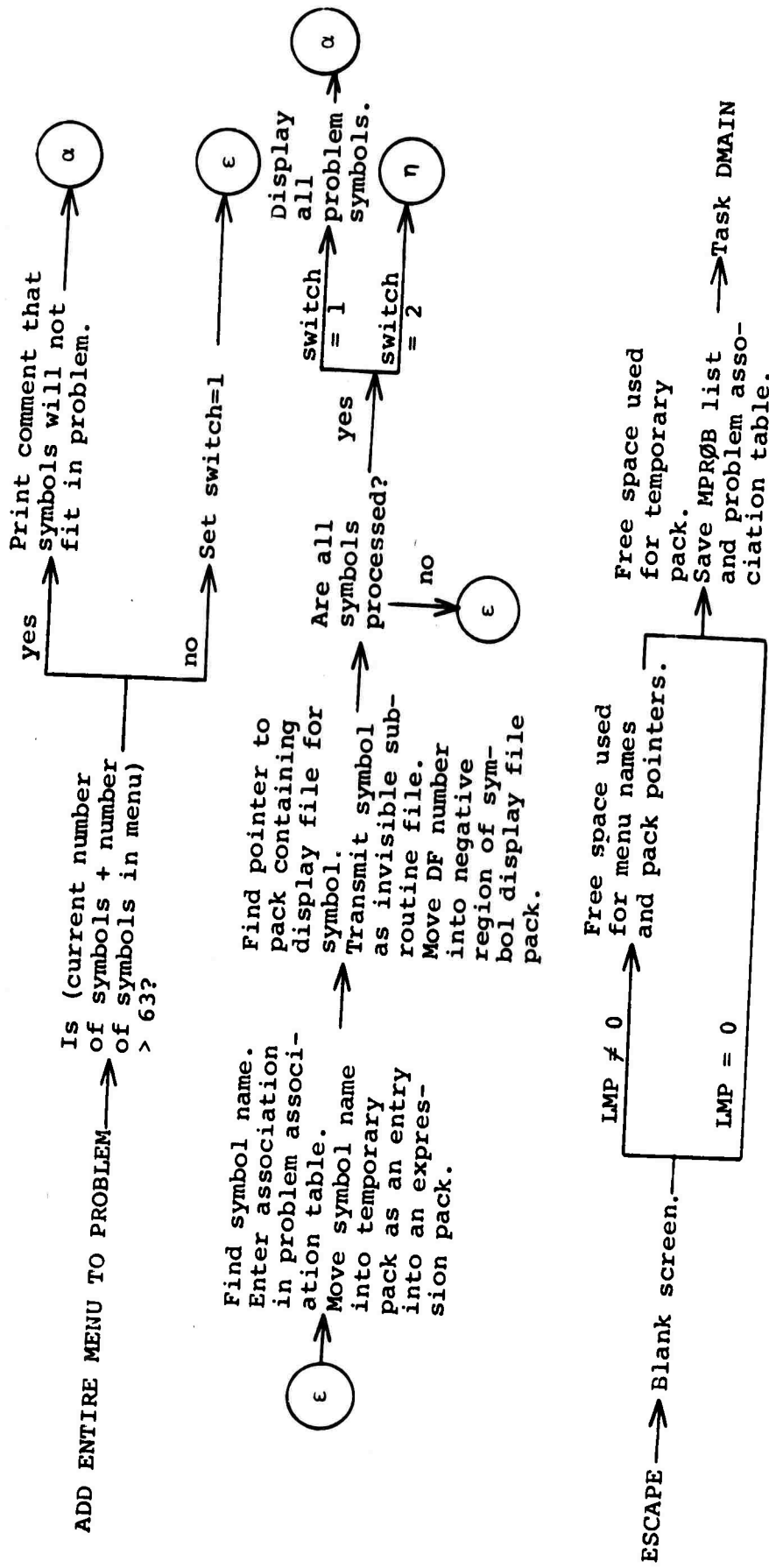

Figure 8. Subroutine DSYSEL, continued

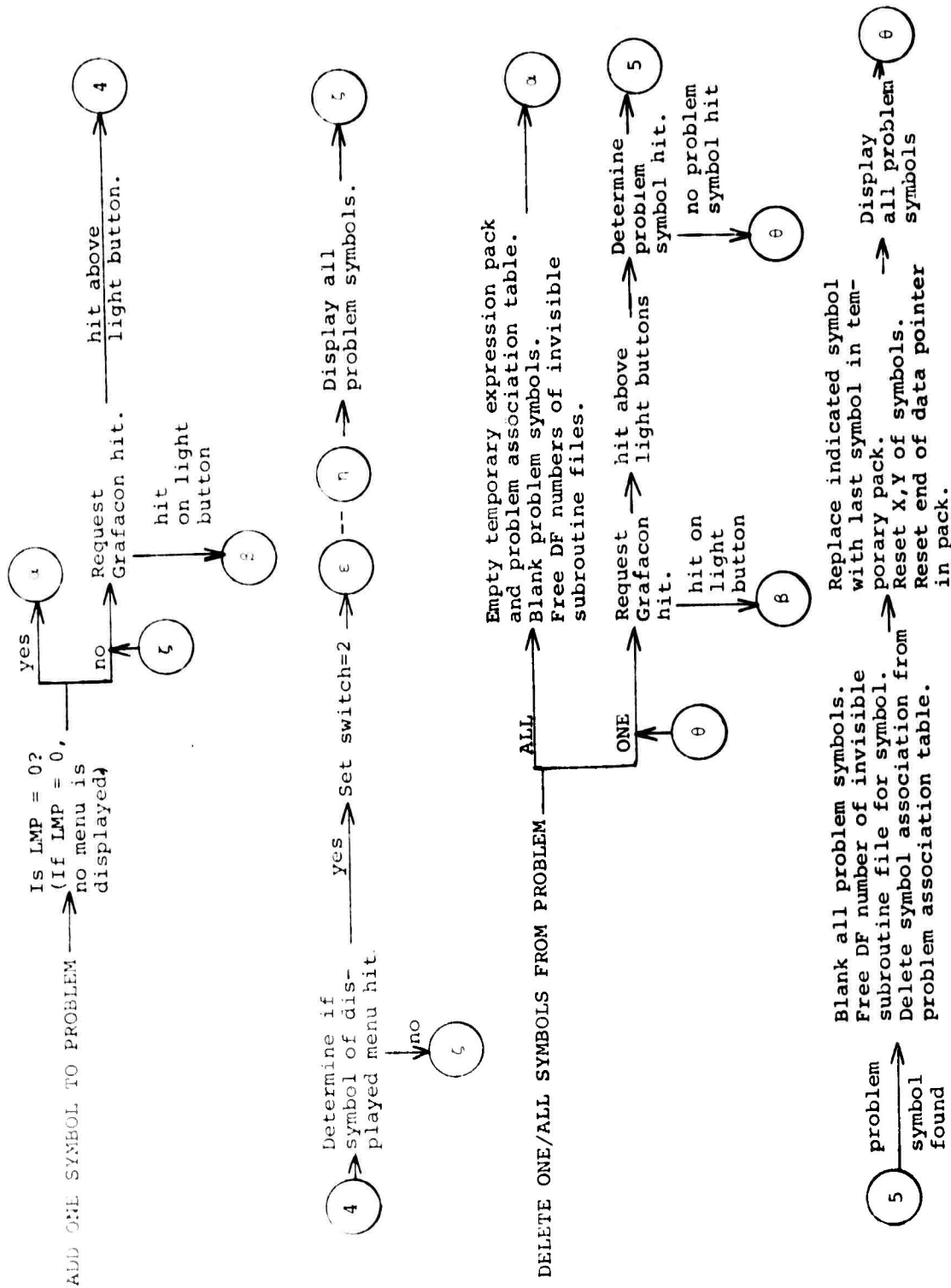

Figure 8. Subroutine DSYSEL, concluded

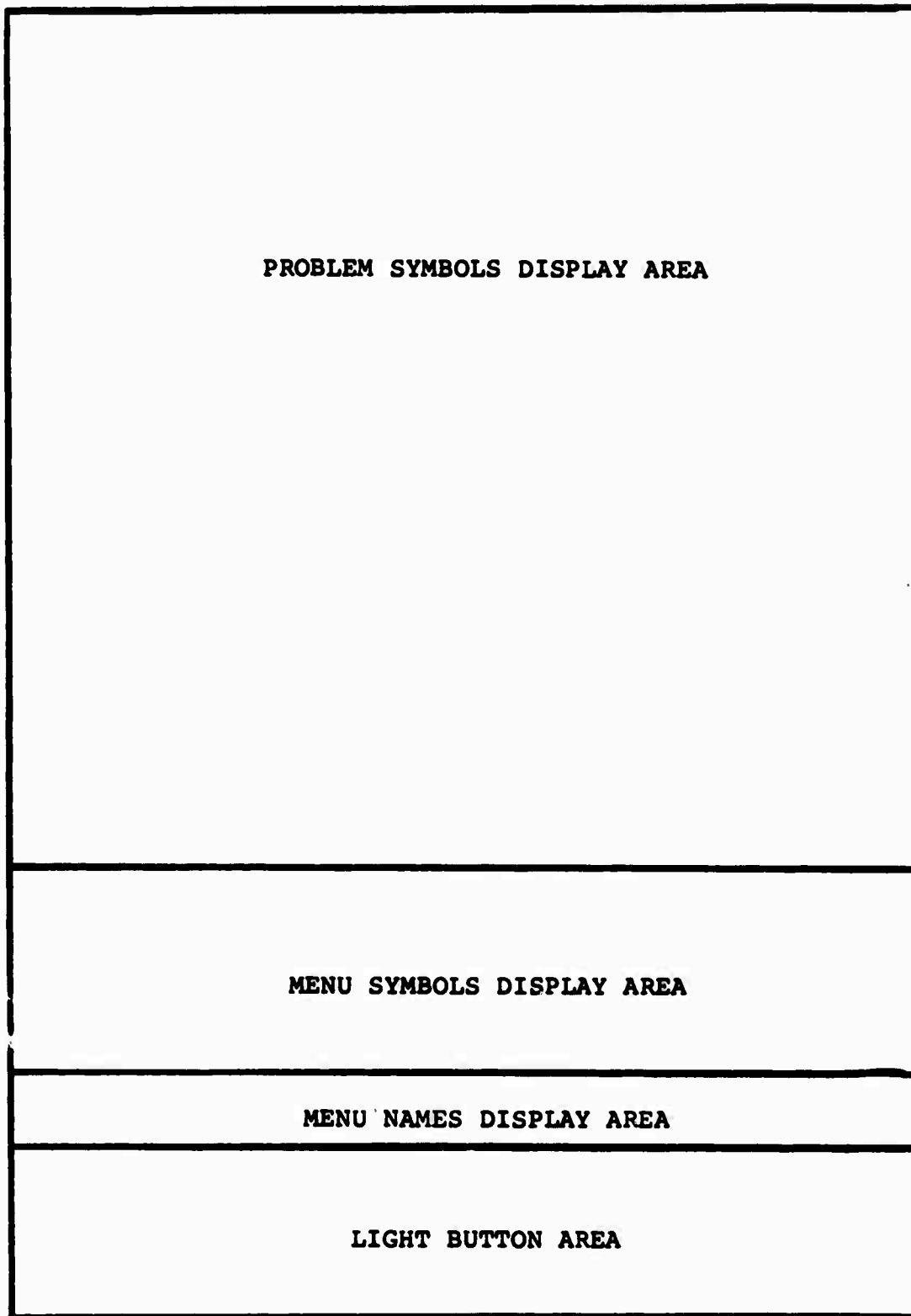

Figure 9. Display Screen for DSYSEL

2.3 SUBROUTINES USED IN DPRØB COMMAND.

Subroutine SE8 is used to display a string of symbols contained in a data pack with entries as shown in Fig. 2. The string could be an expression, entries in a matrix, or a list. The subroutine has one entry point, SE8MY, which can be used to set the minimum Y value to be displayed. This prevents the string from displaying over light buttons or other information located at the bottom of the screen. The execution of SE8 and SE8MY is outlined in Fig. 10.

Subroutine EXØRD orders one expression data pack into another with increasing X, then increasing Y as outlined in Fig. 11.

Subroutine EXLØC examines an expression data pack and returns the displacement to the entry located at a specified coordinate position (see Fig. 12). The entries in the data pack are not in any particular order.

Subroutine INIT8 locates and transmits all the symbols of a problem as invisible display files. The DF numbers are acquired dynamically and then saved for reference in the negative region of the symbol display file data pack. The entry point I8REG also saves the DF numbers in an array with the array subscript equivalent to the position in the problem association table. The execution of INIT8 and I8REG is outlined in Fig. 13.

Arguments:

LPK = pointer to expression data pack,
 NUM = display file number for expression.

Retrieve problem name from negative region of pack.
 Find pointer to problem association table.

Blank display file NUM.
 Initialize display file.

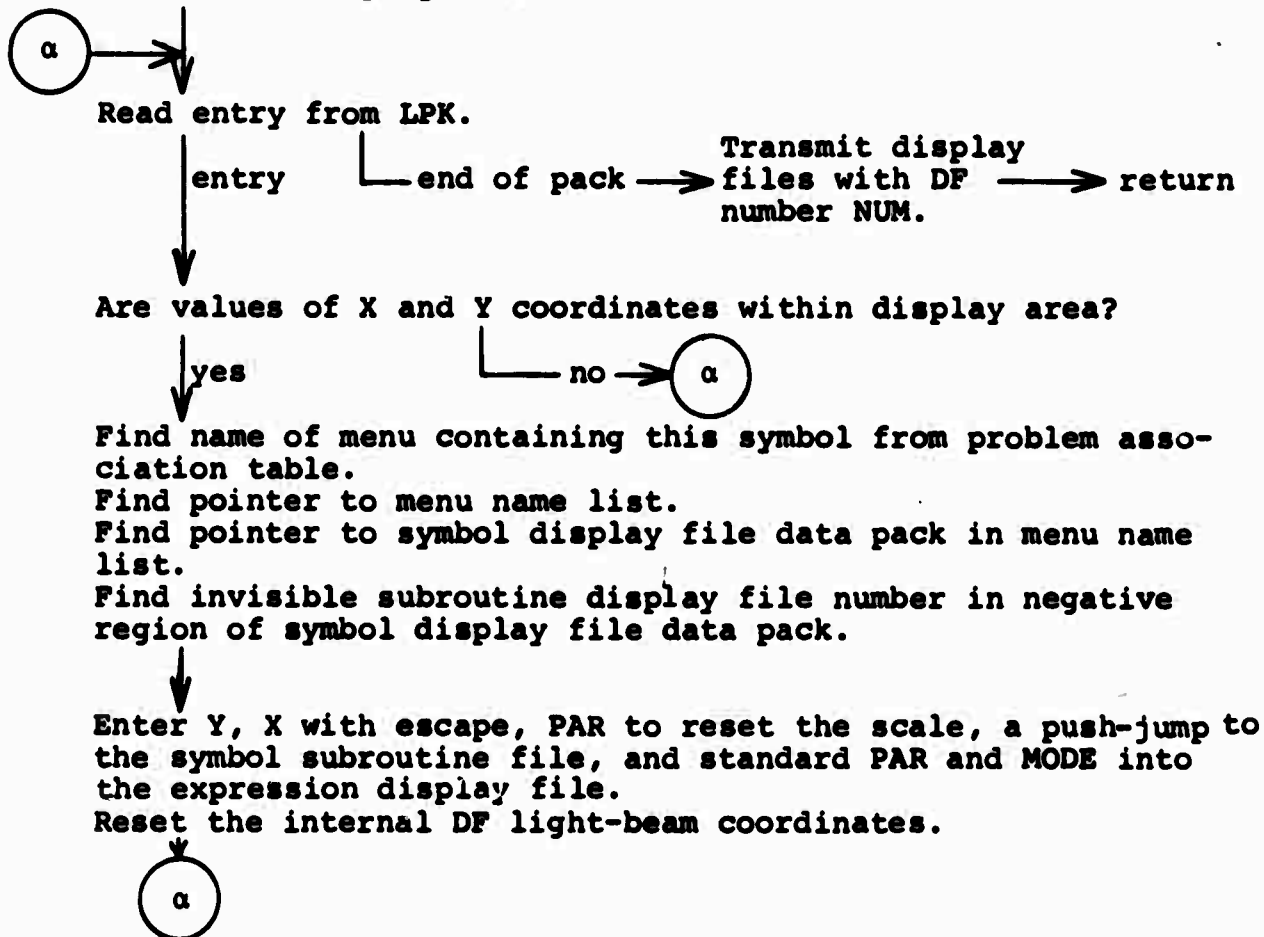

Entry SE8MY in subroutine SE8.

Argument:

MY = minimum Y for display area.

Set minimum Y to be used for display area lower bound in SE8.

Figure 10. Subroutine SE8.

Arguments:

LEXP = pack to be ordered,

LEPK = pack to contain the result of ordering.

Empty pack LEPK.

Set displacement for pack LEPK to 0.

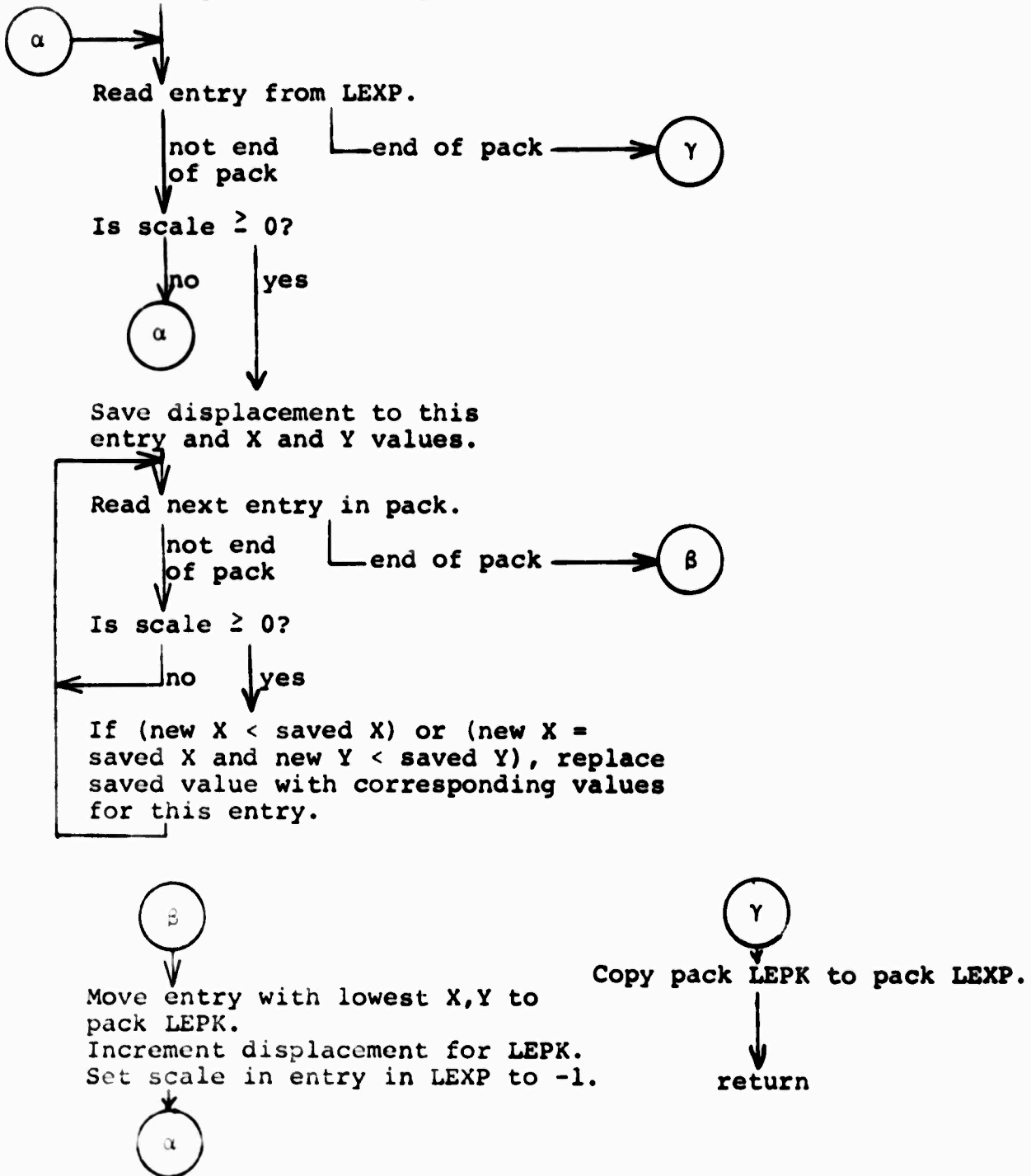

Figure 11. Subroutine EXORD

Arguments:

IXL, IYL = position usually of Grafacon hit,
 LEXP = expression data pack,
 KDIS = displacement.

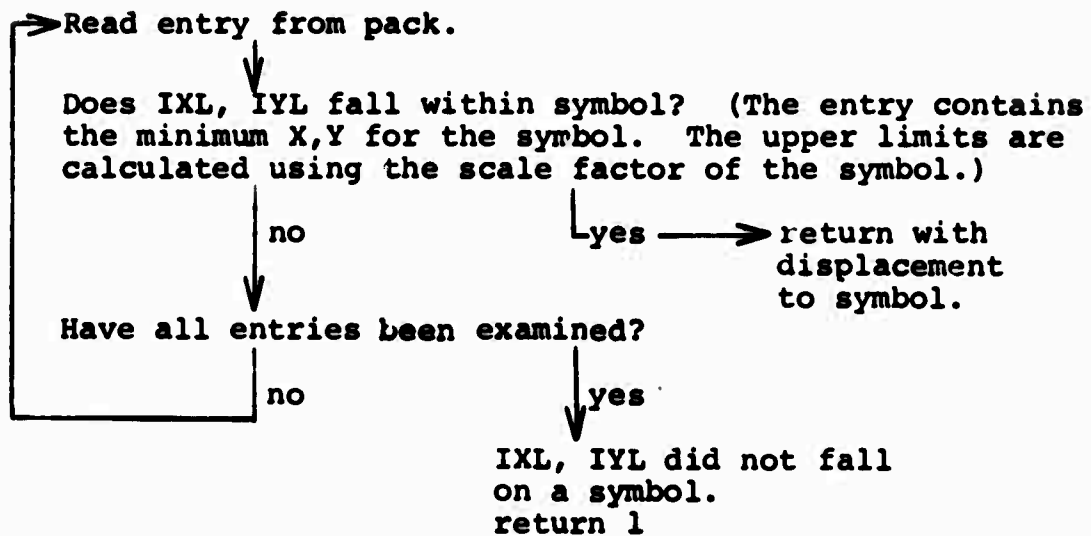
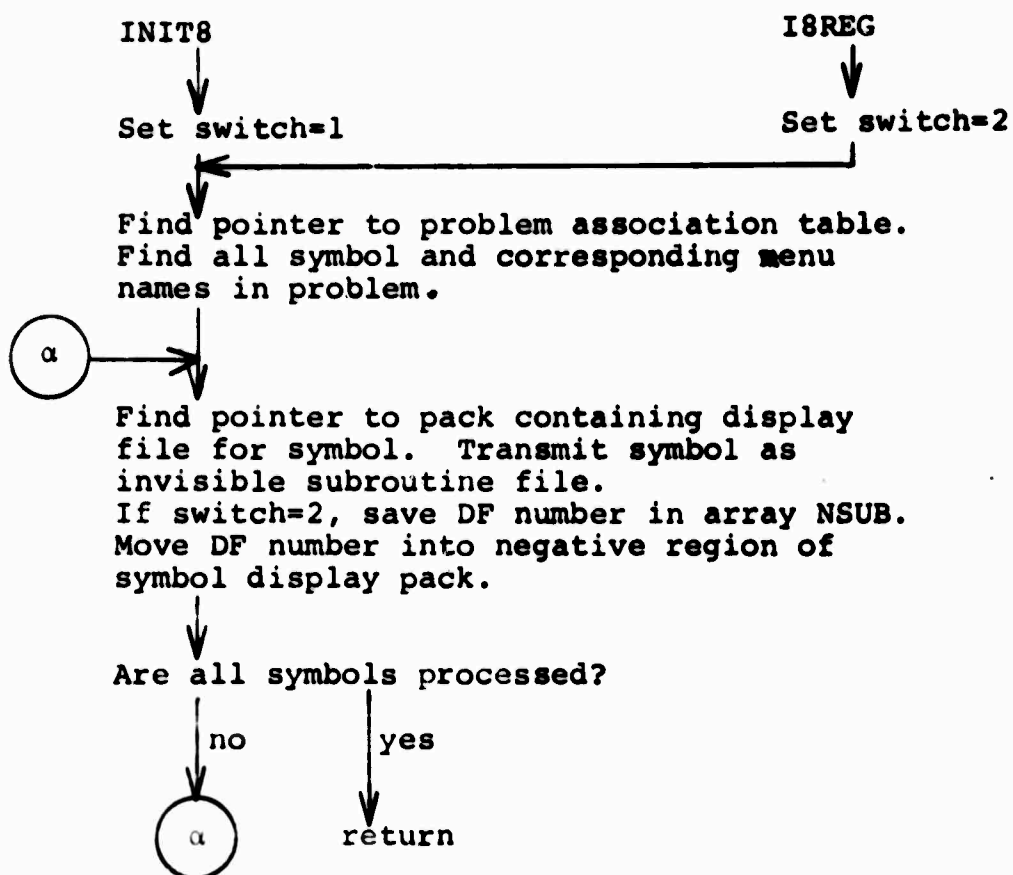

Figure 12. Subroutine EXLØC

Arguments:

SPRØ = problem name.

NSUB = array to save subroutine display file numbers.

Figure 13. Subroutine **INIT8**

Subroutine FONE is used to define and mark entities. The user indicates the position of the entity marks-- above or below the expression--and points to the first and last symbols to be included in the entity. The expression is blanked and redisplayed with the indicated group of symbols marked.

The subroutine exists as a routine independent of CAMA in file FONE with changes necessary to task under CAMA indicated on the listing. A test program is located in FONE (-100,-97). The object of the subroutine only is in FONEO. The RUN command is

```
RUN (test)+FONEO+MATH+SAVE:XDF+SAVE:CAMA/L 2=SS73:TSAV2.
```

The execution sequence of the subroutine is outlined in Fig. 14. The display screen is illustrated in Fig. 15.

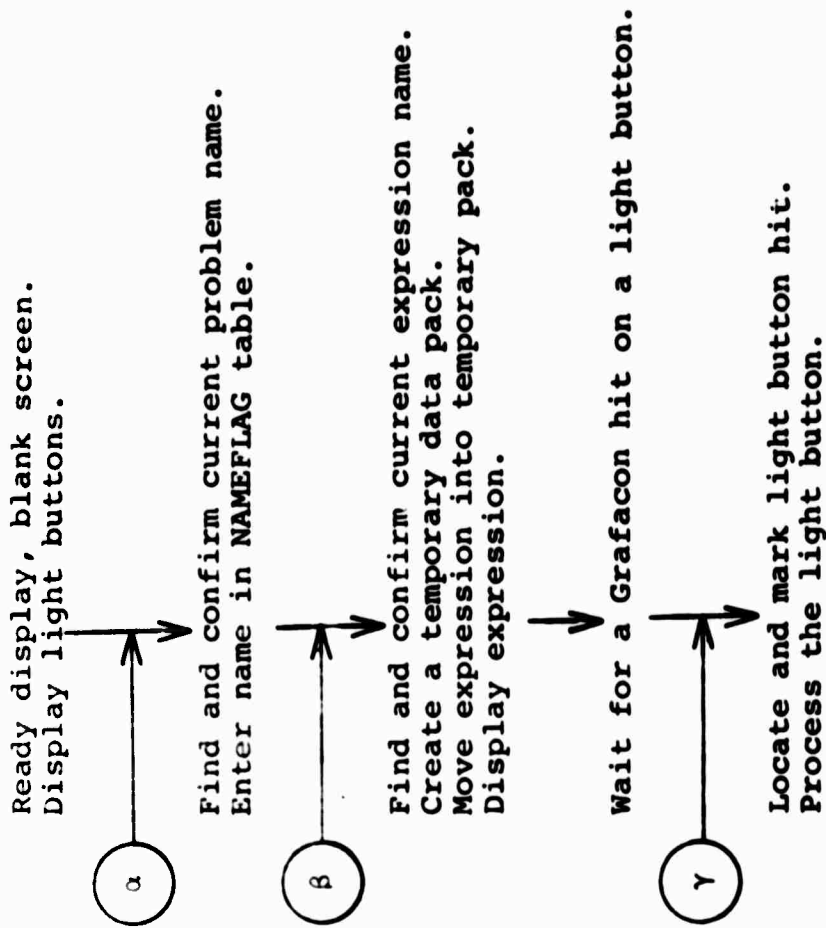

Figure 14. Subroutine EXONE

LIGHT BUTTONS

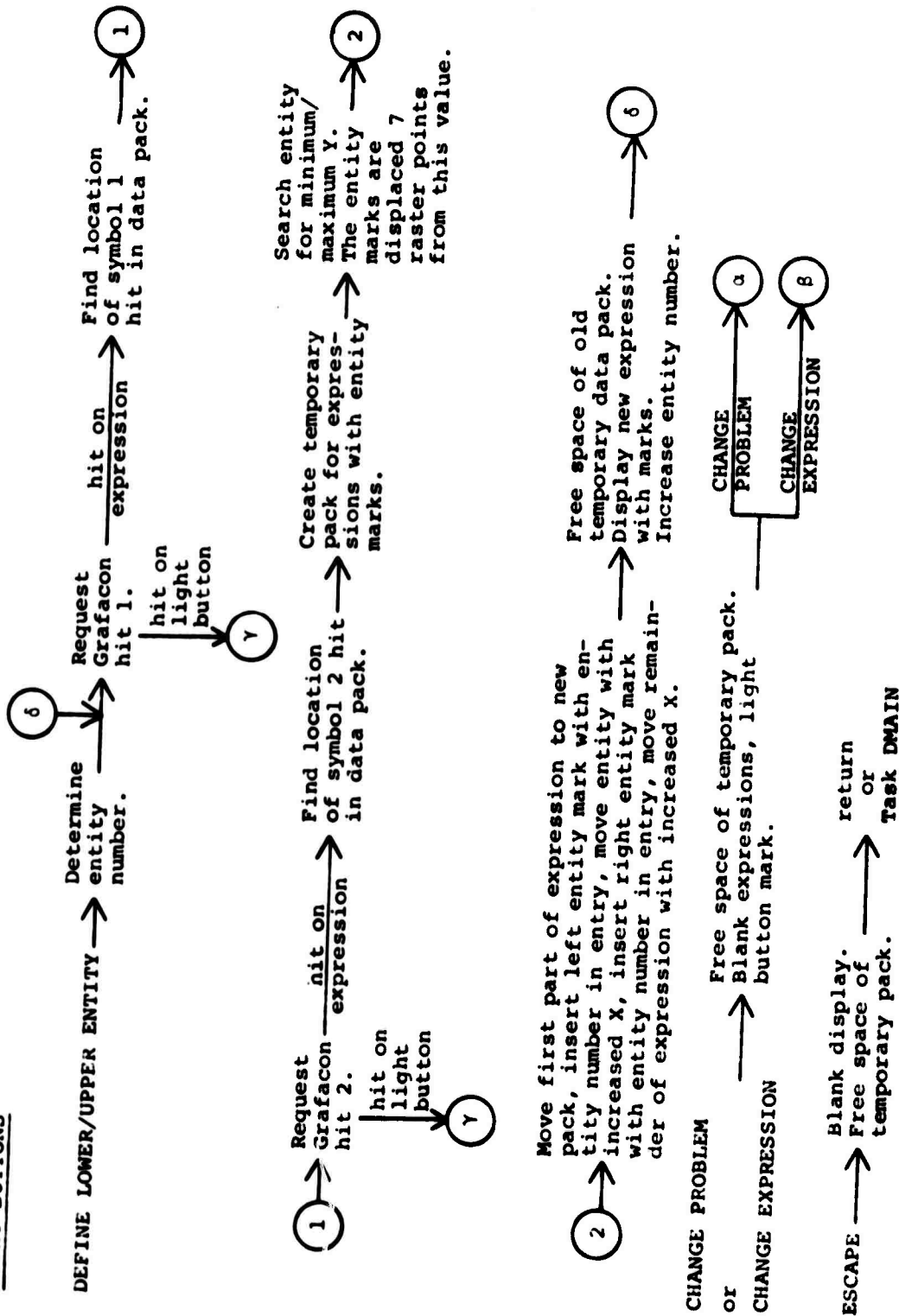

Figure 14. Subroutine EXONE, concluded

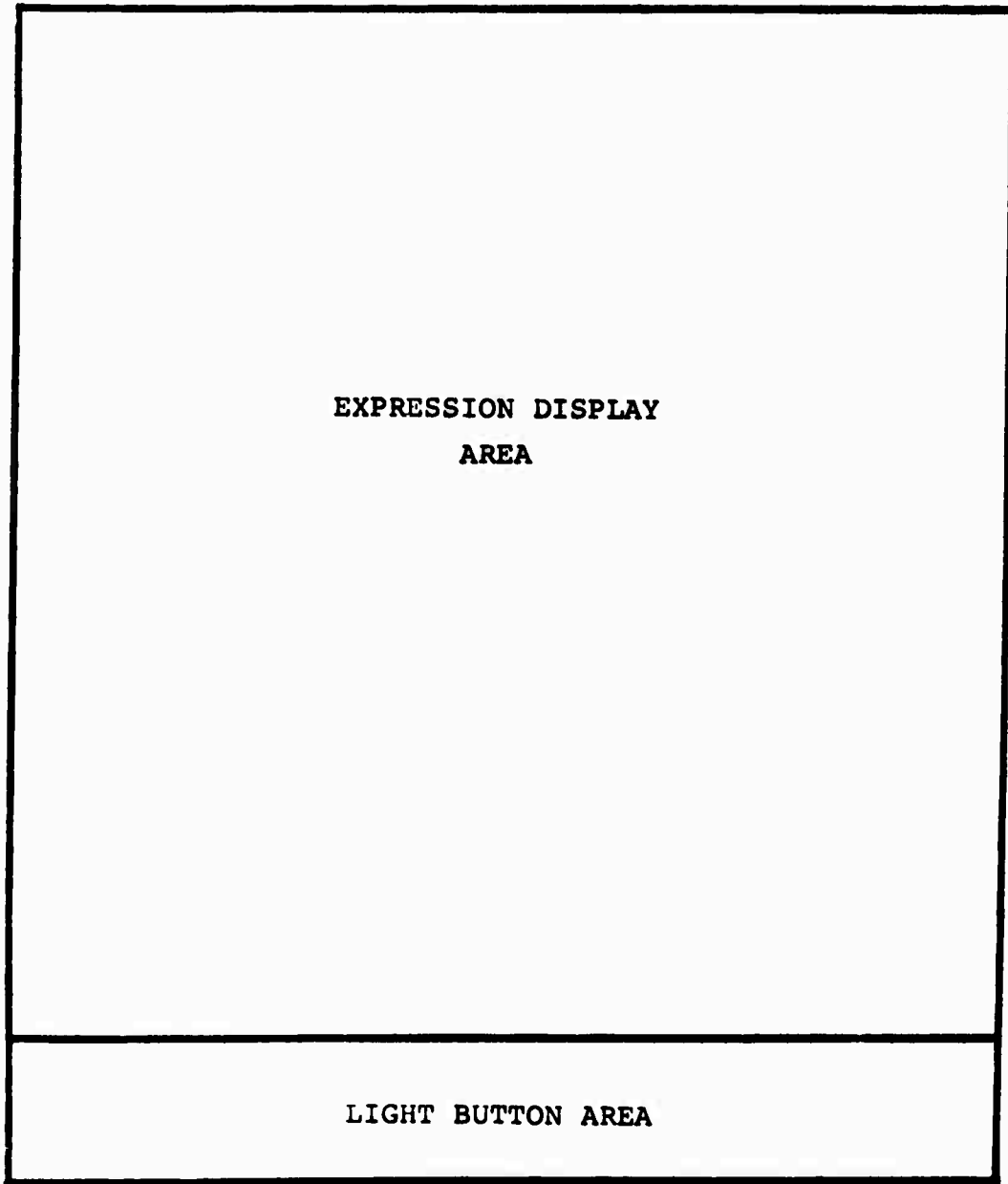

Figure 15. Display Screen for FONE

REFERENCES

1. Cocanower, A.B., The DF Routines User's Guide, Memorandum 23, Concomp Project, University of Michigan, Ann Arbor, May 1969.
2. Bisgrove, J.L., Goodrich, S.D., Symbol Generation, Internal Memorandum, Concomp Project, University of Michigan, Ann Arbor, June 22, 1970.

DOCUMENT CONTROL DATA - R & D

(Security classification of title, body of abstract and index information must be entered even if the overall report is classified)

1. ORIGINATING ACTIVITY (Corporate author)		2a. REPORT SECURITY CLASSIFICATION	
THE UNIVERSITY OF MICHIGAN CONCOMP PROJECT		Unclassified	
		2b. GROUP	
3. REPORT TITLE			
CAMA: DEFINE PROBLEM COMMAND			
4. DESCRIPTIVE NOTES (Type of report and inclusive dates)			
Memorandum 28			
5. AUTHOR(S) (First name, middle initial, last name)			
SUZANNE D. GOODRICH			
6. REPORT DATE		7a. TOTAL NO. OF PAGES	7b. NO. OF REFS
June 1970		31	2
8a. CONTRACT OR GRANT NO.		9a. ORIGINATOR'S REPORT NUMBER(S)	
DA-49-083 OSA-3050		Memorandum 28	
b. PROJECT NO.		9b. OTHER REPORT NO(S) (Any other numbers that may be assigned this report)	
c.			
d.			
10. DISTRIBUTION STATEMENT			
Qualified requesters may obtain copies of this report from DDC.			
11. SUPPLEMENTARY NOTES		12. SPONSORING MILITARY ACTIVITY	
		Advanced Research Projects Agency	
13. ABSTRACT			
<p>The Computer-Aided Mathematical Analysis system (CAMA) permits construction of symbols and expressions, manipulation of expressions, and solution of equations. CAMA operates under MTS in the IBM 360/67 and RAMP in the PDP-8/338 terminal. CAMA operations are divided into tasks which may be inserted into the queue via commands.</p> <p>The command DPRØB is used to define a problem. The user selects symbol. to use in the problem, constructs symbols if necessary, and formulates the expressions which comprise the problem.</p>			

14. KEY WORDS	LINK A		LINK B		LINK C	
	ROLE	WT	ROLE	WT	ROLE	WT
define problem data structure display expression symbol						