

AD 705 635

FLOWCHARTS FOR
INFORMATION RETRIEVAL SYSTEM

Prepared by:
Wolf Research and Development Corporation
6801 Kenilworth Avenue
Riverdale, Maryland

For:
Data Systems Division
Fort Detrick, Frederick, Maryland

November 13, 1969

DDC
RECEIVED
FEB 25 1970

This document has been approved
for public release or sale; its
contents are unlimited.

250

**Best
Available
Copy**

Security Classification

DOCUMENT CONTROL DATA - R & D

(Security classification of title, body of abstract and indexing annotation must be entered when the overall report is classified)

1. ORIGINATING ACTIVITY (Corporate author) Wolf Research & Development Corporation		29. REPORT SECURITY CLASSIFICATION UNCLASSIFIED	
3. REPORT TITLE Information Retrieval System - Vol II (Flowcharts For Information Retrieval System)		28. GROUP	
4. DESCRIPTIVE NOTES (Type of report and inclusive dates) Final Report			
6. AUTHOR(S) (First name, middle initial, last name) Jack D. Mhle, Jr.			
8. REPORT DATE 13 November 1969		78. TOTAL NO. OF PAGES 245	79. NO. OF REFS none
8A. CONTRACT OR GRANT NO. DAAA-13-68-C-0173		8B. ORIGINATOR'S REPORT NUMBER(S) none	
A. PROJECT NO.		8C. OTHER REPORT NO(S) (Any other numbers that may be assigned this report) none	
C.		D.	
10. DISTRIBUTION STATEMENT This document has been approved for public release and sale; its distribution is unlimited.			
11. SUPPLEMENTARY NOTES		12. SPONSORING MILITARY ACTIVITY Department of the Army Fort Detrick Frederick, Maryland 21701	
13. ABSTRACT The Fort Detrick Information Retrieval System is described in a companion document entitled - Information Retrieval System - Vol I (AD-699 387). This document contains the detailed flowcharts for the overall system.			

DD FORM 1473

REPLACES DD FORM 1473, 1 JAN 64, WHICH IS OBSOLETE FOR ARMY USE.

OFFICE SYMBOL _____
SYSTEM CHART NO. 1
RUN NUMBER IROL
PAGE NUMBER 1 OF 12

SYSTEM FLOWCHART

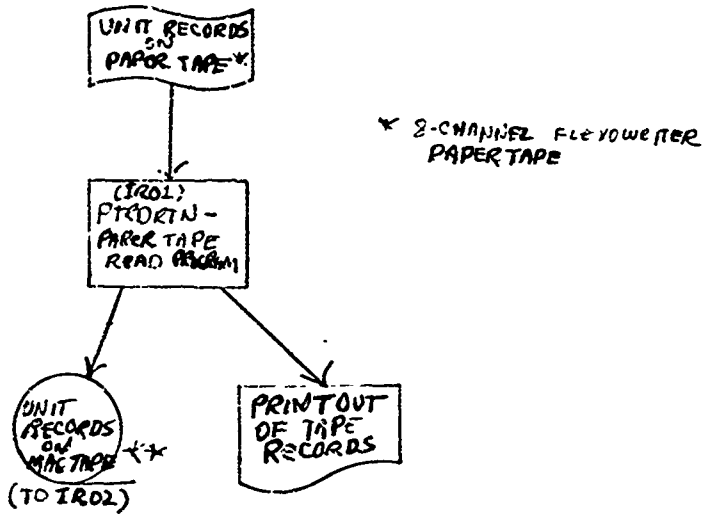

** IN 5-BIT CODE

OFFICE SYMBOL _____
SYSTEM CHART NO. 2
RUN NUMBER IR02
PAGE NUMBER 2 OF 17

SYSTEM FLOWCHART

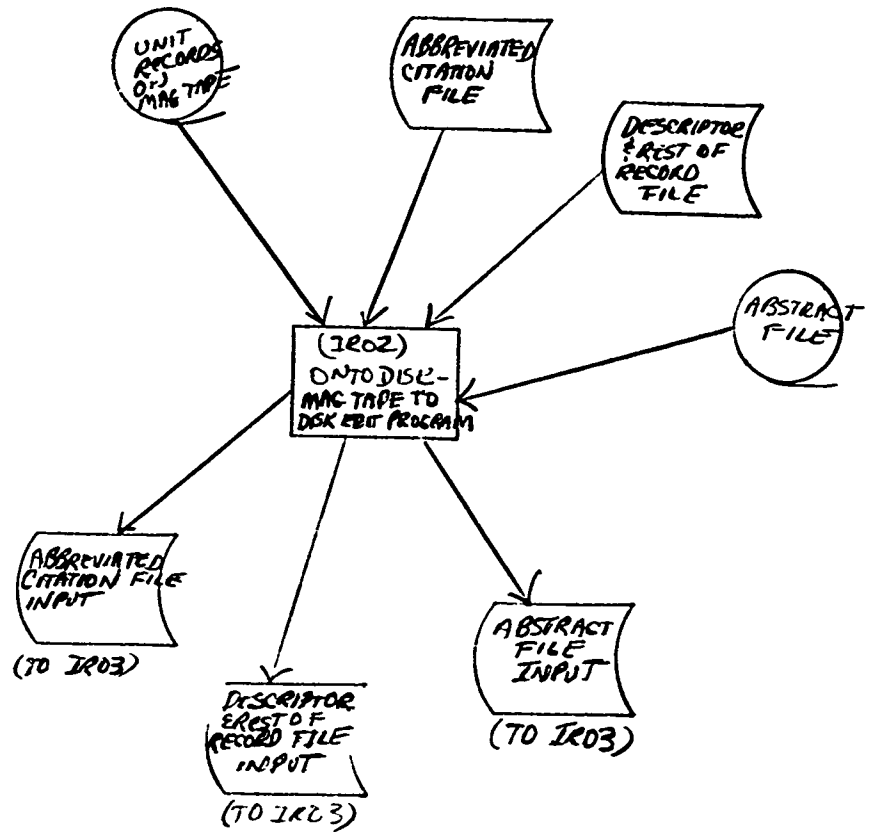

OFFICE SYMBOL _____
 SYSTEM CHART NO. 3
 RUN NUMBER IR03
 PAGE NUMBER 3 OF 12

SYSTEM FLOWCHART

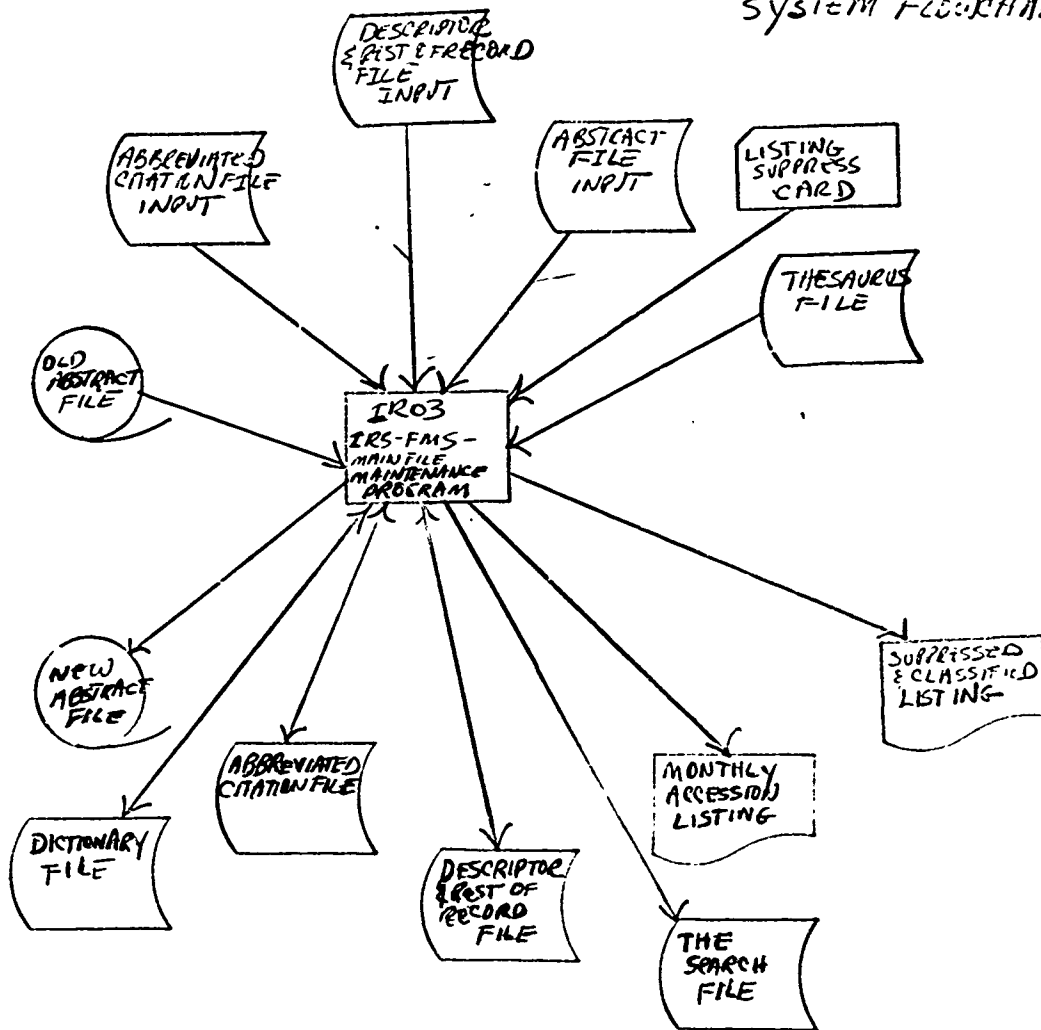

OFFICE SYMBOL _____
SYSTEM CHART NO. 4
RUN NUMBER IR04
PAGE NUMBER 4 OF 12

SYSTEM FLOWCHART

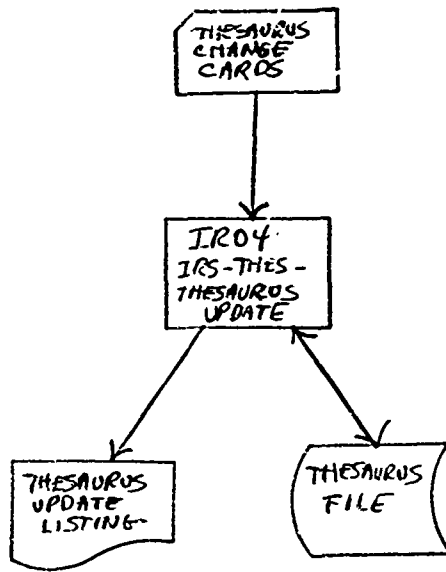

OFFICE SYMBOL _____
SYSTEM CHART NO. 5
RUN NUMBER JR05
PAGE NUMBER 8 OF 12
SYSTEM FLOWCHART

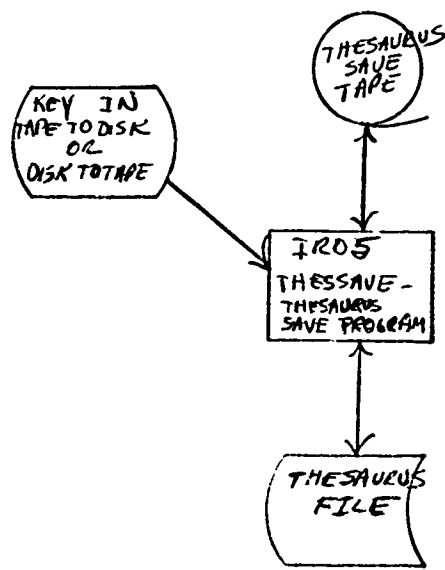

OFFICE SYMBOL _____
SYSTEM CHART NO. 6
RUN NUMBER IROB
PAGE NUMBER 6 OF 12
SYSTEM FLOWCHART

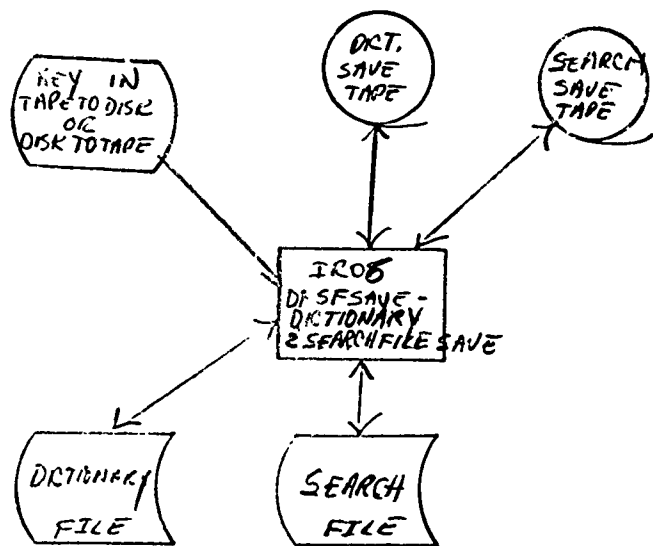

SMUFD FORM 2072-1 71 ip, Mar 68

OFFICE SYMBOL _____
SYSTEM CHART NO. 7
RUN NUMBER JRC7
PAGE NUMBER 7 OF 12
SYSTEM FLOWCHART

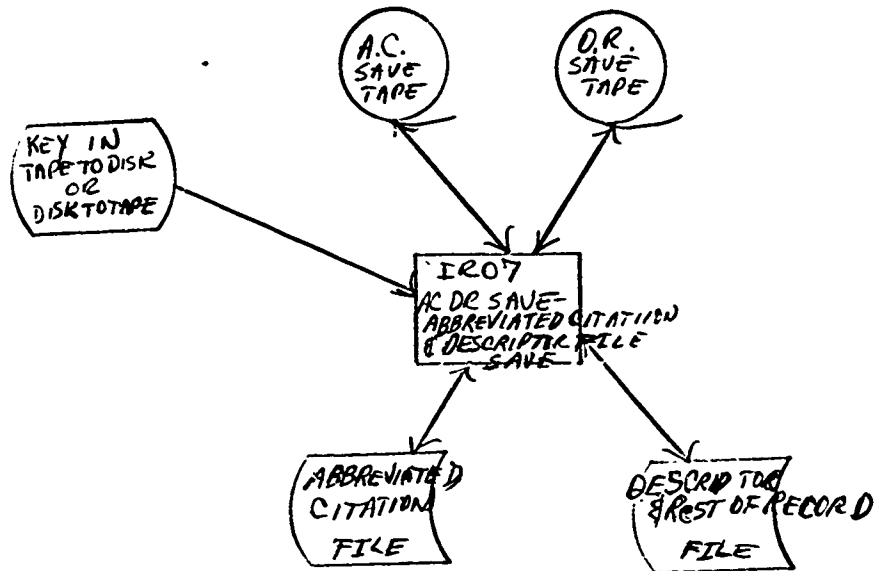

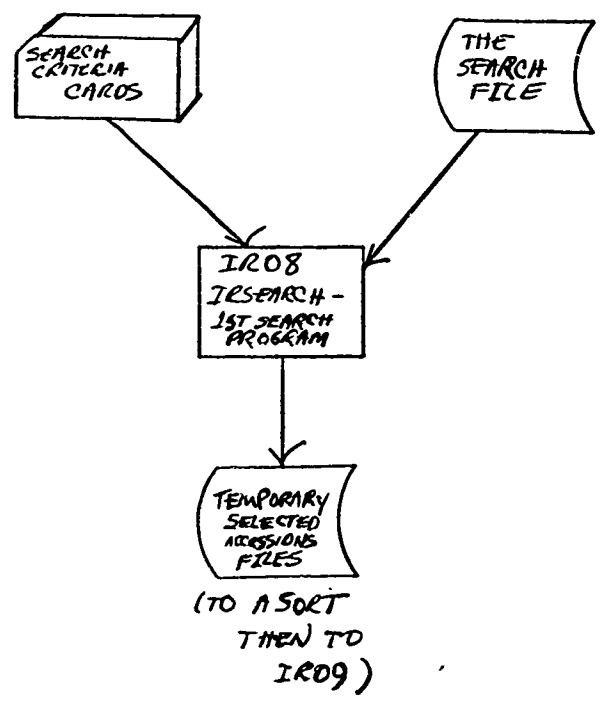

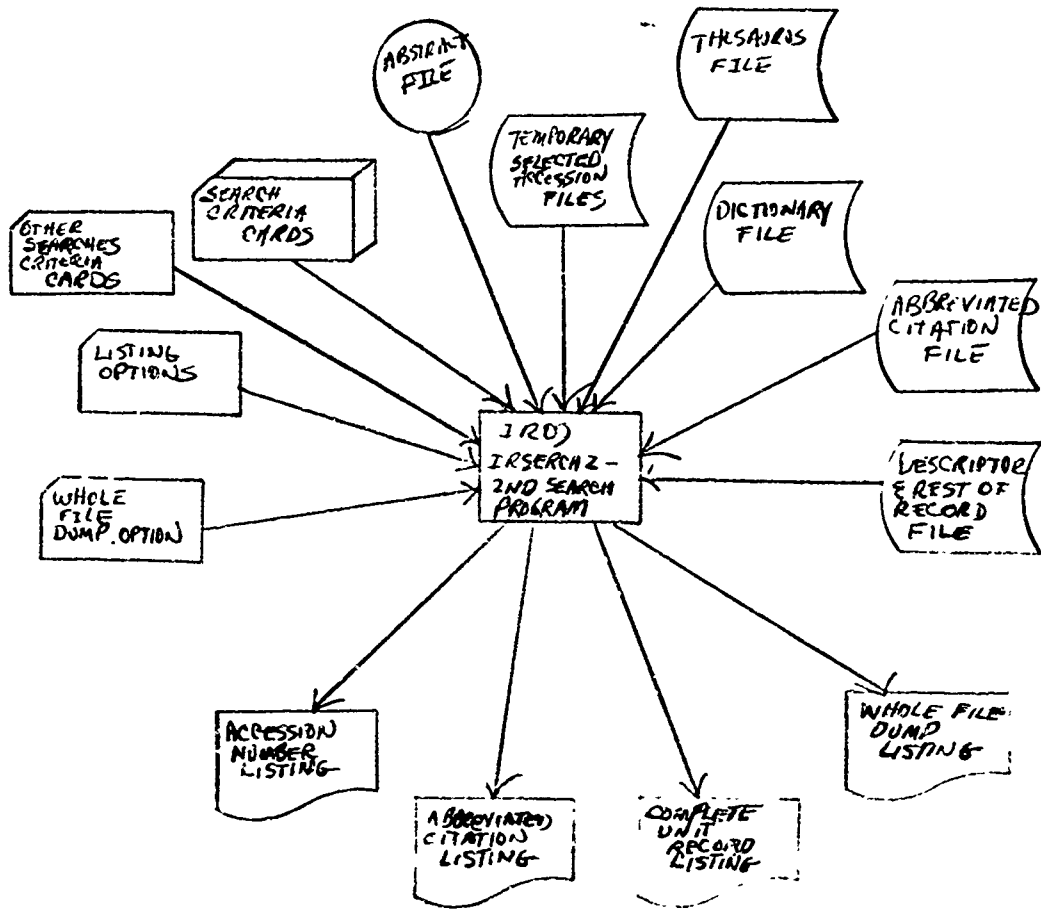

OFFICE SYMBOL _____
SYSTEM CHART NO. 10
RUN NUMBER JR10
PAGE NUMBER 10 OF 12

SYSTEM FLOWCHART

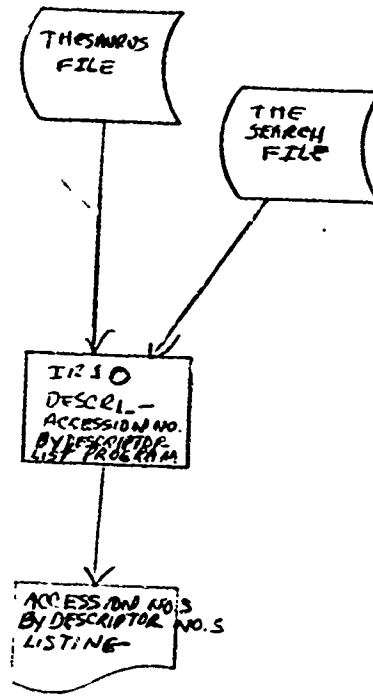

SMUPD FORM 2072-1 1 up Mar 68

OFFICE SYMBOL _____
SYSTEM CHART NO. 12
RUN NUMBER TR12
PAGE NUMBER 12 OF 12

SYSTEM FLOWCHART

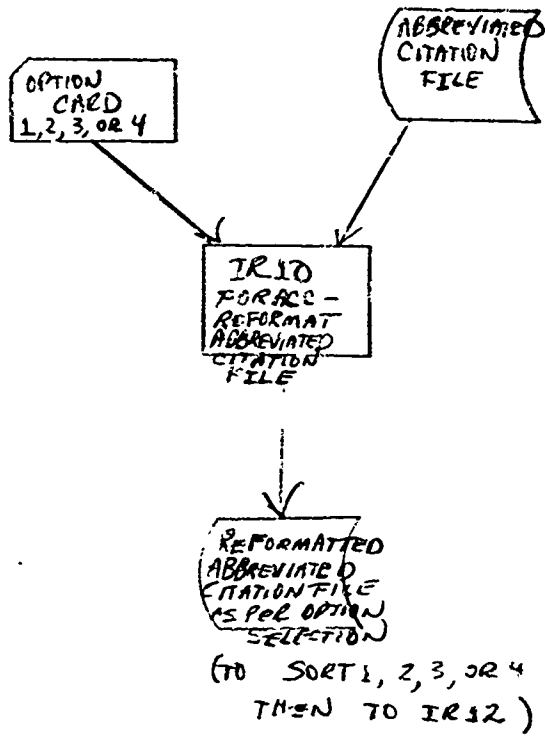

OFFICE SYMBOL _____
SYSTEM CHART NO. 12
RUN NUMBER TR12
PAGE NUMBER 12 OF 12
SYSTEM FLOWCHART

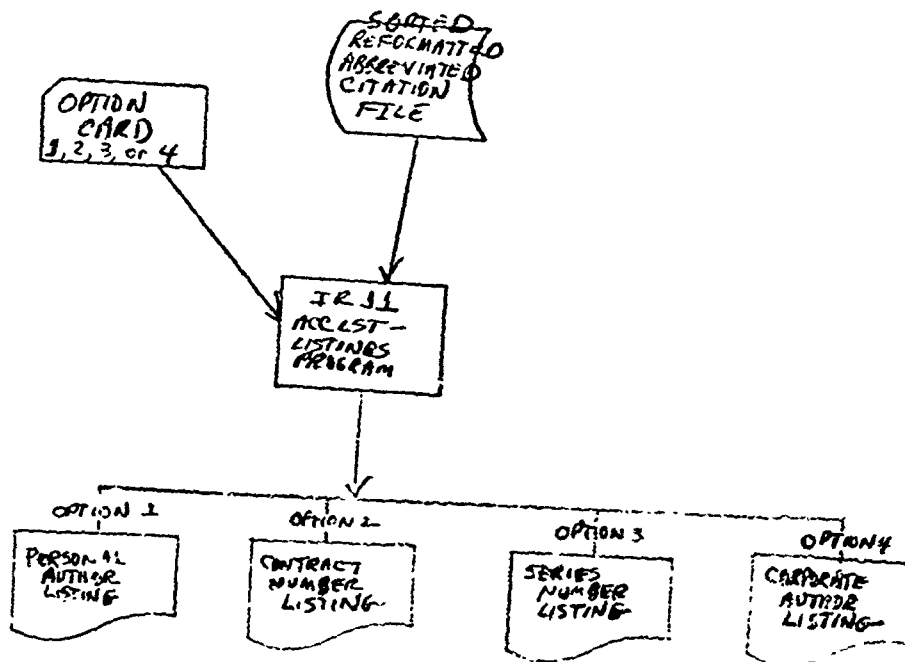

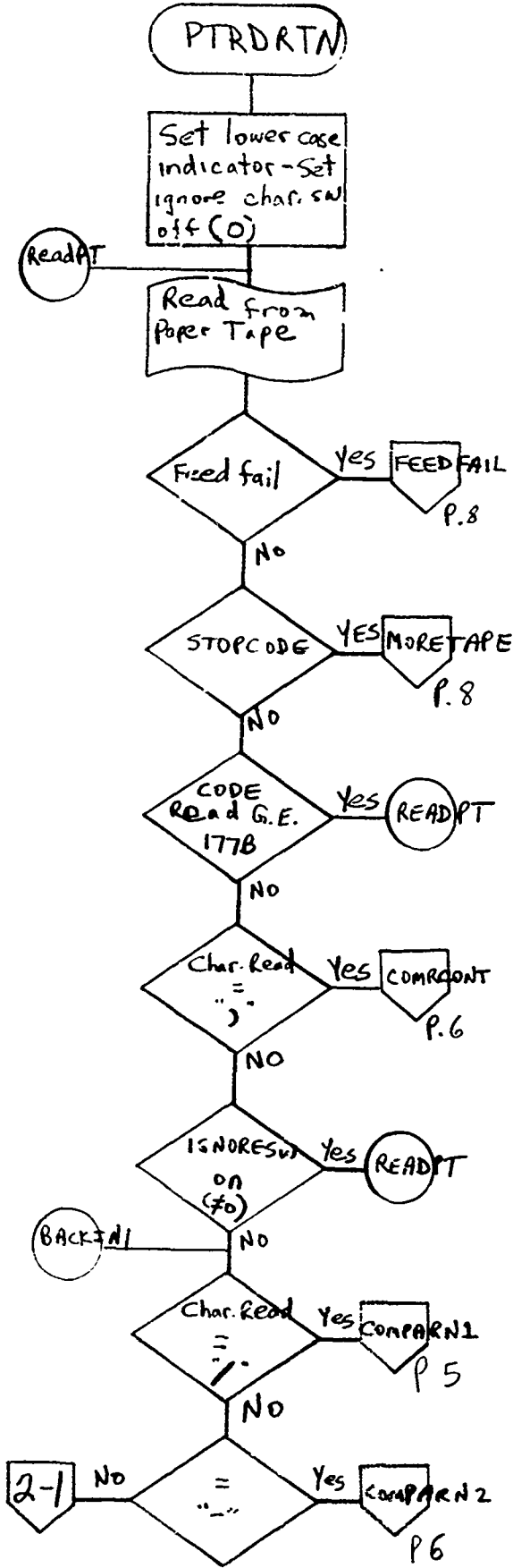

SMUFD FORM 2072-1 (Temp) Mar 68

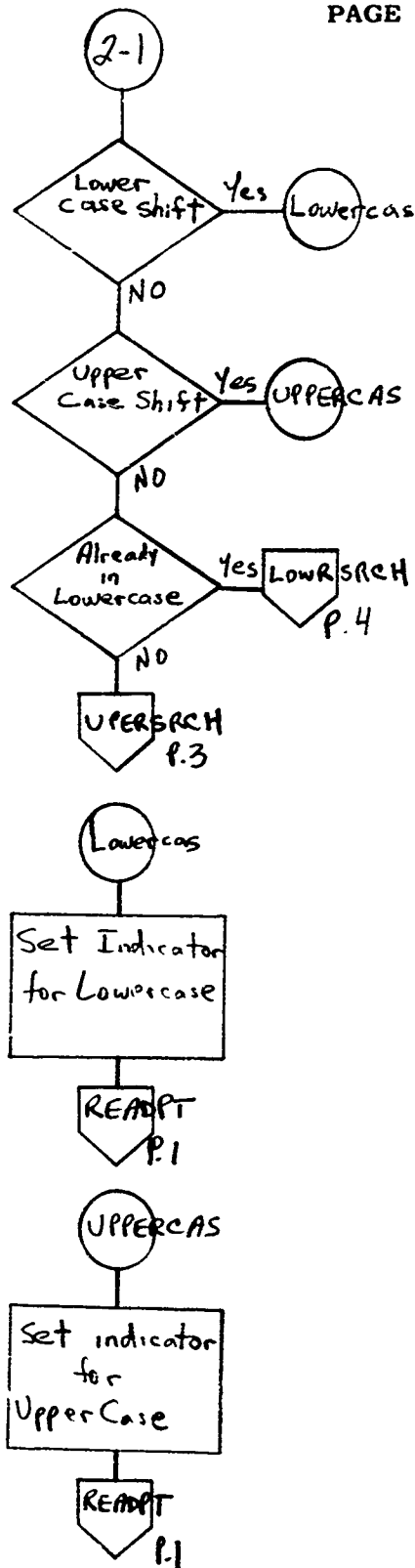

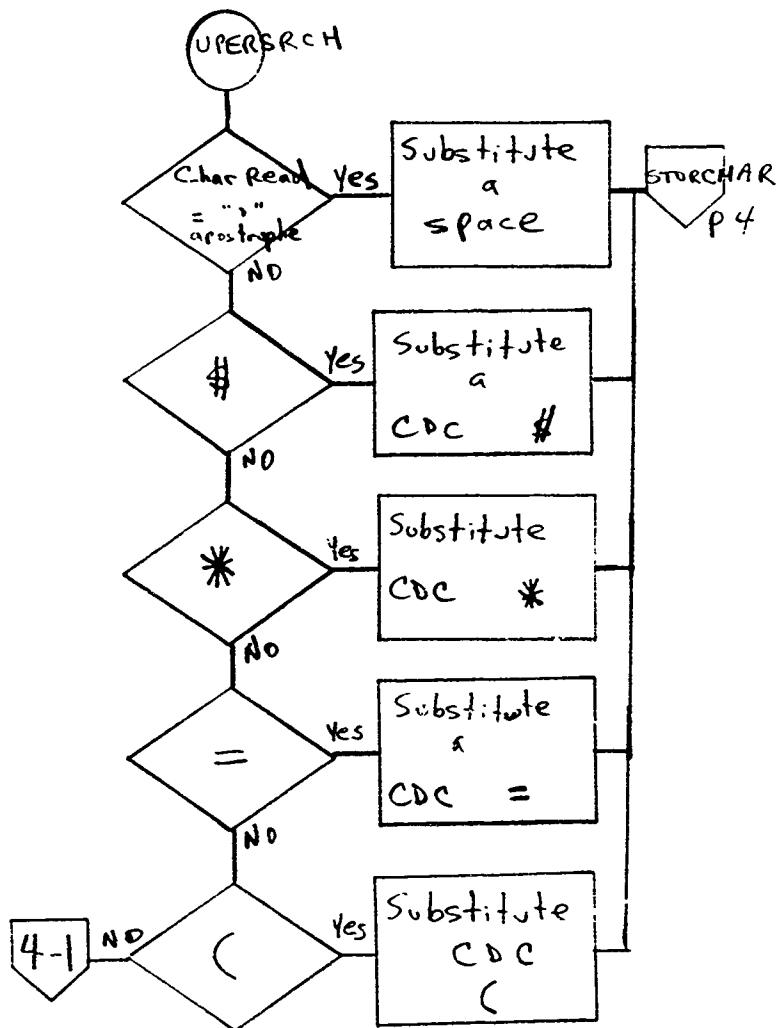
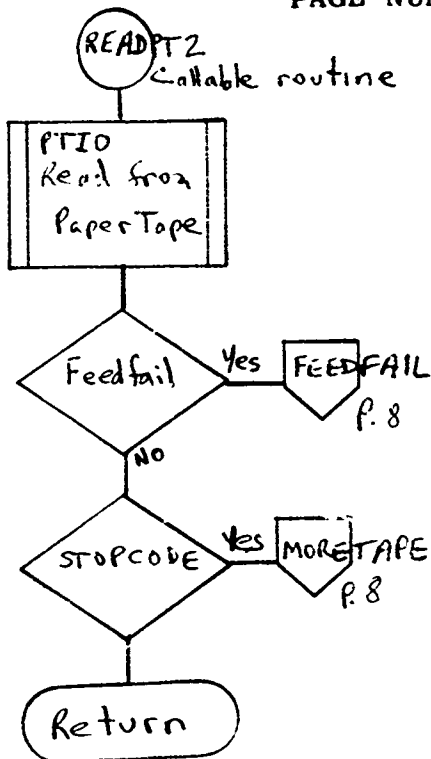

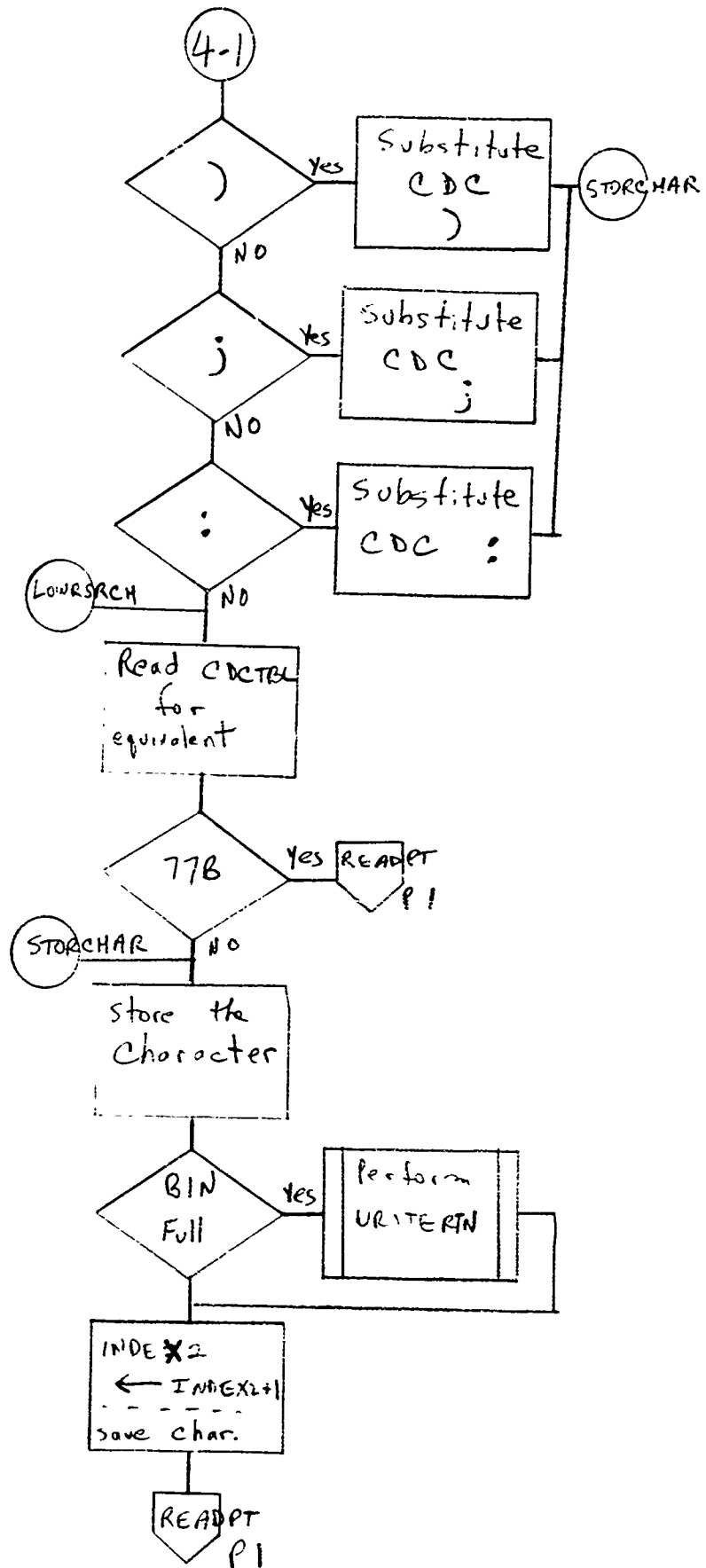

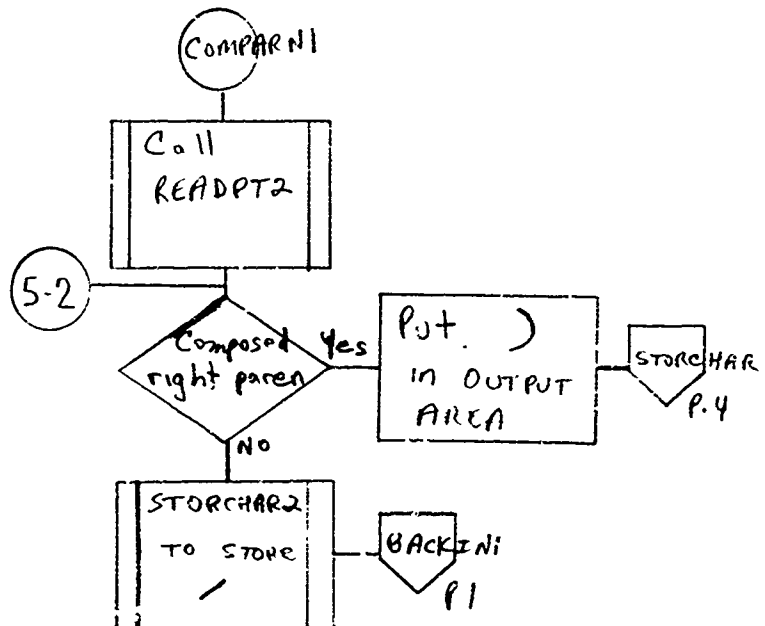
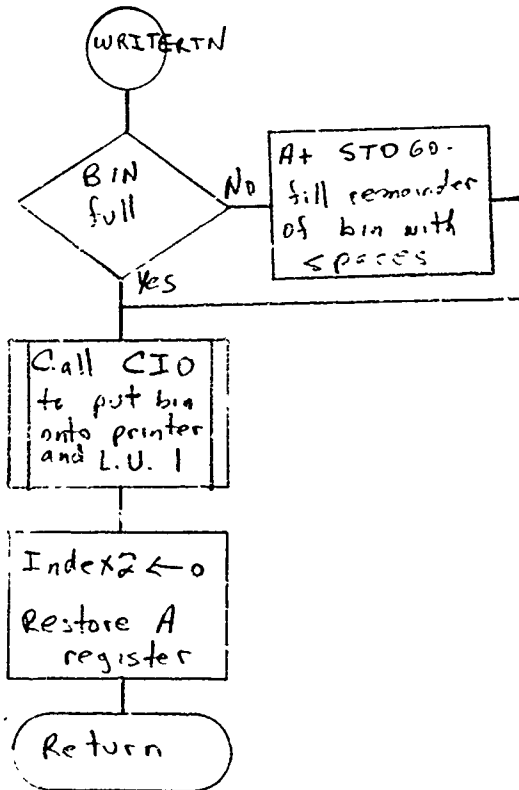
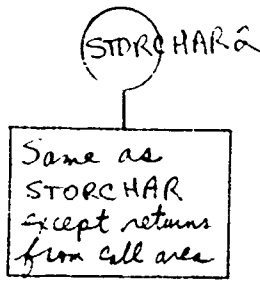

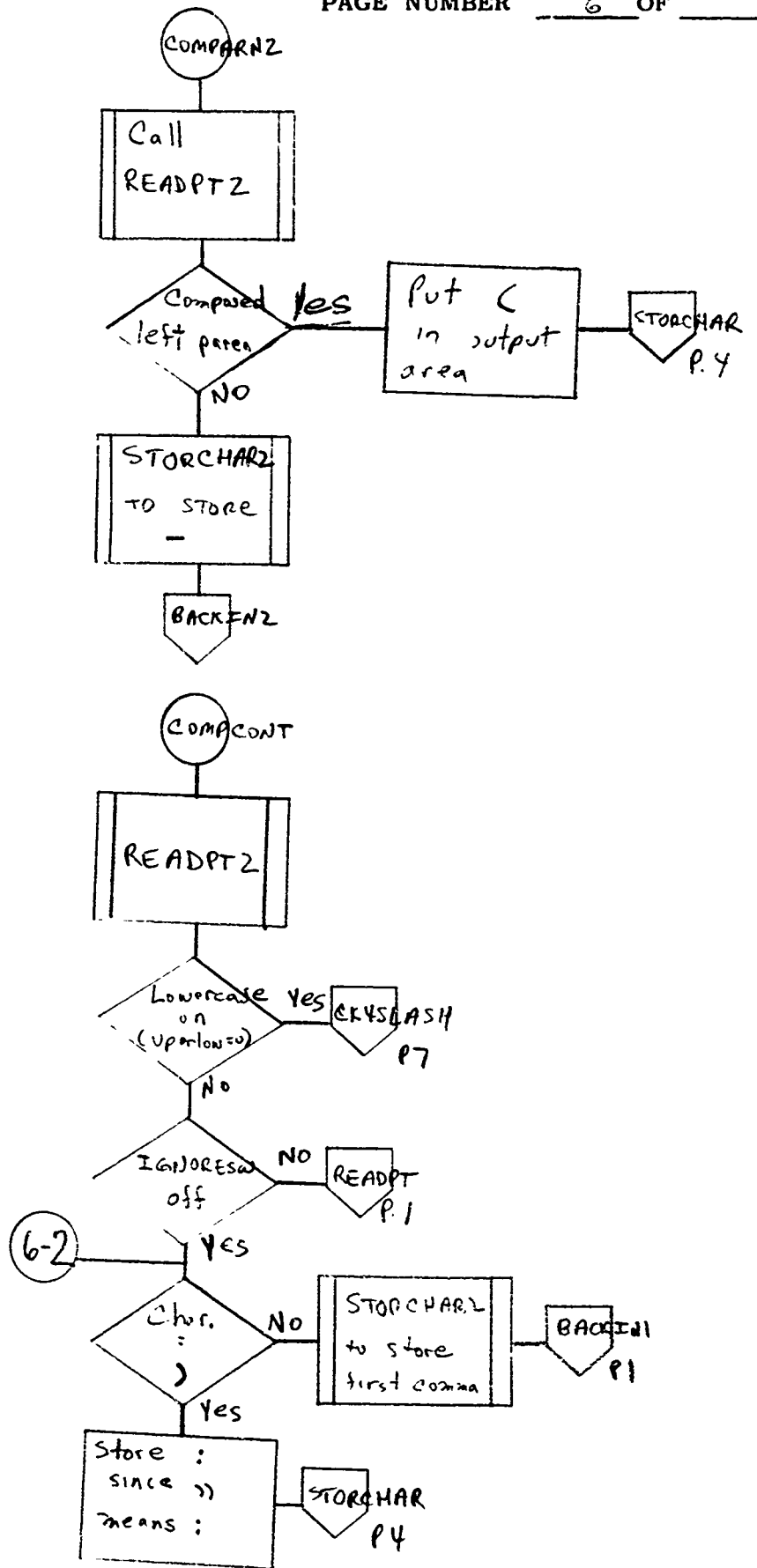

SMUFD FORM 2072-1 (Temp) Mar 68

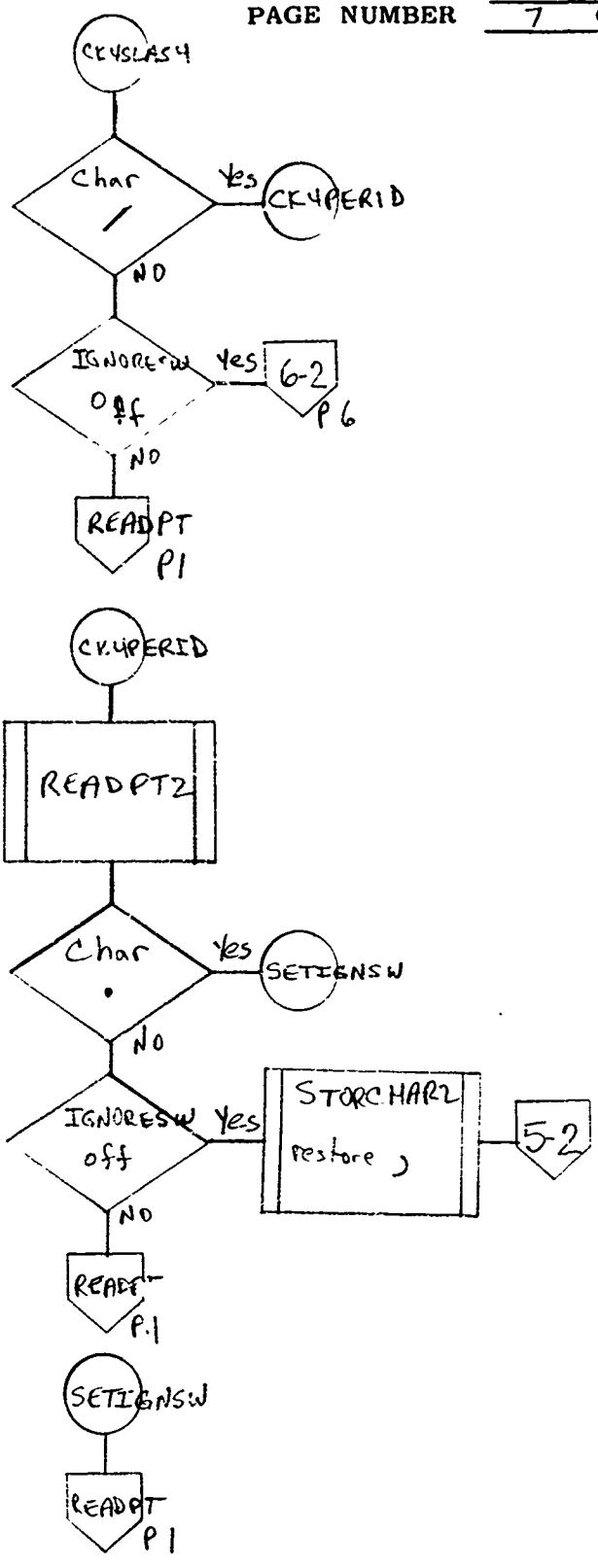

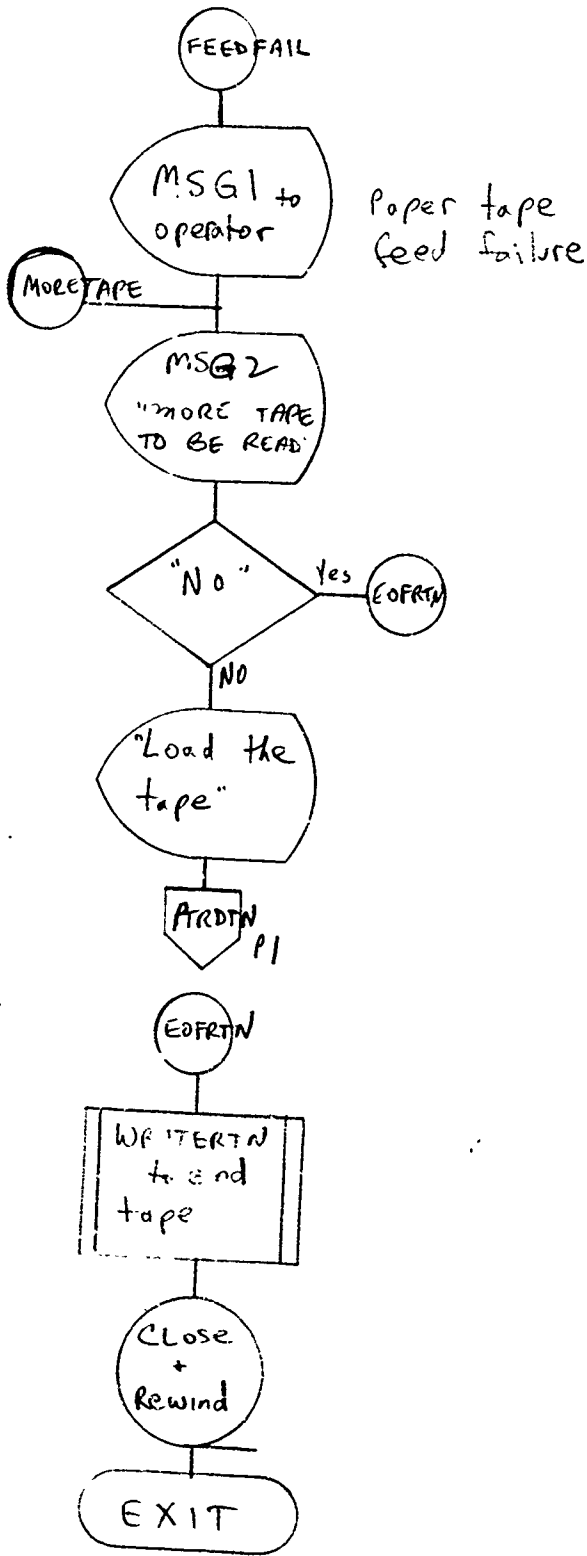

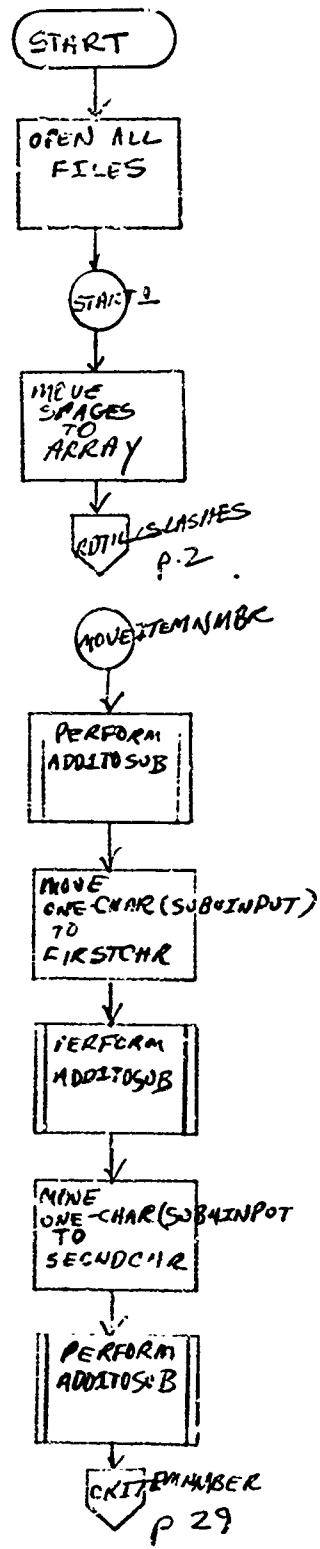

SMUFD FORM 2072-1 '71 up, Mar 68

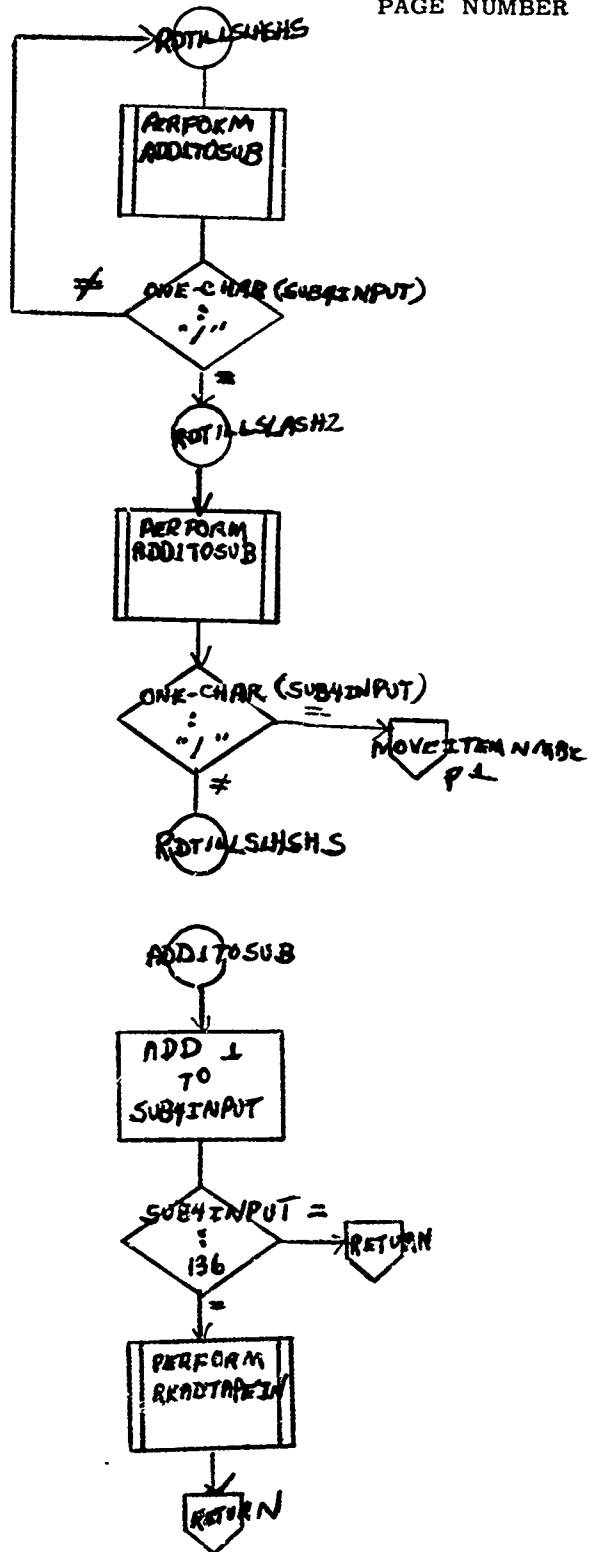

SMUFD FORM 2072-1 1 up Mar 69

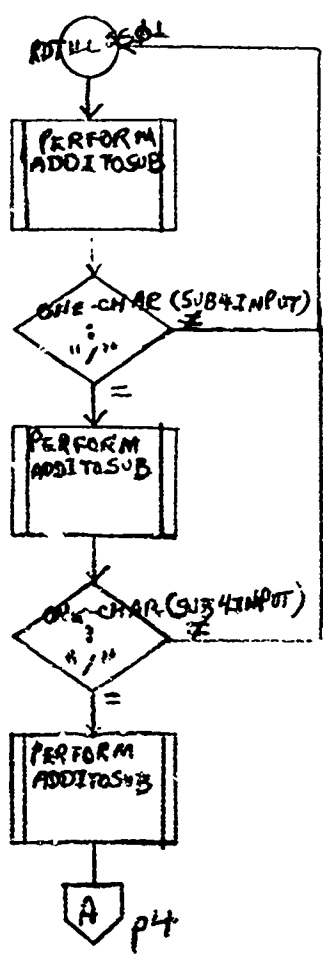
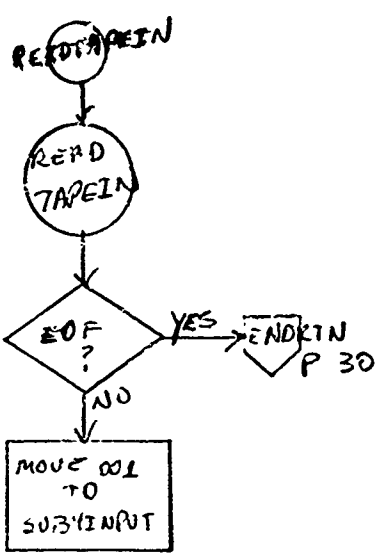

SMUD FORM 2072-1 11 ip, Mar 68

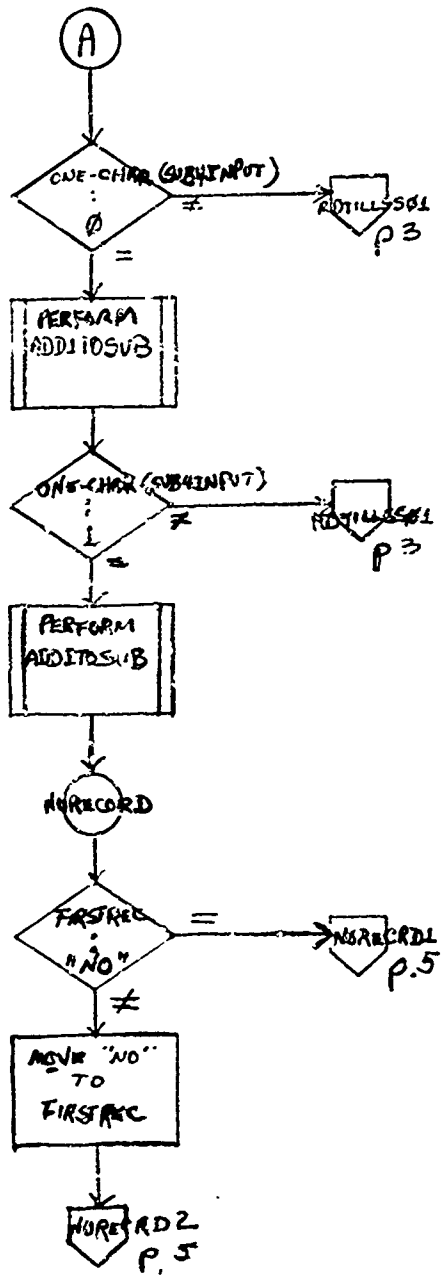

SMUD FORM 2072-1 1 up Mar 68

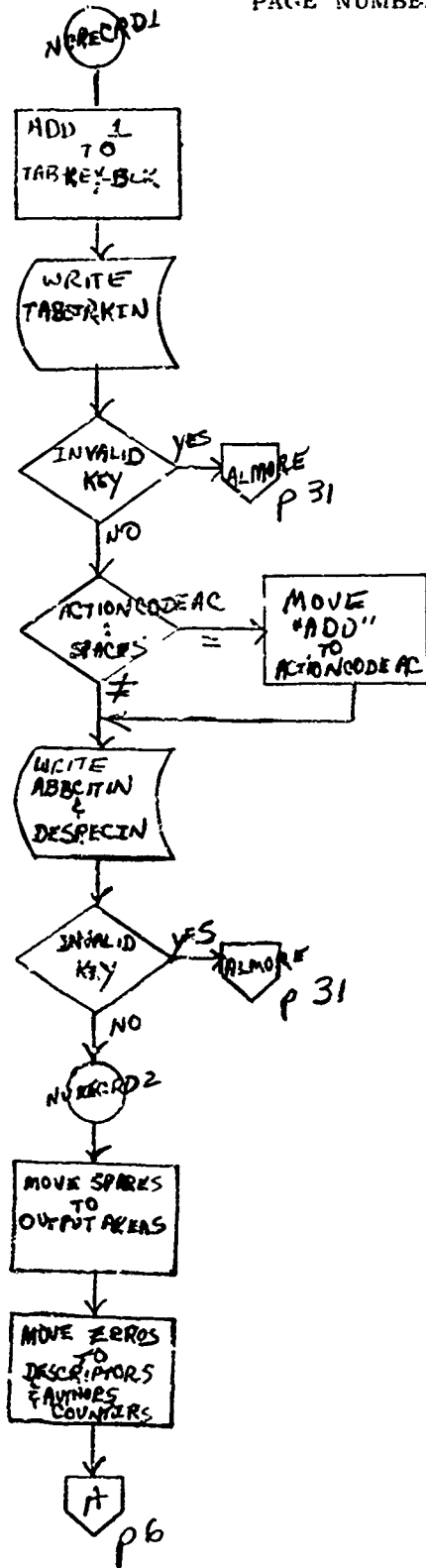

SMUFD FORM 2072-1 / 1 up: Mar 68

SMUFD FORM 2072-1 1 up: Mar 68

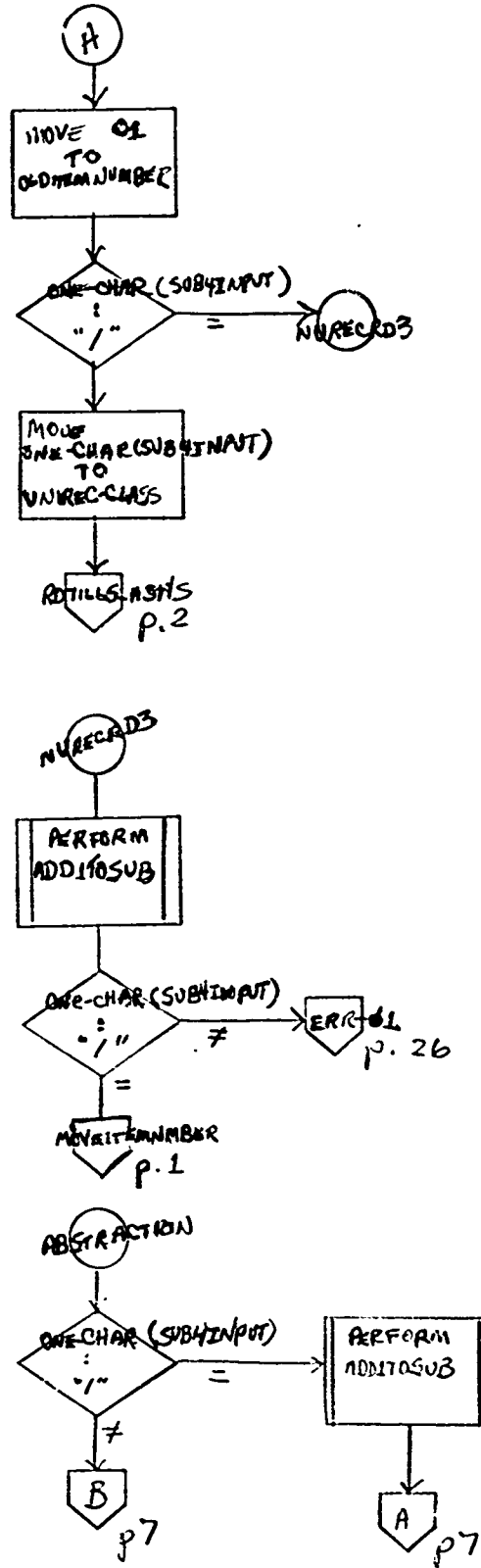

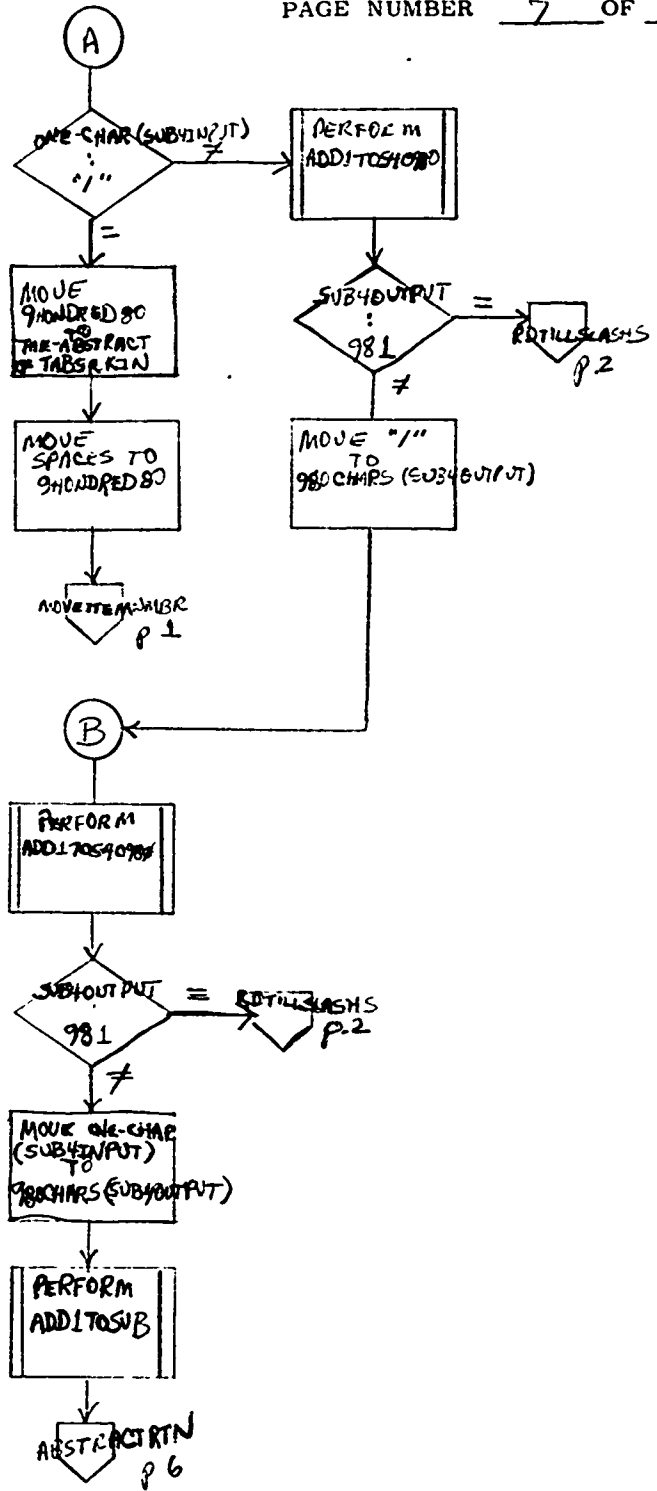

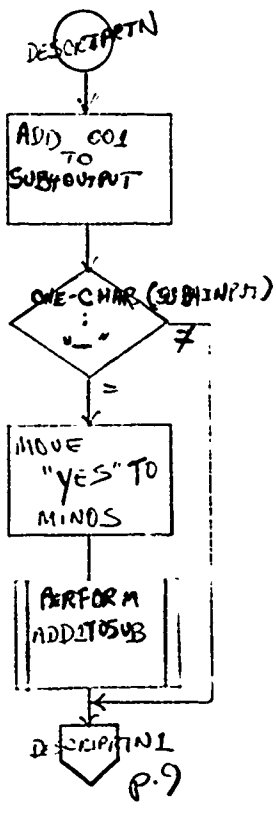
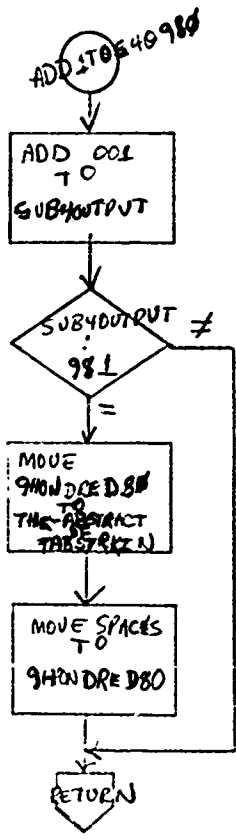

SMUFD FORM 2072-1 1 up Mar 68

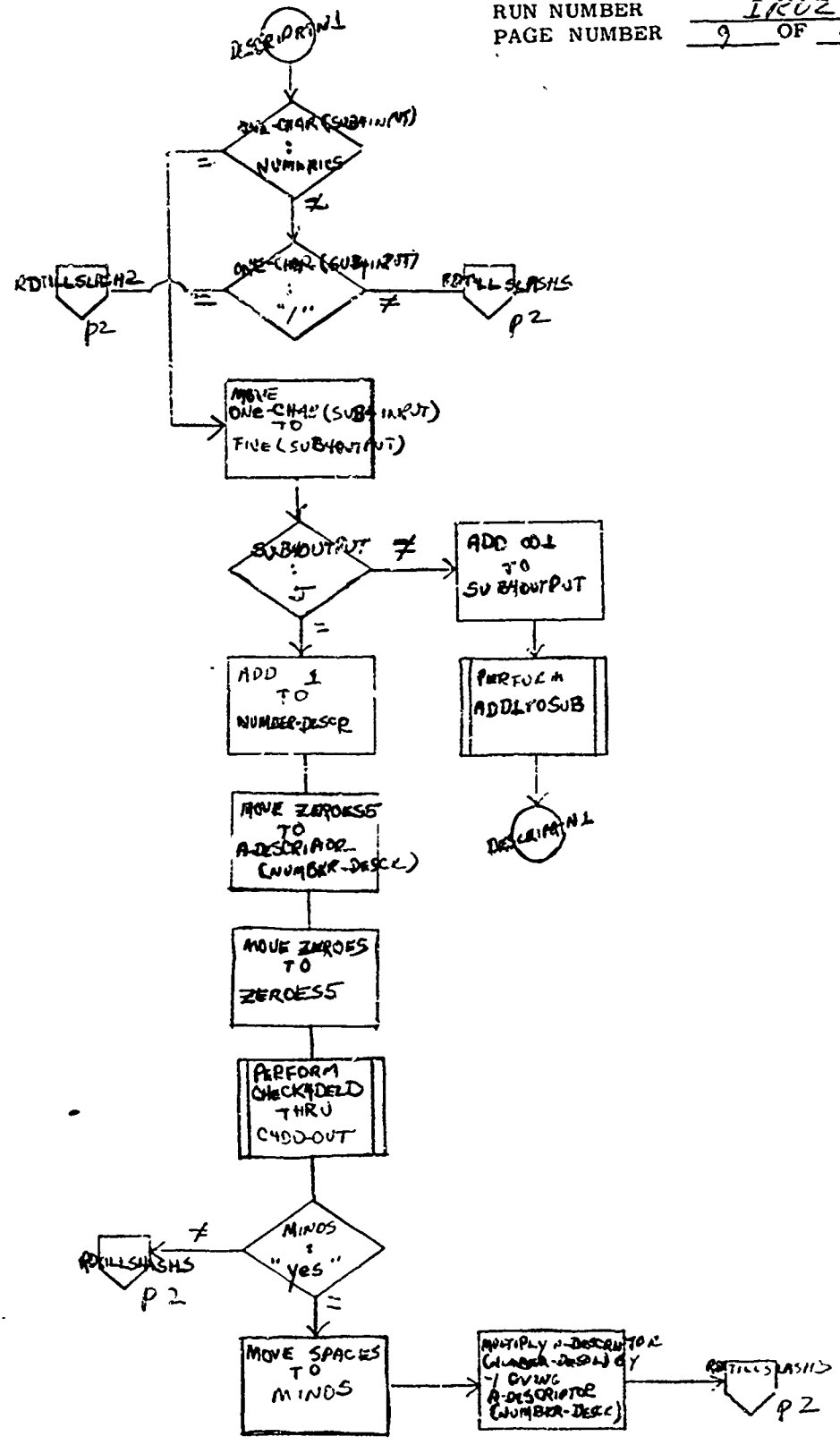

SMUFD FORM 2072-1 7 ip, Mar 68

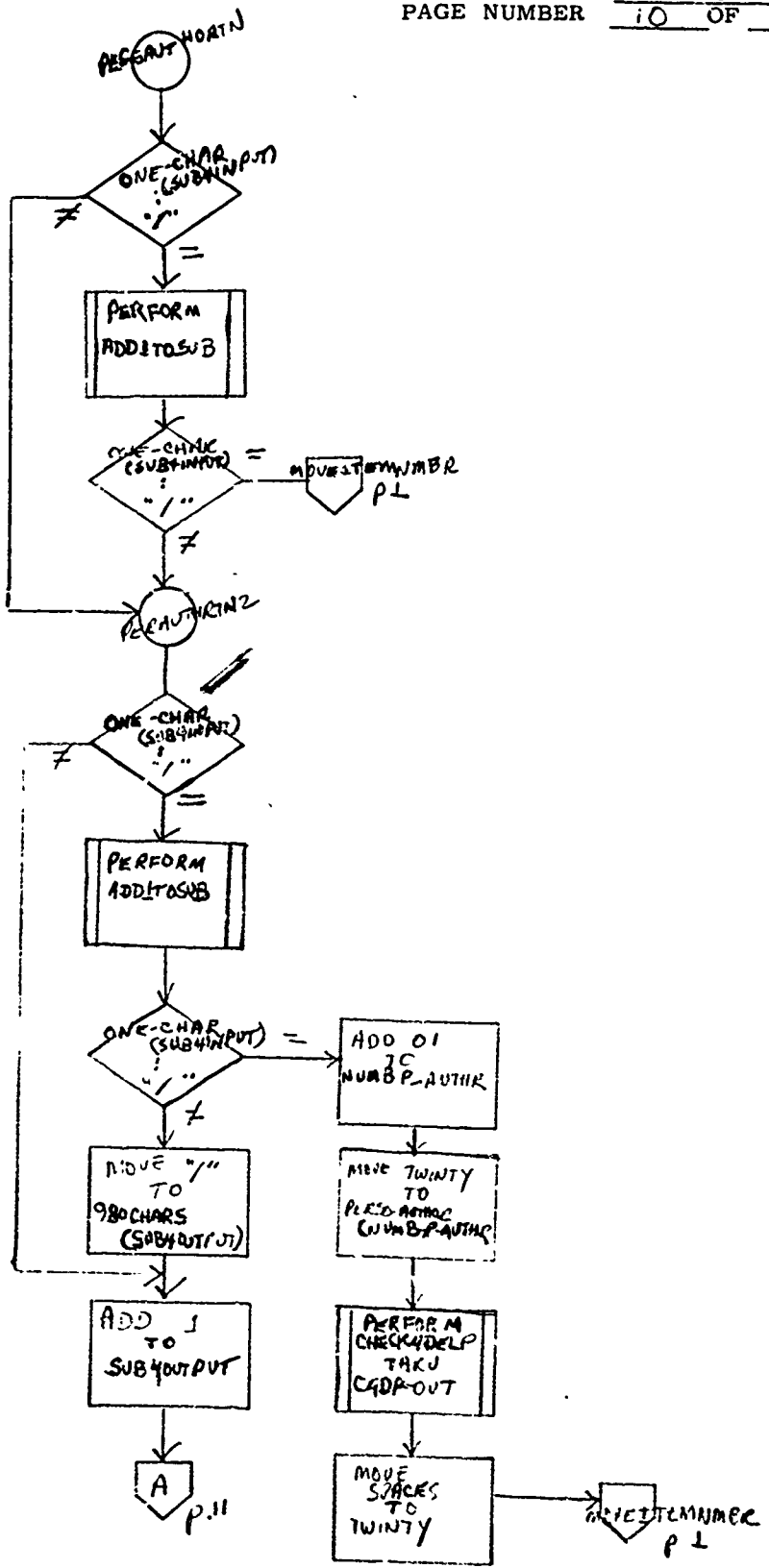

SMUFD FORM 2072-1-1 up. Mar 68

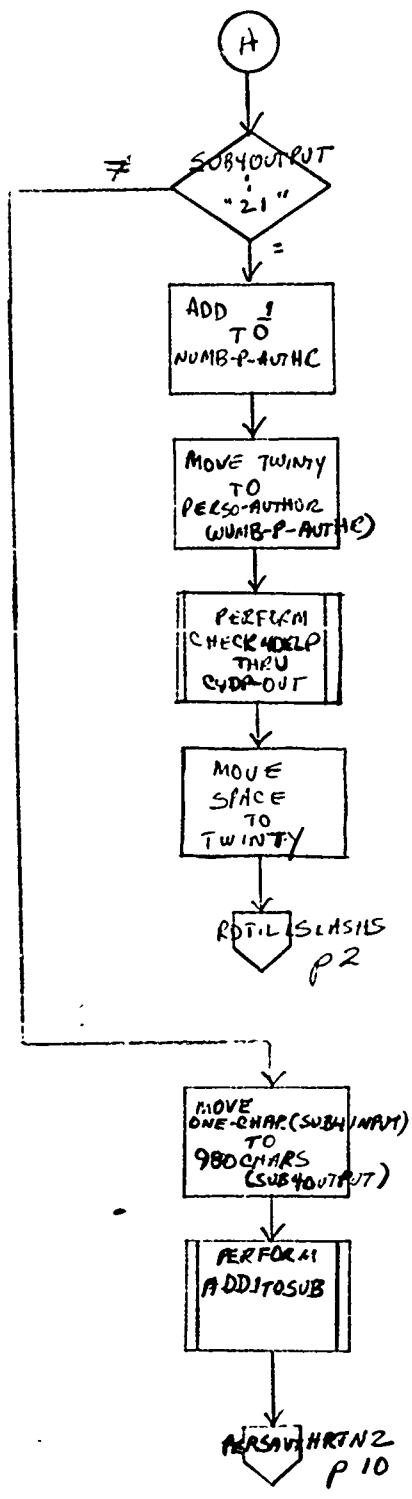

SMUFD FORM 2072-1 'T up, Mar 68

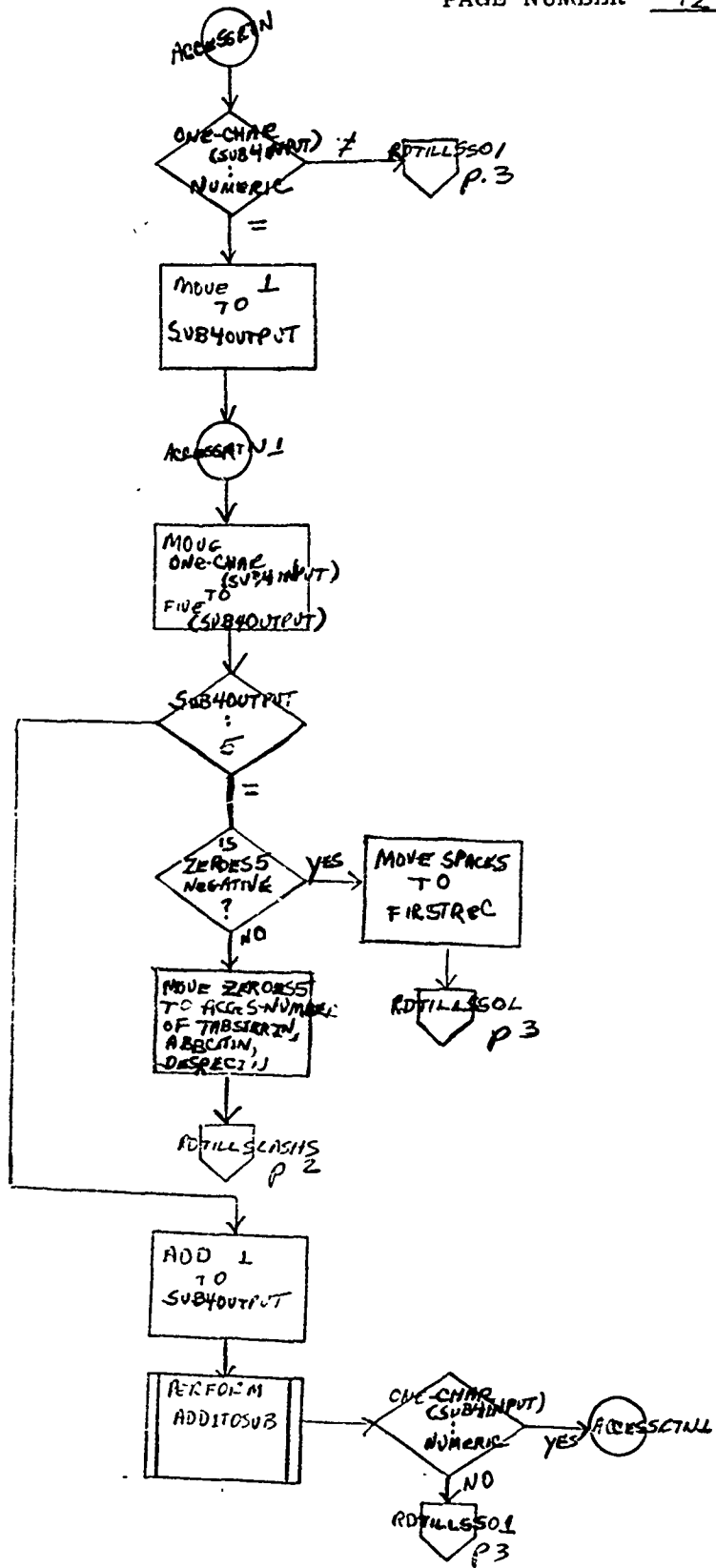

SMUPD FORM 2072-1 7 ip, Mar 68

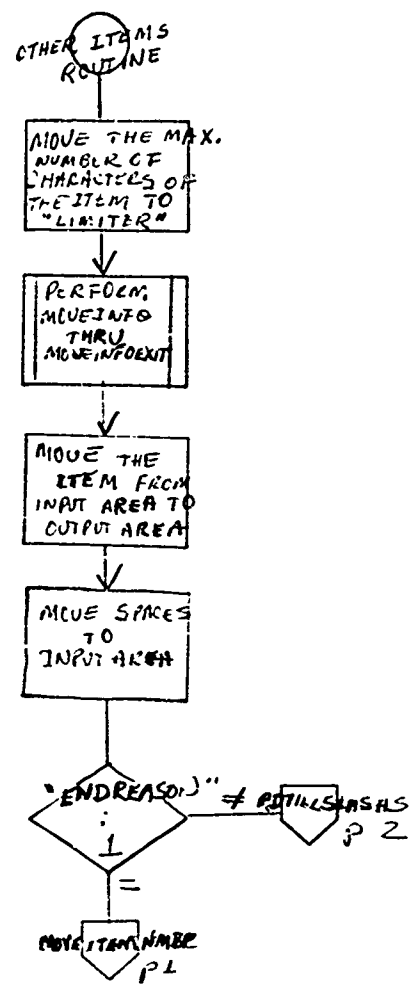

SMUFD FORM 2072-1 11 ip: Mar 68

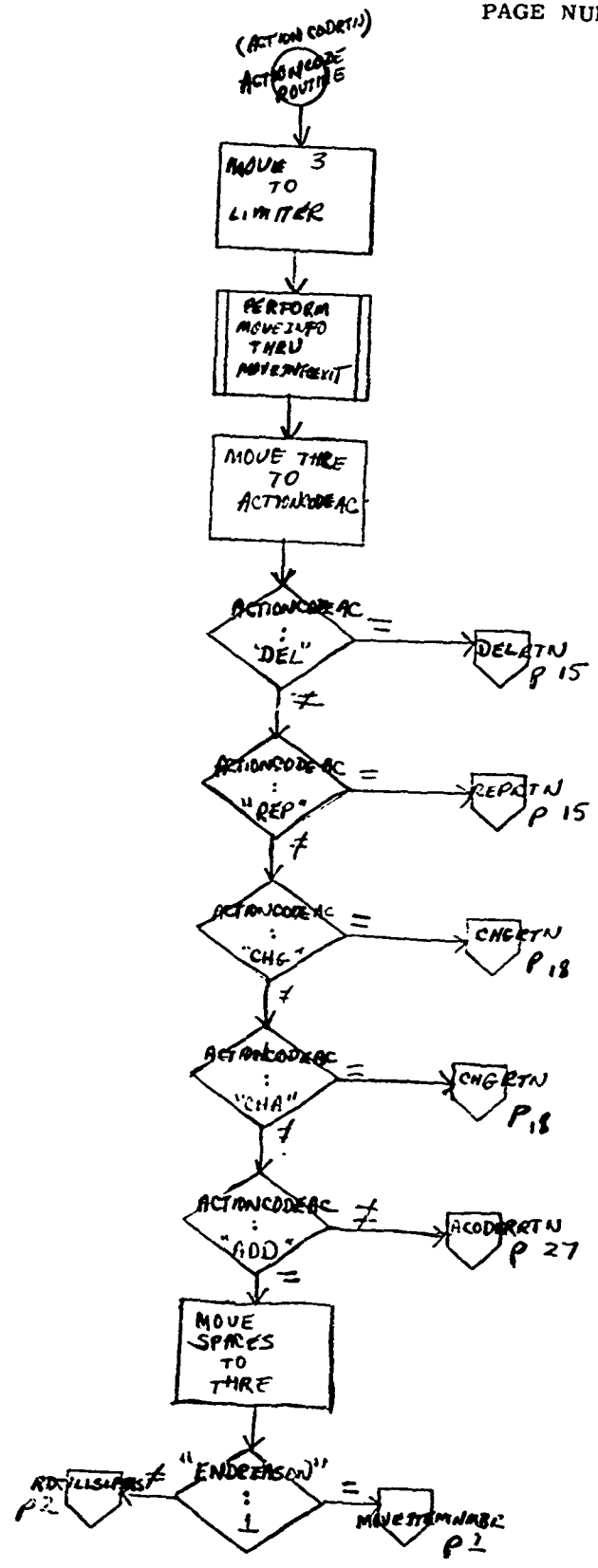

SMUFD FORM 2072-1 7 ip, Mar 68

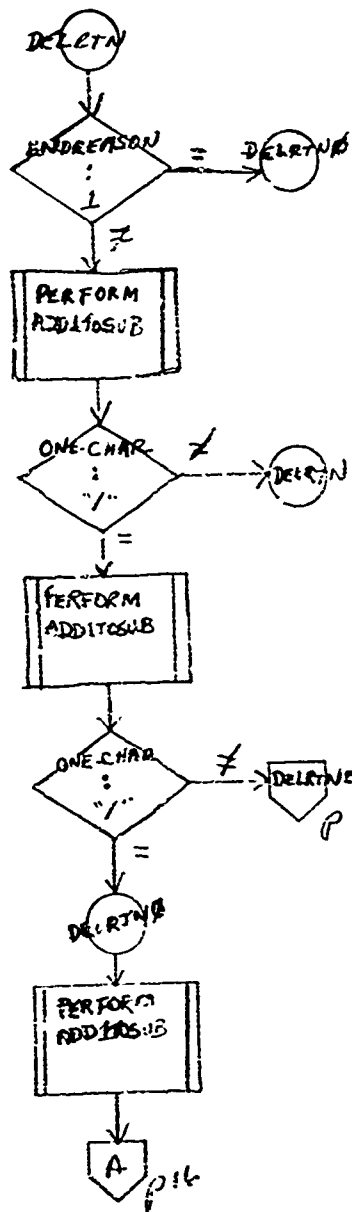
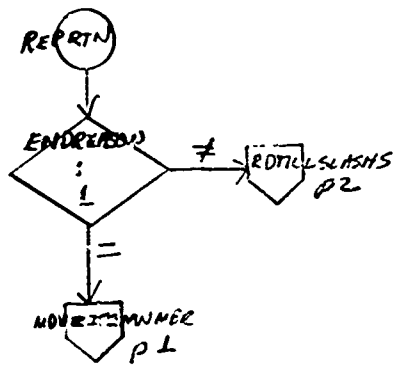

SMUPD FORM 2072-1 1 ip Mar 68

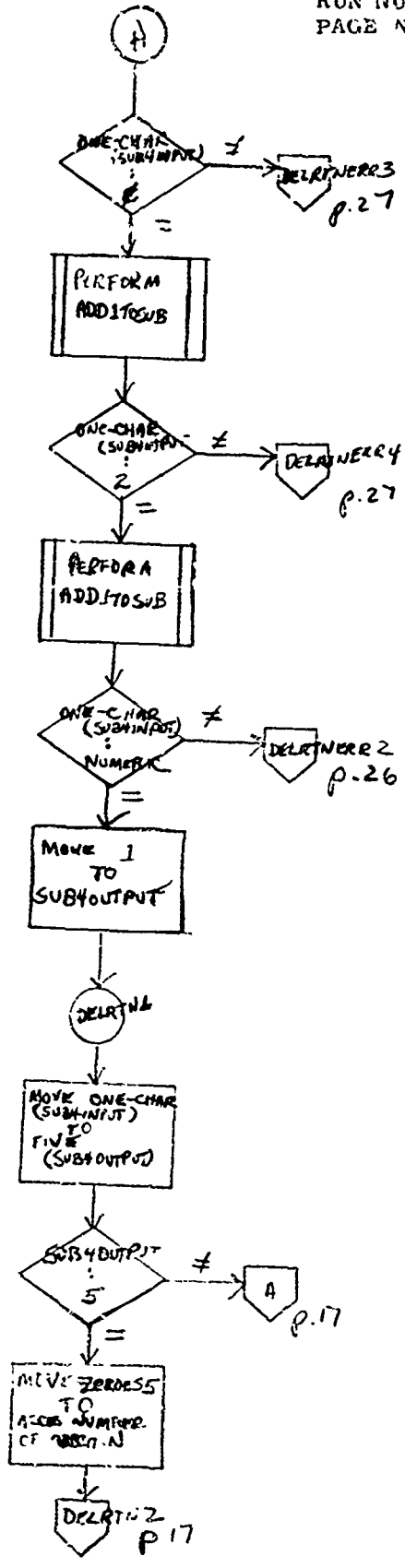

SMUTD FORM 2072-1 4 ip. Mar 68

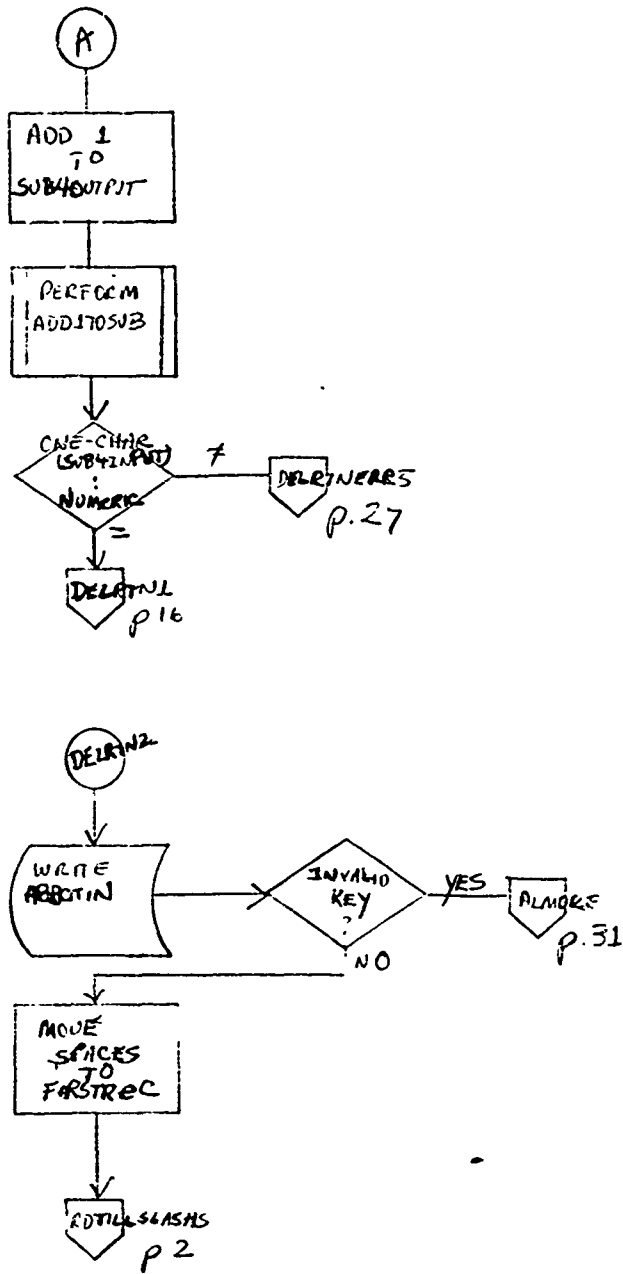

SMUFD FORM 2072-1 11 up: Mar 68

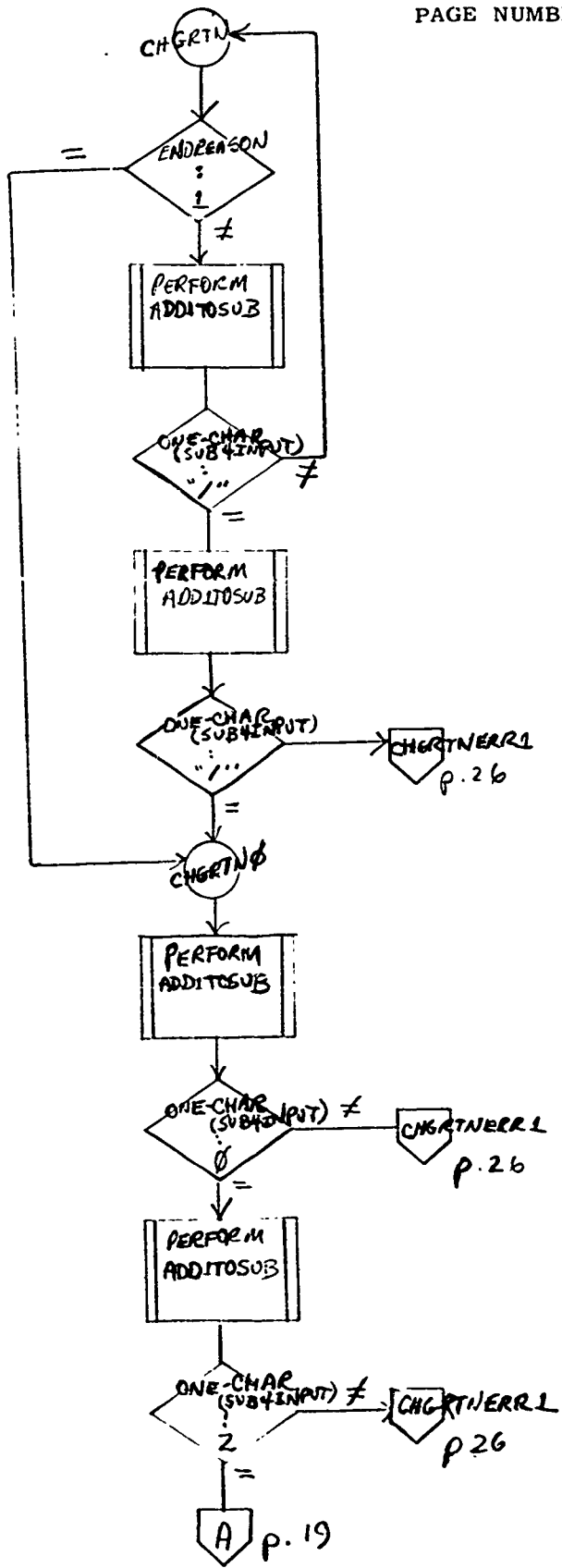

SMUFD FORM 2072-1 7 up Mar 68

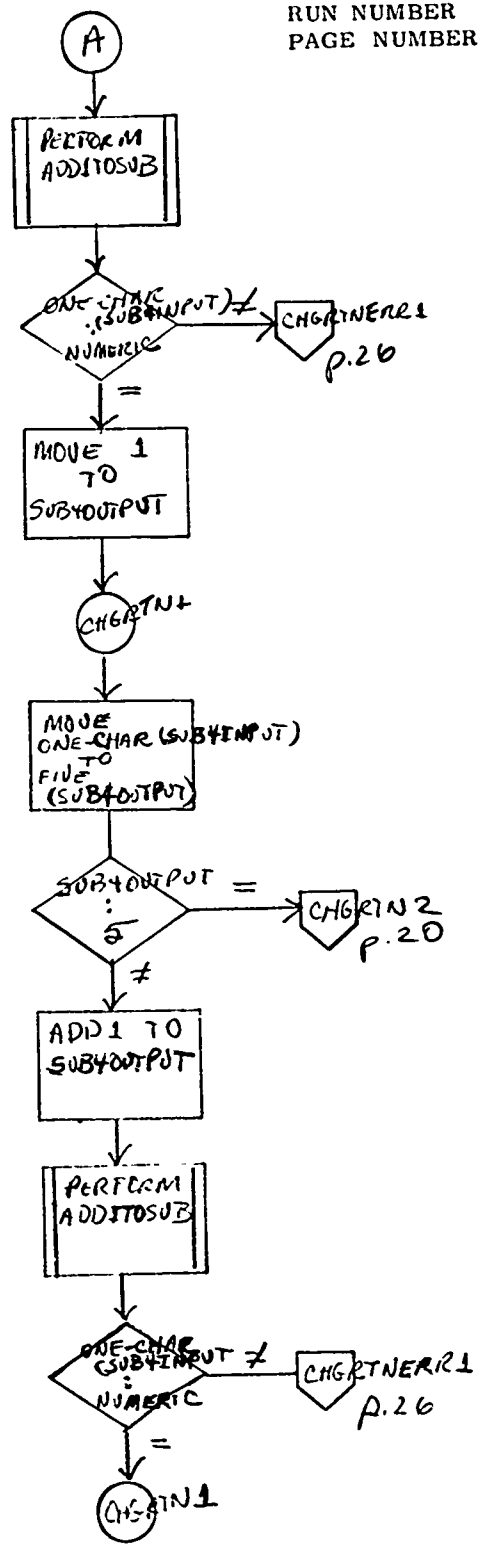

SMUFD FORM 2072-1 71 up: Mar 68

SMUFD FORM 2072-1 11 ip. Mar 68

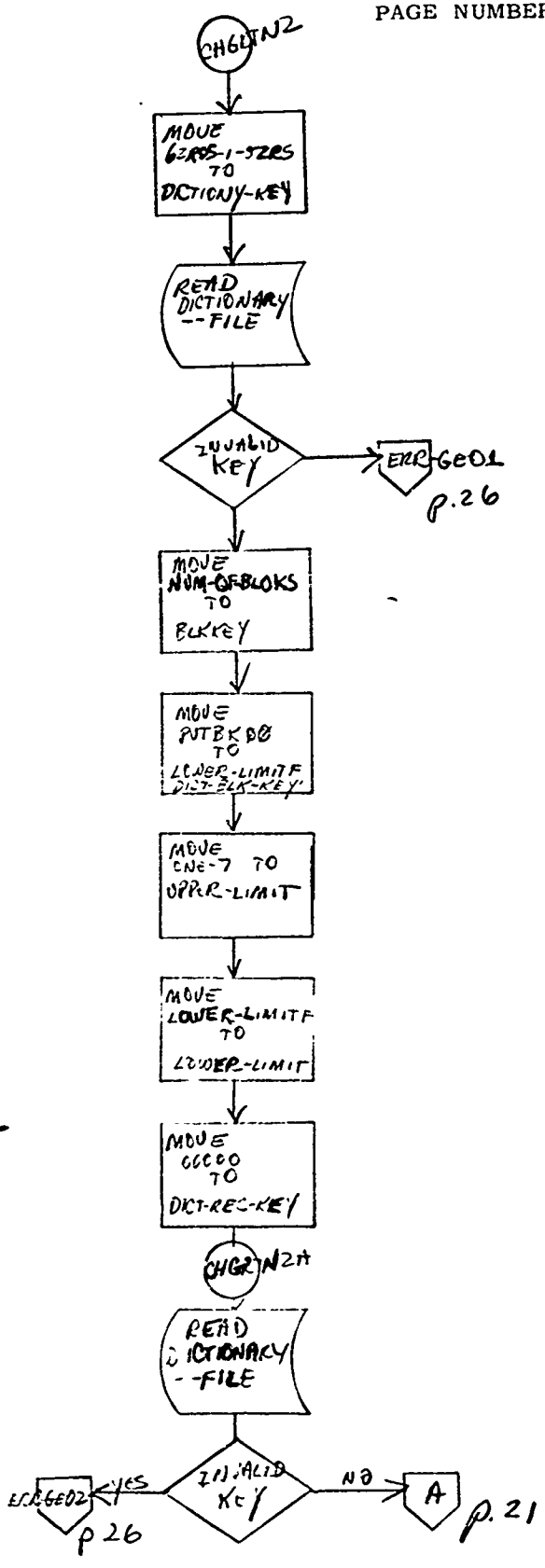

SMUFD FORM 2072-1 '1 up, Mar 68

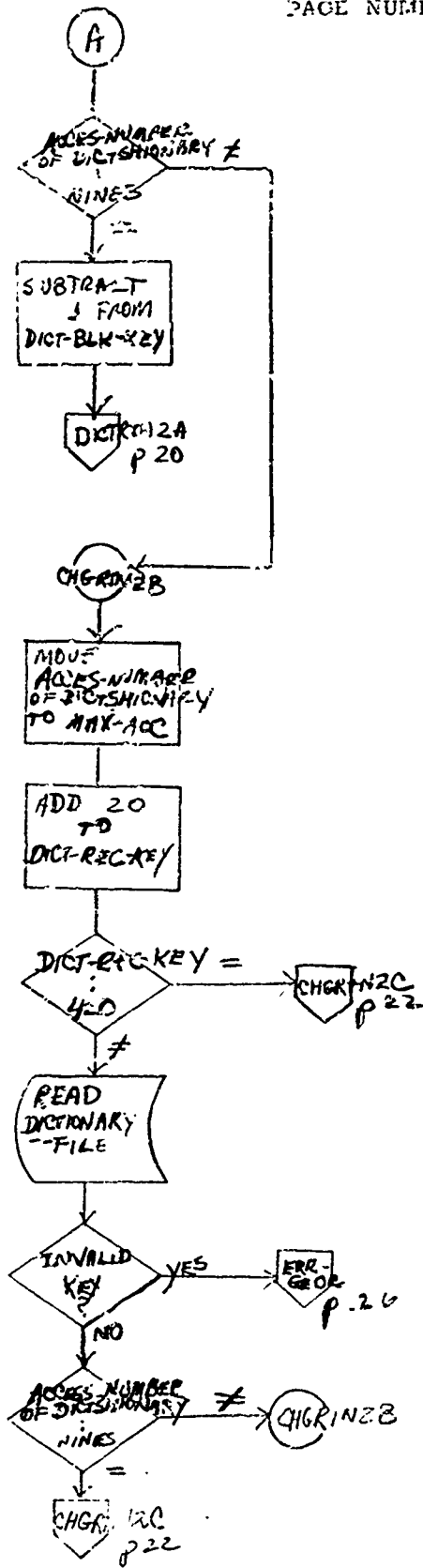

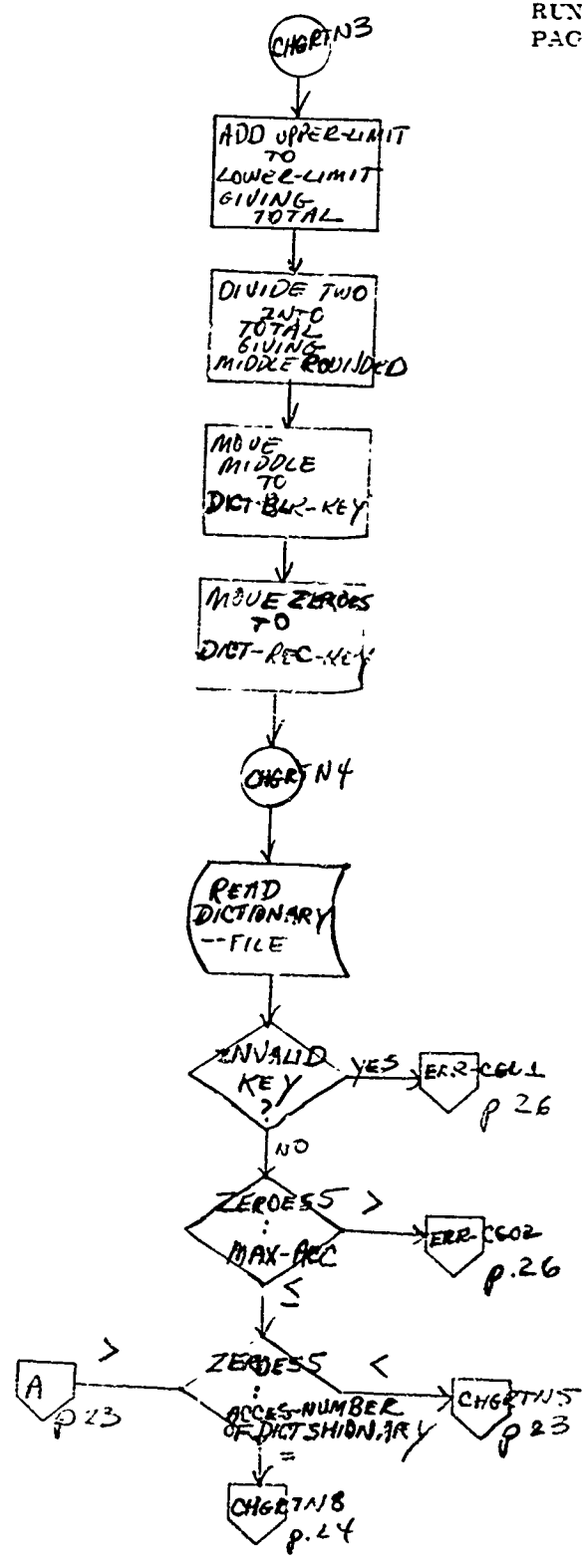

SMUPD FORM 2072-1 1 up Mar 66

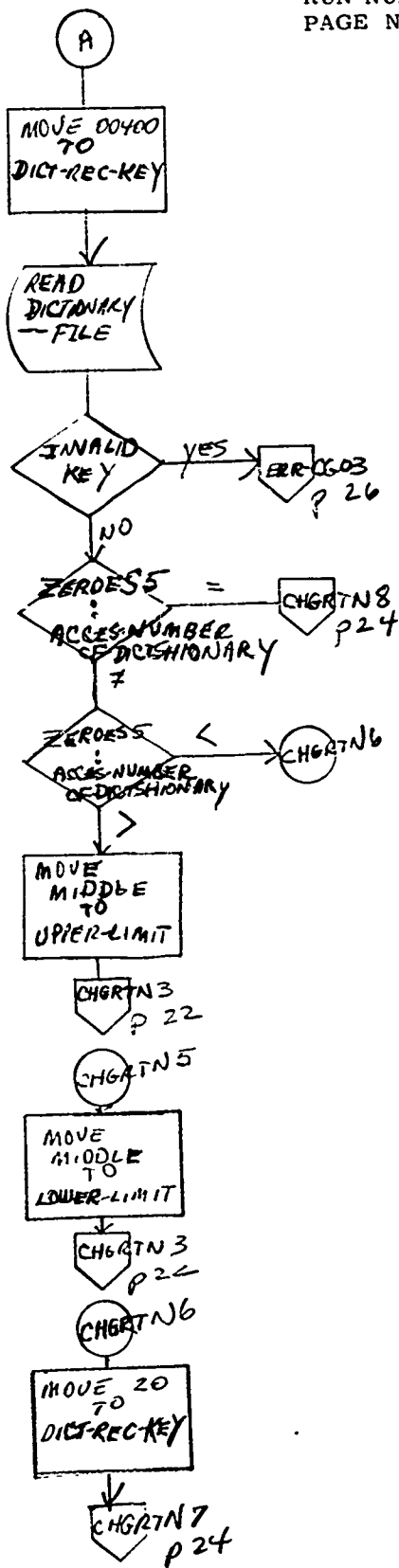

SMUFD FORM 2072-1 11 up Mar 68

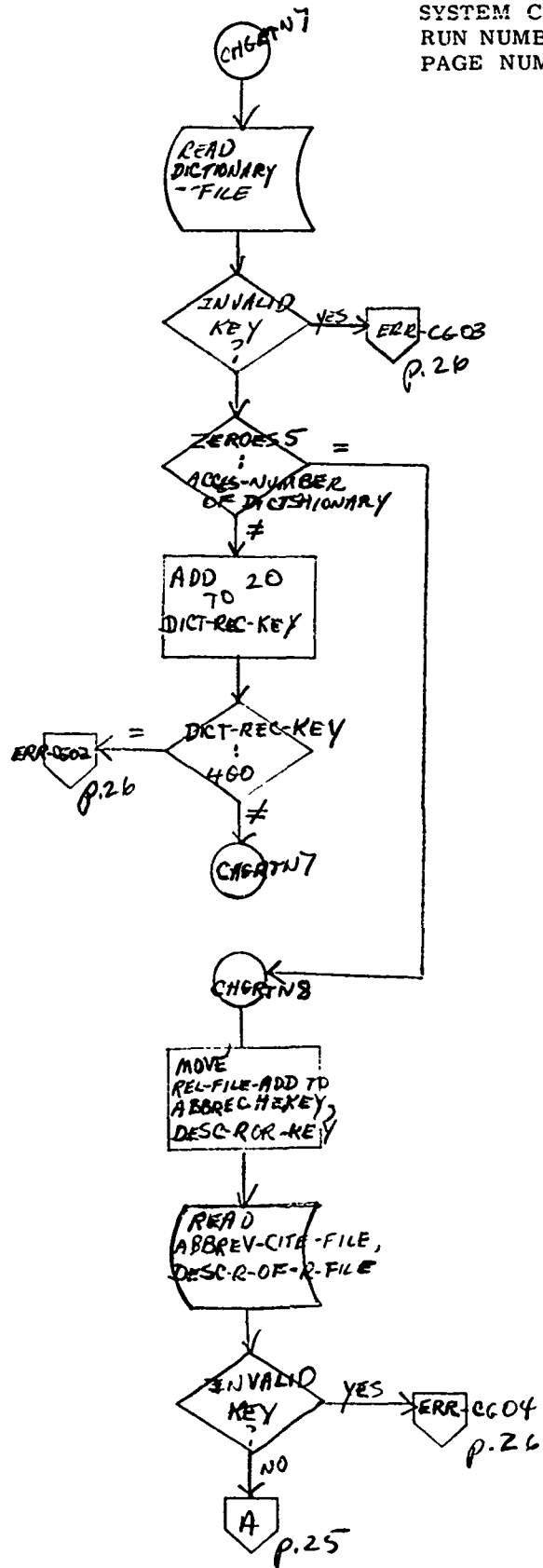

SMUFD FORM 2072-1 4 up Mar 68

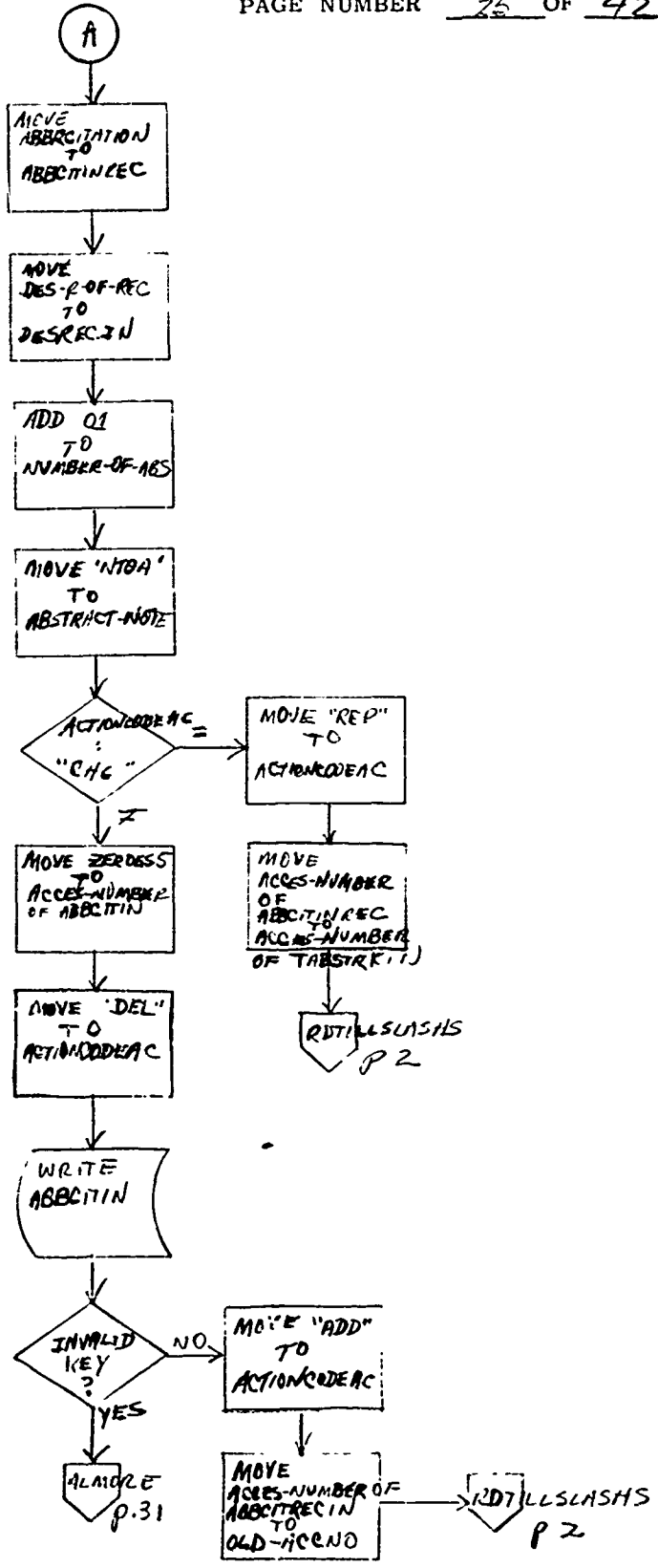

SMUFD FORM 2072-1 1 ip. Ma. 68

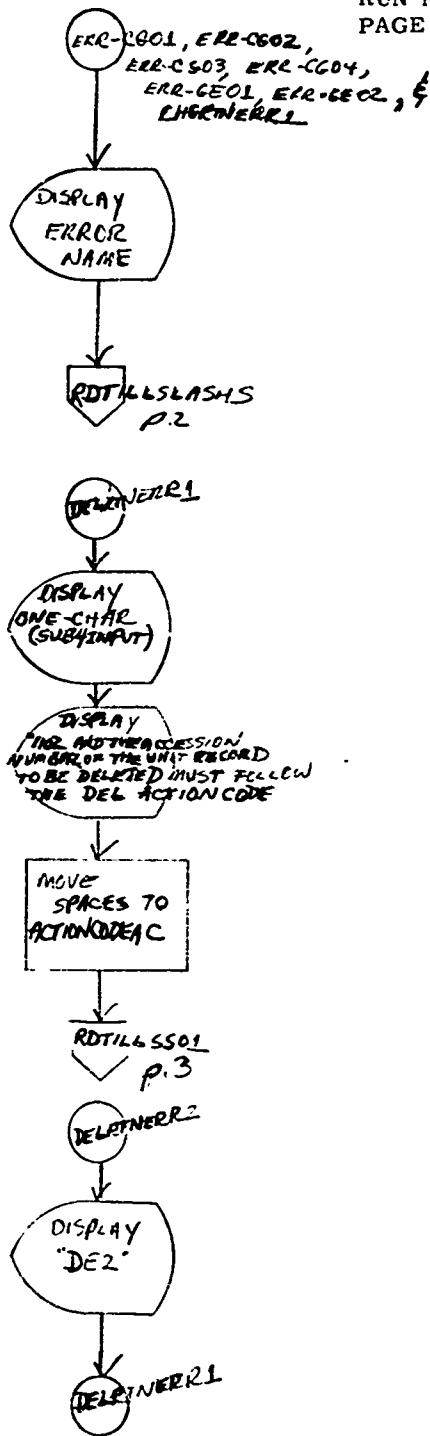

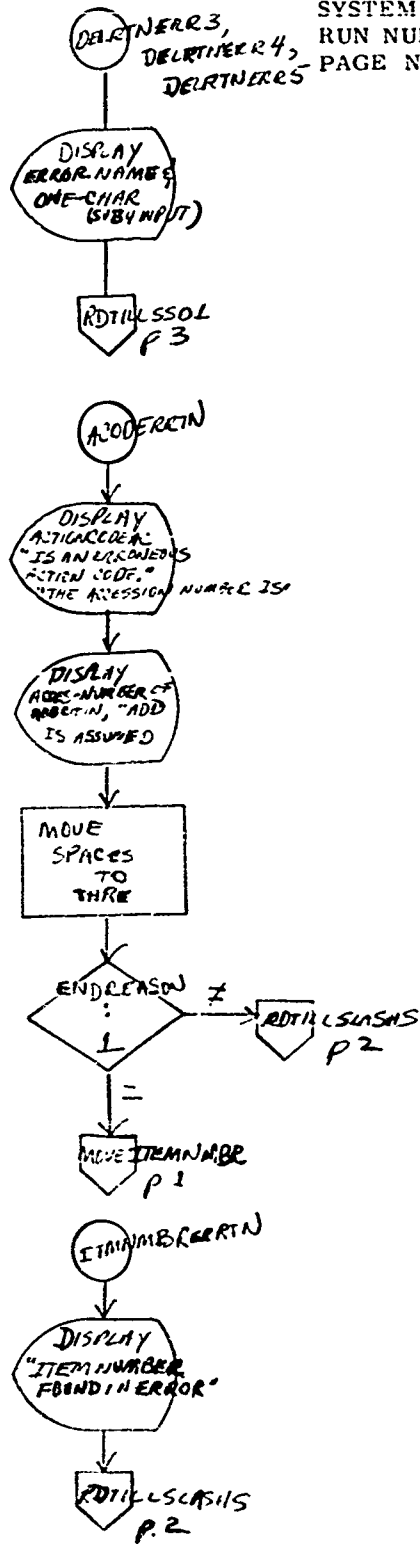

SMUFD FORM 2072-1 "1 up: Mar 68

OFFICE SYMBOL _____
 SYSTEM CHART NO. _____
 RUN NUMBER TR02
 PAGE NUMBER 28 OF 42

SMUFD FORM 2072-1 1 10-19-64

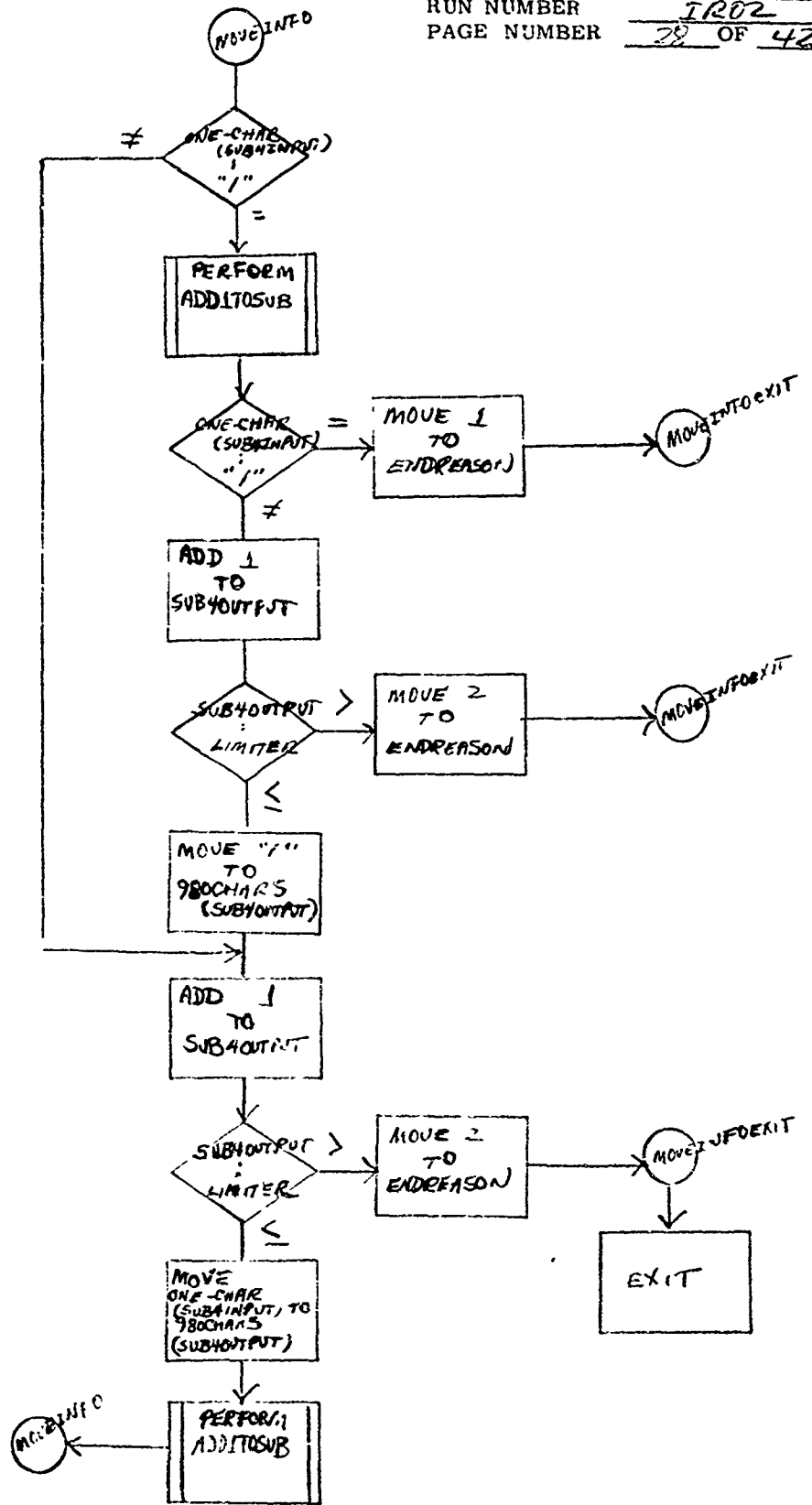

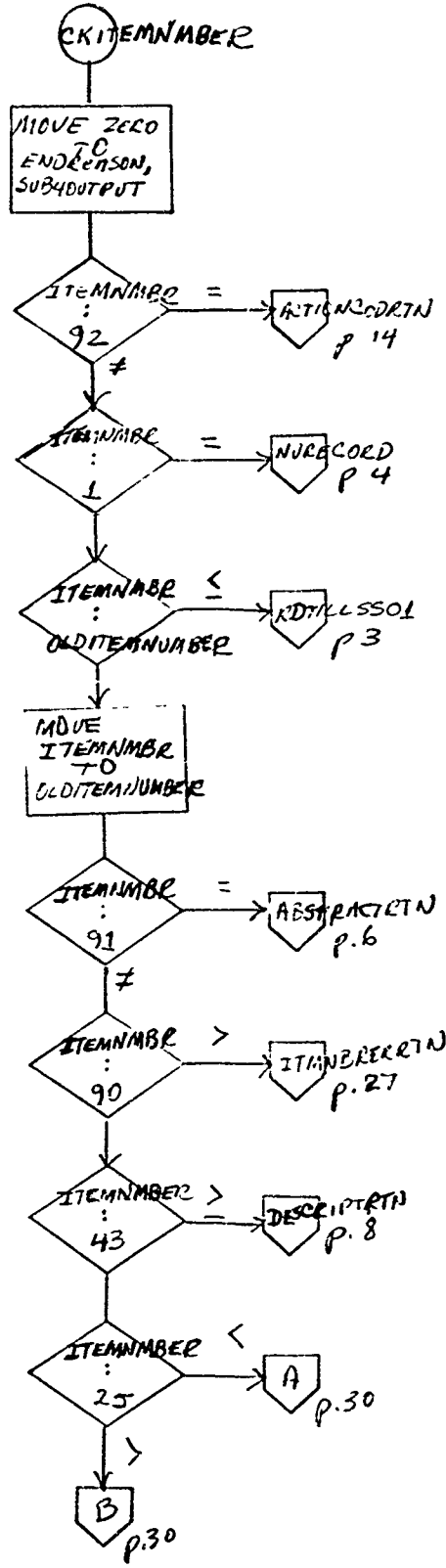

SMUFD FORM 2072-1 7 12 Mar 68

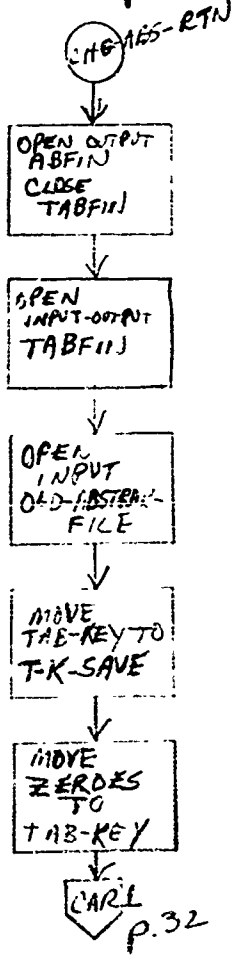
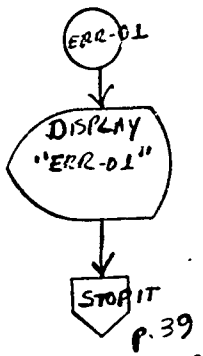
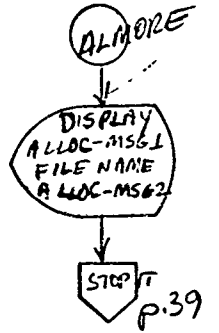

SMUFD FORM 2072-1 1 10-1-68

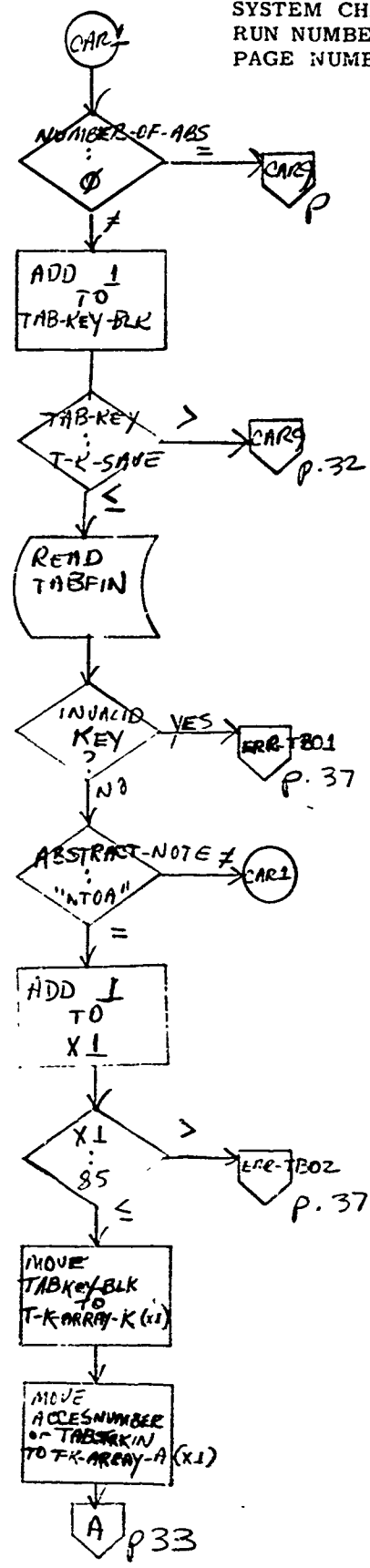

SMUFD FORM 2072-1 1 up Mar 68

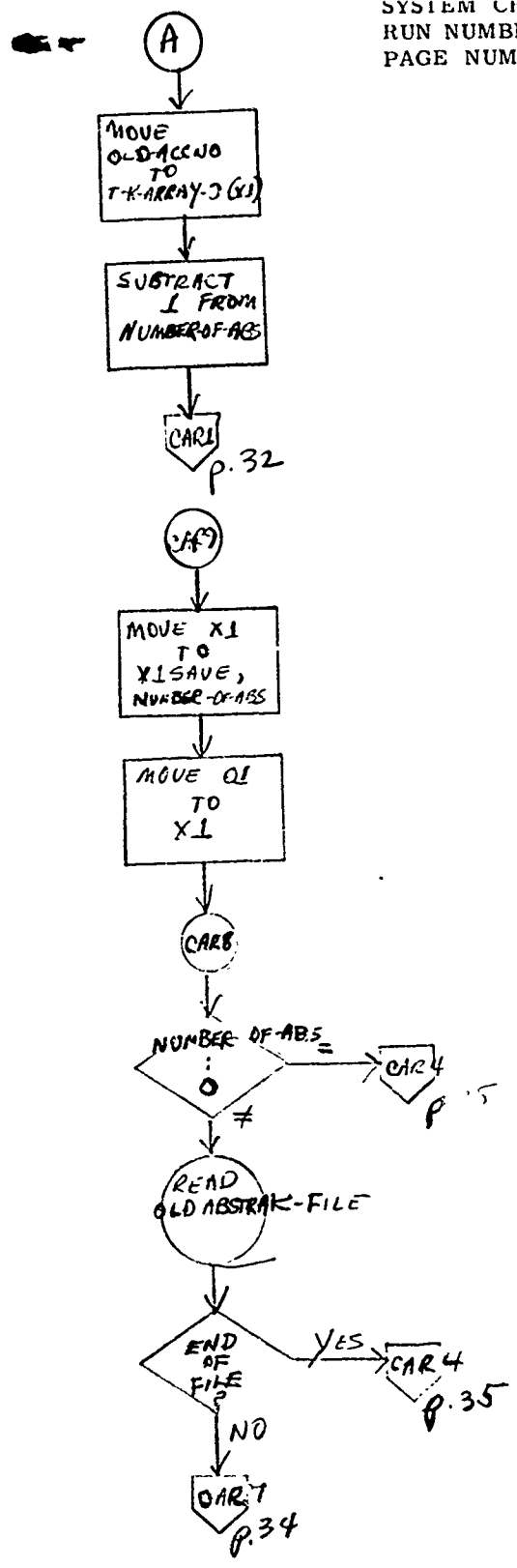

SMUFD FORM 2072-1 3 1p Mar 68

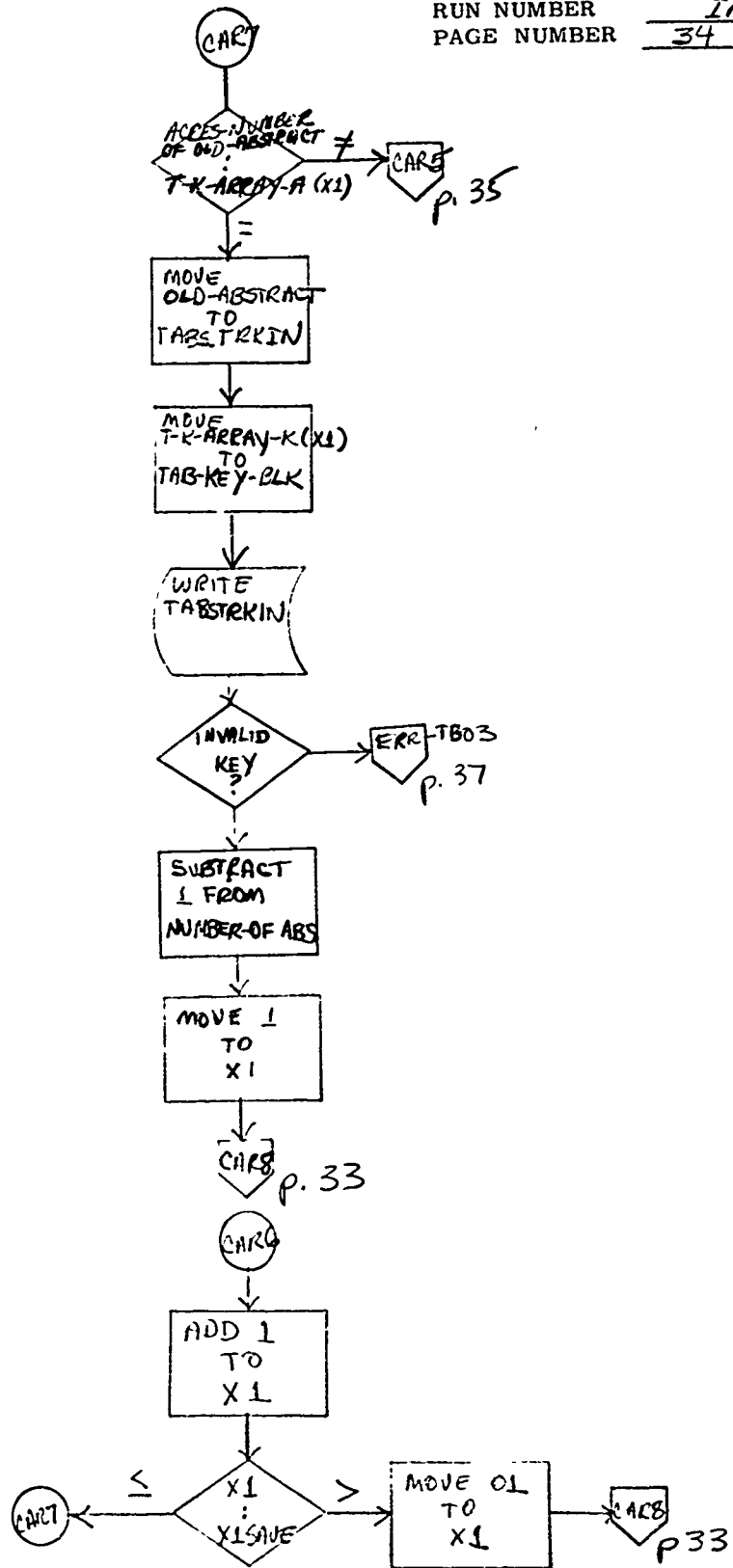

SMUFD FORM 1 2072-1 1 up: Mar 68

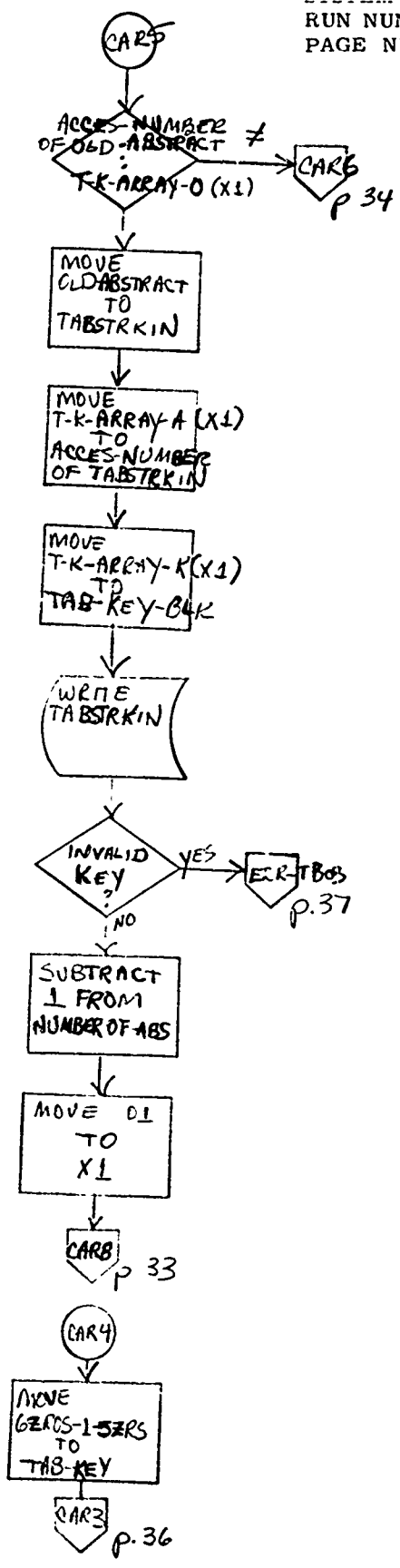

SMUFD FORM 2072-1 4T up, Mar 68

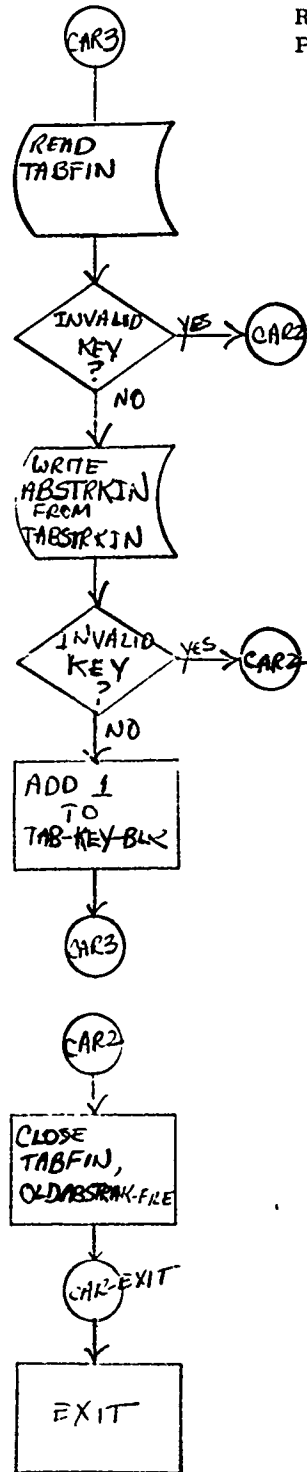

SMUFD FORM 2072-1 71 ip Mar 68

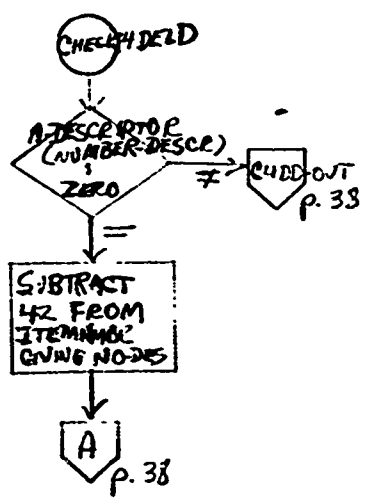
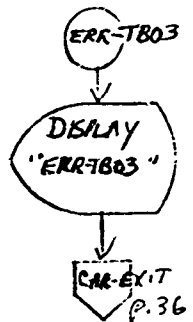
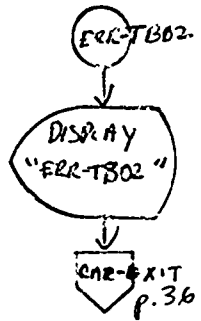
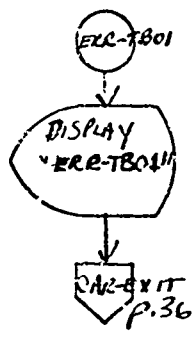

SMUFD FORM 2072-1 71 ip: Mar 68

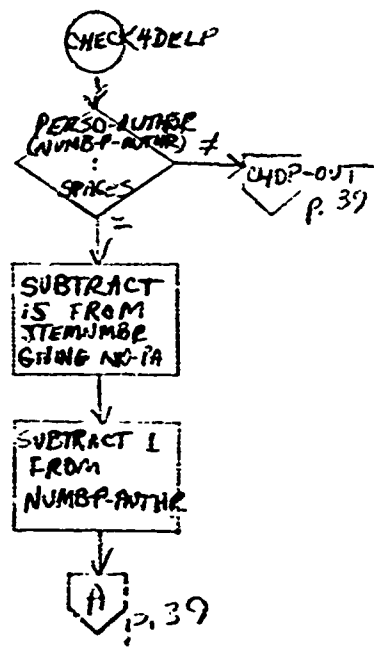
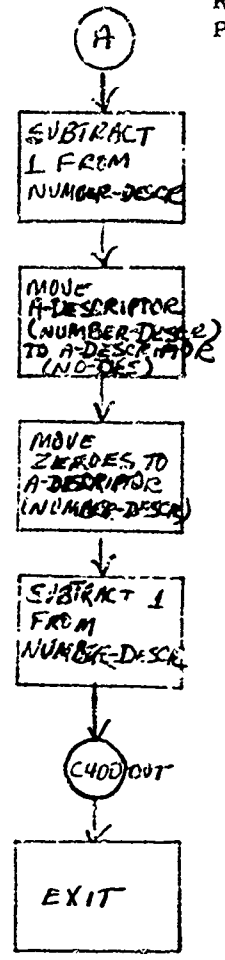

SMUFD FORM 2072-1 41 up: Mar 65

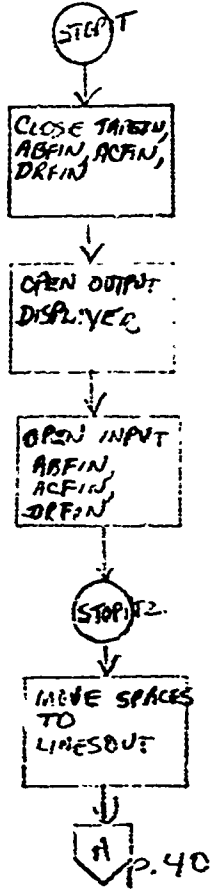
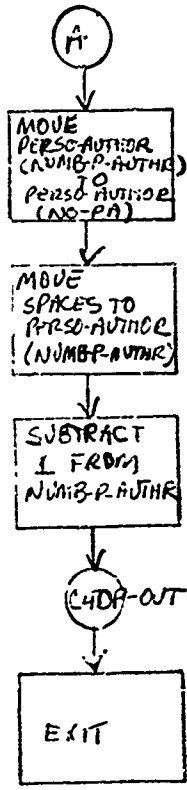

SMUCD FORM 2072-1 (1) (up) Mar 68

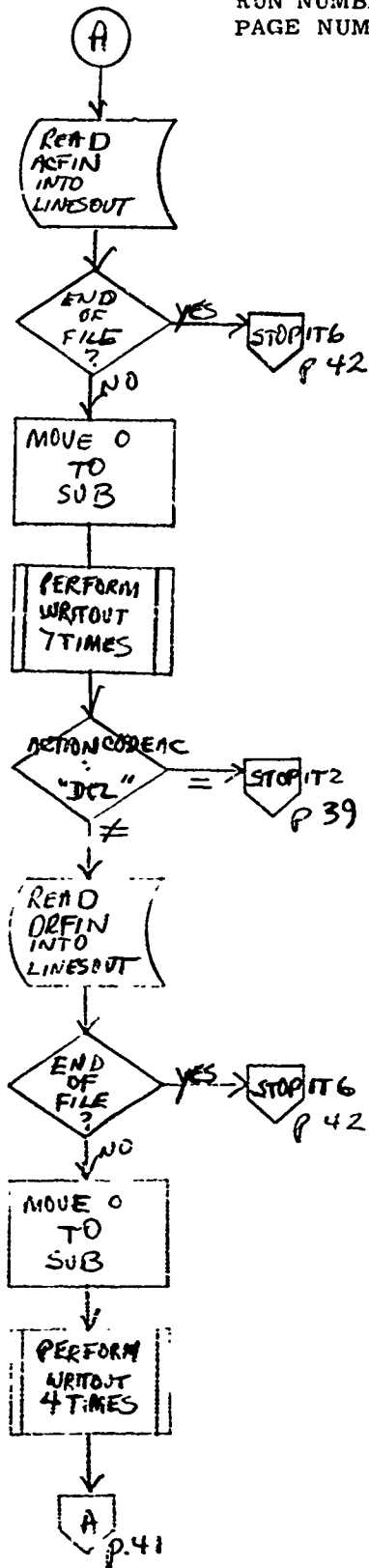

SMCFD FORM 2072-1 7 ip. Mar 68

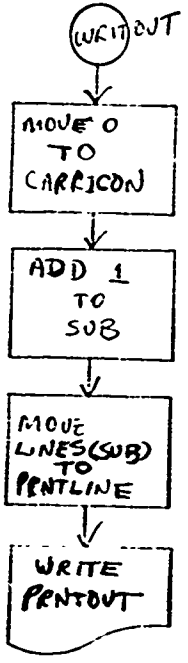
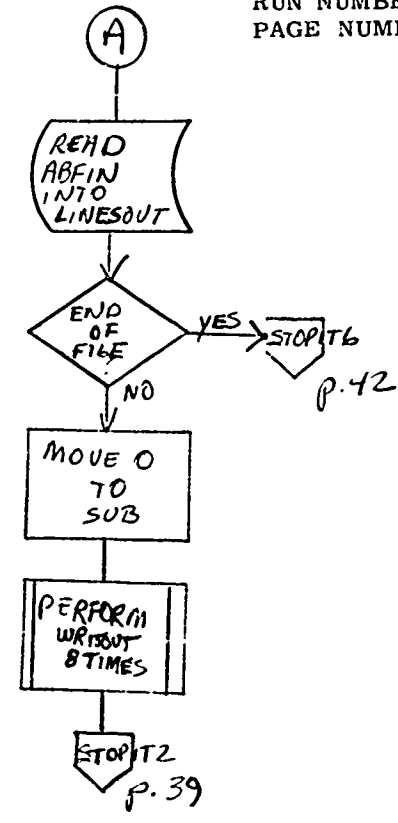

SMUFD FORM 2072-1 1 up Mar 68

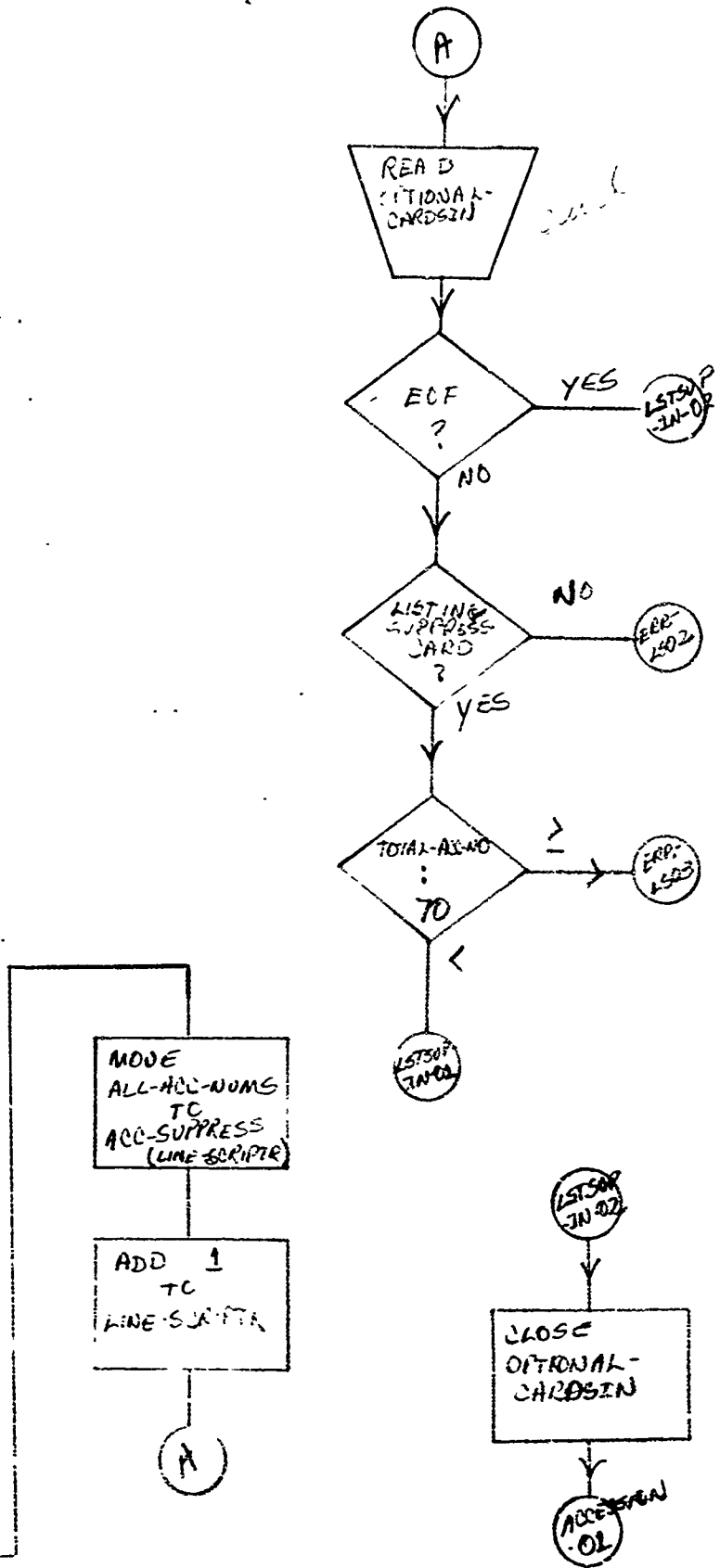
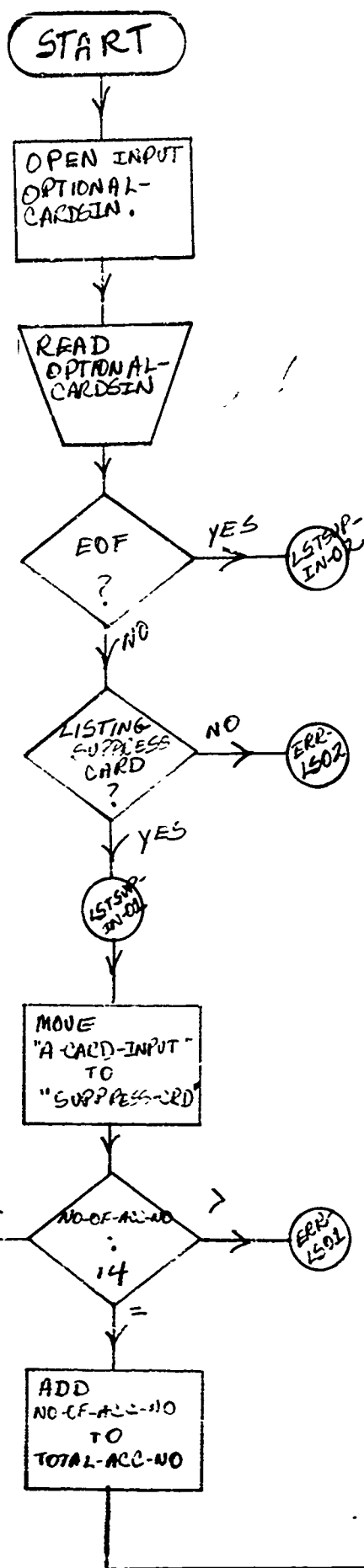

SAIUF FORM 2072-1 (Temp) Mar 68

OFFICE SYMBOL _____
SYSTEM CHART NO. _____
RUN NUMBER 27202
PAGE NUMBER 42 OF 42

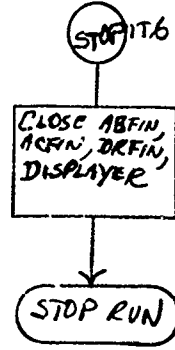

SMUFD FORM 2072-1 . . . ip: Mar 68

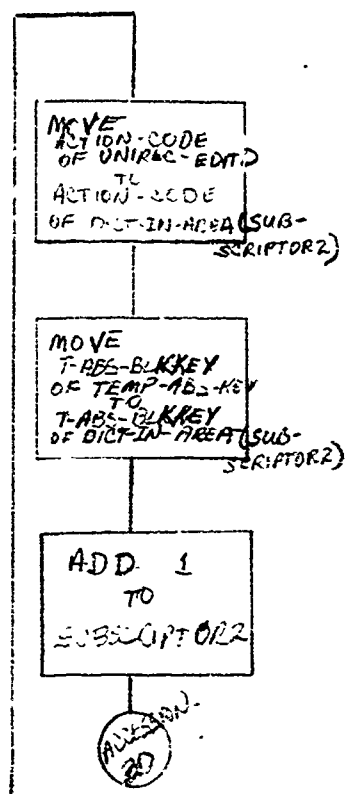
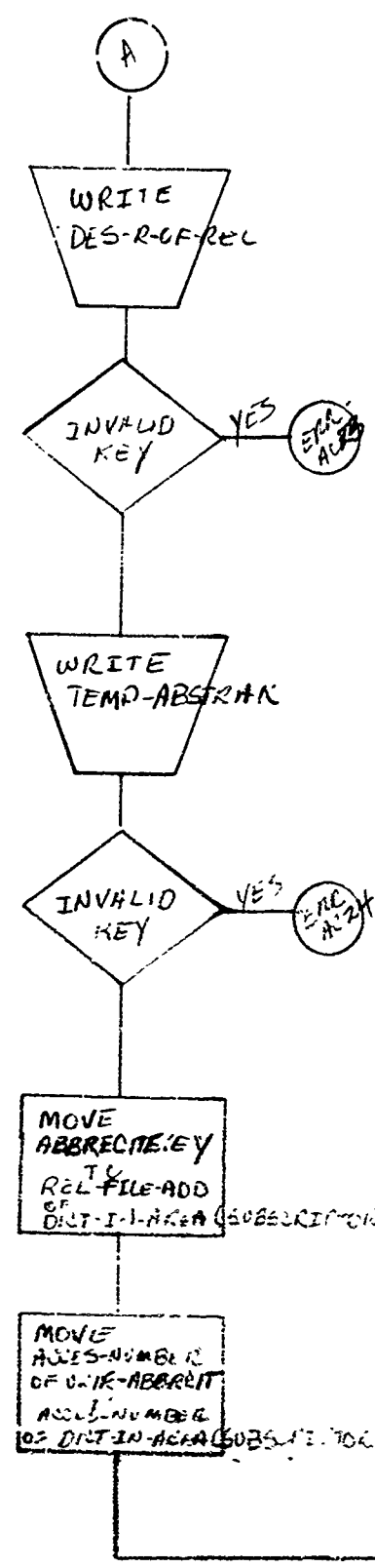
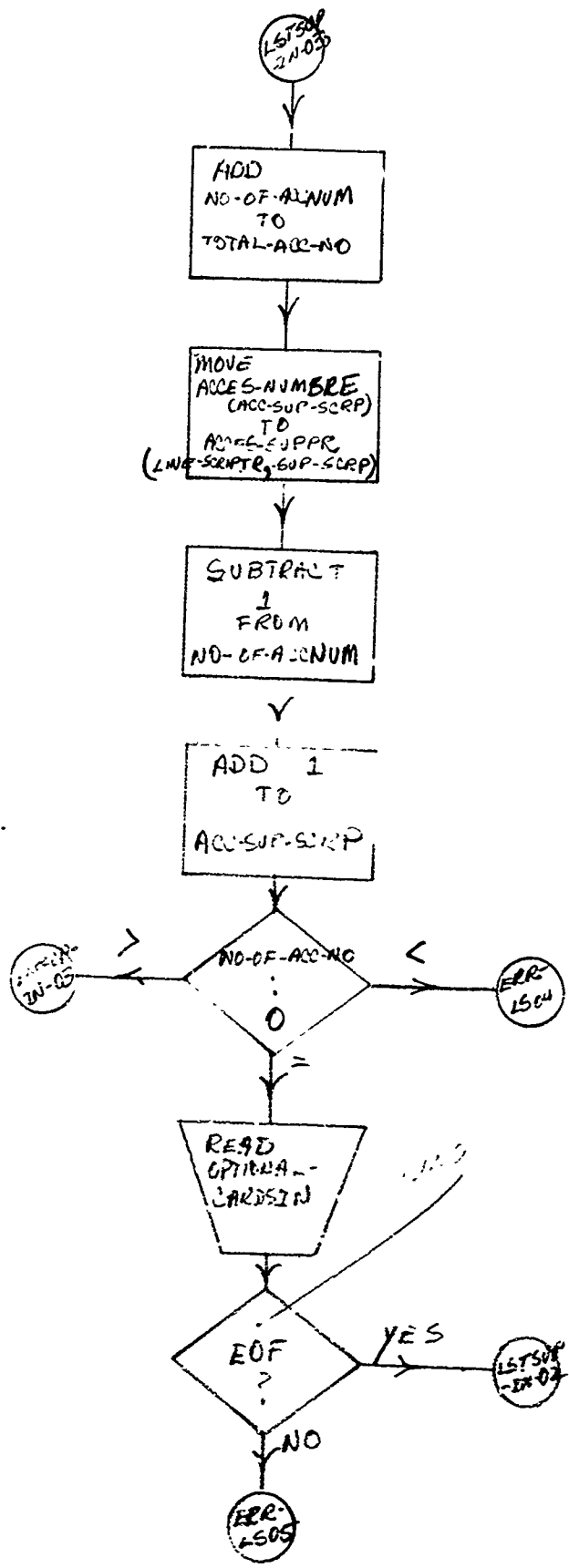

SMUFD FORM 2072-1 (Temp) Mar 68

ACCESSION
20

MOVE
 ACCESSION-NUMBER
 OF UNIR-ABSTRACT
 TO
 ACCESSION-NUMBER
 OF ABBREVIATION,
 ACCESSION-NUMBER
 OF DESK-OF-REC,
 ACCESSION-NUMBER
 OF TEMP-ABSTRACT

MOVE UNIR-ABSTRACT
 TO
 ABBREVIATION

MOVE CORRESPONDING
 UNIR-DESK-OF-REC
 TO
 DESK-OF-REC

MOVE CORRESPONDING
 UNIR-ABSTRACT
 TO
 TEMP-ABSTRACT

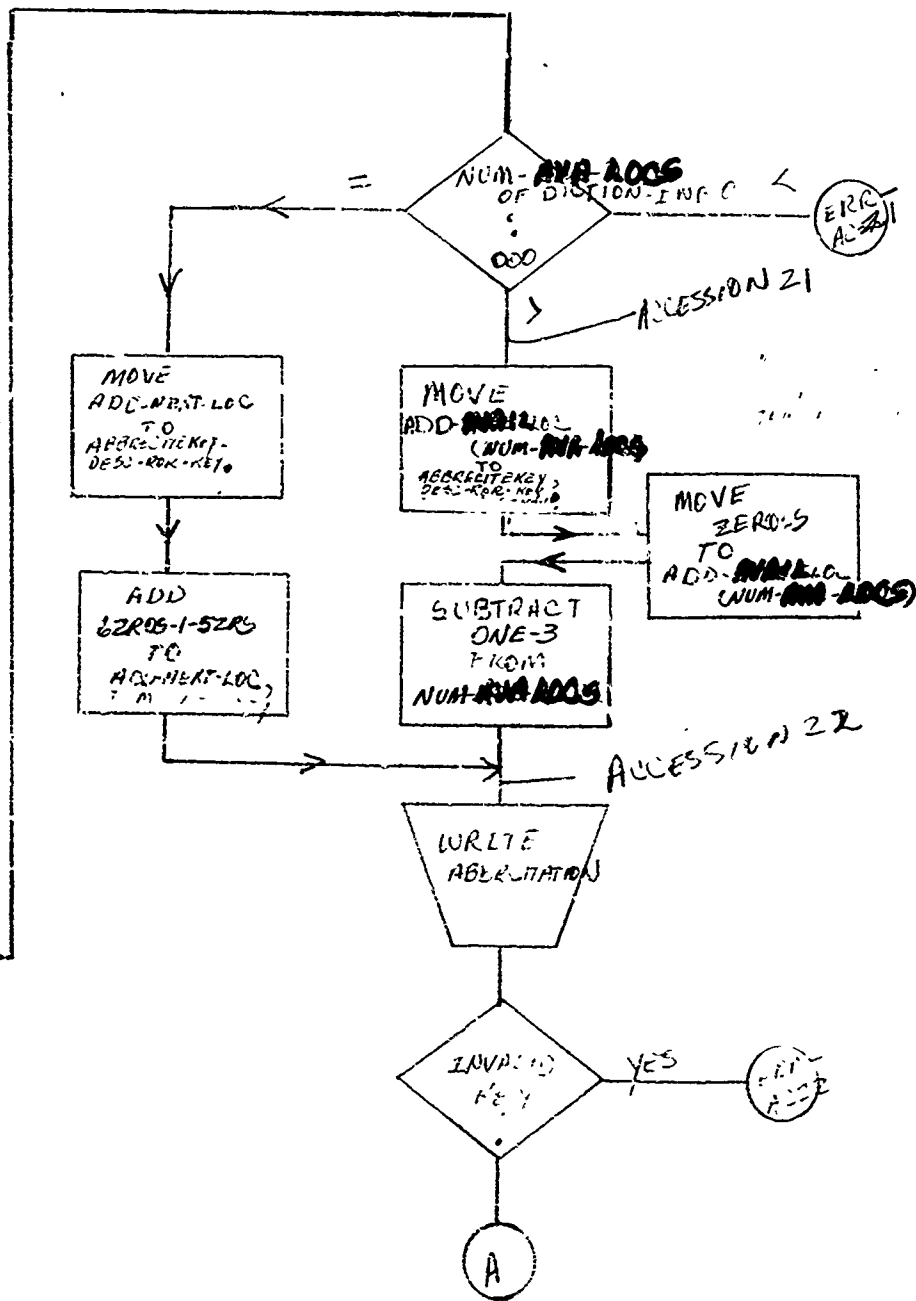

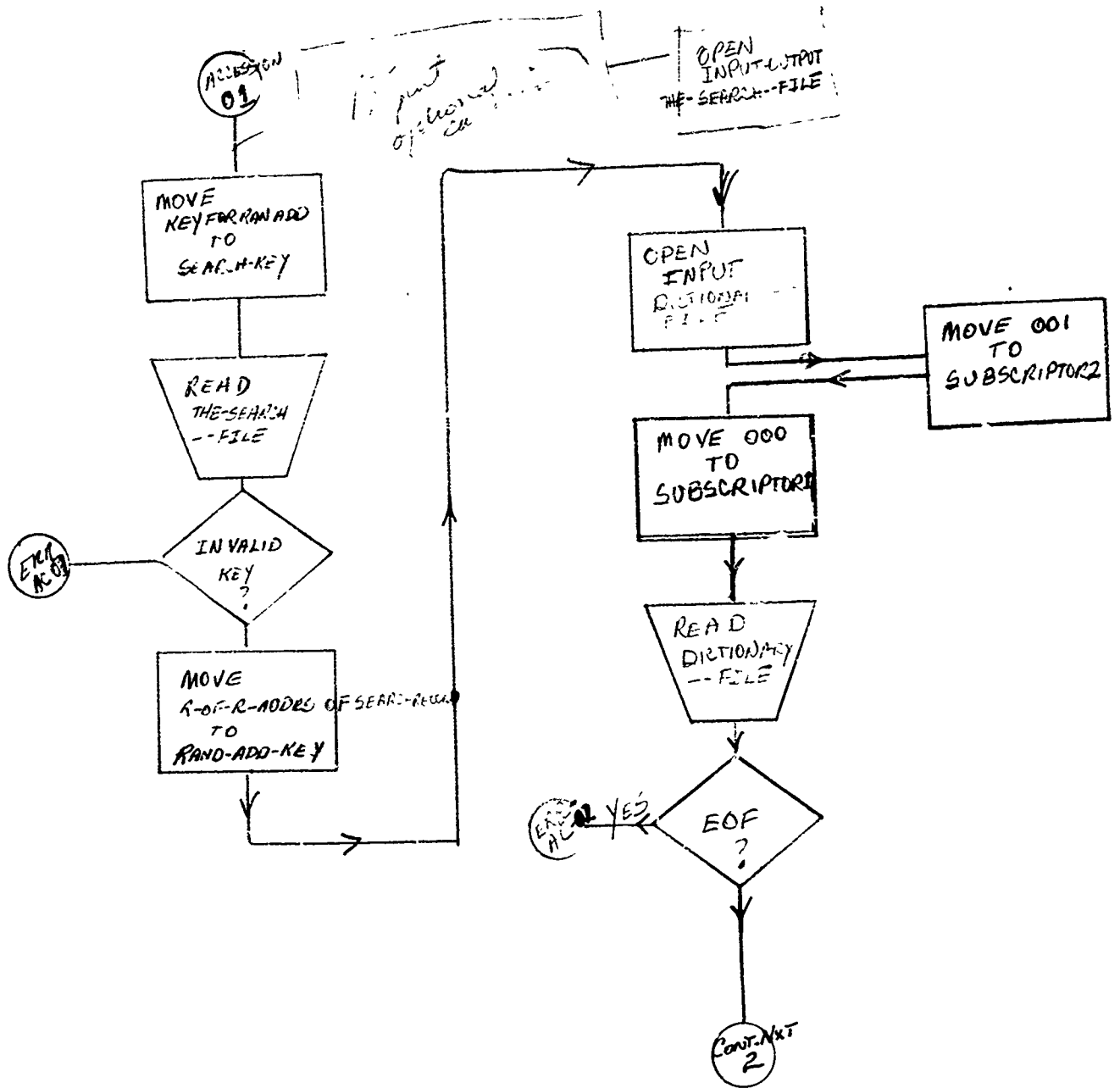

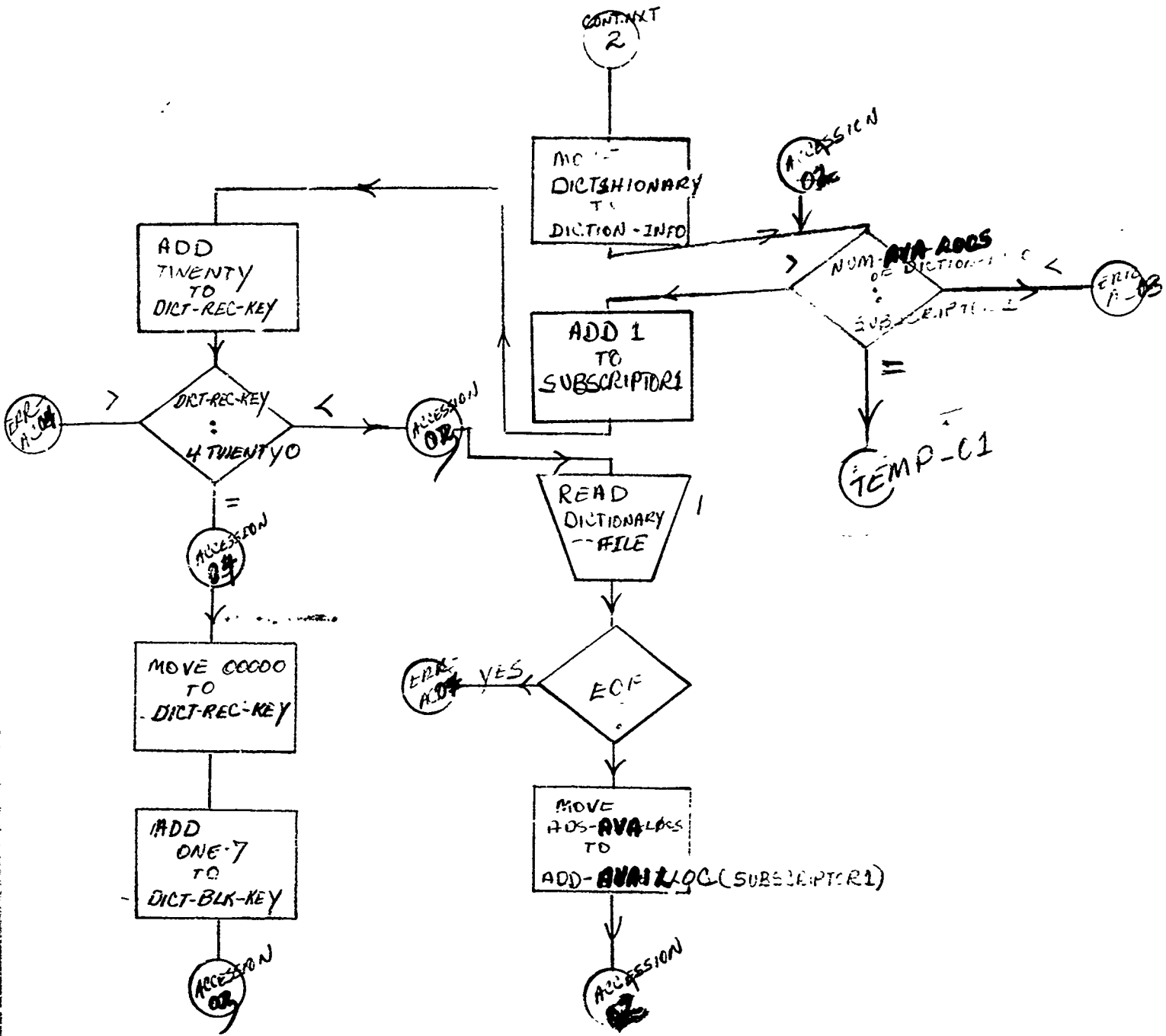

SMUFD FC

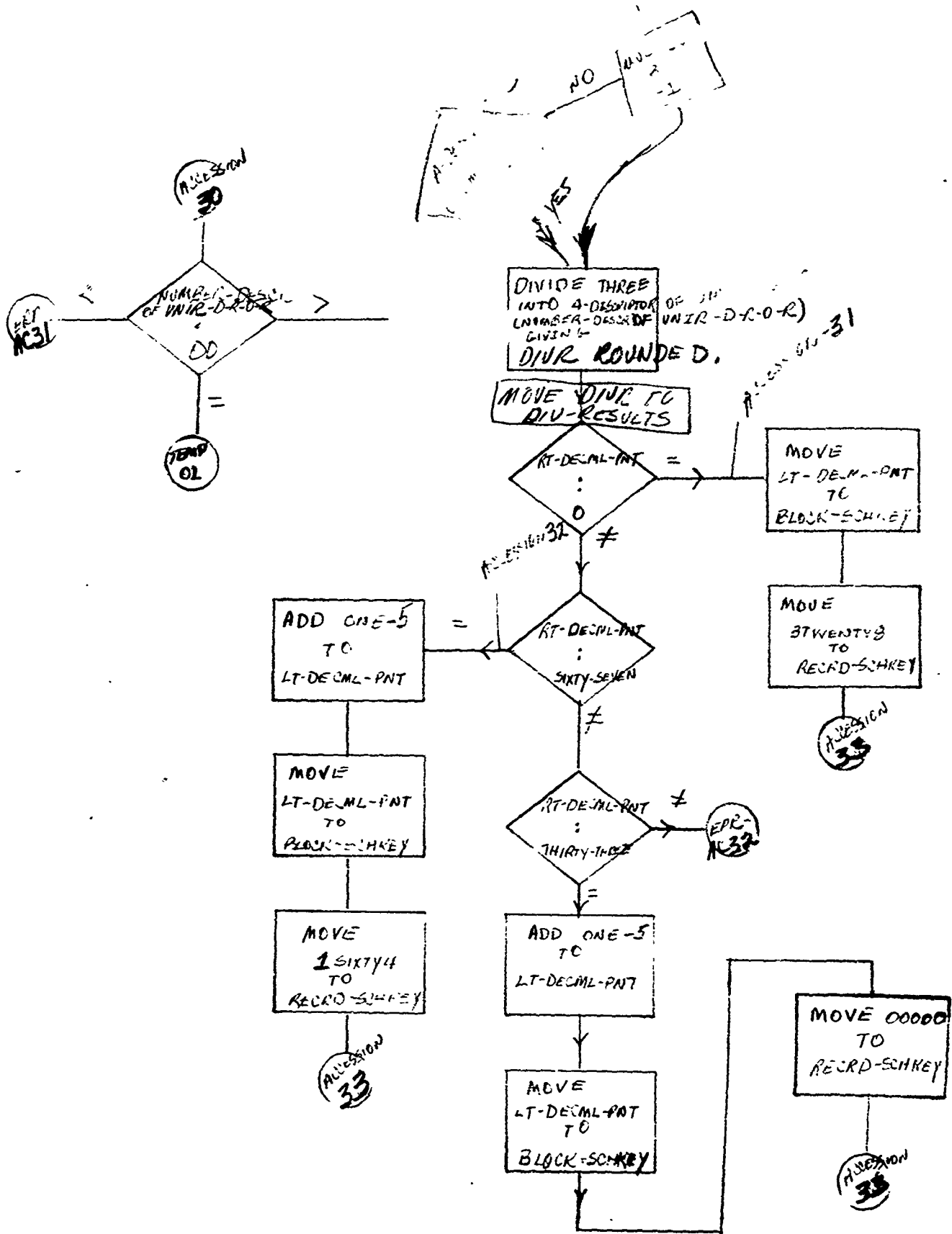

SMUFD FORM 2072-1 (Temp) Mar 68

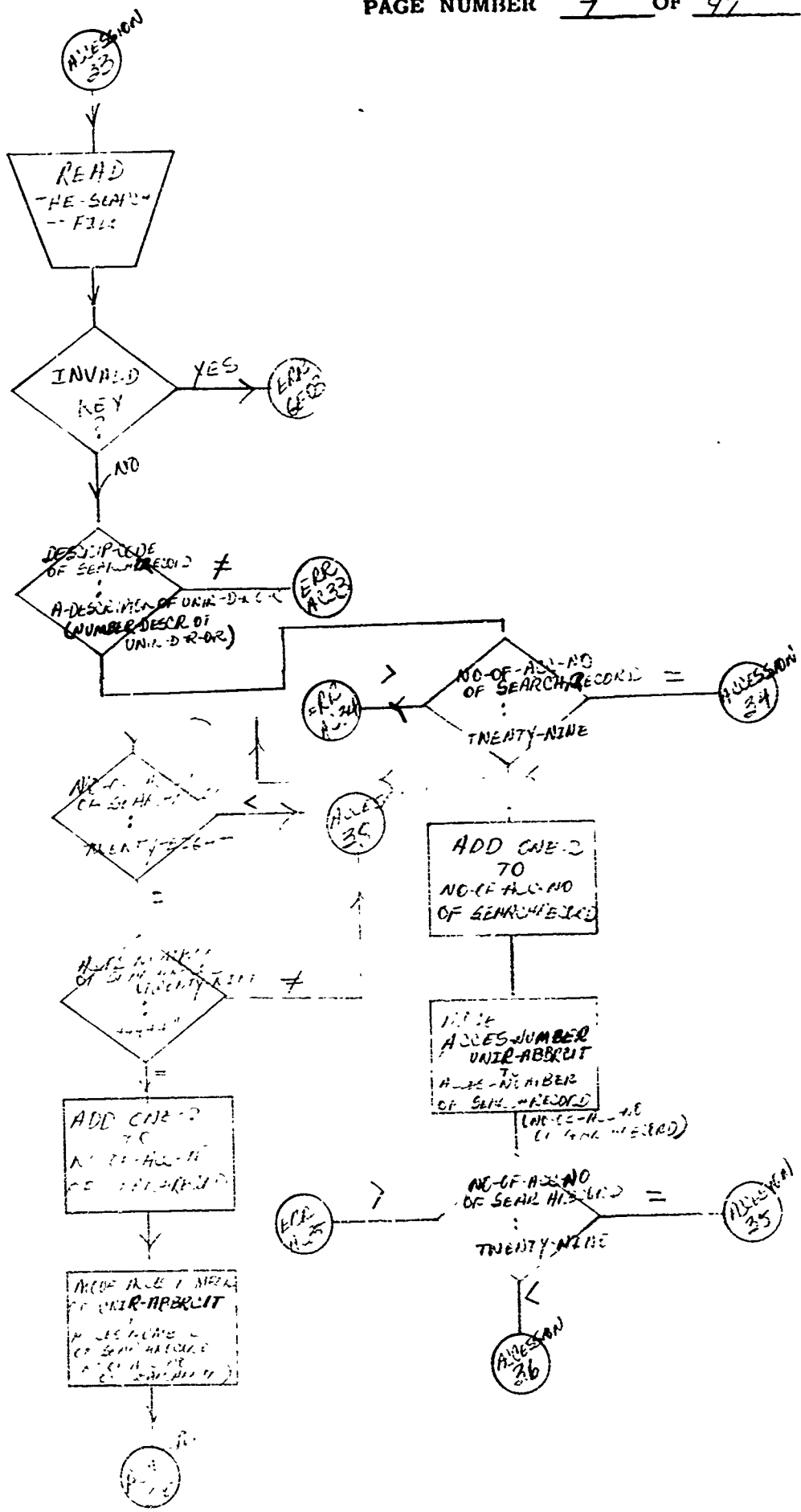

SMUFD FORM 2072-1 (Temp) Mar 68

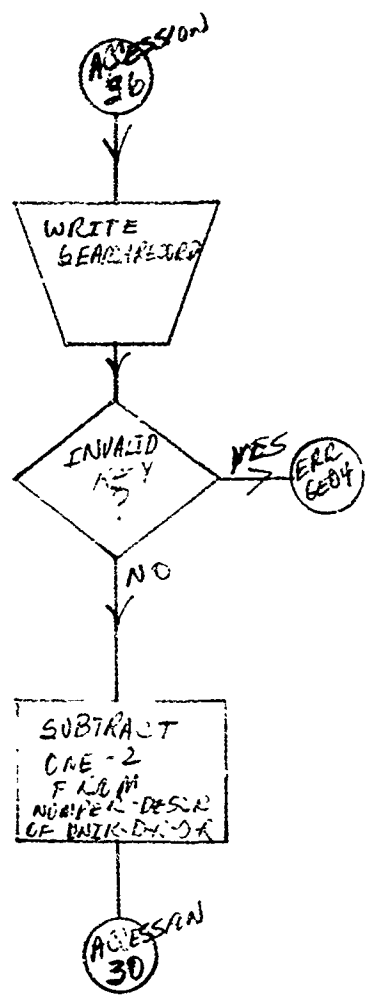
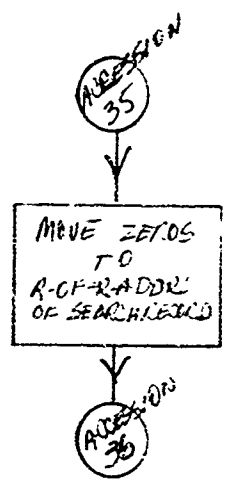
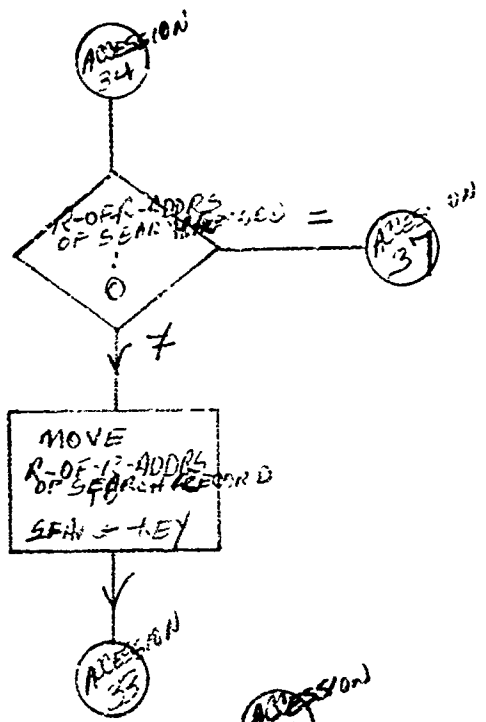
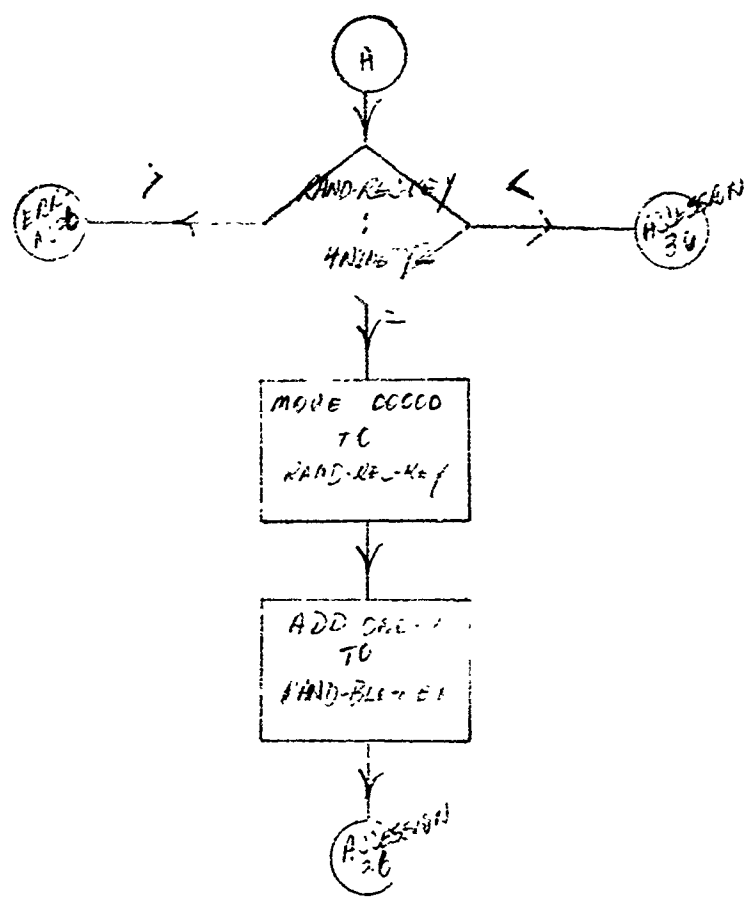

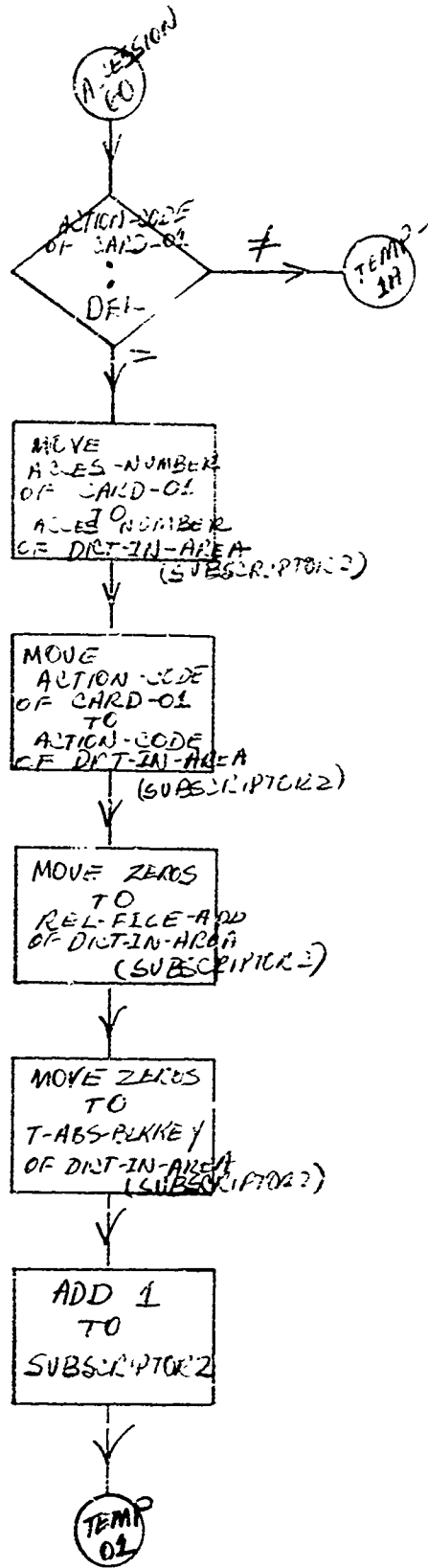
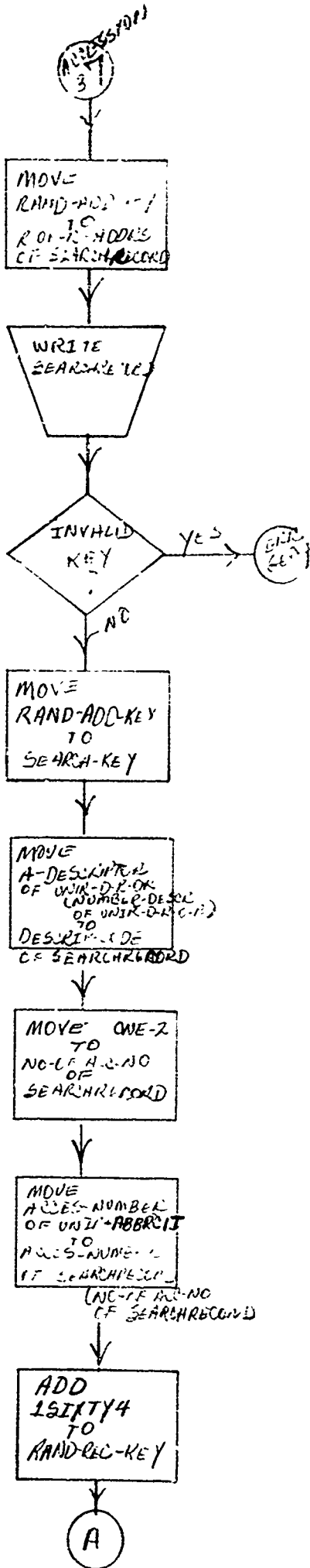

OFFICE SYMBOL _____
 SYSTEM CHART NO. _____
 RUN NUMBER FR05
 PAGE NUMBER 0047

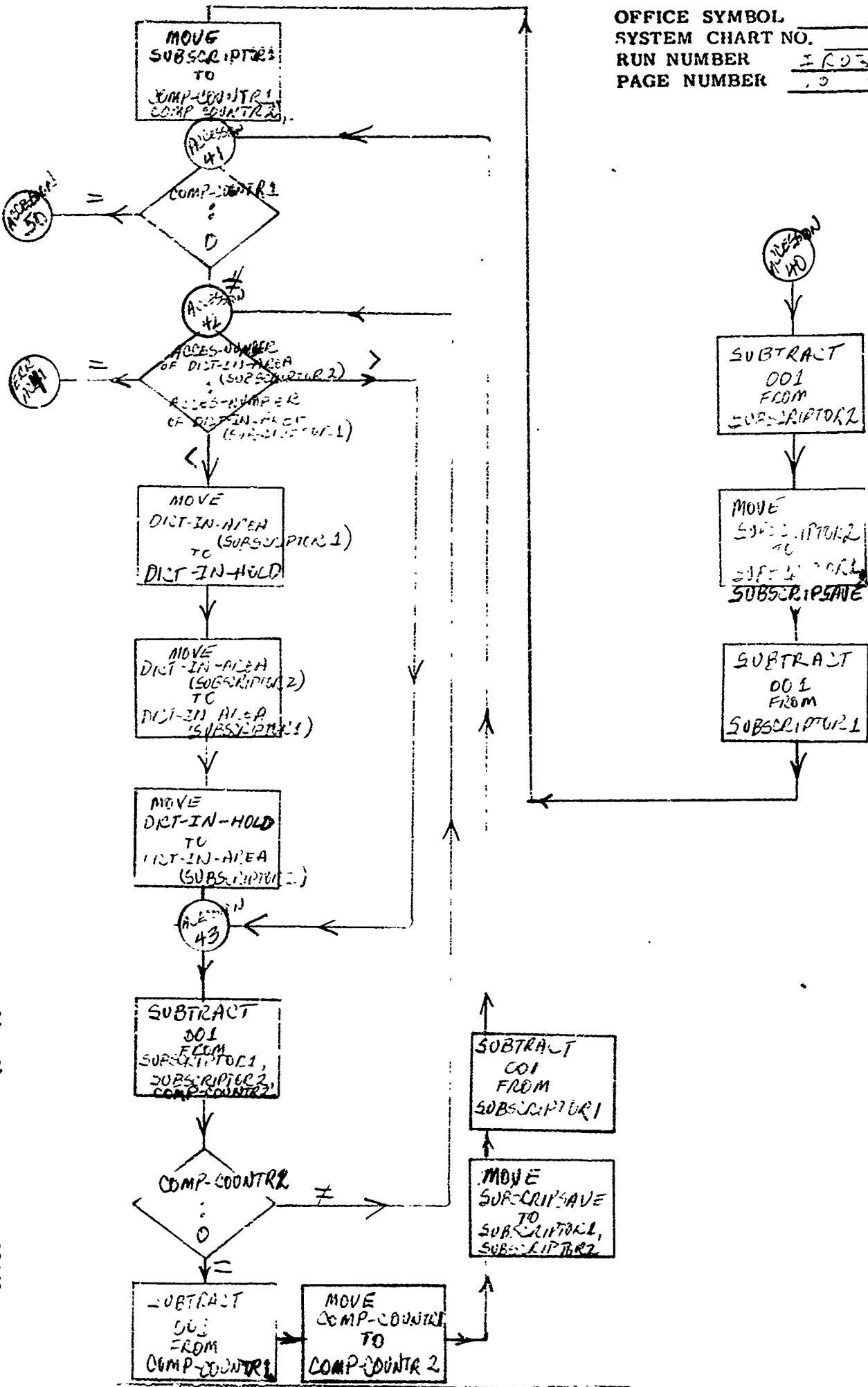

SMUFD FORM 2072-1 (Temp) Mar '68

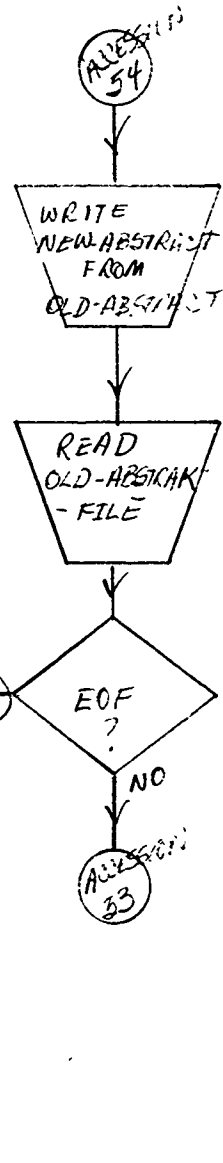
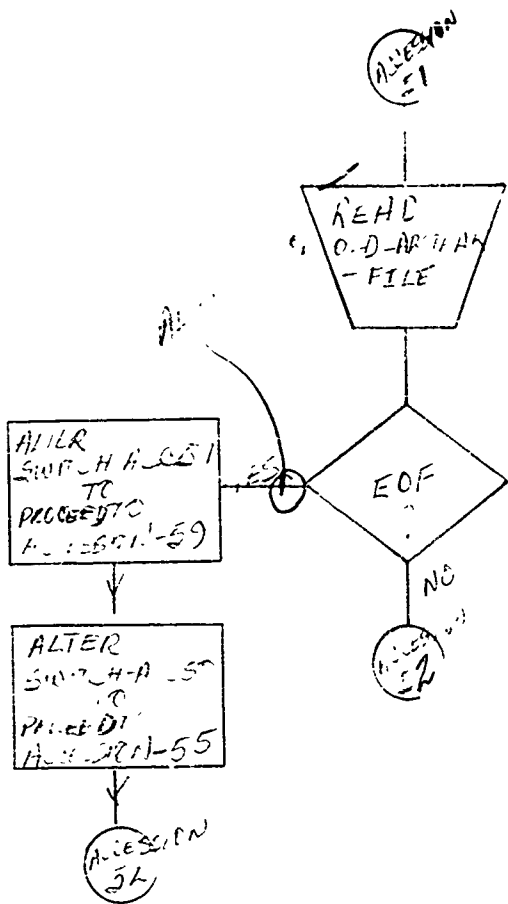
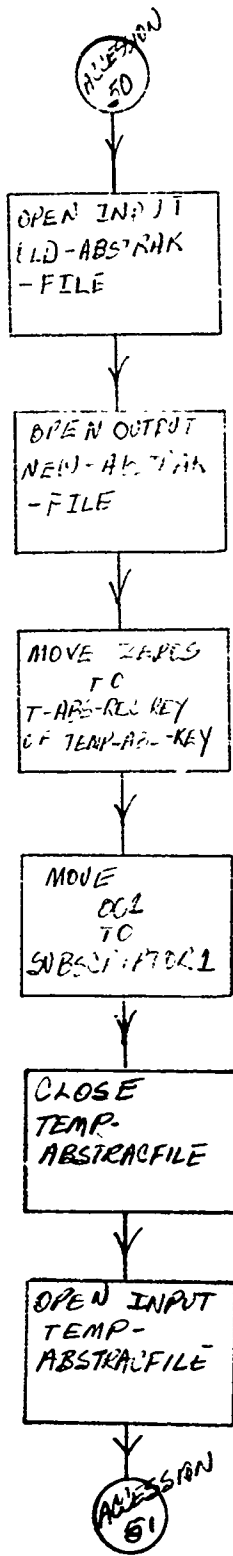

SMUFD FORM 2072-1 (Temp) Mar 68

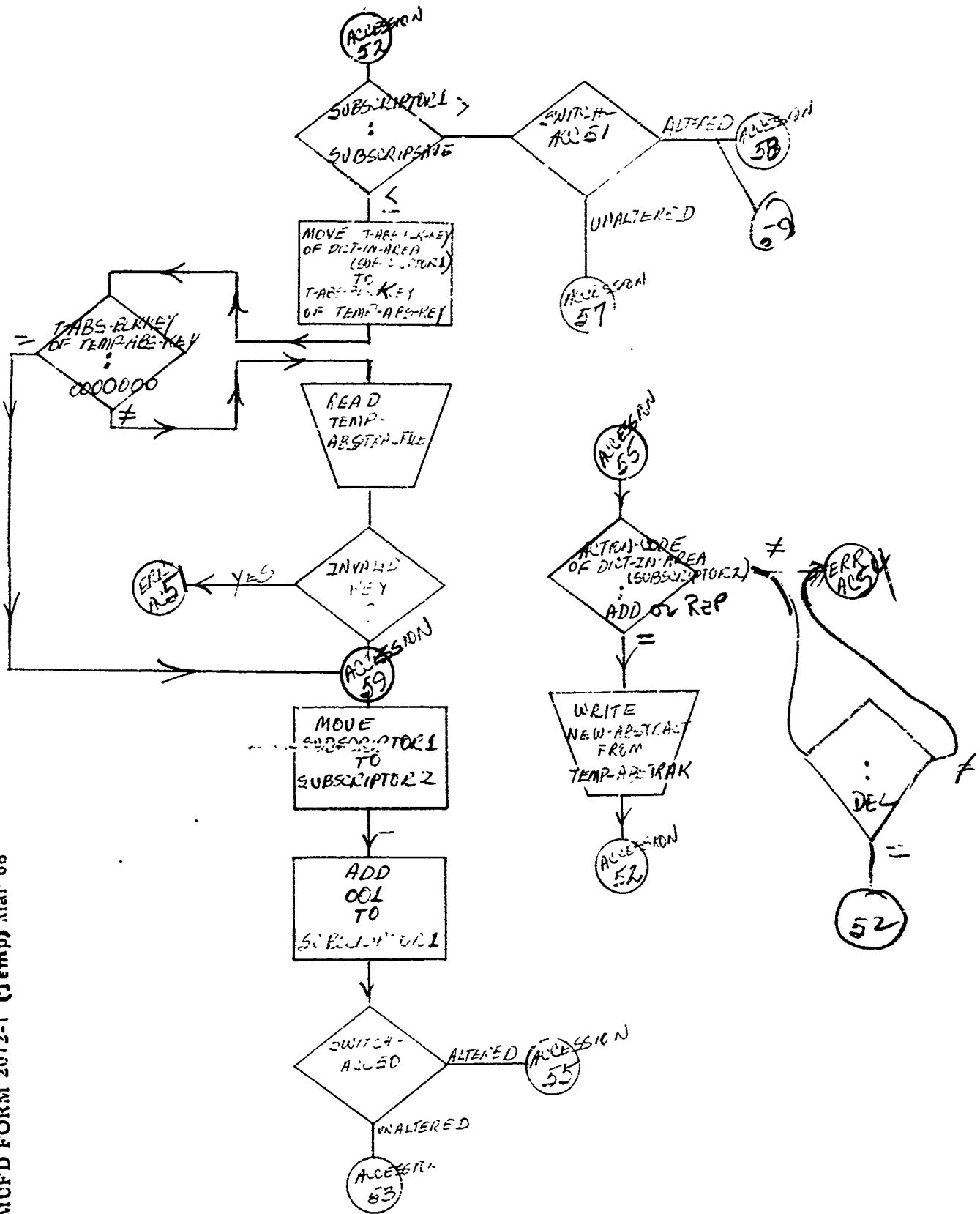

SMUFD FORM 2072-1 (Temp) Mar 68

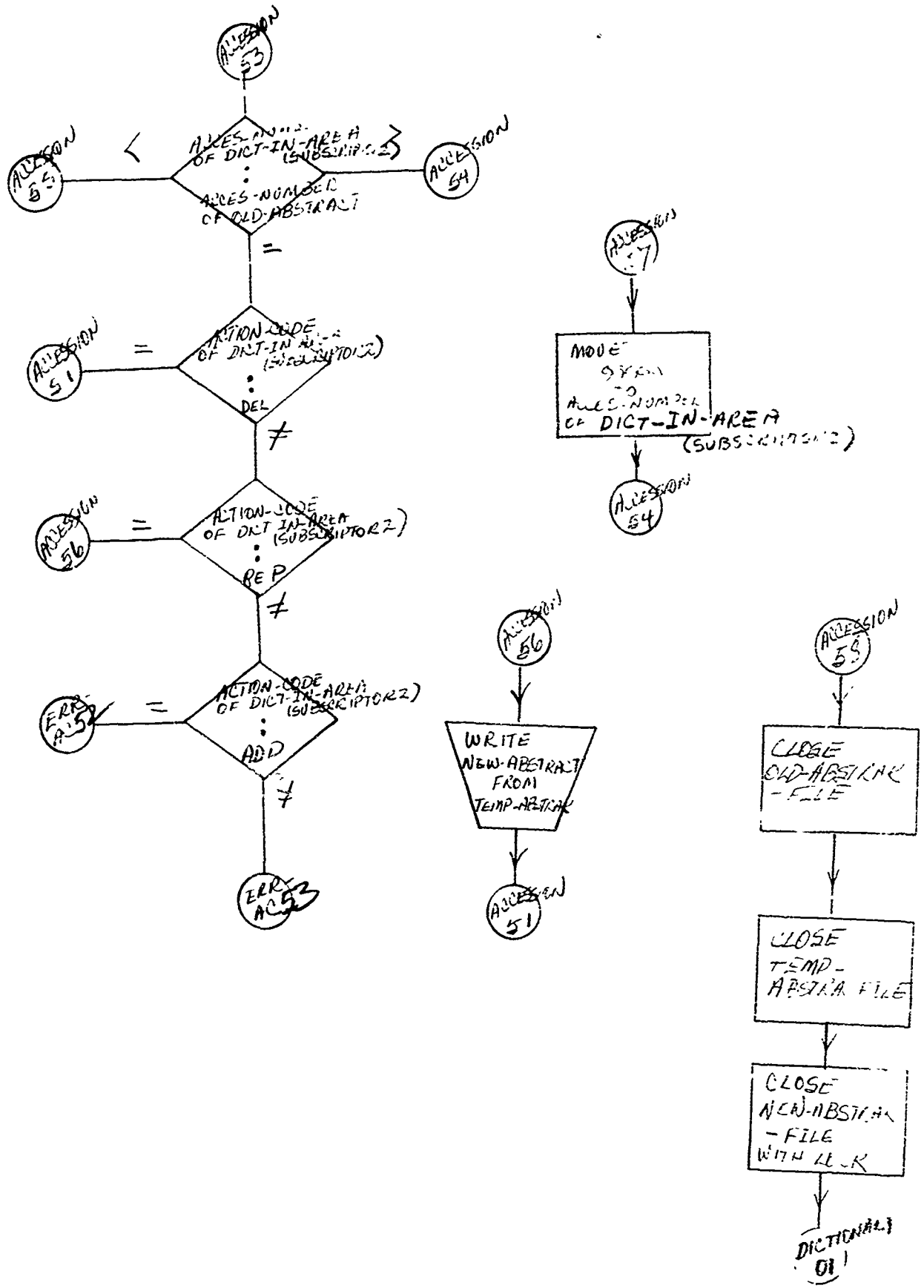

SMUFD FORM 2072-1 (Temp) Mar 68

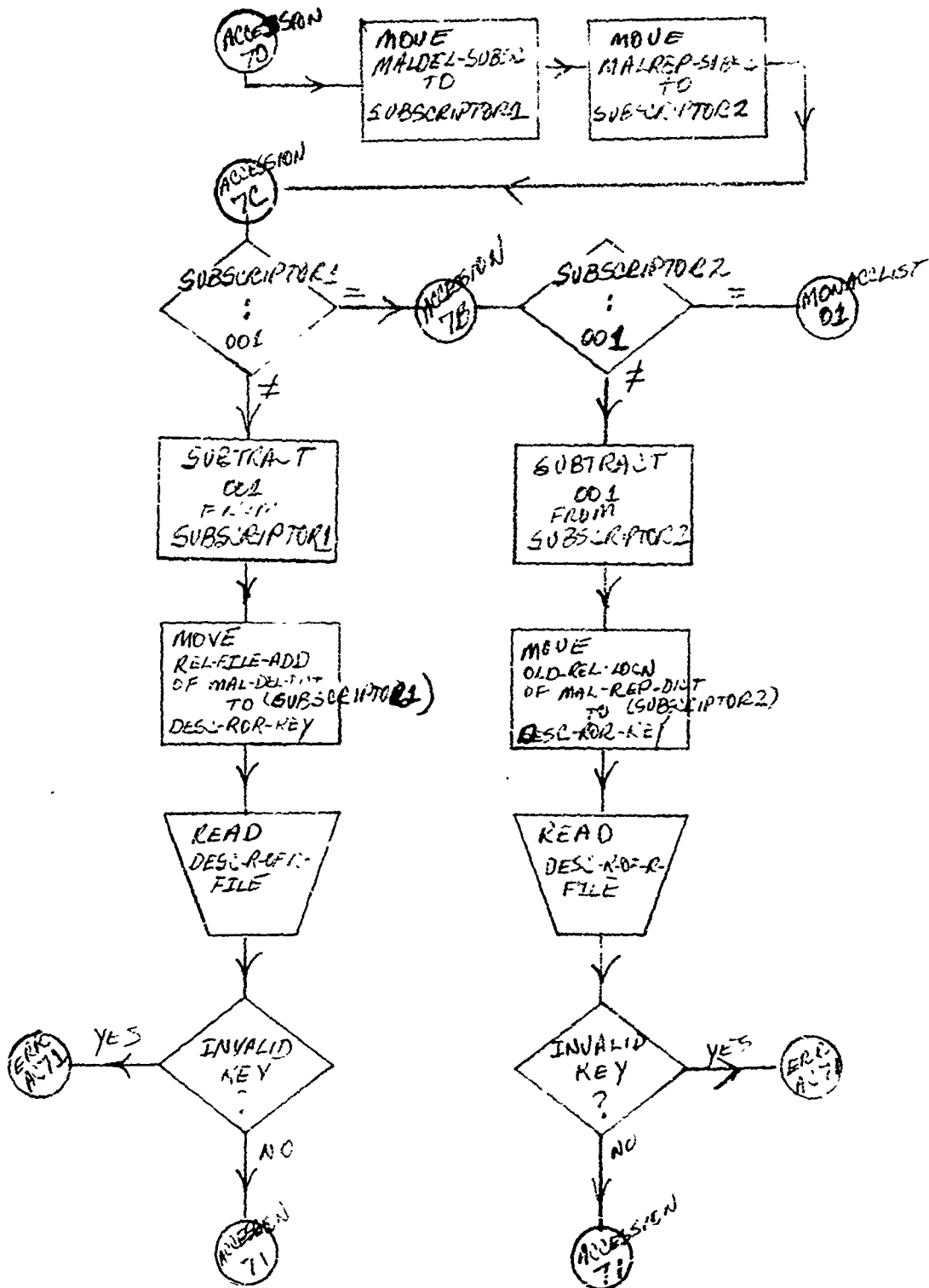

SMUFD FORM 2072-1 (Temp) Mar 68

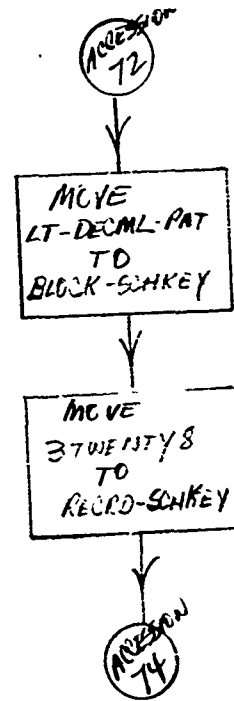
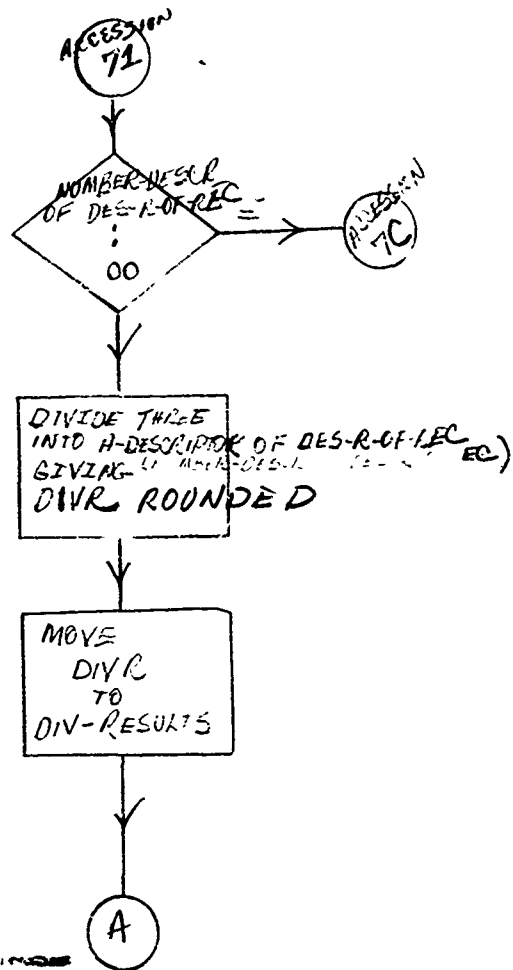
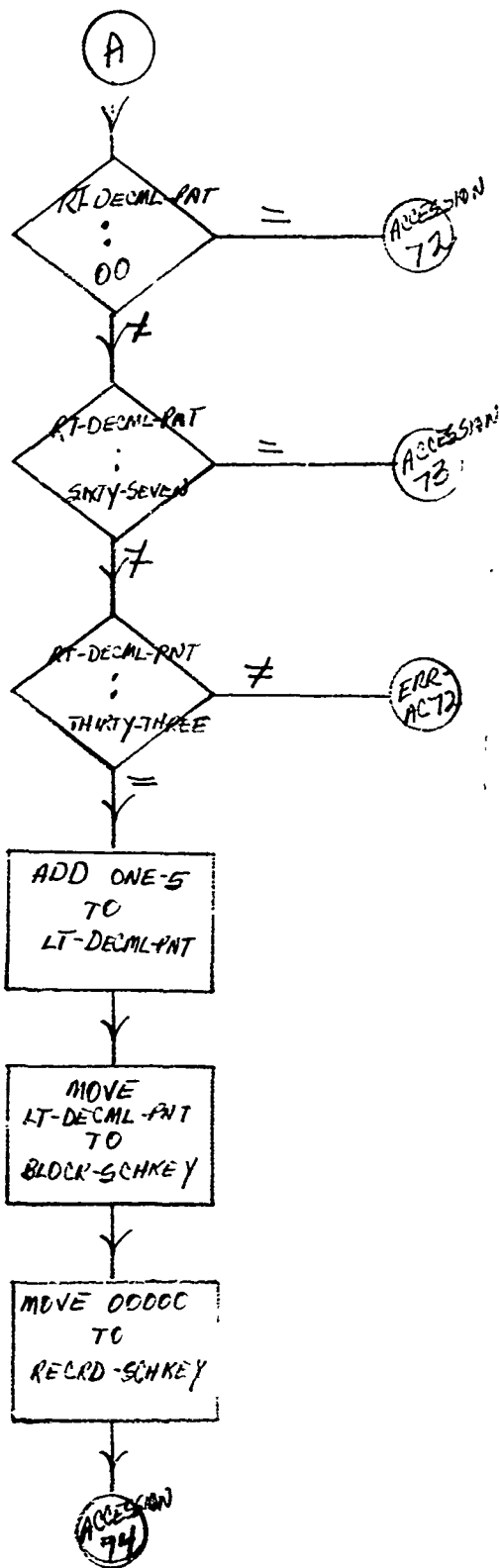

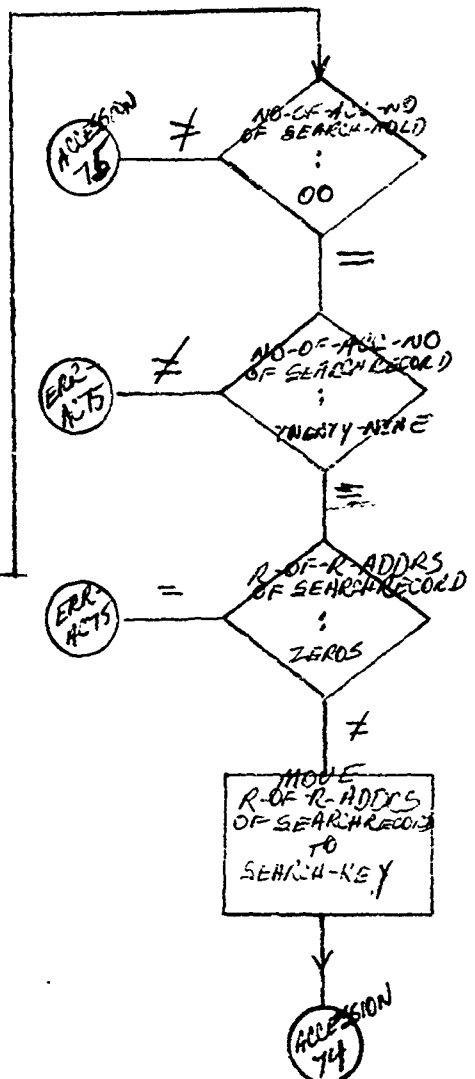
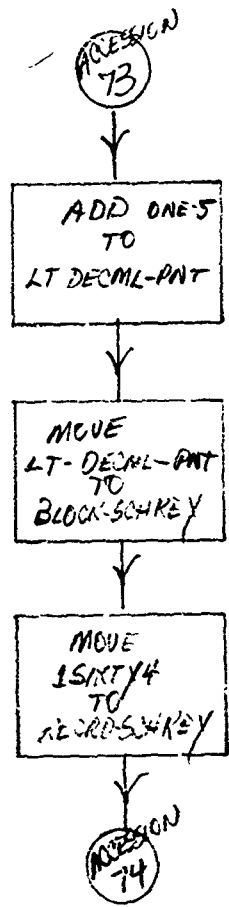
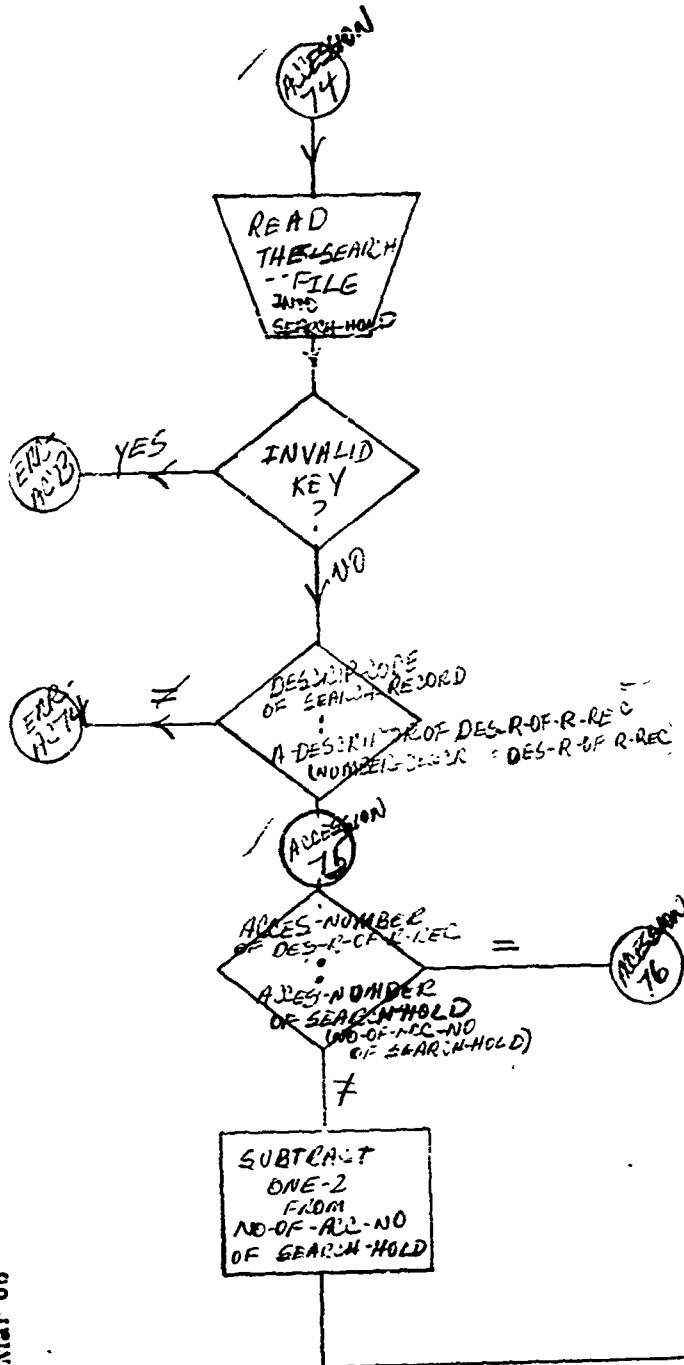

SMUFD FORM 2072-1 (Temp) Mar 68

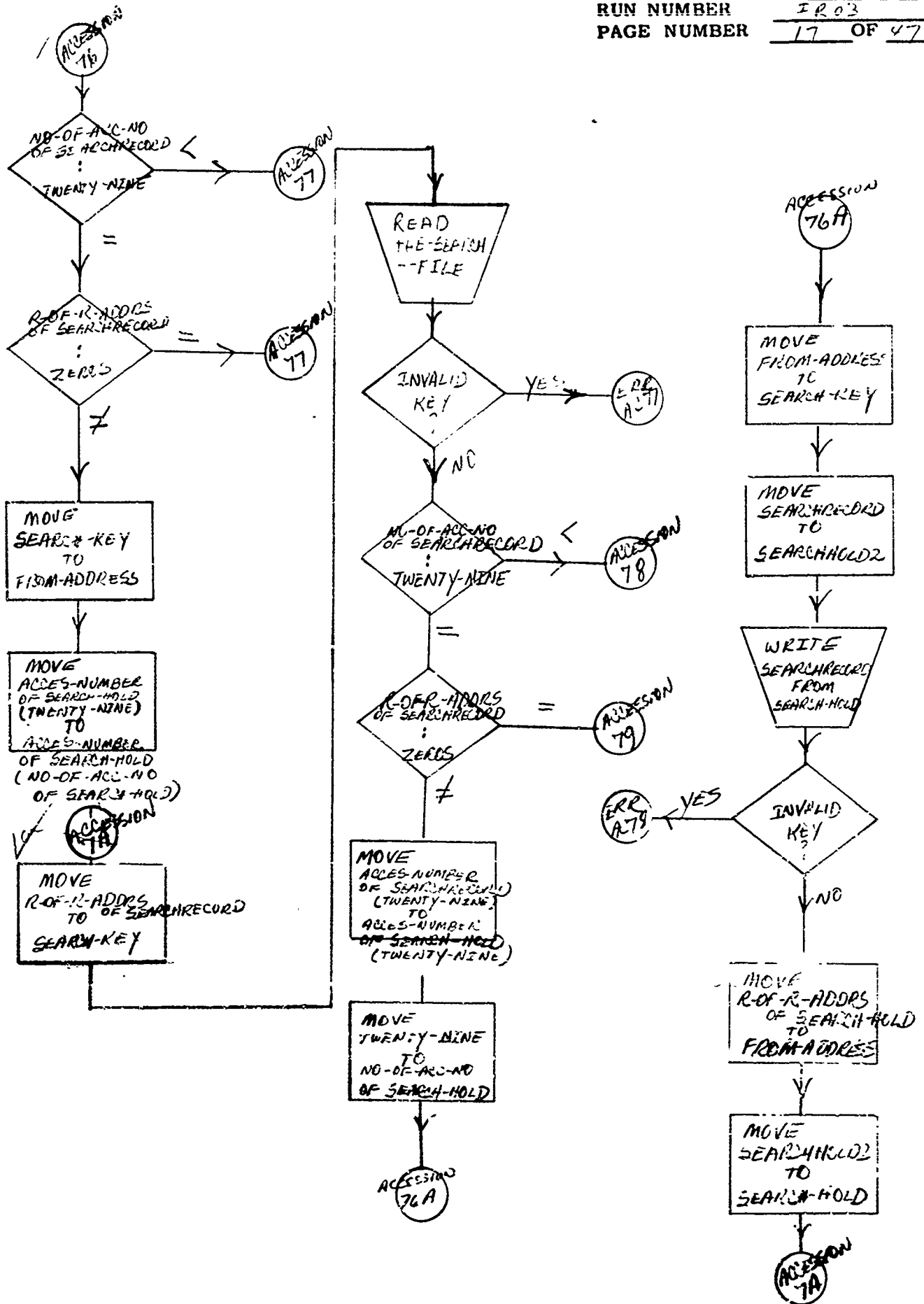

SIUFD FORM 2072-1 (Temp) Mar 68

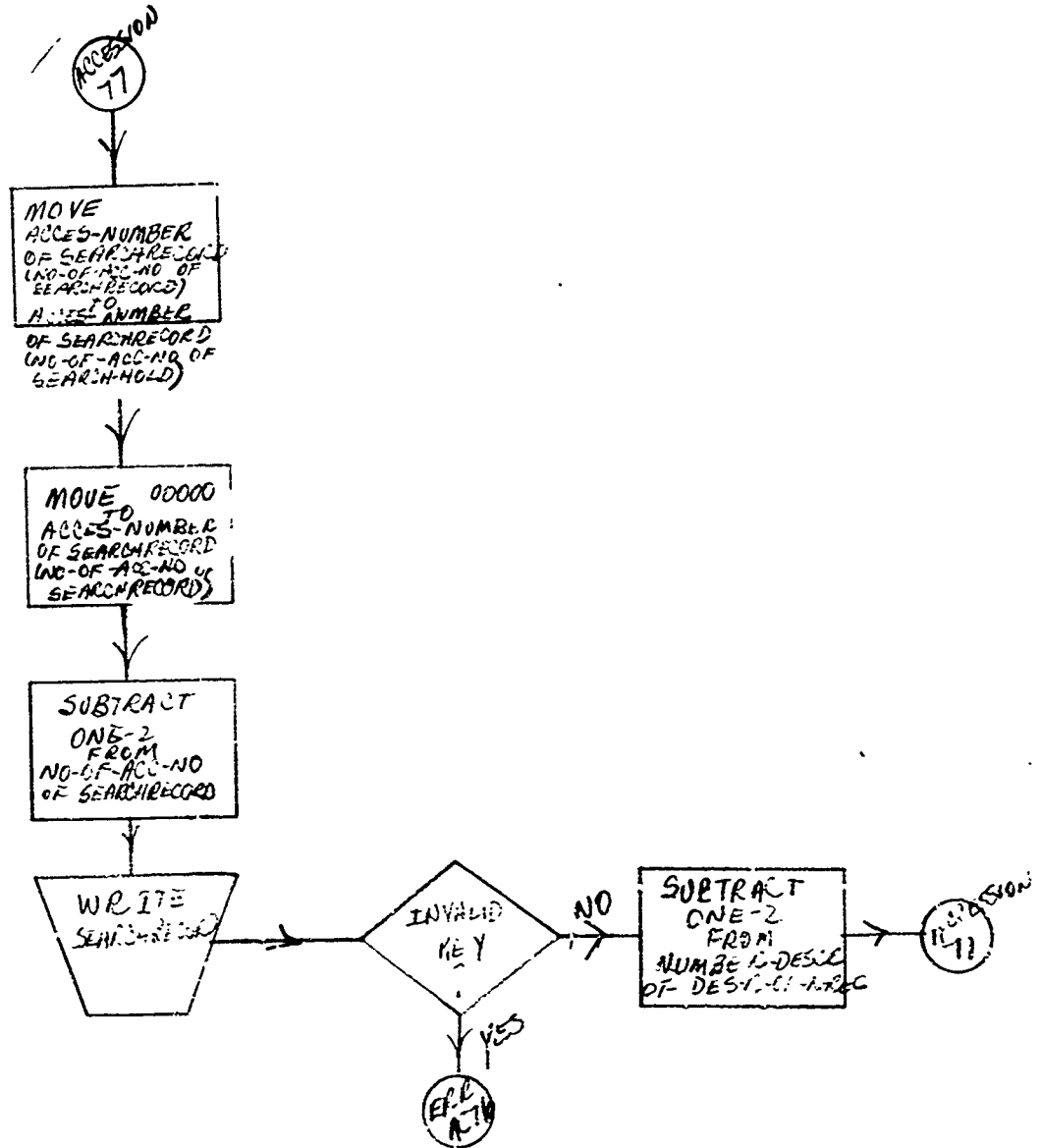

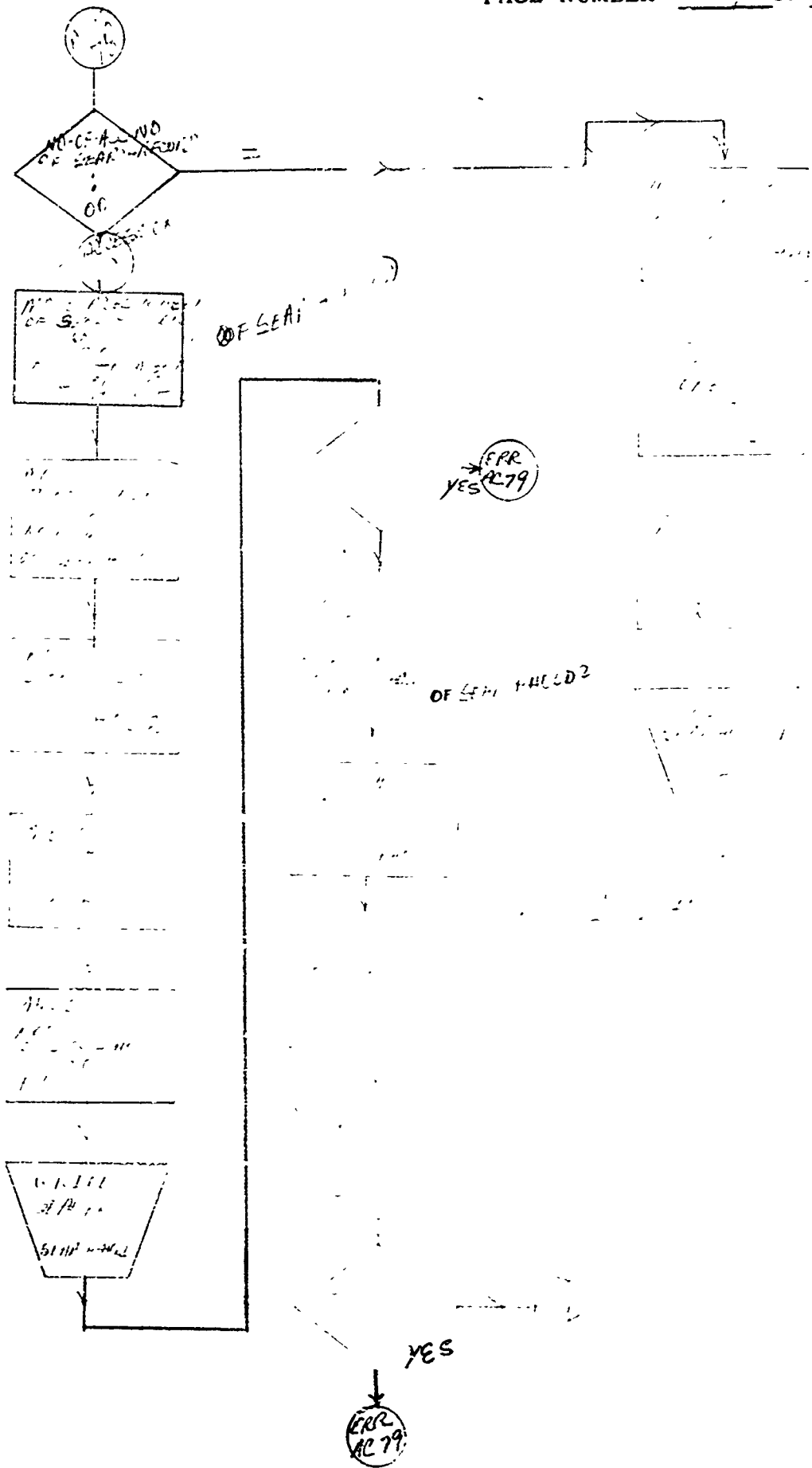

PRIMARY
 (1)

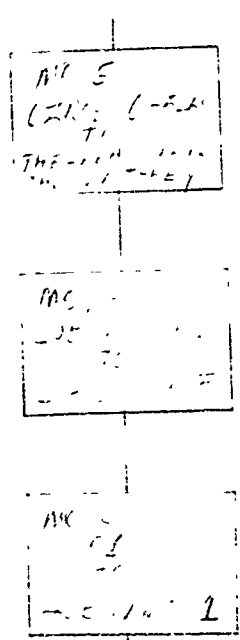

CF

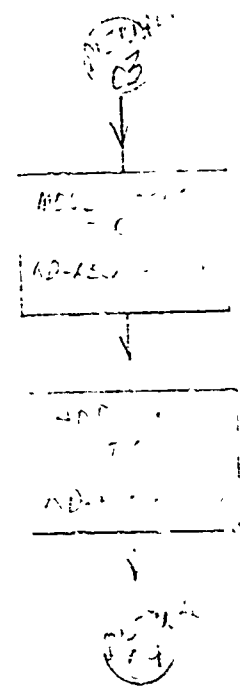

CONF

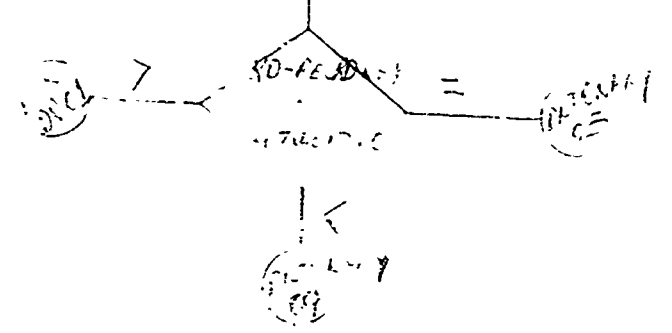
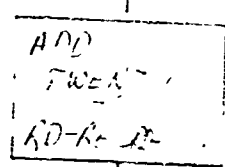
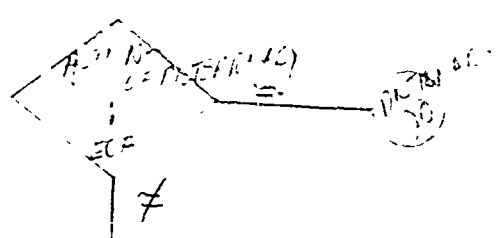
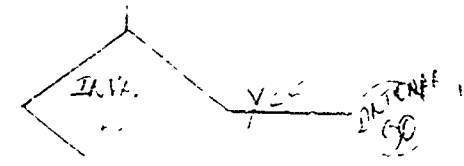
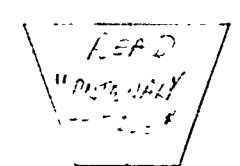
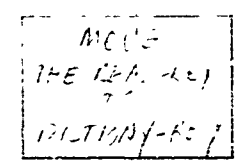

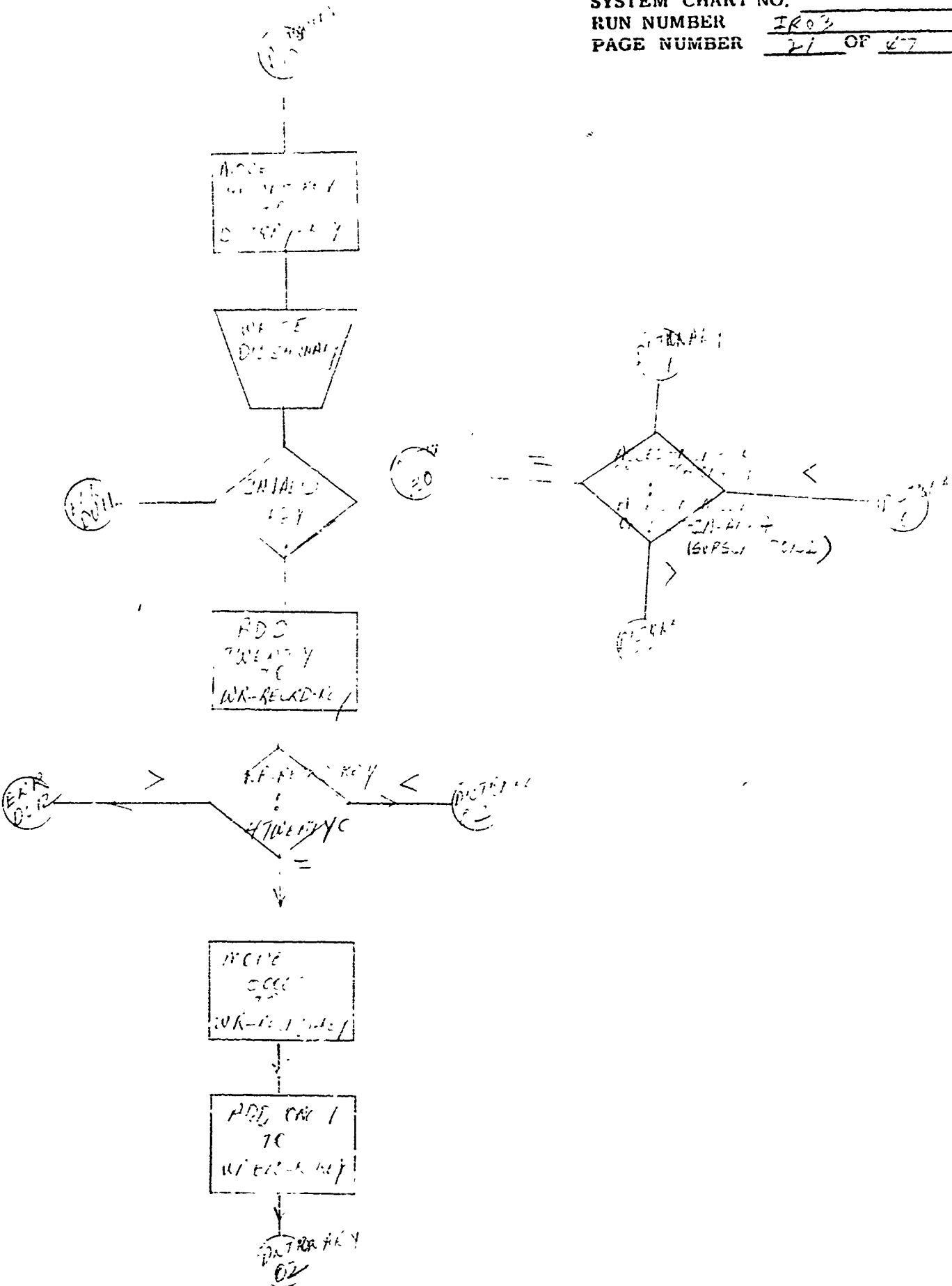

SMUFD FORM 2072-1 (Form 3) Mar 68

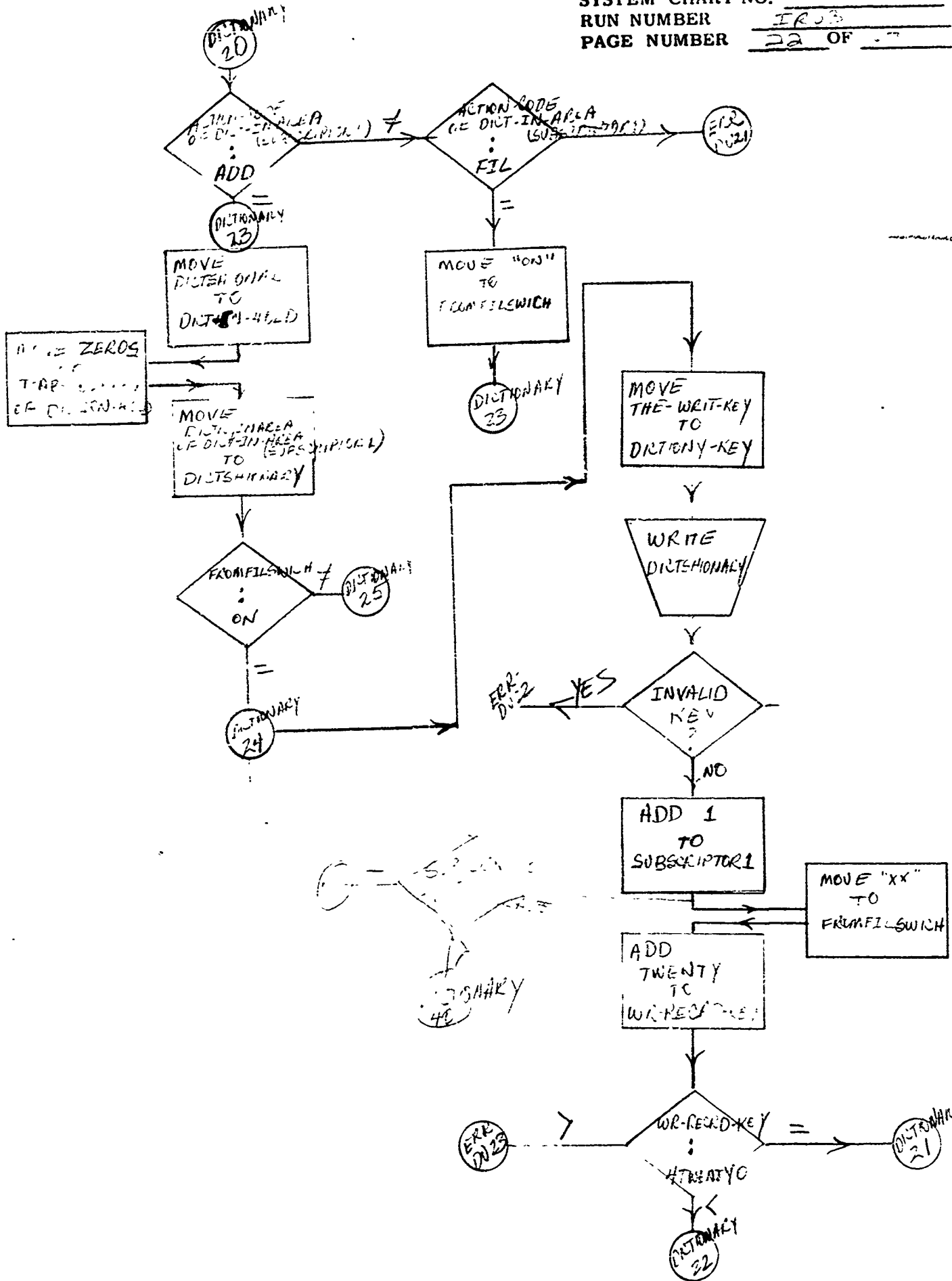

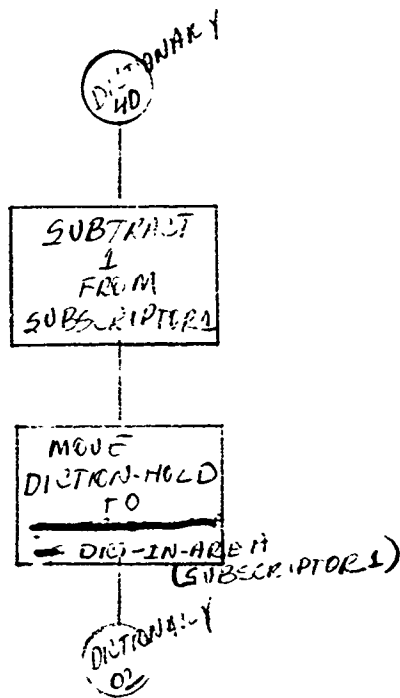
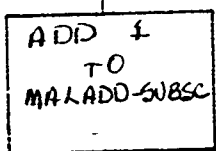
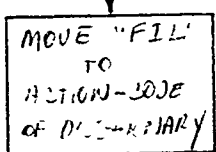
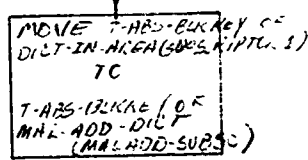
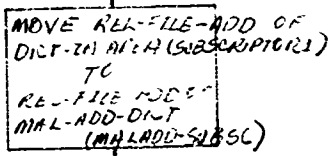
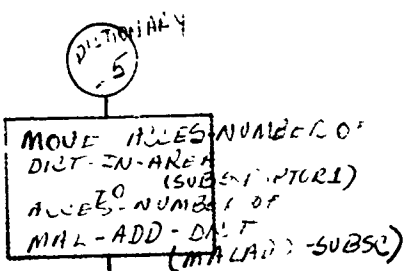
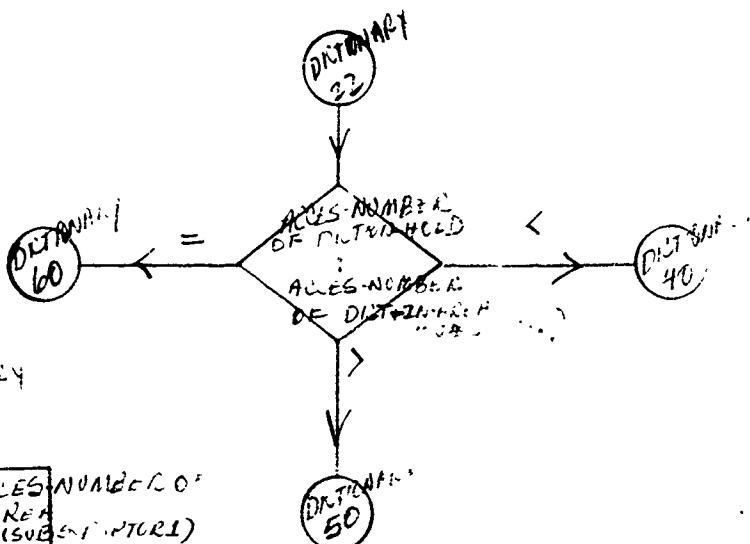
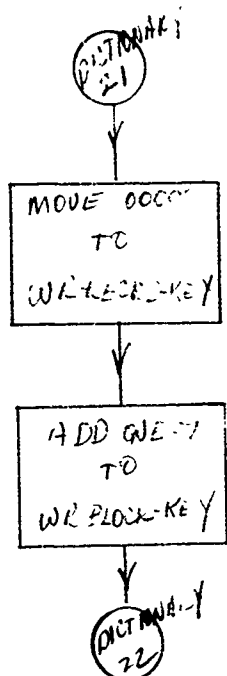

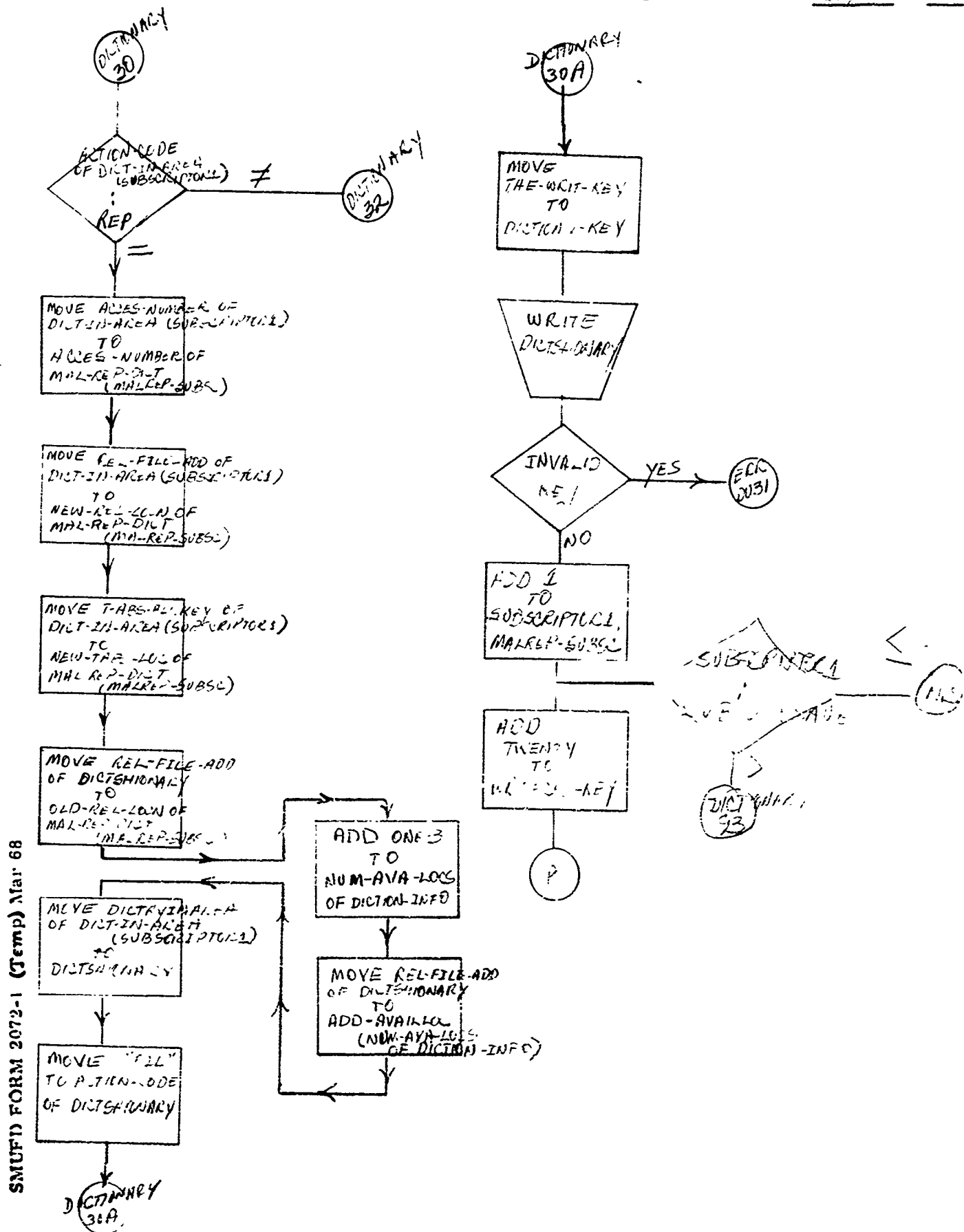

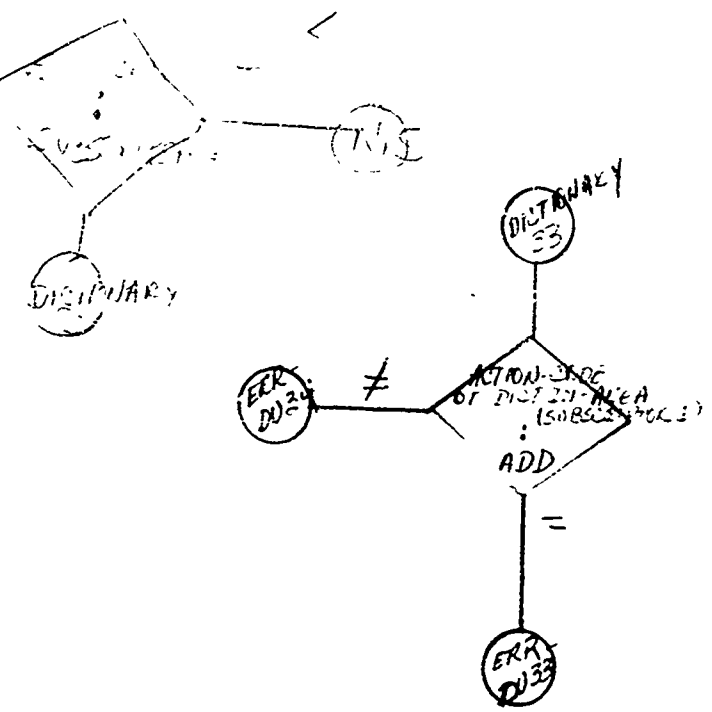
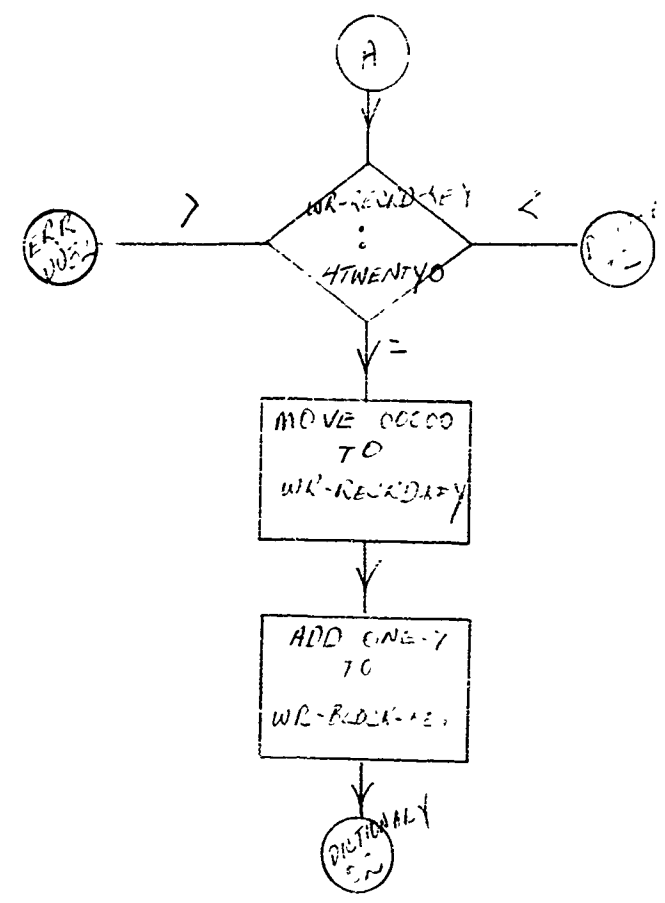
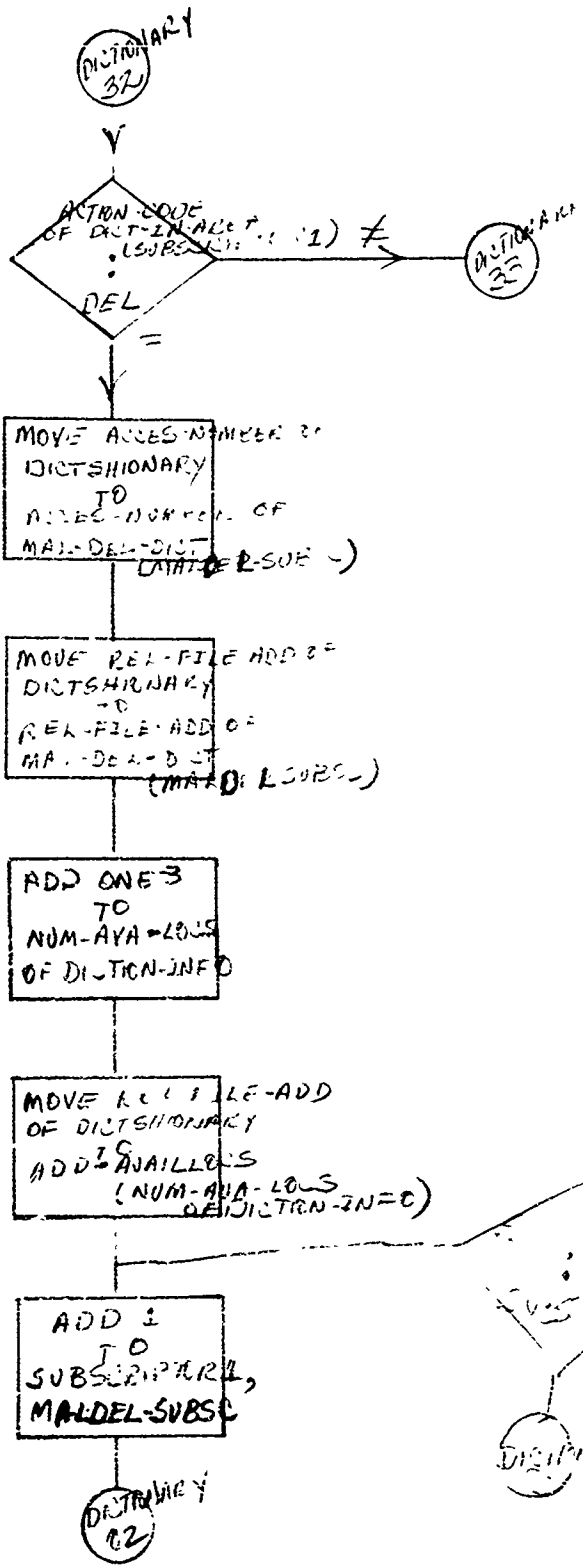

SMUFD FORM 2072-1 (Temp) Mar 68

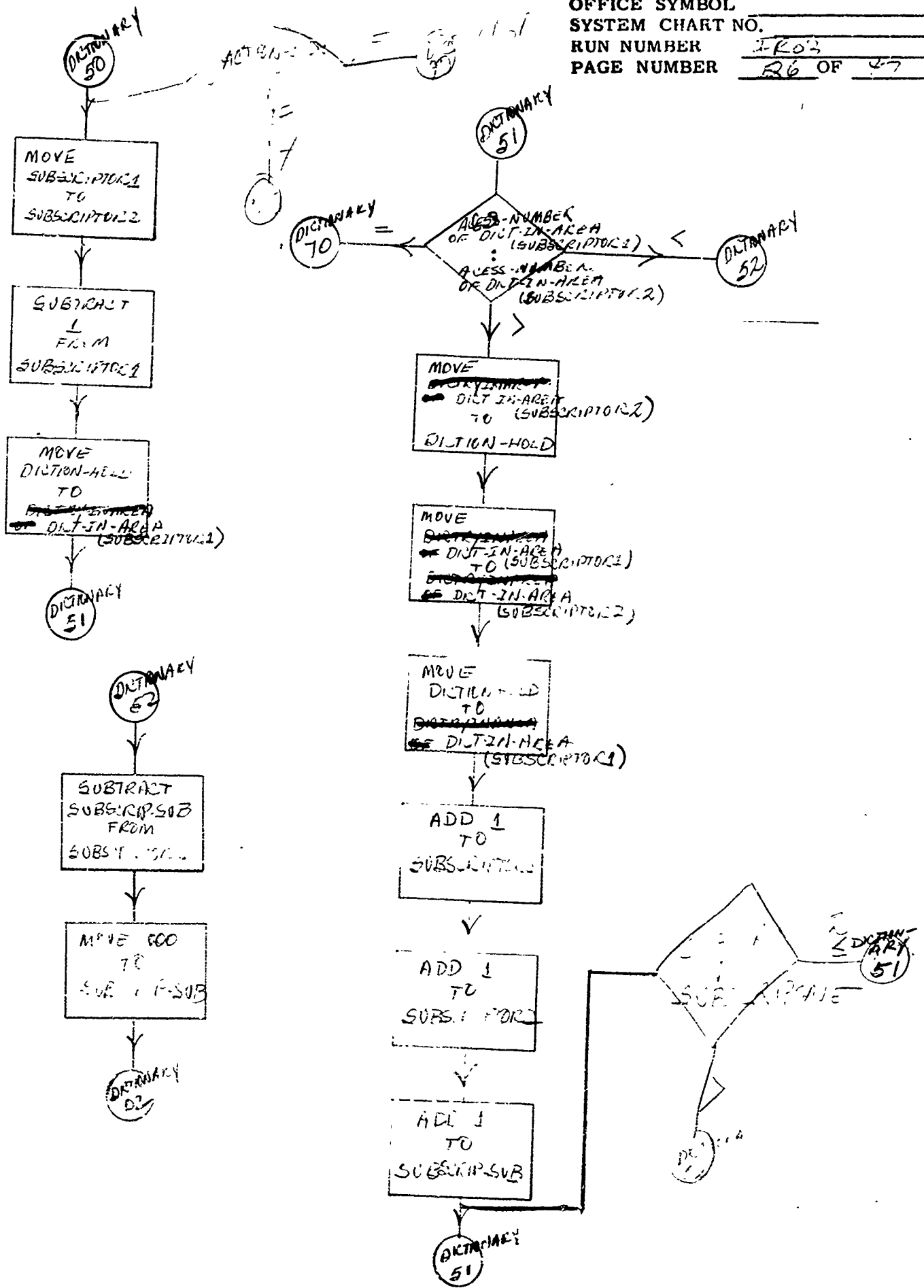

SMUFD FORM 2072-1 (Temp) Mar 68

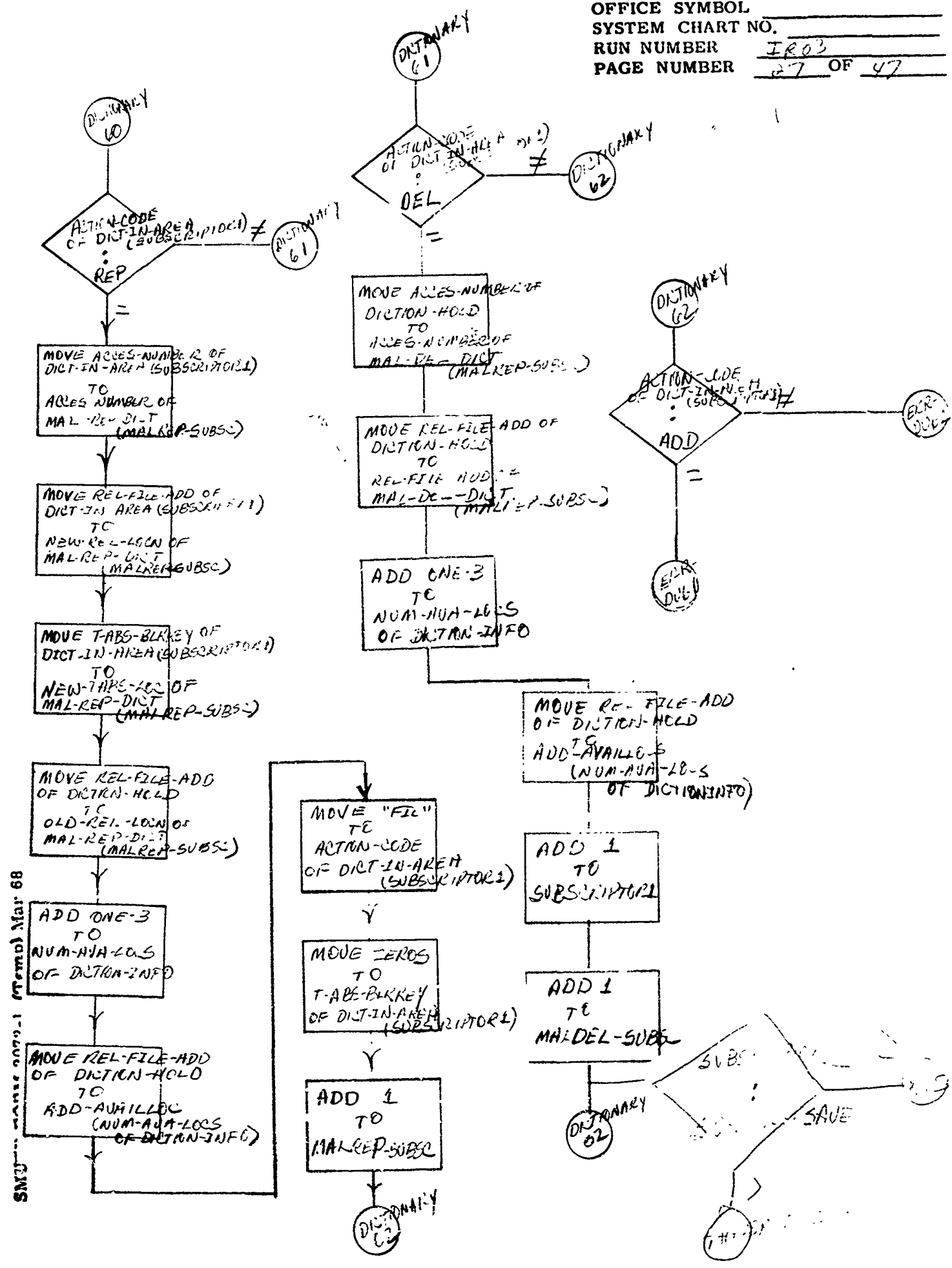

SNUJ... MAR 68

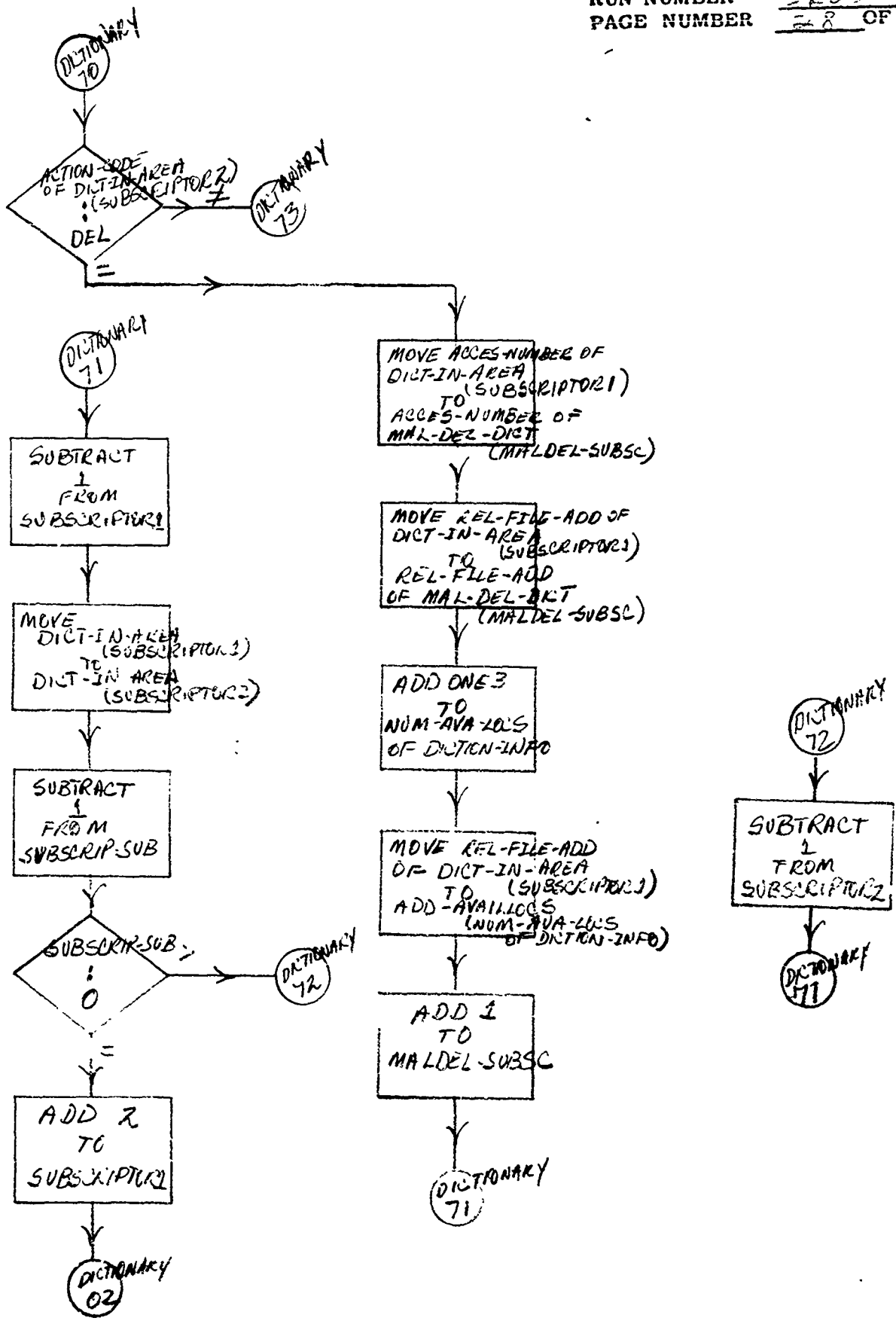

SMUFD FORM 2072-1 (Temp) Mar 68

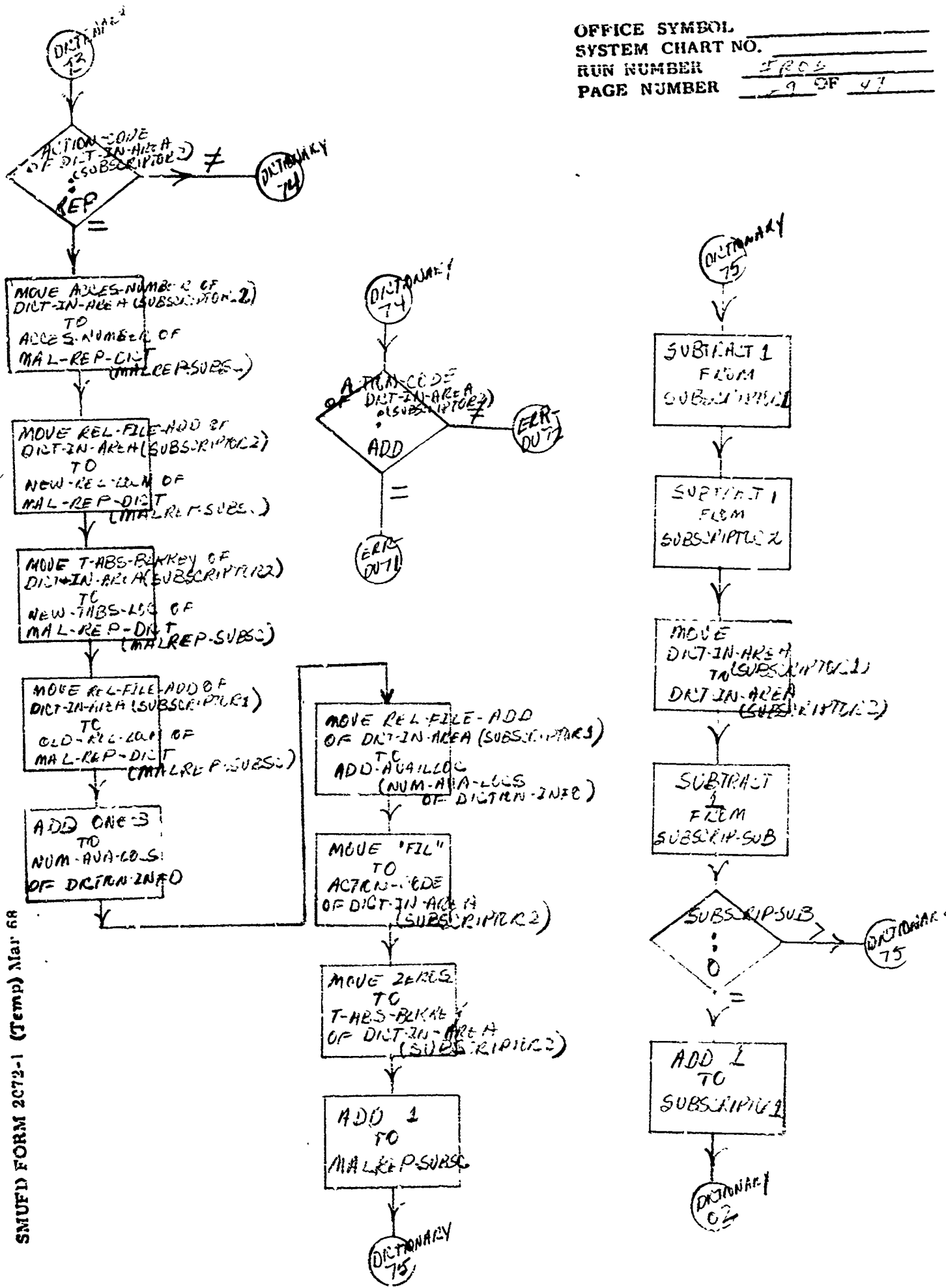

SMUFD FORM 2C72-1 (Temp) Mar 68

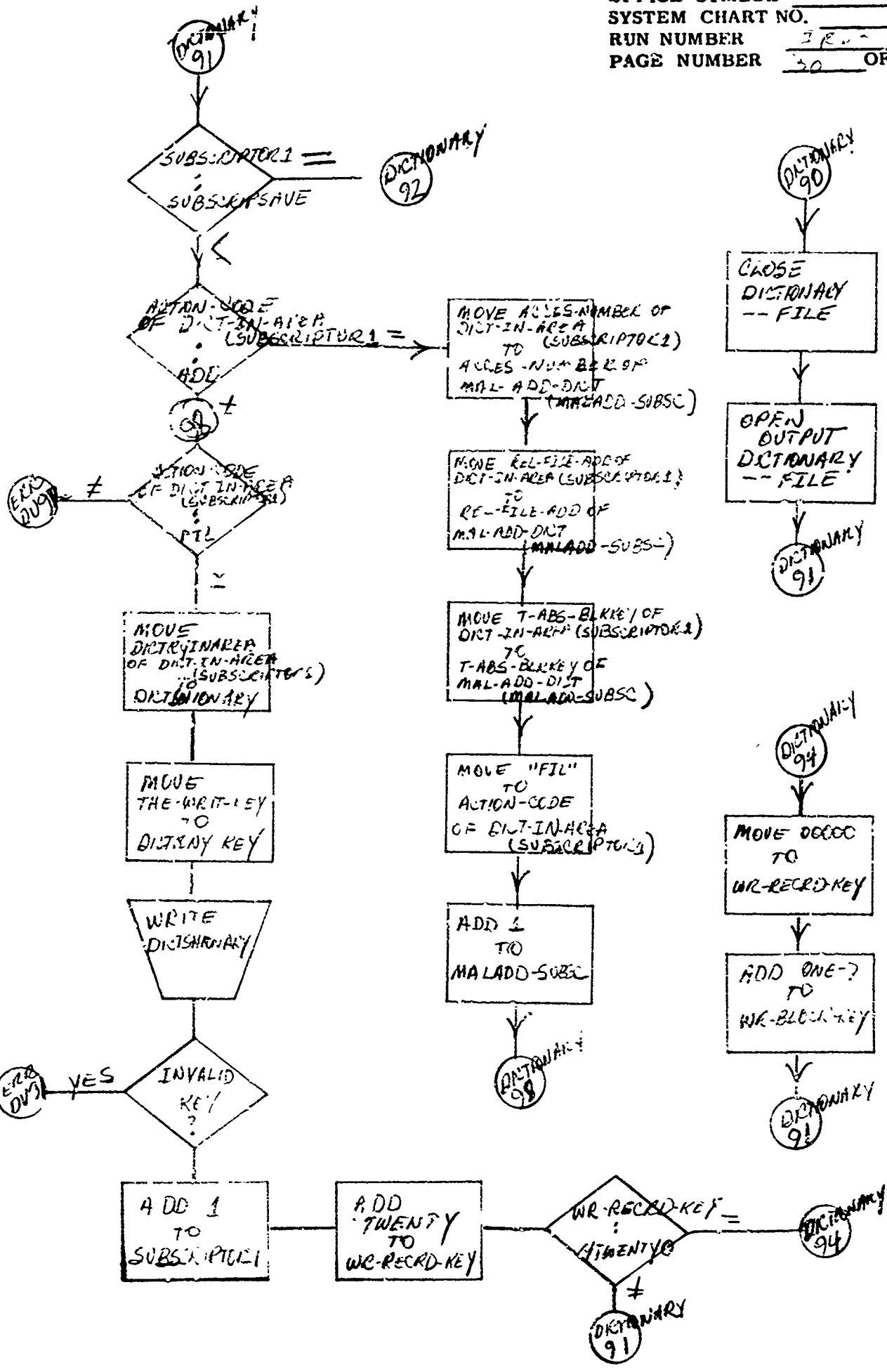

SNUPD FORM 2072-1 (Temp) Mar 68

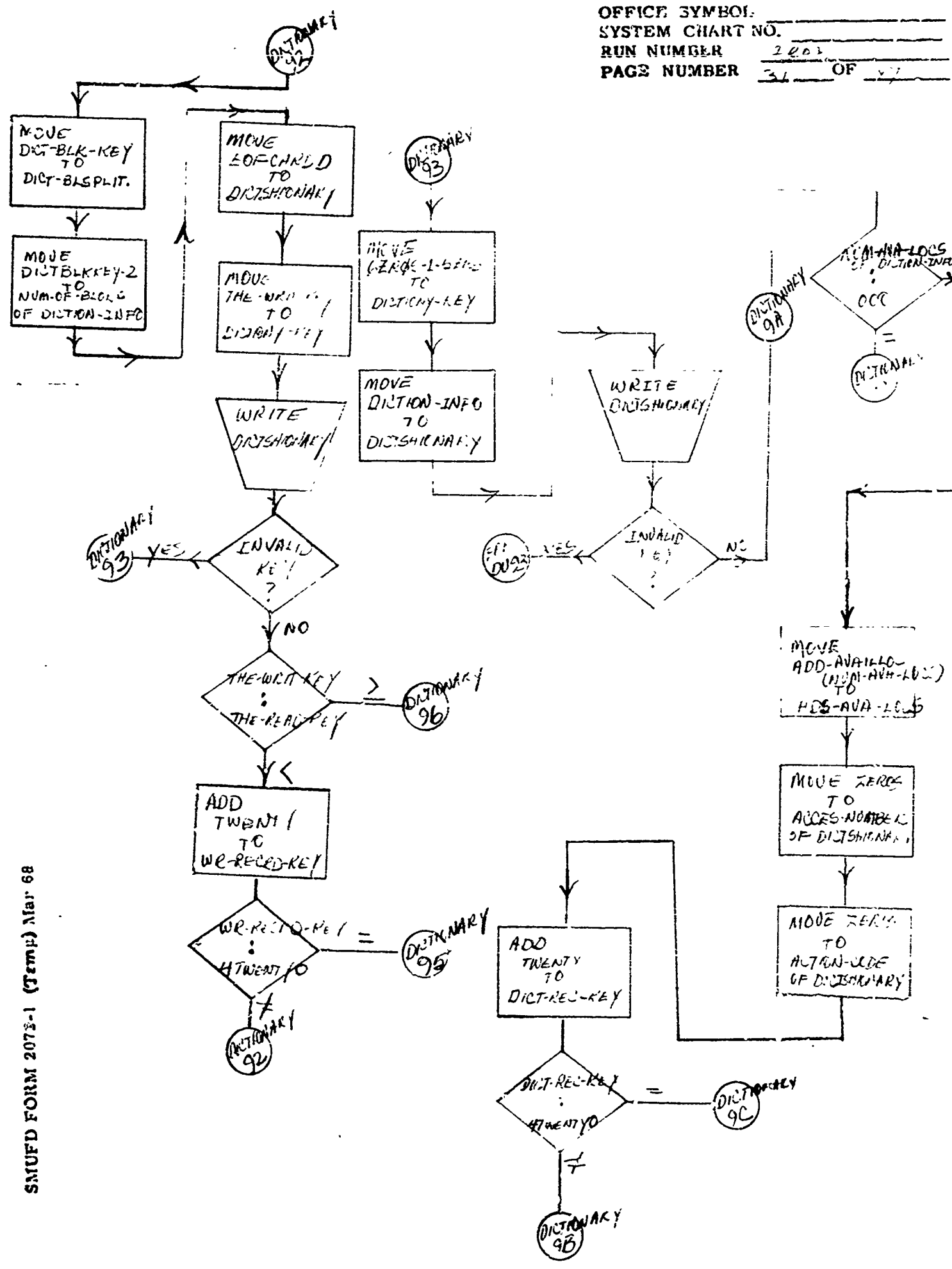

SMUFD FORM 2073-1 (Temp) Mar 68

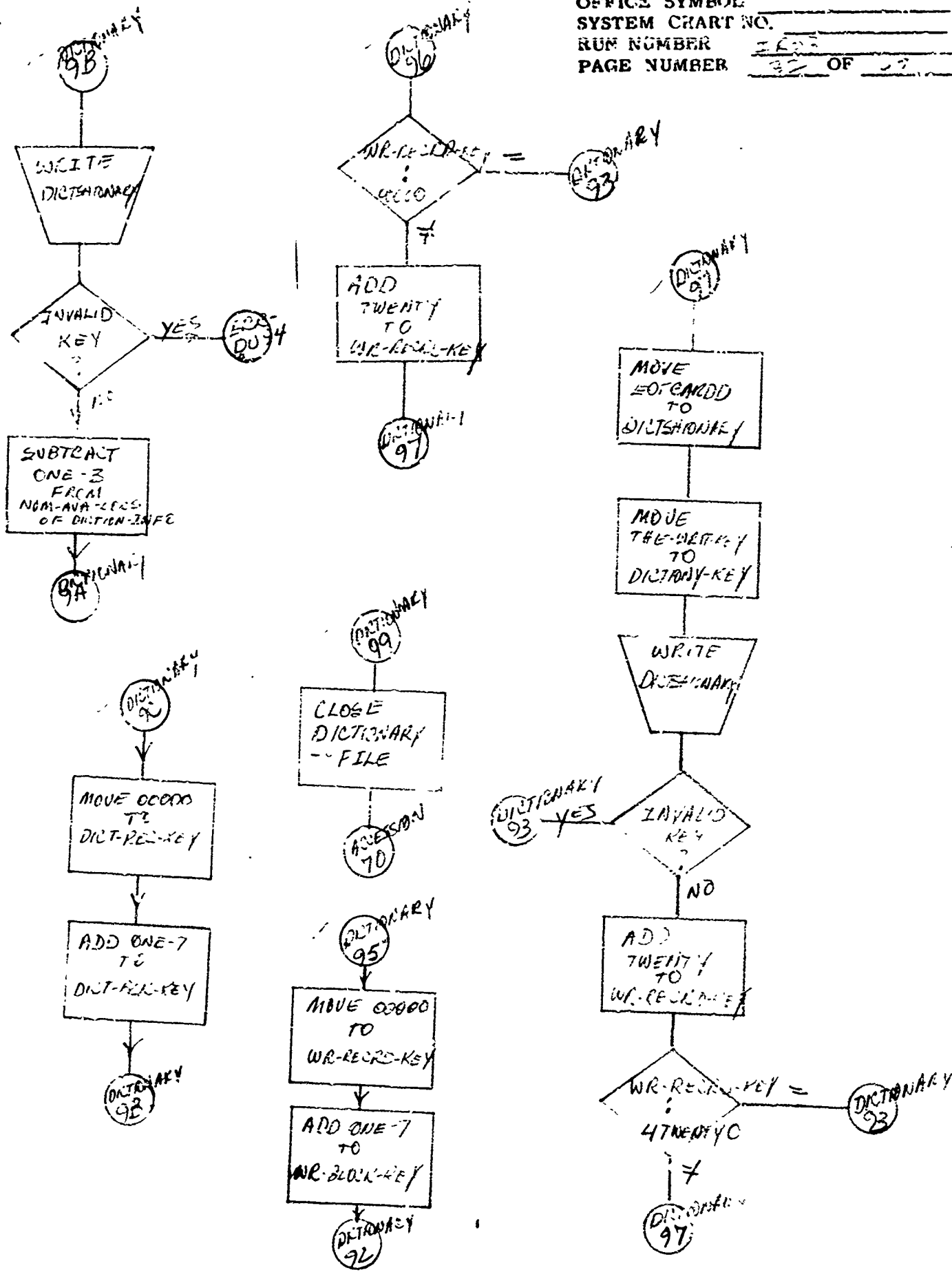

SAUFD FORM 2072-1 (Temp) Mar 68

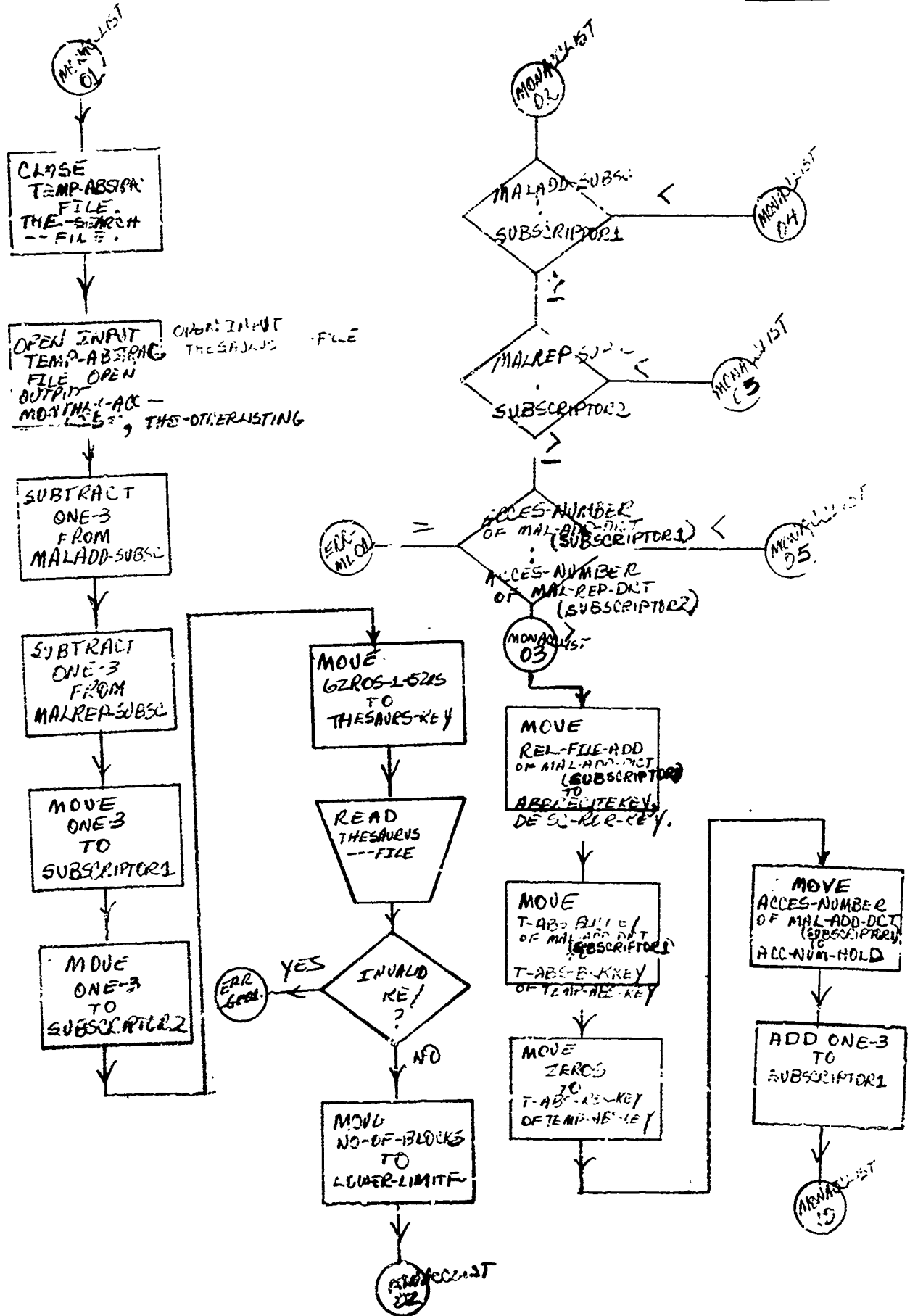

SMITH FORM 2072-1 (Temp) Mar 66

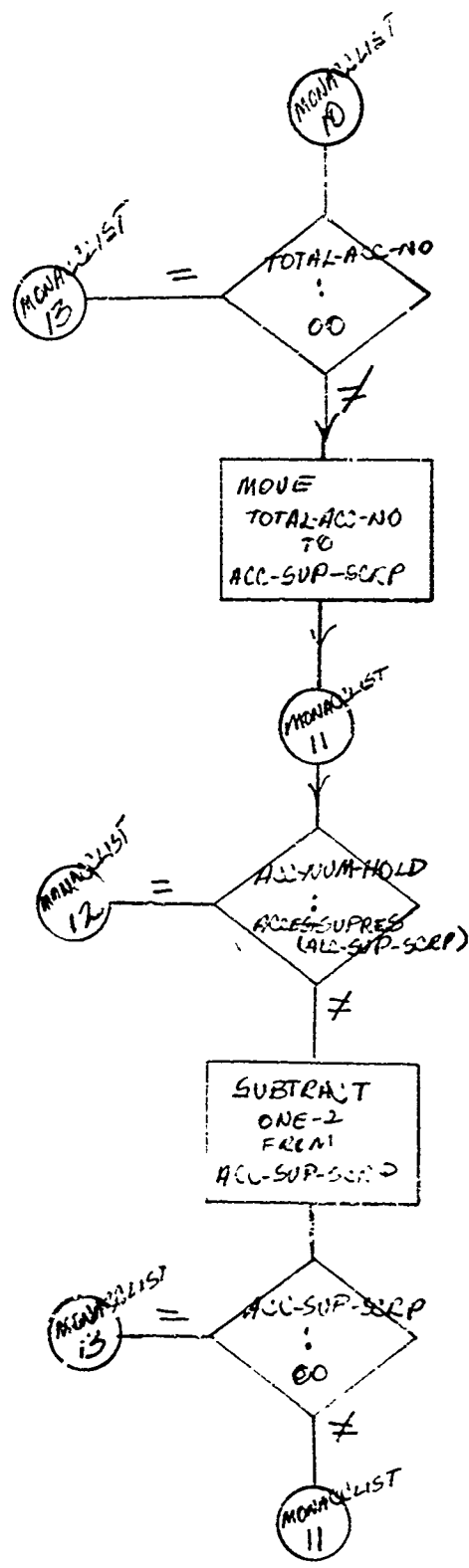
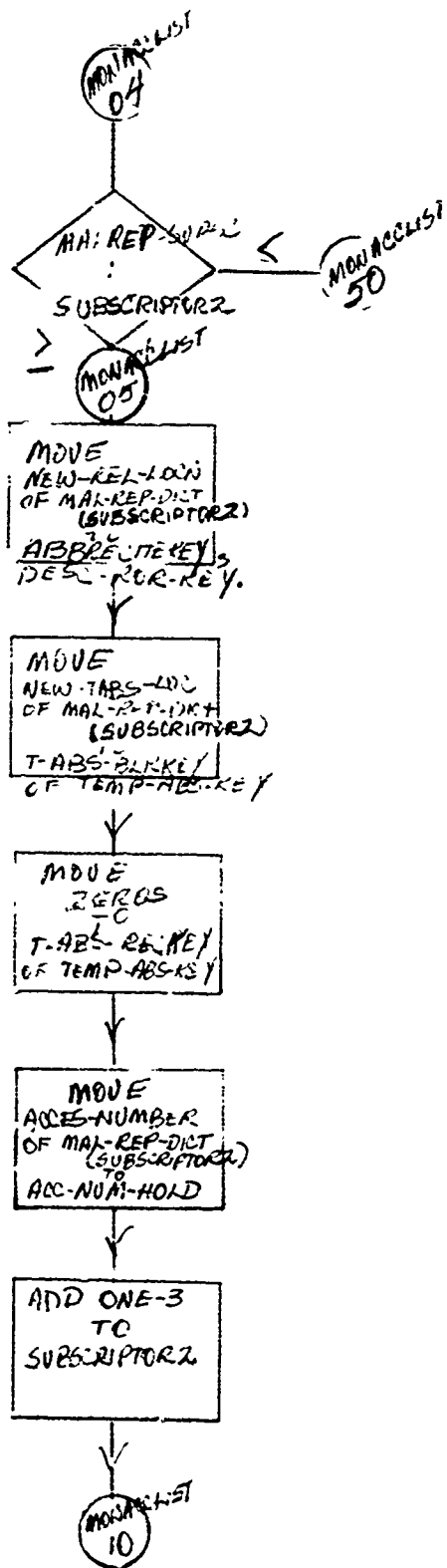

SMUP'D FORM 2072-1 (Temp) Mar 68

SMUFD FORM 2073-1 (Temp) Mar 68

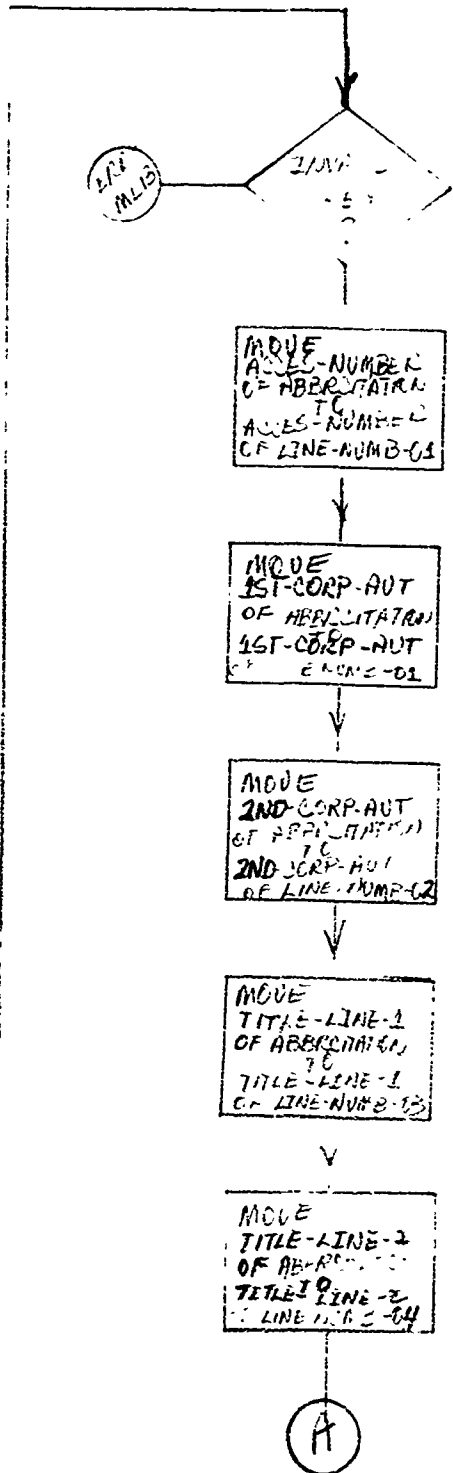
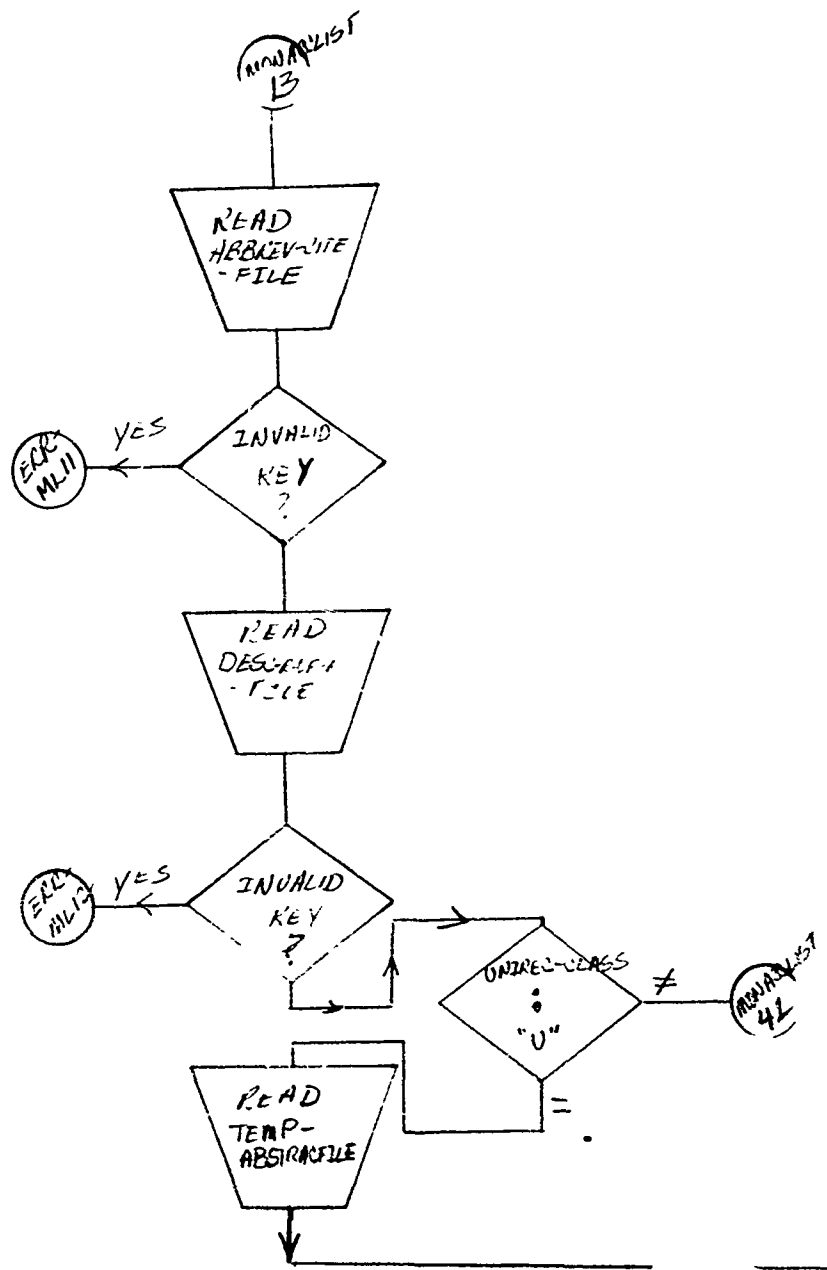

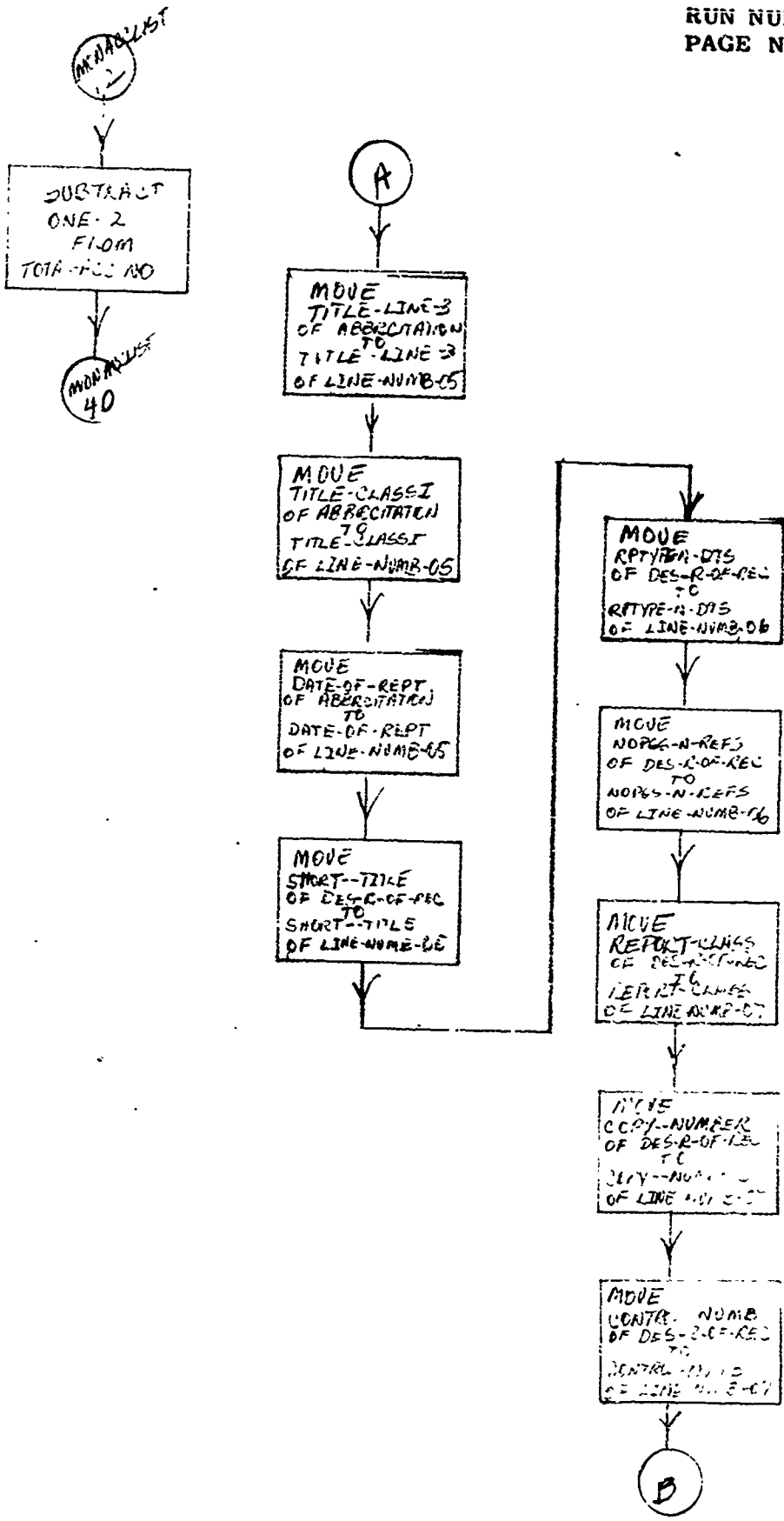

(B)

MOVE
 2CRP-AUT-CDR
 OF DES-R-REF-REC
 TO
 2CRP-AUT-IDE
 OF LINE-NAME-08

MOVE
 2CRP-AUT-CDE
 OF DES-R-REF-REC
 TO
 2CRP-AUT-IDE
 OF LINE-NAME-8

MOVE
 SECURITY-GRP
 OF DES-R-REF-REC
 TO
 SECURITY-GRP
 OF LINE-NAME-8

MOVE
 RELEASING
 OF DES-R-REF-REC
 TO
 RELEASING
 OF LINE-NAME-08

MOVE
 PERSO-AUTHOR
 OF ABBREVIATION
 TO (01)
 AUTHOR-NO-01

MOVE
 PERSO-AUTHOR
 OF ABBREVIATION
 TO (02)
 AUTHOR-NO-02

MOVE
 PERSO-AUTHOR
 OF ABBREVIATION
 TO (03)
 AUTHOR-NO-03

MOVE
 PERSO-AUTHOR
 OF ABBREVIATION
 TO (04)
 AUTHOR-NO-04

MOVE
 PERSO-AUTHOR
 OF ABBREVIATION
 TO (05)
 AUTHOR-NO-05

MOVE
 PERSO-AUTHOR
 OF ABBREVIATION
 TO (06)
 AUTHOR-NO-06

MOVE
 PERSO-AUTHOR
 OF ABBREVIATION
 TO (07)
 AUTHOR-NO-07

MOVE
 PERSO-AUTHOR
 OF ABBREVIATION
 TO (08)
 AUTHOR-NO-08

(C)

(C)

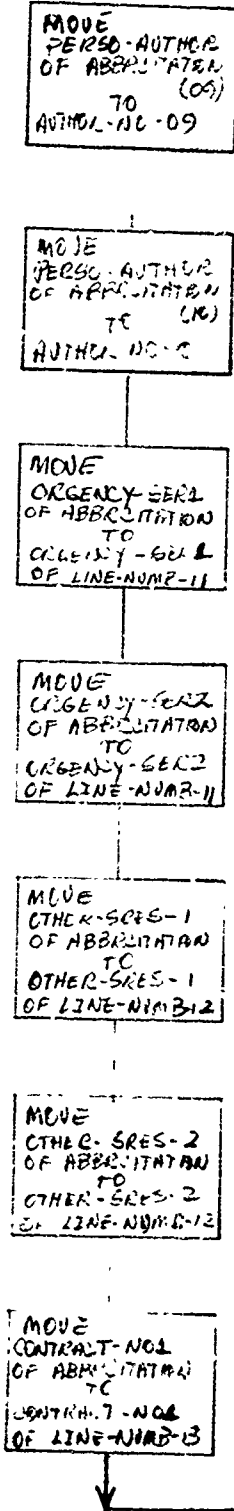

(D)

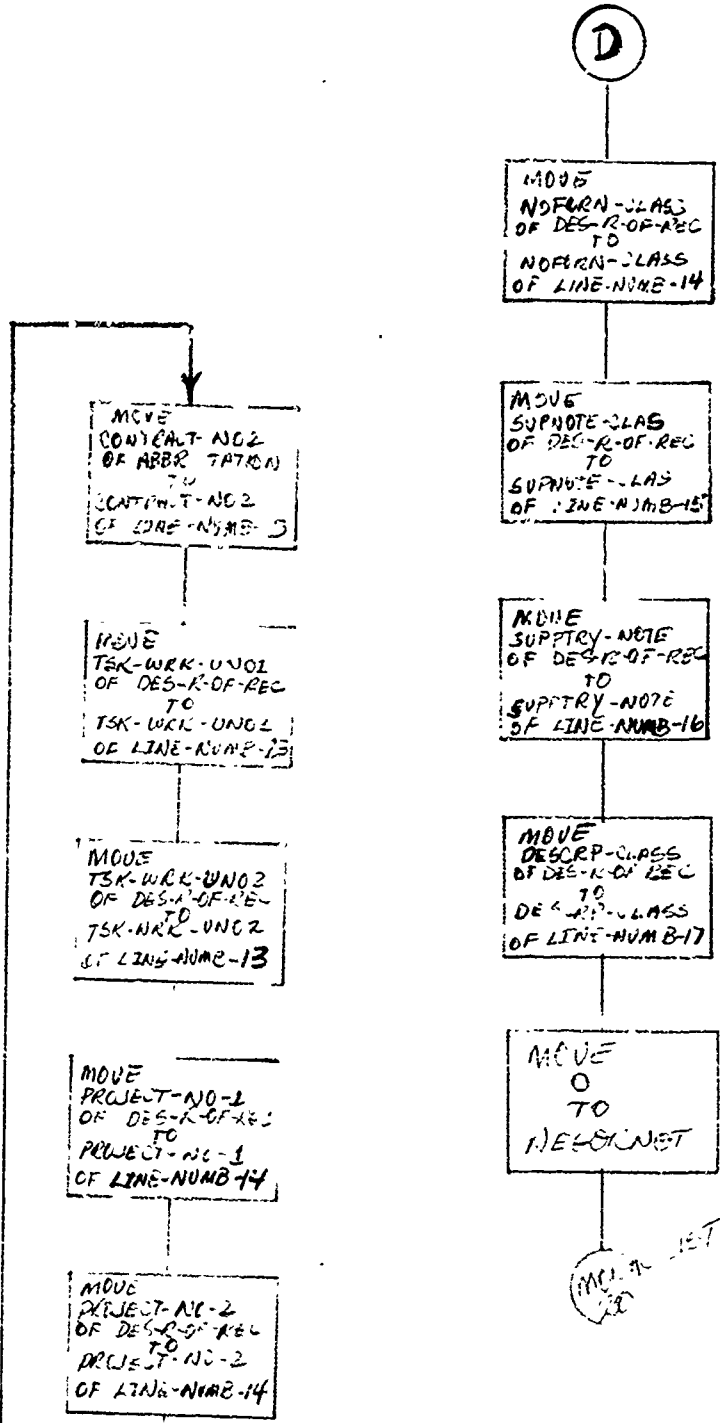

(D)

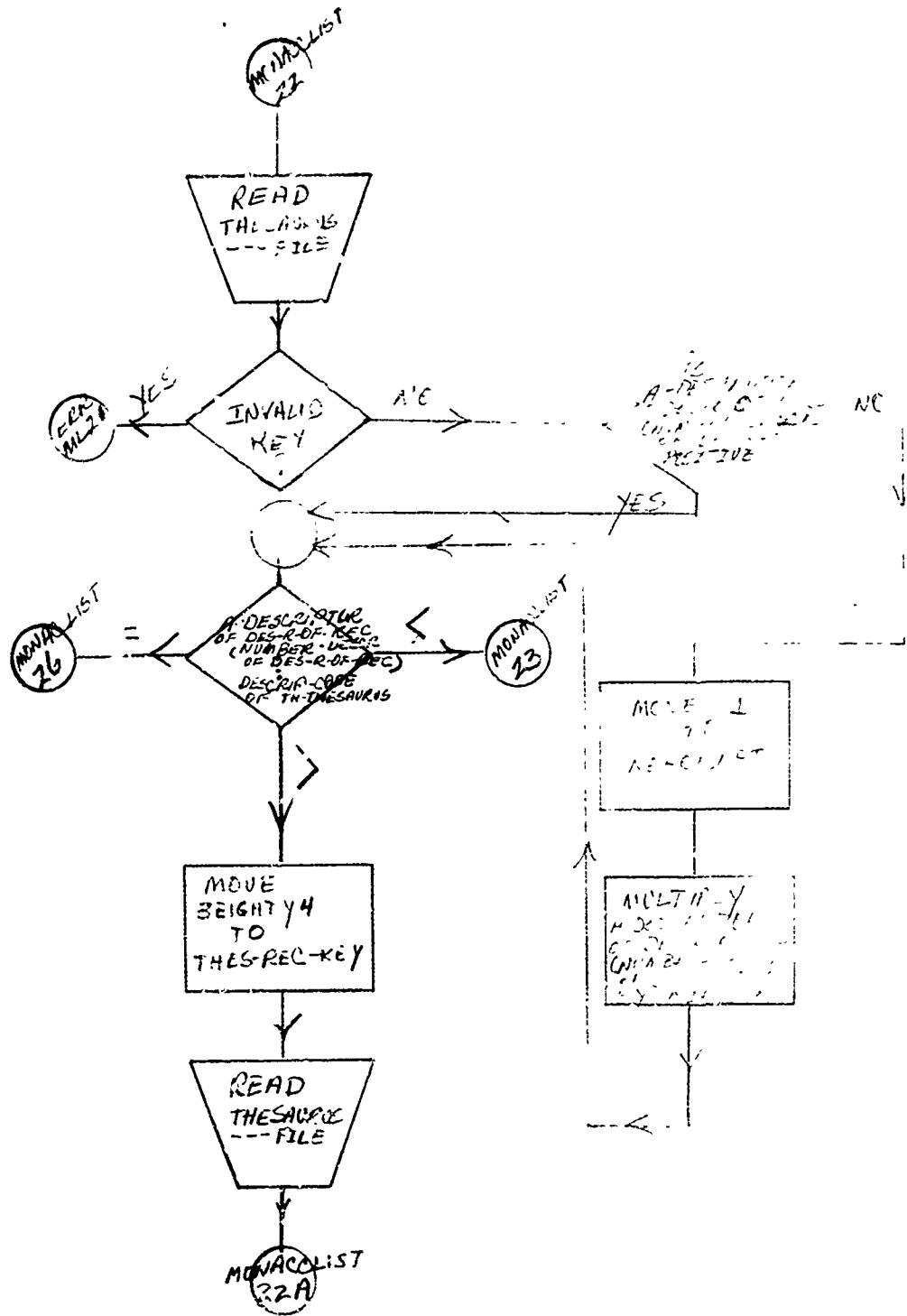
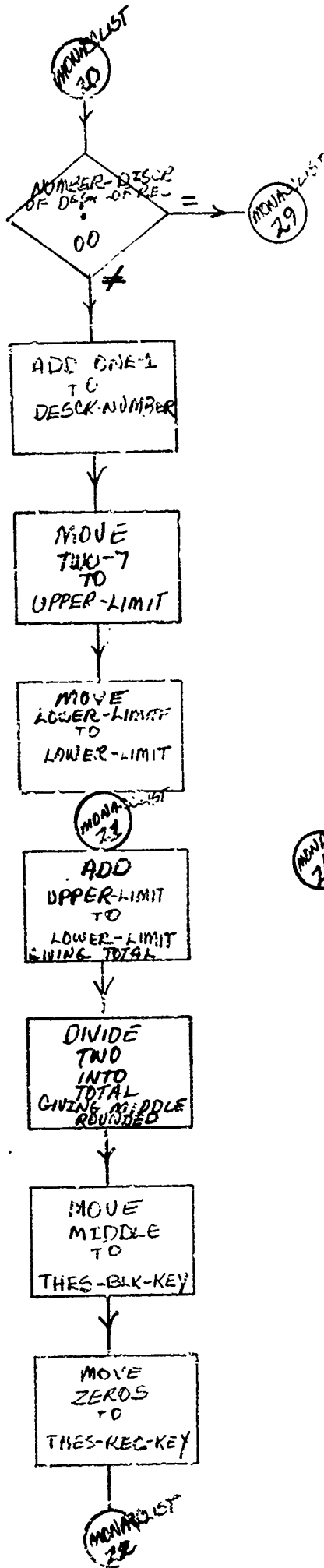

SMUFD FORM 2072-1 (Temp) MAR 68

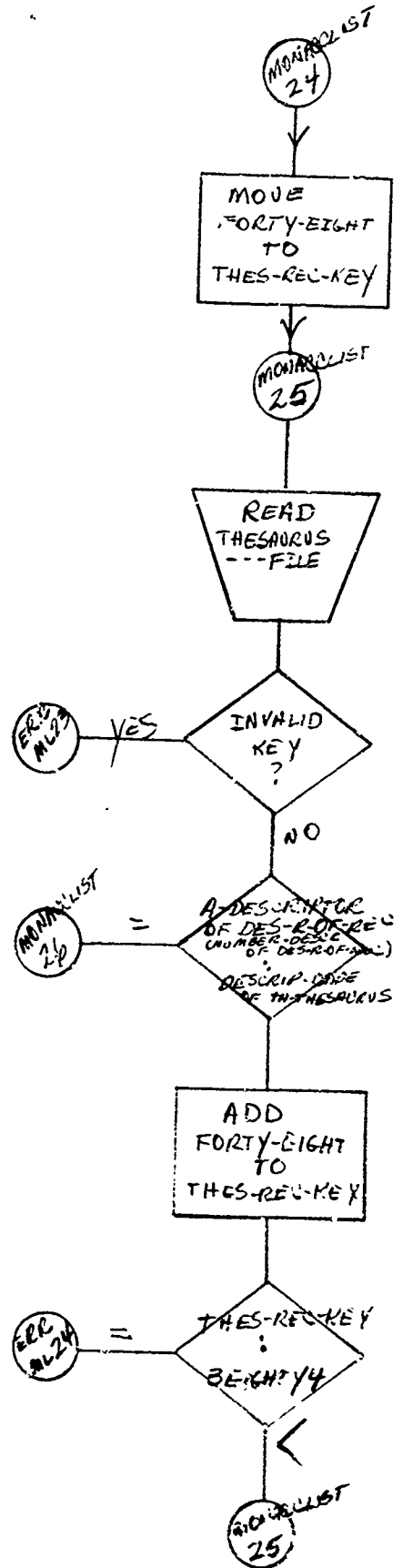
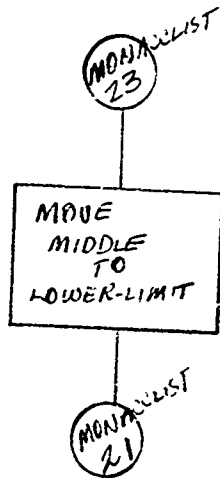
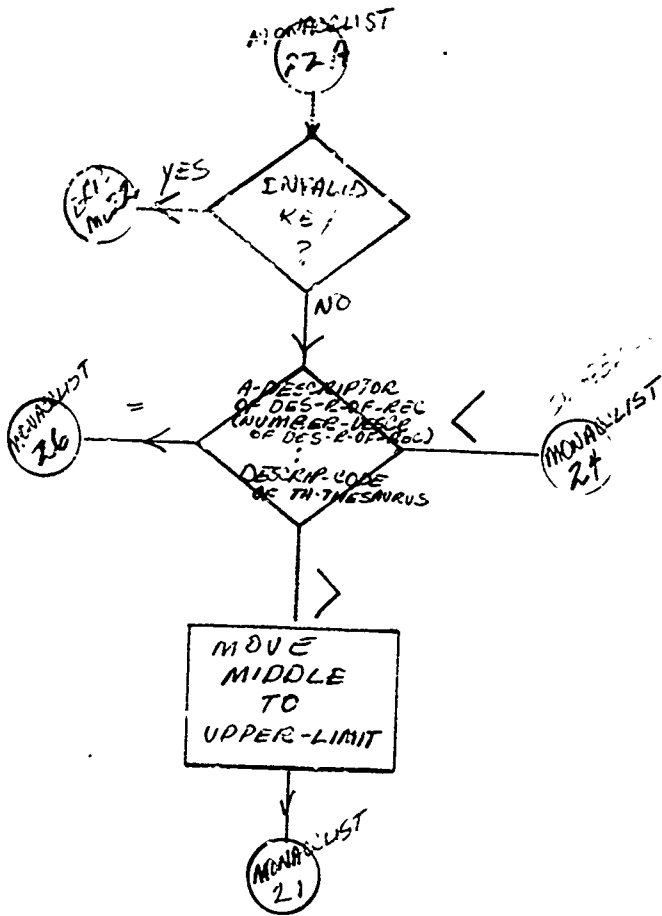

SMUFD FORM 2072-1 (Formal) 11-55-50

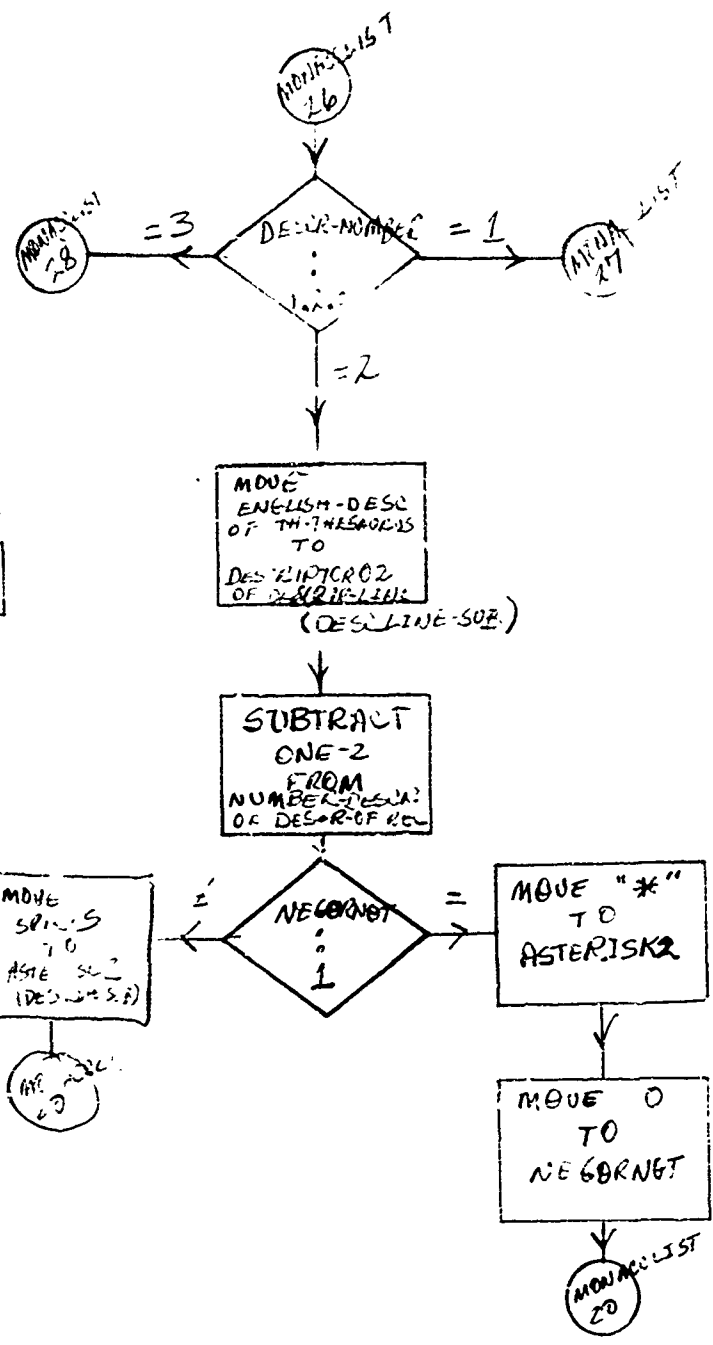
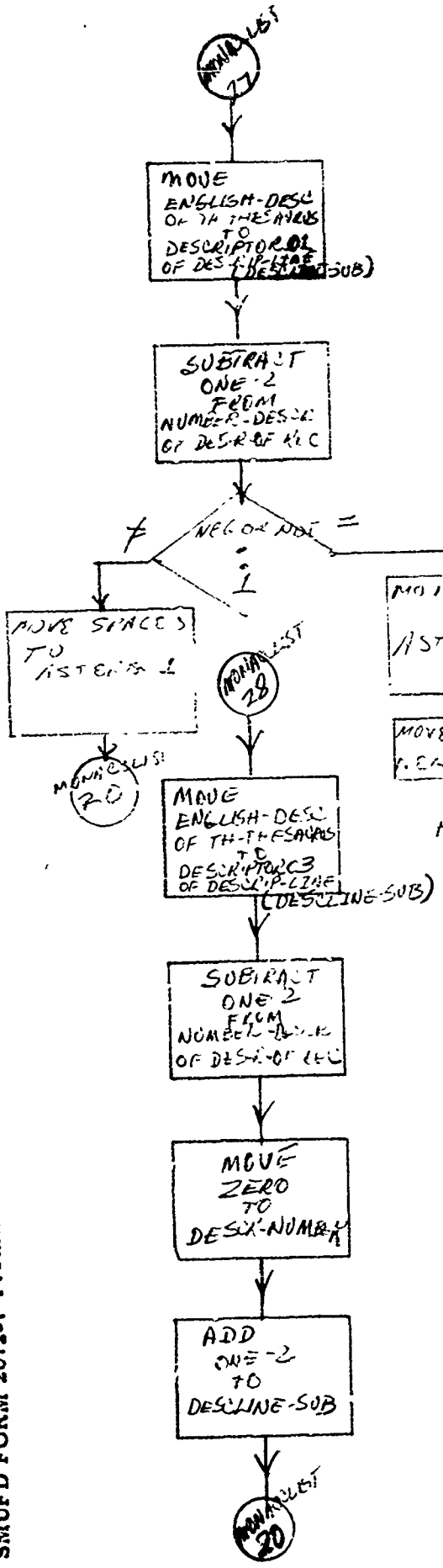

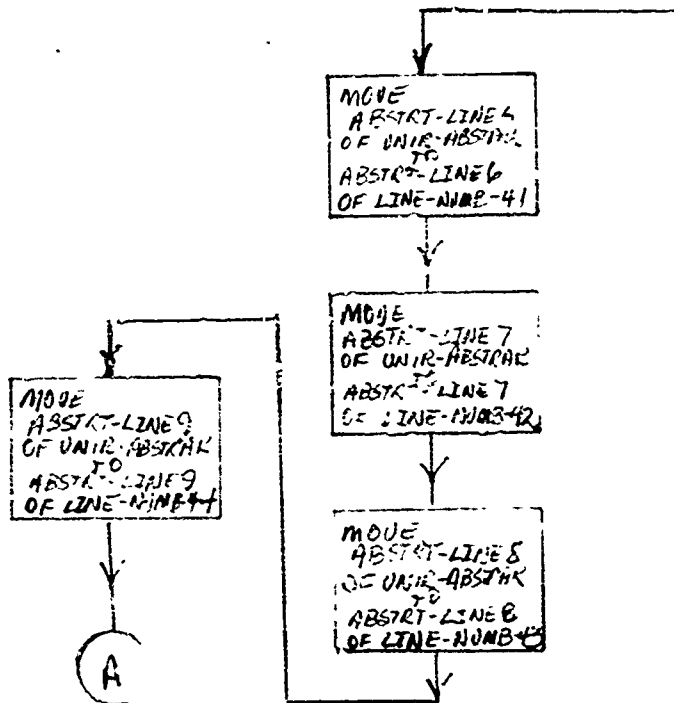
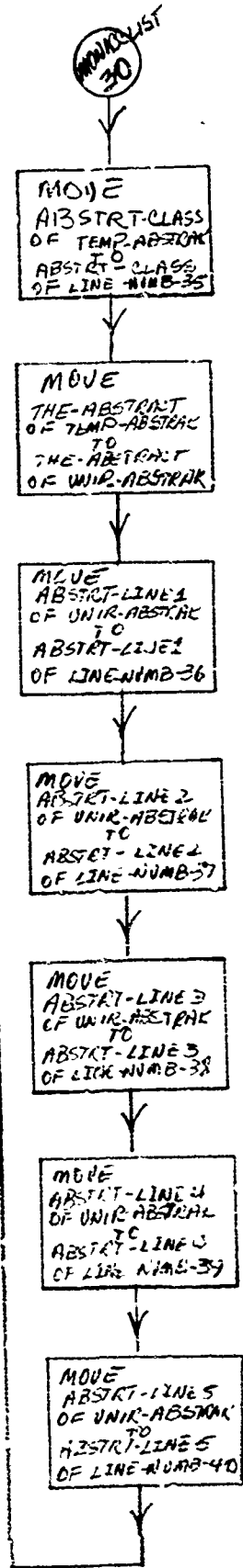
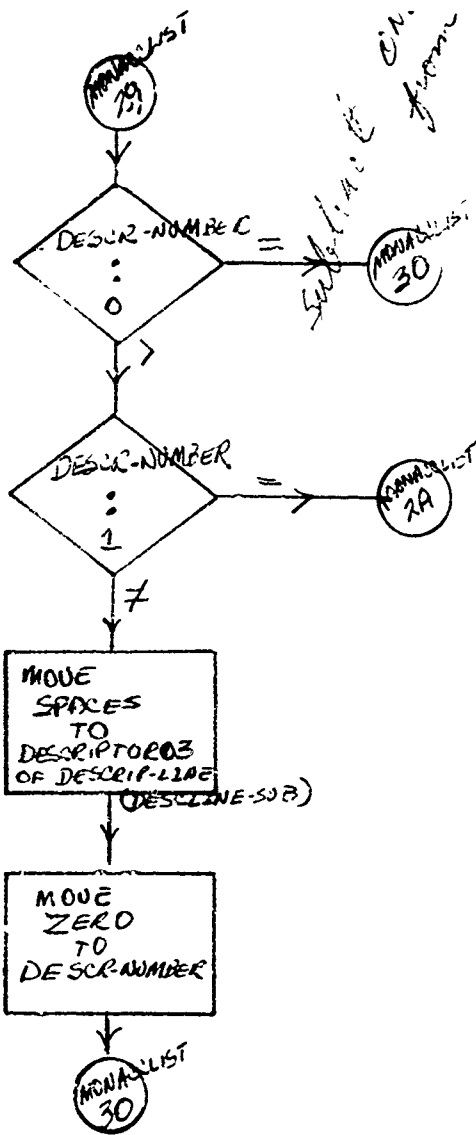
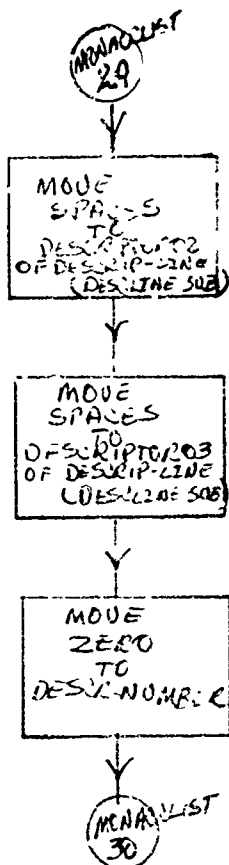

SMUFD FORM 2072-1 (Temp) Mar 68

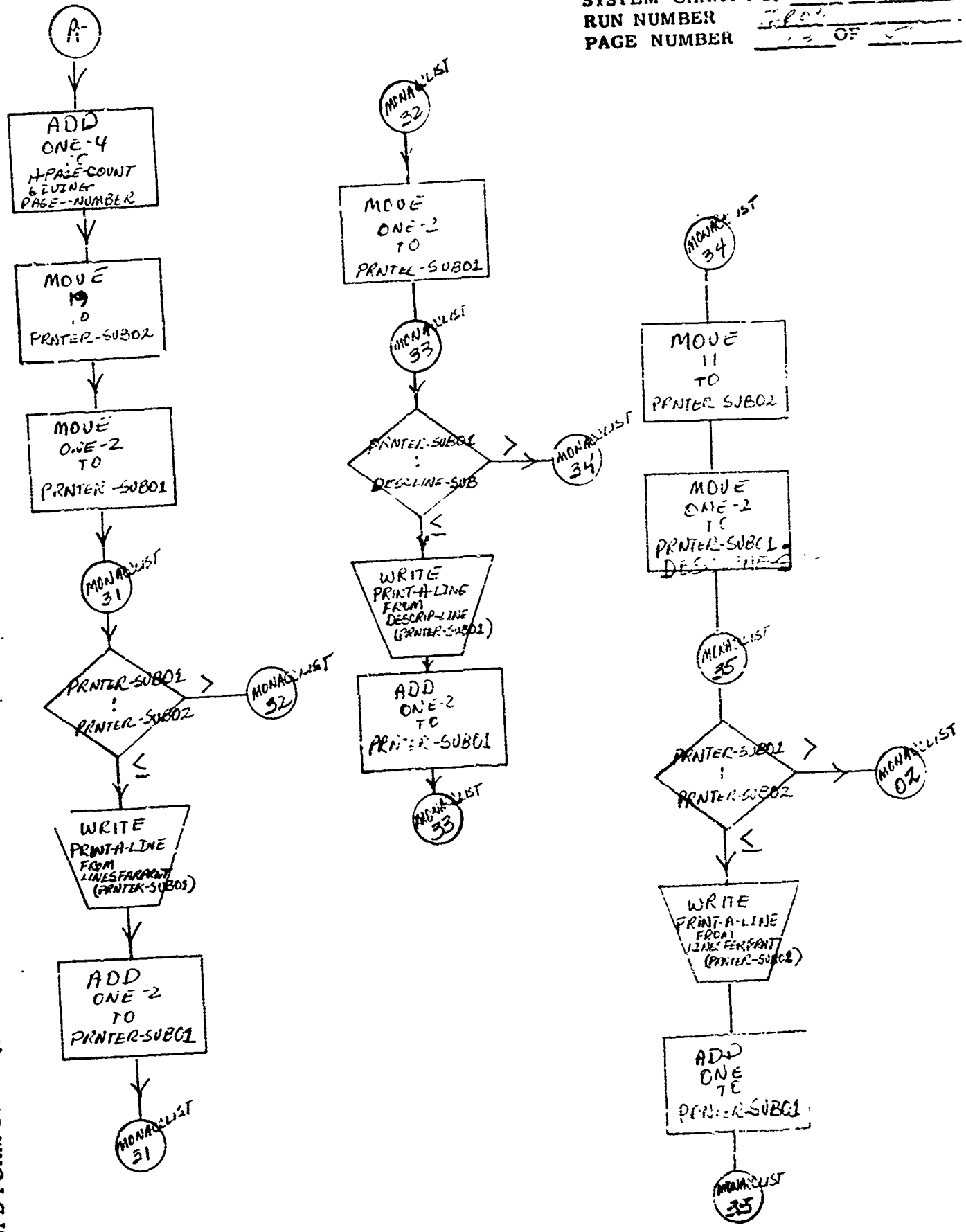

SMUFD FORM 2072-1 (Temp) Mar 68

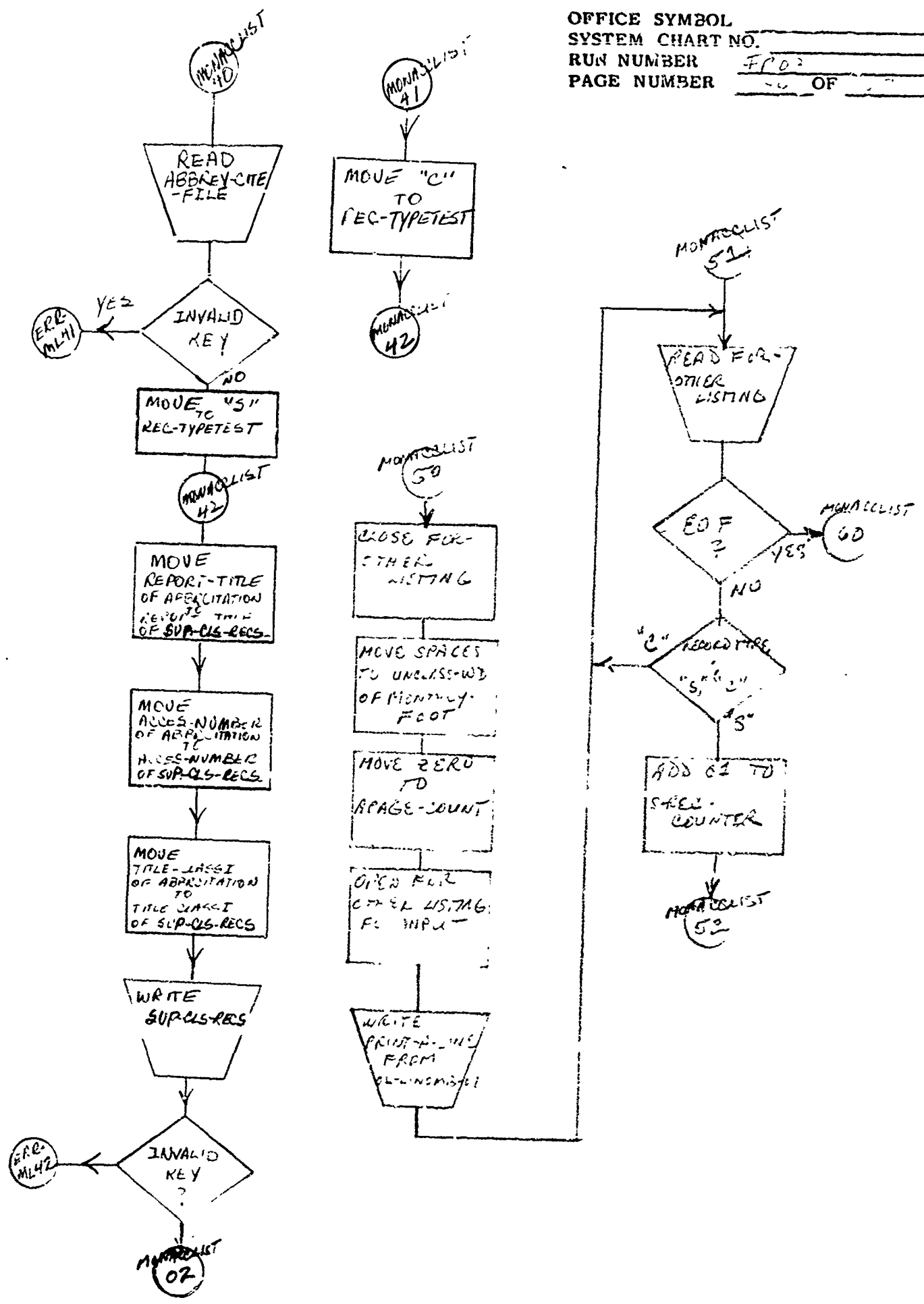

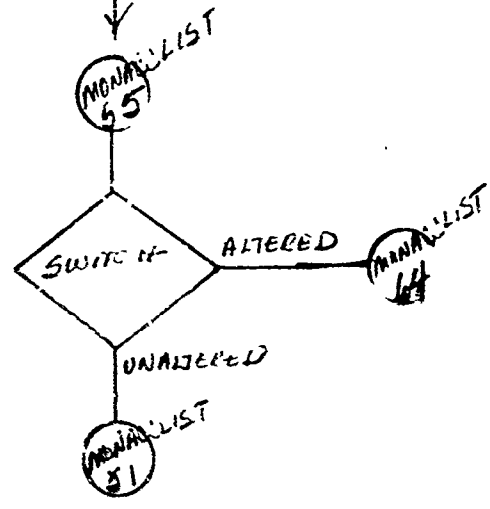
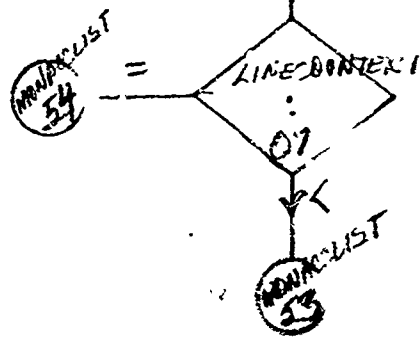
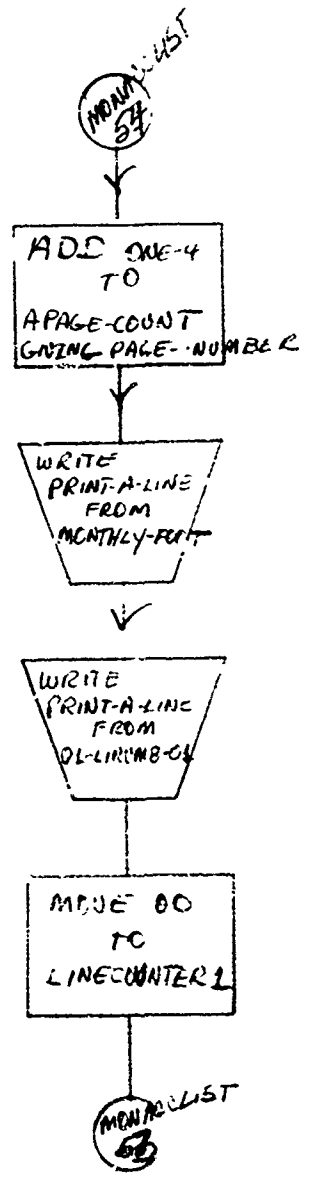
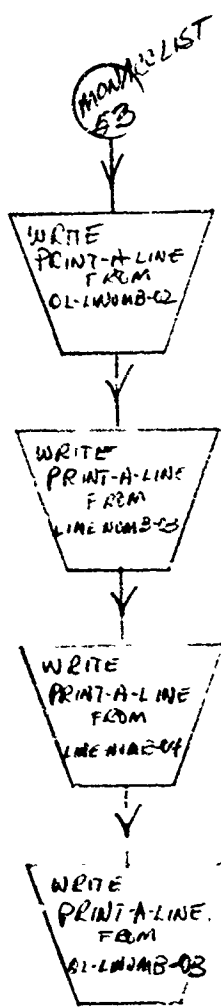
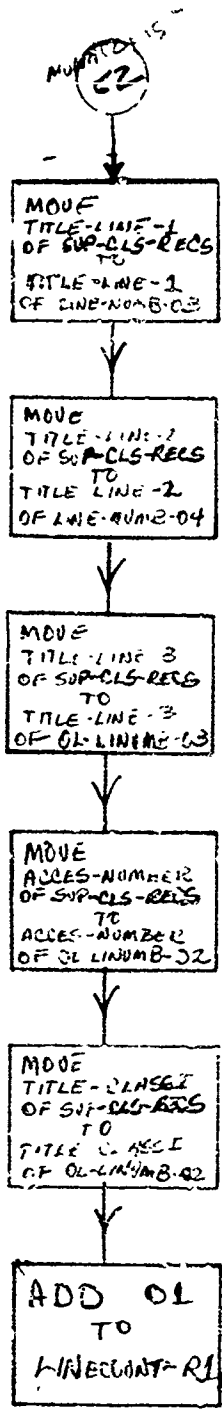

SMUFD FORM 2072-1 (Temp) Mar 68

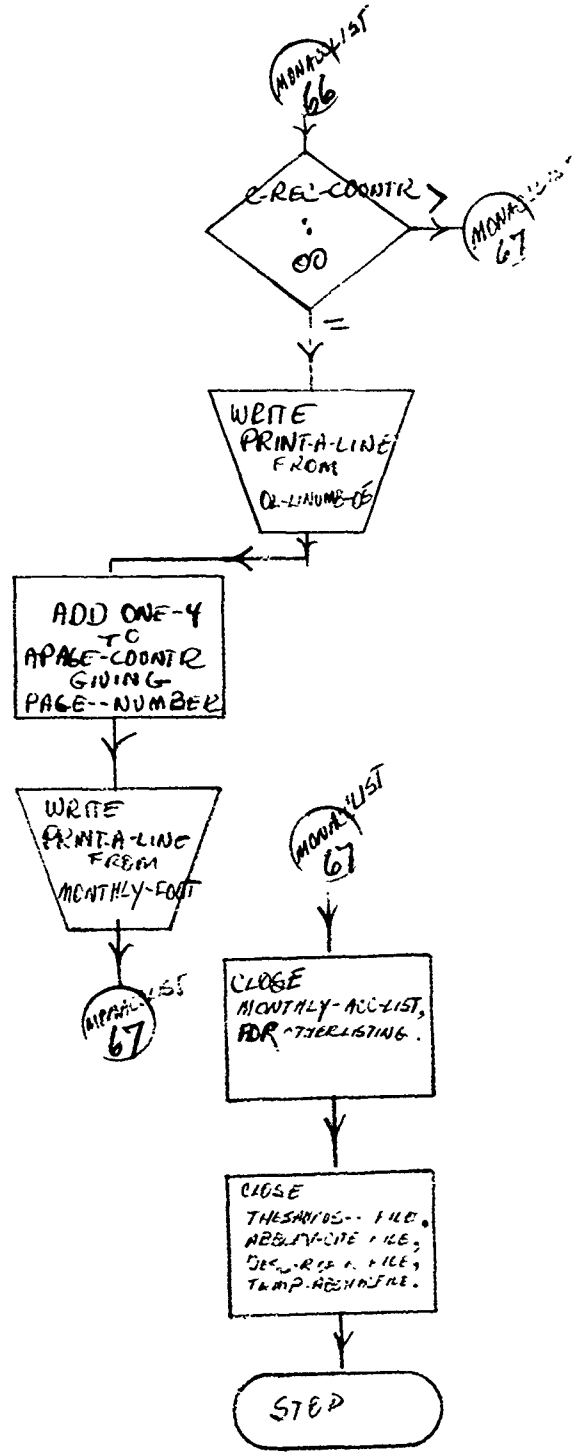

SMUFD FORM 2072-1 7 Apr Mar 63

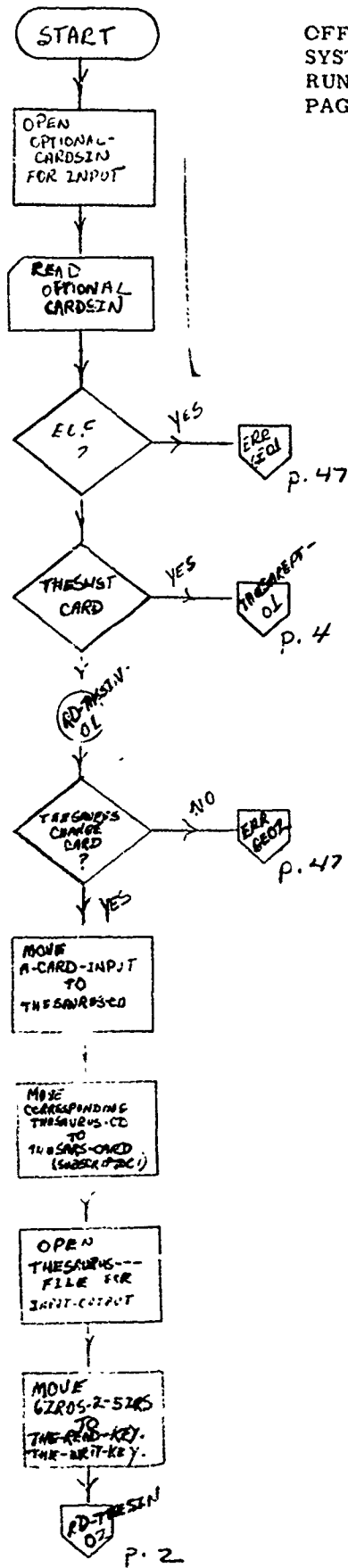

OFFICE SYMBOL _____
SYSTEM CHART NO. _____
RUN NUMBER TR04
PAGE NUMBER 1 OF 17

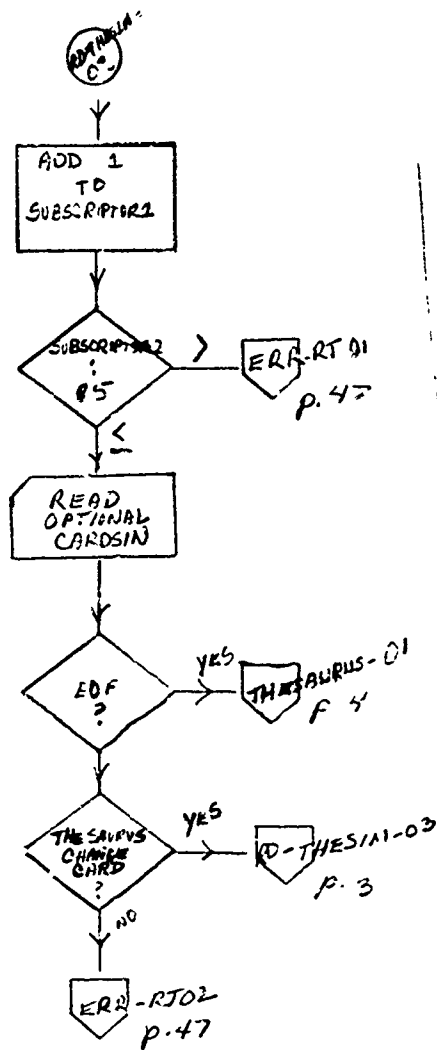

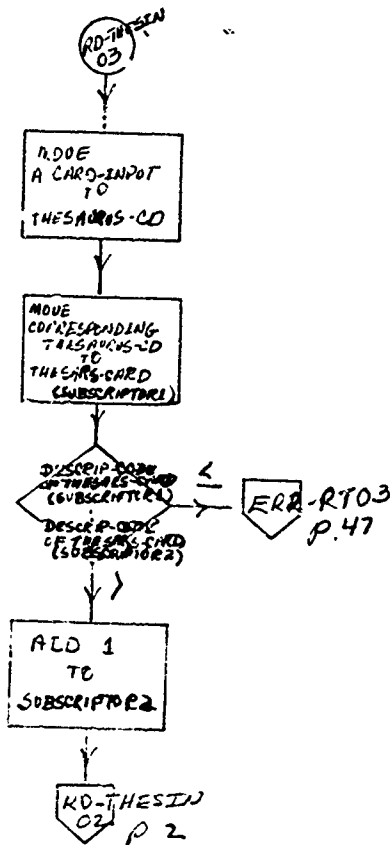

SMUFD FORM 2072-1 1 up, Mar 68

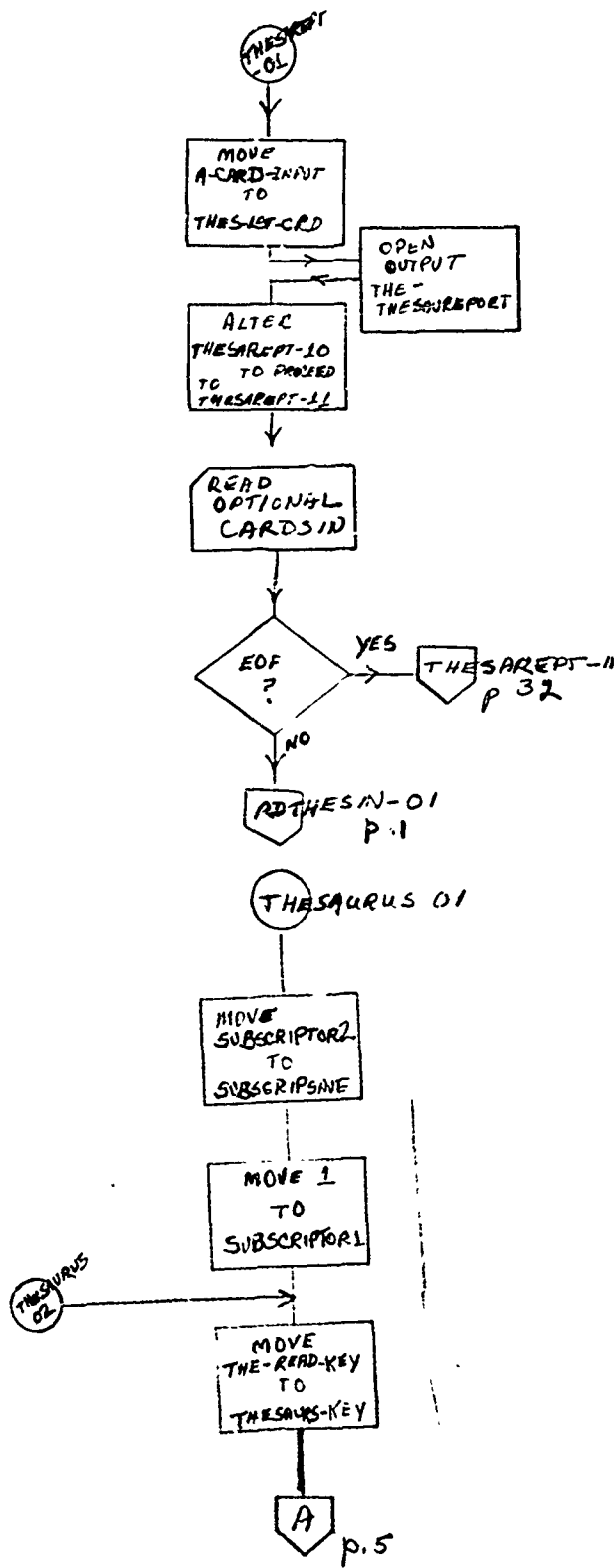

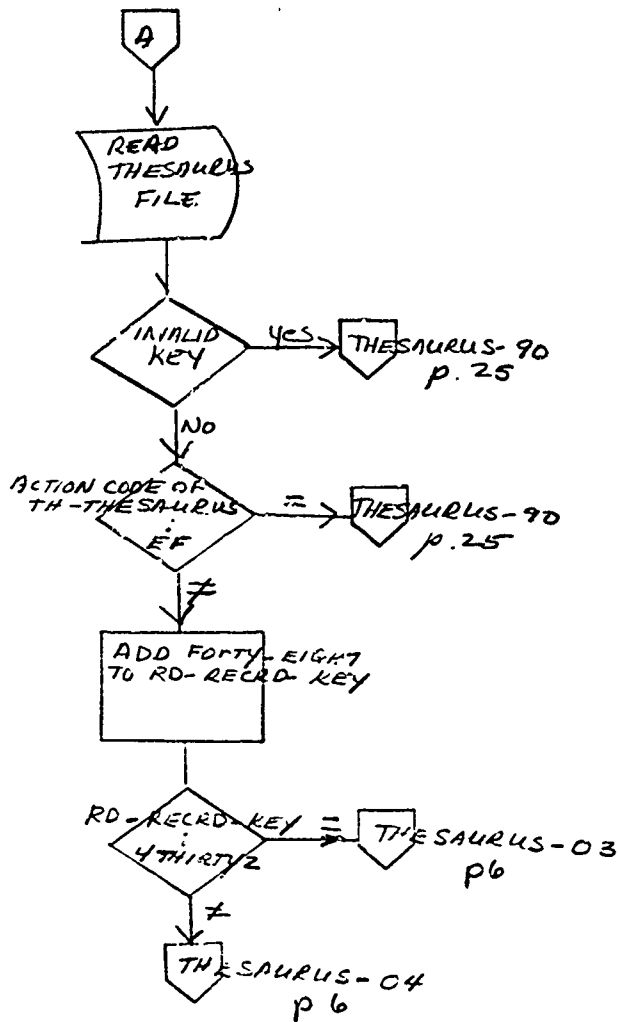

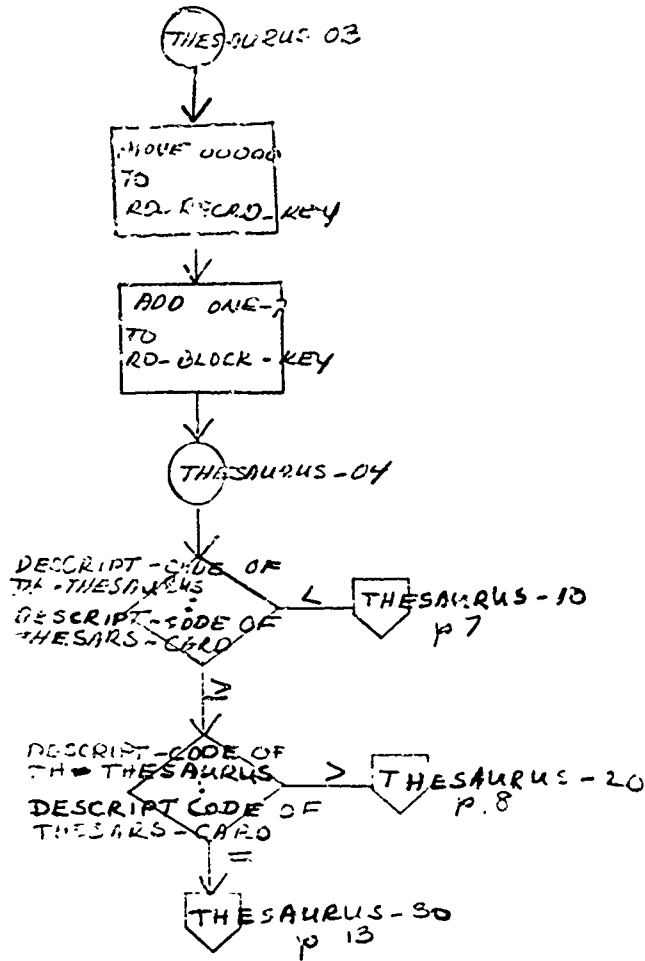

SMUFD FORM 2072-1 '71 up. Mar 68

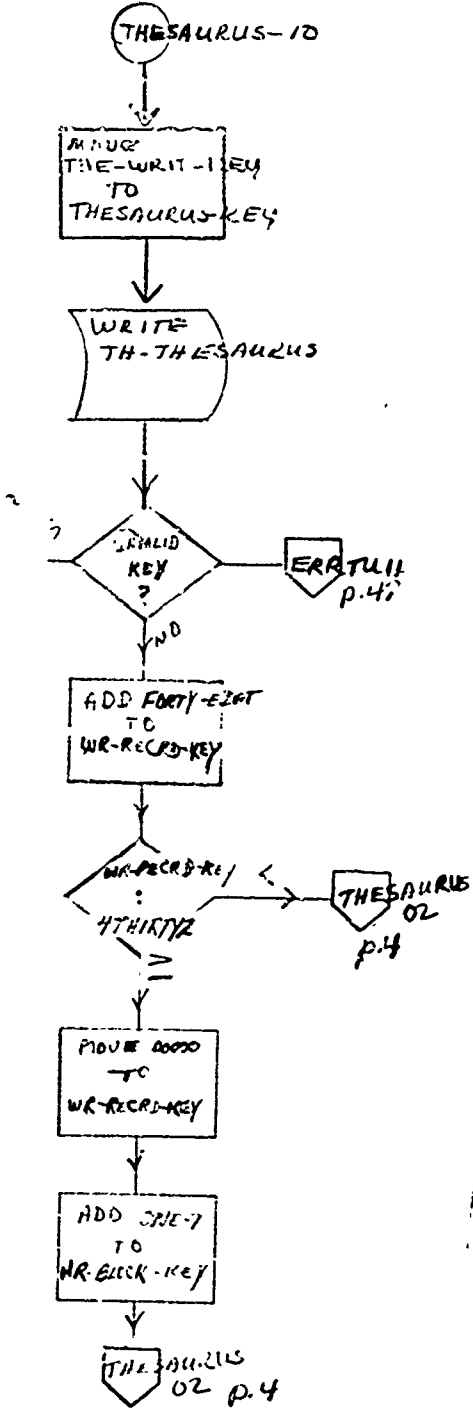

SMUFD FORM 2072-1 1 up: Mar 68

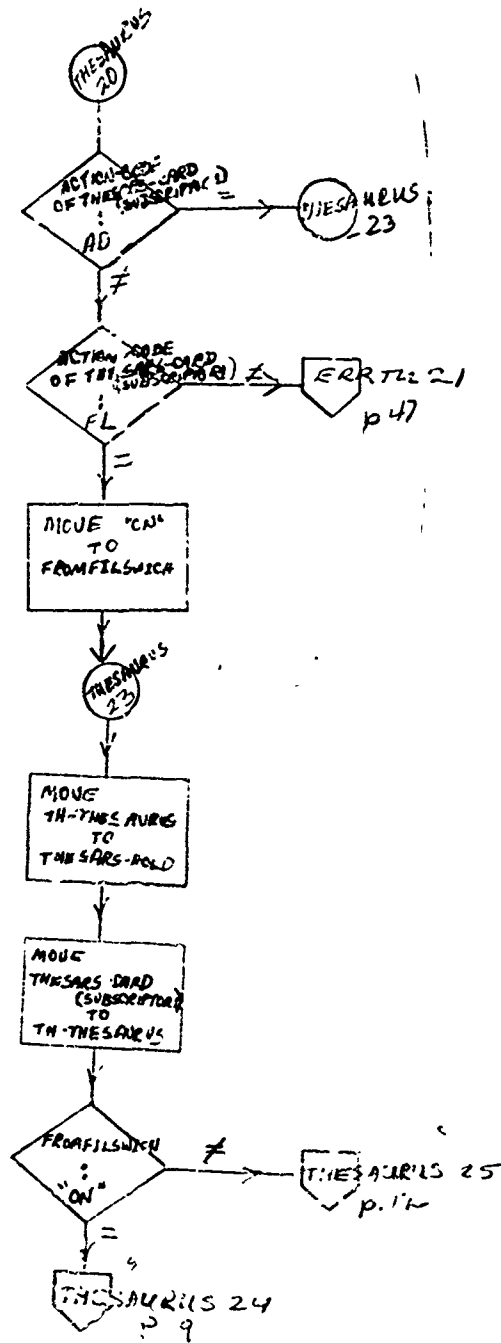

SMUPD FORM 2072-1 7 up-Mar 68

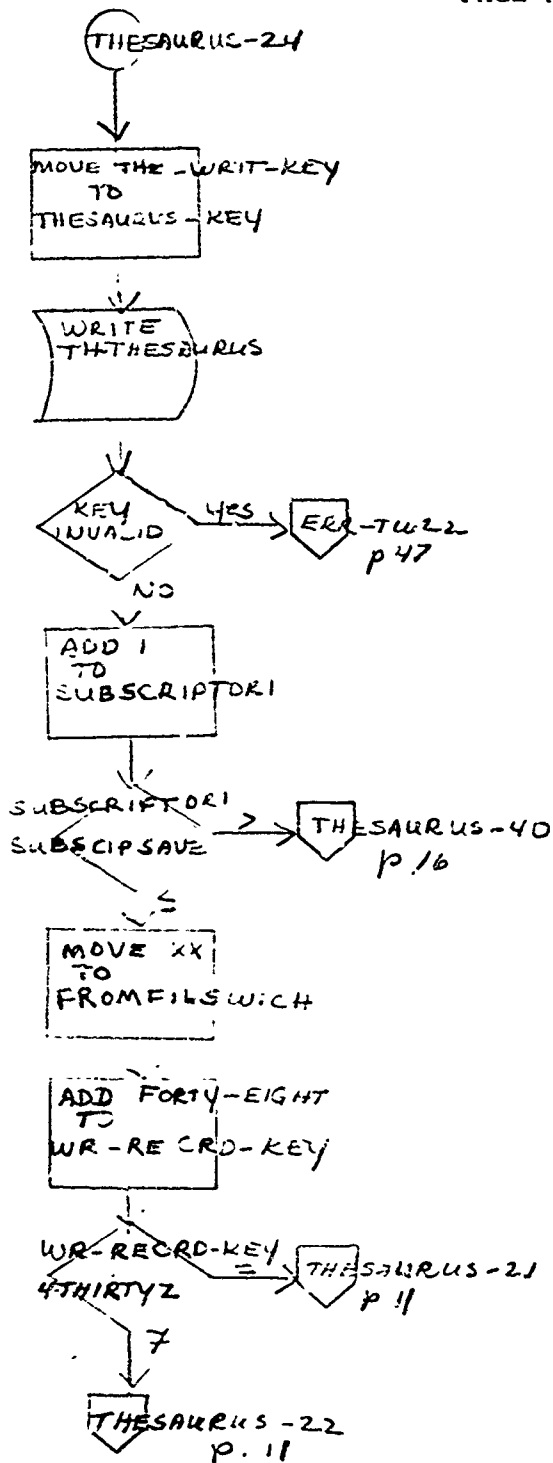

SMUFD FORM 2072-1 1 4p Vol 6b

OFFICE SYMBOL _____
SYSTEM CHART NO. _____
RUN NUMBER _____
PAGE NUMBER 1 OF 17

BLANK

SMUFD FORM 2072-1 11 up. Mar. 68

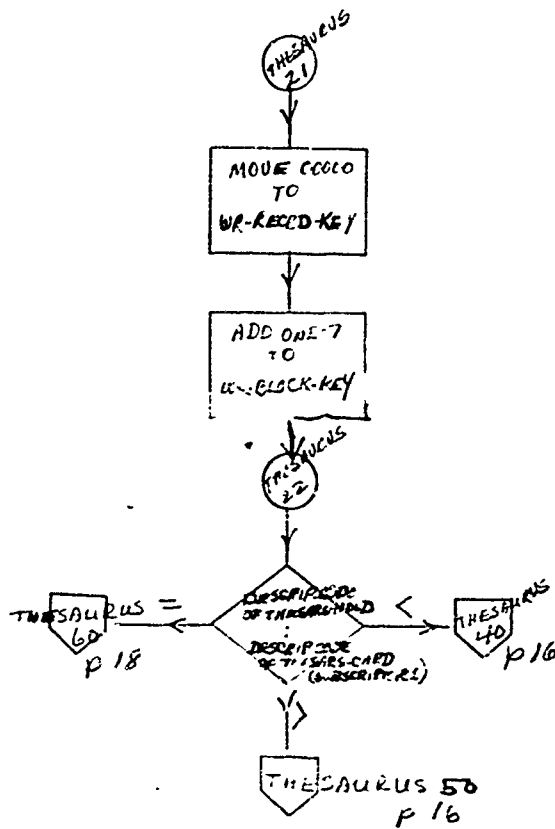

SMUFD FORM 2072-1 1 99 Mar 68

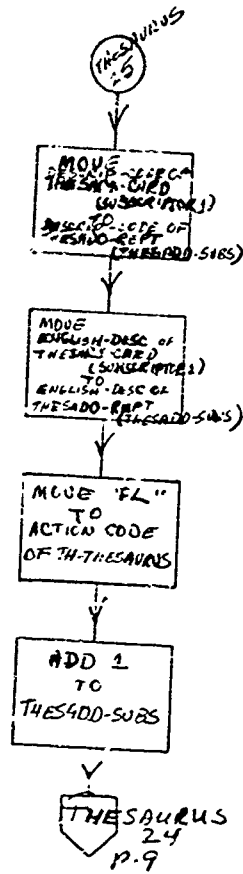

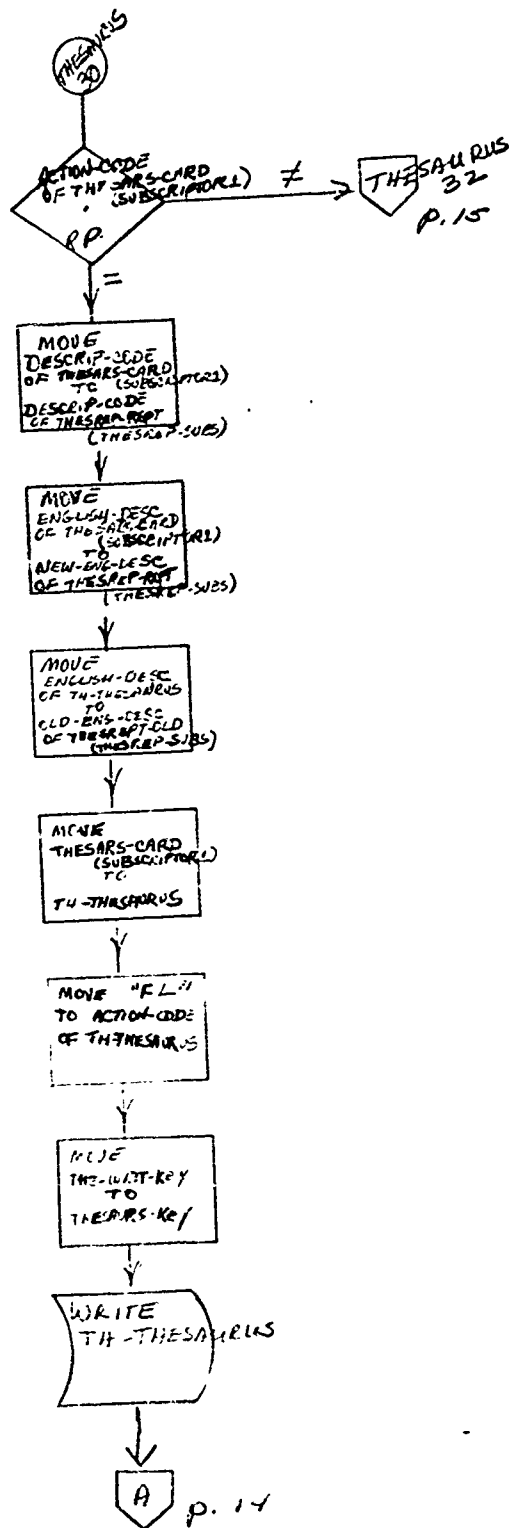

SAUFD FORM 2072-1 1 ip Mar 68

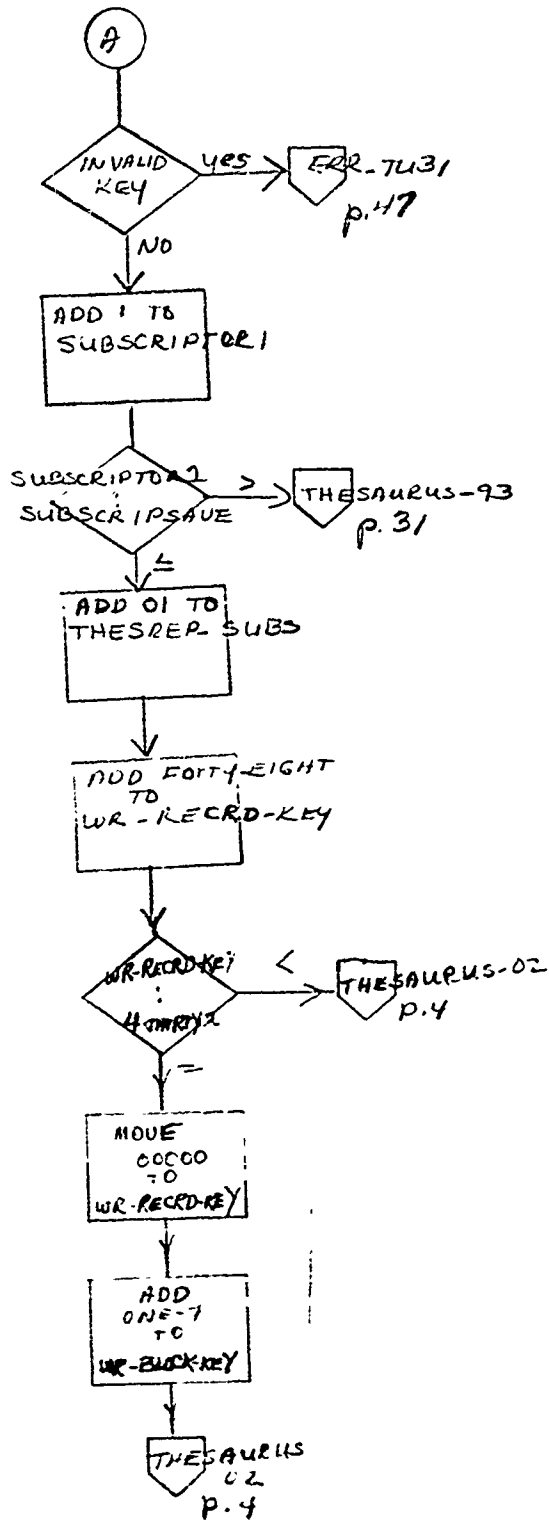

SMUPD FORM 2072-1 1 400 May 68

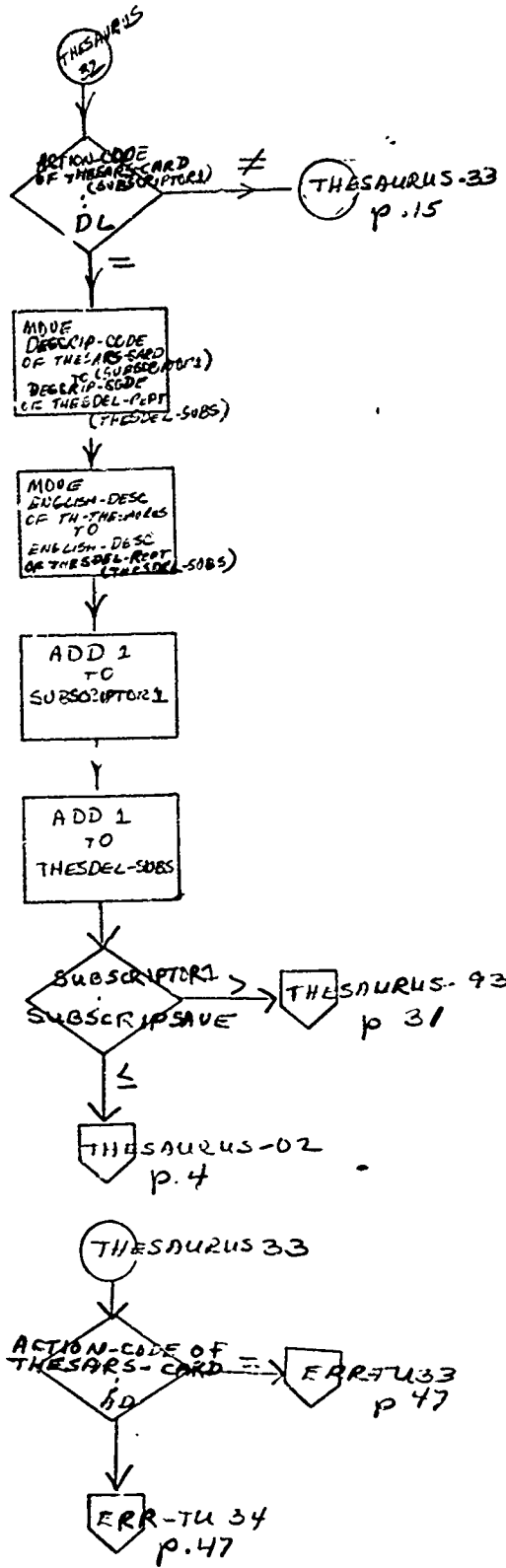

SMUFD FORM 2072-1 1 up Mar 68

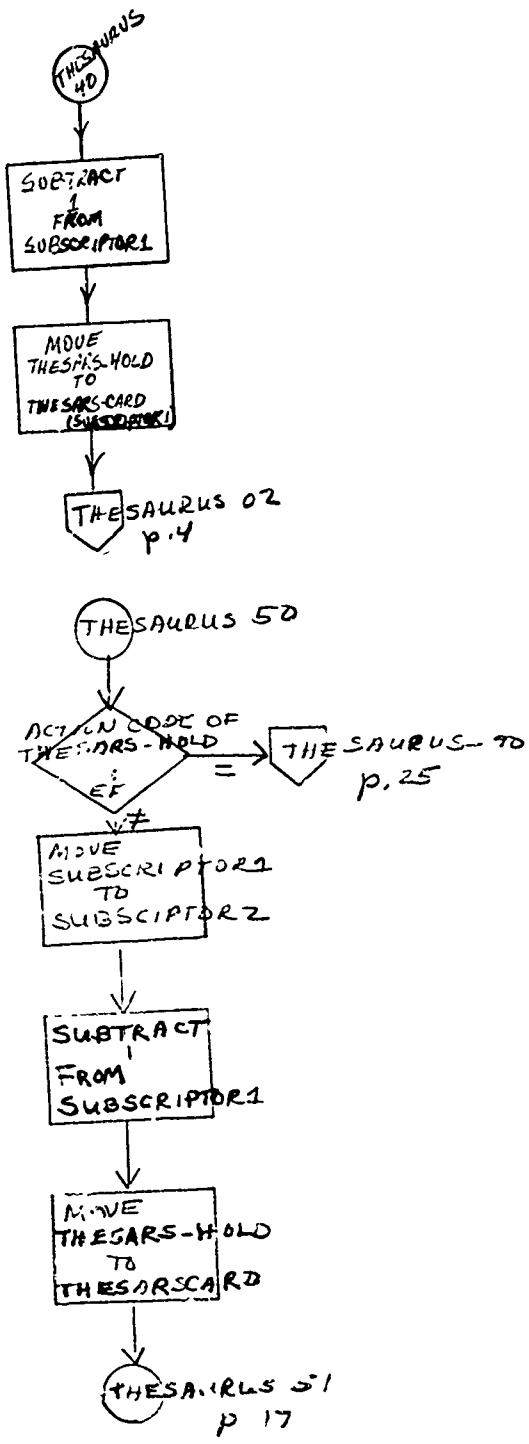

SMUFD FORM 2072-1 11 19 Mar 68

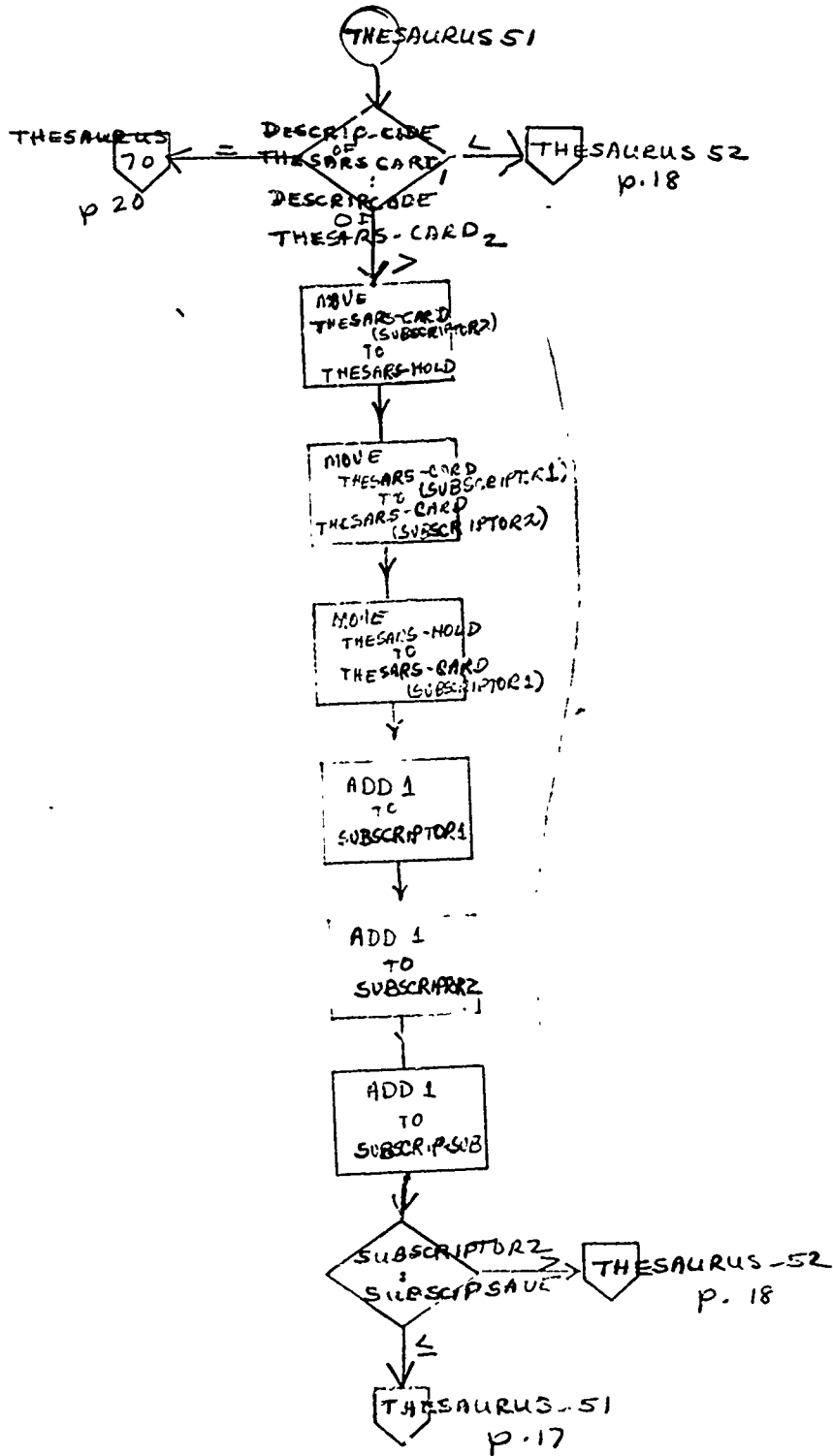

SMUFD FORM 2072-1 4 up. Mar 68

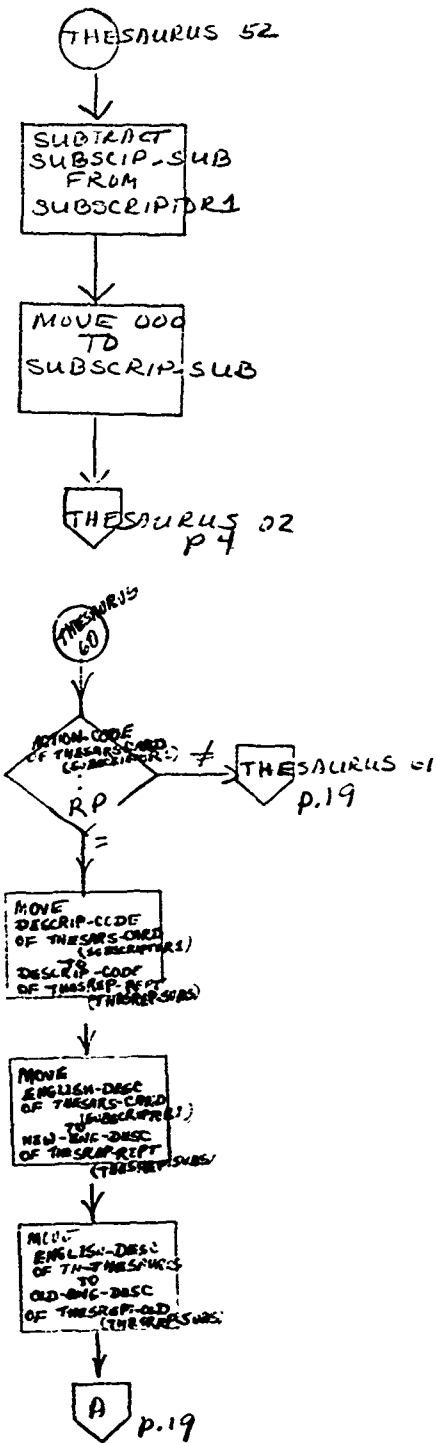

SNIPPED FROM 2072-1 1 ip Mar 68

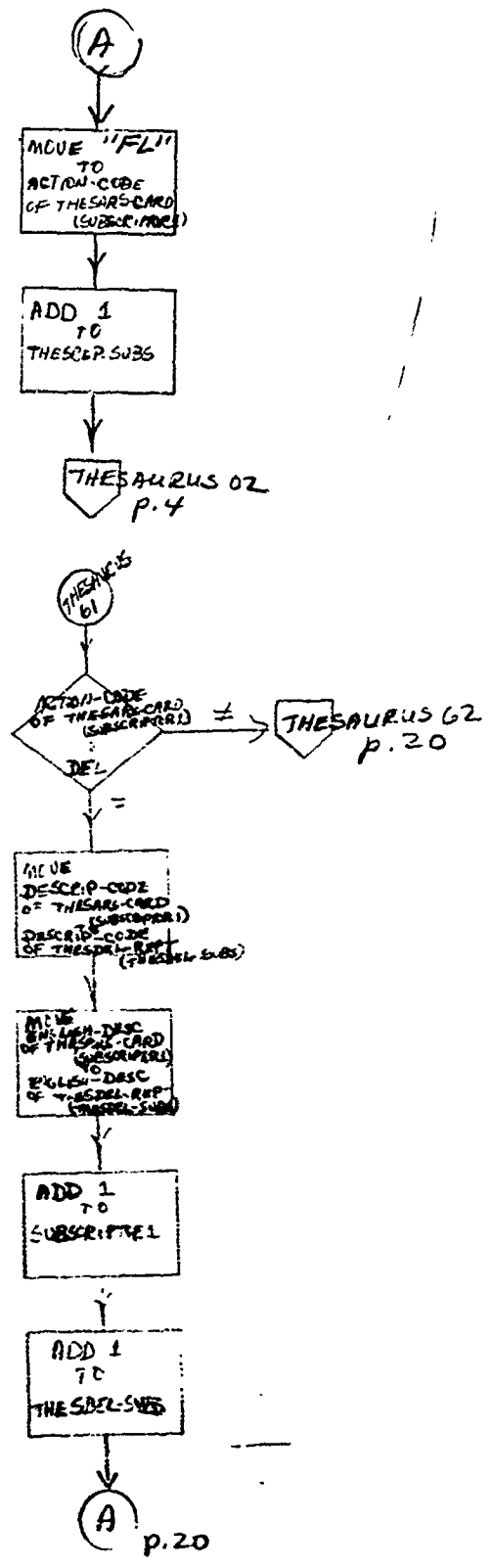

SMUPD FORM 2072-1 11 up Mar 68

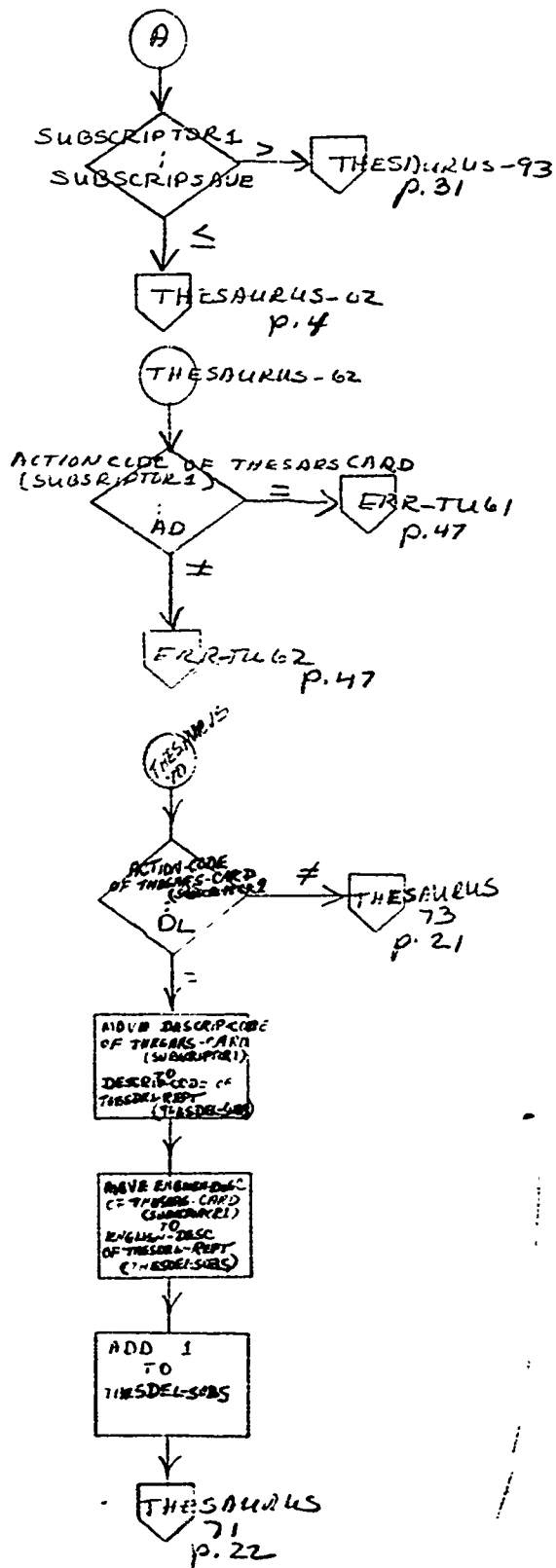

SIUFD FORM 2072-1 7 up Mar 68

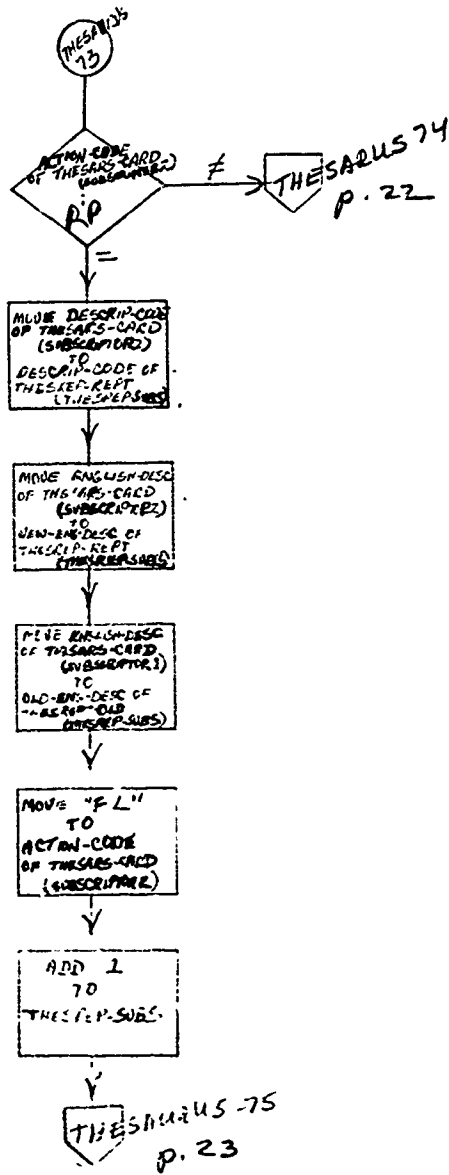

SNUPD FORM 2072-1 : 10 Mar 68

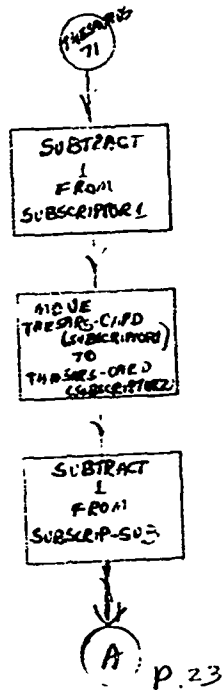
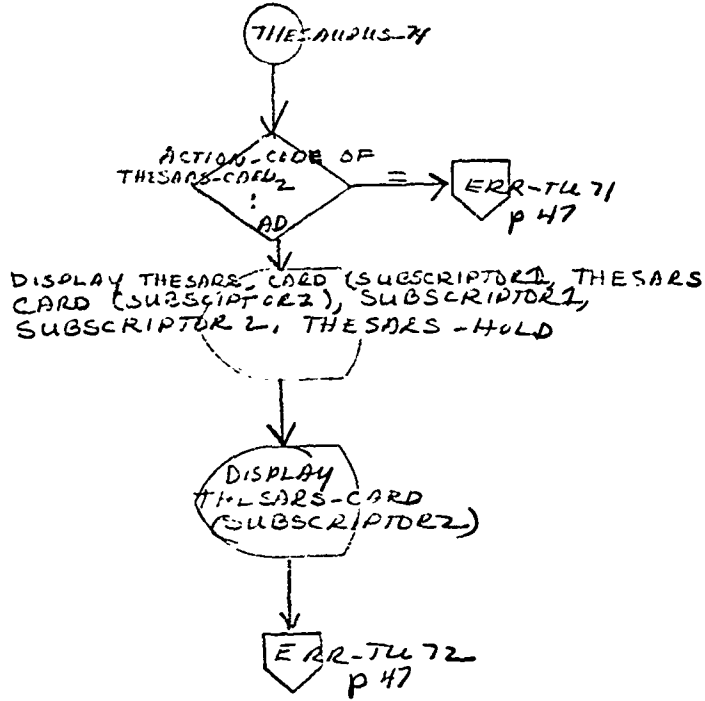

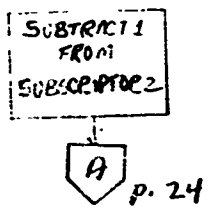
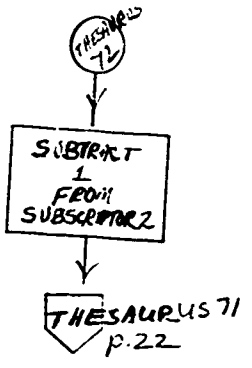
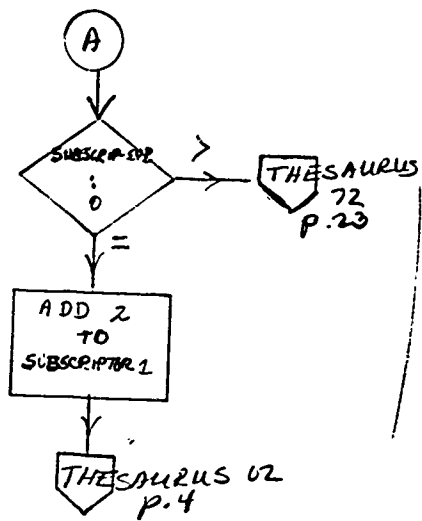

SMUFD FORM 2072-1 1 up Mar 68

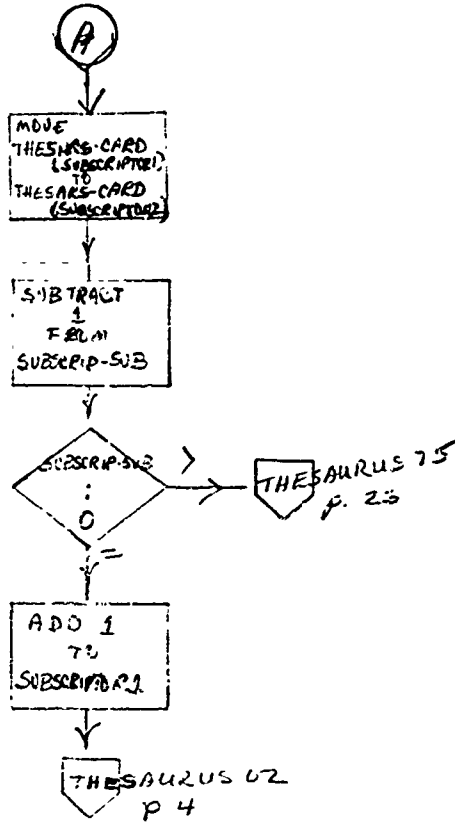

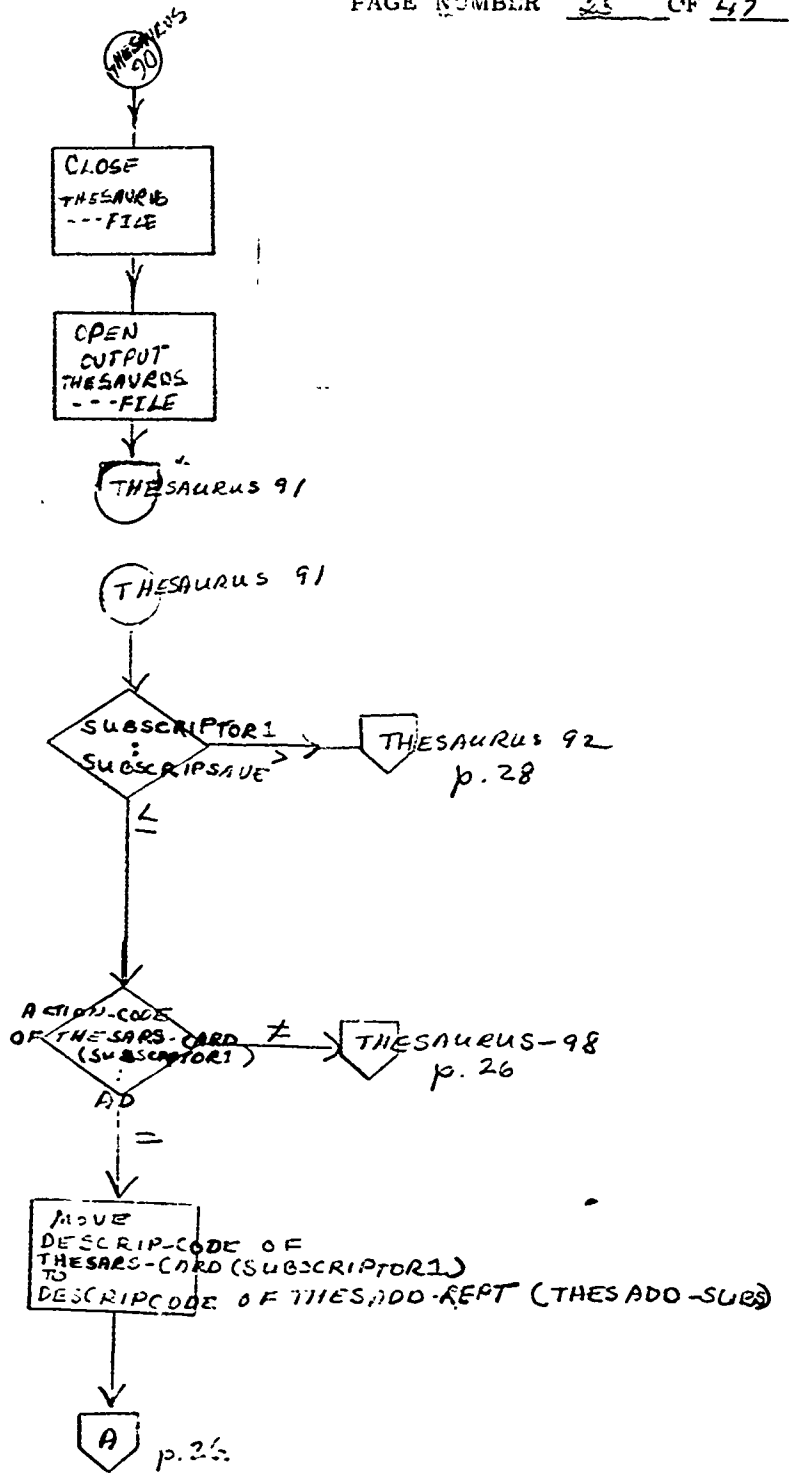

SMUD FORM 2072-1 7 up Mar 68

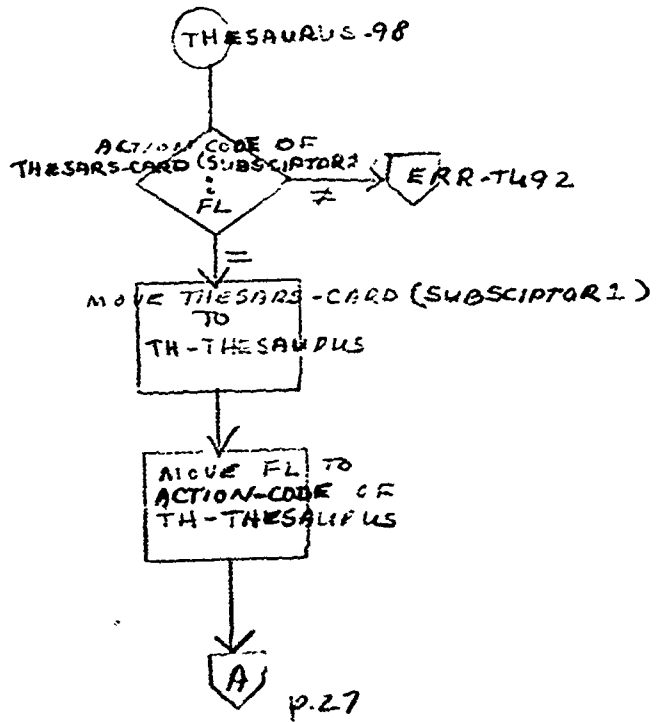
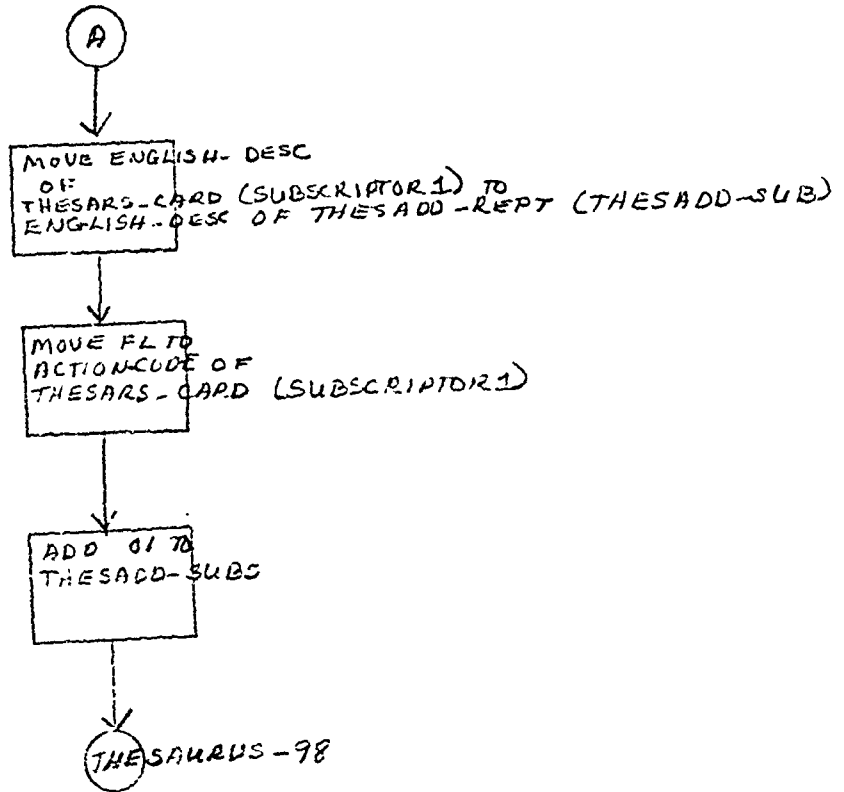

SMUD FORM 2072-1 '1 ip, Mar 68

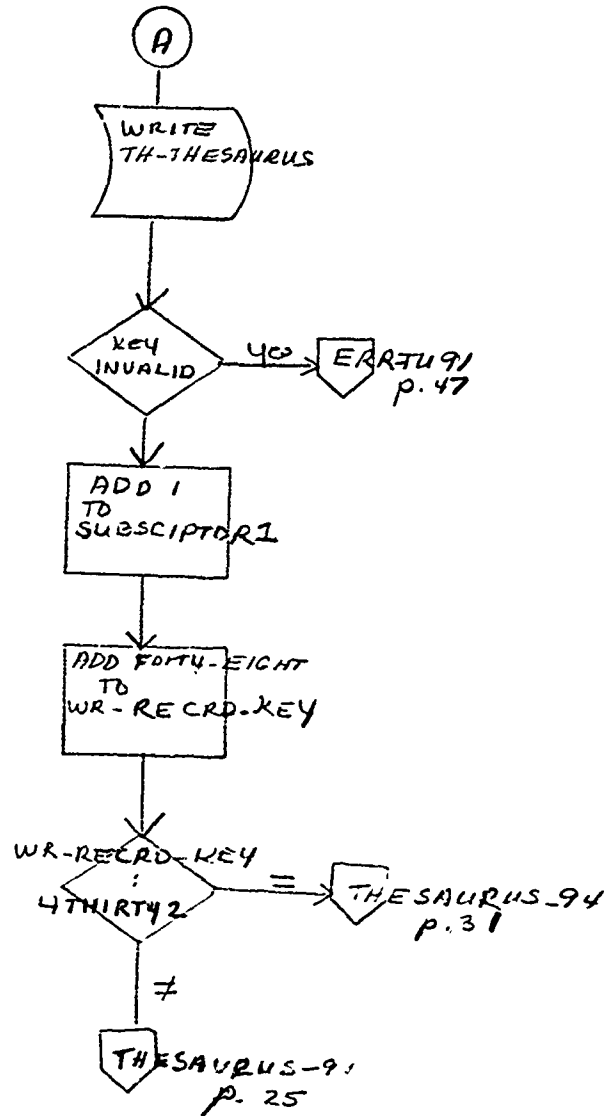

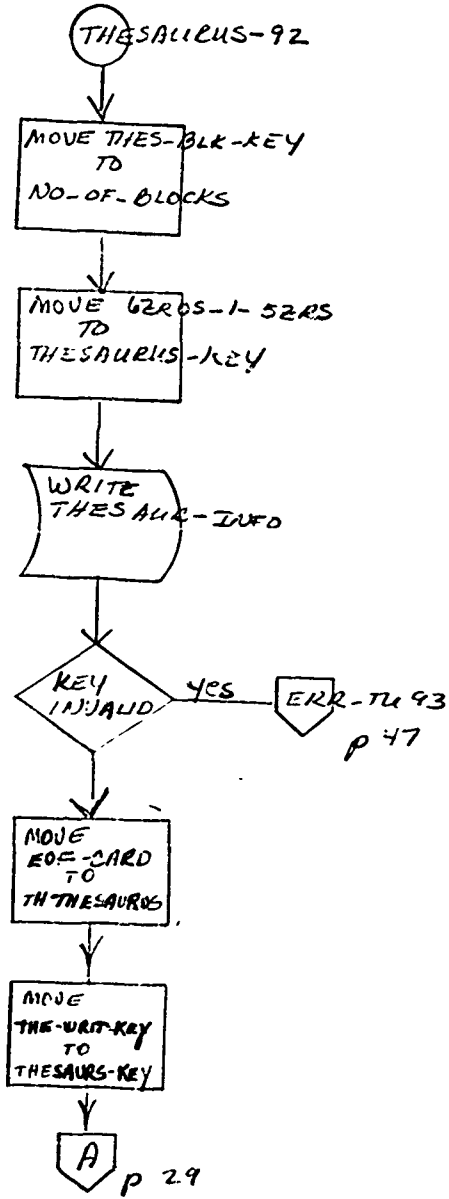

SMUFD FORM 2072-1 (1 up) Mar 68

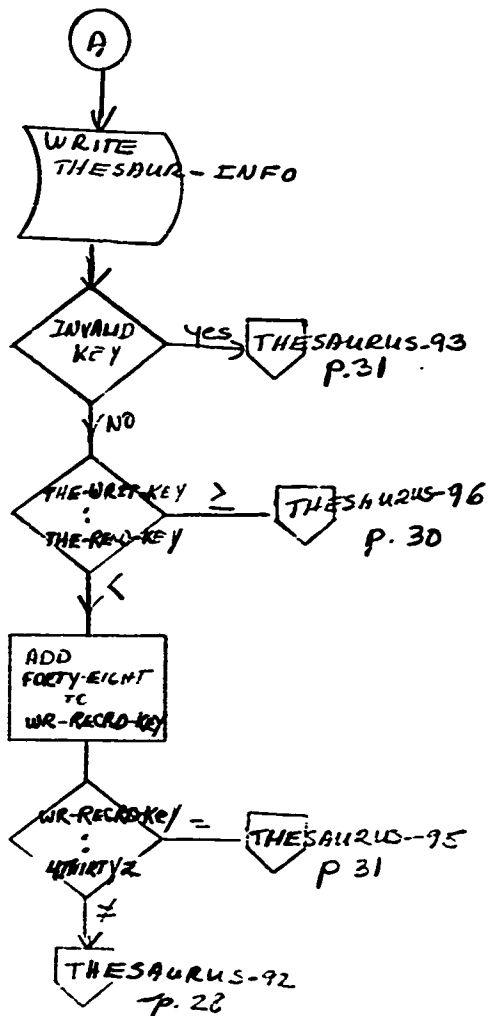

SMCFD FORM 2072-1 17 up, Mar 68

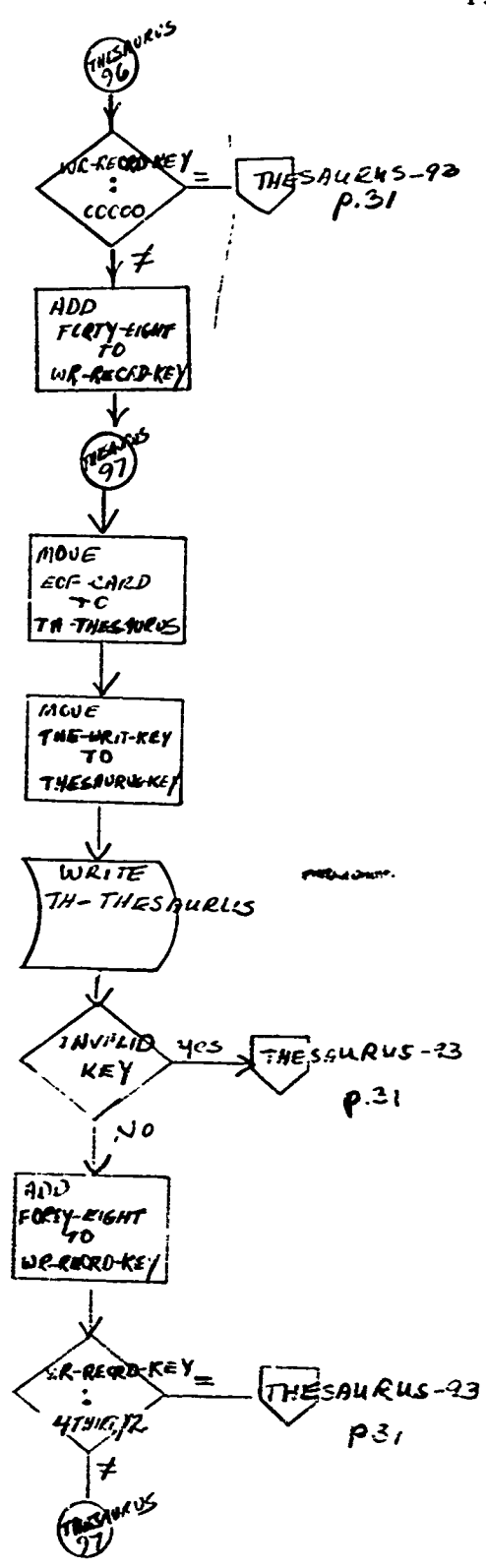

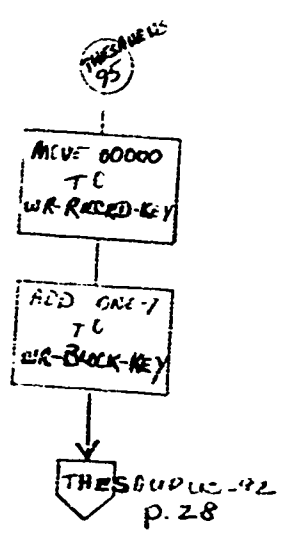
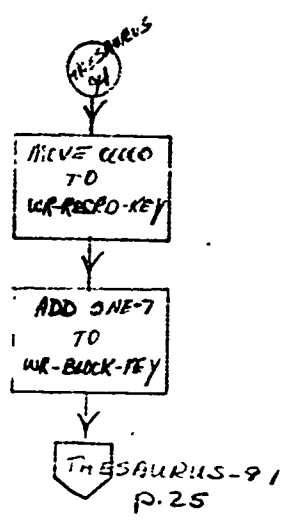
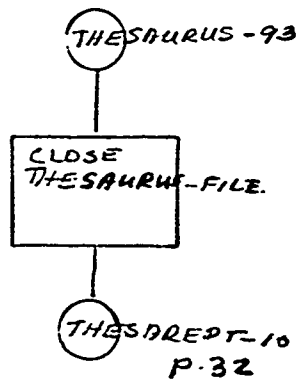

SAICFD FORM 2072-1 : 10-11-68

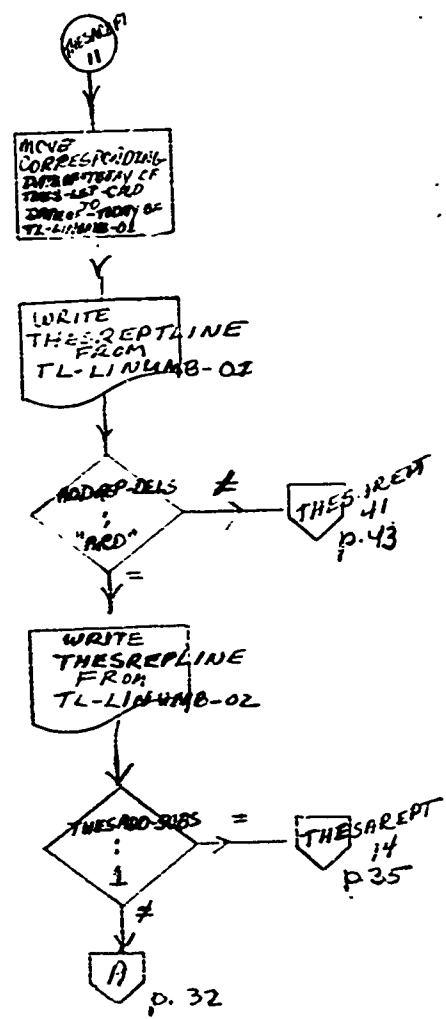
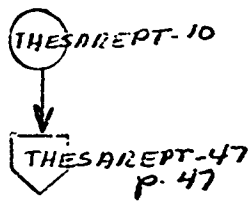

SMUFD FORM 2072-1 1 19- Nov 68

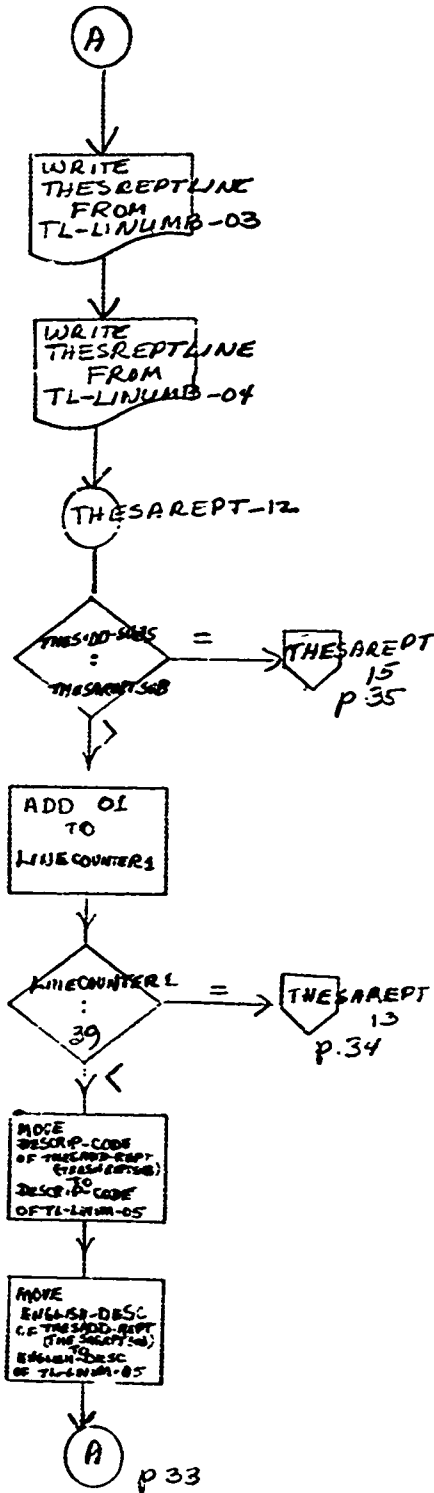

SMUFD FORM 2072-1 3 49 Mar 69

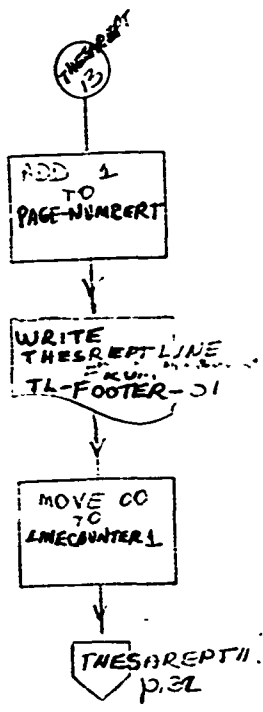
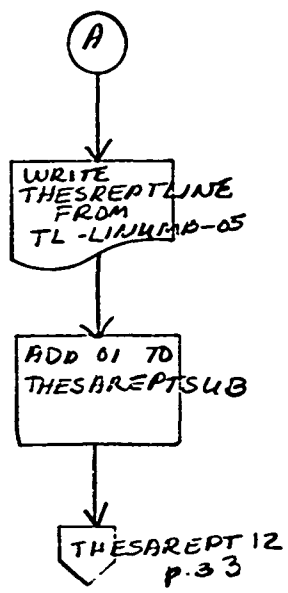

SMUFD FORM 2072-1 1 up Mar 68

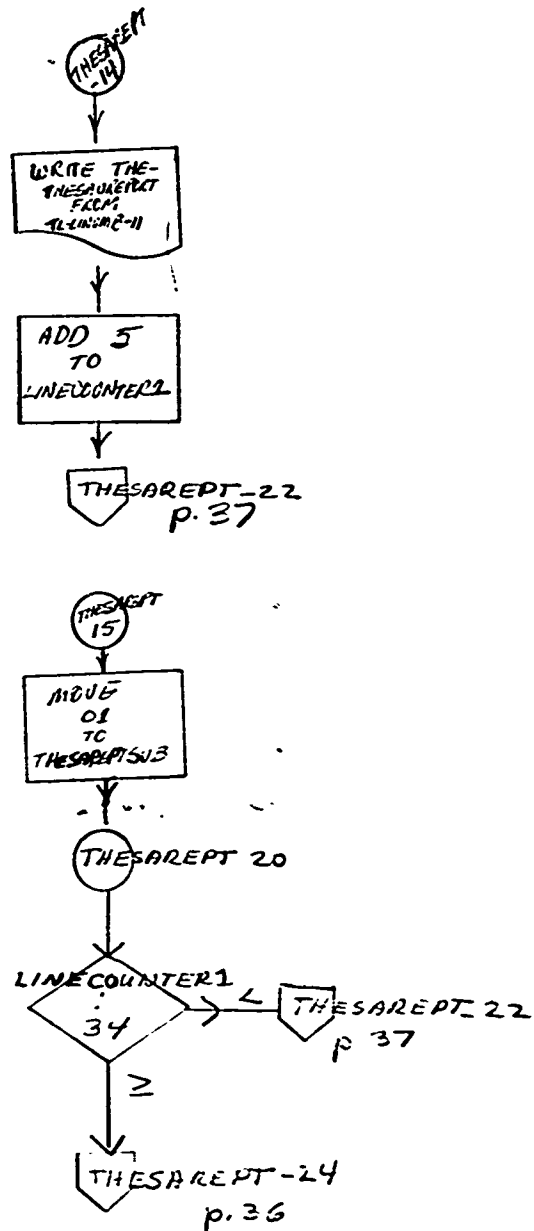

OFFICE SYMBOL _____
SYSTEM CHART NO. _____
RUN NUMBER 1204
PAGE NUMBER 36 OF 47

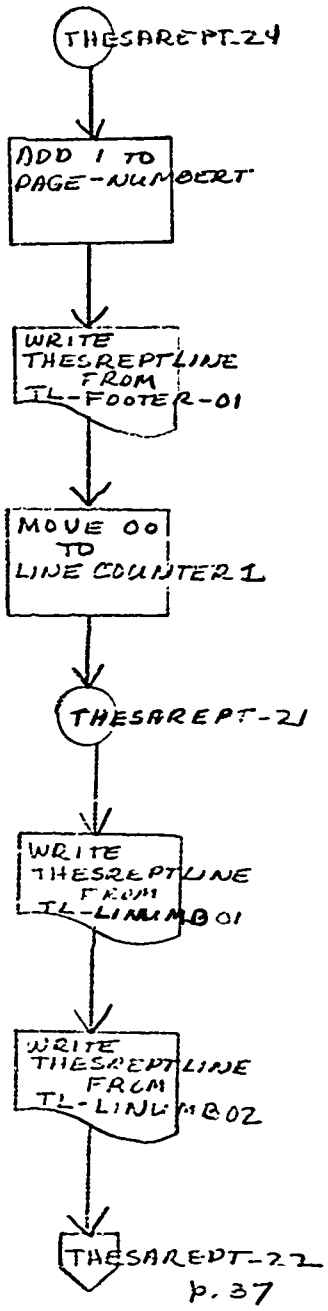

SMUPD FORM 2072-1 7/1 up Mar 68

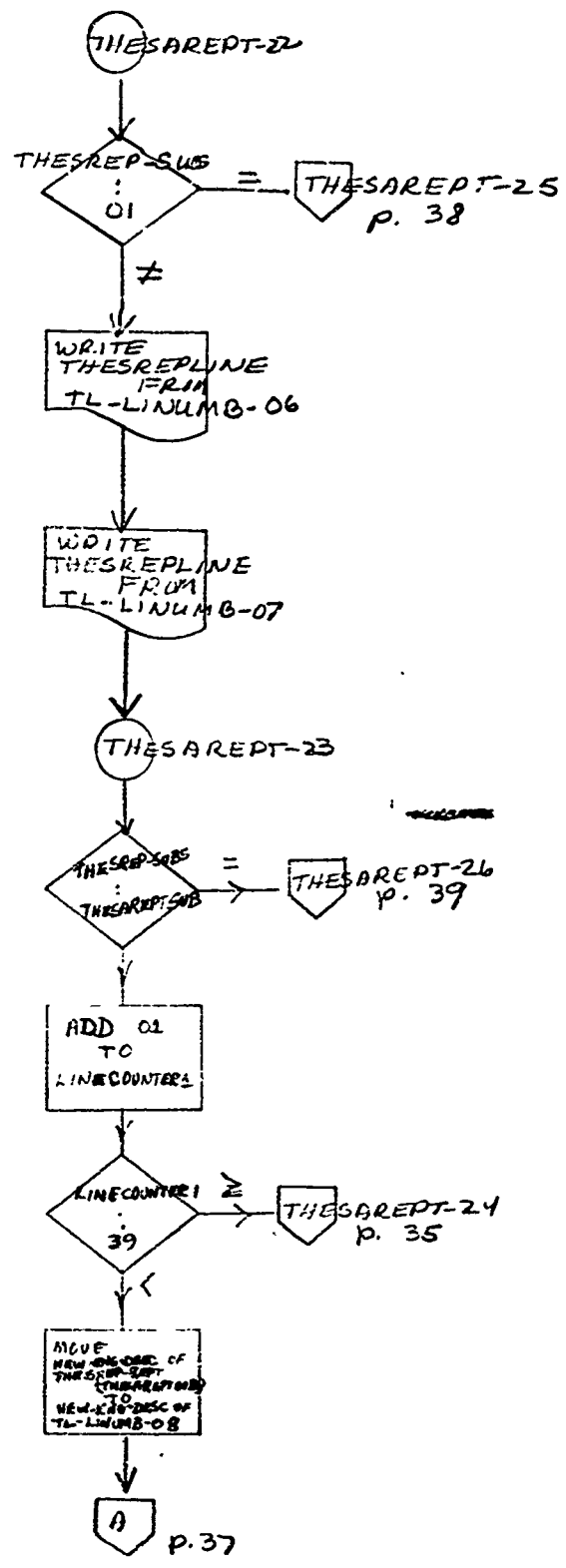

SMUD FORM 2072-1 1 up Mar 68

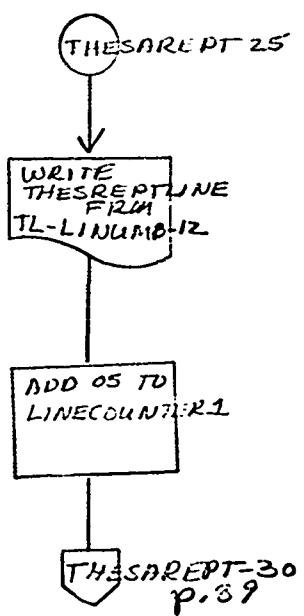
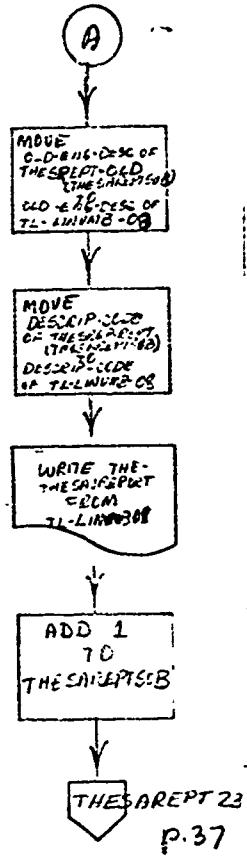

SMUPD FORM 2072-1 11 ip Mar 68

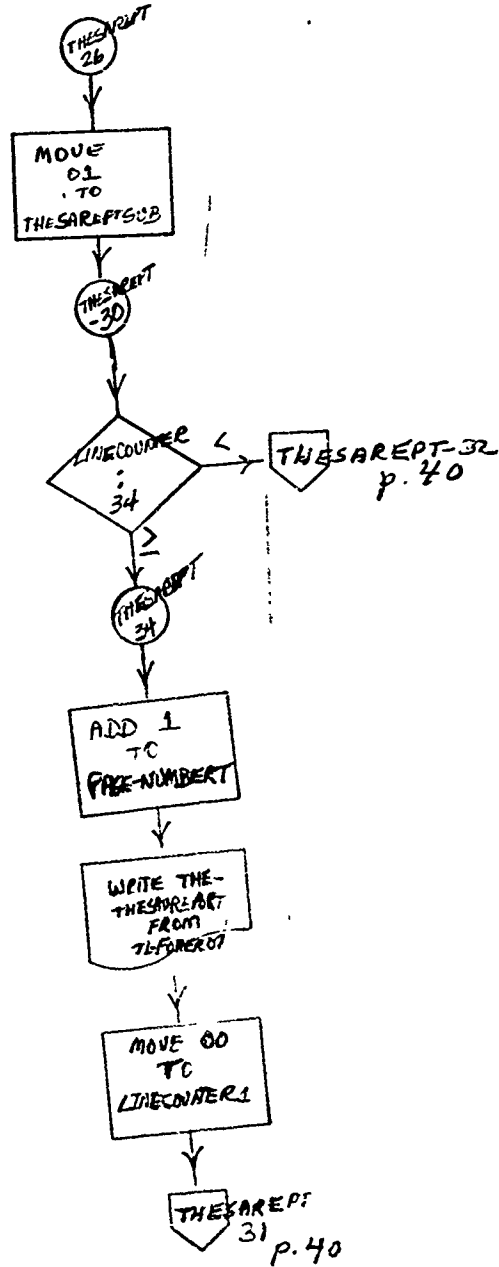

SMCFD FORM 2072-1 7 up, May 68

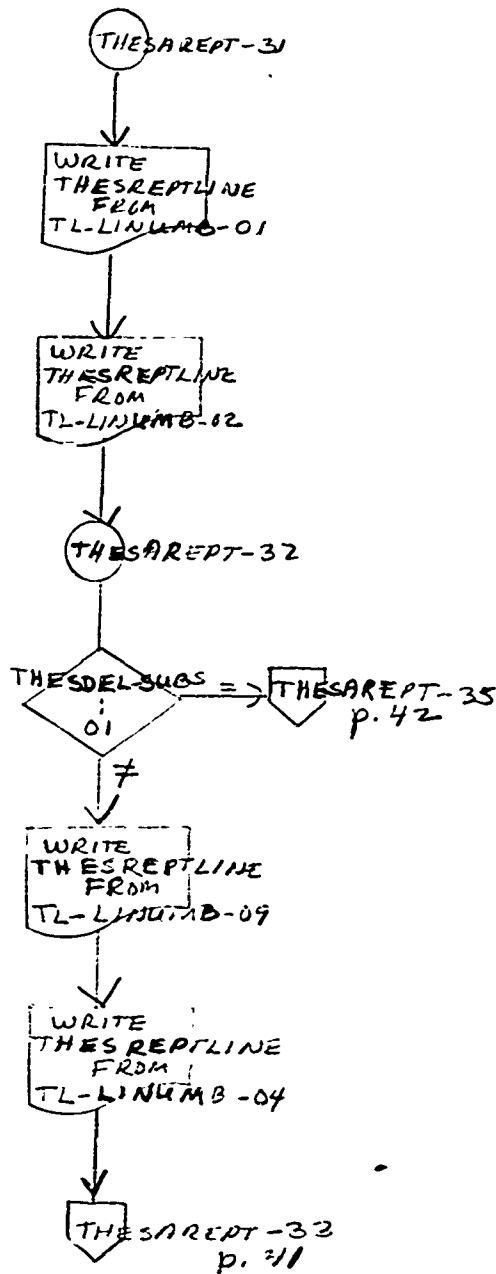

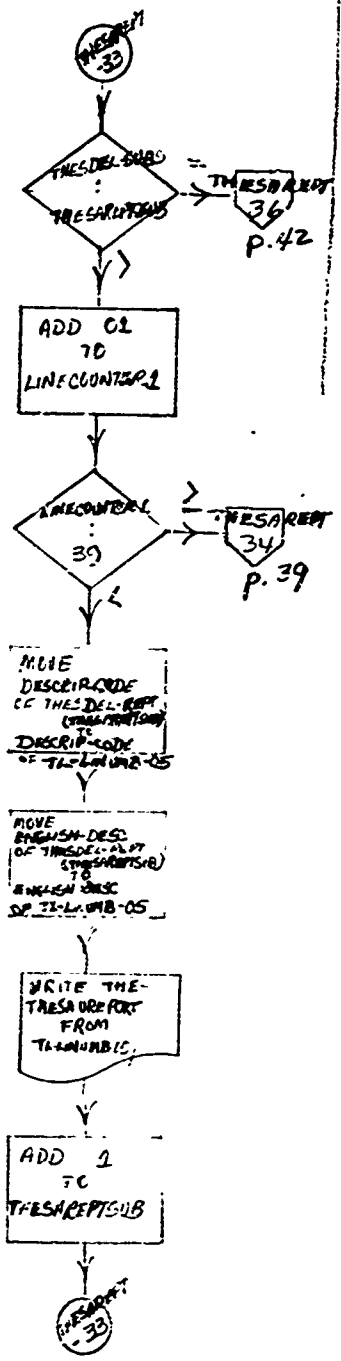

SMCFD FORM 2072-1 1 1p Nov 68

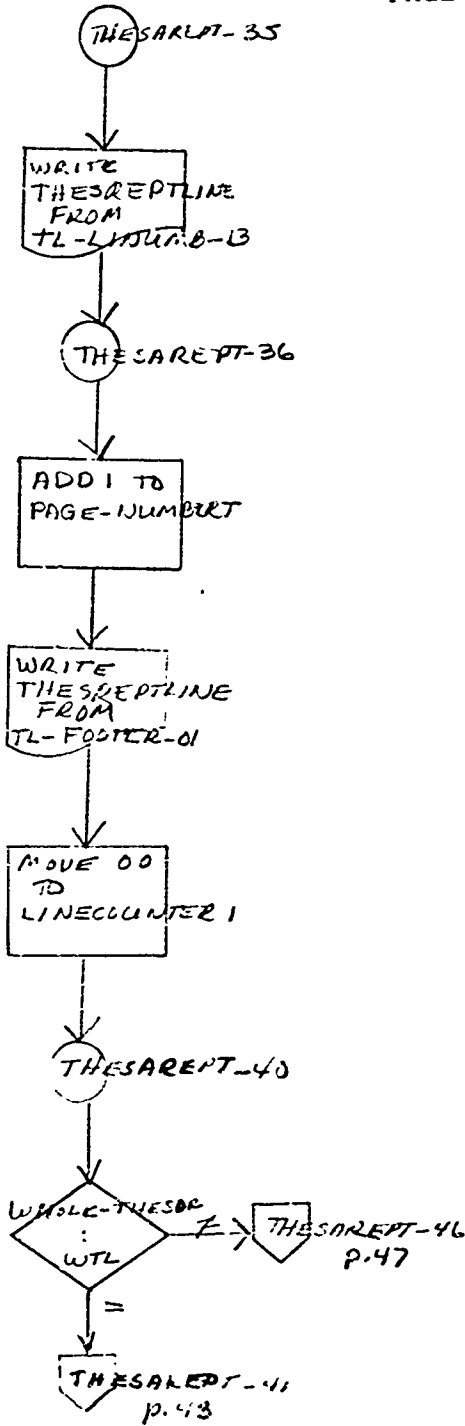

SMUPD FORM 2072-1 1 up Mar 68

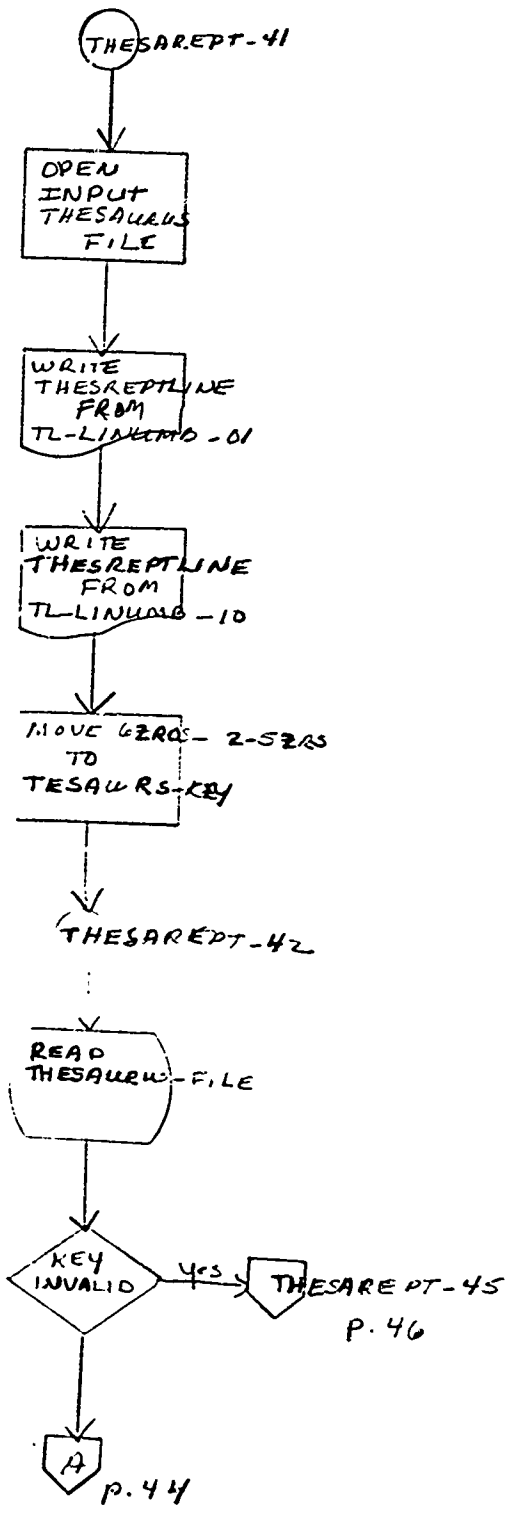

SMICFD FOR Y 2072-1 1 10 Mar 68

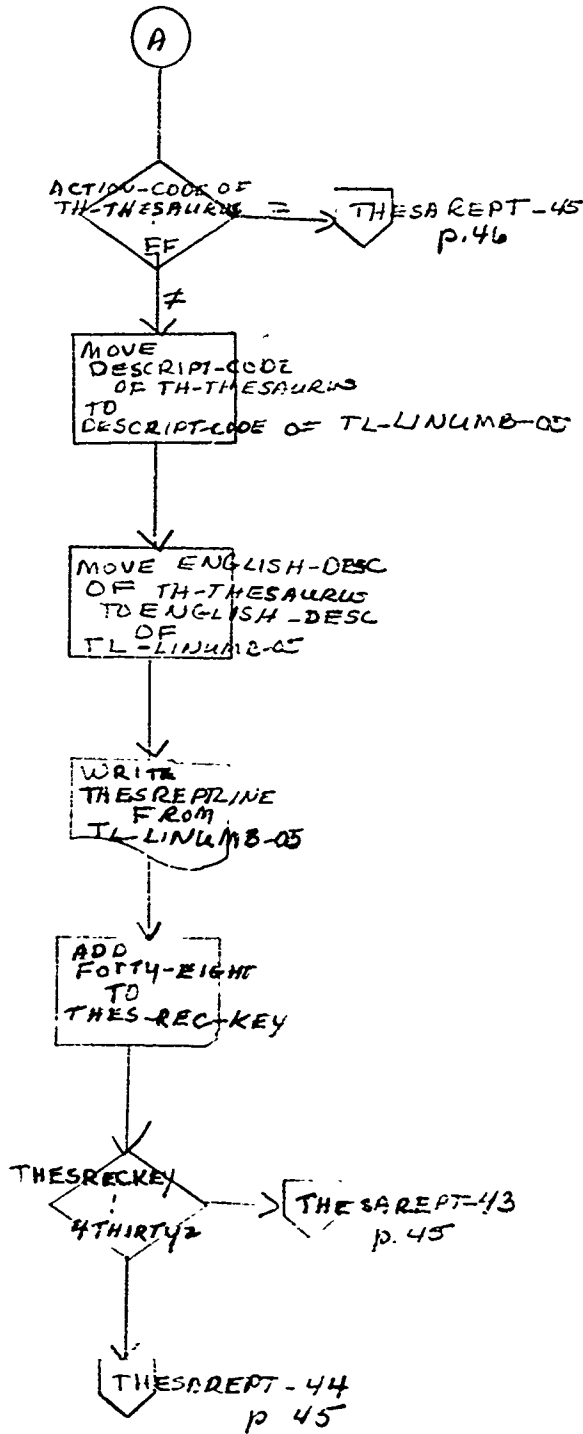

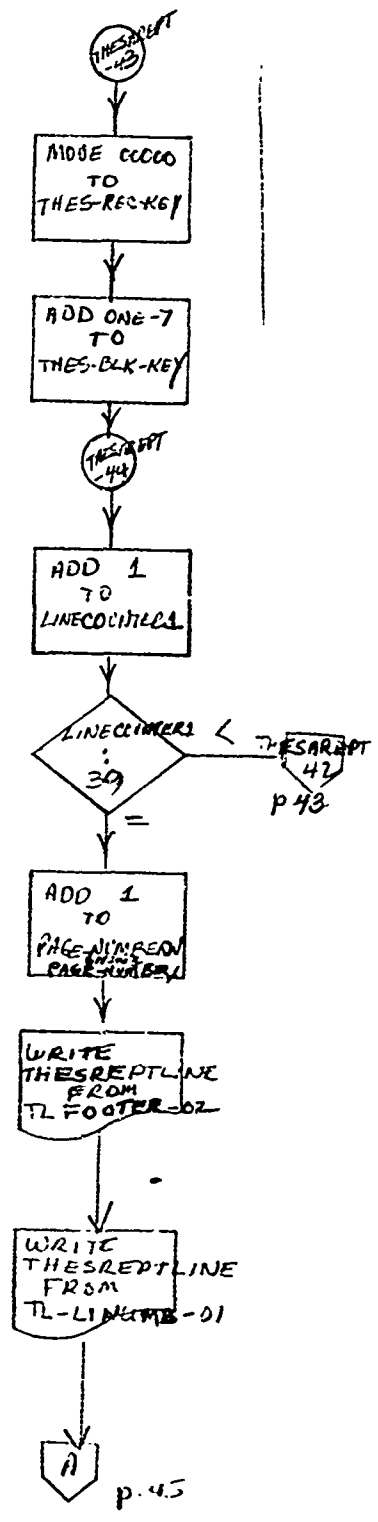

SMCFD FORM 2072-1 1 up Mar 68

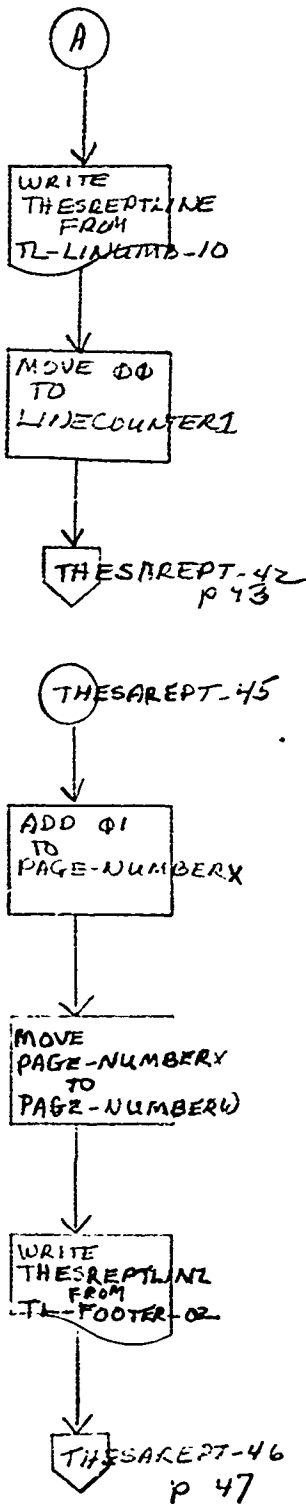

SMCFD FORM 2072-1 71 up, Mar 68

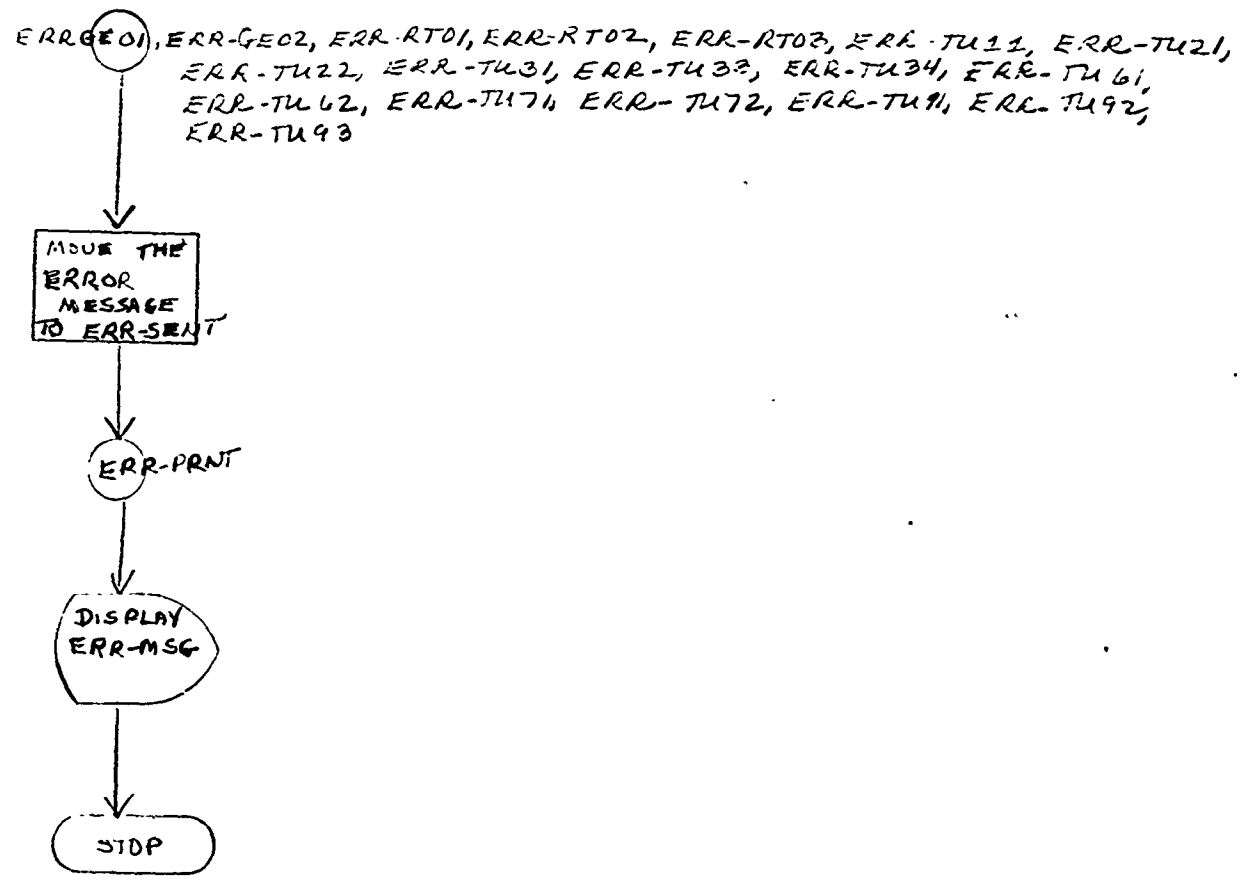
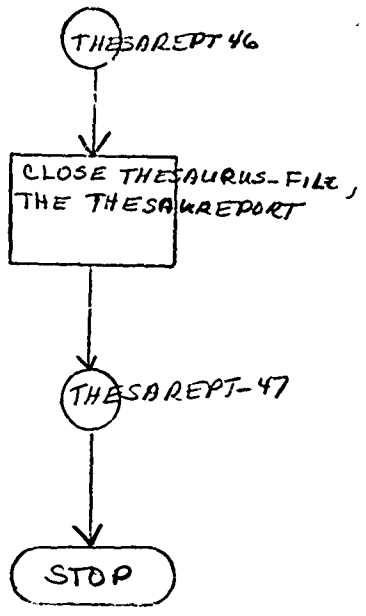

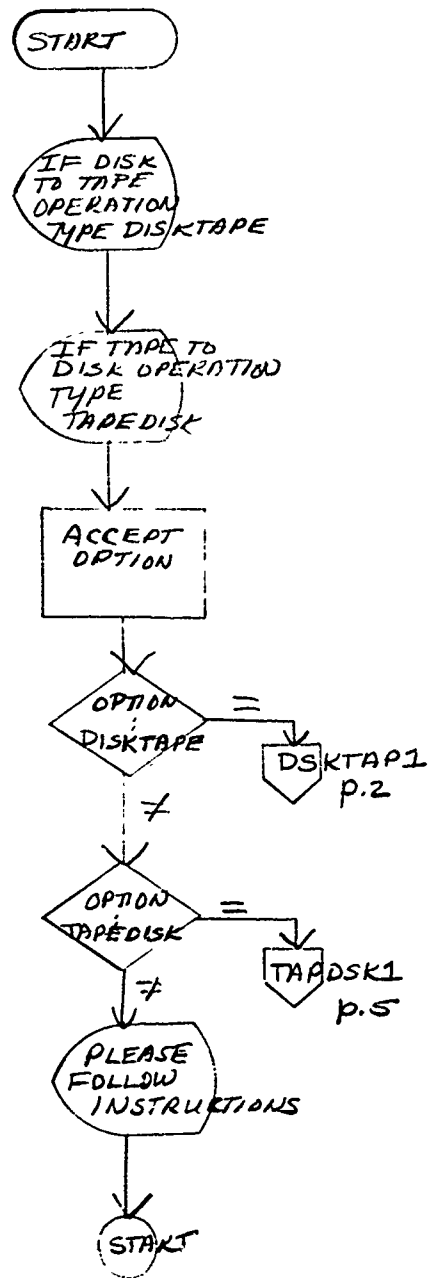

SMUFD FORM 2072-1 (11/68) (1/68) Mar 68

SMUFD FORM 2072-1 (T) 10p, Mar 68

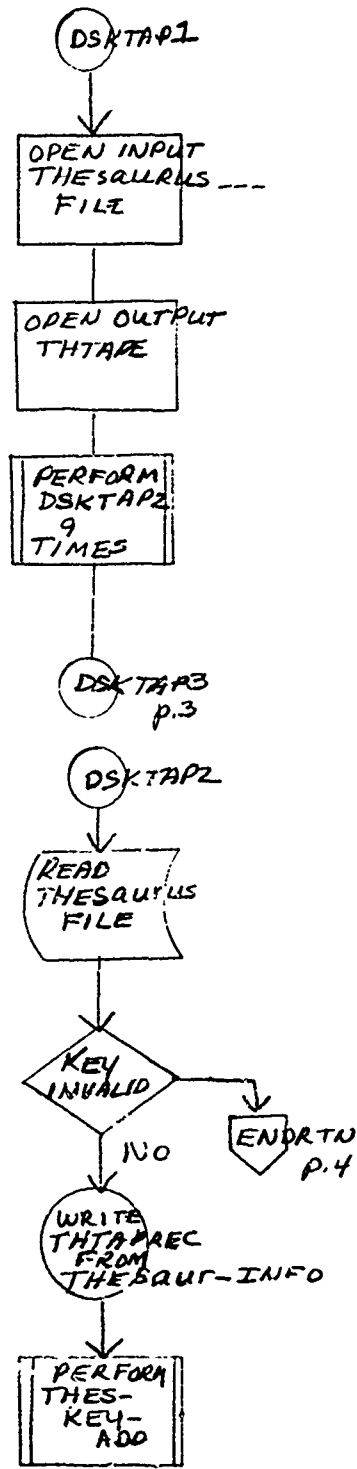

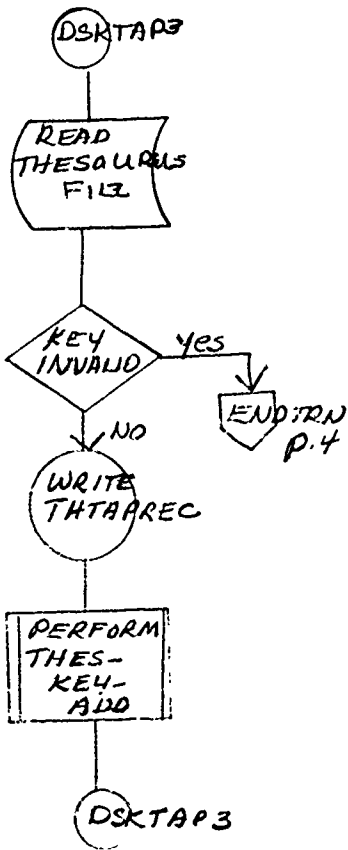

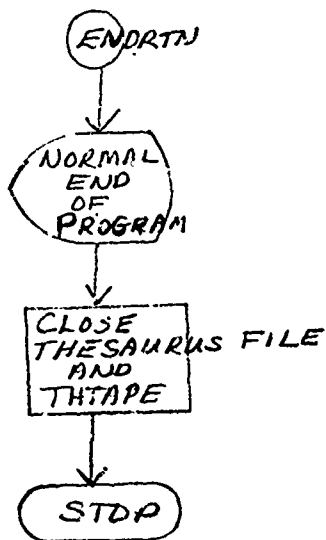
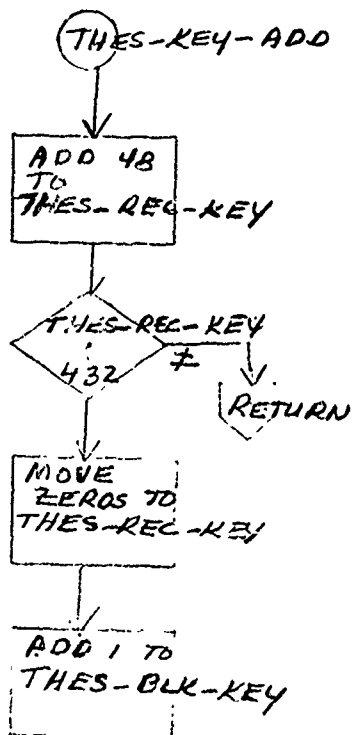

SMUFD FORM 2072-1 (T) up; Mar 68

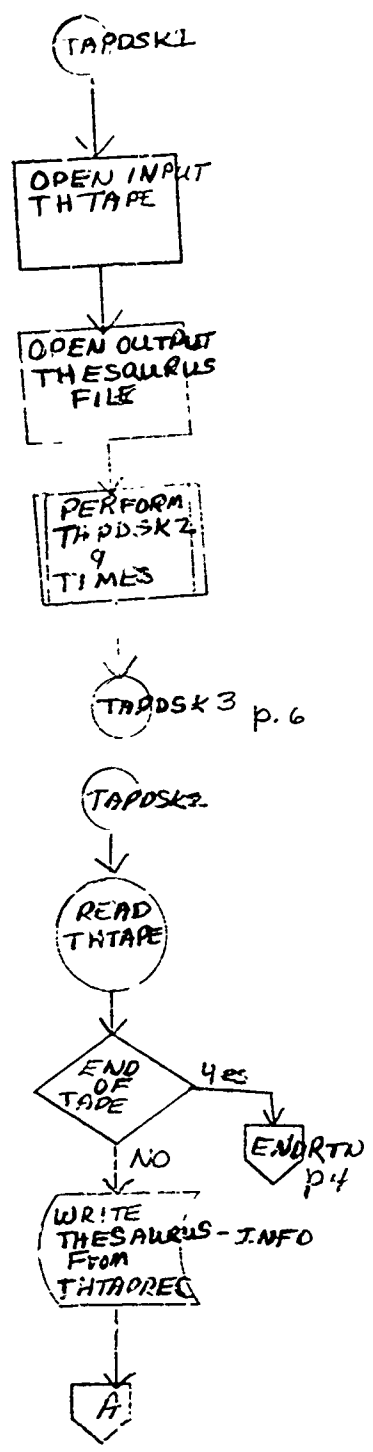

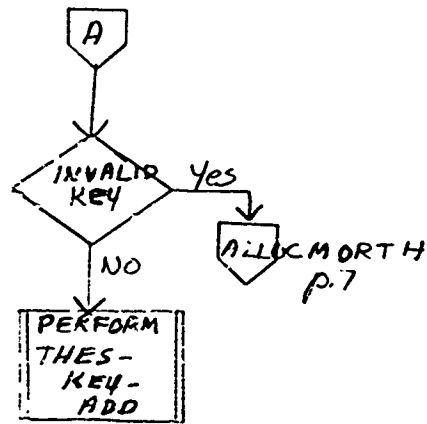

TAPDSK3

READ TH TAPE

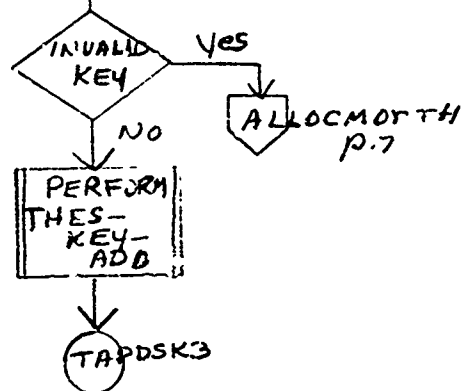
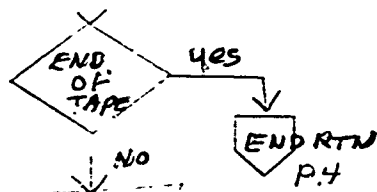

SMUPD FORM 2072-1 1T ip, Mar 68

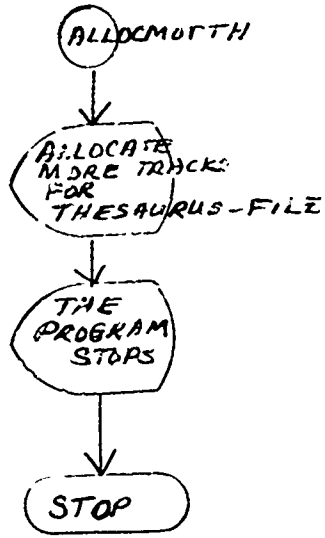

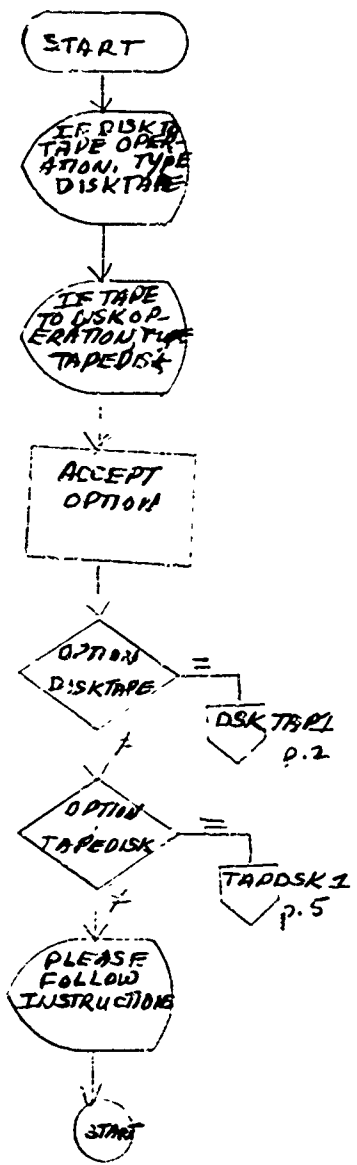

SMUFD FORM 2072-1 -T up Mar 68

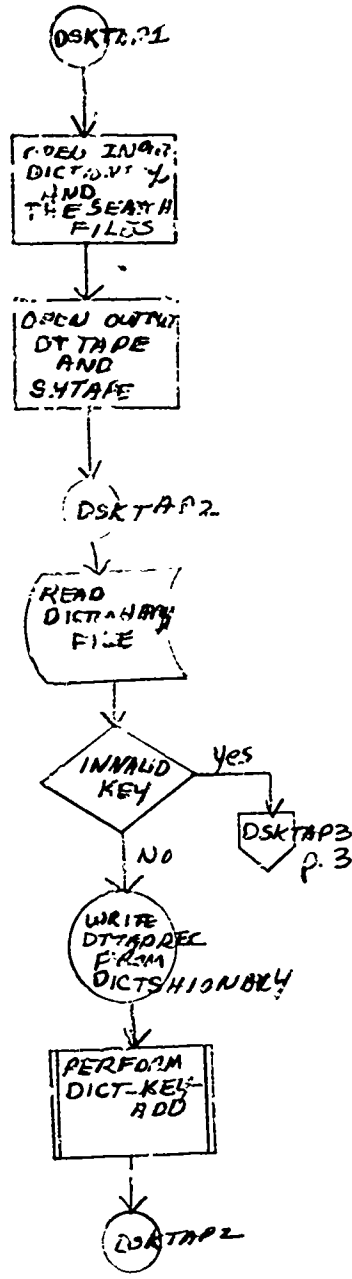

SMUFD FORM 2072-1 (1) 1p, Mar 68

SMUFD FORM 2072-1 'I' ip, Mar 68

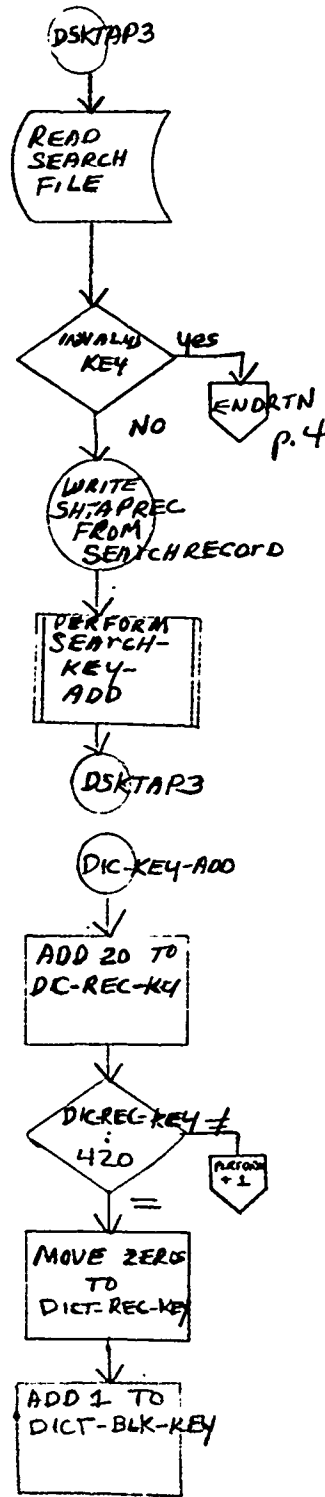

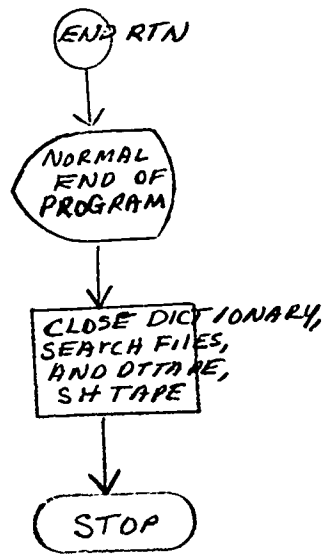
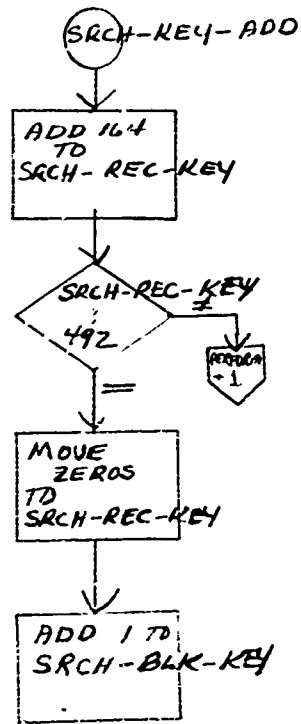

SMUFD FORM 2072-1 (T) 1p, Mar 68

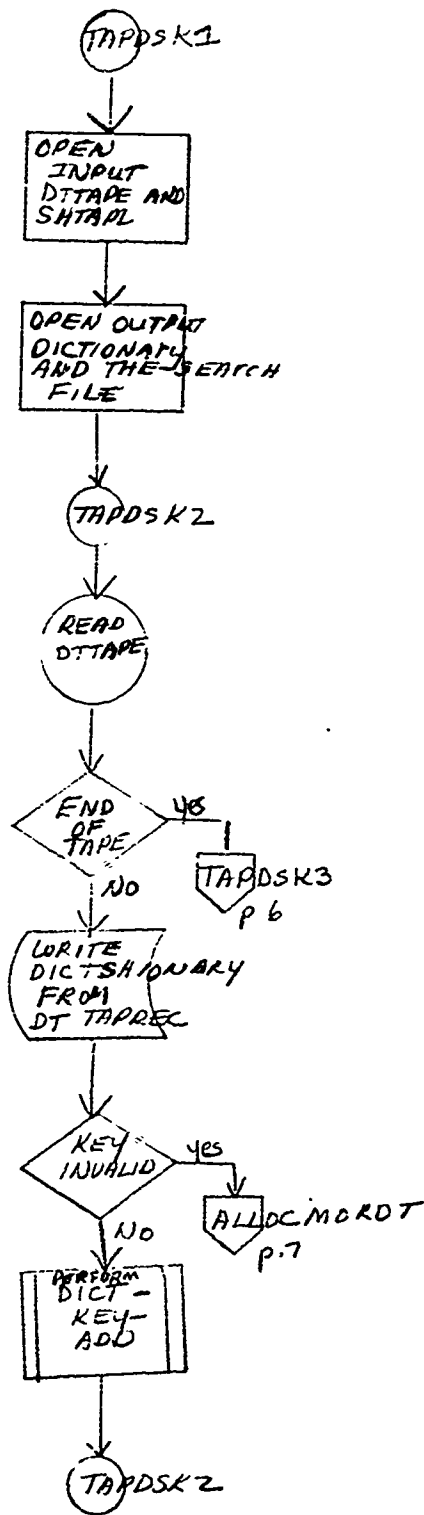

SMUFD FORM 2072-1 (1) -ip, Mar 68

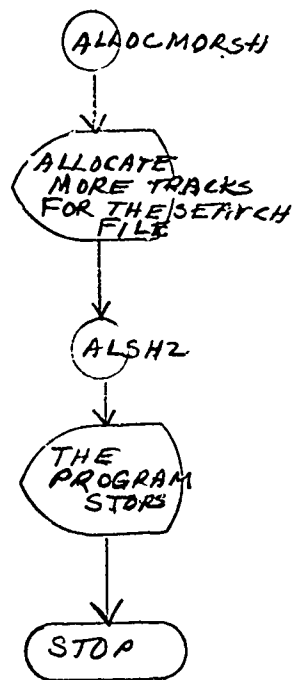
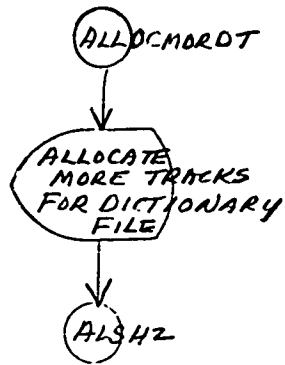

SMUFD FORM 2072-1 'T' ip, Mar 68

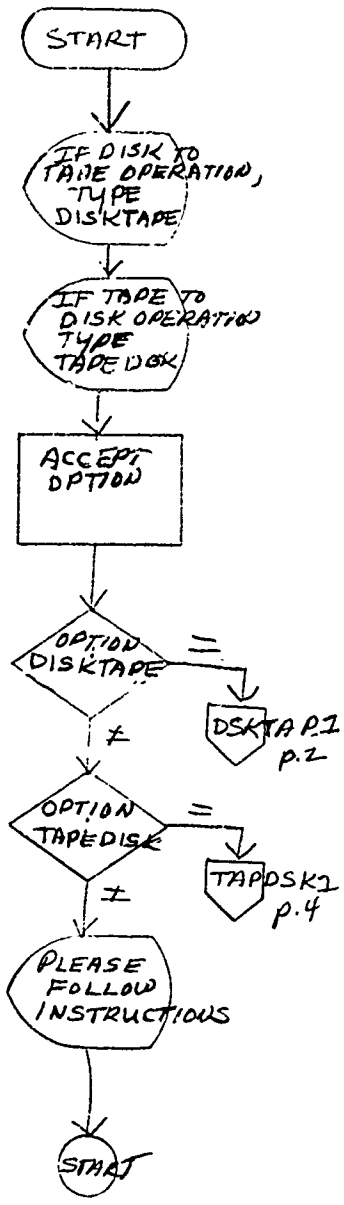

SMUFD FORM 2072-1 (T) 11p, Mar 68

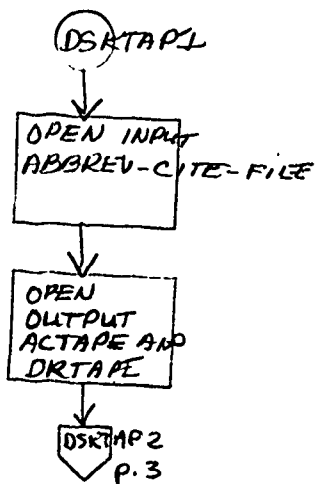

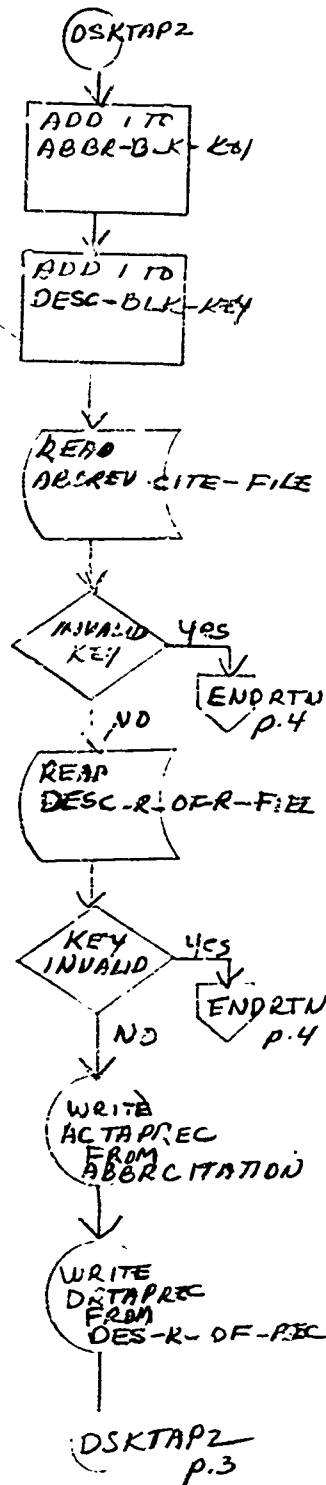

SMUPD FORM 20 2-1 (11/64) Mar 68

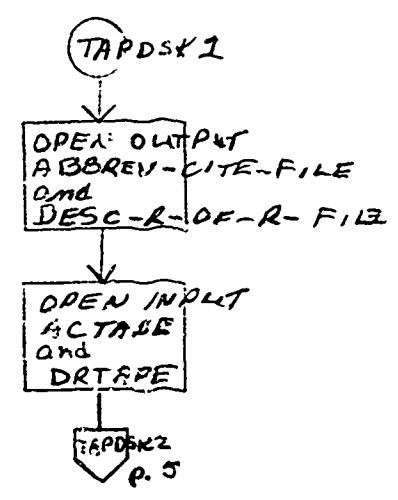
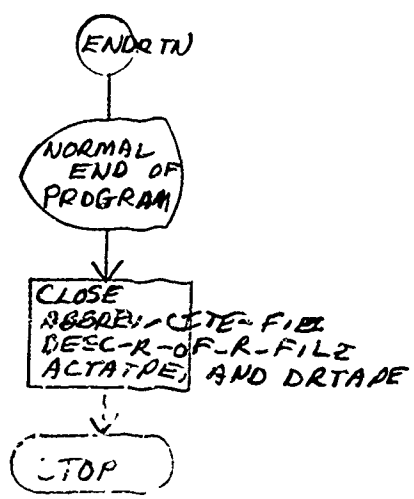

SMUFD FORM 2072-1 '1' ip, Mar 68

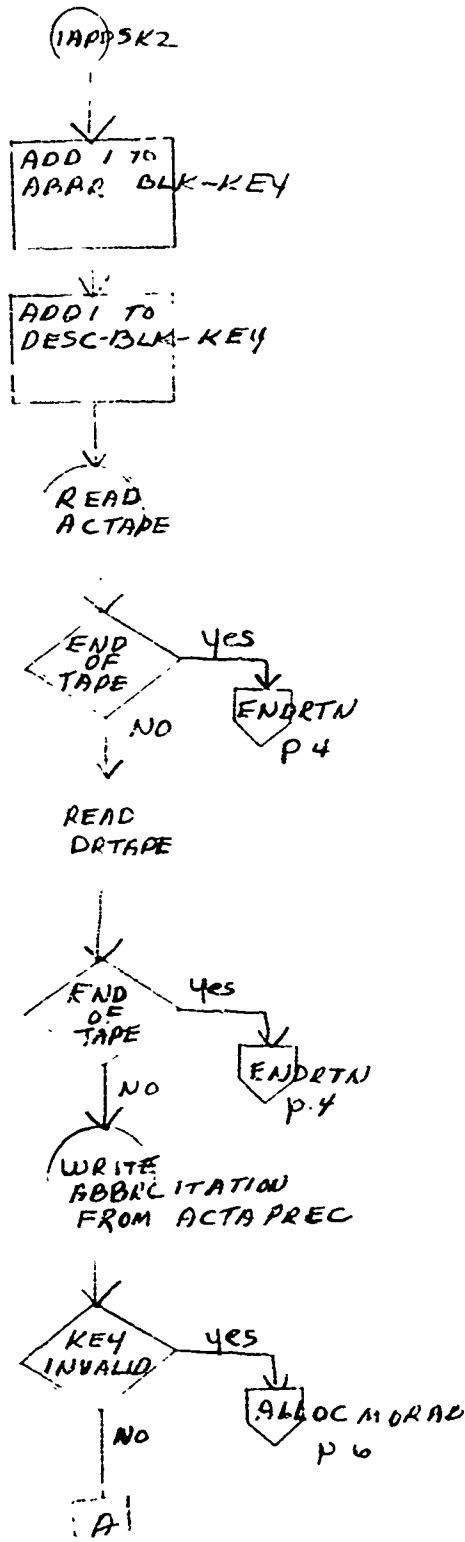

SMUFD FORM 2072-1 (1) 11p, Mar 68

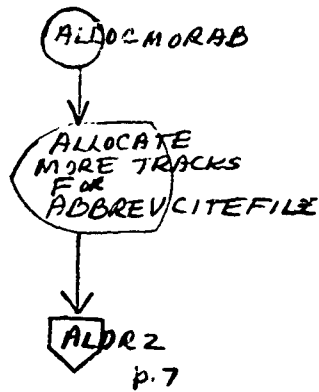
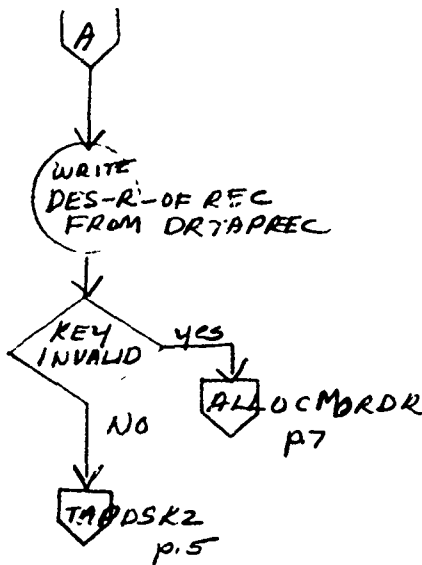

SMUFD FORM 2072-1 17. 11p. Mar 68

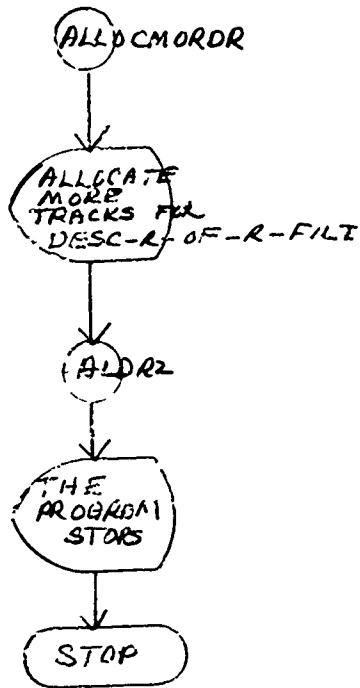

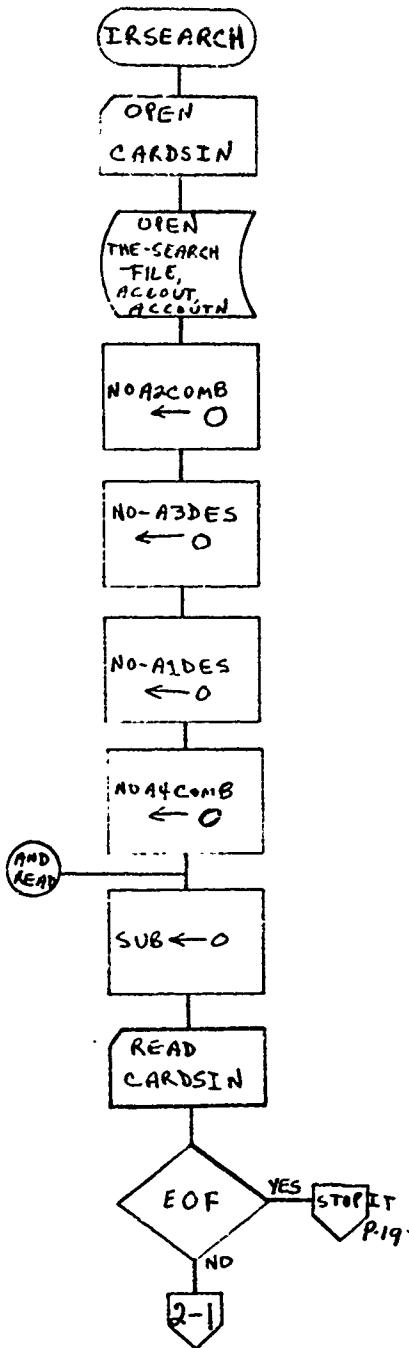

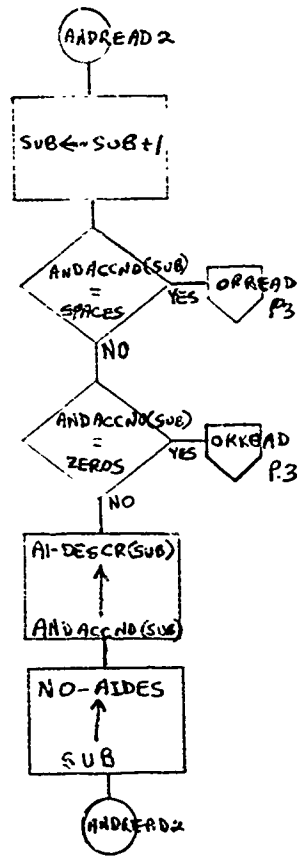
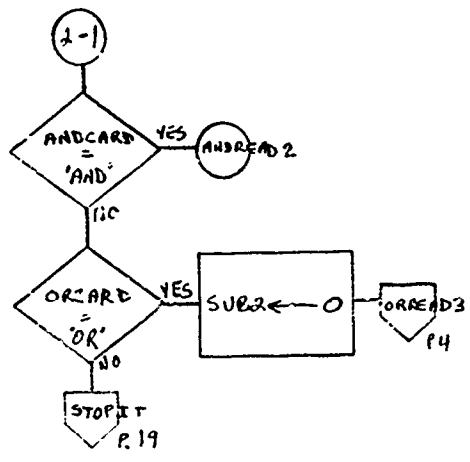

SMUFD FORM 2072-1 (T) (ip) Mar 68

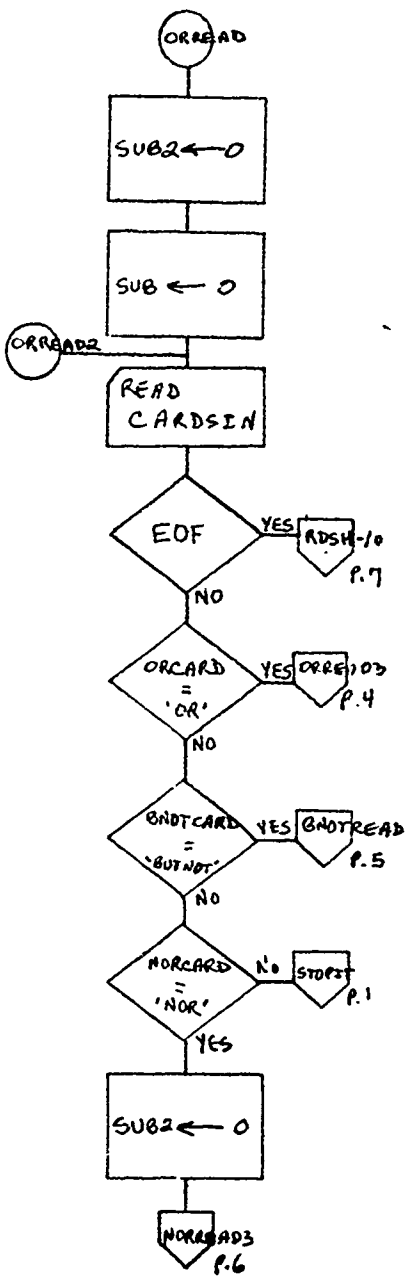

SMUFD FORM 2072-1 'T . ip. Mar 68

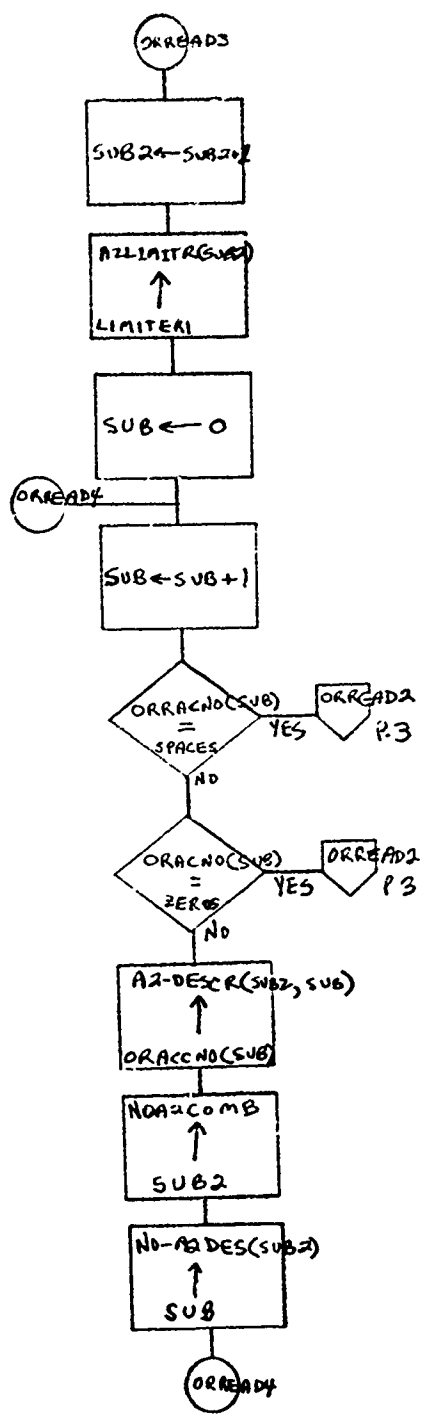

SMUFD FORM 2072-1 (11-11-61) (ip) Ma: 68

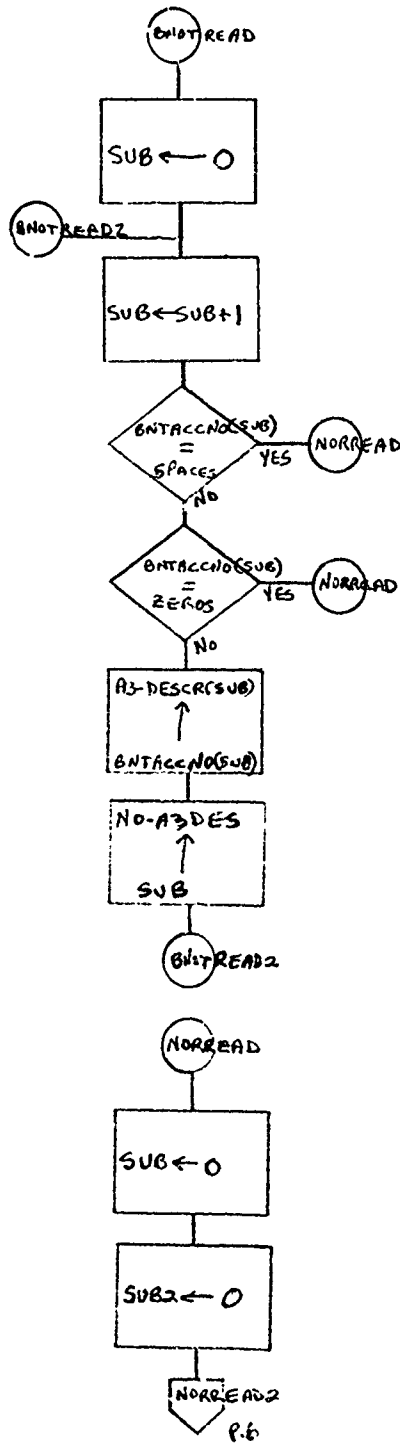

SMUFD FORM 2072-1 171 ip, Mar 68

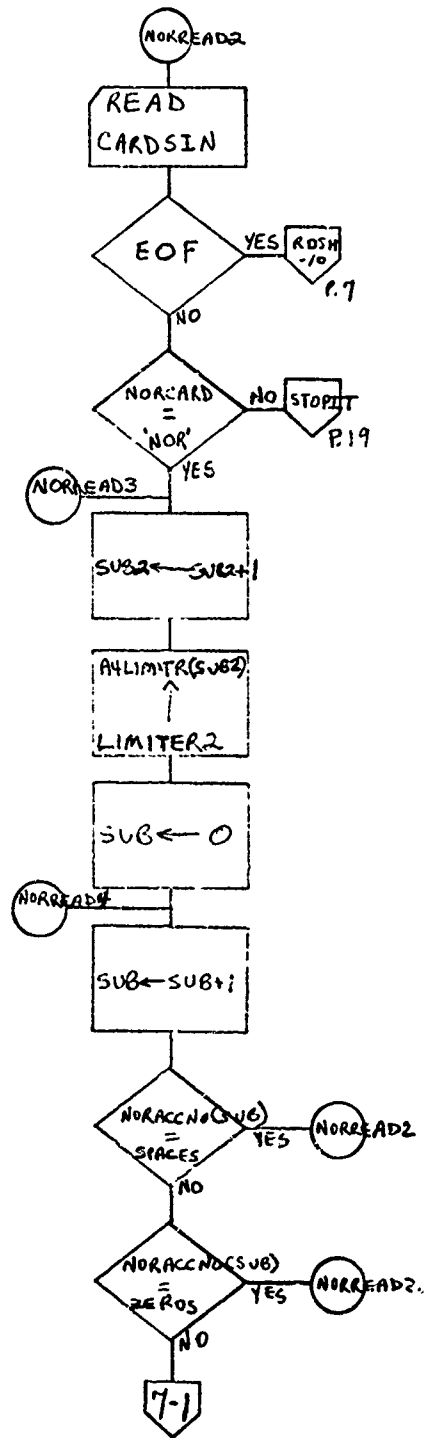

SMUFD FORM 2072-1 (T) ip, Mar 68

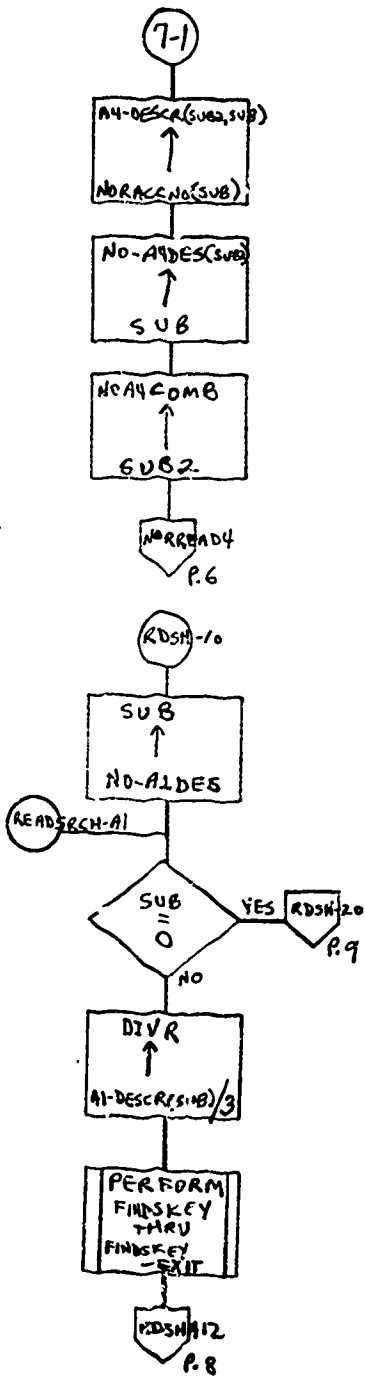

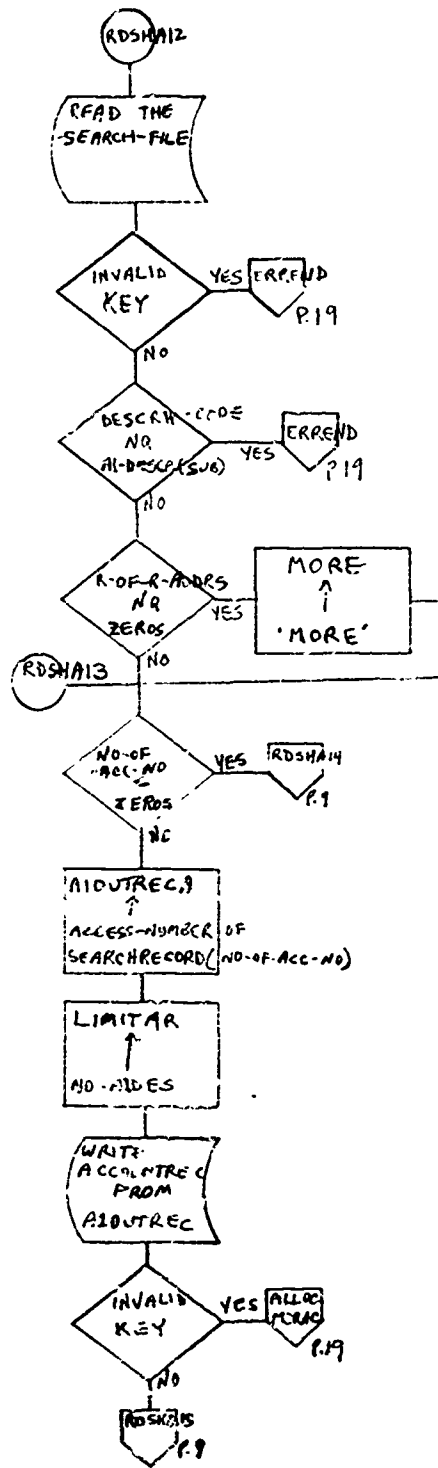

SMUFE FORM 2072-1 (T) (up) Mar 68

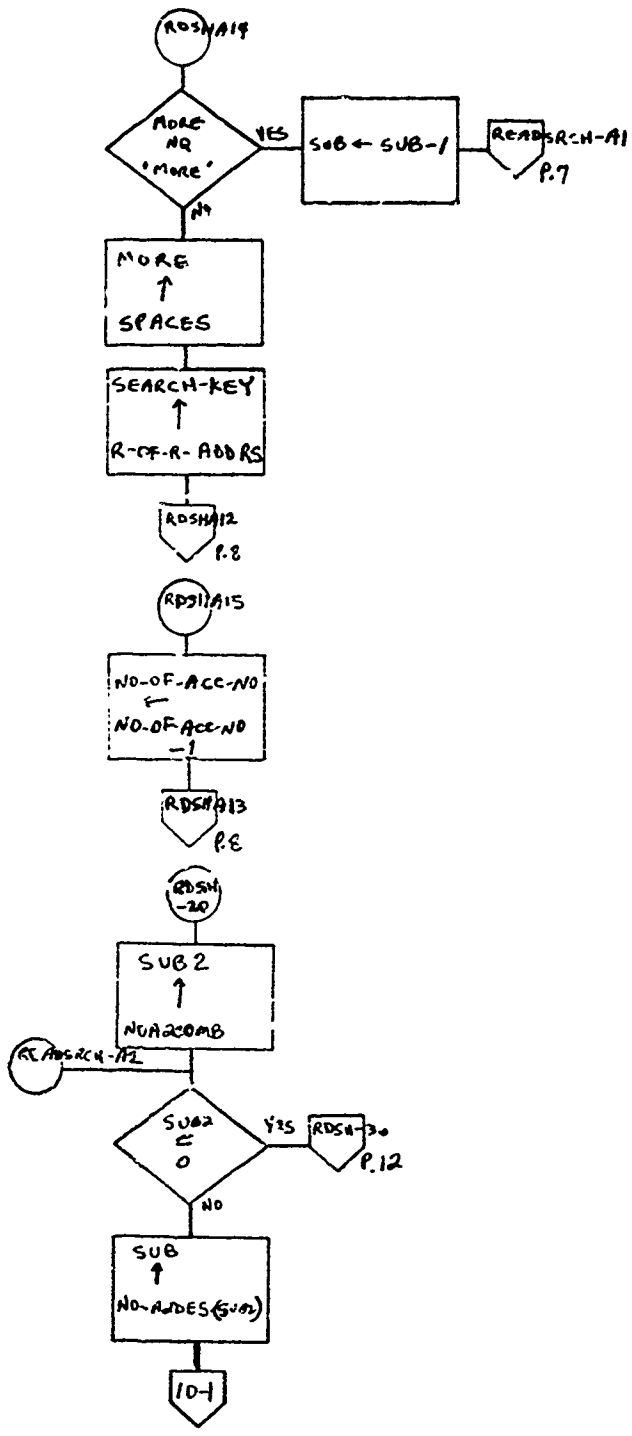

SMUFD FORM 5072-1 11 Apr 68

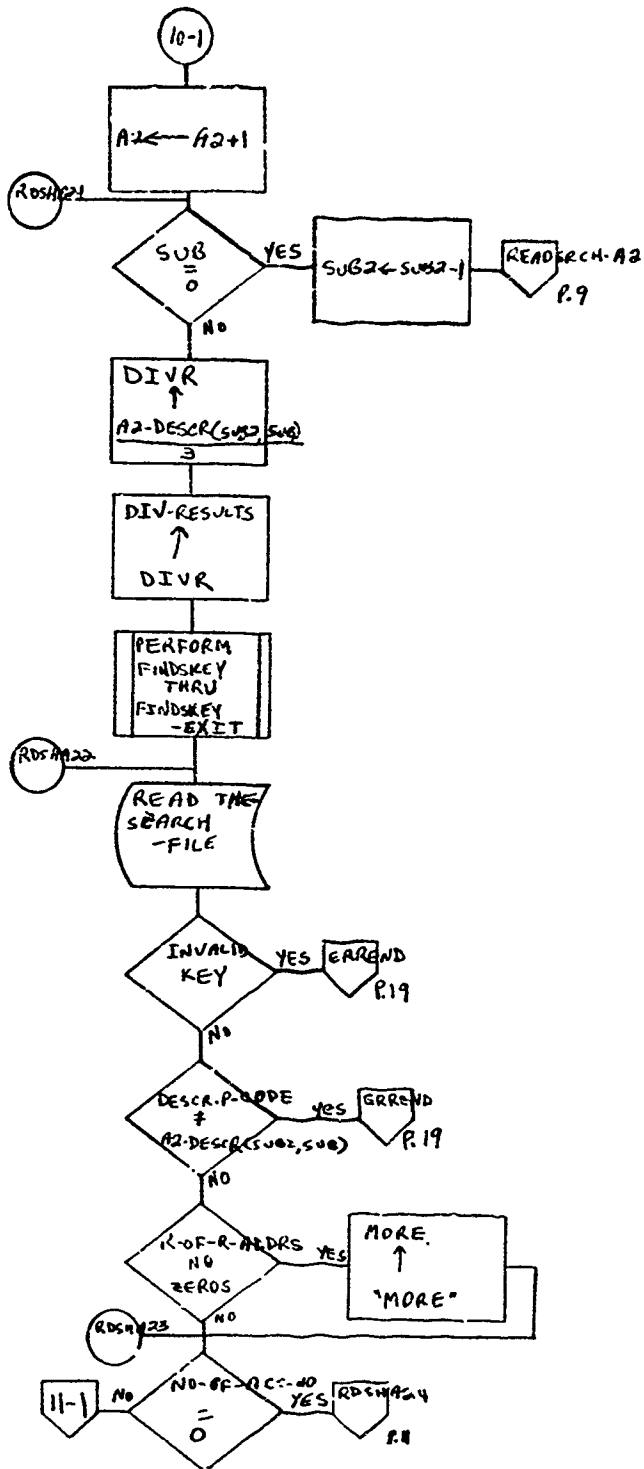

SMUFD FORM 2072-1 (T) (p) Mar 68

SMUFD FORM 2072-1 7 up Nov 68

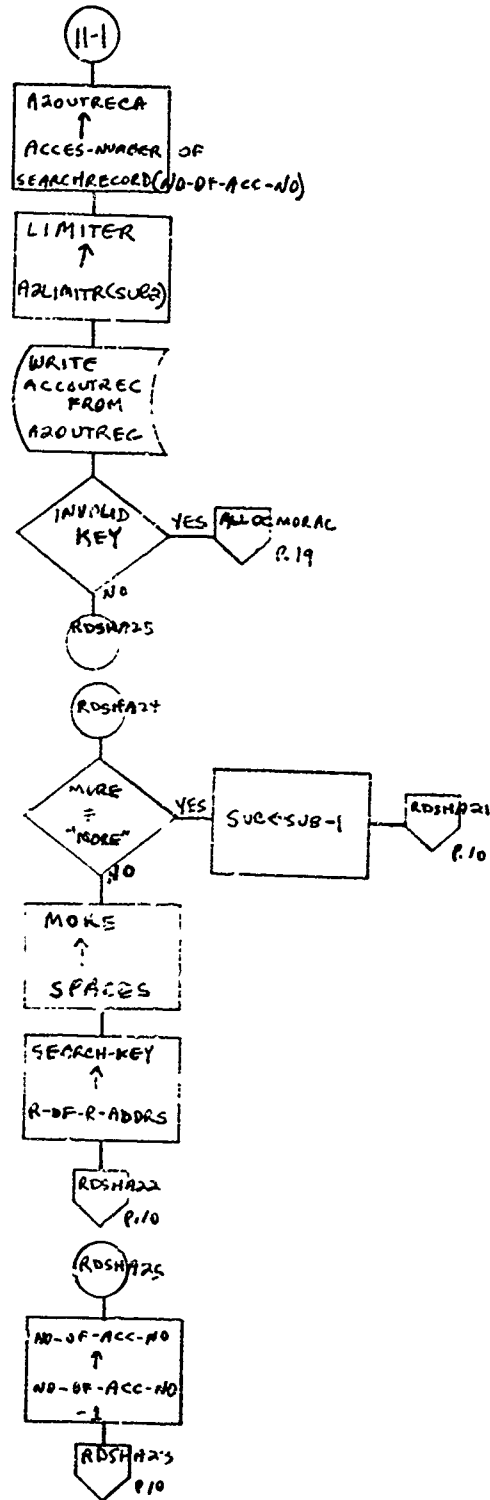

SMUFD FORM 2072-1 (T up) Mar 68

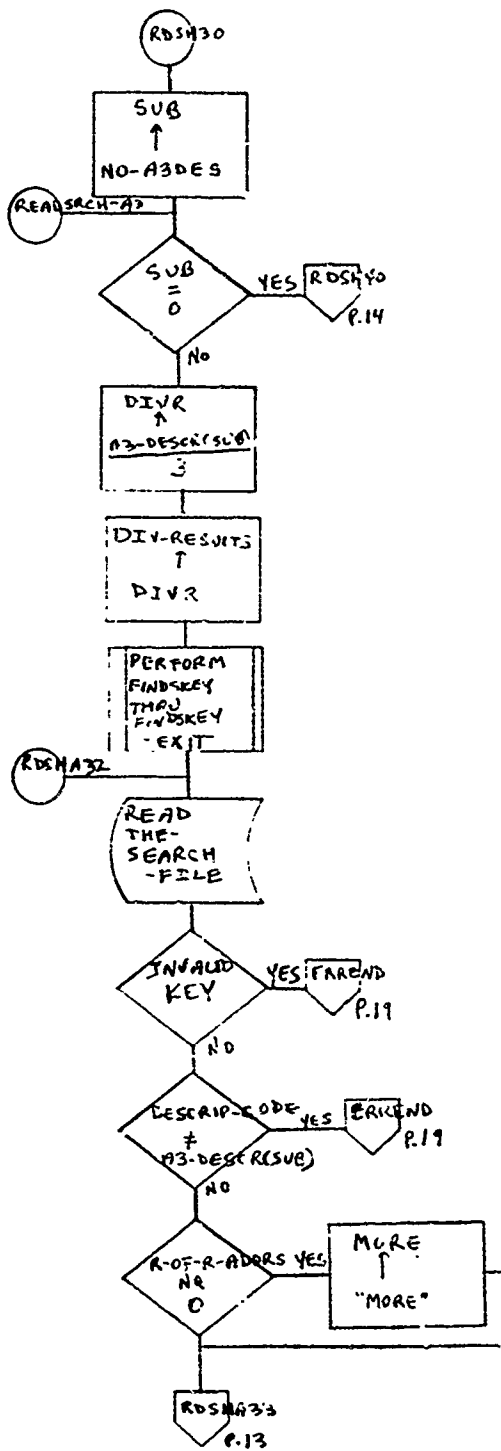

SMUFD FORM 2072-1 71 up. Mar 68

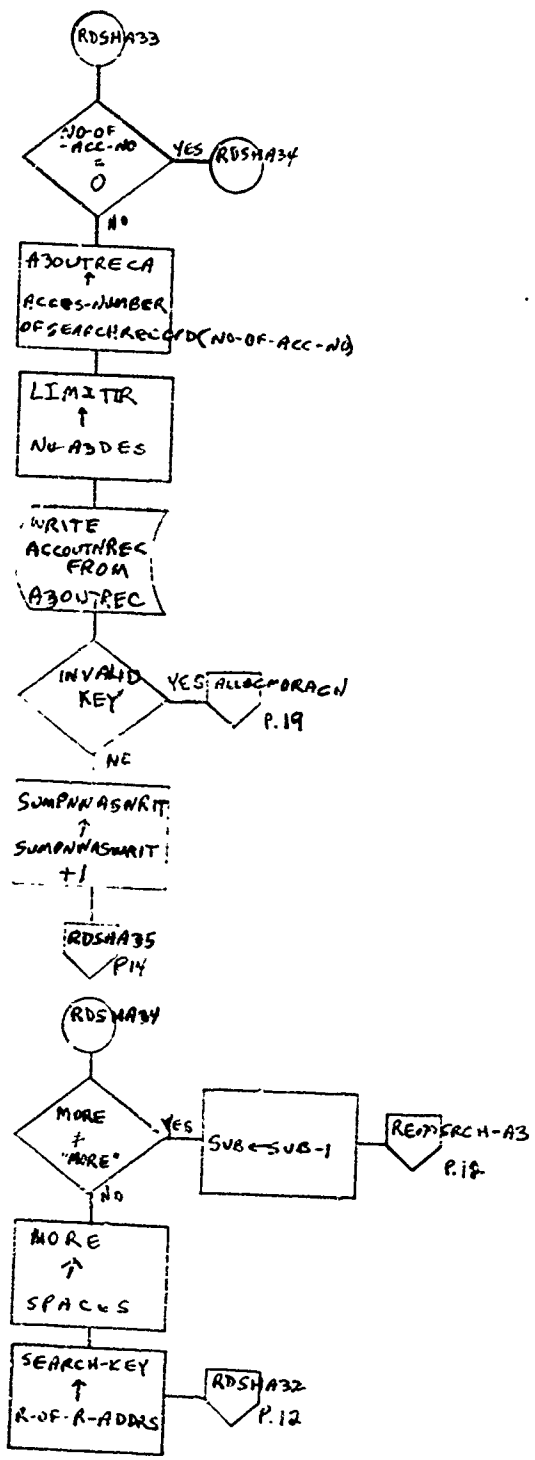

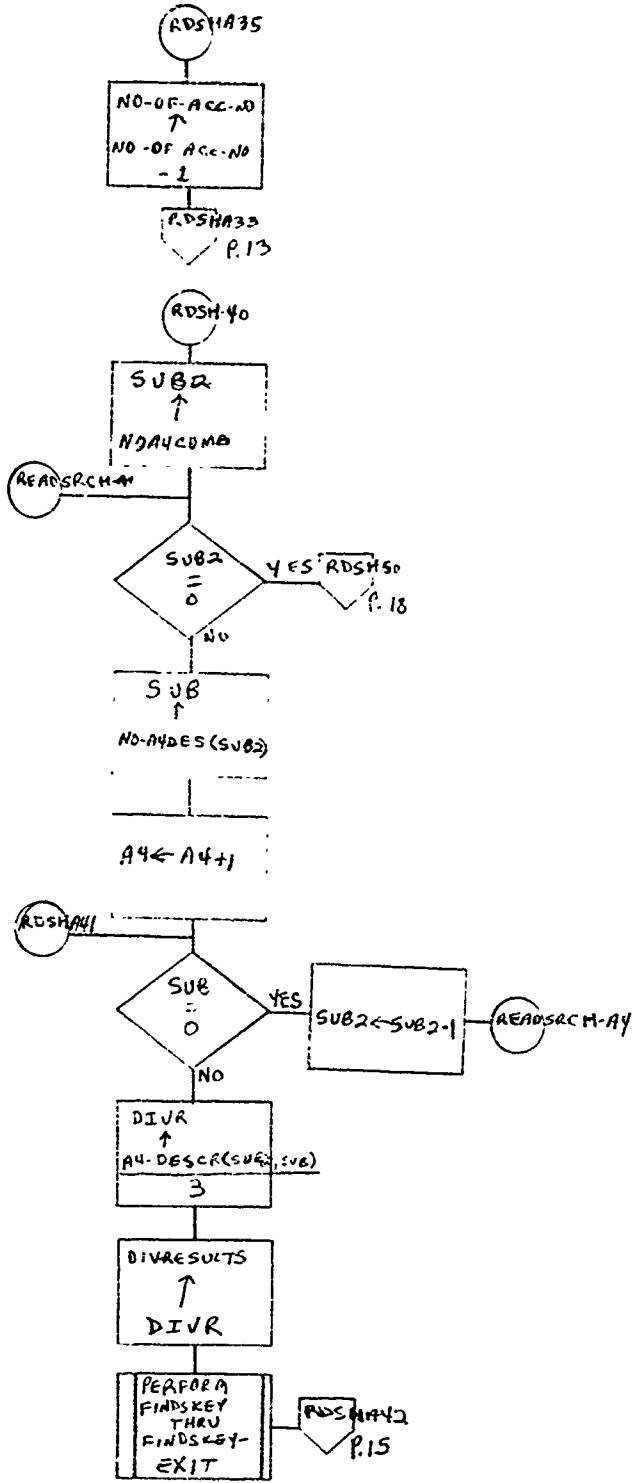

SMUFD FORM 2072-1 17 11p Mar 68

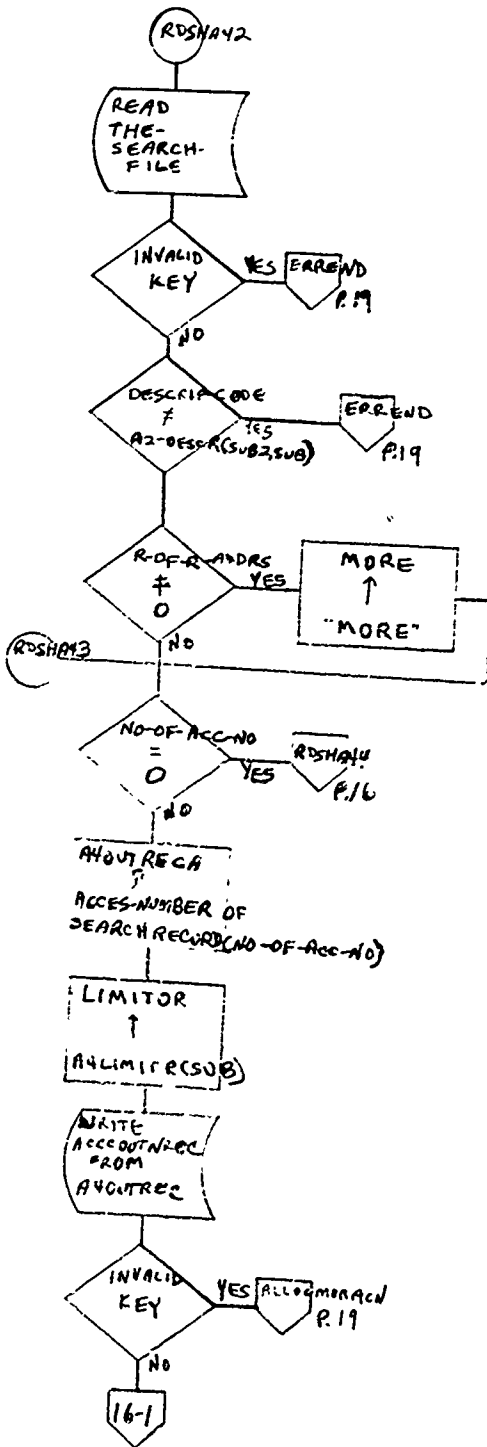

SMUFD FORM 2072-1 71 upr. Mar 68

SMUPD FORM 2073-1 (1) Mar 68

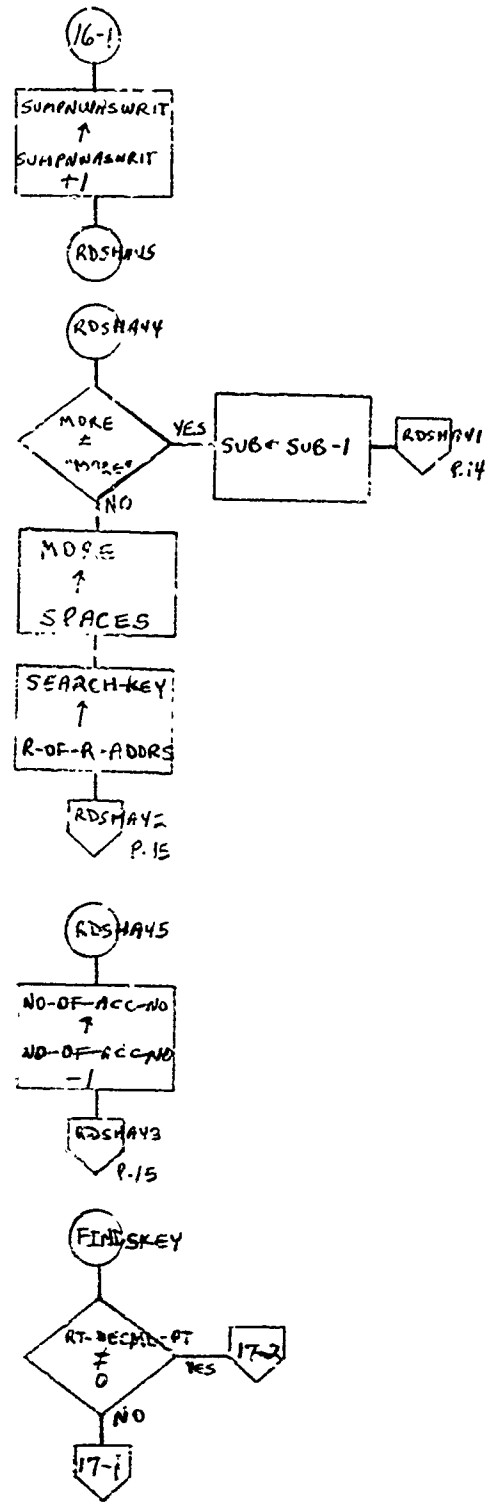

SMUFD FORM 2072-1 (T) up: Mar 68

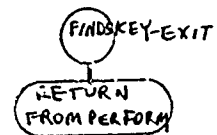
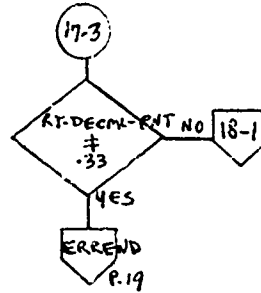
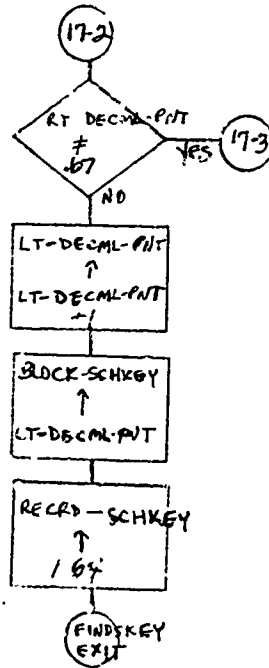
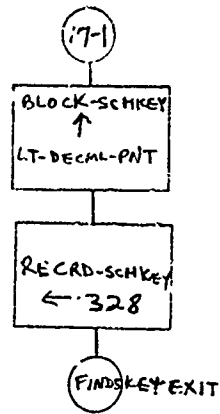

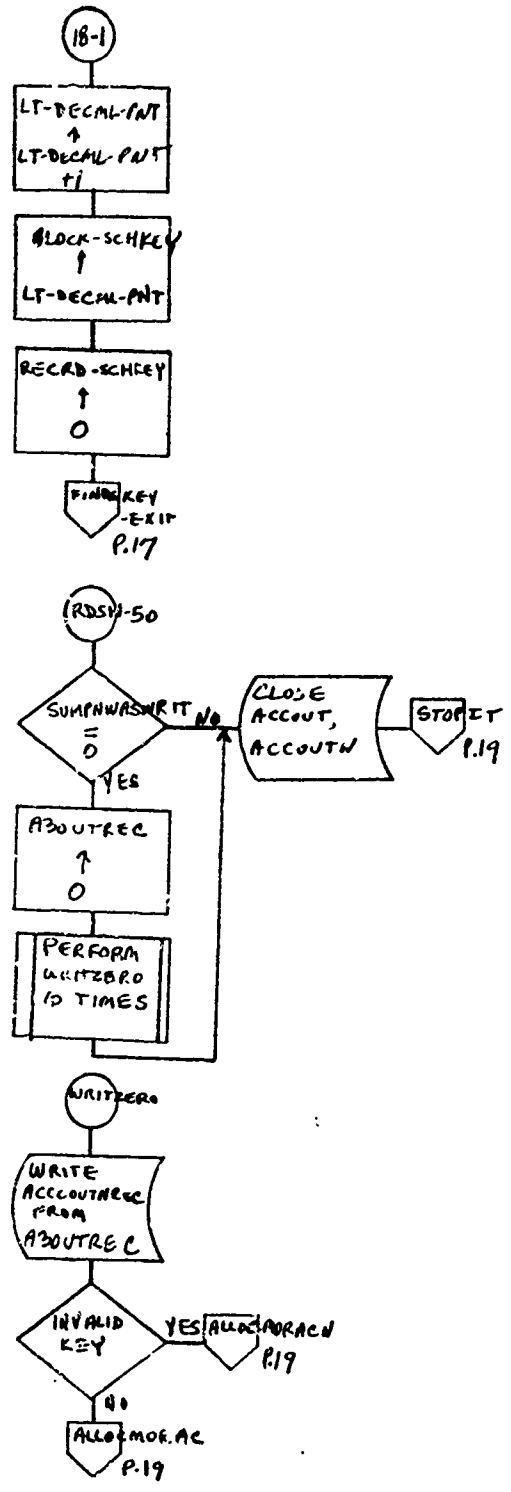

SMUFD FORM 2072-1 (T) 3/68 Mar 68

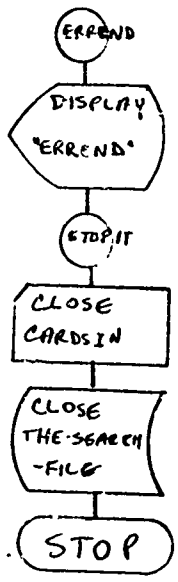
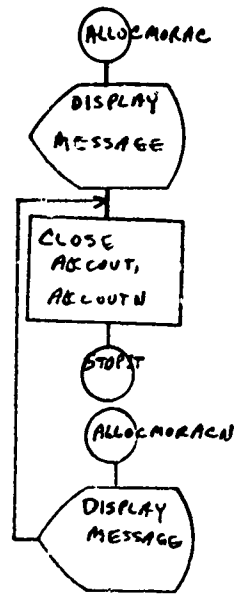

SMUFD FORM 2072-1 (T) 11p, Mar 68

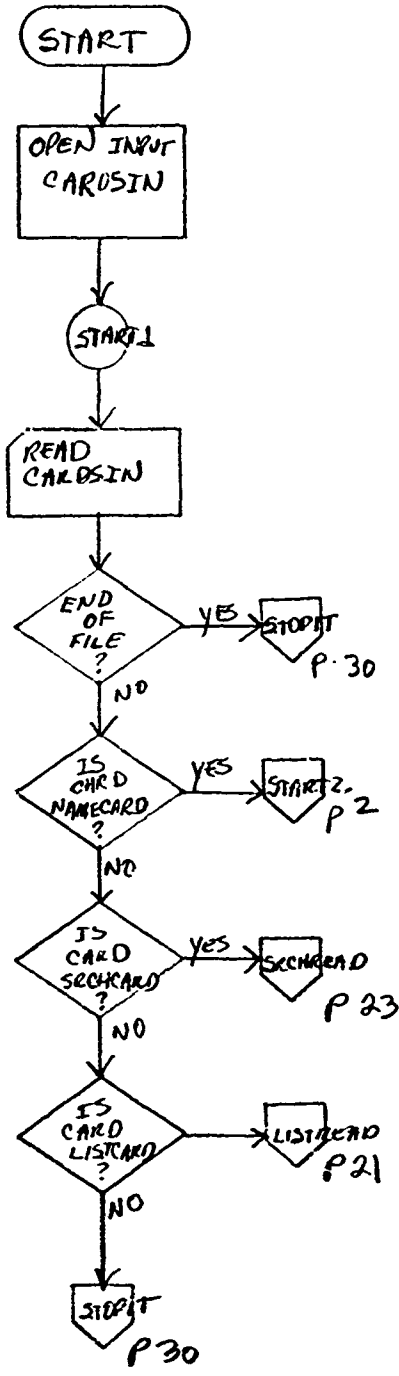

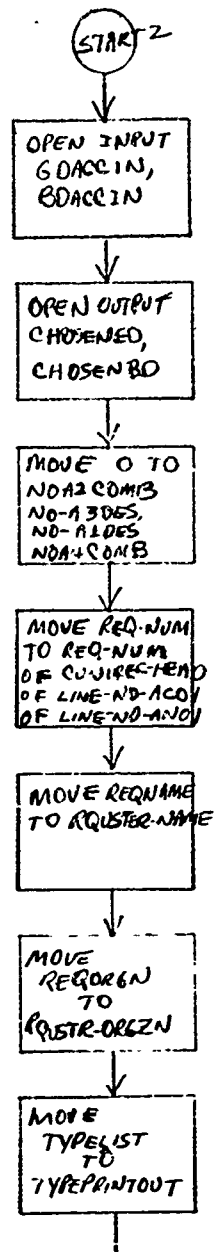

THE IRSERCH2
 ROUTINES ANDREAD, ANDREAD2,
 ORREAD, ORREAD2, ORREAD3, ORREAD4,
 BNOTREAD, BNOTREAD2, NORREAD,
 NORREAD2, NORREAD3, NORREAD4
 ARE EXACTLY THE SAME AS THE
 ROUTINES OF THE SAME NAME IN
 IRSEARCH. SEE THE FLOWCHARTS
 IN IRSEARCH.

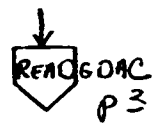

SMUFD FORM 2072-1 11 10 Mar 68

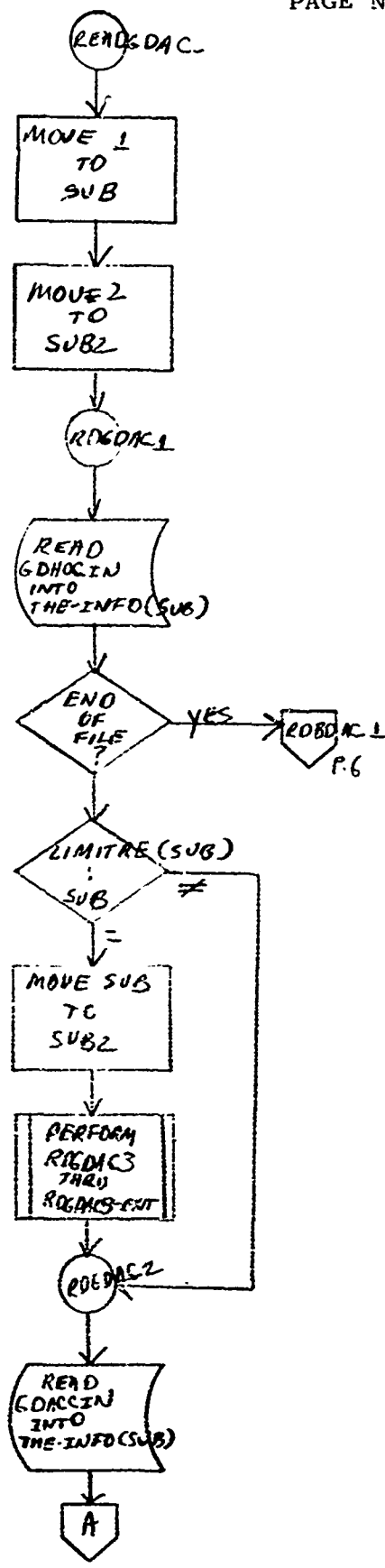

SMUFD FORM 2072-1 (1) (up) Mar 68

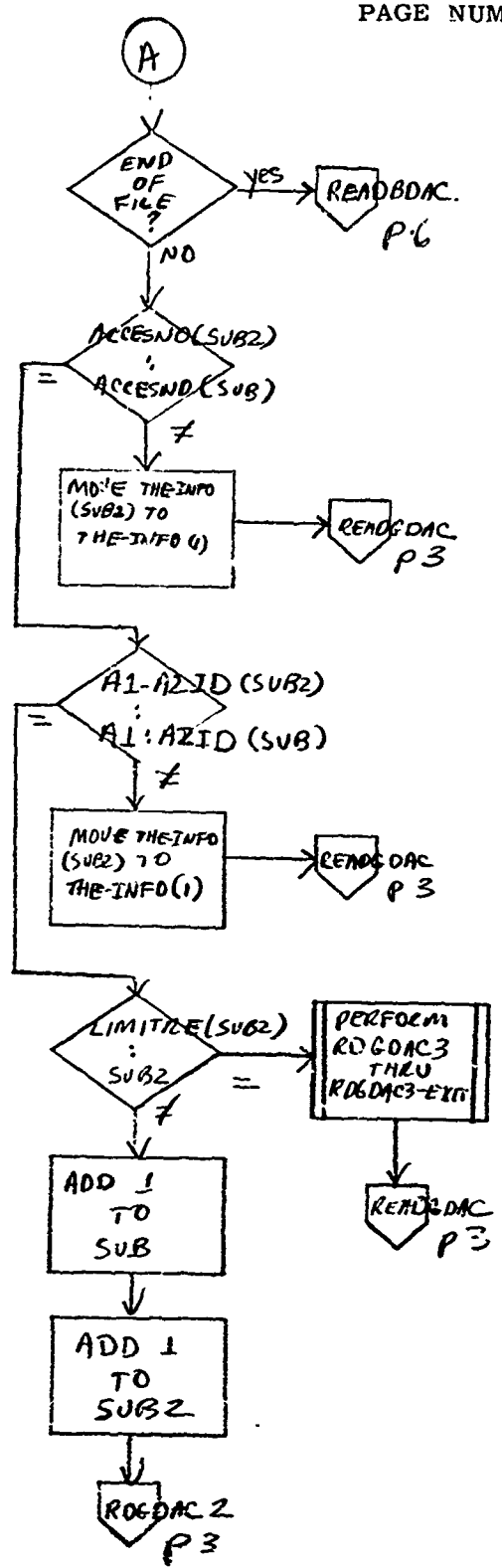

SMUFD FORM 2072-1 11 ip, Mar 68

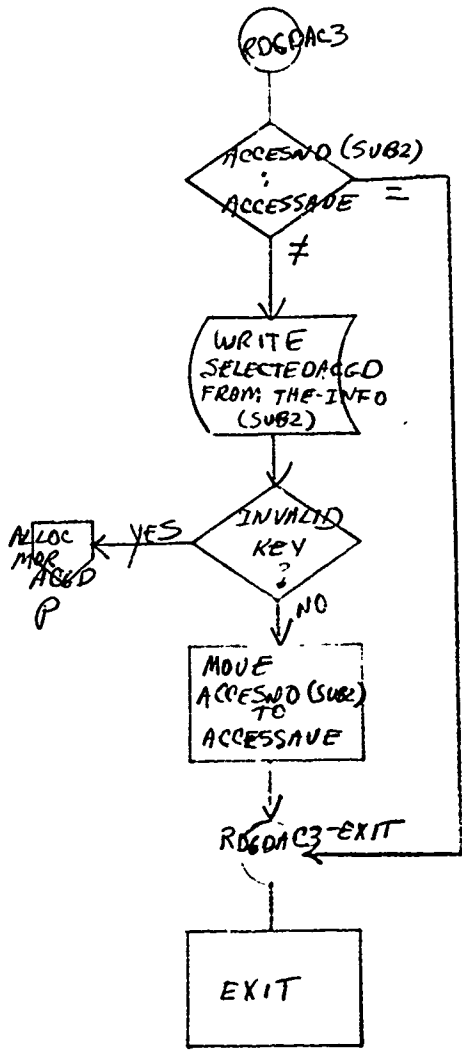

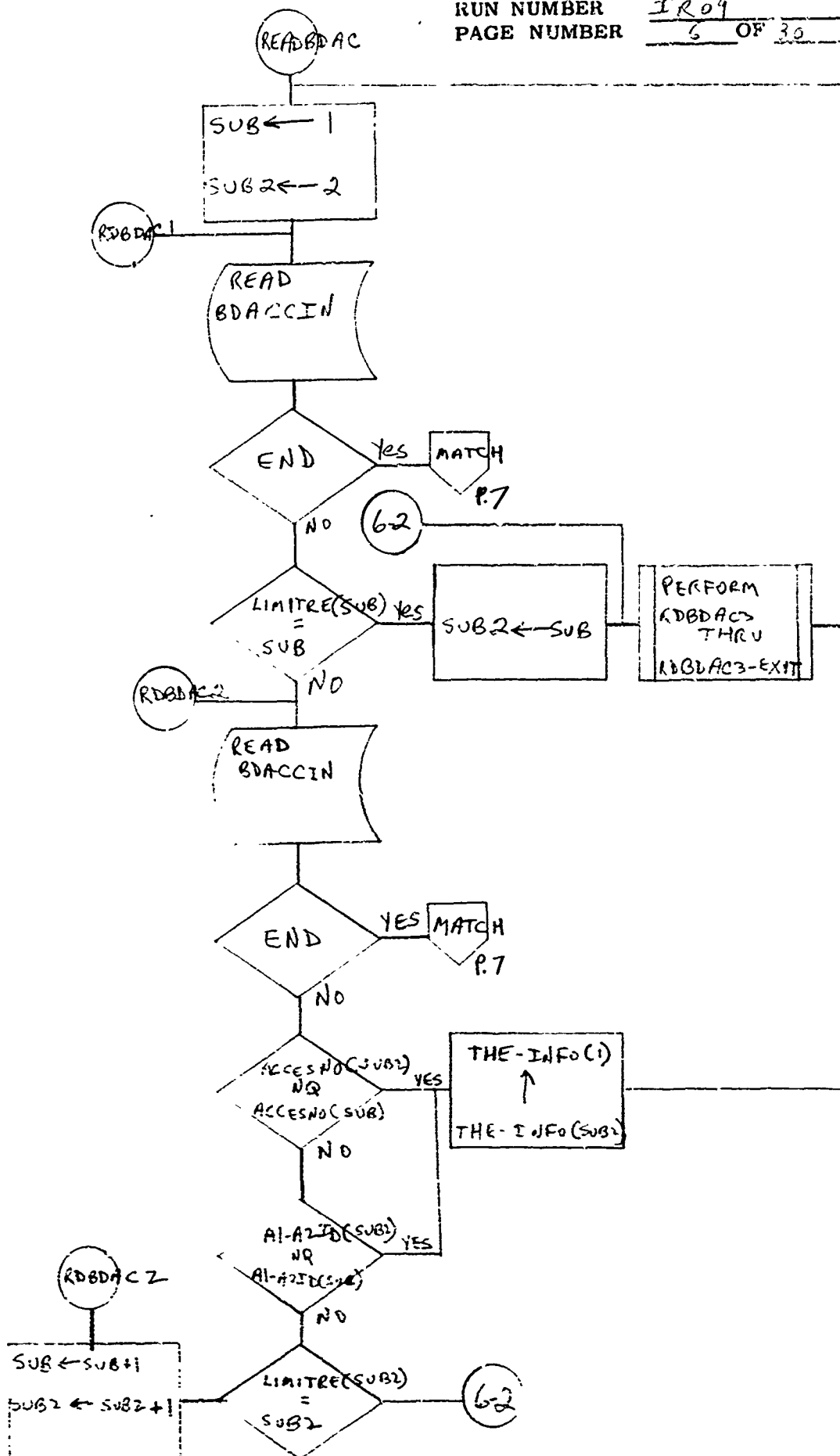

SMUT'D FORM 2072-1 (Temp) Mar 68

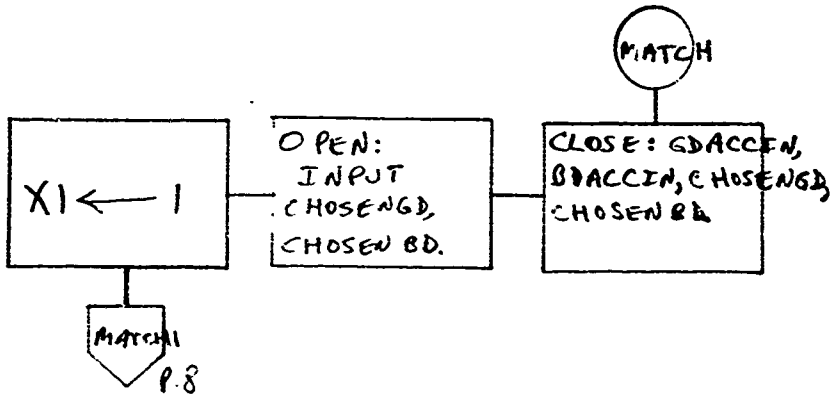
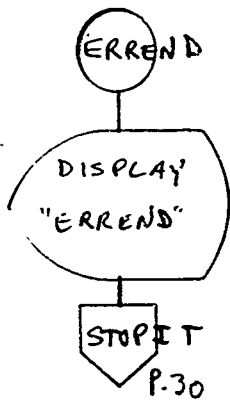
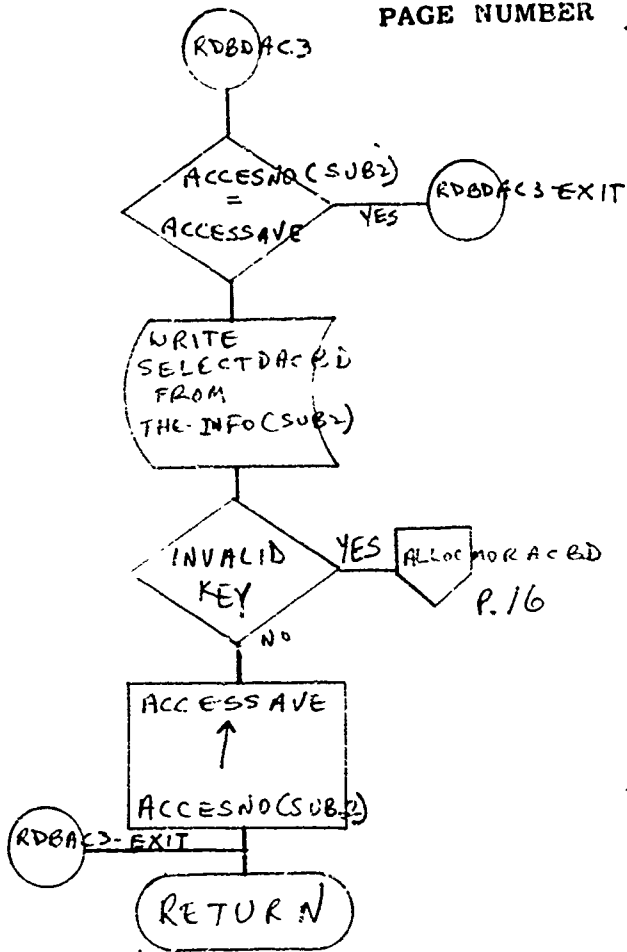

SMUFD FORM 2072-1 (Temp) Mar 68

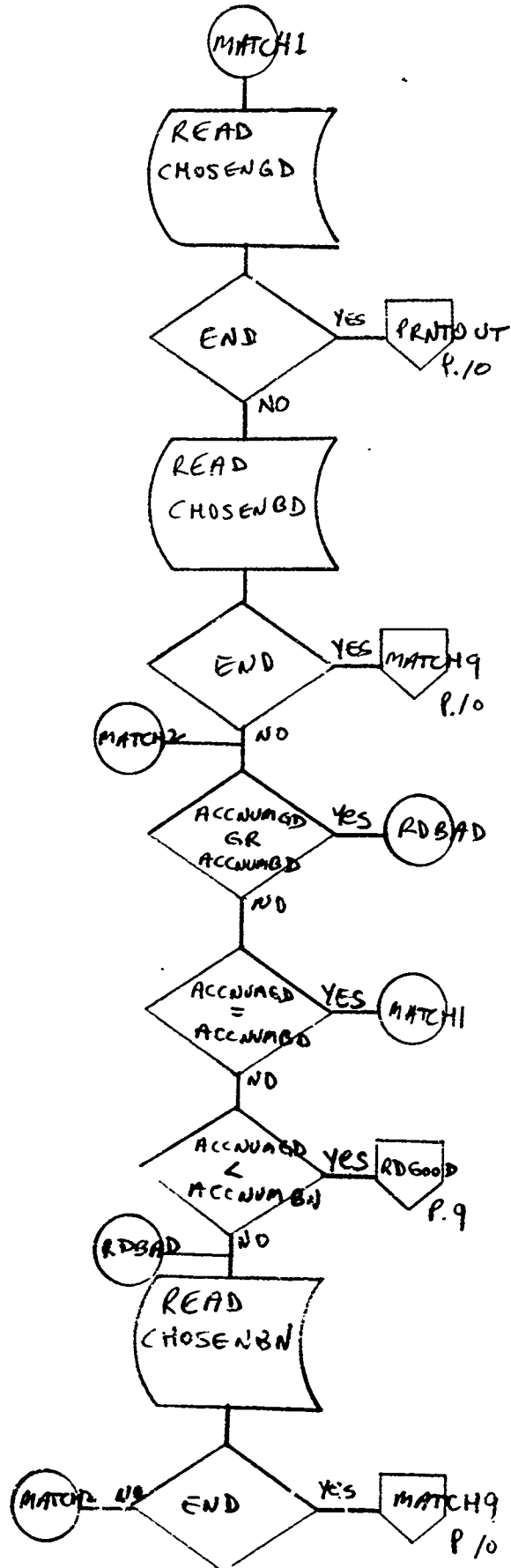

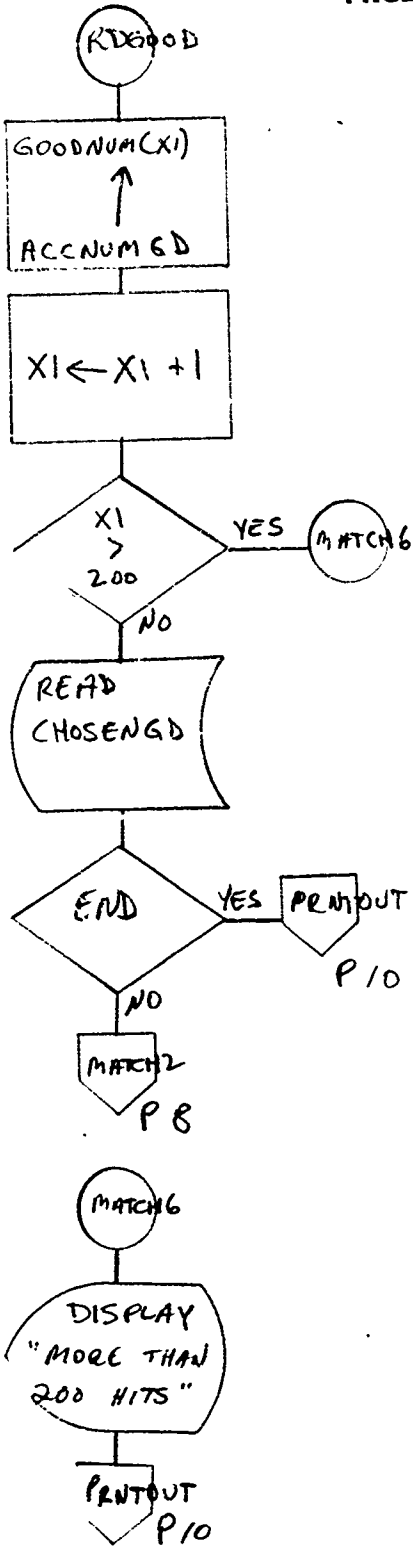

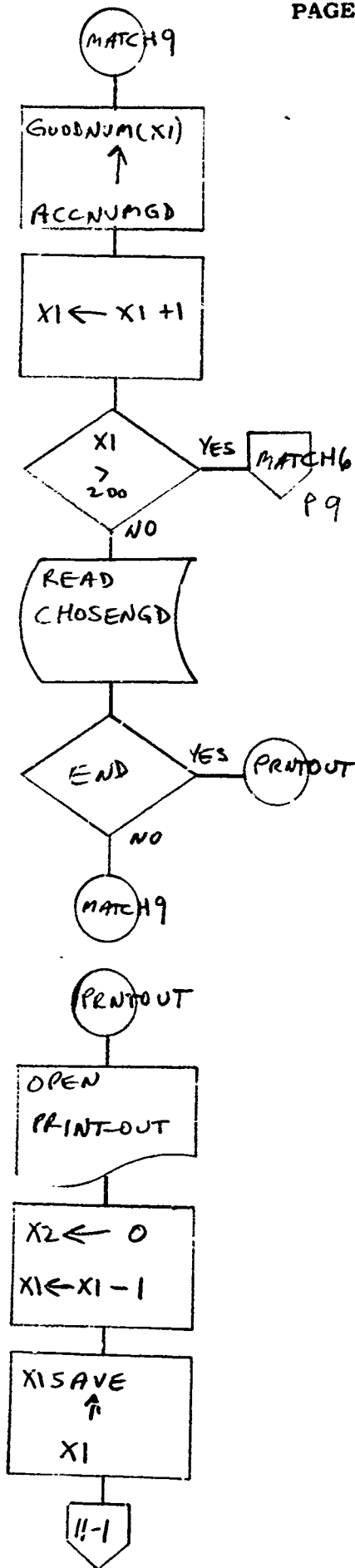

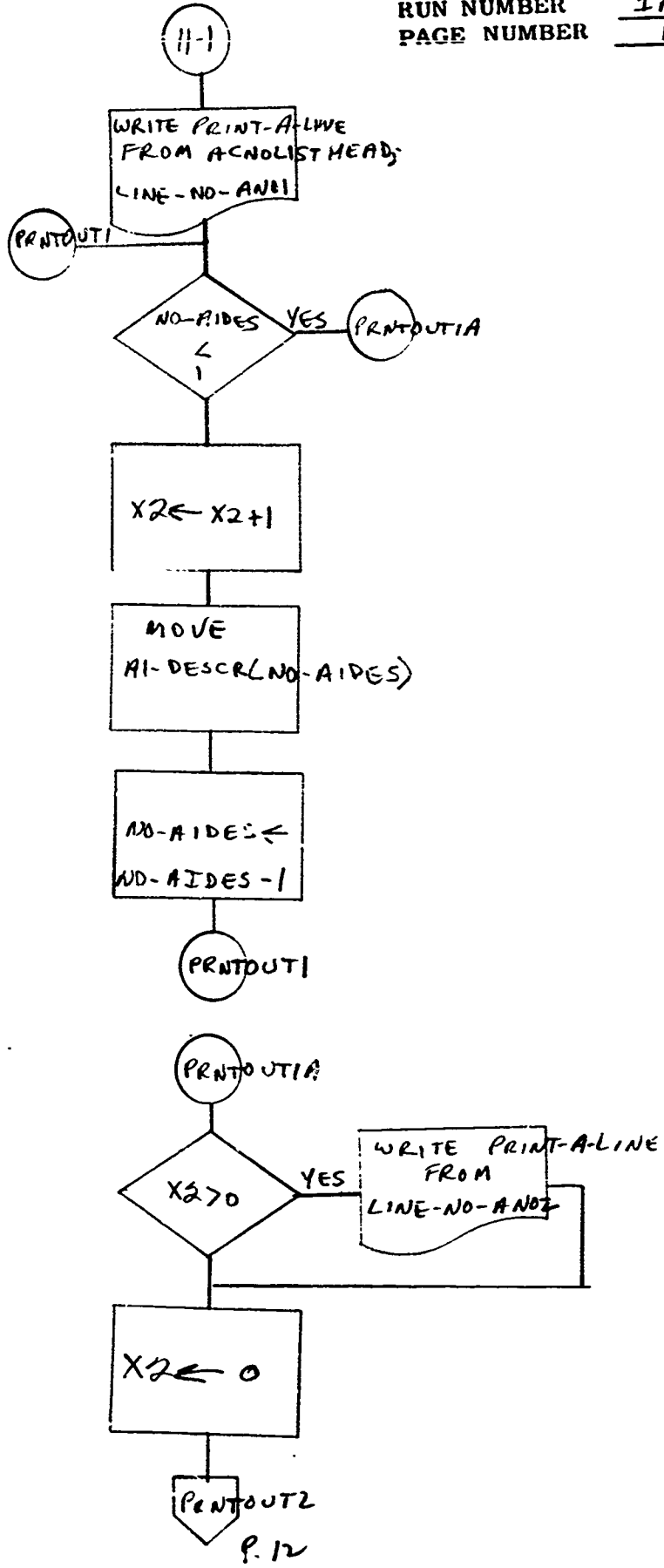

SMUFD FORM 2072-1 (Temp) Mar 68

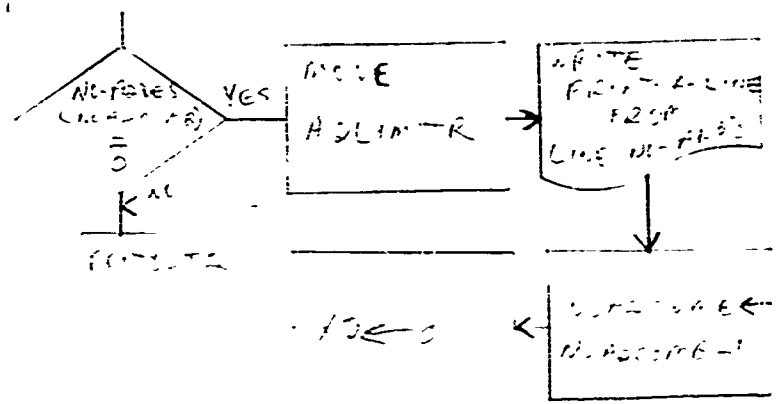
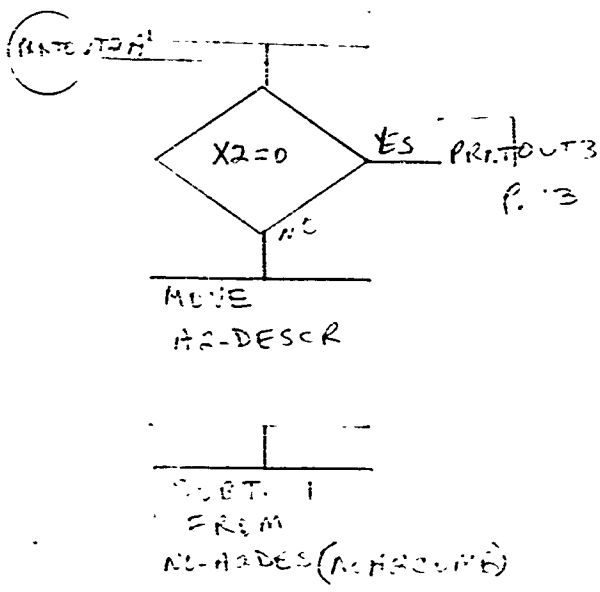
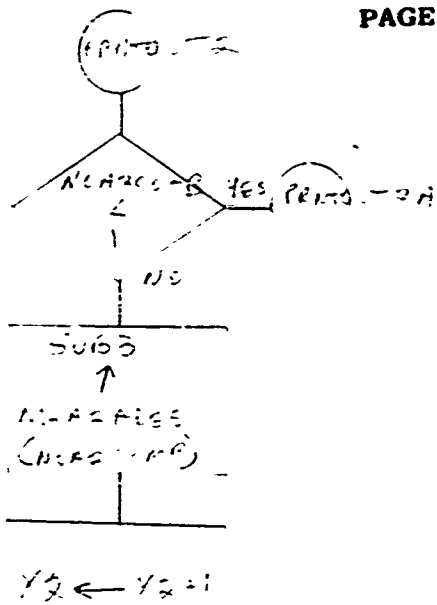

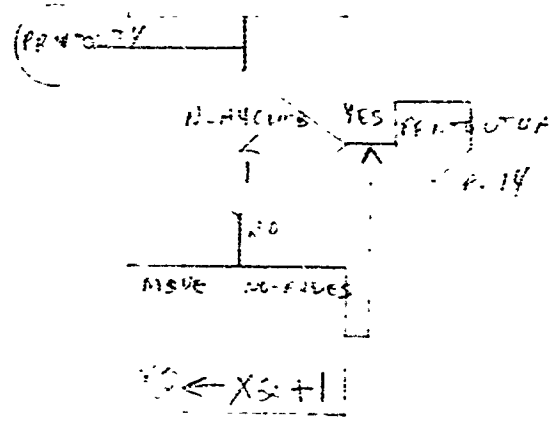
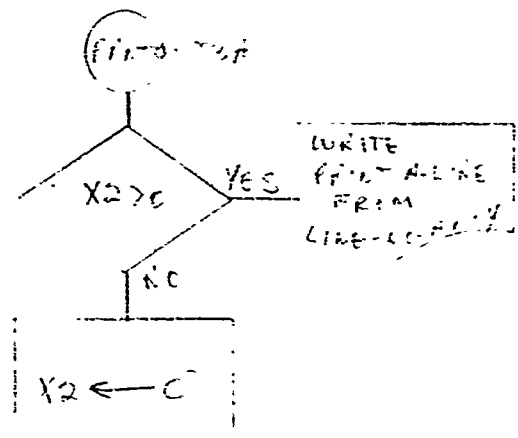
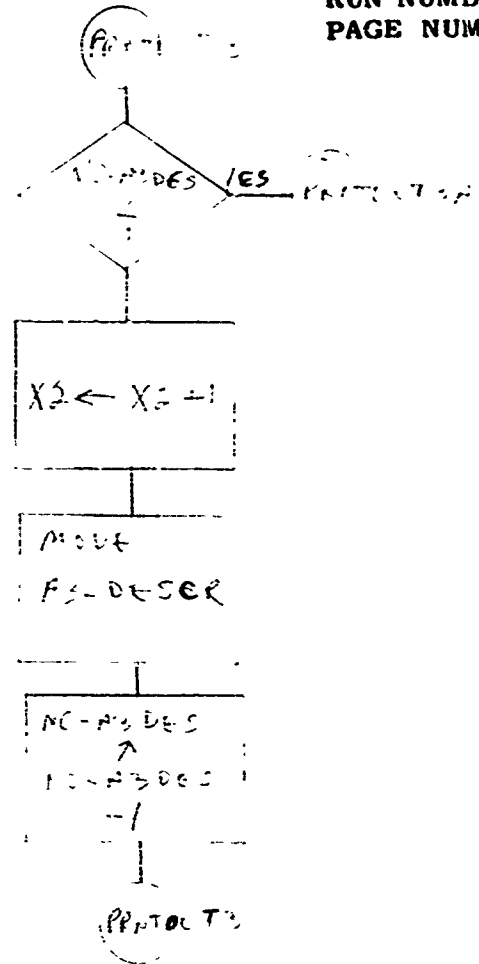

SMUFD FORM 2072-1 (Temp) Mar 68

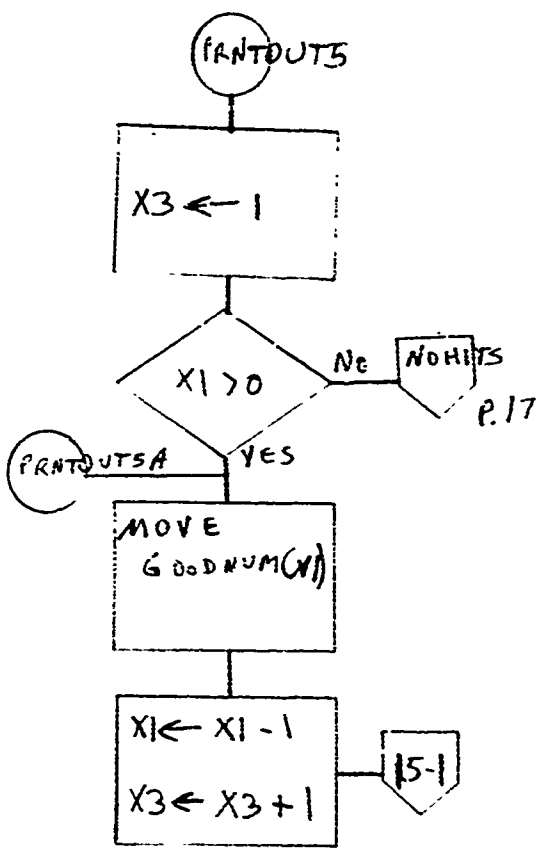
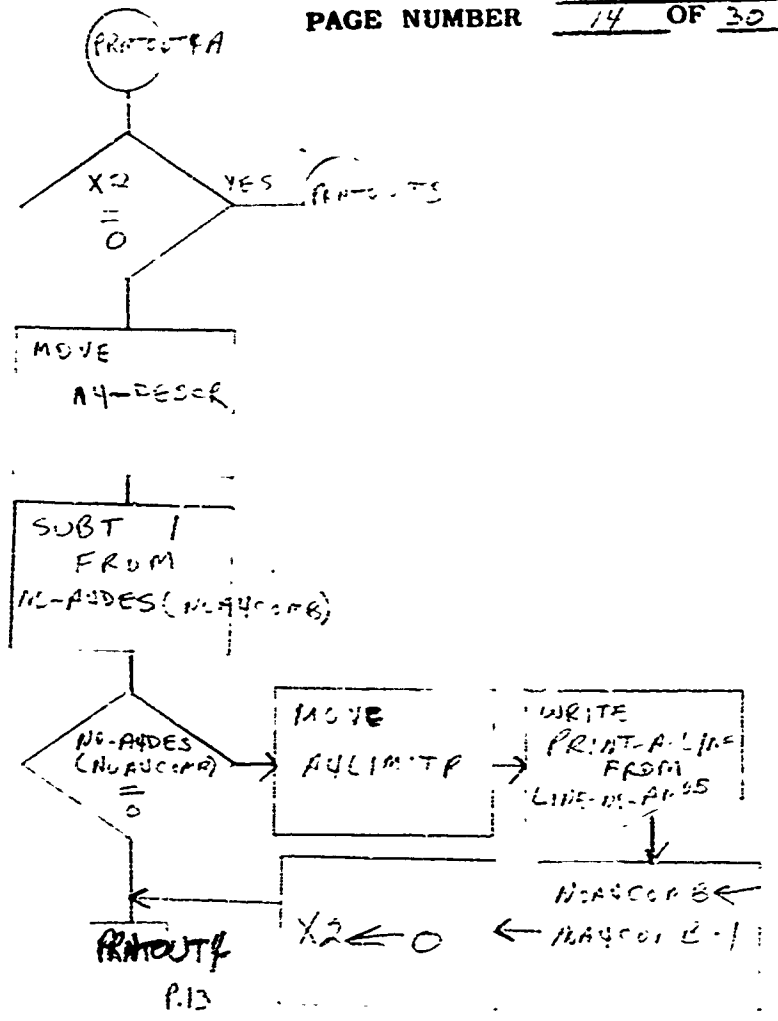

SMUFD FORM 2072-1 (Temp) Mar 68

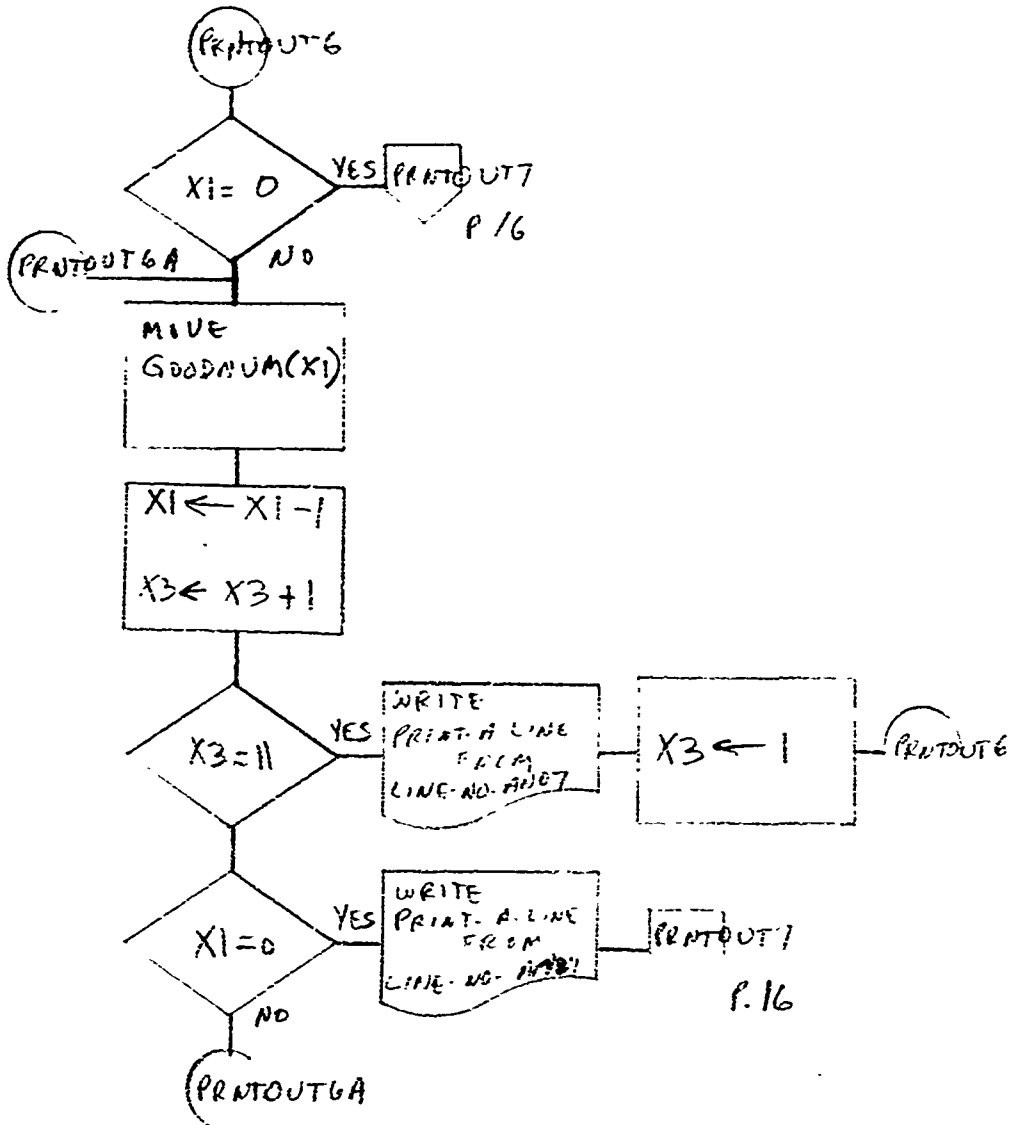
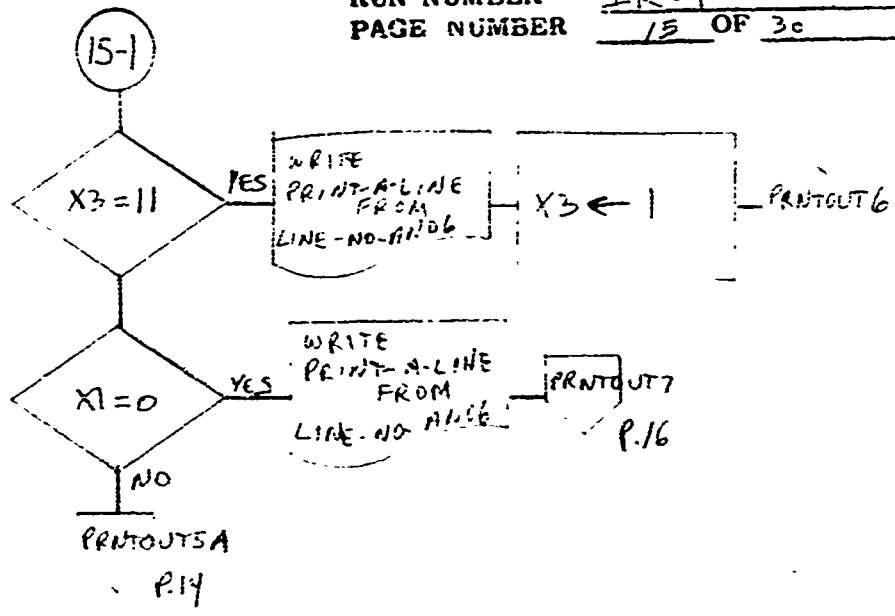

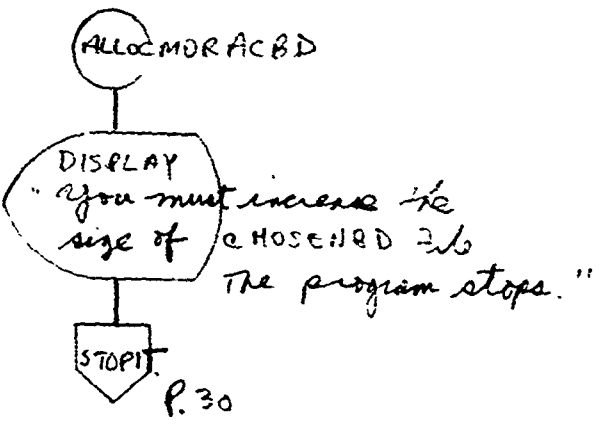
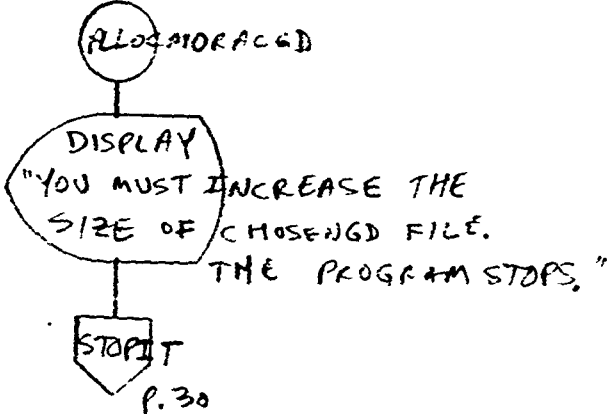
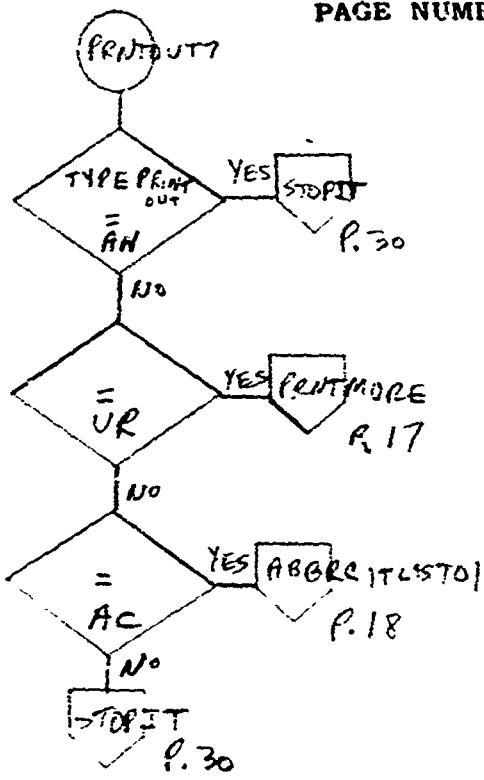

SMUFD FORM 2072-1 (Temp) Mar 68

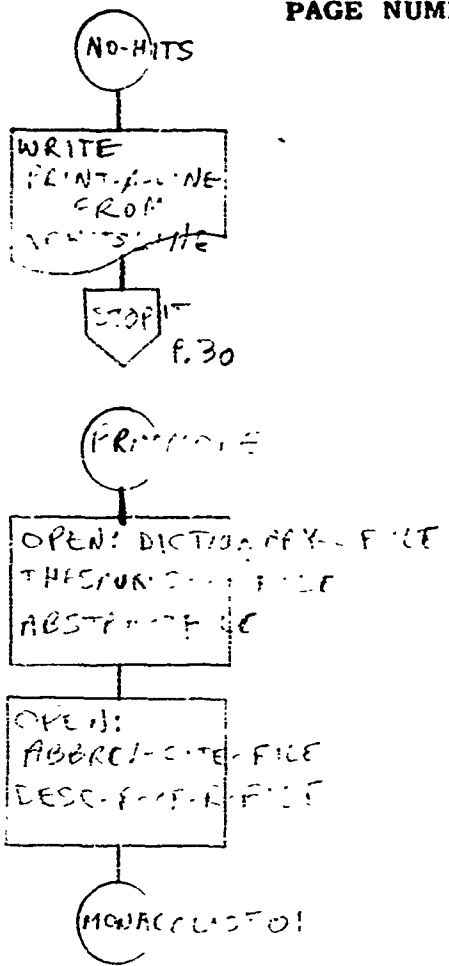

In IRSEARCH2 (IR09)
 MONACCLIST01 THRU
 MONACCLIST50 ARE
 LOGICALLY THE SAME AS
 THE ROUTINES OF THE
 SAME NAME IN IRSEARCH1,
 SEE IRSEARCH1 FOR
 FILE DETAILS

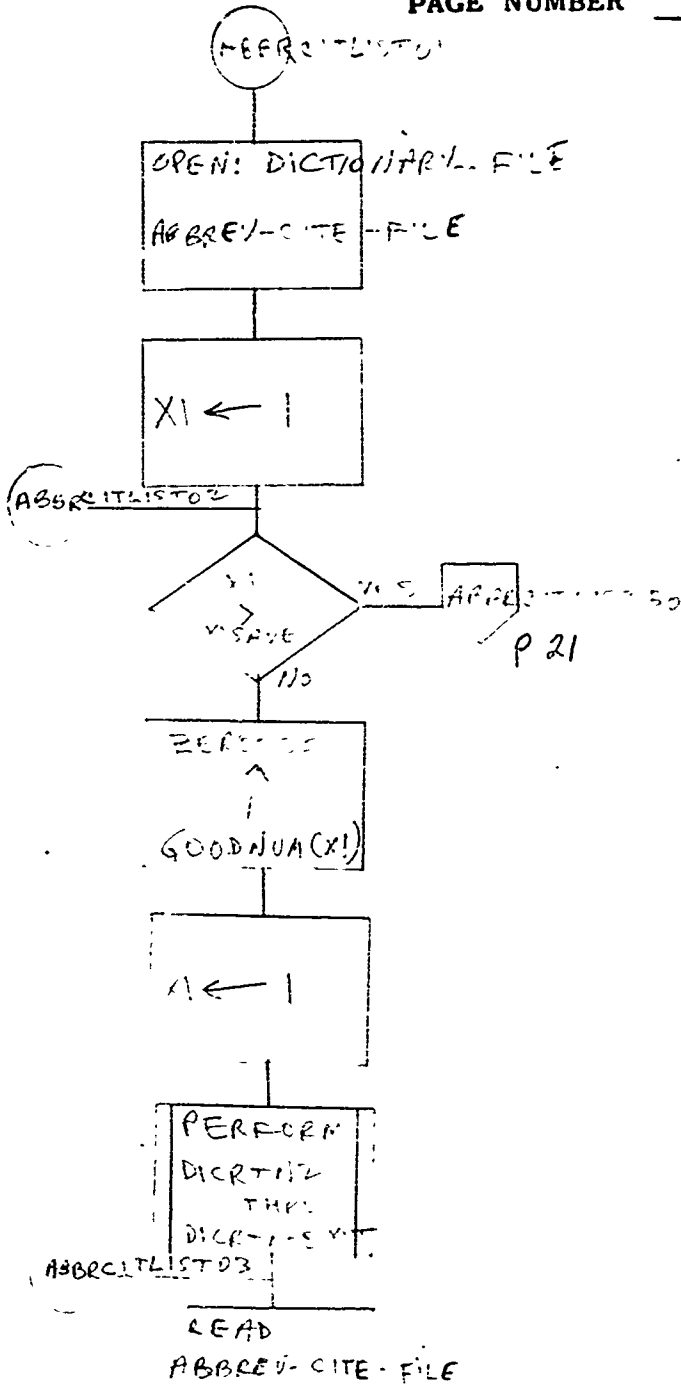

SMUFD FORM 2072-1 (Temp) Mar 68

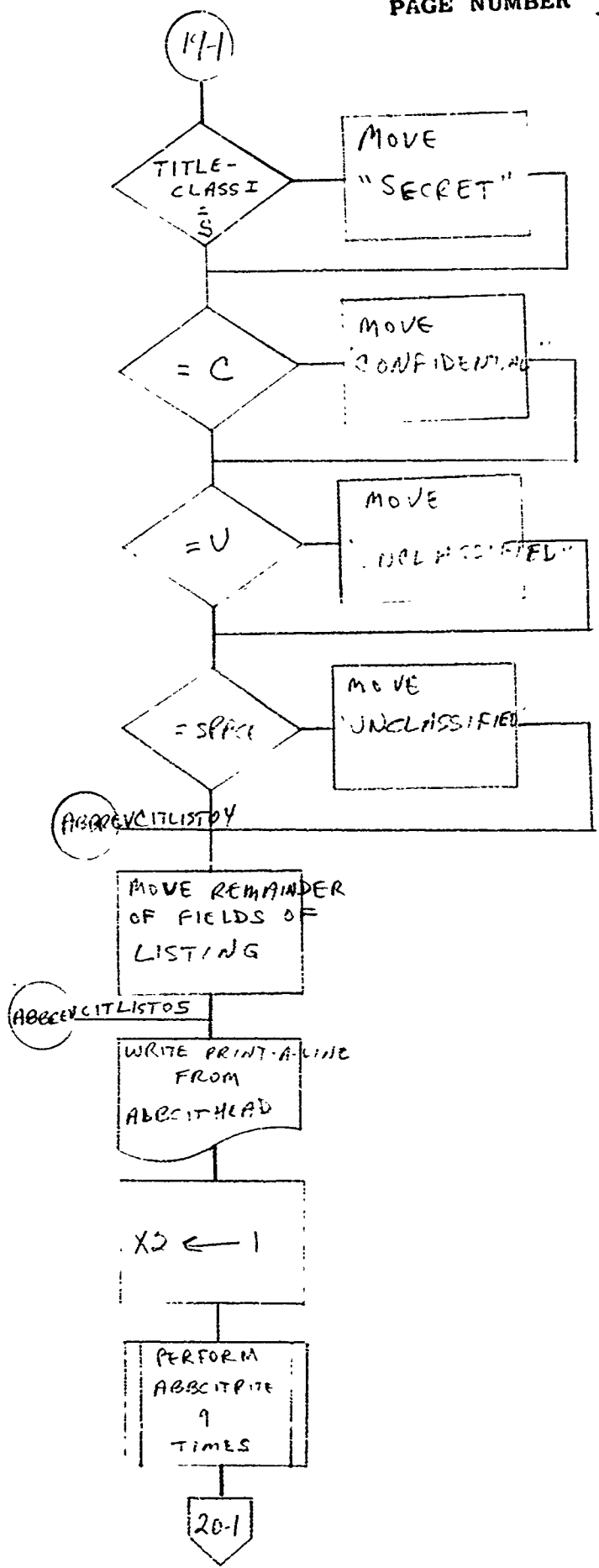

SMUFD FORM 2072-1 (Temp) Mar 68

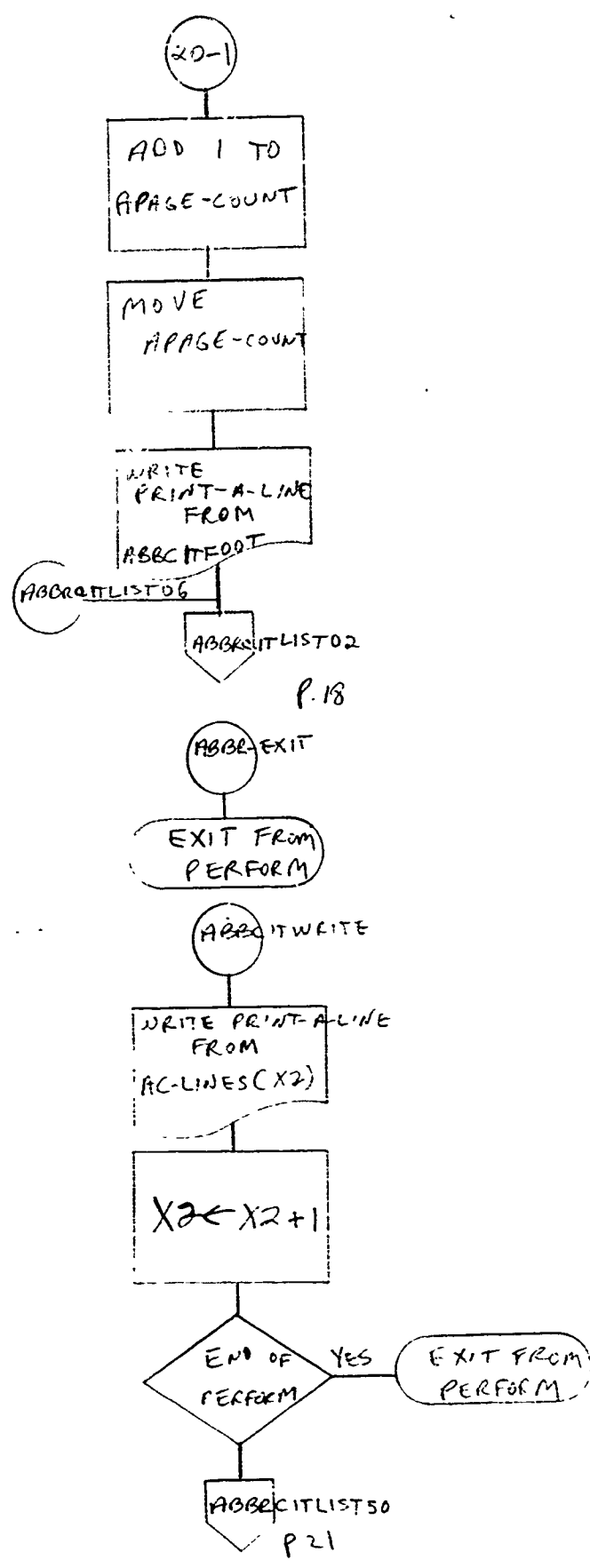

SMUFD FORM 2072-1 (Temp) Mar 68

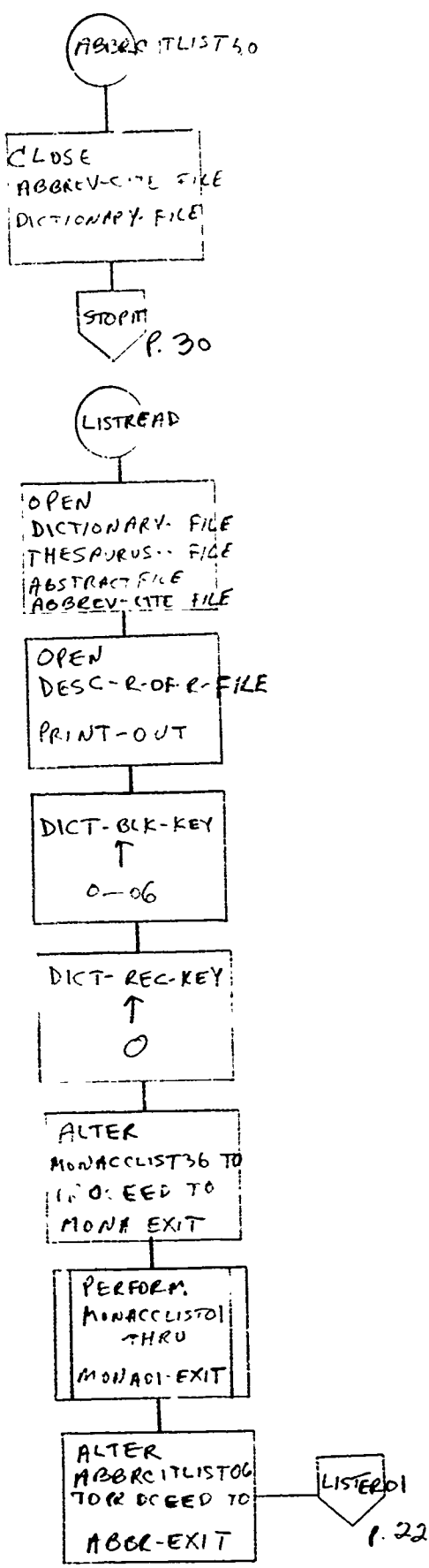

SMUFD FORM 2072-1 (Temp) Mar 68

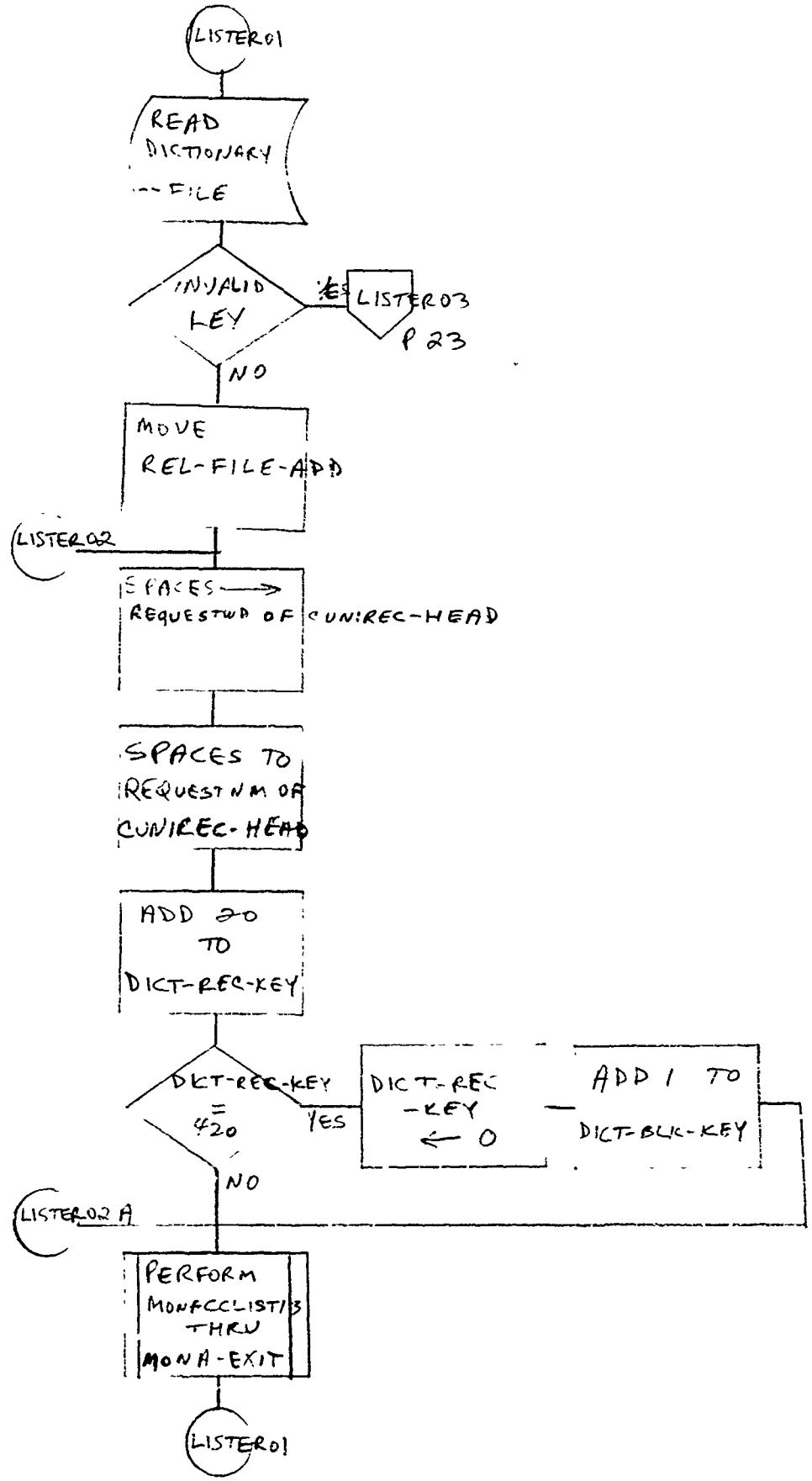

SMUFD FORM 2072-1 (Temp) Mar 68

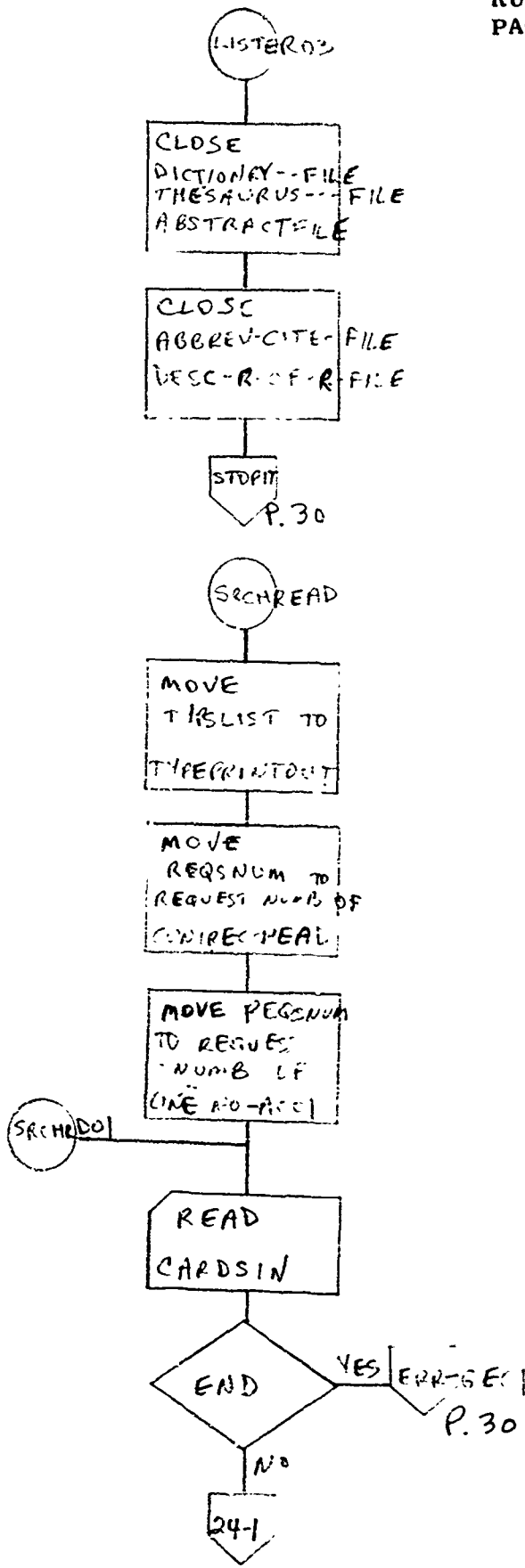

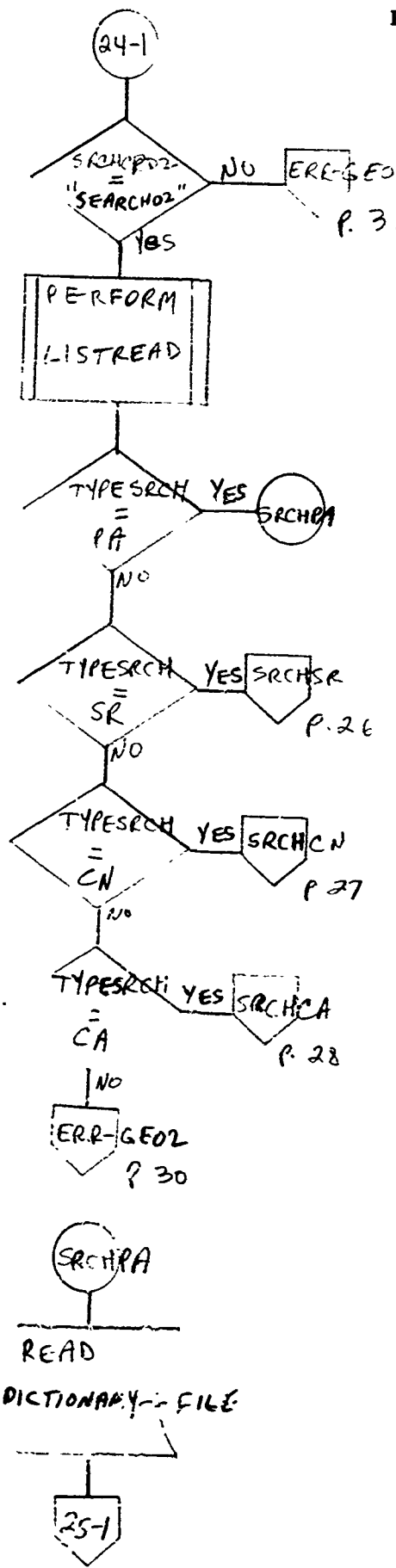

SMUFD FORM 2072-1 (Temp) Mar 68

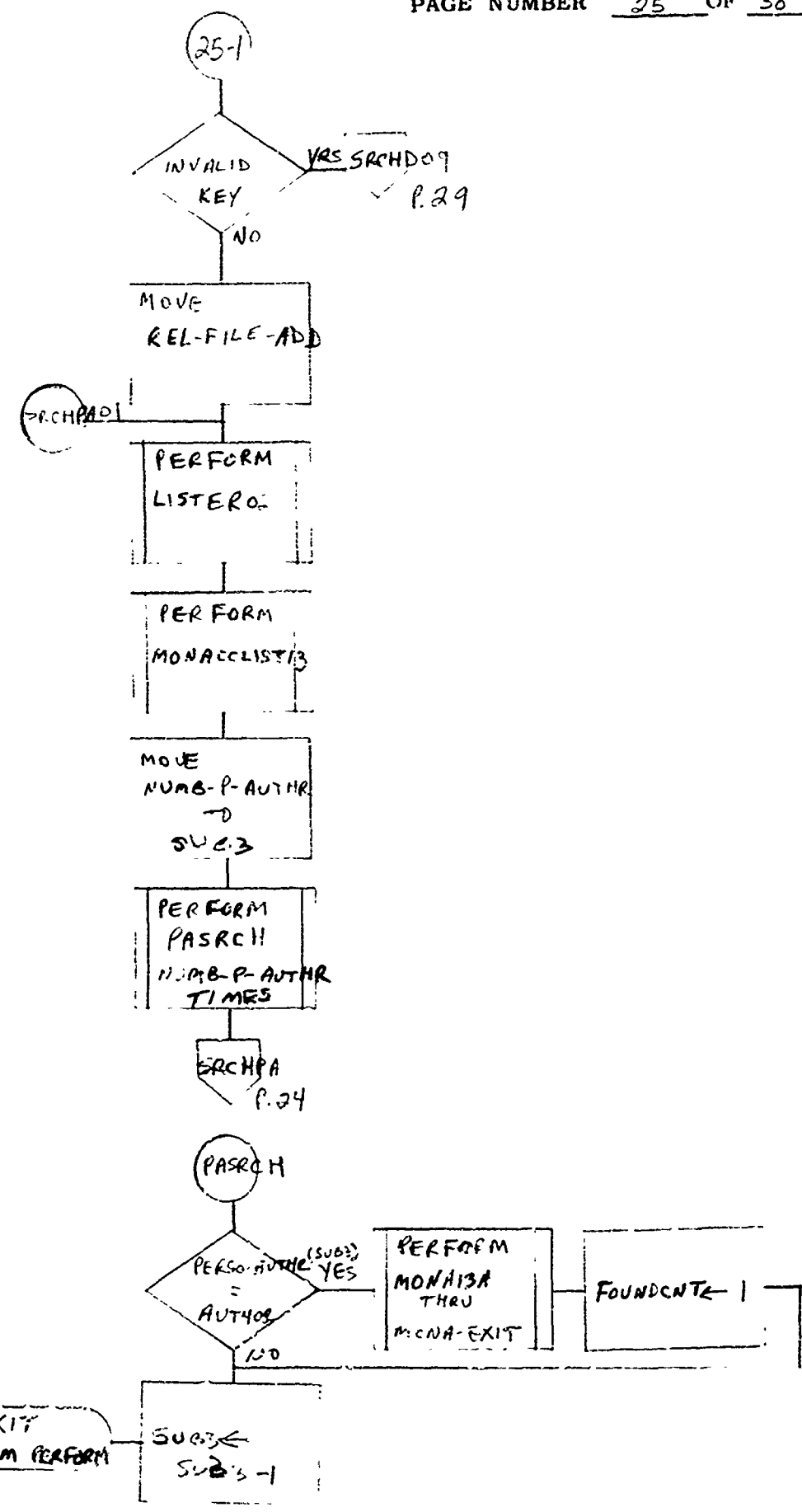

SMUFD FORM 2072-1 (Temp) Mar 68

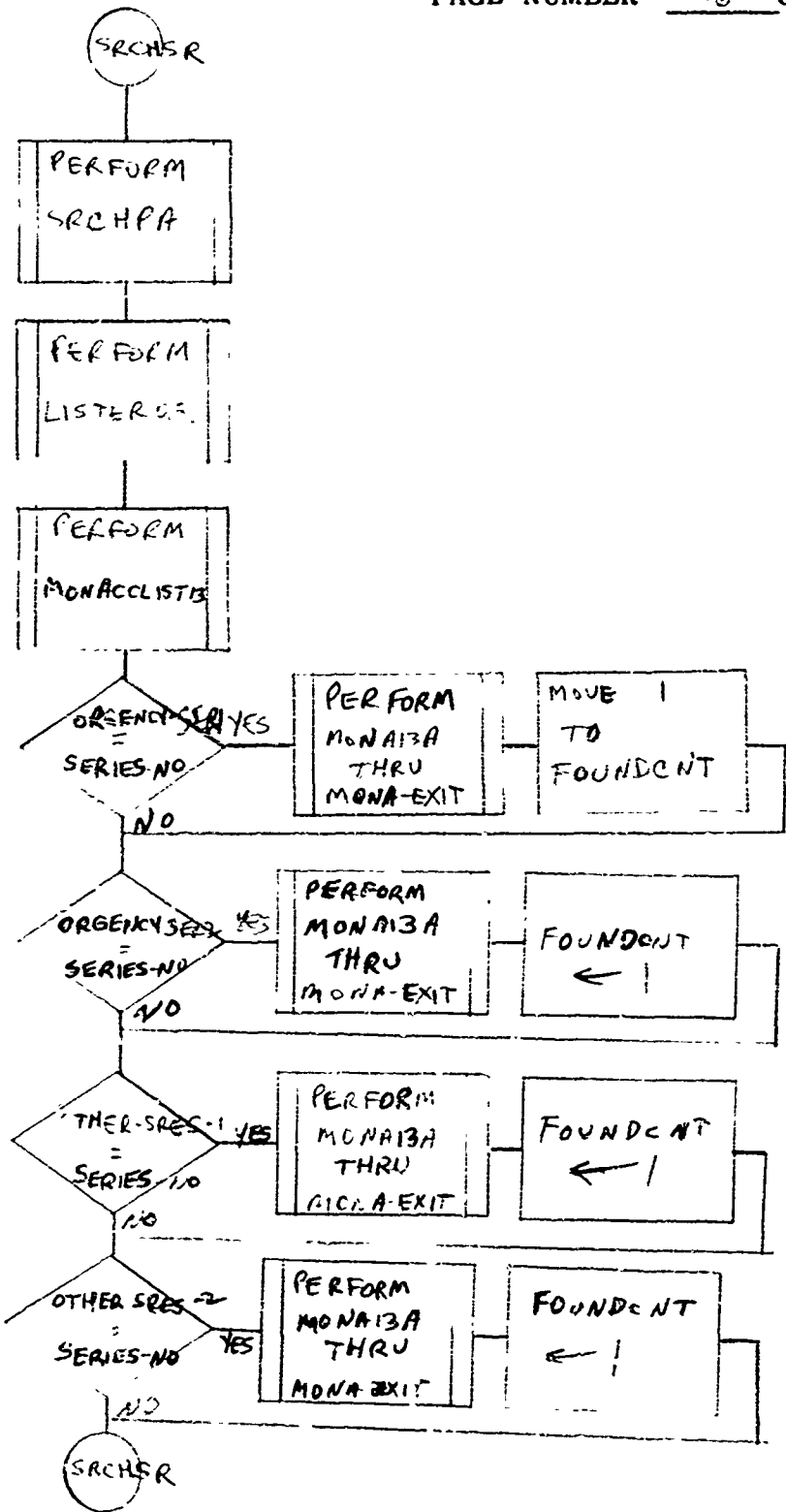

SMUFD FORM 2073-1 (Trans) Mat 68

OFFICE SYMBOL _____
SYSTEM CHART NO. _____
RUN NUMBER 2809
PAGE NUMBER 27 OF 30

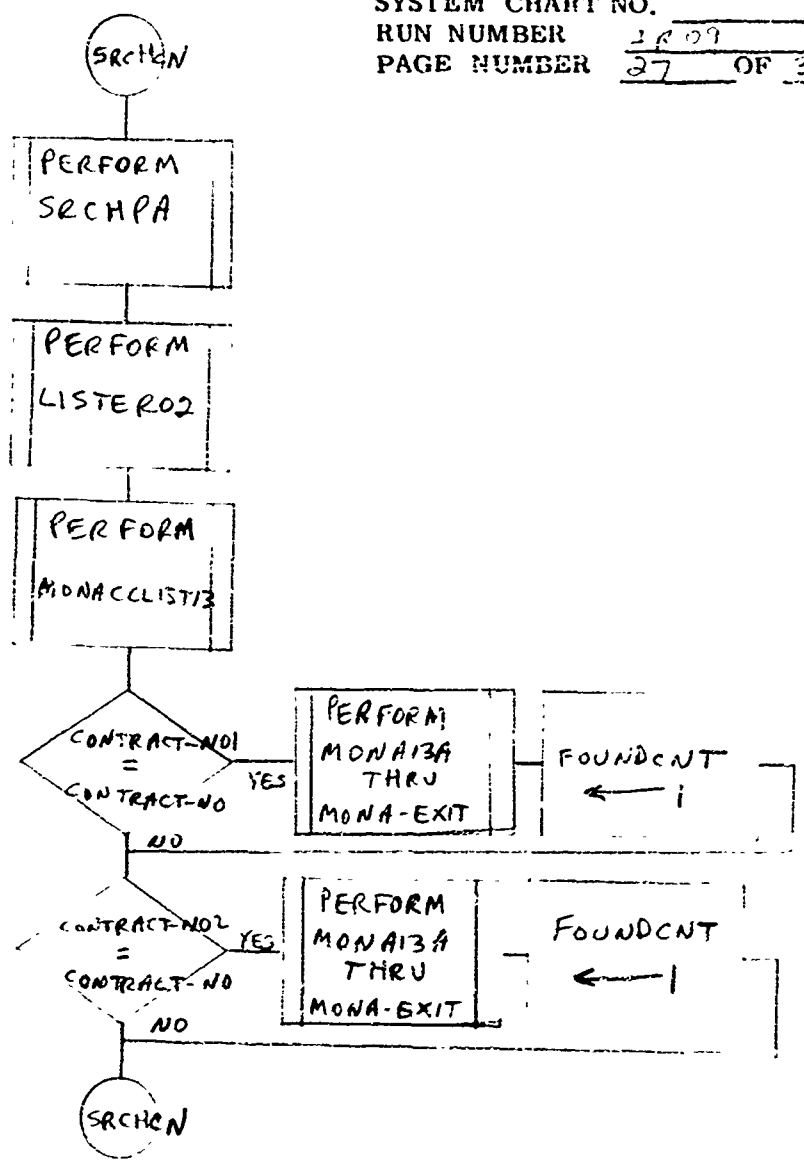

OFFICE SYMBOL _____
SYSTEM CHART NO. _____
RUN NUMBER IR09
PAGE NUMBER 27 OF 30

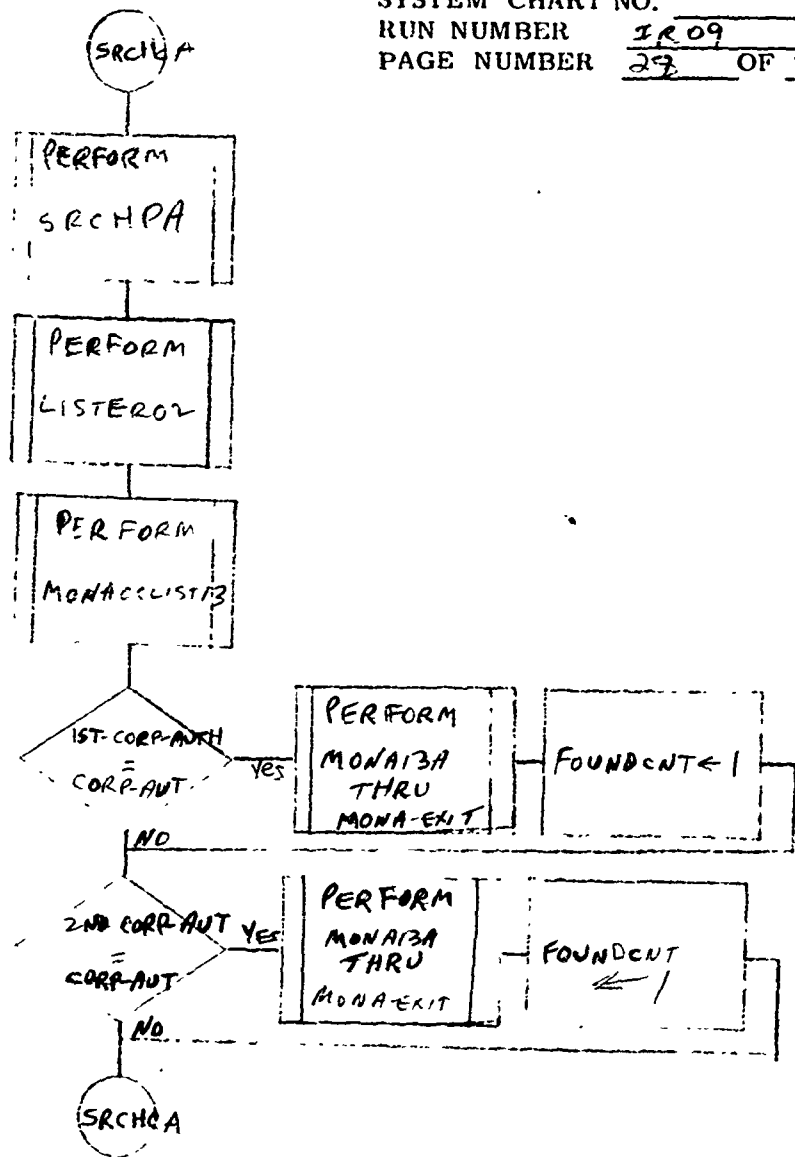

SMUFD FORM 2072-1 (Temp) Mar 68

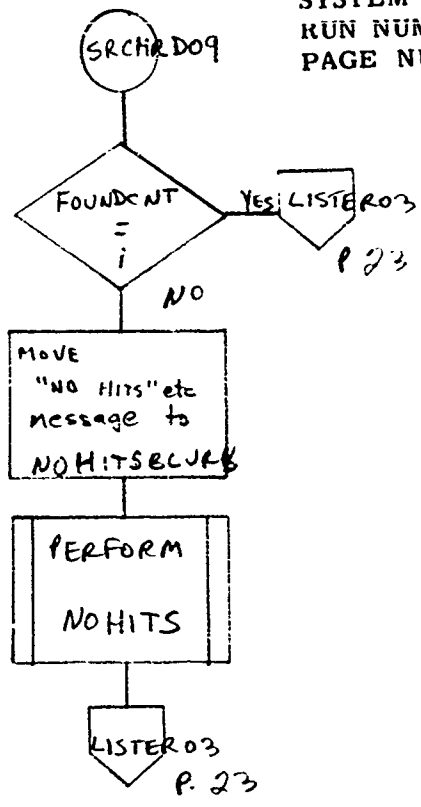

The following routines are logically the same as the ONTODISK routines with prefix CHG instead of DIC.

- DICRTN2
- DICRTN2A
- DICRTN2B
- DICRTN2C
- DICRTN3
- DICRTN4
- DICRTN5
- DICRTN6
- DICRTN7
- DICRTN8

DICRTN-EXIT is added here because the routines are PERFORM ed

Error Messages

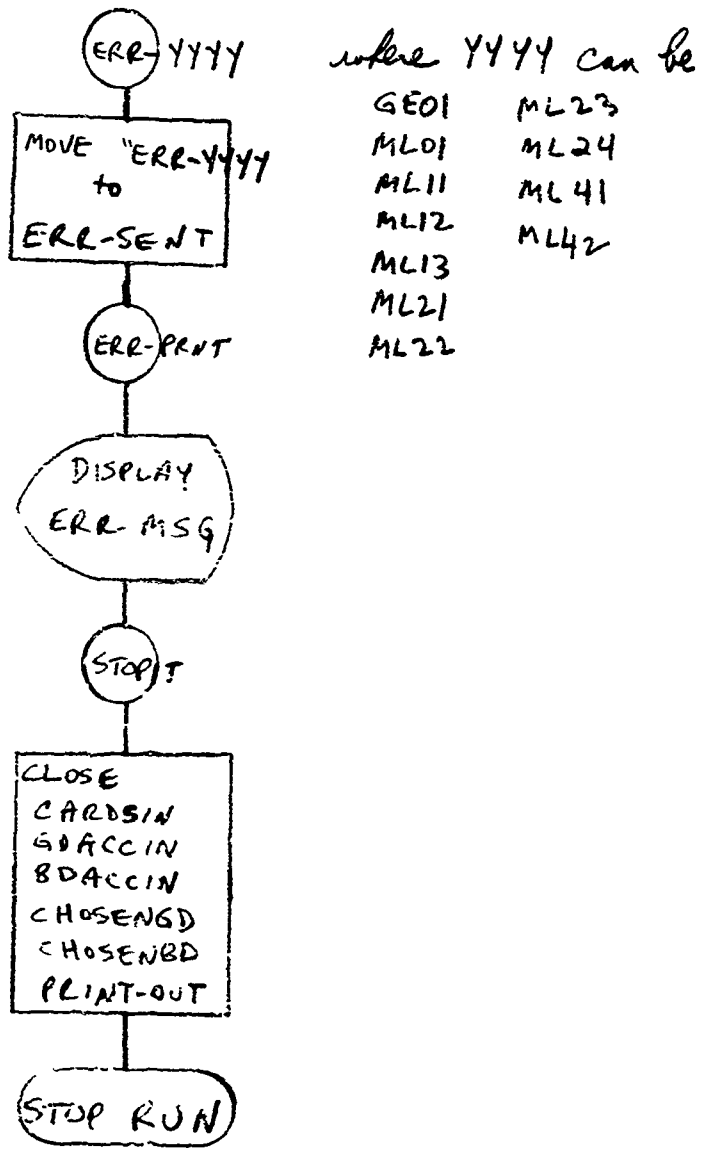
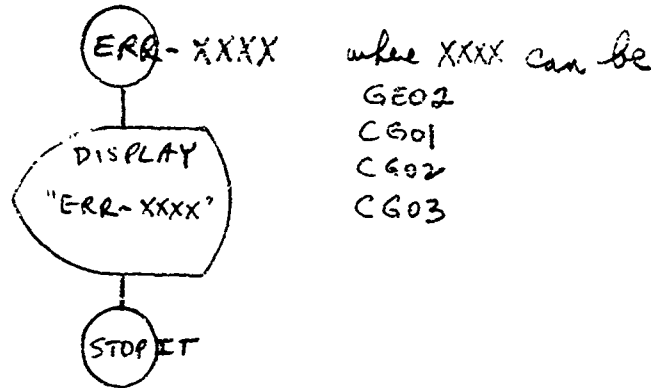

SMUFD FORM 2072-1 (T:up) Mar 68

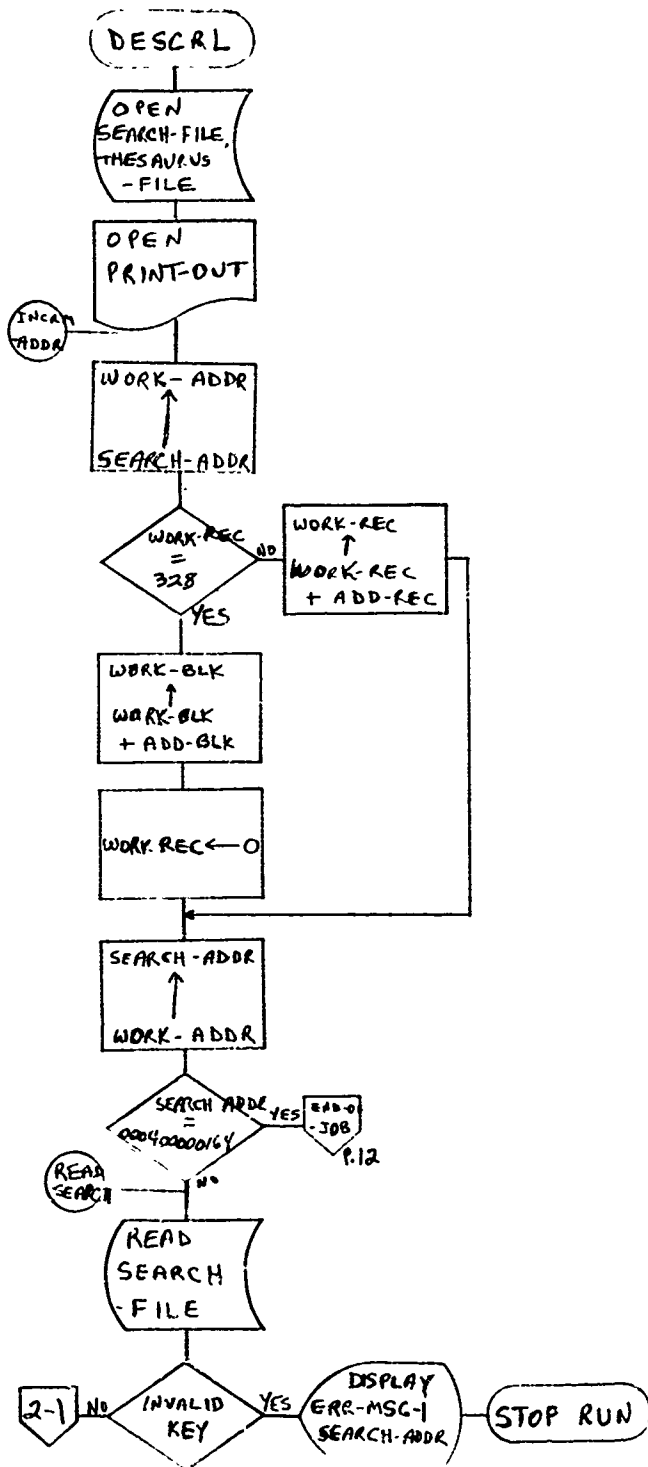

SMUFD FORM 2072-1 (T) 1st Mar 68

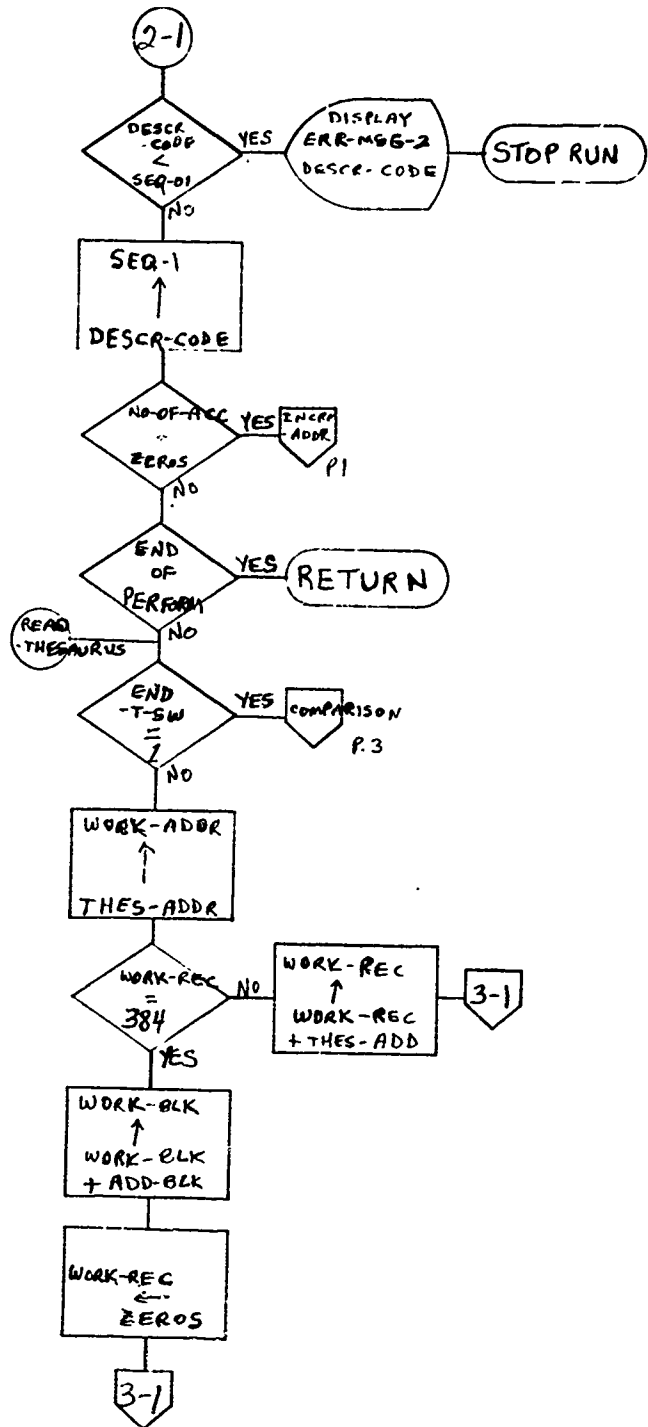

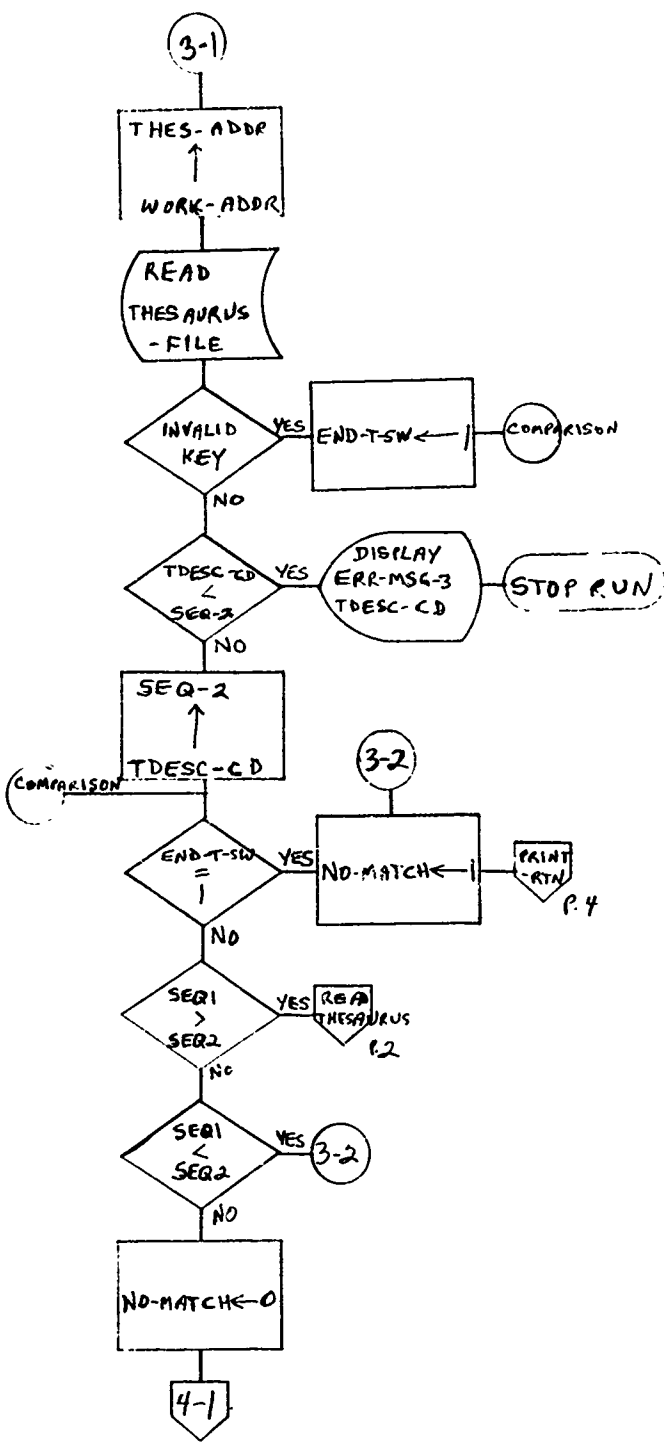

SMUFD FORM 2072-1 (Temp) Mar 68

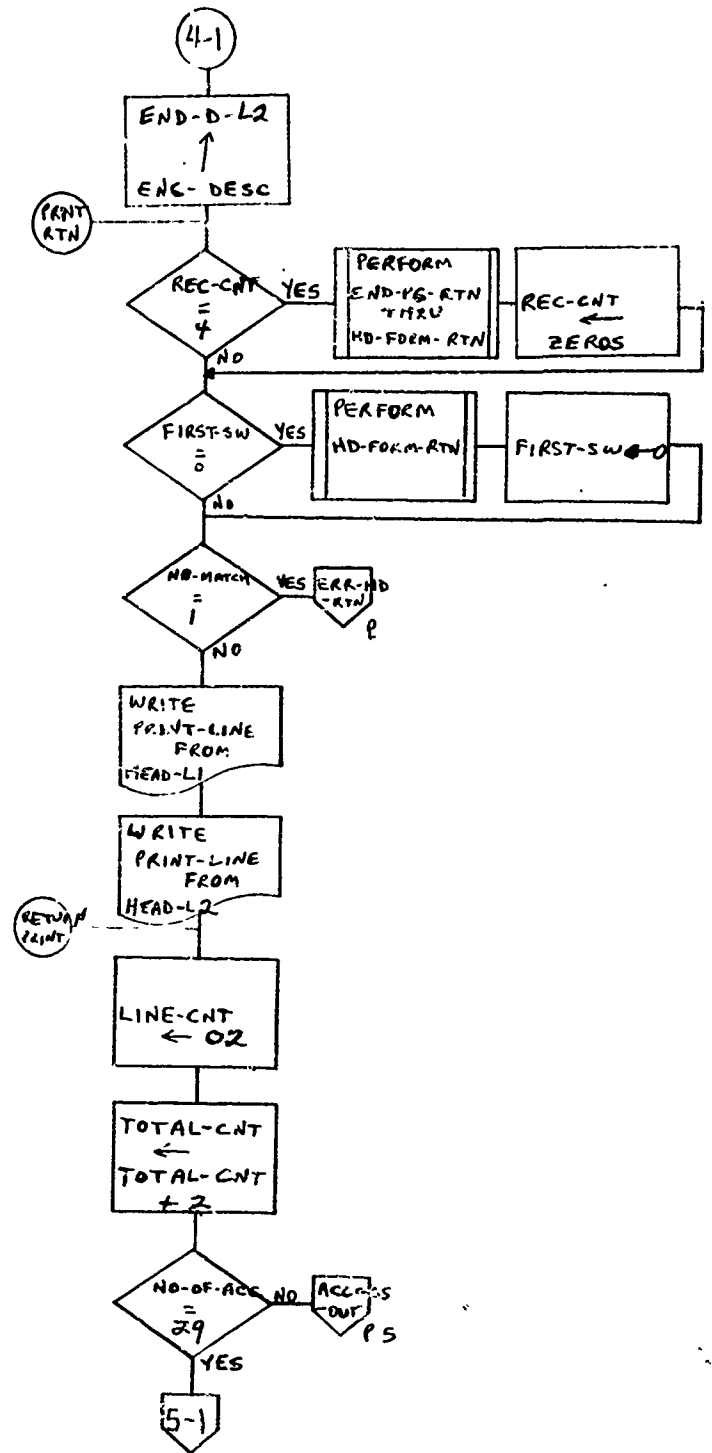

SMUFD FORM 2072-1 (T) (ip) Mar 68

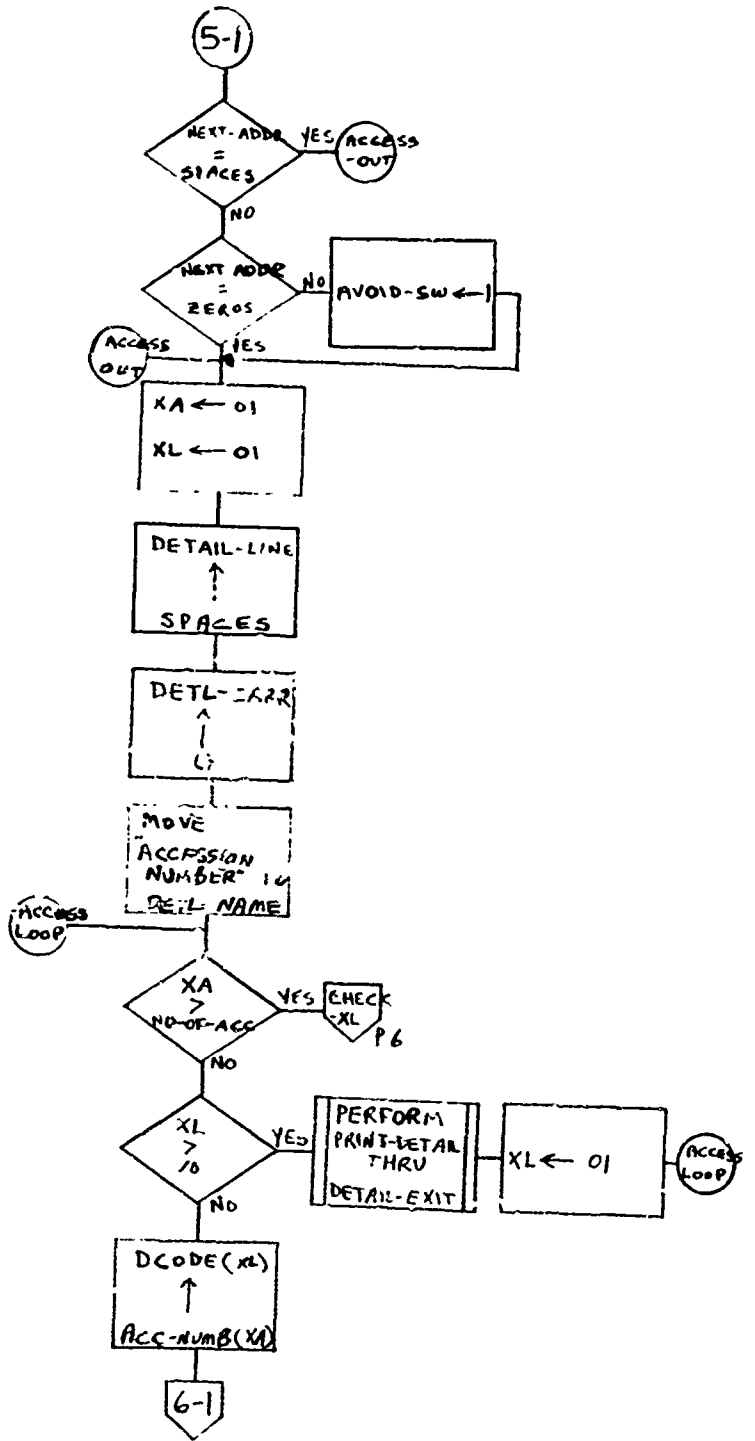

STANDARD FORM 2072-1 (7-64) Mar 68

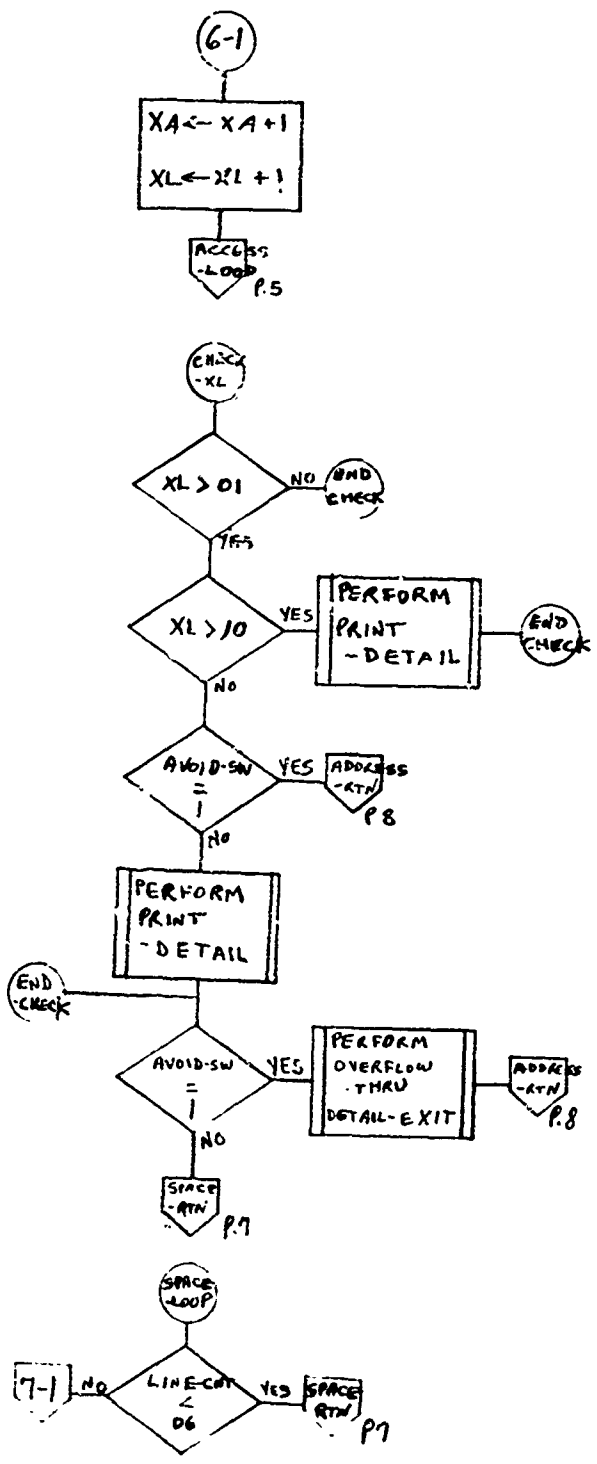

SMUFD FORM 3072-1 (T) (P) Mar 68

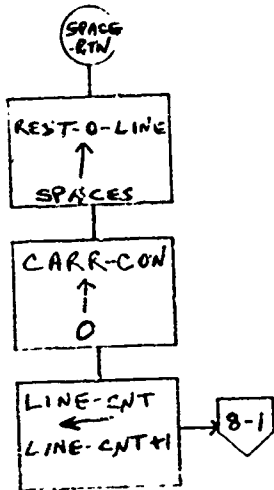
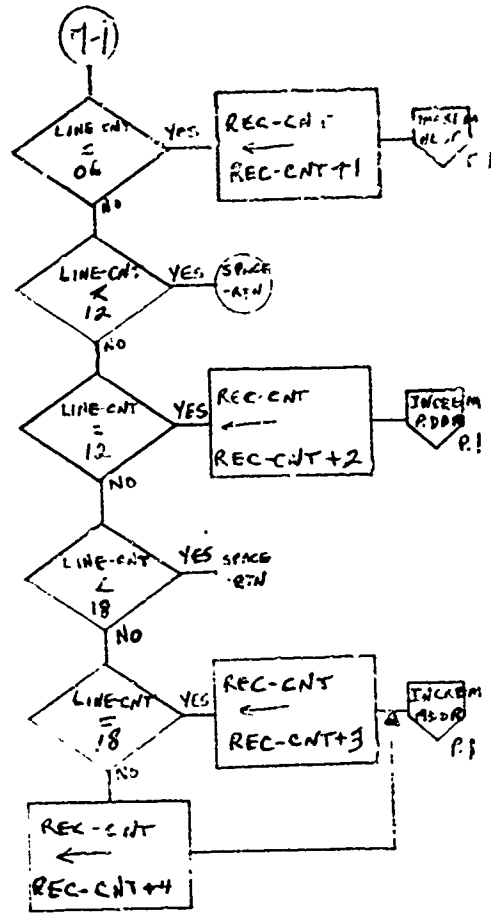

SMUFD FORM 2072-1 (T) 3/68 Mar 68

SMUFD FORM 2072-1 'T' up, Mar 58

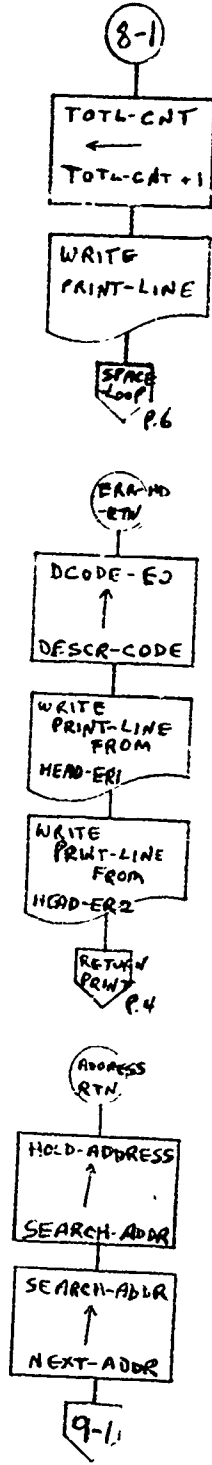

SMUFD FORM 2072-1 (T) 31p; Mar 68

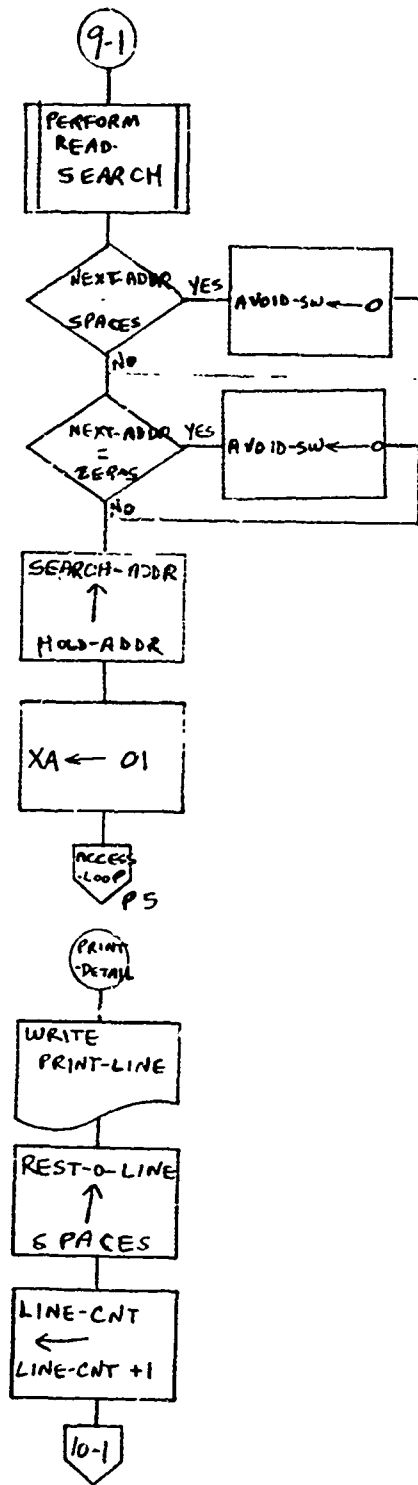

SMUFD FORM 2072-1 (T) . ip, Mar 58

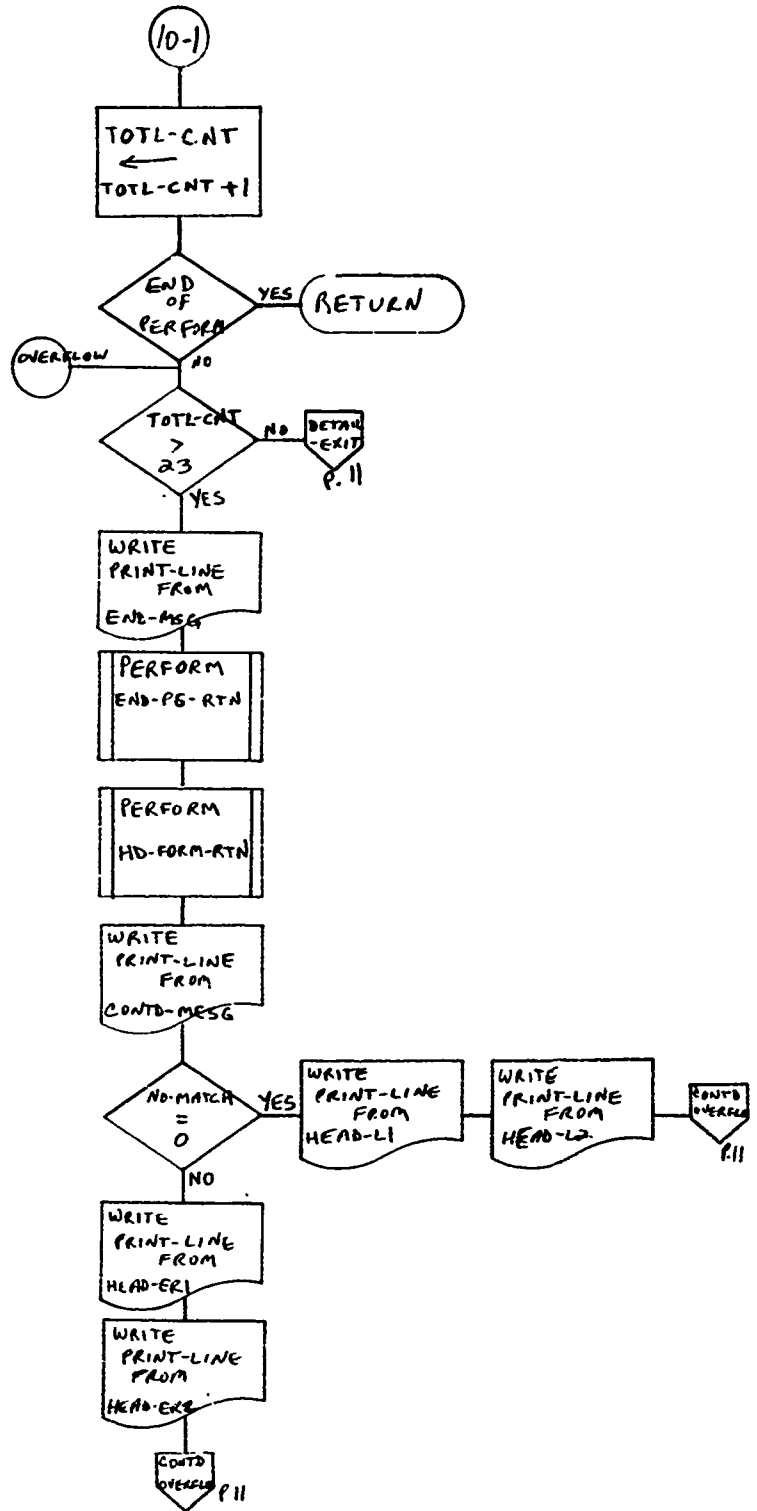

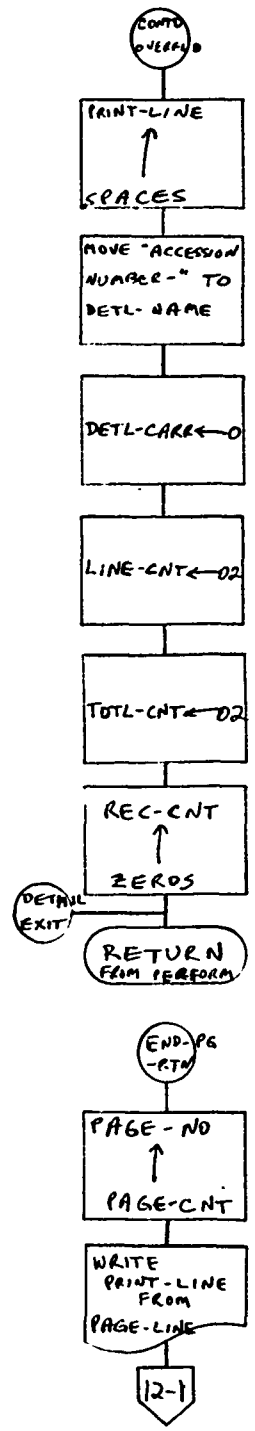

SMUFD FORM 2072-1 (T) 30p Mar 68

SMUFD FORM 2072-1 (T) ip, Mar 68

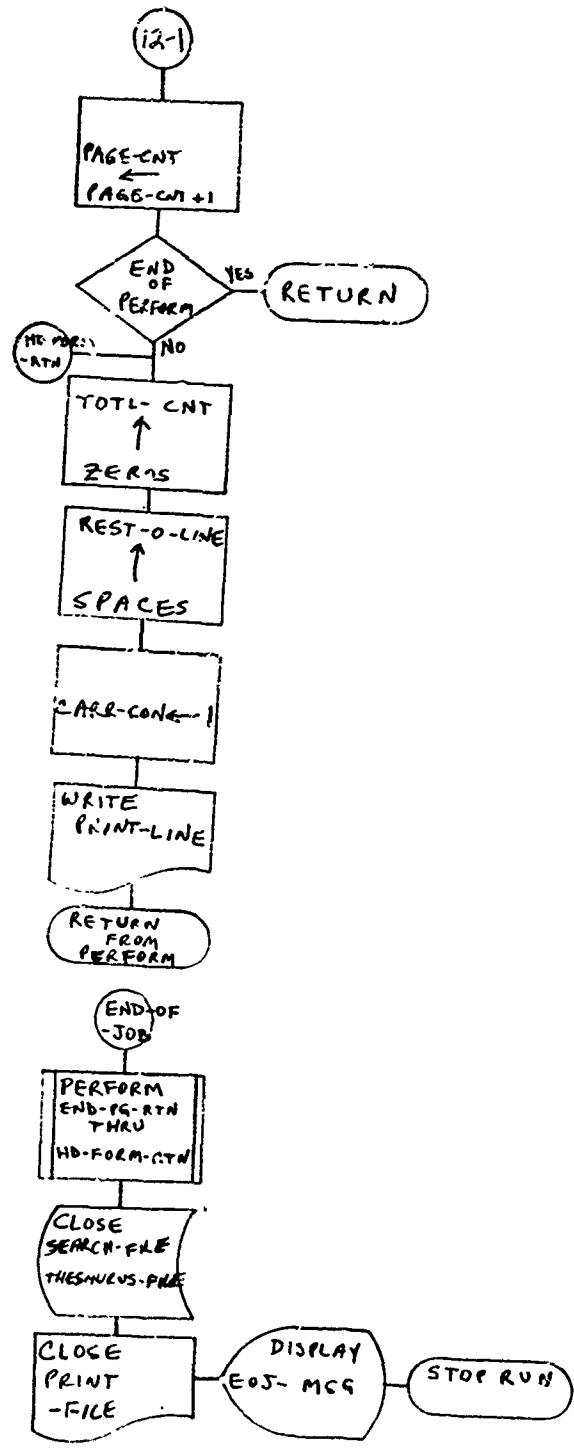

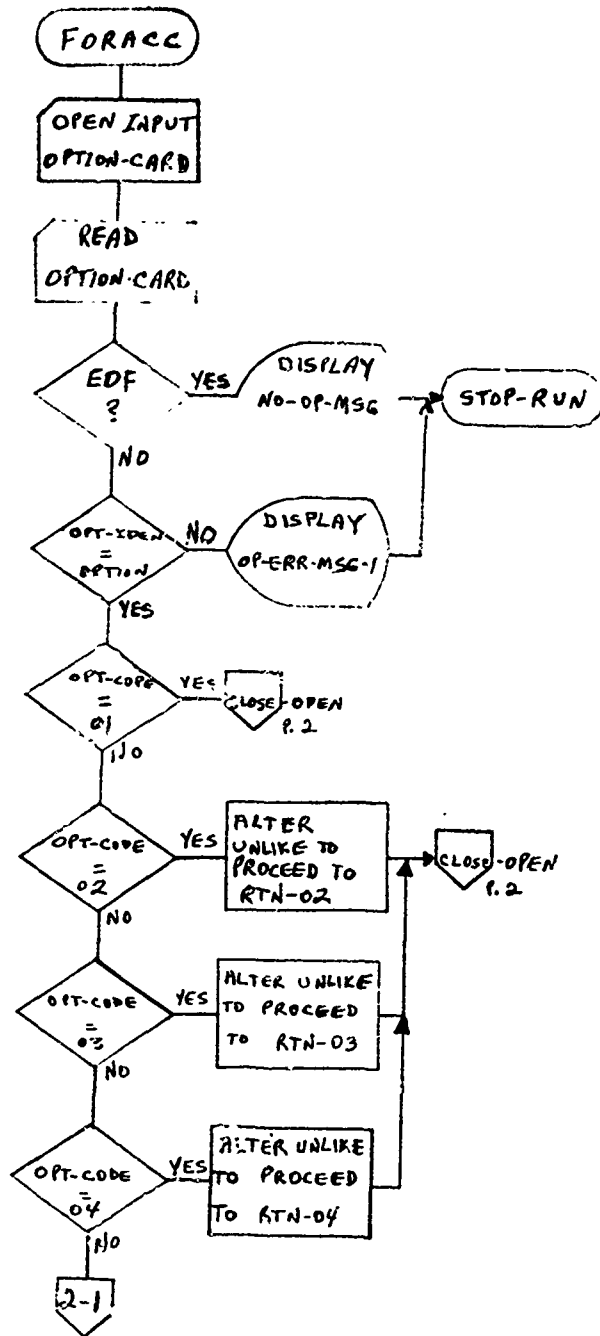

SMUFD FORMS 2072-1 (Temp) Mar 68

SMUFD FORM 2072-1 (Temp) Mar 68

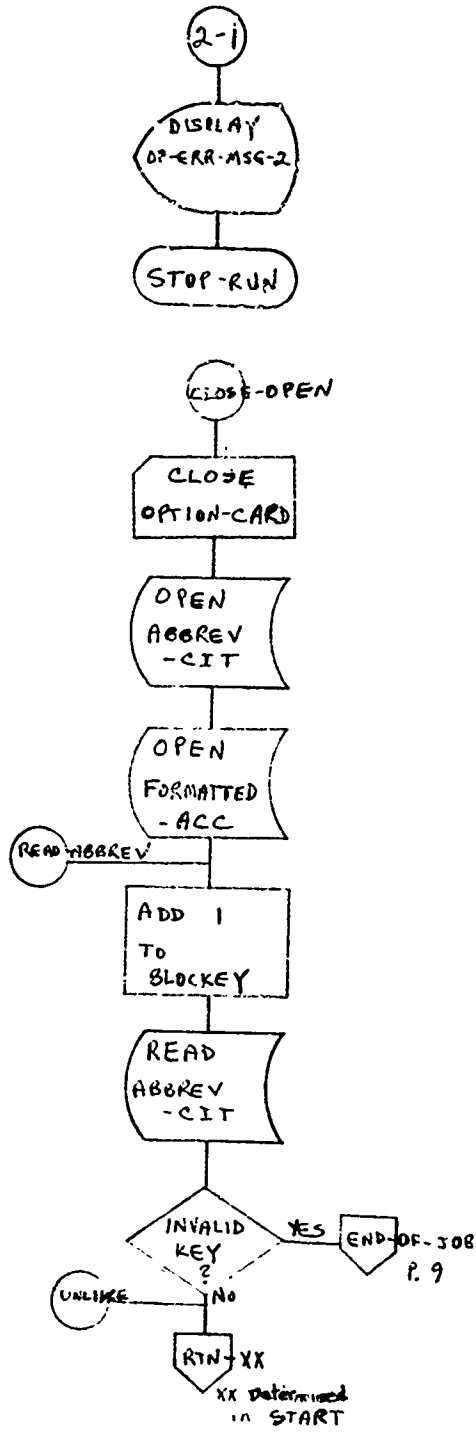

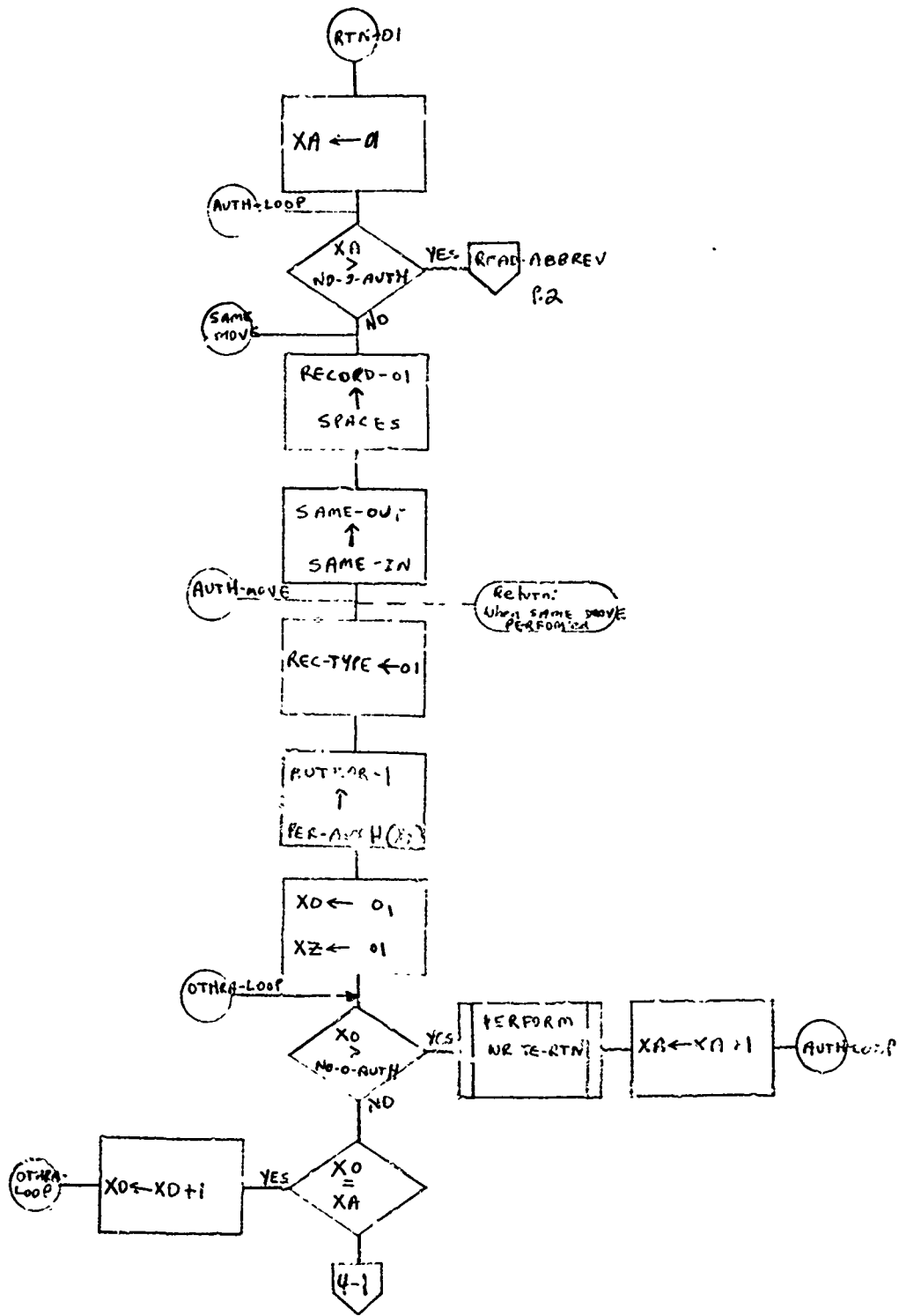

SMUFD FORM 2072-1 (Temp) Mar 68

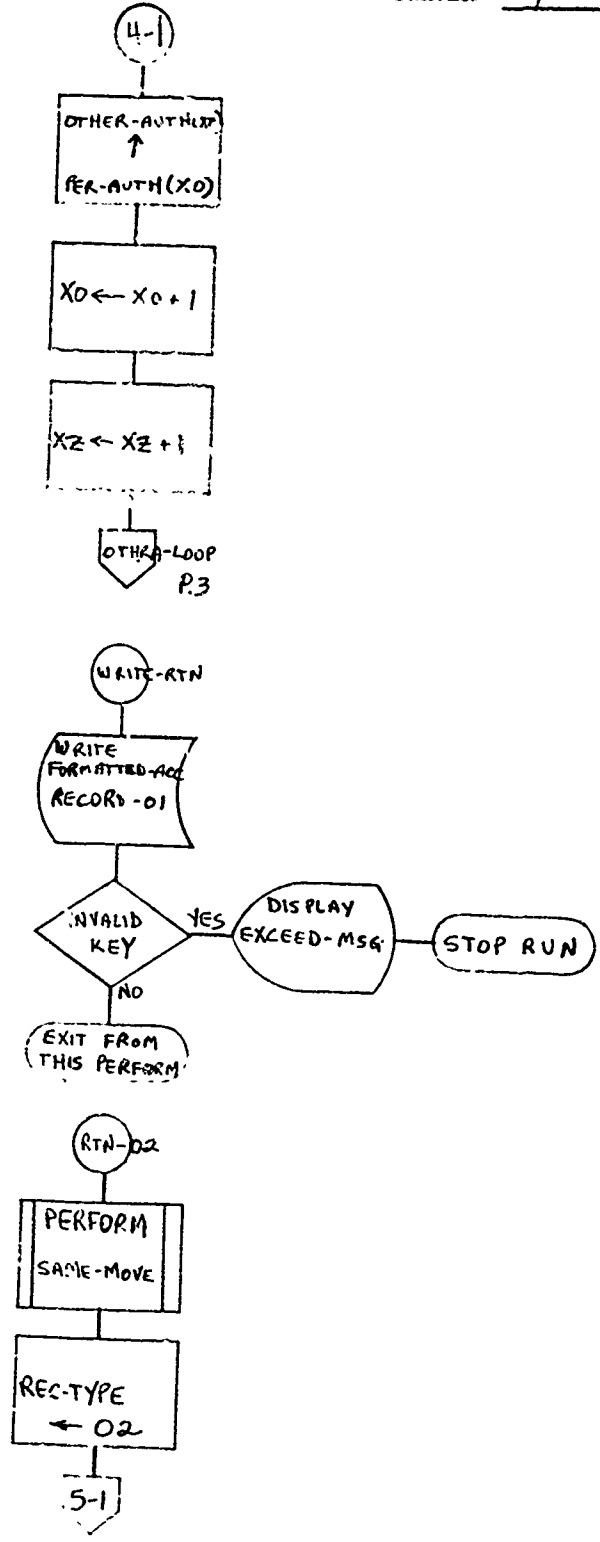

SMUFD FORM 2072-1 (Temp) Mar 68

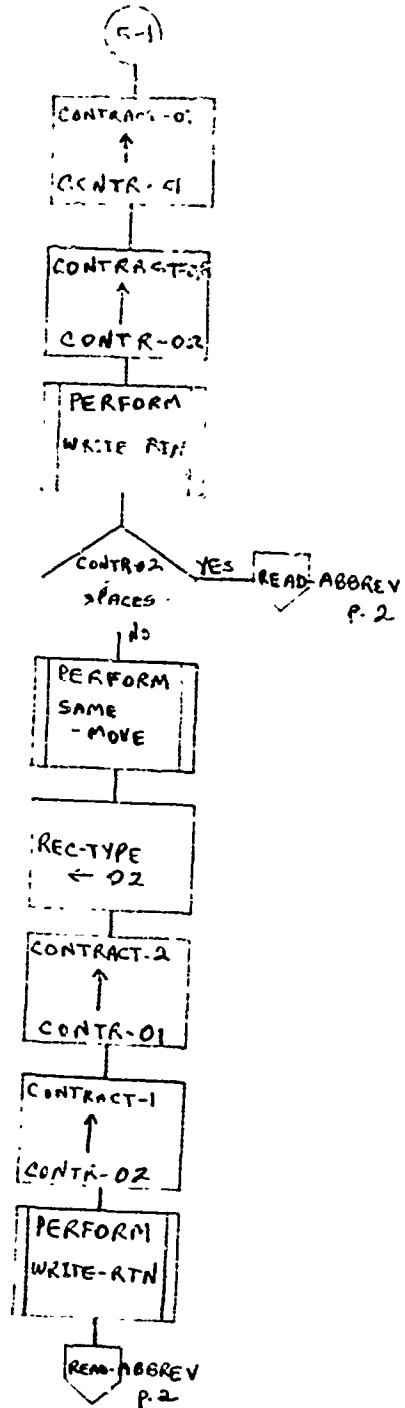

SMUD FORM 2072-1 (Temp) Mar 68

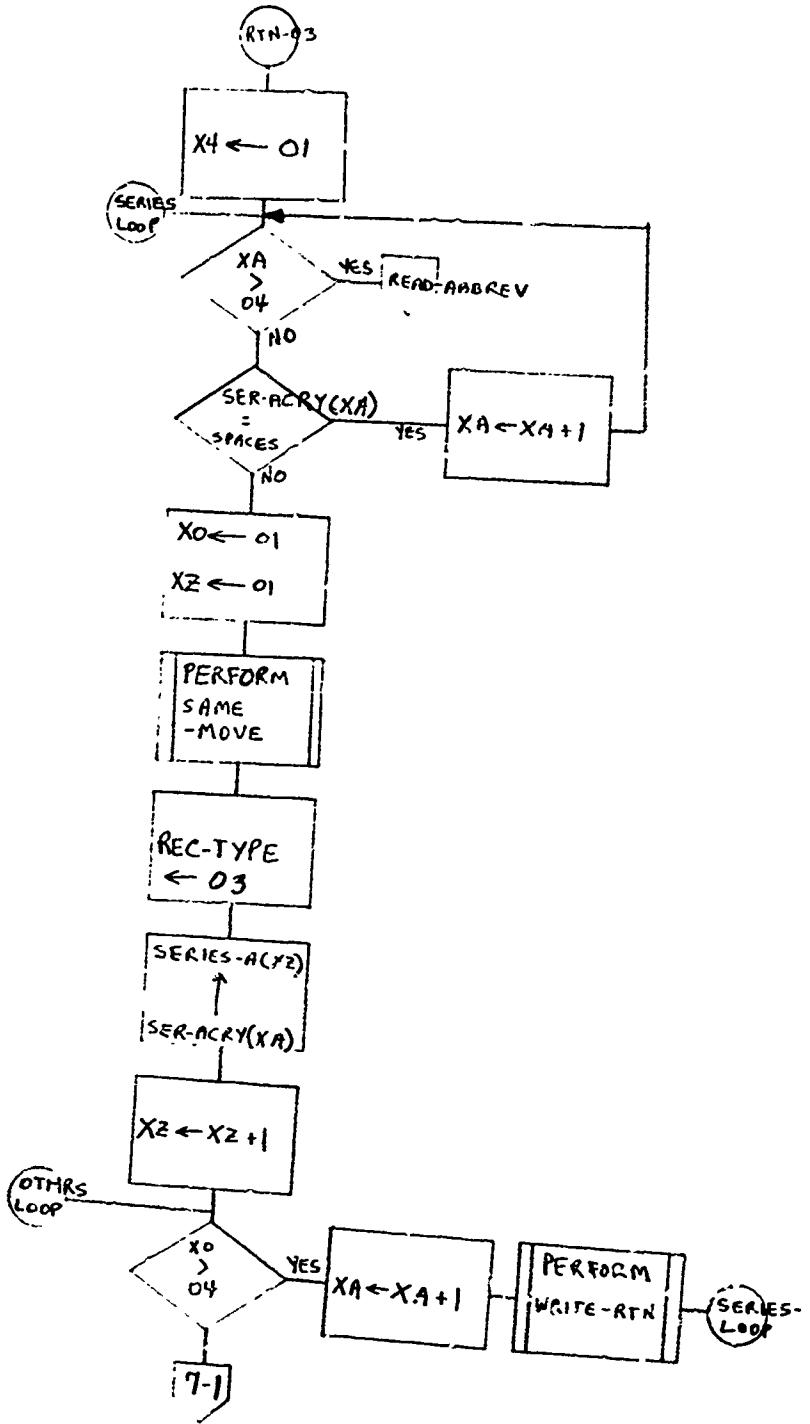

SMUFD FORM 3072-1 (Temp) Mar 68

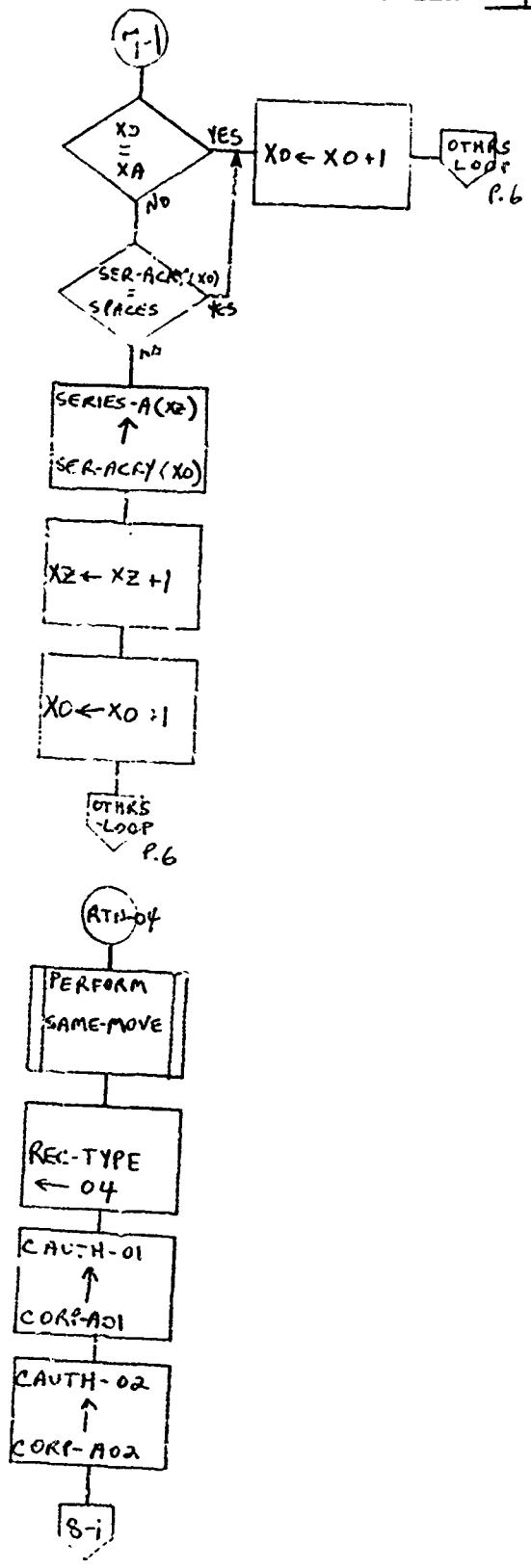

SMUFD FORM 2072-1 (Temp) Mar 68

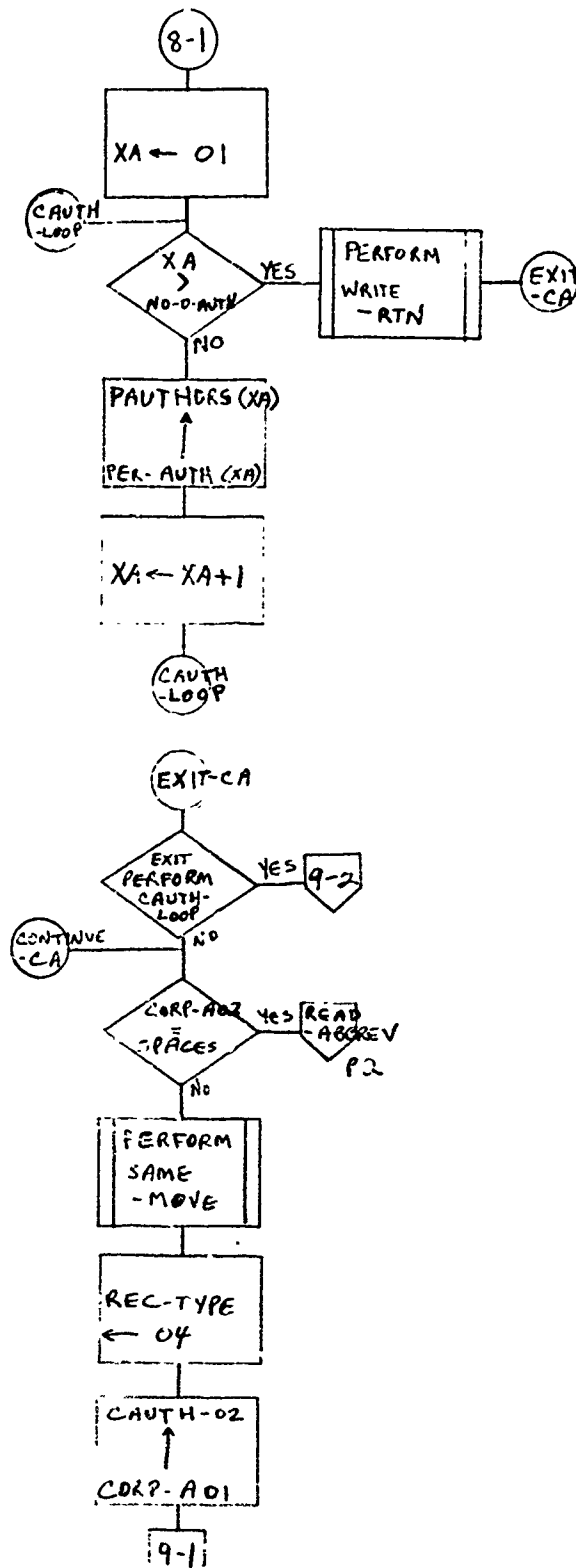

SMUFD FORM 2072-1 (Temp) Mar 68

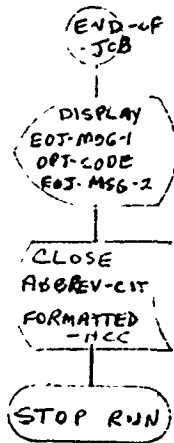
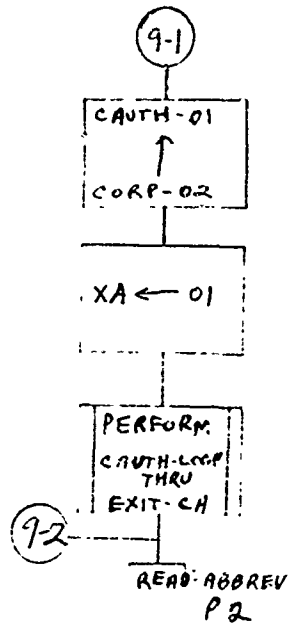

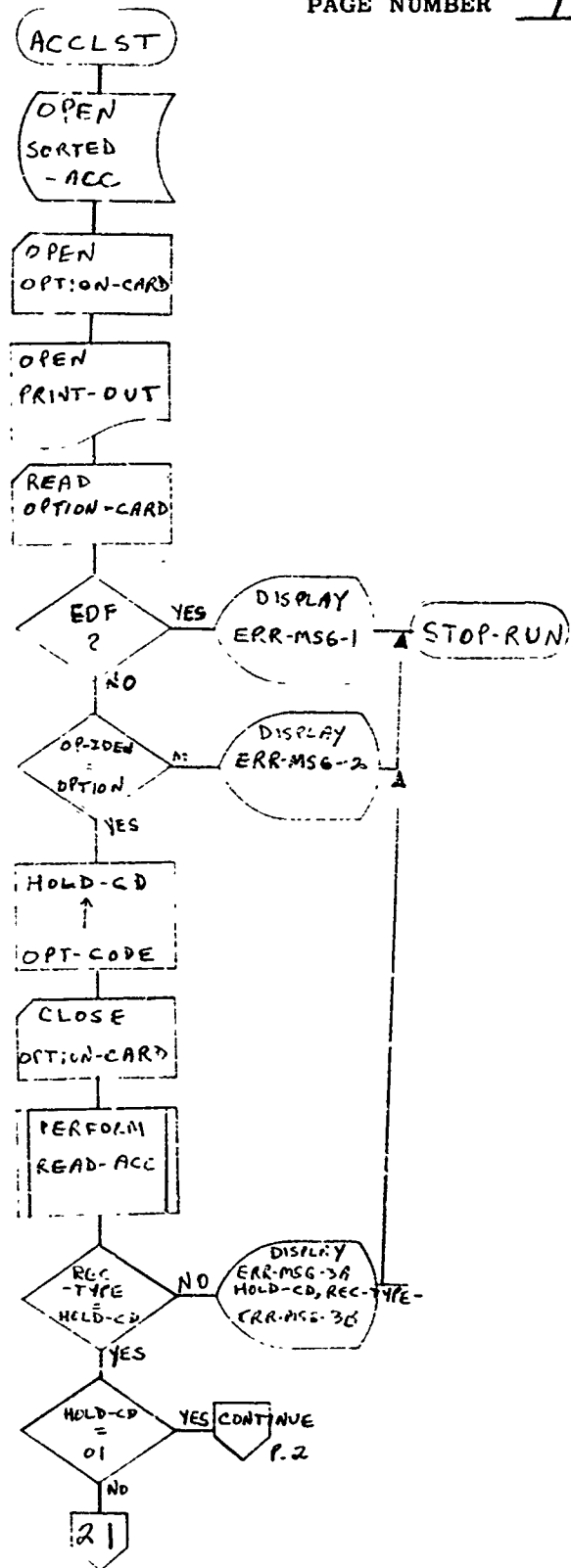

SMUFD FORM 2072-1 (Temp) Mat 68

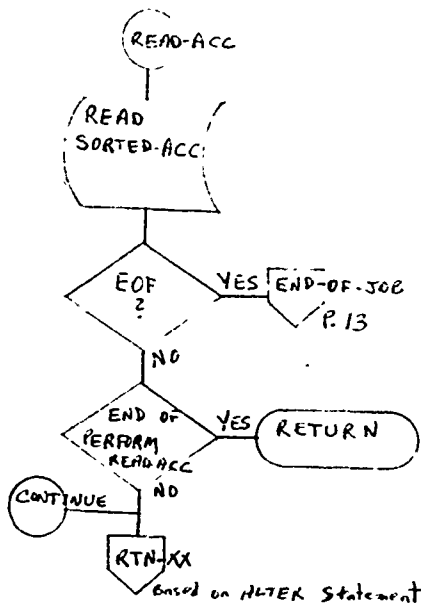
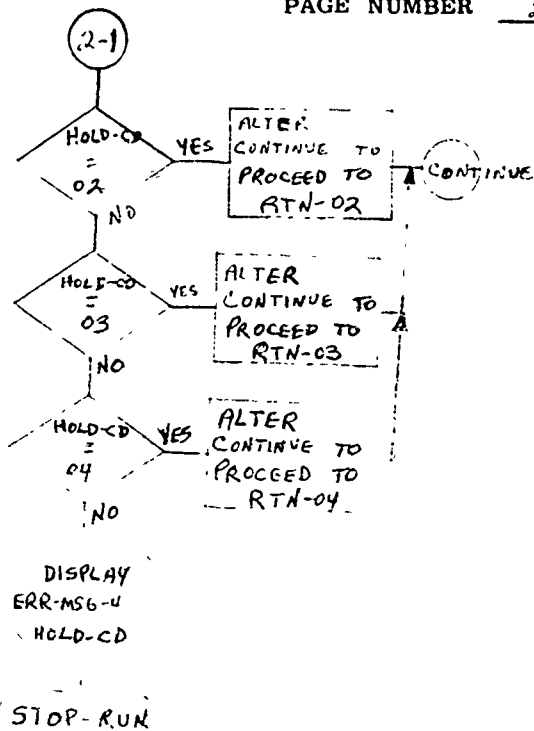

SMUFD FORM 2072-1 (Temp) Mar 68

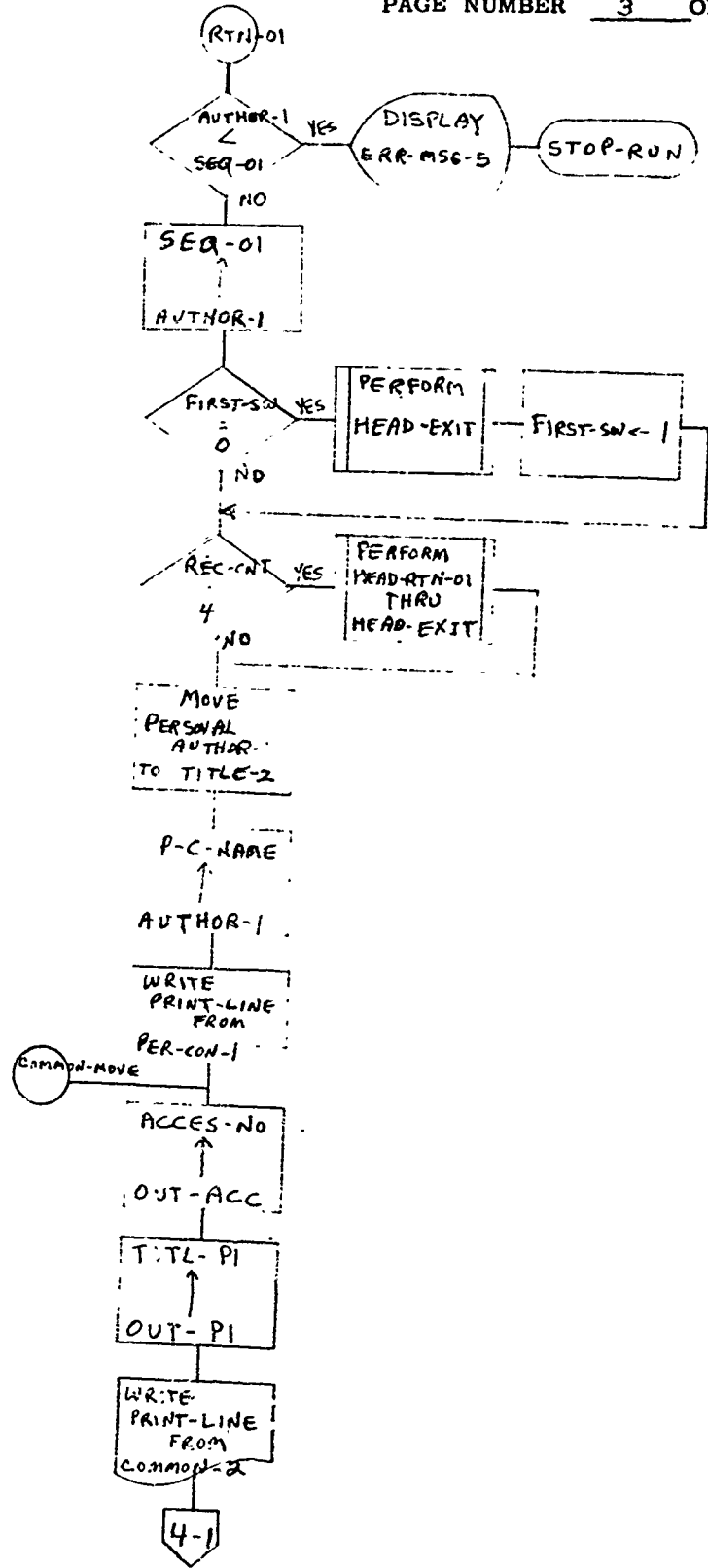

SMUFD FORM 2072-1 (Temp) Mar 68

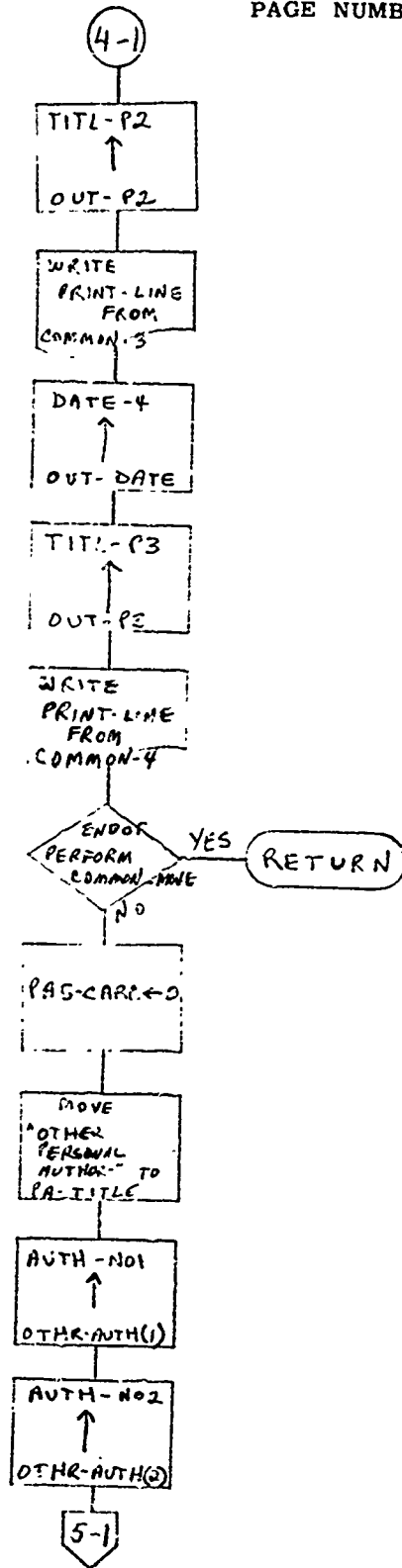

SMUFL FORM 2072-1 (Temp) Mar 68

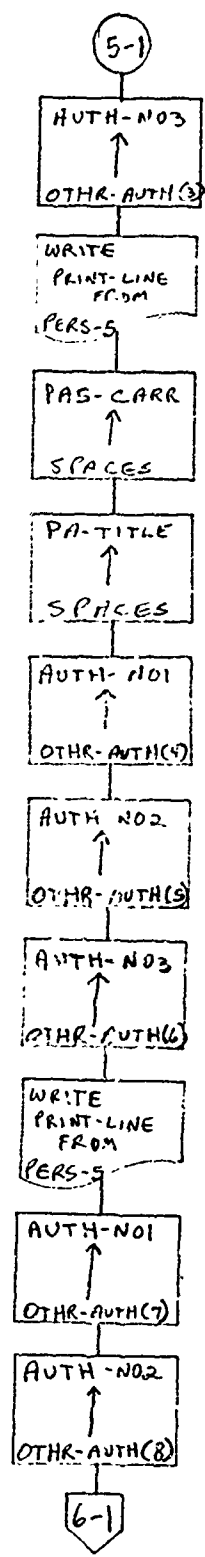

SMUFD FORM 2072-1 (Temp) Mar. 68

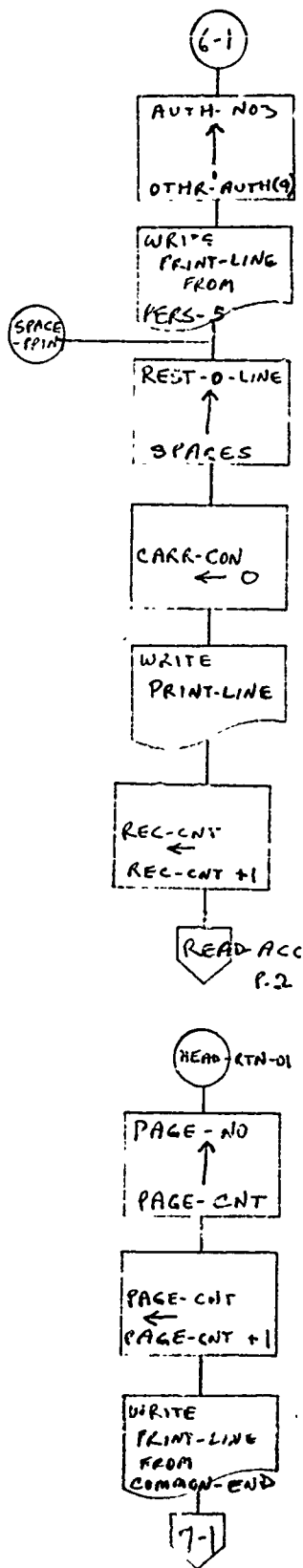

SMUFD FORM 2072-1 (Temp) Mar 68

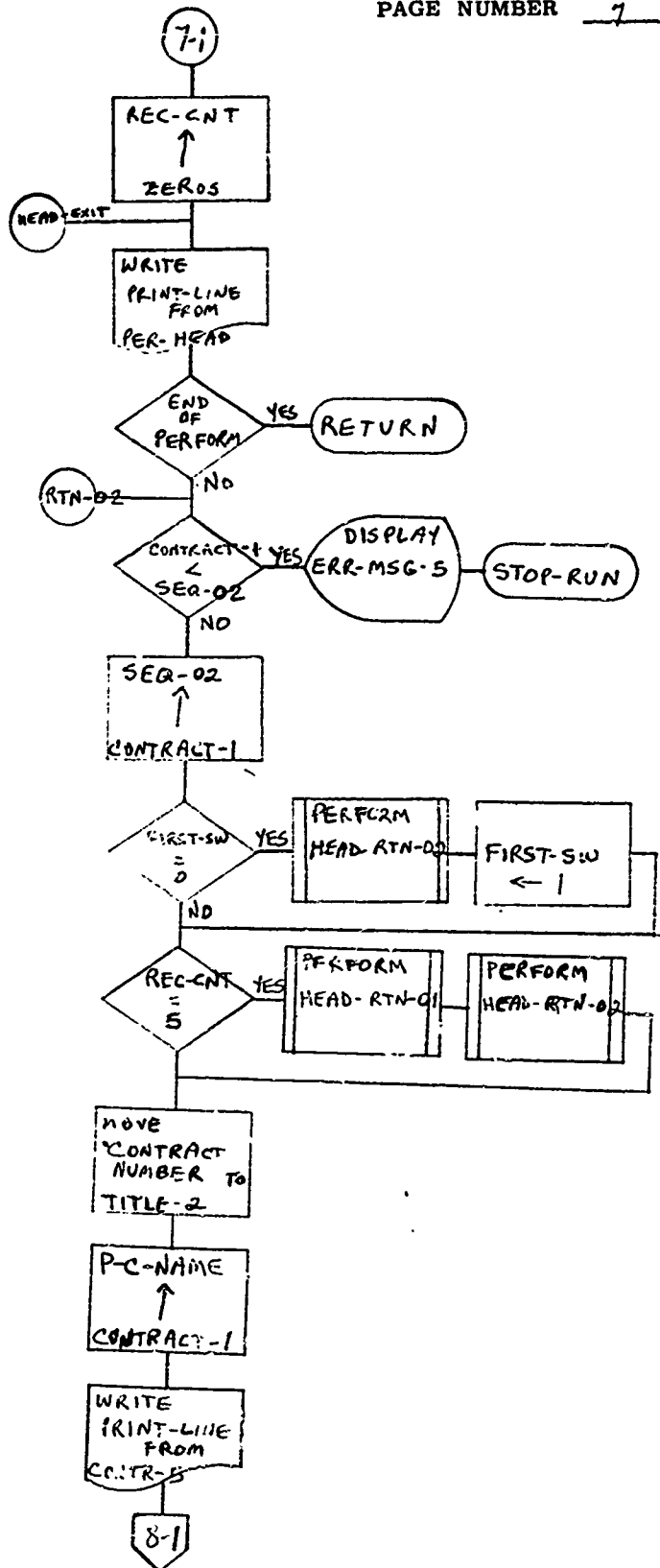

SMUFD FORM 2072-1 (Temp) Mar 68

SMUFD FORM 2072-1 (T) (up) Mar 68

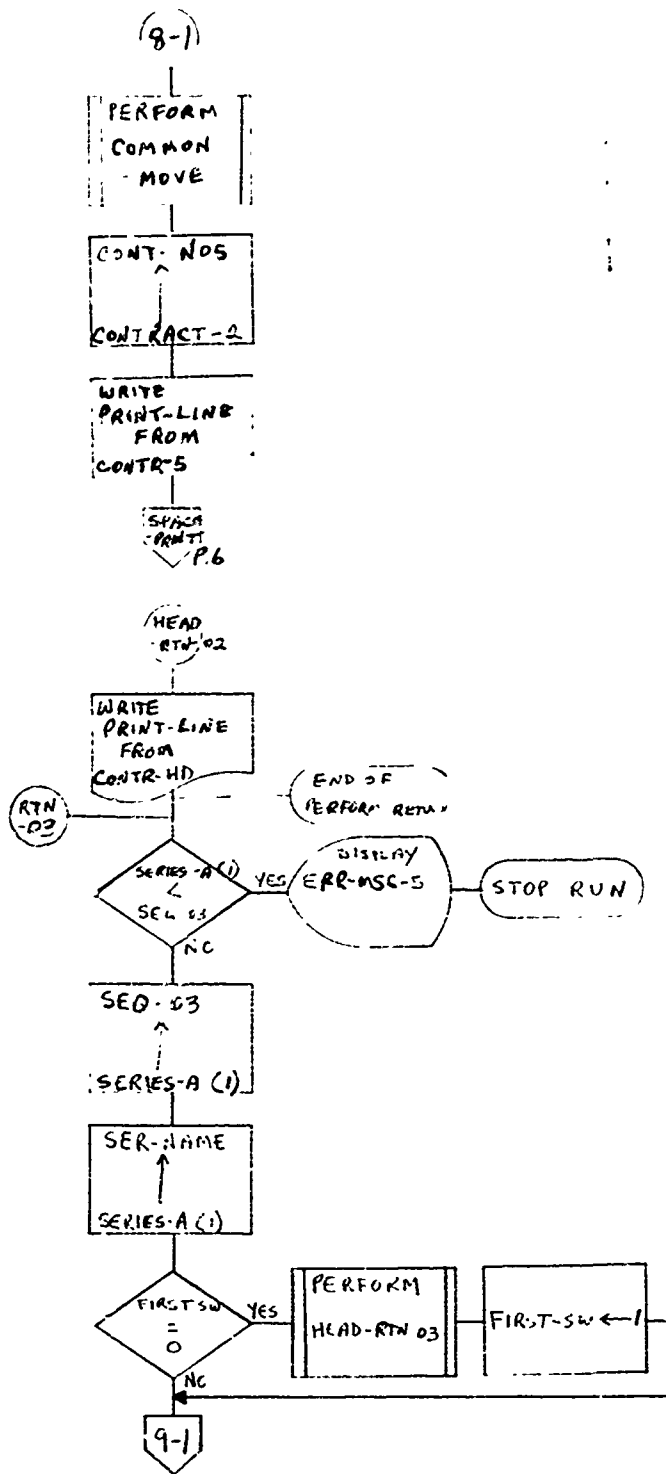

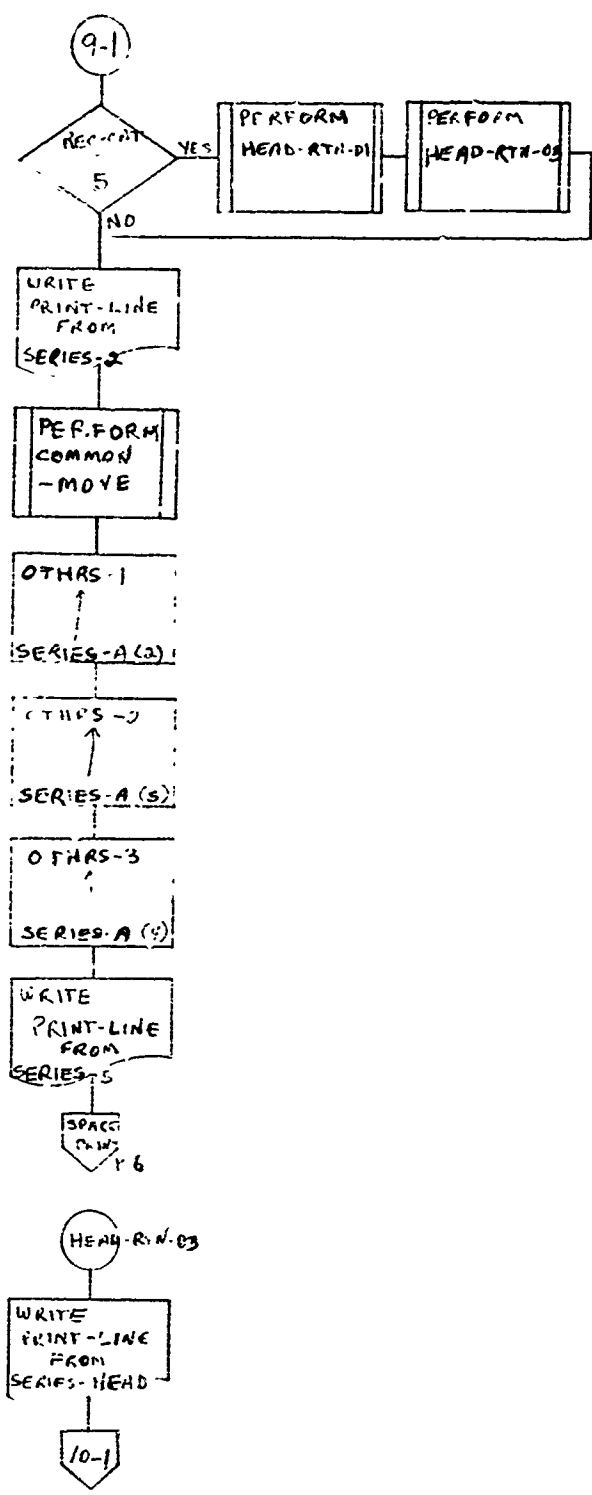

SMUFD FORM 2072-1 (T) ip: Mar 68

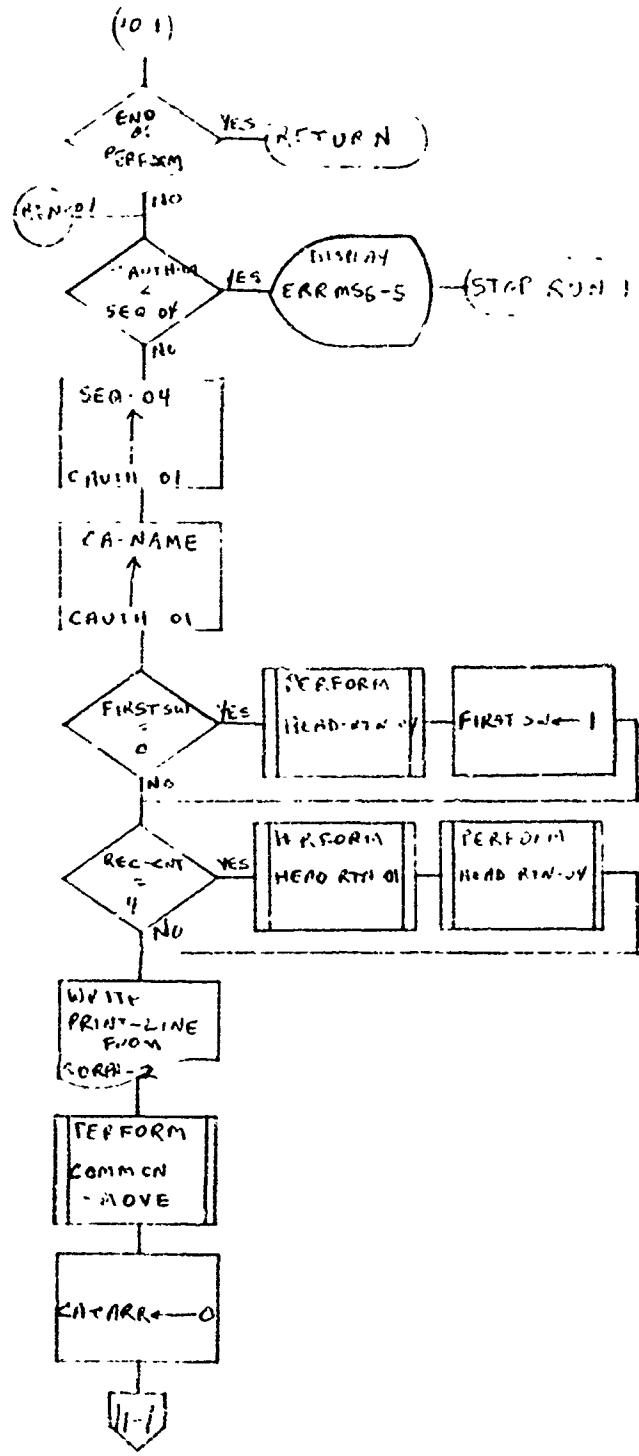

SMUFD FORM 2072-1 T ip. Mar 68

SMUFD FORM 2072-1 71 ip, Mar 68

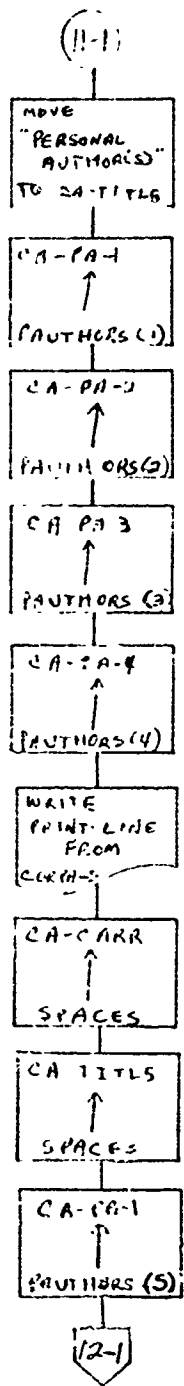

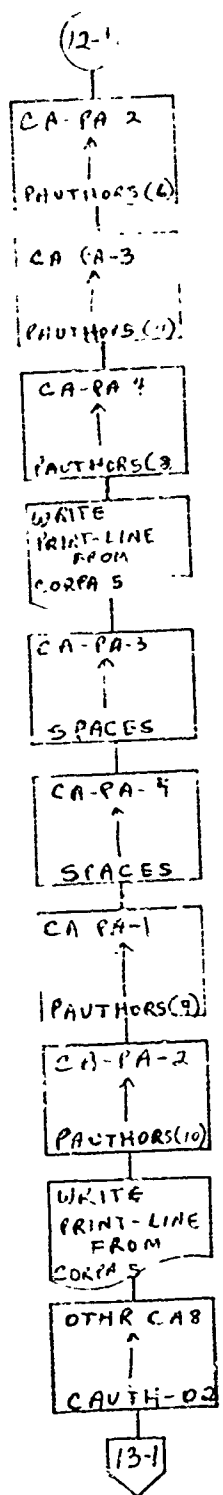

SMUFD FORM 2072-1, 11T ip Mar 68

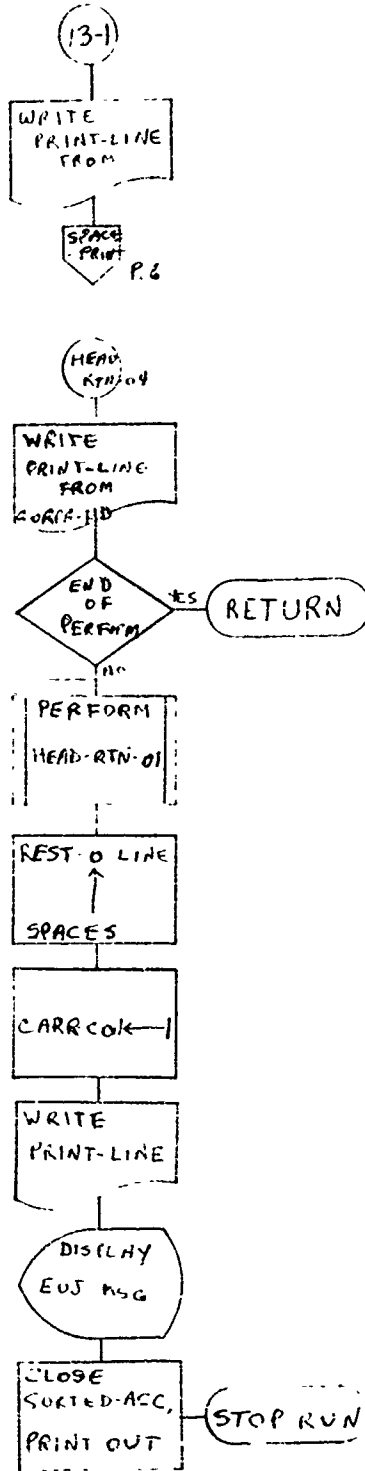

SMUFD FORM 2072-1 1 1p Mar 68