

GEOPHYSICAL INSTITUTE

AD6656683

UNIVERSITY
OF ALASKA

COLLEGE,
ALASKA

UAG R-188



LARGE APERTURE SEISMIC TELEMETERING SYSTEM FOR CENTRAL ALASKA

by

Eduard Berg, Norbert Sperlich and William Feetham

SCIENTIFIC REPORT

May 1967

Supported by

AIR FORCE OFFICE OF SCIENTIFIC RESEARCH

Grant 701-66

RECEIVED

AUG 24 1967

CFSTI

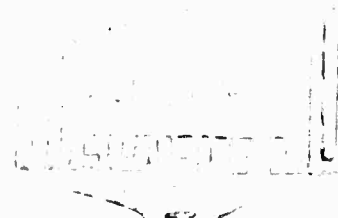

50

GEOPHYSICAL INSTITUTE
of the
UNIVERSITY OF ALASKA

Scientific Report

LARGE APERTURE SEISMIC TELEMETERING SYSTEM FOR CENTRAL ALASKA

by

Eduard Berg, Norbert Sperlich and William Feetham

Air Force Office of Scientific Research
Grant 701-66

Principal Investigator:

E. Berg

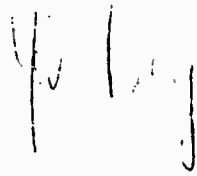

Approved by:

Keith B. Mather
Director

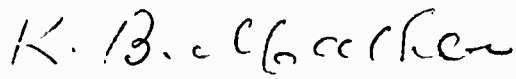

GEOPHYSICAL INSTITUTE
OF THE
UNIVERSITY OF ALASKA

Scientific Report

AFOSR Grant No. AF-AFOSR-701-66
Project File: Tectonic Movement and Deformation Release
in Alaska
ARPA Order No.: 292-66
AKPA Project Code: 8652
Date Grant Starts: 1 January 1966
Date Grant Terminates: 31 December 1967
Amount of Grant: \$129,676.00
Project Scientist: Professor Eduard Berg
Telephone No.: 907-479-7373

TABLE OF CONTENTS

	Page
TABLE OF CONTENTS	1
LIST OF ILLUSTRATIONS	11
ABSTRACT	111
INTRODUCTION	1
BASIC REQUIREMENTS	3
<u>Noise</u>	3
<u>Components</u>	4
<u>Reliability</u>	4
<u>Flexibility</u>	4
<u>Cost</u>	5
DESIGN CONSIDERATIONS	5
SITE SELECTION AND INSTALLATION	6
REMOTE EQUIPMENT	7
<u>Seismometer and Amplifier</u>	7
DATA TRANSMISSION	7
<u>Voltage Controlled Oscillator</u>	8
RECEIVING AND RECORDING EQUIPMENT	9
<u>Discriminator</u>	9
<u>Recorder</u>	11
<u>Timing</u>	11
SYSTEM CALIBRATION	12
GEOGRAPHICAL LOCATION	13
NETWORK SENSITIVITY	14
ACKNOWLEDGEMENTS	16
REFERENCES	17

LIST OF ILLUSTRATIONS

- Fig. 1 Seismic Stations, Geophysical Institute, University of Alaska
- Fig. 2 Remote seismic station subsystem.
- Fig. 3 Receiving and recording system.
- Fig. 4 Remote subsystem calibration.
- Fig. 5 Terminal voltage of seismometer. (Taken from Instruction Manual)
- Fig. 6 SPA-1 low pass filter response. (Taken from Instruction manual)
- Fig. 7 VCO - Discrimination response.
- Fig. 8 Develocorder Sensitivity
- Fig. 9 Pedro Dome (PJD) system magnification ground to trace amplitude and develocorder view screen.
- Fig. 10A Monthly epicenters for central Alaska - February to May 1967.
through
10D
- Fig. 11A Examples of recorded earthquakes in the distant Range 17° to 154° .
through
17A
- Fig. 18 Station sensitivities for BIC, PJD, SCM and TNN each.
through
21
- Fig. 22 University of Alaska telemeter network sensitivity.

Large Aperture Seismic Telemetering System for Central Alaska

by

Eduard Berg, Norbert Sperlich and William Feetham

ABSTRACT

The Geophysical Institute has established and now operates a large aperture seismic telemeter network in Alaska. At present four stations are operated and two more will be added shortly.

The system is described in its technical details, including the remote site equipment and the method of recording at the Geophysical Institute.

Without the use of methods for improving signal-to-noise ratio (such as velocity and/or frequency filtering) the sensitivity of the seismic stations for detecting distant earthquakes is similar to that of the U.S.C.&G.S. College Observatory. This sensitivity allows recording of earthquakes down to magnitude 4 (U.S.C.&G.S. magnitude) in the 80° distant range.

Epicenter maps for three 1-month periods for interior and coastal Alaska are presented.

INTRODUCTION

The State of Alaska, especially in the coastal ranges, the Alaska Range and the Aleutian Chain, is one of the most active seismic belts in the United States and the circum-Pacific structures. Prior to the March 28, 1964 earthquake, coverage with seismic stations was extremely poor compared with similar or less active regions within the United States or other parts of the world. The only installation worthy of note was the U. S. Coast and Geodetic Survey College Station which has proved to be one of the best in the world. Since the destructive earthquake, university groups and other government agencies have devoted much attention to seismic research in Alaska. The Earthquake Prediction Report to the President (September 1965) has selected this region and California for a ten-year effort towards better understanding and eventual prediction of major disastrous earthquakes.

The present program at the Geophysical Institute of the University of Alaska was established prior to the earthquake. It was intended to fill partially the existing gap in seismographic coverage and to initiate a solid-earth geophysical research effort. The first generation seismic network consisted of conventional recording stations at Tanana (TNN), McKinley (MCK) and Black Rapids (BLR) (see Fig. 1), while records from the World Wide Standard System of the U. S. Coast and Geodetic Observatory

at College were also made available. The operation of the conventional stations with partly obsolete equipment proved tedious and expensive under the extreme climatic conditions (Berg, 1966). In the present paper the second generation of equipment and its operation will be described. Past experience with the conventional stations and from field operation during seismological investigations in the very remote area of the Katmai volcanoes suggested the design philosophy for the present telemeter network. Considerable experience for the selection of very low noise sites was gained during "Operation Longshot", the recording of an underground nuclear blast in the Aleutian Arc.

The present seismic system was planned in detail by the end of 1965 and was put into operation in the winter months of 1966-1967. It possesses, as far as is known, the largest aperture in the U. S. (745 km). However, a still larger system is presently under construction for tsunami warning purposes by the U. S. Coast and Geodetic Survey. In comparison, the University of California network at Berkeley spans about 320 km. The sensitivity is high enough to identify earthquakes of Richter magnitudes 4 to $4\frac{1}{2}$ in many areas of the world, whereas practically all earthquakes in the world over magnitude 5 to $5\frac{1}{2}$ are recorded. It also was found that the signals of the P-wave arrivals are usually very coherent through this telemeter network, a factor very important for the detection of small events in the presence of the seismic noise background (Abramson, 1963). The high sensitivity is due to two important factors: site selection and equipment response below 1 cycle/sec.

BASIC REQUIREMENTS

The present system was built primarily for local earthquake research in Alaska, including the volcanic area of the Alaskan Peninsula; although readings of teleseisms are made available on a daily basis to the U. S. Coast and Geodetic Survey for use in their epicenter location program. The basic requirements of the system therefore are dominated by the necessity of recording local earthquakes over a rather large area and in a broad magnitude range.

Noise

A prime requirement for an efficient short period seismograph station is a low noise background in the frequency band of operation (Carder, 1963). Since this background is continuous in nature, we tried to reduce its effects by: (1) Selecting a station site where noise is low, remote from man made disturbances and located, as far as possible, in regions which experience relatively little wind. (2) Careful selection of the high and low frequency cutoff points in the equipment. Alaska is characterized by strong microseisms in the 2 to 4 sec period range, which effectively limit the maximum gain of the world wide standard system in College to around 100,000 at 0.5 sec; whereas, using equipment described in this report, the Pedro Dome station (PJD) operates at a gain of over 250,000 at 1 cycle/sec. Carder (1963) indicates (p. 11) microseismic noise levels of 60 μ at 5 sec and 11 μ at 2 sec for College. We found that this value corresponds rather to a minimum of microseismic activity in that area; the usual amplitude at 2 sec period being closer to 20 to 25 μ (peak to peak).

Components

It was decided that a greater benefit would derive from having a larger number of stations with a single vertical component, rather than a greatly reduced number of stations with 3 components for the same amount of investment (for present distribution see Fig. 1).

Reliability

Since most of the telemeter stations will be required to operate under extreme climatic conditions (air temperatures may reach -50°C in some areas) and unattended for long periods, high reliability components are a prime requirement. In addition, failure-free operation diminishes drastically the labor and travel cost, and is essential if for no other reason than the fact that the seismometers are inaccessible during the winter months.

Flexibility

One of the most effective cost reductions has been achieved by using the same equipment for all new stations. In this way, no handling or calibration difficulties arise from the use of different kind of seismometers, amplifiers, voltage controlled oscillators, etc. In addition, variations in calibration amplitudes resulting from interchange of a seismometer, amplifier, VCO or recording equipment stay well within the 5% limit and are usually less than 2%. The system therefore is extremely flexible. Its use during special events is greatly enhanced by the fact that a vertical seismometer can be set up in a very short time and the signal telemetered to the Geophysical Institute if the equipment is available. As a test, we deliberately set up the last station during the month of January in temperatures below 0°F . It took about 4 hours to dig

the seismometer in the frozen ground, freeze it in, calibrate it and record it at the Institute, despite the fact that a quarter mile of cable had to be laid out on snow shoes.

Cost

Ultimately, however, every system will be limited by its cost. A compromise, especially for a university operated system, has to be achieved between the basic requirement of a low noise site and reliable data link and the overall cost of the initial installation of the hardware and the operational expenses. We believe that the present system is one of the most reliable and cheapest in the U. S.

DESIGN CONSIDERATIONS

The design of the system was governed by the previous two-season experience with Geotech model 18300 short period seismometers and Electrotech SPA-1 amplifiers. It was found that the seismometer could be left in its underground housing over the winter (unclamped) in the Katmai volcanic range and still be properly centered and operational in the following summer. Not a single failure has occurred among seismometers and eight amplifiers that we have used to this date. The Geotech seismometer was the only one available with temperature specifications over the full range down to -50°C (without recentering). It is watertight to 100 ft. of water pressure. Water tightness is essential for use in Alaska during spring breakup and in view of the fact that the seismometers are covered with up to 6 or 8 ft. of snow during the winter and water is allowed to seep in the seismometer vault.

The construction of the 'vault' had to be very inexpensive. Alaska labor prices are significantly higher than elsewhere in the U. S. and we did not intend to invest a great deal in construction. Since Carder (1963, p. 6) has shown that a good tank vault is almost as efficient as a concrete vault in a similar geologic setting and under high wind conditions, we opted for the inexpensive vault structure. For a winter setup, the seismometer is simply frozen into the ground. This procedure has given excellent results at the Pedro Dome (PJD) site.

SITE SELECTION AND INSTALLATION

Sites are selected by considering (1) the noise criteria outlined earlier, (2) desired geographic locations, and (3) the availability of a telephone terminal.

Noise measurements are carried out at several sites before the final choice is made. These are accomplished by using a Geotech Model 18300 seismometer, an SPA-1 amplifier (internal battery for 8-hour operation), and a single channel Sanborn recorder, which is conveniently powered from a car battery through a DC to AC converter. Once a site with a telephone terminal is selected, the seismometer is located some distance from the terminal in a solid rock outcrop. Usually it is necessary to dig 3 feet or so through the overburden to the rock. A container of 5 to 10 gal. volume is cemented firmly to the rock, the seismometer is placed inside and then connected by spiral 4 cable to the remote telemeter panel at the phone terminal. All connectors are filled abundantly with silicon grease to avoid penetration of moisture. The container is then covered

over with rock or whatever fill is available. The whole process of installation, including insertion of the amplifier-VCO panel into the telephone terminal, calibration of the seismometer and checking of the signal at the Geophysical Institute takes just the time the concrete around the container needs to set. The investment into such a site is therefore limited to the time spent for installation and two sacks of concrete, the container being found easily and the spiral 4 cable being obtained on the surplus market.

REMOTE EQUIPMENT

Seismometer and Amplifier

The research goals dictate a system sensitive in the frequency band from about 1 to 20 cycle/sec and a dynamic range of approximately 60 to 70 db. The Geotech model 18300 seismometer and the Electrotech amplifier SPA-1 were chosen since these components have proven their reliability under Alaskan conditions. A remote station subsystem is described in Fig. 2 and seismometer and amplifier response are presented in Figs. 5 and 6 (manufacturer's data).

DATA TRANSMISSION

The data transmission could be achieved in different ways over the existing telephone system. Either a digital system or an FM system is feasible. Because of the wide and standardized use, we opted for the FM system. One question remained unresolved: Should we use the IRIG standard system with constant percentage frequency deviation from the carrier frequency or the constant band width system (which is not yet standardized)?

Technically speaking, the IRIG system gives a different phase delay in a different channel for a given data frequency to be transmitted. This problem becomes very serious if a small tripartite net with only a few kilometers seismometer spacing is used and a time resolution of a millisecond or so is needed. The phase delay between the lowest and the highest center frequency channel which can be transmitted on a regular phone line amounts to about 8 milliseconds. In a net of greater dimensions, this time delay is negligible compared to other influences, such as the geology of the site or even station elevation. In addition, the price for a constant bandwidth system (avoiding differences in phase delays) is about 150 to 200 dollars more per channel. Such a constant bandwidth system is not an "off-the-shelf" item.

Voltage Controlled Oscillator

To simplify further the operation, we wanted to use a simple power supply with only one voltage required for the seismic amplifier and the variable voltage controlled oscillator (VCO), with the negative end grounded. Small power consumption was not a prime requirement since commercial power is available at the telephone terminals where the amplifier-VCO panel is installed. After very helpful discussions with Mr. Ed Sparis (Earthquake Mechanism Laboratory, San Francisco) selection was made of Dorsett Electronics fully transistorized model O-18 VCO, which covers a larger dynamic range than required (see Appendix), and which is available with IRIG Standard Center frequencies of channels 1 through 7 with maximum frequency deviations of $\pm 7.5\%$. Total power consumption for one telemeter panel, which includes a seismic amplifier, 2

VCO's and one separation amplifier, is 60 to 65 ma at 26V. Two transmitting channels are required for each seismometer to cover a 70 db dynamic range. The SPA-1 amplifier outputs are 30 db apart. Since the frequency response of the 3 lower IRIG telemetering channels is much more limited than the required 15 to 20 cycle/sec response (for a modulation index MI = 5) the three channels with the lower center frequencies are used to transmit the low gain channels of the amplifier at the various stations since the high frequency content of signals from seismic events diminishes with increasing magnitude. A separation amplifier including an isolation transformer, is used between the 2 VCO's or a station and the phoneline input (see Fig. 2).

The seismometers have the standard coil configuration (160Ω) and a damping resistor for 0.7 critical damping is soldered directly into the case. Since the amplifier input resistance is higher ($2.2\text{ K}\Omega$), a slight mismatch results but the cable resistance of about 20Ω per roll of spiral 4 cable does not significantly affect the calibration if more than one roll length is required. Figures 5 and 6 show the relative response of the seismometer and the amplifier system for various filter settings of the amplifier. It was found that incorporating the different filter positions directly into the amplifier facilitates the operation in sites of unknown noise background and adds greatly to the system's flexibility.

RECEIVING AND RECORDING EQUIPMENT

Discriminator

Up to seven carrier frequencies can be mixed in one phone channel for transmission to the Geophysical Institute. There, each phone line is

terminated by an isolation transformer. The output of the transformer is then shunted by two 10 volt Zener diodes in order to eliminate the possibility of the introduction of potentially harmful voltage spikes into the Astrodata Model 405-101 discriminators. The discriminators are silicon solid state devices. They are all housed, together with an Astrodata model 405-800 power supply, in a 405-900 rack adapter. Each discriminator requires a nominal 3 Watts DC from the power supply. Major control points and the level setting are accessible on the front panel of each discriminator. Since the beginning of the operation, we have had trouble with only one of the discriminators. The discriminator output current is limited to ± 15 ma, and the output voltage required for maximum deviation ($\pm 7.5\%$ of center frequency) can be continuously adjusted from ± 1 to ± 10 V. We have adjusted all discriminators to the same output level as the VCO's input level for band edge deviation. The deviation polarity for both VCO and discriminator is positive. This means that an input signal increasing in a positive sense causes the output frequency of the VCO to rise and, conversely, that an increased input frequency to the discriminator results in an output which is increasing positively. Each discriminator includes a three pole, low pass-high frequency cut off filter (18 db/octave). We have chosen a constant amplitude response with a cutoff frequency at 20 cycle/sec. Figure 7 shows the transmission response of the VCO-discriminator circuit. Each pole of the filter can be obtained with different cutoff frequencies. Using one pole with cutoff at the seismometer frequency and the two others with cutoff at 20 cycle/sec, a flat response to ground motion may be obtained from 1 to 20 cycle/sec.

Recorder

Each discriminator output is fed through a 20 K Ω resistor to the 16-cycle/sec galvanometers of the Geotech model 4000 C Develocorder, which records up to 20 channels on a 16 mm film at 30 mm/min film speed. The film is viewed, using this device, at X10 magnification. All figures on magnification which are quoted in this paper are related to this viewer. Figure 8 shows the response of a galvanometer circuit, including the input resistor, at the setting used. The overall response of the PJD station from ground motion to trace amplitude is given in Fig. 9 for different filter settings (for calibration see later section). Filter settings at the remote stations are adjusted to noise conditions, but we try to retain all frequencies below 10 cycle/sec. A Geotech model 2484 Helicorder is used for monitoring any station. The receiving and recording system is depicted in Fig. 3.

Timing

The time marks for the develocorder are obtained from two sources:

a) The Geophysical Institute time standard which generates minute marks on the signal traces. Accuracy of this system is better than 10^{-2} sec and drift rates are of the order of 10^{-9} per day. b) A Sprengnether model TS 100 crystal chronometer which generates minutes and hour marks on a separate time channel. This clock also drives, from its 60 cycle/sec output, a 6 RPM synchronous motor, which operates a microswitch and puts 10 sec marks on all traces. The position of the microswitch is adjustable by a simple screw to correct offset due to aging of the TS 100 chronometer.

A standby radio receiver and a time signal convertor complete the system.

SYSTEM CALIBRATION

In an attempt at standardization, and in order to avoid confusion, we use only the standard coil in all of the Geotech model 300 seismometers which are used by the Geophysical Institute. When a new seismometer arrives, the appropriate damping resistor for 0.7 critical damping is soldered into the case. Calibration coil constants are immediately determined for each instrument. The subsystem response of the damped seismometer and amplifier is then determined for different filter settings. We adopted a cutoff filter frequency of 5 cycle/sec (F5) for field calibration purposes. It was found that the 0-to-peak amplitude (in mm) on the record resulting from a 1 gram weight-lift need merely to be multiplied by $241 \pm 1\%$ (under field conditions) to obtain the "calibration magnification"--the maximum of the response curve at 5 cycle/sec. In order to perform this test, the gain of the amplifier must, of course, be turned down. A typical output (at F5 and 72 db attenuation) for a 1 gram weight-lift is 1.9 volts. Deviations from this figure due to interchange of the SPA-1 amplifiers have, in no case, been greater than $\pm 5\%$ and differences due to using different seismometers are considerably less.

Once the seismometer has been installed in the vault, a weight-lift is performed and the output of the amplifier is measured. The response of the discriminator (see Fig. 1) is very flat to 20 cycle/sec, at which point there is 3 db attenuation and 18 db/octave rolloff. Since the galvanometer response cuts off at a somewhat lower frequency, the discriminator response is considered, for all practical purposes, to be flat. The galvanometer response incorporating a 20 K Ω decoupling resistor has

been measured (Fig. 8). Multiplying the amplifier output by the galvanometer sensitivity therefore yields the total response of the system as referred to the viewing screen of the develocorder. This presumes, however, that (within the frequency band DC to 20 cycle/sec) the input to the VCO and the output of the discriminator are set equal. A response curve thus obtained is shown in Fig. 9.

All seismometers in the system are connected to the amplifiers in such a way that the weight-lift (corresponding to downward ground motion) gives a negative pulse at the output of the amplifier, a frequency decrease at the output of the VCO (and input to the discriminator), a negative pulse at the discriminator output and a down-going pulse on the view screen of the recorder.

GEOGRAPHICAL LOCATION

The geographical locations of the telemeter stations currently in operation are given in the following table:

<u>Name</u>	<u>Code</u>	<u>Latitude</u>	<u>Longitude</u>	<u>Altitude</u>	<u>Magnification at 5 c/sec</u>
Tanana	TNN	65°15.4'N	151°54.7'W	504 m	
Big Mountain	BIG	59°23.4'N	155°13.0'W	562 m	approx 0.6 to 0.8 x 10 ⁶
Sheep Creek	SCM	61°50.0'N	147°19.7'W	1020 m	1.0 x 10 ⁶
Pedro Lome	PJD	65°02.1'N	147°30.5'W	740 m	1.6 x 10 ⁶

Figure 1 shows the location of the telemeter stations TNN, BIG, SCM, and PJD, as well as the two conventionally operated stations MCK and BLR. The usual operating gains at 5 cycle/sec are around (or exceed) 1 million. Sample records are shown in Figs. 11 through 17. The station locations

were chosen to cover the area of the highest seismicity in central Alaska (Berg, 1964) and the active volcanic area adjacent to Cook Inlet and in the Alaskan Peninsula. Sample maps for earthquakes recorded during the months of February, March and April, 1967 and located by the four telemeter stations are given in Figs. 10A through 10C.

NETWORK SENSITIVITY

This section briefly deals with the sensitivity of the telemeter array system for recording distant earthquakes. The results, however, must be considered very preliminary and the sensitivities noted here do not truthfully correspond to the full capabilities of the network.

First, those earthquakes which are here considered are only ones for which we have provided readings to the U. S. Coast and Geodetic Survey, and for which two or more of our stations have been acknowledged by that organization in one of their epicenter determination reports numbered 1 through 13 of this year. The information provided in Figs. 11 through 17 are taken from these reports, although the associated epicentral distances given in the various figures are only approximated. The six traces on the seismograms (seven on the later records) are associated with the individual seismographic stations as follows (in order from top to bottom): (1) BIG high gain (2) BIG log gain (3) SCM high gain (4) SCM low gain (5) TMN high gain (6) PJD high gain (7) secondary time trace. These examples of representative distant earthquakes are ordered by increasing epicentral distances and by region. It should be noted that only earthquakes of lower magnitudes are included. The seismograms are reproduced at half the scale at which the image appears

on the development screen. Further, no special effort has been made during the past months to report very weak phases arriving at the network from distant shocks, and it has not been possible to achieve adequate global coverage in the short period of time (about 2 months) that the net has been in operation.

It has become increasingly obvious that the recorded amplitudes for similar earthquakes in the same distance range depend greatly on the azimuth of wave approach, and perhaps even more strongly on station position with respect to the Alaska Range and the continuation of the Aleutian Chain into the Alaska Peninsula. An extreme example of this phenomenon is provided by the South Sandwich Island earthquake of 22 February 1967 (Fig. 17A). Despite the fact that PJD was operating at higher magnification, the P-wave at SCM showed twice the amplitude, although the epicentral distances were about the same. The difference in this case seems certainly to be due to the intervening mass of the Alaska Range.

The other records show approximately the lower limit in magnitude of easily recognizable distant earthquakes as a function of distance. Figures 18 through 21 give the magnitudes of reported earthquakes-versus-distance individually for each station (only earthquakes for which these stations are listed in the U.S.C.&G.S. epicenter determination reports have been plotted). Figure 22 gives the minimum recorded magnitudes for each station versus distance. It may be pointed out that the U.S.C.&G.S. does not usually report earthquakes with body-wave magnitudes below 4, so that the sensitivity in the 80° distance range is not fully

known. The total sensitivity (Fig. 22) is, in most distance ranges, better than the theoretical curve (which is based on background noise levels) given by Carder (1963) for the College U.S.C.&G.S. station, and exceeds it in the distance range from 80° to 90° by 0.4 to 0.7 of a magnitude. In this same report, Carder gives the 90% capability of the Wichita Mountain Observatory. In the distance range from 80° to 90°, the Geophysical Institute's telemetered network nearly equals that Observatory's sensitivity. Even greater sensitivity may actually exist, but cannot be documented, since the U.S.C.&G.S. epicenter reports do not list many of the smaller earthquakes which are actually recorded by the net.

ACKNOWLEDGEMENTS

This research has been supported primarily by Air Force Office of Scientific Research Grant 701-66 in collaboration with the Alaskan Air Command, and by NSF Grants Numbers GP-4360 and GA-469. In particular, we wish to extend our thanks to Mr. William Best (AFOSR) for his continued encouragement to develop the Alaska seismic network. We are indebted to Mr. Ed Sparks (ESSA Earthquake Mechanism Laboratory) for helpful advice and many technical suggestions. Mr. Larry Gedney edited the text.

REFERENCES

- Abramson, N., Further consideration on large seismometer arrays, Group report 64 G 3, Lincoln Lab. MIT, Nov. 1963.
- Berg, Eduard, Fundamental and applied research in seismology in Alaska, Final Report, Geophysical Institute, Univ. of Alaska, UAG R-179, May 1966.
- Berg, Eduard, The Alaskan Earthquake: Location and seismic setting, Alaska, Science Conference, Sept. 1964, Proceedings 15th Alaskan Science Conference, p. 218-232, 1964.
- Carder, Dean S., The requirements of a high sensitivity seismograph static, Vesiac State of the Art Report 4410-63-x, Acoustics and Seismic Lab., Institute of Science and Technology, Univ. of Michigan, Oct. 1963.
- Geotech Corporation: Preliminary operation and maintenance manual, portable short period seismometer model 18300.
- Press, Frank, Chairman, earthquake prediction, Report prepared for the Office of Science and Technology, by the Ad Hoc Panel, Washington, D. C., Sept. 1965.
- Smith, Remy, United Electro Dynamics Inc., Final Report: Design, Fabrication and Testing of an FM Seismic system, Feb. 1964.
- U. S. Coast and Geodetic Survey, Epicenter Determination Report No. 1 through 13, 1967.

Figure 1

SEISMIC STATIONS

GEOPHYSICAL INSTITUTE, UNIVERSITY OF ALASKA

- TELEMETER STATION
- OTHER STATION



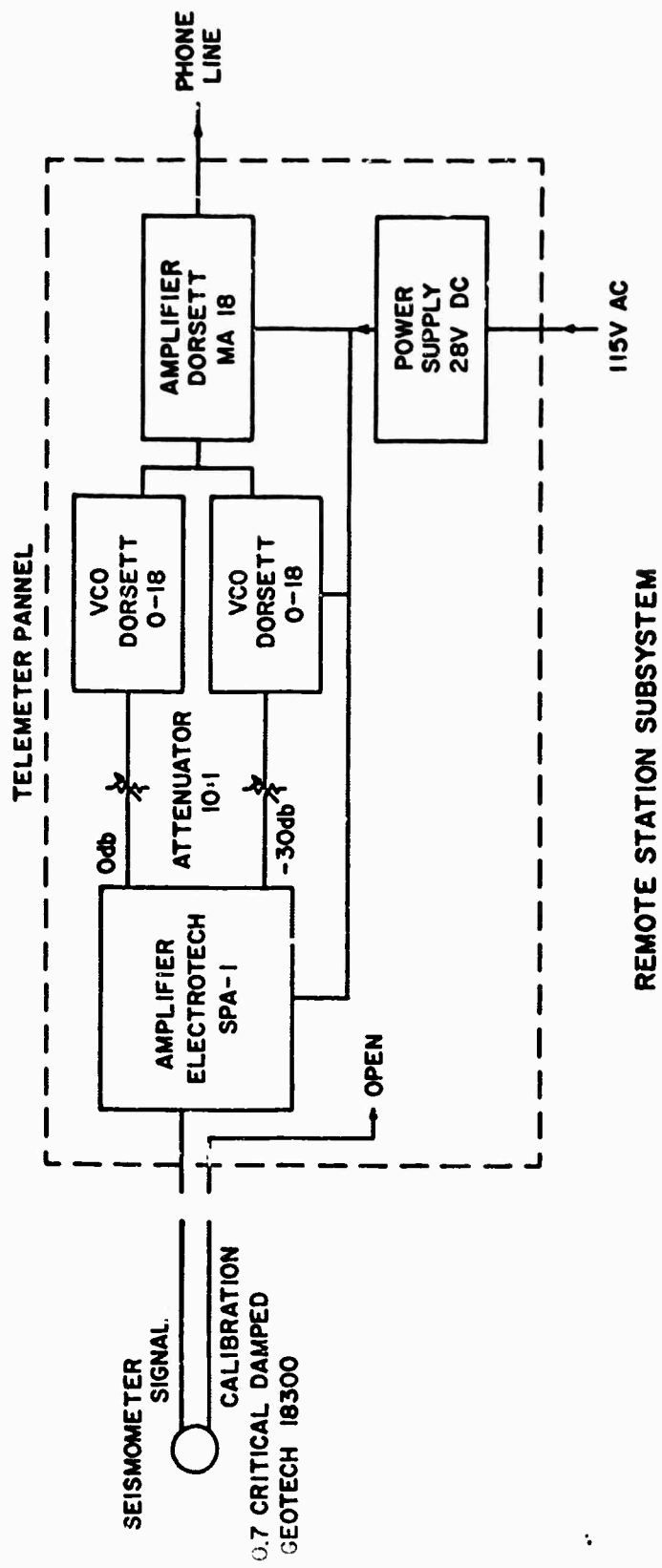
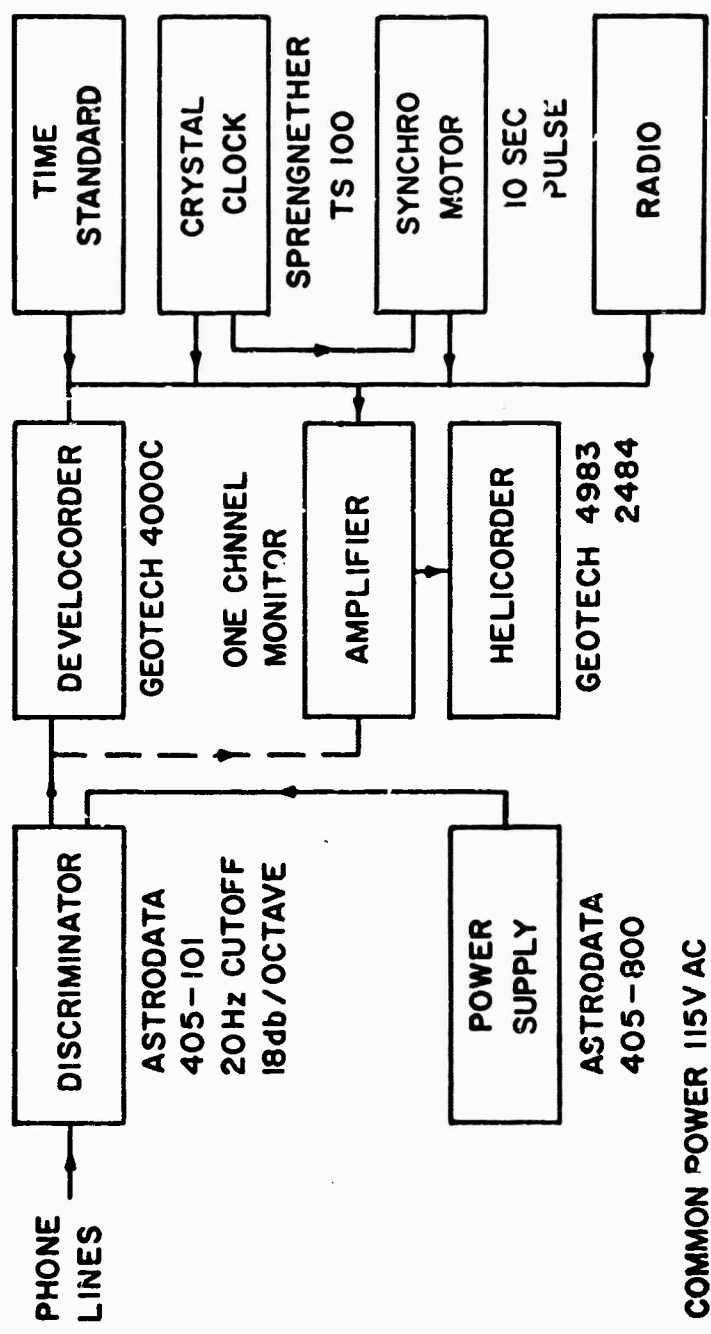

Figure 2



COMMON POWER 115V AC

RECEIVING AND RECORDING SYSTEM

Figure 3

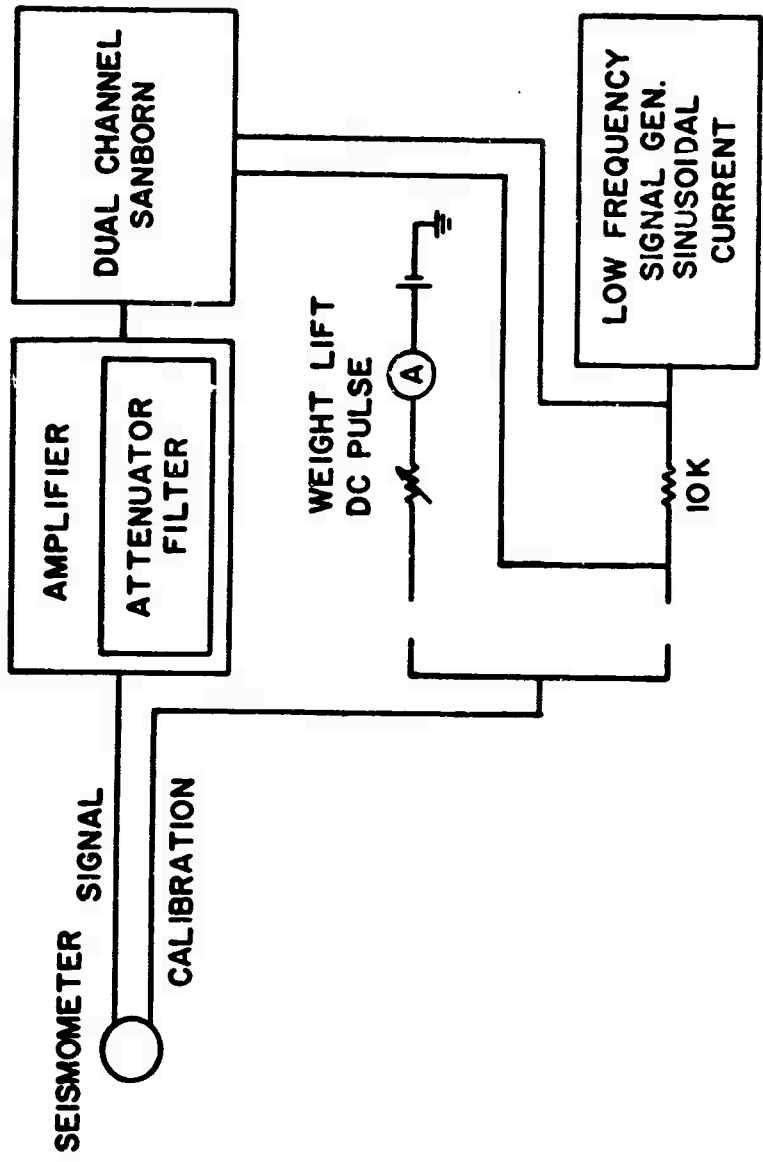

REMOTE SUBSYSTEM CALIBRATION

Figure 4

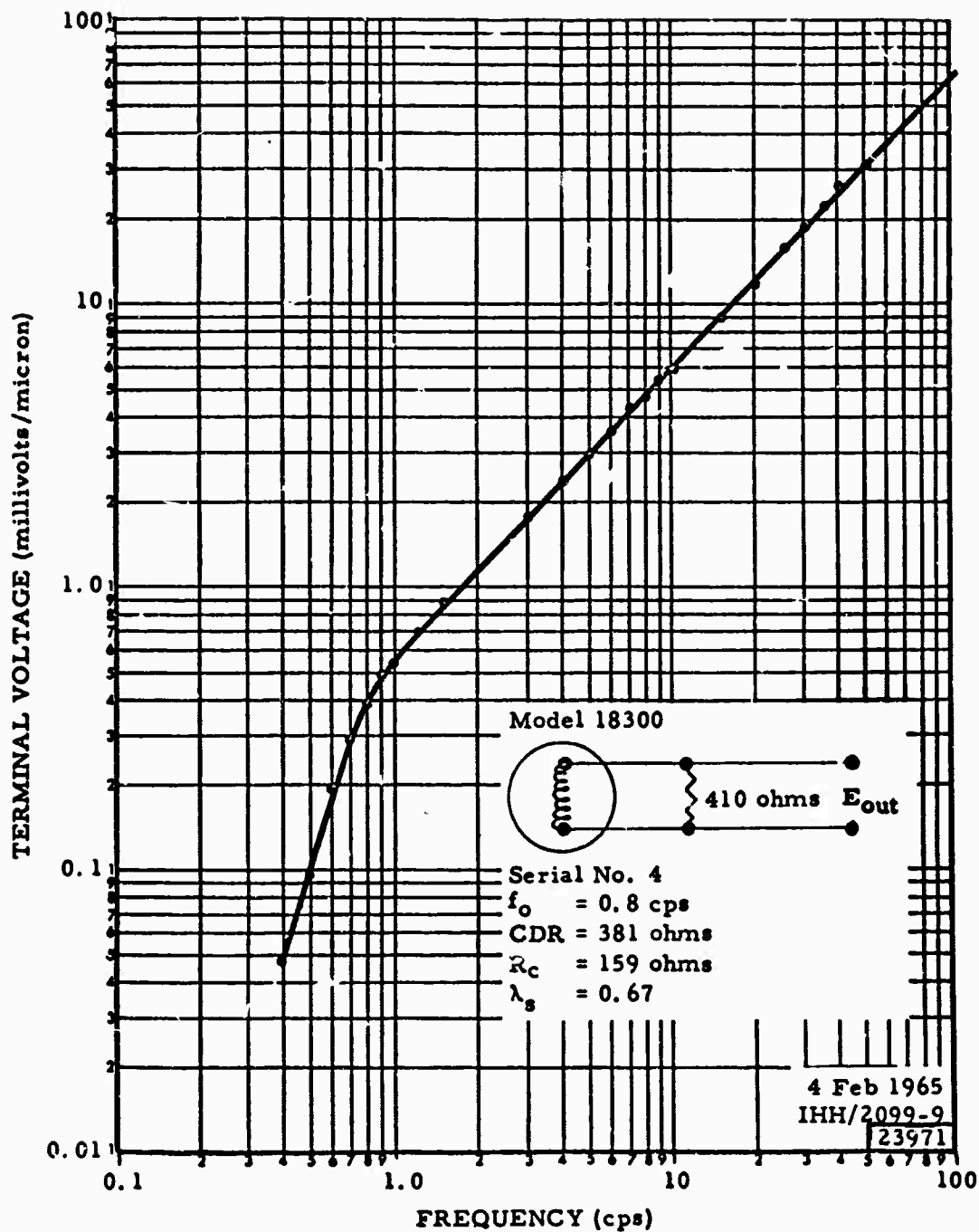

Terminal voltage of Portable Short-Period Seismometer,
Model 18300, with standard coil

Figure 5

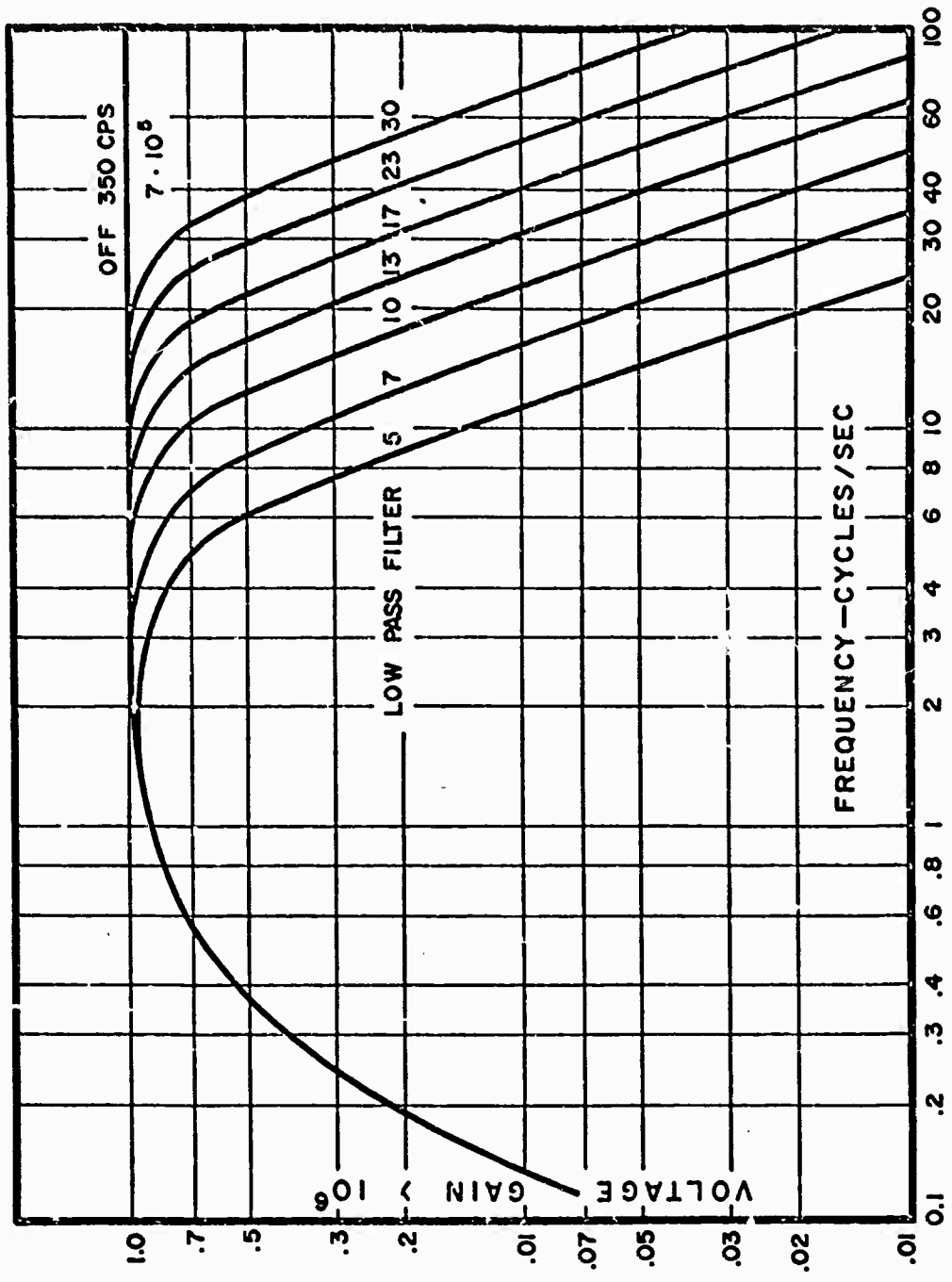

SPA-1 LOW PASS FILTER RESPONSE

Figure 6

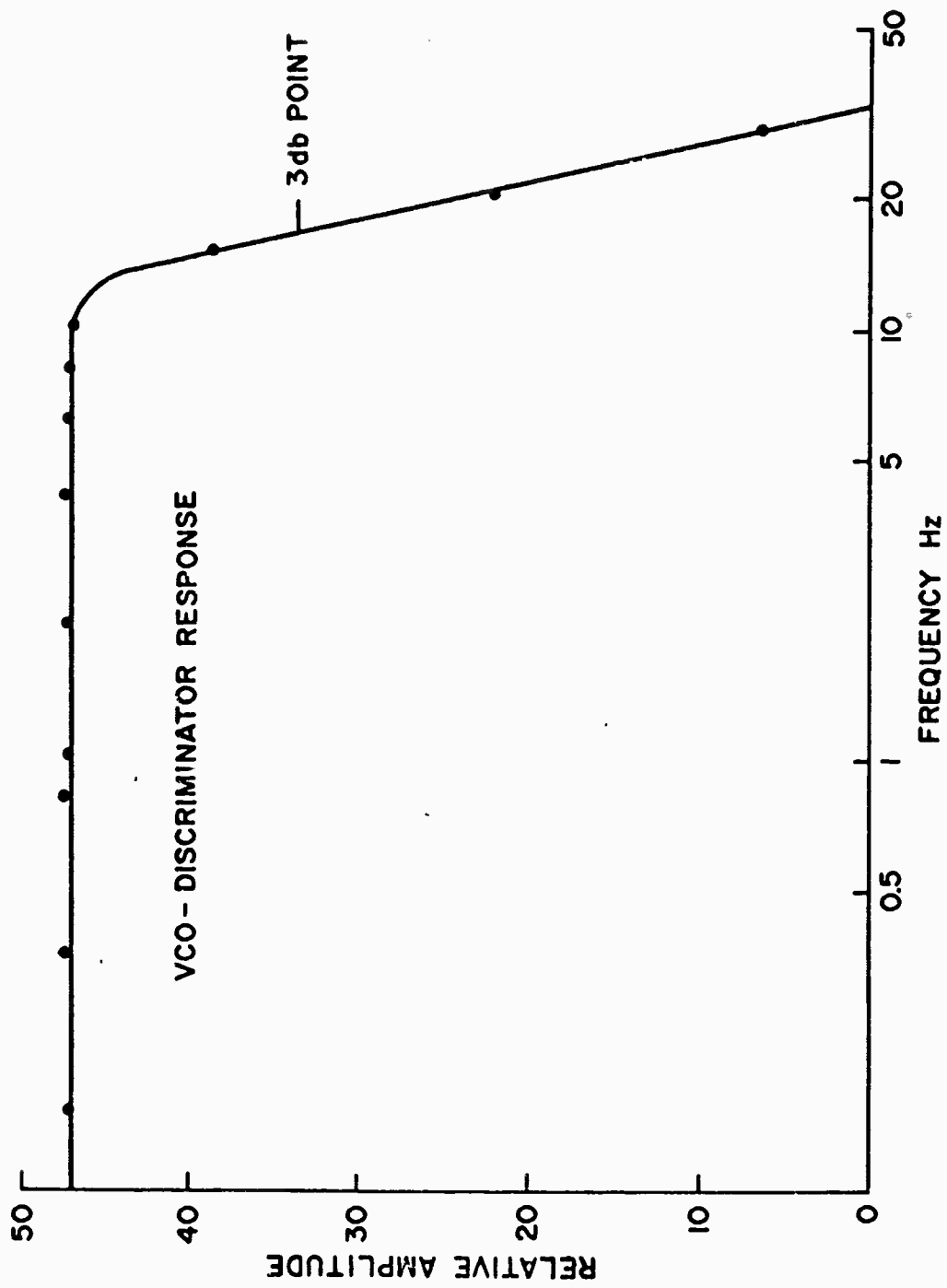

Figure 7

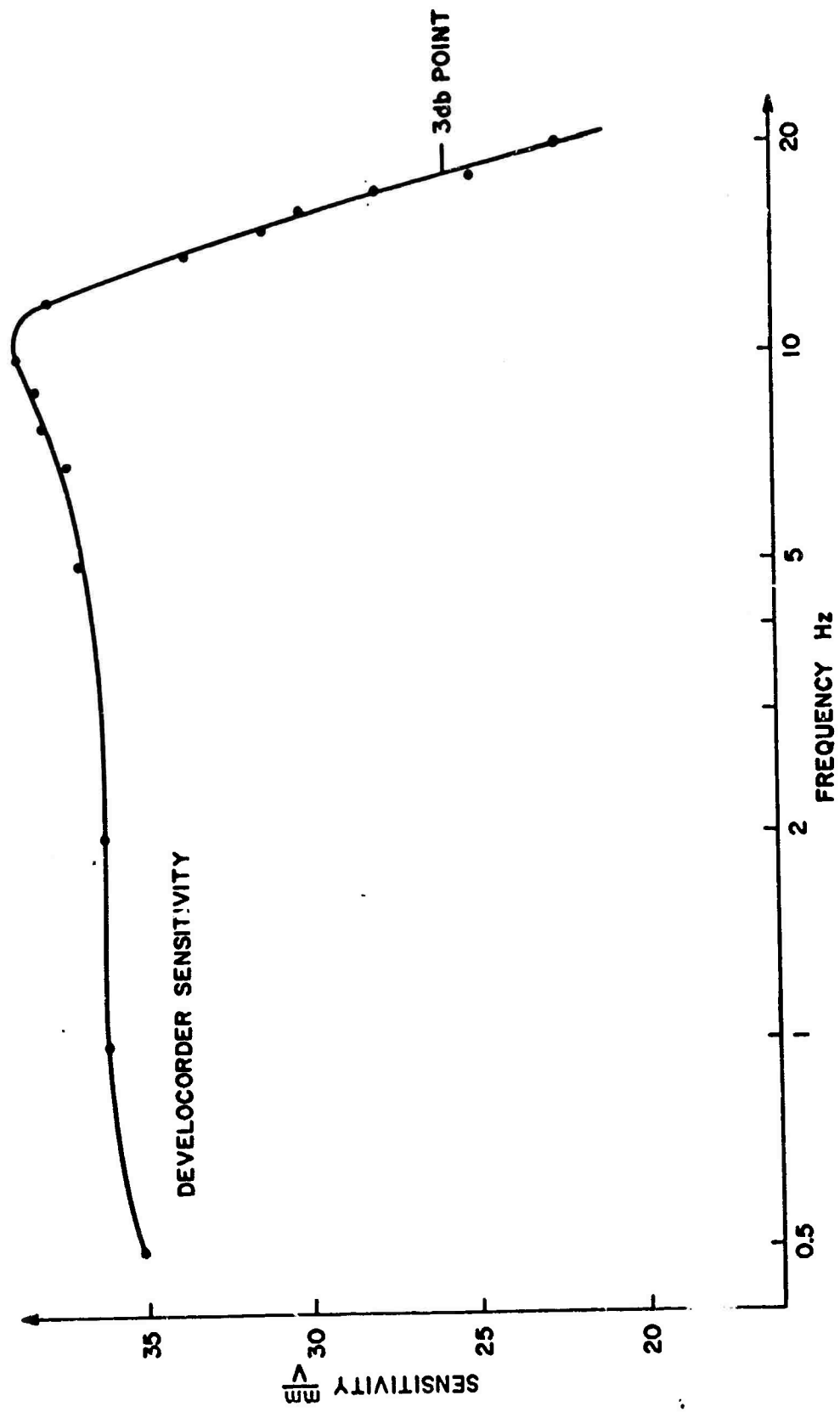
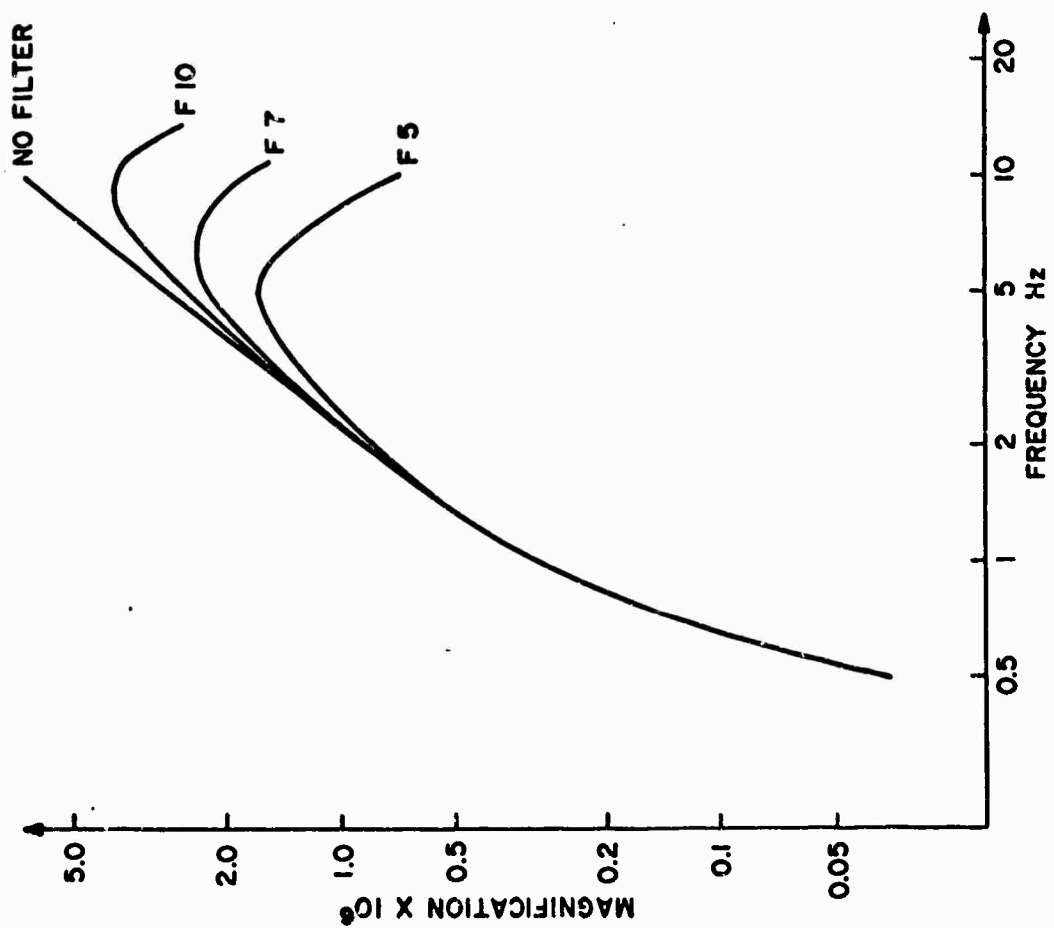

Figure 8



Pedro Dome (PJD) system magnification ground to trace amplitude and developer viewscreen

Figure 9

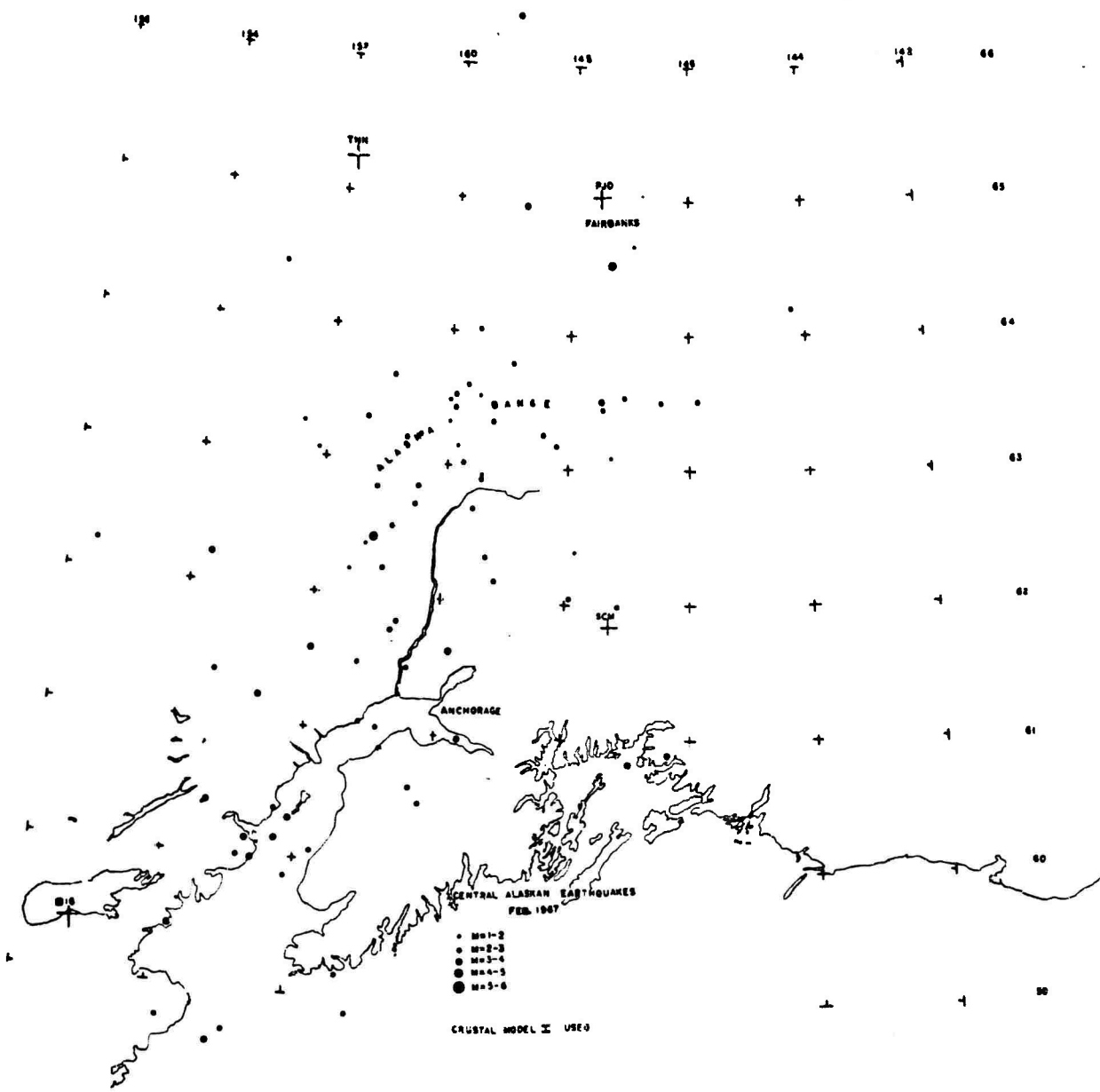

Figure 10A

Figure 10B

GEOPHYSICAL INSTITUTE
UNIVERSITY OF ALASKA

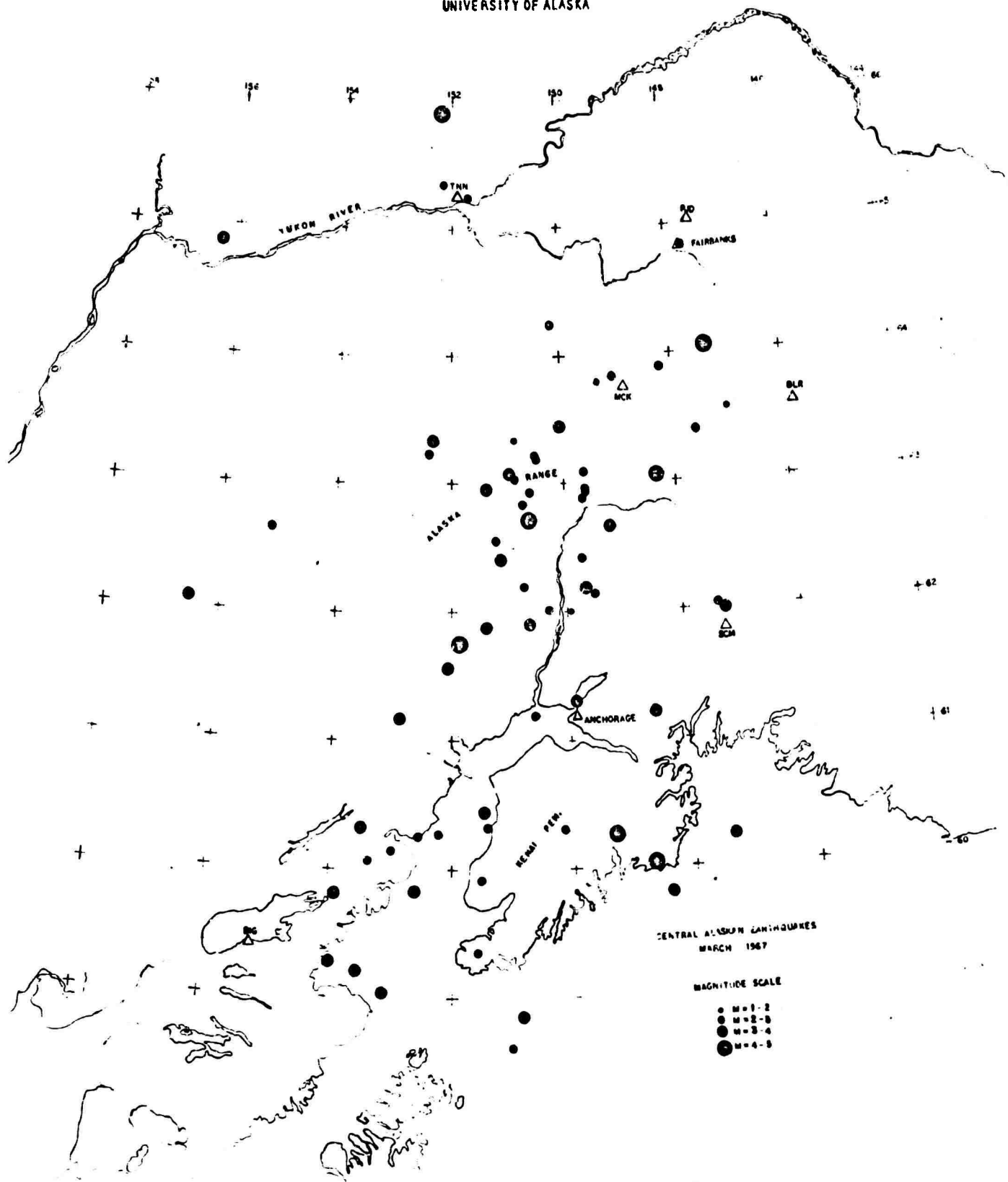
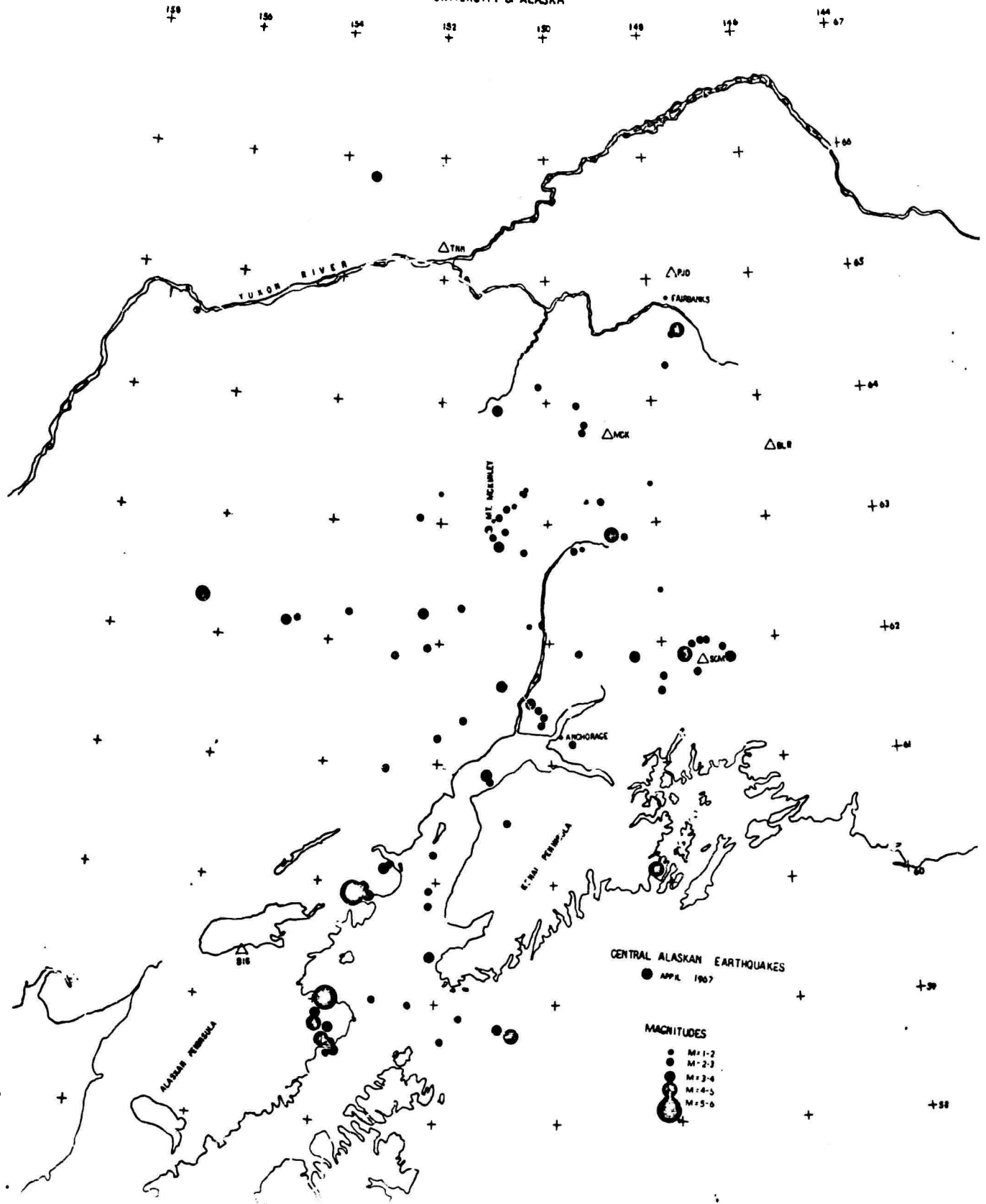

Figure 10C

GEOPHYSICAL INSTITUTE
UNIVERSITY OF ALASKA



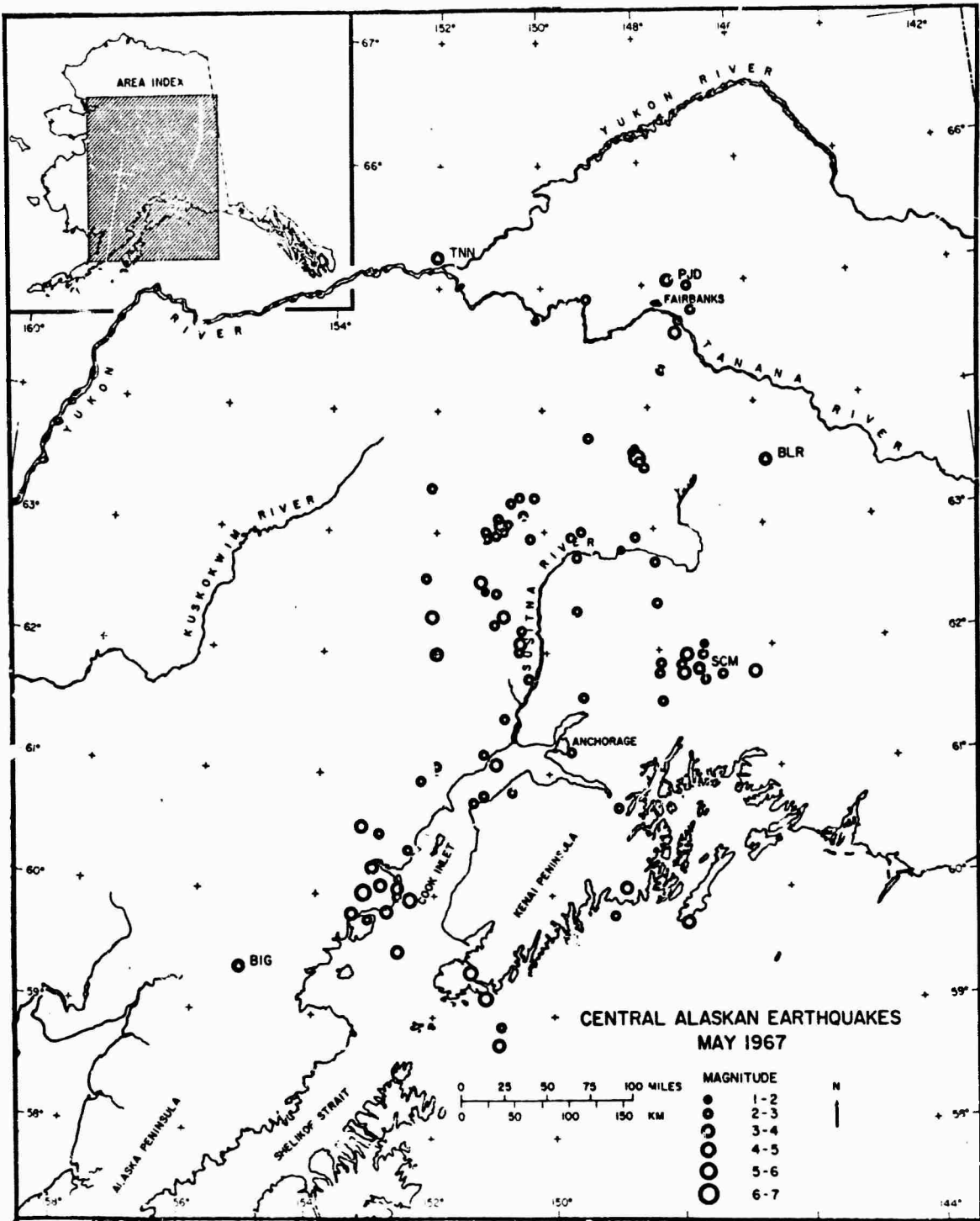

Figure 10D

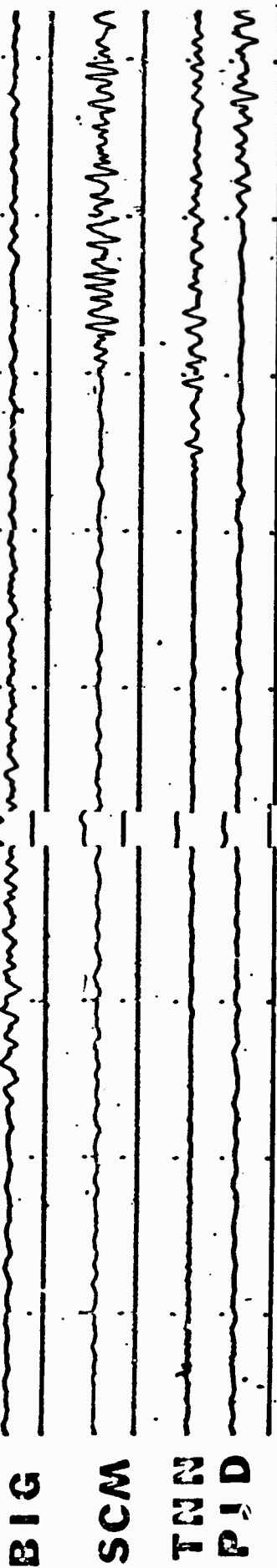
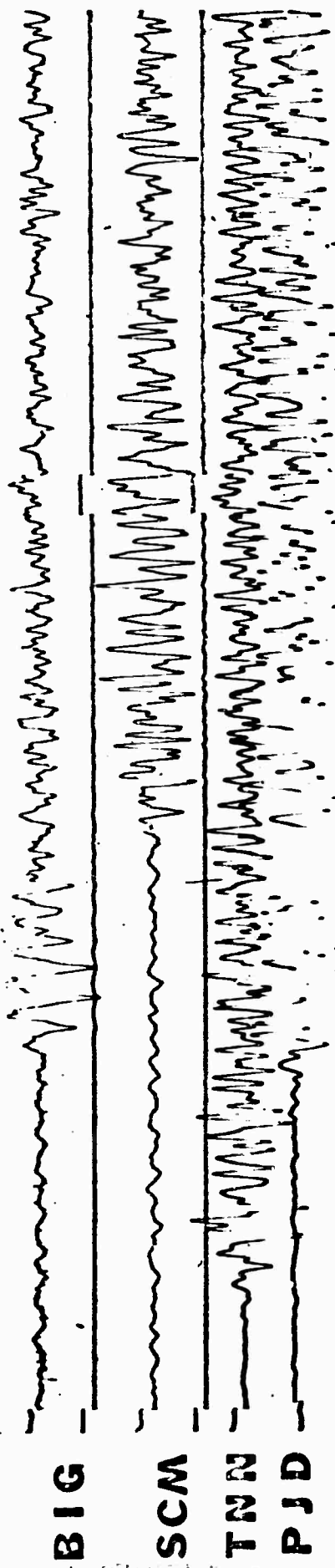

Figure 11A

14 Feb.	22 02 44.5	51.7 N	178.2 E	18 km	m=4.4
		Rat Island, Aleutians,	dist:BIG 16.8°, TNN 20.4°, SCM (21°)		
18 Jan.	05 34 32.6	56.6 N	120.8 E	11 km	m=6.1
		Eastern Russia,	dist:TNN 39.9°, PJD (41½°), BIG 41.8°		



BIG

SCM

TNN

PJD

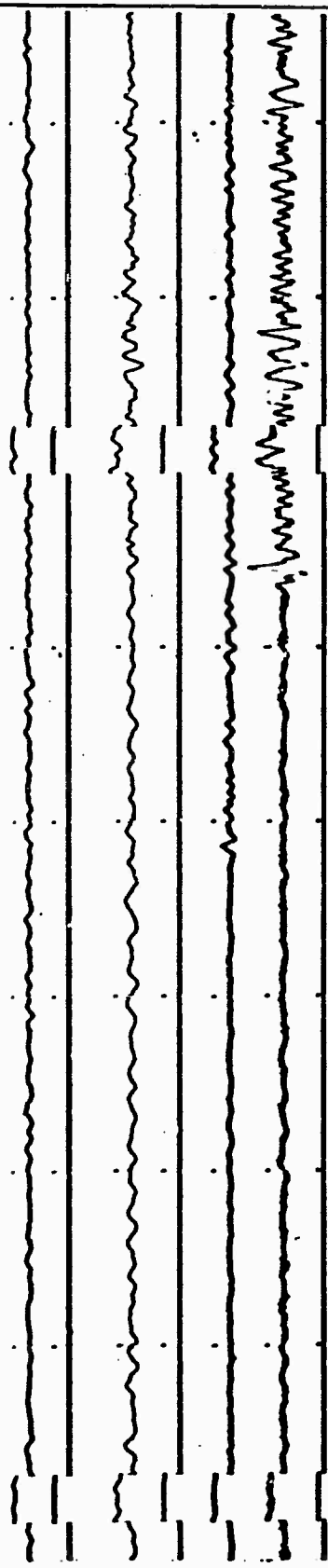

Figure 12A

11 Feb.	14 33 06.3	48.3 N	154.8 E	26 km	m=4.7
					Kurile Islands, dist:TNN 32.6; PJD (34½°)
18 Jan.	04 20 52.9	48.9 N	154.9 E	40 km	m=5.4
					Kurile Islands, dist: BIG 30.4; TNN 32.0; SCM (34°)

BIG

SCM

TNN

PJD

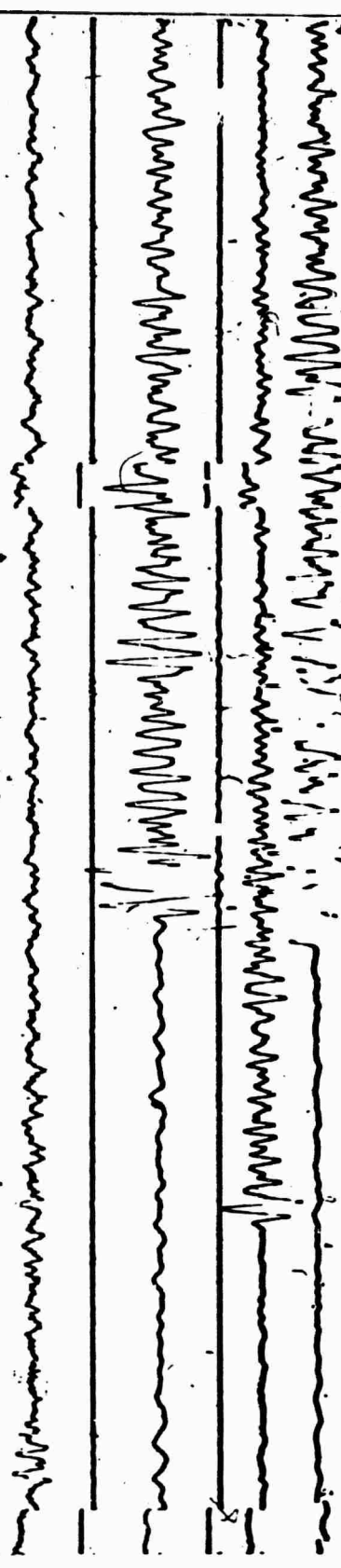

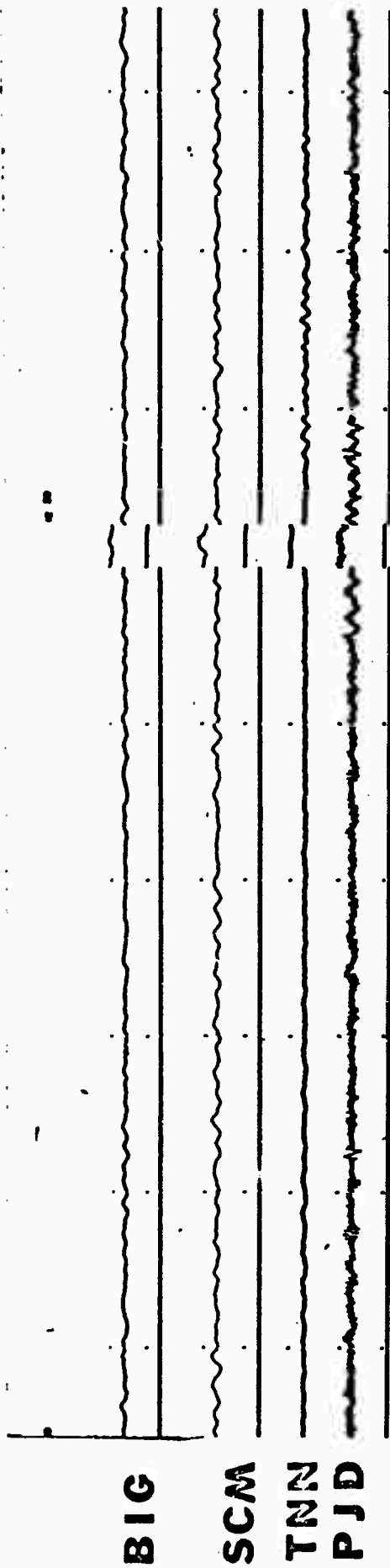
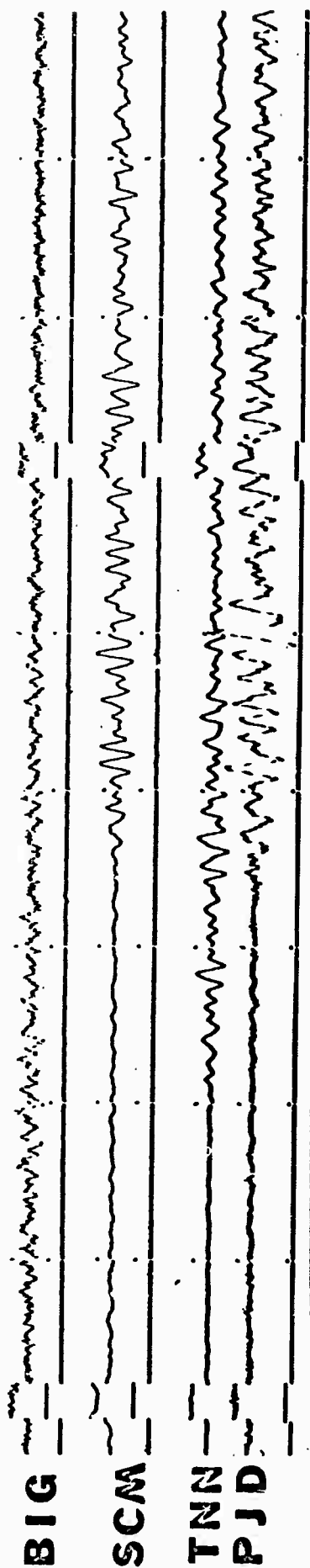
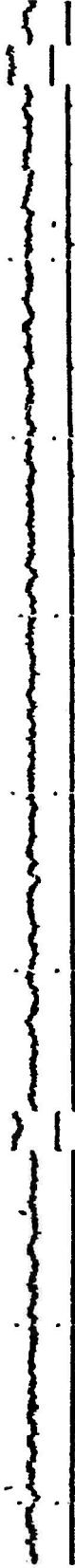

Figure 13A 11 Feb. 12 29 44.0 19.4 N 108.0 W normal $m=4.3$
 Revilla Gigedo Isl. Region, dist:TNN 54.2°, PJD(53°)
 28 Feb. 09 37 18.0 32.7 N 141.7 E 23 km $m=5.5$
 South of Honshu, dist:BIG 49.0°, TNN 51°, SCM(53°)



BIG



SCM



TNN

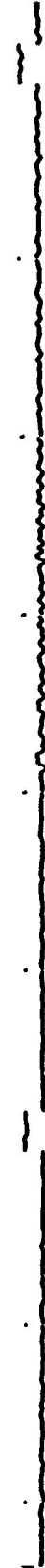

PJD



Figure 14A 16 Feb. '9 52 11.6 16.1 N 96.9 W 60 km $m=4.6$
Oaxaca, Mexico, dist:TNN 61.2°, PJD(59½°)

Not given by USCGS approximately same direction of approach.
January 19 (time on record)

BIG



SCM



TNN



PJD



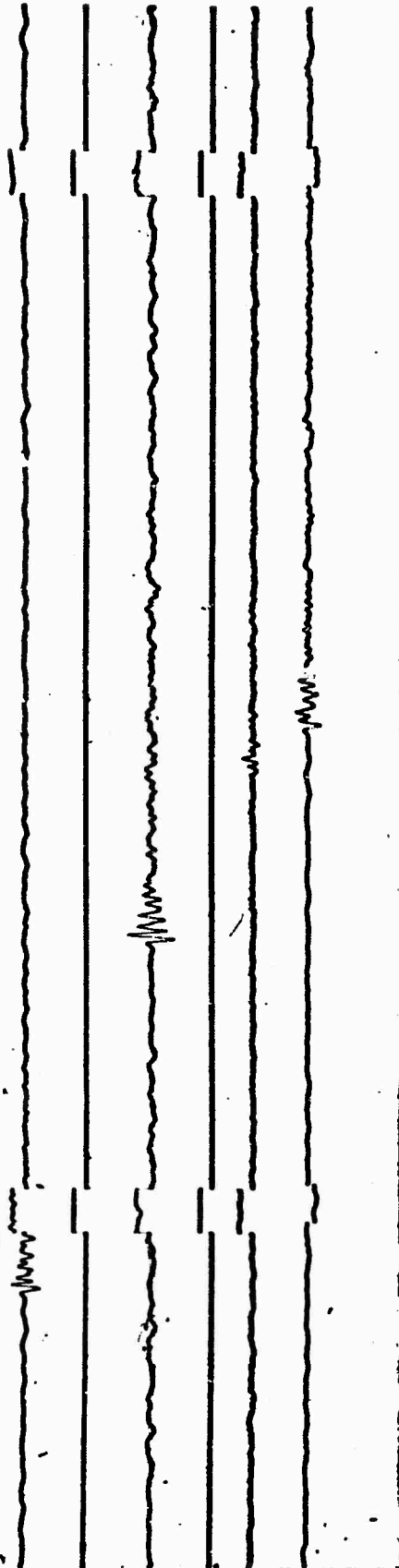

BIG
SCM
TNN
PJD

Figure 15A 22 Jan. 22 35 50.6 18.0 S 178.5 W 600 km $m=4.5$
 FIJI ISLAND REGION dist:BIG 79.5°; SCM (83°),TNN 85.5°; PJD(86½°)
 12 Feb. 16 06 47.8 35.8 N 71.0 E 100 km $m=5.2$
 HINDU KUSH, dist:BIG 77.8°; SCM(78°), PJD(75°)

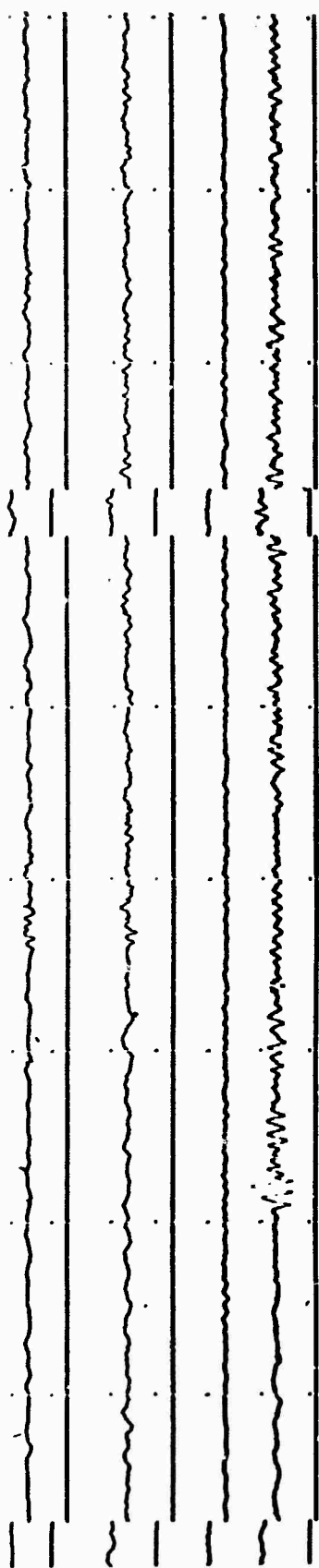

BIG
SCM
TNN
PJD

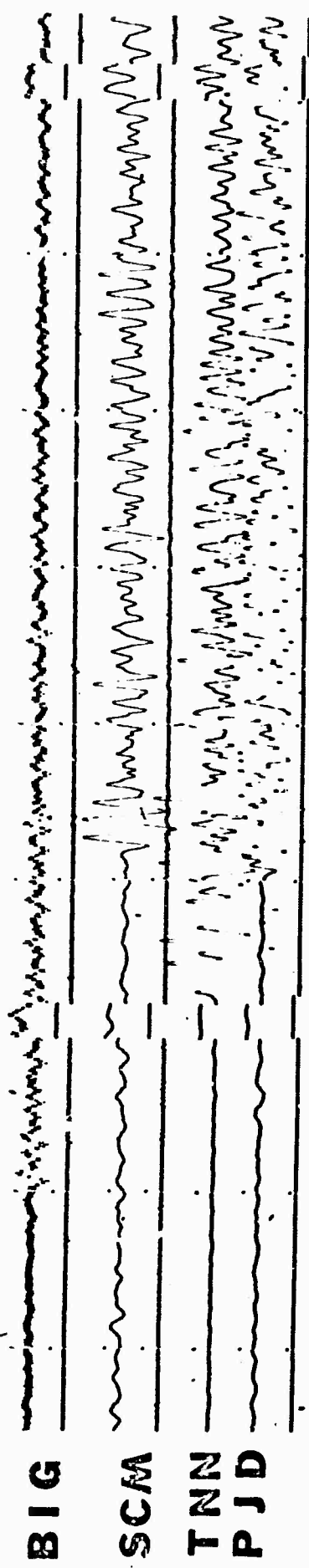
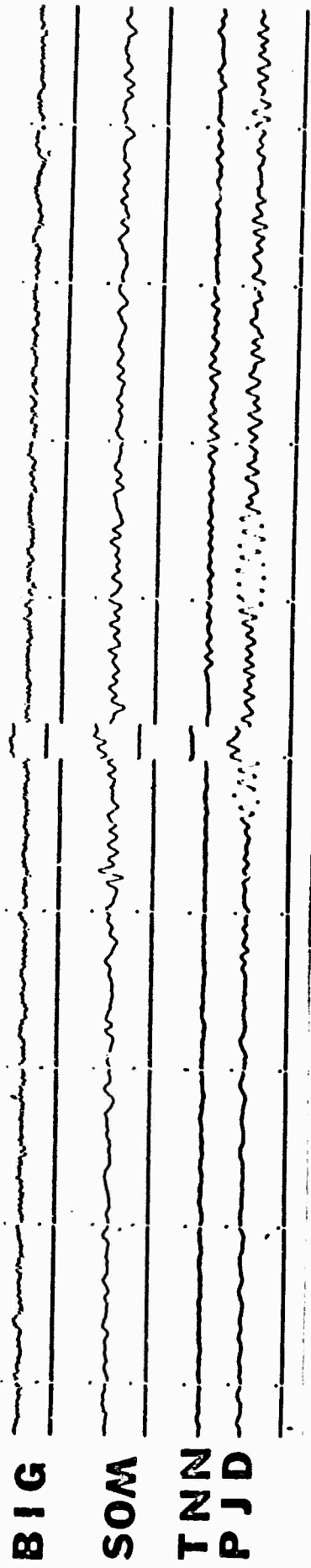

Figure 16A 17 Feb. 00 37 42.5 4.4 N 125.6E 66 km m=5.5
 TALAUD ISLANDS, dist. BIG 80.7; TNN 82.8; SCM(84½°), PJD(84½°)
 27 Feb 02 06 42.5 2.9 N 74.8 W 69 km m=5.2
 COLUMBIA, dist:PJD (80.2°), TNN 80.2; BIG 82.0°



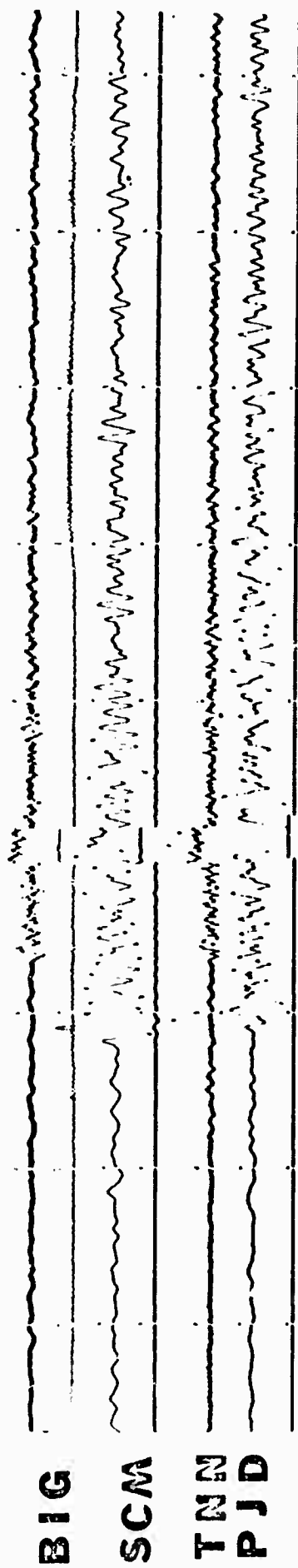
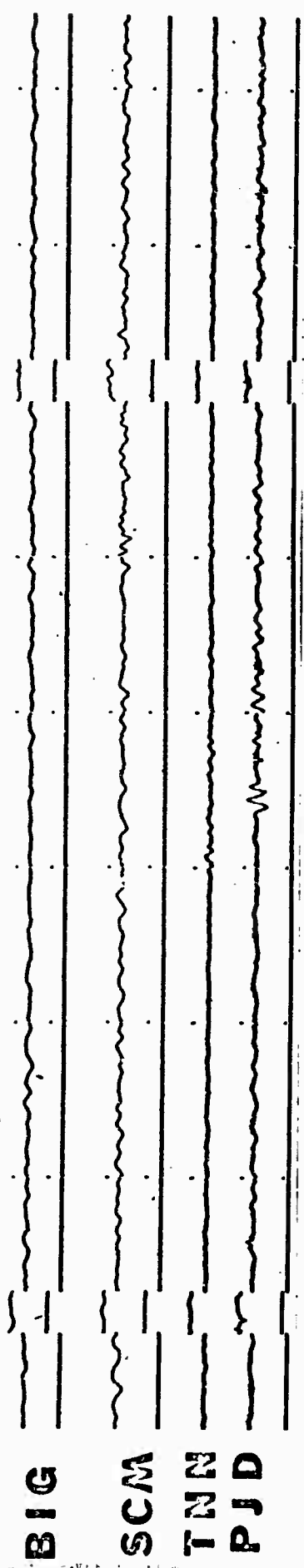

Figure 17A 22 Feb. 23 27 58.0 58.1 S 25.7 W normal m=5.0
 SOUTH SANDWICH ISLAND REGION, dist:PJD(152.½°), TNN 154.3°; BIG 154.3°
 11 Feb. 15 18 06.3 30.5 N 50.7 E 42 km m=5.0
 IRAN, dist:TNN 83.0°; PJD(83.8°), SCM(87°)



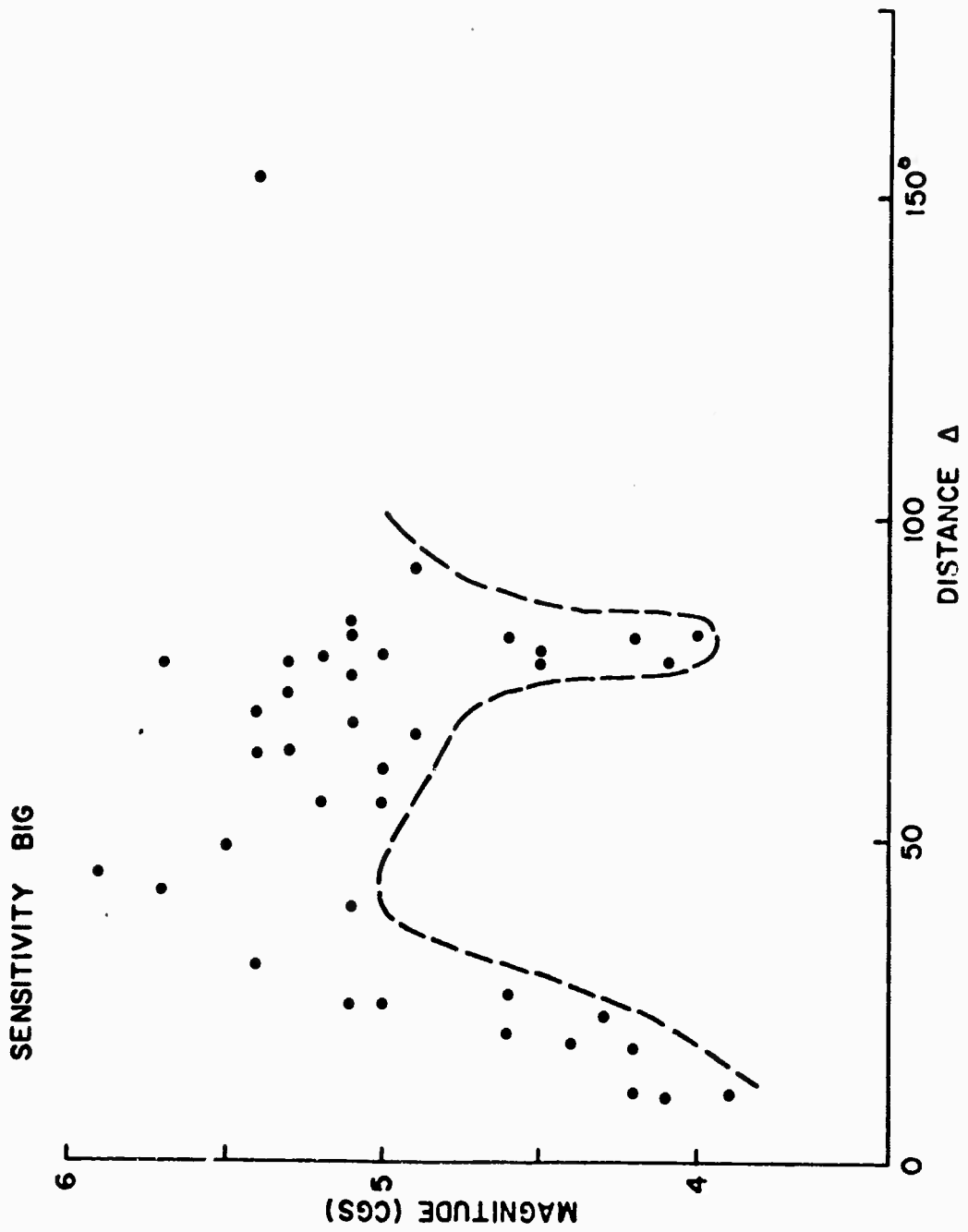

Figure 18

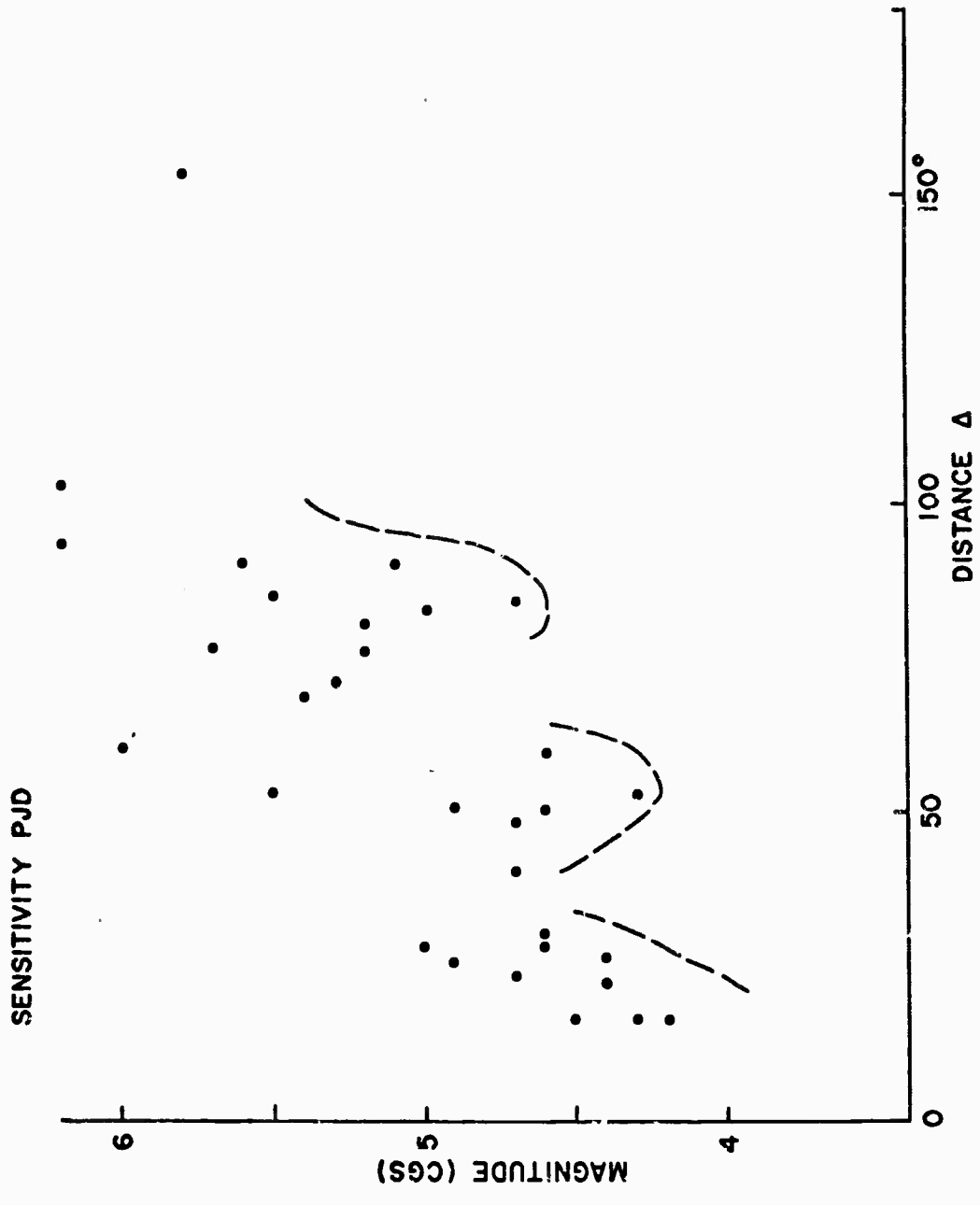

Figure 19

SENSITIVITY SCM

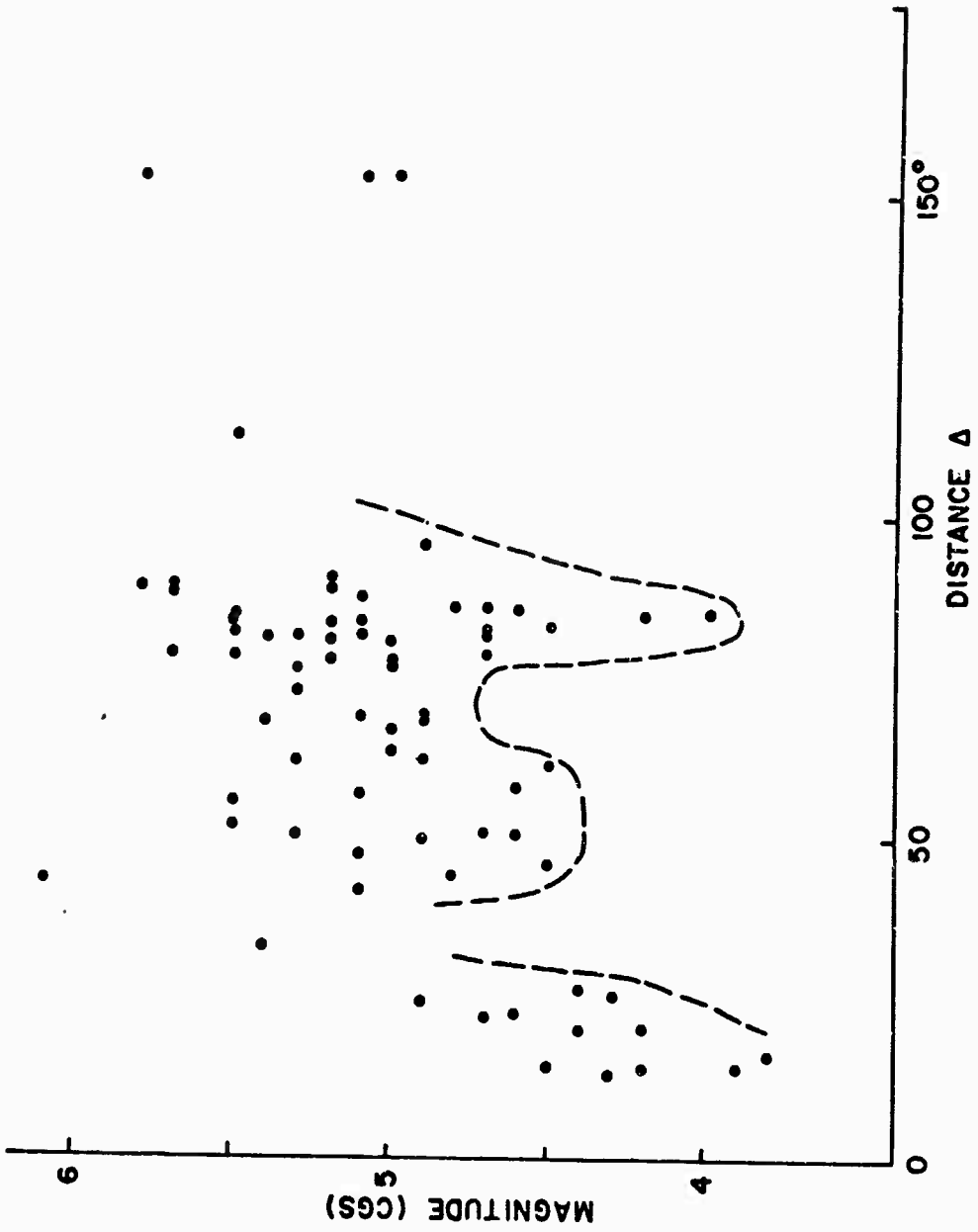

Figure 20

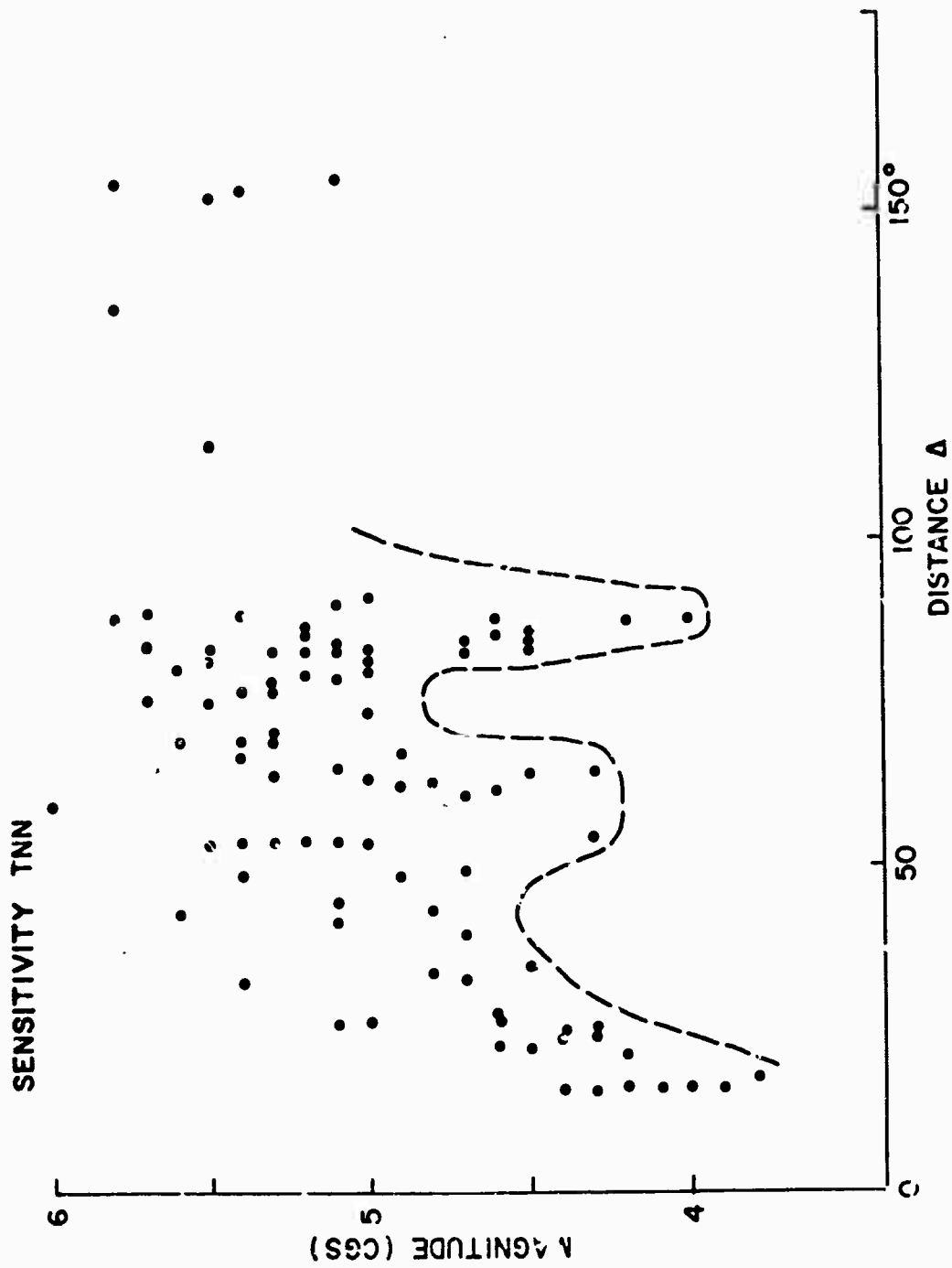

Figure 21

UNIVERSITY OF ALASKA
TELEMETER NETWORK
SENSITIVITY

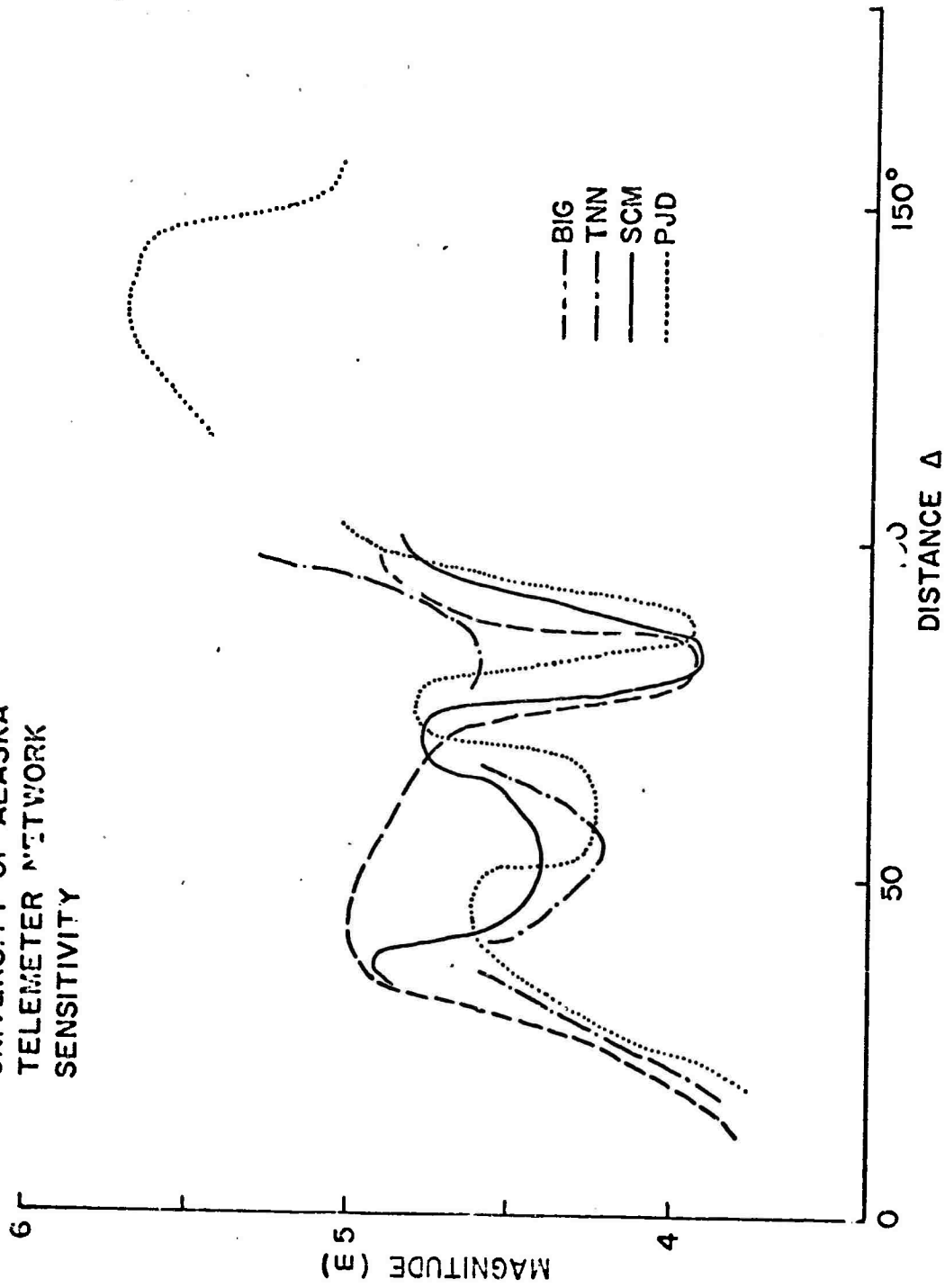

Figure 22

DOCUMENT CONTROL DATA - R&D

(Security classification of title, body of abstract and indexing annotation must be entered when the overall report is classified)

1. ORIGINATING ACTIVITY (Corporate author) Geophysical Institute University of Alaska		2a. REPORT SECURITY CLASSIFICATION Unclassified	
		2b. GROUP	
3. REPORT TITLE Large Aperture Seismic Telemetering System for Central Alaska			
4. DESCRIPTIVE NOTES (Type of report and inclusive dates) Scientific Interim			
5. AUTHOR(S) (Last name, first name, initial) Berg, Eduard; Sperlich, Norbert; Feetham, William			
6. REPORT DATE May 1967		7a. TOTAL NO. OF PAGES 47	7b. NO. OF REFS 8
8a. CONTRACT OR GRANT NO. AF-AFOSR-701-66		9a. ORIGINATOR'S REPORT NUMBER(S) UAGR 188	
b. PROJECT NO. 8652		9b. OTHER REPORT NO(S) (Any other numbers that may be assigned this report)	
c. 292-66			
d.			
10. AVAILABILITY/LIMITATION NOTICES			
11. SUPPLEMENTARY NOTES		12. SPONSORING MILITARY ACTIVITY Air Force Office of Scientific Research	
13. ABSTRACT The Geophysical Institute has established and now operates a large aperture seismic telemeter network in Alaska. At present four stations are operated and two more will be added shortly. The system is described in its technical details, including the remote site equipment and the method of recording at the Geophysical Institute. Without the use of methods for improving signal-to-noise ratio (such as velocity and/or frequency filtering) the sensitivity of the seismic stations for detecting distant earthquakes is similar to that of the U.S.C. & G.S. College Observatory. This sensitivity allows recording of earthquakes down to magnitude 4 (U.S.C. & G.S. magnitude) in the 80° distant range. Epicenter maps for three 1-month periods for interior and coastal Alaska are presented. Note During Print: The installation of the Black Rapids station (BLR) has been completed.			

14. KEY WORDS	LINK A		LINK F		LINK C	
	ROLE	WT	ROLE	WT	ROLE	WT
720 km Aperture seismic Telemeter system, Alaska Installation, calibration, reliability and operation Network sensitivity for distant earthquakes Local seismicity						

INSTRUCTIONS

1. **ORIGINATING ACTIVITY:** Enter the name and address of the contractor, subcontractor, grantee, Department of Defense activity or other organization (Corporate author) issuing the report.
- 2a. **REPORT SECURITY CLASSIFICATION:** Enter the overall security classification of the report. Indicate whether "Restricted Data" is included. Marking is to be in accordance with appropriate security regulations.
- 2b. **GROUP:** Automatic downgrading is specified in DoD Directive 5200.10 and Armed Forces Industrial Manual. Enter the group number. Also, when applicable, show that optional markings have been used for Group 3 and Group 4 as authorized.
3. **REPORT TITLE:** Enter the complete report title in all capital letters. Titles in all cases should be unclassified. If a meaningful title cannot be selected without classification, show title classification in all capitals in parenthesis immediately following the title.
4. **DESCRIPTIVE NOTES:** If appropriate, enter the type of report, e.g., interim, progress, summary, annual, or final. Give the inclusive dates when a specific reporting period is covered.
5. **AUTHOR(S):** Enter the name(s) of author(s) as shown on or in the report. Enter last name, first name, middle initial. If military, show rank and branch of service. The name of the principal author is an absolute minimum requirement.
6. **REPORT DATE:** Enter the date of the report as day, month, year; or month, year. If more than one date appears on the report, use date of publication.
- 7a. **TOTAL NUMBER OF PAGES:** The total page count should follow normal pagination procedures, i.e., enter the number of pages containing information.
- 7b. **NUMBER OF REFERENCES:** Enter the total number of references cited in the report.
- 8a. **CONTRACT OR GRANT NUMBER:** If appropriate, enter the applicable number of the contract or grant under which the report was written.
- 8b, 8c, & 8d. **PROJECT NUMBER:** Enter the appropriate military department identification, such as project number, subproject number, system numbers, task number, etc.
- 9a. **ORIGINATOR'S REPORT NUMBER(S):** Enter the official report number by which the document will be identified and controlled by the originating activity. This number must be unique to this report.
- 9b. **OTHER REPORT NUMBER(S):** If the report has been assigned any other report numbers (either by the originator or by the sponsor), also enter this number(s).
10. **AVAILABILITY/LIMITATION NOTICES:** Enter any limitations on further dissemination of the report, other than those

imposed by security classification, using standard statements such as:

- (1) "Qualified requesters may obtain copies of this report from DDC."
- (2) "Foreign announcement and dissemination of this report by DDC is not authorized."
- (3) "U. S. Government agencies may obtain copies of this report directly from DDC. Other qualified DDC users shall request through _____."
- (4) "U. S. military agencies may obtain copies of this report directly from DDC. Other qualified users shall request through _____."
- (5) "All distribution of this report is controlled. Qualified DDC users shall request through _____."

If the report has been furnished to the Office of Technical Services, Department of Commerce, for sale to the public, indicate this fact and enter the price, if known.

11. **SUPPLEMENTARY NOTES:** Use for additional explanatory notes.

12. **SPONSORING MILITARY ACTIVITY:** Enter the name of the departmental project office or laboratory sponsoring (paying for) the research and development. Include address.

13. **ABSTRACT:** Enter an abstract giving a brief and factual summary of the document indicative of the report, even though it may also appear elsewhere in the body of the technical report. If additional space is required, a continuation sheet shall be attached.

It is highly desirable that the abstract of classified reports be unclassified. Each paragraph of the abstract shall end with an indication of the military security classification of the information in the paragraph, represented as (TS), (S), (C), or (U).

There is no limitation on the length of the abstract. However, the suggested length is from 150 to 225 words.

14. **KEY WORDS:** Key words are technically meaningful terms or short phrases that characterize a report and may be used as index entries for cataloging the report. Key words must be selected so that no security classification is required. Identifiers, such as equipment model designation, trade name, military project code name, geographic location, may be used as key words but will be followed by an indication of technical context. The assignment of links, roles, and weights is optional.