

NOLC REPORT 655

1 NOVEMBER 1966

NOLC REPORT 655

AD 646636

**FC-2 LIQUID AMMONIA RESERVE BATTERY
STATUS OF PROTOTYPE STUDY**

J. C. DALEY

RESEARCH DEPARTMENT

DDC
RECORDED
FEB 14 1967
B

Distribution of this document
is unlimited.



NAVAL ORDNANCE LABORATORY CORONA
CORONA, CALIFORNIA

ARCHIVE COPY

NAVAL ORDNANCE LABORATORY CORONA

B. JARMAN, BAPT., USN
Commanding Officer

F. S. ATCHISON, Ph. D.
Technical Director

FOREWORD

This summary report on the initial studies of the FC-2 liquid ammonia battery represents both the work accomplished under Task V of NOLC contract N123(62738)34633A, and in-house supporting research. Authorization was by Bureau of Naval Weapons WEPTASK RMMO-22-030/211-1/F009-08-001 and RRRE-06017/211-1/F009-06-05.

This will be the only report of work done by the contractor on this study during FY 1964 and FY 1965. It is a continuation of efforts begun in 1962 and reported in NAVWEPS Report 7240, Feasibility Study of Reserve Liquid Ammonia Batteries for Guided Missile Fuzing. The 1963 work was reported in NAVWEPS Report 8178, Liquid Ammonia Reserve Batteries for Guided Missile Fuzing.

Commercial materials and equipment used in experiments are sometimes mentioned in the interest of accurate reporting. It is to be emphasized, however, that neither the use of any commercial product nor the mention of the supplier's name constitutes an endorsement of the product of one manufacturer over that of another.

ABSTRACT

The Naval Ordnance Laboratory Corona and the Livingston Electronic Corp. jointly investigated the use of the FC-2 Liquid Ammonia Prototype Battery for short-life reserve primary battery applications. The completely self-contained unit, in a volume of 90 cm^3 (5.5 in.^3), proved capable of operating for 5 min at a nominal 28 V, 1 A. Performance was satisfactory under simulated missile environments, including shock, vibration, spin, and temperature (-54 to $+74^\circ\text{C}$ or -65 to $+165^\circ\text{F}$). An organic oxidant, m-dinitrobenzene (mDNB), is used as the cell cathode, and the reserve activation feature is provided by storing the electrolyte solvent, anhydrous liquid ammonia, in a separate compartment of the battery case. The basic electrochemical system is Mg/KSCN/ NH_4SCN -mDNB-C/stainless steel (Type 302). The measured volume energy density of this model for a 5 min discharge is 54 J/cm^3 (0.1 Wh/in.^3), and weight energy density is 20 J/g (2.5 Wh/lb).

CONTENTS

	<u>Page</u>
ABSTRACT	Inside front cover
FOREWORD	Inside front cover
INTRODUCTION	1
BACKGROUND	1
BATTERY DESCRIPTION	2
Physical Characteristics	2
Functional Characteristics	2
BATTERY FABRICATION	2
Cells	2
Ammonia Chamber-Case Assembly	6
Terminal Plate	7
Cell Stack Assembly	7
Gas Generator	7
TESTING	8
Instrumentation	8
Methods	8
Results	17
SUPPORTING STUDIES	17
Livingston Electronic Corp.	17
NOLC Studies	24
SUMMARY	41
CONCLUSIONS	44
APPENDIXES:	
A. FC-2 Battery Target Specifications	45
B. Computer Printout of Test Data	47
C. Computer Data Printout Code	48
GLOSSARY	51
REFERENCES	53

Figures:

1. FC-2 Liquid Ammonia Reserve Battery	3
2. FC-2 Battery Components	4
3. Cutaway of FC-2 Battery	5

<u>Figures (Contd.)</u>	<u>Page</u>
4. FC-2 Battery Lot 13 Cell Composition	6
5. Automatic Four-Section Test-Set Circuit	9
6. Positive-Voltage Module Circuit	10
7. Negative-Voltage Module Circuit	11
8. Automatic Four-Section Test-Set Panel	12
9. Mod 1 Single-Cell Test Fixture	13
10. Test Chamber	15
11. Reference Electrode	16
12. Results of FC-2 Battery Test No. 5C2050	18
13. Effect of Temperature on Battery Discharge Lot 13	19
14. Voltage Rise at Activation in Experiment 18	34
15. Experiment 19 Noload Cell Performance for Pasted Cathode Construction Only	35
16. Cell Performance with Reference Electrodes, Experiment 20	37
17. Cell Performance with Reference Electrodes, Experiment 21	38
18. Cell Performance with Reference Electrodes, Experiment 22	39
19. Traces of Noload Pulses after 3-min Discharge for (a) LiClO ₄ Solution-Activated Cell and (b) NH ₄ ClO ₄ Solution-Activated Cell	40
20. Geometry of Shock Test	46

Tables:

1. Contractor Supporting Studies	20
2. Cathode Pad Formulation For Experiment 22	23
3. NOLC Supporting Studies	25
4. Characteristics of FC-1 and FC-2 Batteries	41
5. Variations in Statistically Designed Experiments	42

INTRODUCTION

The feasibility of liquid-ammonia-activated reserve batteries was established in 1963 with the FC-1 fuze battery (Ref. 1), which led to investigation of a single-section ammonia battery with a higher energy density (enersity). This work was undertaken by the Naval Ordnance Laboratory Corona and the Livingston Electronic Corp., a wholly owned subsidiary of G.& W. H. Corson Co. of Plymouth Meeting, Pennsylvania.

The major battery requirements that dictated the development program were:

1. Small size
2. Wide operating temperature range
3. Self-contained reserve activation
4. Single voltage section
5. Current above 1 A

BACKGROUND

The encouraging results of the FC-1 battery program indicated that the ammonia system might be capable of producing a much higher ener-sity battery. The FC-1 unit had an enersity of 6.7 J/g(0.85 Wh/lb) and 20 J/cm³ (0.03 Wh/in.³). It was decided that a limited effort would be extended to define the problems expected with a unit having high discharge rate.

The target specifications assigned to the FC-2 battery were adopted from projected ordnance needs described under the NOLC-2 designation in Ref. 2. These specifications are contained in Appendix A of this report.

In an attempt to limit expenditures, the fixtures and assembly techniques from the FC-1 work were utilized. In retrospect, the utilization of this thick-cell technology appears to have been mainly responsible for the failure to reach the full design goal. Even though only 30% of the power output desired was obtained, much valuable information regarding power-battery design was collected.

The results of concurrent studies at the Livingston Electronic Corp. and NOLC are presented in the following pages and include the data from tests performed at the Naval Ammunition Depot, Crane, Indiana, as well as at the contractor's facilities and at NOLC.

BATTERY DESCRIPTION

PHYSICAL CHARACTERISTICS

The FC-2 Liquid Ammonia Reserve Battery shown in Figure 1 has a volume of 90 cm³ (5.5 in.³), a weight of 285 g (0.63 lb), a height of 5.08 cm (2.00 in.), and a diameter of 4.76 cm (1.88 in.). The mild steel case is mechanically rolled over the terminal plate and hermetically sealed with an epoxy adhesive. The battery terminals are fed through the terminal plate with conventional metal-to-glass seals. The terminal plate is cadmium plated, and the case is painted. It is possible to electroplate the complete battery with the gas generator in place if desired. The gas generator is screwed into the bottom of the battery case as shown in Figure 2. The threads are sealed with Loctite, an epoxy sealant. The battery stack consists of 15 cells connected in series, and weighs approximately 0.50 g with electrolyte.

FUNCTIONAL CHARACTERISTICS

The battery is initiated by an electric impulse delivered to the pyrochemical train of the gas generator. This produces a specific gas pressure that is exerted on the liquid ammonia chamber shown in Figure 2. The chamber is designed so that the pressure effects a deformation, causing the internally mounted lance to pierce the bulkhead between the ammonia and the cells. The collapsing ammonia chamber squeezes the ammonia into the battery compartment, activating the unit in less than 1 s. The ammonia chamber has a nonreturn characteristic that prevents backup after initiation. The ammonia is delivered to the cells through the fill holes in the plastic tube in the center of the cell stack as shown in Figure 3.

BATTERY FABRICATION

CELLS

The electrochemical system used in the final lot of FC-2 batteries produced by the contractor is shown in Figure 4. The weights and thicknesses for the bimetal are based on a commercial product that



a



b

FIGURE 1. FC-2 Liquid Ammonia Reserve Battery

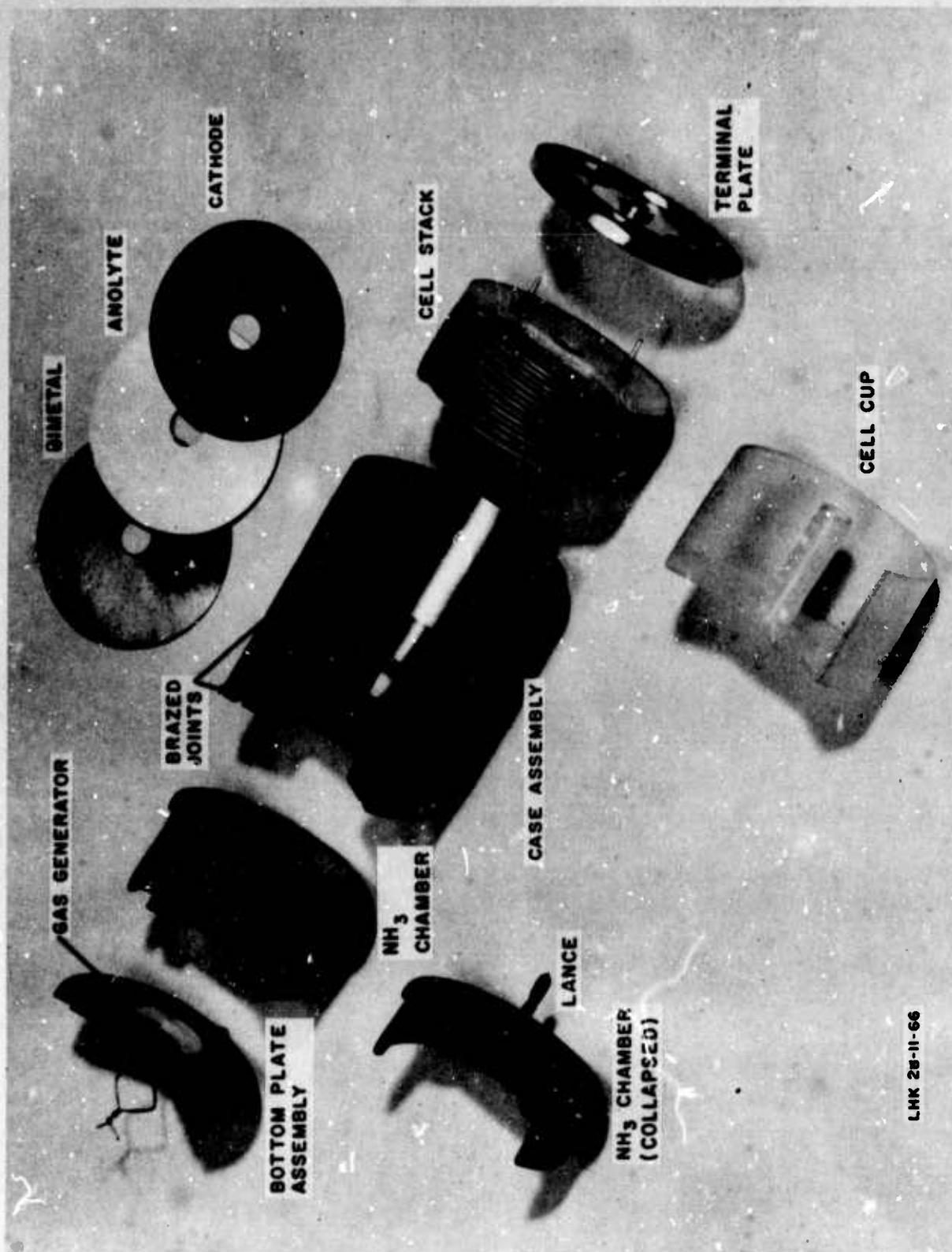

LHK 25-11-66

FIGURE 2. FC-2 Battery Components

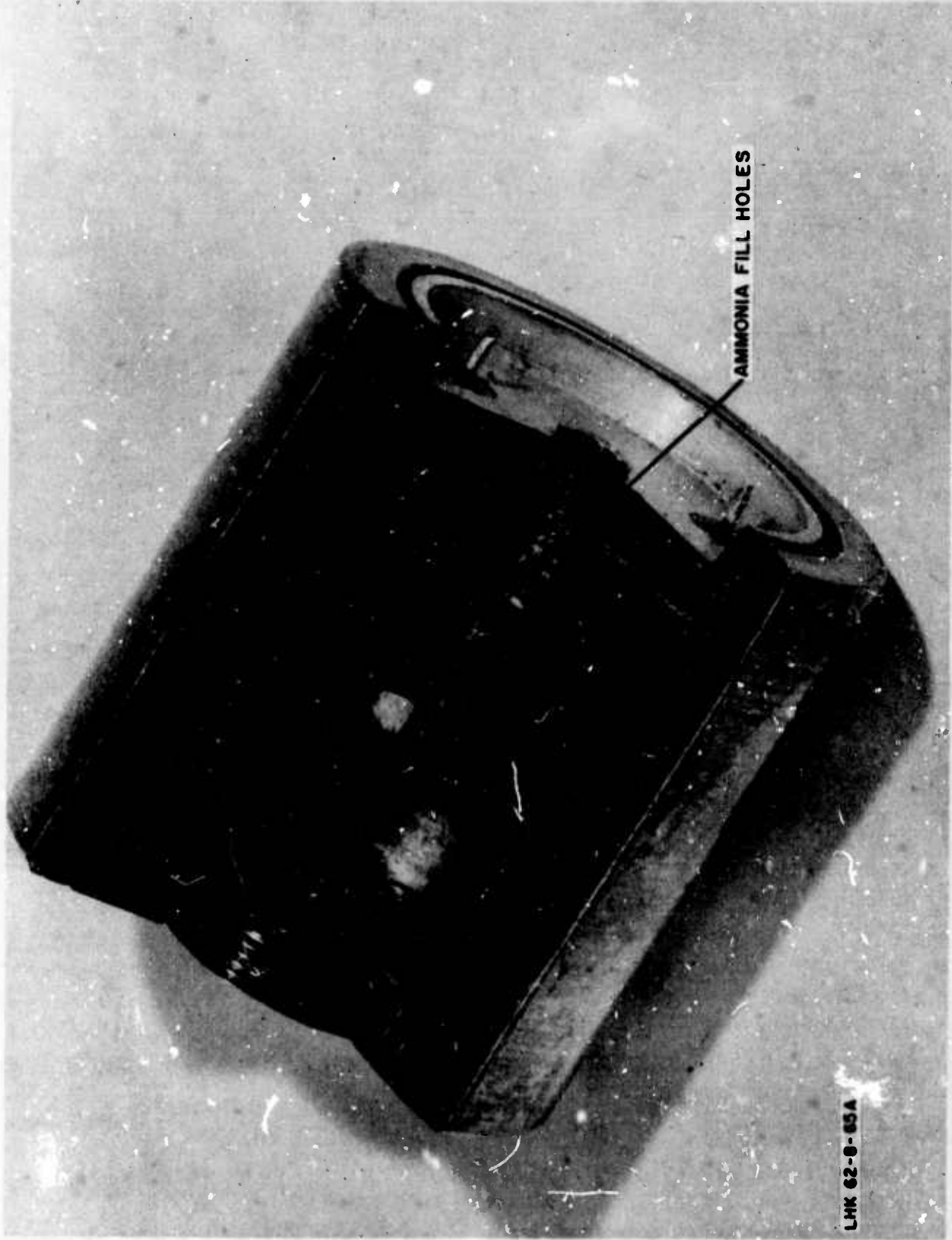
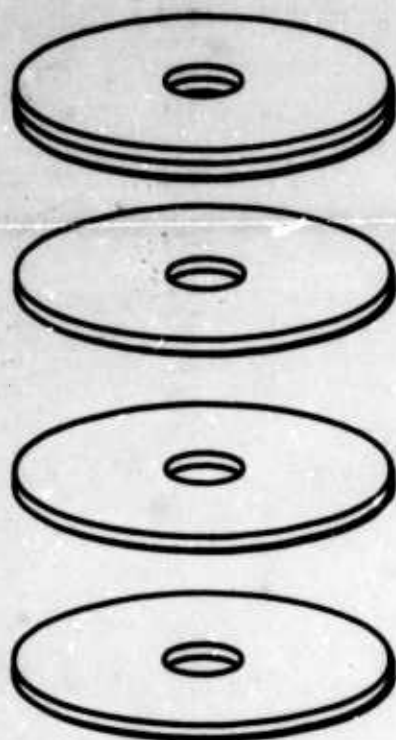

FIGURE 3. Cutaway of FC-2 Battery



BIMETAL ANODE 15.2 cm² AREA
 Ag 0.05 mm THICK
 0.045 g
 Mg 0.09 mm THICK
 0.015 g

ANOLYTE PAD
 WHATMAN NO.50 FILTER PAPER
 CONTAINING 84 Mg KSCN

SEPARATOR
 PELLON NO.990 NYLON-FIBER PAPER

CATHODE PAD
 0.451g mDNB
 0.158g CARBON
 0.021g PAPER PULP
 0.288g NH₄SCN

FIGURE 4. FC-2 Battery Lot 13 Cell Composition

utilized standard materials and represent considerable excess. In an application that dictated limited weight, the bimetal could be tailored to the specific requirement.

A Whatman No. 50 anolyte pad, a nitric-acid-hardened cellulose fiber, is impregnated with KSCN from an aqueous solution. A Pellon No. 990 nylon-fiber paper separator is positioned between the anolyte pad and the cathode pad to reduce migration of NH₄SCN to the anode. The cathode pad is fabricated on a paper maker's sheet mold from a slurry of paper pulp, carbon, and mDNB prepared in a high-speed blender. This slurry is added to the mold, where it is uniformly deposited as a paper sheet. After the excess water is removed by pressing the sheet between blotters, the cell parts are punched with steel-rule dies. The resulting cathode pads are first air dried and then loaded with NH₄SCN from an aqueous solution.

AMMONIA CHAMBER-CASE ASSEMBLY

The NH₃ chamber (Figure 2) consists of a thin, mild steel shell, which is brazed to a heavier steel bulkhead. A twist-drill lance is welded in alignment with a centered, thin, bulkhead section. A disk, welded to the outside of the shell, promotes even collapse. The case is machined with internal steps that receive the bottom plate and NH₃ chamber. First the

bottom plate and then the NH_3 chamber are positioned in the case and hydrogen brazed in one operation. After it is filled with NH_3 through a threaded port in the bulkhead, the chamber is sealed with a Teflon-gasketed set screw. The case assembly is then ready for stack insertion.

TERMINAL PLATE

Metal-to-glass seals are formed directly in a machined plate blank. A polypropylene cup is positioned on the inside surface with the two terminal pins extending through holes in the bottom of the cup. One of the pins is made long enough to extend through a small hole in the battery stack and is insulated with Teflon. The shorter pin is soldered to the first bimetal of the cell stack, placed in the bottom of the cup. This sub-assembly is then ready for insertion of the cells.

CELL STACK ASSEMBLY

The cells are assembled, over the above-mentioned longer terminal pin, in a series stack and heat-sealed in the polypropylene cup. Care must be exercised during assembly to prevent smearing carbon from the cathode pad on the wall of the cup. Small swabs are used to clean the wall after each cell is inserted. Carbon bridges between cells cause intercell leakage which is detrimental to battery cell performance. After the terminal plate-stack assembly is inserted in the case, the case is rolled over the terminal plate. Hermetic seal is provided by an epoxy sealant applied to the joint during the rolling operation. This joint has withstood all of the environmental tests assigned to the battery in accordance with the specifications outlined in Appendix A.

GAS GENERATOR

The gas generator was developed under the FC-1 effort and is described in detail in Ref. 1, page 3. It is believed that this device could be simplified to produce a cheap reliable source of gas generation that would be useful for other small devices where controlled amounts of gas are required. Surveillance information on the material used in the manufacture of the gas generator indicates storage life to be in excess of 5 yr.

TESTING

INSTRUMENTATION

Battery testing was greatly implemented by the development of an automatic test set at NOLC. This equipment monitors voltage and noise, in addition to providing load programming control. Complete details of its capabilities and operation are given in Ref. 3. All instruments used were of 1% accuracy or better. The set was designed to accommodate batteries having up to four voltage outputs of either positive or negative polarity. This multisection capability is reflected in the circuit schematic shown in Figure 5. The plug-in modules whose circuits are shown in Figures 6 and 7 provide the polarity accommodation feature and also ensure ease of maintenance. Activation time of the test unit is recorded with millisecond resolution on the high-speed clock shown in Figure 8.

METHODS

Two basic approaches were taken in evaluating the performance of FC-2 cells and batteries:

1. Stimulus test fixtures were used that duplicated conditions encountered in complete, cased, self-contained batteries.
2. Complete units were tested, some with externally activated ammonia chambers and others with internally contained gas generators.

Two stimulus fixtures were used for testing. Most of the work was done at room temperature on the 1 cm² single-cell fixture shown in Figure 9.

The device consists of a frame (1) that supports the test chamber (2) and the force gage (3). A threaded rod (4) can be adjusted to exert pressure on the cell assembly. The force gage is mounted so that multiple cell stacks can be tested as well as single cells. Temperature control is achieved by immersion of a heat-conducting rod (5) into a cold bath of dry ice and acetone (6) and with a resistance-wire heating tape (7), which is wrapped around the test chamber. The thermal insulation has been removed for illustration. For low-temperature control, the heat-conducting rod (5) is adjusted by raising and lowering the device in the cold bath (6). Adjustment is made to hold the device at a level that provides just enough conduction to cause the test chamber to be below the desired temperature. Control is obtained by adding heat with the heating tape (7). A copper-constantan thermocouple is mounted in the test chamber at (8) and is connected to a type N-15 Alnor Pyrotroller (12). The ammonia chamber (9) is fitted with a relief valve (10) to

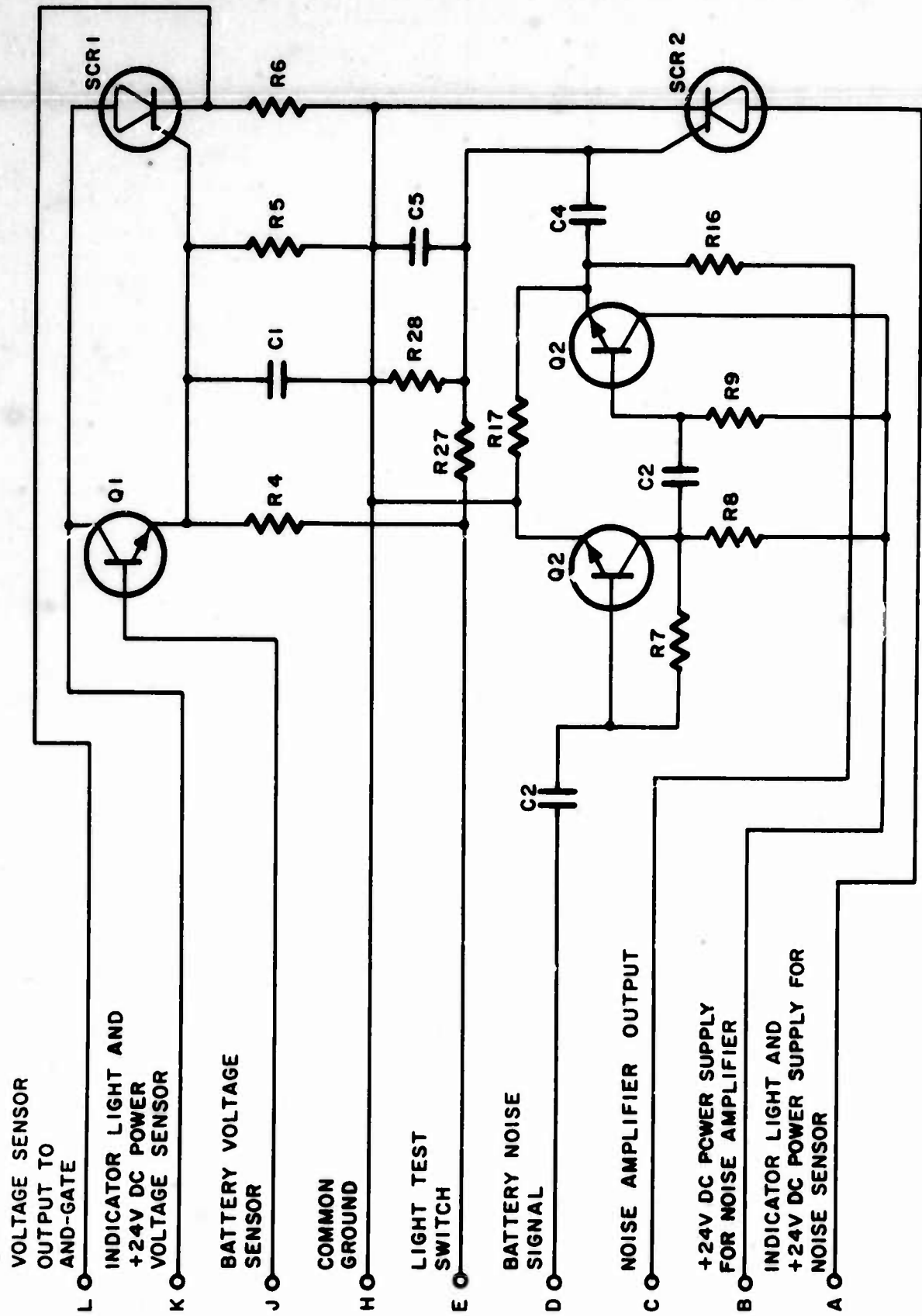

FIGURE 6. Positive-Voltage Module Circuit

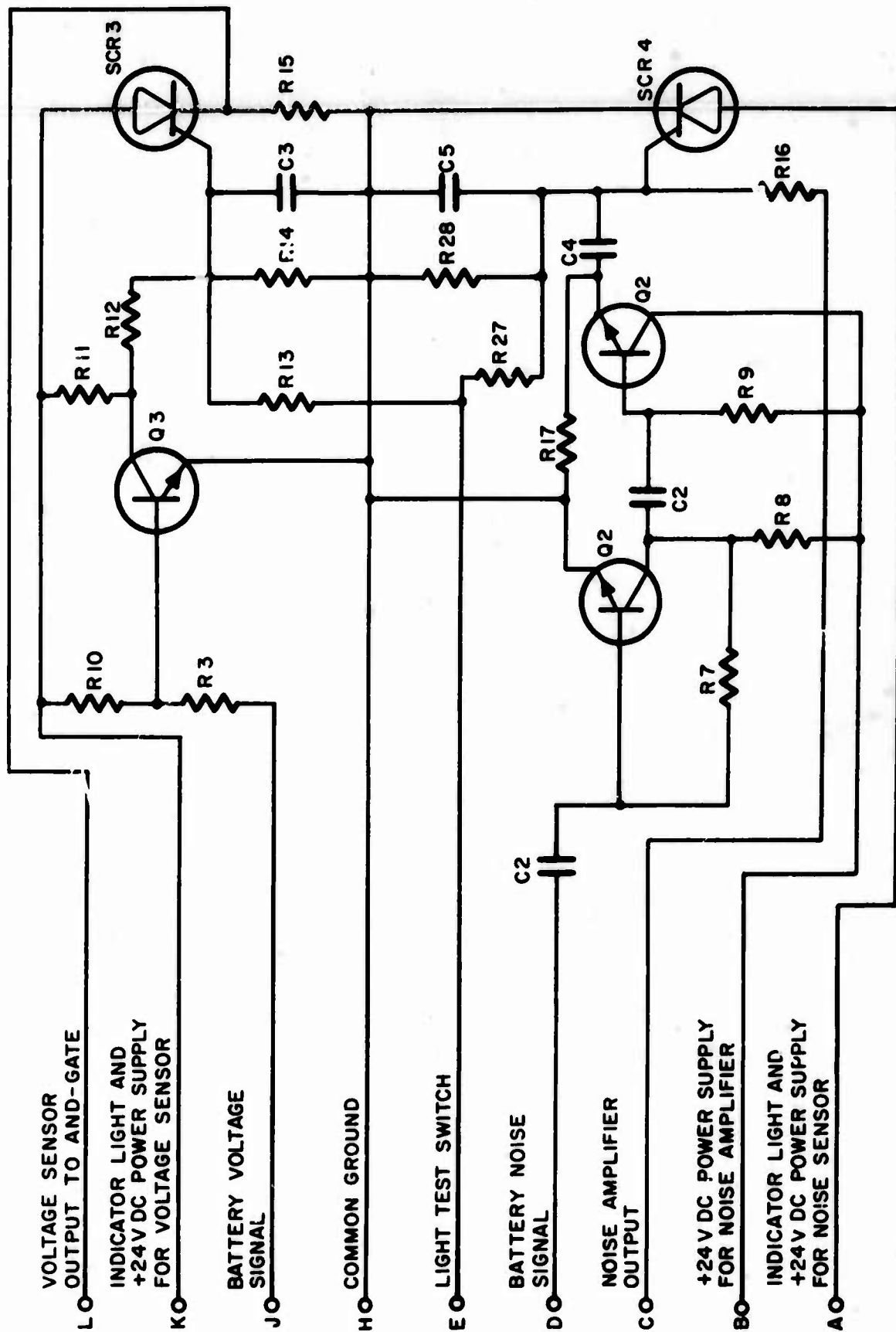

FIGURE 7. Negative-Voltage Module Circuit

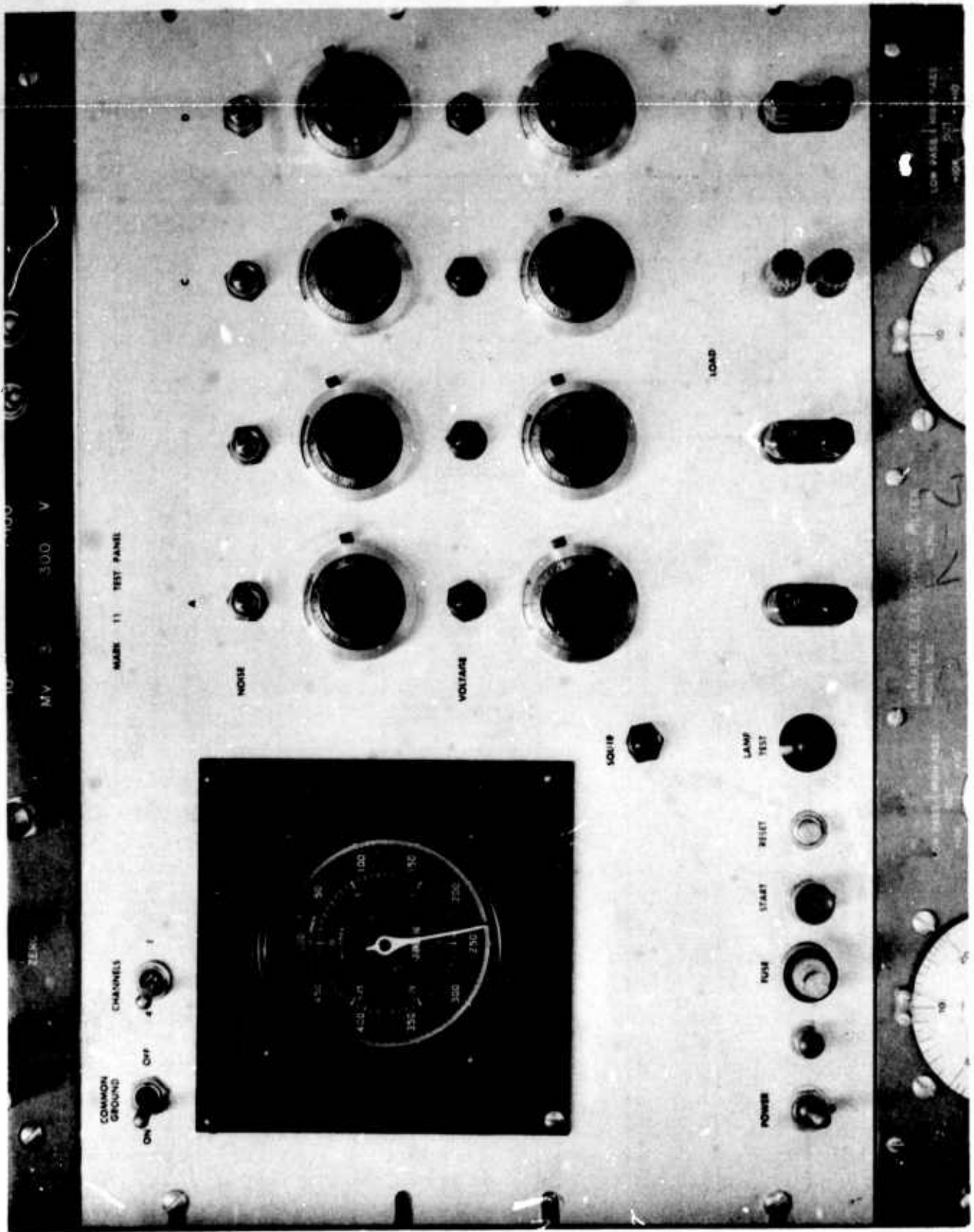

FIGURE 8. Automatic Four-Section Test-Set Panel

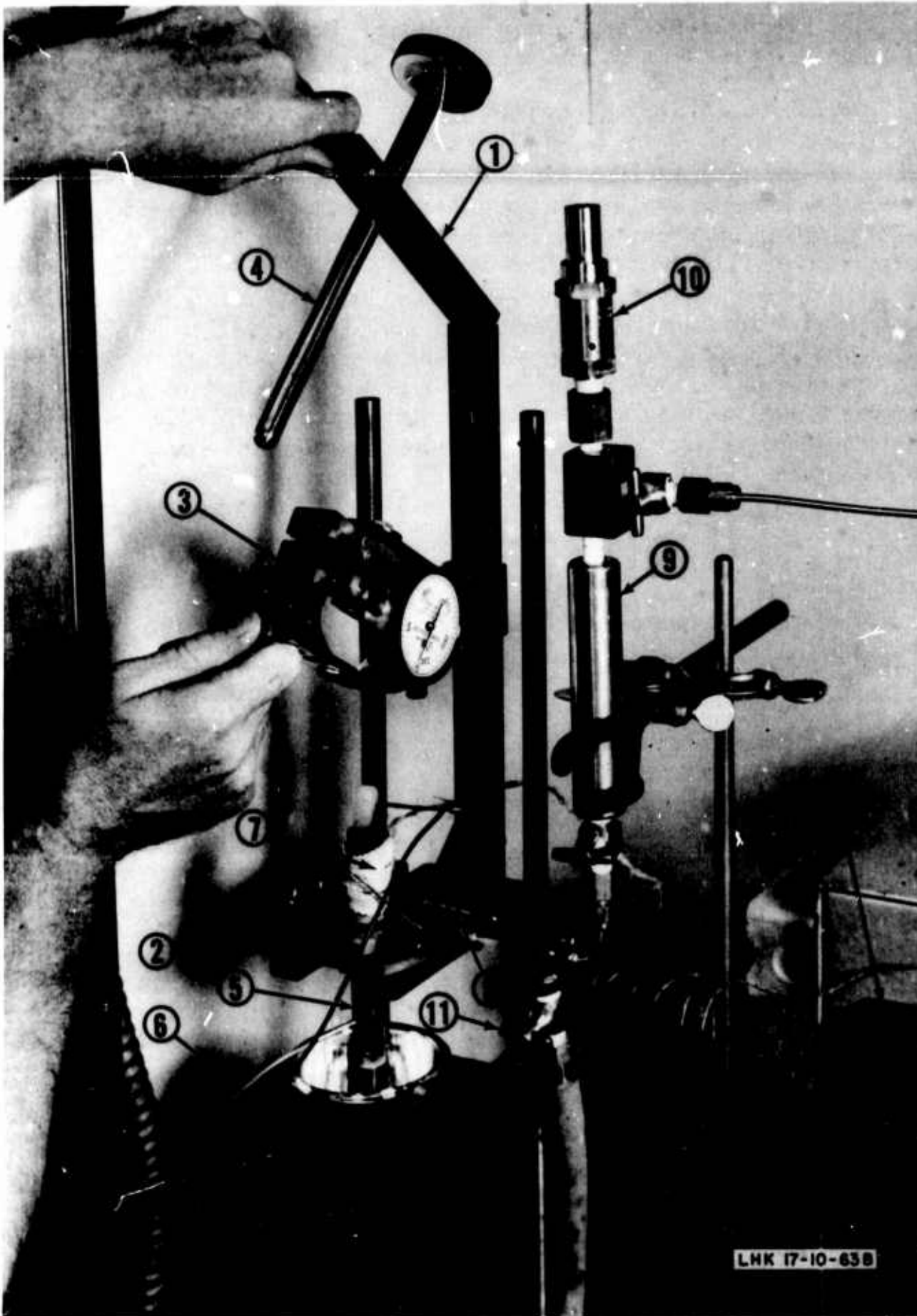

FIGURE 9. Mod 1 Single-Cell Test Fixture

prevent overpressure on the test chamber. Valve (11) provides for evacuation of the test chamber.

The test chamber (Figure 10) consists of a beryllium copper cup (1) that is coated on the inside with 0.001-in. of Teflon to provide electrical insulation as well as corrosion resistance. The cell parts are contained between two anvils (2). Leads for the anode and the cathode electron collector (cathector) are fed through holes in the center of the two anvils. This joint is sealed with an epoxy cement. The anvils are located inside a polypropylene sleeve that is slotted to provide a porting path for the ammonia. Standard O-ring seals (3), SAE designation SC725BCDE₁E₃F₁, are used to seal the anvils in the cup. A 0.625-in. stainless steel tube (4) is wrapped around the cup and provides the reservoir for the ammonia that is in the temperature-cooled zone. A special valve (5) is arranged so that the free volume of the cell is held at a minimum.

Early in the NOLC testing program, the test chamber was revised to utilize a reference electrode as shown in Figure 11. The Pb/PbCl₂ electrode¹ is formed by electrolyzing the Pb in a dilute HCl solution. Electrolytic connection to the cathode pad surface is provided by a salt bridge. All tests have been conducted at room temperature for these investigations.

A transistorized fast-switching circuit was developed to measure the internal resistance of the battery by removing the electronic load for 1 ms. Longer time under no-load conditions produced unwanted effects on cell performance. Even though this technique is difficult to interpret when used on porous cathodes, valuable insight was gained on cell problems. It was possible to determine that IR drop due to the internal resistance of the cells ranged between 0.5 and 5.0 Ω , depending on the particular construction and the time during discharge that the measurement was taken. Photos of no-load voltage traces for NOLC Experiment 22 are shown in Figure 19. The second approach to battery-performance evaluation involved the testing of 67 complete units. These FC-2 batteries were only subjected to the temperature-range environment because in previous ammonia battery testing it was found to be the only condition that affected performance. All batteries were activated under load.

Statistically designed experiments were used extensively in the single-cell test program. Details of the use of this technique are included in Ref. 4. The computer program was extended to include interaction tables which help to identify specific interactions of experimental param-

¹Developed at NOLC by Dr. Richard E. Panzer and G. E. McWilliams.

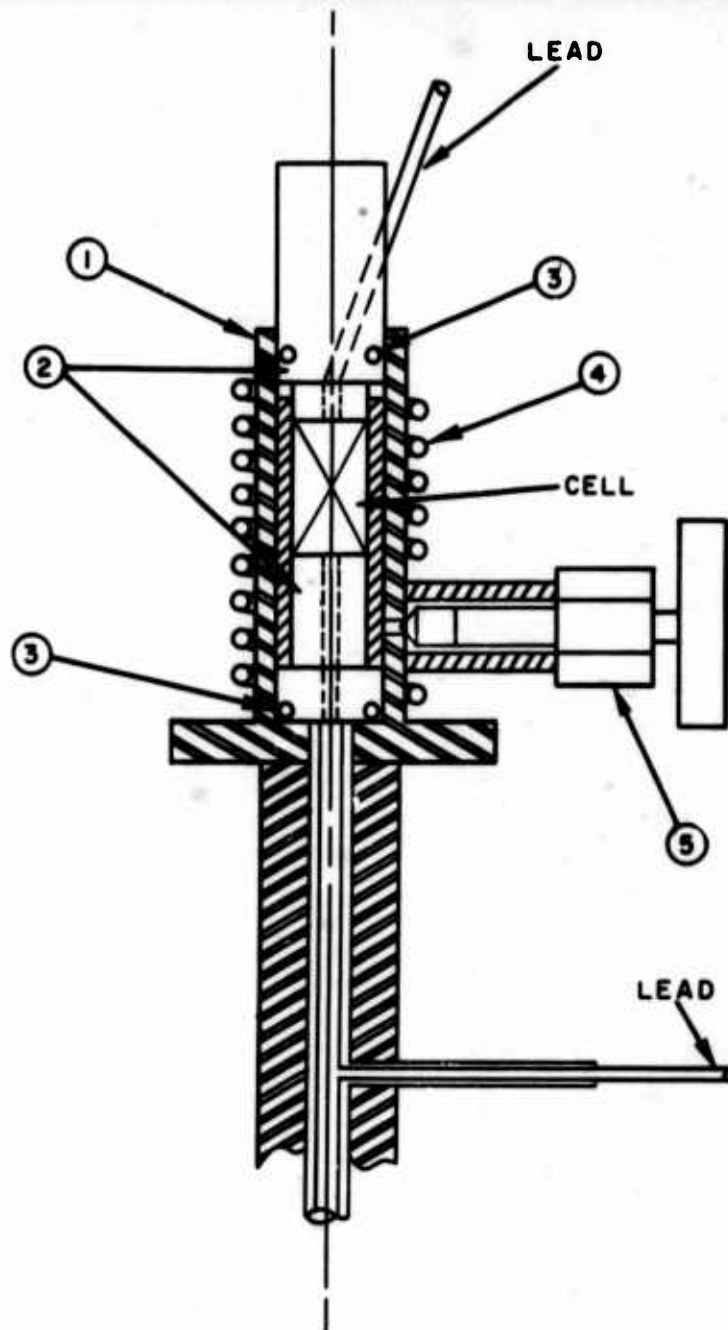

FIGURE 10. Test Chamber

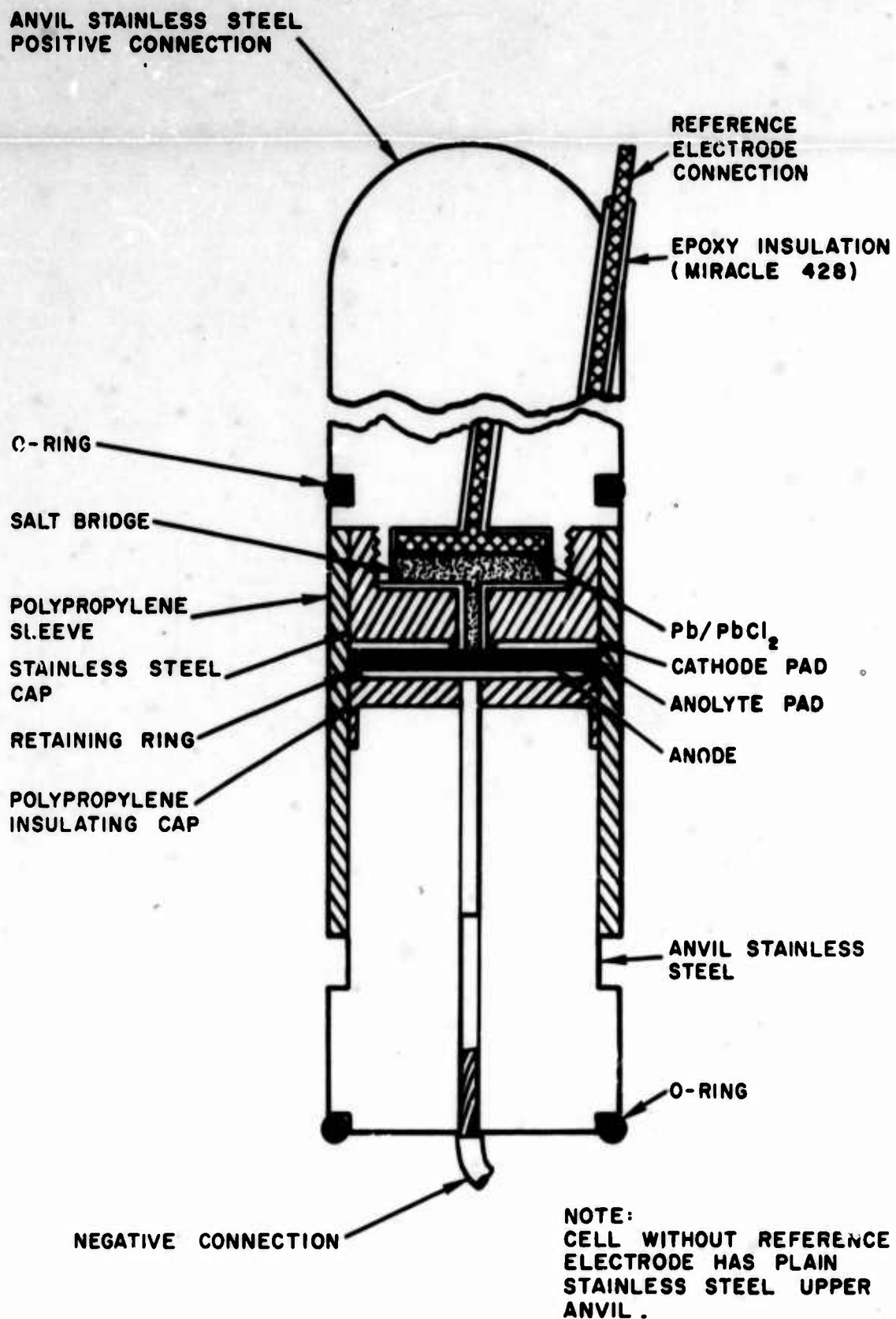

FIGURE 11. Reference Electrode

eters. The factorial experiment technique, together with the computer analysis, greatly increased the confidence in data obtained and broadened the scope of each evaluation.

Further documentation of battery data utilized an IBM card system illustrated in Appendix B. Explanation of the column headings is given in Appendix C. This system greatly enhanced the evaluation of the large number of test parameters used in this study.

RESULTS

Although cell technology at the start of this program was not sufficiently advanced to permit discharge at a 3 A rate, it was believed practical to start at 1 A and seek improvements. However, because materials and processes in the contractor's plant had been developed for thicker cells and lower discharge rates, it proved impossible to obtain the required performance. Finally, in order to avoid compromising the rigid volume specification, it was necessary to reduce both the number of cells and the current, thus closing out the model construction program on a lower level than planned. The best performance of a cased battery tested at 1 A is presented in Figure 12. The test results for the last lot of batteries (Lot 13) produced on the contract are shown in Figure 13.

SUPPORTING STUDIES

LIVINGSTON ELECTRONIC CORP.

Factorial experiments performed by the contractor covered both construction features and composition changes. Efforts centered on the basic Mg/KSCN/mDNB-NH₄SCN-C/SST system. Table 1 presents a summary of the conditions and results of these experiments. The data have been organized so that the reader may focus his attention on the main findings of the experiments. The factorial plan is given to indicate the confidence with which the data may be regarded. Most of the experiments were replicated.

It should be kept in mind that the purpose of these experiments was to determine the effect of variations in cell formulation, etc., on cell performance. This results in tests with a wide performance spread when sensitive experimental parameters are chosen. In order to visualize each experiment more readily, voltages, current densities (currents), and discharge curves are presented that represent the best and worst-cell performance for each experiment. The parameters that produced these performances are indicated in the results column. The low-level factors are identified as minus (-), and the high-level factors are identified as plus (+). In experiments with more than two levels, the

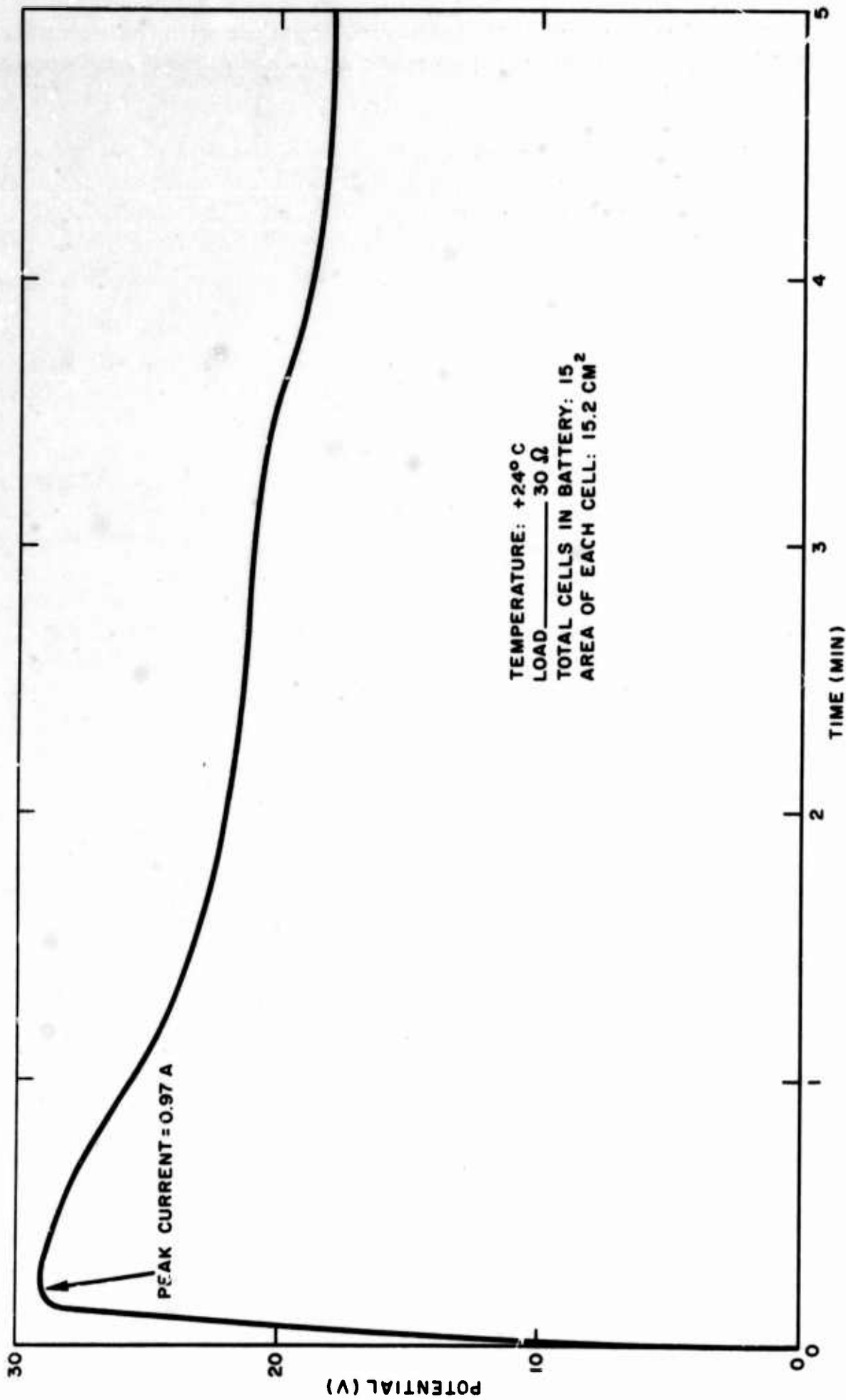

FIGURE 12. Results of FC-2 Battery Test No. 5C2050

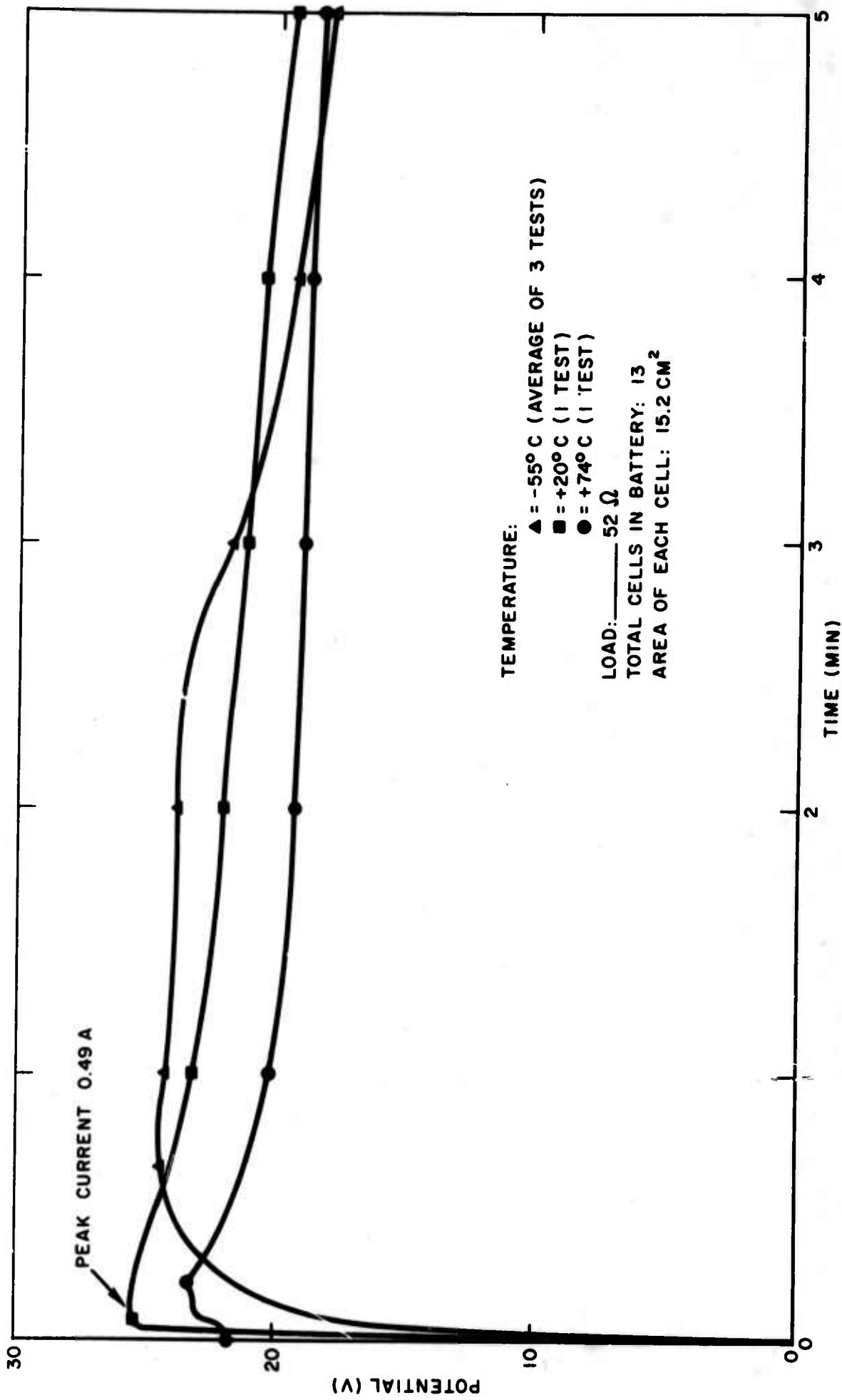
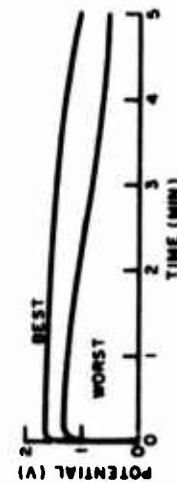
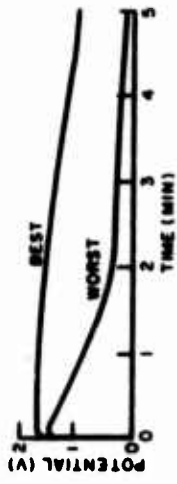

FIGURE 13. Effect of Temperature on Battery Discharge, Lot 13

TABLE 1. Contractor Supporting Studies

Abbreviations are defined as follows: PNV = peak no-load voltage; PLV = peak load voltage; PCY = peak cursivity; PCY = peak cursivity; * = significance > 95% based on F-test ratio.

Exp. No.	Plan	Factors and levels Lo(-), Hi(+)	Best and worst performance						Results
			Voltage			PCY ma/cm ²			
			PNV	PLV	V1	V3	V5	PCY	
16	2 ³	A. Amount of KSCN anolyte Lo, 4.3 mg/cm ² Hi, 6.5 mg/cm ²	2.23	1.84	1.76	1.31	1.05	60	1. No statistical significance shown 2. Best cell A ⁺ , B ⁻ , C ⁺ 3. Worst cell A ⁺ , B ⁺ , C ⁺
		B. Amount of NH ₄ SCN catholyte Lo, 4.3 mg/cm ² Hi, 6.5 mg/cm ²	1.80	1.32	1.27	0.97	0.80	43	
		C. Temperature, (°C) Lo, -55 Hi, +74							
17	2 ³	A. Conductor material Lo, carbon Hi, silicon	2.32	1.69	1.67	1.36	0.92	55	1. Carbon superior* 2. Best cell A ⁻ , B ⁺ , C ⁺ 3. Worst cell A ⁺ , B ⁻ , C ⁻
		B. Cell edge sealed Lo, none Hi, with	2.08	1.40	0.84	0.24	0.08	46	
		C. Temperature, (°C) Lo, -55 Hi, +74							
18	2 ³	A. Amount of KSCN anolyte Lo, 6.5 mg/cm ² Hi, 13.0 mg/cm ²	2.10	1.68	1.62	1.45	1.05	55	1. No statistical significance shown 2. Best cell A ⁻ , B ⁰ , C ⁻ 3. Worst cell A ⁺ , B ⁺ , C ⁻
		B. Amount of NH ₄ SCN catholyte Lo, 4.3 mg/cm ² Med, 8.6 mg/cm ² Hi, 13.0 mg/cm ²	2.12	1.33	1.25	0.82	0.55	44	
		C. Cathode pad mix Lo, 9:9:1 ratio Hi, 10:6:1 ratio							



Abbreviations are defined as follows: PNV = peak no-load voltage; PLV = peak load voltage; PLY = peak cursivity; PCY = peak cursivity; * = significance > 95% based on F-test ratio.

Exp. No.	Plan	Factors and levels Lo(-), Hi(+)	Best and worst performance					Results	
			Voltage				PCY ma/cm ²		
			PNV	PLV	V1	V3			V5
22	2-4 ³	<p>A. Temperature (°C) 0, +24 1, 0 2, -24 3, -48</p> <p>B. Amount of KSCN anolyte Lo, 1.4 mg/cm² Hi, 4.3 mg/cm²</p> <p>C. Cathode pad mix 2 1, 28.0 mg/cm² 2, 35.4 mg/cm² 3, 57.3 mg/cm² (all 0.76 mm thick)</p>	2.25 2.10	1.85 1.66	1.79 1.15	1.65 0.73	1.51 0.60	61 55	<p>1. -24, -48°C performance poor*</p> <p>2. Cathode mix best at 35.4, > 98% significance</p> <p>3. Best cell A⁰, B⁺, C¹</p> <p>4. Worst cell A¹, B⁺, C¹</p>
23	2 ³	<p>A. Catholyte material Lo, KSCN Hi, NH₄SCN</p> <p>B. Plastic screen against anode Lo, none Hi, with</p> <p>C. Temperature (°C) Lo, -55 Hi, +24</p>	2.05 1.76	1.80 1.36	1.80 0.40	1.70 0.04	1.44 0.03	59 45	<p>1. NH₄SCN superior*</p> <p>2. +24°C best > 99%</p> <p>3. Zinc reference electrode shows the voltage decline at the cathode</p> <p>4. Best cell A⁻, B⁺, C⁺</p> <p>5. Worst cell A⁻, B⁻, C⁻</p>
27	2 ⁴	<p>A. Cathode pad mix ratio Lo, 7:7:1 Hi, 8:7:1</p> <p>B. Anolyte pad material Lo, glass fibers and ion membrane Hi, glass fibers and 541 paper</p> <p>C. Catholyte material Lo, NH₄SCN Hi, (NH₄)₂SO₄</p>	2.26 2.04	1.85 1.43	1.83 1.43	1.59 0.58	1.18 0.20	61 47	<p>1. NH₄SCN catholyte better*</p> <p>2. Best cell A⁻, B⁻, C⁻</p> <p>3. Worst cell A⁻, B⁻, C⁺</p>



TABLE 1. (Contd.)

Abbreviations are defined as follows: PNV = peak no-load voltage; PLV = peak load voltage; FCY = peak cursivity; * = significance > 95% based on F-test ratio.

Exp. No.	Plan	Factors and levels Lo(-), Hi(+)	Best and worst performance					Results	
			Voltage			FCY ma/cm ²			
			PNV	PLV	V1	V3	V5		
28	2 ⁴	A. Powdered Mg against Mg of the bimetal Lo, none Hi, with B. Anolyte pad material Lo, Dynel with 478 Hi, foam with 478 C. Amount of mDNB Lo, 16.3 mg/cm ² Hi, 18.6 mg/cm ² D. Catholyte salt Lo, NH ₄ SCN Hi, NH ₄ NO ₃	2.20	1.79	1.75	1.74	1.28	59	1. NH ₄ SCN superior* 2. Best cell A ⁺ , B ⁺ , C ⁻ , D ⁻ 3. Worst cell A ⁻ , B ⁻ , C ⁺ , D ⁺
			2.10	1.24	1.16	1.19	0.92	41	
29	2 ³	A. Amount of mDNB Lo, 13.1 mg/cm ² Hi, 34.5 mg/cm ² B. Ratio of mDNB to Carbon Lo, 1:1 Hi, 1:2 C. Ratio of mDNB to NH ₄ SCN Lo, 1:2 Hi, 1:4	2.08	1.72	1.67	1.61	1.36	56	1. Best cell A ⁻ , B ⁻ , C ⁺ , 2. Worst cell A ⁺ , B ⁻ , C ⁺
			1.60	0.82	0.19	0.72	0.57	27	

symbols representing the level are shown under each factor level. All of the cells tested in these experiments were 15.2 cm² in area and were activated with liquid ammonia.

Experiment 16

The purpose of Experiment 16 was to evaluate the effect of variations of salt concentrations on the basic Mg/KSCN/mDNB-NH₄SCN-C/SST system during discharge at the hot and cold temperature ranges. The anolyte pads were made of Webril, and the cathode pads utilized paper pulp as the fiber.

Experiment 17

The two systems, Mg/KSCN/mDNB-NH₄SCN-C/SST and Mg/KSCN/mDNB-NH₄SCN-Si/SST, were used in Experiment 17 to determine the effect of two different conductive matrices on cell performance. In addition, an attempt was made to seal the edge of the cells with Krylon, in order to prevent displacement of the conductive matrix, which contributes to intercell shorting. The tests were carried out at the two temperature extremes.

Experiment 18

The Mg/KSCN/mDNB-NH₄SCN-C/SST system was tested in Experiment 18 with variations in the amounts of both anolyte and catholyte salts, coupled with two ratios of carbon content in the cathode pads. These cells contained either 29 or 36 mg of mDNB/cm².

Experiment 22

The study of the effect of variations in the amount of KSCN anolyte continued with Experiment 22 on the Mg/KSCN/mDNB-NH₄SCN-C/SST system. In addition, the cathode pad density was varied by changing the total quantity of pad materials as shown in Table 2.

TABLE 2. Cathode Pad Formulation
for Experiment 22 (mg/cm²)

Variation No.	Cathode	Matrix	Catholyte	Fiber
1	28.0	28.0	13.8	3.5
2	35.4	35.4	13.8	4.0
3	57.3	57.3	13.8	7.2

Experiment 23

Experiment 23 compared the performance of a neutral (KSCN) catholyte with an acid (NH₄SCN) catholyte. Also, a nylon screen was inserted in the cell in such a way as to promote better flow of the ammonia. The electrochemical systems were Mg/KSCN/mDNB-NH₄SCN-C/SST and Mg/KSCN/mDNB-KSCN-C/SST. Anode voltages measured by a zinc reference electrode were stable. Cathode voltage decayed rapidly when KSCN was used as a catholyte.

Experiment 27

The two systems evaluated—Mg/KSCN/mDNB-NH₄SCN-C/SST and Mg/KSCN/mDNB-(NH₄)₂SO₄-C/SST—were identical in Experiment 27, except for the different catholyte material. It was theorized that the insoluble (NH₄)₂SO₄ would reduce migration to the anode and subsequent undesirable reactions. The Gelman ion X membrane was also tried to determine its effectiveness in reducing this migration.

Experiment 28

The two systems used in Experiment 28—Mg/KSCN/mDNB-NH₄SCN-C/SST and Mg/KSCN/mDNB-NH₄NO₃-C/SST—were again identical with the exception of the different catholyte salts. An attempt was made to increase the number of reaction sites by spreading powdered magnesium over the regular Mg sheet. Two variations of anolyte-pad fibers were used to improve NH₃ flow into the cell. Two levels of cathode material amounts were also tested.

Experiment 29

Experiment 27 utilized the system Mg/KSCN/mDNB-NH₄SCN-C/SST and was an attempt to optimize the amounts of anolyte and catholyte salts and of carbon in the cell.

NOLC STUDIES

Statistically designed and conventional experiments performed at NOLC are covered in detail in the Quarterly Reports on the Chemoelectric Energy Conversion for Nonaqueous Reserve Batteries Program, Ref. 5 through 12. Table 3 summarizes the results of the experiments in a manner similar to that used in Table 1. The choice of best or worst cells was made on the basis of the individual cell application in a battery.

TABLE 3. NOLC Supporting Studies

Abbreviations are defined as follows: PNV = peak no-load voltage; PLV = peak load voltage; PCY = peak current; * = significance > 95% based on F-test ratio.

Exp. No.	Plan	Factors and Levels Lo(-), Hi(+)	Best and Worst Performance						Results
			Volts/Cell			PCY ma/cm ²			
			PNV	PLV	1 min	3 min	5 min	27	
1	2 ²	A. Pads pressed, 620 kg/cm ² Lo, cathode and anode Hi, cathode only B. Salt concentrations in both cathode and anolyte pads Lo, 6 mg/cm ² Hi, 12 mg/cm ²	2.18 2.00	2.00 1.49	1.98 1.36	2.00 1.49	1.94 1.44	27 21	1. Best cell A ⁻ , B ⁻ 2. Worst cell A ⁺ , B ⁺
2	2 ²	A. Assembly pressure Lo, none Hi, 4.5 kg/cm ² B. KSCN anolyte amount Lo, 6.5 mg/cm ² Hi, 13 mg/cm ²	2.13 2.14	2.06 2.05	2.03 2.00	2.03 1.83	1.98 1.62	28 28	1. Best cell A ⁺ , B ⁻ 2. Worst cell A ⁻ , B ⁺
3	2 ²	A. Assembly pressure Lo, slight void Hi, 4.5 kg/cm ² B. Cathode-cathode pad contact Lo, more Hi, less	2.19 2.11	2.10 2.00	2.06 1.74	2.00 1.42	1.91 1.31	29 27	1. Best cell A ⁻ , B ⁻ 2. Worst cell A ⁺ , B ⁺

TABLE 3. (Contd.)

Abbreviations are defined as follows: PNV = peak no-load voltage; PLV = peak load voltage; PCY = peak cursity; * = significance > 95% based on F-test ratio.

Exp. No.	Plan	Factors and Levels Lo(-), Hi(+)	Best and Worst Performance					Results
			PNV	Volts/Cell			PCY ma/cm ²	
				PLV	1 min	3 min		
4	2 ³	A. Solder on cathector Lo, without Hi, with	2.22	2.08	2.05	2.02	1.94	1. Best cell A ⁻ , B ⁻ , C ⁻ 2. Worst cell A ⁺ , B ⁺ , C ⁺
		B. Mfr. of cathode pads Lo, NOLC Hi, contractor	2.09	2.07	1.83	1.59	1.51	
		C. Assembly pressure Lo, slight void Hi, 1 kg/cm ²						
6	2 ³	A. 5% alcohol in ammonia (by volume) Lo, none Hi, with	2.07	2.07	1.92	1.80	1.95	1. KSCN better analyte* 2. Best cell A ⁻ , B ⁺ , C ⁻ 3. Worst cell A ⁻ , B ⁺ , C ⁺
		B. Anolyte salt Lo, KSCN Hi, NH ₄ SCN	2.01	2.07	1.52	1.17	1.02	
		C. Assembly pressure Lo, slight void Hi, 1 kg/cm ²						
7	2 ³	A. Water or alcohol in the ammonia (by volume) Lo, 1% alcohol Hi, 1% water	2.15	2.11	2.07	1.97	1.99	1. 100Ω load better* 2. Best cell A ⁻ , B ⁻ , C ⁻ 3. Worst cell A ⁺ , B ⁺ , C ⁺
		B. Load (Ω) Lo, 100 Hi, 30	2.09	1.99	1.85	1.73	1.55	
		C. Mfr. of cathode pads Lo, NOLC Hi, contractor						

TABLE 3. (Contd.)

Abbreviations are defined as follows: PNV = peak no-load voltage; PLV = peak load voltage; PCY = peak cursivity; * = significance > 95% based on F-test ratio.

Exp. No.	Plan	Factors and Levels Lo(-), Hi(+)	Best and Worst Performance						Results	
			PNV		Volts/Cell			PCY ma/cm ²		
			PLV	1 min	3 min	5 min				
9	2 ³	A. Anode material Lo, pure Mg Hi, 14 wt. % Li-Mg alloy B. Electrolyte salt Lo, NH ₄ SCN Hi, KSCN C. Oxidant material Lo, mDNB Hi, pNA	2.14 1.65	1.80 1.32	1.60 1.00	0.27 0.85	---	---	90 66	1. Li-Mg cells better* 2. NH ₄ SCN better* 3. mDNB better* 4. Best cell A ⁺ , B ⁺ , C ⁻ 5. Worst cell A ⁻ , B ⁻ , C ⁺
13	2 ³	A. Anode/anolyte Lo, Li/LiNO ₃ Hi, Mg/Ki-HgI ₂ B. Catholyte Lo, (NH ₄) ₂ SO ₄ Hi, NH ₄ SCN C. Load (Ω) Lo, 40 Hi, 16	2.10 0.79	1.96 0.41	1.91 0.27	1.81 0.15	1.35 0.08		49 26	1. NH ₄ SCN better* 2. Best cell A ⁺ , B ⁺ , C ⁻ 3. Worst cell A ⁻ , B ⁻ , C ⁺
14	2 ³	A. Cathode Lo, mDNB Hi, 2,4DNA B. Cathode form Lo, sheet Hi, pasted C. Anolyte Lo, NaNO ₃ Hi, NH ₄ NO ₃	2.00 1.42	2.09 2.17	1.73 1.32	1.51 1.18	1.29 1.06		130 136	1. 2,4DNA and pasted cathodes better* 2. Best cell A ⁺ , B ⁻ , C ⁻ 3. Worst cell A ⁻ , B ⁻ , C ⁺

TABLE 3. (Contd.)

Exp. No.	Plan	Factors and Levels Lo(-), Hi(+)	Best and Worst Performance						Results
			PNV	Volts/Cell				PCY ma/cm ²	
				PLV	1 min	3 min	5 min		
16	23	A. Ion precipitant Lo, none Hi, with	1.67	1.64	1.19	0.85	0.65	79	1. Cell resistance was from 1 to 3Ω/cell 2. Best cell A ⁺ , B ⁺ , C ⁻ 3. Worst cell A ⁻ , B ⁺ , C ⁺
		B. Cathode matrix Lo, carbon Hi, AgFib	1.53	1.19	0.88	0.67	0.51	57	
		C. Anolyte pad thickness Lo, 0.48 mm Hi, 0.96 mm							
18	23	A. Reference electrode Lo, none Hi, with	---	2.25	2.01	1.81	1.47	104	1. Presence of the reference electrode does not affect discharge 2. Li cells short on open circuit condition 3. Best cell A ⁻ , B ⁻ , C ⁻ 4. Worst cell A ⁻ , B ⁻ , C ⁺
		B. Electronic load Lo, load Hi, none	---	1.74	1.16	0.51	0.34	90	
		C. Anode material Lo, Li Hi, Mg							
19	3x3	A. Cathector SST, Ag, Pt	---	2.50	2.21	2.16	2.19	10	1. Sheet Mg approx. 10% better than rolled 2. AgFib may short cells 3. Best cell SST, Li, light load 4. Worst cell Pt, rolled Mg, heavy load
		B. Anode Li, rolled Mg, sheet Mg	---	1.59	1.05	0.67	0.57	44	
		C. Electronic load open circuit, light, heavy							

Abbreviations are defined as follows: PNV = peak no-load voltage; PLV = peak load voltage; PCY = peak capacity; * = significance > 95% based on F-test ratio.

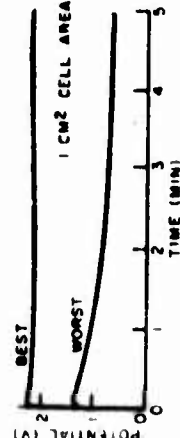
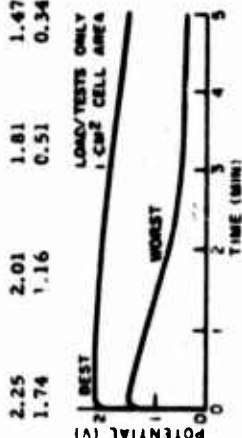
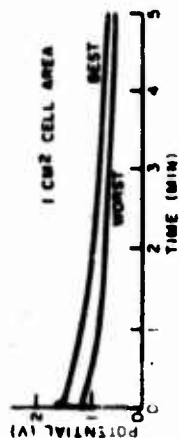

TABLE 3. (Contd.)

Abbreviations are defined as follows: PNV = peak no-load voltage; PLV = peak load voltage; PCY = peak cursivity;
 * = significance > 95% based on F-test ratio.

Exp. No.	Plan	Factors and Levels Lo(-), Hi(+)	Best and Worst Performance					PCY ma/cm ²	Results
			Volts/Cell						
			PNV	PLV	1 min	3 min	5 min		
20	2 ³	A. Cell construction Lo, Mg Hi, Li B. Activation method Lo, solvent Hi, solution C. Cursivity Lo, ma/cm ² Hi, 100 ma/cm ²	2.28 1.09	2.31 1.41	2.16 0.75	2.08 0.36	2.02 0.30	48 72	1. Li cells better* 2. Best cell A ⁺ , B ⁻ , C ⁻ 3. Worst cell A ⁻ , B ⁺ , C ⁺
21	2 ³	A. Magnesium type Lo, BT9256 Hi, AZ31 B. Binder Lo, none Hi, with C. Cathode amount ² Lo, 13 mg/cm ² Hi, 26 mg/cm ²	2.05 2.11	1.98 2.05	1.94 2.01	1.83 1.55	1.72 1.29	99 102	1. Cathode potential more stable at 26 mg/cm ² 2. Best cell A ⁺ , B ⁻ , C ⁺ 3. Worst cell A ⁻ , B ⁺ , C ⁺
22	2 ³	A. Mg Anode Lo, plain Hi, amalgamated B. Activation method Lo, solvent Hi, solution C. Anolyte Lo, NH ₄ ClO ₄ Hi, LiClO ₄	1.34 0.74	1.28 0.74	1.05 0.72	0.80 0.53	0.75 0.07	62 36	1. Solvent activation shows less voltage decay* 2. Best cell A ⁻ , B ⁻ , C ⁻ 3. Worst cell A ⁻ , B ⁺ , C ⁻

Experiment 1

The system for Experiment 1 was Mg/KSCN/mD₄NB-NH₄SCN-C/SST. The anode material was 0.0035 to 0.0045 in. evaporated Mg on a 0.0010 to 0.0015 in. thick Type 302 stainless steel anector. The cathector was SST. The anolyte and catholyte pads utilized glass fibers. The carbon consisted of a mixture of graphite and carbon black. The cathode pads each contained 29 Mg of mD₄NB and a like amount of carbon. The pads were pressed in a pill die prior to assembly in the test fixture. The anode surfaces of the discharged cells exhibited varied etch patterns that indicated erratic reactions at the anode surface and were similar to those observed in NOLC Experiment 6.

Experiment 2

The same system and materials were used in both Experiments 1 and 2, except that the anolyte and catholyte pads used in Experiment 2 were not pressed prior to assembly in the test fixture. The assembly pressure applied during the test was measured with a force gage.

Experiment 3

The same system and materials were used in both Experiments 1 and 3, except that a silver screen was soldered to the cathector in Experiment 3 to increase its effective area. For the cells designated as less contact, the cathode pads were assembled against the screen without pressure. The cells with more pressure were pressed, so that the cathode pad extruded into the screen voids, thus markedly increasing the contact area.

Experiment 4

The same system as that of Experiment 1 was tested in Experiment 4 to evaluate the possibility of the tin-lead solder alloy, used to secure the silver screen to the cathector in Experiment 3, entering into the reaction. The known difference between the cathode pads made by the contractor and those made by NOLC were that (1) the pads made by the contractor used paper pulp as the pad fiber while those made at NOLC used glass fibers, and (2) the application of the NH₄SCN salt to the pads employed two different techniques that probably affected salt distribution.

Experiment 6

Experiment 6 applied the electrochemical system of Experiment 1 with two basic variations. First, the substitution of NH₄SCN for KSCN as the anolyte salt was made to determine its effect on performance. Second, the use of 5 wt. % ethyl alcohol was tried to determine whether or not it would tend to keep the anode surface more reactive. Various

etch patterns observed on the anode surfaces after discharge suggested that erratic reactions might have occurred there.

Experiment 7

Tests in Experiment 7 were made on the Mg/KSCN/mDNB-NH₄SCN-C/SST system. This system is identical with that of Experiment 1. One of the procedures in these experiments was to remove the electronic load for a few seconds and then replace it. In previous tests, cell voltage was noticeably lower when the load was reapplied; but, when water or alcohol was contained in the ammonia, this phenomenon was reduced.

Experiment 9

Experiment 9 involved several major deviations from previous construction techniques and materials. Two anode materials were used: evaporated Mg and a 14 wt. % Li, 86 wt. % Mg alloy spot welded to a stainless steel anector. Two anolyte salts were tried: NH₄SCN and KSCN. Two cathode materials were tested: mDNB and p-nitroaniline (pNA). The cathode matrix consisted of a porous stainless steel sintered disk, which was loaded with mDNB by melting the cathode and dipping the disk into the melt. The catholyte was applied to the stainless disk from an alcohol solution. Overall performance of this experiment was poor in contrast with a previous exploratory test that had a PLV of 2.00 V and a 4 min voltage of 1.81 V at 27 ma/cm²PCY. The system was

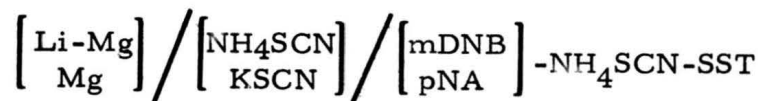

Experiment 13

Experiment 13 employed both Li and amalgamated Mg anodes, each with two catholyte salts, NH₄SCN (soluble) and (NH₄)₂SO₄ (insoluble). The two systems were

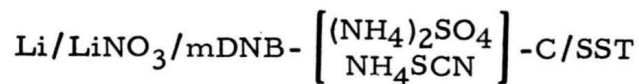

and

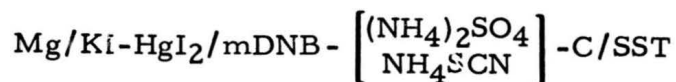

Experiment 14

Experiment 14 employed 2,4-dinitroaniline (2,4DNA) as a cathode in hardware cells for the first time at NOLC. The system used two anolyte salts, and two methods of fabricating the cathode pads. The pasted cathode method differs from the previously described sheet method in that it does not contain fibers to bind it together. The constituents are blended into a paste form with water, spread on a porous SST cathector, and then air dried. The electromechanical system used was

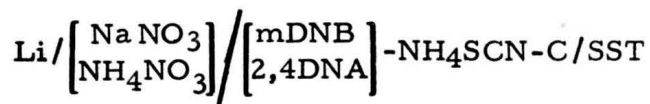

An important parameter in this experiment may be that the particle size of the 2,4DNA is smaller than that of the mDNB. This is because it may be ground easily, whereas the waxy mDNB crystal cannot be finely ground by conventional techniques.

Experiment 16

Experiment 16 was devoted to evaluating amalgamated Mg anodes with a new technique for reducing the migration of Mg cations to the cathode. This involved the use of $(\text{NH}_4)_2\text{SO}_4$ applied close to the anode to "precipitate" the cations and form MgSO_4 . In addition, a substitute for carbon was tried. Agfib, made of glass fibers plated with Ag by the Brashear process, was used in place of carbon. In order to determine the importance of the thickness of the anolyte pad, one-half the cells had two anolyte pads. The resulting system was

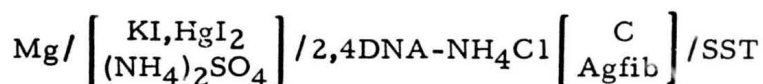

This experiment incorporated the use of a new cathode-pad fabricating technique that utilized Freon as a vehicle rather than water. A fast-switching technique was used in this experiment for the first time. This solid-state device provides a means of opening the electronic circuit of the cell cleanly for 1 ms duration, which allows cell resistance determinations to be made without measurably affecting the cell performance.

Experiment 18

Experiment 18 employed a reference electrode for the first time in hardware cells at NOLC. Details of this design are shown in Figure 11. The electrochemical systems of this experiment were



and

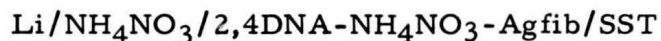

The presence of the reference electrode in these cells did not affect cell performance. It was found that Li anode cells are "poisoned" by an open-circuit condition. This made it impossible to analyze the experiment factorially. The rise time of the cell was monitored on an oscilloscope that was triggered when the activating NH_3 pressure reached 10.6 kg/cm^2 (150 psi). Figure 14 shows the voltage curves obtained at activation.

Experiment 19

Experiment 19 investigated the use of three cathector materials, three anode materials, and three electronic loading conditions. The systems were



and

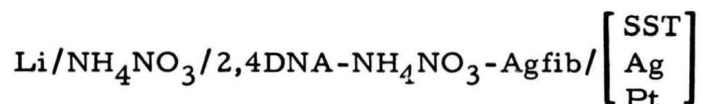

The cells containing Mg anodes utilized two new materials: (1) rolled Mg cells produced by bonding the Mg to the SST substrate with a high-pressure rolling technique² and (2) sheet Mg cells produced by bonding BT92-56 Mg sheet to the SST substrate with a silver-filled epoxy resin. Figure 15 shows the discharge characteristics of the pasted-cathode cells with reference electrode traces superimposed on the total cell potential. The cell potential, prior to activation, could not be reduced by applying a vacuum in the same way that was used for the other nine cells of the experiment. On activation, the cell potential actually lowered. The reason for this has not been discovered.

Experiment 20

Experiment 20 was conducted to evaluate electrolyte solution-activation for the first time at NOLC. The electrolyte concentrations of both salts

²Metals and Controls, Inc., Attleboro, Massachusetts.

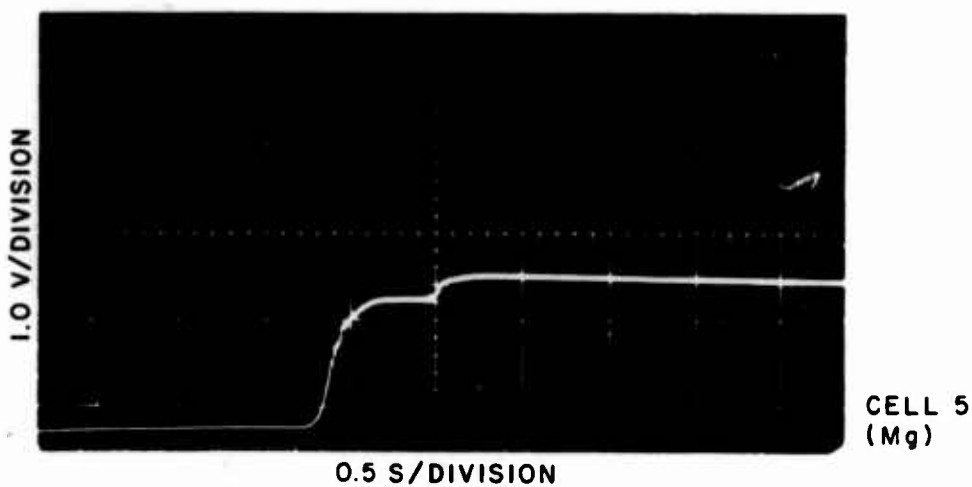

FIGURE 14. Voltage Rise at Activation
in Experiment 18

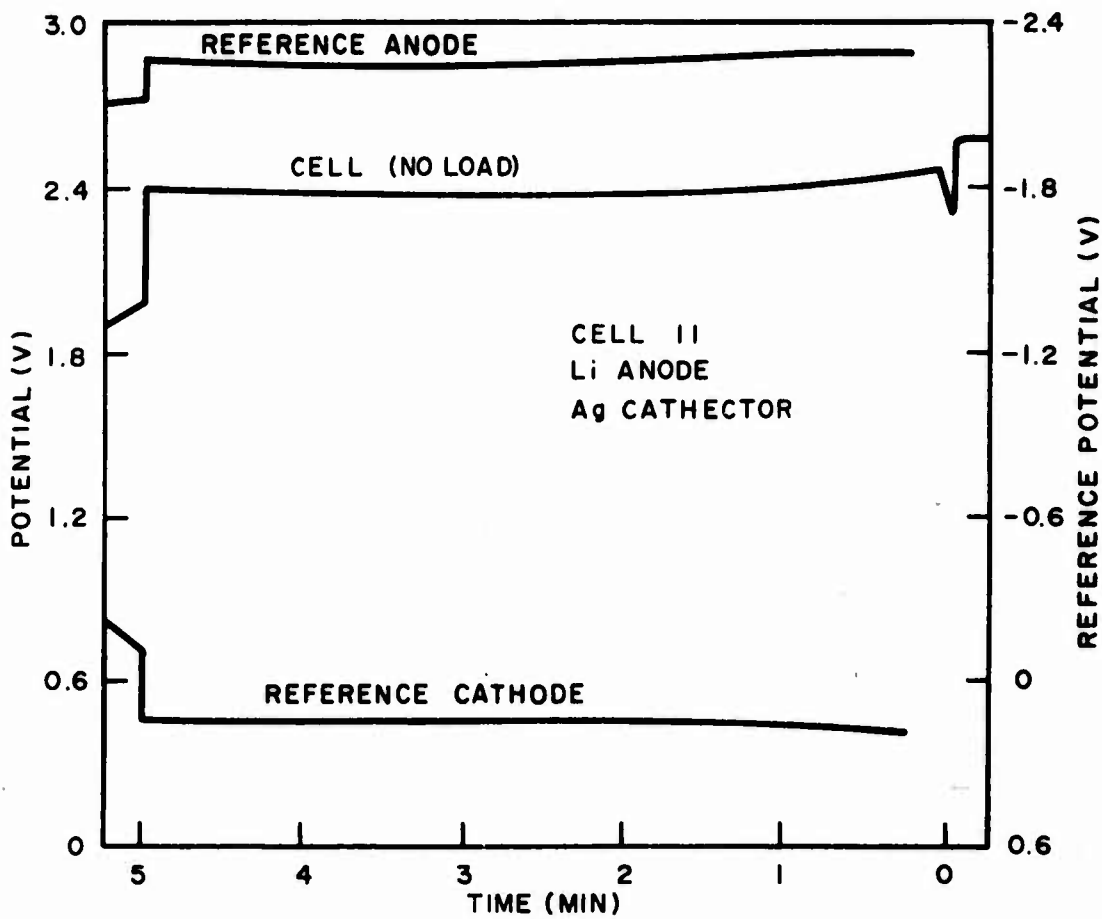
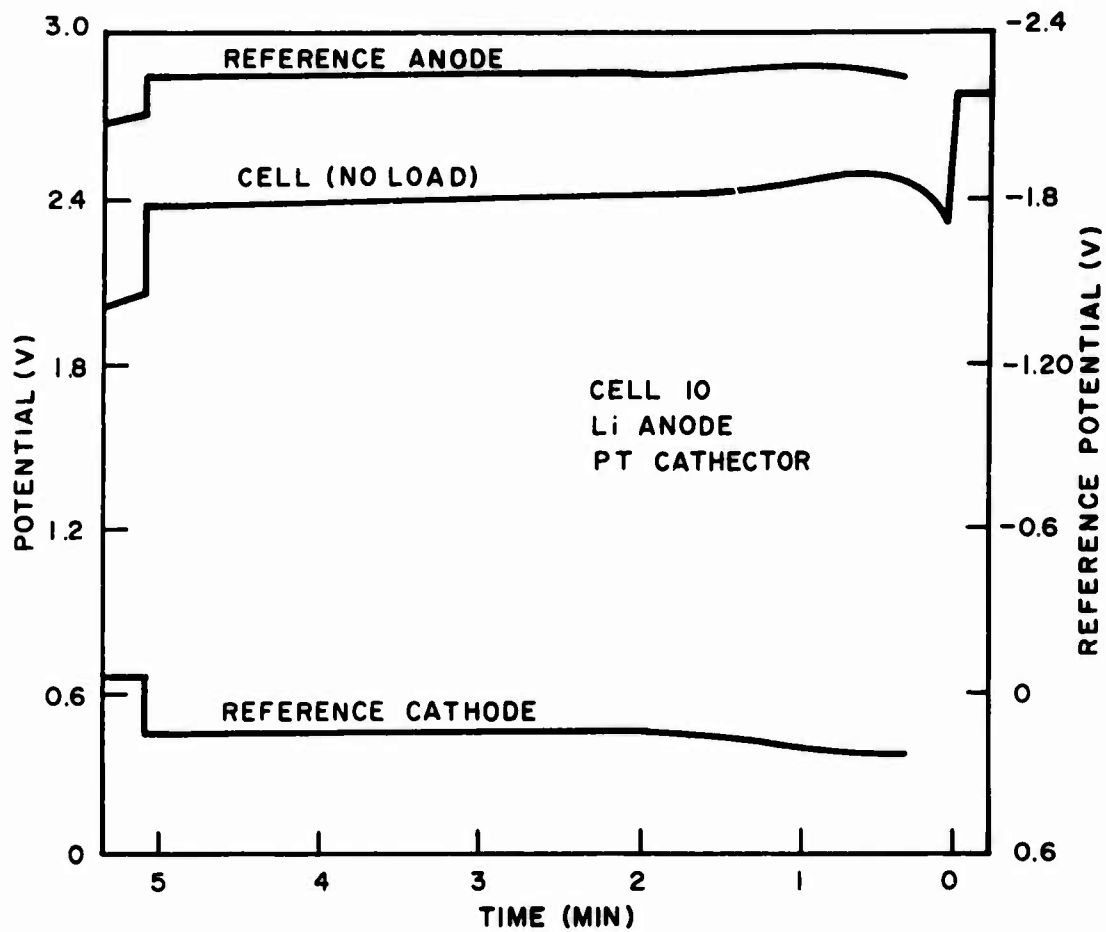

FIGURE 15. Experiment 19 Noload Cell Performance for Pasted Cathode Construction Only

were 35 wt. %. Both Li and Mg anodes were tested. The Mg system used mDNB as the cathode, differing from the Experiment 19 formulation. The two systems were:



and



The cells were activated at 58 atm electrolyte solution pressure. Figure 16 shows the discharge characteristics of the best and worst cells of the experiment. In seven of the eight tests, the cell potential followed the anode potential.

Experiment 21

Two types of Mg anodes were compared in Experiment 21. The AZ31 Mg was spot welded to the cathector, whereas the BT92-56 was bonded with a silver-filled epoxy resin. Methyl cellulose was tried as a binder for holding the cathode pad together. The cathodes were of pasted construction. Two amounts of cathode material were tested. The system was



and the cells were activated at 58 atm with 35 wt. % NH_4SCN in NH_3 . The assembly pressure was $4\text{kg}/\text{cm}^2$. The best cell decayed 12% in 5 min and reached a peak current density of $99\text{ma}/\text{cm}^2$. Figure 17 shows the discharge characteristics of the best and worst cell of the experiment. In conjunction with the results of Experiment 20, these data indicate that solution activation produces a higher level of cell performance.

Experiment 22

In Experiment 22, another attempt was made to achieve satisfactory performance from the amalgamated Mg anode. Solution activation was compared with solvent activation, and perchlorate anolyte salts were tried. The system was



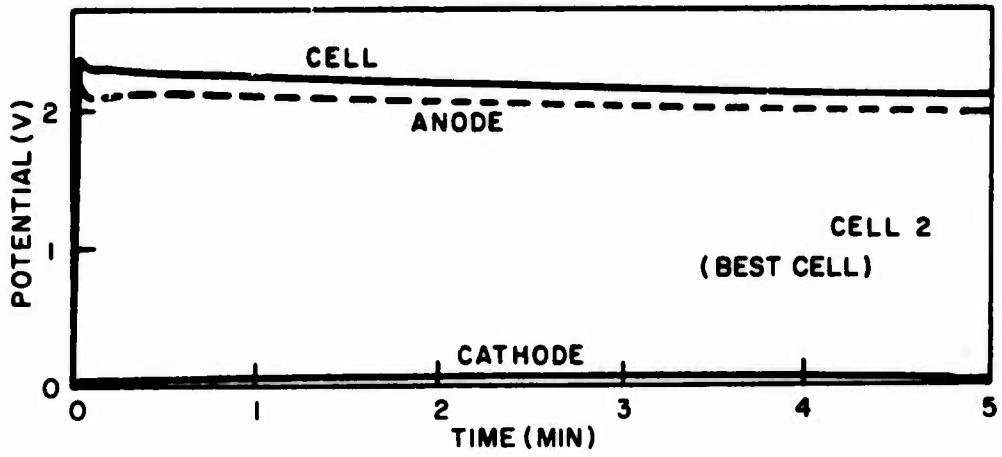
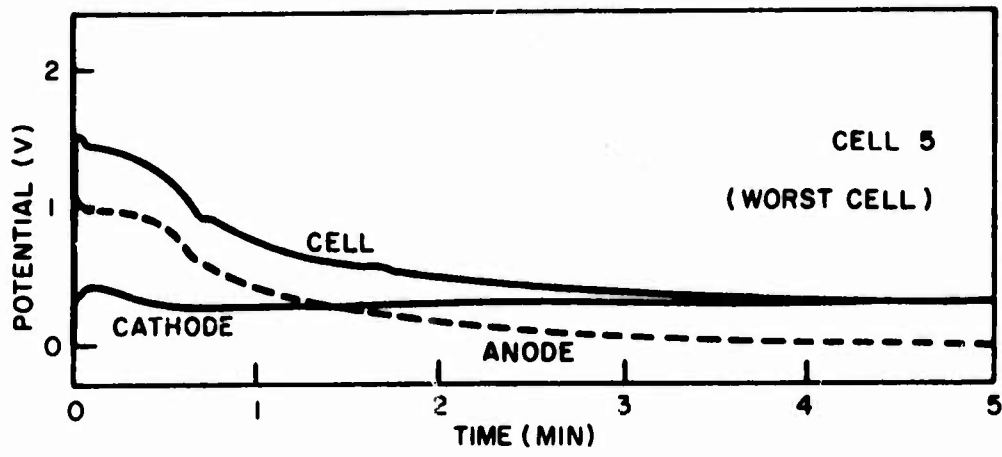

FIGURE 16. Cell Performance With Reference Electrodes, Experiment 20

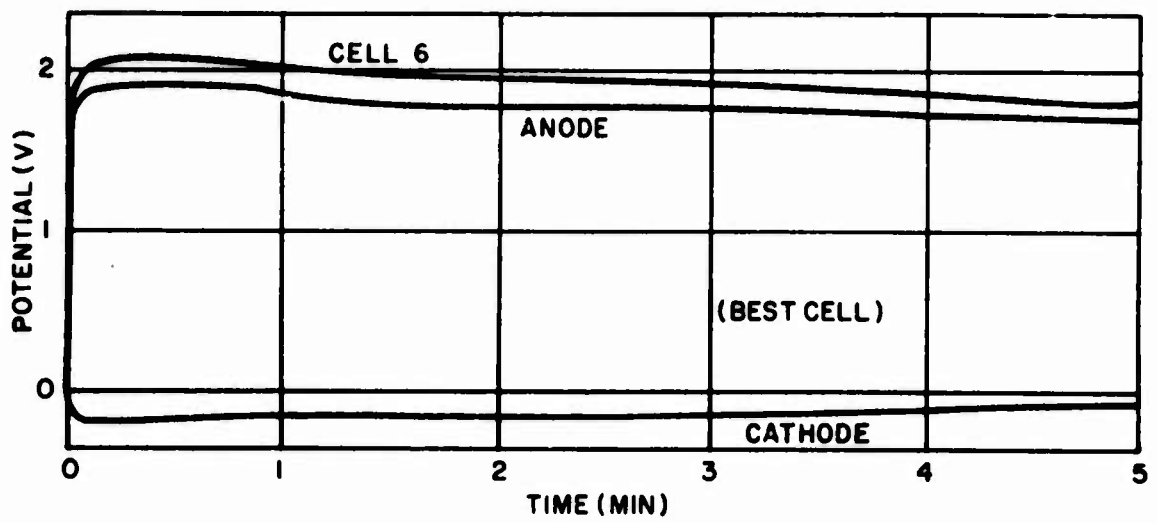
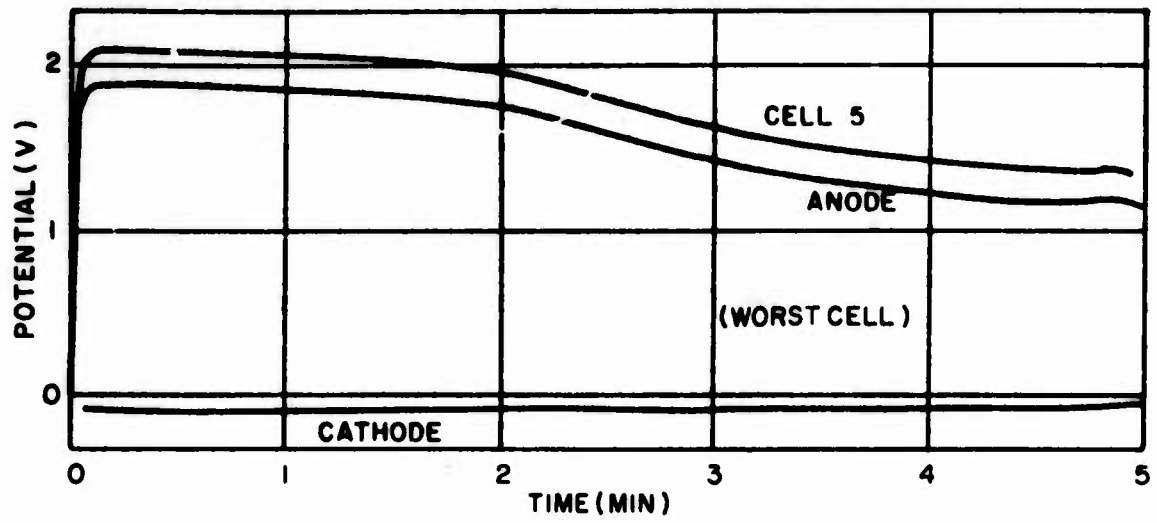

FIGURE 17. Cell Performance With Reference Electrodes, Experiment 21

$\text{NH}_4\text{ClO}_4\text{-NH}_3$ solution 52 wt. %

$\text{LiClO}_4\text{-NH}_3$ solution 49 wt. %

These cells all performed very poorly. It was observed that a thick gel of electrolyte solution which liquefied in a few minutes was ejected from the cell fixture when the test was vented upon test termination. The perchlorates apparently do not remain a liquid under the test conditions. This may account for the extremely poor discharge. Figure 18 shows the discharge characteristics of the best and worst cells of the experiment. Figure 19 shows the results of fast-switched no-load pulses for two cells of this experiment.

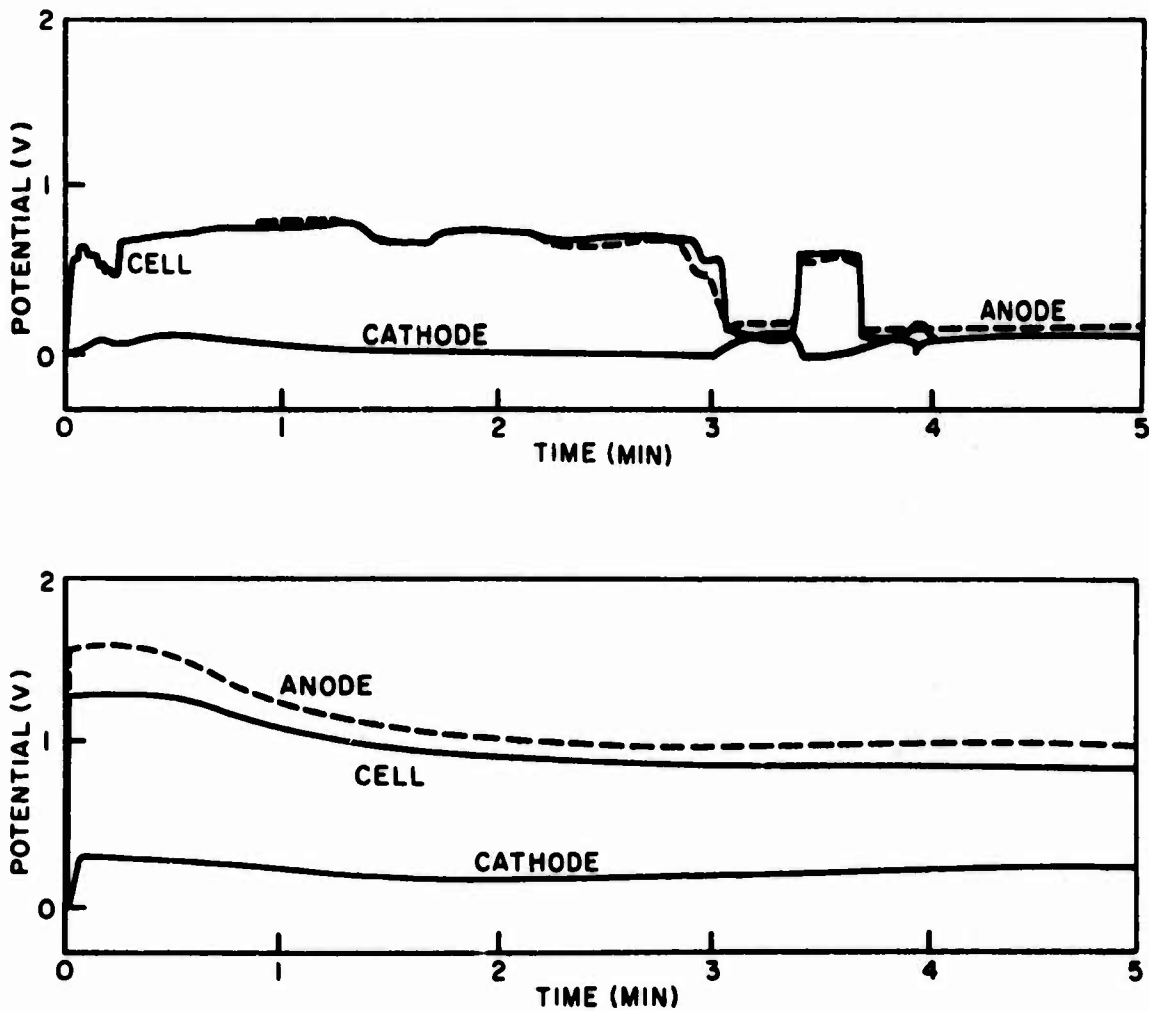

FIGURE 18. Cell Performance With Reference Electrodes, Experiment 22

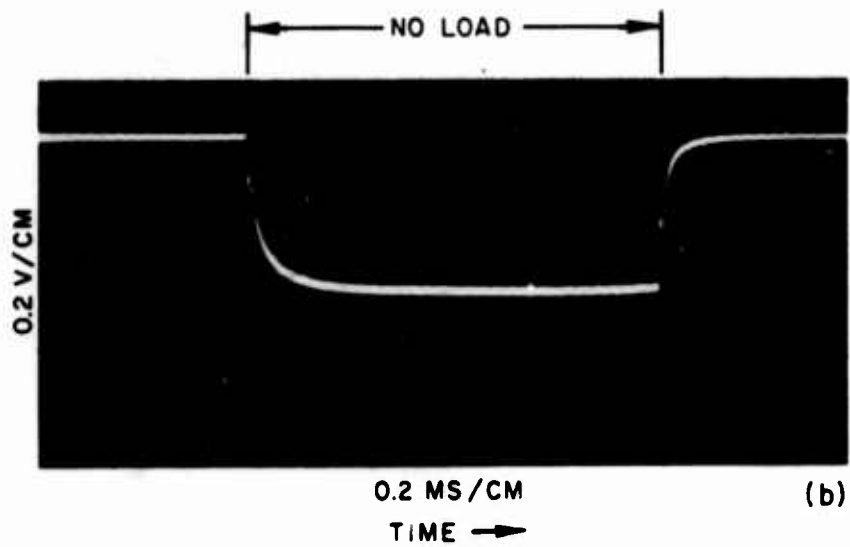
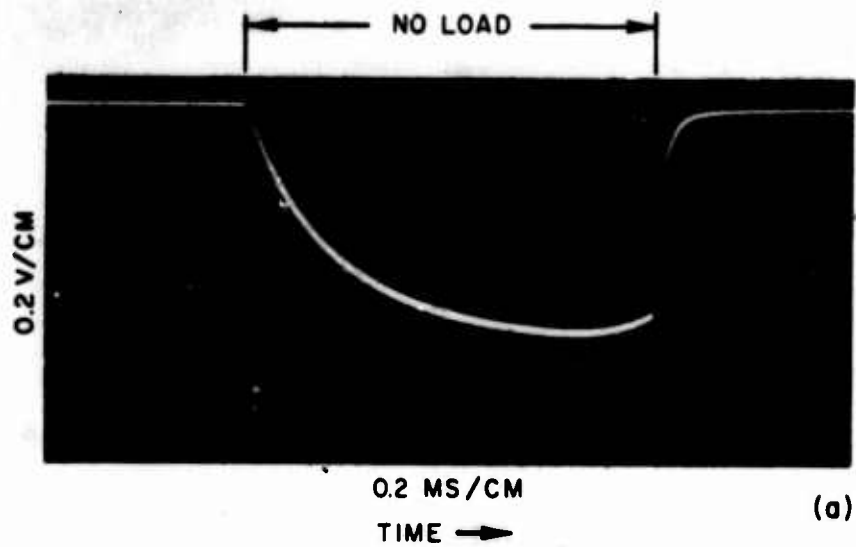

FIGURE 19. Traces of Noload Pulses after 3-min discharge for (a) LiClO_4 Solution-Activated Cell and (b) NH_4ClO_4 Solution-Activated Cell

SUMMARY

During 1964 and 1965, a prototype development effort was carried out to establish a reserve-activated primary power supply utilizing the liquid ammonia activated battery system Mg/KSCN/mDNB-NH₄SCN-C/SST. The FC-2 battery, developed under this program, used the case, gas generator, and ammonia chamber of the previously developed low-discharge-rate FC-1 battery. The two units are compared in Table 4.

TABLE 4. Characteristics of FC-1
and FC-2 Batteries

Characteristic	FC-2	FC-1
Volume enersity (J/cm ³)	54	20
(Wh/in. ³)	0.1	0.03
Weight enersity (J/g)	20	6.7
(Wh/lb)	2.5	0.85
Discharge time (min)	5	3
Weight (g)	285	285
Volume (cm ³)	90	90

The Contractor, Livingston Electronic Corp., constructed a total of 67 complete, self-contained batteries, which were tested at both NOLC and the Contractor's facilities.

Twenty-two statistically designed experiments were cooperatively conducted, encompassing variations in composition and construction of the electrochemical components of the battery. The variations are shown in Table 5 with the corresponding experiment in which they were evaluated.

Several new techniques were devised to carry out the electrochemical investigations. Among the most significant were:

1. The Pb/PbCl₂ reference electrode used in NOLC Experiments 18, 19, 20, and 21.

TABLE 5. Variations in Statistically Designed Experiments

Variation	Experiment No.	
	NOLC	LEC
Anode		
1. AZ31B sheet	21	16, 17, 18, 27, 23, 27, 28, 29
2. BT92-56 sheet	20, 21, 22	
3. Evaporated Mg on SST sheet	1, 2, 3, 4, 6, 7, 9, 13, 18	
4. Rolled Mg on SST sheet	19	16, 17, 18, 22, 23, 27, 28, 29
5. Bonded Mg on Ag and SST	19, 20, 21, 22	
6. Amalgamated Mg	13, 16, 22	
7. Li-Mg alloy	9	
8. Pure Li	13, 14, 18, 19, 20	
Anolyte		
1. KSCN	1, 2, 3, 4, 7, 9	16, 17, 18, 22, 23, 27, 28, 29
2. NH_4SCN	6, 9, 18, 19, 20, 21	
3. NH_4ClO_4	22	
4. LiClO_4	22	
5. NH_4NO_3	18, 19, 20	
6. KI, HgI_2	13, 16	
7. $(\text{NH}_4)_2\text{SO}_4$	16	
8. NaNO_3	14	
9. NH_4NO_3	14	
10. LiNO_3	13	
Cathode		
1. mDNB	1, 2, 3, 4, 6, 7, 9, 13, 14, 20, 21	16, 17, 18, 22, 23, 27, 28, 29
2. (2, 4DNA	14, 16, 18, 19, 20, 22	
3. (pNA)	9	

TABLE 5. (Contd.)

Variation	Experiment No.	
	NOLC	LEC
Catholyte		
1. NH_4SCN	1, 2, 3, 4, 6, 7, 9, 13, 14, 18, 19, 20, 21	16, 17, 18, 22, 23, 27, 28, 29
2. $(\text{NH}_4)_2\text{SO}_4$	13	27
3. NH_4NO_3	18, 19, 20	28
4. NH_4Cl	16	
5. NH_4ClO_4	22	
6. LiClO_4	22	
7. KSCN		23
Matrix		
1. Carbon	1, 2, 3, 4, 6, 7, 13, 14, 16, 20, 21, 22	16, 17, 18, 22, 23, 27, 28, 29
2. Silicon		17
3. (Agfib)	16, 18, 19, 20	
4. Porous SST	9, 14	
5. Ag Screen	3	
Cathector		
1. Ag	19	
2. SST	1, 2, 3, 4, 6, 7, 9, 13, 14, 16, 18, 19, 20, 21, 22	16, 17, 18, 22, 23, 27, 28, 29
3. Pt	19	
Electrolyte		
1. NH_3	1, 2, 3, 4, 9, 13, 14, 16, 18, 19, 22	16, 17, 18, 22, 23, 27, 28, 29
2. NH_3 -Salt Solution	20, 21, 22	
3. NH_3 - H_2O	7	
4. NH_3 -Alcohol	6, 7	

2. A fast-switching device for determination of internal cell resistance without disturbing discharge performance used in NOLC Experiments 16, 20, 21, and 22.

3. The Mod 1 single-cell test fixture, which closely duplicates an actual battery environment.

CONCLUSIONS

Results of the FC-2 Prototype Study have led to the following conclusions:

1. The 28 V, 1 A FC-2 battery, developed during this program, demonstrated the feasibility of using the ammonia system for high-discharge-rate requirements where small-volume short-life reserve units are needed. The FC-2 is particularly competitive with existing thermal and Zn/Ag reserve batteries intended for missile applications with service times of 1 to 5 min, wide operating temperature range -54 to $+74^{\circ}\text{C}$ (-65 to $+165^{\circ}\text{F}$) and normal shock and vibration environment.

2. The energies obtained from this unit could be greatly improved by reducing the weight of the case. It should be kept in mind that the packaging techniques used for the FC-2 battery were developed for a volume-limited design (FC-1), where weight was of no importance. This case represented 80% of the battery weight.

3. The use of computer analysis of statistically-designed experiments provided maximum utilization of limited numbers of cell tests. This approach to exploratory development in the battery field is sound and can be extended by further use of modern data processing techniques and equipment.

4. The development of hardware-cell testing techniques has effectively bridged the long-existing gap between laboratory tests and finished batteries. Further refinements of such tools as the hardware-cell reference electrode and the fast-switching no-load technique will lead to significant advancement of hardware-oriented electrochemical knowledge.

5. The promising performance of Li and Li alloy anodes indicates that more work should be done to define their capabilities.

Appendix A

FC-2 BATTERY TARGET SPECIFICATIONS

1. Voltage

30 V nominal $\pm 10\%$ for 5 min

2. Load

10 Ω

3. Activation Time

Less than 1 s

4. Noise

Less than 20 mV allowable peak-to-peak voltage variation with components in the band from 5 to 10,000 Hz at the battery terminals during the operating life of the battery after activation

5. Internal Resistance

The internal resistance, with the battery not operating, is to be not less than 5 M Ω between all combination pairs of terminals and case, measured with a vacuum-tube voltmeter.

6. Size and Weight

Volume less than 100 cm³; weight not critical but less than 500 g

7. Temperature Range

Storage : -55 to +75°C for 5 yr

Discharge: -55 to +75°C with environment during discharge to be specified but not to increase more than 33°C/min external to the battery

8. Shock

200 g for 15 ms with a half-sine waveform parallel to the longitudinal axis as shown in Figure 20

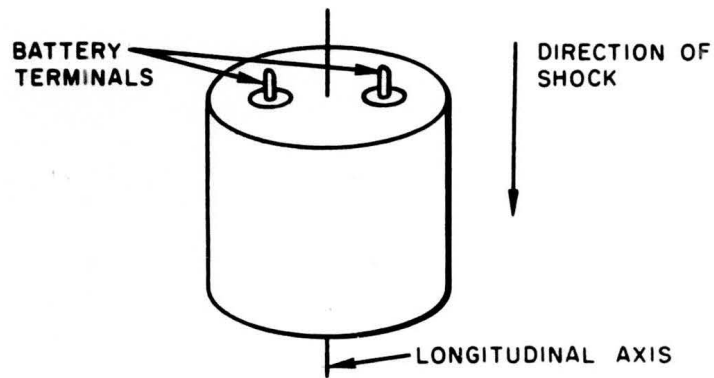

FIGURE 20. Geometry of Shock Test

9. Acceleration

15 g continuous acceleration both longitudinally and transversely, and spin of 10 rps maximum sustained throughout operating life

10. Vibration

Nonoperating Battery: Along each of the three principal axes, a continuously variable vibration from 30 to 5000 Hz and return in approximately 90 min, with a concurrent continuously variable change in acceleration amplitude from 10 to 5 g and return

Operating Battery: A steady vibration of 100 Hz at 15 g, sustained throughout operating life; both longitudinal and transverse tests required

Appendix B

COMPUTER PRINTOUT OF LOT 13, CLASS 5 TEST DATA

FC-2 NH3 BATTERY TEST DATA SUMMARY LOT 13

TEST NUMBER	ALCL	V&B	V-P	V&E	SEC ACT	T PEAK	INT. PK V	REMARKS	N V C
				END SEC	A AMPS	RES	/ CL		
5C5010	LC13	00.0	03.2	00.0	300	---	E 0.49	1.95 SN 1382	- V
5C5011	LC13	00.0	03.6	00.0	300	---	E 0.48	1.92 SN 1383	- V
5C5012	LC13	00.0	03.8	00.0	300	---	E 0.48	1.91 SN 1384	- V
5C5013	LC13	00.0	05.1	00.0	300	---	E 0.45	1.81 SN 1385	- V
5C5014	LC13	00.0	05.8	00.0	300	---	E 0.44	1.75 SN 1386	- V

FC-2 NH3 BATTERY TEST DATA LOT 13

TEST NUMBER	DATE	ITEM	TEMP	LOAD	INLV	PLV	V0.2	V1.0	V2.0	V3.0	V4.0	V5.0	PK C
			C	OHMS									CTY
5C5010AD	8175	CFC2131382	£020	52.0	26.8	25.4	----	23.2	22.0	21.2	20.5	19.5	038
5C5011AD	8175	CFC2131383	-055	52.0	27.2	25.0	----	25.0	24.8	24.5	23.0	19.2	037
5C5012AD	8175	CFC2131384	-055	52.0	27.5	24.6	----	24.6	24.4	23.5	21.2	17.0	031
5C5013AD	7295	CFC2131385	-055	52.0	27.5	23.5	----	23.5	22.2	17.2	14.0	----	030
5C5014AD	7295	CFC2131386	£074	52.0	24.8	22.8	----	20.2	19.4	19.0	18.8	18.4	029

FC-2 CELL MATERIALS SUMMARY LOT 13

TEST	ANODE	ANOLYTE	SEPARATOR	CATHOLYTE	ABSORBANT	OXIDANT	CONDUCTOR	CATHECTOR
5C5010	MG RL	KSCN	WT50PL990	'SCN	----	MCNB	C	AG
5C5011	MG RL	KSCN	WT50PL990	'SCN	----	MCNB	C	AG
5C5012	MG RL	KSCN	WT50PL990	'SCN	----	MDNB	C	AG
5C5013	MG RL	KSCN	WT50PL990	'SCN	----	MDNB	C	AG
5C5014	MG RL	KSCN	WT50PL990	'SCN	----	MDNR	C	AG

Appendix C

COMPUTER DATA PRINTOUT CODE

Items in Column 1 appear as headings in Appendix B		
Column Heading	Card Column Number	Example
NH₃ Battery Test Data Summary Lot		
Test	1-6	5N0167
	1	5 battery test
	2	N N = NOLC; C = Corson (test location)
	3-6	0167 test number
ALCL	8-11	NCO1 no-load constant, 1 cell LCO1 load constant, 1 cell LP10 load pulsed, 10 cells LV10 load variable, 10 cells
V + B	13-16	voltage above minimum specifications at 15 s
V - P	18-21	voltage below maximum specifications at peak voltage
V + E	23-26	voltage above minimum specifications at end of test
Sec End	28-30	time in seconds to end of test
Act Sec	32-34	activation time in seconds to minimum specified voltage
T A	36	type of activation E = external pneumatic G = internal gas generator H = external hydraulic pressure N = external NH ₃ source A = external electrolyte source
Peak Amps	38-41	peak current in amperes
Int Res	43-46	internal resistance of battery at 15 s (Ω)
Pk V C1	48-51	peak voltage per cell at PLV
Remarks	53-74	special details: design code, etc.

Appendix C (Co. td.)

Column Heading	Card Column Number	Example
NH ₃ Battery Test Data Summary Lot (Contd.)		
N	76	Noise + over specification - under specification zero not measurable
V	78	V valid; I invalid
C	80	card number for multiple-load tests; if no number appears, only one card exists
Test Number	1-8	5N0167AD
	1	5 battery test
	2	N N = NOLC; C = Corson; D = NAD Crane (test locations)
	3-6	0167 test number
	7	A A = section; B = B section, etc.
	8	D D = discharge; P = pre-mortem; R = re-test
Date	10	1-9 Jan-Sep; O = Oct, N = Nov, D = Dec
	11-12	day
	13	year (last digit)
Item	15	mfr.: C = Corson, N = NOLC
	16-18	battery type
	19-20	lot number
	21-24	serial number
Temp C	26-29	+ or - °C
Load Ohms	31-34	Load direct reading (Ω)
INLV	36-39	Noload reading at 15 s (V)
PLV	41-44	Peak load voltage
V0.2	46-49	Voltage at 12 s
V1.0	51-54	Voltage at selected times (min)
V2.0	56-59	Voltage at selected times (min)
V3.0	61-64	Voltage at selected times (min)
V4.0	66-69	Voltage at selected times (min)
V5.0	71-74	Voltage at selected times (min)

APPENDIX C (Contd.)

Column Heading	Card Column Number	Example
Cell Materials Summary Lot		
PK CTY	76-78	Peak cursity (current density)(ma/cm ²)
C	80	Numerical order of cards (e.g., 1, 2, 3, etc.); if only one card exists, leave blank
Test	1-6	sequential number of test
Anode	8-12	chemical symbol for anode material
Anolyte	14-20	chemical symbol for anolyte material
Separator	22-30	code or chemical symbol for separator material
Catholyte	32-40	chemical symbol for catholyte material
Absorbent	42-50	code name or abbreviation for absorbent material
Oxidant	52-58	chemical symbol or code name for oxidant material
Conductor	60-68	chemical symbol for conductive matrix
Cathector	70-78	code or chemical symbol for cathector material
C	80	Numerical order of cards (e.g., 1, 2, 3, etc.); if only one card exists, leave blank

GLOSSARY OF TERMS AND CONVERSION FACTORS

Agfib

(Ag + fiber) - Glass fibers plated with silver by the Brashear process.

Anector

(Anode + electron + collector) - the electronic conductor to the cell anode.

Anolyte

(Anode + electrolyte) - the electrolyte adjacent to the cell anode.

Cathector

(Cathode + electron + collector) - the electronic conductor to the cell cathode.

Catholyte

(Cathode + electrolyte) - the electrolyte adjacent to the cell cathode.

Cursity

(Current + density)

Enersity

(Energy + density)

mDNB

m - dinitrobenzene.

2,4DNA

2,4 - dinitroaniline.

pNA

p - nitroaniline.

PLV

Peak voltage under load condition.

GLOSSARY OF TERMS AND CONVERSION
FACTORS (Contd.)

PCY

Peak cursity.

PNV

Peak voltage under noload condition .

Conversion Factors

$$1 \text{ in.} = 2.54 \text{ cm}$$

$$1 \text{ lb} = 454 \text{ g}$$

$$1 \text{ lb/in.}^2 = 70.3 \text{ g/cm}^2$$

$$1 \text{ A/ft}^2 = 1.15 \text{ mA/cm}^2$$

$$1 \text{ Wh} = 3600 \text{ J}$$

$$1 \text{ Wh/lb} = 7.94 \text{ J/g}$$

$$1 \text{ Wh/in.}^3 = 219 \text{ J/cm}^3$$

REFERENCES

1. Naval Ordnance Laboratory Corona. Liquid Ammonia Reserve Batteries for Guided Missile Fuzing: Final Report on Feasibility Study, by W. C. Spindler and J. C. Daley, Corona, California, NOLC, 30 December 1963. NAVWEPS Report 8178.
2. _____. General Design Characteristics for Primary Batteries for Future NOLC Applications, Corona, California, NOLC, March 1962. Tech Memo 44-14.
3. _____. Automatic Test Set for Ammonia Reserve Batteries, by Robert W. Yancey, Corona, California, NOLC, 15 June 1964. NAVWEPS Report 8195.
4. _____. Method and Computer Program For Analyzing 2ⁿ Factorial Experimental Data, by L. E. Hanson, Corona, California, NOLC, November 1963, Tech Memo 44-16.
5. _____. Quarterly Report: Chemoelectric Energy Conversion for Nonaqueous Reserve Battery Systems, October-December 1963, Corona, California, NOLC, 15 January 1964. NAVWEPS Report 8182.
6. _____. _____, January-March 1964, Corona, California, NOLC, 15 May 1964. NAVWEPS Report 8193.
7. _____. _____, April-June 1964, Corona, California, NOLC, 15 August 1964. NAVWEPS Report 8203.
8. _____. _____, July-September 1964, Corona, California, 15 November 1964, NAVWEPS Report 8210.
9. _____. _____, October-December 1964, Corona, California, January 1965. NAVWEPS Report 8229.
10. _____. _____, January-March 1965, Corona, California, 15 April 1965. NAVWEPS Report 8813.
11. _____. _____, April-June 1965, Corona, California, 15 July 1965. NAVWEPS Report 8821.
12. _____. _____, July-September 1965, Corona, California, 1 November 1965. NAVWEPS Report 8832.

INITIAL DISTRIBUTION

	<u>Copies</u>		<u>Copies</u>
Commander Naval Ordnance Systems Command Navy Department Washington, D. C. 20360 Attn: Code ORD-9132 (2)	2	Commanding General Army Electronics Research & Development Laboratory Fort Monmouth, N. J. 07703 Attn: SELRA/PS	1
ORD-033, B. E. Drimmer (3)	3		
Commander Naval Air Systems Command Navy Department Washington, D. C. 20360 Attn: AIR-340C, M. A. Knight	3	U. S. Army Engineer R&D Laboratory Electrical Power Division Fort Belvoir, Va. 22060 Attn: Dr. G. Frysinger (OMEFB-EP)	1
AIR-604	1		
Commander Naval Ordnance Laboratory White Oak Silver Spring, Md. 20910 Attn: WB Division	1	Commanding Officer Picatinny Arsenal Dover, N. J. 07801 Attn: AADL/TW4, D. Yedwab	1
Commander Naval Ordnance Test Station China Lake, Calif. 93557 Attn: Library	1	Picatinny Arsenal Taw Laboratory, Bldg. 65 Dover, N. J. 07801 Attn: A. E. Magistro	1
Commander Naval Ordnance Test Station Pasadena Annex 3202 East Foothill Blvd. Pasadena, Calif. 91103	1	Headquarters U. S. Army Material Command Washington, D. C. 20315 Attn: J. W. Crellin, AMCRD-RD-P	1
Chief, Office of Naval Research Navy Department Washington, D. C. 20360 Attn: Code 425	1	U. S. Atomic Energy Commission Chief, Tech. Eval. Br. Army Reactors Div. of Reactor Development Washington, D. C. 20545 Attn: D. A. Hoatson	1
Director Naval Research Laboratory Washington, D. C. 20390 Attn: Code 6160	1	Commanding Officer Harry Diamond Laboratories Washington, D. C. 20438 Attn: Power Supply Branch	1
Commanding Officer & Director Navy Marine Engineering Laboratory Annapolis, Md. 21402 Attn: J. H. Harrison, Code 751	1	Administrator Defense Documentation Center Bldg. 5, Cameron Station Alexandria, Va. 22314	20
AF Cambridge Research Laboratory L. S. Hanscom Field Bedford, Mass. 01731 Attn: CRFE, Dr. R. Payne	1	NASA—Electronic Research Center 575 Technology Square Cambridge, Mass. 02139 Attn: Dr. F. Schwarz	1
Commander Aerospace Power Division Wright-Patterson Air Force Base Ohio 45433 Attn: APIP-2	1	NASA—Langley Research Center Langley Station Hampton, Va. 23365 Attn: J. Bene (MS234)	1
		NASA—Headquarters Washington, D. C. 20546 Attn: RNW	1

DOCUMENT CONTROL DATA - R&D

(Security classification of title, body of abstract and indexing annotation must be entered when the overall report is classified)

1. ORIGINATING ACTIVITY (Corporate author) Naval Ordnance Laboratory Corona, California		2a. REPORT SECURITY CLASSIFICATION UNCLASSIFIED	
		2b. GROUP	
3. REPORT TITLE FC-2 LIQUID AMMONIA RESERVE BATTERY			
4. DESCRIPTIVE NOTES (Type of report and inclusive dates) Status of Prototype Study			
5. AUTHOR(S) (Last name, first name, initial) Daley, John C.			
6. REPORT DATE 1 November 1966		7a. TOTAL NO. OF PAGES 55	7b. NO. OF REFS 12
8a. CONTRACT OR GRANT NO.		8a. ORIGINATOR'S REPORT NUMBER(S) NOLC Report 655	
b. PROJECT NO. WEPTASKS: RMMO-22-030/211-1/F009-08-001 c. RRE-06017/211-1/F009-06-05 d.		8b. OTHER REPORT NO(S) (Any other numbers that may be assigned this report)	
10. AVAILABILITY/LIMITATION NOTICES Distribution of this document is unlimited.			
11. SUPPLEMENTARY NOTES		12. SPONSORING MILITARY ACTIVITY Bureau of Naval Weapons	
13. ABSTRACT <i>An investigation was made of</i> The Naval Ordnance Laboratory Corona and the Livingston Electronic Corp. jointly investigated the use of the FC-2 Liquid Ammonia Prototype Battery for short-life reserve primary battery applications. The completely self-contained unit, in a volume of 90 cm^3 (5.5 in.^3), proved capable of operating for 5 min at a nominal 28 V, 1 A. Performance was satisfactory under simulated missile environments, including shock, vibration, spin, and temperature (-54 to +74°C or -65 to +165°F). An organic oxidant, m-dinitrobenzene (mDNB), is used as the cell cathode, and the reserve activation feature is provided by storing the electrolyte solvent, anhydrous liquid ammonia, in a separate compartment of the battery case. The basic electrochemical system is Mg/KSCN/NH ₄ SCN-mDNB-C/stainless steel (Type 302). The measured volume energy density of this model for a 5 min discharge is 54 J/cm^3 (0.1 Wh/in.^3), and weight energy density is 20 J/g (2.5 Wh/lb). <i>(1) ↑</i>			

14. KEY WORDS	LINK A		LINK B		LINK C	
	ROLE	WT	ROLE	WT	ROLE	WT
Ammonia Battery Nonaqueous Electrochemistry Reserve Battery High-Rate Discharge Hardware-Cell Reference Electrode Energy Conversion Gas Generator Anodes - Li, Mg Cathodes - organic nitro compounds						

INSTRUCTIONS

1. **ORIGINATING ACTIVITY:** Enter the name and address of the contractor, subcontractor, grantee, Department of Defense activity or other organization (*corporate author*) issuing the report.
- 2a. **REPORT SECURITY CLASSIFICATION:** Enter the overall security classification of the report. Indicate whether "Restricted Data" is included. Marking is to be in accordance with appropriate security regulations.
- 2b. **GROUP:** Automatic downgrading is specified in DoD Directive 5200.10 and Armed Forces Industrial Manual. Enter the group number. Also, when applicable, show that optional markings have been used for Group 3 and Group 4 as authorized.
3. **REPORT TITLE:** Enter the complete report title in all capital letters. Titles in all cases should be unclassified. If a meaningful title cannot be selected without classification, show title classification in all capitals in parenthesis immediately following the title.
4. **DESCRIPTIVE NOTES:** If appropriate, enter the type of report, e.g., interim, progress, summary, annual, or final. Give the inclusive dates when a specific reporting period is covered.
5. **AUTHOR(S):** Enter the name(s) of author(s) as shown on or in the report. Enter last name, first name, middle initial. If military, show rank and branch of service. The name of the principal author is an absolute minimum requirement.
6. **REPORT DATE:** Enter the date of the report as day, month, year, or month, year. If more than one date appears on the report, use date of publication.
- 7a. **TOTAL NUMBER OF PAGES:** The total page count should follow normal pagination procedures, i.e., enter the number of pages containing information.
- 7b. **NUMBER OF REFERENCES:** Enter the total number of references cited in the report.
- 8a. **CONTRACT OR GRANT NUMBER:** If appropriate, enter the applicable number of the contract or grant under which the report was written.
- 8b, 8c, & 8d. **PROJECT NUMBER:** Enter the appropriate military department identification, such as project number, subproject number, system numbers, task number, etc.
- 9a. **ORIGINATOR'S REPORT NUMBER(S):** Enter the official report number by which the document will be identified and controlled by the originating activity. This number must be unique to this report.
- 9b. **OTHER REPORT NUMBER(S):** If the report has been assigned any other report numbers (*either by the originator or by the sponsor*), also enter this number(s).
10. **AVAILABILITY/LIMITATION NOTICES:** Enter any limitations on further dissemination of the report, other than those

imposed by security classification, using standard statements such as:

- (1) "Qualified requesters may obtain copies of this report from DDC."
- (2) "Foreign announcement and dissemination of this report by DDC is not authorized."
- (3) "U. S. Government agencies may obtain copies of this report directly from DDC. Other qualified DDC users shall request through _____."
- (4) "U. S. military agencies may obtain copies of this report directly from DDC. Other qualified users shall request through _____."
- (5) "All distribution of this report is controlled. Qualified DDC users shall request through _____."

If the report has been furnished to the Office of Technical Services, Department of Commerce, for sale to the public, indicate this fact and enter the price, if known.

11. **SUPPLEMENTARY NOTES:** Use for additional explanatory notes.
12. **SPONSORING MILITARY ACTIVITY:** Enter the name of the departmental project office or laboratory sponsoring (*paying for*) the research and development. Include address.
13. **ABSTRACT:** Enter an abstract giving a brief and factual summary of the document indicative of the report, even though it may also appear elsewhere in the body of the technical report. If additional space is required, a continuation sheet shall be attached.

It is highly desirable that the abstract of classified reports be unclassified. Each paragraph of the abstract shall end with an indication of the military security classification of the information in the paragraph, represented as (TS), (S), (C), or (U).

There is no limitation on the length of the abstract. However, the suggested length is from 150 to 225 words.

14. **KEY WORDS:** Key words are technically meaningful terms or short phrases that characterize a report and may be used as index entries for cataloging the report. Key words must be selected so that no security classification is required. Identifiers, such as equipment model designation, trade name, military project code name, geographic location, may be used as key words but will be followed by an indication of technical context. The assignment of links, roles, and weights is optional.