

TR 92

ADDC 40974



# Technical Report 92

## EFFECT OF EXPLOSIONS ON SNOW STRUCTURES

by

Henryk Szostak and Robert Benert

CLEARINGHOUSE FOR FEDERAL SCIENTIFIC AND TECHNICAL INFORMATION		
Hardcopy	Microfiche	
\$3.00	\$ .75	64 pp. ad
/ ARCHIVE COPY		

APRIL 1966

U.S. ARMY MATERIEL COMMAND  
COLD REGIONS RESEARCH & ENGINEERING LABORATORY  
HANOVER, NEW HAMPSHIRE

DDC  
RECEIVED  
OCT 31 1966  
RECORDED  
C

F

**TR 92**



**Technical Report 92**

**EFFECT OF EXPLOSIONS  
ON SNOW STRUCTURES**

by

**Henryk Szostak and Robert Benert**

**APRIL 1966**

**U.S. ARMY MATERIEL COMMAND  
COLD REGIONS RESEARCH & ENGINEERING LABORATORY  
HANOVER, NEW HAMPSHIRE**

**DA Task IV025001A13001**



**Distribution of this document is unlimited**

#### PREFACE

This report is part of a study on the feasibility of subsurface snow structures for quartering, storing, and sheltering personnel and/or equipment in arctic areas. The field work, conducted on the Greenland Ice Cap at Site 2 during the summer of 1960, was directed by Robert Benert under W. K. Boyd, then Chief, Applied Research Branch. This data report was prepared by Pfc H. Szostak for the Applied Research Branch.

All instrumentation was done by the U. S. Army Waterways Experiment Station test team under the supervision of Mr. Ingram. Other support was given by U. S. Army Engineer Research and Development Detachment (ER&DD) and U. S. Army Polar Research and Development Center (PR&DC).

USA CRREL is an Army Materiel Command laboratory.

Department of the Army Project 8-66-02-400

## CONTENTS

	Page
Preface-----	ii
Summary-----	iv
Introduction-----	1
Test preparation and procedures-----	1
Vertical arches-----	1
Horizontal arches-----	4
Test results-----	6
Discussion of test results-----	7
Vertical arches-----	7
Horizontal arches-----	9
Conclusions-----	12
Recommendations-----	13
Appendix A: Diagrams of shot damage-----	27

## ILLUSTRATIONS

Figure		
1.	Plan of the test site-----	2
2.	Construction of vertical arches-----	3
3.	Layout for vertical arches-----	4
4.	Vertical wall instrumented for surface overpressure measurement-----	4
5.	Construction of horizontal arches-----	5
6.	Arch formed with inflatable nylon cylinder-----	5
7.	Arch formed with removable steel forms-----	6
8.	Layout for horizontal arches-----	6
9.	Typical pressure-time trace over processed snow surface-----	7
10.	Mach stem formation-----	8
11.	Height of burst curves for processed snow surface-----	8
12.	Surface overpressure versus ratio of arch span to arch crown thickness-----	9
13.	Arch span versus crown thickness for various surface overpressures-----	10
14.	Surface overpressure versus arch span for various arch crown thicknesses-----	11

## TABLES

Table		
I.	Pressure measurements over processed snow surface-----	14
II.	Vertical arches under dynamic loading-----	16
IIIA.	Horizontal arches under dynamic loading (instrumented)-----	22
IIIE.	Horizontal arches under dynamic loading (uninstru- mented)-----	23
IV.	Overpressure vs S/T-----	24

#### SUMMARY

Tests were made to study the effects on snow structures of surface and above-surface high explosive blasts from 4- and 32-lb spherical cast TNT charges. A number of small- and full-scale vertical and full-size horizontal arches were constructed in processed snow pads. Arch spans and arch crown thickness were varied to establish a relation between surface overpressure and the ratio of arch span (S) to arch crown thickness (T). Some correlation was found for vertical arches but none between vertical and horizontal arches. The results show that, for the same charge weight and S/T ratio, the horizontal arches can withstand over 100 psi overpressure while small-scale vertical arches fail at 20 psi.

## EFFECT OF EXPLOSIONS ON SNOW STRUCTURES

by

Henryk Szostak and Robert Benert

### INTRODUCTION

During summer 1960, USA SIPRE\*, with the cooperation of U. S. Army Waterways Experiment Station, conducted tests near Camp Fistclench (Site 2), 220 miles inland and east of Thule, Greenland, at an elevation of 7000 ft. The purpose of the project was to study the resistance and behavior of snow structures when subjected to dynamic loading from a surface or above-surface high explosive air blast. More specifically, the experiment was aimed at establishing a relation of surface overpressure on arches to different ratios of arch span to crown thickness.

U. S. Army Waterways Experiment Station (USAEWES) participated by investigating the basic phenomena associated with the reflection of a shock wave from a natural snow surface and establishing height of burst curves from blasts over undisturbed snow. Their results are reported elsewhere. They also instrumented selected CRREL shots to determine overpressures over a snow surface processed by a Peter snow miller. In view of limited data available, no analysis has been made.

### TEST PREPARATION AND PROCEDURES

The test area was located approximately 1 mile north of Camp Fistclench (Fig. 1). At the center of the area, a Jamesway hut was set up as an office and for the protection of a William Miller CR-1A Cathode-Ray Recorder, its auxiliary equipment, and other electronic and photographic apparatus. A 15-kva portable diesel-driven generator supplied a fairly constant electrical power for the Miller unit. On the northeast and southwest quadrants, processed snow pads were constructed for small- and full-size snow arches. USAEWES used the northwest sector for their shock-wave studies over an undisturbed snow surface. Their tests were conducted at a sufficient distance from CRREL's trenches to prevent any disturbance from the pressure wave. The southeast quadrant was used as a magazine area.

Vertical arches. A diagrammatic sequence of vertical arch construction is shown in Figure 2. Trenches 9-ft wide, 8-ft deep and 150- to 500-ft long were cut into the natural snow with a Peter snow miller and backfilled with disaggregated snow. The refill was leveled to the original snow surface and vertical holes—simulating snow arches—were drilled or dug in the pad at a predetermined span and distance from a reference line. Each pad was allowed to age from 13 to 33 days before the final cut was made along the reference line to fix the arch crown thickness. Most of the vertical arches were small-scale, but a few large-scale arches were tested. Arch spans varied from 6- to 108-in. and the arch crowns ranged from 3- to 36-in. Because of shortage of time and inexperience of the drill operators, drilling perfectly vertical holes proved to be very difficult. This, combined with the obvious inability of the Peter miller to work to close limits (fractions of an inch) in its final cut, resulted in some unavoidable inconsistencies in the crown thickness.

The first trench (shots 1 through 10) was 8-ft deep, 27-ft wide and had an 8-ft deep processed snow pad. Analysis of the first few shots indicated possible effects on the arches from secondary pressure wave reflection off the base and the back wall of the trench. To minimize this effect, the other trenches, with one exception, were cut 12-ft deep and 36-ft wide; the processed snow pads, however, remained 8-ft deep. Trench no. 6 (shot 31, 32 and 33) was 16-ft deep, 45-ft wide, with a 12-ft deep pad. In all cases, the length of the vertical arches equalled the depth of the processed snow pad.

Dynamic loading was provided by detonation of 4- and 32-lb spherical cast TNT charges primed with U. S. Army special blasting caps. Figure 3 shows a typical arrangement for vertical arch studies. The explosives were elevated on wooden pedestals to a

\*Now a part of U. S. Army Cold Regions Research and Engineering Laboratory (USA CRREL).

EFFECT OF EXPLOSIONS ON SNOW STRUCTURES

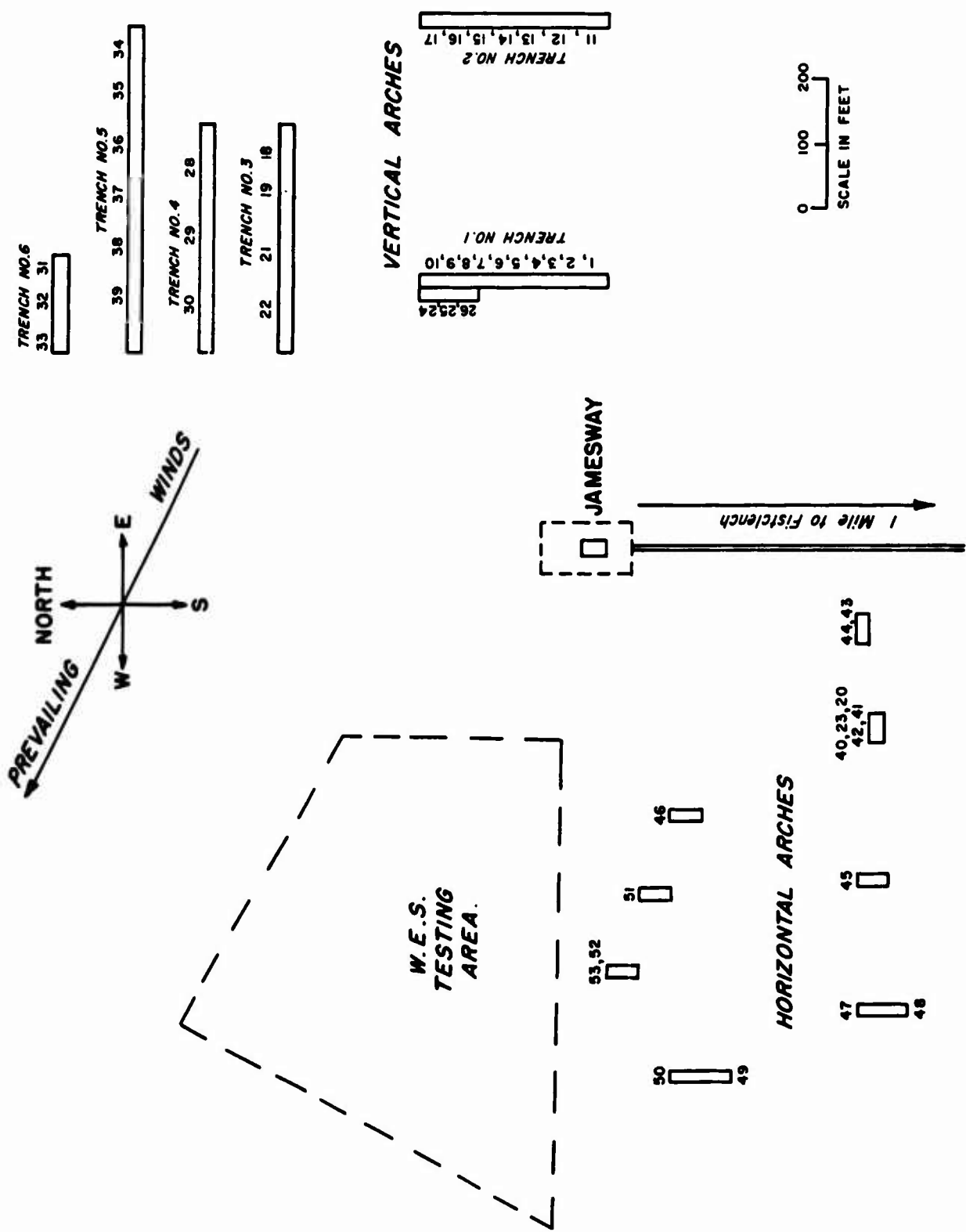

Figure 1. Plan of the test site.

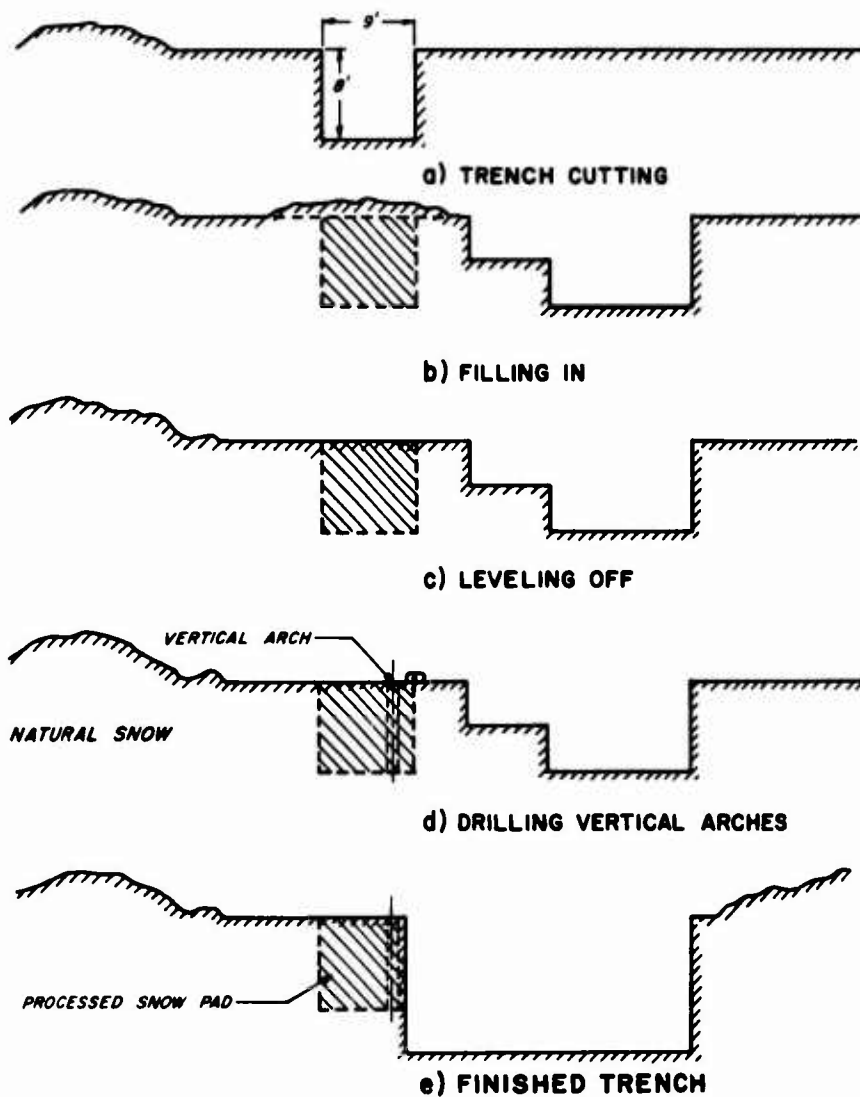

Figure 2. Construction of vertical arches.

height equal to the depth of the undercut below the pad plus half the depth of the processed snow pad. The charge elevation, however, was actually the horizontal distance between the explosive and the vertical arch surface. (Rotating Fig. 3 through  $90^\circ$  will clearly demonstrate this.)

Charge elevations and other distances are referred to as the reduced (or scaled) charge elevations ( $\lambda_c$ ) and reduced distances ( $\lambda_R$  and  $\lambda_X$ ). Reduced values are obtained by dividing the actual distances (in ft) by lambda ( $\lambda$ ), where  $\lambda = \sqrt[3]{W}$ ,  $W$  = charge weight in pounds. To find what reduced charge elevation ( $\lambda_c$ ) produced destruction over the widest surface area,  $\lambda_c$  was varied from  $\lambda_c = -1\lambda$  to  $\lambda_c = 6\lambda$  ( $\lambda_c = -1\lambda$  denotes a buried charge  $1\lambda$  deep). This was found to occur between  $\lambda_c = 4\lambda$  and  $\lambda_c = 5\lambda$ .



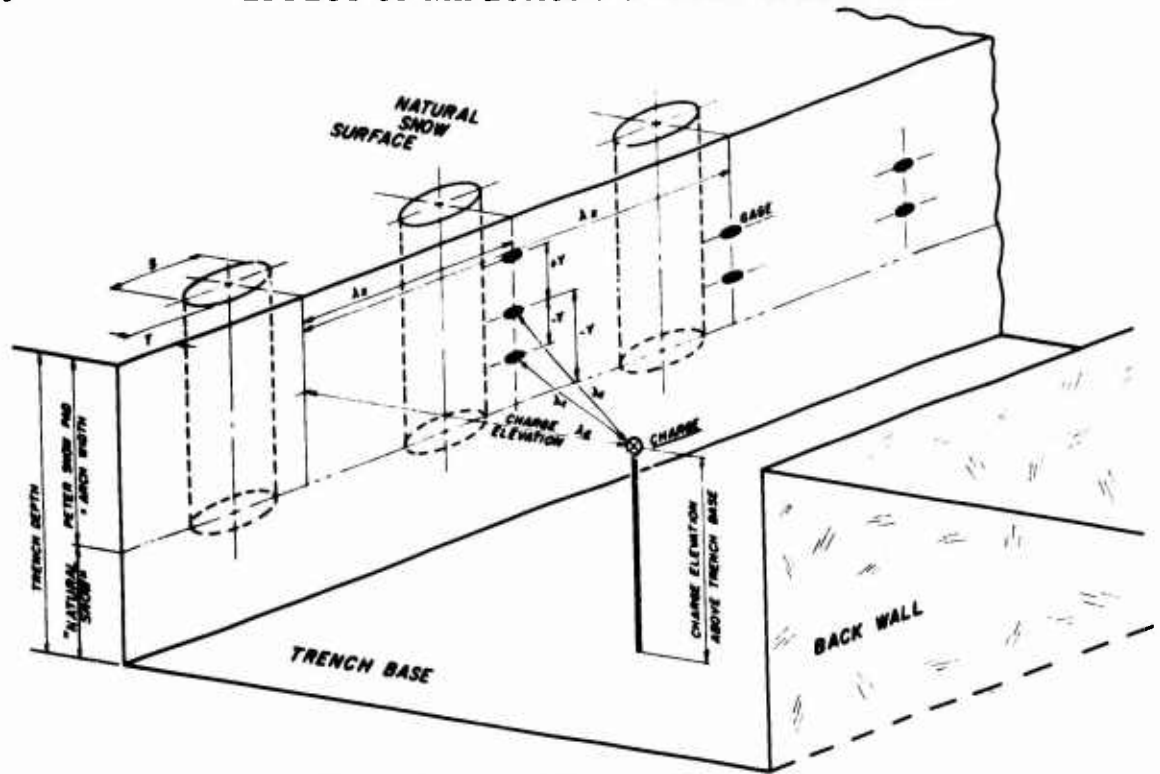

Figure 3. Layout for vertical arches.



Figure 4. Vertical wall instrumented for surface overpressure measurement. Note 4-lb TNT charge in position, lower right corner.

To determine surface overpressures created by the pressure wave, 14 shots were instrumented — (12 on a vertical wall, 2 on a horizontal surface). Piezoelectric gages, placed in a predetermined geometrical pattern, recorded peak pressure magnitudes and durations (Fig. 4). In both cases, peak overpressures were almost equal — although pressure-time traces from the vertical wall tests show evidence of trench base and back wall reflections (Fig. 9).

**Horizontal arches.** To check for possible correlation between the small-scale vertical arches and full-size horizontal arches, covered trenches 9-ft wide and 50- or 100-ft long were constructed (Fig. 5).

Inflatable nylon cylinders, 9-ft  $\phi$  am and 50-ft long were used as forms for most of the arches, but removable steel forms were used for three (shots 51, 52, and 53).

In all cases, the arch forms were placed on natural snow. Inflatable nylon cylinders required less time and handling but arch covers thus formed proved somewhat inferior to those constructed with corrugated steel forms. Peter snow possesses little strength when fresh but becomes hard and strong only hours after it is deposited. The highest rate of increase in strength and hardness occurs during the first 12 hours

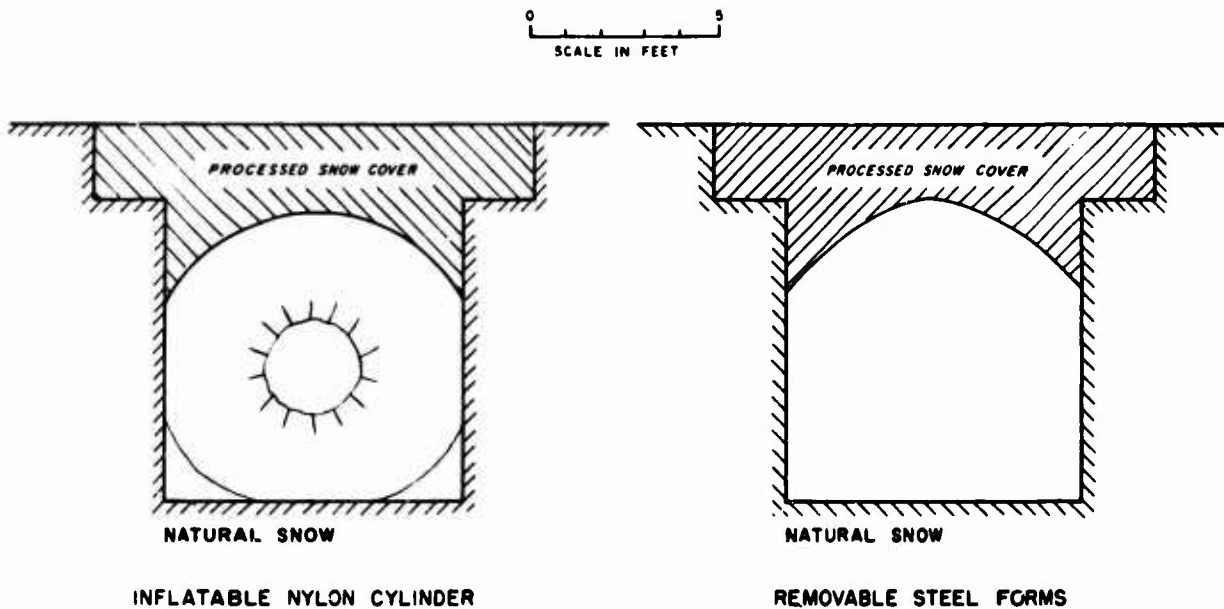

Figure 5. Construction of horizontal arches.

(when the initial values are doubled) after which further increase becomes gradual (Nakaya, 1959). The flexible arch support (4 psi inflation pressure) and immediate deflation of the nylon cylinders resulted in plastic deformation in the newly formed cover under its own weight. Signs of flattening, interior cracks, scaling and poor cohesion (especially at the haunches) can be seen in Figure 6. The rigid steel forms were left in place for 24 hours before removal, allowing the cover to age-harden. Consequently, none of the above defects were visible (Fig. 7).

As before, the dynamic loading was provided by detonation of 4 or 32 lb TNT charges elevated to a desired height on wooden pedestals. A typical arrangement is presented on Figure 8.

After each shot, the damage sustained by the arches was carefully examined and a scaled picture of the deformed structure drawn, noting all important dimensions. Each processed snow pad and horizontal arch cover was core-sampled and checked for density, porosity, and unconfined compressive strength. Also, wind speed and direction, and temperature data were collected for each shot.



Figure 6. Arch formed with inflatable nylon cylinder, 9-ft diam, 50-ft wide. Note cracks and signs of poor bonding at haunches.

## TEST RESULTS

In all, 49 shots were fired—28 on vertical arches (7 instrumented), 16 over horizontal arches (2 instrumented), and 5 against a vertical processed-snow trench wall with no holes (all instrumented). Damage plots were prepared for each shot showing blast effect and depression contour (in ft) of wall surface. Significant plots are included in the Appendix.

Table I shows peak surface overpressures on the vertical arches and wall at various reduced lateral distances ( $\lambda_x$ ) for reduced charge elevations of  $\lambda_c = 0\lambda, 2\lambda, 3\lambda, 4\lambda$  and  $5\lambda$ . From these data the curves shown in Figure 11 were derived. The curve can indicate the charge elevation ( $\lambda_c$ ) and maximum surface radius ( $\lambda_x$ ) within which an explosion will collapse a snow structure at a known pressure. For example: if the failure pressure of a snow structure is 25 psi, a charge detonated at  $\lambda_c = 3\lambda$  will produce destruction over a maximum surface radius of up to  $\lambda_x = 7.2\lambda$ . Also, for any charge elevation ( $\lambda_c$ ), surface overpressures can be determined at any reduced lateral distance ( $\lambda_x$ ) along the processed snow surface, e.g., at  $\lambda_c = 4\lambda$  surface overpressure is 25 psi at  $\lambda_x = 6.6\lambda$  away from ground zero.

Table II describes the effect of a pressure wave on vertical arches from 4- or 32-lb TNT charges, detonated at  $\lambda_c = 0\lambda$  to  $6\lambda$ .

Table III shows the blast effects on full-size horizontal arches. Shots 20 and 23 were instrumented for pressure to check the correlation between these and shots against vertical walls.



Figure 7. Arch formed with removable steel forms. No cracks or other defects visible.

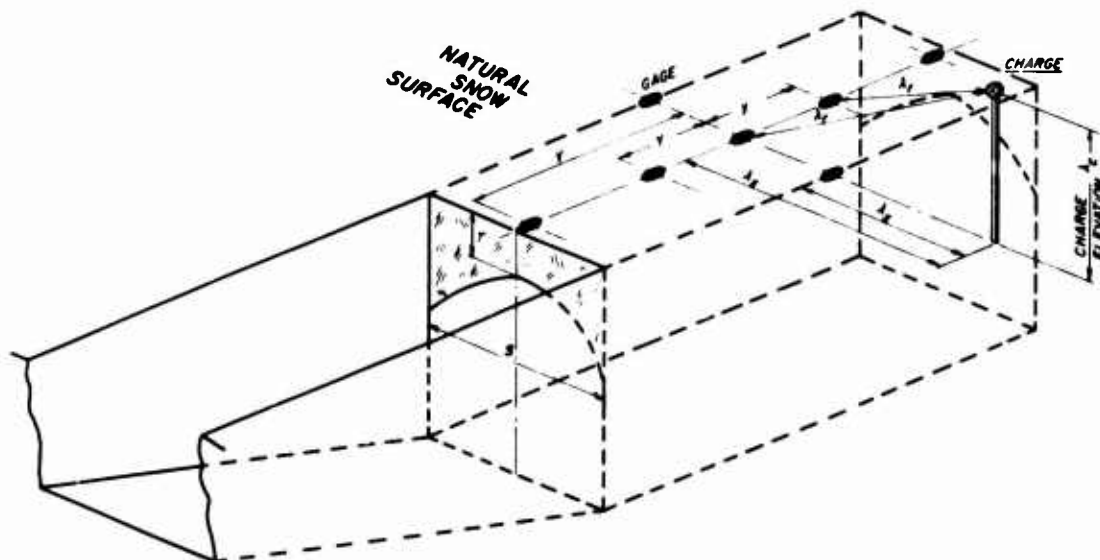

Figure 8. Layout for horizontal arches.

## EFFECTS OF EXPLOSIONS ON SNOW STRUCTURES

7

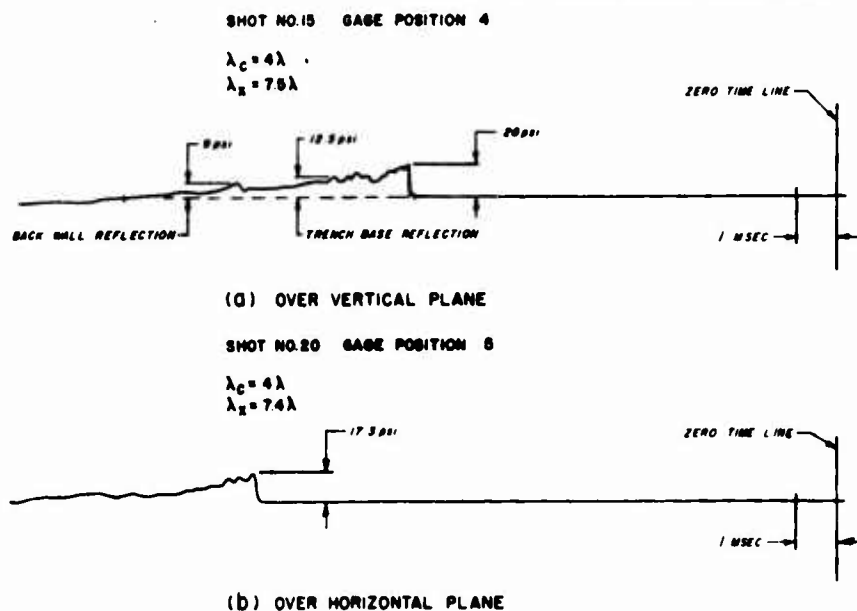

Figure 9. Typical pressure-time trace over processed snow surface.

### DISCUSSION OF TEST RESULTS

The tests on vertical arches were performed under the assumption that they could be treated as horizontal structures turned through  $90^\circ$ . Small-scale structures in a vertical plane could be constructed more accurately and in less time with the equipment available. Unfortunately, vertical arches were subjected to conditions not present in horizontal structures and therefore the two types are analyzed separately.

#### Vertical arches

Blast loading of vertical arches was found to be more involved than originally anticipated. Pressure-time traces indicate base and back wall reflections, lagging the pressure wave by a few milliseconds (Fig. 9). Of the two, the former had an appreciable effect on the arches and largely contributed to their destruction. Measurements showed higher pressures at the base of the trench than near the snow surface — particularly for higher charge elevations, i. e., at  $\lambda_c = 4\lambda$  or  $5\lambda$ . For example, in shot 15 at  $\lambda_c = 4\lambda$  and  $\lambda_x = 5.5\lambda$  (with the charge  $3.75\lambda$  above the trench base), the pressure was 47 psi (gage) at the base but only 32 psi (gage) half way up the wall. The effect of the base reflection on the arch surface varied with the height of the explosive above the trench base. Explosions close to the base resulted in an early mach stem formation along the base. (Mach stem is the reinforced pressure front resulting from the merger of the incident wave and the reflected wave at some distance away from the blast Fig. 10). In Trench 1 (shots 1 through 10) with the charges only 4-ft (or  $2.5\lambda$  for a 4 lb charge) above the base, the mach stem formed at  $5\lambda$  from ground zero according to USAEWES's preliminary findings. Cutting the trenches an additional 4 ft deeper resulted in slightly lower reflected pressures at the bottom end of the arches and the mach stem met the arch surface a little further away from the blast— $9\lambda$  compared to  $5\lambda$  in trench 1. Nevertheless, pressures were still higher near the base.

Laterally, across the span, pressure distribution varied from almost uniform for small spans (6, 10, and 14 inches) to as much as 100% for 3-, 6- and 9-lb spans. For example, a 4 lb TNT charge exploded from  $\lambda_c = 4\lambda$  at  $\lambda_x = 11\lambda$  away produced 21 psi (gage) at the side near the blast but only 10 psi (gage) at the far end of a 9 ft span—shot 39.

Arches in a vertical plane were also subjected to gravity effects. The initial impact will be absorbed by the arching action but any loosened mass will break away

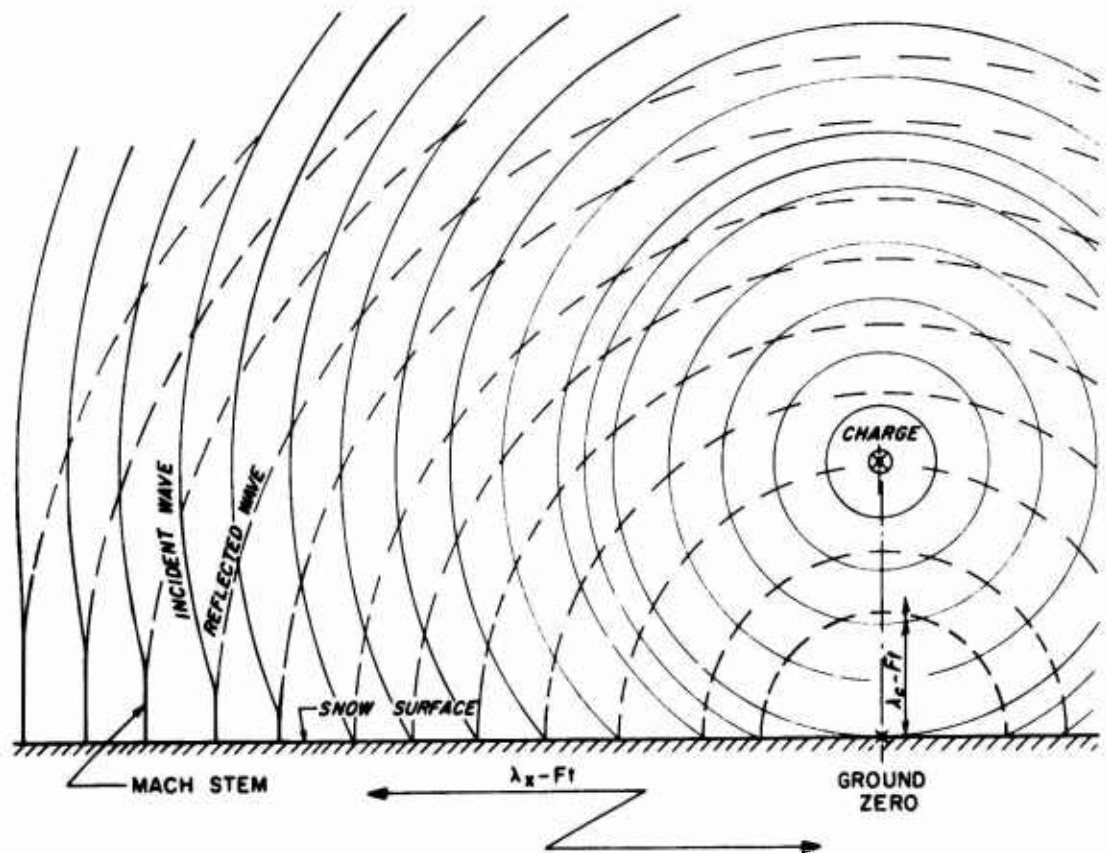

Figure 10. Mach stem formation.

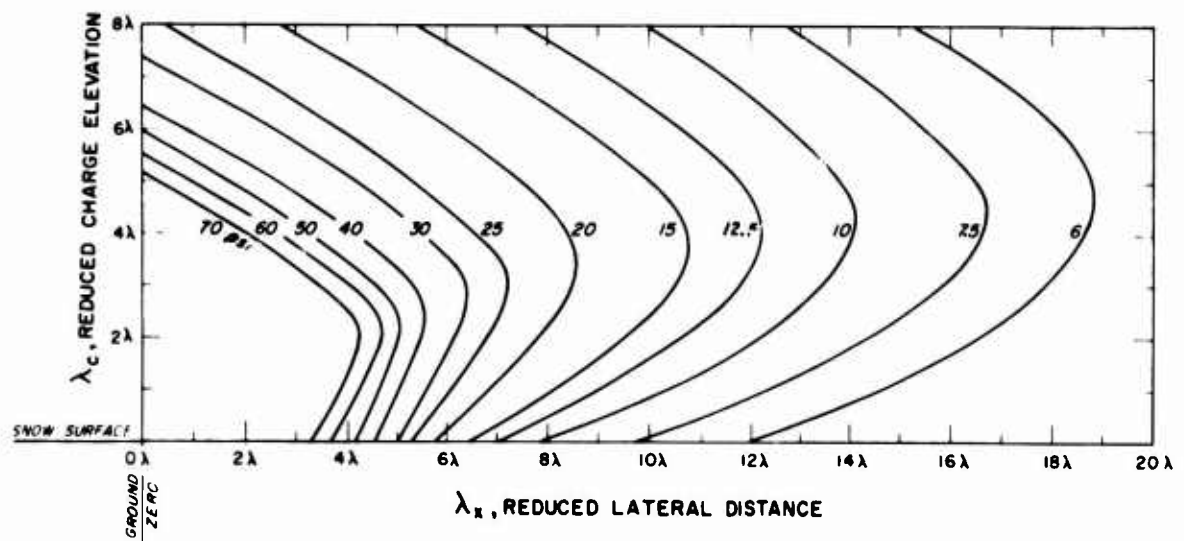

Figure 11. Height of burst curves for processed snow surface. Nos. on curves indicate peak pressure (psi).

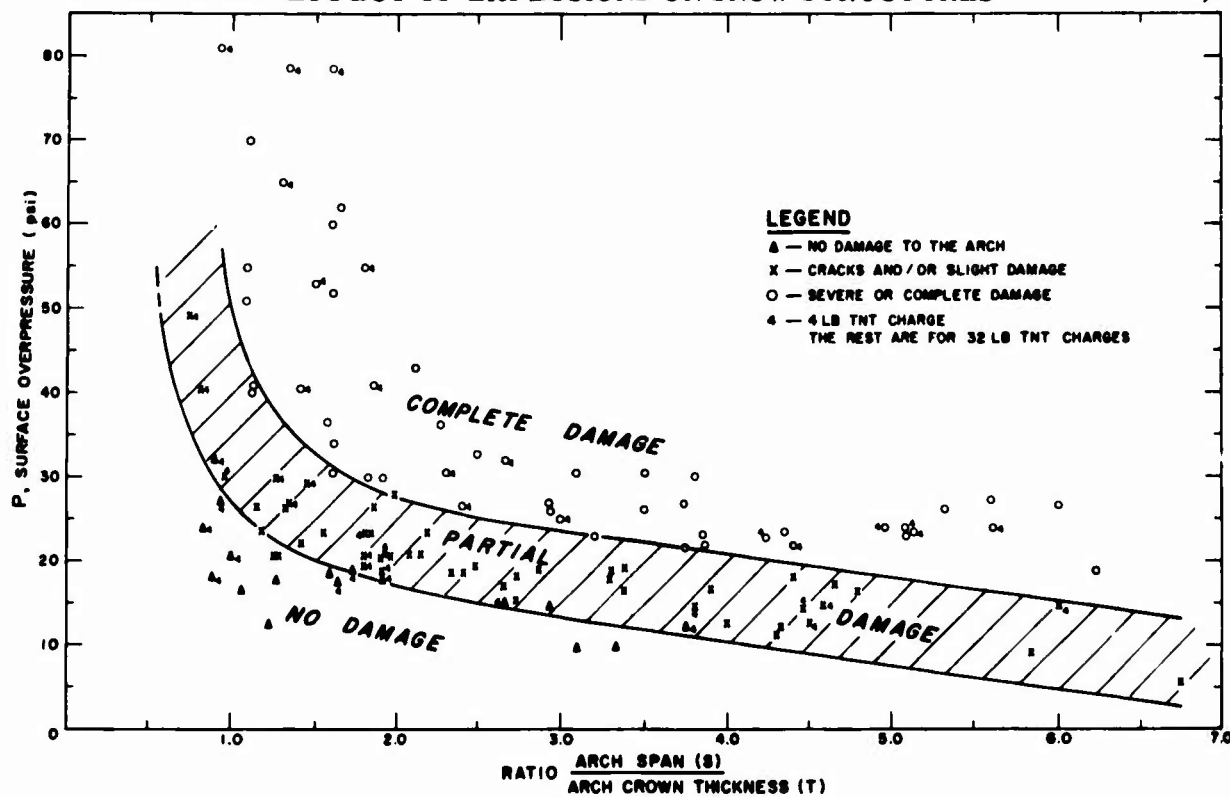

Figure 12. Surface overpressure versus ratio of arch span to arch crown thickness.

and gravitate away from the wall. Evidence of this was observed in some shots where big blocks (some up to 8 ft long) sheared off the vertical wall.

Vertical arches are tabulated according to damage (complete, part, or none) in Table IV. From these data curves  $S/T$  versus surface overpressure ( $P$ ) are plotted and each damage range is shown (Fig. 12). The y-axis corresponds to surface overpressures at the midpoint of the cover surface. Data from horizontal arches did not correlate and are not shown. Results show that for the same spans, crown thickness, and explosives, horizontal structures withstood over 5 times as much overpressure at the midpoint of the cover.

To develop some scaling procedure, preliminary curves were derived of arch crown thickness ( $T$ ) versus arch span ( $S$ ) for various surface overpressures that produced part damage (Fig. 13) and surface overpressure versus arch span for various minimum crown thicknesses (Fig. 14). Wide variation in test conditions — particularly loading distribution — necessitated a fair amount of guesswork in evaluating the data. The family of curves obtained suggests a linear relation between  $S$  and  $T$  for the range of spans tested, if the load distribution is fairly constant — as indicated by the 5 and 10 psi lines. The same relation holds for higher pressures (about 20 psi) but for smaller spans (up to 36-inch). No mathematical expression can be derived at this stage but the results can be used as the basis for further testing.

#### Horizontal arches

The pressure distribution over full-size horizontal arches was uneven and this undoubtedly affected the results. For example, a 32 lb TNT charge at  $\lambda_c = 3\lambda$ ,  $\lambda_x = 3\lambda$  produced surface overpressures from 80 psi to 20 psi over an arch 9 ft span and 50 ft long. The effect of this local pressure concentration was visible on all arches that showed any damage. All damage occurred in the midsection of the trench, i.e., closest to the blast. It is also presumed that the shock wave through the snow coupled

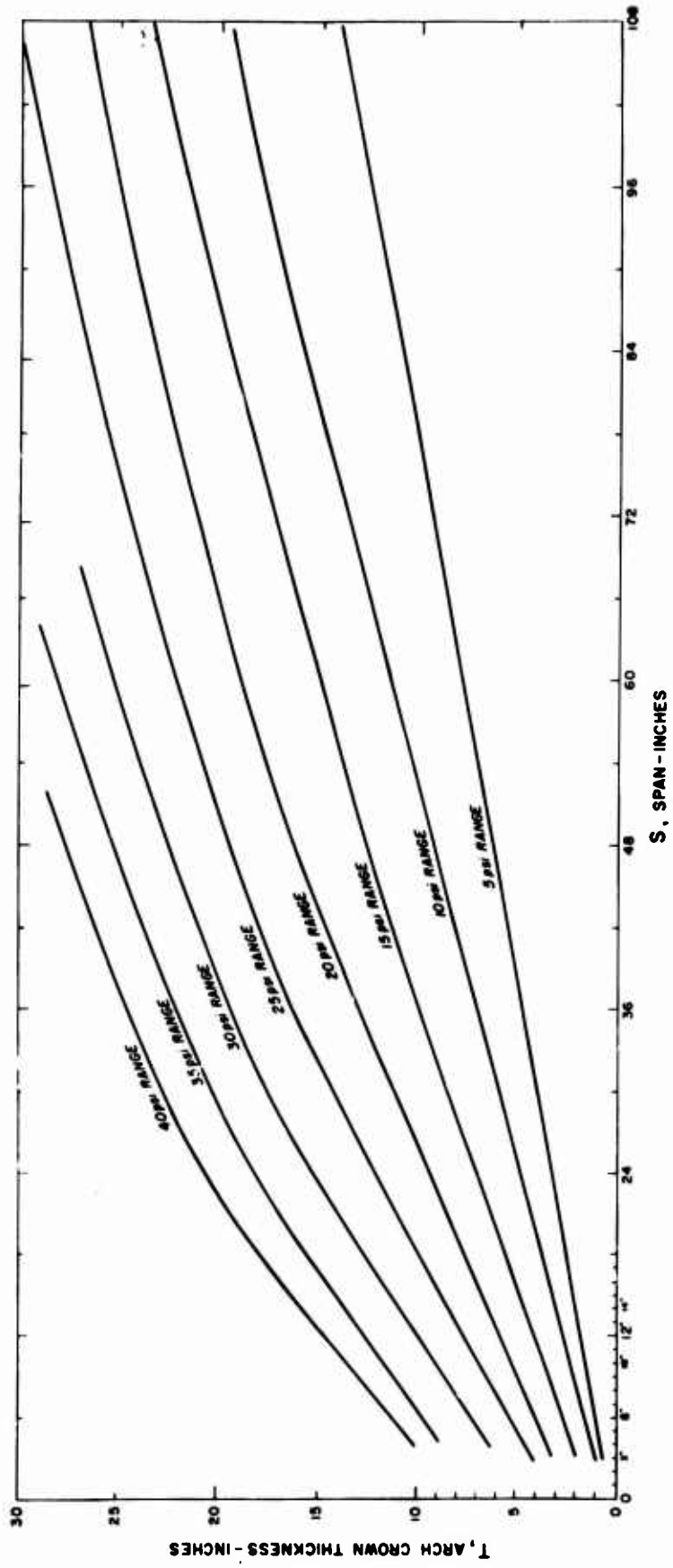

Figure 13. Arch span versus crown thickness for various surface overpressures.

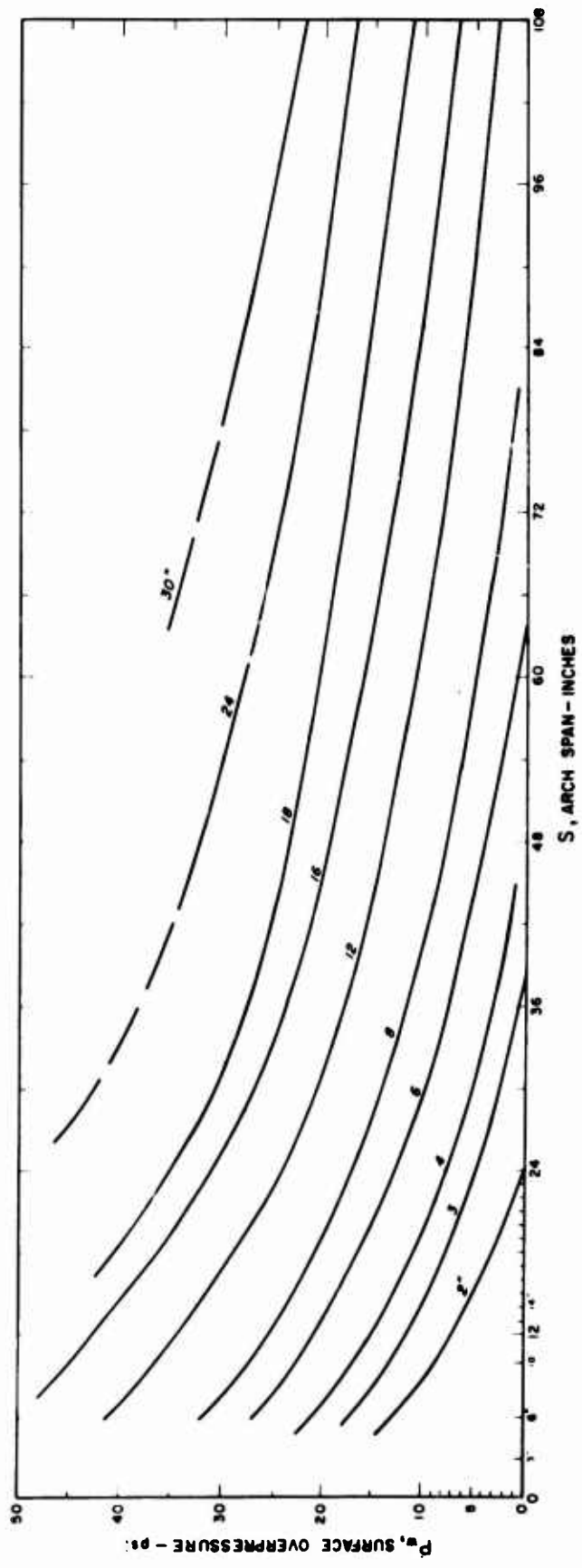

Figure 14. Surface overpressure versus arch span for various arch crown thicknesses.



with the high pressures on the blast side collapsed the snow on which the arch was placed. This would account for the occurrence of a slight depression under the blast and occasional longitudinal surface cracks. The degree of damage varied with the crown thickness and the geometrical position of the charge relative to the center of the arch. Structures that showed little or no damage were subjected to further testing until appreciable damage occurred.

Only in shot 42, with the explosive at  $\lambda_c = 0\lambda$ ,  $\lambda_x = 0\lambda$ , the damage was complete. At  $\lambda_c = 2\lambda$ ,  $\lambda_x = 2\lambda$  (with surface overpressures of 100 psi at the center, 19 psi at the ends) an arch with a 35.5-in. cover sustained some interior damage (shot 50) while shot 44 broke the arch at the closed end of the trench. However, this can be attributed to the large variation in crown thickness at the point of failure from 42-in. to 27-in. and also to previous minor damage from shot 43. With  $\lambda_c = 3\lambda$ ,  $\lambda_x = 3\lambda$ , surface overpressures of 80 psi (center), 22 psi (at the ends) produced some outside surface cracks (shot 48), and interior spalling at the cover (shot 49). Arches sustaining such minor damage could regain their full strength if allowed to heal for a few days. At  $\lambda_c = 4\lambda$ ,  $\lambda_x = 4\lambda$ , the surface overpressures ranged from 42 to 19 psi. Very slight interior spalling at the haunches resulted from shots 40, 43 and 47, two longitudinal surface cracks from shot 46. In shot 45 a hole (approximately 2 ft diam) was blown through the center of the cover in addition to some interior cracks. This undoubtedly was due to local poor cohesion in the snow cover, and poor arch construction in general: numerous cracks and signs of bad bonding were visible on the inside of the arch before the explosion. Shots detonated further away from the trench had no damaging effect whatsoever.

High stress concentration from a 4 lb TNT charge was confined to an even smaller area over a full size horizontal arch. A blast from  $\lambda_c = 4\lambda$ ,  $\lambda_x = 0\lambda$  gave pressures from about 100 psi directly under the charge to only 8 psi at the ends of a 9-ft span 50-ft long arch cover (shot 52). Even though the arch cover was reduced to 24-in., a 4-lb charge proved insufficient to inflict any noticeable damage (shots 51, 52). Shot 52 produced only very minor surface spalling on the outside but no visible interior damage. Detonation of a 32-lb TNT charge placed inside the trench at 30-in. above the floor, resulted in complete destruction (shot 53).

The removable steel forms used for three arches (shots 51, 52, and 53) produced stronger structures than the inflatable nylon cylinders used for the others. The discrepancy in the test results is partly attributed to this difference. The inhomogeneity of the snow undoubtedly explains part of the scatter of the results.

Lack of time and equipment prevented any extensive testing on the horizontal structures. The few results obtained bear no relation to the results from vertical arches and merely show the effect of 4 or 32 lb TNT charge on 9-ft span arches with 24- to 37-in. crown thickness. Likewise, this limited test program was not sufficient to investigate range of snow properties with respect to blast effects.

### CONCLUSIONS

No correlation was found between vertical arches and horizontal arches. For the same charge weight and position and the same arch span and crown thickness, horizontal structures withstood 5 times as much surface overpressure concentrated at the center of the cover as vertical arches.

Results from vertical arches show a possible direct relation between the arch span and arch crown thickness for uniform blast loading. A family of curves have been derived for use as a guide for future work on scaling of snow structures.

A 32-lb TNT charge producing 50 psi at the center and 20 psi at the ends of the trench, had no visible damaging effect on a 9 ft span 36-in. cover.

## RECOMMENDATIONS

Further tests should be conducted on horizontal arches with predetermined arch spans, width, crown thickness and adequate charge weight to give uniform pressure distribution over the whole projected surface area of the structure. For example, a 32-lb TNT charge detonated at  $\lambda_c = 6\lambda$  above the arch center will give about 40 psi surface overpressure over an arch 3-ft span 10-ft long.

Model arches can be either formed or drilled horizontally in Peter snow pads.

As an alternative, a number of structures of various  $\frac{S}{T}$  ratio could be scattered over a wide area in a radial pattern and subjected to a blast from a large explosive. Pressure magnitude at various radii from the blast would be measured. Those bigger blasts could also be used for better extrapolation of scaling predictions into the nuclear range.

Partly damaged structures should be allowed to heal and then subjected to further testing to determine the ability to heal and the recovery time of snow structures.

## EFFECT OF EXPLOSIONS ON SNOW STRUCTURES

TABLE I. PRESSURE MEASUREMENTS OVER PROCESSED SNOW SURFACE, JULY - AUGUST, 1960.

Gage position	Distance from charge to gage				y (ft)	Measured gage pressure P (psi)	
	Actual (ft)		Reduced (ft/W <sup>1/3</sup> )				
	R	x	$\lambda_R$	$\lambda_x$			
Shot 11, 1435 hr, 26 July							
1	19.5	17.5	6.15	5.5	+2.0	46.0	W = 32 lb, $\lambda = 3.175$ $\lambda_c = 2\lambda$ Pad age = 13 days Wind 12.5 knots SE Temp 19.6F
2	19.5	17.5	6.1	5.5	0	38.1	
3	19.7	17.5	6.2	5.5	-3.0	42.6	
4	23.2	22.2	7.32	7.0	+2.0	22.6	
5	23.1	22.2	7.28	7.0	0	21.1	
6	29.2	28.6	9.3	9.0	0	16.7	
7	35.3	34.9	11.3	11.0	0	12.3	
8	41.7	41.2	13.3	13.0	0	9.3	
Shot 12, 1700 hr, 26 July							
1	20.0	17.45	6.33	5.5	+2.0	42.8	W = 32 lb, $\lambda = 3.175$ $\lambda_c = 3\lambda$ Pad age = 13 days Wind 11.0 knots SE Temp 19.6F
2	19.9	17.45	6.3	5.5	0	38.0	
3	20.1	17.45	6.34	5.5	-3.0	45.2	
4	22.8	20.6	7.18	6.5	+2.0	29.5	
5	22.67	20.6	7.1	6.5	0	27.0	
6	25.6	23.8	8.1	7.5	0	26.0	
7	33.1	31.75	10.4	10.0	0	16.4	
8	45.4	44.5	14.3	14.0	0	9.4	
Shot 13, 1500 hr, 27 July							
1	24.2	20.6	7.62	6.5	+2.0	24.2	W = 32 lb, $\lambda = 3.175$ $\lambda_c = 4\lambda$ Pad age = 14 days Wind 10 knots SE Temp 20.0F
2	24.1	20.6	7.6	6.5	0	24.5	
3	24.3	20.6	7.63	6.5	-3.0	30.5	
4	29.8	27.0	9.4	8.5	0	20.8	
5	33.8	31.3	10.6	9.86	0	19.2	
6	39.3	37.1	12.4	12.0	0	-	
7	52.0	50.7	16.4	16.0	0	6.5	
8	64.7	63.5	20.3	20.0	0	4.7	
Shot 14, 1105 hr, 28 July							
1	23.7	17.45	7.45	5.5	0	23.9	W = 32 lb, $\lambda = 3.175$ $\lambda_c = 5\lambda$ Pad age = 15 days Wind 10 knots ESE Temp 14.2F
2	24.0	17.45	7.54	5.5	-3.5	21.6	
3	24.7	17.45	7.78	5.5	-7.0	42.0	
4	28.6	23.8	9.0	7.5	0	19.6	
5	34.1	30.2	10.7	9.5	0	16.4	
6	40.4	37.1	12.7	12.0	0	12.9	
7	53.0	50.7	16.0	16.0	0	6.6	
8	66.0	63.5	20.7	20.0	0	5.0	
Shot 15, 1611 hr, 28 July							
1	21.6	17.45	6.8	5.5	0	32.2	W = 32 lb, $\lambda = 3.175$ $\lambda_c = 4\lambda$ Pad age = 15 days Wind 8 knots E Temp 15.9F
2	21.9	17.45	6.88	5.5	3.5	31.6	
3	22.7	17.45	7.14	5.5	-7.0	47.2	
4	26.8	23.8	8.5	7.5	0	20.0	
5	32.8	30.2	10.3	9.5	0	21.1	
6	39.3	37.1	12.4	12.0	0	12.9	
7	52.0	50.7	16.4	16.0	0	6.7	
8	64.7	63.5	20.3	20.0	0	4.8	
*Shot 16, 1100 hr, 29 July							
1	11.85	8.75	7.45	5.5	0	22.1	W = 4 lb, $\lambda = 1.59$ $\lambda_c = 5\lambda$ Pad age = 16 days Wind 15 knots ESE Temp 18.5F
2	12.0	8.75	7.55	5.5	-1.5	21.5	
3	12.28	8.75	7.73	5.5	3.0	33.0	
4	14.4	11.9	9.05	7.5	0	-	
5	17.2	15.1	10.8	9.5	0	17.2	
6	20.8	19.1	13.05	12.0	0	12.2	
7	26.8	20.4	16.85	16.0	0	6.2	
8	33.0	31.8	20.7	20.0	0	5.8	

\* Shot fired against vertical processed-snow trench wall (no holes).

TABLE I: (cont'd)

Gage position	Distance from charge to gage				y (ft)	Measured gage pressure P (psi)	
	Actual (ft)	Reduced (ft/W <sup>1/3</sup> )					
R	x	$\lambda_R$	$\lambda_x$				
<b>*Shot 17, 1502 hr, 29 July</b>							
1	11.9	8.75	7.5	5.5	0	18.5	
2	12.0	8.75	7.55	5.5	-1.5	22.7	
3	12.3	8.75	7.73	5.5	-3.0	27.2	
4	14.4	11.9	9.05	7.5	0	15.2	
5	17.2	15.1	10.8	9.5	0	16.5	
6	20.7	19.1	13.05	12.0	0	11.6	
7	26.8	20.4	16.85	16.0	0	5.6	
8	33.0	31.8	20.75	20.0	0	4.0	
W = 4 lb, $\lambda = 1.59$ $\lambda_c = 5\lambda$ Pad age = 16 days Wind 12 knots ESE Temp 20.1F							
<b>Shot 18, 1535 hr, 30 July</b>							
1	23.6	17.45	7.42	5.5	0	28.0	
2	23.8	17.45	7.48	5.5	-3.0	24.3	
3	25.5	17.45	7.75	5.5	-7.0	43.0	
4	25.9	20.6	8.15	6.5	0	23.0	
5	29.9	25.4	9.4	8.0	0	23.3	
6	34.1	30.2	10.4	9.5	0	20.0	
7	40.4	37.1	12.7	12.0	0	11.9	
8	53.0	50.7	16.7	16.0	0	8.3	
W = 32 lb, $\lambda = 3.175$ $\lambda_c = 5\lambda$ Pad age = 17 days Wind 10.5 knots ESE Temp 23.2F Density = 0.489 g/cm <sup>3</sup> Porosity = 48.45% Comp. strength = 37.5 psi							
<b>Shot 19, 1655 hr, 30 July</b>							
1	15.88	15.88	5.0	5.0	0	56.6	
2	20.6	20.6	6.5	6.5	0	13.6	
3	25.4	25.4	8.0	8.0	0	9.2	
4	30.2	30.2	9.5	9.5	0	6.5	
5	34.9	34.9	11.0	11.0	0	7.3	
6	42.8	42.8	13.5	13.5	0	7.9	
7	47.6	47.6	15.0	15.0	0	6.0	
W = 32 lb, $\lambda = 3.175$ $\lambda_c = 0\lambda$ Pad age = 17 days Wind 10 knots ESE Temp 23.2F Density = 0.489 g/cm <sup>3</sup> Porosity = 48.45% Comp. strength = 37.5 psi							
<b>*Shot 24, 1623 hr, 3 August</b>							
1	10.6	6.9	6.65	4.34	-3.0	57.0	
2	11.0	6.9	6.92	4.34	0	28.5	
3	10.62	6.9	6.70	4.34	+1.0	-	
4	15.85	13.6	10.0	8.55	-2.0	24.3	
5	15.75	13.6	9.9	8.55	0	13.5	
6	15.8	13.6	9.95	8.55	+1.0	13.0	
7	19.4	17.5	12.2	11.0	-2.0	14.3	
8	19.3	17.5	12.15	11.0	0	16.8	
9	23.2	21.6	14.6	13.6	-2.0	11.3	
10	23.1	21.6	14.55	13.6	0	11.0	
11	26.8	25.5	16.85	16.0	0	8.7	
W = 4 lb, $\lambda = 1.59$ $\lambda_c = 5\lambda$ Pad age = 33 days Wind 8 knots S Temp 26.9F Density = 0.4953 g/cm <sup>3</sup> Porosity = 47.5% Comp. strength = 54.4 psi							
<b>*Shot 25, 1700 hr, 3 August</b>							
1	9.9	6.9	6.23	4.34	-3.0	44.1	
2	9.45	6.9	5.95	4.34	0	39.0	
3	9.65	6.9	6.06	4.34	+2.0	-	
4	15.2	13.5	9.56	8.55	-2.0	22.1	
5	15.1	13.5	9.5	8.55	0	-	
6	15.2	13.5	9.56	8.55	+2.0	-	
7	18.8	17.5	11.82	11.0	-2.0	11.8	
8	18.7	17.5	11.76	11.0	0	14.6	
9	22.8	21.6	14.32	13.6	-2.0	10.1	
10	22.7	21.6	14.25	13.6	0	9.6	
11	26.2	25.5	16.6	16.0	0	8.7	
W = 4 lb, $\lambda = 1.59$ $\lambda_c = 4\lambda$ Pad age = 33 days Wind 5 knots SE Temp 26.5F Density = 0.4953 g/cm <sup>3</sup> Porosity = 47.5% Comp. strength = 54.4 psi							
<b>*Shot 26, 2020 hr, 3 August</b>							
1	8.9	6.9	5.6	4.34	-3.0	102.0	
2	8.4	6.9	5.3	4.34	0	49.0	
3	14.65	13.5	9.2	8.55	-2.0	20.9	
4	14.5	13.5	9.15	8.55	0	13.5	
5	18.3	17.5	11.5	11.0	-2.0	11.7	
6	-	-	-	-	-	-	
7	18.2	17.5	11.45	11.0	0	13.7	
8	22.4	21.6	14.1	13.6	-2.0	8.4	
9	22.3	21.6	14.0	13.6	0	9.0	
10	26.0	25.5	16.35	16.0	0	7.5	
W = 4 lb, $\lambda = 1.59$ $\lambda_c = 3\lambda$ Pad age = 33 days Wind 5 knots SE Temp 27F Density = 0.4953 g/cm <sup>3</sup> Porosity = 47.5% Comp. strength = 54.4 psi							

\*Shot fired against vertical processed-snow trench wall (no holes)

## EFFECT OF EXPLOSIONS ON SNOW STRUCTURES

TABLE II. VERTICAL ARCHES UNDER DYNAMIC LOADING, JULY - AUGUST 1960.

Arch no.	Distance from charge to arch crown		Reduced (ft./w <sup>1/2</sup> )		Crown thickness, T (in.)			$\frac{S}{T}$	Estimated pressure on arch crown, P <sub>g</sub> (psi)	Damage
	Actual (ft)	R	x	R	Top	Bottom	Avg			
Shot 1, 14 July, 1355 hr v <sub>c</sub> = -0.1\, S = 6 in. W = 4.08 lb, \ = 1.59 Pad age = 13 days Wind 8 knots E, Temp 24.9F ρ = 0.4953 g/cm <sup>3</sup>										
1	12.71	12.71	8.0	8.0	4.25	3.25	3.75	1.0	9.6	None
2	9.77	9.0	6.15	6.04	4.25	3.0	3.67	1.03	17.5	None
3	6.58	6.25	4.14	3.92	4.75	3.25	4.0	1.5	54.0	Part
4	3.56	3.1	1.95	1.95	4.75	3.25	4.0	1.5	>100	Complete
5	3.56	3.1	1.95	1.95	2.75	2.5	2.67	2.25	>100	Complete
6	6.6	6.3	4.16	3.96	2.0	2.5	2.25	2.67	53.0	Complete
7	9.7	9.5	6.1	5.97	3.25	3.0	3.13	1.91	18.0	None
8	12.63	12.6	7.95	7.93	3.75	3.5	3.63	1.63	9.7	None
Comp. strength = 54.4 psi										
Shot 2, 15 July, 0800 hr v <sub>c</sub> = -1\, S = 6 in. W = 4.08 lb, \ = 1.59 Pad age = 14 days Wind 12 knots SE, Temp 20.8F ρ = 0.4953 g/cm <sup>3</sup>										
1	12.58	12.7	7.91	8.0	4.0	2.0	3.0	2.0		None
2	9.56	9.3	6.02	5.74	4.0	2.0	3.25	1.8		None
3	6.33	6.25	3.98	3.92	2.5	1.0	1.75	3.4		Part
4	3.13	3.0	1.97	1.89	5.0	-	-	-		Complete
5	3.15	3.2	1.98	2.01	3.5	3.5	3.5	1.7		Part
6	6.25	6.3	3.93	3.96	4.0	1.25	2.6	2.3		Cracks
7	9.62	9.6	6.06	6.04	3.0	3.0	3.0	2		None
8	12.75	12.9	8.02	8.13	4.0	3.5	3.75	1.6		None
Comp. strength = 54.4 psi										
Shot 3, 15 July, 1330 hr v <sub>c</sub> = 1\, S = 6 in. W = 4.03 lb, \ = 1.59 Pad age = 14 days Wind 7.5 knots SE, Temp 22.0F ρ = 0.4953 g/cm <sup>3</sup>										
1	12.83	12.75	8.02	8.0	2.75	1.75	2.25	2.67	15.5	None
2	9.79	9.7	6.16	6.1	2.0	2.0	2.0	3.0	25.0	Complete
3	6.67	6.5	4.2	4.1	1.75	-	-	-	62.0	Complete
4	3.71	3.3	2.34	2.08	2.0	3.0	2.5	2.4	>100	Complete
5	1.58	0	1.0	0	3.5	3.5	3.5	1.7	>100	Complete
6	3.58	3.2	2.25	2.01	4.5	4.0	4.25	1.4	>100	Complete
7	6.54	6.3	4.12	3.95	5.0	4.0	4.5	1.3	68.0	Complete
8	9.46	9.4	5.96	5.9	3.75	3.0	3.37	1.8	26.0	None
9	12.5	12.4	7.86	7.8	5.0	4.5	4.75	1.26	16.0	None
Comp. strength = 54.4 psi										
Shot 4, 15 July, 1510 hr v <sub>c</sub> = 2\, S = 6 in. W = 4.05 lb, \ = 1.59 Pad age = 14 days Wind 6 knots SE, Temp 23.0F ρ = 0.4953 g/cm <sup>3</sup>										
1	13.0	12.63	8.87	7.95	2.75	4.0	3.38	1.78	19.5	Part
2	10.3	9.83	6.47	6.19	4.5	3.75	4.13	1.45	29.2	Part
3	7.08	6.3	4.46	3.96	4.0	5.0	4.5	1.33	78.0	Complete
4	4.42	3.08	2.78	1.94	2.75	2.5	2.53	2.23	>100	Complete
5	3.17	0	2.0	0	2.25	2.0	2.13	2.82	>100	Complete
6	4.5	3.4	2.84	2.13	4.0	4.0	4.0	1.50	>100	Complete
7	7.21	6.5	4.54	4.09	2.75	4.75	3.75	1.60	75.0	Complete
8	10.17	9.67	6.40	6.09	3.5	6.0	4.75	1.26	30.0	Part
9	13.25	12.93	8.37	8.14	4.0	3.0	3.5	1.72	18.8	None
Comp. strength = 54.4 psi										
Shot 5, 16 July, 0945 hr v <sub>c</sub> = 3\, S = 6 in. W = 4.09 lb, \ = 1.59 Pad age = 15 days Wind 10 knots SE, Temp 17.9F ρ = 0.4953 g/cm <sup>3</sup>										
1	14.54	13.75	9.15	8.7	3.0	4.0	3.5	1.72	19.3	None
2	10.67	9.6	6.71	6.04	2.5	2.0	2.25	2.60	32.0	Complete
3	8.0	6.5	5.04	4.1	2.5	2.5	2.5	2.40	58.5	Complete
4	5.79	3.45	3.64	2.15	4.5	4.0	4.25	1.41	>100	Complete
5	4.67	0	2.94	0	3.0	3.5	3.25	1.85	>100	Complete
6	5.63	3.2	3.54	2.01	3.0	3.5	3.25	1.85	>100	Complete
7	7.75	6.2	4.88	3.9	3.5	4.0	3.75	1.60	62.0	Complete
8	10.42	9.3	6.56	5.8	3.5	4.0	3.75	1.60	34.2	Complete
9	13.42	12.6	8.45	7.9	4.5	4.0	4.25	1.41	22.0	Part
Comp. strength = 54.4 psi										

EFFECT OF EXPLOSIONS ON SNOW STRUCTURES

TABLE II: (cont'd)

Arch no.	Distance from charge to arch crown		Reduced (ft/W <sup>1/2</sup> )		Crown thickness, T (in.)			S/T	Estimated pressure on arch crown, P <sub>g</sub> (psi)	Damage
	Actual (ft)	x	R	x	Top	Bottom	Avg			
Shot 6, 16 July, 1030 hr λ <sub>c</sub> = 4', S = 6 in. W = 4.06 lb, λ = 1.59 Pad age = 15 days Wind 9 knots SE, Temp 19.1F ρ = 0.4953 g/cm <sup>3</sup> Comp. strength = 54.4 psi										
1	14.33	12.8	9.0	8.04	2.25	4.0	3.13	1.92	20.7	Part
2	11.54	9.7	7.23	6.1	0.75	4.25	2.5	2.4	26.5	Complete
3	9.04	6.3	5.68	3.96	2.0	4.5	3.25	1.85	41.0	Complete
4	7.17	3.2	4.51	2.01	2.37	2.75	2.63	2.28	69.0	Complete
5	6.36	0	4.0	0	3.37	3.0	3.18	1.89	>100	Complete
6	7.25	3.3	4.56	2.08	5.5	5.0	5.25	1.14	68.0	Complete
7	9.08	6.4	5.71	4.03	4.5	4.0	4.25	1.41	40.2	Complete
8	11.54	9.6	7.25	6.04	5.25	3.75	4.5	1.33	26.8	Part
9	14.21	12.7	8.94	8.0	3.75	3.0	3.38	1.76	20.8	Part
Shot 7, 18 July, 1025 hr λ <sub>c</sub> = 5', S = 6 in. W = 4.07 lb, λ = 1.59 Pad age = 17 days Wind 4 knots ESE, Temp 21.8F ρ = 0.4953 g/cm <sup>3</sup> Comp. strength = 54.4 psi										
1	14.83	12.5	9.32	7.9	1.0	0	0.5	12.0	19.0	Complete
2	12.5	9.6	7.86	6.04	2.0	0.62	1.31	4.6	23.3	Complete
3	10.5	6.4	6.60	4.03	0.75	0	0.38	15.8	30.3	Complete
4	8.62	3.25	5.42	2.04	1.25	0	0.63	9.5	44.3	Complete
5	8.0	0	5.03	0	2.75	2.0	2.37	2.5	75.0	Complete
6	8.62	3.25	5.42	2.04	3.0	2.25	2.63	2.3	44.3	Complete
7	10.21	6.3	6.43	3.95	2.75	2.5	2.63	2.3	30.4	Complete
8	12.5	9.6	7.86	6.0	3.75	3.0	3.37	1.9	23.3	Part
9	15.0	12.7	9.45	8.0	3.25	3.0	3.12	1.8	18.8	Part
Shot 8, 18 July, 1045 hr λ <sub>c</sub> = 0', S = 6 in. W = 4.04 lb, λ = 1.59 Pad age = 17 days Wind 5 knots SE, Temp 23.2F ρ = 0.4953 g/cm <sup>3</sup> Comp. strength = 54.4 psi										
1	11.1	11.1	7.0	7.0	6.0	7.0	6.5	0.92	12.3	None
2	7.92	7.92	5.0	5.0	6.25	6.25	6.25	0.96	30.0	Part
3	4.58	4.67	2.88	2.88	6.0	7.0	6.5	0.92	80.0	Complete
4	1.67	1.67	1.05	1.05	5.9	6.0	5.95	1.00	>100	Complete
5	0	0	0	0	5.75	-	-	-	>100	Complete
6	3.33	3.33	2.10	2.10	4.25	6.5	5.37	1.12	>100	Complete
7	6.25	6.25	3.9	3.92	4.5	6.5	5.5	1.09	54.0	Complete
8	9.42	9.42	5.92	5.92	6.75	7.0	6.87	0.88	18.5	None
9	12.64	12.64	7.94	7.94	6.25	7.5	6.87	0.88	9.8	None
Shot 9, 19 July, 0915 hr λ <sub>c</sub> = 4', S = 6 in. W = 4.08 lb, λ = 1.59 Pad age = 18 days Wind 10 knots SE, Temp 17.5F ρ = 0.4953 g/cm <sup>3</sup> Comp. strength = 54.4 psi										
1	12.83	11.1	8.07	7.0	6.5	8.0	7.25	0.83	23.3	None
2	10.38	8.1	6.54	5.1	6.25	7.0	6.67	0.90	31.8	None
3	8.0	4.8	5.04	3.2	7.0	9.0	8.0	0.75	49.2	Part
4	6.36	0	4.0	0	7.25	9.0	8.13	0.74	>100	Complete
5	7.21	3.2	4.54	2.01	6.25	6.5	6.37	0.94	67.0	Complete
6	9.04	6.3	5.68	3.96	6.5	8.0	7.25	0.83	40.6	Part
7	11.5	9.5	7.24	6.0	6.0	6.75	6.37	0.94	26.9	None
8	14.21	12.7	8.95	8.0	6.5	5.5	6.0	1.0	20.8	None
Shot 10, 19 July, 0930 hr λ <sub>c</sub> = 0', S = 14 in. W = 32 lb, λ = 3.175 Pad age = 18 days Wind 10 knots SE, Temp 18.2F ρ = 0.4953 g/cm <sup>3</sup> Comp. strength = 54.4 psi										
1	16.73	18.73	5.9	5.9	7.5	10.0	8.87	1.5	18.5	None
2	12.7	12.7	4.0	4.0	8.5	9.0	8.75	1.6	52.0	Complete
3	9.33	9.33	3.0	2.94	6.75	5.0	5.87	2.4	77.5	Complete
4	6.45	6.45	2.0	2.03	5.5	5.0	5.25	2.7	>100	Complete
5	0	0	0	0	7.0	-	-	-	>100	Complete
6	6.45	6.45	2.0	2.03	6.0	6.5	6.25	2.2	>100	Complete
7	13.2	13.2	4.16	4.16	3.5	0	1.75	9.0	47.0	Complete
8	19.45	19.45	6.11	6.11	4.0	4.0	3.0	4.6	17.0	Part
9	25.55	25.55	8.04	8.04	4.0	5.0	4.5	3.0	9.6	None

EFFECT OF EXPLOSIONS ON SNOW STRUCTURES

TABLE II: (cont'd)

Arch no.	Distance from charge to arch crown		$\lambda$	$\lambda_x$	Crown thickness, T (in.)		$\frac{S}{T}$	Estimated pressure on arch crown, P (psi)	Damage
	Actual (ft)	Reduced (ft/W <sup>1/3</sup> )			Top	Bottom			
1	26.08	25.4	8.2	8.0	6.0	5.25	2.49	19.2	Part
2	20.17	19.2	6.36	6.15	7.25	7.25	1.93	30.0	Complete
3	17.17	16.0	5.4	5.04	7.0	8.25	1.83	50.0	Complete
4	14.59	13.1	4.55	4.12	6.0	6.0	2.34	75.0	Complete
5	9.0	6.5	2.84	2.1	6.5	5.5	0	>100	Complete
6	6.35	0	2.0	0	10.5	0	0	>100	Complete
7	8.93	6.35	2.84	2.0	6.25	6.0	2.28	>100	Complete
8	14.45	13.02	4.55	4.1	0	-	-	75.0	Complete
9	17.17	15.88	5.4	5.0	2.0	1.5	8.0	47.5	Complete
10	20.09	19.05	6.56	6.0	0.75	-	-	31.3	Complete
11	26.25	25.4	8.26	8.0	4.0	4.25	3.39	19.2	Part
1	30.07	28.6	9.56	9.0	4.5	4.0	3.3	18.5	Part
2	27.33	25.6	8.6	8.06	3.25	4.25	3.74	21.5	Complete
3	24.33	22.3	7.25	7.03	3.50	4.50	3.50	26.0	Complete
4	21.58	19.36	6.8	6.1	4.25	4.0	3.39	31.5	Complete
5	19.75	16.2	6.2	5.1	5.25	5.0	3.73	42.0	Complete
6	15.92	12.7	5.03	4	7.0	4.0	2.54	60.0	Complete
7	15.33	12.39	4.83	3.9	8.0	9.0	1.65	62.0	Part
8	19.75	16.2	6.2	5.1	3.0	3.0	4.67	42.0	Complete
9	21.58	19.36	6.8	6.1	0.5	3.0	8.0	31.5	Complete
10	24.17	22.25	7.6	7.0	1.75	3.5	5.32	26.0	Complete
11	26.25	25.4	8.25	8.0	1.75	5.5	3.86	21.7	Complete
12	30.18	28.9	10.0	9.1	4.25	6.0	2.73	18.2	Part
1	37.25	34.9	11.72	11.0	5.5	4.0	2.94	14.5	None
2	34.3	31.75	10.8	10.0	4.75	3.5	3.39	16.4	Part
3	31.45	28.9	9.9	9.1	5.0	3.5	3.29	18.3	Part
4	28.0	25.4	8.8	8.0	7.25	7.0	1.96	20.8	Part
5	25.58	22.25	8.04	7.0	6.5	6.25	2.19	23.3	Part
6	23.0	19.36	7.24	6.1	4.5	5.0	2.94	26.5	Complete
7	14.33	6.48	4.51	2.04	2.5	2.25	2.38	5.88	Complete
8	15.92	9.43	5.02	3.0	2.75	0.75	1.75	8.0	Complete
9	18.0	12.7	5.66	4.0	3.0	3.5	4.0	40.6	Complete
10	20.5	16.06	6.45	5.06	3.0	3.5	3.25	32.2	Complete
11	22.9	19.05	7.2	6.0	2.0	3.0	2.5	26.9	Complete
12	25.8	22.55	8.14	7.1	3.0	4.25	3.85	23.1	Complete
1	35.5	31.75	11.2	10.0	4.25	6.0	2.73	15.2	Part
2	32.25	28.3	10.2	8.9	3.5	7.0	2.66	17.1	Part
3	30.2	25.4	9.5	8.0	3.5	6.25	2.86	18.8	Part
4	27.55	22.25	8.66	7.0	5.25	7.25	2.15	20.9	Part
5	24.9	19.05	7.82	6.0	1.5	2.0	1.75	23.3	Complete
6	22.5	15.88	7.08	5.0	4.5	3.0	3.73	26.2	Complete
7	18.67	9.74	5.88	3.05	1.0	3.25	2.13	35.5	Complete
8	20.42	12.7	6.44	4.0	4.0	4.75	4.38	30.3	Complete
9	22.5	15.88	7.08	5.0	4.0	5.5	4.75	26.2	Complete
10	25.0	19.36	7.87	6.1	3.75	5.0	4.38	23.0	Complete
11	27.55	22.25	8.66	7.0	2.5	3.0	2.75	20.9	Complete
12	30.2	25.4	9.5	8.0	2.5	2.0	2.25	18.8	Complete

Shot 11, 26 July, 1435 hr  
 $\lambda_c = 2\lambda$ ,  $S = 14$  in.  
 $W = 32$  lb,  $\lambda = 3.175$   
 Pad age = 13 days  
 Wind 12.5 knots SE, Temp 19.6F

Shot 12, 26 July, 1630 hr  
 $\lambda_c = 3\lambda$ ,  $S = 14$  in.  
 $W = 32$  lb,  $\lambda = 3.175$   
 Pad age = 13 days  
 Wind 11 knots SE, Temp 20.0F

Shot 13, 27 July 1500 hr  
 $\lambda_c = 4\lambda$ ,  $S = 14$  in.  
 $W = 32$  lb,  $\lambda = 3.175$   
 Pad age = 14 days  
 Wind 10 knots SE, Temp 20.0F

Shot 14, 28 July, 1105 hr  
 $\lambda_c = 5\lambda$ ,  $S = 14$  in.  
 $W = 32$  lb,  $\lambda = 3.175$   
 Pad age = 15 days  
 Wind 10 knots ESE, Temp 14.2F

EFFECT OF EXPLOSIONS ON SNOW STRUCTURES

TABLE II: (cont'd)

Arch no.	Distance from charge to arch crown		$\lambda \times$	Crown thickness, T (in.)		$\frac{S}{T}$	Estimated pressure on arch crown, P (psi) <sup>g</sup>	Damage		
	Actual (ft)	Reduced (ft/W <sup>1/2</sup> )		Top	Bottom				Avg	
1	34.3	31.75	10.8	10.0	12.25	15.0	13.13	1.07	16.4	None
2	28.0	25.4	8.8	8.0	10.5	11.5	11.0	1.27	20.8	Part
3	25.58	22.25	8.04	7.0	11.0	13.0	12.0	1.17	23.3	Part
4	23.0	19.36	7.24	6.1	11.25	13.0	12.13	1.15	26.5	Part
5	18.20	13.02	5.72	4.1	10.0	15.0	12.5	1.12	39.7	Complete
6	12.7	0	4.0	0	13.0	14.5	13.75	1.02	>100	Complete
7	14.3	6.35	4.5	2.0	11.75	13.5	12.63	1.11	69.7	Complete
8	15.88	9.85	5.0	3.1	12.5	13.5	13.0	1.08	50.5	Complete
9	18.0	12.7	5.66	4.0	12.5	12.25	12.38	1.13	40.6	Complete
1	30.2	25.4	9.5	8.0	3.25	5.0	4.13	2.42	18.8	Part
2	27.6	22.55	8.7	7.1	3.75	6.75	5.25	1.9	20.6	Part
3	24.83	19.04	7.8	6.0	5.5	7.5	6.5	1.54	23.3	Part
4	22.55	15.88	7.1	5.0	4.5	6.25	5.37	1.86	26.2	Part
5	20.35	12.7	6.4	4.0	2.5	3.25	2.86	3.5	30.3	Complete
6	18.58	9.58	5.85	3.05	4.0	5.0	4.5	2.22	36.1	Complete
7	18.45	9.42	5.8	2.97	5.75	7.0	6.37	1.57	36.3	Complete
8	20.3	12.42	6.4	3.93	5.0	7.5	6.26	1.60	30.7	Complete
9	22.25	15.5	7.0	4.9	6.0	8.75	7.37	1.36	26.5	Part
10	24.67	18.92	7.85	5.96	4.75	6.25	5.5	1.82	23.3	Part
11	27.35	22.17	8.6	7.0	7.0	9.0	8.0	1.25	20.9	Part
12	30.2	25.4	9.5	8.0	5.5	7.0	5.25	1.60	18.8	Part
1	25.4	25.4	8.0	8.0	2.75	3.25	3.0	3.33	9.6	None
2	22.25	22.25	7.0	7.0	2.0	3.0	2.5	4.0	12.3	Part
3	19.05	19.05	6.0	6.0	0	1.25	0.62	16.1	17.7	Complete
4	15.88	15.88	5.0	5.0	2.0	3.25	2.62	3.8	31.0	Complete
5	12.7	12.7	4.0	4.0	2.0	1.5	1.75	5.7	32.0	Complete
6	9.67	9.67	3.04	3.04	2.75	2.75	2.75	3.6	75.5	Complete
7	9.42	9.42	3.0	3.0	7.0	7.0	7.0	1.43	77.5	Complete
8	12.58	12.58	3.9	3.9	5.75	5.50	5.62	1.78	54.0	Complete
9	15.75	15.75	4.96	4.96	4.75	6.25	5.5	1.82	30.0	Complete
10	19.05	19.05	6.0	6.0	7.75	8.0	7.88	1.27	17.7	Part
11	22.08	22.08	6.95	6.95	8.0	8.25	8.12	1.23	12.1	None
12	25.4	25.4	8.0	8.0	6.25	8.0	7.12	1.40	11.1	None
1	36.2	28.6	11.4	9.0	14.75	16.25	15.5	2.34	2.5	Part
2	27.42	19.33	8.64	6.08	13.0	15.75	14.37	2.5	32.0	Complete
3	21.58	13.02	6.8	4.1	12.25	14.25	13.25	2.71	58.0	Complete
4	15.88	6.35	5.0	2.0	12.5	13.0	12.75	2.82	>100	Complete
5	9.42	6.76	3.0	2.13	15.75	16.5	16.12	2.23	>100	Complete
6	12.5	11.33	3.94	3.57	14.0	17.75	15.87	2.27	67.0	Complete
7	18.92	15.75	5.96	4.95	14.75	19.25	17.0	2.12	43.0	Complete
8	24.83	20.75	7.8	6.53	17.5	18.75	18.12	1.99	28.0	Part

Shot 15, 28 July, 1611 hr  
 $\lambda c = 4\lambda$ ,  $S = 14$  in.  
 $W = 32$  lb,  $\lambda = 3.175$   
 Pad age = 15 days  
 Wind 8 knots E, Temp 15.9F

Shot 18, 30 July, 1435 hr  
 $\lambda c = 5\lambda$ ,  $S = 10$  in.  
 $W = 32$  lb,  $\lambda = 3.175$   
 Pad age = 17 days  
 Wind 10.5 knots ESE, Temp 23.2F  
 $\rho = 0.489$  g/cm<sup>3</sup>

Comp. strength = 37.5 psi

Shot 19, 30 July, 1655 hr  
 $\lambda c = 0\lambda$ ,  $S = 10$  in.  
 $W = 32$  lb,  $\lambda = 3.175$   
 Pad age = 17 days  
 Wind 10 knots ESE, Temp 23.2F  
 $\rho = 0.489$  g/cm<sup>3</sup>

Comp. strength = 37.5 psi

Shot 21, 2 August, 0900 hr  
 $\lambda c = 4\lambda$ ,  $S = 36$  in.  
 $W = 32$  lb,  $\lambda = 3.175$   
 Pad age = 19 days  
 Wind 15 knots ESE, Temp 17.8F  
 $\rho = 0.489$  g/cm<sup>3</sup>  
 Comp. strength



## EFFECT OF EXPLOSIONS ON SNOW STRUCTURES

TABLE II: (cont'd)

Arch no.	Distance from charge to arch crown		Reduced (ft/W <sup>1/3</sup> )			Crown thickness, T (in.)			Estimated pressure on arch crown, P (psi)	Damage	
	Actual (ft)	R	x	R	λ	λ <sub>x</sub>	Top	Bottom			Avg
Shot 22, 2 August, 1030 hr λ <sub>c</sub> = 4λ, S = 36 in. W = 32 lb, λ = 3.175 Pad age = 19 days Wind 17 knots ESE, Temp 18.2F ρ = 0.489 g/cm <sup>3</sup> Comp. strength = 37.5 psi											
1	23.08	14.55	7.25	6.15	6.0	6.0	6.0	6.0	26.5	Complete	
2	16.0	9.75	5.04	3.07	6.75	9.0	7.87	4.57	51.0	Complete	
3	34.1	31.67	10.74	9.96	9.5	9.0	9.25	3.90	16.5	Part	
4	43.2	41.3	13.6	13.0	7.75	9.0	8.37	4.30	11.3	Part	
Shot 31, 6 August, 1100 hr λ <sub>c</sub> = 6λ, S = 108 in. W = 32 lb, λ = 3.175 Pad age = 9 days Wind 6 knots S, Temp 30.9F											
1	39.58	34.8	12.45	11.0	25.0	25.0	4.31	12.0	12.0	Part	
2	29.17	22.25	9.18	7.0	24.5	24.5	4.4	18.0	18.0	Part	
Shot 32, 6 August, 1300 hr λ <sub>c</sub> = 6λ, S = 108 in. W = 32 lb, λ = 3.175 Pad age = 9 days Wind 7 knots S, Temp 32.9F											
1	48.25	44.4	15.2	14.0	18	19	18.5	5.84	8.5	Part	
Shot 33, 6 August, 1500 hr λ <sub>c</sub> = 6λ, S = 108 in. W = 32 lb, λ = 3.175 Pad age = 9 days Wind 10 knots S, Temp 32.8F											
1	60.58	57.83	19.1	18.2	16	16	6.75	5.5	5.5	Part	
Shot 34, 8 August, 0830 hr λ <sub>c</sub> = 4λ, S = 14 in. W = 4 lb, λ = 1.59 Pad age = 12 days Wind 9 knots E, Temp 21F ρ = 0.491 g/cm <sup>3</sup> Comp. strength = 14.98 psi											
1	12.75	11.08	8.05	6.96	2.75	3.75	5.09	23.0	23.0	Complete	
2	20.5	19.5	13.0	12.3	3.75	3.75	3.73	12.3	12.3	Part	
Shot 35, 8 August, 0900 hr λ <sub>c</sub> = 4λ, S = 36 in. W = 4 lb, λ = 1.59 Pad age = 12 days Wind 9 knots E, Temp 23.8F ρ = 0.491 g/cm <sup>3</sup> Comp. strength = 14.98 psi											
1	20.3	19.3	12.8	12.2	8.0	8.0	4.5	12.4	12.4	Part	
2	13.0	11.4	8.2	7.2	8.5	8.5	4.23	22.8	22.8	Complete	
3	17.0	15.9	10.6	10.0	7.5	7.5	4.8	16.4	16.4	Part	

TABLE II: (cont'd)

Arch no.	Distance from charge to arch crown		Distance from charge to crown, $\lambda^2 x$		Crown thickness, T (in.)		S	Estimated pressure on arch crown, P (psi)	Damage
	R	x	R	x	Top	Bottom			
Shot 36, 8 August, 1330 hr $\lambda_c = 4\lambda$ , S = 72 in. W = 4 lb, $\lambda = 1.59$ Pad age = 12 days Wind 7.5 knots ESE, Temp 31F $\rho = 0.491 \text{ g/cm}^3$ Comp. strength = 14.98 psi									
1	13.0	11.25	8.2	7.1	16.0	12.0	14.0	23.1	Complete Part
2	18.5	17.5	11.7	11.0	17.5	14.0	15.75	14.5	
Shot 37, 8 August, 1400 hr $\lambda_c = 4\lambda$ , S = 108 in. W = 4 lb, $\lambda = 1.59$ Pad age = 12 days Wind 8 knots ESE, Temp 31.0F $\rho = 0.491 \text{ g/cm}^3$ Comp. strength = 14.98 psi									
1	13.58	12.0	8.6	7.6	26.0	23.0	24.5	21.8	Complete Part
2	18.42	17.5	11.6	11.0	29.0	28.0	28.5	14.5	
Shot 38, 8 August, 1415 hr $\lambda_c = 4\lambda$ , S = 72 in. W = 4 lb, $\lambda = 1.59$ Pad age = 12 days Wind 9 knots ESE, Temp 30.1F $\rho = 0.491 \text{ g/cm}^3$ Comp. strength = 14.98 psi									
1	12.83	11.08	8.1	6.96	13.0	16.0	14.5	20.7	Complete Part
2	18.67	17.6	11.8	11.1	13.25	19	16.12	14.3	
Shot 39, 8 August, 1430 hr $\lambda_c = 4\lambda$ , S = 108 in. W = 4 lb, $\lambda = 1.59$ Pad age = 12 days Wind 9 knots ESE, Temp 30.1F $\rho = 0.491 \text{ g/cm}^3$ Comp. strength = 14.98 psi									
1	18.58	17.5	11.7	11.0	18.5	17.5	18.0	14.5	Part Complete
2	12.5	10.83	7.9	6.85	17.5	21.0	19.25	23.8	

## EFFECT OF EXPLOSIONS ON SNOW STRUCTURES

TABLE IIIA: HORIZONTAL ARCHES UNDER DYNAMIC LOADING, AUGUST 1960.

Arch span S = 108 in.

Gage	Distance from charge to arch surface		Reduced (ft/W <sup>1/3</sup> )		Avg ratio $\frac{S}{T}$	$\lambda_y$ (ft/W <sup>1/3</sup> )	Measured pressure on arch surface P (psi) gage	Damage
	Actual (ft)	R	$\lambda_x$	$\lambda_R$				
Shots instrumented for pressure								
Shot 20, 2 August, 0930 hr								
1	24.5	21.0	6.6	7.71	0	0	25.6	None
2	28.4	25.4	8.0	8.95	2.92	0	22.6	None
3	30.6	25.4	8.0	9.6	2.92	3	13.2	None
4	30.6	25.4	8.0	9.6	2.92	3	12.3	None
5	32.4	29.9	9.4	10.2	0	0	17.3	None
6	37.2	25.4	8.0	11.7	2.92	7.5	9.2	None
7	37.2	25.4	8.0	11.7	2.92	7.5	10.8	None
Shot 21, 2 August, 1400 hr								
1	19.4	14.6	4.6	6.1	0	0	32.4	None
2	22.5	19.05	6.0	7.07	2.92	0	26.1	None
3	24.8	19.05	6.0	7.8	2.92	3	21.0	None
4	24.8	19.05	6.0	7.8	2.92	3	19.2	None
5	26.8	23.6	7.4	8.42	0	0	22.3	None
6	33.1	19.05	6.0	10.4	2.92	7.5	10.7	None
7	33.1	19.05	6.0	10.4	2.92	7.5	12.1	None

$\lambda_c = 4\lambda$ ,  $W = 32$  lb,  $\lambda = 3.175$   
 Pad age = 15 days,  
 Avg crown thickness (T) = 37 in.  
 Wind 16 knots SSE, Temp 18.1F  
 $\rho = 0.497$  g/cm<sup>3</sup>  
 Comp. strength = 24.7 lb/in.

$\lambda_c = 4\lambda$ ,  $W = 32$  lb,  $\lambda = 3.175$   
 Pad age = 15 days,  
 Avg crown thickness (T) = 37 in.  
 Wind 15 knots SSE, Temp 21.7F  
 $\rho = 0.497$  g/cm<sup>3</sup>  
 Comp. strength = 24.7 lb/in.

TABLE III B: HORIZONTAL ARCHES UNDER DYNAMIC LOADING, AUGUST 1960.

Arch span  $5 \frac{1}{2}$  108 in.

Uninstrumented shots

Shot	Pad date (days) fired	Date fired	Time fired (hr)	Wind (knots)	Temp °F	Density (g/cm <sup>3</sup> )	Porosity % (K)	Comp. strength (lb/in. <sup>2</sup> )	Distance from center to arch crown		Average arch crown thickness T (in.)	Ratio S/T	Estimated surface pressure P (psi) gage	Damage	
									Actual (ft) R	Reduced (ft/W <sup>1/2</sup> ) R/x					
$\lambda_c = 4\lambda, W = 32 \text{ lb}, \lambda = 3.175 \text{ (except shot 42)}$															
40	23 Aug	1630	9 SE	18.1	0.497	44.85	24.7	18.0	12.7	5.66	4.0	37.0	2.92	42.0	Minor spalling
41	24 Aug	0930	11 SE	25.9	0.497	44.85	24.7	12.7	0	4.0	0	37.0	2.92	>100.0	Minor spalling
42*	24 Aug	1045	8 SSE	26.9	0.497	44.85	24.7	0	0	0	0	37.0	2.92	>100.0	Complete
43	22 Aug	1300	12 S	29.5	0.491	51.3	21.7	18.0	12.7	5.66	4.0	34.5	3.13	42.0	Minor cracks
45	21 Aug	1400	10 SE	29.9	0.473	50.3	23.0	18.0	12.7	5.66	4.0	30.0	3.60	42.0	Cracks and small hole
46	21 Aug	0830	11 ESE	18.9	0.481	57.0	26.0	18.0	12.7	5.66	4.0	31.0	3.49	42.0	Surface cracks, spalling
47	19 Aug	0900	11 ESE	21.8	0.471	58.6	23.4	18.0	12.7	5.66	4.0	33.5	3.23	42.0	Minor spalling
$\lambda_c = 3\lambda, W = 32 \text{ lb}, \lambda = 3.175$															
48	19 Aug	0930	11 ESE	22.3	0.471	58.6	23.4	13.1	9.54	4.13	3.0	33.5	3.23	80.0	Surface cracks
49	18 Aug	1000	11 ESE	23.5	0.480	74.1	19.9	13.1	9.54	4.13	3.0	32.5	3.33	80.0	Inside scaling
$\lambda_c = 2\lambda, W = 32 \text{ lb}, \lambda = 3.175$															
44	22 Aug	1330	10 SE	29.7	0.491	51.3	21.7	14.2	6.35	4.47	2.0	34.5	3.13	>100.0	Complete
50	18 Aug	1030	12 ESE	24.6	0.480	74.1	19.9	9.0	6.35	2.83	2.0	35.5	3.05	>100.0	Inside scaling
$\lambda_c = 4\lambda, W = 4 \text{ lb}, \lambda = 1.59$															
51	9 Aug	0800	7 ESE	17.8	0.485	65.7	18.85	9.0	6.35	5.66	4.0	24.0	4.5	42.0	None
52	9 Aug	0830	7 ESE	17.8	0.495	50.2	23.4	6.35	0	4.0	0	24.0	4.5	>100.0	None
$W = 32 \text{ lb}, \lambda = 3.175, \text{ charge placed inside the trench.}$															
53	9 Aug	0930	9 ESE	17.7	0.485	65.7	18.85	Center placed, 3-ft above floor in 9 x 25 x 8 ft high trench, 2-ft cover						Complete	

\* Charge placed on snow surface, i.e.,  $\lambda_c = 0\lambda$ .

## EFFECT OF EXPLOSIONS ON SNOW STRUCTURES

TABLE IV: OVERPRESSURE VS S/T.

<u>Arches not damaged</u>							
Shot no.	Arch span, S (in.)	Avg crown thickness T (in.)	S/T	Estimated pressure on arch crown P <sub>g</sub> (p.s.i.)	Age of snow (days)	Charge weight, W (lb)	Reduced %
1	6	3.67	1.63	17.5	13	4	0
1	6	3.13	1.91	18.0	13	4	0
3	6	2.25	2.67	15.0	14	4	1
4	6	3.5	1.72	18.8	14	4	2
8	6	6.87	0.88	18.0	17	4	0
9	6	7.25	0.83	23.4	18	4	4
9	6	6.67	0.90	32.0	18	4	4
9	6	6.37	0.94	27.0	18	4	4
9	6	6.0	1.0	20.7	18	4	4
10	14	8.87	1.58	18.5	18	32	0
10	14	4.5	3.1	9.6	18	32	0
13	14	4.75	2.94	14.5	14	32	1
15	14	13.13	1.07	16.4	15	32	4
19	10	3.0	3.33	9.6	17	32	0
19	10	7.88	1.27	17.7	17	32	0
19	10	8.12	1.23	12.3	17	32	0
34	14	3.75	3.73	12.2	12	4	4
<u>Arches completely damaged</u>							
1	6	4.0	1.5	53.0	13	4	0
3	6	2.0	3.0	25.0	14	4	1
3	6	4.5	1.33	65.0	14	4	1
4	6	4.5	1.33	78.5	14	4	2
4	6	3.75	1.6	78.5	14	4	2
5	6	2.25	2.67	32.0	15	4	3
6	6	2.5	2.4	26.5	15	4	4
6	6	3.25	1.85	41.0	15	4	4
6	6	4.25	1.41	40.5	15	4	4
7	6	1.31	4.6	23.2	17	4	5
7	6	2.63	2.3	30.5	17	4	5
8	6	6.5	0.92	81.0	17	4	0
8	6	5.5	1.09	55.0	17	4	0
10	14	8.75	1.6	52.0	18	32	0
11	14	7.25	1.93	30.0	13	32	2
12	14	3.75	3.74	21.5	13	32	3
12	14	4.0	3.5	26.0	13	32	3
12	14	8.5	1.65	62.0	13	32	3
12	14	2.63	5.32	26.0	13	32	3
12	14	3.63	3.86	21.7	13	32	3
13	14	4.75	2.94	26.5	14	32	4
13	14	2.5	5.6	27.0	14	32	4
13	14	3.63	3.85	23.0	14	32	4
14	14	1.75	8.0	23.2	15	32	5
14	14	3.75	3.73	26.2	15	32	5
14	14	4.38	3.19	30.2	15	32	5
14	14	4.75	2.94	26.2	15	32	5
14	14	4.38	3.2	23.0	15	32	5
14	14	2.75	5.09	20.8	15	32	5
14	14	2.22	6.22	18.8	15	32	5
15	14	12.5	1.12	40.0	15	32	4
15	14	12.63	1.11	70.0	15	32	4
15	14	13.0	1.08	51.0	15	32	4
15	14	12.38	1.13	40.7	15	32	4
18	10	2.86	3.5	30.2	17	32	5
18	10	4.5	2.22	36.2	17	32	5
18	10	6.37	1.57	36.5	17	32	5
18	10	6.25	1.6	30.5	17	32	5
19	10	2.62	3.8	30.0	17	32	0
19	10	5.62	1.78	55.0	17	32	0
19	10	5.5	1.82	30.0	17	32	0
21	36	14.37	2.5	32.7	19	32	3
21	36	17.0	2.12	33.0	19	32	3
22	36	6.0	6.0	26.5	19	32	4
34	14	2.75	5.09	23.4	12	4	4

## EFFECT OF EXPLOSIONS ON SNOW STRUCTURES

25

TABLE IV: (cont'd)

Shot no.	Arch span, S (in.)	Avg crown thickness T (in.)	S/T	Estimated pressure on arch crown P <sub>g</sub> (psi)	Age of snow (days)	Charge weight, W (lb)	Reduced λ <sub>c</sub>
<u>Arches completely damaged (cont'd)</u>							
35	36	8.5	4.23	22.8	12	4	4
36	72	14.0	5.14	23.0	12	4	4
37	108	24.5	4.4	21.8	12	4	4
38	72	14.5	4.96	23.4	12	4	4
39	108	19.25	5.61	23.8	12	4	4
<u>Arches cracked or partly damaged</u>							
4	6	3.38	1.78	19.5	13	4	2
4	6	4.13	1.45	29.2	13	4	2
4	6	4.75	1.26	30.0	13	4	2
5	6	4.25	1.41	22.0	13	4	3
6	6	3.13	1.92	20.7	15	4	4
6	6	4.5	1.33	26.7	15	4	4
6	6	3.38	1.78	20.7	15	4	4
7	6	3.37	1.8	23.2	17	4	5
7	6	3.12	1.9	18.8	17	4	5
8	6	6.25	0.96	30.0	17	4	0
9	6	8.0	0.75	49.3	18	4	4
9	6	7.25	0.83	40.7	18	4	4
10	14	3.0	4.65	17.0	18	32	0
11	14	5.60	2.49	19.2	13	32	2
11	14	4.13	3.39	19.2	13	32	2
12	14	4.25	3.3	18.6	13	32	3
12	14	5.13	2.73	18.2	13	32	3
13	14	4.13	3.39	16.3	14	32	4
13	14	1.25	3.29	18.2	14	32	4
13	14	7.13	1.96	20.7	14	32	4
13	14	6.38	2.19	23.4	14	32	4
14	14	5.13	2.73	15.2	15	32	5
14	14	5.25	2.66	17.0	15	32	5
14	14	4.88	2.86	18.8	15	32	5
14	14	6.5	2.15	20.8	15	32	5
15	14	11.0	1.27	20.7	15	32	4
15	14	12.0	1.17	23.4	15	32	4
15	14	12.13	1.15	26.5	15	32	4
18	10	4.13	2.42	18.8	17	32	5
18	10	5.25	1.9	20.6	17	32	5
18	10	6.5	1.54	23.2	17	32	5
18	10	5.37	1.86	26.5	17	32	5
18	10	7.37	1.36	26.5	17	32	5
18	10	5.5	1.82	23.2	17	32	5
18	10	8.0	1.25	20.8	17	32	5
18	10	6.25	1.6	18.8	17	32	5
19	10	2.5	4.0	12.5	17	32	0
21	36	15.5	2.34	18.6	19	32	3
21	36	18.12	1.99	22.4	19	32	3
22	36	9.25	3.90	16.5	19	32	4
22	36	8.37	4.30	11.3	19	32	4
31	108	25.0	4.31	12.0	9	32	6
31	108	24.5	4.4	18.0	9	32	6
32	108	18.5	5.84	9.0	9	32	6
33	108	16.0	6.75	5.5	9	32	6
35	36	8.0	4.5	12.5	12	4	4
35	36	7.5	4.8	16.4	12	4	4
36	72	15.75	4.58	14.5	12	4	4
37	108	28.5	3.8	14.5	12	4	4
38	72	16.12	4.46	14.2	12	4	4
39	108	18.0	6.0	14.5	12	4	4

APPENDIX A: DIAGRAMS OF SHOT DAMAGE

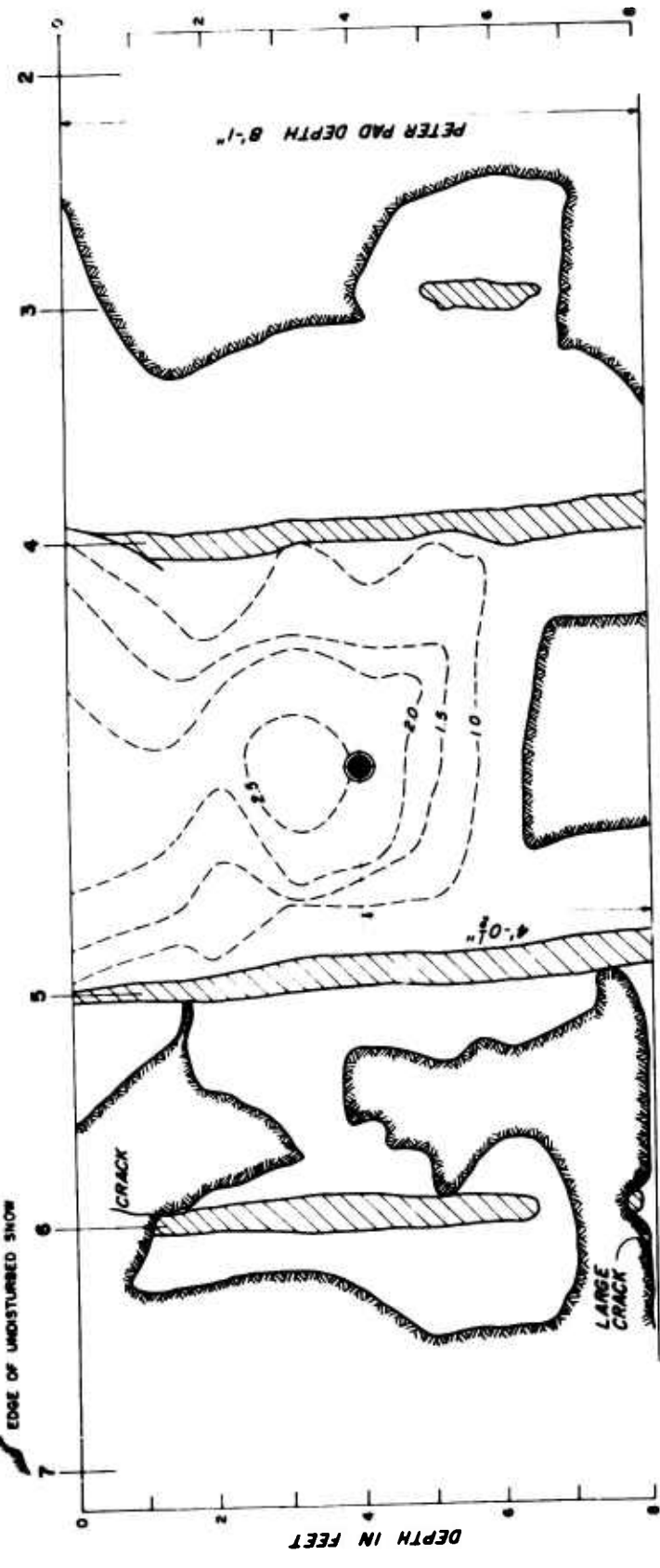
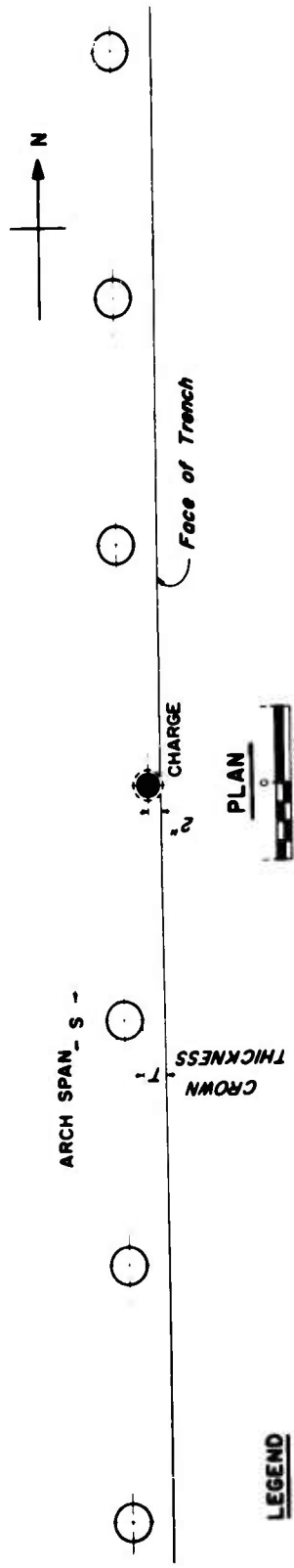

FACE OF TRENCH

SHOT NO. 1



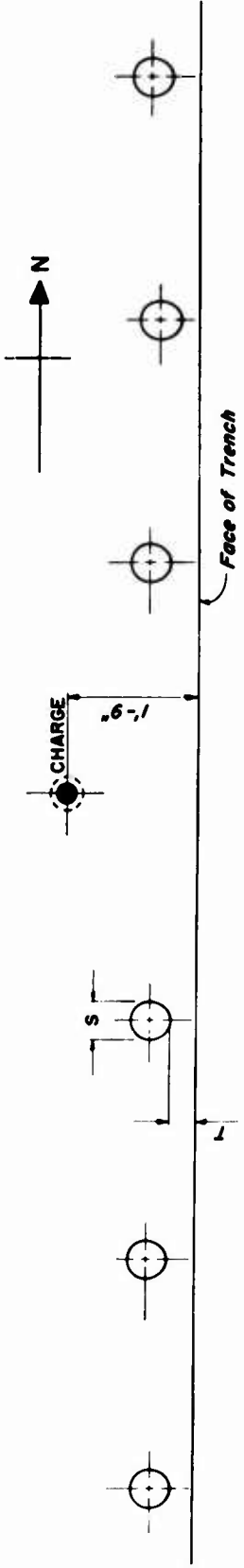

**LEGEND**  
 EXPOSED HOLE  
 UNDISTURBED SNOW

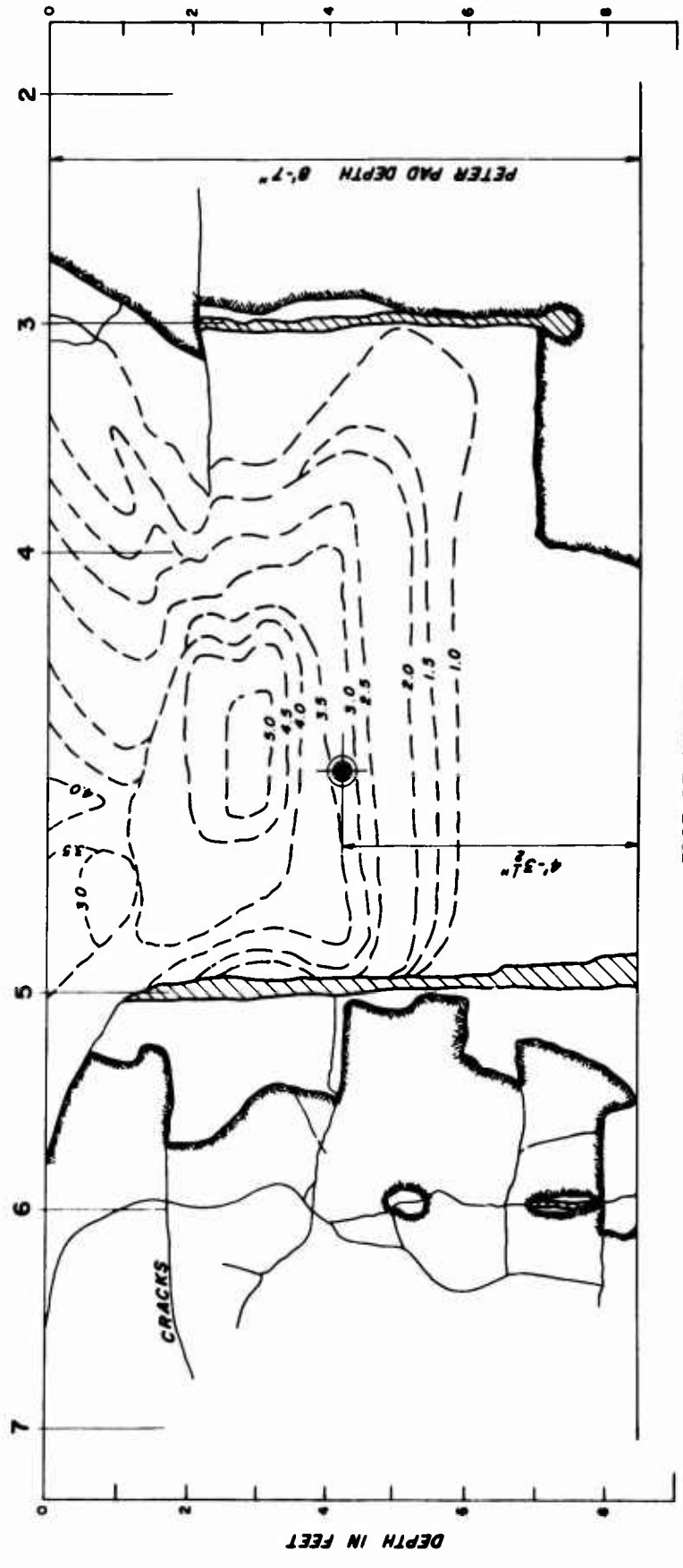

**FACE OF TRENCH**  
**SHOT NO. 2**



Face of Trench

PLAN



CHARGE



LEGEND

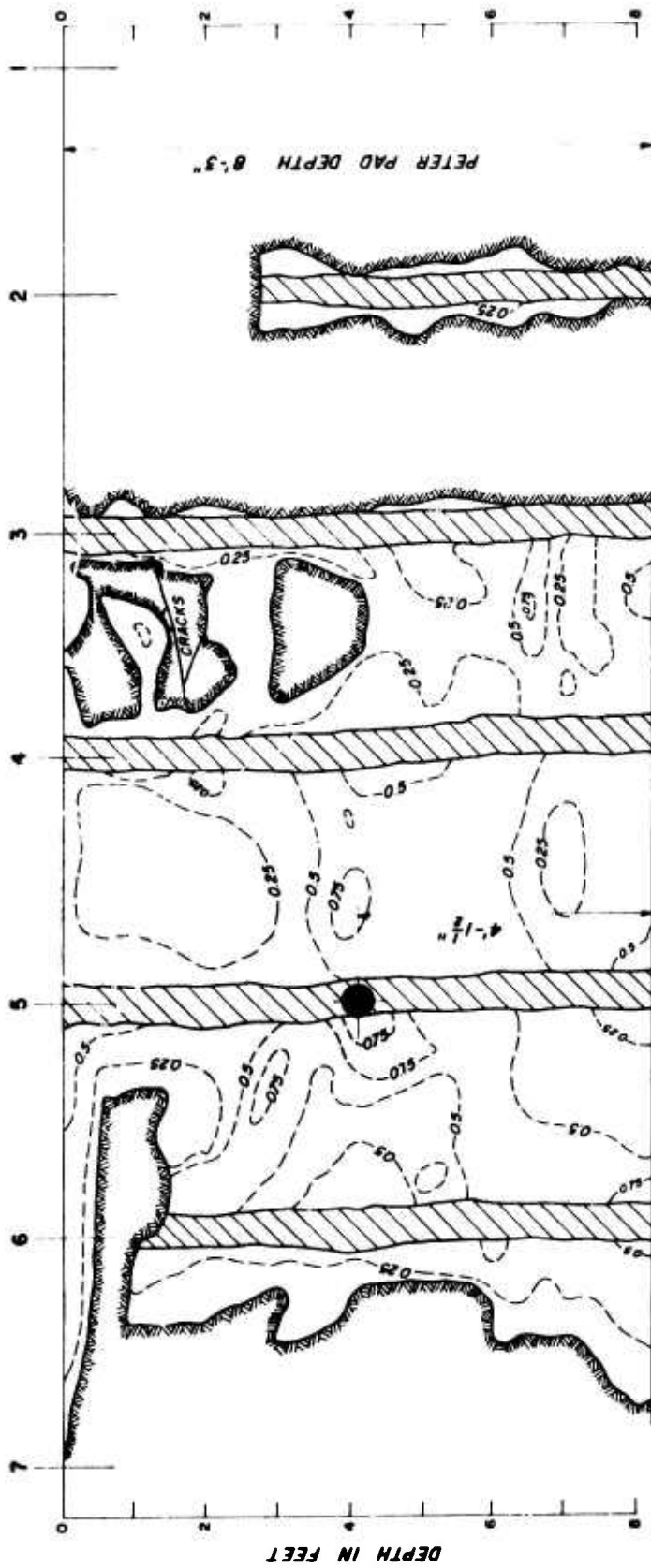
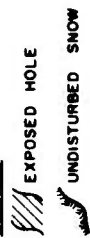

FACE OF TRENCH

SHOT NO. 3

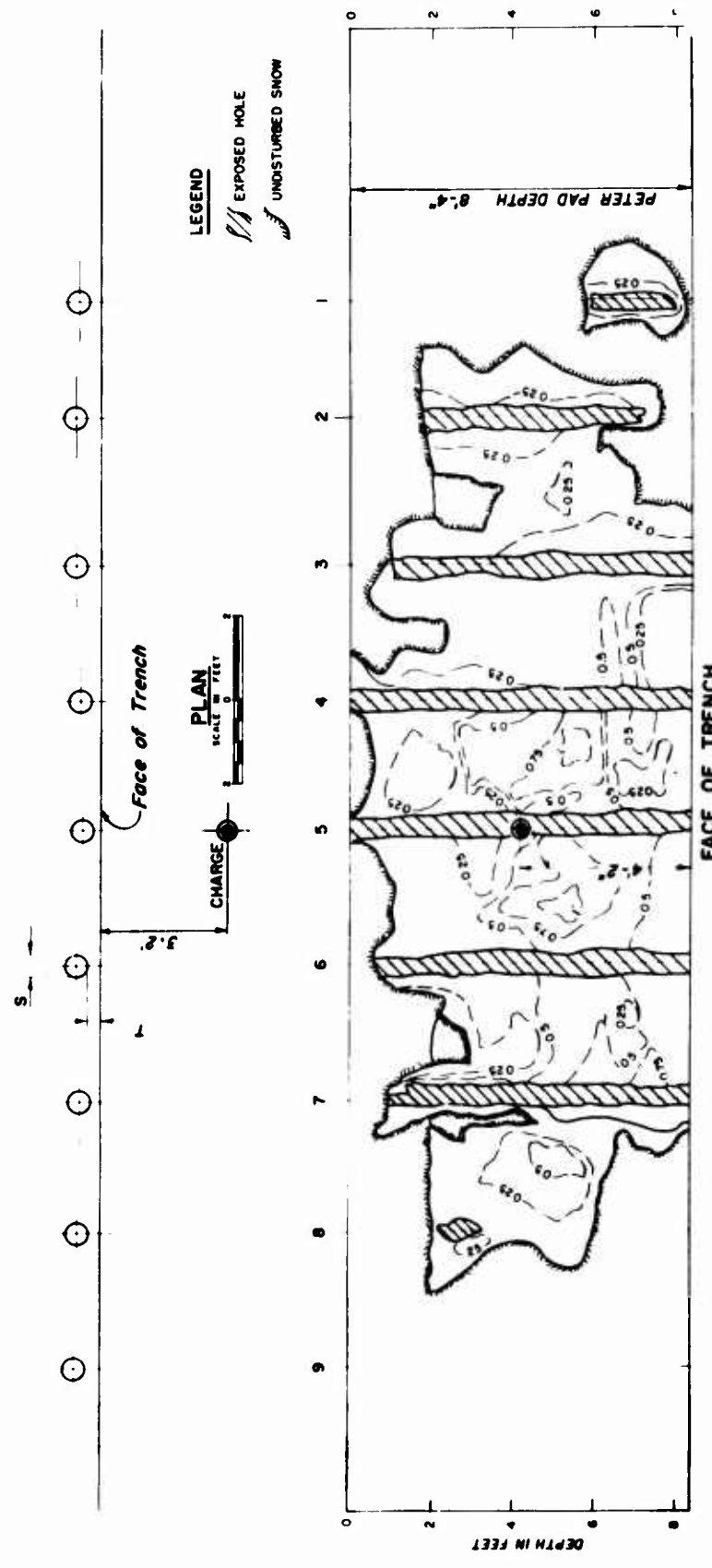

**LEGEND**  
/ / EXPOSED HOLE  
~ ~ ~ UNDISTURBED SNOW

**PLAN**  
SCALE IN FEET

**FACE OF TRENCH**

**SHOT NO. 4**

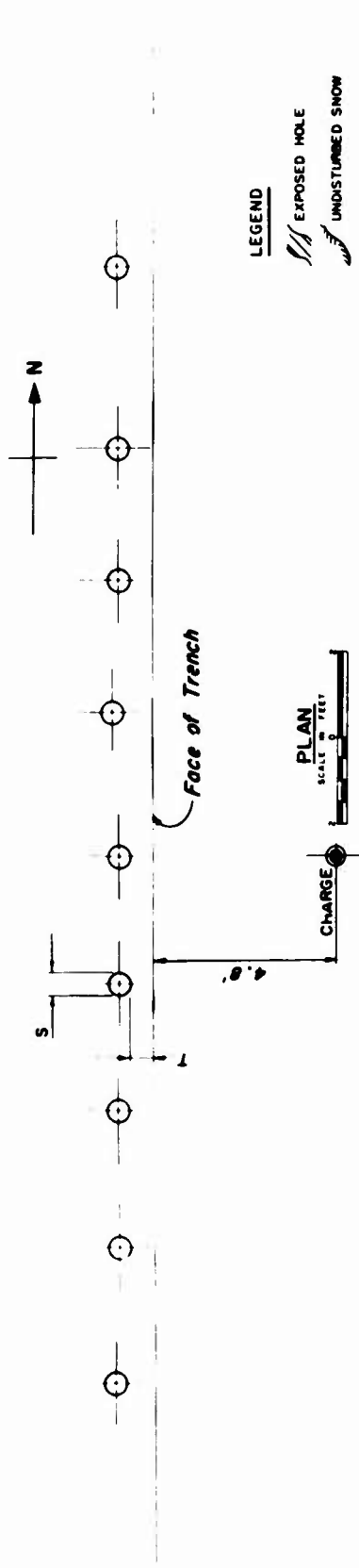

LEGEND

EXPOSED HOLE

UNDISTURBED SNOW

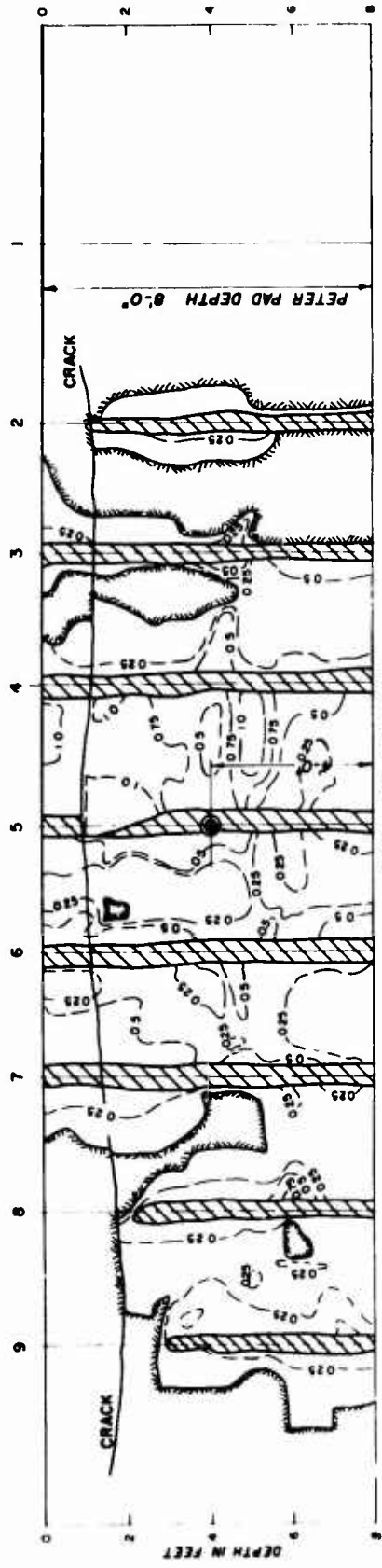

SHOT NO. 5

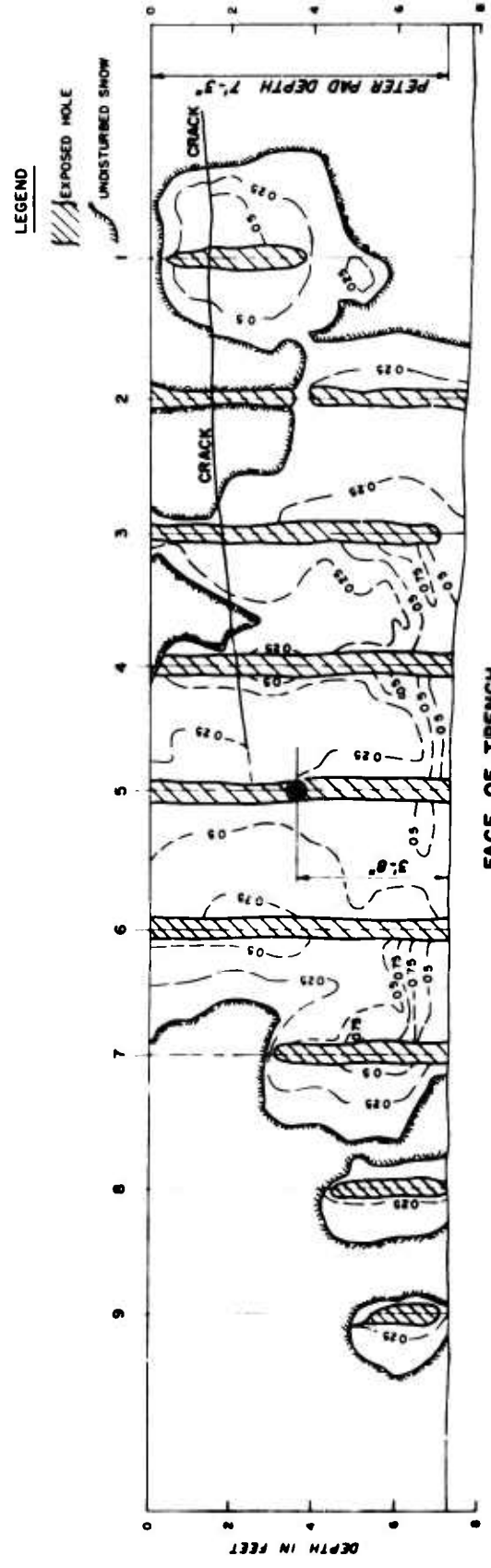
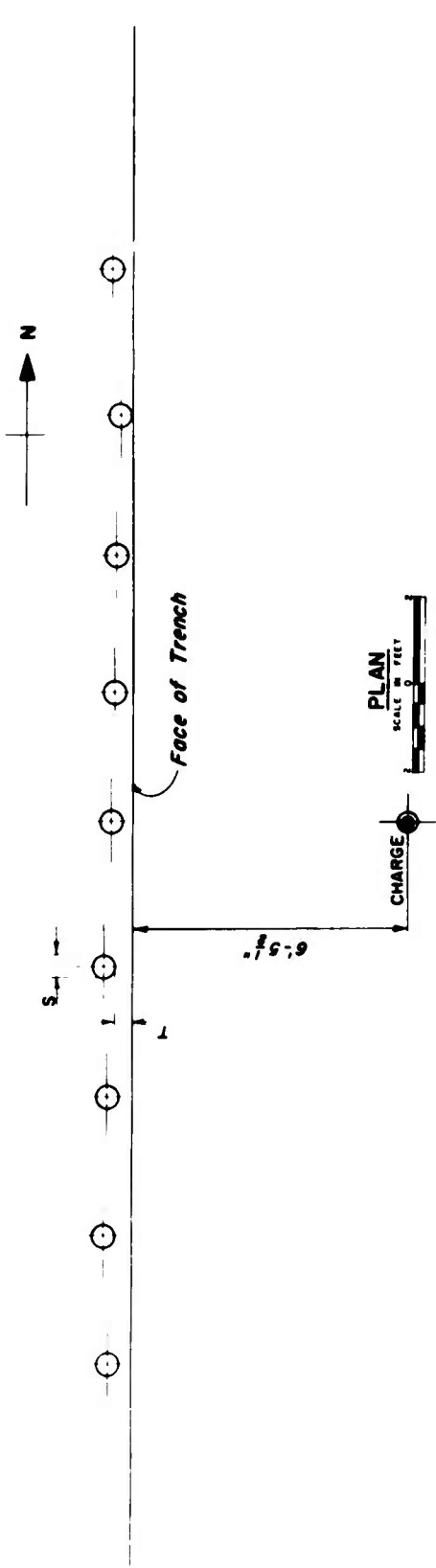

SHOT NO. 6



S - - -



Face of Trench

0.8



PLAN  
SCALE IN FEET

CHARGE

LEGEND

EXPOSED HOLE

UNDISTURBED SNOW

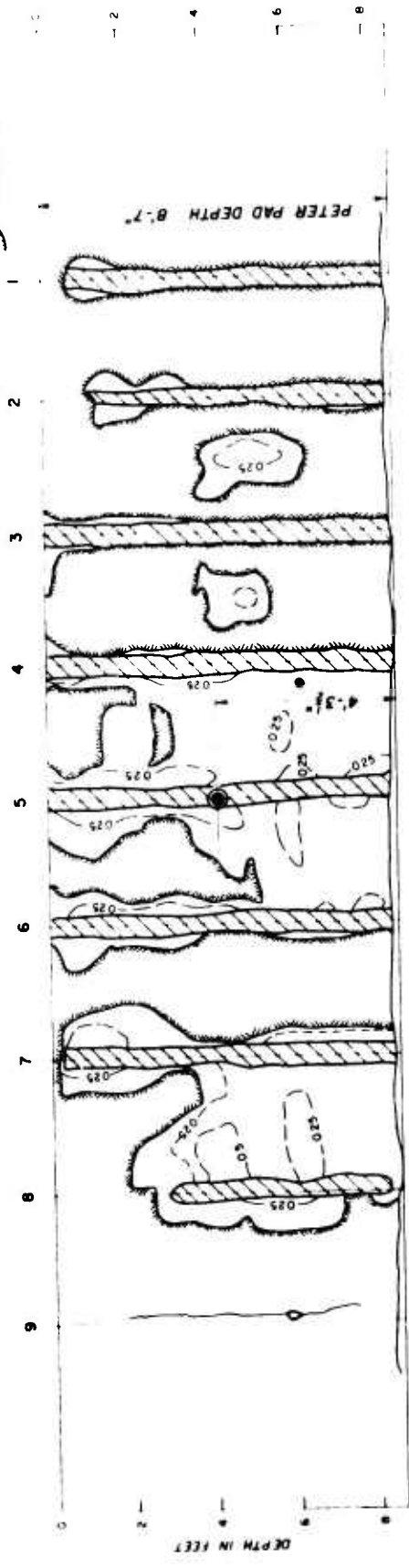

PETER PAD DEPTH 8.7"

FACE OF TRENCH

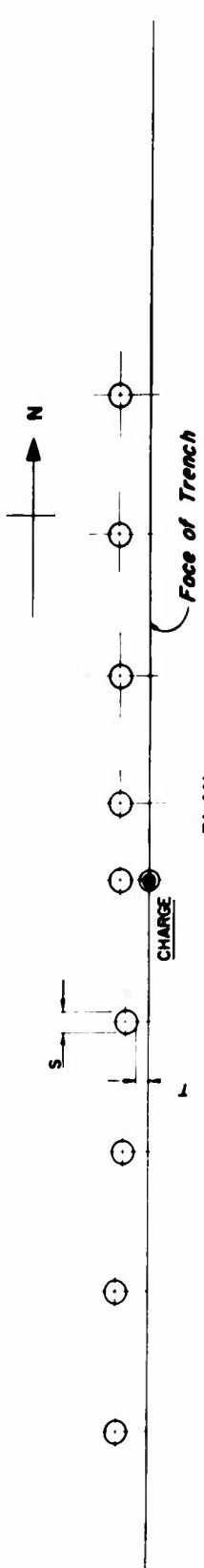

**LEGEND**  
 ▨ EXPOSED HOLE  
 / UNDISTURBED SNOW

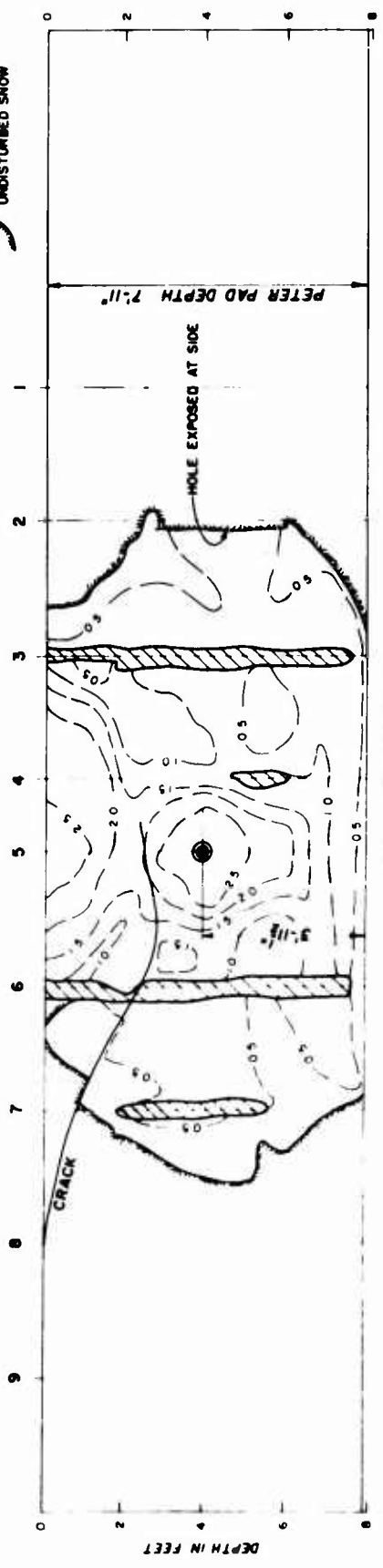

SHOT NO. 8

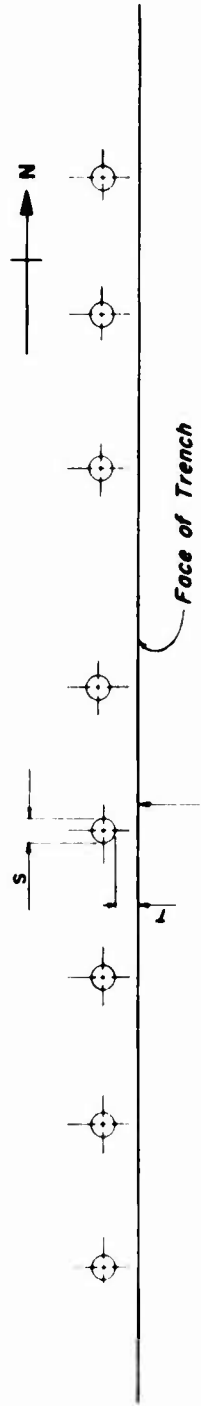

LEGEND  
 EXPOSED HOLE  
 UNDISTURBED SNOW

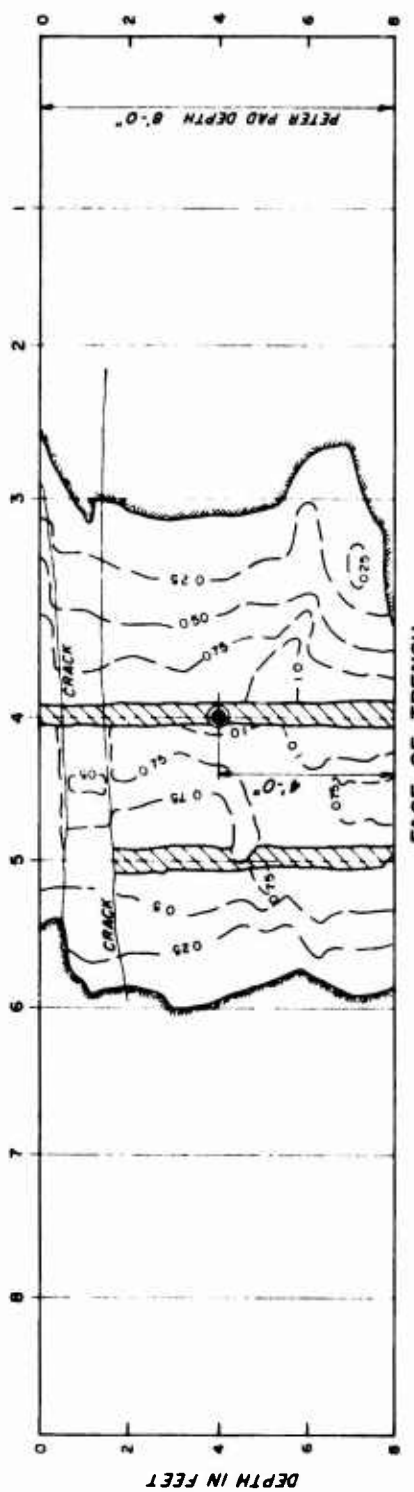

SHOT NO. 9





S - - -

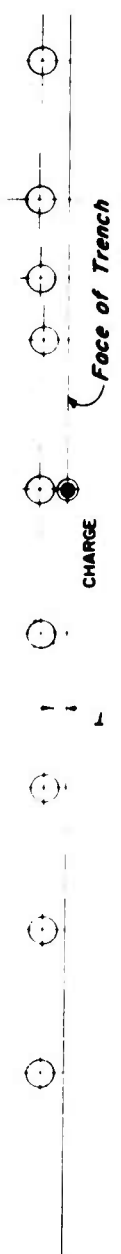

**LEGEND**  
EXPOSED MOLE  
UNDISTURBED SNOW

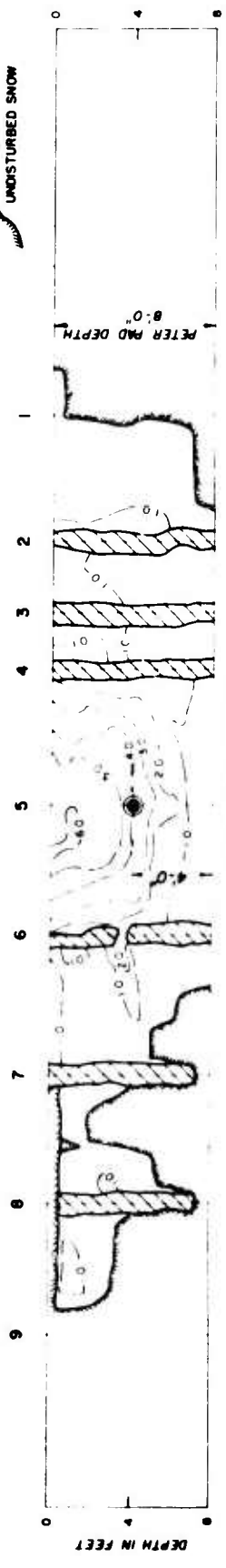

SHOT NO. JO

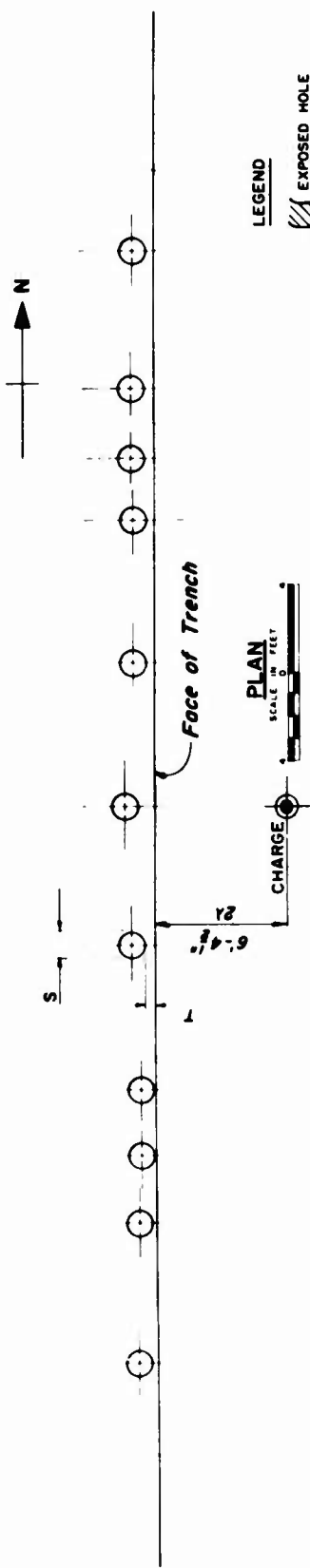

LEGEND

EXPOSED HOLE

UNDISTURBED SNOW

G GAGE

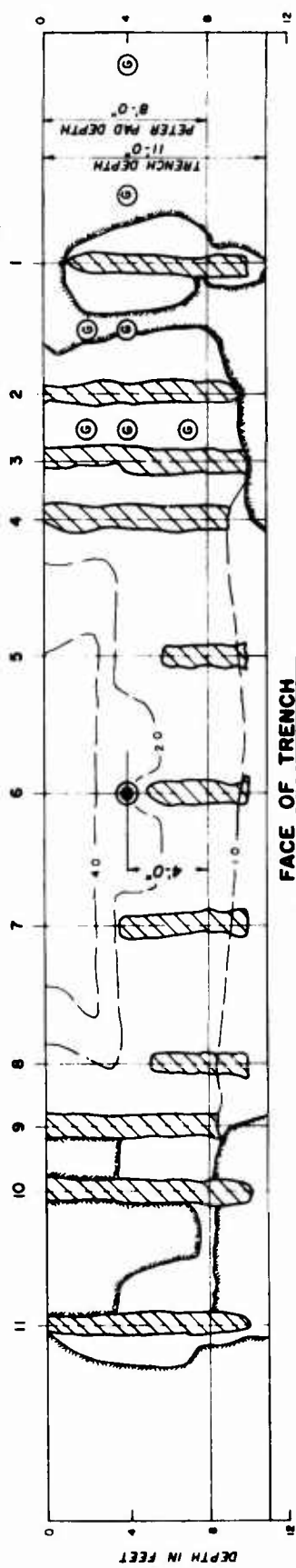

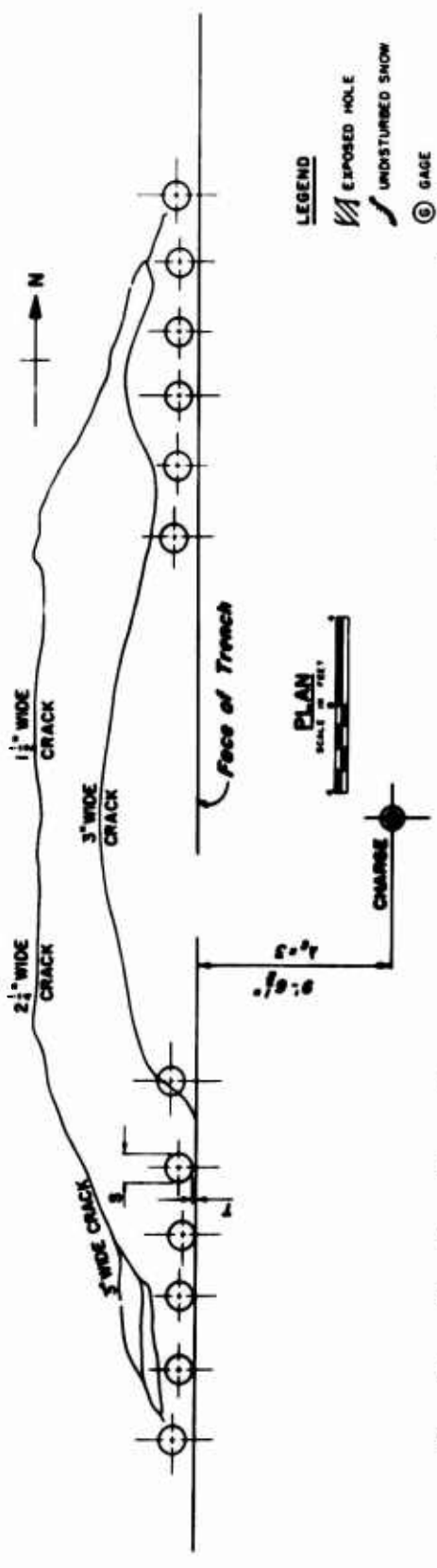

**LEGEND**

- Exposed Hole
- Undisturbed Snow
- GAGE

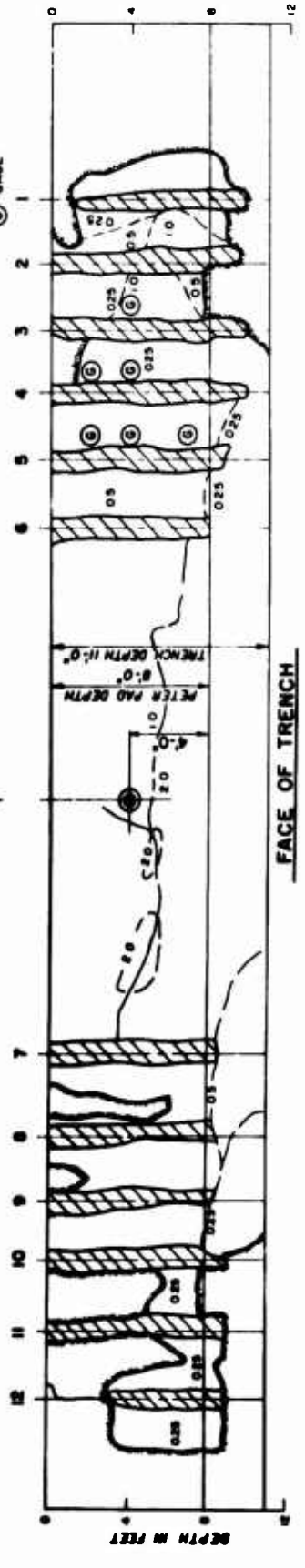

SHOT NO. 12

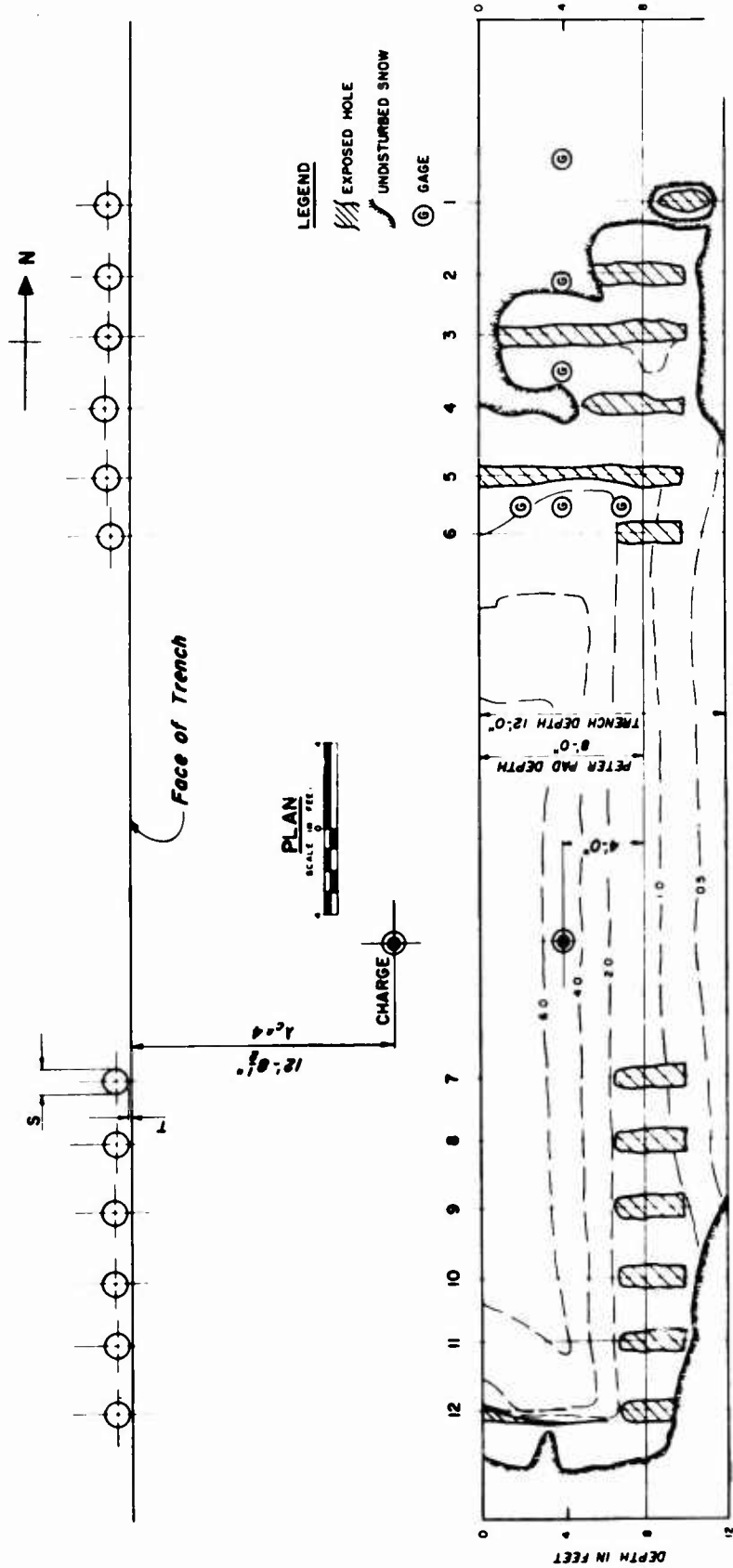

- LEGEND**
- EXPOSED MOLE
  - UNDISTURBED SNOW
  - G GAGE

FACE OF TRENCH



SHOT NO.13



15'-10"  
4'-8"



**LEGEND**

-  EXPOSED HOLE
-  UNDISTURBED SNOW
-  GAGE

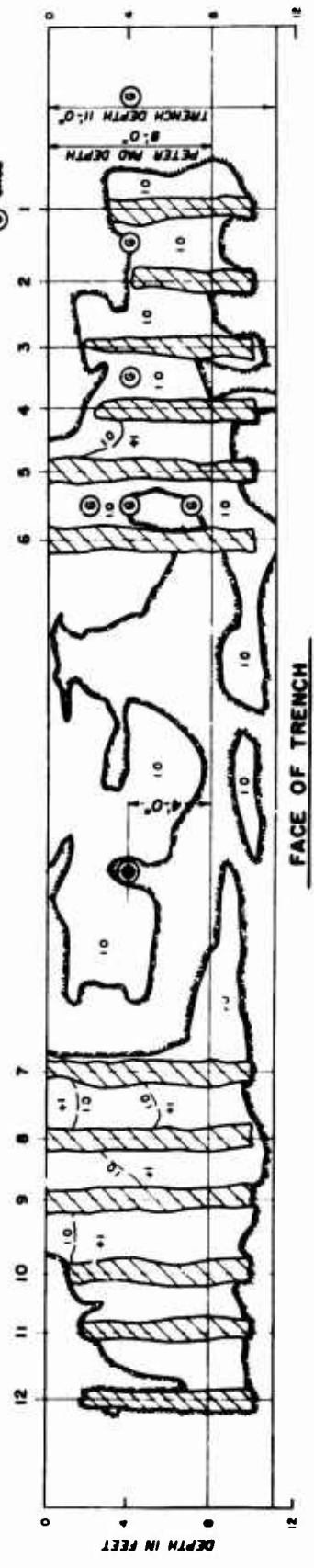

SHOT NO. 14

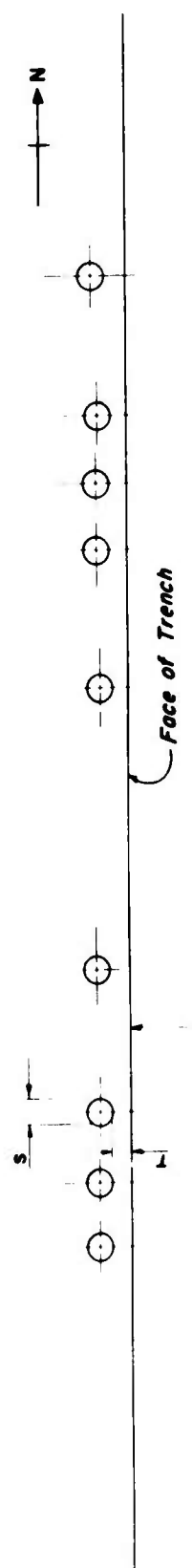

**LEGEND**

EXPOSED HOLE

UNDISTURBED SNOW

GAGE

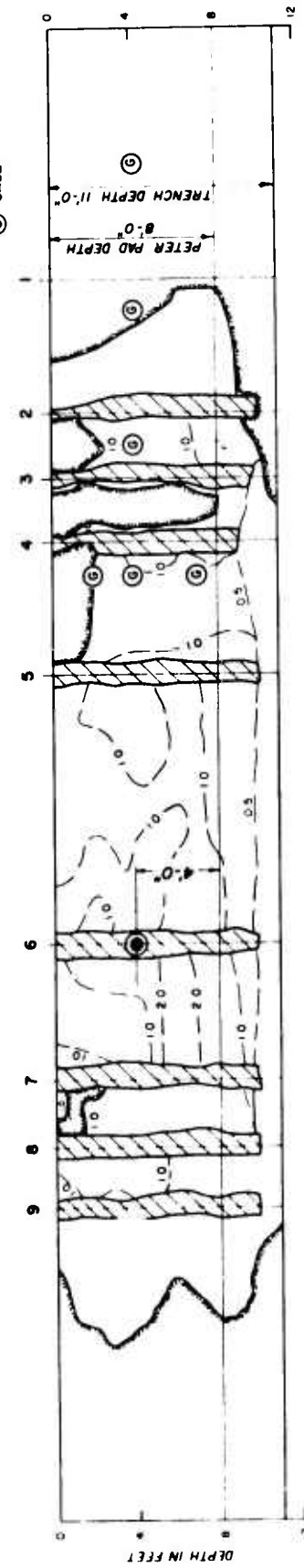

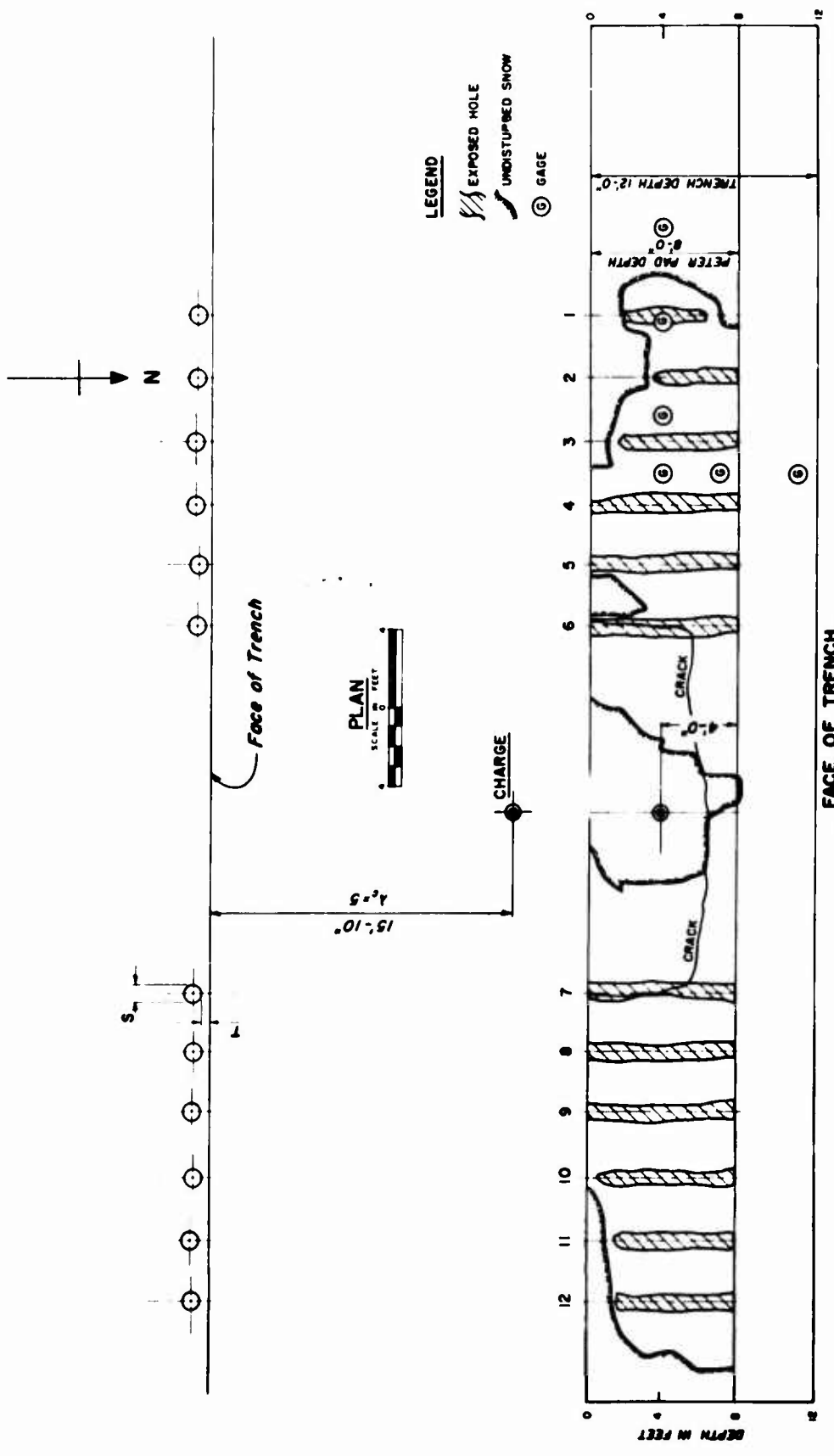

**LEGEND**

- EXPOSED HOLE
- UNDISTURBED SNOW
- GAGE

**FACE OF TRENCH**

**SHOT NO. 18**



- LEGEND**
- EXPOSED HOLE
  - UNDISTURBED SING.
  - GAGE

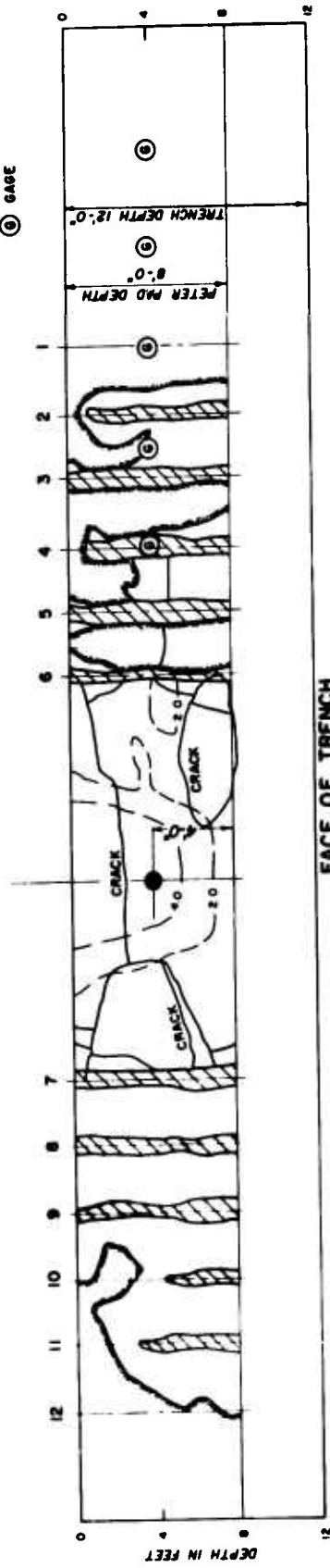

FACE OF TRENCH

SHOT NO.19



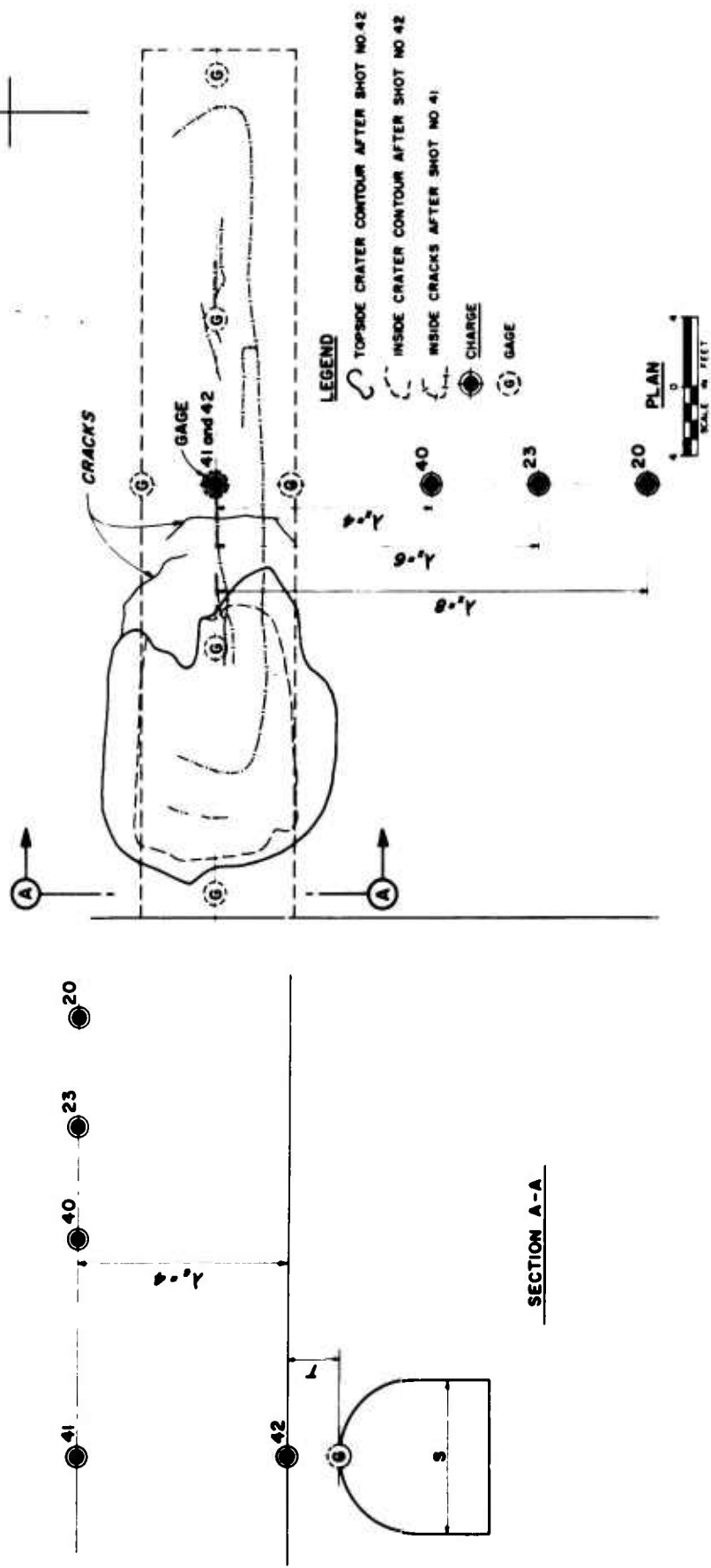

SHOT NO. 20, 23, 40, 41 and 42

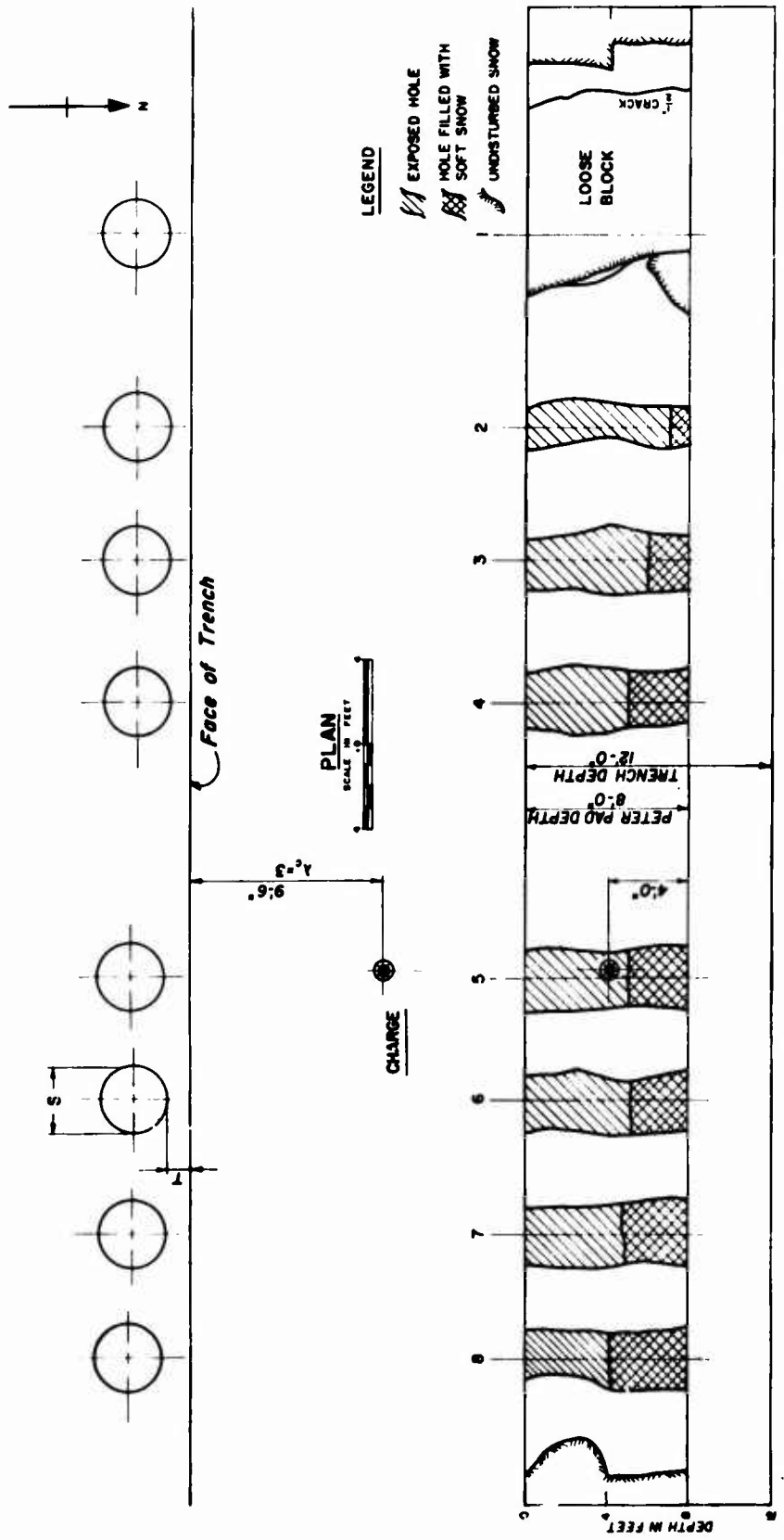

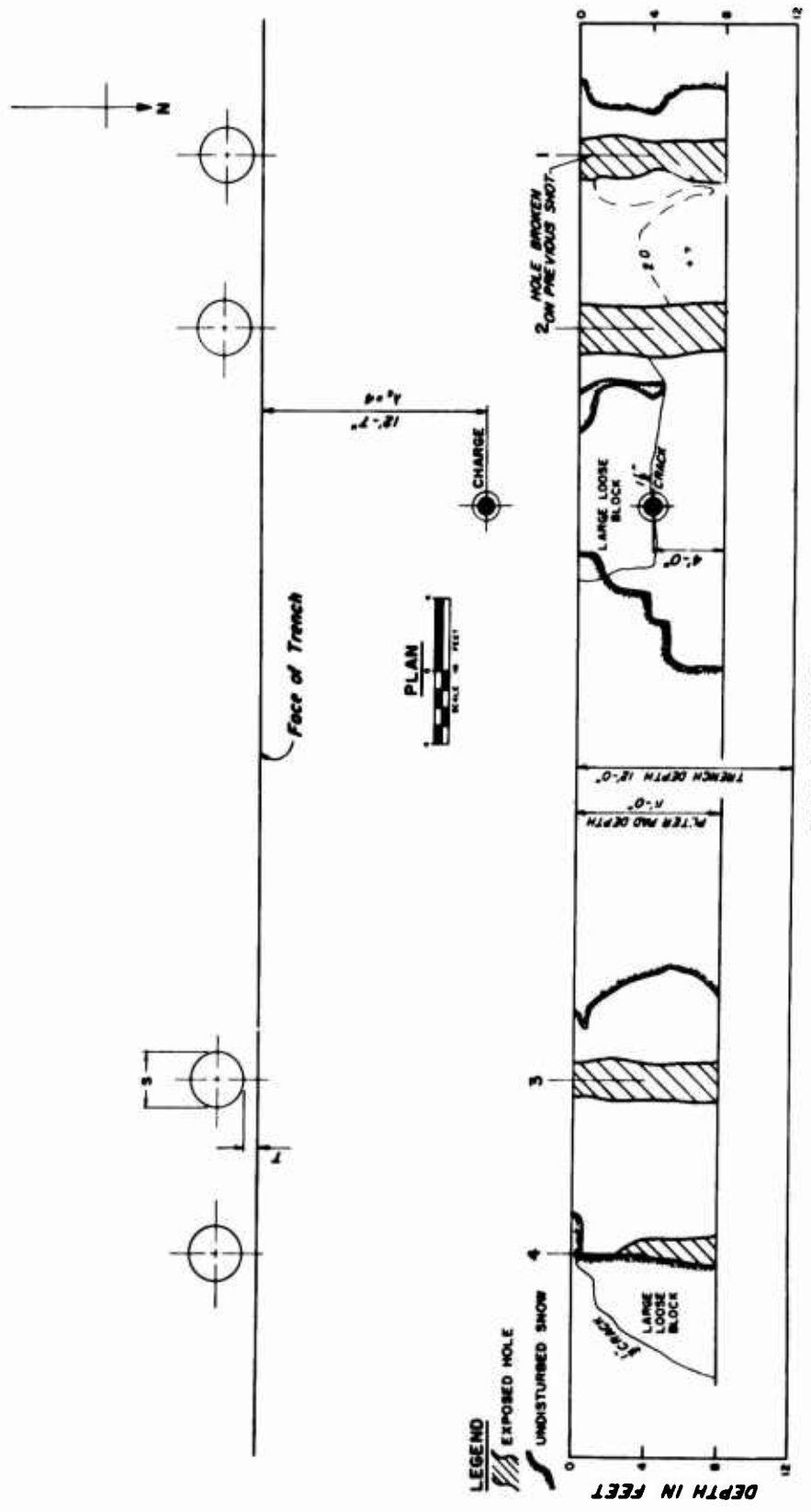

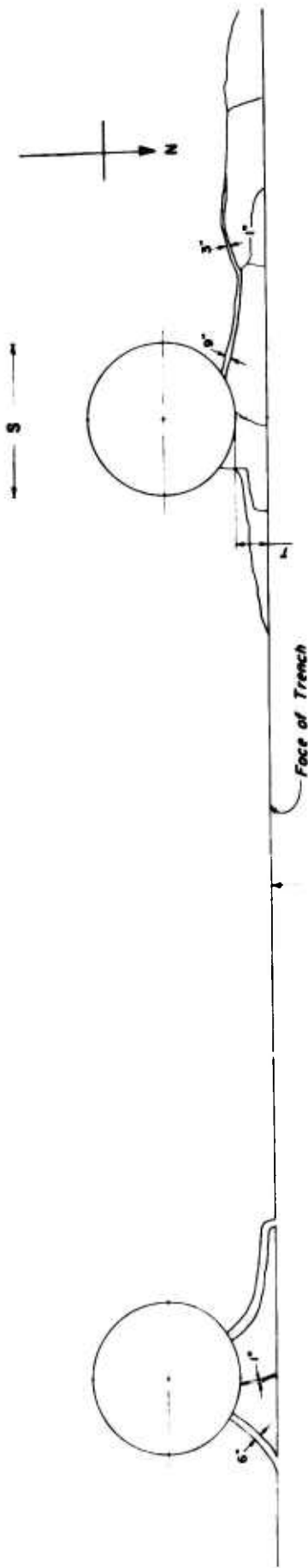

19'-0"

**LEGEND**  
 EXPOSED MOLE  
 UNDISTURBED SNOW

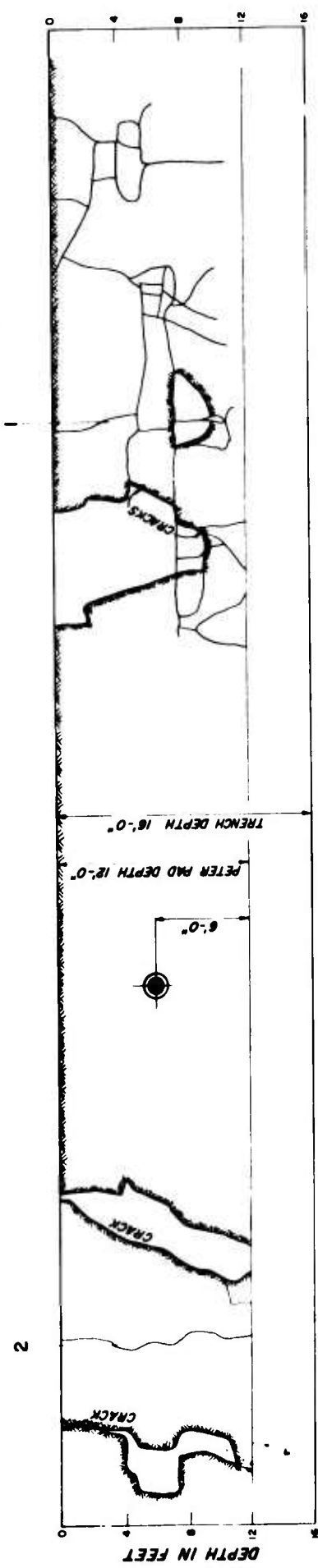

FACE OF TRENCH

SHOT NO.31

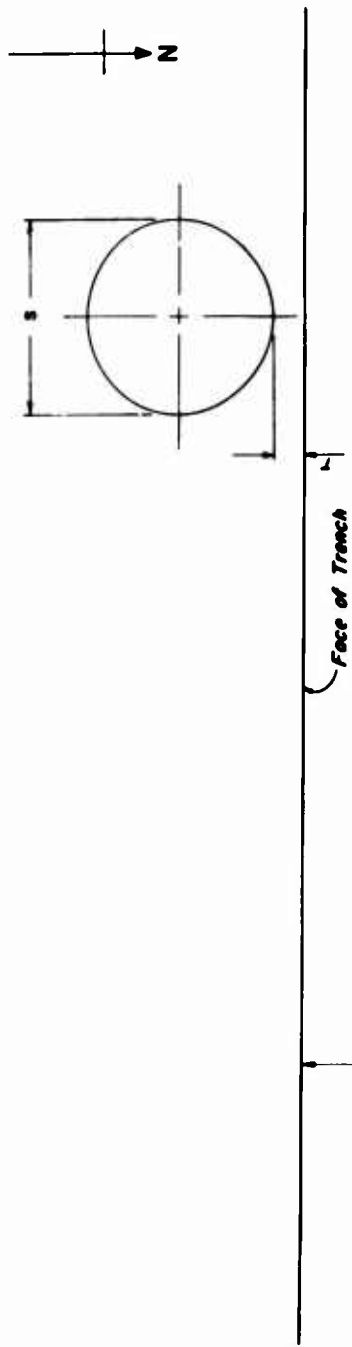

LEGEND  
 EXPOSED HOLE  
 UNDISTURBED SNOW

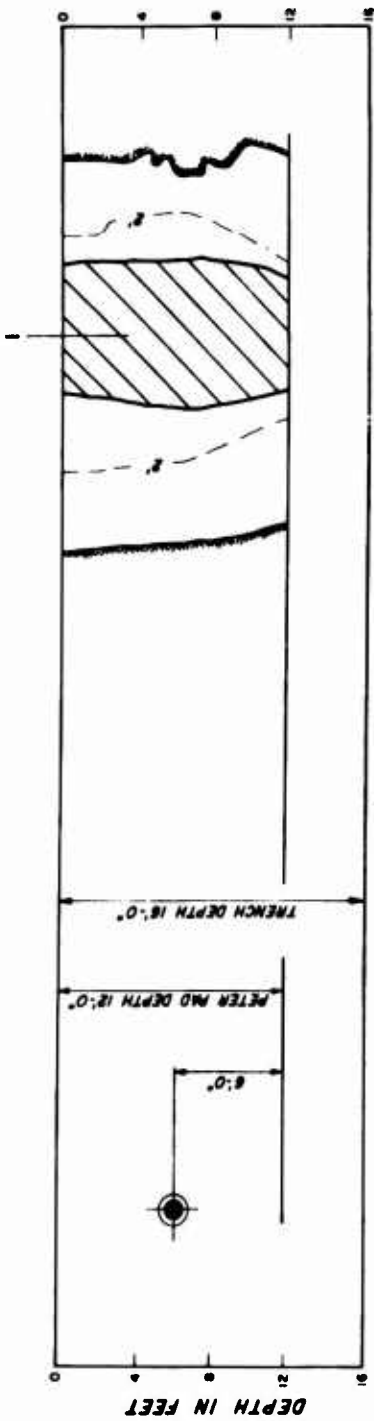

SHOT NO.32



S ←

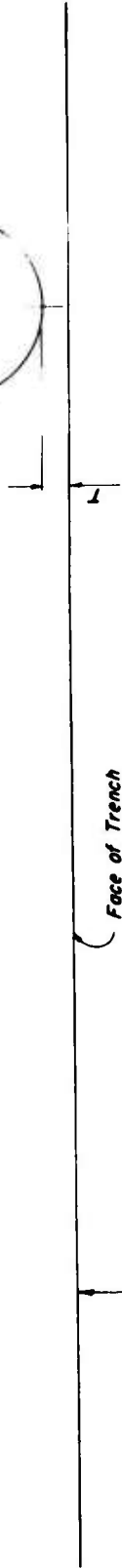
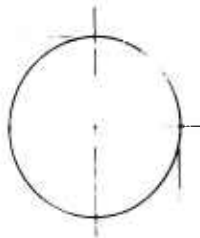

CHARGE

LEGEND

EXPOSED HOLE

UNDISTURBED SNOW

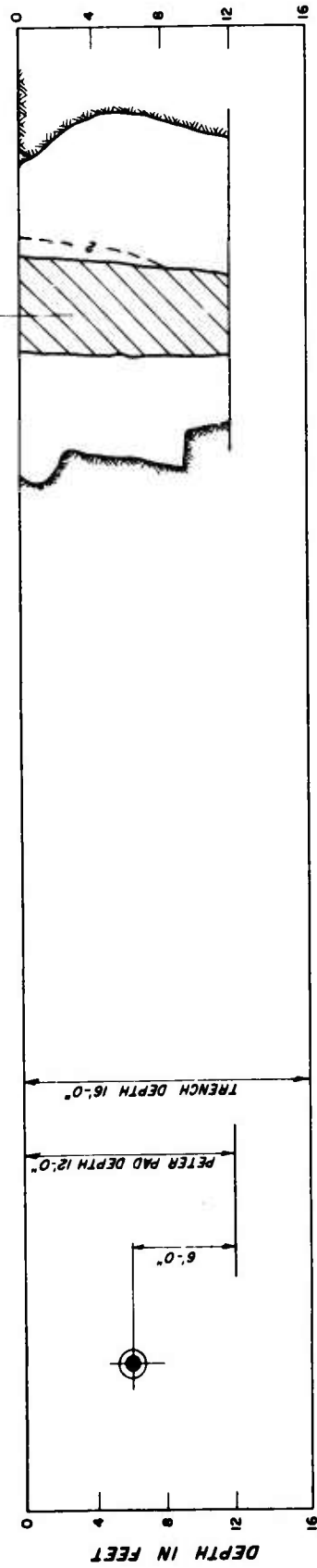

FACE OF TRENCH

SHOT NO.33

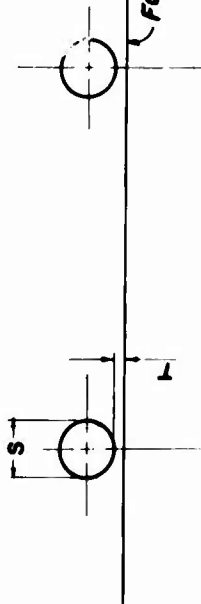

Face of Trench

6.4'

4.4'

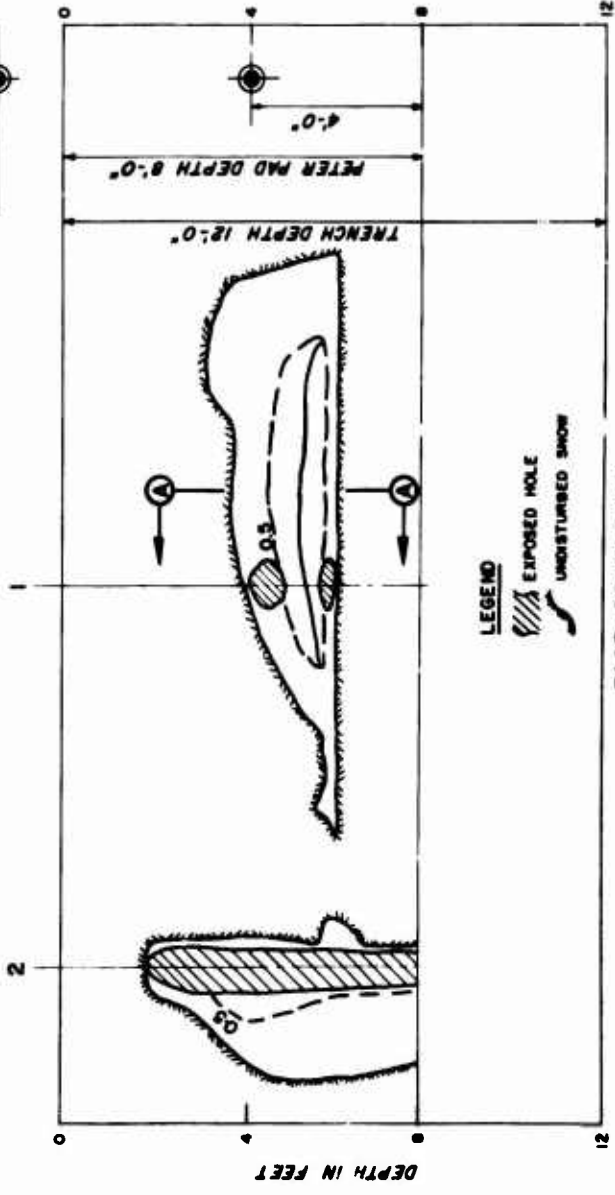

LEGEND

- EXPOSED HOLE
- UNDISTURBED SNOW

FACE OF TRENCH

SHOT NO. 34

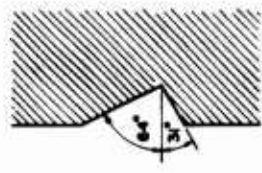

SECTION A-A

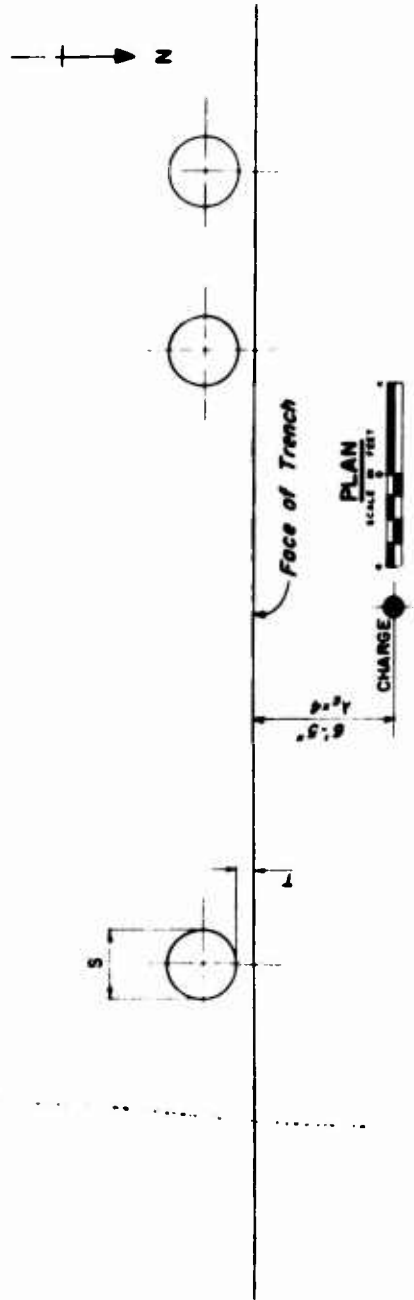

**LEGEND**

-  EXPOSED HOLE
-  UNDISTURBED SNOW

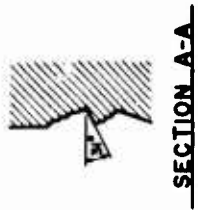
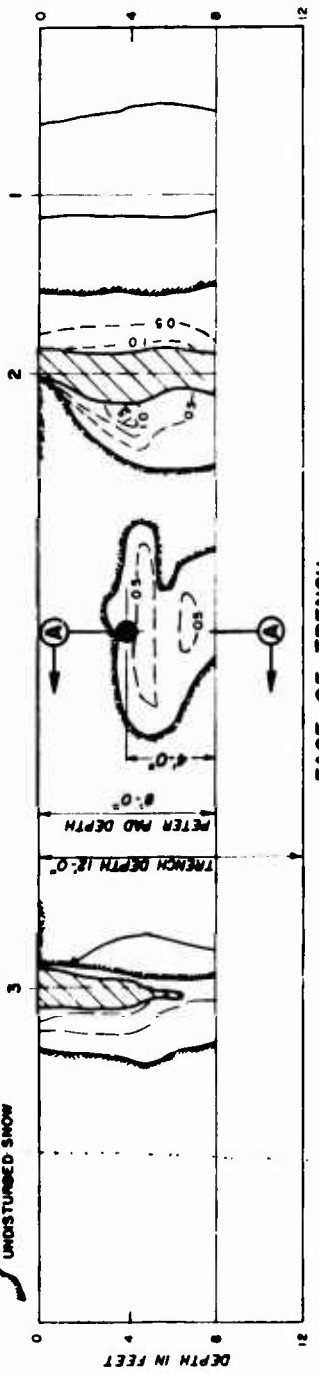

SHOT NO. 35



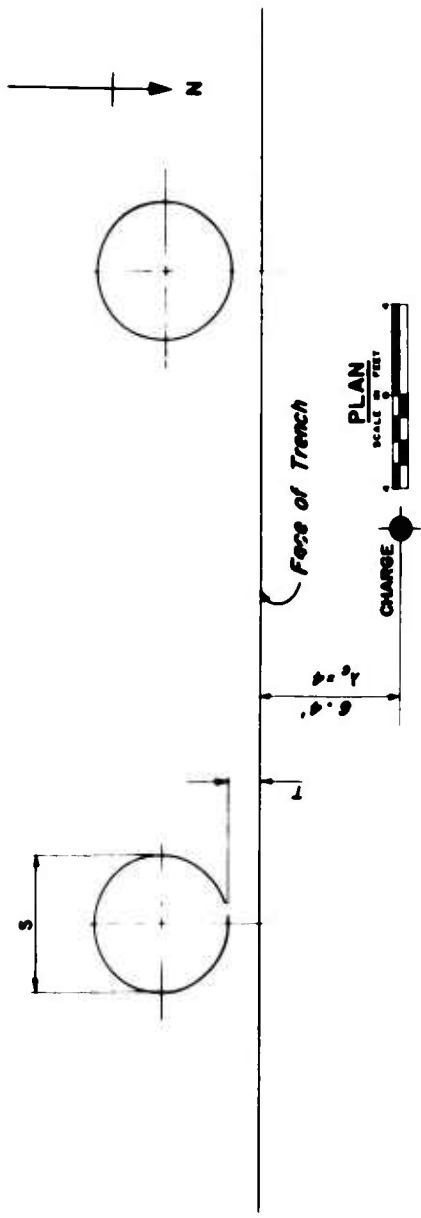

**LEGEND**

EXPOSED HOLE

UNDISTURBED SNOW

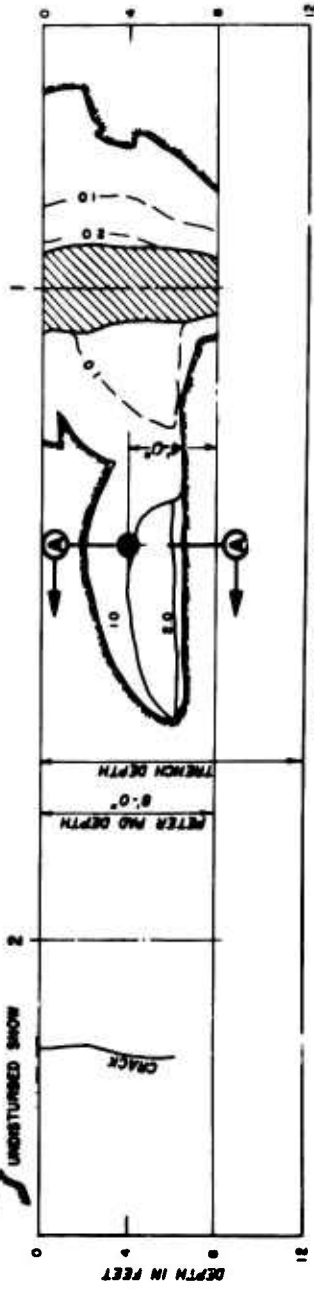

SHOT NO. 36

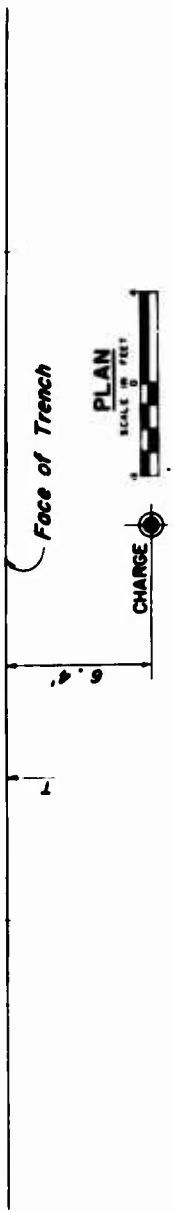

**LEGEND**

- EXPOSED HOLE
- UNDISTURBED SNOW

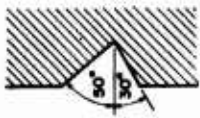
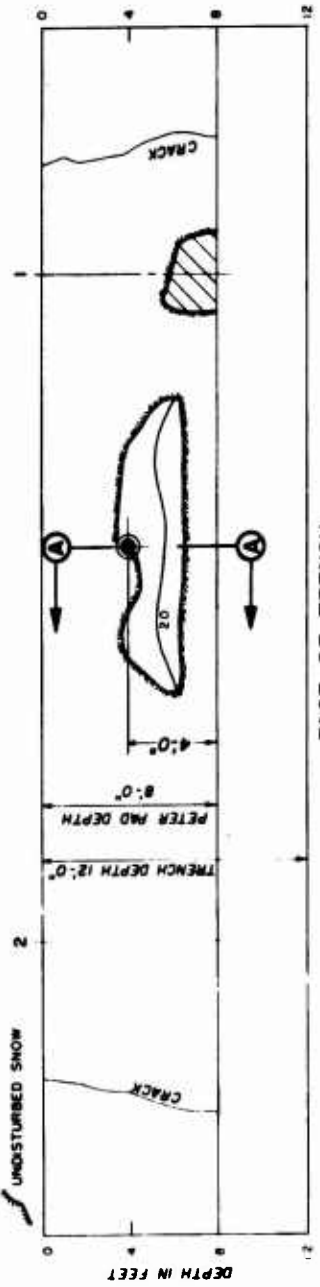

**SECTION A-A**

**SHOT NO. 37**

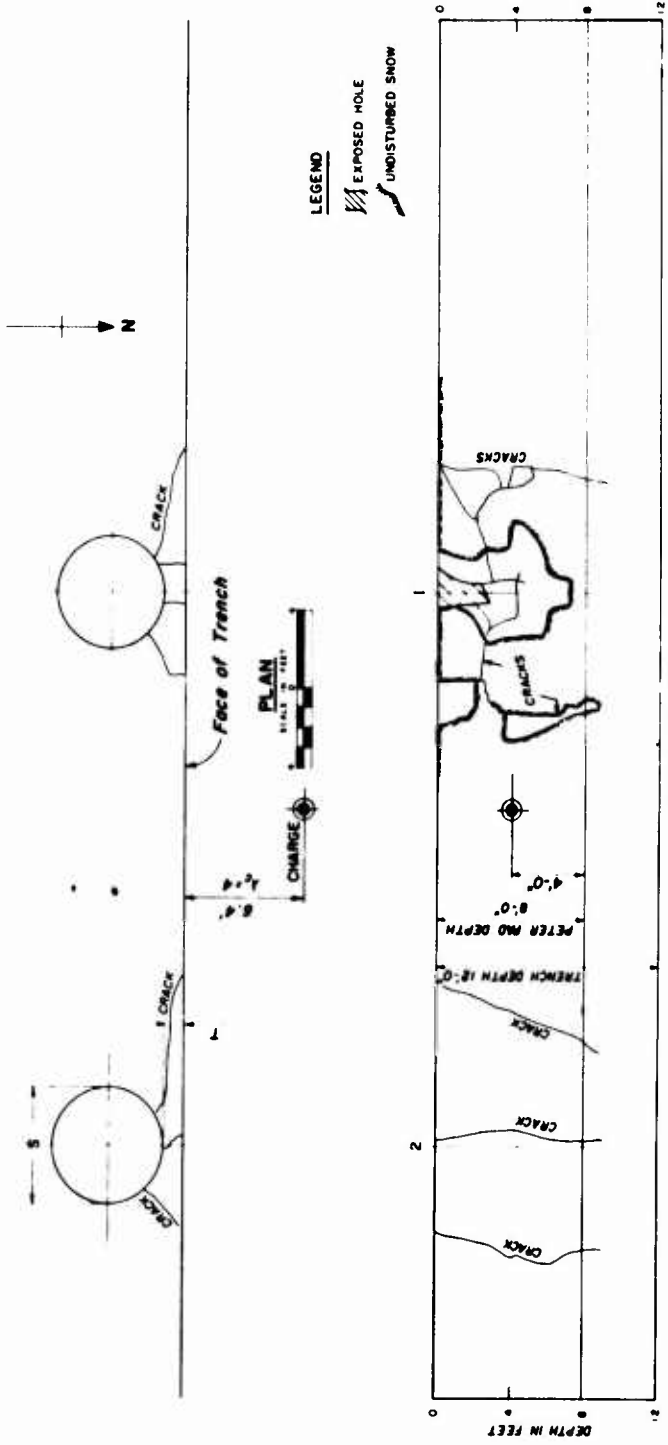

FACE OF TRENCH  
SHOT NO. 38

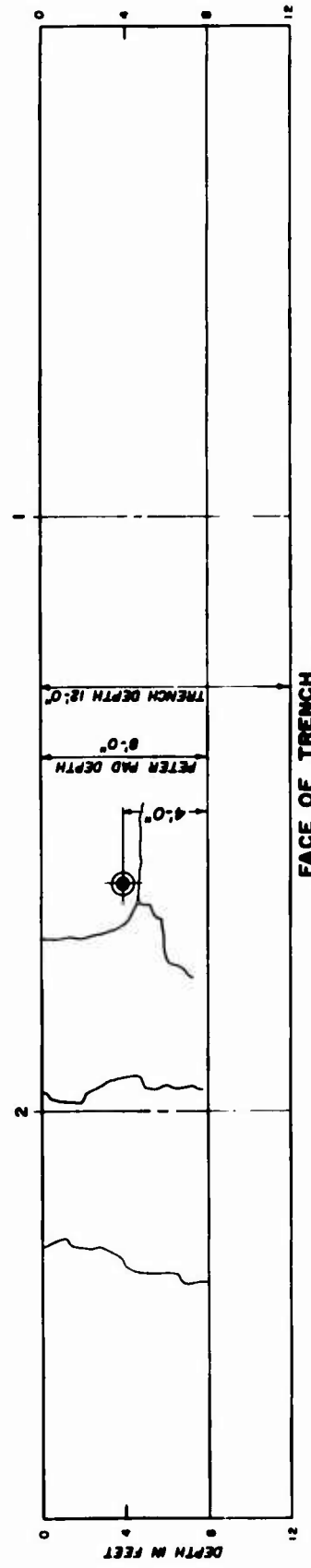
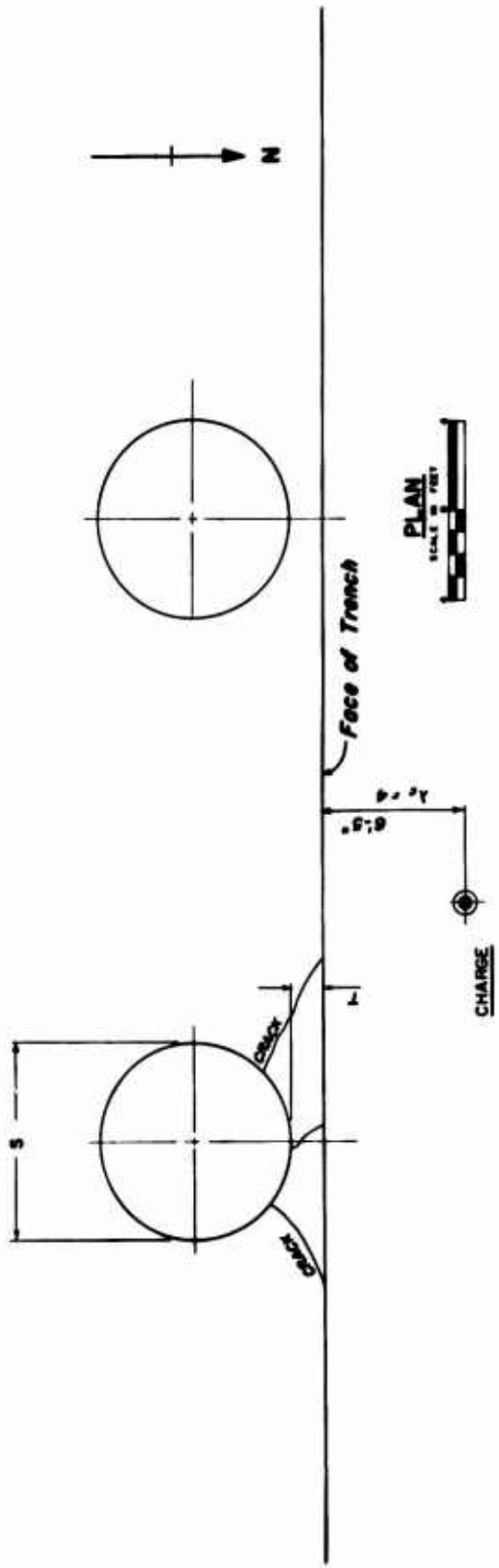

SHOT NO. 39

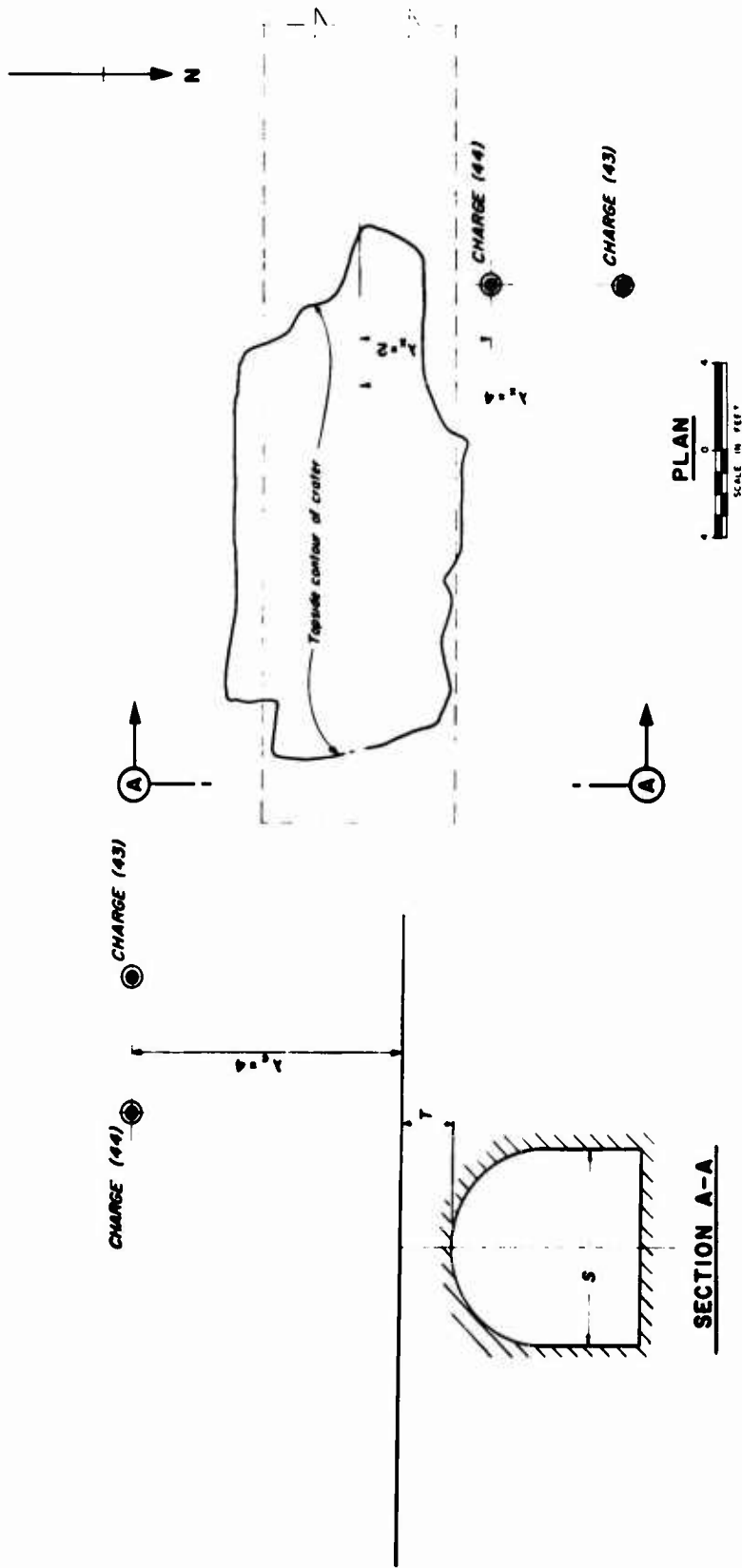

SHOT NO. 43 AND 44

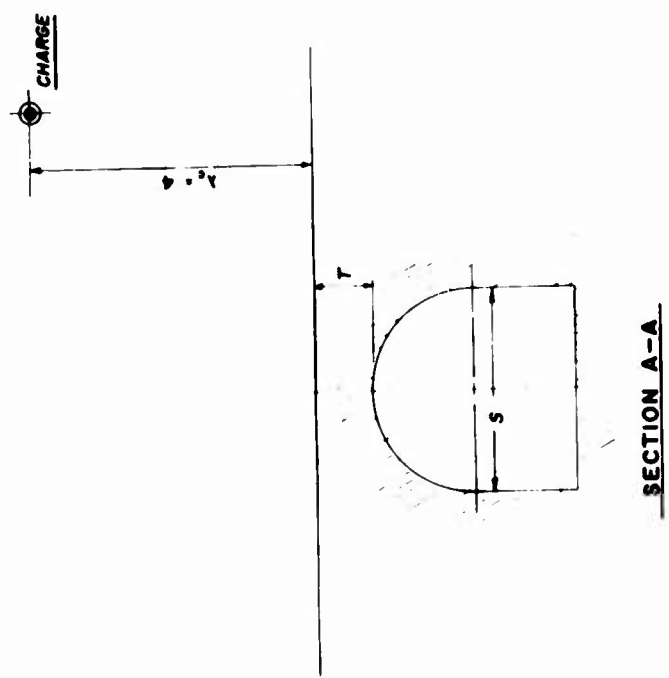
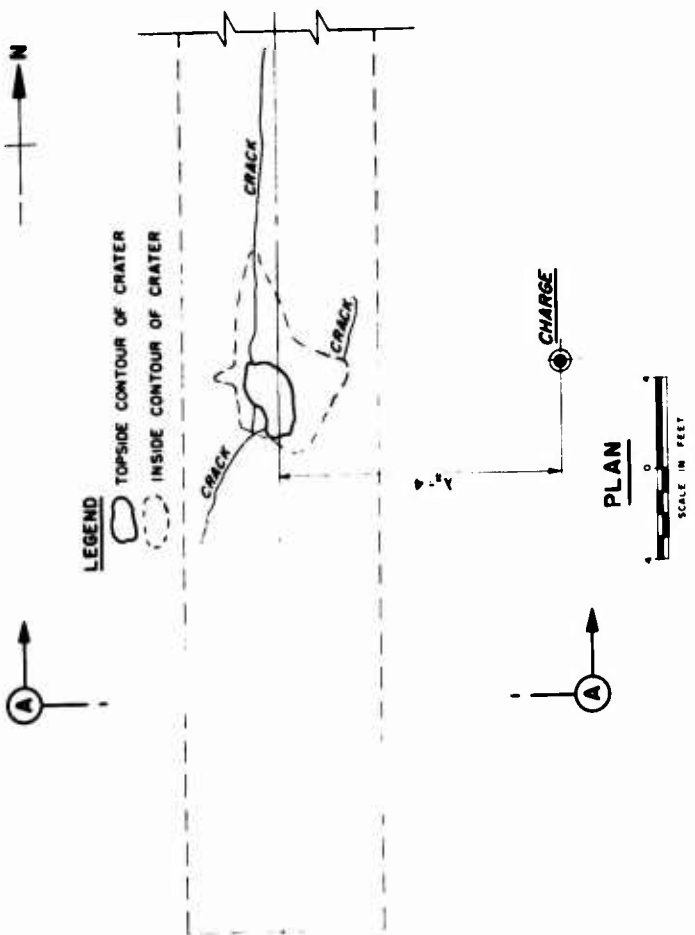

Unclassified  
Security Classification

DOCUMENT CONTROL DATA - R&D		
<i>(Security classification of title, body of abstract and indexing annotation must be entered when the overall report is classified)</i>		
1. ORIGINATING ACTIVITY (Corporate author) U. S. Army Cold Regions Research and Engineering Laboratory, Hanover, N.H.		2a. REPORT SECURITY CLASSIFICATION Unclassified
		2b. GROUP
3. REPORT TITLE EFFECT OF EXPLOSIONS ON SNOW STRUCTURES		
4. DESCRIPTIVE NOTES (Type of report and inclusive dates) Technical Report 92		
5. AUTHOR(S) (Last name, first name, initial) Szostak, Henryk and Benert, Robert		
6. REPORT DATE April 66	7a. TOTAL NO. OF PAGES 62	7b. NO. OF REFS 0
8a. CONTRACT OR GRANT NO.	9a. ORIGINATOR'S REPORT NUMBER(S) Technical Report 92	
b. PROJECT NO.	9b. OTHER REPORT NO(S) (Any other numbers that may be assigned this report)	
c. DA Task IV025001A13001		
d.		
10. AVAILABILITY/LIMITATION NOTICES Distribution of this document is unlimited		
11. SUPPLEMENTARY NOTES	12. SPONSORING MILITARY ACTIVITY U. S. Army Cold Regions Research and Engineering Laboratory	
13. ABSTRACT During the summer of 1960, tests were conducted on the Greenland Ice Cap to study the resistance and behavior of snow structures to dynamic loading from a surface or above-surface air blast of 4 or 32 lb. spherical cast TNT. A number of small-and full-scale vertical and full-size horizontal arches were constructed in processed snow pads. Arch spans and arch crown thickness were varied to establish a relation between surface overpressure and the ratio of arch span (S) to arch crown thickness (T). Some correlation was found for vertical structures but none between vertical and horizontal arches. The results show that, for the same charge weight and S/T ratio, the horizontal structures can withstand over 100 psi overpressure, while small-scale vertical arches fail at 20 psi.		

DD FORM 1473  
1 JAN 64

Unclassified  
Security Classification

Unclassified  
Security Classification

14. KEY WORDS	LINK A		LINK B		LINK C	
	ROLE	WT	ROLE	WT	ROLE	WT
Snow (Construction material) Explosives--Applications Utilities--Arctic regions						

**INSTRUCTIONS**

**1. ORIGINATING ACTIVITY:** Enter the name and address of the contractor, subcontractor, grantee, Department of Defense activity or other organization (*corporate author*) issuing the report.

**2a. REPORT SECURITY CLASSIFICATION:** Enter the overall security classification of the report. Indicate whether "Restricted Data" is included. Marking is to be in accordance with appropriate security regulations.

**2b. GROUP:** Automatic downgrading is specified in DoD Directive 5200.10 and Armed Forces Industrial Manual. Enter the group number. Also, when applicable, show that optional markings have been used for Group 3 and Group 4 as authorized.

**3. REPORT TITLE:** Enter the complete report title in all capital letters. Titles in all cases should be unclassified. If a meaningful title cannot be selected without classification, show title classification in all capitals in parenthesis immediately following the title.

**4. DESCRIPTIVE NOTES:** If appropriate, enter the type of report, e.g., interim, progress, summary, annual, or final. Give the inclusive dates when a specific reporting period is covered.

**5. AUTHOR(S):** Enter the name(s) of author(s) as shown on or in the report. Enter last name, first name, middle initial. If military, show rank and branch of service. The name of the principal author is an absolute minimum requirement.

**6. REPORT DATE:** Enter the date of the report as day, month, year, or month, year. If more than one date appears on the report, use date of publication.

**7a. TOTAL NUMBER OF PAGES:** The total page count should follow normal pagination procedures, i.e., enter the number of pages containing information.

**7b. NUMBER OF REFERENCES:** Enter the total number of references cited in the report.

**8a. CONTRACT OR GRANT NUMBER:** If appropriate, enter the applicable number of the contract or grant under which the report was written.

**8b, 8c, & 8d. PROJECT NUMBER:** Enter the appropriate military department identification, such as project number, subproject number, system numbers, task number, etc.

**9a. ORIGINATOR'S REPORT NUMBER(S):** Enter the official report number by which the document will be identified and controlled by the originating activity. This number must be unique to this report.

**9b. OTHER REPORT NUMBER(S):** If the report has been assigned any other report numbers (*either by the originator or by the sponsor*), also enter this number(s).

**10. AVAILABILITY/LIMITATION NOTICES:** Enter any limitations on further dissemination of the report, other than those imposed by security classification, using standard statements such as:

- "Qualified requesters may obtain copies of this report from DDC."
- "Foreign announcement and dissemination of this report by DDC is not authorized."
- "U. S. Government agencies may obtain copies of this report directly from DDC. Other qualified DDC users shall request through \_\_\_\_\_."
- "U. S. military agencies may obtain copies of this report directly from DDC. Other qualified users shall request through \_\_\_\_\_."
- "All distribution of this report is controlled. Qualified DDC users shall request through \_\_\_\_\_."

If the report has been furnished to the Office of Technical Services, Department of Commerce, for sale to the public, indicate this fact and enter the price, if known.

**11. SUPPLEMENTARY NOTES:** Use for additional explanatory notes.

**12. SPONSORING MILITARY ACTIVITY:** Enter the name of the departmental project office or laboratory sponsoring (*paying for*) the research and development. Include address.

**13. ABSTRACT:** Enter an abstract giving a brief and factual summary of the document indicative of the report, even though it may also appear elsewhere in the body of the technical report. If additional space is required, a continuation sheet shall be attached.

It is highly desirable that the abstract of classified reports be unclassified. Each paragraph of the abstract shall end with an indication of the military security classification of the information in the paragraph, represented as (TS), (S), (C), or (U).

There is no limitation on the length of the abstract. However, the suggested length is from 150 to 225 words.

**14. KEY WORDS:** Key words are technically meaningful terms or short phrases that characterize a report and may be used as index entries for cataloging the report. Key words must be selected so that no security classification is required. Identifiers, such as equipment model designation, trade name, military project code name, geographic location, may be used as key words but will be followed by an indication of technical context. The assignment of links, rules, and weights is optional.