

AD630822

# THE STANDARD NAVY MAINTENANCE AND MATERIAL MANAGEMENT SYSTEM (3-M SYSTEM)

A. J. RUFFINI

DISTRIBUTION OF THIS DOCUMENT IS UNLIMITED

CLEARINGHOUSE FOR FEDERAL SCIENTIFIC AND TECHNICAL INFORMATION		
Hardcopy	Microfiche	
\$ 3.00	\$ 0.50	51 pp as
ARCHIVE COPY		

DDC  
 RECEIVED  
 APR 14 1966  
 E

Code 1

ASSOCIATION OF SENIOR ENGINEERS BUREAU OF SHIPS  
THIRD ANNUAL TECHNICAL SYMPOSIUM



**DISTRIBUTION OF THIS DOCUMENT IS UNLIMITED**

**THE STANDARD NAVY MAINTENANCE  
AND MATERIAL MANAGEMENT SYSTEM (3-M)  
ITS STATUS AND APPLICATION**

**ANTHONY J. RUFFINI**

## SYNOPSIS

This paper defines and discusses both elements of the 3-M System initialed by the Chief of Naval Operations in March 1963, i.e, the Planned Maintenance System (PMS) and The Maintenance Data Collection System (MDCS) from a historical, current and future viewpoint.

The PMS is a realistic minimum planned maintenance program which has proven to be a very effective management tool used to schedule, monitor, and manage maintenance. The Work Study technique used to develop planned maintenance requirements as well as the software and hardware associated with the System is discussed.

The MDCS concept is discussed in considerable detail. It will be fleet-wide superseding all other maintenance reports by January 1967. MDCS has been extended to tenders and is scheduled to be extended to shipyards. The products of the 3-M System has been used to a limited degree and will be used more extensively as a vital input to equipment design, maintainability, reliability, logistic and acquisition as well as personnel requirements and maintenance standards.

## INTRODUCTION

The Standard Navy Maintenance and Material Management System, commonly referred to as the "3-M System" is a revolutionary concept of management currently being implemented in the active U.S. Navy Fleet. This System takes cognizance of and offers remedial solutions for the increasing complexity of equipment being introduced into the Fleet and the decreasing availability of skilled personnel to maintain them.

Many people are amazed to learn that costs associated with maintenance of equipment account for as much of the Department of Defense budget as does the procurement of new equipments. These costs become even more apparent when one realizes that all the gold in Fort Knox would not pay for the maintenance costs incurred by the Department of Defense for one year. How many realize the increase in logistic parts support costs? The most expensive electronic tube in World War II was approximately \$170 - today it runs as high as \$16,000.

The 3-M System was introduced into the Navy on 8 March 1963 by the Chief of Naval Operations Instruction 4700.16. This Instruction contained two basic milestones as shown in Illustration No. 1. The first was to develop and implement a standard of maintenance planning and control that would provide for the uniform accomplishment of planned maintenance throughout the operating forces and the second, to develop and implement a uniform system for collecting, processing, analyzing and distributing feedback information to enable line commanders and support Bureaus to better carry out their management functions in support of the operating forces. The former is referred to as the PLANNED MAINTENANCE SYSTEM (PMS), while the latter is known as the MAINTENANCE DATA COLLECTION SYSTEM (MDCS).

The objective of the 3-M System simply stated is to improve material readiness of the Fleet through improved management of maintenance and material functions.

The 3-M System encompasses all segments of the Navy and is applicable to all shipboard departments and disciplines. It is directed by the Chief of Naval Operations and is being executed by the Chief of Naval Material. Thus a user - producer relationship exists. Policies necessary to achieve the goals of the 3-M System are established by a Steering Group composed of flag rank members from the Chief of Naval Operations, the Chief of Naval Material and all participating Bureaus. The efforts of the participating Bureaus are coordinated and monitored weekly by means of a Staff Working Group chaired by the Chief of Naval Material 3-M System Director.

Prior to initiating the 3-M System, the Navy reviewed the maintenance procedures that prevailed in an attempt to determine their shortcomings. Basically, the problems associated with them can be summed up and categorized as follows:

- Non-uniform Maintenance Procedures and Practices

Each ship's department head was responsible for evolving his own maintenance program based on existing directives, experience and motivation. This, of necessity, resulted in extremely subjective maintenance programs ranging in quality from poor to outstanding.

- Myriad Reports

Ships were required to submit reports to all echelons of command. A survey taken revealed that an engineer officer from a typical destroyer was required to maintain or forward over 200 reports per month. From a practical viewpoint, this was a physical impossibility. The result was that many reports were not submitted. Some might view this last statement with alarm until they are informed that very little was done with those reports that were submitted primarily due to the fact that the Bureaus were attempting to establish trends by manual manipulation of data. This also was a physical impossibility.

- Lack of Real Maintenance Management at the Command Level

Without a uniform maintenance system, it was extremely difficult for command to exercise meaningful management. As could be anticipated, this management responsibility was delegated to lower echelons who lacked commensurate authority.

- Inexperienced Officers

Inexperienced officers were often given responsibility for major power plants or complex electronic systems with very little guidance and direction. Typically, a destroyer engineer officer

is a Lieutenant with several years of service. Less than half of them have engineering degrees. It is truly remarkable that these young men performed as well as they did in spite of the handicaps that prevailed.

• Varying and Conflicting Maintenance Documentation

As if the young inexperienced officer didn't have enough to cope with, the guidance available to him was often meager, general and conflicting. Manufacturer's instruction books were often at variance with Bureau directives or technical manuals. Which was right? Many of the issues involved could be debated by seasoned engineers and specialists, yet, these young officers were asked to make decisions that would challenge the masters.

• Poor Material Support for Maintenance

Inevitably, we frequently failed to get the right part to the right place at the right time.

The 3-M System planners took stock of these deficiencies and made sincere efforts to compensate for them. The 3-M System did not evolve overnight. It was developed in the Fleet environment with the Fleet's participation and evolved only after considerable study, planning, trials and errors. The time spent on the "Fleet's Drawing Board" has reaped tremendous dividends for the System has been enthusiastically received by the Fleet from the shipboard sailor to the Fleet Commander.

Let's now discuss the two basic milestones of the 3-M System.

THE PLANNED MAINTENANCE SYSTEM (PMS)

Essentially, the Planned Maintenance System is a tool which affords the department heads aboard ship the ability to manage, schedule and control the maintenance of their equipment. A scheduling technique has been developed which balances the workload yet gives the department head the flexibility to determine when the required maintenance task can best be performed based on his operational commitments and availability of required manpower. It is worthy to mention that the System is not mailed to the ship "to be implemented upon receipt." It is installed by a trained team who spend anywhere from three days to three weeks with the ship. All shipboard personnel, from the commanding officer to the unrated sailor, are indoctrinated into the System. Each has a vital role to perform in the execution of this System and accordingly, each is appraised of this role and what the System has to offer him.

A Planned Maintenance System Installation Package consists of:

## Hardware

- Maintenance Control Boards
- Weekly Schedule Holders
- Maintenance Requirement Card and Space Manual Holders

## Software

- Planned Maintenance System Manuals
- Cycle Schedules
- Quarterly Schedules
- Weekly Schedules
- Maintenance Requirement Cards

The Software will now be discussed individually.

### The Planned Maintenance System Manual

This Manual consists of: a list of effective pages showing the equipment covered by this System; Maintenance Index Pages summarizing all the planned maintenance prescribed for each equipment along with the rates and time required to accomplish these tasks and any related maintenance that can be accomplished concurrently; a manhour summary by rate required to accomplish the minimum maintenance prescribed; and a listing of equipment for which no maintenance is required. This Manual is retained by the department head and used in scheduling maintenance tasks. Applicable portions of the Manual are made up for each maintenance group and are located in the work spaces for use by the leading petty officers in preparing their weekly schedule.

Illustrations 2 through 4 are typical pages from a Manual prepared for the fireroom of a destroyer.

### The Cycle Schedule

The Cycle Schedule, Illustration No. 5, is prepared by the installation team and attempts to evenly divide the prescribed maintenance tasks over the operational cycle of a ship between overhauls. It recommends the quarter after overhaul during which certain maintenance tasks should be performed. The flexibility of the System will become obvious as we go along. Notice that the cycle schedule depicted prescribes the quarter in which the maintenance task is to be accomplished as opposed to specifying a specific month, week or day.



### The Quarterly Schedule

The Quarterly Schedule is located adjacent to the cycle schedule in a holder known as the Maintenance Control Board. This is used by the department head to schedule his planned maintenance for the operational quarter after overhaul the ship is currently in. Illustration No. 6 encompasses the 5th quarter after overhaul, specifically the months of October, November and December. The department head would review the cycle schedule to establish which maintenance tasks must be performed during the 5th quarter after overhaul. Based on the ship's operational commitments, which he enters in the space provided at the top, he selects the week of the month best suited to accomplish the task. You will note that the department head had complete flexibility in selecting the month and week best suited to him. The Maintenance Control Board is usually mounted outside the department head's office. Each maintenance group has a leaf on the board with a tailored cycle schedule and an accompanying quarterly schedule. Depending on the type of ship, anywhere from one to eight boards may be utilized.

### The Weekly Schedule

The Weekly Schedules are located in the work spaces and are used by the petty officer-in-charge of the space. Illustration No. 7 depicts a weekly schedule for the Number 1 Fireroom on a typical destroyer. The petty officer-in-charge prepares his weekly schedule the beginning of each week and bases it on the maintenance tasks assigned to him by his department head on the quarterly schedule. Once again, we see the flexibility of the System. The department head has schedule the maintenance tasks to be accomplished during this specific week but the space petty officer has the flexibility of selecting the day of the week best suited to him. For example, if we look at the composite cycle, quarterly and weekly schedule in Illustration No. 8, we observe that all of the maintenance tasks prescribed on the quarterly schedule for the second week of October have been scheduled for that week on the weekly schedule. In preparing the Weekly Schedule, the space petty officer assigns men by name to accomplish the tasks. His selection of men is based on the rates required for the task which are listed in his space manual.

The weekly schedule is posted in the work space and is used by all personnel within that space to determine their assigned tasks. The holder used to contain this schedule is called the Weekly Schedule Holder.

## Maintenance Requirement Cards

Below or adjacent to the weekly schedule is a card and manual holder which contains the space manual and all the Maintenance Requirement Cards required for the proper maintenance of equipment installed in the work space. To demonstrate how the System works, let us assume that you are Smith BT 2/C. You would review the weekly schedule and note that you have been scheduled to perform an annual maintenance on the emergency feed pump. The code used is significant and simple. In this example, the Maintenance Requirement Card involved would be F7-A1, the first part of this designation indicating the work space, which in this case is the fireroom while the second part designates the periodicity or frequency with which the task must be accomplished. The periodicity codes used are:

- D - Daily
- W - Weekly
- M - Monthly
- Q - Quarterly
- S - Semi-annual
- A - Annual
- R - Situation Requirement based on hours of operation.

Smith would sort through the Maintenance Requirement Cards contained in the card holder and pull out F7-A1. This Card is shown as Illustration No. 9. What does the card tell Smith? It tells him what is to be done, the tools, parts and materials required to accomplish the task, unique safety precautions to be observed and a step-by-step procedure for performing the task.

These requirements have been developed by equipment specialists thoroughly acquainted with the capability of shipboard personnel. Each developer has been specially trained in work study techniques wherein he is taught to critically examine all requirements and establish what must be done, who should do it, why should it be done, when should it be done, and by whom? Developers are guided but not bound by precedence.

The monitoring of maintenance actions accomplished has been intentionally simplified. The petty officer-in-charge denotes the accomplishment of a scheduled maintenance action by crossing out the action on the weekly schedule. If the task were not accomplished, he would indicate this by circling the action on the weekly schedule. At the end of the week, the petty officers of the respective spaces report the status of scheduled maintenance by properly annotating the appropriate quarterly schedule with "Xs" or circles. Thus the department head can establish the condition and readiness of his equipment by merely reviewing his maintenance control board.



The Planned Maintenance System has been installed in every major ship type of the active Fleet. To date approximately 650 ships have received this System and ships are being implemented at the rate of 40 to 60 per month. Current milestones schedule the complete active Fleet to be implemented by March 1967. Illustration No. 10 depicts the ship types that have received the System and percentage covered.

To keep the System dynamic and current, a Feedback Form, Illustration No. 11, has been developed. Through this media, shipboard personnel can express any comments they have relative to the System or request Maintenance Requirement Cards for new or modified equipment. To date, over 9,000 forms has been received from the Fleet. Our average response time is seven days. Every quarter, each ship receives a complete accounting of the disposition of their feedbacks submitted. This report is prepared utilizing computer techniques. An additional procedure has been developed which enables us to completely replace and update a ships' Planned Maintenance System at the end of every overhaul.

Illustration No. 12 shows our System assets to date. As can be seen, over 39,000 Master Maintenance Requirement Cards and Maintenance Index Pages have been developed to date for Bureau of Ships' equipment. A mechanized control has been established which enables us to know the holders of every card and page. Revisions to cards and pages are sent to only those ships concerned and not to the Fleet at large.

#### THE MAINTENANCE DATA COLLECTION SYSTEM (MDCS)

The Maintenance Data Collection System is a standard system used by all departments of all ships to report all maintenance actions accomplished or deferred. Whereas the Planned Maintenance System encompasses only that maintenance which can be scheduled, the Maintenance Data Collection System is concerned with all maintenance, scheduled and unscheduled. The concept involved in this System is that a maintenance action will be reported only once to a central data processing center where the data elements reported will be structured into format to suit the varying requirements of the individual commands ashore and afloat. This concept is depicted in Illustration No. 13.

Similar to the Planned Maintenance System, the Maintenance Data Collection System did not evolve overnight. In fact, strange as it may sound, the Navy came out of its parochial shell and looked at what the Air Force had done. Impressed with the Air Force's data collection system, the Navy evaluated it aboard fourteen ships for approximately nine months. Concurrent with this evaluation, the Office of Naval Research was chartered to determine the quantitative

requirement for an information system. The initial step in this direction was a user survey conducted under their guidance. This survey extended to 131 major organizational activities within the Navy and included interviewing 1600 persons. Basically, all Naval activities who had a report requirement from the Fleet were visited and queried as to what data elements they required. A summary of this survey is shown on Illustration No. 14. Notice that 75% of all alleged requirements could be satisfied by collecting 10 elements of data from the Fleet, 85% by collecting 15 and 100% by collecting 25.

The Navy Maintenance Data Collection Forms 4700.2B, 4700.2C and 4700.2D evolved only after considerable study of the Air Force System and the user survey. These forms are presently in use in over 550 ships of the active Fleet.

Illustration No. 15 shows the 4700.2B form. This form is used by shipboard personnel to report all maintenance actions accomplished. The upper portion of the form identifies the ship reporting and the date of the report. The middle portion identifies the equipment on which the action was accomplished, how it malfunctioned, when discovered, action taken, manhours involved in accomplishing the action, equipment serial number, operating time and whether an alteration was involved or not. The bottom portion is used to identify the person accomplishing the action. Parts used in support of the maintenance action is reported on existing supply forms, i.e., DD-1348 and NAVSANDA 1250.

An action which cannot be accomplished by shipboard personnel due to lack of skill, part, drawing, instruction manual or other similar reasons are reported on forms 4700.2C and 4700.2D. 4700.2C is used as a tender work request and is scheduled to become the work request for shipyards. 4700.2D is used to report deferred maintenance actions. Both of these forms are multi-copy and contain data elements similar to those on the 4700.2B form. These forms are shown in Illustration Nos. 16 and 17.

The System utilizes a unique functional Equipment Identification Code which was developed expressly for use in this program. This Code associates the part replaced with the system it serves. The code is alpha-numeric and utilizes seven digits. Illustration No. 18 shows the significance of each digit of the code and illustrates how the lowest designated assembly is tied to the system it is a part of.

The Equipment Identification Code Manual is system oriented and assembled to suit each ship's equipment configuration by the Maintenance Support Office in Mechanicsburg, Pennsylvania. Thus a ship which has a pressure fired steam generator would get the portion of the Code structured for this power plant as opposed to the portion applicable to diesel engines or 600-pound plants. Illustration No. 19 is a sample page from the Code showing the System, Sub-System, Component, Assembly, Sub-Assembly breakdown.

The Maintenance Data Collection System is currently installed in over 550 ships, primarily in the destroyer and mine forces. Illustration No. 20 shows the schedule for implementation. Once again, it must be mentioned that this System is not mailed to the ship to be implemented upon receipt. It is personally introduced aboard ship by a trained team from the Fleet Work Study Group. This team thoroughly indoctrinates shipboard personnel into the System by means of formal schooling which varies from one to three days depending on the personnel involved.

The Maintenance Data Collection System has not been as enthusiastically received by the Fleet as has the Planned Maintenance System. With a little thought, the reason becomes obvious. In the Planned Maintenance System, we are giving them something they can see, use and evaluate. Conversely, the Maintenance Data Collection System requires them to give us something. Although the objective of both Systems is to assist the Fleet improve their material readiness, the benefit of the former System is more immediately apparent to the Fleet than the latter. Unfortunately, the programming required to process and analyze the data coming from this System has lagged behind established milestones due to limited resources. The result has been that the Fleet has seen very little return for its reporting to date.

In spite of this discouraging note, the Fleet's response to this reporting system has been phenomenal. Ships, that under prior reporting systems such as the Equipment Failure Report (NAVSHIPS 3621), were reporting 40 to 50 maintenance actions per month are now reporting 500 to 600 actions per month. We have succeeded in getting the Fleet to report their maintenance actions - the question that remains to be answered is what will we do with this massive amount of data? Currently, one type commander is receiving over 150,000 maintenance actions per month. If we take this as an average figure and multiply by the number of type commanders, we realize that this System will feed over  $1\frac{1}{2}$  million actions per month to the Maintenance Support Office. Pro-rating this over a year, we see that over 18 million documents will have to be machine processed and analyzed. It is obvious that the days of manual massaging of data must give way to mechanized techniques. This massive data will strangle us unless we adopt and accept the products of the computer. Since a computer output is no better than its input, great care must be taken in the establishment of requirements. The Maintenance Data Collection System, properly used, will enable us to act rather than react to the Fleet's problems. Our history of operation shows us to be continually expending our efforts to "put out fires" rather than preventing them. This new System will enable us to direct our efforts and resources to the Fleet's most pressing problems.

Programs have been written that will enable us to receive printouts of the twenty high manhour or parts user per month. This information can then be further analyzed as to the predominant cause for the excessive parts or manhour consumption focusing on the specific assembly or sub-assembly involved. Printouts based on this rationale



have recently been prepared. Illustration Nos. 21 through 23 are samples of such reports.

In addition to the reports mentioned above, we have recently circulated a report showing where the manhours and parts are being expended in the Fleet. This was primarily prepared as a management report and can be backed up with considerable detail to suit the Bureau engineer. Illustration NOs. 24 through 26 are examples of this pie chart type of reporting. Notice how the charts go from the system to the component thereby focusing on the specific problem area.

A third approach developed by our office has been to account for those items which will never make the high ten or twenty hit parade but yet are nuisance items affecting habitability or morale aboard ship. These reports are prepared based on the number of failures related to the equipment population. A sample of these Deficiency Identification Reports is shown on Illustration No. 27. They are intentionally abbreviated and highlight the problem involved. These reports are the result of a computer data analysis and an engineering review.

#### SHIPBOARD AUTOMATIC DATA PROCESSING EQUIPMENT

An adjunct to the MDCS is the shipboard installation of automatic data processing equipment. To facilitate supply accounting and workload planning aboard carriers, tenders and repair ships, the 3-M System has procured UNIVAC 1500 Systems known in Navy parlance as the AN/UYK-5(V). The computer of this System is similar to those utilized in the Navy Tactical Data System (NTDS). A novel feature of the AN/UYK-5(V) System is the Card-Reader-Printer-Interpreter (CRPI). The CRPI is a new development and enables concurrent interpretation of two lines. Illustration No. 28 is a schematic of the System and Illustration No. 29 is a summary of the quantity being procured and the ship types scheduled to receive them.

#### STATUS OF THE PMS AND MDCS

As discussed earlier, the Planned Maintenance System is implemented in over 60% of the Fleet. At the current rate of over 40 ships per month, the Fleet is scheduled to be completely implemented by March 1967. This should be qualified to state that a PMS is delivered when at least 85% of all maintainable equipment is covered. The Maintenance Data Collection System has been implemented in over 550 ships to date. Complete fleet-wide implementation of the System is scheduled to be accomplished by January 1967.

Extension of the MDCS to the shipyards is scheduled to commence this May with an interim procedure. This phase will require the yards to

accept work requests on 4700.2C forms and reports to the Maintenance Support Office in a compatible manner. Implementation of the final procedures is scheduled for October 1967. The completion of this phase of the MDCS implementation will result in all maintenance actions performed by any level of maintenance being reported to a central data bank.

#### CURRENT PROBLEMS

The 3-M System, similar to other new Systems, is suffering from growing pains due primarily to the phenomenal rate with which it was implemented. Unfortunately, the Navy-wide resources applied were not commensurate with the ambitious milestones established.

The predominant problems of the Planned Maintenance System are:

- Equipment Configuration Accounting and Identification for ships in the active fleet, under construction, conversion or activation or undergoing overhaul. Equipment lists are not current or sufficiently accurate necessitating an on-site inventory which is costly and time-consuming.
- Implementation aboard ship. Due to lack of personnel, type commanders cannot always divert necessary manpower to properly install the Planned Maintenance System. The result is that some installations are not adequately accomplished imposing an undue burden on ship personnel.
- Inadequate monitoring. The shortage of personnel prohibits type commanders to follow-up on installations as often as they would like to. Periodic follow-up is an essential part of the installation of any new system.

The principal problems associated with the Maintenance Data Collection are:

- Lead time required for data to arrive at the Bureau. Currently there is a ninety day lag from the time the ship reports a maintenance action to the time this information arrives at the Bureau. The long lead time can be directly attributable to inadequate resources. Action is presently underway to improve this situation.



- Data being collected lacks reliability and maintainability information. Due to an intense desire to keep the data elements to a minimum, certain reliability and maintainability data elements are not currently being collected. The Bureau has requested that these data elements be included and action is being taken to respond to satisfy our requirements. The major problem is deciding which data elements are essential and which are desirable.
  
- Reporting of planned maintenance too time consuming. The forces afloat are required to report all planned maintenance accomplished. This accounts for over fifty percent of all reports received. Since we have developed the planned maintenance requirements, it is redundant to require shipboard personnel to report what they have done. The Bureau has recommended exception type reporting of planned maintenance actions not accomplished. This would eliminate ninety percent of planned maintenance reports currently being submitted.
  
- Remarks not being captured, source documents not being retained. The remarks portion of the form is often times the most important data element received for it gives the reviewer a clue as to the cause which would otherwise not be readily apparent. To attempt to capture all remarks would result in an excessive amount of punch cards. The Bureau has recommended that only selected remarks be captured. Specifically, the department head involved would decide if the remarks were significant. A code letter in the upper right hand portion of the form would inform the key punch operator that the remarks were to be captured. Action is underway to adopt this proposal.
  
- Prematurely extending the System and Shipyards. As can be seen from Illustration 30, extension of this System to the shipyards is scheduled to commence May 1966. Originally our plan was to identify the interface problems by undertaking a paper exercise for a ship which had completed a restricted availability. This was accomplished in conjunction with the Boston Naval Shipyard and involved rewriting all of the work requests, received from the ship, on 4700.2C forms. Problems identified as a result of this study were resolved to a large degree. However, this effort was restricted. The results of this study were scheduled to be applied to a ship coming in for a regular overhaul. Restriction of time prevented this. Additionally, time prevents us from implementing this System a yard at a time. Current milestones will force us to run before we have really learned to walk. Additionally implementing all yards concurrently will sacrifice some of the personal attention required for the initial introduction period as well as follow-up.

## APPLICATION OF THE 3-M SYSTEM

The techniques and products developed as a result of this program have endless application in the design, reliability, maintainability, personnel, logistics, acquisition and standards disciplines. This section will attempt to highlight a few to serve as a catalyst or stimuli for the reader to project from based on his particular experience and needs.

### DESIGN

Both Planned Maintenance and Maintenance Data Collection Systems data have already been profitably used in conducting manning studies for new ship design concepts. Based on skill levels and manhours required to perform maintenance actions for specific equipments, these studies established the personnel skill that would be required to properly maintain the equipment proposed for the new ship design. Essentially then, these studies enabled the ship to be designed with the "required men in their bunks." Studies of this nature have been conducted on new ship designs for submarine tenders (AS), landing ships (LST), transports (AKA) and destroyer escorts (DE).

### RELIABILITY AND MAINTAINABILITY

The massive volume of data being collected in one central bank will subject commonly accepted classical theories to very rigid tests. Performance specifications will be modified based on actual experience rather than subjective interpretation of fragmented information. Wear-out and replacement rates will be readily identifiable. Equipment overhaul cycles will be based on established needs rather than desire or judgment.

### PERSONNEL

Personnel training requirements aboard ship are easily established and scheduled utilizing the Planned Maintenance System. Division heads aboard ship are currently assessing their personnel skill deficiencies by reviewing the required rates established by the Planned Maintenance System. Shipboard personnel training plans are established in conjunction with the Planned Maintenance Schedule. Lower rated personnel are scheduled to observe planned maintenance actions performed by higher rated personnel. Where required ratings are not available, as often is the situation, lower ratings can more easily learn the skills required by means of the Maintenance Requirement Cards.

### LOGISTICS SUPPORT

The 3-M System products will enable the establishment of realistic supply support requirements. Based on the actual shipboard equipment

configuration identified through the Planned Maintenance System and the parts usage reported by the Maintenance Data Collection System, only those parts will be carried aboard in quantities required to properly maintain the equipment in optimum readiness condition.

### ACQUISITIONS

A high percentage of acquisitions are currently awarded based on low initial cost rather than on total cost primarily due to insufficient information. This new data bank encompassing maintenance accomplished by the organizational (ship), intermediate (tender) and depot (shipyard) levels will readily enable total cost assessment. Thus awards will not have to be made to the low initial cost bidder for sufficient total cost information will be available to justify rejection.

### STANDARDS

Maintenance routines are currently being standardized through the Planned Maintenance System. The result has been that personnel transferred from one ship to another are essentially productive upon reporting aboard. Prior to the introduction of this System, maintenance routines and standards were non-existent resulting in new personnel expending considerable time casting away old procedures and techniques and adopting new ones. A natural evolution of this System is its extension to tenders and shipyards.

Corrective maintenance actions of a repetitive nature, such as overhauling a pump or replacing a motor bearing, can be standardized utilizing the same techniques developed under the Planned Maintenance System. Standardizing repetitive corrective maintenance actions will enable us to establish standard costs. When one considers that at least 70 percent of ship overhauls are repetitive in nature, this approach will enable us to accurately forecast the cost of ship overhauls.

### CONCLUSION

The revolutionary aspects of the 3-M System can best be summed up in the following manner:

#### - Planned Maintenance System

- . supersedes all existing documentation upon installation.
- . is uniform for all Navy Bureaus and all ship departments.
- . provides a standard maintenance management system throughout the Fleet.

- . is developed in conjunction with the Fleet.
- . prescribes realistic maintenance that can be accomplished by shipboard personnel.
- . is flexible to fit varying operational commitments.
- . is tailored to fit each ship's equipment configuration.
- . is installed aboard ship by a trained installation team.
- . has command attention, interest and support.
- . enhances the training of shipboard personnel.

- Maintenance Data Collection System

- . replaces all other reporting requirements.
- . consists of a standard form for use by all departments aboard ship.
- . eliminates the need for maintaining numerous logs and machinery history records.
- . makes maximum utilization of technological advancements made in data processing.
- . results in timely response and action.
- . reports directly back to the Fleet.
- . utilizes a central data collection and processing facility.

The 3-M System is a management concept that will enhance the management of maintenance. It was never intended to replace management and therefore never will. Since it is a tool of management it is not a self starter and requires the attention of all personnel involved.

A fitting closing for this paper would be to quote a man who has been an inspiration and guiding light - Rear Admiral W.A. Brockett, formerly Chief of the Bureau of Ships:

PMS: "The effectiveness and utility of the Planned Maintenance System has been clearly demonstrated in actual service in the Fleet. The Bureau of Ships, in keeping with its assigned mission, will continue to actively support this program until complete Fleet implementation is achieved."

MDC: "Not so many years ago, shipboard maintenance lessons were shared as gray-haired Engineer Officers of sister ships met over coffee in Log Rooms or Wardrooms, and the expertise of care and feeding the plant endured by dint of long tours of duty. The idea of profiting from hard knocks is as old as man himself, but a more fluid and demanding technology, plus the mobility of our human resources, demand that we systematize the vast mass of experience, so organizing the bits of data as to find the meaningful trends, share the lessons, and progress toward a higher level of effective resource utilization and Fleet material readiness. This is the meaning of Maintenance Data Collection --- a BUSHIPS - Fleet team effort that has my support ---and deserves yours."



**THE STANDARD NAVY**

**3 MAINTENANCE MATERIAL MANAGEMENT SYSTEM**

**THE  
PLANNED  
MAINTENANCE  
SYSTEM**

**THE  
MAINTENANCE  
DATA  
COLLECTION  
SYSTEM**

**LIST OF EFFECTIVE PAGES AND EQUIPMENT LIST**

**(DD-945)**

<b>MMP No.</b>	<b>DESCRIPTION</b>	<b>APL/CID</b>	<b>QTY</b>	<b>NAVSHIPS</b>	<b>MANUFACTURER</b>
F-1/8-64	Boilers Boilers, Left Hand Boiler, Right Hand	021200168 021200168 021200167	2 2 2	351-0592 351-0592 351-0592	Babcock and Wilcox Babcock and Wilcox Babcock and Wilcox
F-2/6-64	Main Forced Draft Blower	057990002	8	353-0161	Carrier Corp.
F-3/7-94	Fuel Oil Heaters	070010012	8	355-0428	Davis Engineering Corp.
F-4/5-64	Fuel Oil Service Pump Fuel Oil Service Pump Fuel Oil Service Turbine	016160254 057150171	4 4	347-3091 347-3091	DeLaval DeLaval
F-5/7-84	Fuel Oil Transfer Pump	016160312	2	347-3032	DeLaval
F-7/4-54	Emergency Feed Pump Auxiliary Feed Pump Auxiliary Feed Turbine	016160281 057150144	2 2	347-2359 347-2539	DeLaval DeLaval
F-8/7-64	Electric Driven Fuel Oil Service Pump	016160315	2	347-3091	DeLaval

System, Subsystem, or Component Emergency Feed Pump				Reference Publications and/or Maintenance Significant Number		
Bureau Card Control No.		Maintenance Requirement	M. R. No.	Rate Req'd.	Man Hours	Related Maintenance
MJ ZY7FPJ7	54 2962	W 1. Sample and inspect lube oil. 2. Turn idle turbine by hand. 3. Lubricate speed limiting governor.	W-1	BT2	0.2	None
MJ ZY7FPJ7	54 2963	M 1. Lift pump discharge relief valve by hand. 2. Test speed limiting governor.	M-1	BT2	0.2	None
MJ ZY7FPJ7	54 2964	Q 1. Clean sump and renew oil. 2. Clean lube oil filter. 3. Sound and tighten foundation bolts.	Q-1	BT2 FN	2.2 2.2	None
MJ ZY7FPJ7	54 2965	Q 1. Measure turbine thrust clearance. 2. Measure pump thrust clearance.	Q-2	BT2 FN	0.3 0.3	None
MJ ZYSFVA1	54 1038	Q 1. Test combination exhaust and relief valve.	Q-3	BT2 FN	0.2 0.2	None
MJ ZY7FPJ7	16 5316	A 1. Renew stuffing box packing.	A-1	BT2 FN	1.0 1.0	None
MJ ZZFFTR1	54 2967	A 1. Inspect shaft journals, thrust collars, and bearings for condition. Measure bearing and oil seal clearance. 2. Measure thrust clearances.	A-2	BT2 FN	12.0 12.0	Q-2
MJ ZY7FPJ7	54 2968	A 1. Clean and inspect flexible coupling for alignment. 2. Clean and inspect steam strainer.	A-3	BT1 FN	3.0 3.0	None
MJ ZY7FPJ7	54 2969	C 1. Inspect internal parts for condition and measure wearing ring clearance.	C-1	BT1 BT3 FN	3.3 3.3 3.3	Q-2, A-1 A-2
MJ ZZFFTR1	54 2970	C 1. Inspect turbine exterior. 2. Test feed water relief valve. 3. Inspect steam and air gland clearances on the turbine.	C-2	BT2 FN	1.0 1.0	None

DD-945

MANHOUR ANALYSIS

M/R SHEET	RATE	HOURS	SHEET TOTAL
F-4/5-64	BT2	148.0	212.8
	BT3	8.0	
	FN	56.8	
F-5/7-84	BT2	7.0	17.4
	FN	10.4	
F-7/4-54	BT1	8.2	149.0
	BT2	84.0	
	BT3	2.2	
	FN	54.6	
F-8/7-64	BT2	7.0	17.4
	FN	10.4	
F-9/8-64	MM3	10.8	600.3
	BT2	534.7	
	BT3	10.8	
	FN	44.0	
TOTAL			

ILLUSTRATION 4

EQUIP PAGE	TYPE DD	SCHEDULE AS INDICATED				EACH QUARTER
		CLASS 945	QUARTER AFTER OVERHAUL			
MAINTENANCE GROUP FIREROOM # 1		1	2	3	4	
COMPONENT		5	6	7	8	
		9	10	11	12	
F-5	FUEL OIL TRANS AND BOOSTER PUMP		AI, A2 CI, 2(2)			MI QI, 2, 3
F-6	FIRE AND BILGE PUMP			AI		QI
F-7	EMERGENCY FEED PUMP	(AI)				QI
F-8	ELECTRIC FUEL OIL SERVICE PUMP				AI, CI(4)	QI, 2
F-9	FEEDWATER AND FUEL OIL SYSTEM	CI(1)	SI	AI, 2	SI C2(I2)	QI
F-10	PIPING AND VALVES (FWD)	AI	CI(2)		A3 C2(I2)	MI, 3, QI, 2
F-10	PIPING AND VALVES (AFT)	A3	A2	CI(3)	C2(I2)	M2, 3 QI, 2

CYCLE SCHEDULE OPNAV FORM 4700-4 (4-64)



MAINTENANCE GROUP #1 FIREROOM		YEAR 1965		QUARTER AFTER OVERHAUL								
MONTH	OCT	MONTH	NOV	MONTH	DEC							
4-9	11-16	18-23	25-30	1-5	8-13	15-20	22-27	29,30,1-4	6-11	13-18	20-25	27-31
		(A1)		Q1								
	Q1				Q2							
			Q1									
	M1	Q1			A1	M1		Q2		M1		
	M2	Q1	M3		M2		M3	A3	M2		M3	Q2
		Q3	A2				Q4		A1			
		M1				M1				M1		
			M2					M2			M2	

QUARTERLY MAINTENANCE SCHEDULE OPNAV FORM 4700-5 (4-64)

ILLUSTRATION 6

DD945 GROUP FIREROOM # 1 WORK SCHEDULE FOR WEEK OF 18th

COMPONENT	MAINTENANCE RESPONSIBILITY	PAGE	MONDAY	TUESDAY	WEDNESDAY	THURSDAY	FRIDAY	SAT/SUN	OUTSTANDING REPAIRS AND P.M. CHECKS DUE IN NEXT 4 WEEKS
FUEL OIL TRANS. AND BOOSTER PUMP		F5	W1						
FIRE AND BILGE PUMP		F6	W1						
EMERGENCY FEED PUMP	SMITH	F7	W1		(A1)				
ELECTRIC FUEL OIL SERVICE PUMP		F8	W1						
FEEDWATER AND FUEL OIL SYSTEM		F9	D1,D2,W1	D1, D2	D1, D2	D1, D2	D1, D2	D1, D2	
PIPING AND VALVES (FWD)		F10	W1						
PIPING AND VALVES (AFT)		F10	W2						
GAGES		F11							
ZINC S(FWD)		F12							
ZINC S(AFT)		F12							

WEEKLY SCHEDULE

ILLUSTRATION 7

EQUIP	TYPE CLASS	DD 945	SCHED. QUART
	FIREROOM #1		1
	COMPONENT		5
			9
F-1	BOILER #1		
F-1	BOILER #2		A1, A2
F-2	FORCED DRAFT BLOWER #1		C1, 2
F-2	FORCED DRAFT BLOWER #2		A1
F-2	FORCED DRAFT BLOWER #3		C1, 2
F-2	FORCED DRAFT BLOWER #4		
F-3	FUEL OIL HEATERS		A1
F-4	FUEL OIL SERVICE PUMP #1		C1(5)
F-4	FUEL OIL SERVICE PUMP #2		A1, A2
F-5	FUEL OIL TRANSFER AND BOOSTER PUMP		
F-6	FIRE AND BILGE PUMP		
F-7	EMERGENCY FEED PUMP		A1

CYCLE SCHEDULE

#1 FIREROOM		5TH QTR
MONTH	OCT	
4-9	11-16	18-23
A1		A2
	A1	
A1		C1
	A1, A2	
		(A1)

QUARTERLY SCHEDULE

GROUP FIREROOM #1 WEEK OF 18 OCT		
COMPONENT	MAINTENANCE RESPONSIBILITY	PAGE
		WED
BOILER #1		F1
BOILER #2		F1 A2
FORCED DRAFT BLOWER #1		F2
FORCED DRAFT BLOWER #2		F2
FORCED DRAFT BLOWER #3		F2
FORCED DRAFT BLOWER #4		F2
FUEL OIL HEATERS		F3 C1
FUEL OIL SERVICE PUMP #1		F4
FUEL OIL SERVICE PUMP #2		F4
FUEL OIL TRANSFER AND BOOSTER PUMP		F5
FIRE AND BILGE PUMP		F6
EMER FEED PUMP	SMITH	F7 (A1)

WEEKLY SCHEDULE

SYSTEM Propulsion	COMPONENT Emergency Feed Pump	M R. NUMBER F-7      A-1	
SUB-SYSTEM Feed Water and Condensate	RELATED M.R. None	RATES BT2 FN	M H 1.0 1.0
M. R. DESCRIPTION  1. Renew stuffing box packing.		TOTAL M H 2.0 ELAPSED TIME: 1.0	
SAFETY PRECAUTIONS 1. Observe standard safety precautions. 2. Wire steam inlet and outlet valves shut and tag "Do Not Open."			
TOOLS, PARTS, MATERIALS, TEST EQUIPMENT 1. 1/2" Wrench 2. 1/2" Packing puller 3. Knife 4. 3/4" Packing, Symbol 1433, 16 rings 5. 1/4" Packing, Symbol 1433, 8 rings 6. Wire, 24 gauge 7. 6" Slip-joint pliers 8. Safety tags			
PROCEDURE <u>Preliminary</u> a. Ensure pump is secured and cool.  1. <u>Renew Stuffing Box Packing.</u> a. Remove all packing glands. b. Remove old packing. c. Clean the stuffing boxes.  NOTE: Cut new packing ends square and stagger joints around the shaft while installing.  d. Install packing: (1) 8 rings-pump piston rod (2) 8 rings-steam piston rod (3) 4 rings-each end auxiliary piston valve rod. e. Reinstall packing glands and tighten nuts hand-tight. f. Remove tag and wire from steam inlet and exhaust valve. g. Adjust leakoff during operation to 5 drops per minute from pump piston rod and a slight whiff of steam from steam piston rod and auxiliary piston valve rod.			MJ ZY7F PJ7 16 5316
LOCATION			A

# PMS DELIVERED

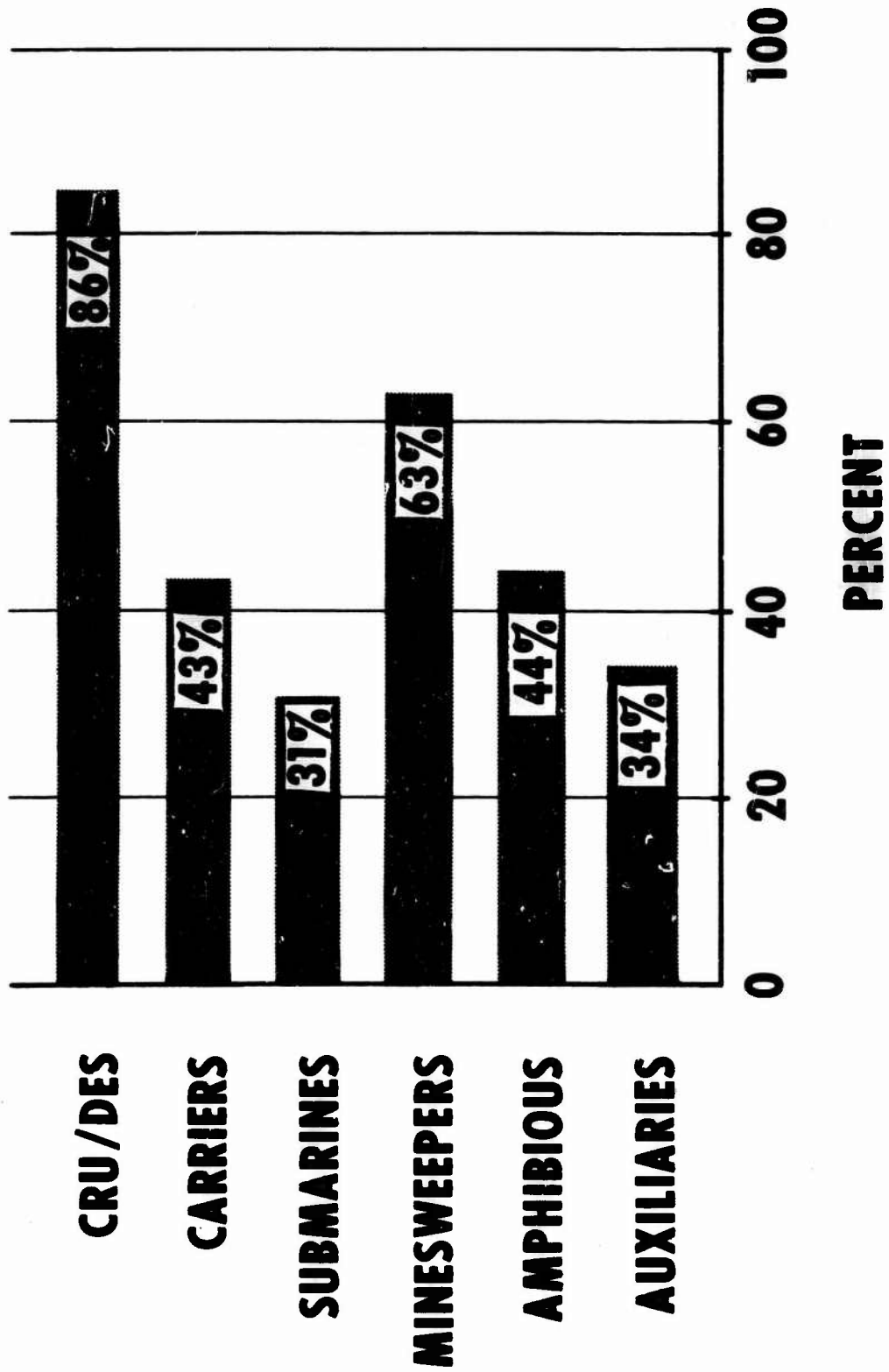

ILLUSTRATION 10



**INSTRUCTIONS ON BACK OF GREEN PAGE**

FROM:

SERIAL #: \_\_\_\_\_

TO: **BUSHIPS/BUWEPs MAINTENANCE  
MANAGEMENT FIELD OFFICE**

DATE \_\_\_\_\_

VIA:

**SUBJECT: PLANNED MAINTENANCE SYSTEM FEEDBACK REPORT**

SYSTEM

COMPONENT

SUB-SYSTEM

M. R. NUMBER

BU. CONTROL NO.

**DESCRIPTION OF DISCREPANCY:**

- |   |   |   |
|---|---|---|
| <input type="checkbox"/> M. R. Description                          | <input type="checkbox"/> Equipment Change                     | <input type="checkbox"/> Typographical          |
| <input type="checkbox"/> Safety Precautions                         | <input type="checkbox"/> Missing Maintenance Index Page (MIP) | <input type="checkbox"/> Technical Publications |
| <input type="checkbox"/> Tools, Etc.                                | <input type="checkbox"/> Technical                            | <input type="checkbox"/> Miscellaneous          |
| <input type="checkbox"/> Missing Maintenance Requirement Card (MRC) | <input type="checkbox"/> Procedure                            |   |

\_\_\_\_\_  
SIGNATURE

THIS COPY FOR:

**ADDRESSEE**

**1**

# PMS STATISTICS

● PERCENTAGE OF FLEET COVERED WITH PMS: 63%

	MASTER MRCS		MASTER MIPS	
	DEV	TOT. EST.	DEV	TOT. EST
MACH/ELEC/HULL	27,000	38,000	8,300	12,000
ELEX	2500	5,000	974	2000
TOTAL	29,500	43,000	9,274	14,000

● ESTIMATED COMPLETION DATE: MARCH 1967

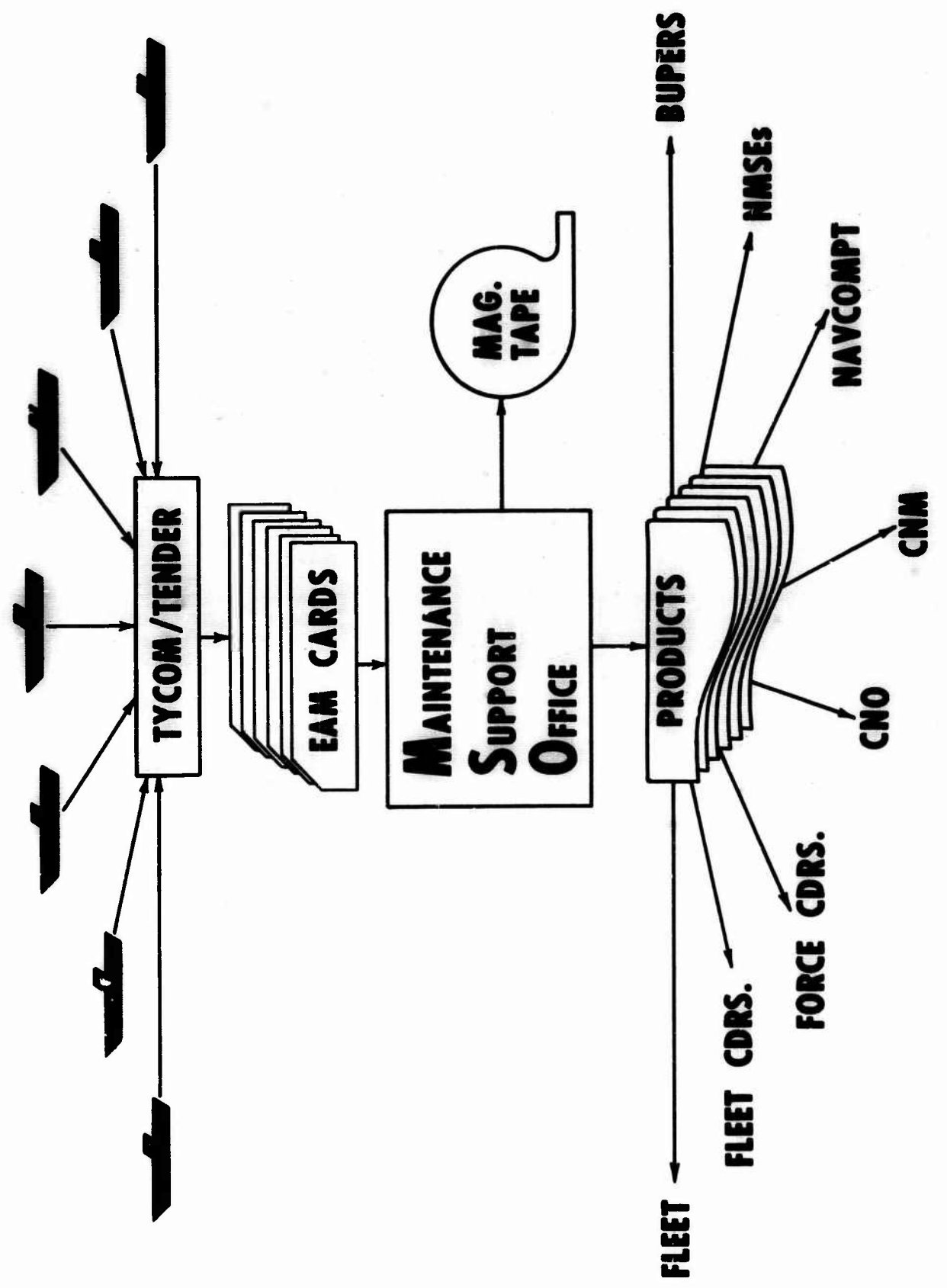
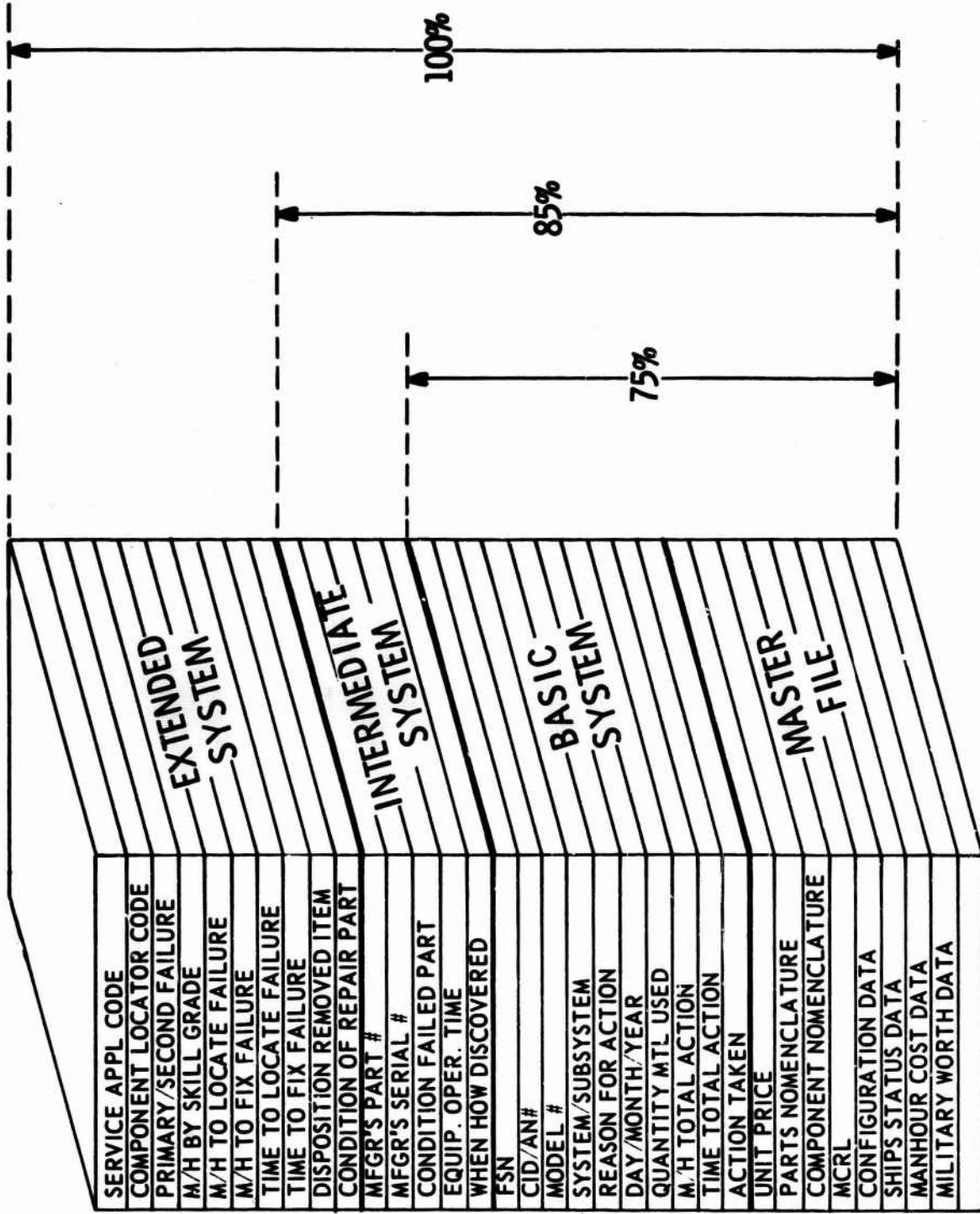

ILLUSTRATION 13

RESULTS OF SURVEY TAKEN TO ESTABLISH  
 INFORMATION REQUIRED FROM A  
 MAINTENANCE DATA COLLECTION SYSTEM



SOURCE  
 DOC.

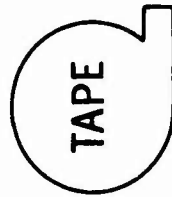
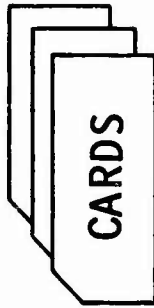

ILLUSTRATION 14

MAINTENANCE DATA COLLECTION  
OPNAV FORM 4700-2B (8-64)

SHIPBOARD MAINTENANCE ACTION

A. SHIP NAME AND HULL NO./ACTIVITY		1. ADMIRALTY ORG.	2. SHIP ACTG. NO.	3. MAINT. CTRL. NO.	4. DATE		MONTH	YEAR	B.
[Hatched Area]		[Hatched Area]		[Hatched Area]		[Hatched Area]		[Hatched Area]	
		[Hatched Area]		[Hatched Area]		[Hatched Area]		[Hatched Area]	
5. EQUIPMENT ID CODE	6. W.C.	7. ASST. #C	8. REPAIR ACT. ACFT. NO.	9. MAT. #NRG.	10. DISC. A/I	11. DISC. A/I	12. ESTIM.	13. MAN.-HOURS (OTHS)	1.
14. SERIAL NO.	20. EQUIP. TIME		21. ALTERATION IDENTIFICATION						
F. DESCRIPTION/REMARKS									
[Hatched Area]									

FOR LOCAL USE ONLY

L. SIG. (3)

M. SIG. (4)

ILLUSTRATION 15

# WORK REQUEST

A. SHIP NAME AND HULL NO./ACTIVITY		1. ADMIN. ORG.		2. SHIP ACCTG. NO.		3. MAINT. CTRL. NO.		4. DATE		B.	
5. EQUIPMENT ID CODE		8. REPAIR ACT. ACCT. NO.		9. MAL/MRC.		10. DISC		12. UNITS		C.	
14. SERIAL NO.		15. T/A		16. REG. W.C.		17. DESIRED CMLPN. DATE		18. SERV.		D.	
F. DESCRIPTION/REMARKS											



**FOR LOCAL USE ONLY**

G. NO. 1 CONTACT	J. SIG. (1)
H. NO. 2 CONTACT	K. SIG. (2)



**DEFERRED ACTION**

A. SHIP NAME AND HULL NO./ACTIVITY		1. ADMIN. ORG.		2. SHIP ACCTG. NO.		3. MAINT. CTRL. NO.		4. DATE		B.	
[REDACTED]		7. ASST. W.C.		8. REPAIR ACT. ACCT. NO.		9. MAL/MRC.		10. DISC		11. A/T	
		6. W.C.		20. EQUIP/TIME		21. ALTERATION IDENTIFICATION		12. UNITS		13. MANHOURS	
5. EQUIPMENT ID CODE		14. SERIAL NO.		F. DESCRIPTION/REMARKS							

L. SIG. (3)
M. SIG. (4)

FOR LOCAL USE ONLY

[REDACTED]

# EQUIPMENT IDENTIFICATION CODE

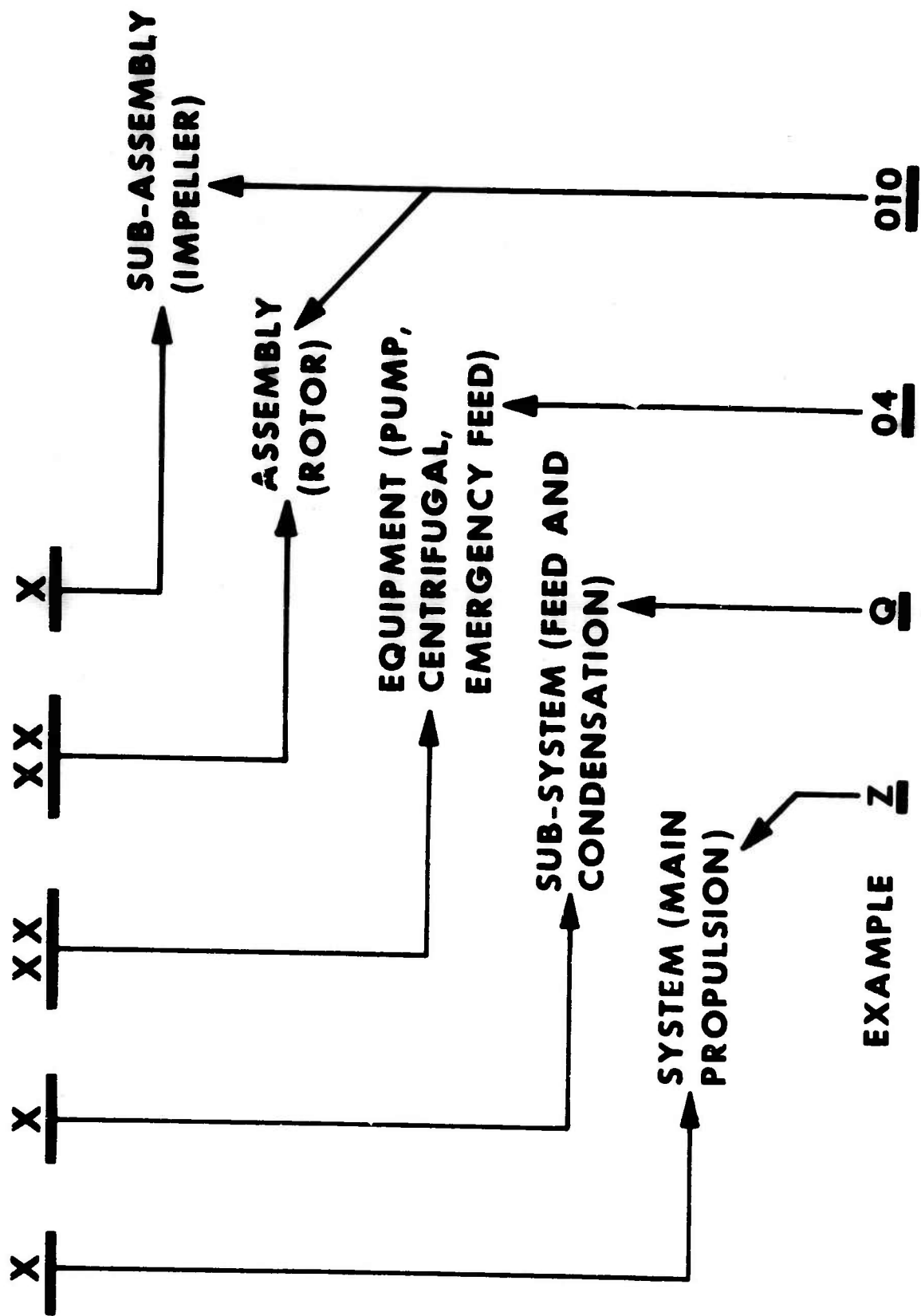

ILLUSTRATION 18

**LISTING OF EQUIPMENT IDENTIFICATION CODES**

**E. I. C.**

**NOMENCLATURE**

Z000000	MAIN PROPULSION, STEAM
ZN00000	STEAM GENERATOR SUPERCHARGED
ZN01000	PRESSURE PARTS
ZN01100	EXTERNAL CONNECTING PIPE
ZN01110	RISERS
ZN01120	DOWNCOMERS
ZN01121	FEEDERS 6--INCH
ZN01122	FEEDERS 8--INCH
ZN01130	SUPERHEATER CONNECTING PIPE
ZN01140	D. S. H. INLET PIPING
ZN01150	S. H. SAFETY VALVE ACTUATING LINE
ZN01200	SUPERHEATER
ZN01210	INLET HEADER
ZN01211	HANDHOLE PLUG, OVAL
ZN01212	HANDHOLE GASKET, OVAL
ZN01213	HANDHOLE PLUG, ROUND
ZN01214	HANDHOLE GASKET, ROUND
ZN01220	OUTLET HEADER
ZN01221	HANDHOLE PLUG, OVAL
ZN01222	HANDHOLE GASKET, OVAL
ZN01223	HANDHOLE PLUG, ROUND
ZN01224	HANDHOLE GASKET, ROUND
ZN01230	ELEMENTS
ZN01240	SPACER ASSEMBLY
ZN01250	SUPPORT ASSEMBLY
ZN01300	GENERATING TUBES AND HEADERS
ZN01310	FURNACE HEADER TUBES
ZN01311	1ST ROW
ZN01312	2ND ROW
ZN01313	3RD ROW
ZN01314	4TH ROW
ZN01320	CONVECTION HEADER TUBES
ZN01321	1ST ROW
ZN01322	2ND ROW
ZN01323	3RD ROW
ZN01324	4TH ROW
ZN01330	FURNACE HEADER
ZN01331	HANDHOLE PLUG
ZN01332	HANDHOLE GASKET
ZN01340	CONVECTION HEADER
ZN01341	HANDHOLE PLUG
ZN01342	HANDHOLE GASKET
ZN01350	UPPER HEADER
ZN01351	HANDHOLE PLUG
ZN01352	HANDHOLE GASKET
ZN01400	STEAM DRUM AND INTERNALS
ZN01410	STEAM DRUM
ZN01420	MANHOLE COVER
ZN01430	MANHOLE COVER GASKET
ZN01440	HINGE ASSEMBLY
ZN01450	HINGE LINK ASSEMBLY
ZN01460	HINGE LUG ASSEMBLY

MDCS IMPLEMENTATION SCHEDULE FOR SHIPS

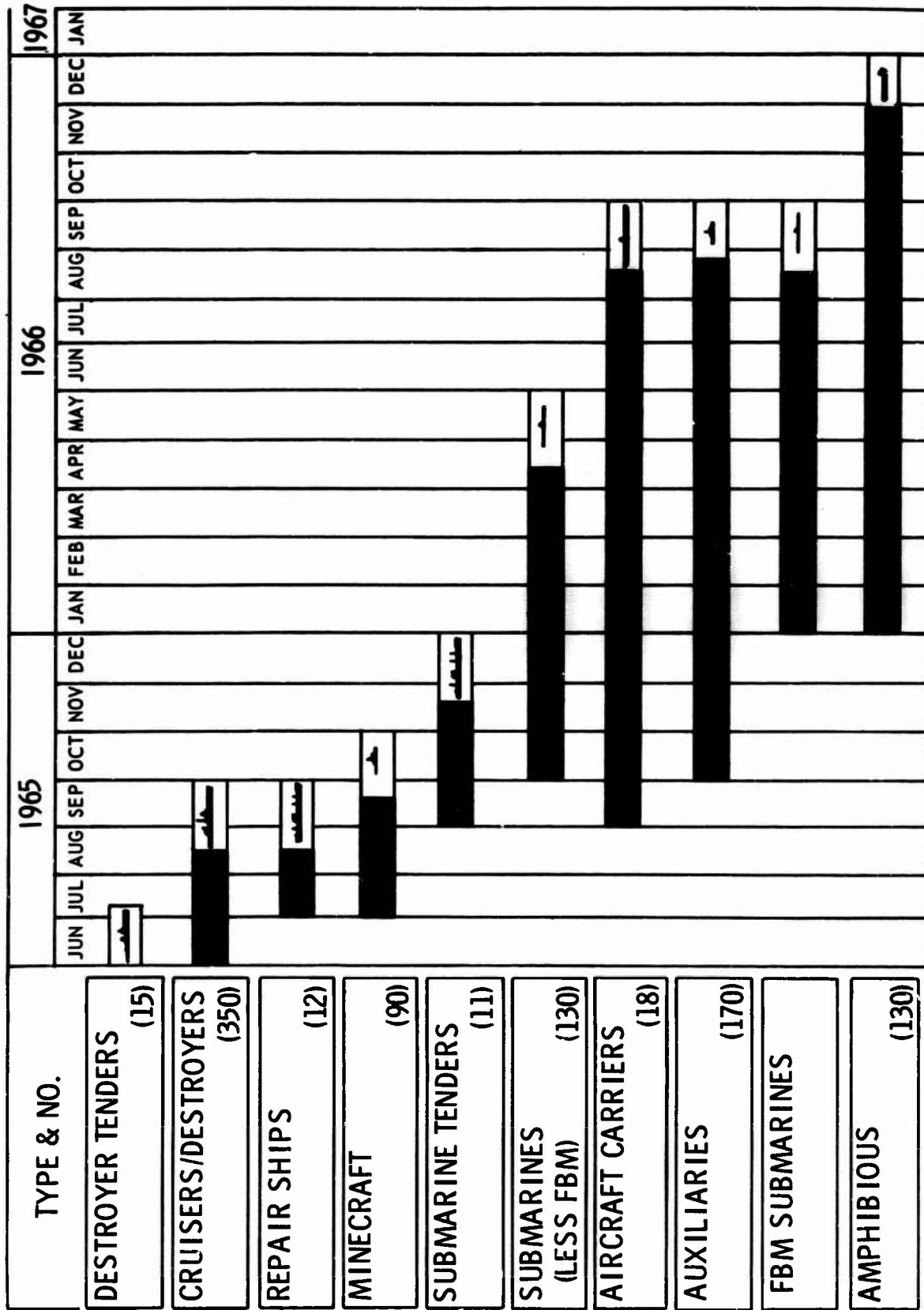

MDCS IMPLEMENTATION SCHEDULE FOR SHIPS

1 AUG 65 - 30 OCT 65

SYSTEM MAINTENANCE SUMMARY

SYSTEM CLASS	NO. OF SHIPS REPORTING	TOTAL NO. MAINT. ACTIONS	NO. OF DEFERRED MAINTENANCE ACTIONS		NUMBER OF UNITS	TOTAL MAN HOURS	NO. OF PARTS USED	NUMBER OF FSN-S	PARTS COST \$
			PARTS	ASSISTANCE					
1000 MN PROP SYS DSL/GAS	109	1212	7	15	3282	7264	3686	419	67115
3000 DAMAGE CONTROL	372	4118	9	35	21901	13784	10515	674	40409
4000 MISSILE HANDLING EQP	9	21	0	0	23	16	1	1	1
5000 HULL STRUCTURE	325	2329	0	43	8141	8508	15802	262	18215
6000 MISSILE HANDLING EQUIP	0	0	0	0	0	0	3	2	600
A000 AUX SYS. ENGINEERING	476	15415	28	125	39453	56256	42403	2890	168914
B000 AUX SYS. SHIPS CNTRL	197	498	1	3	776	2224	7168	87	46538
C000 CNTRMEAS EQ., ELEX	235	1197	16	2	1702	4650	3549	447	35319
D000 RDR IFF. ELE NAV SYS	340	5862	52	6	7020	24929	22990	2154	427102
E000 TEST EQ., GEN PURP	294	2885	15	3	3145	2930	3863	664	9303
F000 COMM AND COMPTN SYS	376	9169	39	28	12038	24648	34058	2442	146288
GW00 AMMO HANDLING EQUIP	38	62	0	1	165	168	96	7	100
J100 SONAR SEARCH	205	1437	6	1	2523	6450	8209	536	38620
J200 SONAR VARIABLE DEPTH	28	245	1	0	300	856	365	96	1663
J300 SONAR CLASSIFICATION	17	35	0	0	37	66	308	25	997

ILLUSTRATION 21

# HIGH 20 SYSTEM PARTS COST SUMMARY

1 AUG 65 - 30 OCT 65

## Number of Maintenance Actions

SYSTEM CLASS	NO. OF SHIPS REPORTING	* TOTAL * ACTS	NO. OF WHEN DISC. A, B, C	NO. OF WHEN DISC. D & O	NUMBER DEFERRED FOR PARTS	* TOTAL * NO. OF UNITS	NO. OF PARTS USED	NO. OF FSN-S RPRTD	PARTS COST \$	TOTAL MAN HOURS
AE00	312	1794	590	977	2	3080	4017	282	31517	6610
AD00	301	1488	644	672	1	6604	6725	348	12702	3836
BA00	171	400	96	281	1	563	7082	74	44775	2008
AZ00	198	478	169	255	2	1153	4647	158	16121	1918
AB00	229	646	178	427	1	1155	1810	298	12629	2383
CA00	222	1052	476	416	13	1421	3065	344	18783	3610
DA00	252	780	449	275	5	862	2459	268	43025	2671
DC00	65	414	300	72	7	541	2524	376	148048	2613
DB00	211	918	576	218	17	979	3867	601	175798	5058
CF00	32	66	23	31	3	85	173	48	14302	505
FF00	276	2578	648	1760	2	3317	6095	555	27984	4748
F200	228	1001	474	418	6	1215	5036	645	7937	1990
FH00	257	1500	677	709	12	1734	4656	524	47177	5229
FD00	142	429	133	256	2	512	4982	103	8151	908
FK00	283	2117	839	1149	10	2587	4842	526	35347	7312
J400	118	263	108	141	0	279	448	112	1611	528
J500	91	176	59	105	1	187	187	55	1016	339
J600	16	25	14	8	1	27	28	14	1536	16
J100	205	1437	567	680	6	2523	8209	536	38620	6450
J200	28	245	83	133	1	300	365	96	1663	856

ILLUSTRATION 22



1 AUG 65 - 30 OCT 65

# HIGH 20 SYSTEM MAN-HOUR USER SUMMARY

## Number of Maintenance Actions

SYSTEM CLASS	NO. OF SHIPS REPORTING	NO. OF WHEN DISC.		NO. OF WHEN DISC. D & O	NUMBER DEFERRED FOR PARTS	NUMBER OF UNITS	NO. OF PARTS USED	NO. OF FSN-S RPRTD.	PARTS COST \$	TOTAL MAN HOURS
		TOTAL ACTS	A, B, C							
AEOO DISTILLING PLANTS	312	1794	590	977	13	3080	4017	282	31517	6610
APOO GENRTR, SHP SVC, STEAM	263	1722	309	1301	14	2301	2983	182	7898	5941
AKOO HEATING/VENTILATING SY	304	1160	678	316	13	5179	3369	246	7154	6981
AAOO AIR CONDITIONING SYS	255	1258	456	730	4	2792	2316	315	8994	5503
AMOO REFRIGERATION SYSTEM	292	1576	519	968	2	3283	2801	310	10344	4065
CAOO INTERCPT/ANALYS, SURF	222	1052	476	416	1	1421	3065	344	18783	3610
DEOO IFF EQUIPMENT	202	779	386	297	2	923	3634	361	10911	2835
DMOO RDR DISPLY STANDARD	257	1247	648	536	1	1515	4413	368	12972	5224
DN00 RDR DISPLY, OFFCENTRD	197	1034	515	445	1	1277	3238	356	12234	3475
DB00 AIR-SEARCH	211	918	576	218	0	979	3867	601	175798	5058
FDOO ANTENNA MULTCPL - TUNR	142	429	133	256	1	512	4982	103	8151	908
F200 TELETYPE	228	1001	474	418	3	1215	5036	645	7937	1990
FF00 COMMUNICATION RECVR	276	2578	648	1760	14	3317	6095	555	27984	4748
FH00 COMMUNICATION XCVRS	257	1500	677	709	1	1734	4656	524	47177	5229
FK00 COMMUNICATION XMTRS	283	2117	839	1149	4	2587	4842	526	35347	7312
JF00 ASW HANDLING EQUIP	34	110	11	94	0	126	32	11	149	105
J500 SONAR UNDRWTR COMMUN	91	176	59	105	0	187	187	55	1016	339
J400 SONAR NAVIGATION	118	263	108	141	0	279	448	112	1611	528
J100 SONAR SEARCH	205	1437	567	680	1	2523	8209	536	38620	6450
J200 SONAR VARIABLE DEPTH	28	245	83	133	0	300	365	96	1663	856

SYSTEM MAINTENANCE SUMMARY  
MAN-HOUR USER SUMMARY

Reporting Period:  
March-August 1965

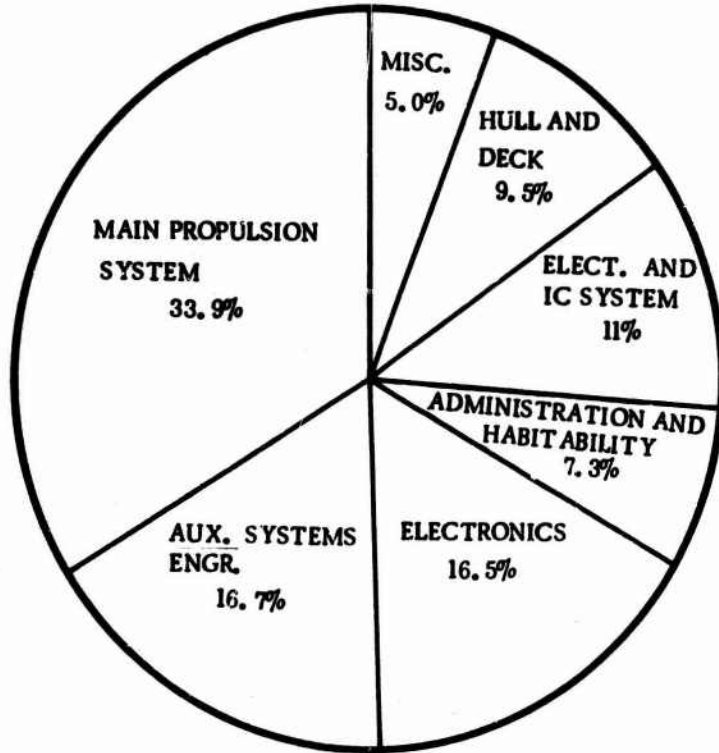

Total Man-Hours  
1,149,762

MAN-HOUR DISTRIBUTION

SYSTEM MAINTENANCE SUMMARY  
PARTS-COST SUMMARY

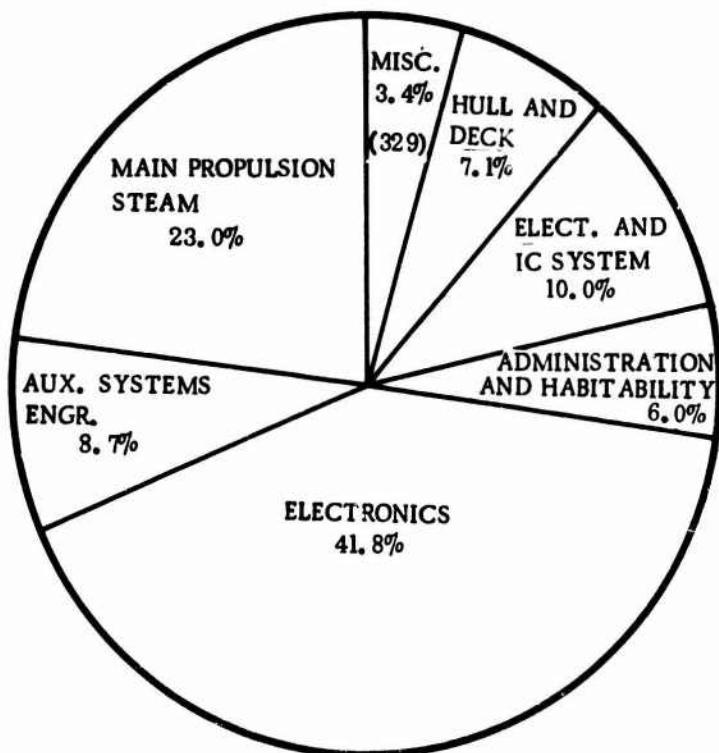

Total Parts Cost:  
\$2,601,646

PARTS-COST DISTRIBUTION

**ELECTRONICS  
MAN - HOUR USER SUMMARY**

**Reporting Period:  
March-August 1965**

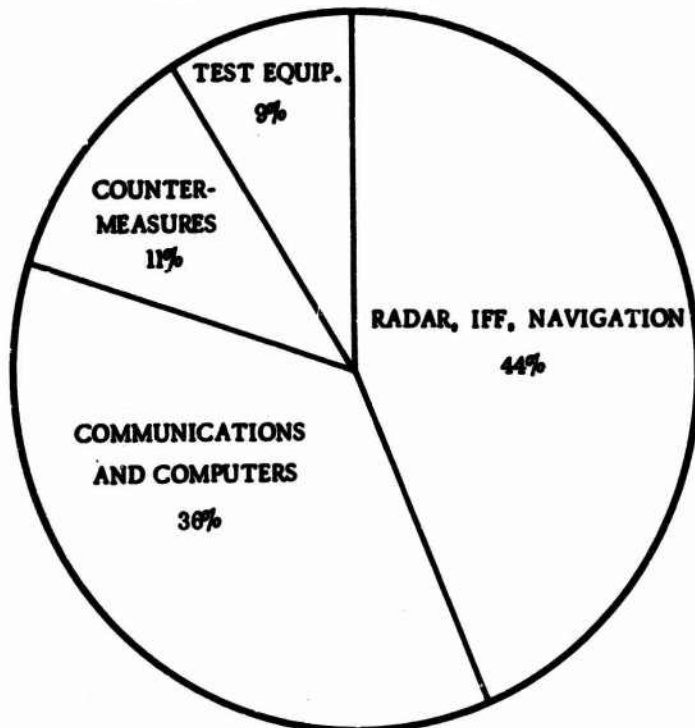

**MAN-HOUR DISTRIBUTION**

**Total Man-Hours  
190,261**

**ELECTRONICS  
PARTS - COST SUMMARY**

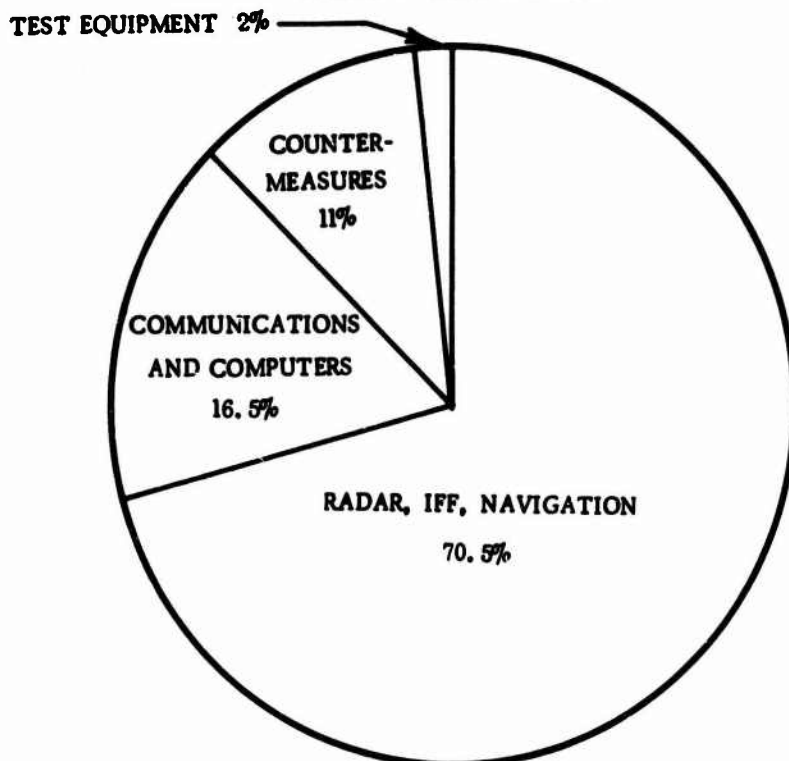

**PARTS - COST DISTRIBUTION**

**Total Parts Cost:  
\$1,088,330**

**ELECTRONICS  
RADAR AND COUNTERMEASURES  
HIGH MAN-HOUR USER SUMMARY**

**Reporting Period:  
March-August 1965**

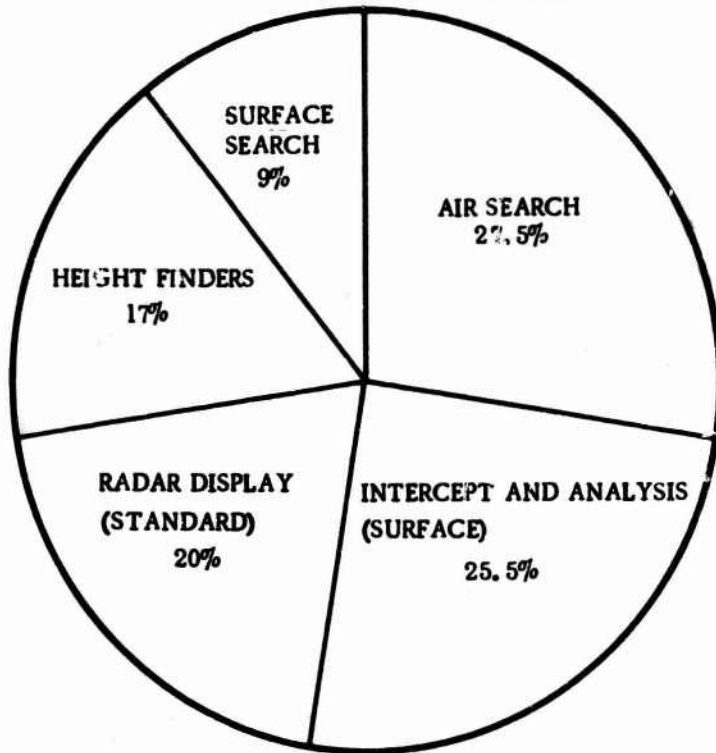

**Total Man-Hours  
65,427**

**MAN-HOUR DISTRIBUTION**

**ELECTRONICS  
RADAR AND COUNTERMEASURES  
HIGH PARTS - COST SUMMARY**

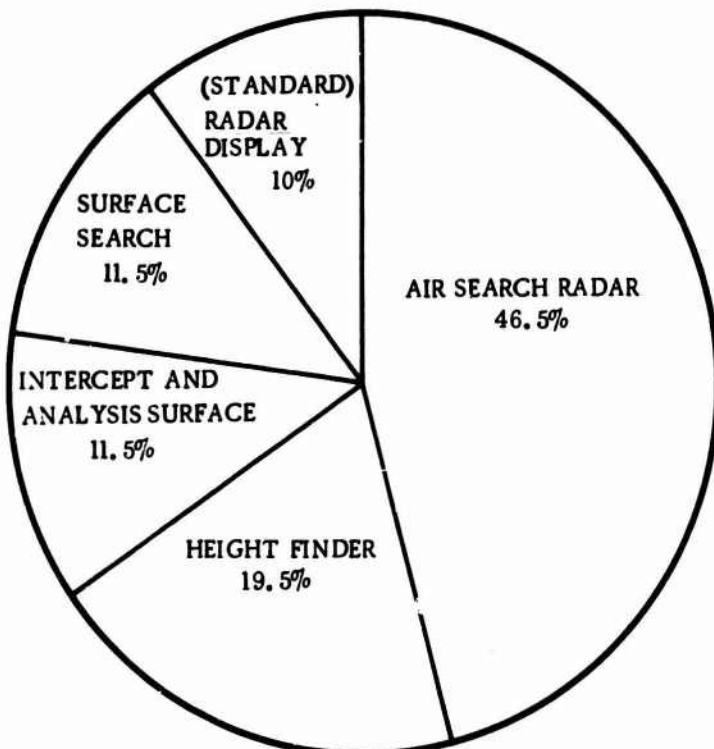

**Total Parts Cost  
\$739,084**

**PARTS - COST DISTRIBUTION**

**DEFICIENCY EVALUATION REPORT NO. 6**  
**BOILER SYSTEM, CONDENSATE BOOSTER PUMP MOTOR**  
**CID 174320067**

---

**MSO-421 CLASS**  
**12 NOV. 1965**

**STATISTICS:**

436	Insul. Failure (Bilge Water)	6/30/64
437	Insul. Failure (Bilge Water)	1/21/65
448	Insul. Failure (Bilge Water)	7/3/64
	Insul. Failure (Bilge Water)	2/17/65
455	Insul. Failure (Bilge Water)	10/26/64
	Insul. Failure (Bilge Water)	11/1/64
	Insul. Failure (Bilge Water)	12/29/64
458	Insul. Failure (Bilge Water)	11/3/64
467	Insul. Failure (Bilge Water)	9/30/64
	Insul. Failure (Pump Water)	1/19/65
	Insul. Failure (Pump Water)	2/20/65
	Insul. Failure (Water)	4/14/65
508	Insul. Failure (Bilge Water)	11/16/64

**BRIEF:**

Seventy-nine reports of equipment failure were reviewed, covering all electric motors installed on MSO-421 Class Minesweepers. These reports covered a period of 1 July 1964 through 30 September 1965. From the data reviewed, it was determined that the condensate booster pump motor was the deficient item.

The consensus of the seven reporting ships was that the location (under the deck plate, in the bilge, of the forward engine room) of the subject motor was primarily responsible for its repeated failures, i.e., the pump and motor are located in an environment detrimental to proper prolonged motor operation. Most ships reporting, suggested that the pump and motor be relocated out of the bilge.

There are 61 MSO-421 Minesweepers in the Fleet. Of these, seven have reported a total of 13 winding failures relating to water getting into the motor. Past experience has shown that many ships do not report all failures.

**EVALUATION:**

There are several possible causes why this item is a deficiency. The specifications to which the unit was built and the atmosphere to which the item is subjected are probably the major factors influencing the failure.

The subject item's enclosure was built to a specification, MIL-M-1940, 31 January 1950 which states: "D 1rr Totally Enclosed. A totally enclosed motor is one so enclosed as to prevent exchange of air between the inside and outside of the enclosure, but not sufficiently to be termed as airtight."

**NOTE:** The above specification for totally enclosed items is not intended to exclude air or water from entering the enclosure; however, louvers or other openings are not permitted.

A further specification from MIL-M-1940 states: "D 2h (6) Condensation Drain. On all spraytight, watertight, and submersible motors, a drain and plug shall be provided in the lowest part of the motor."

A totally enclosed machine built to the above specifications is so constructed as to admit water and then trap it since no method is provided for drainage. The light shaded area of Figure 1 shows the pocket where water might be trapped and stored.

The instruction manual, NAVSHIPS 347-1797, states: "Mount . . . in a place as free as is practical from dust and moisture"... In the selection of a motor enclosure for the subject application, it appears that poor judgment was used. The subject motor could not be more misapplied without submerging it, and apparently this too may happen at times, at least partially.

#### RECOMMENDATIONS:

It is recommended that further information be obtained in an effort to attain the best engineering solution to this problem.

1. Shipcheck two or more MSO-421 Class Minesweepers to gain insight as to how water is entering the motor.
2. Investigate the possibility of raising the pump and motor to a higher level versus replacing the existing motor with one suitable for the environment.

It is further recommended that the following interim fix be accomplished:

1. A SHIPALT be issued providing a drainage capability for condensate booster pump motors installed on MSO-421 Class ships. This should be accomplished as shown in Figure 1:
  - (a) Drill and tap a 1/4-inch hole in the endbell of the motor in a location approximately as shown.



(b) Fit this hole out with clear tubing long enough to be seen by the watch.

(c) Put a petcock valve at the end of the tubing.

2. Issue instructions for the watch to check the plastic tube at least once during each watch, more often during rough seas.
3. Issue instructions to keep the forward engine room bilges to a minimum water level in an effort to improve the motor's environment.

DE REPORT NO. 6  
12 NOVEMBER 1965

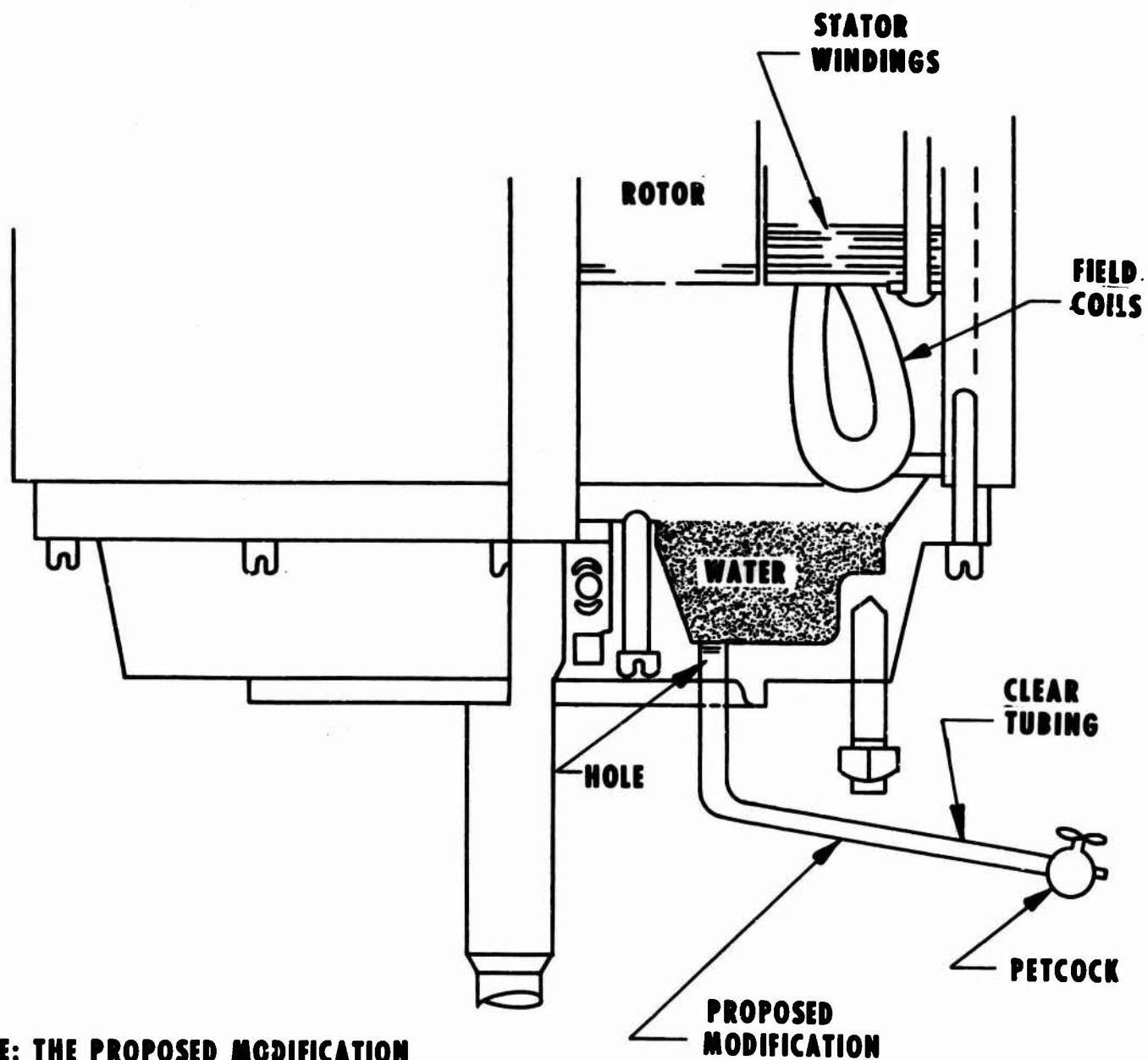

**NOTE: THE PROPOSED MODIFICATION  
INCLUDES DRILLING THE HOLE  
AND FITTING IT OUT WITH  
CLEAR TUBING AND A PETCOCK.**

**FIGURE 1 - AC MOTOR CUT-A-WAY WITH PROPOSED MODIFICATION.**

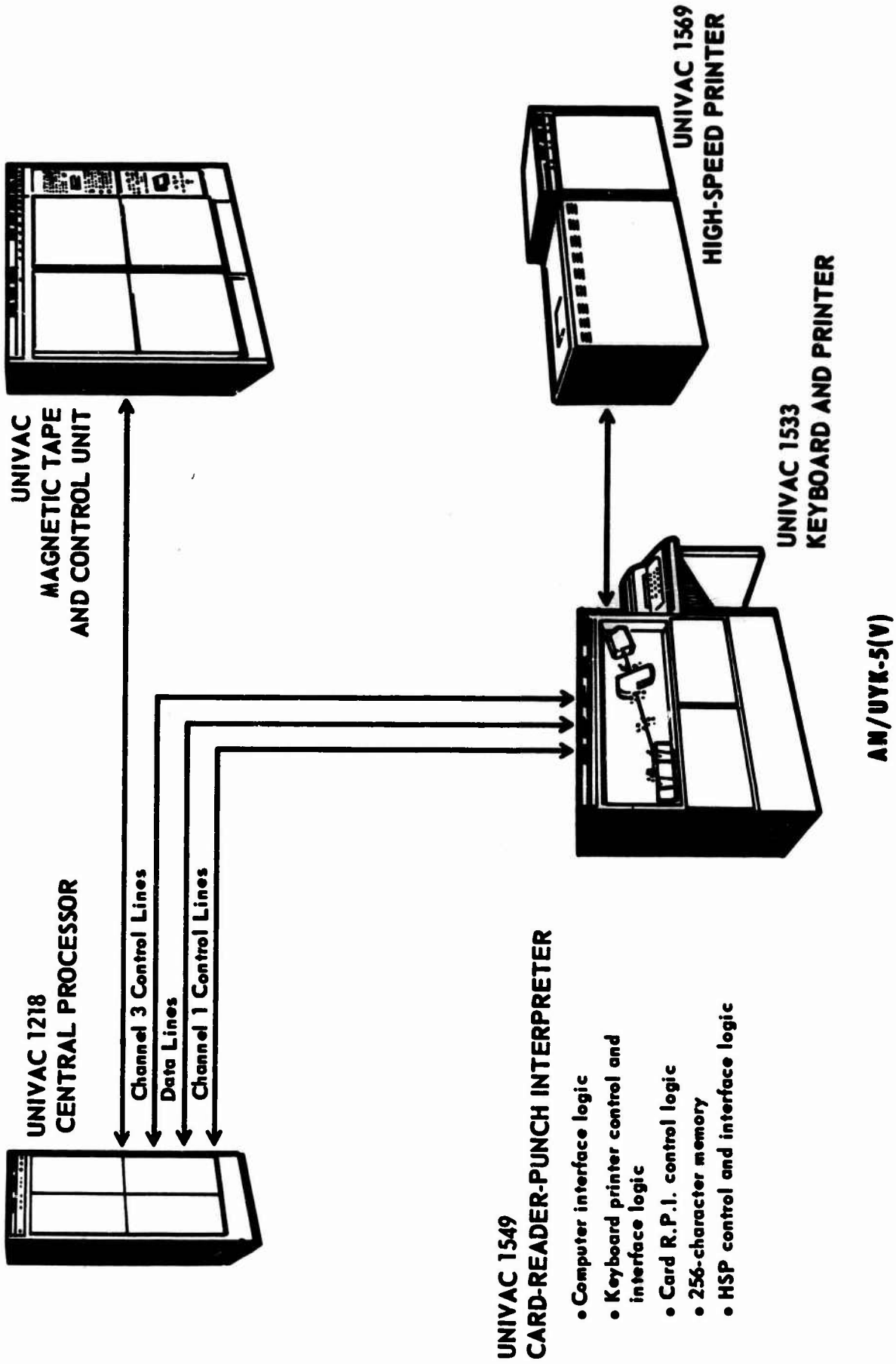

**UNIVAC 1549  
CARD-READER-PUNCH INTERPRETER**

- Computer interface logic
- Keyboard printer control and interface logic
- Card R. P. I. control logic
- 256-character memory
- HSP control and interface logic

# SHIPBOARD INSTALLATION OF ADPE

## AN/UYK (5--V)

	FY 1966	FY 1967
SUB TENDERS (FBM)	3	2
LPH's	2	5
DD TENDERS	3	12
CARRIERS	6	19
REPAIR SHIPS	4	6
SUB TENDERS (CONVENTIONAL)		6
<b>SUB TOTAL</b>	<b>18</b>	<b>50</b>
<b>TOTAL</b>	<b>68</b>	

PLVS ALL NEW CONSTRUCTION &  
ACTIVATIONS OF SAME TYPE

**PROCUREMENT COST PER SYSTEM**                    \$148,116  
**TOTAL PROCUREMENT COST TO DATE**            \$11 MILLION  
**TOTAL ESTIMATED INSTALLATION COST**           5 MILLION

# **EXTENDING MDACS TO SHIPYARDS**

**BSN NSY RAV STUDY**

**NOV. 1965**

**IMPLEMENT INTERIM MDACS**

**PROCEDURES AT NSY**

**MAY 1966**

**IMPLEMENT INTERIM MDACS**

**PROCEDURES AT COMM. SHIPYARDS**

**NOV. 1966**

**IMPLEMENT FINAL PROCEDURES**

**AT ALL YARDS**

**OCT. 1967**