

AD614805

STRUCTURAL STUDIES OF INORGANIC OXIDIZERS

QUARTERLY REPORT NO. 3
M.R.I. Project No. 2790-C
Contract No. AF 04(611)-10215

1 January - 31 March 1965

Sponsored by
ADVANCED RESEARCH PROJECTS AGENCY
Propellant Chemistry Office
Washington, D. C. 20301
ARPA Order No. 24

DDC

MAY 12 1965

Monitored by
Air Force Systems Command
Research and Technology Division
ROCKET PROPULSION LABORATORY
Edwards, California

JA B



MIDWEST RESEARCH INSTITUTE

425 VOLKER BOULEVARD/KANSAS CITY, MISSOURI 64110/AC 816 LO 1-0202

ARCHIVE COPY

COPY	2	OF	3	led
HARD COPY	\$. 2 . 0 0			
MICROFICHE	\$. 0 . 5 0			

34P

STRUCTURAL STUDIES OF INORGANIC OXIDIZERS

QUARTERLY REPORT NO. 3
M.R.I. Project No. 2790-C
Contract No. AF 04(611)-10215

1 January - 31 March 1965

Sponsored by
ADVANCED RESEARCH PROJECTS AGENCY
Propellant Chemistry Office
Washington, D. C. 20301
ARPA Order No. 24

Monitored by
Air Force Systems Command
Research and Technology Division
ROCKET PROPULSION LABORATORY
Edwards, California

PREFACE

This program has been conducted under the general supervision of Mr. R. L. Hughes, Head, Physical and Inorganic Section. Dr. F. I. Metz, Principal Chemist, is project leader; Dr. F. E. Welsh, Associate Chemist, has been responsible for the EPR analysis; Dr. W. B. Rose and Dr. John Nebgen are responsible for the preparation and purification of materials and the visible-ultraviolet and infrared spectroscopic studies. Mr. J. Hennon has been assisting in all phases of the program. The Air Force Project Monitor is Lt. Eugene A. Irene (RPCL), Edwards Air Force Base. This report has been prepared by project personnel.

Approved for:

MIDWEST RESEARCH INSTITUTE

F. V. Morriss

F. V. Morriss, Director
Chemistry Division

4 May 1965

TABLE OF CONTENTS

	<u>Page No.</u>
I. Introduction	1
II. Technical Accomplishments	1
A. Electron Paramagnetic Resonance Studies	1
B. Preparation and Purification of Materials	5
C. Other Spectroscopic Studies	7
III. Discussion	11
IV. Future Work	11
Appendix - Electron Paramagnetic Resonance Spectrum of Liquid Oxygen Difluoride	12

I. INTRODUCTION

The synthesis of "superoxidizers" based on energetic combinations of hydrogen, oxygen, nitrogen, and fluorine has received more emphasis than has the interpretation of structure and bonding characteristics of the representative compounds. The present investigation is directed toward determining the feasibility of obtaining certain structures of primary interest to solid propellant technology.

There are, at present, eight compounds of interest in the study of the structure of inorganic oxidizers. These are: the four known oxygen-fluorine compounds, OF_2 , O_2F_2 , O_3F_2 and O_4F_2 ; and the four nitrogen-fluorine compounds, NF_3 , N_2F_4 , N_2F_2 and N_3F . Each of these compounds is a potential source of O-F or N-F ion or radical species. The specific objective of this program is the investigation of stable ions such as NF_4^+ , NF_2^+ , and OF^+ .

The experimental approach to structural studies has been the assumption that the ions will exist in solution. A suitable solvent system for the detection of O-F or N-F ions is the oxidizer itself. The present study has, therefore, been concerned with the analysis of ion or radical species present in the pure liquid oxidizers and in the liquid systems: $\text{OF}_2\text{-NF}_3$, $\text{O}_2\text{F}_2\text{-NF}_3$, $\text{O}_3\text{F}_2\text{-NF}_3$ and $\text{OF}_2\text{-N}_2\text{F}_4$.

The present program has established that OF_2 dissociates photolytically into a paramagnetic species in which there is a hyperfine interaction between the unpaired electron and one fluorine nucleus. The radical has been characterized by means of the EPR spectrum, but not identified. However, the characteristics of the spectrum indicate that the radical is $\text{O}_x\text{F}\cdot$, rather than $\text{F}\cdot$. It is highly probable that the same $\text{O}_x\text{F}\cdot$ radical exists in the higher oxygen fluorides and, indeed, may be the basic structural unit for synthesizing O_xF_y and related compounds.

The interaction of the photolytic OF_2 species in NF_3 (liquid) solvent results in a destruction of the paramagnetic entity rather than a stabilization. This is further evidence that photolysis of OF_2 produces a radical rather than an ion species.

II. TECHNICAL ACCOMPLISHMENTS

A. Electron Paramagnetic Resonance Studies

The results of the EPR studies on liquid OF_2 were presented at the Symposium on Advanced Propellant Chemistry, 149th National Meeting,

American Chemical Society, April 3 - 9, 1965. The Symposium has been accepted for publication as a volume in "Advances in Chemistry Series." The complete text of this publication is given in the Appendix, the abstract is presented below.

Electron Paramagnetic Resonance Spectrum of
Liquid Oxygen Difluoride

F. I. Metz, F. E. Welsh, W. B. Rose

ABSTRACT

The electron paramagnetic resonance spectrum of liquid oxygen difluoride (OF_2) has been investigated. The shape, linewidth, and complexity of the resonance signal obtained was dependent on the purity of the liquid OF_2 . The strength of the signal was found to be photolysis dependent and the rate of decay was slow.

A sample of chromatographed liquid OF_2 prepared in the absence of light showed no signal. A strong doublet with a peak-to-peak linewidth of 1.6 gauss and a hyperfine splitting of 13.5 gauss appeared when the sample was photolyzed. The line center of the doublet had a g-value of 2.0032 . The line shape closely approximated a Lorentzian curve. The number of the paramagnetic species ($\text{O}_x\text{F}\cdot$) was calculated to be on the order of 10^{16} per sample, corresponding to a concentration of about 0.001 mole per cent.

The photolytic rate of formation and the subsequent decay of the paramagnetic species in the absence of light is discussed.

In addition to the work summarized in the Appendix, O^{17}F_2 has been prepared and its EPR spectrum examined. In order to increase the yield of OF_2 , the material was prepared by the reaction of F_2 with KOH . The concentration of O^{17} in the EPR sample was less than 1 per cent and may account for the fact that no splitting was observed. No further work is anticipated on $\text{O}^{17}\text{-F}$ compounds at this time, since this work has been extensively pursued at several other laboratories.

The study of the photolytic behavior of OF_2 (liquid) has led to the general mechanism:

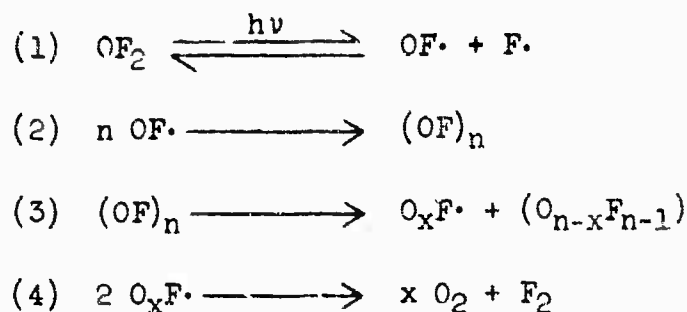

The radicals $\text{OF}\cdot$ and $\text{F}\cdot$ should be relatively short-lived, and would probably not be directly observable via EPR. However, if $\text{OF}\cdot$ associates as $(\text{OF})_n$, reaction (2), then fragmentation, reaction (3), might well produce a longer-lived species, $\text{O}_x\text{F}\cdot$. This species could be present in all O-F compounds where x may have the same or different values.

O_2F_2 and O_3F_2 : Samples of O_2F_2 were synthesized by an electric discharge in equimolar mixtures of oxygen and fluorine.^{1/} An EPR tube was sealed onto the base of the discharge vessel.^{2/} The dewar surrounding the discharge tube was lowered slowly, and the liquid O_2F_2 was collected in the EPR tube. Conditions were maintained such that only a very small volume (less than 0.01 ml.) of O_2F_2 was condensed in the tube. If the sample was greater than 0.01 ml., the EPR spectrum could not be obtained because of the presence of an excessive number of paramagnetic species.

The EPR spectrum of solid O_2F_2 at 77°K contained a signal that exhibited an anisotropic powder pattern with a total width of about 100 gauss; the center of the pattern was near $g = 2.0$. Similar spectra were obtained at temperatures up to 109°K. The normal melting point of O_2F_2 is given as 109.7°K.^{3/} The change in the EPR pattern as a function of temperature is shown by the spectra in Fig. 1. Curve A was obtained at 95°K; Curve B was obtained at 109°K with the same instrumental settings used for Curve A. The intensity of the anisotropic component decreases and a doublet with a splitting of approximately 15.9 gauss can be seen developing in the center of Pattern B. In Curve C, taken at 111°K, the anisotropic components are very weak. The amplification factor for the outer peaks in Curve C is the same as that used for Curves A and B. The doublet in C has a splitting of approximately 15.9 gauss, a g -value of 2.0033, and is of sufficient intensity that the amplification factor is one-tenth that used for the outer components.

^{1/} Kirshenbaum, A. D., and A. V. Jrosse, *J. Am. Chem. Soc.*, 81, 1277 (1959).

^{2/} Midwest Research Institute, Contract No. AF 04(611)-10215, "Structural Studies of Inorganic Oxidizers," Quarterly Report No. 2, pp. 4 - 7, January 1965.

^{3/} Ruff, O., and W. Menzel, *Z. Anorg. Allgem. Chem.*, 211, 204 (1933).

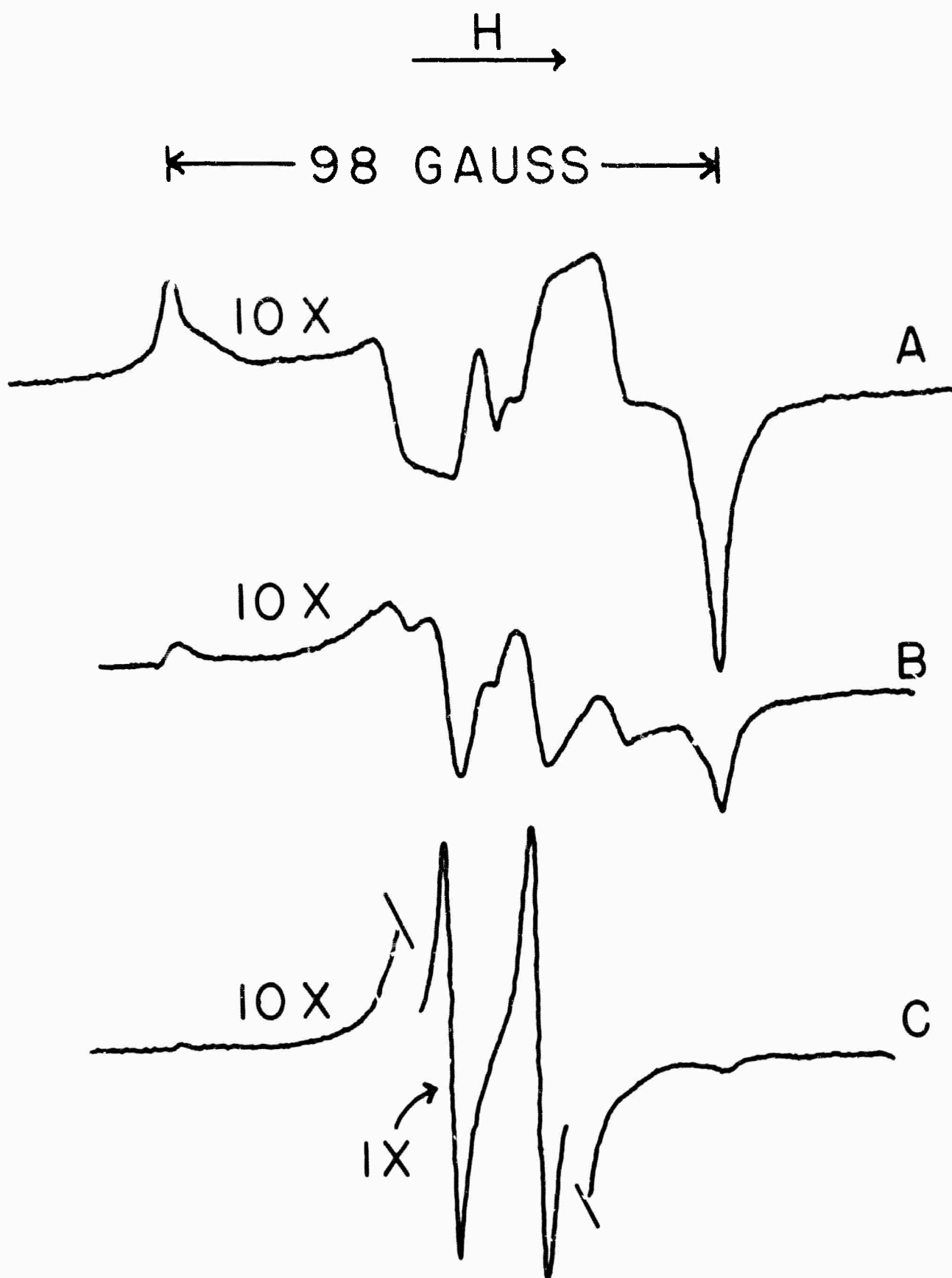

Fig. 1 - EPR Spectra of O_2F_2 : Curve A, $95^\circ K$; Curve B, $109^\circ K$; Curve C, $111^\circ K$

The doublet characteristics have been observed in the EPR spectrum of O_2F_2 at temperatures as high as $237^\circ K$. The intensity at this temperature was quite low, but increased as the temperature was lowered. At $95^\circ K$, the anisotropic pattern was again observed, but with reduced intensity compared to the pattern shown in Curve A, Fig. 1. The radical causing the doublet splitting contains one fluorine nucleus experiencing a hyperfine interaction with the unpaired electron. Further work on the variation of the signal intensity of the O_2F_2 EPR pattern with temperature is in progress.

The effect of photolysis ($\lambda = 3650 \text{ \AA}$) upon the EPR spectrum of O_2F_2 at $77^\circ K$ has been studied. During a 3-hr. photolysis, the signal intensity increased and the central features of the EPR pattern shown in Curve A, Fig. 1, were washed out. The extremes of the broad band obtained (width approximately 100 gauss) correspond to the extremes of the anisotropic pattern observed prior to photolysis. The anisotropic pattern reappeared when the sample was warmed slightly after photolysis.

The EPR patterns obtained from solid and liquid O_3F_2 were similar to that obtained for O_2F_2 . The transition point was $110^\circ K$, which indicated that a large percentage of each sample was probably O_2F_2 . Further work is in progress on the characterization of O_3F_2 .

Mixtures: The EPR studies on OF_2-NF_3 are now in progress. No resonance signal has been observed in equimolar molar mixtures of OF_2 and NF_3 prepared in the dark. Photolysis of pure liquid NF_3 does not produce a resonance signal. However, photolysis of the mixture results in an EPR signal. This signal, like that of pure OF_2 , increases linearly, although at a slower rate, with time during photolysis. The temperature and concentration dependence of this photolytic system are being determined.

The investigation of the system $OF_2-N_2F_4$ (liquid) also has been started. However, the purity of N_2F_4 must be improved before the results are meaningful.

B. Preparation and Purification of Materials

The OF_2 , NF_3 and N_2F_4 used in this investigation have been obtained commercially. The O_2F_2 and O_3F_2 were prepared from premixed commercial oxygen and fluorine by the technique previously described.^{2/}

The purification of OF_2 is described in detail in the Appendix; NF_3 is purified in a similar manner.

The N_2F_4 obtained from Air Products is reported to be of 99.9 per cent purity; the major impurities are NO and N_2O with small quantities of other (unknown) materials. The purification technique used in this investigation was that outlined by Schoenfelder.^{4/} A 5 ft. x 1/4 in. silica gel (60 - 80 mesh) column was maintained at $-78^\circ C$ by an acetone-dry ice mixture. The chromatography of the commercial (Air Products) gas revealed as many as eight compounds present.

Although some of the impurities may have been the result of interactions of N_2F_4 with the (glass) purification lines, this initial work indicated that the commercial product contained impurities not identified by the manufacturer.

The eluted impurity gases have been sampled and tentatively identified; column length was varied; and finally, temperature was varied. Complete separation of the N_2F_4 from its impurities was accomplished in a 10 ft. x 1/4 in. silica gel (60 - 80 mesh) column at room temperature.

The identified and postulated impurities in N_2F_4 are air (N_2 and O_2), CF_4 , NO, SiF_4 , N_2O , NF_3 and N_2F_4 . All the impurities are eluted well ahead of the N_2F_4 , thus yielding an extremely pure sample. The infrared spectrum of the chromatographed N_2F_4 shows only the major absorptions of this compound.

The preparation of $O^{17}F_2$ for the EPR studies has continued. A micro-technique was devised for the preparation, after repeated attempts at electrolysis failed to yield desirable quantities of OF_2 . Fluorine was reacted with a 0.5 N KOH solution made with H_2O^{17} (4.0 per cent O^{17}). The fluorine was bubbled through the alkaline solution for 1 hr.; the system was then purged with helium, forcing the $O^{17}F_2$ through the dry ice bath into the liquid O_2 trap. The $O^{17}F_2$ was then transferred from this trap to an EPR tube or storage bomb. The resultant product contained impurities, and it was necessary to dilute the sample with commercial OF_2 prior to chromatographic separation of the impurities. The final product contained less than 1 per cent O^{17} , a concentration which was too low for the satisfactory observation of EPR splitting. The preparation of O^{17} substituted oxygen fluorides has been discontinued since similar work is being pursued at other laboratories.

^{4/} Schoenfelder, C. W., J. Chromatography, 7, 281 (1962).

C. Other Spectroscopic Studies

The investigations of the visible-ultraviolet spectra of the pure oxygen and nitrogen fluorides and mixtures of oxygen and nitrogen fluorides (all liquids) has continued. This work has replaced the flash photolysis studies of liquid OF_2 . As was previously reported, the flash photolysis studies of liquid OF_2 were unsuccessful due to our inability to concentrate enough photolysis energy into the liquid sample.^{5/}

The visible-ultraviolet spectra of OF_2 and NF_3 (liquids) have been obtained with a Beckman DU spectrophotometer adapted to hold the low-temperature cells designed for the flash photolysis studies.^{5/} The readings are recorded point by point throughout the range of 220 $\text{m}\mu$ to 1,000 $\text{m}\mu$.

In the study of the pure liquids, there is no solvent and hence no reference solution. However, with several cells of differing path length, the existence of regions of 100 per cent transmittance becomes apparent. By using the absorbances measured in these regions as a "cell constant," and assuming that this correction is independent of wavelength, it was found that the ratio of the absorbances agrees well with the ratio of the cell path lengths, and hence, that the molar extinction coefficients can be determined. Table I shows the absorbance data for pure liquid OF_2 and the correction factor for each cell. The extinction coefficients agree well from cell to cell; indicating that OF_2 does obey Lambert's Law.

The molar extinction coefficients for liquid OF_2 compare quite favorably to those reported by Glissmann and Schumacher^{6/} for gaseous OF_2 . Liquid NF_3 is essentially transparent in the region 300 - 1,000 $\text{m}\mu$, as can be seen from the data in Table II.

^{5/} Midwest Research Institute, Contract No. AF 04(611)-10215, "Structural Studies of Inorganic Oxidizers," Quarterly Report No. 1, October 1964.

^{6/} Glissmann, A., and H. J. Schumacher, Z. Physik. Chem., B24, 328 (1934).

TABLE I

DATA FOR PURE LIQUID OF₂ IN THE THREE CELLS
USED IN THIS WORK

A. Path length = 0.1 cm., cell constant = 0.04 absorbance unit

<u>λ</u>	<u>A (abs.)</u>	<u>A (corr.)</u>	<u>ϵ</u>
700	0.04	0.00	0.000
650	0.04	0.00	0.000
600	0.04	0.00	0.000
550	0.06	0.06	0.006
500	0.08	0.04	0.016
450	0.14	0.10	0.030
400	0.22	0.18	0.054
350	0.66	0.62	0.187

B. Path length = 0.2 cm., cell constant = 0.03 absorbance unit

<u>λ</u>	<u>A (abs.)</u>	<u>A (corr.)</u>	<u>ϵ</u>
700	0.03	0.00	0.000
650	0.03	0.00	0.000
600	0.03	0.00	0.000
550	0.05	0.02	0.006
500	0.10	0.07	0.011
450	0.23	0.20	0.030
400	0.40	0.37	0.056
350	1.24	1.21	0.181

C. Path length = 0.5 cm., cell constant = 0.05 absorbance unit

<u>λ</u>	<u>A (abs.)</u>	<u>A (corr.)</u>	<u>ϵ</u>
700	0.05	0.00	0.000
650	0.05	0.00	0.000
600	0.06	0.01	0.001
550	0.10	0.05	0.003
500	0.24	0.19	0.011
450	0.53	0.46	0.029
400	0.92	0.87	0.053
350	-	-	-

TABLE II

ABSORBANCE OF NF₃ (200 - 1,000 mμ)

<u>λ mμ</u>	<u>Absorbance</u>
200	0.6
250	0.1
300	0.05
350	0.01
400	0.01
500	-
600	-
700	-
800	-
900	-
1,000	-

The present studies on the mixtures of OF₂ and NF₃ are directed toward establishing any interaction of the photolytic species present in OF₂.

Other workers have examined the visible-ultraviolet spectra of O₂F₂ and O₃F₂,^{7/} hence our work with these materials will examine the variation of the observed spectra with temperature. For these studies the low temperature Dewar has been replaced with the variable temperature cell and dewar shown in Fig. 2. This cell and Dewar unit can be used with the Beckman DK or DU spectrophotometer. Studies of mixtures containing NF₃ and the higher oxygen fluorides are also in progress.

No infrared data on the pure liquids or mixtures are available at this time. A satisfactory fixed-thickness AgCl cell has been fabricated. The sample inlet system is a 4 mm. pyrex to Kovar tube, which is silver soldered to the stainless inlet line which passes through the body of the dewar. (The cryogenic optical dewar and associated equipment have been previously described.^{8/}) Considerable difficulty has been experienced in maintaining the dewar vacuum at low temperatures, but most of the problems have been resolved. A longer flexible cable will permit continuous evacuation during the infrared observations thus assuring that sample temperature is constant.

^{7/} Kirshenbaum, A. D., and A. G. Streng, *J. Chem. Phys.*, **35**, 1440 (1961).

^{8/} Midwest Research Institute, Contract No. AF 04(611)-9372, "Structural Studies of Inorganic Oxidizers," Annual Summary Report, RPL-TDR-64-98, pp. 1-8, June 1964.

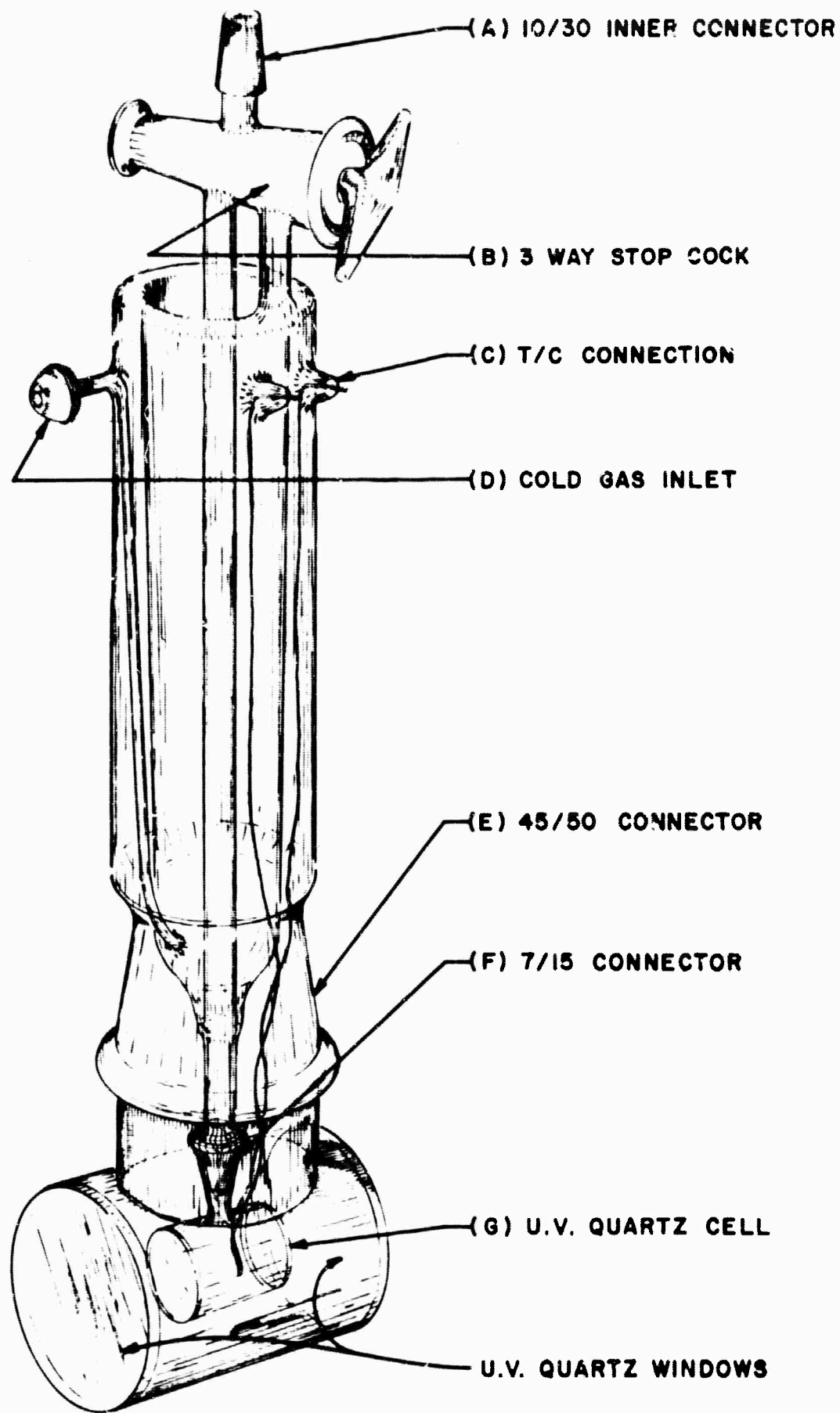

Fig. 2 - Variable Temperature Dewar and Cell for Visible-Ultraviolet Studies of Liquid Oxidizers

III. DISCUSSION

The spectroscopic studies of the oxygen-fluorine, nitrogen-fluorine compounds have not shown the existence of any of the postulated ions. However, of equal importance with ionic species, is the presence of an extremely long-lived radical. This study has shown that photolysis of OF_2 (liquid) produces such an entity. One possible route to the formation of this species in OF_2 is given by reactions (1) - (3), Section II-A. It is conceivable that the same species exists in the photolyzed products of O_2F_2 and O_3F_2 . Thus, the paramagnetic species observed is $\text{O}_x\text{F}\cdot$ where $x = 2$ in the case of OF_2 .

The visible-ultraviolet studies contribute to the understanding of the photolytic processes because they indicate the regions where OF_2 begins to absorb light. The absorption of light corresponds to electronic transitions from the ground state to an excited electronic state. This excited state is probably short-lived, and may well be the $\text{OF}\cdot$ of reaction (1). The nature of this electronic transition in liquid OF_2 , as well as the other transitions contributing to the weak maxima at 294 and 421 μ in gaseous OF_2 will be better understood after the investigation of the temperature and photolytic behavior of the spectra have been obtained. Of equal importance will be the infrared data on liquids, since the associated intermediate, $(\text{OF})_n$ of reaction (2), may not be present in gaseous or solid OF_2 .

The further characterization of $\text{O}_x\text{F}\cdot$ and $(\text{OF})_n$ in the pure materials and in solution, will form the basis of continuing studies in which these entities will be utilized in the formation of other oxygen-fluorine compounds.

IV. FUTURE WORK

During the next quarter the investigation of the paramagnetic resonance of O_2F_2 , O_3F_2 and mixtures of these with N-F compounds will continue. The emphasis in this work will be the determination of mechanism of photolytic behavior and possible techniques for stabilization of the radical or radicals produced.

The visible, ultraviolet and infrared spectroscopic studies will continue. The emphasis in this phase will be on the interpretation of changes observed as the temperature is varied during photolysis. These studies will be made on pure materials and mixtures.

APPENDIX

ELECTRON PARAMAGNETIC RESONANCE SPECTRUM OF LIQUID OXYGEN DIFLUORIDE

F. I. Metz, F. E. Welsh, W. B. Rose

Midwest Research Institute
425 Volker Boulevard
Kansas City, Missouri 64110

INTRODUCTION

The electron paramagnetic resonance spectrum of liquid oxygen difluoride has been determined in conjunction with a study of the structure of liquid inorganic oxidizers. The EPR spectra of the higher oxygen fluorides (O_2F_2 , O_3F_2 , and O_4F_2) have been studied by Kirshenbaum and Grosse (4). They have observed two EPR signals from samples of O_2F_2 at 77°K. The resonances were assigned to the presence of intermediates in the decomposition $O_2F_2 \longrightarrow O_2 + F_2$ rather than to O_2 , F_2 , or O_2F_2 itself. The stronger of the two signals has been interpreted in terms of the presence of a radical with one unpaired electron, having a hyperfine interaction with only one fluorine nucleus. $O_2F\cdot$ was considered to be a likely possibility. The weaker resonance was associated with the presence of a radical in the triplet state.

The EPR spectrum of O_3F_2 showed (4) the same resonances as were obtained from O_2F_2 , except that the intensity of the stronger signal in the case of O_3F_2 was 50 - 100 times greater than the intensity of the corresponding resonance in O_2F_2 , while the triplet resonance in O_3F_2 is only twice as

intense as the triplet resonance in O_2F_2 . The strong signal in O_3F_2 was also assigned to the $O_2F\cdot$ radical. Contamination of the O_2F_2 with O_3F_2 was ruled out by the observation of the resonances after the O_2F_2 sample had been heated above the decomposition temperature of O_3F_2 .

O_4F_2 was found to be paramagnetic (4). The EPR spectrum at 77°K consisted of a strong doublet with an average g-value of 2.009 and a doublet separation on the order of 13 gauss. In view of the dissimilarity between the spectrum of O_4F_2 and the spectra of O_2F_2 and O_3F_2 , it was unlikely that the paramagnetic species in O_4F_2 was the $O_2F\cdot$ radical.

The EPR spectrum of O_3F_2 at 90°K has also been investigated by Maguire (5). A doublet with a splitting of 13.6 gauss and a g-value of 1.975 was obtained. These results have been interpreted in terms of diradical O_3F_2 being the paramagnetic species involved. One unpaired electron is thought to be localized near each of the fluorine nuclei. The coupling between the two fluorine nuclei is considered to be weak, or zero.

In this study, pure liquid OF_2 exhibited no EPR signal when condensed in the absence of light. Upon photolysis, a strong doublet with a hyperfine splitting of 13.5 gauss and a g-value of 2.0032 was obtained. Concentrations were on the order of 10^{16} unpaired electrons per sample. Oxygen difluoride is a colorless gas at room temperature, and a pale yellow liquid at temperatures below 128°K, its normal boiling point. It is relatively stable, with thermal decomposition beginning at about 200 - 250°C. OF_2 is nonlinear, with two equivalent O-F bonds having an FOF angle of 104°.

EXPERIMENTAL

Electron Paramagnetic Resonance

EPR measurements were made using a Varian V-4502 X-band spectrometer equipped with a 6 in magnet and using 100 kc field modulation. The frequency used was 9.1 Gc. The sample tube was a 3.0 mm I.D. quartz tube connected to a stopcock and a male ground glass joint by means of a graded seal. Sample volumes were approximately 0.05 ml. One spectrum was run on a Varian V-4503 K-band spectrometer using a frequency of 34.8 Gc. For measurements at 77°K, the sample tube was placed in a small quartz dewar which was inserted into the cavity. Measurements in the range from 88°K to 138°K were made using a V-4557 variable temperature accessory. Peroxylamine disulfonate was used for the scan calibration. The total hyperfine splitting of the spectrum was taken to be 26.0 gauss (9). Polycrystalline DPFH ($g = 2.0036$) in a capillary inside the dewar was used as the standard for the g -value determination. The frequency in the X-band region was determined using a Hewlett-Packard Model 5243L Electronic Counter, a Model 5253A Frequency Converter, and a Model 540B Transfer Oscillator. Concentration measurements were made relative to a Varian 0.1 per cent pitch sample in KCl, with the number of spins taken to be 3×10^{15} spins/cm length of sample. The accuracy of this value is estimated to be $\pm 25\%$ (10). Relative values of the intensities of the OF_2 spectrum at various temperatures (compared with the pitch standard) are of primary interest, while absolute values of the spin concentrations are of less importance.

Photolysis studies were performed using a PEK-110 100 watt high pressure mercury arc lamp. The 3660 angstrom line was selected by means of a Bausch and Lomb second order interference filter.

Purification

A schematic of the purification system is shown in Fig. 3. The OF_2 was bled slowly from the storage tank through an HF trap and condensed on the cold vertical column. The HF trap removed hydrogen fluoride and silicon tetrafluoride (7), while the cold column separated any carbon dioxide present. This vertical column was at 77°K and jacketed with a dewar. The OF_2 condensed and drained below the cold region of the tube where it refluxed and slowly distilled into the first liquid nitrogen trap. Following Schoenfelder's procedure for N_2F_4 (6), the OF_2 was chromatographed. Table III shows the relative elution times of the impurities found to be present. Prior to the introduction of the helium carrier gas, it was passed through reduced copper oxide wire at 500°C (2) to remove oxygen and Linde molecular sieve to remove H_2O .

TABLE III

RELATIVE ELUTION TIMES ON $\frac{1}{2}$ " x 10' SILICA GEL COLUMN,
FLOW RATE, 150 ml/min

<u>Substance</u>	<u>Elution Time of Maximum (min)</u>
O_2	4.7
N_2	5.1
OF_2	10.8
F_2	13.0
CF_4	16.5
CO_2	120.0
SiF_4	>120.0

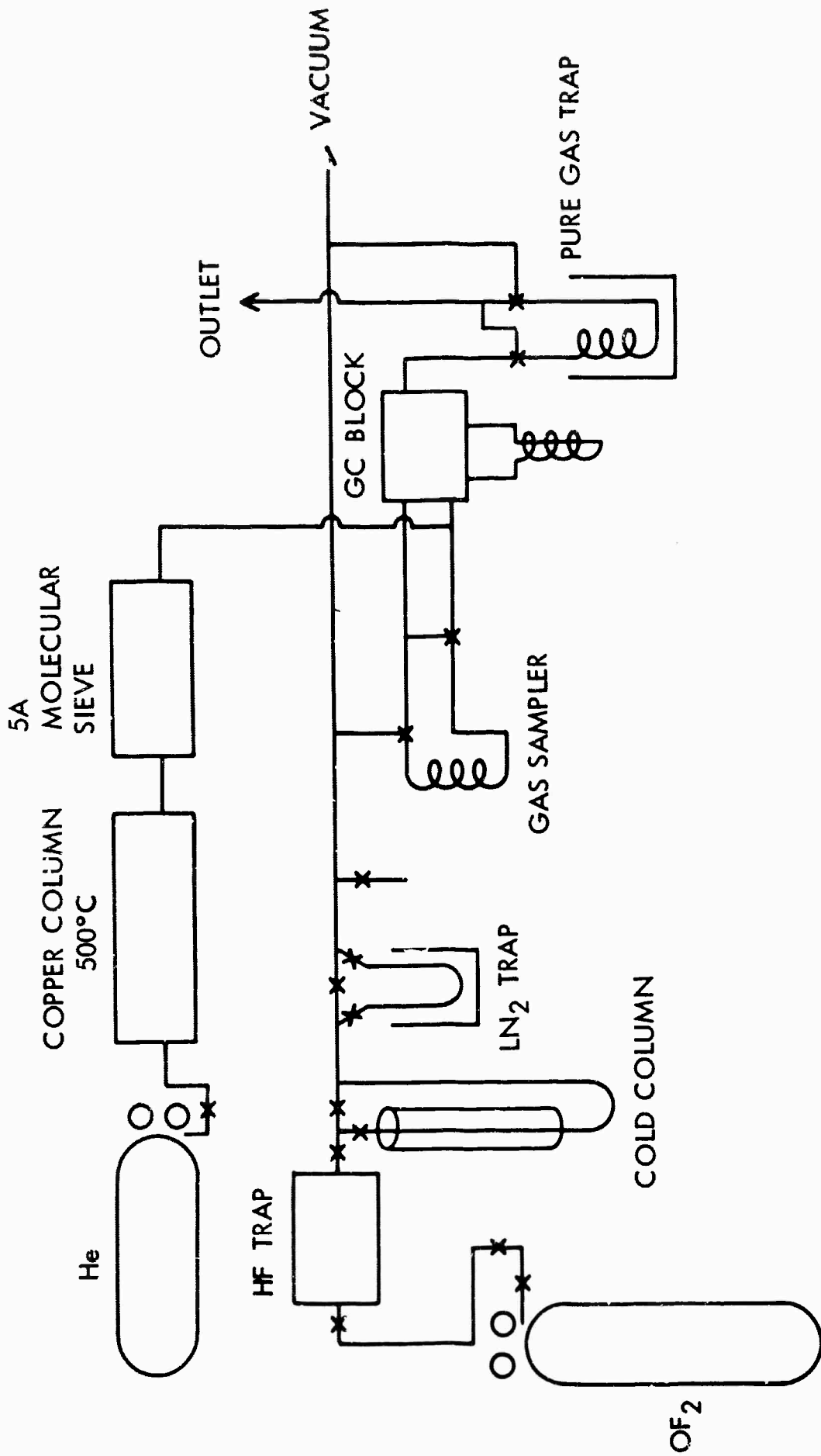

Fig. 3 - Purification System and Vacuum Line

Chemicals

The copper oxide wire was Mallinckrodt reagent grade. The molecular sieve was Linde 5A 1/16-in pellets. The OF_2 was obtained from Allied Chemical Corporation and was approximately 93 per cent pure. The silica gel (60/80 mesh) was purchased from Matheson Company.

RESULTS

No EPR signal was obtained on samples of liquid OF_2 prepared in the absence of light. Liquid OF_2 taken directly from the tank in the presence of room light showed a fairly strong, complex signal with a total linewidth of about 100 gauss. Similar results were obtained from OF_2 which had been swept through an HF trap and subsequently distilled.

The EPR spectrum of a sample of chromatographed liquid OF_2 , prepared in the absence of light, showed a strong doublet (Fig. 4) with a splitting of 13.5 gauss when photolyzed. The linewidth was temperature dependent with values in the range of 1.6 - 3.6 gauss. The line center of the doublet had a g -value of 2.0032 ± 0.0003 . The line shape closely approximated a Lorentzian curve. The spectra were examined at various modulation amplitudes and microwave power levels in order to ensure that no distortion due to overmodulation or power saturation occurred. The intensity of the doublet increased with time during photolysis. The number of paramagnetic species was calculated to be on the order of 10^{16} per sample, corresponding to a concentration of about 0.001 mole per cent. An EPR spectrum of chromatographed liquid OF_2 prepared in normal room light was similar to the

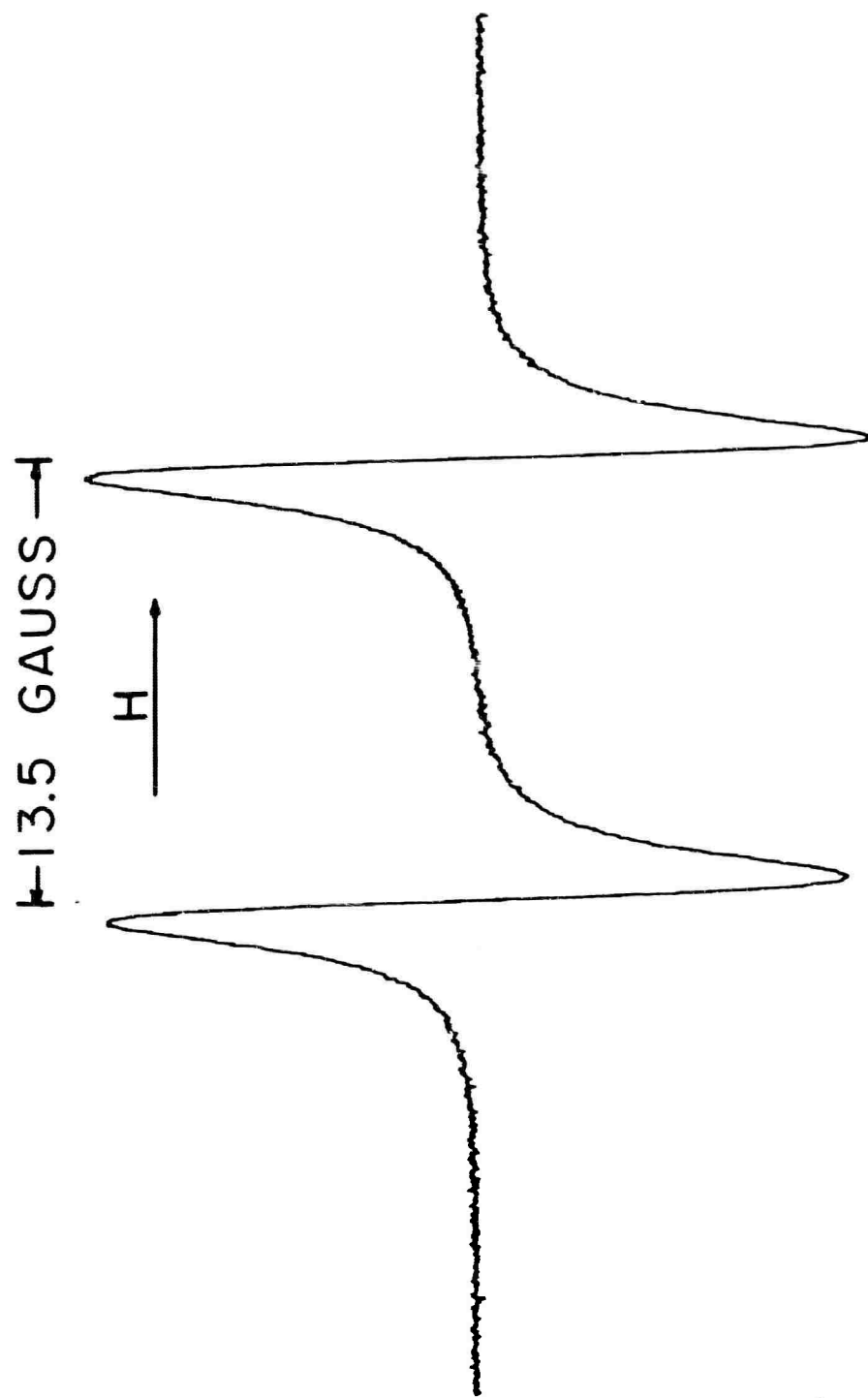

Fig. 4 - EPR Spectrum Liquid OF₂, After Photolysis, 77°K (9.1 Gauss)

spectrum obtained from the photolyzed samples. An EPR spectrum of photolyzed liquid OF_2 observed at a frequency of 34.8 Gc is shown in Fig. 5. A hyperfine splitting of 13.7 gauss was observed, in agreement with the value of 13.5 gauss observed at 9.1 Gc. Part of the asymmetry of the signal observed on the high field side of each peak was due to a recorder malfunction. It is also possible that anisotropies may be observed at the higher frequency used.

In a series of experiments, EPR spectra of different samples of OF_2 were taken during $7\frac{1}{2}$ min of photolysis and afterwards in the absence of light for sufficient time to observe trends in the signal intensity. The change of the signal intensity with photolysis is shown in Fig. 6 for a number of temperatures. The calculated intensity at each temperature was corrected for the change in the Boltzmann distribution of radicals in the lowest energy state. The rate of formation of the radical species increased with temperature. The intensity at the maximum and the signal intensity behavior after photolysis were also strongly temperature dependent. At 77°K the signal strength increased rapidly after the lamp was turned off, then more slowly. At intermediate temperatures, 87°K , 100°K , and 105°K , the intensity leveled off after photolysis. The curves fall off more rapidly at 121°K in the absence of light. The decay at 77°K did not proceed to zero intensity, but usually reached a value which persisted even after several days storage of the sample in the dark. The signal may be caused to vanish, or at least reach a very low level by vaporization and recondensation of the sample in the absence of light.

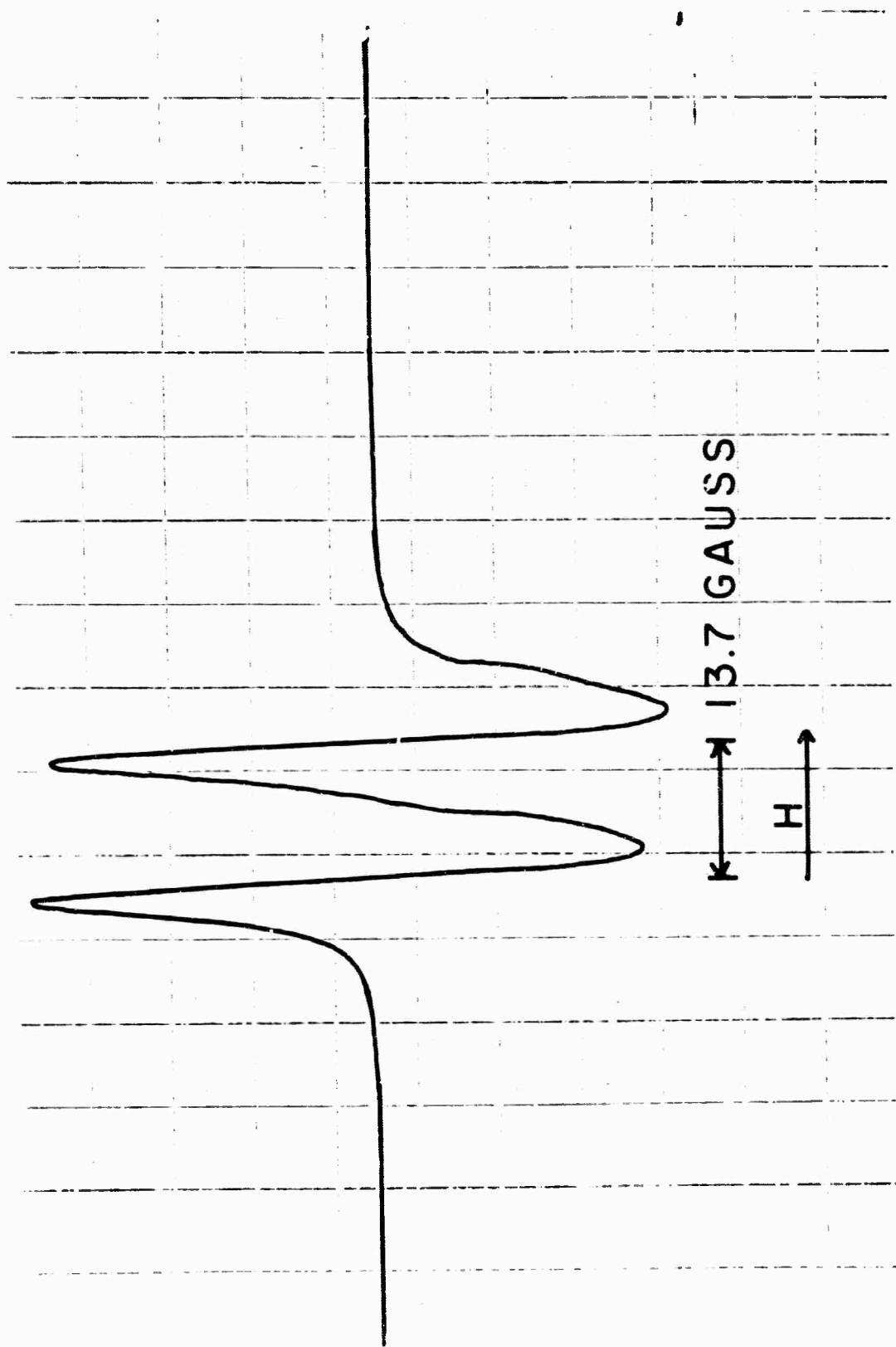

Fig. 5 - EPR Spectrum Liquid OF_2 , After Photolysis, 77°K (34.8 Gauss)

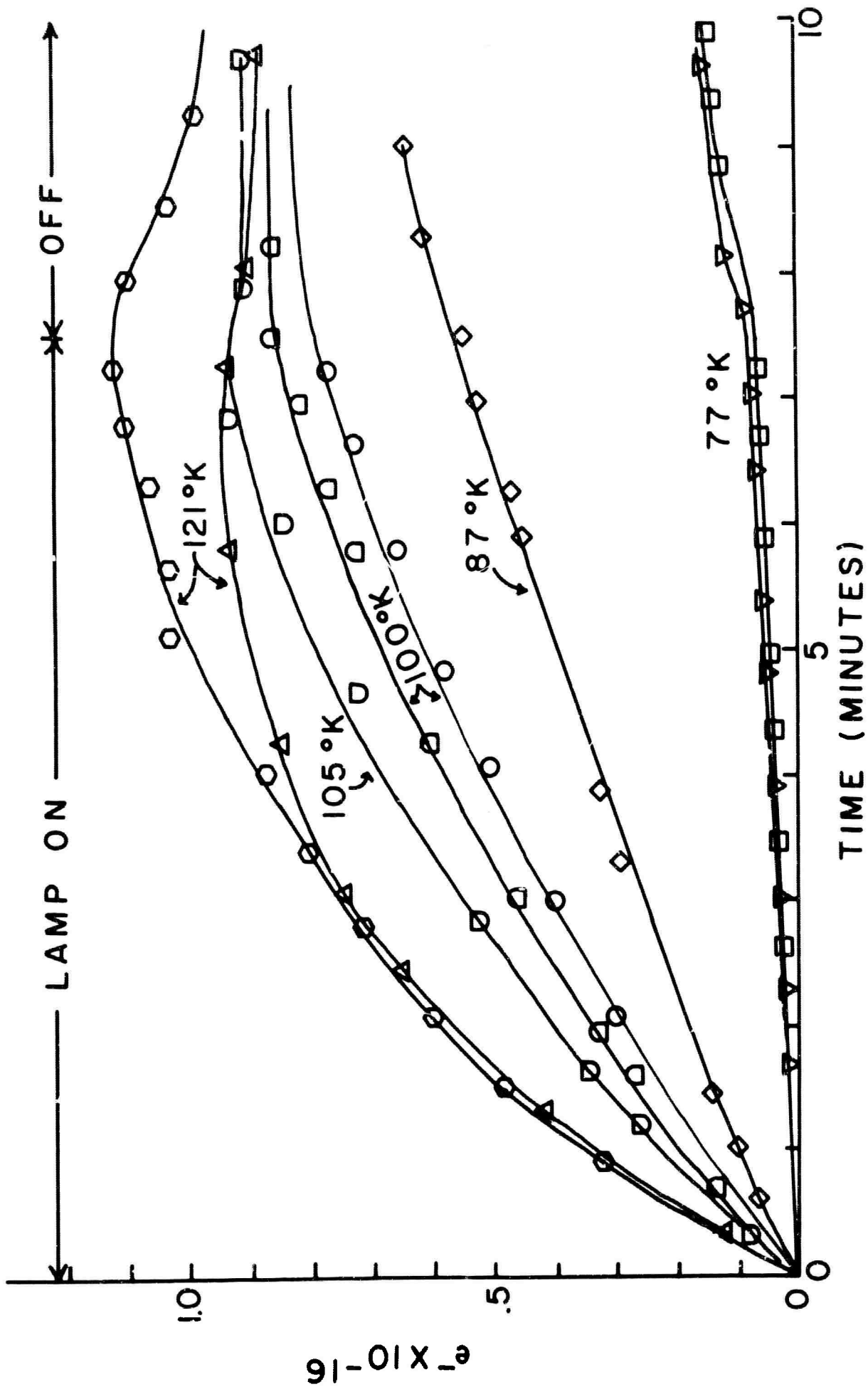

Fig. 6 - Variation in Paramagnetic Resonance of Photolyzed OF_2 , at Various Temperatures

Figure 7 shows the change in signal strength with continued photolysis at 77°K for two different intensities of irradiation. With low intensity illumination, a peak concentration was reached at 10 min photolysis, after which time additional photolysis produced a diminution of the signal. At 24½ min, the signal strength corresponded to approximately 10^{12} unpaired electrons. After the lamp was extinguished, the concentration immediately increased to a value on the order of 5×10^{13} unpaired electrons. The concentration continued to increase in the absence of light. If the sample was irradiated again, the signal level rapidly dropped to the previous low value. With high intensity illumination, the signal intensity of a different sample of pure liquid OF_2 reached a maximum after 3 min of photolysis, then rapidly decreased. The lamp was turned off at 7½ min, whereupon the signal intensity increased rapidly. In general, the intensity of the EPR resonance increased with continued photolysis, reached a maximum, and dropped to a very low level.

The presence of oxygen may affect the results of these experiments in several ways. Two possible results are a change in the mechanism of the photolytic reactions, or a broadening of the EPR signal. Large amounts of oxygen (of the order of 1%) cause the signal to be broadened. In experiments in which this percentage of oxygen was added to OF_2 , the spectrum was similar to that obtained from pure OF_2 in that the doublet was observed, and the radical concentration was photolysis dependent. Small amounts of oxygen in the range of 0.06% to 0.1% caused no change in either the rate of formation

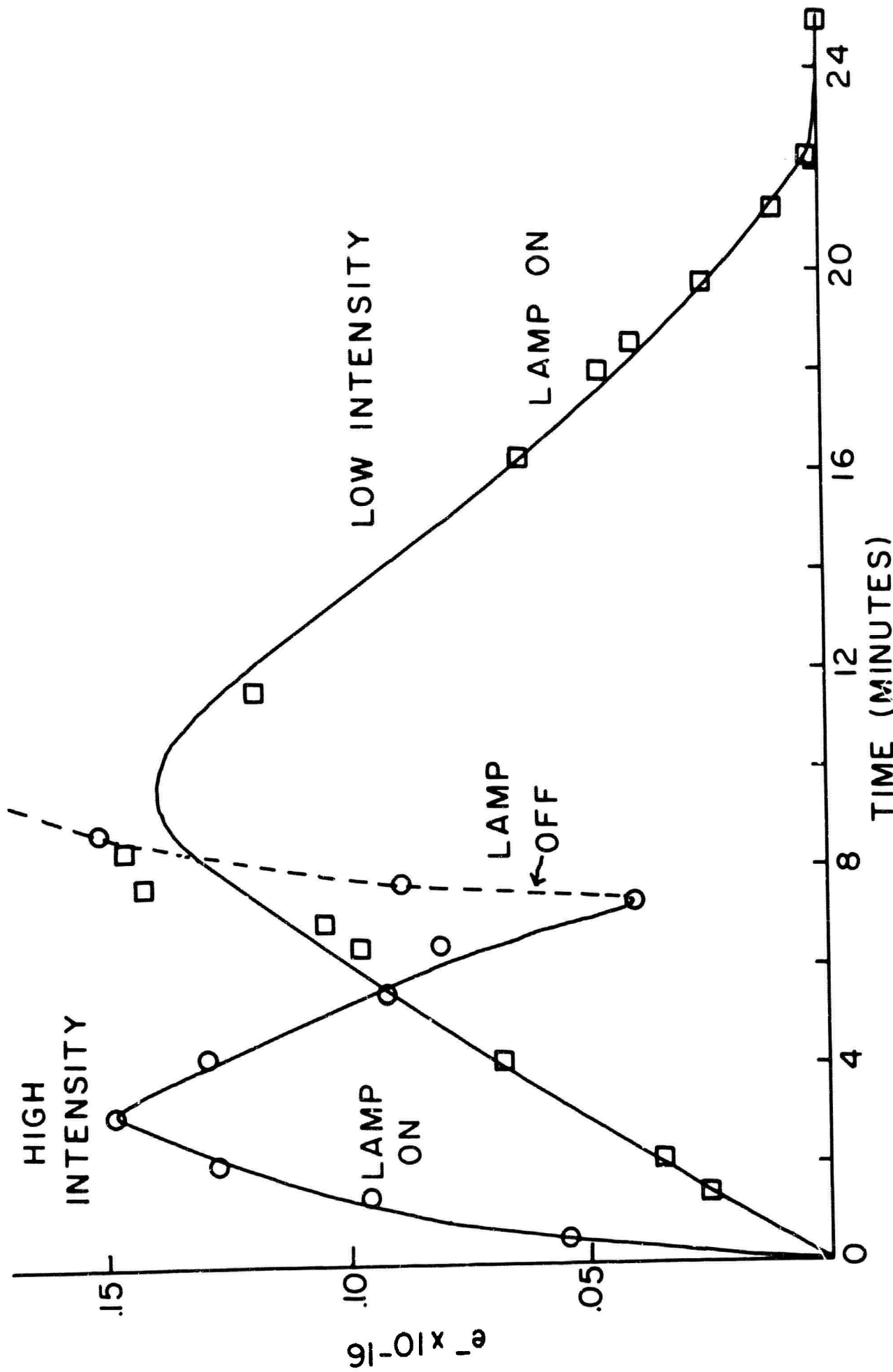

Fig. 7 - Variation in Paramagnetic Resonance of OF₂ for High and Low Intensity Irradiation ($\lambda = 3660 \text{ \AA}$)

of the radical or the characteristics of the signal. It is estimated that the amount of oxygen present in the pure OF_2 was 0.03% or less, probably from a slight decomposition of OF_2 accompanying vaporization and recondensation.

DISCUSSION

The lack of an EPR signal in the spectra of samples chromatographed in the absence of light is strong evidence that liquid OF_2 is not paramagnetic. In addition, a hyperfine triplet rather than the observed doublet would be expected from a paramagnetic species such as $\text{OF}_2\cdot$. The fact that the separation between the two peaks was due to hyperfine splitting was demonstrated by the agreement between the separation in gauss observed in spectra taken at frequencies of 9.1 Gc and 34.8 Gc. If hyperfine splitting was not present, the separation would be expected to increase as the ratio (34.8/9.1) of the frequencies of observation.

Considering the system involved, the doublet could arise from $\text{O}_x\text{F}\cdot$ or $\text{F}\cdot$ radicals, due to hyperfine interaction with a fluorine nucleus which has a spin of $\frac{1}{2}$. However, it is to be expected that the fluorine atom would react via recombination or abstraction much more rapidly than would the $\text{O}_x\text{F}\cdot$ radical. The fluorine radical has not been observed in the condensed phase, but has been observed in the gas phase as six well-spaced resonances with a g-value of $4/3$. At frequency of 9.249 Gc, 4,159 gauss was the lowest value of the magnetic field at which a resonance occurred (8). We have studied the EPR of liquid F_2 at 77°K. Tank fluorine and fluorine run through

an HF trap and distilled have exhibited a weak signal with a linewidth of about 75 gauss and a g-value near 2.0. The signal strength increased with photolysis and seemed to broaden. It is probable that the observed resonance in liquid fluorine was due to an interaction with impurities. It is thus highly improbable that the resonances observed are due to $F\cdot$.

The value of the coupling constant in OF_2 (13.5 gauss) is not what one would expect from hyperfine interaction of an electron with a fluorine nucleus, this interaction usually being much greater. As a comparison, the hyperfine splitting due to two equivalent fluorine nuclei in $NF_2\cdot$ in liquid N_2F_4 is 64 ± 2 gauss (1). It is probable that the greater electronegativity of the oxygen in $O_yF\cdot$ decreases the unpaired electron density at the fluorine and thus accounts for the small value of the hyperfine splitting. From the above, it is probable that the unpaired electron species observed in the present study is $O_xF\cdot$, and not $F\cdot$.

The EPR spectrum of O_2F_2 also has been studied in this laboratory. Solid O_2F_2 showed a broad, anisotropic EPR pattern similar to that reported (4). In addition, the EPR spectrum of neat liquid O_2F_2 contained a doublet near $g = 2.0$, with a hyperfine splitting of approximately 13 gauss.

The radicals present in the four binary OF compounds (OF_2 , O_2F_2 , O_3F_2 , and O_4F_2) may be $OF\cdot$, $O_2F\cdot$, $O_3F\cdot$, and $O_4F\cdot$. However, radicals with the same hyperfine interaction with a fluorine nucleus (13 gauss) have been observed in all four binary OF compounds. It may be that the same paramagnetic species is present in each compound. It is possible that the hyperfine

splitting due to the unpaired electron density with the fluorine nucleus would be changed by the addition of more oxygens on the $O_xF\cdot$ species, due to the electronegativity of the oxygen nucleus. From this line of reasoning, one would expect a different hyperfine splitting with fluorine in each of the radicals. An unambiguous method of identifying the value of x in $O_xF\cdot$ is the use of ^{17}O , which has a nuclear spin of $5/2$, and which would have a hyperfine interaction with the unpaired electron. The number of oxygens in the radical could be determined by the EPR hyperfine pattern. $^{17}OF_2$ is being prepared in order to confirm the identity of the paramagnetic species in photolyzed liquid OF_2 .

The kinetics of the photolysis suggests a number of possible reactions involved in the formation and decay of the observed fluorine containing paramagnetic entity.

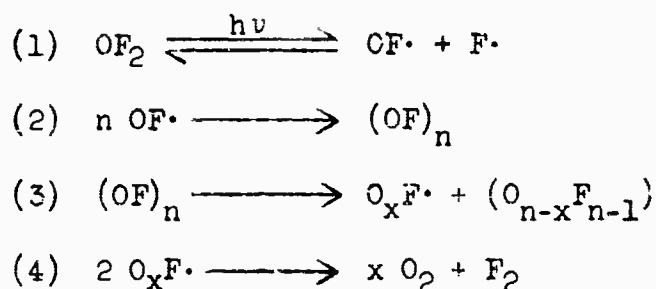

In addition, other reactions of the radicals produced in reaction (1) with solvent (OF_2) or O_2 may occur:

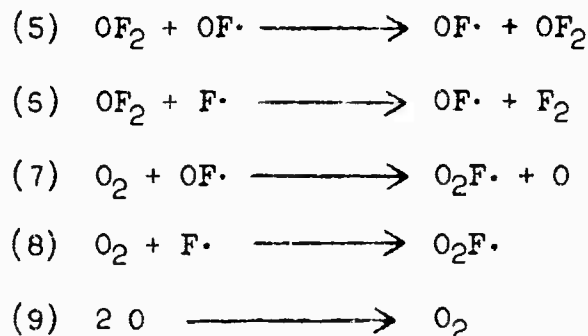

Reaction (1) is the primary photolysis reaction. Both $OF\cdot$ (3) and $F\cdot$ should be short-lived entities and not directly observable via EPR. It is possible that $OF\cdot$ would associate as in reaction (2). Reaction (3) shows the fragmentation of the associated species to give a smaller OF polymer and an $O_xF\cdot$ radical. Reaction schemes involving an associated OF entity could also be written for the higher oxygen fluorides. Thus, one could rationalize the existence of the same $O_xF\cdot$ radical in the four binary OF compounds, if the similarity in the hyperfine coupling of the radicals obtained was interpreted in these terms. However, if the fluorine hyperfine coupling is insensitive to the presence of more than one oxygen on the radical, the value of x in $O_xF\cdot$ may be different in the various OF compounds. Reaction (4) shows the decay of $O_xF\cdot$ to O_2 and F_2 .

Reactions (5) and (6) show possible combinations of the initially generated radicals with solvent molecules, and (7) and (8) are possible reactions of the radicals with oxygen impurity to produce $O_2F\cdot$.

The above reactions are not proposed as the only possible ones, but it is felt that they are reasonable in view of the characteristics and intensity behavior of the EPR spectra.

As the temperature was increased (Fig. 6), the rate of formation of the radical increased. More energy was available to increase the rate of the dissociation of OF_2 following its photolytic activation. In addition, dependent upon the temperature, the signal intensity increased in the absence of light. Hence, an increase in the rate of formation at 77°K after the lamp was extinguished was observed.

At higher temperatures (87°K, 100°K, 105°K), the decay of the signal is slow in the absence of light. Finally, at 120°K, the signal decays more rapidly after photolysis. Thus, the rate of the decay reactions was temperature dependent.

Figure 7 shows that continued photolysis caused the signal to reach a very low level. Thus, there must be a critical concentration which allowed the decay processes to predominate over the formation reactions.

SUMMARY

This study has established that oxygen difluoride dissociates photolytically into a paramagnetic species in which there is a hyperfine interaction between the unpaired electron and one fluorine nucleus. The photolytic rate of formation of the radical species increased with temperature. The behavior of the signal intensity in the absence of light after photolysis was also temperature dependent. The kinetics have been interpreted in terms of a photolytic formation scheme. The radical has been characterized by means of the EPR spectrum, but not identified. However, the characteristics of the spectrum indicated that the radical was $O_xF\cdot$, rather than $F\cdot$.

ACKNOWLEDGEMENT

This research was sponsored by the Advanced Research Projects Agency, Washington 25, D. C., and was monitored by Rocket Propulsion Laboratories, Edwards, California, under Contracts Nos. AF 04(611)-9372 and AF 04(611)-10215.

We would like to thank Dr. William Landgraf of Varian Associates for his assistance in obtaining the EPR spectra at 34.8 Gc.

LITERATURE CITED

1. Doorenbos, H. E., and B. R. Loy, J. Chem. Phys., 39, 2393 (1963).
2. Elliott, K. A. C., Can. J. of Research, 27F, 299 (1949).
3. Gatti, R., E. Staricco, J. E. Sicre and H. J. Schumacher, Zeit. Phys. Chem., 35, 343 (1962).
4. Kirshenbaum, A. D., and A. V. Grosse, Temple Research Institute, "Production, Isolation, and Identification of the $OF\cdot$, $O_2F\cdot$, and $O_3F\cdot$ Radicals," Contract No. AF 04(611)-9555, First, Second, and Third Quarterly Progress Reports; Dec. 31, 1963; March 31, 1964; and June 30, 1964.
5. Maguire, R. G., Armour Research Foundation, "Determination of the Structure of O_3F_2 ," ARL Technical Report 60-287, Contract No. AF 33(616)-6433, August 1960.
6. Schoenfelder, C. W., J. of Chromatography, 7, 281 (1962).
7. Streng, A. G., Chem. Rev., 63, 607-624 (1963).
8. Vanderkooi, N., Jr., and J. S. MacKenzie, Adv. Chem. Series, 36, 98 (1962).
9. Varian Associates, EPR at work No. 28.
10. Varian Associates, Instruction Manual for V-4502 E.P.R. Spectrometer System, pp. 5-11.

DISTRIBUTION LIST

Quarterly Report No. 3, Contract No. AF 04(611)-10215

U. S. Department of the Interior 1 Bureau of Mines 4800 Forbes Avenue Pittsburgh, Pennsylvania 15213 Attn: M. M. Dolinar Repts. Librarian Explosives Research Center	Nat'l Aeronautics and Space Admin. 3 Langley Research Center Langley Air Force Base Virginia 23365 Attn: Library
Central Intelligence Agency 1 2430 E Street, N. W. Washington, D. C. 20505 Attn: OCD, Standard Dist.	Nat'l Aeronautics and Space Admin. 1 Washington, D. C. 20546 Attn: Office of Technical Information and Education Programs, Code ETL
Office of the Director of Defense 1 Research and Engineering Washington, D. C. 20301 Attn: W. E. Sheehan Office of Asst. Dir. (Chemical Technology)	Scientific and Technical 2 Information Facility P.O. Box 5700 Bethesda, Maryland 20014 Attn: NASA Representative
Nat'l Aeronautics and Space Admin. 1 Lewis Research Center 21000 Brookpark Road Cleveland, Ohio 44135 Attn: Library	Nat'l Aeronautics and Space Admin. 1 Washington, D. C. 20546 Attn: R. W. Ziem (RPS)
John F. Kennedy Space Center, NASA 1 Cocoa Beach, Florida 32931 Attn: Library	Nat'l Aeronautics and Space Admin. 1 Goddard Space Flight Center Greenbelt, Maryland 20771 Attn: Library
Nat'l Aeronautics and Space Admin. 1 Manned Spacecraft Center P.O. Box 1537 Houston, Texas 77001 Attn: Library	Defense Documentation Center 20 Cameron Station Alexandria, Virginia 22314
Nat'l Aeronautics and Space Admin. 1 George C. Marshall Space Flight Center Huntsville, Alabama 35800 Attn: Library	RTD (RTNP) 1 Rolling Air Force Base Washington, D. C.
	AFRPL (RPR) 1 Edwards, California 92523
	AFRPL (RFM) 1 Edwards, California 92523

AFFTC (FTBAT-2)	1	Commanding Officer	1
Edwards Air Force Base		Frankford Arsenal	
California 93523		Philadelphia, Pennsylvania 19137	
		Attn: Propellant and Explosives	
		Section, 1331	
Office of Research Analysis (OAR)	1		
Attn: RRRT			
Holloman Air Force Base		Commanding Officer	1
New Mexico 88330		Picatinny Arsenal	
		Dover, New Jersey 07801	
		Attn: Library	
Air Force Missile Test Center	1		
Attn: MTBAT			
Patrick Air Force Base		Commanding Officer	1
Florida 32925		Picatinny Arsenal	
		Liquid Rocket Propulsion Laboratory	
		Dover, New Jersey 07801	
		Attn: Technical Library	
Air Force Materials Laboratory	1		
Wright-Patterson Air Force Base			
Ohio 45433			
Attn: MAAE		U. S. Army Missile Command	4
		Redstone Scientific Information Center	
		Redstone Arsenal, Alabama 35808	
		Attn: Chief, Document Section	
Commanding Officer	1		
Ballistic Research Laboratories			
Aberdeen Proving Ground			
Maryland 21005		Commanding General	1
Attn: AMXBR-1		White Sands Missile Range	
		New Mexico 88002	
		Attn: Technical Library	
Commanding Officer	1		
Harry Diamond Laboratories			
Washington, D. C. 20438		Bureau of Naval Weapons	2
Attn: AMXDO-TIB		Department of the Navy	
		Washington, D. C. 20360	
		Attn: DLI-3	
Commanding Officer	1		
U. S. Army Research Office (Durham)			
Box CM, Duke Station		Bureau of Naval Weapons	2
Durham, North Carolina 27706		Department of the Navy	
		Washington, D. C. 20360	
		Attn: RMMP-2	
Commanding Officer	1		
U. S. Army Chemical Research and			
Development Laboratories		Bureau of Naval Weapons	1
Edgewood Arsenal, Maryland 21010		Department of the Navy	
Attn: Chief, Physicochemical		Washington, D. C. 20360	
Research Division		Attn: RMMP-3	

Bureau of Naval Weapons Department of the Navy Washington, D. C. 20360 Attn: RMMP-4	1	Director Special Projects Office Department of the Navy Washington, D. C. 20360	1
Bureau of Naval Weapons Department of the Navy Washington, D. C. 20360 Attn: RRRE-6	1	Commanding Officer U. S. Naval Underwater Ordnance Station Newport, Rhode Island 02844 Attn: W. W. Bartlett	1
Commander U. S. Naval Missile Center Point Mugu, California 93041 Attn: Technical Library	2	Aerojet-General Corporation P.O. Box 296 Azusa, California 91703 Attn: F. M. West, Chief Librarian	1
Commander U. S. Naval Ordnance Laboratory White Oak Silver Spring, Maryland 20910 Attn: Library	2	Aerojet-General Corporation Chemical Products Division Azusa, California 91703 Attn: Dr. Richard Holzmann	1
Commander U. S. Naval Ordnance Test Station China Lake, California 93557 Attn: Code 45	5	Aerojet-General Corporation 11711 South Woodruff Avenue Downey, California 90241 Attn: Florence Walsh, Librarian	1
Commander (Code 753) U. S. Naval Ordnance Test Station China Lake, California 93557 Attn: Technical Library	2	Aerojet-General Corporation P.O. Box 1947 Sacramento, California 95809 Attn: Technical Information Office	3
Superintendent U. S. Naval Postgraduate School Naval Academy Monterey, California	1	Aeronutronic Div. Philco Corp. Ford Road Newport Beach, California 92600 Attn: Dr. L. H. Linder, Manager Technical Information Dept.	1
Commanding Officer U. S. Naval Propellant Plant Indian Head, Maryland 20640 Attn: Technical Library	1	Aeroprojects, Inc. 310 East Rosedale Avenue West Chester, Pennsylvania 19380 Attn: C. D. McKinney	1
Commanding Officer Office of Naval Research 1030 E. Green Street Pasadena, California 91101	1	Aerospace Corporation P.O. Box 95085 Los Angeles, California 90045 Attn: Library-Documents	2
Director (Code 6180) U. S. Naval Research Laboratory Washington, D. C. 20390 Attn: H. W. Carhart	1		

Allied Chemical Corporation General Chemical Division Research Laboratory P.O. Box 405 Morristown, New Jersey 07960 Attn: L. J. Wiltrakis Security Officer	1	Bell Aerosystems Box 1 Buffalo, New York 14205 Attn: T. Reinhardt	1
Amcel Propulsion Company Box 5049 Asheville, North Carolina 28802	1	The Boeing Company Aero Space Division P.O. Box 3707 Seattle, Washington 98124 Attn: R. R. Barber, Lib. Ut. Ch.	1
American Cyanamid Company 1937 W. Main Street Stamford, Connecticut 06902 Attn: Security Officer	1	Chemical Propulsion Information Agency Applied Physics Laboratory 8621 Georgia Avenue Silver Spring, Maryland 20910	3
IIT Research Institute Technology Center Chicago, Illinois 60616 Attn: C. K. Hersh Chemistry Division	1	Defense Metals Information Center Pattelle Memorial Institute 505 King Avenue Columbus, Ohio 42301	1
ARO, Inc. Arnold Engineering Dev. Center Arnold Air Force Station Tennessee 37389 Attn: Dr. B. H. Goethert Director of Engineering	1	Douglas Aircraft Company, Inc. Santa Monica Division 3000 Ocean Park Boulevard Santa Monica, California 90405 Attn: Mr. J. L. Waisman	1
Atlantic Research Corporation Shirley Highway and Edsall Road Alexandria, Virginia 22314 Attn: Library	2	The Dow Chemical Company Security Section Box 31 Midland, Michigan 48641 Attn: Dr. R. S. Karpiuk 1710 Building	1
Atlantic Research Corporation Western Division 48-506 Easy Street El Monte, California Attn: H. Niederman	1	E. I. duPont deNemours and Company Eastern Laboratory Gibbstown, New Jersey 08027 Attn: Mrs. Alice R. Steward	1
Battelle Memorial Institute 505 King Avenue Columbus, Ohio 43201 Attn: Report Library, Room 6A	1	Esso Research and Engineering Co. Special Projects Unit P.O. Box 8 Linden, New Jersey 07036 Attn: Mr. D. L. Baeder	1

General Dynamics/Astronautics P.O. Box 1128 San Diego, California 92112 Attn: Library and Information Services (128-00)	1	Martin Company Baltimore, Maryland 21203 Attn: Science - Technology Library - Mail 398	1
General Electric Company Flight Propulsion Division Evendale Cincinnati, Ohio 45215	1	Minnesota Mining and Manufacturing Company 900 Bush Avenue St. Paul, Minnesota 55106 Attn: Code 0013 R & D VIA: H. C. Zeman Security Administrator	2
Hercules Powder Company Allegany Ballistics Laboratory P.O. Box 210 Cumberland, Maryland 21501 Attn: Library	1	Monsanto Research Corporation Boston Labs., Everett Station Chemical Lane Boston, Massachusetts 02149 Attn: Library	1
Hercules Powder Company Research Center Wilmington, Delaware 19899 Attn: Dr. Herman Skolnik, Manager Technical Information Division	1	New York University Dept. of Chemical Engineering New York, New York 10053 Attn: P. F. Winternitz	1
Jet Propulsion Laboratory 4800 Oak Grove Drive Pasadena, California 91103 Attn: Library (TDS) Mr. N. E. Devereux	1	North American Aviation, Inc. Space and Information Systems Division 12214 Ladewood Boulevard Downey, California 90242 Attn: W. H. Morita	1
Arthur D. Little, Inc. 15 Acorn Park Cambridge, Massachusetts 02140 Attn: W. H. Varley	1	Rocketdyne 6633 Canoga Avenue Canoga Park, California 91304 Attn: Library, Dept. 596-306	3
Lockheed Propulsion Company P.O. Box 111 Redlands, California 92374 Attn: Miss Belle Berlad Librarian	3	Rohm and Haas Company Redstone Arsenal Research Division Huntsville, Alabama 36808 Attn: Librarian	1
Marquardt Corporation 16555 Saticoy Street Box 2013 - South Annex Van Nuys, California 91404	1	Space Technology Laboratory, Inc. 1 Space Park Redondo Beach, California 90200 Attn: STL Tech. Lib. Doc. Acquisitions	2

Texaco Experiment Incorporated P.O. Box 1-T Richmond, Virginia 23202 Attn: Librarian	1	Union Carbide Chemicals Co. P.O. Box 8584 (Technical Center) South Charleston West Virginia 25303 Attn: Dr. H. W. Schulz	1
United Technology Center P.O. Box 358 Sunnyvale, California 94088 Attn: Librarian	1	United Aircraft Corporation Pratt and Whitney Florida Res. and Dev. Ctr. P.O. Box 2691 W. Palm Beach, Florida 33402 Attn: Library	1
Thiokol Chemical Corporation Alpha Division, Huntsville Plant Huntsville, Alabama 35800 Attn: Technical Director	1	United Aircraft Corporation Corporation Library 400 Main Street East Hartford, Connecticut 06118 Attn: Dr. David Rix	1
Thiokol Chemical Corporation Alpha Division Space Booster Plant Brunswick, Georgia 31500	1	General Electric Company Apollo Support Department P.O. Box 2500 Daytona Beach, Florida 32015	1
Thiokol Chemical Corporation Elkton Division Elkton, Maryland 21921 Attn: Librarian	1	British Defence Staff British Embassy 3100 Massachusetts Avenue Washington, D. C. 20008 Attn: Scientific Information Officer VIA: Headquarters Air Force Systems Command Attn: SCS-41(3-1833) Andrews Air Force Base Washington, D. C. 20331	4
Thiokol Chemical Corporation Reaction Motors Division Denville, New Jersey 07834 Attn: Librarian	1	Defence Research Member Canadian Joint Staff (W) 2450 Massachusetts Avenue Washington, D. C. 20008 VIA: Headquarters Air Force Systems Command Attn: SCS-41(3-1833) Andrews Air Force Base Washington, D. C. 20331	4
Thiokol Chemical Corporation Rocket Operations Center P.O. Box 1640 Ogden, Utah 84401 Attn: Librarian	1		
Thiokol Chemical Corporation Wasatch Division P.O. Box 524 Brigham City, Utah 84302 Attn: Library Section	2		

Headquarters, U. S. Air Force Washington, D. C. 20330 Attn: AFRSTD	1	Pennsalt Chemicals Corporation Technological Center 900 First Avenue King of Prussia, Pennsylvania 19406	1
AFRPL (RPCL) Edwards, California 92523	2	Shell Development Company 1400 53rd Street Emeryville, California 94608	1
AFRPL (RPCS) Edwards, California 92523	1	Texaco, Inc. P.O. Box 509 Beacon, New York 12508 Attn: Dr. R. E. Conary, Manager	1
Callery Chemical Company Research and Development Callery, Pennsylvania 16024 Attn: Document Control	1	Los Alamos Scientific Laboratory University of California P.O. Box 1663 Los Alamos, New Mexico 87544	1
Chem. Research and Dev. Center FMC Corporation P.O. Box 8 Princeton, New Jersey 08540 Attn: Security Officer	1	Aerojet-General Nucleonics Foot of Fostoria Way San Ramon, California 94583 Attn: Dr. Carpenter	1
Ethyl Corporation P.O. Box 3091 Istrouma Branch Baton Rouge, Louisiana 70805	1	Purdue University Lafayette, Indiana 47907 Attn: Henry Feuer	1
Hynes Research Corporation 308 Bon Air Avenue Durham, North Carolina 27704	1	Union Carbide Corporation P.O. Box 278 Tarrytown, New York 10592 Attn: Dr. R. G. Breckenridge, Dir.	1
Walter Kidde Company 675 Main Street Belleville, New Jersey 07109 Attn: Security Librarian	1	Peninsular Chem. Research, Inc. P.O. Box 14318 University Station Gainesville, Florida 32003 Attn: Security Officer	1
Olin Mathieson Chemical Corp. Research Library 1-K-3 275 Winchester Avenue New Haven, Connecticut 06511 Attn: Mail Control Room Miss Laura M. Kajuti	1	RTD (RTTG) Bolling Air Force Base Washington, D. C. 20332	1

Director 6
Advanced Research Projects Agency
Washington, D. C. 20301

Arnold Eng. Development Center 1
Attn: AEOIM
Air Force Systems Command
Tullahoma, Tennessee 37389

Midwest Research Institute 1
Attn: Chemistry Division File

Midwest Research Institute 3
Attn: Dr. Florence Metz

Midwest Research Institute 1
Attn: Library