

AD609863

AMRL-TR-64-110

**MOMENTS OF INERTIA AND CENTERS OF GRAVITY
OF THE LIVING HUMAN BODY
ENCUMBERED BY A FULL-PRESSURE SUIT**

J. DuBOIS
W. R. SANTSCHI
D. M. WALTON
C. O. SCOTT
F. W. MAZY

NORTH AMERICAN AVIATION, INC.

COPY	2	OF	3	7R
HARD COPY			\$.	3.00
MICROFICHE			\$.	0.75

62P

NOVEMBER 1964

BEHAVIORAL SCIENCES LABORATORY
AEROSPACE MEDICAL RESEARCH LABORATORIES
AEROSPACE MEDICAL DIVISION
AIR FORCE SYSTEMS COMMAND
WRIGHT-PATTERSON AIR FORCE BASE, OHIO

ARCHIVE COPY

NOTICES

When US Government drawings, specifications, or other data are used for any purpose other than a definitely related government procurement operation, the government thereby incurs no responsibility nor any obligation whatsoever; and the fact that the government may have formulated, furnished, or in any way supplied the said drawings, specifications, or other data is not to be regarded by implication or otherwise, as in any manner licensing the holder or any other person or corporation, or conveying any rights or permission to manufacture, use, or sell any patented invention that may in any way be related thereto.

Qualified requesters may obtain copies from the Defense Documentation Center (DDC), Cameron Station, Alexandria, Virginia 22314. Orders will be expedited if placed through the librarian or other person designated to request documents from DDC (formerly ASTIA).

Do not return this copy. Retain or destroy.

Stock quantities available, for sale to the public, from the Office of Technical Services, Department of Commerce, Washington, D. C. 20230.

Change of Address

Organizations and individuals receiving reports via the Aerospace Medical Research Laboratories automatic mailing lists should submit the addressograph plate stamp on the report envelope or refer to the code number when corresponding about change of address.

**MOMENTS OF INERTIA AND CENTERS OF GRAVITY
OF THE LIVING HUMAN BODY
ENCUMBERED BY A FULL-PRESSURE SUIT**

J. DuBOIS
W. R. SANTSCHI
D. M. WALTON
C. O. SCOTT
F. W. MAZY

FOREWORD

This study, a follow-up on a previous investigation, was initiated by the Behavioral Sciences Laboratory of the Aerospace Medical Research Laboratories, Wright-Patterson Air Force Base, Ohio. The research was conducted by North American Aviation, Inc., Los Angeles 9, California, under the provisions of Contract No. AF 33(657)-11619. Mr. J. DuBois, Biophysicist, Life Sciences, was the principal investigator for North American Aviation, Inc. Mr. W. R. Santschi, Head of Bioscience Unit, acted as program manager. Mr. D. M. Walton, Physiologist, was responsible for the subject measurements. Mrs. C. O. Scott, Physical Anthropologist, carried out the anthropometry and subject selection. Mr. F. W. Mazy, Senior Design Specialist, designed the pendulums used in the subject measurements. Mr. Charles E. Clauser of the Anthropology Branch, Human Engineering Division, who had originated and monitored the first study, also monitored this contract for the Aerospace Medical Research Laboratories. The work was performed in support of Project No. 7184, "Human Performance in Advanced Systems," Task No. 718408, "Anthropology for Design." The research sponsored by this contract was initiated in July 1963 and completed in December 1963. This report is catalogued by North American Aviation as NA-64-527.

The authors are grateful to Lt. Col H. R. Bratt, Maj. R. N. Richardson, SMSgt. H. G. Frogge and the other personnel of the Bioastronautics Branch, Air Force Flight Test Center, Edwards Air Force Base, whose willing cooperation both as subjects and as technical assistants, made this study possible. We also thank Mrs. B. R. Taylor, Programmer, Numerical Sciences Group, North American Aviation, Inc., for coding the modifications to the computer program, and Mr. H. T. E. Hertzberg, Chief of the Anthropology Branch, Aerospace Medical Research Laboratories, for a critical review of the manuscript.

This technical report has been reviewed and is approved.

WALTER F. GREYNER, PhD
Technical Director
Behavioral Sciences Laboratory

ABSTRACT

The center of gravity and the moments of inertia of each of 19 male subjects, representative in stature and weight of the U. S. Air Force population, were determined. Two body positions: sitting and relaxed; and three modes of dress: nude, suited-unpressurized, and suited-pressurized were investigated. The theoretical accuracy of the experimental procedures, based on a compound pendulum, ranged from 2 to 8 percent, depending on body position and axis. The moments of inertia were found to vary significantly between body positions and between nude and suited conditions. Correlation coefficients between the moments of inertia and stature and weight exceeded 0.9. Fifty anthropometric dimensions and frontal and profile photographs were obtained on each subject to serve as the basis for additional biodynamic analyses.

TABLE OF CONTENTS

Section		Page
1	Introduction	1
2	Theoretical Considerations	3
3	Description of Apparatus and Full Pressure Garment	9
4	Experimental Procedure	15
5	Results	23
	References	54

LIST OF APPENDIXES

Appendix		
I	Statistical Data	29
II	Subject Data	34
III	Descriptions of Anthropometric Dimensions	46
IV	Data Sheets	51
V	Skeletal Anthropometric Points	52

LIST OF ILLUSTRATIONS

Figure		
1	Schematic of Compound Pendulum	4
2	Body Coordinate System	6
3	Reference Landmarks for Location of Center of Gravity	7
4	Body Positions	8
5	Measurement Apparatus - Pendulums	9
6	Measurement Apparatus - Pendulum Fulcrum	10

LIST OF ILLUSTRATIONS (Continued)

Figure		Page
7	Measurement Apparatus - Oxygen System	10
8	Schematic of Oxygen Breathing and Pressurization System	11
9	Photodiode Switch	13
10	Electronic Counter and Pulse Inhibitor	13
11	Full-Pressure Assembly Type A/P22S-2	14
12	Subject Stature-Weight Scatter Diagram	15
13	Subject Restrained in I_{ox}/I_{oy} Pendulum - Sitting Position	19
14	Subject Restrained in I_{ox}/I_{oy} Pendulum - Relaxed Position	19
15	Subject Restrained in I_{oz} Pendulum - Sitting Position	20
16	Subject Restrained in I_{oz} Pendulum - Relaxed Position	21
17	Comparison of Unpressurized and Pressurized Modes - I_{oz} Pendulum, Sitting Position	22
18	Mean Centers of Gravity	27

SECTION I

INTRODUCTION

Data on the locations of the centers of gravity and the magnitudes of the moments of inertia of the human body encumbered by a full-pressure suit are fundamental to the design of escape systems, self-maneuvering, self-stabilizing units, one-man space-excursion vehicles, and the like. These basic biodynamical parameters appear as constants in the general equations of motion of the body; they must be known accurately for optimal design of restraint, escape and propulsion systems.

It is the purpose of this study to measure these parameters for a sample of subjects representative of the U. S. Air Force population, and to determine the influence of a full-pressure garment upon them.

SECTION 2

THEORETICAL CONSIDERATIONS

METHOD

The details of the compound pendulum method upon which this study is based are treated in reference 2; a brief description is given here for general background information.

The compound or physical pendulum is an elementary dynamic system consisting of an extended mass oscillating about a fixed horizontal axis under the force of gravity. If two parallel axes of oscillation are provided and certain simplifying assumptions made, it is not difficult to show that the simultaneous solution of the torque equations for the two axes yields expressions for the moment of inertia and center of gravity of the pendulum in terms of its weight, periods, axis separation, and acceleration due to gravity. Since the sums of the moments of inertia of two or more masses with respect to the same axis equal the moment of inertia of the combined masses with respect to that axis, the moment of inertia and the center of gravity of a mass (the human subject) distinct from the pendulum can be found.

In general (reference 2), the distance from the short suspension axis (figure 1) to the center of gravity of the subject is given by

$$L_s = \frac{4\pi^2 \Delta L \left[\left(\frac{W'}{g} + \rho V' \right) (2L'_s + \Delta L) + \Delta L \left(\frac{W}{g} + \rho V \right) - \frac{T_1^2}{4\pi^2} (W + W') \right] - W' L'_s (T_1^2 - T_s^2)}{W(T_1^2 - T_s^2) - 8\pi^2 \left(\frac{W}{g} + \rho V \right) \Delta L},$$

while the moment of inertia of the subject about the axis through his center of gravity and parallel to the fulcrum axis is given by

$$I_o = \frac{T_s^2}{4\pi^2} (W' L'_s + W L_s) - I'_s - \left(\frac{W}{g} + \rho V \right) L_s^2.$$

In these expressions,

T_s = the period of the pendulum about the short suspension axis;

T_1 = the period of the pendulum about the long suspension axis;

I'_s = the moment of inertia of the pendulum (without subject) about the short axis;

g = the acceleration due to gravity;

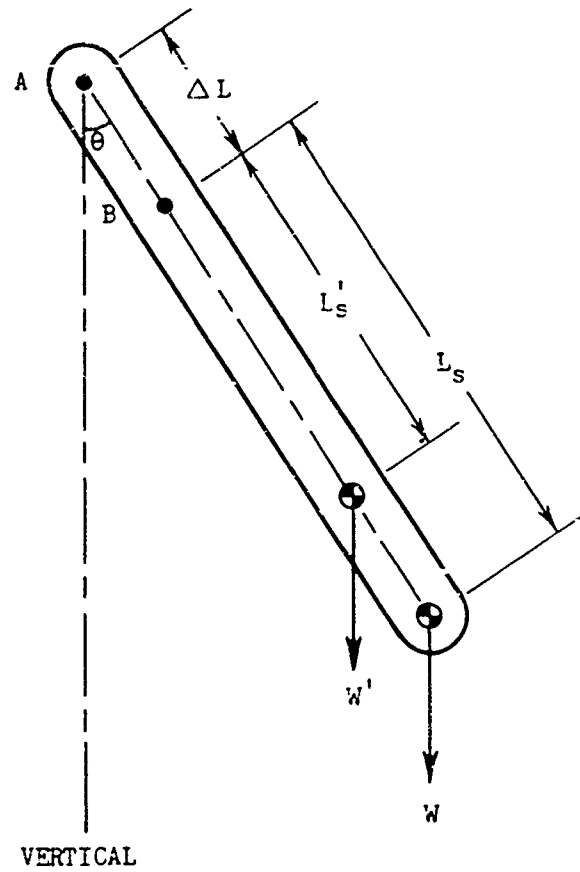

- A - Long suspension axis
- B - Short suspension axis
- θ - Angular displacement of pendulum
- W - Weight of subject, suit and pressurized oxygen within suit
- W' - Weight of pendulum without subject
- ΔL - Distance between pendulum axes, A and B
- L_S - Distance from short suspension axis, B, to CG of subject
- L'_S - Distance from short suspension axis, B, to CG of pendulum

Figure 1. Schematic of Compound Pendulum

V = the effective subject volume based upon subject, suit, and pressurized oxygen weights and densities;

V' = the pendulum volume based upon weight and mean density;

ρ = the ambient air density;

and the remaining symbols are as given in figure 1.

The basic determination of the center of gravity and moment of inertia of an individual involves only five measurements: air temperature, body weight, the two pendulum periods about the short and long suspension axes, and a reference distance from the pendulum fulcrum to a body landmark (the back and seat planes in this case). For measurements taken on the suited subject, this procedure is modified only slightly (appendix IV); unpressurized suited weight and suit-gas weight are the only additional requirements.

Buoyancy correction factors appear in the expressions for cg and I_0 in the terms involving ρV . In this experiment, the subject, pressure-suit, and pressurized-gas volumes were not measured directly, but were replaced by their equivalent weight-to-density ratios. In the case of the subject, a mean body density of 65.25 lb/ft^3 was assumed. The 0.02-lb correction for the pressure-suit mass, computed from suit weight and estimated suit density, was neglected. The mass of the gas contained within the pressurized suit was weighed by a difference method which, to a first approximation, eliminated the buoyancy correction.

A desirable feature of the compound pendulum method is the determination of the center of gravity of the subject in proper relationship with the gravity vector, as contrasted with balance methods in which the soft tissues of the body are displaced orthogonally with respect to the direction of measurement.

ACCURACY

The theoretical limits of accuracy obtainable with the compound pendulum technique (as applied to living human measurement) were estimated (reference 2) from the total differentials of L_s and I_0 . These limits depend upon the magnitude of the moment of inertia which in turn is a function of body weight, dimensions, position, and axis. Provided the crucial experimental variables are carefully controlled, accuracies of $\pm 2\%$ for maximum I_0 values and $\pm 3\%$ for minimum I_0 values appear within the realm of possibility (reference 2). The distance to the center of gravity can be measured to within $\pm 0.5\%$ or less along the x and z axes.

Accuracy of measurement of the suited subject is essentially that of the nude individual except for positioning problems, whose influences are difficult to assess. The procedure followed here involved positioning and restraint prior to pressurization, and the use of the minimum suit pressure (1 psig) required to produce maximum significant suit growth in terms of

mass distribution. Although suit growth is evidenced at pressures between 1 and 3.5 psig, it is small in magnitude relative to that which occurs in the range of zero to 1 psig.

DATA RECORDING AND PROCESSING

Experimental data, body dimensions included, were recorded directly on decimal data key punch sheets (appendix IV), an arrangement designed to minimize transcription errors and provide an orderly procedure for the experiment. Computations were carried out on the IBM 7094 computer using a modification of a program employed in a previous study (reference 7).

BODY COORDINATE SYSTEM

An orthogonal axis system was defined by the intersection of the three principal planes of the body passing through the center of gravity of the body as shown in figure 2. The z-axis is formed by the intersection of the sagittal plane and the frontal plane; the y-axis, by the intersection of the frontal and transverse planes; and the x-axis by the intersection of the sagittal and transverse planes.

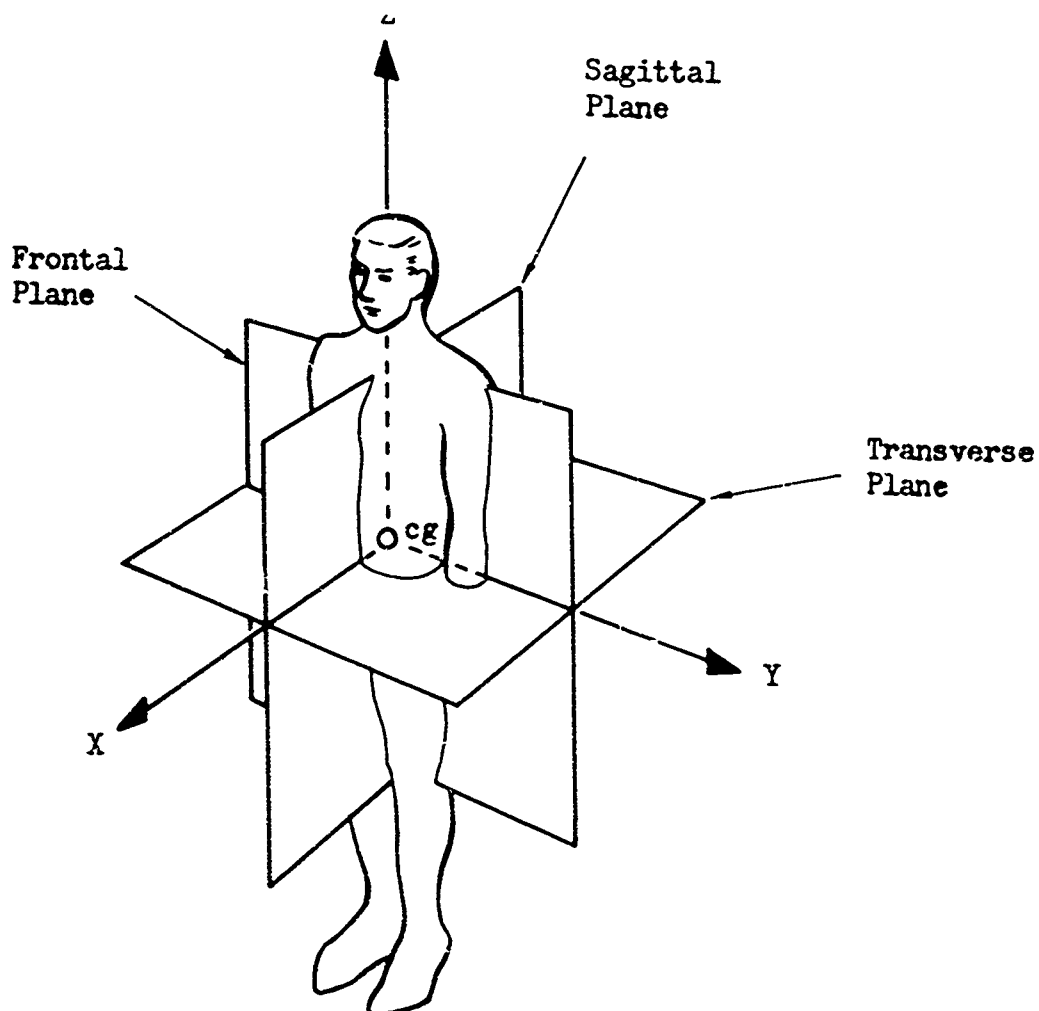

Figure 2. Body Coordinate System

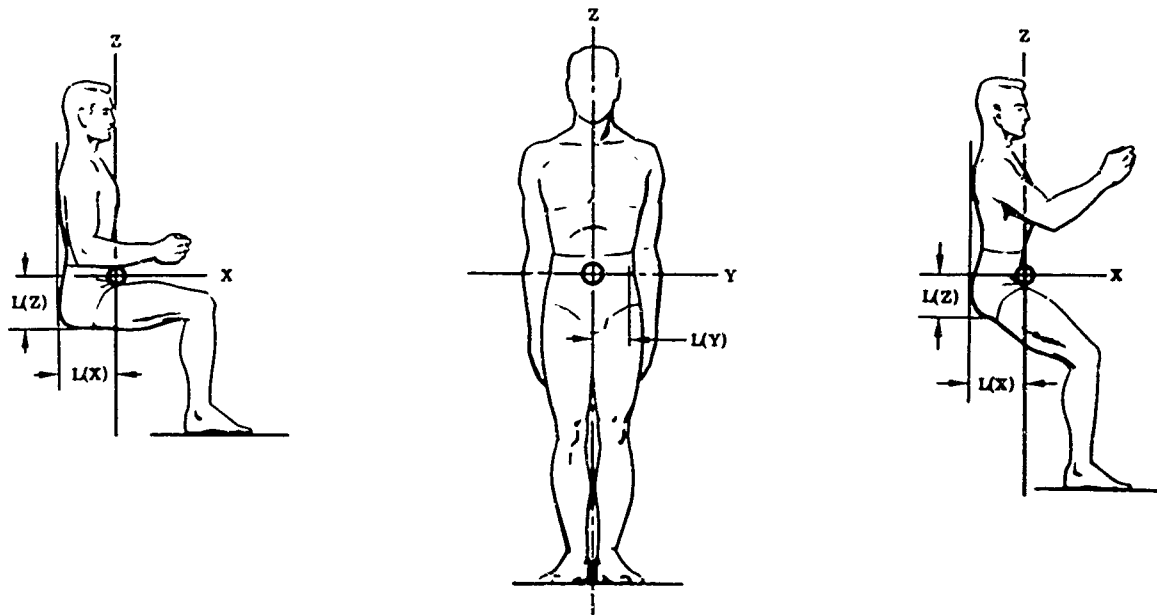

Figure 3. Reference Landmarks for Location of Center of Gravity

The axis system is referenced to body landmarks as shown in figure 3. $L(X)$ is the distance from the back plane to the center of gravity measured along the x-axis. $L(Z)$ is the distance from the seat plane to the cg measured along the y-axis. $L(Y)$ is the distance from the anterior-superior spine of the ilium to the cg measured along the y-axis. Bilateral symmetry is assumed for both body positions and $L(Y)$ defined as one-half the bispinous breadth (appendix III).

BODY POSITIONS

The two body positions shown in figure 4, Sitting and Relaxed (Weightless), were selected for measurement. These particular positions were chosen in part because of their appropriateness with respect to the practical situation and also because they are readily attainable in the A/P22S-2 suit when pressurized. The standard anthropometric position, Standing, would also have been a desirable choice, but preliminary tests indicated significant distortion of the position as a result of suit inflation. The Sitting and Relaxed configurations are defined below.

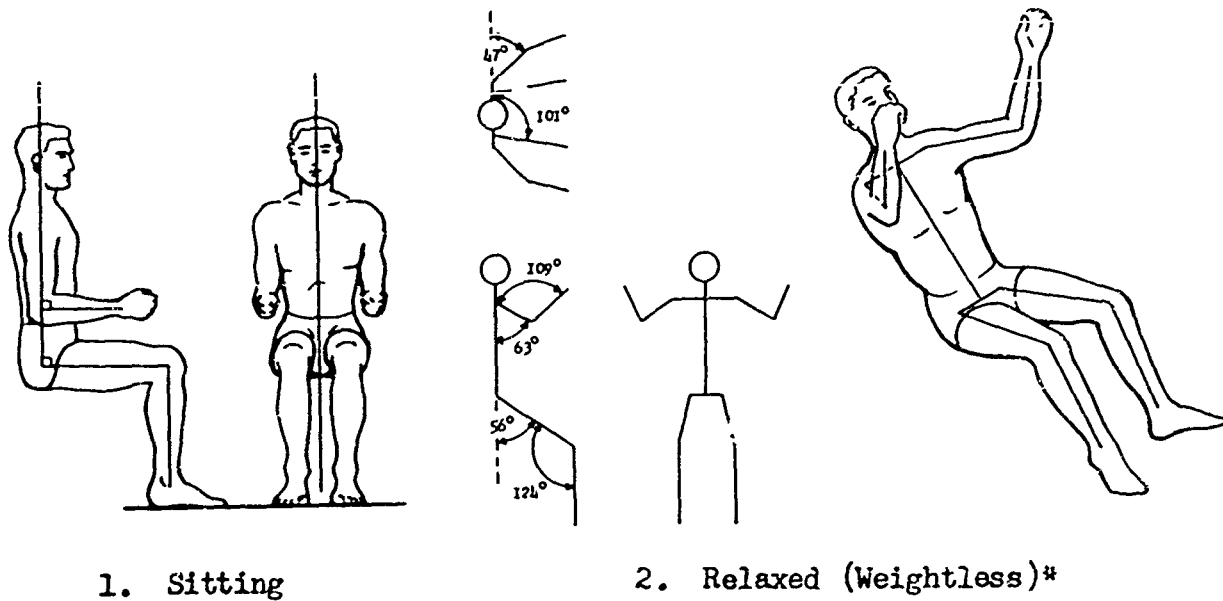

Figure 4. Body Positions

1. SITTING

Upper legs and forearms parallel to x-axis; upper arms, lower legs, and spine parallel to z-axis; soles parallel to xy-plane; wrist axes parallel to z-axis; hands slightly clenched; head in Frankfort plane.

2. RELAXED (WEIGHTLESS)

Position predicted to be assumed by a human being when relaxed in the weightless state.*

*After K. W. Kennedy (Anthropology Branch), in Simons, J. C., "An Introduction to Surface-Free Behavior", Ergonomics, Vol. 7, No. 1, p. 24-25, January 1964.

SECTION 3

DESCRIPTION OF APPARATUS AND FULL-PRESSURE GARMENT

PENDULUMS

The two compound pendulums, shown in figure 5 suspended from their fulcrum and axis transfer mechanisms, were originally designed and fabricated in accordance with the criteria presented in reference 2. Modifications of the earlier fixtures (reference 7) consisted of: (a) structural redesign to accommodate the range of subjects in the Sitting and Relaxed positions both while nude and while wearing the pressure suit, and (b) installation of the oxygen breathing and pressurization systems. One pendulum (I_{ox}/I_{oy}) was used to measure the z-axis centers of gravity and the x and y-axis moments of inertia; the other (I_{oz}) was employed in determining x-axis centers of gravity and z-axis moments of inertia. As stated previously, y-axis centers of gravity were defined as one-half the bipinnous breadth and, therefore, not measured by the pendulum method. All fulcrums (figure 6) were of the cone-plane type with contact surfaces of ground and polished tungsten steel. Prior to use they were cleaned with carbon tetrachloride and then coated with a thin film of instrument oil.

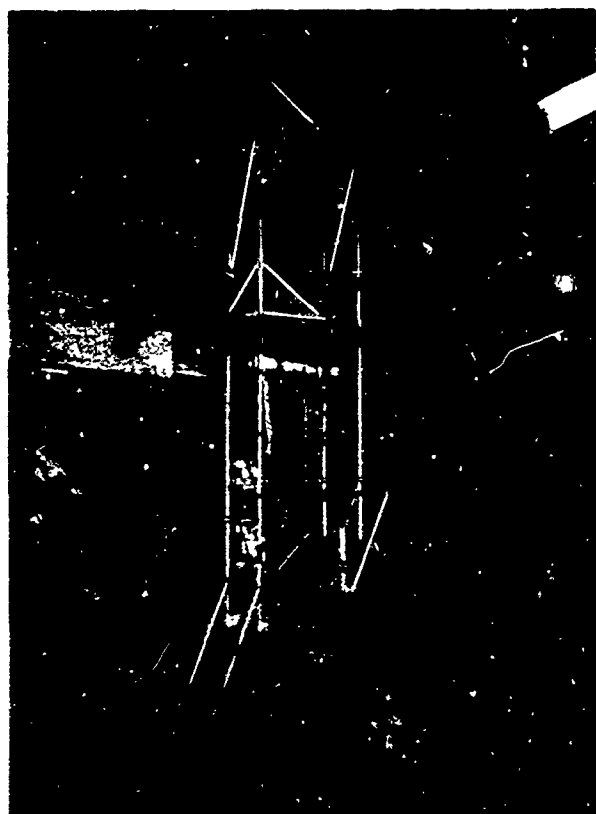

I_{ox}/I_{oy} Pendulum

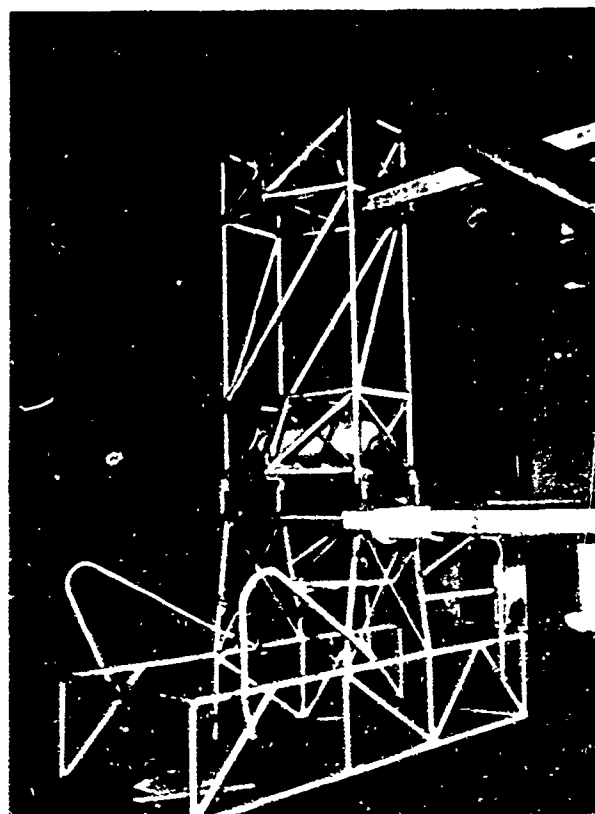

I_{oz} Pendulum

Figure 5. Measurement Apparatus - Pendulums

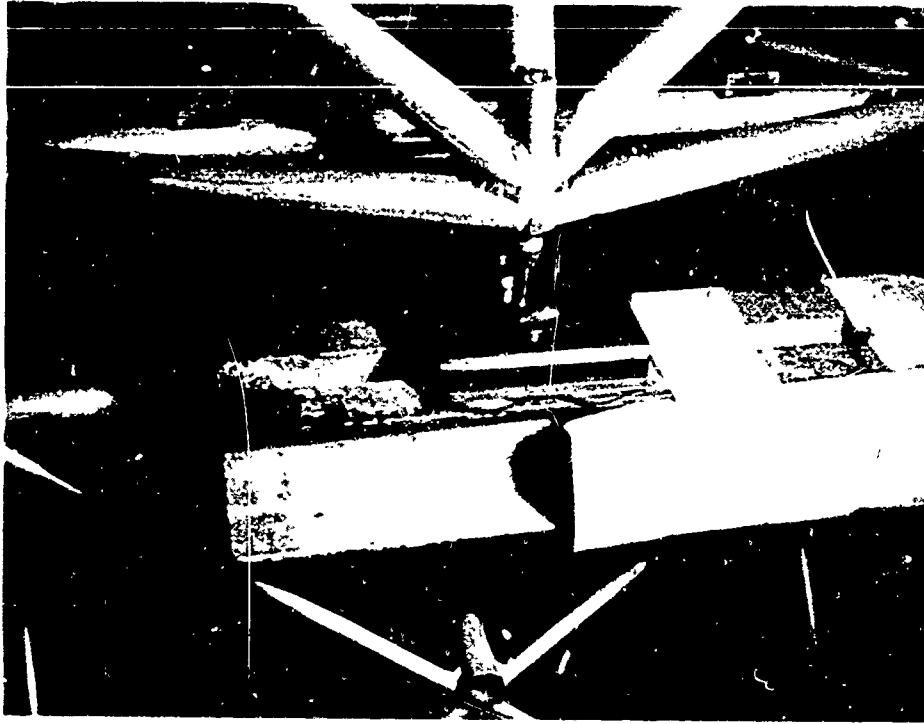

Figure 6. Measurement Apparatus - Pendulum Fulcrum

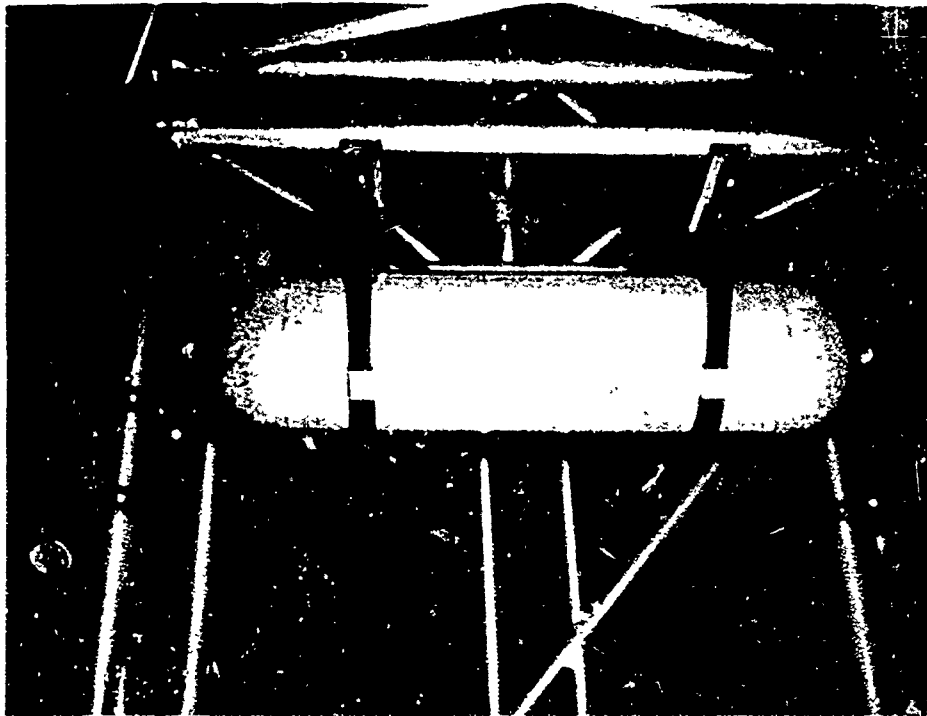

Figure 7. Measurement Apparatus - Oxygen System

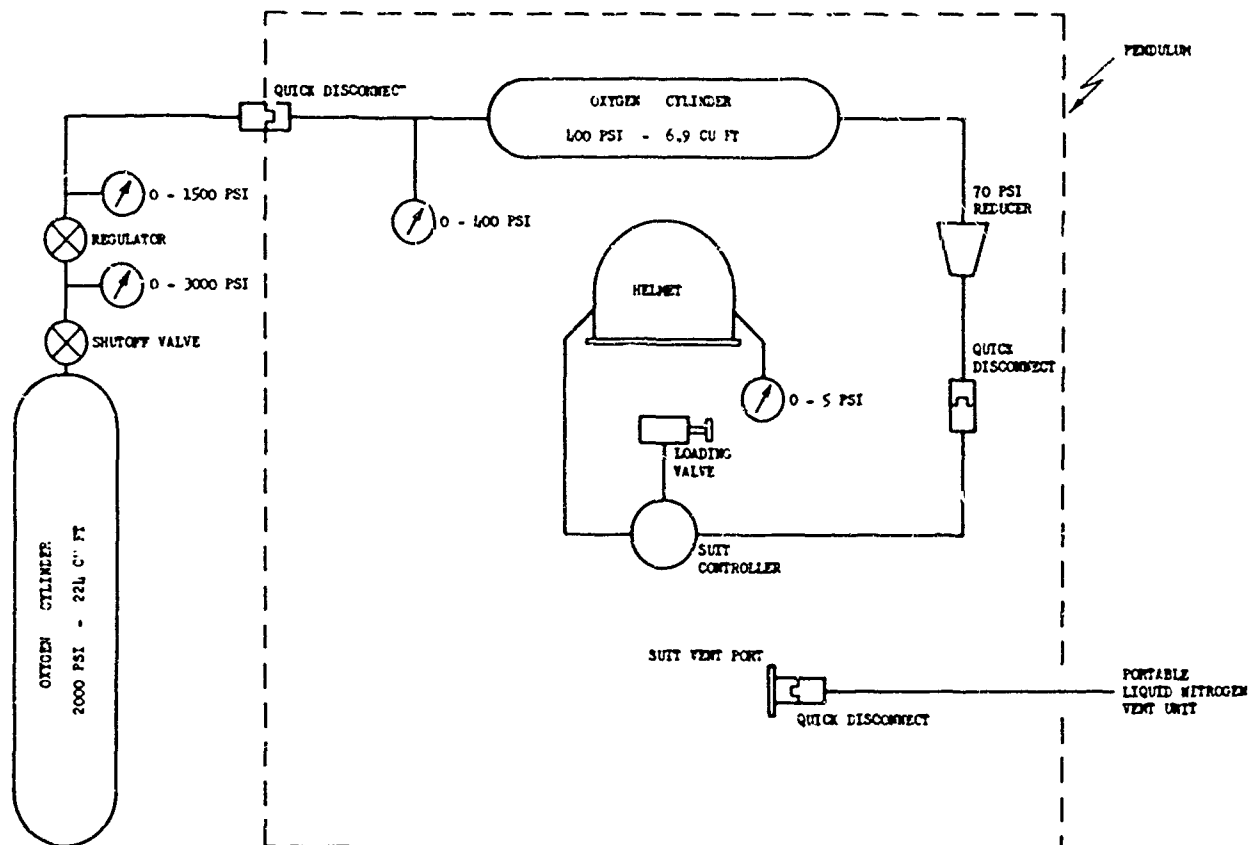

Figure 8. Schematic of Oxygen Breathing and Pressurization System

OXYGEN SYSTEMS

Lightweight oxygen systems were fabricated and installed in each pendulum to provide the subject with oxygen and to maintain suit pressure during the period determinations (figure 7). Figure 8 shows a schematic of the system with the primary oxygen source attached. The pressure in the pendulum oxygen cylinder (Type D-2) was maintained at 400 psi at all times during the pendulum calibrations and subject measurements. Suit pressurization to 1 psi was achieved by adjusting helmet pressure with the suit-controller loading valve; the primary oxygen cylinder was then removed from the system and respiratory flow and suit leakage supplied by the pendulum source. Bleed-down seldom exceeded 25 psi during the pendulum-period measurements. With the exception of these 1-to-2-minute intervals, the suited subject was cooled continuously by gas from a portable liquid-nitrogen ventilation unit.

INSTRUMENTATION

The period of the pendulum is measured to within 1 part in 10^4 by an electronic system consisting of a photodiode switch (figure 9), a decade and overflow mechanical counter and a pulse inhibitor (figure 10). When the rod attached to the base of the pendulum interrupts the light falling on the diode (figure 9), a pulse is generated which opens the gate in the decade counter (Hewlett Packard Model 522B). The counter records elapsed time (with overflow to the mechanical counter) until the gate is closed, i.e., for $2n$ succeeding pulses, where n is the number of periods over which the average is being taken. Inhibition of the $2n-1$ unwanted pulses following the initial triggering pulse is accomplished with conventional solid-state decade-counter circuitry. The complete instrumentation system provides for the measurement of average pendulum period over a range of 1 to 10 cycles.

BODY RESTRAINT

A system developed during a previous study (reference 7) was found to be reasonably satisfactory for the restraint of the suited individual. It entailed the use of masking tape, Velcro tape, and rigid low-density polystyrene foam blocks. (See figures 13 through 17 for examples of nude and suited body restraint.) In the case of x- and y-axis moments of inertia measurements, however, a lap belt and shoulder straps made of lightweight nylon were found necessary. The assembly weighed 0.61 pounds. This was assumed to be a part of the garment weight, as was the oxygen hose and suit-pressure gage.

FULL-PRESSURE GARMENT

Photographs of the A/P22S-2 full-pressure assembly are shown in figure 11; a complete description of the garment can be found in reference 5. Briefly, the suit consists of four-layer coveralls, a helmet, gloves, and boots. The coveralls, gloves, and boots are sized to fit a range of individuals; table I shows the system used by the U.S. Air Force in sizing the coveralls. The helmet is available in one size only. Pads and an adjustment mechanism within the helmet are used to accommodate the wearer.

A suit pressure of 1 psig was used throughout all pressurized measurements; this was found to be adequate in terms of suit distension and subject comfort.

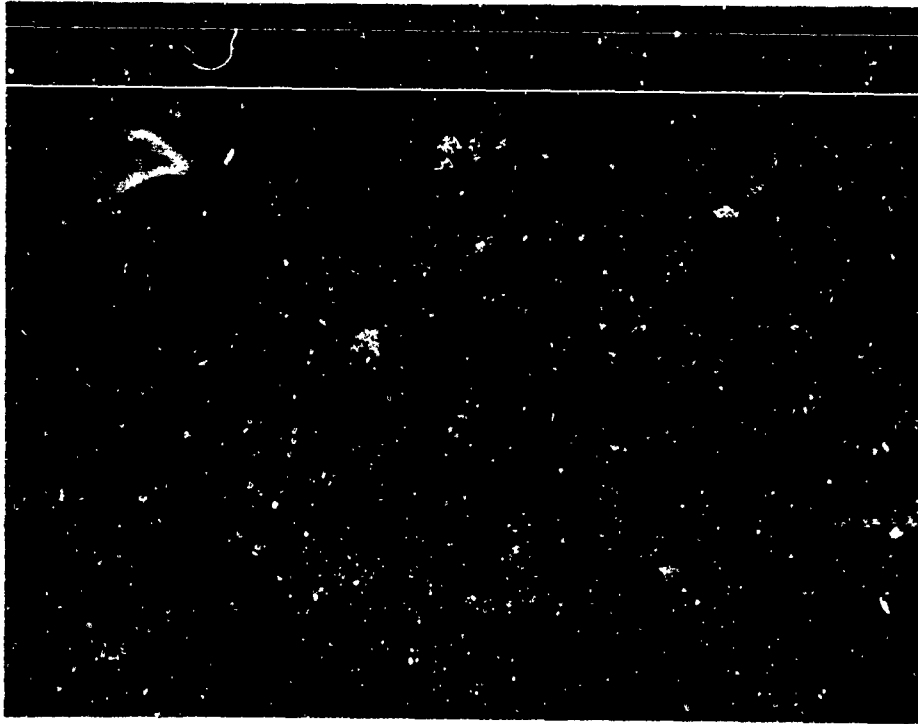

Figure 9. Photodiode Switch

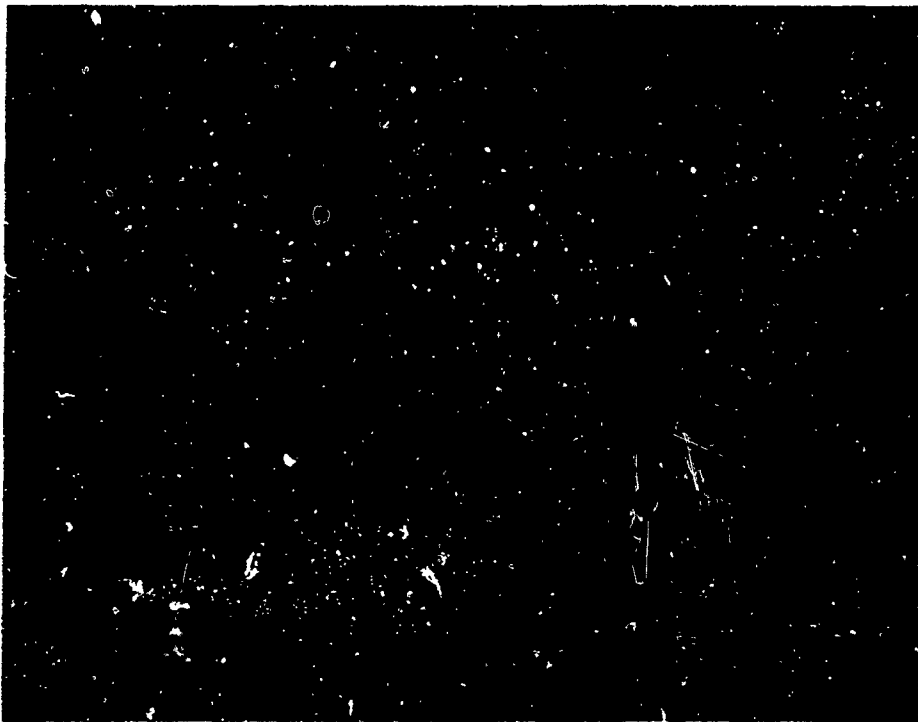

Figure 10. Electronic Counter and Pulse Inhibitor



Figure 11. Full-Pressure Assembly Type A/P22S-2

TABLE I
PRESSURE-SUIT SIZING SYSTEM

Stature - in.		Weight - lb.		Suit Size
63.00	67.50	125	149	Small Regular
67.50	72.00	125	149	Small Long
64.50	69.00	150	174	Medium Regular
69.00	73.50	150	174	Medium Long
66.00	70.50	175	199	Large Regular
70.50	75.00	175	199	Large Long
67.50	72.00	200	224	Extra-Large Regular
72.00	76.50	200	224	Extra-Large Long

SECTION 4

EXPERIMENTAL PROCEDURE

SELECTION OF SUBJECTS

The experimental sample employed in this study consisted of 19 male individuals selected from personnel from the Bioastronautics Branch, Air Force Flight Test Center, Edwards Air Force Base, and North American Aviation employees having pressure-suit experience. Selection was based upon stature and weight, and the sample was chosen so as to be representative of the stature-weight distribution of the U. S. Air Force population as defined in reference 4.

The stature-weight distribution of the subjects participating in this study is shown in figure 12. The statistical properties of the sample are: stature-weight correlation coefficient, $r_{sw} = 0.44$, mean weight = 164.6, S.D. = 17.4; mean stature = 69.0, S.D. = 2.3. These indicate an acceptable fit to the Air Force population for which an r_{sw} of 0.47 (reference 3) has been reported, using a mean weight = 163.66, S.D. = 20.86, and mean stature = 69.1, S.D. = 2.4 (reference 4).

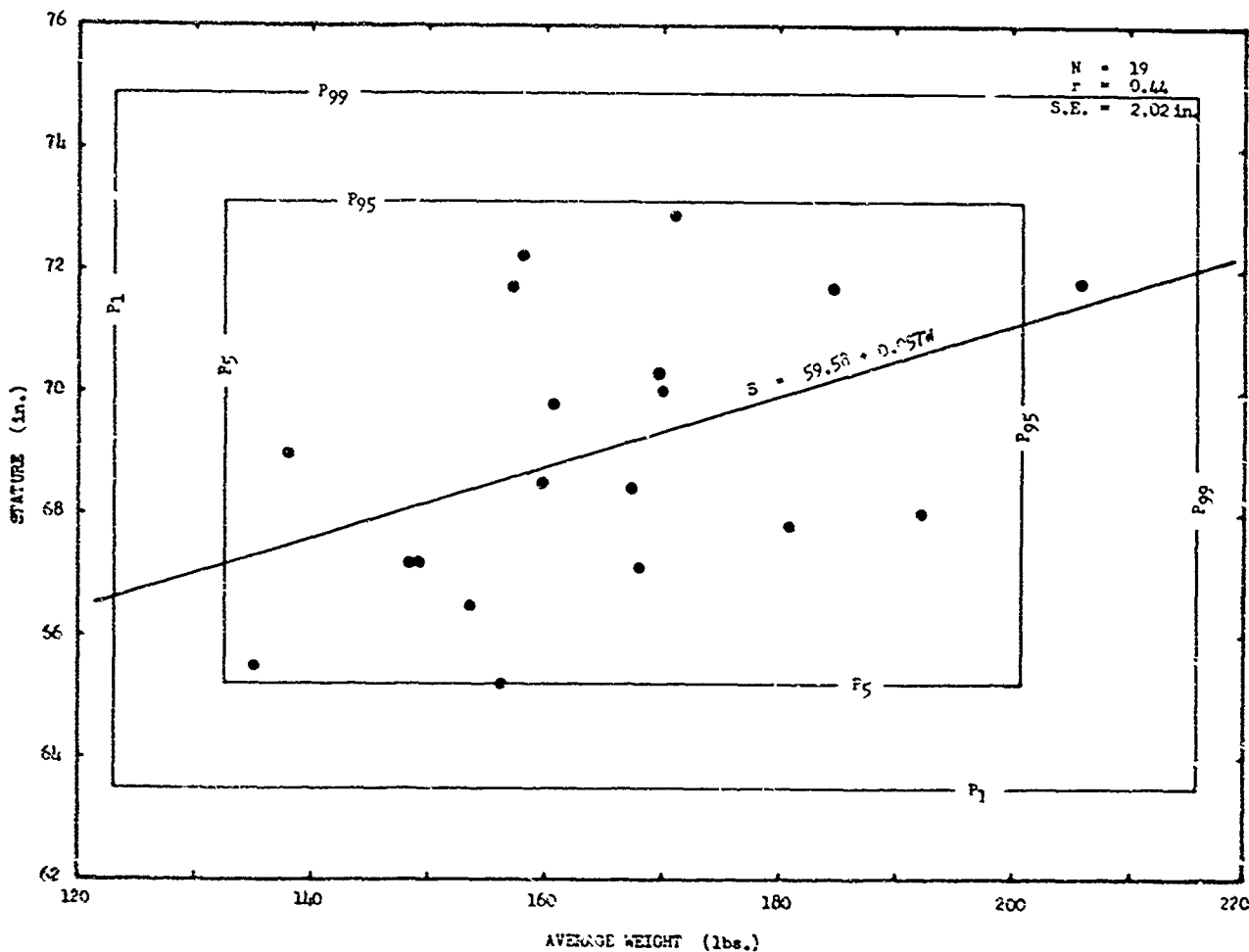

Figure 12. Subject Stature-Weight Scatter Diagram

Pressure-suit sizing and fitting were accomplished by technical personnel at the Flight Test Center. Their procedure followed for the most part the system shown in table I. Since suits were loaned on a noninterference basis, off-size substitutions were occasionally necessary. This procedure did not materially influence experimental results because the overall variation in clothing weight was quite small (S.D. = 0.5 lb for the total sample).

ANTHROPOMETRY OF SUBJECTS

Fifty dimensions were taken on each subject. They are listed in table II and include thirty-five standard dimensions contained in reference 4, and fifteen others. The former are useful in describing the characteristics of the experimental sample in relation to the Air Force population, while the latter are expected to be useful in determining other biophysical characteristics such as the weight of certain body segments, etc. A description of each dimension can be found in appendix III.

TABLE II

ANTHROPOMETRY

Age	Hip Breadth, Sitting
Ankle Circumference	Iliac Spine Height
Axillary Arm Circumference	Knee Circumference, Standing
Acromial Diameter	Lower Arm Length
Biceps Circumference (Extended)	Lower Thigh Circumference
Bispinous Breadth	Shoulder Height (Acromial Height)
Buttock-Popliteal Length	Sitting Height
Buttock Circumference	Skinfold, Juxta-nipple
Buttock Depth	Skinfold, Mid-axillary Line, Xiphoid
Calf Circumference	Skinfold, Triceps
Cervical Height	Span
Chest Breadth	Sphyrion Height
Chest Circumference	Stature
Chest Depth	Substernale Height
Elbow Circumference (Extended)	Suprasternale Height
Fist Circumference	Thigh Circumference
Foot Breadth	Tibiale Height
Foot Length	Trochanteric Height
Forearm Circumference (Extended)	Upper Arm Length
Hand Breadth at Metacarpale	Waist Breadth
Hand Length	Waist Circumference
Head Breadth	Waist Depth
Head Circumference	Waist Height
Head Length	Weight
Hip Breadth	Wrist Circumference

All measurements were made with standard anthropometric instruments. Lange skinfold calipers* were used in obtaining skinfold thicknesses (reference 6).

CALIBRATION OF APPARATUS

Calibration of the I_0 - and cg-measurement apparatus, consisting of the timer and pendulums, was accomplished in a manner similar to that described previously (reference 7), the only difference being the pressurization of the onboard oxygen systems prior to pendulum weighing and calibration. The period of the oscillator in the Hewlett Packard electronic counter was adjusted to correspond with that of a secondary frequency standard maintained by the North American Aviation Metrology Laboratory. This calibration insured a basic counter accuracy of 2 parts in 10^6 . The design of the photo-diode switch provided a pulse rise time at the input to the counter of approximately 1 microsec.

Reproducibility of period measurements was evaluated with the aid of an 8-foot, simple pendulum oscillating through a 1-degree arc. It was found to be approximately ± 0.0001 sec. for single-cycle comparisons and approximately ± 0.00005 sec. for 10-cycle averages.

Moments of inertia and centers of gravity of the pendulums with respect to their short suspension axes were measured by taking ten 10-cycle averages of the periods for each suspension, axis, and position. Fulcrum separations (ΔL) were measured with a height gage to about ± 0.001 inch. The pendulums were weighed to an accuracy of ± 0.01 lb. on a calibrated Triner scale.

The pendulum calibration was repeated periodically throughout the subject measurements; in this manner the stability of I_0 , the pendulum moment of inertia, was monitored. Variations in I_{0x} , I_{0y} , and I_{0z} were exceedingly small: ± 0.08 , ± 0.08 , and ± 0.13 percent.

MOMENT OF INERTIA AND CG DETERMINATION

The restraint material was identical to that employed previously (reference 7), consisting of masking tape, Velcro tape, and polystyrene foam shim blocks; however, a lightweight nylon lap belt and shoulder straps were used in the I_{0x}/I_{0y} fixture for the suited modes. No difficulty was experienced in achieving good restraint for the suited subject, and restraint following pressurization was unnecessary.

Subject weight, both nude and suited, was recorded on a Fairbanks, Morse and Company scale (accuracy ± 0.05 lb.); nude body weight included shorts weighing approximately 4 ounces. Restraint material was also assumed a part of the subject's body weight.

* Cambridge Scientific Industries, 18 Poplar Street, Cambridge, Maryland

The experimental procedure was planned to reduce error and to minimize inconvenience to the participants. This was achieved as follows: (1) by a time-and-motion study of the entire experiment prior to any actual measurements, (2) by coding the computer program to accept data in optimum order, and (3) by recording all data directly on keypunch sheets.

Appendix IV shows a typical set of data. Each sheet is divided into three sections: Number (the raw experimental data), Identification (card sequence number), and Description (experimental procedure). The suited x- and y-axis measurements are recorded: air temperature, suit and boot sizes are recorded; the subject is weighed nude, then is dressed in the pressure suit and weighed again; the weight of the gas required to pressurize the suit to 1 psig is measured; the subject is restrained in the sitting position and, while unpressurized, short and long suspension periods are measured for the x- and then y-axes; the suit is pressurized and periods again measured and recorded; the subject is then re-restrained in the Relaxed position and the period measurement sequence again repeated; finally the subject's suited weight, with shims and tape, is remeasured, and air temperature is again recorded. Figures 13 through 16 show a subject as he appeared during a complete set of measurements. Figure 17 illustrates the almost undetectable effect of pressurization upon body position.

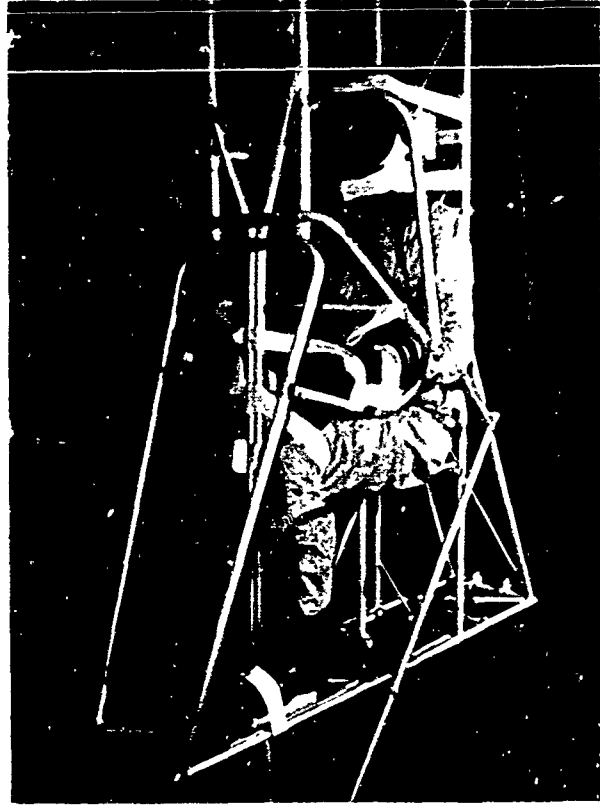
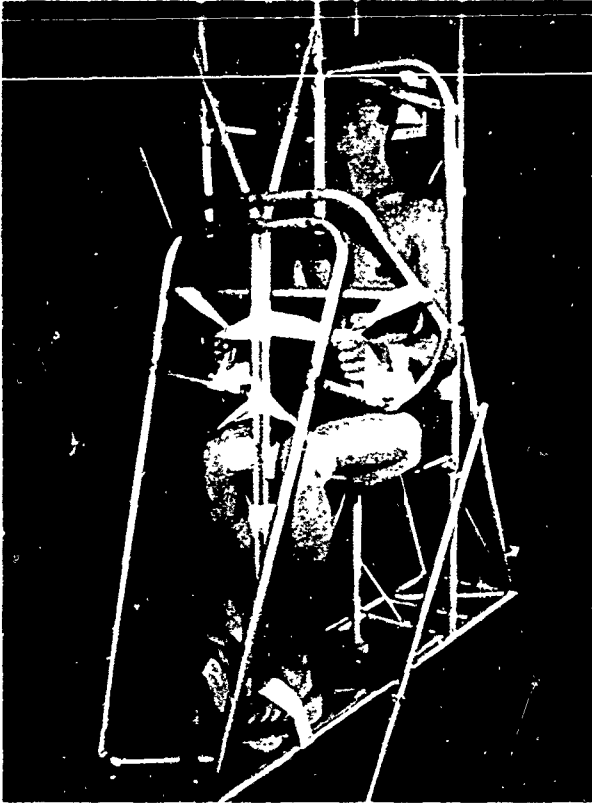

Figure 13. Subject Restrained in I_{ox}/I_{oy} Pendulum - Sitting Position

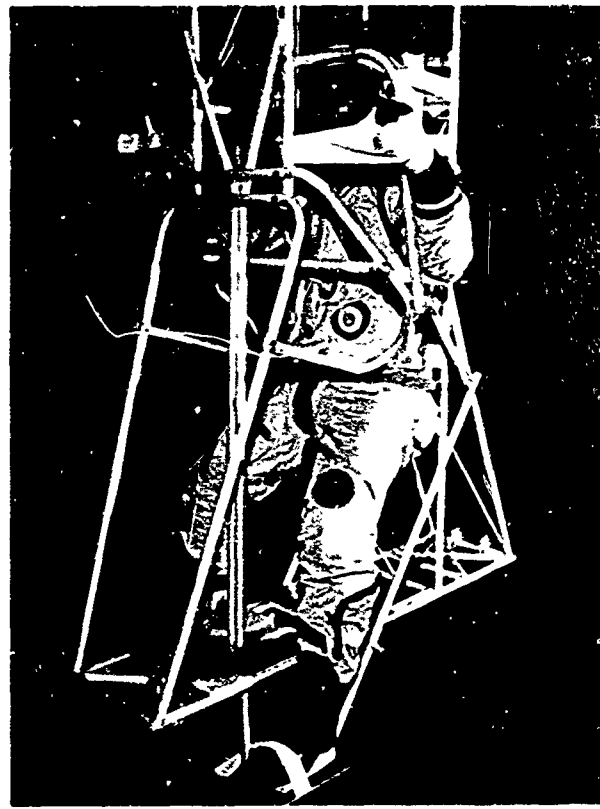

Figure 14. Subject Restrained in I_{ox}/I_{oy} Pendulum - Relaxed Position

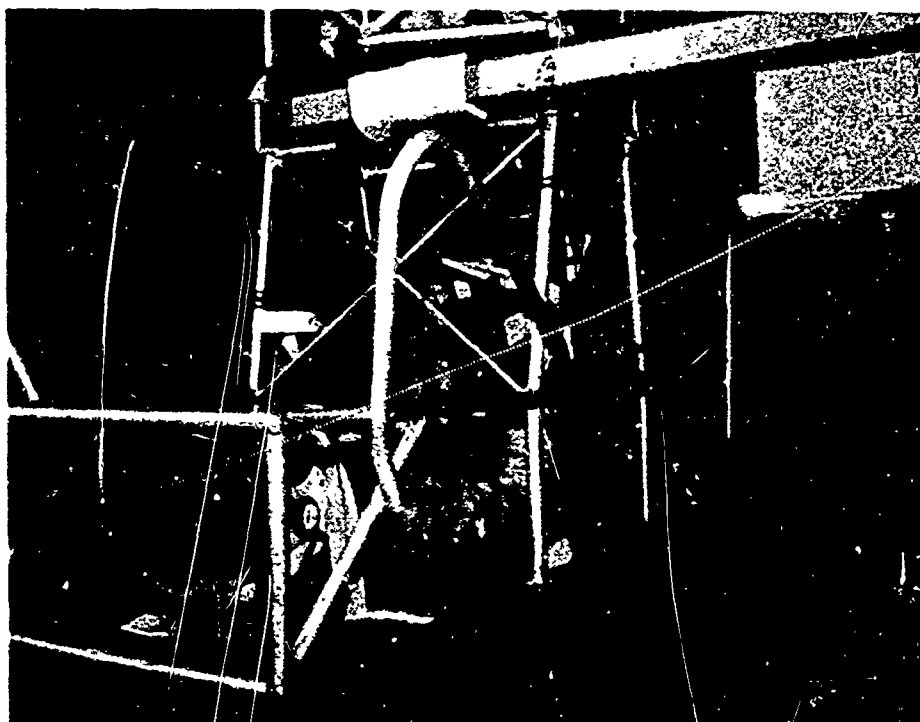
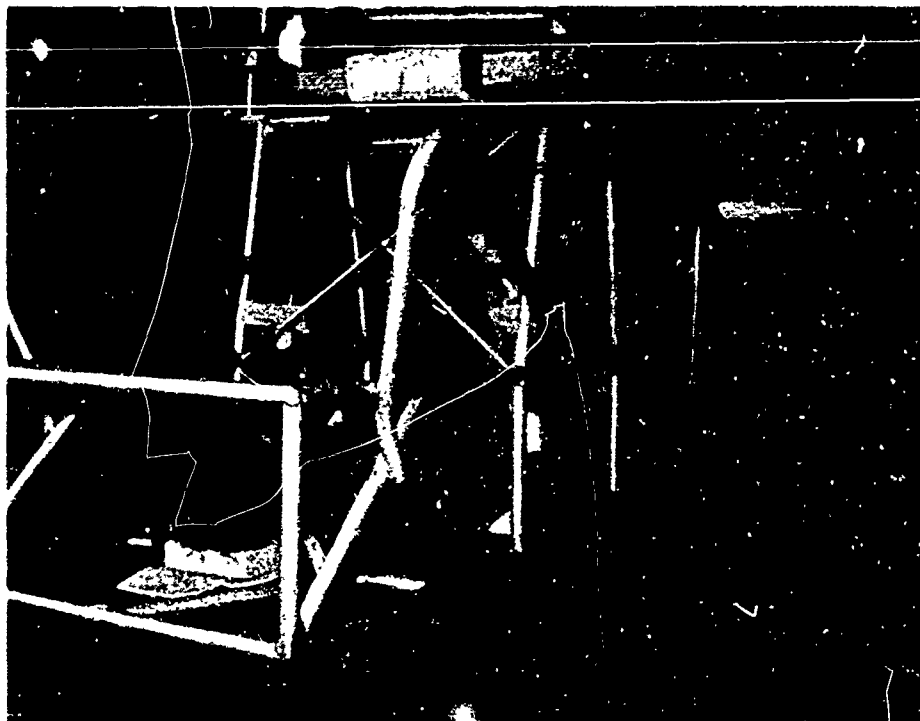

Figure 15. Subject Restrained in I_{OZ} Pendulum - Sitting Position

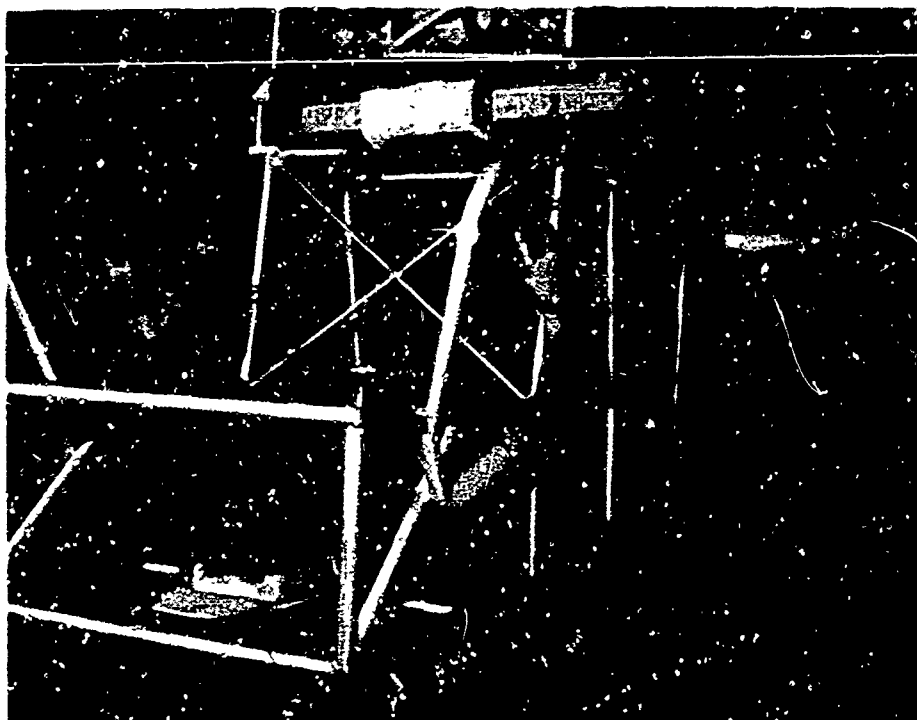
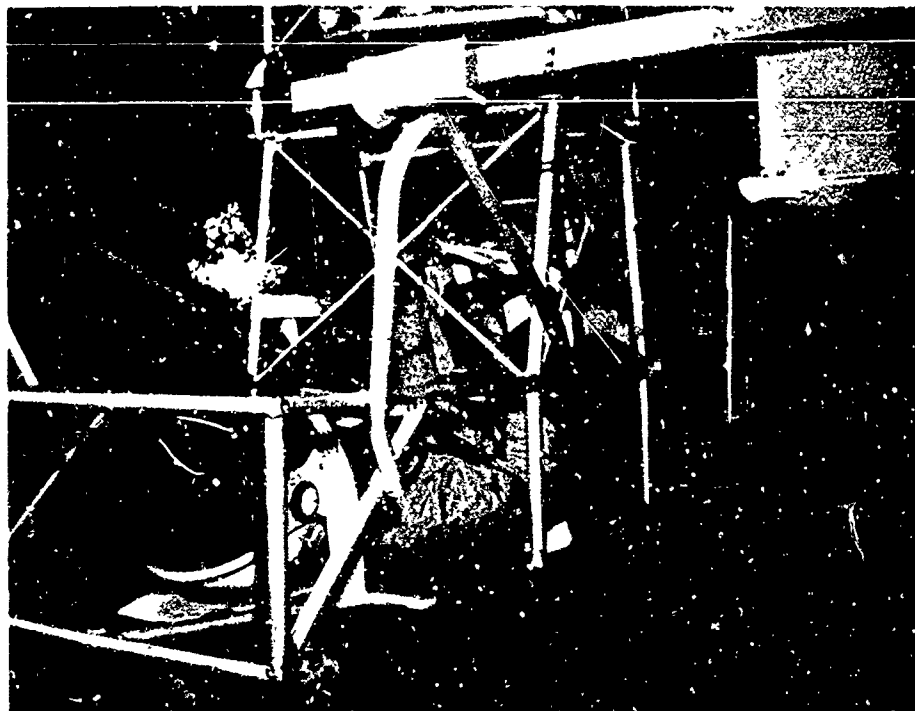
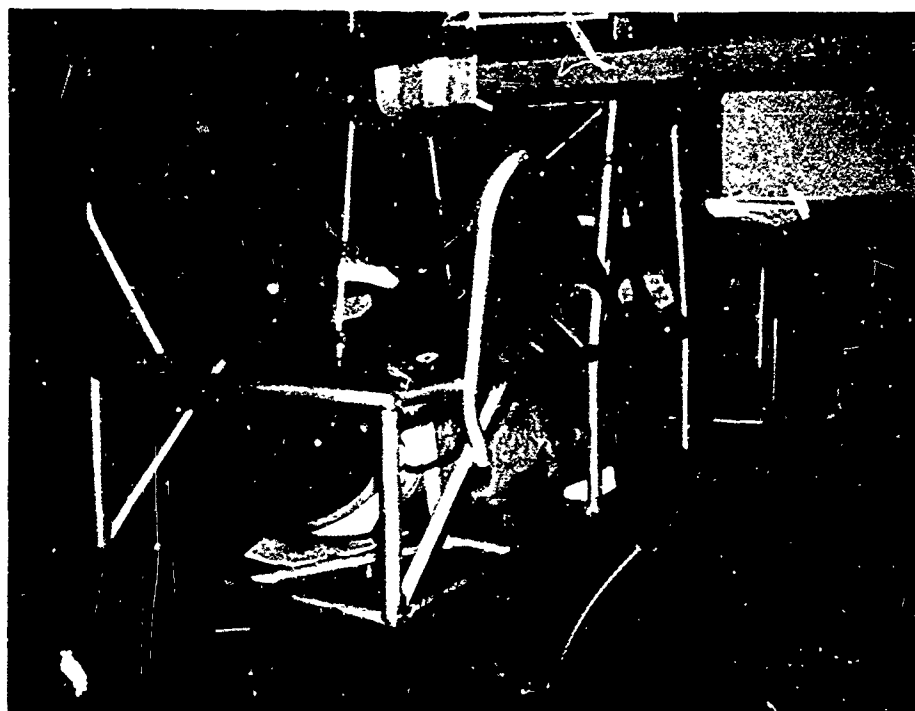

Figure 16. Subject Restrained in I_{Cz} Pendulum - Relaxed Position



Unpressurized



Pressurized

Figure 17. Comparison of Unpressurized and Pressurized Modes - I_{oz} Pendulum, Sitting Position

SECTION 5

RESULTS

Tables III, IV, and V summarize the experimental and statistical results of the study. All statistical data sheets printed out by the computer are presented in appendix I; individual subject data, viz., centers of gravity, moments of inertia, anthropometry and clothing information, are contained in appendix II. Lists of symbols used in the printout can also be found in appendixes I and II.

Correlations given in the tables, including those for the unpressurized and pressurized modes, are based upon nude subject weight, specifically the mean of two nude weights taken prior to the nude and suited measurements. In most cases the measurements for the three modes were made during the same day, and variation in nude weight seldom exceeded ± 0.5 lb. Mean nude weight is recorded for each subject on his individual data sheet in appendix II.

The arithmetic means and standard deviations of the centers of gravity and moments of inertia of the sample are presented in table III together with the means and standard deviations of age, weight, stature, and clothing weight. Mean centers of gravity for both positions and all modes are shown in figure 18; since body symmetry was assumed with respect to the sagittal plane, y-axis centers of gravity are independent of body position and mode. It is evident that the pressure suit displaces the center of gravity in a positive direction along both the x-axis (anteriorly) and z-axis (headwardly). The average effect of the suit on the moments of inertia about the x, y, and z axes is an increase of approximately 20, 19, and 20 percent for the Sitting position, and 19, 27, and 16 percent for the Relaxed position.

An interesting aspect of the center-of-gravity data is the behavior of the x-axis means for the unpressurized and pressurized modes. For both the Sitting and Relaxed positions, pressurization produces positive cg displacements of the means of approximately 0.3 inch; the shifts are significant at the 5-percent level. The corresponding changes in moments of inertia (about the z-axis) show no significant differences. A probable explanation for the observed displacements can be found in the experimental procedure. During z-axis moment-of-inertia measurement (x-axis center-of-gravity measurement), the subject's weight is distributed over a large area, a shoulder harness and lap belt are not employed, and pressurization, therefore, can produce a significant total-body linear translation normal to the back plane (the plane of cg reference). Overall body position, on the other hand, is not significantly altered because of the restraint system, and z-axis moment of inertia remains, within the limitations of measurement accuracy, essentially constant.

Table IV shows the results of the linear regression analysis of moment of inertia versus stature and weight. Correlation coefficients range between 0.91 and 0.97; standard errors of estimate are approximately 3 to 6 percent of their corresponding means. The very high correlations and low standard errors denote an almost perfect linear dependence of moment of inertia on the subject's stature and nude weight; the derived regression equations are, consequently, useful expressions from which the moments of inertia of the suited as well as the nude individual can be computed.

The results of the t-tests for significance (reference 1) of the differences of the means of the moments of inertia of the various modes are given in table V. All means of the nude and suited modes differ significantly below the 1-percent level; none of the means of the unpressurized and pressurized modes show significant differences at the 5-percent level.

TABLE III
ARITHMETIC MEANS AND STANDARD DEVIATIONS OF THE SAMPLE CENTERS
OF GRAVITY AND MOMENTS OF INERTIA (N = 19)

	Axis	Center of Gravity (in.)		Moment of Inertia (lb. in. sec. ²)	
		Mean	S.D.	Mean	S.D.
1. Sitting					
Nude	x	7.89	0.41	56.3	8.22
	y	4.79	0.27	66.5	9.98
	z	9.16	0.29	28.3	5.10
Unpressurized	x	8.33	0.39	67.5	9.16
	y	4.79	0.27	82.8	11.30
	z	9.76	0.30	33.6	5.72
Pressurized	x	8.62	0.38	68.8	8.70
	y	4.79	0.27	82.4	11.30
	z	9.70	0.28	34.0	5.72
2. Relaxed (Weightless)					
Nude	x	7.34	0.38	99.2	14.20
	y	4.79	0.27	89.8	15.20
	z	7.39	0.42	31.2	5.04
Unpressurized	x	7.81	0.20	118.0	15.30
	y	4.79	0.27	114.0	15.00
	z	7.86	0.45	36.2	5.03
Pressurized	x	8.08	0.29	118.0	15.20
	y	4.79	0.27	114.0	15.70
	z	7.81	0.48	36.1	4.85

Mean Age 27.4 yrs. S.D. Age 5.3 yrs.
 Mean Weight 164.6 lbs. S.D. Weight 17.4 lbs.
 Mean Stature 69.0 in. S.D. Stature 2.3 in.
 Mean Clothing Weight 23.2 lbs. S.D. Clothing Weight 0.5 lb.

TABLE IV

CORRELATION OF MOMENT OF INERTIA WITH
 STATURE AND WEIGHT
 (N = 19)

	Axis	$R_{I,sw}$	S.E.*	I_0	Regression Equation*
1. Sitting					
Nude	x	0.95	2.67	-105.0	+ 1.59S + 0.317W
	y	0.91	4.07	-135.0	+ 2.10S + 0.344W
	z	0.97	1.17	- 70.4	+ 0.923S + 0.212W
Unpressurized	x	0.93	3.42	-114.0	+ 1.82S + 0.337W
	y	0.97	2.77	-181.0	+ 2.96S + 0.362W
	z	0.97	1.47	- 79.5	+ 1.09S + 0.229W
Pressurized	x	0.93	3.24	-120.0	+ 2.06S + 0.28 W
	y	0.94	3.79	-157.0	+ 2.54S + 0.389W
	z	0.96	1.53	- 78.1	+ 1.07S + 0.230W
2. Relaxed (Weightless)					
Nude	x	0.97	3.30	-191.0	+ 2.88S + 0.556W
	y	0.95	4.60	-265.0	+ 4.04S + 0.461W
	z	0.94	1.75	- 46.0	+ 0.567S + 0.231W
Unpressurized	x	0.95	4.62	-197.0	+ 3.19S + 0.574W
	y	0.96	4.38	-217.0	+ 3.59S + 0.506W
	z	0.96	1.33	- 54.8	+ 0.801S + 0.217W
Pressurized	x	0.97	3.93	-208.0	+ 3.42S + 0.550W
	y	0.96	4.44	-254.0	+ 4.18S + 0.482W
	z	0.96	1.36	- 48.7	+ 0.720S + 0.214W

$$r_{sw} = 0.44 \quad S.E. = 2.02 \text{ in.} \quad S = 59.58 + 0.057W$$

* I_0 and S.E. in lb.in.sec.²

S in in.

W in lbs.

TABLE V

TESTS FOR SIGNIFICANCE OF DIFFERENCES OF SAMPLE MOMENT-OF-INERTIA

MEANS (N = 19)

	t - Values		
	I_x	I_y	I_z
1. Sitting			
Nude - Unpressurized	3.863*	4.583*	2.967*
Nude - Pressurized	4.424*	4.512*	3.161*
Unpressurized - Pressurized	0.428	0.083	0.184
2. Relaxed (Weightless)			
Nude - Unpressurized	3.750*	4.736*	2.982*
Nude - Pressurized	3.873*	4.639*	2.941*
Unpressurized - Pressurized	0.098	0.022	0.094

*Significant ($t_{0.01} = 2.720$, $t_{0.05} = 2.028$)

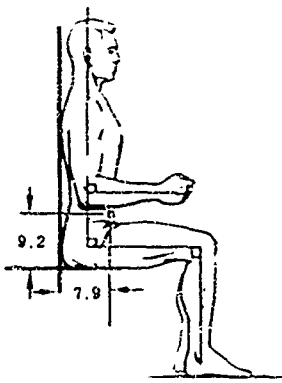

Nude

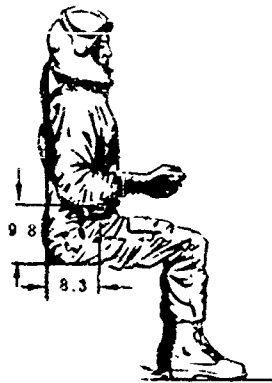

Unpressurized

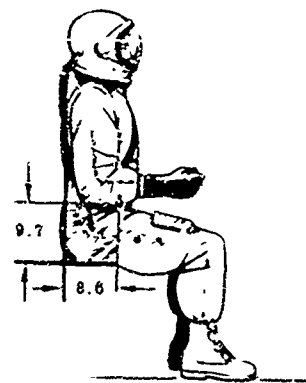

Pressurized

1. Sitting

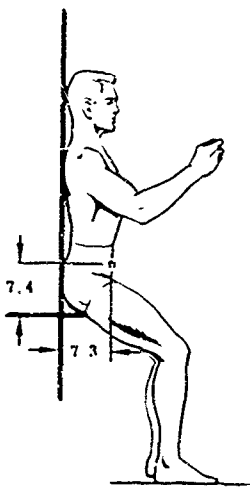

Nude

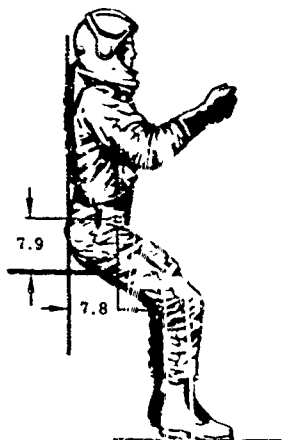

Unpressurized

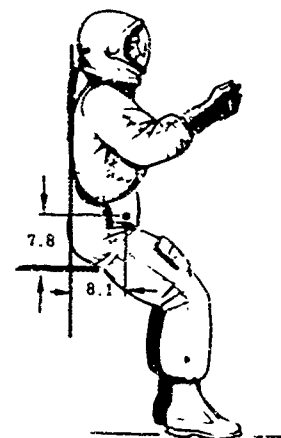

Pressurized

2. Relaxed (Weightless)

Figure 18. Mean Centers of Gravity

APPENDIX I

STATISTICAL DATA

SYMBOLS USED IN PRINTOUT

A, B	Regression equation constants, stature versus weight
A(X), A(Y), ..., C(Z)	Regression equation constants with respect to denoted axis for single and multiple moment-of-inertia correlations
AV	Arithmetic mean of the sample
AVL(X)	Arithmetic mean of the centers of gravity along the x-axis measured with respect to the back plane
AVL(Y)	Arithmetic mean of the centers of gravity along the y-axis; equal to one-half the average bispinous distance
AVL(Z)	Arithmetic mean of the centers of gravity along the z-axis measured with respect to the plane of the seat
AVI(X), AVI(Y), AVI(Z)	Arithmetic means of the moments of inertia with respect to the x-, y-, and z-axes, respectively
E	Probability level in t-test
I(X), I(Y), I(Z)	Moments of inertia about the x-, y-, and z-axes through the center of gravity of the subject
N	Total number of subjects
R	Correlation coefficient
R(X), R(Y), R(Z)	Correlation coefficients with respect to x-, y-, and z-axes for single and multiple moment-of-inertia correlations
S	Standard error of estimate
S(X), S(Y), S(Z)	Standard errors of estimates with respect to the x-, y-, and z-axes for single and multiple moment-of-inertia correlations
SD	Standard deviation from the mean

SDL(X), SDL(Y), SDL(Z) Standard deviations of the centers of gravity from AVL(X), AVL(Y), and AVL(Z), respectively

SDI(X), SDI(Y), SDI(Z) Standard deviations of the moments of inertia from AVI(X), AVI(Y), and AVI(Z), respectively

T Independent variable in t-distribution

T(E) Magnitude of T for 2N-2 degrees of freedom at E level of probability

STATISTICAL DATA (N = 19)
ARITHMETIC MEANS AND STANDARD DEVIATIONS

POSITION	AVL (X)	AVL (Y)	AVL (Z)	SDL (X)	SDL (Y)	SDL (Z)
1 SITTING						
NUDE	789+01	479+01	916+01	408-00	271-00	290-00
UNPRESSURIZED	833+01	479+01	976+01	387-00	271-00	302-00
PRESSURIZED	862+01	479+01	970+01	379-00	271-00	275-00
2 RELAXED (WEIGHTLESS)						
NUDE	734+01	479+01	739+01	382-00	271-00	420-00
UNPRESSURIZED	781+01	479+01	786+01	297-00	271-00	447-00
PRESSURIZED	808+01	479+01	781+01	288-00	271-00	484-00
POSITION	AVI (X)	AVI (Y)	AVI (Z)	SDI (X)	SDI (Y)	SDI (Z)
1 SITTING						
NUDE	563+02	665+02	283+02	822+01	998+01	510+01
UNPRESSURIZED	675+02	828+02	336+02	916+01	113+02	572+01
PRESSURIZED	688+02	824+02	340+02	870+01	113+02	572+01
2 RELAXED (WEIGHTLESS)						
NUDE	992+02	898+02	312+02	142+02	152+02	504+01
UNPRESSURIZED	118+03	114+03	362+02	153+02	150+02	503+01
PRESSURIZED	118+03	114+03	361+02	152+02	157+02	485+01

AVERAGE AGE 27.4 AVERAGE STATURE 69.0
STANDARD DEVIATION AGE 5.3 STANDARD DEVIATION STATURE 2.3

AVERAGE NUDE WEIGHT 164.6 AVERAGE CLOTHING WEIGHT 23.2
STANDARD DEVIATION NUDE WEIGHT 17.4 STANDARD DEVIATION CLOTHING WEIGHT 0.5

(WEIGHT IN POUNDS, LENGTH IN INCHES, MOMENT OF INERTIA IN LB-IN-(SEC)²)

STATISTICAL DATA (N = 19)
SIMPLE LINEAR CORRELATION - MOMENT OF INERTIA VS STATURE

POSITION	R (X)	R (Y)	R (Z)	S (X)	S (Y)	S (Z)
1 SITTING						
NUDE	731+00	732+00	726+00	561+01	673+01	351+01
UNPRESSURIZED	729+00	822+00	737+00	627+01	628+01	386+01
PRESSURIZED	780+00	772+00	732+00	544+01	715+01	390+01
2 RELAXED (WEIGHTLESS)						
NUDE	757+00	829+00	605+00	928+01	852+01	401+01
UNPRESSURIZED	754+00	798+00	690+00	101+02	901+01	364+01
PRESSURIZED	784+00	832+00	671+00	942+01	872+01	359+01
POSITION	A (X)	A (Y)	A (Z)	B (X)	B (Y)	B (Z)
1 SITTING						
NUDE	-128+03	-159+03	-853+02	267+01	327+01	165+01
UNPRESSURIZED	-137+03	-206+03	-956+02	297+01	419+01	187+01
PRESSURIZED	-139+03	-184+03	-942+02	302+01	386+01	186+01
2 RELAXED (WEIGHTLESS)						
NUDE	-230+03	-297+03	-622+02	478+01	561+01	135+01
UNPRESSURIZED	-237+03	-253+03	-701+02	514+01	531+01	154+01
PRESSURIZED	-247+03	-288+03	-637+02	529+01	582+01	145+01

(WEIGHT IN POUNDS, LENGTH IN INCHES, MOMENT OF INERTIA IN LB-IN-(SEC)²)

STATISTICAL DATA (N = 19)
SIMPLE LINEAR CORRELATION - MOMENT OF INERTIA VS WEIGHT

POSITION	R(X)	R(Y)	R(Z)	S(X)	S(Y)	S(Z)
1 SITTING						
NUDE	861+00	808+00	902+00	418+01	587+01	220+01
UNPRESSURIZED	836+00	814+00	886+00	502+01	658+01	265+01
PRESSURIZED	796+00	824+00	885+00	527+01	637+01	266+01
2 RELAXED (WEIGHTLESS)						
NUDE	882+00	788+00	909+00	670+01	937+01	209+01
UNPRESSURIZED	856+00	825+00	909+00	792+01	847+01	209+01
PRESSURIZED	852+00	795+00	912+00	794+01	954+01	199+01

POSITION	A(X)	A(Y)	A(Z)	B(X)	B(Y)	B(Z)
1 SITTING						
NUDE	-108+02	-997+01	-154+02	408-00	464-00	265-00
UNPRESSURIZED	-507+01	-465+01	-144+02	441-00	531+00	292-00
PRESSURIZED	319+01	-550+01	-140+02	399-00	534+00	292-00
2 RELAXED (WEIGHTLESS)						
NUDE	-195+02	-240+02	-122+02	721+00	692+00	264-00
UNPRESSURIZED	-685+01	-332+01	-708+01	757+00	711+00	263-00
PRESSURIZED	-448+01	-487+01	-584+01	745+00	721+00	255-00

STATURE-WEIGHT CORRELATION R = 0.44 S = 2.02 A = 59.58 B = 0.057

(WEIGHT IN POUNDS, LENGTH IN INCHES, MOMENT OF INERTIA IN LB-IN-(SEC)SQ)

STATISTICAL DATA (N = 19)
MULTIPLE LINEAR CORRELATION - MOMENT OF INERTIA VS STATURE AND WEIGHT

POSITION	R(X)	R(Y)	R(Z)	S(X)	S(Y)	S(Z)
1 SITTING						
NUDE	946+00	913+00	973+00	267+01	407+01	117+01
UNPRESSURIZED	928+00	970+00	966+00	342+01	277+01	147+01
PRESSURIZED	928+00	942+00	963+00	324+01	379+01	153+01
2 RELAXED (WEIGHTLESS)						
NUDE	973+00	953+00	937+00	330+01	460+01	175+01
UNPRESSURIZED	954+00	956+00	964+00	462+01	438+01	133+01
PRESSURIZED	966+00	959+00	960+00	393+01	444+01	136+01

POSITION	A(X)	A(Y)	A(Z)	B(X)	B(Y)	B(Z)	C(X)	C(Y)	C(Z)
1 SITTING									
NUDE	-105+03	-135+03	-704+02	159+01	210+01	923+00	317-00	344-00	212-00
UNPRESSURIZED	-114+03	-181+03	-795+02	182+01	296+01	109+01	337-00	362-00	229-00
PRESSURIZED	-120+03	-157+03	-781+02	206+01	254+01	107+01	281-00	389-00	230-00
2 RELAXED (WEIGHTLESS)									
NUDE	-191+03	-265+03	-460+02	288+01	404+01	567+00	556+00	461-00	231-00
UNPRESSURIZED	-197+03	-217+03	-548+02	319+01	359+01	801+00	574+00	506+00	217-00
PRESSURIZED	-208+03	-254+03	-487+02	342+01	418+01	720+00	550+00	482-00	214-00

(WEIGHT IN POUNDS, LENGTH IN INCHES, MOMENT OF INERTIA IN LB-IN-(SEC)SQ)

STATISTICAL DATA (N = 19)
 TEST FOR SIGNIFICANCE OF DIFFERENCE OF MEANS
 (F = 0.01 , T(F) = 2.720)

POSITION	I (X)	T VALUES I (Y)	I (Z)
1 SITTING			
NUDE--UNPRESSURIZED	3.863 *	4.583 *	2.967 *
NUDE--PRESSURIZED	4.424 *	4.512 *	3.161 *
UNPRESSURIZED--PRESSURIZED	0.428	0.083	0.184
2 RELAXED (WEIGHTLESS)			
NUDE--UNPRESSURIZED	3.750 *	4.736 *	2.982 *
NUDE--PRESSURIZED	3.873 *	4.539 *	2.941 *
UNPRESSURIZED--PRESSURIZED	0.098	0.022	0.094

* = SIGNIFICANT

APPENDIX II

SUBJECT DATA

The computed moments of inertia and centers of gravity for the individual subjects together with the corresponding anthropometric dimensions are presented in the following pages. The data are for the most part self-explanatory. Definitions of the symbols and abbreviations are reproduced here for the convenience of the reader. Floating point numbers are read conventionally, e.g., 274+02 means 0.274×10^2 or 27.4.

- L(X) Distance to the center of gravity of the subject as measured along the x-axis from the back plane
- L(Y) Distance to the center of gravity of the subject measured along the y-axis from the iliac crest. Since body symmetry with respect to the sagittal plane is assumed, L(Y) is equal to one-half the bispinous breadth.
- L(Z) Distance to the subject center of gravity measured along the z-axis from the plane of the seat
- I(X) Moment of inertia about the x-axis through the subject's center of gravity
- I(Y) Moment of inertia about the y-axis through the subject's center of gravity
- I(Z) Moment of inertia about the z-axis through the subject's center of gravity

ABBREVIATIONS OF ANTHROPOMETRIC DIMENSIONS

Ankle C	Ankle Circumference
Axilarm C	Axillary Arm Circumference
Biacrom D	Biacromial Diameter
Bicep C	Biceps Circumference (Extended)
Bispin B	Bispinous Breadth
Butpop L	Buttock-Popliteal Length
Butt C	Buttock Circumference
Butt D	Buttock Depth
Calf C	Calf Circumference
Cervic H	Cervicale Height
Chest B	Chest Breadth
Chest C	Chest Circumference
Chest D	Chest Depth
Elbow C	Elbow Circumference (Extended)
Fist C	Fist Circumference
Foot B	Foot Breadth
Foot L	Foot Length
Forearm C	Forearm Circumference (Extended)
Hand B	Hand Breadth at Metacarpale
Hand L	Hand Length
Head B	Head Breadth
Head C	Head Circumference
Head L	Head Length
Hip B	Hip Breadth
Hip B Sit	Hip Breadth, Sitting
Iliac H	Iliac Spine Height
Juxta S	Skinfold, Juxta-nipple
Knee C	Knee Circumference, Standing
Lowarm L	Lower Arm Length
Lowthigh C	Lower Thigh Circumference
Malx S	Skinfold, Mid-axillary Line, Xiphoid
Shldr H	Shoulder Height (Acromial Height)
Sit H	Sitting Height
Span	Span
Sphyri H	Sphyrion Height
Substern H	Substernale Height
Supstern H	Suprasternale Height
Thigh C	Thigh Circumference
Tibiale H	Tibiale Height
Tricep S	Skinfold, Triceps
Trochan H	Trochanteric Height
Uparm L	Upper Arm Length
Waist B	Waist Breadth
Waist C	Waist Circumference
Waist D	Waist Depth
Waist H	Waist Height
Wrist C	Wrist Circumference

SUBJECT NUMBER 1 AGE 33.0 STATURE 68.5 MEAN NUDE WEIGHT 159.8
 SUIT SIZE 3 BOOT SIZE 10.0 CLOTHING TOTAL WEIGHT 22.8 STRAP WEIGHT (X,Y AXES) 0.61

POSITION	L(X)	L(Y)	L(Z)	I(X)	I(Y)	I(Z)
1 SITTING						
NUDE	734+01	470+01	971+01	537+02	581+02	245+02
UNPRESSURIZED	787+01	470+01	104+02	656+02	765+02	294+02
PRESSURIZED	816+01	470+01	101+02	658+02	712+02	298+02
2 RELAXED (WEIGHTLESS)						
NUDE	689+01	470+01	827+01	892+02	774+02	269+02
UNPRESSURIZED	759+01	470+01	857+01	106+03	987+02	335+02
PRESSURIZED	782+01	470+01	874+01	107+03	103+03	330+02

CERVIC H	58.6	SHLDR H	56.7	SUPSTERN H	56.0	SUBSTERN H	48.3	WAIST H	43.0
ILIAC H	37.8	TROCHAN H	35.4	TIBIAL H	18.0	UPARM L	13.0	LOWARM L	10.5
CHEST D	9.4	WAIST D	9.3	BUTT D	10.0	CHEST B	13.3	WAIST B	11.3
HIP B	13.2	AXILARM C	12.8	BICEP C	11.9	ELBOW C	10.7	FOREARM C	10.7
WRIST C	7.2	FIST C	11.4	CHEST C	38.2	WAIST C	32.0	BUTT C	38.1
THIGH C	22.0	LOWTHIGH C	15.4	KNEE C	14.8	CALF C	13.7	ANKLE C	8.3
SPHYRI H	2.8	FOOT L	10.3	FOOT B	3.5	SPAN	68.6	SIT H	36.4
BIACROM D	15.0	HIP B SIT	14.3	BUTPOP L	18.3	HAND L	7.1	HAND B	3.3
HEAD C	22.6	HEAD L	7.8	HEAD B	6.2	MALX S	0.5	JUXTA S	0.6
TRICEP S	0.4	BISPIN B	9.4						

(SUIT SIZES 1-SMALL REG, 2-SMALL LONG, 3-MED REG, 4-MED LONG, 5-LARGE REG, 6-LARGE LONG, 7-EXTRA LARGE REG, 8-EXTRA LARGE LONG)

(WEIGHT IN POUNDS, LENGTH IN INCHES, MOMENT OF INERTIA IN LB-IN-(SEC)SQ)

SUBJECT NUMBER 2 AGE 35.7 STATURE 70.3 MEAN NUDE WEIGHT 169.7
 SUIT SIZE 6 BOOT SIZE 11.5 CLOTHING TOTAL WEIGHT 23.4 STRAP WEIGHT (X,Y AXES) 0.61

POSITION	L(X)	L(Y)	L(Z)	I(X)	I(Y)	I(Z)
1 SITTING						
NUDE	822+01	520+01	878+01	592+02	679+02	304+02
UNPRESSURIZED	873+01	520+01	942+01	696+02	841+02	377+02
PRESSURIZED	895+01	520+01	935+01	700+02	829+02	381+02
2 RELAXED (WEIGHTLESS)						
NUDE	774+01	520+01	694+01	107+03	939+02	342+02
UNPRESSURIZED	830+01	520+01	765+01	125+03	118+03	414+02
PRESSURIZED	852+01	520+01	773+01	126+03	111+03	407+02

CERVIC H	61.4	SHLDR H	58.6	SUPSTERN H	58.1	SUBSTERN H	48.5	WAIST H	46.3
ILIAC H	41.0	TROCHAN H	37.8	TIBIAL H	20.2	UPARM L	13.9	LOWARM L	10.8
CHEST D	9.6	WAIST D	9.3	BUTT D	10.3	CHEST B	12.9	WAIST B	12.5
HIP B	14.2	AXILARM C	12.4	BICEP C	11.9	ELBOW C	10.6	FOREARM C	11.4
WRIST C	6.9	FIST C	12.1	CHEST C	38.9	WAIST C	34.6	BUTT C	39.1
THIGH C	21.8	LOWTHIGH C	16.1	KNEE C	15.6	CALF C	15.0	ANKLE C	11.8
SPHYRI H	3.0	FOOT L	10.8	FOOT B	3.9	SPAN	73.6	SIT H	35.3
BIACROM D	15.6	HIP B SIT	15.2	BUTPOP L	20.9	HAND L	7.6	HAND B	3.5
HEAD C	22.0	HEAD L	7.8	HEAD B	6.0	MALX S	0.6	JUXTA S	0.4
TRICEP S	0.3	BISPIN B	10.4						

(SUIT SIZES 1-SMALL REG, 2-SMALL LONG, 3-MED REG, 4-MED LONG, 5-LARGE REG, 6-LARGE LONG, 7-EXTRA LARGE REG, 8-EXTRA LARGE LONG)

(WEIGHT IN POUNDS, LENGTH IN INCHES, MOMENT OF INERTIA IN LB-IN-(SEC)SQ)

SUBJECT NUMBER 3 AGE 26.2 STATURE 71.7 MEAN NUDE WEIGHT 157.3
 SUIT SIZE 4 BOOT SIZE 10.0 CLOTHING TOTAL WEIGHT 22.8 STRAP WEIGHT (X,Y AXES) 0.61

POSITION	L(X)	L(Y)	L(Z)	I(X)	I(Y)	I(Z)
1 SITTING						
NUDE	806+01	502+01	953+01	552+02	671+02	280+02
UNPRESSURIZED	842+01	502+01	101+02	642+02	859+02	332+02
PRESSURIZED	873+01	502+01	997+01	646+02	836+02	332+02
2 RELAXED (WEIGHTLESS)						
NUDE	744+01	502+01	792+01	984+02	928+02	302+02
UNPRESSURIZED	798+01	502+01	835+01	113+03	114+03	370+02
PRESSURIZED	829+01	502+01	846+01	115+03	118+03	369+02

CERVIC H	61.7	SHLDR H	59.3	SUPSTERN H	58.4	SUBSTERN H	50.4	WAIST H	45.9
ILIAC H	40.7	TROCHAN H	37.7	TIBIALE H	19.0	UPARM L	13.7	LOWARM L	10.4
CHEST D	8.7	WAIST D	3.2	BUTT D	9.8	CHEST B	12.3	WAIST B	11.4
HIP B	14.1	AXILARM C	12.6	BICEP C	11.7	ELBOW C	10.6	FOREARM C	11.3
WRIST C	6.6	FIST C	11.9	CHEST C	36.1	WAIST C	31.3	BUTT C	39.6
THIGH C	22.2	LOWTHIGH C	14.8	KNEE C	15.0	CALF C	13.4	ANKLE C	8.3
SPHYRI H	2.6	FOOT L	10.6	FOOT B	3.7	SPAN	70.8	SIT H	36.1
BIACROM D	14.9	HIP B SIT	14.3	BUTPOP L	21.3	HAND L	7.5	HAND B	3.5
HEAD C	22.0	HEAD L	8.0	HEAD B	6.1	MALX S	0.5	JUXTA S	0.5
TRICEP S	0.6	BISPIN B	10.0						

(SUIT SIZES 1-SMALL REG, 2-SMALL LONG, 3-MED REG, 4-MED LONG,
 5-LARGE REG, 6-LARGE LONG, 7-EXTRA LARGE REG, 8-EXTRA LARGE LONG)

(WEIGHT IN POUNDS, LENGTH IN INCHES, MOMENT OF INERTIA IN LB-IN-(SEC)SQ)

SUBJECT NUMBER 4 AGE 23.4 STATURE 72.9 MEAN NUDE WEIGHT 171.3
 SUIT SIZE 6 BOOT SIZE 13.0 CLOTHING TOTAL WEIGHT 24.0 STRAP WEIGHT (X,Y AXES) 0.61

POSITION	L(X)	L(Y)	L(Z)	I(X)	I(Y)	I(Z)
1 SITTING						
NUDE	845+01	543+01	917+01	703+02	820+02	334+02
UNPRESSURIZED	880+01	543+01	996+01	813+02	998+02	385+02
PRESSURIZED	906+01	543+01	979+01	860+02	983+02	384+02
2 RELAXED (WEIGHTLESS)						
NUDE	780+01	543+01	721+01	120+03	115+03	354+02
UNPRESSURIZED	808+01	543+01	755+01	139+03	137+03	414+02
PRESSURIZED	835+01	543+01	755+01	141+03	139+03	408+02

CERVIC H	62.5	SHLDR H	59.8	SUPSTERN H	59.6	SUBSTERN H	51.0	WAIST H	46.4
ILIAC H	42.0	TROCHAN H	39.1	TIBIALE H	20.8	UPARM L	14.0	LOWARM L	10.6
CHEST D	9.5	WAIST D	7.7	BUTT D	9.8	CHEST B	12.6	WAIST B	10.7
HIP B	14.3	AXILARM C	12.0	BICEP C	11.6	ELBOW C	10.7	FOREARM C	11.5
WRIST C	7.3	FIST C	11.7	CHEST C	36.6	WAIST C	29.3	BUTT C	39.5
THIGH C	22.1	LOWTHIGH C	15.8	KNEE C	15.4	CALF C	15.7	ANKLE C	9.6
SPHYRI H	2.9	FOOT L	10.9	FOOT B	3.9	SPAN	74.7	SIT H	37.7
BIACROM D	16.0	HIP B SIT	14.3	BUTPOP L	20.9	HAND L	7.8	HAND B	3.4
HEAD C	23.6	HEAD L	8.3	HEAD B	6.2	MALX S	0.2	JUXTA S	0.2
TRICEP S	0.4	BISPIN B	10.9						

(SUIT SIZES 1-SMALL REG, 2-SMALL LONG, 3-MED REG, 4-MED LONG,
 5-LARGE REG, 6-LARGE LONG, 7-EXTRA LARGE REG, 8-EXTRA LARGE LONG)

(WEIGHT IN POUNDS, LENGTH IN INCHES, MOMENT OF INERTIA IN LB-IN-(SEC)SQ)

SUBJECT NUMBER 5 AGE 24.7 STATURE 66.5 MEAN NUDE WEIGHT 153.6
 SUIT SIZE 3 BOOT SIZE 9.5 CLOTHING TOTAL WEIGHT 23.1 STRAP WEIGHT (X,Y AXES) 0.61

POSITION	L(X)	L(Y)	L(Z)	I(X)	I(Y)	I(Z)
1 SITTING						
NUDE	763+01	451+01	905+01	518+02	560+02	234+02
UNPRESSURIZED	813+01	451+01	975+01	632+02	767+02	288+02
PRESSURIZED	835+01	451+01	957+01	624+02	728+02	286+02
2 RELAXED (WEIGHTLESS)						
NUDE	723+01	451+01	744+01	892+02	767+02	284+02
UNPRESSURIZED	779+01	451+01	795+01	105+03	103+03	337+02
PRESSURIZED	806+01	451+01	790+01	106+03	103+03	336+02

CERVIC H	57.2	SHLDR H	55.4	SUPSTERN H	54.1	SUBSTERN H	45.9	WAIST H	42.2
ILIA C H	37.0	TROCHAN "	34.9	TIBIALE H	17.9	UPARM L	12.5	LOWARM L	10.3
CHEST D	8.8	WAIST D	8.5	UTT D	10.1	CHEST B	12.7	WAIST B	11.3
HIP B	12.9	AXILARM "	12.0	BICEP C	11.7	ELBOW C	10.0	FOREARM C	10.6
WRIST C	6.8	FIST C	11.1	CHEST C	37.0	WAIST C	31.5	BUTT C	37.5
THIGH C	22.2	LOWTHIGH C	15.4	KNEE C	14.3	CALF C	15.0	ANKLE C	8.9
SPHYRI H	2.2	FOOT L	10.5	FOOT B	3.9	SPAN	69.6	SIT H	34.6
BIACROM D	15.1	HIP B SIT	14.0	BUTPOP L	17.7	HAND L	7.3	HAND B	3.5
HEAD C	22.2	HEAD L	7.4	HEAD B	6.5	MALX S	0.3	JUXTA S	0.2
TRICEP S	0.3	BISPIN B	9.0						

(SUIT SIZES 1-SMALL REG, 2-SMALL LONG, 3-MED REG, 4-MED LONG,
 5-LARGE REG, 6-LARGE LONG, 7-EXTRA LARGE REG, 8-EXTRA LARGE LONG)

(WEIGHT IN POUNDS, LENGTH IN INCHES, MOMENT OF INERTIA IN LB-IN-(SEC)SQ)

SUBJECT NUMBER 6 AGE 32.2 STATURE 65.6 MEAN NUDE WEIGHT 135.1
 SUIT SIZE 1 BOOT SIZE 11.0 CLOTHING TOTAL WEIGHT 22.4 STRAP WEIGHT (X,Y AXES) 0.61

POSITION	L(X)	L(Y)	L(Z)	I(X)	I(Y)	I(Z)
1 SITTING						
NUDE	728+01	478+01	954+01	392+02	513+02	204+02
UNPRESSURIZED	774+01	478+01	988+01	495+02	601+02	243+02
PRESSURIZED	799+01	478+01	992+01	519+02	602+02	240+02
2 RELAXED (WEIGHTLESS)						
NUDE	682+01	478+01	754+01	716+02	600+02	225+02
UNPRESSURIZED	734+01	478+01	821+01	868+02	895+02	263+02
PRESSURIZED	762+01	478+01	808+01	891+02	845+02	268+02

CERVIC H	56.5	SHLDR H	54.0	SUPSTERN H	53.7	SUBSTERN H	46.3	WAIST H	40.5
ILIA C H	36.7	TROCHAN H	35.4	TIBIALE H	18.0	UPARM L	12.9	LOWARM L	10.0
CHEST D	9.1	WAIST D	8.6	BUTT D	9.9	CHEST B	12.2	WAIST B	11.5
HIP B	12.8	AXILARM C	11.9	BICEP C	10.1	ELBOW C	9.8	FOREARM C	9.7
WRIST C	6.2	FIST C	10.7	CHEST C	36.1	WAIST C	31.8	BUTT C	36.0
THIGH C	20.4	LOWTHIGH C	13.8	KNEE C	13.3	CALF C	12.8	ANKLE C	7.8
SPHYRI H	2.3	FOOT L	9.8	FOOT B	3.5	SPAN	78.1	SIT H	34.1
BIACROM D	14.4	HIP B SIT	14.0	BUTPOP L	18.3	HAND L	5.8	HAND B	3.2
HEAD C	21.9	HEAD L	7.4	HEAD B	6.3	MALX S	0.9	JUXTA S	0.9
TRICEP S	0.4	BISPIN B	9.6						

(SUIT SIZES 1-SMALL REG, 2-SMALL LONG, 3-MED REG, 4-MED LONG,
 5-LARGE REG, 6-LARGE LONG, 7-EXTRA LARGE REG, 8-EXTRA LARGE LONG)

(WEIGHT IN POUNDS, LENGTH IN INCHES, MOMENT OF INERTIA IN LB-IN-(SEC)SQ)

SUBJECT NUMBER 7 AGE 25.4 STATURE 65.2 MEAN NUDE WEIGHT 156.2
 SUIT SIZE 3 BOOT SIZE 9.5 CLOTHING TOTAL WEIGHT 23.2 STRAP WEIGHT (X,Y AXES) 0.61

POSITION	L(X)	L(Y)	L(Z)	I(X)	I(Y)	I(Z)
1 SITTING						
NUDE	744+01	447+01	928+01	498+02	562+02	229+02
UNPRESSURIZED	788+01	447+01	941+01	577+02	685+02	276+02
PRESSURIZED	815+01	447+01	954+01	588+02	719+02	286+02
2 RELAXED (WEIGHTLESS)						
NUDE	705+01	447+01	769+01	829+02	723+02	261+02
UNPRESSURIZED	770+01	447+01	827+01	982+02	953+02	326+02
PRESSURIZED	791+01	447+01	819+01	100+03	917+02	325+02

CERVIC H	55.0	SHLDR H	53.1	SUPSTERN H	52.4	SUBSTERN H	45.1	WAIST H	40.3
ILIAC H	34.6	TROCHAN H	32.6	TIBIALE H	17.0	UPARM L	12.4	LOWARM L	9.8
CHEST D	9.2	WAIST D	8.7	BUTT D	9.6	CHEST B	13.1	WAIST B	11.5
HIP B	13.3	AXILARM C	13.3	BICEP C	12.3	ELBOW C	10.9	FOREARM C	11.3
WRIST C	6.9	FIST C	11.4	CHEST C	38.5	WAIST C	33.1	BUTT C	38.2
THIGH C	23.3	LOWTHIGH C	16.2	KNEE C	14.8	CALF C	15.2	ANKLE C	10.7
SPHYRI H	2.5	FOOT L	10.0	FOG, B	4.0	SPAN	67.4	SIT H	35.3
BIACROM D	15.0	HIP B SIT	14.1	BUTPOP L	18.1	HAND L	7.0	ND B	3.3
HEAD C	22.6	HEAD L	7.8	HEAD B	6.1	MALX S	0.8	JUXTA S	1.0
TRICEP S	0.6	BISPIN B	8.9						

(SUIT SIZES 1-SMALL REG, 2-SMALL LONG, 3-MED REG, 4-MED LONG,
 5-LARGE REG, 6-LARGE LONG, 7-EXTRA LARGE REG, 8-EXTRA LARGE LONG)

(WEIGHT IN POUNDS, LENGTH IN INCHES, MOMENT OF INERTIA IN LB-IN-(SEC)SQ)

SUBJECT NUMBER 8 AGE 20.0 STATURE 67.1 MEAN NUDE WEIGHT 167.9
 SUIT SIZE 3 BOOT SIZE 11.0 CLOTHING TOTAL WEIGHT 22.4 STRAP WEIGHT (X,Y AXES) 0.61

POSITION	L(X)	L(Y)	L(Z)	I(X)	I(Y)	I(Z)
1 SITTING						
NUDE	785+01	480+01	917+01	574+02	743+02	279+02
UNPRESSURIZED	814+01	480+01	951+01	684+02	783+02	321+02
PRESSURIZED	839+01	480+01	979+01	688+02	884+02	315+02
2 RELAXED (WEIGHTLESS)						
NUDE	716+01	480+01	702+01	102+03	797+02	320+02
UNPRESSURIZED	753+01	480+01	764+01	116+03	111+03	338+02
PRESSURIZED	782+01	480+01	747+01	115+03	108+03	337+02

CERVIC H	57.1	SHLDR H	55.5	SUPSTERN H	54.1	SUBSTERN H	45.6	WAIST H	42.0
ILIAC H	37.3	TROCHAN H	35.4	TIBIALE H	17.6	UPARM L	12.2	LOWARM L	10.3
CHEST D	9.9	WAIST D	9.4	BUTT D	10.4	CHEST B	12.7	WAIST B	11.9
HIP B	13.7	AXILARM C	12.8	BICEP C	12.2	ELBOW C	10.8	FOREARM C	11.2
WRIST C	7.0	FIST C	12.1	CHEST C	38.6	WAIST C	34.4	BUTT C	38.8
THIGH C	23.5	LOWTHIGH C	16.9	KNEE C	15.0	CALF C	15.0	ANKLE C	9.0
SPHYRI H	2.8	FOOT L	10.7	FOG, B	3.9	SPAN	69.9	SIT H	34.4
BIACROM D	16.1	HIP B SIT	14.3	BUTPOP L	18.9	HAND L	7.5	HAND B	3.5
HEAD C	22.5	HEAD L	8.0	HEAD B	6.1	MALX S	0.7	JUXTA S	0.7
TRICEP S	0.6	BISPIN B	9.6						

(SUIT SIZES 1-SMALL REG, 2-SMALL LONG, 3-MED REG, 4-MED LONG,
 5-LARGE REG, 6-LARGE LONG, 7-EXTRA LARGE REG, 8-EXTRA LARGE LONG)

(WEIGHT IN POUNDS, LENGTH IN INCHES, MOMENT OF INERTIA IN LB-IN-(SEC)SQ)

SUBJECT NUMBER 9 AGE 37.6 STATURE 69.0 MEAN NUDE WEIGHT 138.0
 SUIT SIZE 4 BOOT SIZE 11.5 CLOTHING TOTAL WEIGHT 23.9 STRAP WEIGHT (X,Y AXES) 0.61

POSITION	L(X)	L(Y)	L(Z)	I(X)	I(Y)	I(Z)
1 SITTING						
NUDE	743+01	476+01	945+01	488+02	595+02	227+02
UNPRESSURIZED	800+01	476+01	100+02	627+02	716+02	285+02
PRESSURIZED	840+01	476+01	100+02	648+02	734+02	291+02
2 RELAXED (WEIGHTLESS)						
NUDE	674+01	476+01	735+01	873+02	752+02	242+02
UNPRESSURIZED	731+01	476+01	814+01	109+03	103+03	297+02
PRESSURIZED	766+01	476+01	796+01	108+03	102+03	298+02

CERVIC H	58.6	SHLDR H	56.5	SUPSTERN H	56.1	SUBSTERN H	47.4	WAIST H	43.6
ILIAC H	38.2	TROCHAN H	35.8	TIBIALE H	18.2	UPARM L	12.8	LOWARM L	10.2
CHEST D	8.5	WAIST D	8.3	BUTT D	10.0	CHEST B	12.7	WAIST B	10.7
HIP B	12.9	AXILARM C	12.2	BICEP C	11.2	ELBOW C	9.8	FOREARM C	10.6
WRIST C	6.8	FIST C	11.5	CHEST C	35.8	WAIST C	30.5	BUTT C	36.4
THIGH C	20.2	LOWTHIGH C	14.3	KNEE C	14.7	CALF C	13.3	ANKLE C	8.3
SPHYRI H	2.8	FOOT L	10.7	FOOT B	3.8	SPAN	65.1	SIT H	36.8
BIACROM D	15.2	HIP 3 SIT	13.4	BUTPOP L	19.9	HAND L	7.5	HAND B	3.5
HEAD C	21.5	HEAD L	7.3	HEAD B	6.1	MAX S	0.4	JUXTA S	0.3
TRICEP S	0.4	BISPIN B	9.5						

(SUIT SIZES 1-SMALL REG, 2-SMALL LONG, 3-MED REG, 4-MED LONG,
 5-LARGE REG, 6-LARGE LONG, 7-EXTRA LARGE REG, 8-EXTRA LARGE LONG)

(WEIGHT IN POUNDS, LENGTH IN INCHES, MOMENT OF INERTIA IN LB-IN-(SEC)SQ)

SUBJECT NUMBER 10 AGE 33.7 STATURE 71.7 MEAN NUDE WEIGHT 184.6
 SUIT SIZE 8 BOOT SIZE 13.5 CLOTHING TOTAL WEIGHT 24.2 STRAP WEIGHT (X,Y AXES) 0.61

POSITION	L(X)	L(Y)	L(Z)	I(X)	I(Y)	I(Z)
1 SITTING						
NUDE	870+01	476+01	909+01	666+02	819+02	380+02
UNPRESSURIZED	906+01	476+01	961+01	772+02	971+02	446+02
PRESSURIZED	941+01	476+01	953+01	797+02	969+02	458+02
2 RELAXED (WEIGHTLESS)						
NUDE	826+01	476+01	734+01	118+03	114+03	407+02
UNPRESSURIZED	839+01	476+01	792+01	138+03	139+03	445+02
PRESSURIZED	867+01	476+01	771+01	140+03	134+03	445+02

CERVIC H	62.8	SHLDR H	60.4	SUPSTERN H	59.8	SUBSTERN H	52.6	WAIST H	47.5
ILIAC H	42.4	TROCHAN H	40.4	TIBIALE H	21.2	UPARM L	14.5	LOWARM L	12.0
CHEST D	9.3	WAIST D	9.4	BUTT D	11.2	CHEST B	13.1	WAIST B	11.7
HIP B	14.1	AXILARM C	13.2	BICEP C	12.7	ELBOW C	10.9	FOREARM C	10.9
WRIST C	6.7	FIST C	11.9	CHEST C	38.4	WAIST C	33.6	BUTT C	39.8
THIGH C	24.0	LOWTHIGH C	16.6	KNEE C	15.9	CALF C	14.6	ANKLE C	9.1
SPHYRI H	2.6	FOOT L	11.3	FOOT B	3.8	SPAN	77.1	SIT H	35.4
BIACROM D	15.7	HIP B SIT	14.2	BUTPOP L	22.2	HAND L	8.1	HAND B	3.5
HEAD C	22.8	HEAD L	8.0	HEAD B	6.1	MAX S	0.6	JUXTA S	0.7
TRICEP S	0.7	BISPIN B	9.5						

(SUIT SIZES 1-SMALL REG, 2-SMALL LONG, 3-MED REG, 4-MED LONG,
 5-LARGE REG, 6-LARGE LONG, 7-EXTRA LARGE REG, 8-EXTRA LARGE LONG)

(WEIGHT IN POUNDS, LENGTH IN INCHES, MOMENT OF INERTIA IN LB-IN-(SEC)SQ)

SUBJECT NUMBER 11 AGE 21.2 STATURE 72.2 MEAN NUDE WEIGHT 158.1
 SUIT SIZE 4 BOOT SIZE 11.0 CLOTHING TOTAL WEIGHT 23.6 STRAP WEIGHT (X,Y AXES) 0.61

POSITION	L(X)	L(Y)	L(Z)	I(X)	I(Y)	I(Z)
1 SITTING						
NUDE	826+01	498+01	868+01	584+02	717+02	289+02
UNPRESSURIZED	870+01	498+01	936+01	695+02	885+02	356+02
PRESSURIZED	904+01	498+01	923+01	725+02	885+02	359+02
2 RELAXED (WEIGHTLESS)						
NUDE	733+01	498+01	664+01	104+03	966+02	286+02
UNPRESSURIZED	782+01	498+01	680+01	120+03	117+03	354+02
PRESSURIZED	807+01	498+01	674+01	121+03	118+03	348+02

CERVIC H	61.8	SHLDR H	59.8	SUPSTERN H	59.3	SUBSTERN H	49.8	WAIST H	46.1
ILIAC H	40.8	TROCHAN H	38.7	TIBIALE H	19.8	UPARM L	13.1	LOWARM L	10.8
CHEST D	8.9	WAIST D	7.5	BUTT D	9.3	CHEST B	11.9	WAIST B	10.7
HIP B	13.6	AXILARM C	11.7	BICEP C	11.5	ELBOW C	10.3	FOREARM C	10.8
WRIST C	6.7	FIST C	11.0	CHEST C	34.8	WAIST C	29.6	BUTT C	37.9
THIGH C	22.5	LOWTHIGH C	15.6	KNEE C	14.8	CALF C	14.3	ANKLE C	8.8
SPHYRI H	2.8	FOOT L	10.4	FOOT B	3.9	SPAN	72.4	SIT H	35.6
BIACROM D	14.6	HIP B SIT	14.3	BUTPOP L	20.4	HAND L	7.4	HAND B	3.4
HEAD C	23.1	HEAD L	7.8	HEAD B	6.4	MALX S	0.3	JUXTA S	0.3
TRICEP S	0.3	BISPIN B	10.0						

(SUIT SIZES 1-SMALL REG, 2-SMALL LONG, 3-MED REG, 4-MED LONG,
 5-LARGE REG, 6-LARGE LONG, 7-EXTRA LARGE REG, 8-EXTRA LARGE LONG)

(WEIGHT IN POUNDS, LENGTH IN INCHES, MOMENT OF INERTIA IN LB-IN-(SEC)SQ)

SUBJECT NUMBER 12 AGE 24.3 STATURE 67.8 MEAN NUDE WEIGHT 180.8
 SUIT SIZE 5 BOOT SIZE 11.0 CLOTHING TOTAL WEIGHT 23.8 STRAP WEIGHT (X,Y AXES) 0.61

POSITION	L(X)	L(Y)	L(Z)	I(X)	I(Y)	I(Z)
1 SITTING						
NUDE	775+01	453+01	915+01	626+02	753+02	208+02
UNPRESSURIZED	841+01	453+01	981+01	751+02	869+02	7+02
PRESSURIZED	871+01	453+01	968+01	734+02	857+02	373+02
2 RELAXED (WEIGHTLESS)						
NUDE	716+01	453+01	755+01	103+03	921+02	326+02
UNPRESSURIZED	768+01	453+01	775+01	129+03	118+03	381+02
PRESSURIZED	803+01	453+01	772+01	123+03	119+03	381+02

CERVIC H	58.0	SHLDR H	55.5	SUPSTERN H	55.3	SUBSTERN H	47.4	WAIST H	42.7
ILIAC H	37.7	TROCHAN H	34.3	TIBIALE H	18.0	UPARM L	12.0	LOWARM L	10.1
CHEST D	10.2	WAIST D	8.5	BUTT D	11.4	CHEST B	14.0	WAIST B	11.6
HIP B	13.8	AXILARM C	14.4	BICEP C	13.7	ELBOW C	10.8	FOREARM C	11.5
WRIST C	7.2	FIST C	12.3	CHEST C	40.7	WAIST C	32.9	BUTT C	40.2
THIGH C	24.7	LOWTHIGH C	16.6	KNEE C	14.9	CALF C	15.7	ANKLE C	8.8
SPHYRI H	2.8	FOOT L	10.3	FOOT B	3.9	SPAN	69.2	SIT H	35.2
BIACROM D	16.4	HIP B SIT	15.2	BUTPOP L	18.8	HAND L	7.1	HAND B	3.5
HEAD C	22.6	HEAD L	8.1	HEAD B	6.2	MALX S	0.6	JUXTA S	0.6
TRICEP S	0.7	BISPIN B	9.1						

(SUIT SIZES 1-SMALL REG, 2-SMALL LONG, 3-MED REG, 4-MED LONG,
 5-LARGE REG, 6-LARGE LONG, 7-EXTRA LARGE REG, 8-EXTRA LARGE LONG)

(WEIGHT IN POUNDS, LENGTH IN INCHES, MOMENT OF INERTIA IN LB-IN-(SEC)SQ)

SUBJECT NUMBER 13 AGE 24.5 STATURE 70.0 MEAN NUDE WEIGHT 170.1
 SUIT SIZE 4 BOOT SIZE 11.5 CLOTHING TOTAL WEIGHT 23.4 STRAP WEIGHT (X,Y AXES) 0.61

POSITION	L(X)	L(Y)	L(Z)	I(X)	I(Y)	I(Z)
1 SITTING						
NUDE	790+01	484+01	905+01	565+02	664+02	294+02
UNPRESSURIZED	846+01	484+01	974+01	725+02	900+02	341+02
PRESSURIZED	872+01	484+01	969+01	725+02	885+02	347+02
2 RELAXED (WEIGHTLESS)						
NUDE	756+01	484+01	744+01	102+03	963+02	341+02
UNPRESSURIZED	774+01	484+01	764+01	125+03	120+03	364+02
PRESSURIZED	797+01	484+01	734+01	127+03	115+03	358+02

CERVIC H	59.9	SHLDR H	57.1	SUPSTERN H	56.7	SUBSTERN H	47.4	WAIST H	44.9
ILIAC H	39.5	TROCHAN H	37.0	TIBIALE H	19.4	UPARM L	13.3	LOWARM L	10.6
CHEST D	9.4	WAIST D	7.9	BUTT D	9.4	CHEST B	13.7	WAIST B	11.4
HIP B	13.5	AXILARM C	13.1	BICEP C	12.0	ELBOW C	10.9	FOREARM C	11.0
WRIST C	6.3	FIST C	11.9	CHEST C	38.7	WAIST C	32.0	BUTT C	38.0
THIGH C	21.7	LOWTHIGH C	15.4	KNEE C	15.2	CALF C	14.4	ANKLE C	8.5
SPHYRI H	2.8	FOOT L	10.9	FOOT B	3.9	SPAN	73.2	SIT H	35.8
BIACROM D	16.1	HIP B SIT	13.7	BUTPOP L	19.4	HAND L	7.9	HAND B	3.3
HEAD C	23.3	HEAD L	8.3	HEAD B	5.9	MALX S	0.3	JUXTA S	0.4
TRICEP S	0.5	BISPIN B	9.7						

(SUIT SIZES 1-SMALL REG, 2-SMALL LONG, 3-MED REG, 4-MED LONG,
 5-LARGE REG, 6-LARGE LONG, 7-EXTRA LARGE REG, 8-EXTRA LARGE LONG)

(WEIGHT IN POUNDS, LENGTH IN INCHES, MOMENT OF INERTIA IN LB-IN-(SEC)SQ)

SUBJECT NUMBER 14 AGE 22.5 STATURE 68.4 MEAN NUDE WEIGHT 167.4
 SUIT SIZE 3 BOOT SIZE 11.0 CLOTHING TOTAL WEIGHT 22.6 STRAP WEIGHT (X,Y AXES) 0.61

POSITION	L(X)	L(Y)	L(Z)	I(X)	I(Y)	I(Z)
1 SITTING						
NUDE	771+01	459+01	921+01	584+02	642+02	289+02
UNPRESSURIZED	797+01	459+01	101+02	690+02	817+02	327+02
PRESSURIZED	827+01	459+01	101+02	714+02	823+02	334+02
2 RELAXED (WEIGHTLESS)						
NUDE	734+01	459+01	786+01	104+03	100+03	348+02
UNPRESSURIZED	754+01	459+01	831+01	122+03	113+03	362+02
PRESSURIZED	779+01	459+01	639+01	122+03	118+03	360+02

CERVIC H	58.2	SHLDR H	55.1	SUPSTERN H	55.0	SUBSTERN H	47.2	WAIST H	42.0
ILIAC H	36.7	TROCHAN H	34.9	TIBIALE H	17.4	UPARM L	12.9	LOWARM L	10.2
CHEST D	9.5	WAIST D	8.3	BUTT D	9.8	CHEST B	13.1	WAIST B	11.2
HIP B	13.4	AXILARM C	12.6	BICEP C	12.4	ELBOW C	10.6	FOREARM C	11.0
WRIST C	7.6	FIST C	11.8	CHEST C	38.3	WAIST C	32.1	BUTT C	38.2
THIGH C	23.2	LOWTHIGH C	16.3	KNEE C	15.6	CALF C	14.9	ANKLE C	9.4
SPHYRI H	2.7	FOOT L	10.7	FOOT B	3.8	SPAN	69.7	SIT H	36.7
BIACROM D	15.4	HIP B SIT	14.1	BUTPOP L	14.1	HAND L	7.4	HAND B	3.5
HEAD C	23.4	HEAD L	8.0	HEAD B	6.5	MALX S	0.4	JUXTA S	0.3
TRICEP S	0.3	BISPIN B	9.2						

(SUIT SIZES 1-SMALL REG, 2-SMALL LONG, 3-MED REG, 4-MED LONG,
 5-LARGE REG, 6-LARGE LONG, 7-EXTRA LARGE REG, 8-EXTRA LARGE LONG)

(WEIGHT IN POUNDS, LENGTH IN INCHES, MOMENT OF INERTIA IN LB-IN-(SEC)SQ)

SUBJECT NUMBER 15 AGE 30.5 STATURE 71.8 MEAN NUDE WEIGHT 206.7
 SUIT SIZE 6 BOOT SIZE 13.0 CLOTHING TOTAL WEIGHT 23.5 STRAP WEIGHT (X,Y AXES) 0.61

POSITION	L(X)	L(Y)	L(Z)	I(X)	I(Y)	I(Z)
1 SITTING						
NUDE	854+01	504+01	870+01	741+02	859+02	404+02
UNPRESSURIZED	895+01	504+01	936+01	892+02	107+03	464+02
PRESSURIZED	919+01	504+01	939+01	873+02	103+03	465+02
2 RELAXED (WEIGHTLESS)						
NUDE	769+01	504+01	664+01	131+03	119+03	416+02
UNPRESSURIZED	820+01	504+01	692+01	150+03	146+03	473+02
PRESSURIZED	851+01	504+01	689+01	153+03	149+03	469+02

CERVIC H	61.6	SHLDR H	58.9	SUPSTERN H	58.5	SUBSTERN H	49.8	WAIST H	46.7
ILIA C H	41.2	TROCHAN H	37.6	TIBIALE H	19.3	UPARM L	13.3	LOWARM L	10.7
CHEST D	10.1	WAIST D	9.6	BUTT D	10.6	CHEST B	14.9	WAIST B	12.4
HIP B	14.6	AXILARM C	13.7	BICEP C	13.0	ELBOW C	11.9	FOREARM C	12.4
WRIST C	7.8	FIST C	12.8	CHEST C	43.2	WAIST C	35.0	BUTT C	41.7
THIGH C	26.8	LOWTHIGH C	18.9	KNEE C	16.8	CALF C	17.4	ANKLE C	10.4
SPHYRI H	2.8	FOOT L	11.1	FOOT B	4.1	SPAN	74.8	SIT H	36.9
BIACROM D	16.9	HIP B SIT	15.7	BUTPOP L	20.3	HAND L	8.1	HAND B	3.7
HEAD C	23.3	HEAD L	8.0	HEAD B	6.1	MALX S	0.7	JUXTA S	1.0
TRICEP S	1.0	BISPIN B	10.1						

(SUIT SIZES 1-SMALL REG, 2-SMALL LONG, 3-MED REG, 4-MED LONG,
 5-LARGE REG, 6-LARGE LONG, 7-EXTRA LARGE REG, 8-EXTRA LARGE LONG)

(WEIGHT IN POUNDS, LENGTH IN INCHES, MOMENT OF INERTIA IN LB-IN-(SEC)SQ)

SUBJECT NUMBER 16 AGE 20.6 STATURE 69.8 MEAN NUDE WEIGHT 160.7
 SUIT SIZE 4 BOOT SIZE 11.0 CLOTHING TOTAL WEIGHT 23.3 STRAP WEIGHT (X,Y AXES) 0.61

POSITION	L(X)	L(Y)	L(Z)	I(X)	I(Y)	I(Z)
1 SITTING						
NUDE	822+01	449+01	893+01	571+02	675+02	293+02
UNPRESSURIZED	857+01	449+01	966+01	687+02	902+02	348+02
PRESSURIZED	879+01	449+01	941+01	688+02	867+02	346+02
2 RELAXED (WEIGHTLESS)						
NUDE	781+01	449+01	698+01	977+02	946+02	322+02
UNPRESSURIZED	813+01	449+01	765+01	125+03	121+03	368+02
PRESSURIZED	833+01	449+01	767+01	122+03	123+03	367+02

CERVIC H	60.0	SHLDR H	57.8	SUPSTERN H	57.0	SUBSTERN H	49.9	WAIST H	44.4
ILIA C H	40.1	TROCHAN H	37.5	TIBIALE H	19.3	UPARM L	13.6	LOWARM L	10.9
CHEST D	9.6	WAIST D	7.6	BUTT D	9.7	CHEST B	13.2	WAIST B	11.7
HIP B	13.9	AXILARM C	12.7	BICEP C	11.5	ELBOW C	10.6	FOREARM C	10.6
WRIST C	7.1	FIST C	12.1	CHEST C	39.6	WAIST C	32.6	BUTT C	37.2
THIGH C	22.2	LOWTHIGH C	16.1	KNEE C	14.3	CALF C	13.9	ANKLE C	8.5
SPHYRI H	2.8	FOOT L	10.6	FOOT B	3.8	SPAN	72.7	SIT H	34.9
BIACROM D	15.6	HIP B SIT	14.1	BUTPOP L	20.7	HAND L	7.4	HAND B	3.6
HEAD C	23.1	HEAD L	8.3	HEAD B	6.0	MALX S	0.5	JUXTA S	0.5
TRICEP S	0.6	BISPIN B	9.0						

(SUIT SIZES 1-SMALL REG, 2-SMALL LONG, 3-MED REG, 4-MED LONG,
 5-LARGE REG, 6-LARGE LONG, 7-EXTRA LARGE REG, 8-EXTRA LARGE LONG)

(WEIGHT IN POUNDS, LENGTH IN INCHES, MOMENT OF INERTIA IN LB-IN-(SEC)SQ)

SUBJECT NUMBER 17 AGE 24.0 STATURE 67.2 MEAN NUDE WEIGHT 149.2
 SUIT SIZE 3 BOOT SIZE 11.5 CLOTHING TOTAL WEIGHT 23.2 STRAP WEIGHT (X,Y AXES) 0.61

POSITION	L(X)	L(Y)	L(Z)	I(X)	I(Y)	I(Z)
1 SITTING						
NUDE	777+01	443+01	897+01	459+02	568+02	241+02
UNPRESSURIZED	817+01	443+01	935+01	538+02	724+02	287+02
PRESSURIZED	849+01	443+01	941+01	586+02	725+02	296+02
2 RELAXED (WEIGHTLESS)						
NUDE	705+01	443+01	714+01	839+02	772+02	264+02
UNPRESSURIZED	781+01	443+01	786+01	106+03	102+03	323+02
PRESSURIZED	802+01	443+01	783+01	106+03	103+03	324+02

CERVIC H	57.7	SHLDR H	55.6	SUPSTERN H	54.2	SUBSTERN H	45.6	WAIST H	43.2
ILIAC H	38.6	TROCHAN H	36.1	TIBIALE H	18.7	UPARM L	13.3	LOWARM L	10.6
CHEST D	9.5	WAIST D	8.7	BUTT D	10.0	CHEST B	12.8	WAIST B	11.0
HIP B	13.8	AXILARM C	11.9	BICEP C	11.1	ELBOW C	9.7	FOREARM C	10.8
WRIST C	6.2	FIST C	10.2	CHEST C	38.0	WAIST C	32.0	BUTT C	38.0
THIGH C	21.6	LOWTHIGH C	14.7	KNEE C	14.3	CALF C	14.2	ANKLE C	8.1
SPHYRI H	2.8	FOOT L	10.6	FOOT B	3.5	SPAN	71.1	SIT H	34.2
BIACROM D	15.4	HIP B SIT	13.9	BUTPOP L	19.5	HAND L	7.1	HAND B	3.1
HEAD C	22.8	HEAD L	8.0	HEAD B	6.3	MALX S	0.2	JUXTA S	0.1
TRICEP S	0.2	BISPIN B	8.9						

(SUIT SIZES 1-SMALL REG, 2-SMALL LONG, 3-MED REG, 4-MED LONG,
 5-LARGE REG, 6-LARGE LONG, 7-EXTRA LARGE REG, 8-EXTRA LARGE LONG)

(WEIGHT IN POUNDS, LENGTH IN INCHES, MOMENT OF INERTIA IN LB-IN-(SEC)SQ)

SUBJECT NUMBER 18 AGE 29.8 STATURE 68.0 MEAN NUDE WEIGHT 192.2
 SUIT SIZE 5 BOOT SIZE 11.5 CLOTHING TOTAL WEIGHT 23.4 STRAP WEIGHT (X,Y AXES) 0.61

POSITION	L(X)	L(Y)	L(Z)	I(X)	I(Y)	I(Z)
1 SITTING						
NUDE	789+01	506+01	960+01	579+02	682+02	317+02
UNPRESSURIZED	837+01	506+01	101+02	675+02	860+02	370+02
PRESSURIZED	867+01	506+01	101+02	690+02	844+02	379+02
2 RELAXED (WEIGHTLESS)						
NUDE	711+01	506+01	774+01	109+03	939+02	349+02
UNPRESSURIZED	776+01	506+01	828+01	124+03	120+03	405+02
PRESSURIZED	803+01	506+01	812+01	123+03	116+03	404+02

CERVIC H	58.2	SHLDR H	57.0	SUPSTERN H	56.2	SUBSTERN H	48.3	WAIST H	44.4
ILIAC H	39.3	TROCHAN H	35.4	TIBIALE H	18.6	UPARM L	13.4	LOWARM L	9.8
CHEST D	10.6	WAIST D	9.7	BUTT D	10.9	CHEST B	14.6	WAIST B	12.8
HIP B	14.8	AXILARM C	16.2	BICEP C	13.7	ELBOW C	11.3	FOREARM C	11.8
WRIST C	7.4	FIST C	11.7	CHEST C	42.9	WAIST C	36.3	BUTT C	42.1
THIGH C	24.9	LOWTHIGH C	17.0	KNEE C	15.5	CALF C	15.4	ANKLE C	9.8
SPHYRI H	2.8	FOOT L	10.4	FOOT B	3.8	SPAN	69.6	SIT H	35.0
BIACROM D	15.8	HIP B SIT	16.2	BUTPOP L	19.5	HAND L	7.3	HAND B	3.1
HEAD C	22.0	HEAD L	7.3	HEAD B	6.2	MALX S	1.0	JUXTA S	0.9
TRICEP S	0.8	BISPIN B	10.1						

(SUIT SIZES 1-SMALL REG, 2-SMALL LONG, 3-MED REG, 4-MED LONG,
 5-LARGE REG, 6-LARGE LONG, 7-EXTRA LARGE REG, 8-EXTRA LARGE LONG)

(WEIGHT IN POUNDS, LENGTH IN INCHES, MOMENT OF INERTIA IN LB-IN-(SEC)SQ)

SUBJECT NUMBER 19 AGE 31.9 STATURE 67.2 MEAN NUDE WEIGHT 148.3
 SUIT SIZE 3 BOOT SIZE 11.5 CLOTHING TOTAL WEIGHT 22.6 STRAP WEIGHT (X,Y AXES) 0.61

POSITION L(X) L(Y) L(Z) I(X) I(Y) I(Z)

1 SITTING

NUDE 749+01 453+01 904+01 475+02 524+02 229+02
 UNPRESSURIZED 788+01 453+01 978+01 587+02 712+02 271+02
 PRESSURIZED 833+01 453+01 970+01 614+02 704+02 284+02

2 RELAXED (WEIGHTLESS)

NUDE 724+01 453+01 768+01 848+02 803+02 277+02
 UNPRESSURIZED 762+01 453+01 791+01 100+03 950+02 313+02
 PRESSURIZED 798+01 453+01 795+01 102+03 970+02 320+02

CERVIC H	57.6	SHLDR H	55.9	SUPSTERN H	55.1	SUBSTERN H	47.2	WAIST H	43.0
ILIAC H	37.8	TRGCHAN H	34.9	TIBIALE H	18.5	UPARM L	13.3	LGWARM L	10.4
CHEST D	9.4	WAIST D	8.2	BUTT D	9.5	CHEST B	12.2	WAIST B	10.7
HIP B	13.6	AXILARM C	12.8	BICEP C	11.9	ELBOW C	10.1	FGREARM C	10.5
WRIST C	6.5	FIST C	11.3	CHEST C	36.8	WAIST C	30.6	BUTT C	38.0
THIGH C	22.8	LGWTHIGH C	16.5	KNEE C	14.8	CALF C	14.2	ANKLE C	8.5
SPHYRI H	3.0	FGGT L	10.0	FOGT B	3.5	SPAN	68.4	SIT H	35.5
BIACROM D	14.9	HIP B SIT	14.8	BUTPOP L	19.0	HAND L	7.0	HAND B	3.3
HEAD C	21.5	HEAD L	7.3	HEAD B	6.0	MALX S	0.7	JUXTA S	0.5
TRICEP S	0.9	BISPIN B	9.1						

(SUIT SIZES 1--SMALL REG, 2--SMALL LONG, 3--MED REG, 4--MED LONG,
 5--LARGE REG, 6--LARGE LONG, 7--EXTRA LARGE REG, 8--EXTRA LARGE LONG)

(WEIGHT IN POUNDS, LENGTH IN INCHES, MOMENT OF INERTIA IN LB-IN--(SEC)SQ)

APPENDIX III

DESCRIPTIONS OF ANTHROPOMETRIC DIMENSIONS

1. ANKLE CIRCUMFERENCE: Subject stands. Holding the tape slightly above the projections of the ankle bones, measure the minimum circumference of the right ankle (reference 4).
2. AXILLARY ARM CIRCUMFERENCE: Subject stands, right arm initially raised and then lowered after the tape is in place. Holding the tape in a horizontal plane and as high as possible in the armpit, measure the circumference of the upper arm (reference 4).
3. BIACROMIAL DIAMETER: Subject sits erect, upper arms hanging at sides and forearms extended horizontally. Using the anthropometer, measure between points marked at the ends of the shoulders (acromion to acromion) (reference 4 and appendix V).
4. BICEPS CIRCUMFERENCE (Extended): Subject stands with right arm extended at side. Holding the tape in a horizontal plane, measure the maximum circumference of the biceps muscle.
5. BISPINOUS BREADTH: Subject stands erect. Using the anthropometer, measure the distance between the anterior superior spines of the ilium (most anterior bony projections of the hip bone) previously marked (appendix V).
6. BUTTOCK-POPLITEAL LENGTH: Subject sits with knees bent at right angles. Measure the maximum horizontal distance from the point of intersection of the right angle behind the right knee (popliteal area) to the buttocks.
7. BUTTOCK CIRCUMFERENCE: Subject stands erect. Holding the tape in a horizontal plane, measure the circumference of the buttocks at the level of the greatest rearward protrusion (reference 4).
8. BUTTOCK DEPTH: Subject stands erect. Holding the anthropometer horizontally at the subject's right side, measure the depth of the buttocks at the level of the greatest rearward protrusion (reference 4).
9. CALF CIRCUMFERENCE: Subject stands. Holding the tape in a horizontal plane, measure the maximum circumference of the right calf (reference 4).
10. CERVICAL HEIGHT: Subject stands erect. Using the anthropometer, measure the vertical distance from the floor to the point marked on the bony projection (the 7th cervical vertebra) at the posterior base of the neck (reference 4).

11. CHEST BREADTH: Subject stands erect with arms initially raised and then lowered after the anthropometer is placed. Measure the chest breadth at the level of the nipples, during normal breathing (reference 4).
12. CHEST CIRCUMFERENCE: Subject stands erect with arms initially raised and then lowered after the tape is in place. Holding the tape in a horizontal plane at the level of the nipples, measure the maximum circumference of the chest during normal breathing (reference 4).
13. CHEST DEPTH: Subject stands erect with arms initially raised and then lowered after the instrument is in place. Holding the anthropometer horizontally on the subject's right side, at the level of the nipples, measure the chest depth during normal breathing (reference 4).
14. ELBOW CIRCUMFERENCE (Extended): Subject stands with right arm extended. Measure the elbow circumference, holding the tape over the olecranon.
15. FIST CIRCUMFERENCE: Subject makes a tight fist with right hand, thumb lying across the end of the fist. Measure the fist circumference with tape passing over the thumb and the knuckles (reference 4).
16. FOOT BREADTH: Subject stands with right foot in the foot box, weight equally distributed, the foot just touching the side and rear walls, and long axis of the foot parallel to the side wall. Using the scale on the base of the foot box, measure the widest breadth of the foot (reference 4).
17. FOOT LENGTH: Subject stands with right foot in the foot box, weight equally distributed, foot just touching the side and rear walls, and long axis of the foot parallel to the side wall. Using the scale on the base of the foot box, measure the length of the foot along the long axis (reference 4).
18. FOREARM CIRCUMFERENCE (Extended): Subject stands, right arm extended. Measure the maximum circumference of the forearm with tape.
19. HAND BREADTH AT METACARPALE: Subject extends right hand. With the bar of sliding caliper across the palm, measure the maximum breadth across the distal ends of the metacarpal bones (knuckles) (reference 4).
20. HAND LENGTH: Subject extends right hand. With the bar of the sliding caliper lying across the palm, measure the hand length from the proximal edge of the navicular bone at the wrist to the tip of the middle finger (reference 4).
21. HEAD BREADTH: Using spreading calipers, measure the maximum breadth of the head in a plane perpendicular to the mid-sagittal plane (reference 4).

22. HEAD CIRCUMFERENCE: With tape passing above (not including) the brow ridges, measure the maximum circumference of the head (reference 4).
23. HEAD LENGTH: Using spreading calipers, measure the maximum length of the head from glabella to the occipital region (reference 4).
24. HIP BREADTH: Subject stands erect. Holding the anthropometer horizontally, measure the maximum breadth of the hips (reference 4).
25. HIP BREADTH, SITTING: Subject sits erect. Holding the anthropometer horizontally, measure the maximum breadth of the hips (reference 4).
26. ILIAC SPINE HEIGHT: Subject stands erect. Using the anthropometer, measure the vertical distance from the floor to the mark of the anterior superior spine of the ilium on the right side (appendix V).
27. KNEE CIRCUMFERENCE, STANDING: Subject stands. Measure the right knee circumference at the mid-patella level holding the tape in a horizontal plane.
28. LOWER ARM LENGTH: Subject stands with right arm extended at side. Using an anthropometer, measure the distance along the long axis of the lower arm between points marked at radiale and stylium (appendix V).
29. LOWER THIGH CIRCUMFERENCE: Subject stands. Holding the tape in a horizontal plane, measure the circumference of the lower thigh just above the right knee (reference 4).
30. SHOULDER HEIGHT (Acromial Height): Subject stands erect. Using the anthropometer, measure the vertical distance from the floor to the right acromion, previously marked (reference 4).
31. SITTING HEIGHT: Subject sits erect, head oriented in the Frankfort plane and feet resting on a surface so that knees are bent at about right angles. Using the anthropometer, measure the vertical distance from the sitting surface to the top of the head by placing the anthropometer firmly against the scalp (reference 4).
32. SKINFOLD, JUKTA-NIPPLE: Subject stands erect. Using skinfold calipers, measure the skinfold thickness just adjacent to the right nipple, along the line between the anterior crease of the axilla and the nipple. Grasp skinfold between thumb and index finger, enough to include two thicknesses of skin and subcutaneous fat but not muscle or fascia. Apply the calipers 1 cm from the fingers holding the skinfold, and at a depth from the edge of the skinfold equal to the thickness of the fold. Skinfold thickness is taken in the vertical plane except when lines of Linn result in torsion of the skinfold, and then the skinfold is taken along these lines (reference 6).

33. SKINFOLD, MID-AXILLARY LINE, XIPHOID: Subject stands erect. Using skinfold calipers, measure the skinfold thickness in the mid-axillary line at the level of the xiphoid on the right side of the body. Grasp skinfold between thumb and index finger, enough to include two thicknesses of skin and subcutaneous fat but not muscle or fascia. Apply the calipers 1 cm from the fingers holding the skinfold, and at a depth from the edge of the skinfold equal to the thickness of the fold. Skinfold thickness is taken in the vertical plane except when lines of Linn result in torsion of the skinfold, and then the skinfold is taken along these lines (reference 6).
34. SKINFOLD, TRICEPS: Subject stands with right upper arm extended downward and elbow in 90°-flexion. Mark the posterior midpoint between the tip of the acromion and tip of elbow. Grasp skinfold between thumb and index fingers, enough to include two thicknesses of skin and subcutaneous fat but not muscle or fascia. Allowing the subject's right forearm to drop straight along the side, apply the calipers 1 cm from the fingers holding the skinfold, and at a depth from the edge of the skinfold equal to the thickness of the fold. Skinfold thickness is taken in the vertical plane except when lines of Linn result in torsion of the skinfold and then the skinfold is taken along these lines (reference 6).
35. SPAN: Subject stands erect against a previously-calibrated rear wall with arms extended laterally at their maximum. With one hand touching a surface perpendicular to the rear wall, measure the maximum span by placing a block against the finger tips of the other hand (reference 4).
36. SPHYRION HEIGHT: Subject stands with legs slightly apart. Using measuring block, measure the vertical distance from floor to sphyrion previously marked (appendix V).
37. STATURE: Subject stands erect with head oriented in the Frankfort plane. Using the anthropometer, measure the vertical distance from the floor to the top of the head by placing the anthropometer firmly against the scalp (reference 4).
38. SUBSTERNALE HEIGHT: Subject stands erect. Using the anthropometer, measure the vertical distance from the floor to the marked point at the lower edge of the breastbone (substernale) (reference 4 and appendix V).
39. SUPRASTERNALE HEIGHT: Subject stands erect. Using the anthropometer, measure the vertical distance from the floor to the marked point at the upper edge of the breastbone (suprasternale) (reference 4 and appendix V).
40. THIGH CIRCUMFERENCE: Subject stands with legs slightly apart. Holding the tape in a horizontal plane just below the lowest point in the gluteal furrow, measure the circumference of the right thigh (reference 4).

41. TIBIALE HEIGHT: Subject stands with legs slightly apart. Using the anthropometer, measure the vertical distance from floor to right tibiale previously located and marked (appendix V).
42. TROCHANTERIC HEIGHT: Subject stands erect. Using the anthropometer, measure the vertical distance from the floor to trochanterion as previously marked on the right side (appendix V).
43. UPPER ARM LENGTH: Subject stands with right arm extended at side. Using the anthropometer, measure the distance along the long axis of the upper arm, between the points previously marked at acromion and at radiale (appendix V).
44. WAIST BREADTH: Subject stands erect with abdomen relaxed. Using the anthropometer, measure the minimum horizontal distance between the points marking the greatest lateral indentation in the abdominal region (reference 4).
45. WAIST CIRCUMFERENCE: Subject stands erect with abdomen relaxed. Using the tape, measure the minimum circumference around the abdominal region, passing over the waist points which mark the greatest lateral indentations (reference 4).
46. WAIST DEPTH: Subject stands erect with abdomen relaxed. Holding the anthropometer horizontally on the subject's right side, measure the anteroposterior diameter of the abdomen at the level of the waist points which mark the greatest lateral indentation (reference 4).
47. WAIST HEIGHT: Subject stands erect. Using the anthropometer, measure the vertical distance from the floor to the marked point indicating the most lateral indentation of the waist on the right side (reference 4).
48. WRIST CIRCUMFERENCE: Right arm and hand extended. Passing the tape just proximal to the styloid process of the ulna, measure the minimum circumference of the wrist (reference 4).

APPENDIX IV

DATA SHEETS

FORTRAN FIXED 10 DIGIT DECIMAL DATA

DECK NO. 26163 PROGRAMMER J. DUBOIS DATE 8-2-63 PAGE 25 OF 42 JOB NO. 1225-07

NUMBER	IDENTIFICATION	DESCRIPTION	DO NOT KEY PUNCH
77.71		Alt. Temp.	Comments
191.63		Rate W.	
2.44557		Revised - 1 - 1/2	
2.99562		- Long	
1.0038		- 1 - Long	
2.46576	1800011	- Short	
2.51114		Revised - 1 - 1/2	
3.03740		- Long	
2.03297		- 1 - Long	
2.50463		- Short	
191.93		Rate W.	
1.76619		Revised - 1 - 1/2	
2.51103		- Long	
2.52590		Revised - 1 - 1/2	
1.98565		- Short	
191.91		Rate W.	
78.4		Alt. Temp.	
		Subject Name: <i>hullor</i>	
		Subject Number: <i>19</i>	
		Date: <i>6-2-63, am</i>	

Page 2 of 3

FORTRAN FIXED 10 DIGIT DECIMAL DATA

DECK NO. 26163 PROGRAMMER J. DUBOIS DATE 8-2-63 PAGE 25 OF 42 JOB NO. 1225-07

NUMBER	IDENTIFICATION	DESCRIPTION	DO NOT KEY PUNCH
78.8		Alt. Temp.	
11.5	5	Rate W. (Revised, Short, Long, 1/2 - 1/2, 1/2 - 1/2, 1/2 - 1/2)	
192.87		Rate W.	Subject Number: <i>19</i>
2.16.28		Revised W. - 1	Date: <i>4-2-63, pm</i>
2.05	15000015	Rate W. W.	Comments
2.42585		Revised - 1 - 1/2 - Short	
2.98870		- Long	
2.99115		- 1 - Long	
2.44917		- Short	
2.48883		- 1 - 1/2 - Short	
2.99830		- Long	
2.99003		- 1 - Long	
2.42782		- Short	
2.48887		Revised - 1 - 1/2 - Short	
3.03008		- Long	
2.03229		- 1 - Long	
2.47827		- Short	
2.49807		- 1 - 1/2 - Short	
2.03234		- Long	
2.03113		- 1 - Long	
2.49662		- Short	
2.16.53		Revised W. - 1	
78.9		Alt. Temp.	

Page 2 of 3

FORTRAN FIXED 10 DIGIT DECIMAL DATA

DECK NO. 26163 PROGRAMMER J. DUBOIS DATE 8-2-63 PAGE 25 OF 42 JOB NO. 1225-07

NUMBER	IDENTIFICATION	DESCRIPTION	DO NOT KEY PUNCH
1.54140		Revised - 1 - 1/2 - Short	Comments
2.56440		- Long	
2.51209		- 1 - 1/2 - Long	
1.83819		- Short	
1.85828		Revised - 1 - 1/2 - Short	
2.51670	1800011	- Long	
2.51219		- 1 - 1/2 - Long	
1.85159		- Short	
2.16.59		Revised W. - 1	
79.2		Alt. Temp.	

Page 3 of 3

APPENDIX V

SKELETAL ANTHROPOMETRIC POINTS

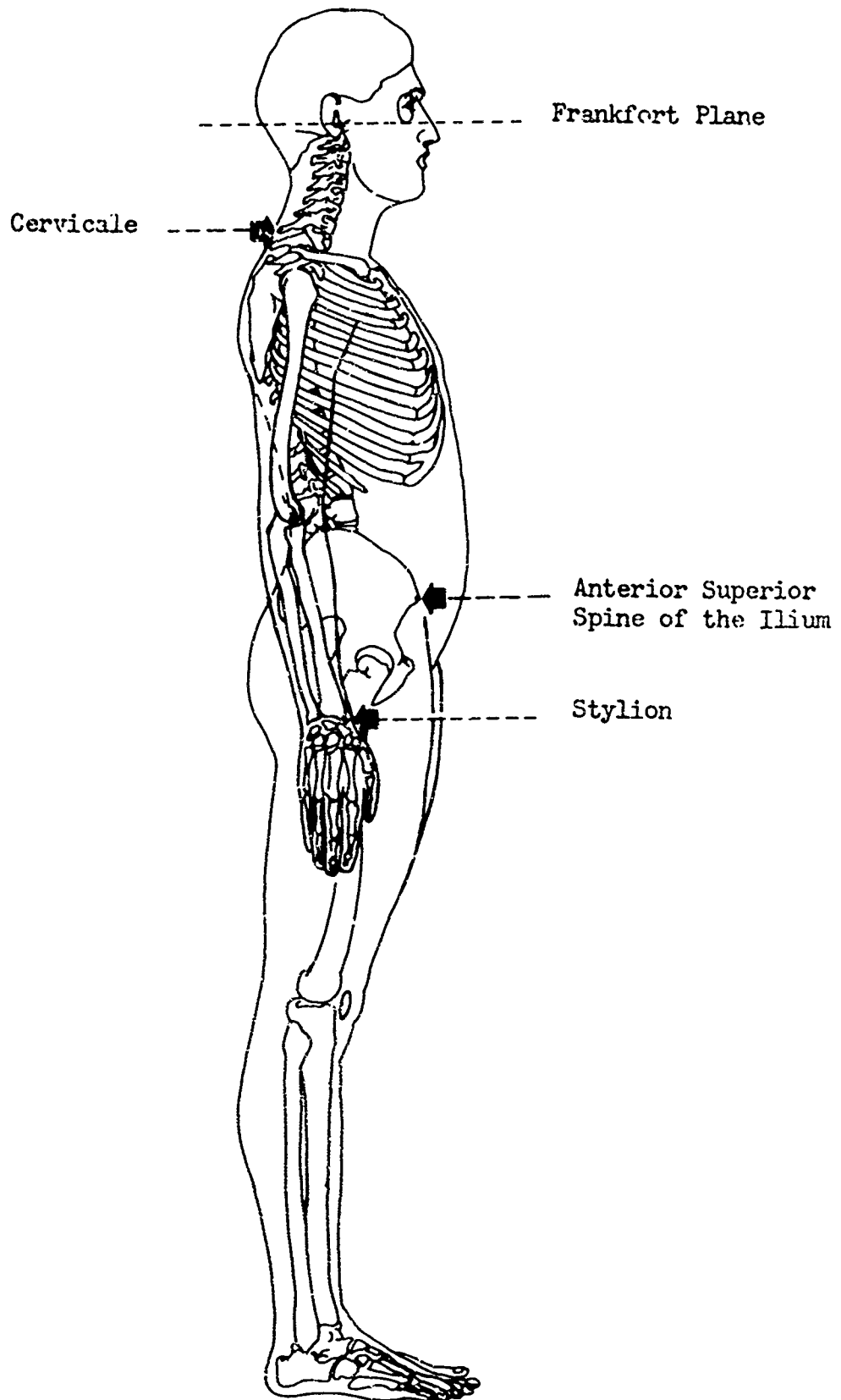

SKELETAL ANTHROPOMETRIC POINTS

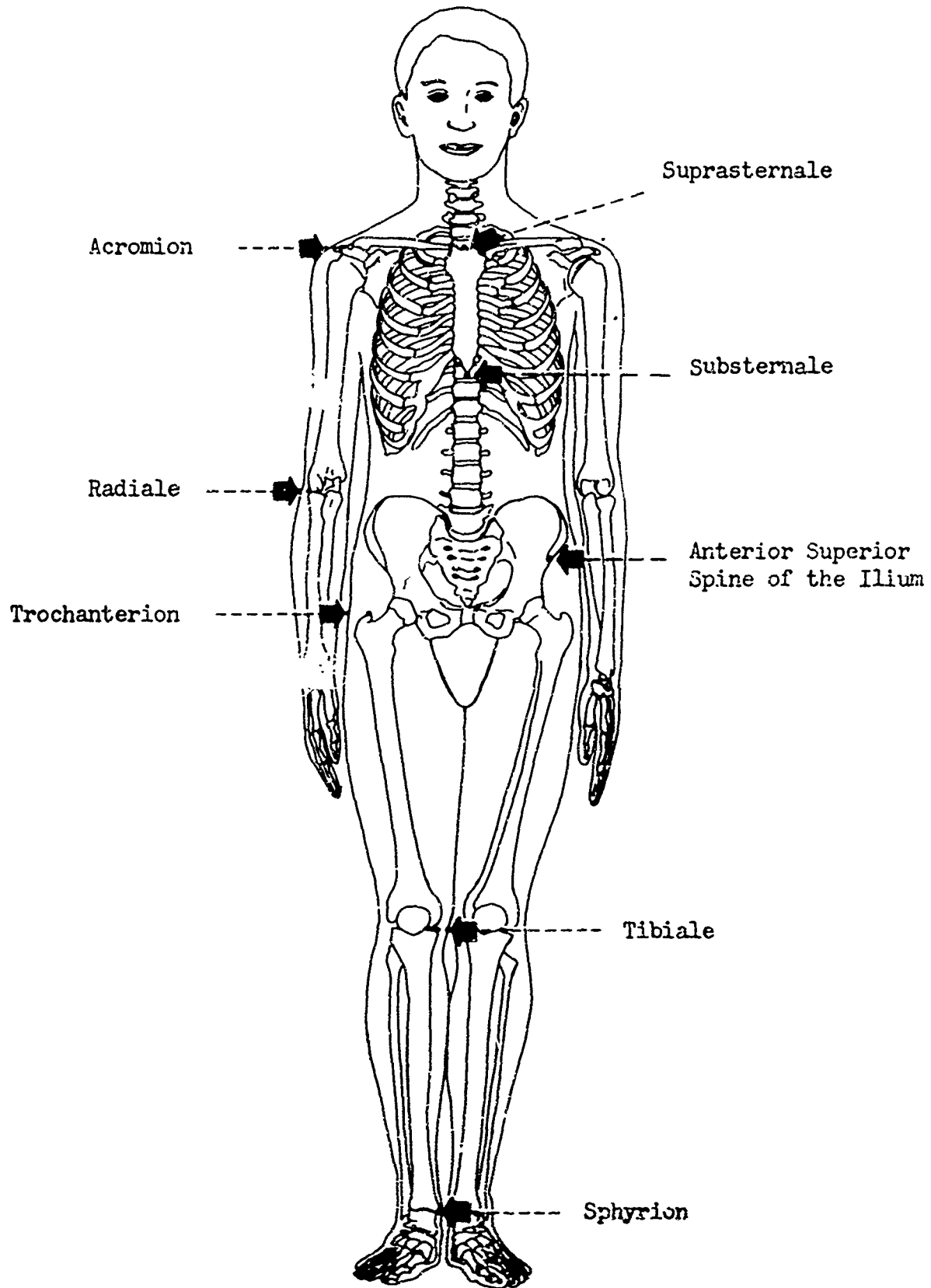

REFERENCES

1. Burington, R. S. and D. C. May, Handbook of Probability and Statistics With Tables, Handbook Publishers, Inc., Sandusky, Ohio, 1953.
2. DuBois, J. and W. R. Santschi, "The Determination of the Moment of Inertia of the Living Human Organism", John W. Senders, ed., John Wiley and Sons, Inc., New York, N. Y., 1963, In Press.
3. Emanuel, I., M. Alexander, E. Churchill and B. Truett, A Height-Weight Sizing System for Flight Clothing, WADC Technical Report 56-365, Wright Air Development Center, Wright-Patterson Air Force Base, Ohio, April 1959.
4. Hertzberg, H. T. E., G. S. Daniels and E. Churchill, Anthropometry of Flying Personnel - 1950, WADC Technical Report 52-321, Wright Air Development Center, Wright-Patterson Air Force Base, Ohio, March 1950.
5. Outfit, Flying, Full Pressure High Altitude Type A/P22S-2, Technical Manual T.O.14P3-6-81, Published under the Authority of the Secretary of the Air Force, 20 September 1962.
6. Pascale, L. R., M. I. Grossman, and H. S. Sloane, Correlation Between Thickness of Skinfolts and Body Density in 88 Soldiers, Report No. 162, 9937 TU, Medical Nutrition Laboratory, Fitzsimmons Army Hospital, Denver, Colorado, April .
7. Santschi, W. R., J. DuBois, and C. E. Omoto, Moments of Inertia and Centers of Gravity of the Living Human Body, AMRL Technical Documentary Report 63-36, Aerospace Medical Research Laboratories, Wright-Patterson Air Force Base, Ohio, May 1963.

Security Classification

DOCUMENT CONTROL DATA - R&D		
<small>(Security classification of title, body of abstract and indexing annotation must be entered when the overall report is classified)</small>		
1. ORIGINATING ACTIVITY (Corporate author)		2a. REPORT SECURITY CLASSIFICATION
North American Aviation, Inc Los Angeles 9, California		UNCLASSIFIED
		2b. GROUP
		N/A
3. REPORT TITLE		
MOMENTS OF INERTIA AND CENTERS OF GRAVITY OF THE LIVING HUMAN BODY ENCUMBERED BY A FULL-PRESSURE SUIT		
4. DESCRIPTIVE NOTES (Type of report and inclusive dates)		
Final report, July 1963 - December 1963		
5. AUTHOR(S) (Last name, first name, initial)		
DuBois, J.; Santschi, W. R.; Walton, D. M.; Scott, C. O.; and Mazy, F. W.		
6. REPORT DATE	7a. TOTAL NO. OF PAGES	7b. NO. OF REFS
November 1964	59	7
8a. CONTRACT OR GRANT NO. AF 33(657)-11619		9a. ORIGINATOR'S REPORT NUMBER(S)
b. PROJECT NO 7184		North American Aviation Report #NA-64-527
c. Task No. 718408		
d.		9b. OTHER REPORT NO(S) (Any other numbers that may be assigned this report)
		AMRL-TR-64-110
10. AVAILABILITY/LIMITATION NOTICES		
Qualified requesters may obtain copies of this report from DDC. Available, for sale to the public, from the Office of Technical Services, U. S. Department of Commerce, Washington, D. C. 20230.		
11. SUPPLEMENTARY NOTES		12. SPONSORING MILITARY ACTIVITY
		Aerospace Medical Research Laboratories, Aerospace Medical Division, Air Force Systems Command, Wright-Patterson AFB, Ohio
13. ABSTRACT		
<p>The center of gravity and the moments of inertia of each of 19 male subjects, representative in stature and weight of the U. S. Air Force population, were determined. Two body positions: sitting and relaxed; and three modes of dress: nude, suited-unpressurized, and suited-pressurized were investigated. The theoretical accuracy of the experimental procedures, based on a compound pendulum, ranged from 2 to 8 percent, depending on body position and axis. The moments of inertia were found to vary significantly between body positions and between nude and suited conditions. Correlation coefficients between the moments of inertia and stature and weight exceeded 0.9. Fifty anthropometric dimensions and frontal and profile photographs were obtained on each subject to serve as the basis for additional biodynamic analyses.</p>		

Security Classification

14. KEY WORDS	LINK A		LINK B		LINK C	
	ROLE	WT	ROLE	WT	ROLE	WT
Human engineering						
Anthropometry						
Astronautics						
Anthropology						
Anatomy						
Body						
Man						
Weightlessness						
Cravity						
Pressure suits						

INSTRUCTIONS

1. **ORIGINATING ACTIVITY:** Enter the name and address of the contractor, subcontractor, grantee, Department of Defense activity or other organization (*corporate author*) issuing the report.
- 2a. **REPORT SECURITY CLASSIFICATION:** Enter the overall security classification of the report. Indicate whether "Restricted Data" is included. Marking is to be in accordance with appropriate security regulations.
- 2b. **GROUP:** Automatic downgrading is specified in DoD Directive 5200.10 and Armed Forces Industrial Manual. Enter the group number. Also, when applicable, show that optional markings have been used for Group 3 and Group 4 as authorized.
3. **REPORT TITLE:** Enter the complete report title in all capital letters. Titles in all cases should be unclassified. If a meaningful title cannot be selected without classification, show title classification in all capitals in parenthesis immediately following the title.
4. **DESCRIPTIVE NOTES:** If appropriate, enter the type of report, e.g., interim, progress, summary, annual, or final. Give the inclusive dates when a specific reporting period is covered.
5. **AUTHOR(S):** Enter the name(s) of author(s) as shown on or in the report. Enter last name, first name, middle initial. If military, show rank and branch of service. The name of the principal author is an absolute minimum requirement.
6. **REPORT DATE:** Enter the date of the report as day, month, year, or month, year. If more than one date appears, on the report, use date of publication.
- 7a. **TOTAL NUMBER OF PAGES:** The total page count should follow normal pagination procedures, i.e., enter the number of pages containing information.
- 7b. **NUMBER OF REFERENCES:** Enter the total number of references cited in the report.
- 8a. **CONTRACT OR GRANT NUMBER:** If appropriate, enter the applicable number of the contract or grant under which the report was written.
- 8b, 8c, & 8d. **PROJECT NUMBER:** Enter the appropriate military department identification, such as project number, subproject number, system numbers, task number, etc.
- 9a. **ORIGINATOR'S REPORT NUMBER(S):** Enter the official report number by which the document will be identified and controlled by the originating activity. This number must be unique to this report.
- 9b. **OTHER REPORT NUMBER(S):** If the report has been assigned any other report numbers (*either by the originator or by the sponsor*), also enter this number(s).
10. **AVAILABILITY/LIMITATION NOTICES:** Enter any limitations on further dissemination of the report, other than those

imposed by security classification, using standard statements such as:

- (1) "Qualified requesters may obtain copies of this report from DDC."
- (2) "Foreign announcement and dissemination of this report by DDC is not authorized."
- (3) "U. S. Government agencies may obtain copies of this report directly from DDC. Other qualified DDC users shall request through _____."
- (4) "U. S. military agencies may obtain copies of this report directly from DDC. Other qualified users shall request through _____."
- (5) "All distribution of this report is controlled. Qualified DDC users shall request through _____."

If the report has been furnished to the Office of Technical Services, Department of Commerce, for sale to the public, indicate this fact and enter the price, if known.

11. **SUPPLEMENTARY NOTES:** Use for additional explanatory notes.
12. **SPONSORING MILITARY ACTIVITY:** Enter the name of the departmental project office or laboratory sponsoring (*paying for*) the research and development. Include address.
13. **ABSTRACT:** Enter an abstract giving a brief and factual summary of the document indicative of the report, even though it may also appear elsewhere in the body of the technical report. If additional space is required, a continuation sheet shall be attached.

It is highly desirable that the abstract of classified reports be unclassified. Each paragraph of the abstract shall end with an indication of the military security classification of the information in the paragraph, represented as (TS), (S), (C), or (U)

There is no limitation on the length of the abstract. However, the suggested length is from 150 to 225 words.

14. **KEY WORDS:** Key words are technically meaningful terms or short phrases that characterize a report and may be used as index entries for cataloging the report. Key words must be selected so that no security classification is required. Identifiers, such as equipment model designation, trade name, military project code name, geographic location, may be used as key words but will be followed by an indication of technical context. The assignment of link, rules, and weights is optional.