

AD 606515

TOTAL IMPULSE MEASURING SYSTEM FOR SOLID-PROPELLANT ROCKET ENGINE

INSTALLATION AND OPERATION HANDBOOK

FEBRUARY 1964

SECOND PRINTING
AUGUST 1964

AIR FORCE PROPULSION LABORATORIES
AIR FORCE SYSTEMS COMMAND
UNITED STATES AIR FORCE
EDWARDS, CALIFORNIA

PROJECT NO. 3850, TASK NO. 3850306

PREPARED UNDER CONTRACT AF04(611)-8515
BY
V. C. PLANE

COPY	2	OF	3
HARD COPY		\$.	3.00
MICROFICHE		\$.	0.75

67p

APPROVED BY
R. J. THOMPSON, JR.
RESEARCH DIRECTOR

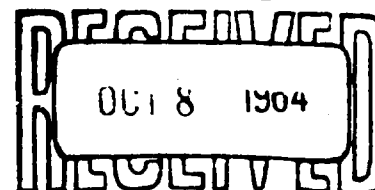
DDC

 DDC-IRA B

ROCKETDYNE
A DIVISION OF NORTH AMERICAN AVIATION, INC.
6633 CANOGA AVENUE, CANOGA PARK, CALIFORNIA

CLEARINGHOUSE FOR FEDERAL SCIENTIFIC AND TECHNICAL INFORMATION CFSTI
DOCUMENT MANAGEMENT BRANCH 410.11

LIMITATIONS IN REPRODUCTION QUALITY

ACCESSION #

AD 606515

- 1. WE REGRET THAT LEGIBILITY OF THIS DOCUMENT IS IN PART UNSATISFACTORY. REPRODUCTION HAS BEEN MADE FROM BEST AVAILABLE COPY.
- 2. A PORTION OF THE ORIGINAL DOCUMENT CONTAINS FINE DETAIL WHICH MAY MAKE READING OF PHOTOCOPY DIFFICULT.
- 3. THE ORIGINAL DOCUMENT CONTAINS COLOR, BUT DISTRIBUTION COPIES ARE AVAILABLE IN BLACK-AND-WHITE REPRODUCTION ONLY.
- 4. THE INITIAL DISTRIBUTION COPIES CONTAIN COLOR WHICH WILL BE SHOWN IN BLACK-AND-WHITE WHEN IT IS NECESSARY TO REPRINT.
- 5. LIMITED SUPPLY ON HAND: WHEN EXHAUSTED, DOCUMENT WILL BE AVAILABLE IN MICROFICHE ONLY.
- 6. LIMITED SUPPLY ON HAND: WHEN EXHAUSTED DOCUMENT WILL NOT BE AVAILABLE.
- 7. DOCUMENT IS AVAILABLE IN MICROFICHE ONLY.
- 8. DOCUMENT AVAILABLE ON LOAN FROM CFSTI (TT DOCUMENTS ONLY).
- 9.

NBS 9/84

PROCESSOR: *[Signature]*

RPL-TDR-64-111

TOTAL IMPULSF MEASURING SYSTEM
FOR SOLID-PROPELLANT
ROCKET ENGINE

INSTALLATION AND OPERATION HANDBOOK

FEBRUARY 1964

SECOND PRINTING
AUGUST 1964

TECHNICAL DOCUMENTARY REPORT NO. RPL-TDR-64-111

AIR FORCE PROPULSION LABORATORIES
AIR FORCE SYSTEMS COMMAND
UNITED STATES AIR FORCE
EDWARDS, CALIFORNIA

PROJECT NO. 3850, TASK NO. 3850306

PREPARED UNDER CONTRACT AF04 (611)-8515

BY

V. C. PLANE

APPROVED BY

R. J. THOMPSON, JR.
RESEARCH DIRECTOR

ROCKETDYNE
A DIVISION OF NORTH AMERICAN AVIATION, INC.
6633 CANOGA AVENUE, CANOGA PARK, CALIFORNIA

FOREWORD

This handbook was prepared by Rocketdyne, a Division of North American Aviation, Inc., Canoga Park, California, on Air Force Contract AF04(611)-8515 under Task No. 3850306 of Project No. 3850, "Total Impulse Measuring System for Solid-Propellant Rocket Engine (Research)." Contract AF04(611)-8515 consists of a program for the analysis and design (Phase I), fabrication and testing (Phase II), and installation and testing (Phase III), of an accurate (0.1%) solid-propellant total impulse measurement system for Edwards Air Force Base. This handbook is submitted to present the installation and operational procedure of the system. It was prepared by the Instrumentation Research Group of the Rocketdyne Research Department.

TABLE OF CONTENTS

Foreword	ii
General System Description	1
Functional	1
Physical	2
Electrical	3
Specifications	5
Installation and Operation	6
Installation	6
Overall Test Stand and Calibrator	6
Control Room Equipment	7
Operation	6
Pre-Calibration Operations	8
Calibrations	10
Integration of Motor Thrusts	12
Detailed Component Descriptions	15
Concrete Attachment and Support Bases	15
Load Cell Assembly	16
Motor Mount Assembly	16
Calibration System	17
Load Cell Power Supply	19
Bridge Balances	20
Integrating Digital Voltmeter	21
Summary of Critical Component Specifications	22
Component Diagrams	27
Photos	33

GENERAL SYSTEM DESCRIPTION

FUNCTIONAL

The Rocketdyne Solid Propellant Total Impulse Measurement System is an electromechanical instrument which provides very precise measurements of motor thrust and its time-integral, total impulse, at thrust levels up to 10,000 pounds. When in use, the solid propellant motor produces a thrust force which compresses a strain-gage load cell to obtain a dc voltage which is linearly proportional to the thrust force. This dc voltage is applied to the input of a voltage-controlled oscillator to produce a train of pulses whose repetition rate is linearly proportional to the dc voltage and, hence, motor thrust. An electronic counter totalizes the number of pulses produced during the propellant burning time, and the number so produced is, consequently, linearly proportional to the time-integral of the thrust, or total impulse, of the burned propellant.

The calibration of the entire system is accomplished by the generation and use of hydraulic pressures produced by very accurate, remotely operated, dead weights supported on an oil column and supplied to a precision piston to produce accurate static forces. The forces so produced are mechanically transmitted to the motor support by rods extending through clearance holes in a massive concrete retaining abutment. The total impulse calibration of the entire system is accomplished by counting the number of pulses generated

in one second by one of the specific static calibration forces. The calibration constant is obtained by the division of this number by the value of the static force. The units of the calibration constant obtained by this method are consequently the number of pulses per pound-second of impulse. In order to obtain the most accurate use of the measurement system, static calibrations are made immediately before and after each propellant test to eliminate the effects of long-term drifts in the determination of the calibration constant used in data reduction operations.

PHYSICAL

The general configuration of the mechanical system and components of the 20' x 5' x 5', approximately 22,000 pounds, two-piece, test stand is shown in Fig. 1 and in most of the accompanying photographs. The larger, 13' long, approximately 18,000 pounds forward section consists of: (1) a motor support section, (2) a thrust collector and distributor section, (3) a concrete abutment and I-beam base frame, and (4) the calibration piston assembly and tie-rods. The smaller, 7' long, approximately 4000 pounds, rear section of the two-piece test stand consists of: (1) the master pressure standard, consisting of precision dead weights and hydraulic cylinder (dead weight gage), pump, valves, and oil reservoir; (2) an electronic calibration control box, (3) a weather-tight enclosure for the protection of the calibration system, and (4) the primary and secondary I-beam base frames.

The installation provisions on the test stand include lifting-eye bolts on both sections, six tiedown bolt locations on the larger, forward section (two each at the fore and aft ends of the concrete abutment and two at the motor end) and four tiedown bolt locations on the smaller, rearward section (two at each end). Elevation adjustment bolts are provided at the sides of both sections to facilitate level installation when used in conjunction with suitable shims located adjacent to the tiedown bolts (see photos for details).

The general configuration of the electronic equipment cabinet located in the control room is shown in photos 2 and 6 . The enclosure contains the integrating digital voltmeter which performs the electronic integration of the thrust-time curve, the load cell power supply and bridge balances, and the control panel for the remote operation of the calibration system. Not shown is a pulse modifier to enable the tape recording of the voltage-controlled oscillator pulses.

ELECTRICAL

The electronic measurement system consists of two specially constructed metal foil strain gage bridges powered and balanced, respectively, by an all-transistor supply and Kelvin-Varley voltage dividers. The bridge output signals are supplied directly to a precision integrating digital voltmeter, with no intermediate attenuating circuitry. To reduce electrical noise to a minimum, the system features a floated and completely shielded measuring circuit

extending from the strain gage load cell on the test stand to the electronic integrator, power supply, and bridge balances in the remotely located control room. The circuitry in the power supply and bridge balances are isolated from their respective chassis, which are, in turn, isolated from their respective front panels. In this manner, these units are insulated from their common mounting rack in order that their separate ground wires would provide maximum versatility in grounding problems invariably encountered in precision electronic measurements.

The measurements of total impulse are presented as a direct reading digital display and also as a pulse train output which, if suitably recorded and played back at a later time, provides the basic information needed in any delayed integration. A very wide range of measurement sensitivity, along with very high resolution, is provided by the dual means of digitally selectable input power to the thrust transducer and the multi-range input circuit of the integrator. Identification of specific components of the measurement circuit includes a Baldwin-Lima-Hamilton Corporation special C3P2S load cell, Systems Research Corporation special power supply and bridge balances, and a Dymec (Hewlett-Packard Company) Model DY-2401A integrating digital voltmeter. Complete specifications for stability, linearity, hysteresis, and temperature effects are given, where applicable, for all electrical measurement system components.

Simplicity, maximum accuracy, and utility of equipment is provided by the single integrating digital voltmeter employed at the strain gage output. Its use provides: (1) the necessary high-accuracy bridge balance indicator during

pre-calibration procedures, (2) the high-accuracy one-second integrator needed in static calibrations of the system, and (3) the externally-gated integrator necessary for extended-time integrations of motor thrust time curves.

The electrical features of the hydraulic calibration system are associated with both its remote operation and its accuracy. Geared-down electric motors rotate the cylinder of the piston assembly, and also the support of the pressure-producing weights in the master pressure standard, to eliminate static friction otherwise present. Associated with the remote programming of static forces are solenoids to actuate the weight-holding pins, electric motor drive of the hydraulic pump, and photocell weight position detection circuits.

SPECIFICATIONS

The overall system performance in preliminary static calibration tests performed at Rocketdyne is described as follows, in which all values are referenced to the maximum level to which it is calibrated:

Linearity	0.005% (Expressed as maximum deviation from a straight line drawn through the origin and the full-scale point.)
Hysteresis	0.025%
Repeatability	0.01 % (Deviation from full-scale point)
<hr/>	
Root sum square	0.027%

INSTALLATION AND OPERATION

INSTALLATION

Overall Test Stand and Calibrator

Test Stand Leveling and Tiedown. Level installation of the forward abutment-motor section of the test stand is accomplished by the use of the elevation adjustment bolts located at the sides of the l-beam base assembly; together with a precision square and spirit level on the machined mounting faces of the concrete abutment. The quality of the square and level should be L. S. Starrett Company No. 20 series (6 inch) and No. 90 series (6 inch), respectively, or equivalent. Fore-and-aft leveling of the abutment is indicated by the level-square combination placed securely against the forward mounting face at the side of the conical load distributor. Adjustment of the elevation bolts at the forward and rear edges of the abutment is then made until the level indicates satisfactorily. Lateral, or transverse, leveling of the abutment is accomplished by inserting two 1/4 inch dowel pins in the top row of holes in the forward mounting face and supporting the level on them. The elevation bolts should be adjusted in pairs during this leveling operation in order that the fore-and-aft leveling will not be disturbed. Upon completion of the abutment leveling operation, suitable shims should be placed as close as possible to the tiedown-bolt locations at the forward and rear edges of the abutment. These bolts are then installed and secured. Installation of shims

and tiedown bolts at the motor end of the test stand is then made and all elevation adjustment bolts backed off so that all of the weight of the section is supported at the six tiedown-bolt locations.

The rear section is installed by butting its I-beam base tightly against that of the forward section to compress the neoprene seal strips extending across the mating edges. The elevation adjustment bolts of the rear section are used to obtain suitable mating of the weathertight enclosure to concrete abutment and its adjoining rear base plate. The separate leveling provisions of the hydraulic calibrator contained within the rear section allow wide use of the elevation bolts for this purpose.

Hydraulic Calibrator Installation. Installation of the hydraulic calibrator is made in the steps referenced in the detailed component description section of this manual.

Control Room Equipment

All control room equipment is contained in a single enclosure (see photo 2) and all cable connectors are located in the rear of each rack-mounted unit (see photo 8). A total of about 250 watts of 110 VAC, 60 cycle, single phase power is used by the various units. Input power cables are supplied with all units to enable their plug-in to common power outlets within the enclosure. Mating connectors for both load cell cables, and all inter-unit cables within the enclosure are supplied by Rocketdyne.

OPERATION

Pre-Calibration Operations

Warm-Up. At least one hour of warm-up time is required for satisfactory operation of the total impulse measurement system to produce the accurate measurements of which the system is capable. Consequently, the 110 VAC power to the Dymec integrating digital voltmeter and the Systems Research Corporation strain-gage power supply, and the correct dc power to the load cell, should be turned on at least one hour before performing any calibrations. No warm-up of the Ruska hydraulic system is required, and electrical excitation of the hydraulic system prior to its use is not recommended in order to conserve the belt drives of the piston and weight support.

Dymec Zero and Span Adjustments. After warm-up the Dymec Integrating Digital Voltmeter is adjusted for zero and span settings according to instructions contained in the handbook for this instrument published by the Hewlett-Packard Company.

Ruska Calibration System. Excitation of the Ruska hydraulic system is performed according to instructions referenced in the detailed component description section. The Ruska calibrator must be vented by depressing the EXECUTE button with the force selector switch set at 0 pounds force before balancing the bridge circuit.

Load Cell Bridge Balance. with the desired dc excitation supplied to the load cell, suitable balance of the strain gage bridge is accomplished by the use of the Dymec integrating digital voltmeter in its direct-reading millivoltmeter mode of operation (see Dymec handbook). Manipulation of the Systems Research Corporation bridge balance dial settings is performed to obtain a bridge balance within one microvolt.

Test Stand Exercise. A pre-calibration load of 10,000 pounds in the sequence of 0-1000-10,000-1000-0 pounds should be applied to the load cell by the calibration system for the purpose of mechanically flexing all stressed components of the test stand. Sufficient exercise of the system is obtained with minimum dwell time at each of the stated force levels. Operation of the calibration system is performed according to the instructions in the description of the Ruska calibrator.

Reset of Bridge Balance. A rebalancing of the strain gage bridges should be made immediately prior to each calibration performed in order that small zero offsets are not incorporated into the calibrations.

A summarized list of the described pre-calibration steps is given below:

Test Number _____
Date _____
Time Equipment Turned on _____ O'clock
Vent Ruska Calibrator _____

PRE-TEST CHECK LIST (After 1½ hour warmup)

1. Time _____ O'clock
2. Ambient temperature _____
3. Barometric Pressure _____
4. Relative Humidity _____
5. Vent Ruska Calibrator _____
6. Set Integrating Digital Voltmeter zero _____
7. Calibrate Integrating Digital Voltmeter _____
8. Load Cell Supply Setting _____
9. Load Cell Supply Voltage Dial Setting _____
10. Adjust Bridge Balance Unit to zero output _____
11. Bridge Balance Unit Dial Setting _____
12. Exercise Ruska Calibrator (0-1000-10,000-1000-0 pounds) _____
13. Repeat 6, 10, and 11. _____
14. Final Bridge Balance Unit Setting _____

Calibrations

Static calibrations of the entire measurement system are performed by the operation of the Ruska hydraulic system, either remotely from the control room or locally at the test stand, and noting the output electrical signals of the load cell with the Dymec integrating digital voltmeter at each step of the loading and unloading sequence of force productions. The most accurate

use of the measurement system is obtained by the calibration of only that part of the total force capacity actually used in propellant tests. For example, if a particular propellant test is expected to be at approximately a 5000 pound thrust level, the system should be calibrated over the 0-5000 pound range. Use of the system in this manner minimizes the hysteresis errors in the calibration and produces system performance consistent with the systems capability of 0.1% maximum error from all causes.

As in bridge balance operations the Dymec integrating digital voltmeter is used in its direct-reading millivoltmeter mode of operation. Since the static calibration yields the total impulse calibration constant of the system, it is necessary to express the constant in the units of "number of pulses per pound-second" of impulse. Hence, if different ranges of sensitivity of the Dymec integrator are used for static calibrations than for motor thrust integrations, appropriate care must be employed to incorporate this difference in the data reduction. For example, static calibrations employ the 0.1 volt range in order to achieve the greatest possible accuracy, whereas motor thrust integrations will usually employ the 1.0 volt range in order that the 5 digit number capacity is not exceeded during a motor test. Hence in this specific case, the actual number displayed by the integrator at the end of a motor run must be multiplied by 10 to obtain the correct number of pulses associated with the more sensitive range used in the static calibrations.

Integration of Motor Thrusts

The preparation and use of the overall system for integration of motor thrust-time curves is accomplished entirely by front-panel controls on the control room equipment enclosure. The following sequence of switching operations is suggested:

1. Vent the Ruska hydraulic system of any small residual pressure by setting the force selector switch to 0 pounds and operating the EXECUTE push-button. This operation raises the entire stack of weights to its elevated position, opens the solenoid relief valve to the oil reservoir, and returns the stack of weights to its unused configuration. This operation insures that no force is applied to the load cell from the calibrator.
2. Balance the strain gage bridge circuit to be used for the integration with the dc input power at the value used in the static calibrations. The Dymec integrator is used as a millivoltmeter on its 0.1 volt range during this step.
3. Convert and use the Dymec integrator in the integration mode by following the steps listed below:
 - a. Select the suitable sensitivity range consistent with the total number of counts expected from operation of the motor. For

example, suppose that a 53.000 millivolt signal was produced by the load cell with a 10,000 pound static calibration load. The basic equation used for motor thrust integration is $N = KI_T$ and K , in this example, is 5.3000 counts per lb.sec., obtained on the 0.1 V range (one second integration time) of the Lymec integrator. Use of the integrator on this range on a motor test in which 10,000 pounds of thrust for 5 seconds was anticipated, would produce a count of 268,000. Since this number exceeds the capacity of the integrator display, it must be reduced by a factor of 10 through the use of the 1 V range of the integrator. To summarize, the system was statically calibrated on the 0.1 V range but used on the 1 V range.

- b. Set the FUNCTION selector to VOLT.
- c. Set the SAMPLE PERIOD selector to START, since an extended sample period is to be used. The system is now ready to integrate any electrical signals from the load cell, and the motor run should be made as soon as possible after this step.
- d. At the end of a motor run, the integration of its thrust curve is stopped by switching the SAMPLE PERIOD selector to STOP as soon as it becomes evident that all propellant burning has ceased.

If motor cutoff produces oscillation of the motor-load cell combination, integration of the negatively-polarized load cell signals must be separately integrated with an additional Dymec integrator in order that the net total impulse measurement can be accomplished. The Dymec integrator handbook discusses its use in full for all modes of operation and will not be repeated here.

In all accurate integration operations it is very important to balance the strain gage bridges as close as possible to zero and to do it at the latest possible time before a calibration or motor test, in order that zero bias signals are not integrated along with the motor thrust.

DETAILED COMPONENT DESCRIPTIONS

CONCRETE ABUTMENT AND SUPPORT BASES

A reinforced-concrete block, 5 feet long, 4 feet high, and 4 feet wide, weighing approximately 6 tons, serves the dual purposes of a rigid restraint and an accurate reference for mounting alignment of critical calibration and measurement components. Two steel plates, measuring 1 foot square and 2 inches thick, were cast in the fore and aft faces of the block at the time of pouring. The entire block was poured on a 2 inch thick steel base plate. All internal steel surfaces were bonded to the concrete by thiopoxy cement. Accurate installation and alignment of the hydraulic calibration piston and the load cell assembly were obtained by accurate machining of the fore and aft mounting plates. A pattern of 1/4 inch holes was accurately machined in each mounting face in which dowel pins are placed during test stand leveling operations. Twenty-two, 3/4 inch diameter bolts secure the concrete block base plate to the forward I-beam base assembly, 10 of which are visible along its edge (5 on each side of the block).

Both of the forward and rear I-beam base assemblies consist of three lengthwise sections of 10 inch high beams welded together by cross beams. The forward base frame is connected to the EAFB test pad by six tiedown bolts of the design presently utilized in the BATES program, and the rear base frame by four tiedown bolts. The forward section is installed first on the test pad, leveled with shims, and bolted down. The rear section is then installed in position for a satisfactory enclosure fit, shimmed, and bolted down.

LOAD CELL ASSEMBLY

The load cell assembly shown in detail B of Fig. 1 and in photo 4 consists of the series combination of the thrust dome, load cell, and distributor. The conical shapes of the dome and distributor, respectively, collect and distribute the motor thrust force to, and from, the load cell. Coaxial alignment of the components of this assembly is accomplished by the use of centerline holes in the load cell into which fit integral centerline pins on the dome and distributor. The entire load cell assembly is aligned with the front mounting face center hole by an integral pin machined on the load distributor.

MOTOR MOUNT ASSEMBLY

The entire motor mount assembly consists of two support blocks on a horizontal platform, two supporting flexures and a secondary mount assembly which connects the platform to the load cell assembly (see photo 4).

The secondary mount assembly also provides connections for the calibration tierods and the stud and clamp ring which secure the motor in the horizontal direction. Alignment of the secondary mount assembly with the load cell assembly is accomplished by a close fitting recess in its mating face. Each motor support block contains two adjustment screws for the vertical and lateral positioning of the motor on the entire assembly. Installation of the entire motor mount assembly without the production of excessive transverse forces on the load cell was accomplished with the use of shims under the feet of the two support flexures.

Tapered dowel pins were used for the positive location of all components of the assembly relative to each other and for the location of the entire assembly on the base plate.

CALIBRATION SYSTEM

The Ruska Instrument Corporation hydraulic force calibrator utilized in the total impulse measurement system produces precise force levels with which the entire measurement system is calibrated. It is operable either locally at the test stand or remotely in the test control room. Remote operation of the calibration system permits its use immediately before and after a propellant test and results in the most accurate system calibrations possible.

The hydraulic force calibrator consists of the combination of a master pressure standard and a precision hydraulic cylinder. Precise hydraulic pressures produced in the pressure standard by accurate dead weights supported on an oil column are transmitted to a precision piston-cylinder assembly to produce the accurate calibration forces. The dead weights were accurately machined to produce forces of 1000, 2000, 4000, 6000, 8000, and 10,000 pounds at locations where the local value of gravity acceleration is 979.477 gals (the value at Test Pad No. 5, Solid Motor Test Area, Rocket Propulsion Laboratory, Edwards AFB on January 18, 1963). More specifically, the calibration system is essentially a hydraulic lever with which a large force may be compared to a smaller force in such a manner and with such precision as to economically justify the hydraulic

method of comparison as opposed to other methods presently in use. The hydraulic lever system consists of two loaded pistons of unequal areas against which a common fluid may be pressurized to obtain equilibrium of the larger and smaller forces. The system is considered to be in equilibrium or in balance when the axial load on one piston divided by the piston area is equal to the load on the other piston divided by its area. In the described calibrator, the smaller piston and a set of standardized masses constitute the dead weight tester portion of the entire apparatus, while the larger piston, independent of the loading mechanism, is referred to as the cell or as the force cell. Photos 3 and 5 show major components of the system.

The entire hydraulic calibration system was calibrated by the National Bureau of Standards, Washington, D. C. prior to its installation in the Rocketdyne test stand. Installation and operating instructions of the hydraulic force calibration are contained in a separate manual prepared by the Ruska Instrument Corporation and are not repeated here. However, one important addition is made to the Ruska instructions as follows:

Immediately prior to a calibration, to a motor test run, and during a motor test run, it is important to relieve any small hydraulic pressure that may accumulate in the hydraulic system during periods of non-operation. This is most easily done by programming the force selector switch to "zero" pounds and operating the EXECUTE push-button switch. Operation of the calibrator in this manner opens the solenoid by-pass valve and vents the hydraulic system to the atmosphere. If this is not done, there is great risk of a false "zero" point in the calibration and a bias error in any total impulse measurement.

LOAD CELL POWER SUPPLY

The Systems Research Corporation digital power supply used for the load cell excitation is a highly stable and electrostatically isolated power supply specifically designed for applications where precision and resettable D.C. voltages are required. Its primary use is in accurately setting the range of the strain gage load cell.

Installation and operation of the unit is simple and straight forward. The unit is energized by the ON switch and selection of voltages is from the front panel by means of five switches. The selected voltage is supplied to two identical outputs at the rear panel for the excitation of the two strain gage load cell circuits. Voltage also appears at the front panel binding posts. Before operating, the rear panel barrier strip should be checked to see that the sensing leads are properly connected to either the load or at the output terminals. The point to which they are connected is the point at which regulation occurs. For most accurate readings, a one hour warmup time is recommended.

The circuit of the power supply is a transistorized, regulated and isolated configuration producing 0-18 VDC output up to 200 ma. Referring to the schematic, 115 VAC, 60 cps power is applied through the rear line cord to the input transformer T1. T1 is a laminated double shielded type transformer providing two secondaries, S1 and S2. S2 is tapped to provide a reference voltage and connects to a full wave bridge and filter network to produce a D.C. voltage. This D.C. voltage is fed through Q1, the series regulator transistor and hence to the output.

Regulation is achieved by comparing the output voltage to a stable zener diode reference circuit Z5. Q7, Q8, Q9 and Z4 comprise a regulator that stabilizes the reference voltage across Z5. The output voltage and reference voltage are compared by the difference amplifier Q5 and Q6. The stability of the difference amplifier is improved by holding the collector voltage constant through the regulator circuit of Z2, Z3 and Q4.

The output of the difference amplifier then serves as the controlling voltage to bias the series regulator transistor Q1 and must be amplified through Q2 and Q3. The gain of this feedback loop controls the response and sensitivity of the overall regulation. The S1 secondary of T1 feeds a separate full wave rectifier and filter to produce the operating voltages for Q2 and Q3.

Photos 6 and 8 show details of the front and rear panels. Specifications of the power supply are contained in the summary description of all components. An electrical schematic diagram of the unit is contained in this manual.

BRIDGE BALANCES

The digital balance unit associated with each load cell strain gage circuit employs decade switching of precision voltage dividers connected in a Kelvin-Varley arrangement. By accurate selection of close tolerance resistors, superior accuracy is obtained and resolution to five significant figures, or 1 part in 100,000, is realized. Six front panel mounted controls allow nulling with bridge unbalances as high as plus or minus 5%. The precision resistors possess excellent

repeatability. Terminals are provided for a limiting resistor, if desired, otherwise these terminals are jumpered. Connections are supplied at the rear panel of each bridge balance unit to its associated strain gage circuit, power supply output, and recorder or indicator. A combination block-schematic diagram of each balance unit is contained in this manual. Photos 5 and 7 show external details.

INTEGRATING DIGITAL VOLTMETER

A Dymec (Hewlett-Packard Company) integrating digital voltmeter is employed for all electrical measurements performed in the calibration and use of the Rocketdyne total impulse measurement system. Its versatility and range provide the means for obtaining very close bridge balance prior to calibration of the system, the accurate indication of load cell output signals during calibration, and the electronic integration of the voltage-time characteristic supplied by the load cell during propellant test operations.

All measurements are indicated on a 5-digit display, and a sixth position on the display is provided to indicate the engineering units of each measurement and the polarity of D.C. voltages. The operational usefulness of these features become apparent with its use in actual test operations. An internal ± 1 volt standard is provided for self-calibration. In addition to visually displayed measurements, means is provided at the rear panel for recording of the basic test data in digital form, namely, a pulse-train output whose pulse repetition rate is directly

proportional to motor thrust. A separate Rocketdyne-designed and constructed unit, used in conjunction with the Dymec unit, enables the tape recording of the pulse-train output. By this means, propellant test data can be stored and processed at a later time.

A full description of the design and use of this instrument is contained in a separate handbook prepared by the Dymec Division of the Hewlett-Packard Company. Its external appearance is shown in photos 5 and 7.

SUMMARY OF CRITICAL COMPONENT SPECIFICATIONS

Concrete Abutment Mounting Faces

Concentric to a common axis within 0.005 inch T.I.R.

Parallel to each other within 0.005 inch total

Normal to their common axis within 0.005 inch total

Load Cell

Mfgr: Baldwin-Lima-Hamilton Corporation

Type: C3P2S double bridge

Full scale load: 10,000 lbs compression

Full scale output: 3 mv/v input (\pm 0.15%)

Input: 18 volts maximum recommended

Bridge resistance: 350 ohms nominal, each bridge

Non-linearity: less than 0.03% full scale

Hysteresis: less than 0.02% full scale

Repeatability: less than 0.01% full scale

Temperature effects: a) on zero output: less than 0.15% F.S./100°F

b) on sensitivity: less than 0.08% of load
per 100°F

Electrical connectors: Cannon CA 3102 E 14S-6P

End-plate pilot and mounting holes: see sketch

Load Cell Power Supply

Mfgr: Systems Research Corporation

Model: 3512

Type: digitally programmable (decade switching)

Input power: 95-135 VAC, 60 cps

Regulation: 0.01% no load-full load and 95-135 VAC

Ripple: 0.05 millivolt, rms

D.C. isolation: 10 K megohms

Stability: 0.005% per °C and \pm 0.01% in any 8 hour period

Noise at bridge (350 ohm): 2 microvolts, rms

Overvoltage protection: fused

Size: 3-1/2" x 19" x 19" for rack mounting

Connectors: barrier strip on rear

Precision: 5 significant figures (five decades)

Mode of operation: either constant-voltage or constant current

Bridge Balance

Mfgr: Systems Research Corporation

Model: 4700

Type: decade switching of precision voltage dividers connected
in a Kelvin-Varley arrangement

Input: 3 wires to strain-gage bridge

Resolution: balance to one microvolt with 350 ohm bridge

Size: 3-1/2" x 19" x 6" for rack mounting

General: Six front panel mounted controls to allow nulling with
bridge unbalances to plus or minus five percent.

Precision tolerance resistors of excellent long term
stability used throughout. Quality switches of low
contact resistance used to assure excellent repeat-
ability. Terminals provided for a limiting resistor
if desired. All switch positions in each decade
numbered to enable repeatable settings.

Integrating Digital Voltmeter

Mfgr: Dymec Division of Hewlett-Packard Company

Model: DY-2401A

Type: integrating digital voltmeter

Input power: 95-135 VAC, 60 cps

1. D.C. voltage measurements

A. Noise rejection:

- (a) Overall effective common mode rejection of 140 db at all frequencies.
- (b) Common mode rejection of 120 db at 60 cps, 160 db at dc.
- (c) Superimposed noise rejection of more than 20 db at 55 cps for 0.1 second sample period, increasing 20 db per decade increase in frequency.

B. Accuracy (specifications hold for $\pm 10\%$ line voltage change)

Stability (at constant temperature): $\pm 0.03\%$ of full scale per day (0.1 volt range)

Linearity: $\pm 0.005\%$ of full scale, zero to full scale

Temperature effects (+ 10°C + 50°C)

(a) Scale factor: $\pm 0.002\%$ of reading per °C
(0.1 and 1V ranges)

(b) Zero: $\pm 0.002\%$ of full scale per °C (0.1V range)

(c) Internal calibration source: $\pm 0.002\%$ per °C

2. D.C. voltage integration

Accuracy same as for D.C. voltage measurement, with exception that errors given as percent of full scale must be multiplied by the integration time in seconds.

Hydraulic Calibration System

1. The arithmetic sum of the errors of calibration and of those arising during use of the cell are less than 0.05% of the value at any of the six test points.
2. The masses on the dead weight tester were computed for a local gravity of 979.477 gals.

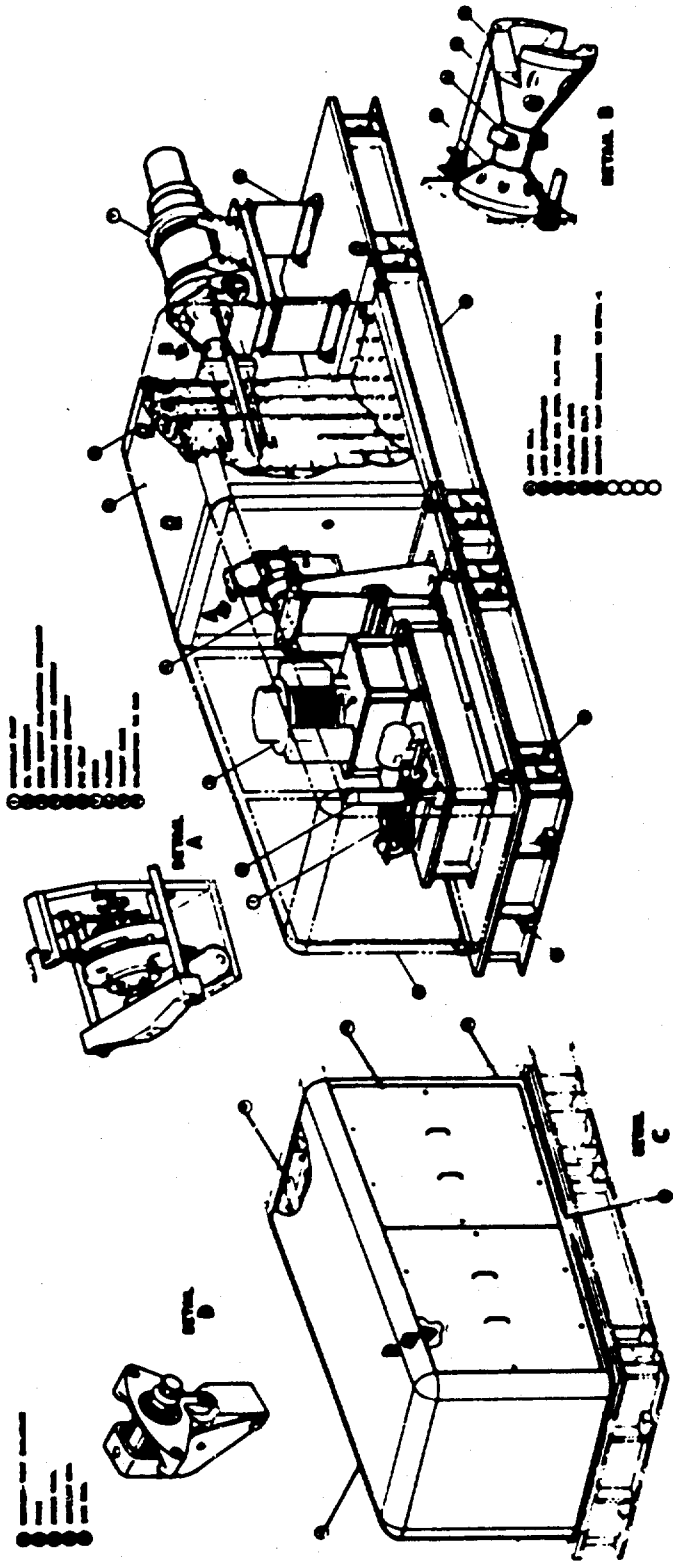
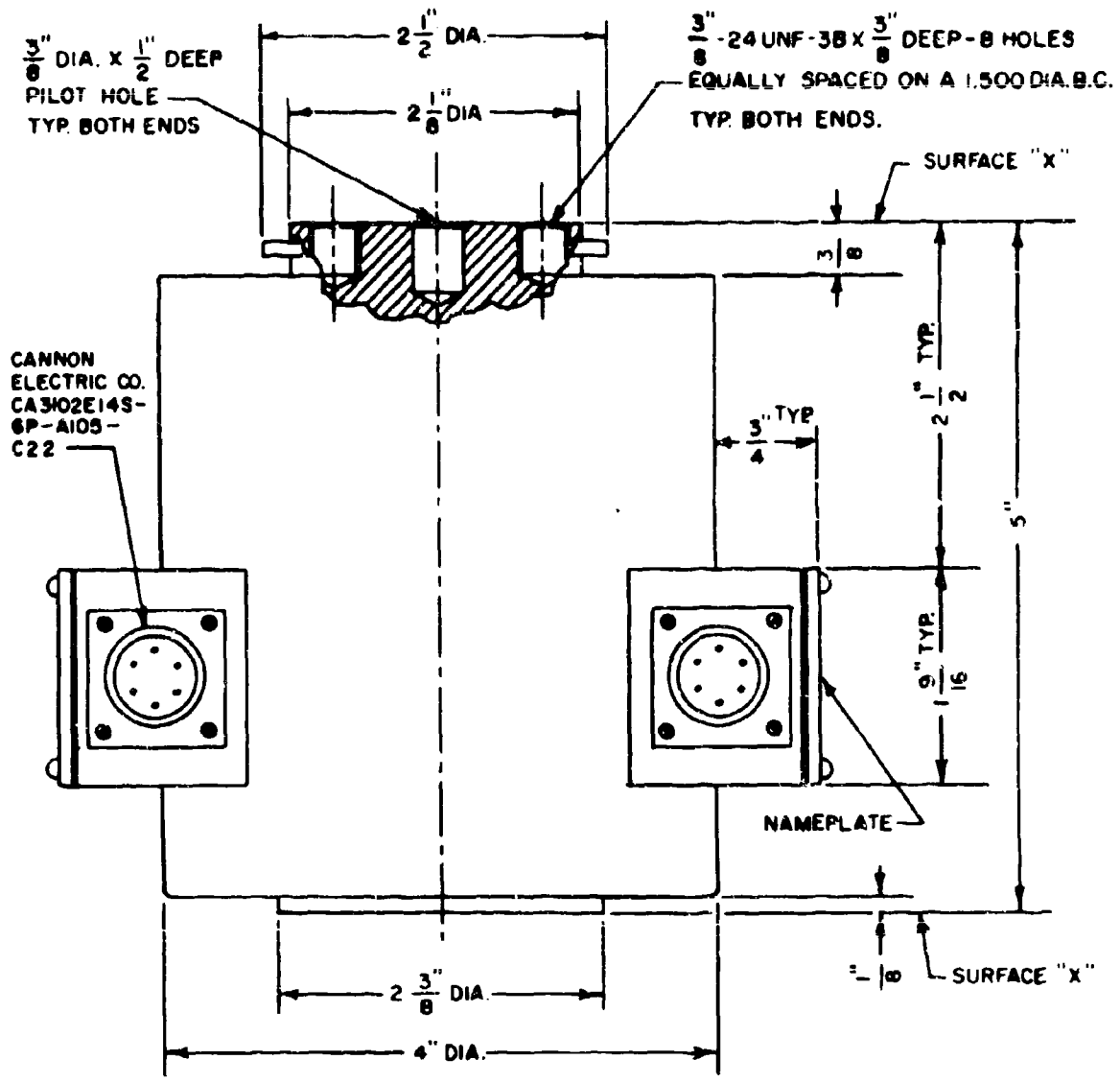

Fig. 1. Test Stand of Rocketdyne Total Impulse Measurement System



GENERAL NOTES

- 1. BEARING SURFACES "X" ARE LAPPED AND ELECTROPLATED WITH LEAD .001 / .002 THK.

Fig. 2. Dimensional Drawing of Load Cell

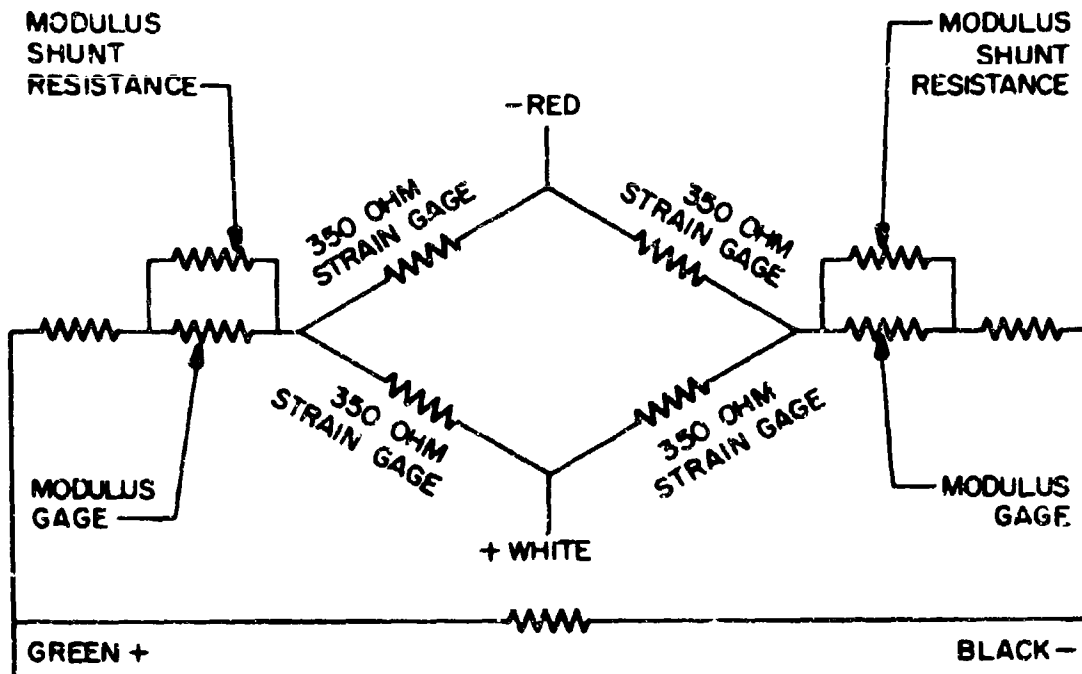

INPUT - BLACK TO GREEN - RESISTANCE 350 ± 3.0 OHMS AT 70°F
 INCREASES 3.5 OHM FOR 50°F RISE
 OUTPUT - RED TO WHITE - RESISTANCE 350 ± 3.0 OHMS AT 70°F

PICKUP	CHANGE IN OPEN CIRCUIT OUTPUT VOLTAGE FOR RATED CAPACITY	OUTPUT VOLTAGE AT ZERO LOAD
C3P T3P	$3.000 \pm .003$ MV/V INPUT	NOT OVER .030 MV/V INPUT
U36	$3.000 \pm .0075$ MV/V INPUT	NOT OVER .060 MV/V INPUT
C2K T2K	$2.400 \pm .006$ MV/V INPUT	NOT OVER .024 MV/V INPUT
U-1A U-3XXA (COMP.)	$3.000 \pm .009$ MV/V INPUT	NOT OVER .030 MV/V INPUT

1. MOD. GAGE VARIES WITH TEMPERATURE TO COMPENSATE FOR THERMOELASTIC COEFFICIENT OF PICKUP METAL.
2. RECOMMENDED INPUT 12 VOLTS AC OR DC. MAX. INPUT 25V AC OR DC
3. POLARITY IS SHOWN FOR COMPRESSIVE LOAD.

Fig. 3. Schematic Diagram of Load Cell

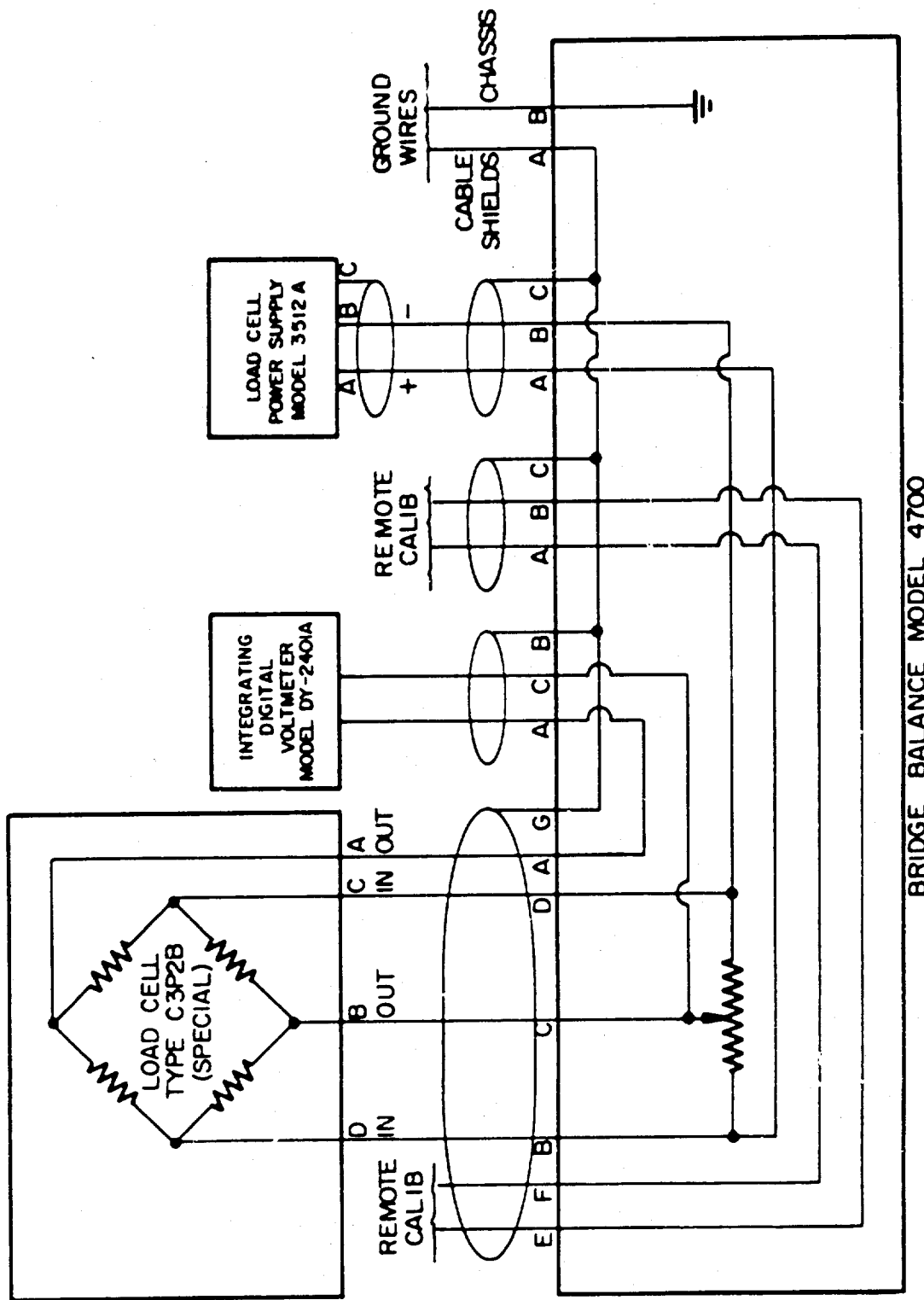

BRIDGE BALANCE MODEL 4700

Fig. 4. Block-Schematic Diagram of Measurement Circuitry

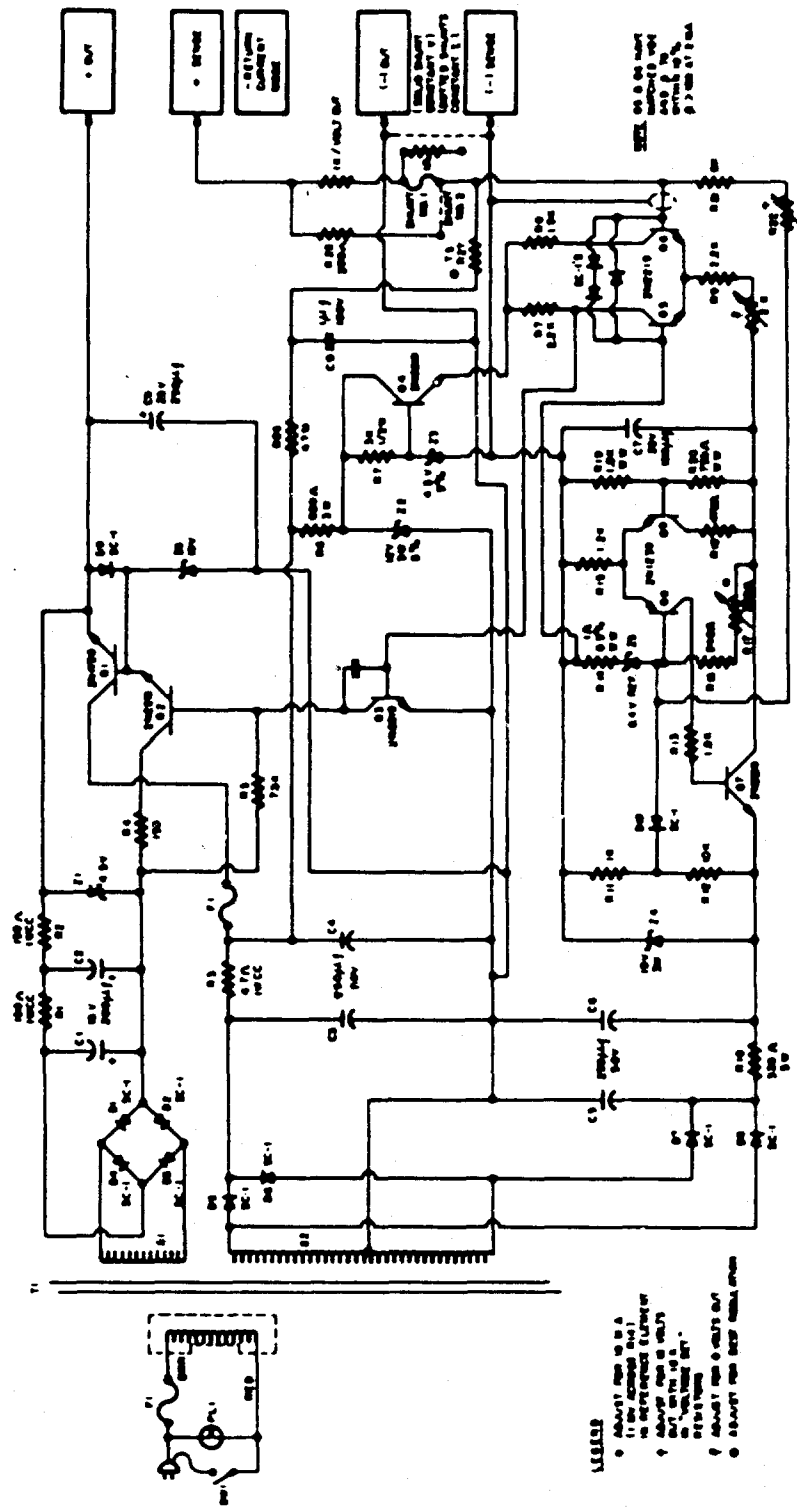

Fig. 5. Schematic Diagram of Load Cell Power Supply

LEGEND
 ① ABOUT 100 Ω IN A
 100 Ω RESISTOR
 ② ABOUT 100 Ω IN A
 100 Ω RESISTOR
 ③ ABOUT 100 Ω IN A
 100 Ω RESISTOR
 ④ ABOUT 100 Ω IN A
 100 Ω RESISTOR

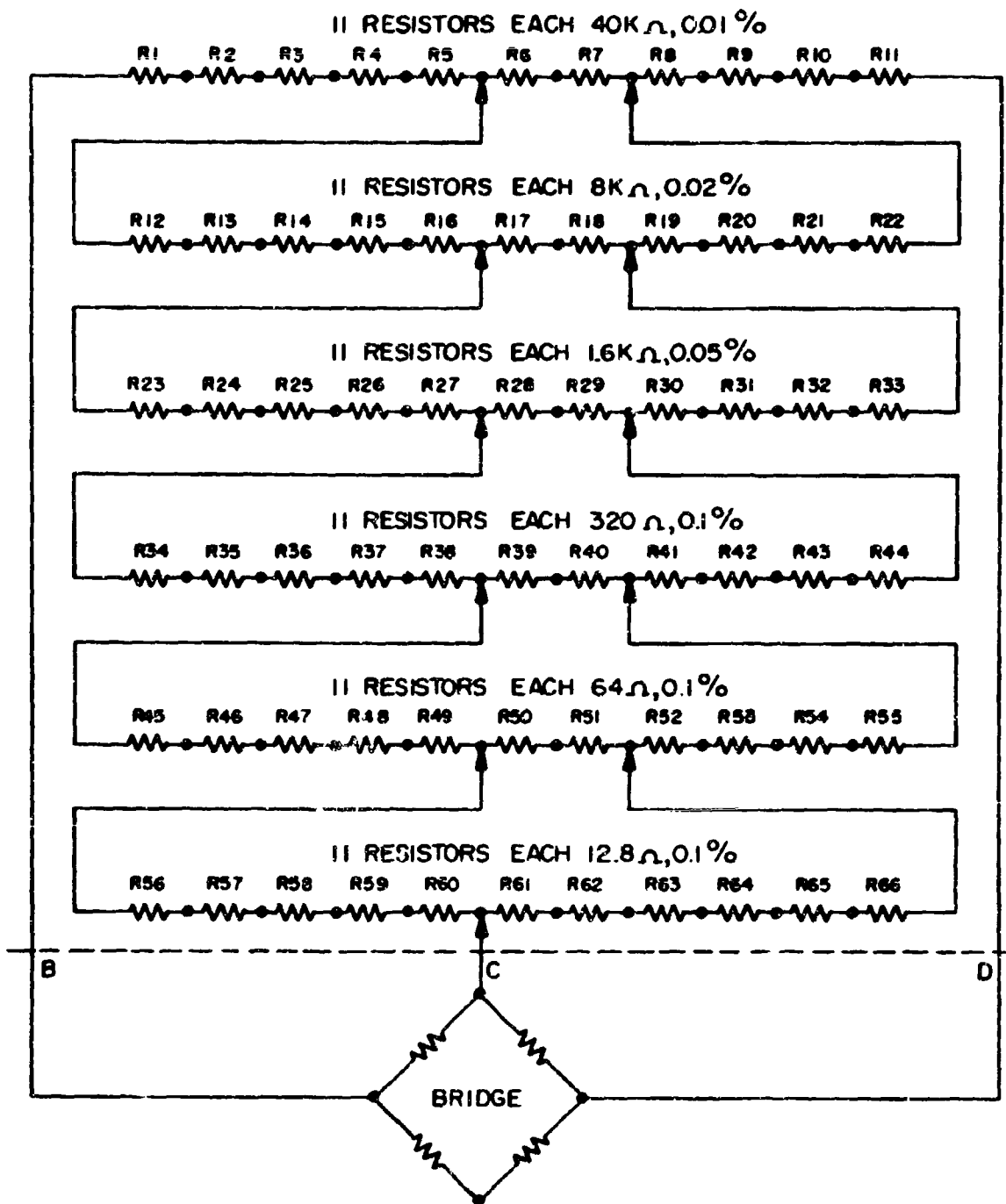

Fig. 6. Schematic Diagram of Bridge Balance

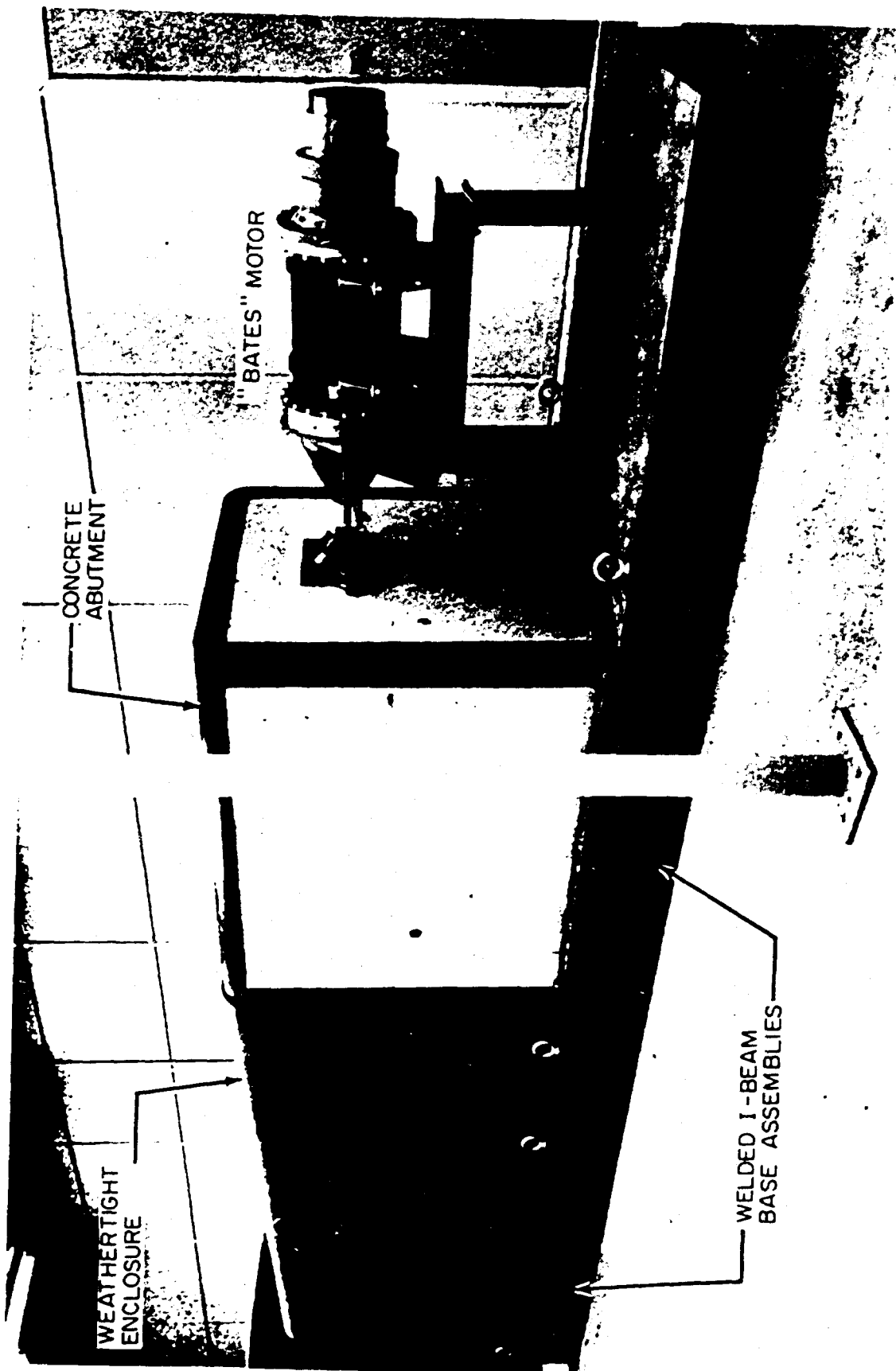

Photo 1. Test Stand of Rocketdyne Solid Propellant Total Impulse Measurement System
(Before Painting)

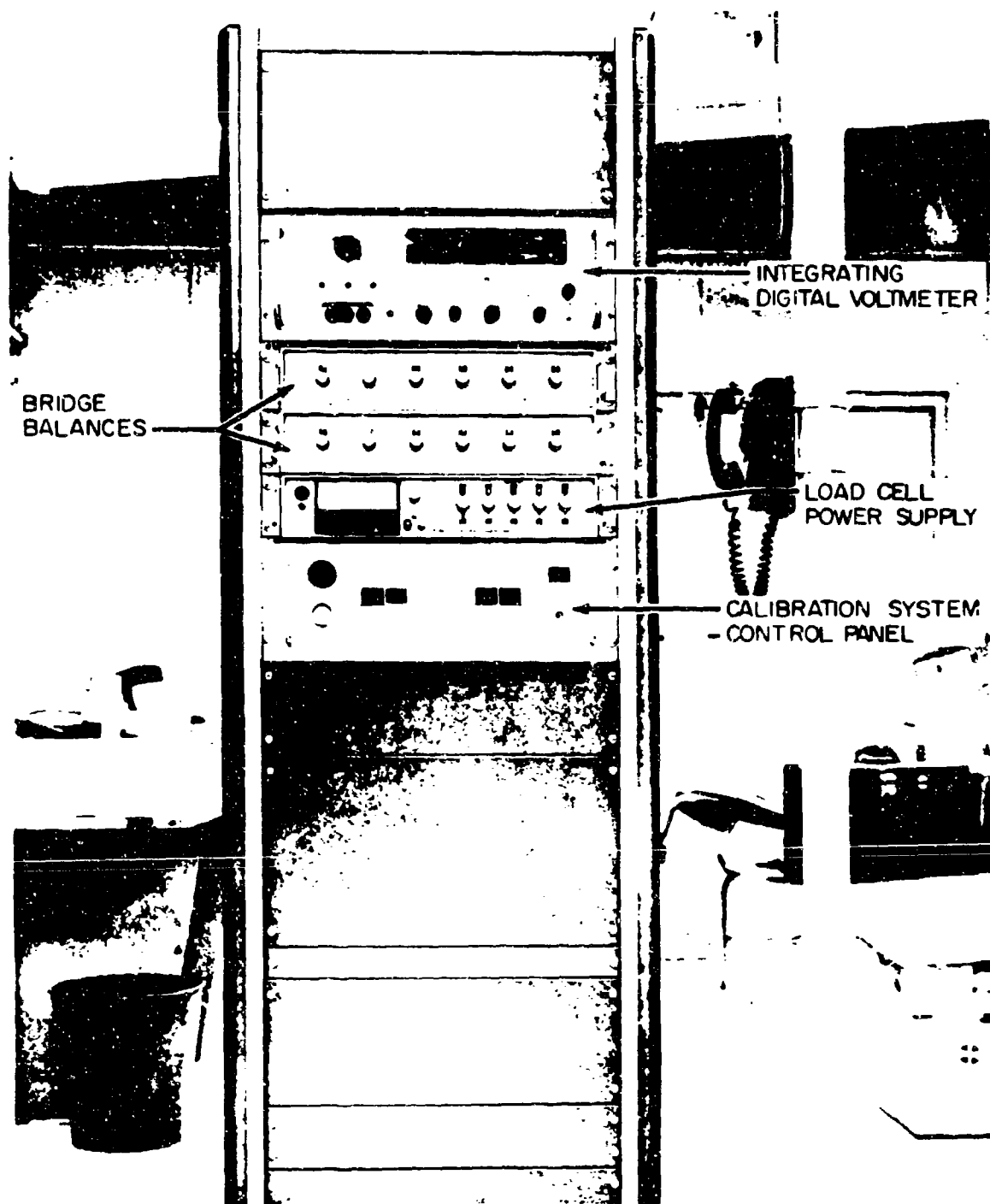

Photo 2. Calibration Control and Measurement Equipment Section of Rocketdyne Total Impulse Measurement System

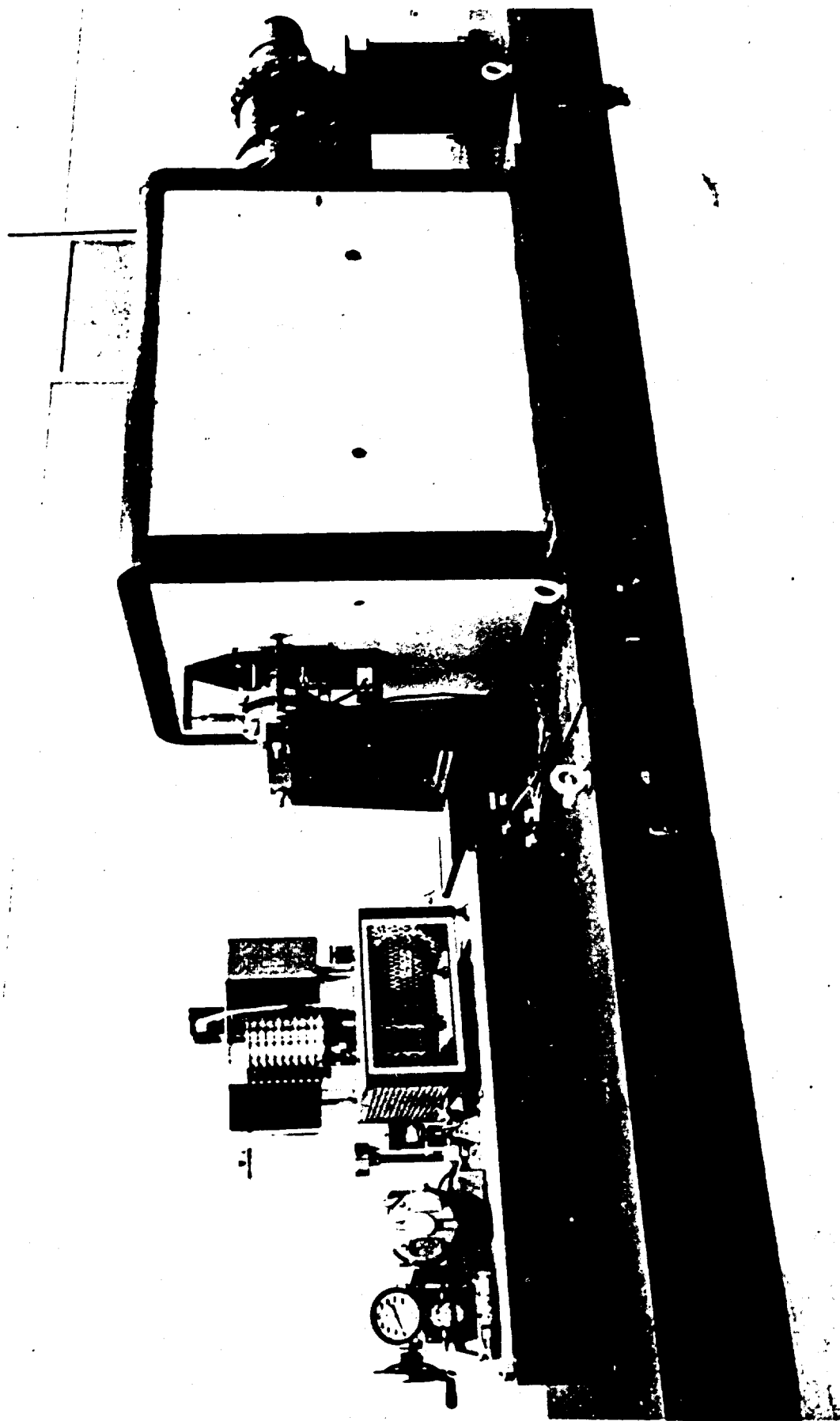

Photo 3. Test Stand Section of Rocketdyne Total Impulse Measurement System
(Weathertight Enclosure Removed)

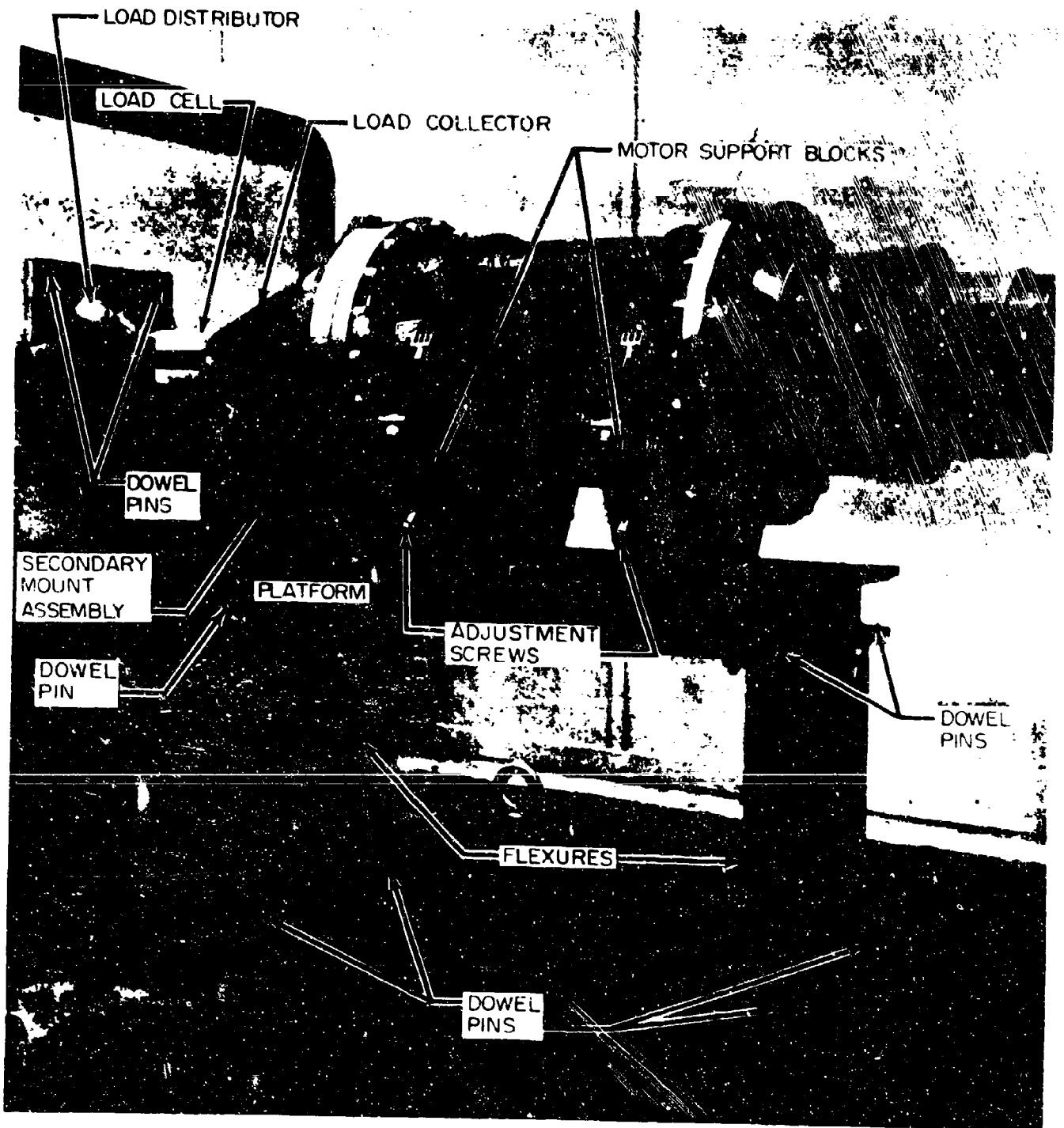

Photo 4. Bates Motor Mount and Thrust Retainer Detail

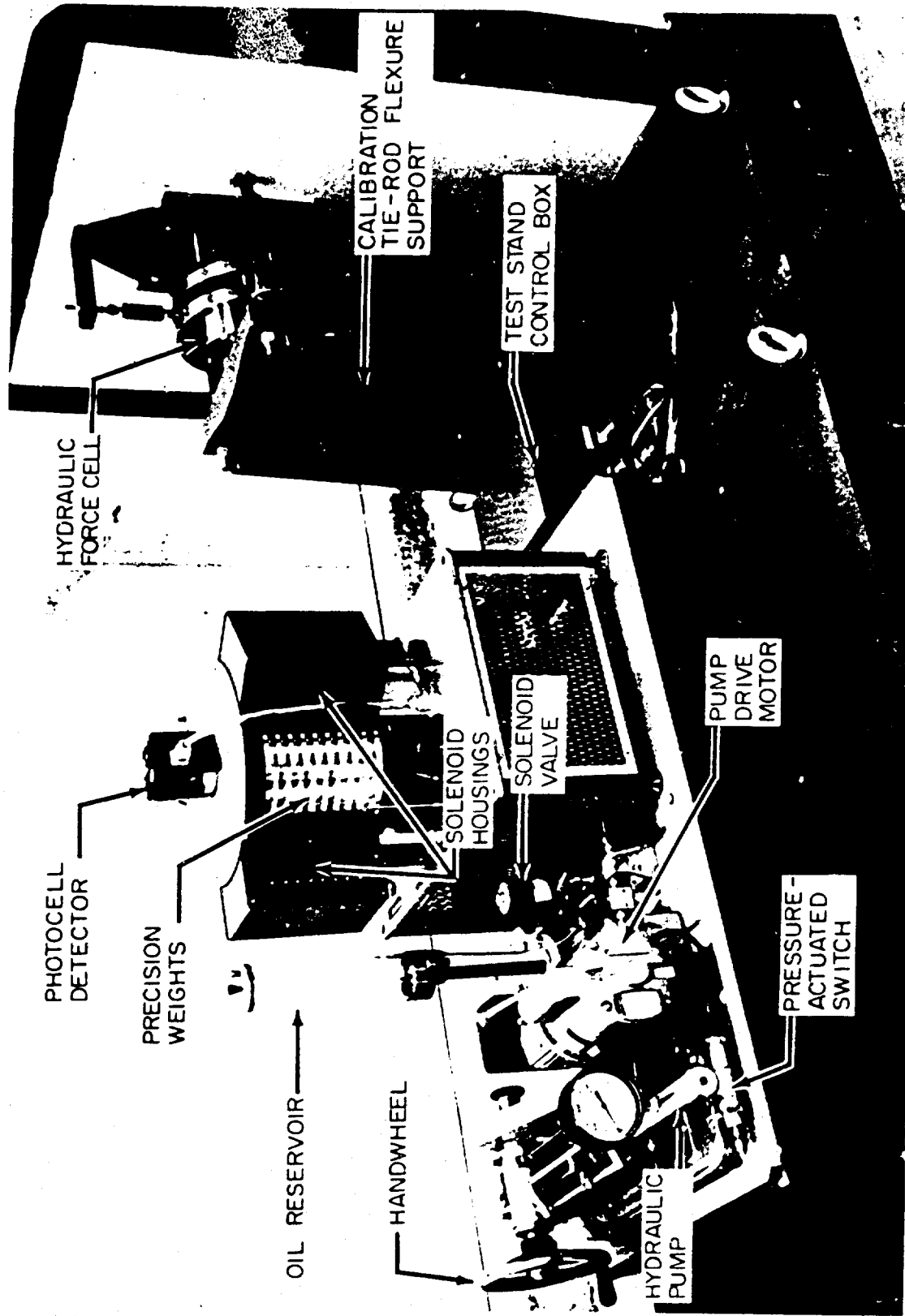

Photo 5. Calibration System Detail

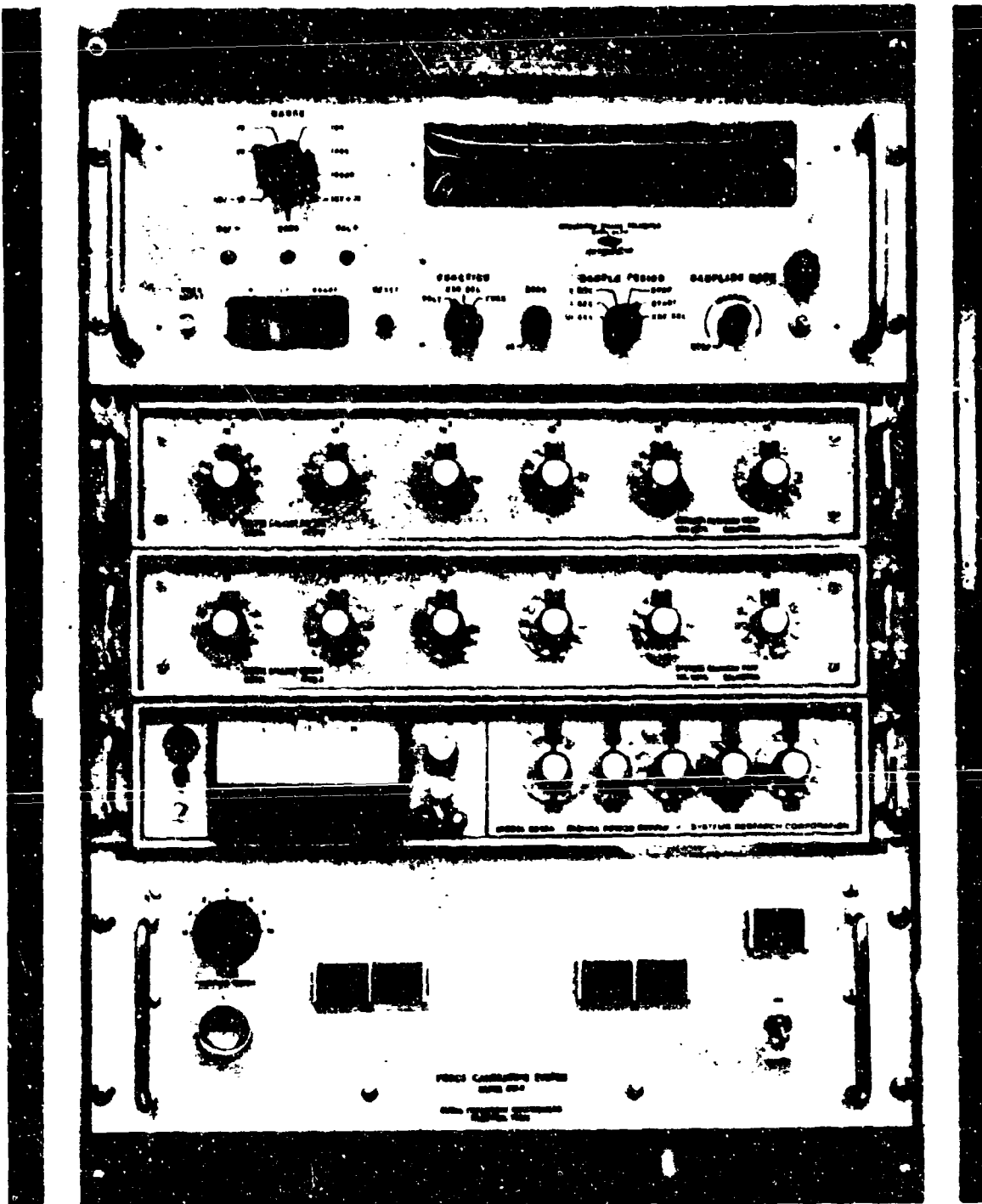

Photo 6. Calibration Control and Measurement Equipment Detail

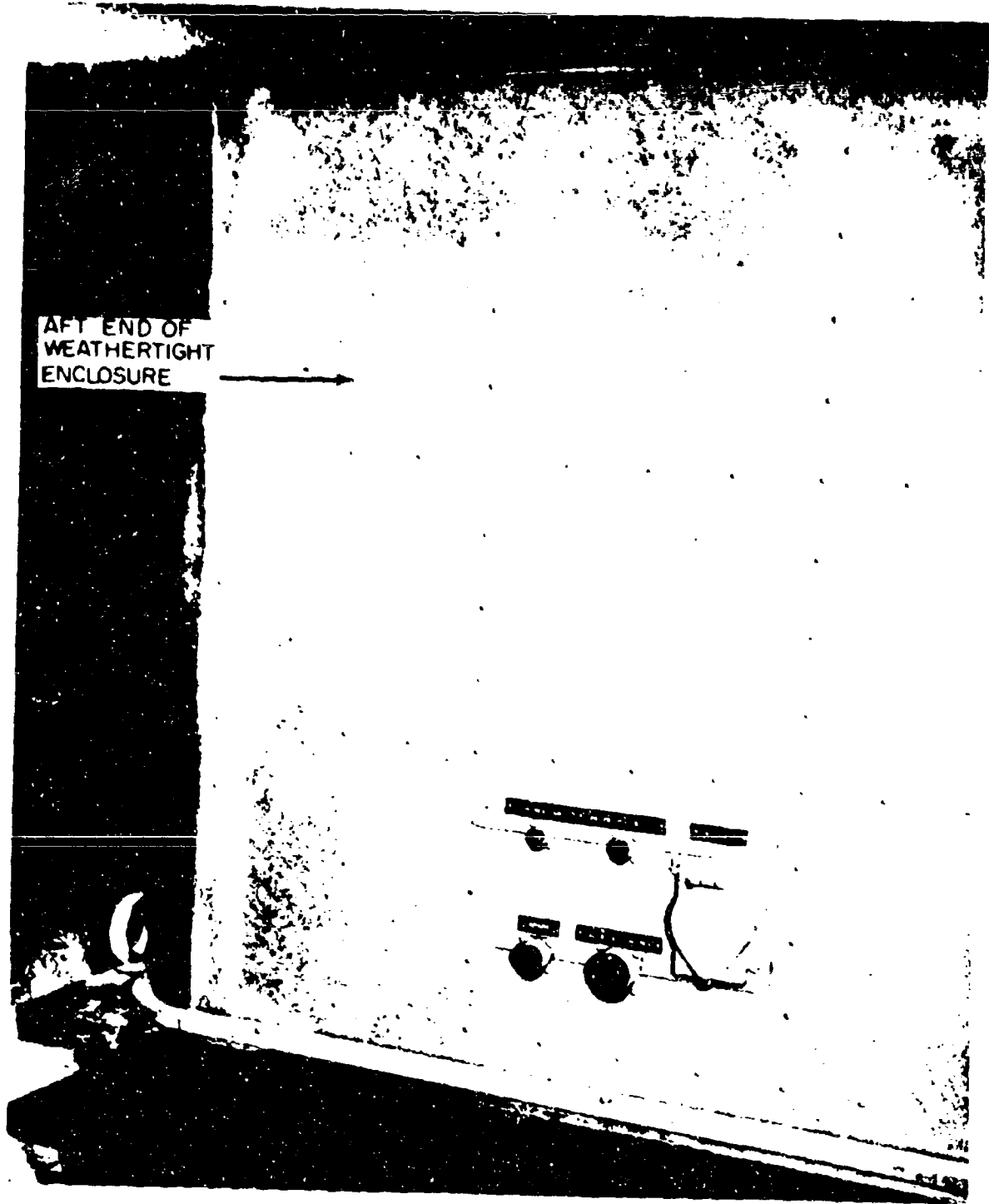

Photo 7. Test Stand Calibration System External Wiring Connections

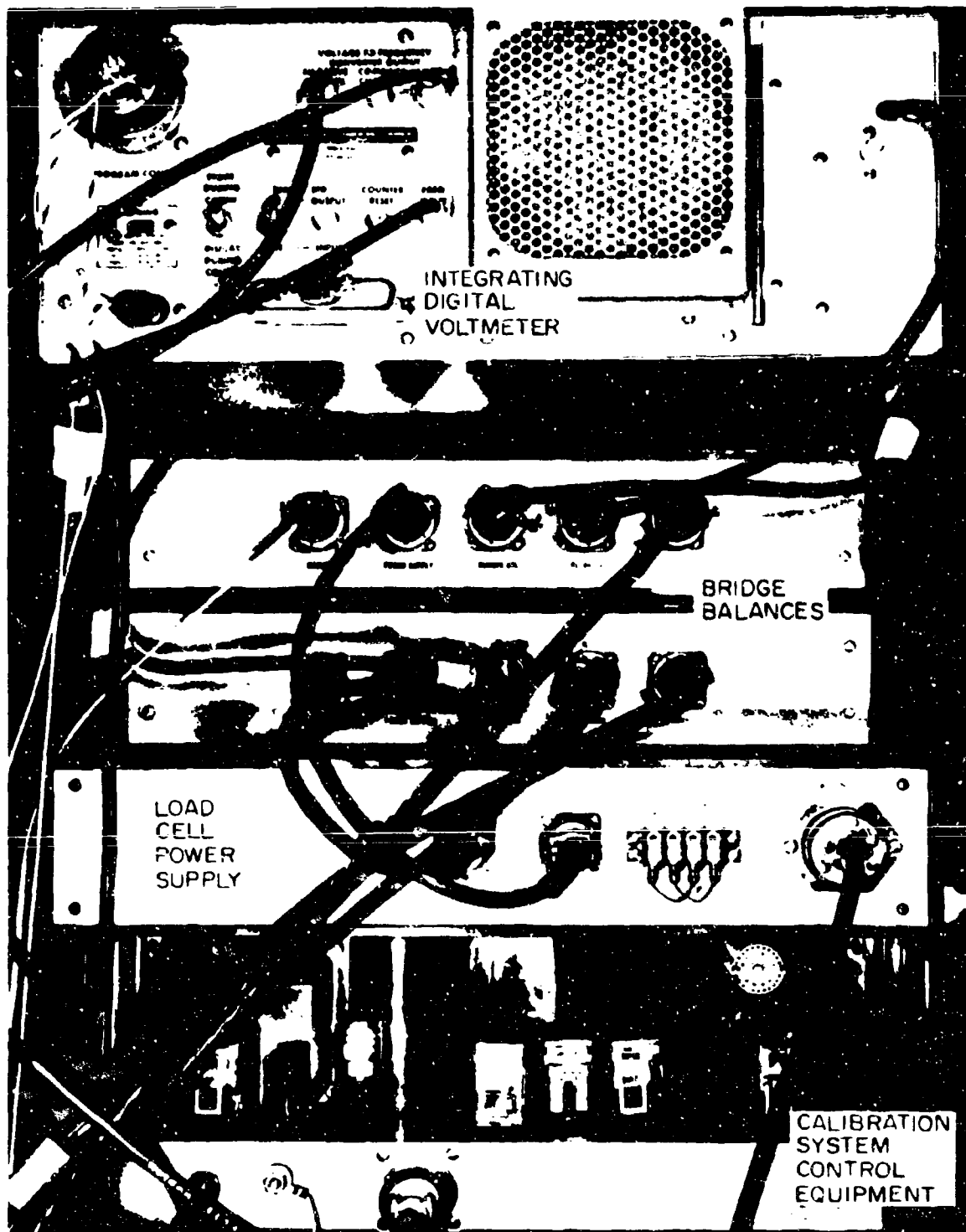

Photo 8. Calibration Control and Measurement Equipment (Rear View)

DISTRIBUTION LIST

<p>U. S. Department of the Interior 1 Bureau of Mines 4800 Forbes Avenue Pittsburgh, Pennsylvania 15213 Attn: M. M. Dolinar, Repts Librarian Explosives Research Center</p>	<p>Nat'l Aeronautics & Space Admin. 3 Langley Research Center Langley Air Force Base Virginia 23365 Attn: Library</p>
<p>Central Intelligence Agency 1 2430 E Street, N. W. Washington, D. C. 20505 Attn: OCD, Standard Dist.</p>	<p>Nat'l Aeronautics & Space Admin. 1 Washington, D. C. 20546 Attn: Office of Technical Information & Education Programs, Code ETL</p>
<p>Office of the Director of Defense 1 Research and Engineering Washington, D. C. 20301 Attn: W. E. Sheehan, Office of Asst. Dir. (Chemical Technology)</p>	<p>Scientific & Tech. Info Facility 2 P. O. Box 5700 Bethesda, Maryland 20014 Attn: NASA Representative</p>
<p>Nat'l Aeronautics and Space Admin. 1 Lewis Research Center 21000 Brookpark Road Cleveland, Ohio 44135 Attn: Library</p>	<p>Nat'l Aeronautics & Space Admin. 1 Washington, D. C. 20546 Attn: R. W. Ziem (RPS)</p>
<p>John F. Kennedy Space Center, 1 NASA Cocoa Beach, Florida 32931 Attn: Library</p>	<p>Nat'l Aeronautics & Space Admin. 1 Goddard Space Flight Center Greenbelt, Maryland 20771 Attn: Library</p>
<p>Nat'l Aeronautics & Space Admin. 1 Manned Spacecraft Center P. O. Box 1537 Houston, Texas 77001 Attn: Library</p>	<p>Defense Documentation Center 20 Cameron Station Alexandria, Virginia 22314</p>
<p>Nat'l Aeronautics & Space Admin. 1 George C. Marshall Space Flight Center Huntsville, Alabama 35800 Attn: Library</p>	<p>RTD (RTNP) 1 Bolling AFB Washington, D. C.</p>
<p>Nat'l Aeronautics & Space Admin. 1 George C. Marshall Space Flight Center Huntsville, Alabama 35800 Attn: Library</p>	<p>Arnold Eng. Development Center 1 Attn: AEOIM Air Force Systems Command Tullahoma, Tennessee 37389</p>
<p>Nat'l Aeronautics & Space Admin. 1 George C. Marshall Space Flight Center Huntsville, Alabama 35800 Attn: Library</p>	<p>AFRPL (RPR) 1 Edwards, California 92523</p>

Distribution List (Cont'd) p 2

AFRPL (RPM) Edwards, California 92523	1	Commanding Officer Picatinny Arsenal Dover, New Jersey 07801	1
AFFTC (FTBAT-2) Edwards AFB, California 93523	1	Attn: Library	
Office of Research Analysis (OAR) Attn: RRRT Holloman AFB, New Mexico 88330	1	Commanding Officer Picatinny Arsenal Liquid Rocket Propulsion Laboratory Dover, New Jersey 07801	1
AFRPL (RPFDE) Edwards, California 92523	33	Attn: Technical Library	
Air Force Missile Test Center Attn: MTEAT Patrick Air Force Base, Florida 32925	1	U. S. Army Missile Command Redstone Scientific Info. Center Redstone Arsenal, Alabama 35808	4
Wright-Patterson AFB, Ohio 45433 Attn: AFML(MAAE)	1	Attn: Chief, Document Section	
Commanding Officer Ballistic Research Laboratories Aberdeen Proving Ground, Maryland Attn: AMXBR-1 21005	1	Commanding General White Sands Missile Range New Mexico 88002	1
Commanding Officer Harry Diamond Laboratories Washington, D. C. 20438 Attn: AMXDO-TIB	1	Attn: Technical Library	
Commanding Officer U. S. Army Research Office (Durham) Box CM, Duke Station Durham, North Carolina 27706	1	Bureau of Naval Weapons Department of the Navy Washington, D. C. 20360	2
Commanding Officer U. S. Army Chemical Research & Development Laboratories Edgewood Arsenal, Maryland 21010 Attn: Chief, Physicochemical Research Division	1	Attn: DLI-3	
Commanding Officer Frankford Arsenal Philadelphia, Pennsylvania 19137 Attn: Propellant & Explosives Section, 1331	1	Bureau of Naval Weapons Department of the Navy Washington, D. C. 20360	2
		Attn: RMMP-2	
		Bureau of Naval Weapons Department of the Navy Washington, D. C. 20360	1
		Attn: RMMP-3	
		Bureau of Naval Weapons Department of the Navy Washington, D. C. 20360	1
		Attn: RMMP-4	
		Bureau of Naval Weapons Department of the Navy Washington, D. C. 20360	1
		Attn: RRRE-6	

Distribution List (Cont'd) p 3

Commander U. S. Naval Missile Center Point Mugu, California 93041 Attn: Technical Library	2	Commanding Officer U. S. Naval Underwater Ordnance Station Newport, Rhode Island 02844 Attn: W. W. Bartlett	1
Commander U. S. Naval Ordnance Laboratory White Oak Silver Spring, Maryland 20910 Attn: Library	2	Aerojet-General Corporation P. O. Box 296 Azusa, California 91703 Attn: F. M. West, Chief Librarian	1
Commander U. S. Naval Ordnance Test Station China Lake, California 93557 Attn: Code 45	5	Aerojet-General Corporation 11711 South Woodruff Avenue Downey, California 90241 Attn: Florence Walsh, Librarian	1
Commander (Code 753) U. S. Naval Ordnance Test Station China Lake, California 93557 Attn: Technical Library	2	Aerojet-General Corporation P. O. Box 1947 Sacramento, California 95809 Attn: Technical Information Office	3
Superintendent U. S. Naval Postgraduate School Naval Academy Monterey, California	1	Aeronutronic Div. Philco Corp. Ford Road Newport Beach, California 92600 Attn: Dr. L. H. Linder, Manager Technical Information Dept.	1
Commanding Officer U. S. Naval Propellant Plant Indian Head, Maryland 20640 Attn: Technical Library	1	Aeroprojects, Inc. 310 East Rosedale Avenue West Chester, Pennsylvania 19380 Attn: C. D. McKinney	1
Commanding Officer Office of Naval Research 1030 E. Green Street Pasadena, California 91101	1	Aerospace Corporation P. O. Box 95085 Los Angeles, California 90045 Attn: Library-Documents	2
Director (Code 6180) U. S. Naval Research Lab. Washington, D. C. 20390 Attn: H. W. Carhart	1	Allied Chemical Corporation General Chemical Division Research Lab., P. O. Box 405 Morristown, New Jersey 07960 Attn: L. J. Wiltrakis, Security Officer	1
Director Special Projects Office Department of the Navy Washington, D. C. 20360	1	Amcel Propulsion Company Box 3049 Asheville, North Carolina 28802	1

Distribution List (Cont'd) p 4

American Cyanamid Company 1937 W. Main Street Stamford, Connecticut 06902 Attn: Security Officer	1	Defense Metals Information Ctr. Battelle Memorial Institute 505 King Avenue Columbus, Ohio 42301	1
IIT Research Institute Technology Center Chicago, Illinois 60616 Attn: C. K. Hersh, Chemistry Div.	1	Douglas Aircraft Co., Inc. Santa Monica Division 3000 Ocean Park Boulevard Santa Monica, California 90405 Attn: Mr. J. L. Waisman	1
ARO, Inc. Arnold Engrg. Dev. Center Arnold AF Station, Tennessee 37389 Attn: Dr. B. H. Goethert Director of Engrg.	1	The Dow Chemical Company Security Section Box 31 Midland, Michigan 48641 Attn: Dr. R. S. Karpiuk, 1710 Bldg.	1
Atlantic Research Corporation Shirley Highway & Edsall Road Alexandria, Virginia 22314 Attn: Library	2	E. I. duPont deNemours & Co. Eastern Laboratory Gibbstown, New Jersey 08' 27 Attn: Mrs. Alice R. Steward	1
Atlantic Research Corporation Western Division 48-506 Easy Street El Monte, California Attn: H. Niederman	1	Esso Research & Engineering Co. Special Projects Unit P. O. Box 8 Linden, New Jersey 07036 Attn: Mr. D. L. Baeder	1
Battelle Memorial Institute 505 King Avenue Columbus, Ohio 43201 Attn: Report Library, Room 6A	1	General Dynamics/Astronautics P. O. Box 1128 San Diego, California 92112 Attn: Library & Information Services (128-00)	1
Bell Aerosystems Box 1 Buffalo, New York 14205 Attn: T. Reinhardt	1	General Electric Company Flight Propulsion Division Evendale Cincinnati, Ohio 45215	1
The Boeing Company Aero Space Division P. O. Box 3707 Seattle, Washington 98124 Attn: R. R. Barber, Lib. Ut Ch.	1	Hercules Powder Company Allegany Ballistics Laboratory P. O. Box 210 Cumberland, Maryland 21501 Attn: Library	1
Chemical Propulsion Information Agency Applied Physics Laboratory 8621 Georgia Avenue Silver Spring, Maryland 20910	3		

Distribution List (Cont'd) p 5

Hercules Powder Company Research Center Wilmington, Delaware 19899 Attn: Dr. Herman Skolnik, Manager Technical Information Division	1	New York University Dept. of Chemical Engineering New York, New York 10053 Attn: P. F. Winternitz	1
Jet Propulsion Laboratory 4800 Oak Grove Drive Pasadena, California 91103 Attn: Library (TDS) Mr. N. E. Devereux	1	North American Aviation, Inc. Space & Information Systems Div. 12214 Lakewood Boulevard Downey, California 90242 Attn: W. H. Morita	1
Arthur D. Little, Inc. 15 Acorn Park Cambridge, Massachusetts 02140 Attn: W. H. Varley	1	Rocketdyne 6633 Canoga Avenue Canoga Park, California 91304 Attn: Library, Dept. 596-306	3
Lockheed Propulsion Company P. O. Box 111 Redlands, California 92374 Attn: Miss Belle Berlad, Librarian	3	Rohn & Haas Company Redstone Arsenal Research Division Huntsville, Alabama 36808 Attn: Librarian	1
Marquardt Corp. 16555 Staticoy Street Box 2013 - South Annex Van Nuys, California 91404	1	Space Technology Laboratory, Inc. 1 Space Park Redondo Beach, California 90200 Attn: STL Tech. Lib. Doc. Acquisitions	2
Martin Company Baltimore, Maryland 21203 Attn: Science - Technology Library - Mail 398	1	Texaco Experiment Incorporated P. O. Box 1-T Richmond, Virginia 23202 Attn: Librarian	1
Minnesota Mining & Manufacturing Co. 900 Bush Avenue St. Paul, Minnesota 55106 Attn: Code 0013 R & D VIA: H. C. Zeman Security Administrator	2	United Technology Center P. O. Box 358 Sunnyvale, California 94088 Attn: Librarian	1
Monsanto Research Corporation Boston Labs., Everett Station Chemical Lane Boston, Massachusetts 02149 Attn: Library	1	Thiokol Chemical Corporation Alpha Division, Huntsville Plant Huntsville, Alabama 35800 Attn: Technical Director	1
		Thiokol Chemical Corporation Alpha Division Space Booster Plant Brunswick, Georgia 31500	1

Distribution List (Cont'd) p 6

Thiokol Chemical Corporation Elkton Division Elkton, Maryland 21921 Attn: Librarian	1	British Defence Staff * British Embassy 3100 Massachusetts Avenue Washington, D. C. 20008 Attn: Scientific Information Officer	4
Thiokol Chemical Corporation Reaction Motors Division Denville, New Jersey 07834 Attn: Librarian	1	Defence Research Member * Canadian Joint Staff (W) 2450 Massachusetts Avenue Washington, D. C. 20008	4
Thiokol Chemical Corporation Rocket Operations Center P. O. Box 1640 Cgden, Utah 84401 Attn: Librarian	1	Commanding Officer Ammunition Procurement & Supply Agency Joliet, Illinois 60400 Attn: Engr. Library	1
Thiokol Chemical Corporation Wasatch Division P. O. Box 524 Brigham City, Utah 84302 Attn: Library Section	2	AFRPL (RPCS) Edwards, California 93523	1
Union Carbide Chemicals Co. P. O. Box 8584 (Technical Center) South Charleston, West Virginia 25303 Attn: Dr. H. W. Schulz	1	Callery Chemical Company Research & Deveopment Callery, Pennsylvania 16024 Attn: Document Control	1
United Aircraft Corporation Pratt & Whitney Fla. Res. & Dev. Ctr. P. O. Box 2691 W. Palm Beach, Florida 33402 Attn: Library	1	Ethyl Corporation P. O. Box 3091 Istrouma Branch Baton Rouge, Louisiana 70805	1
United Aircraft Corporation Corporation Library 400 Main Street East Hartford, Connecticut 06118 Attn: Dr. David Rix	1	Hercules Powder Company Bacchus Works Magna, Utah 84044 Attn: Librarian	1
General Electric Company Apollo Support Department P. O. Box 2500 Dayton Beach, Florida 32015	1	Hynes Research Corporation 308 Bon Air Avenue Durham, North Carolina 27704	1
		Walter Kidde Company 675 Main Street Belleville, New Jersey 07109 Attn: Security Librarian	1

Distribution List (Cont'd) p 7

Olin Mathieson Chemical Corp. Marion, Illinois 62959 Attn: Research Library Box 508	1	Headquarters, U. S. Air Force Washington, D. C. 20330 Attn: AFRSTD	1
Olin Mathieson Chemical Corp. Research Library 1-K-3 275 Winchester Avenue New Haven, Connecticut 06511 Attn: Mail Control Room Miss Laura M. Kajuti	1	AFRPL (RPCL) Edwards, California 93523	1
Pennsalt Chemicals Corporation Technological Center 900 First Avenue King of Prussia, Pennsylvania 19406	1	Callery Chemical Company Research & Development Callery, Pennsylvania 16024 Attn: Document Control	1
Purdue University Lafayette, Indiana 47907 Attn: M. J. Zucrow	1	Chem. Research & Dev. Center FMC Corporation P. O. Box 8 Princeton, New Jersey 08540 Attn: Security Officer	1
Rocketdyne, A Division of North American Aviation, Inc. Solid Propulsion Operations P. O. Box 548, McGregor, Texas 76657 Attn: Library	1	Ethyl Corporation P. O. Box 3091 Istrouma Branch Baton Rouge, Louisiana 70805	1
Shell Development Company 1400 53rd Street Emeryville, California 94608	1	Hynes Research Corporation 308 Bon Air Avenue Durham, North Carolina 27704	1
Southwest Research Institute Department of Structural Research 8500 Culebra Road San Antonio, Texas 78228 Attn: Dr. Robert C. DeHart, Director	1	Walter Kidde Company 675 Main Street Belleville, New Jersey 07109 Attn: Security Librarian	1
Texaco, Inc. P. O. Box 509 Beacon, New York 12508 Attn: Dr. R. E. Conary, Manager	1	Olin Mathieson Chemical Corp. Research Library 1-K-3 275 Winchester Avenue New Haven, Connecticut 06511 Attn: Mail Control Room Miss Laura M. Kajuti	1
Los Alamos Scientific Laboratory University of California P. O. Box 1663 Los Alamos, New Mexico 87544	1	Pennsalt Chemicals Corporation Technological Center 900 First Avenue King of Prussia, Pennsylvania 19406	1

Distribution List (Cont'd) p 8

Purdue University 1
Lafayette, Indiana 47907
Attn: M. J. Zucrow

Shell Development Company 1
1400 53rd Street
Emeryville, California 94608

Southwest Research Institute 1
Department of Structural Research
8500 Culebra Road
San Antonio, Texas 78228
Attn: Dr. Robert C. DeHart, Director

Texaco, Inc. 1
P. O. Box 509
Beacon, New York 12508
Attn: Dr. R. E. Conary, Manager

* Reports prepared under a Department of the Air Force contract or project will be transmitted VIA:

Headquarters
Air Force Systems Command
Attn: SCS-41(3-1833)
Andrews Air Force Base
Washington, D. C. 20331