

UNCLASSIFIED

AD NUMBER

AD483308

LIMITATION CHANGES

TO:

Approved for public release; distribution is unlimited.

FROM:

Distribution authorized to U.S. Gov't. agencies and their contractors; Critical Technology; JAN 1966. Other requests shall be referred to Air Force Flight Dynamics Laboratory, ATTN: FDTR, Wright-Patterson AFB, OH 45433.

AUTHORITY

AFFDL ltr dtd 25 Apr 1972

THIS PAGE IS UNCLASSIFIED

A D048 3308

lost
Eric Camera
coll
KW
JOP
132D
JOP
HH

AFFDL-TR-65-146

**EXPERIMENTAL PROGRAM TO DETERMINE EFFECT OF CRACK
BUCKLING AND SPECIMEN DIMENSIONS ON FRACTURE
TOUGHNESS OF THIN SHEET MATERIALS**

R. G. FORMAN

TECHNICAL REPORT AFFDL-TR-65-146

JANUARY 1966

AF FLIGHT DYNAMICS LABORATORY
RESEARCH AND TECHNOLOGY DIVISION
AIR FORCE SYSTEMS COMMAND
WRIGHT-PATTERSON AIR FORCE BASE, OHIO

20080819 222

Distribution of This Document Is Unlimited.

NOTICES

When Government drawings, specifications, or other data are used for any purpose other than in connection with a definitely related Government procurement operation, the United States Government thereby incurs no responsibility nor any obligation whatsoever; and the fact that the Government may have formulated, furnished, or in any way supplied the said drawings, specifications, or other data, is not to be regarded by implication or otherwise as in any manner licensing the holder or any other person or corporation, or conveying any rights or permission to manufacture, use, or sell any patented invention that may in any way be related thereto.

Copies of this report should not be returned to the Research and Technology Division unless return is required by security considerations, contractual obligations, or notice on a specific document.

**EXPERIMENTAL PROGRAM TO DETERMINE EFFECT OF CRACK
BUCKLING AND SPECIMEN DIMENSIONS ON FRACTURE
TOUGHNESS OF THIN SHEET MATERIALS**

R. G. FORMAN

AD 483308

Distribution of This Document Is Unlimited.

FOREWORD

This report describes work on dimensional similitude requirements for plane stress fracture mechanics testing accomplished in the Structural Test Laboratory of The Boeing Company Transport Division. The testing was conducted from September 1960 through January 1961, and the test results were reported in Structural Test Laboratory Test Progress Report 92-OH, dated 6 June 1961. The testing was performed by Mr. R. Forman and Mr. E. Schwenk under the approval of Mr. S. Engstrom.

In addition to the test results on similitude requirements, the test results also contributed data on slow crack extension, crack buckling, and crack tip yield zone size. This data is particularly important for substantiating recent theoretical studies in fracture mechanics.

This report was written by Mr. R. Forman, Aerospace Engineer, Theoretical Mechanics Branch, Structures Division, Air Force Flight Dynamics Laboratory under Project No. 1467, "Structural Analysis Method," Task No. 146704, "Structural Fatigue Analysis." Approval for publishing the Boeing Company test data was given by Mr. D. R. Donaldson, Unit Chief, Structures, The Boeing Company Supersonic Transport Program.

Manuscript released by author July 1965 for publication as an RTD Technical Report.

This technical report has been reviewed and is approved.



FRANCIS J. JANIK, JR.
Chief, Theoretical Mechanics Branch
Structures Division

ERRATA PAGE
TO
AFFDL-TR-65-146

Experimental Program to Determine Effect of Crack Buckling and
Specimen Dimensions on Fracture Toughness of Thin Sheet Materials

Air Force Flight Dynamics Laboratory
Research and Technology Division
Air Force Systems Command
Wright-Patterson Air Force Base, Ohio

Cover Page and Title Page: Strike out the statement "Distribution
of this Document is Unlimited".

Notices Page: Add the statement: "This document is subject to special
export controls and each transmittal to foreign governments or foreign
nationals may be made only with prior approval of AFFDL(FDIR), WPAFB,
Ohio 45433.".

Alch
1-1'

ABSTRACT

This report presents test results on dimensional similitude requirements for plane stress fracture toughness testing of centrally notched Griffith panels. In addition to the similitude requirements data, the report also presents test results on crack buckling, slow crack extension, and crack tip yield zone size. This data is particularly useful in substantiating recent theoretical studies in fracture mechanics.

TABLE OF CONTENTS

SECTION		PAGE
I	INTRODUCTION	1
II	SUMMARY	2
III	TEST PROGRAM	3
	1. Outline of Test Program	3
	2. Test Specimen Description	3
	3. Test Procedure	3
IV	RESULTS AND DISCUSSION	5
	1. Crack Buckling Deflection	5
	2. Variation in Fracture Toughness with Specimen Dimensions	5
	a. Variation in Fracture Toughness with Panel Length	5
	b. Variation in Fracture Toughness with Panel Width	5
	c. Variation in Fracture Toughness with Crack Length	5
	3. Slow Crack Extension	5
	4. Yield Zone Size	6
	REFERENCES	7

LIST OF ILLUSTRATIONS

FIGURE		PAGE
1	Specimen Configuration	8
2	Load-Strain Curves for .063 Gage 7075-T6 Aluminum Sheet	9
3	Load-Strain Curves for .060 Gage 2024-T3 Aluminum Sheet	10
4	Load-Strain Curves for .060 Gage 2024-T81 Aluminum Sheet	11
5	Load-Strain Curves for .020 Gage AM350CRT Steel Sheet	12
6	Load-Strain Curves for .020 Gage AM355CRT Steel Coil	13
7	Test Setup for Stiffened Specimen	14
8	Variation in σ_o with Crack Buckling Deflection for .060 Gage 2024-T3 Aluminum Sheet	15
9	Variation in σ_o with Crack Buckling Deflection for .060 Gage 2024-T81 Aluminum Sheet	16
10	Comparison of Theoretical and Experimental Buckling Stress for Centrally Cracked Aluminum Panels	17
11	Variation in G_c with L/a for .060 Gage 7075-T6 Aluminum Sheet	18
12	Variation in G_c with L/a for .020 Gage AM355CRT Steel Coil	19
13	Variation in G_c with Panel Width at Constant a_o/b for .063 Gage 7075-T6 Aluminum Sheet	20
14	Variation in G_c with Panel Width at Constant a_o/b for .060 Gage 2024-T81 Aluminum Sheet	21
15	Variation in G_c with Panel Width at Constant a_o/b for .020 Gage AM350CRT Steel Sheet	22
16	Variation in G_c with Panel Width at Constant a_o/b for .020 Gage AM355CRT Steel Coil	23
17	Variation in σ_o with Half Crack Length, a_o , for .060 Gage 2024-T3 Aluminum Sheet	24
18	Variation in σ_o with Half Crack Length, a , for .060 Gage 2024-T81 Aluminum Sheet	25
19	Variation in σ_o with Half Crack Length, a , for .020 Gage AM350CRT Steel Sheet	26
20	Variation in σ_o with Half Crack Length, a , for .020 Gage AM355CRT Steel Coil	27

LIST OF ILLUSTRATIONS (continued)

FIGURE		PAGE
21	Variation in k with Δa for .020 Gage AM355CRT Steel Coil	28
22	Variation in k with Δa	29
23	Variation in k with Δa	30
24	Yield Zone Photographs from Specimen No. 33B - .020 Gage AM350CRT Steel Sheet	31
25	Yield Zone Photographs from Specimen No. 33B - .020 Gage AM350CRT Steel Sheet	32
26	Yield Zone Photographs from Specimen No. 33B - .020 Gage AM350CRT Steel Sheet	33
27	Yield Zone Photographs from Specimen No. 33B - .020 Gage AM350CRT Steel Sheet	34
28	Yield Zone Photographs from Specimen No. 33B - .020 Gage AM350CRT Steel Sheet	35
29	Yield Zone Photographs from Specimen No. 33B - .020 Gage AM350CRT Steel Sheet	36
30	Comparison of Theoretical and Experimental Plastic Zone Sizes for Specimen No. 33B - .020 Gage AM350CRT Steel Sheet	37
31	Variation in k with w for .020 Gage AM355CRT Steel Coil	38
32	Variation in k with w for .020 Gage AM355CRT Steel Coil	39
33	Change in k_c with w for .020 Gage AM355CRT Steel Coil	40

TABLES

TABLE		PAGE
I	Tensile Properties of 2024 and 7075 Aluminum	41
II	Tensile Properties of AM350 and AM355 Steel	42
III	Test Data - Effect of L/a on G_C for .063 Gage 7075-T6 Aluminum Sheet	43
IV	Test Data - Effect of L/a on G_C for .020 Gage AM355CRT Steel Coil	44
V	Test Data - Effect of Panel Width on G_C with Constant a_0 for .063 Gage 7075-T6 Aluminum Sheet	45
VI	Test Data - Effect of Panel Width on G_C with Constant a_0 for .020 Gage AM355CRT Steel Coil	46
VII	Test Data - Effect of a_0 on G_C with Constant a_0/b for .064 Gage 7075-T6 Aluminum Sheet	47
VIII	Test Data - Effect of a_0 on G_C with Constant a_0/b for .060 Gage 2024-T3 Aluminum Sheet	48
IX	Test Data - Effect of a_0 on G_C with Constant a_0/b for .060 Gage 2024-T81 Aluminum Sheet	49
X	Test Data - Effect of a_0 on G_C with Constant a_0/b for .020 Gage AM350CRT Steel Sheet	50
XI	Test Data - Effect of a_0 on G_C with Constant a_0/b for .020 Gage AM355CRT Steel Coil	51

SYMBOLS

E	Young's modulus
F	applied axial force on specimen
G_c	$\pi \frac{k_c^2}{E}$, fracture toughness parameter
L	length of specimen measured between grips
a	$a_0 + \Delta a$, half crack length
a_0	initial half crack length
Δa	half crack length extension
b	half panel width
k	$\sigma_0 \sqrt{a}$, stress intensity factor
k_c	$\sigma_0 \sqrt{a}$, stress intensity factor at fast fracture
l	$2a$, total crack length
l_e	effective crack length for buckling
n	$2a/2b$, ratio of crack length to panel width
t	specimen thickness
w	yield zone size
w_x	yield zone length
w_y	half yield zone width
x, y	cartesian coordinates
α	$\left(\frac{2(n^4 + 2)}{n^8 + 2n^6 - 3n^4 - 4n^2 + 4} \right)^{1/2}$, finite width correction factor
β	$\frac{\pi \sigma_0}{2 \sigma_{yp}}$
σ_0	$F/2bt$, gross area stress
σ_n	$F/2(b-a)t$, net area stress
σ_{yp}	material tensile yield stress
σ_{ult}	material tensile ultimate stress

SECTION I

INTRODUCTION

Tests have been conducted on the following materials to investigate the dimensional similitude requirements for testing plane stress fracture toughness:

1. .063 gage 7075-T6 aluminum sheet
2. .060 gage 2024-T3 aluminum sheet
3. .060 gage 2024-T81 aluminum sheet
4. .020 gage AM350CRT steel sheet
5. .020 gage AM355CRT steel coil

Essentially, the purpose of the test program was to determine the change in fracture toughness due to the following variables:

1. Stress level and crack length
2. Panel length to half crack length ratio (L/a)
3. Crack length to panel width ratio ($2a/2b$)

In addition, an extensive amount of data was recorded on such things as crack buckling, slow crack extension, and crack tip yield zone size. The buckling and yield zone size data was useful in checking existing equations for the buckling stress and yield zone size dimensions.

Crack buckling was considered important because there are two uses for fracture toughness data, one for material evaluation and the other for determining critical crack sizes in structures. For material evaluation, the effect of buckling should be eliminated, but for structural analysis, the effect of crack buckling should be taken into account. Thus, for most specimen sizes tested, two specimens were tested with greased stiffener plates lightly clamped against the panels, and one specimen was tested without stiffener plates to allow buckling to occur.

SECTION II

SUMMARY

This test program has shown that the plane stress fracture toughness of centrally-notched Griffith panels will remain relatively constant with changes in panel width and panel length if the crack length remains constant. However, the plane stress fracture toughness was found to be considerably affected by the stress level, crack length, and crack buckling deflection. In general, when buckling was prevented, the fracture toughness increased with increasing crack length. The effect of crack buckling deflection tended to decrease the fracture toughness values.

A noticeable result of the change in fracture toughness was the variation in the slow crack extension and the yield zone size at crack instability. As the fracture toughness for each material increased, the amount of slow crack extension and the yield zone size at instability both increased.

Other useful results of the test program were that experimental measurements for buckling stress and yield zone size agreed satisfactorily with particular theoretical solutions.

SECTION III

TEST PROGRAM

1. OUTLINE OF TEST PROGRAM

The essential variables in the test program were crack length, panel width, and panel length. The effects of these variables can be listed in the following order:

- a. Crack buckling deflection
- b. Variation in fracture toughness with
 - (1) panel length
 - (2) panel width
 - (3) crack length
- c. Slow crack extension
- d. Yield zone size

These effects are all discussed and the test results are presented in Section IV Results and Discussion.

2. TEST SPECIMEN DESCRIPTION

The specimen materials for the test program are listed as follows:

- a. .063 gage 7075-T6 bare aluminum sheet
- b. .060 gage 2024-T3 bare aluminum sheet
- c. .060 gage 2024-T81 bare aluminum sheet
- d. .020 gage AM350CRT steel sheet
- e. .020 gage AM355CRT steel coil

The specimens were all centrally-notched Griffith panels. A sketch of the specimen configuration is shown in Figure 1. Except for the effect of L/a testing, all specimens for each series of tests (for example, specimens 16A through 21A or 16B through 21B) were taken from the same sheet of material.

Tensile coupon tests were also conducted for each material to determine the material properties. Six coupons (three longitudinal grain and three transverse grain) were taken from one broken half of a 24 inch by 48 inch panel for each material. The coupons were taken from the area adjacent to the sawcut in each panel. The results of these tests are listed in Tables I and II. The load versus strain curves for a longitudinal grain coupon and a transverse grain coupon for each material are shown in Figures 2 through 6.

3. TEST PROCEDURE

All tests were run in a 300 KIP Baldwin Static Test Machine under the following conditions:

Temperature: $70^{\circ} \pm 5^{\circ} \text{F}$

Atmosphere: Air

- Approx. Load Rate:
- a. 50 KIPS per minute from zero load to start of slow crack extension.
 - b. 5 KIPS per minute from start of slow crack extension to specimen failure.

A photograph of the test setup is shown in Figure 7. The slow crack extension was measured at each end of the crack by visual observation. Grid lines were drawn about 0.1 inch apart on each panel. When the crack reached a grid line, loading was stopped, and the crack length was estimated to the nearest 0.03 inches, and the load was recorded. The critical crack length was the length at which the crack began to extend with no increase in load.

For the 2024-T3 and 2024-T81 unstiffened specimens, the buckling deflection at the center of the crack was also recorded. The deflection was measured with a dial indicator held against the edge of the crack on the centerline of the panel.

All fracture tests were conducted without prior load cycling to obtain fatigue cracks. This was considered acceptable due to the large yield zone size to notch tip radius ratio for all specimens. Furthermore, the purpose of the program was to measure trends in experimental results, and the difference between a fatigue crack and a sharp notch would not have appreciably affected the observed trends.

In calculating the fracture toughness, G_c , the correction factor, α , was used only to

account for the finite width of the specimens. No correction factor was used to account for the crack tip yield zone because it was determined that the variations in G_c would not

have appreciably changed if a plastic correction factor (for example, the one in Reference 3) had been used.

SECTION IV

RESULTS AND DISCUSSION

1. CRACK BUCKLING DEFLECTION

The results of the crack buckling deflection measurements are shown in Figure 8 and 9. The stress levels at which the stress-deflection curve makes an apparent change in slope was estimated to be the buckling stress. Figure 10 shows the comparison of Liu's (Reference 1) theoretical buckling stress and the experimental results. The test results show that the effective crack length, l_e , should probably be between $l_e = l/2$ and $l_e = l/3$ for the most accurate solution.

2. VARIATION IN FRACTURE TOUGHNESS WITH SPECIMEN DIMENSIONS

Variation in Fracture Toughness with Panel Length

The results of these tests are listed in Tables III and IV and are plotted in Figures 11 and 12. The results indicate that for a given crack length, the fracture toughness will remain constant for values of L/a greater than 3. Since most fracture tests are conducted with L/a greater than 4, there normally should be no discrepancy in test results due to the length of the specimens.

Variation in Fracture Toughness with Panel Width

The results of these tests are listed in Tables V and VI. The results indicate that for a given crack length, the fracture toughness is moderately affected by the variation in panel width. This test was actually an attempt to determine the effect of the net area stress level while maintaining the crack length constant. The results indicate that the net section stress level has an effect on the value of the fracture toughness.

Variation in Fracture Toughness with Crack Length

The results of these tests are listed in Tables VII through XI and are plotted in

Figures 13 through 16. The variation in crack length was accomplished by varying the panel width while maintaining the ratio of crack length to panel width constant. The curves show that the crack length has a pronounced effect on the value of the fracture toughness. For the stiffened specimens, the fracture toughness always increased with increasing crack length. For the unstiffened specimens, crack buckling affected the results and no general trends were determined, except that buckling appreciably reduced the fracture toughness. The results of the stiffened 7075-T6 aluminum tests shown by the curve in Figure 13 are interesting because the curve indicates the crack length at which buckling commences to reduce the fracture toughness. Using the buckling equation given in Figure 10 and letting $l_e = \frac{5l}{12}$, the unstiffened 7075-T6 panels should have started buckling at a crack length of about 2 inches. The fracture toughness curve in Figure 13 shows that this is approximately the crack length at which buckling started to reduce the fracture toughness value.

3. SLOW CRACK EXTENSION

The results of the slow crack extension measurements are shown in Figures 17 through 23. Essentially, four conclusions can be made concerning these results. These conclusions are:

- a. The amount of slow crack extension before fast fracture increases with an increase in initial crack length.
- b. The fracture toughness increases with the increase in amount of slow crack extension.
- c. The onset of slow crack extension for each material but for different initial crack lengths occurs at a constant value of the stress intensity factor k .
- d. The curve of slow crack extension versus stress intensity factor plots as a straight line

on log-log scale, and thus the amount of slow crack extension can be expressed by the equation

$$\Delta a = ck^n \quad (1)$$

where c and n are constants for particular materials.

4. YIELD ZONE SIZE

Photographs of an enlarging crack tip yield zone observed in AM350CRT Specimen No. 33B are shown in Figures 24 through 29. Similar yield zones were observed in all the AM350CRT and AM355CRT specimens. Figures 30 through 32 show measurements of yield zone sizes and the comparison of theory with experimental results.

Figure 30 shows the excellent correlation between the Dugdale (Reference 2) solution for the yield zone length and the lengths measured from the photographs in Figures 24 through 29. Figures 31 and 32 show how the Dugdale solution can be related to the stress intensity factor, k .

The Dugdale solution for the yield zone length is

$$w_x = a (\sec \beta - 1) \quad (2)$$

where

$$\beta = \frac{\pi \sigma_0}{2 \sigma_{yp}}$$

If $\sec \beta - 1$ is expanded into 4 terms of a series, the solution can be expressed approximately as

$$\frac{w_x}{a} = \frac{\beta^2}{2} + \frac{5}{24} \beta^4 + \frac{61}{720} \beta^6 + \frac{277}{8064} \beta^8 \quad (3)$$

Then, making the substitution

$$\beta^2 = \frac{1}{a} \left(\frac{\pi k}{2 \sigma_{yp}} \right)^2$$

The solution becomes

$$w_x = \frac{Q^2}{2} \left[1 + \frac{5}{12} \left(\frac{Q}{a} \right)^2 + \frac{61}{360} \left(\frac{Q}{a} \right)^3 + \frac{277}{4032} \left(\frac{Q}{a} \right)^4 \right] \quad (4)$$

where

$$Q = \frac{\pi k}{2 \sigma_{yp}}$$

For long cracks, the solution becomes approximately

$$w_x = \frac{1}{2} \left(\frac{\pi k}{2 \sigma_{yp}} \right)^2 \quad (5)$$

which is $\pi^2/4$ times the Reference 3 solution, expressed as

$$w_x = \frac{1}{2} \left(\frac{k}{\sigma_{yp}} \right)^2 \quad (6)$$

In Figure 32, the theoretical solution for $a = 1$ does not appear to agree with the experimental results. However, the experimental points take into account the actual crack length after slow crack extension and the $a = 1$ theoretical curve should not agree with the experimental points.

Figure 33 shows the variation in k_c with yield zone size. As can be expected, k_c increases with the yield zone size at onset of fast fracture.

REFERENCES

1. H. W. Liu, "Discussion of Papers", Proceedings of the Crack Propagation Symposium, Vol. II, College of Aero., Cranfield (England), September 1961, pp 514 - 517.
2. D. S. Dugdale, "Yielding of Steel Sheets Containing Slits", J. Mech. Phys. Solids, Vol. 8, May 1960, pp 100 - 104.
3. ASTM Special Committee on Fracture Testing of High-Strength Metallic Materials: Fracture Testing of High-Strength Sheet Materials, ASTM Bul. 243, January 1960, pp 29 - 40.

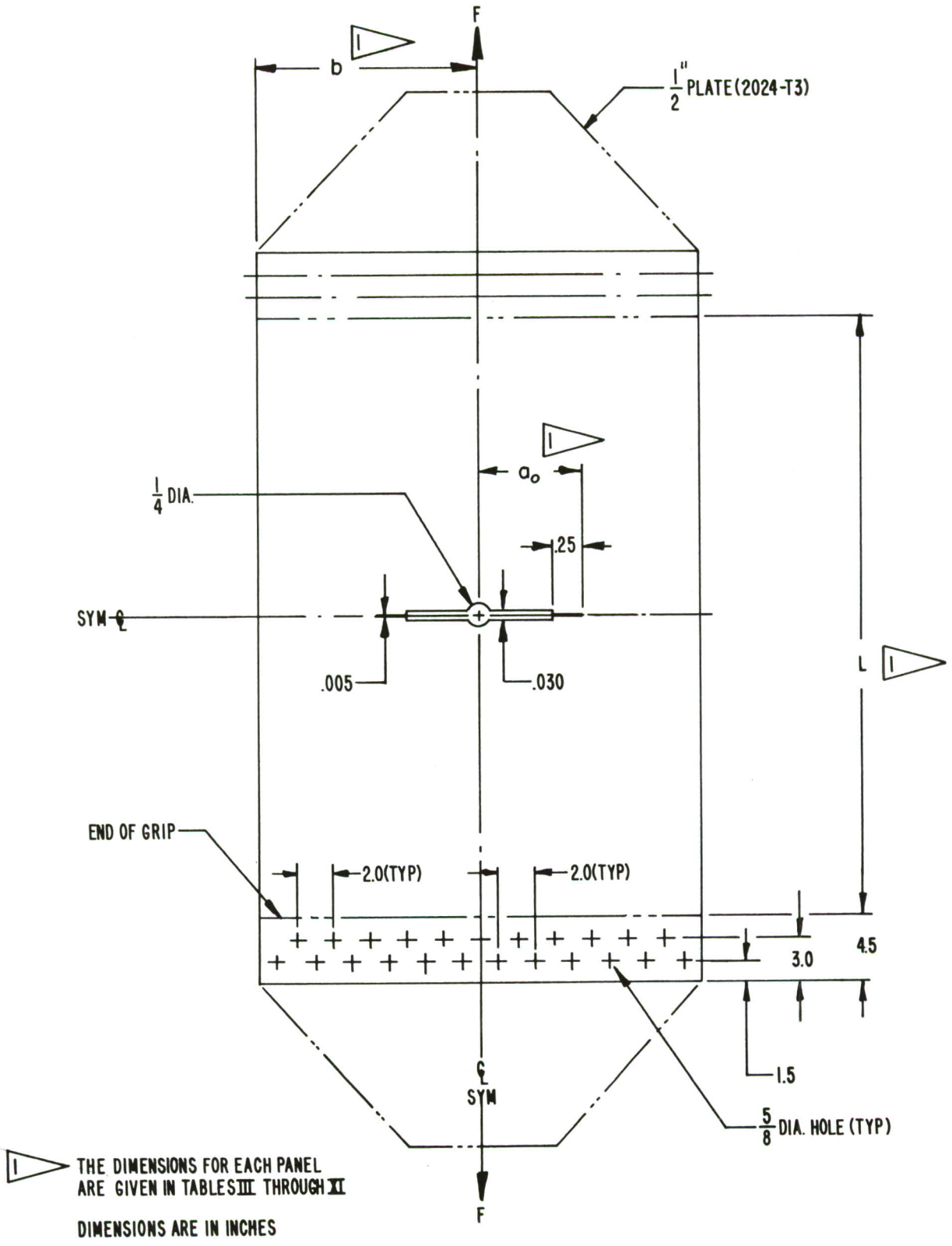

Figure 1. Specimen Configuration

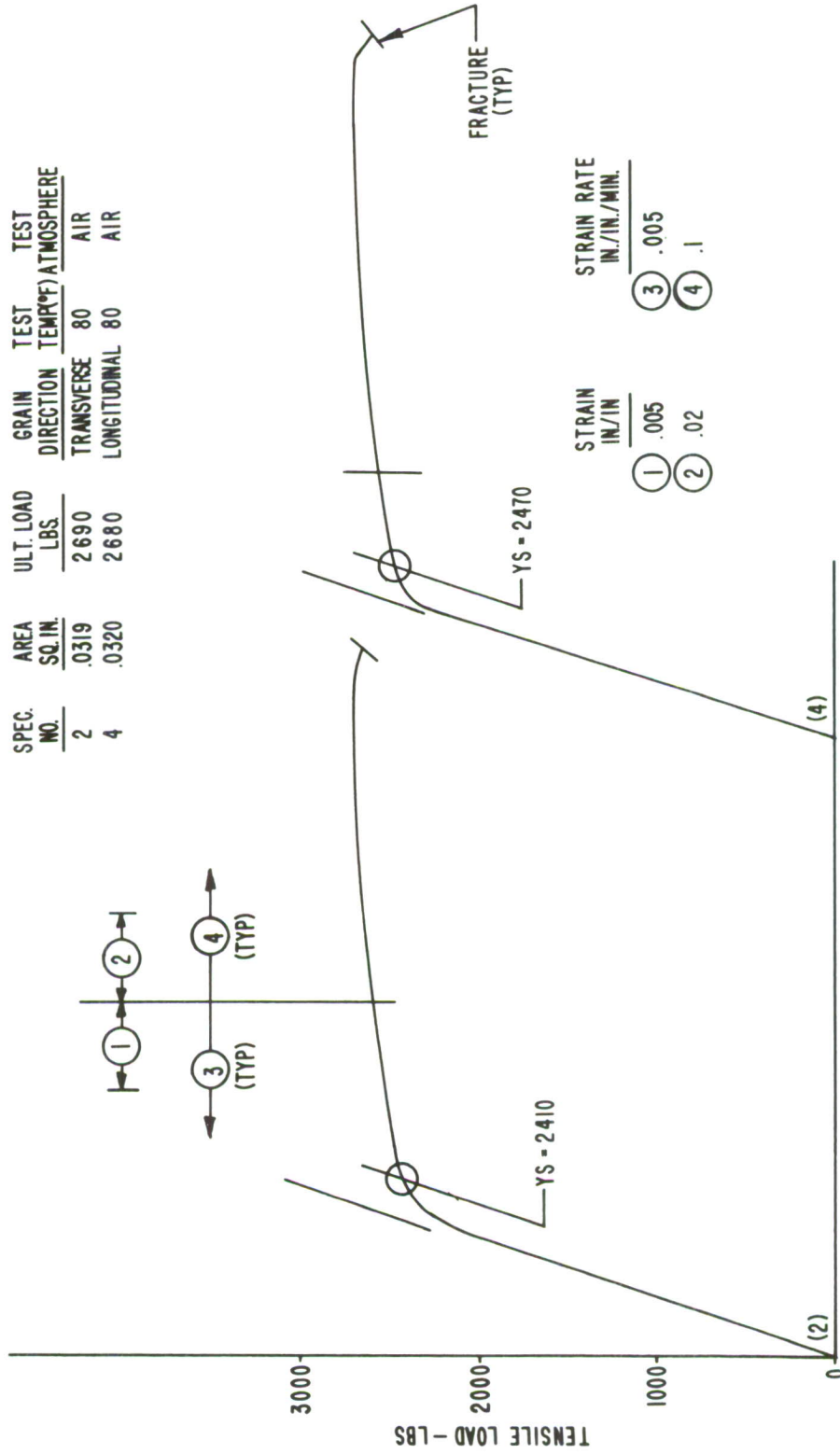

Figure 2. Load-Strain Curves for 0.063 Gage 7075-T6 Aluminum Sheet

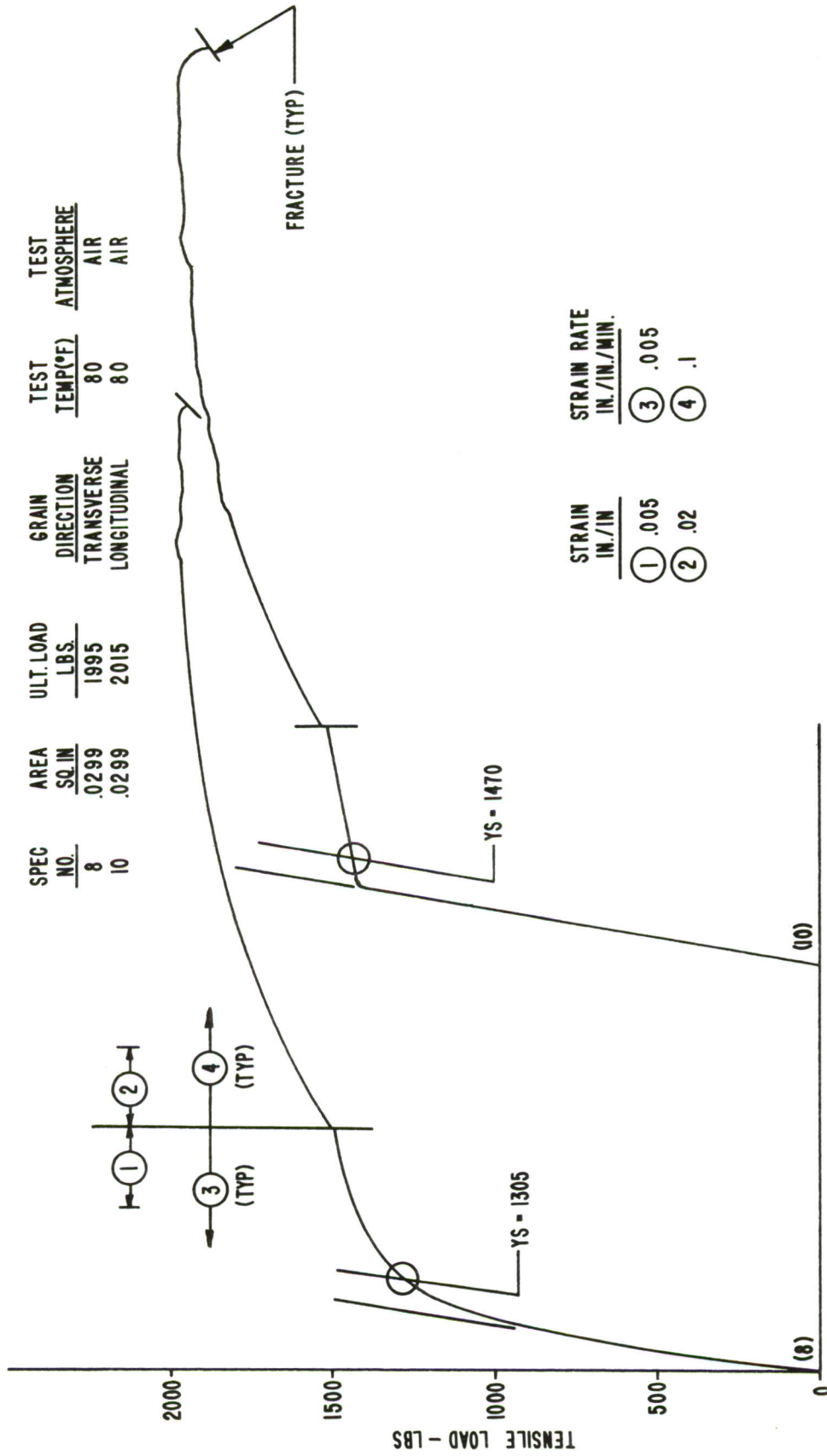

Figure 3. Load-Strain Curves for 0.060 Gage 2024-T3 Aluminum Sheet

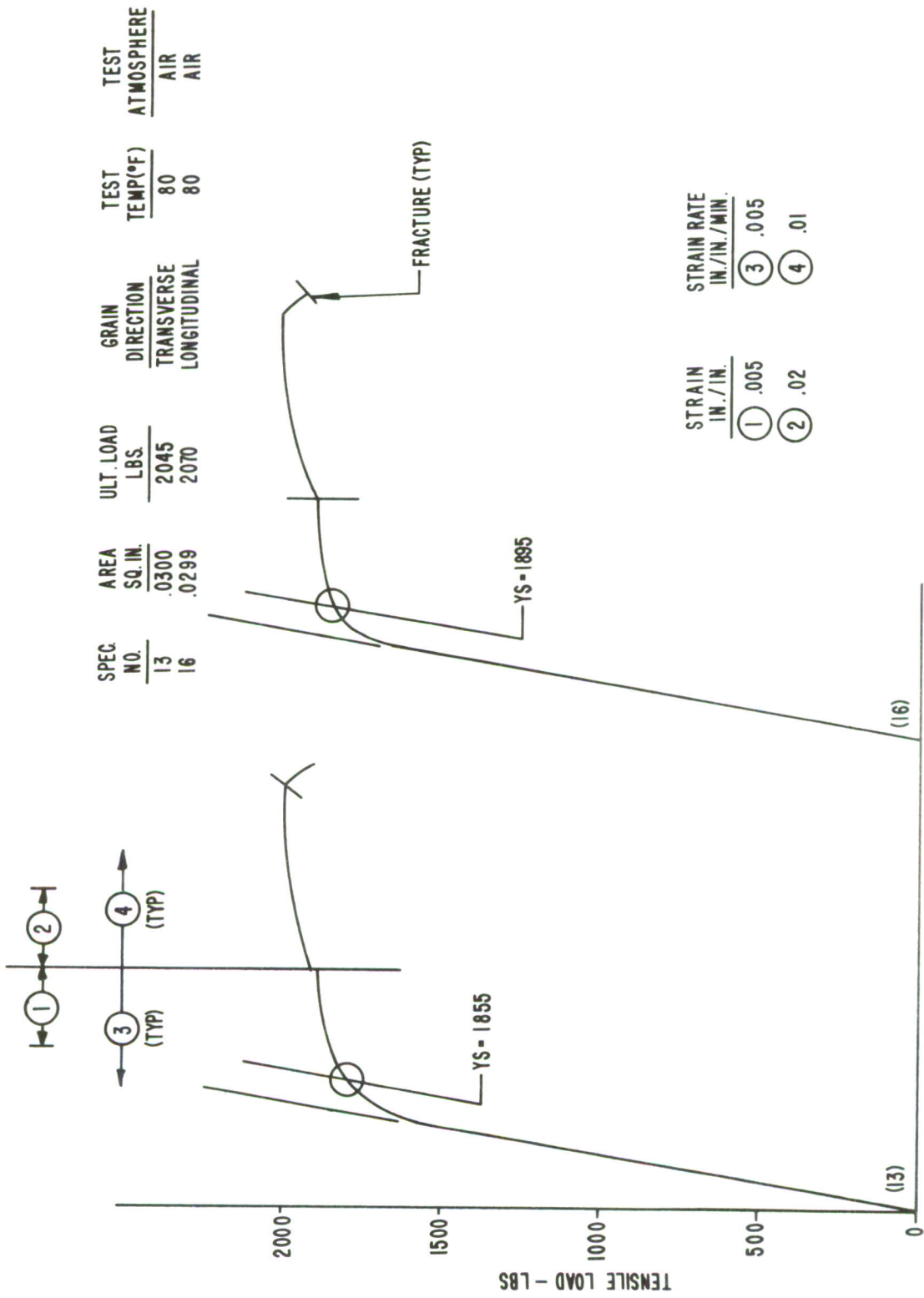

Figure 4. Load-Strain Curves for 0.060 Gage 2024-T81 Aluminum Sheet

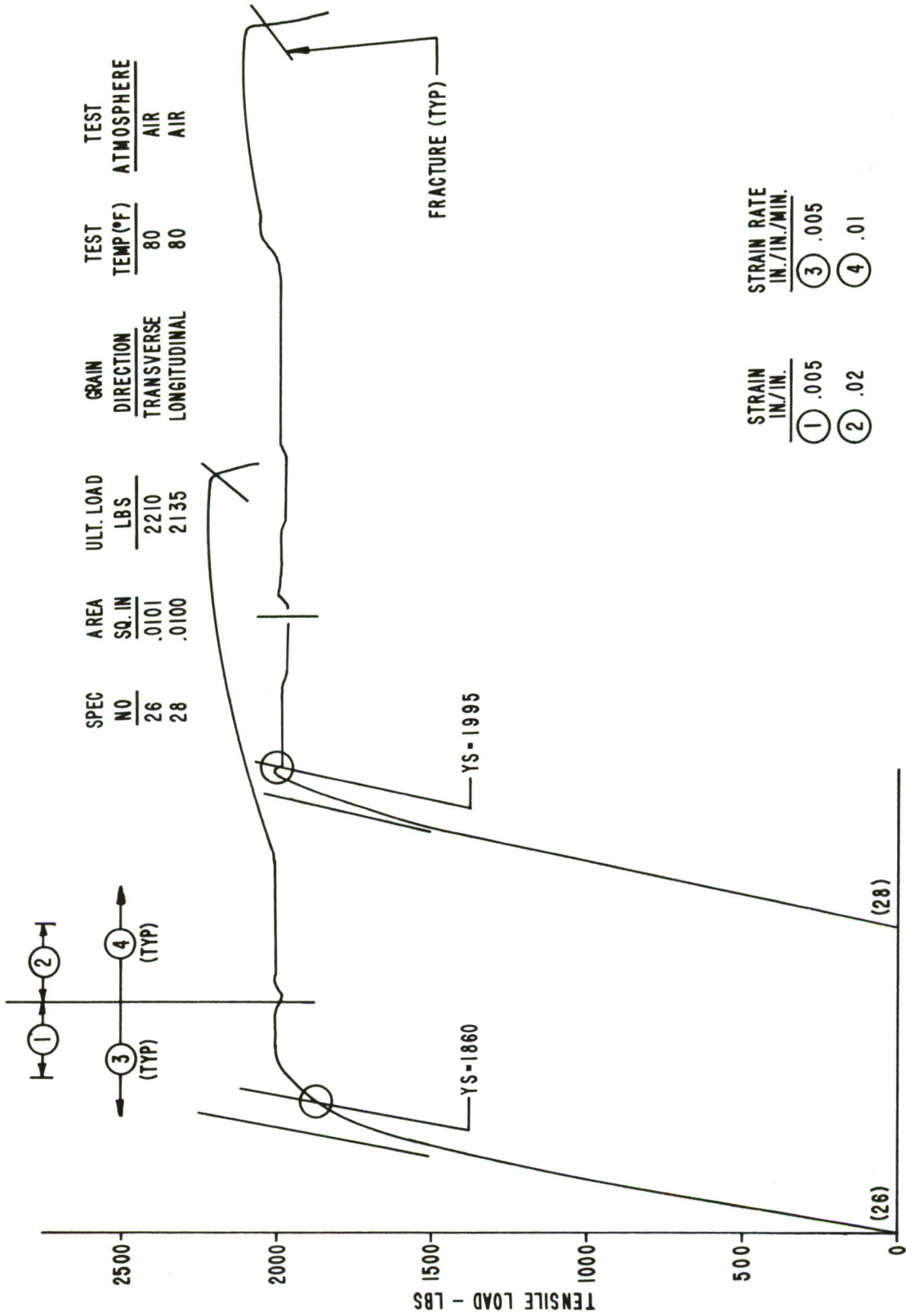

Figure 5. Load-Strain Curves for 0.020 Gage AM350CRT Steel Sheet

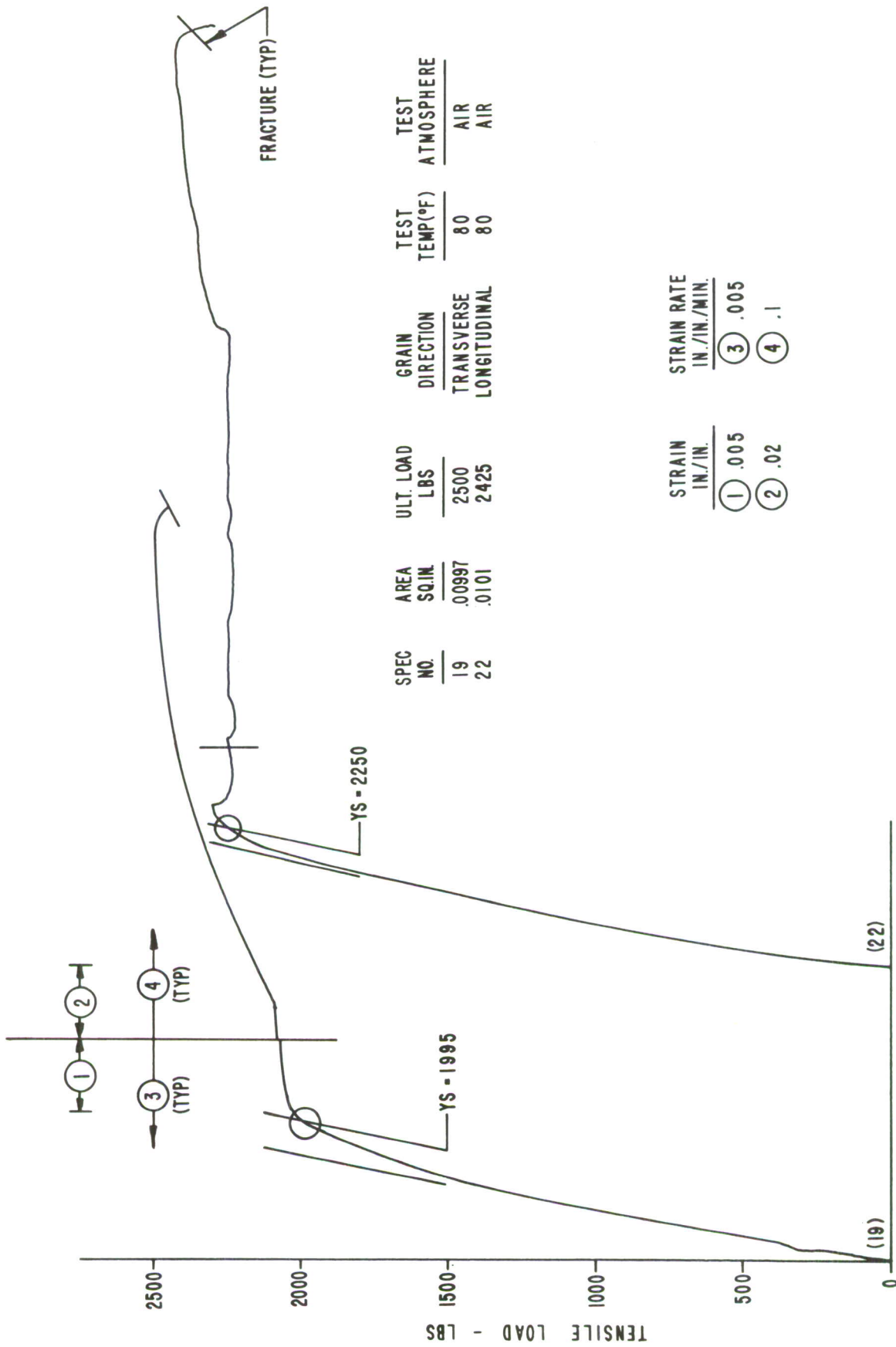

Figure 6. Load-Strain Curves for 0.020 Gage AM355CRT Steel Sheet

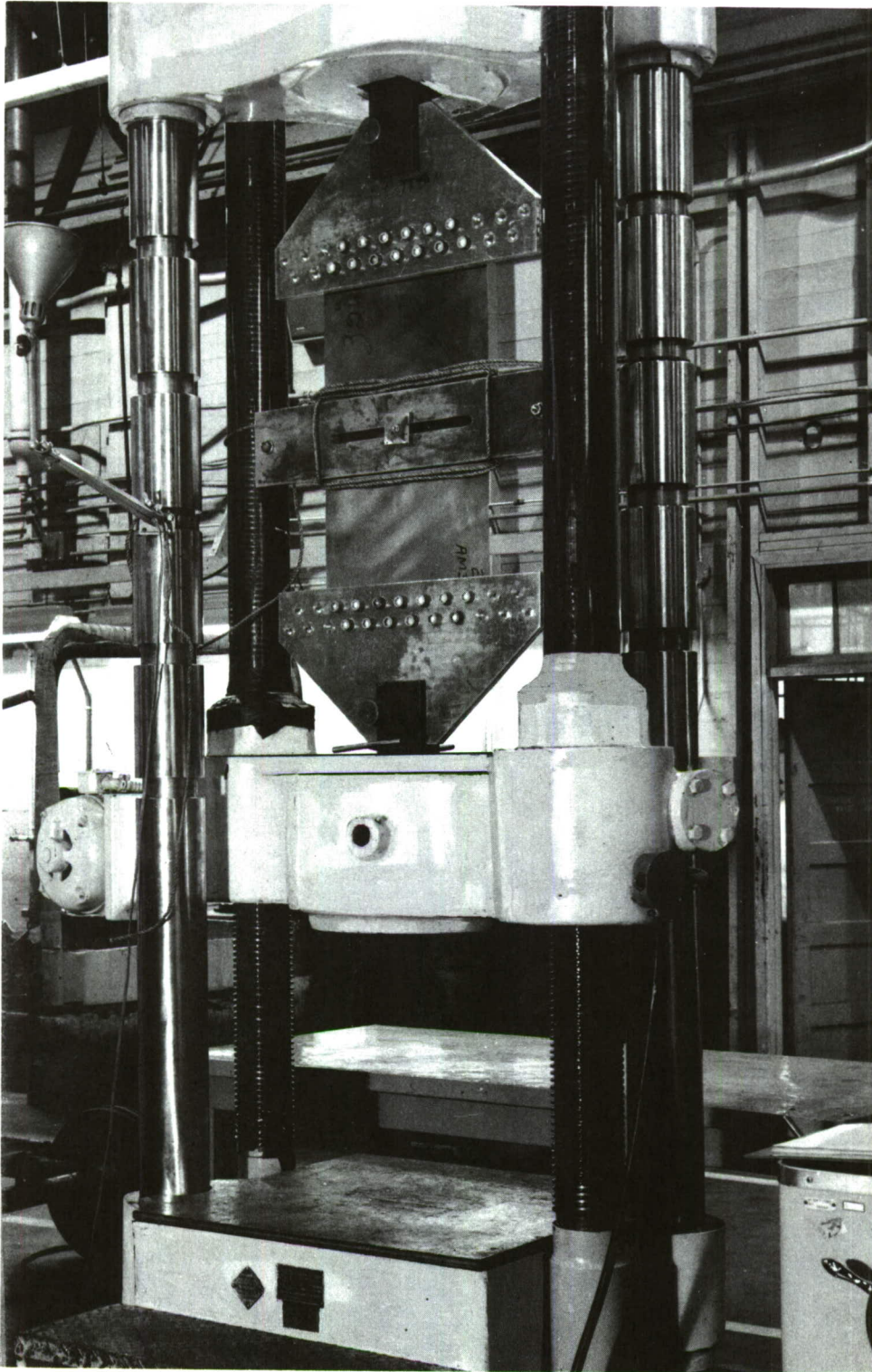

Figure 7. Test Setup for Stiffened Specimen

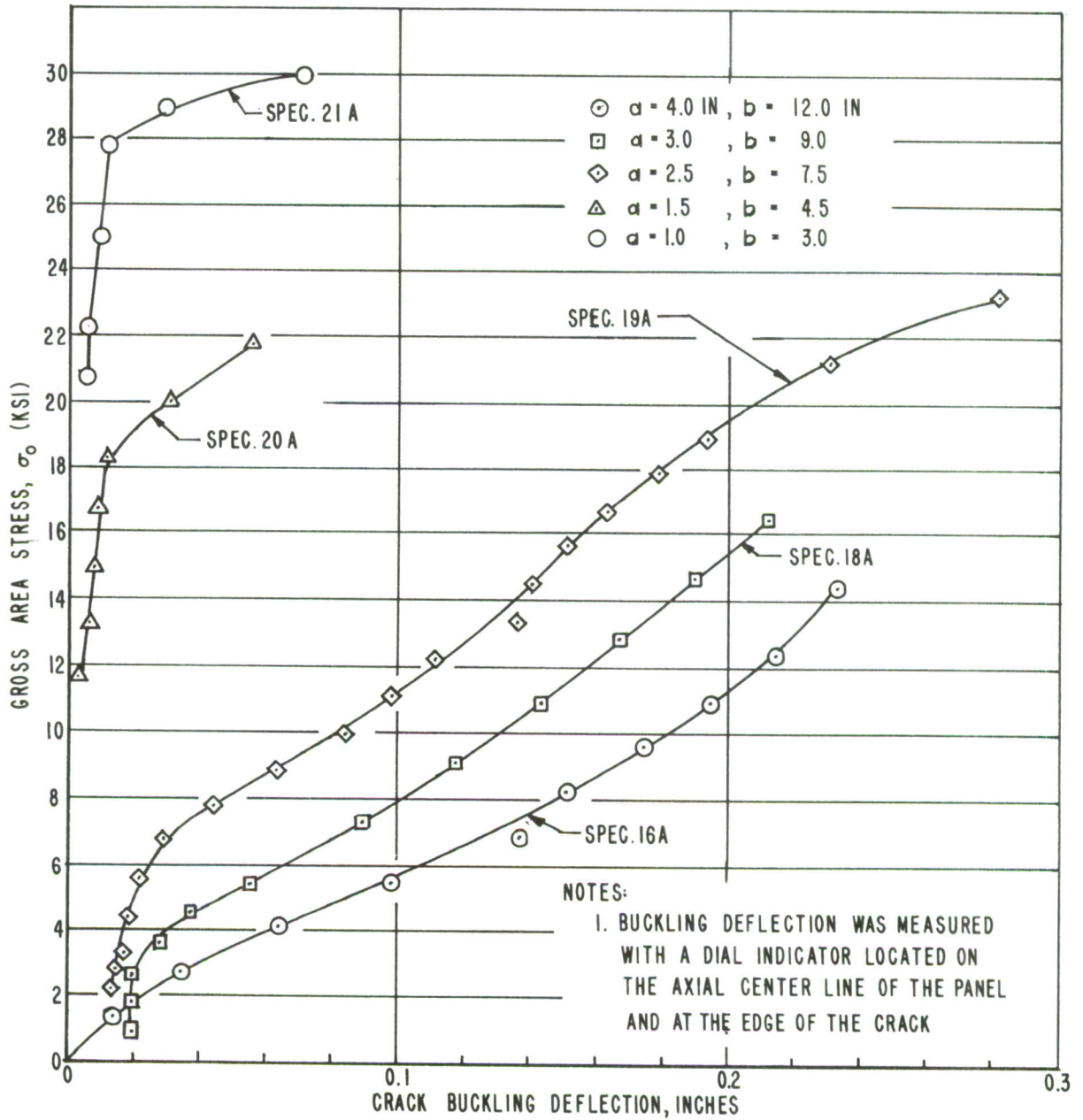

Figure 8. Variation in σ_0 with Crack Buckling Deflection for 0.060 Gage 2024-T3 Aluminum Sheet

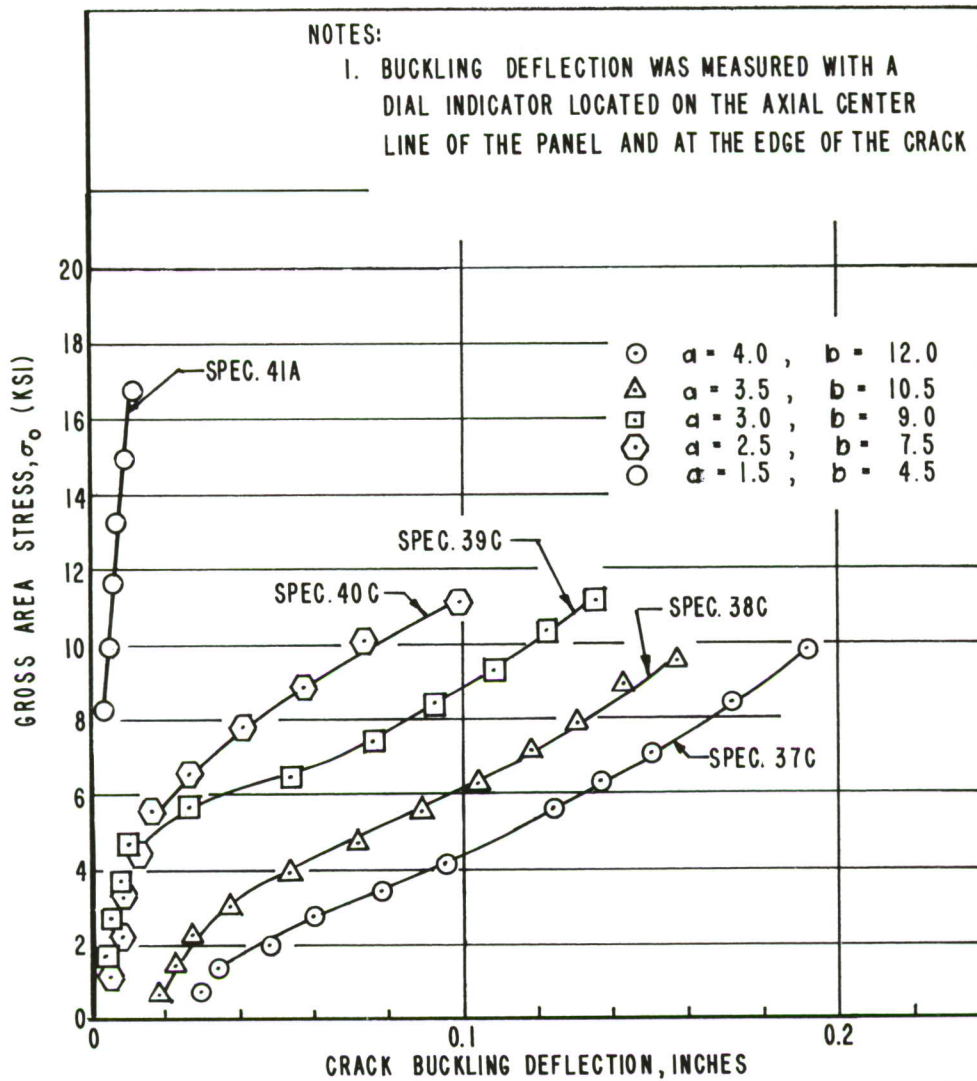

Figure 9. Variation in σ_0 with Crack Buckling Deflection for 0.060 Gage 2024-T81 Aluminum Sheet

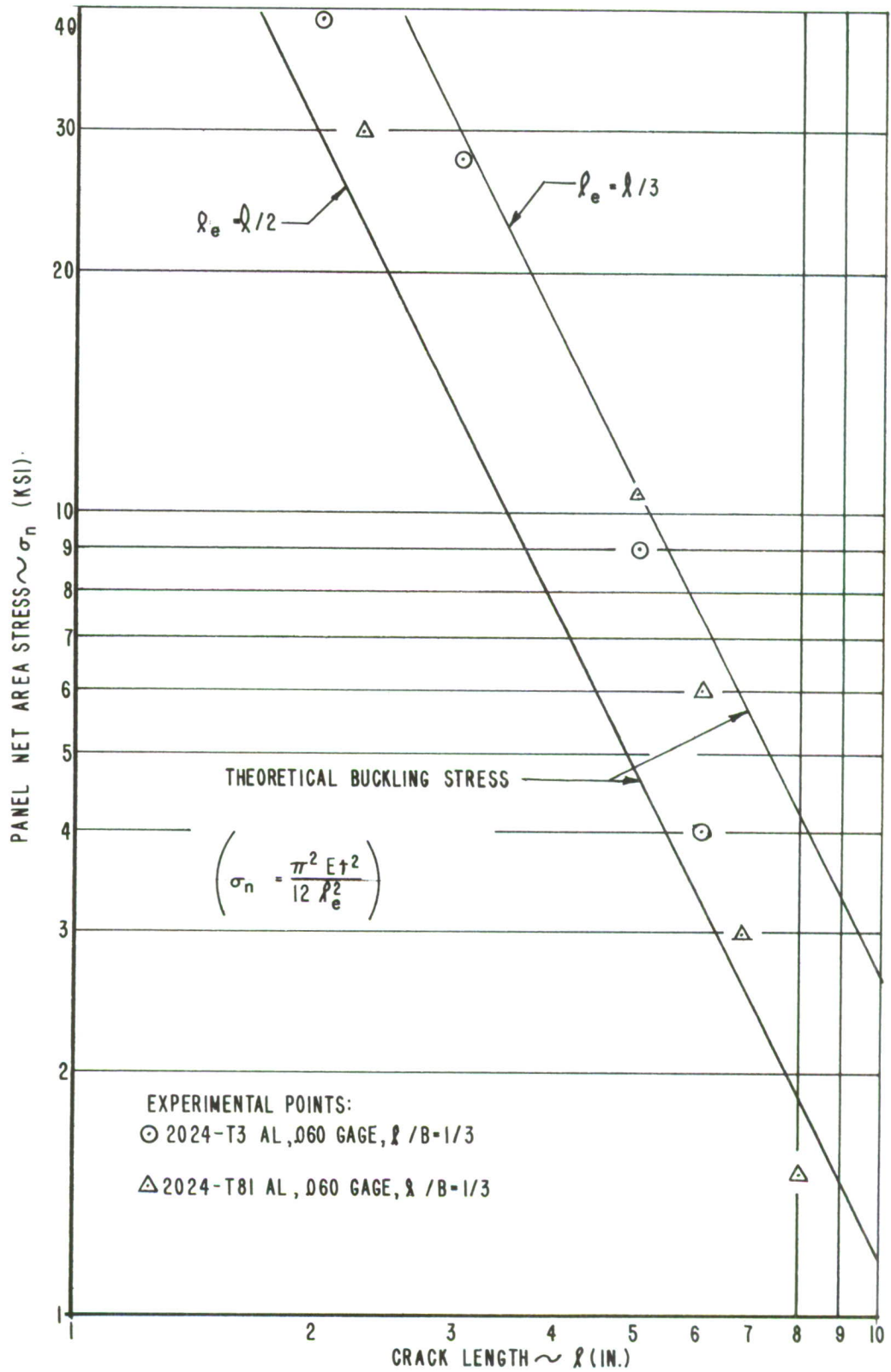

Figure 10. Comparison of Theoretical and Experimental Buckling Stress for Centrally Cracked Aluminum Panels

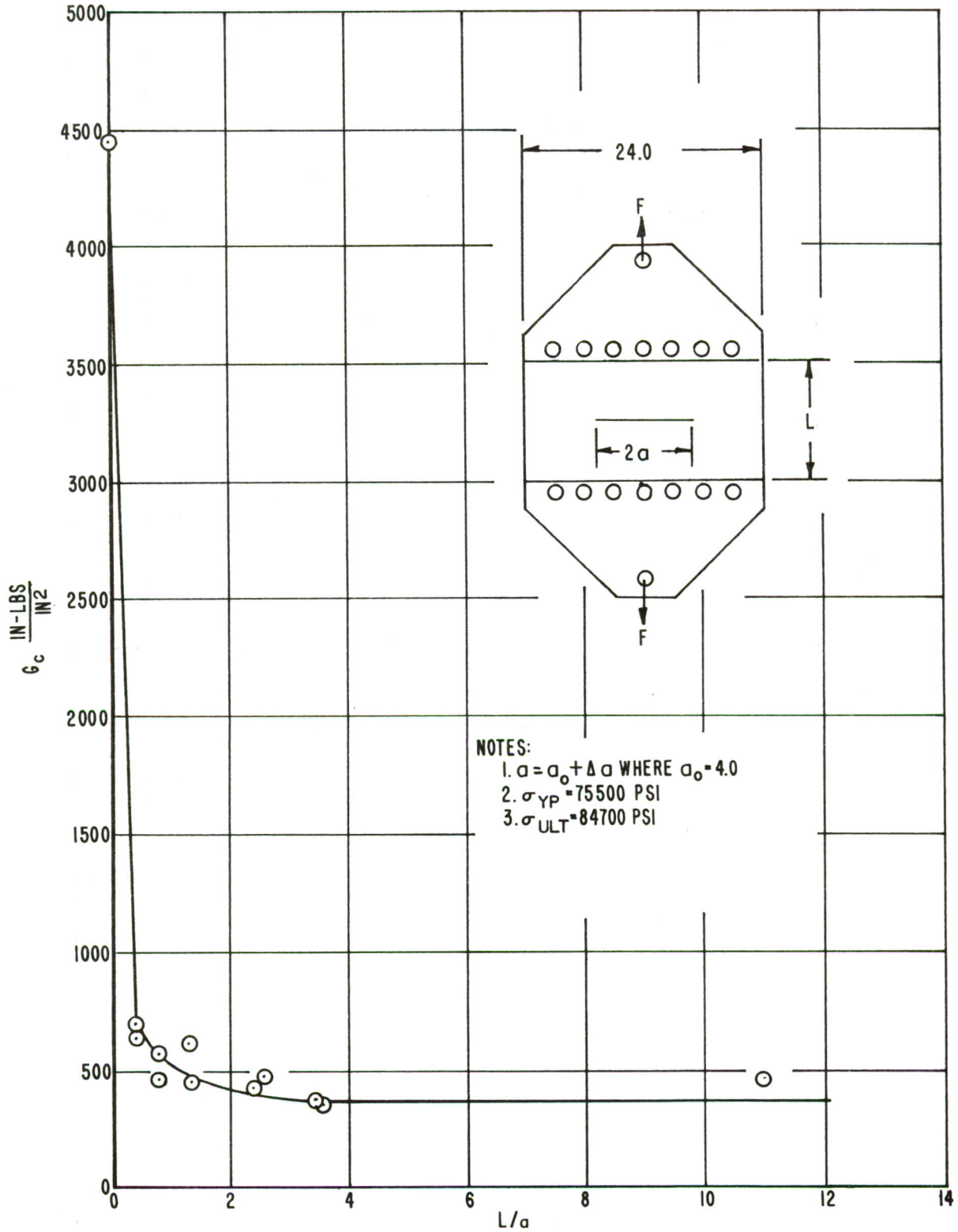

Figure 11. Variation in G_c with L/a for 0.060 Gage 7075-T6 Aluminum Sheet

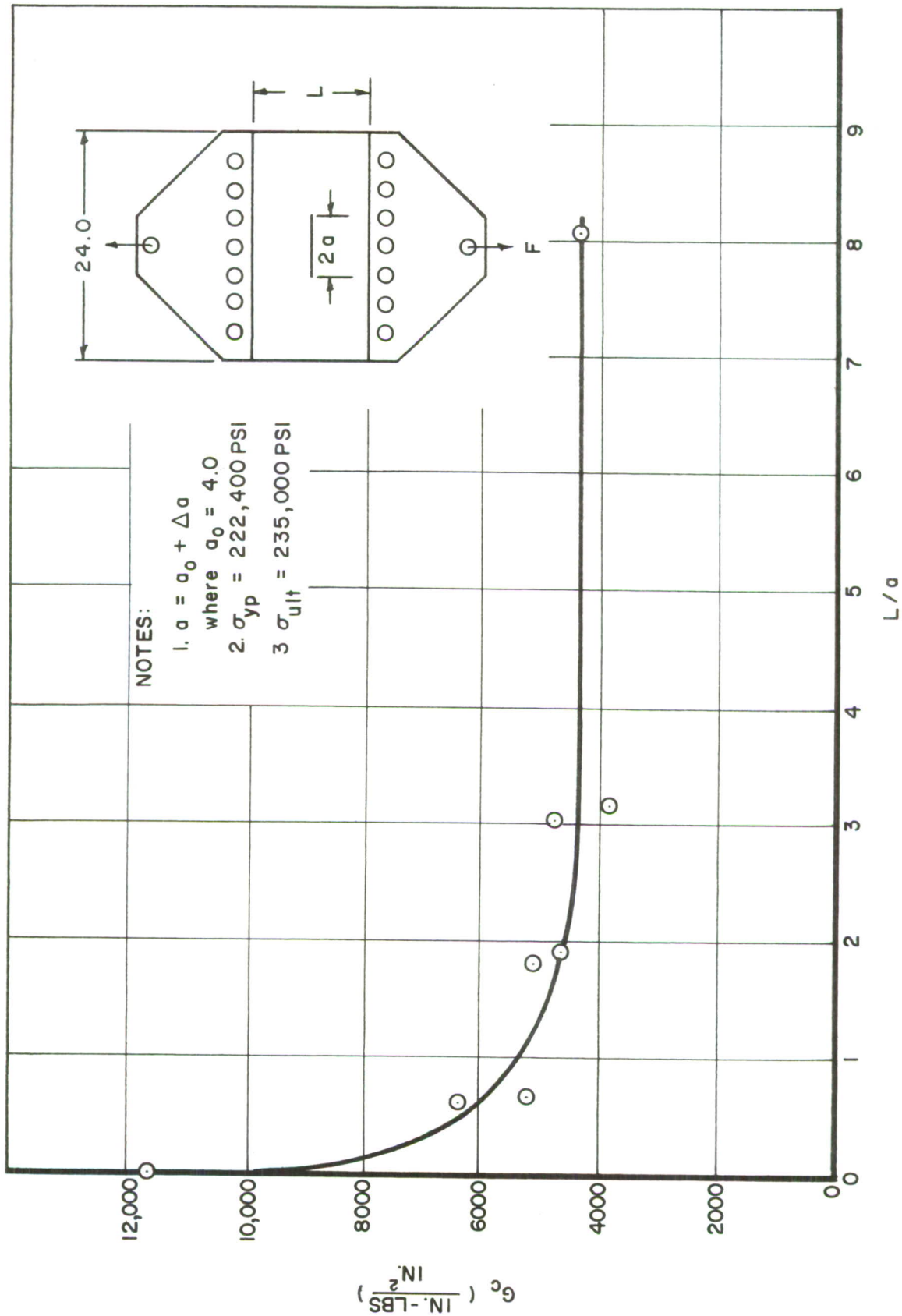

Figure 12. Variation in G_c with L/a for 0.020 Gage AM355CRT Steel Coil

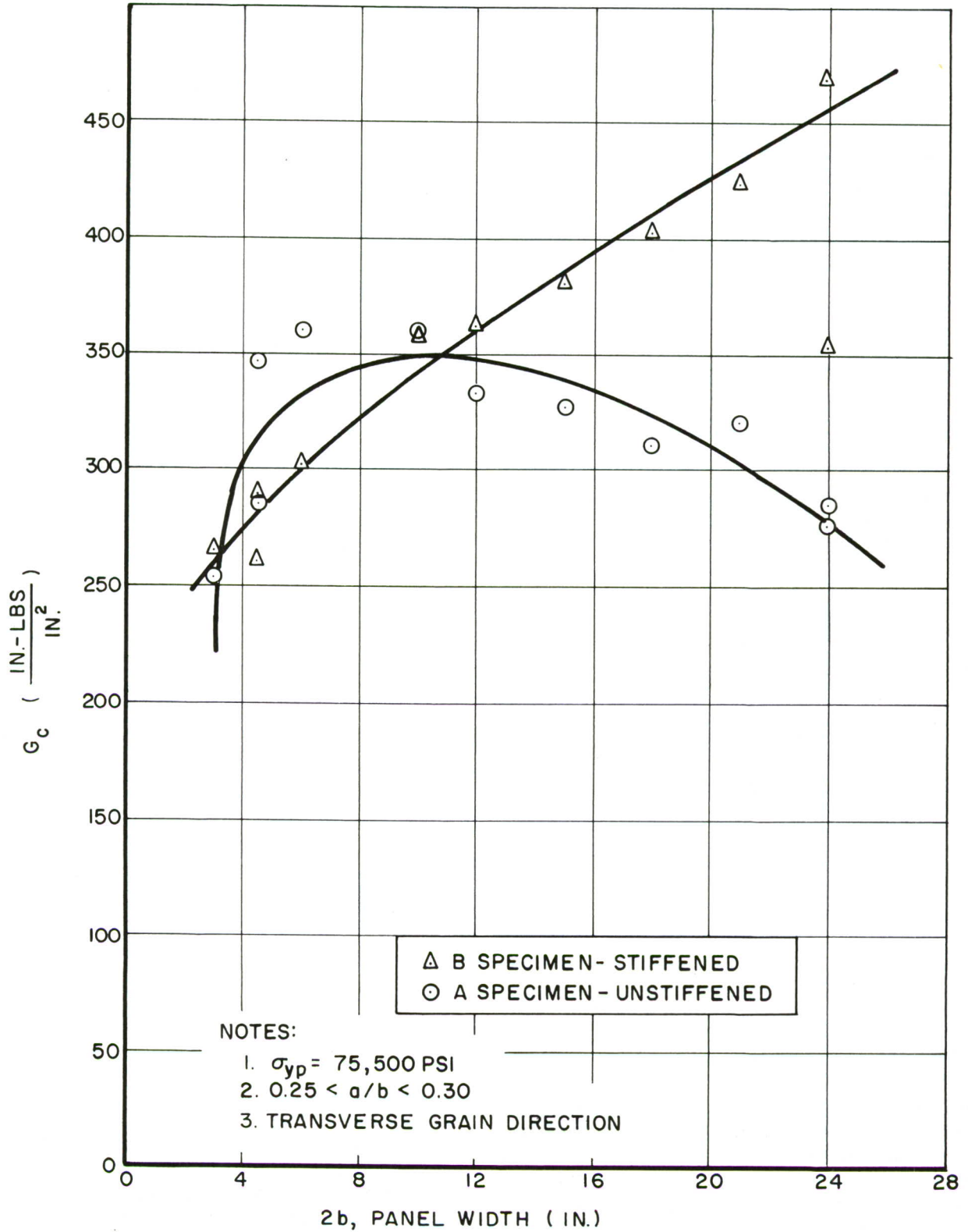

Figure 13. Variation in G_c with Panel Width at Constant a_o/b for 0.063 Gage 7075-T6 Aluminum Sheet

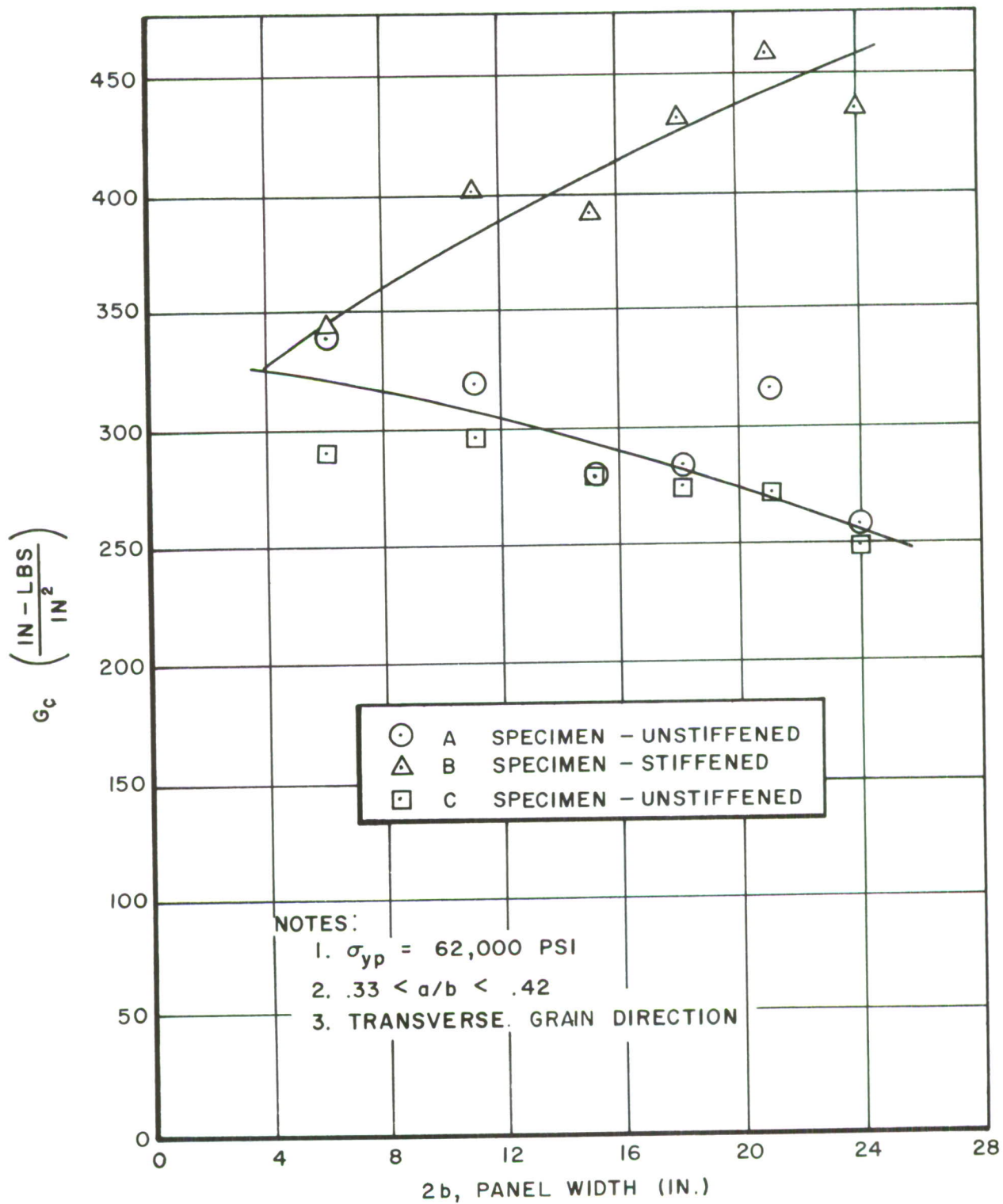

Figure 14. Variation in G_c with Panel Width at Constant a_o/b for 0.060 Gage 2024-T81 Aluminum Sheet

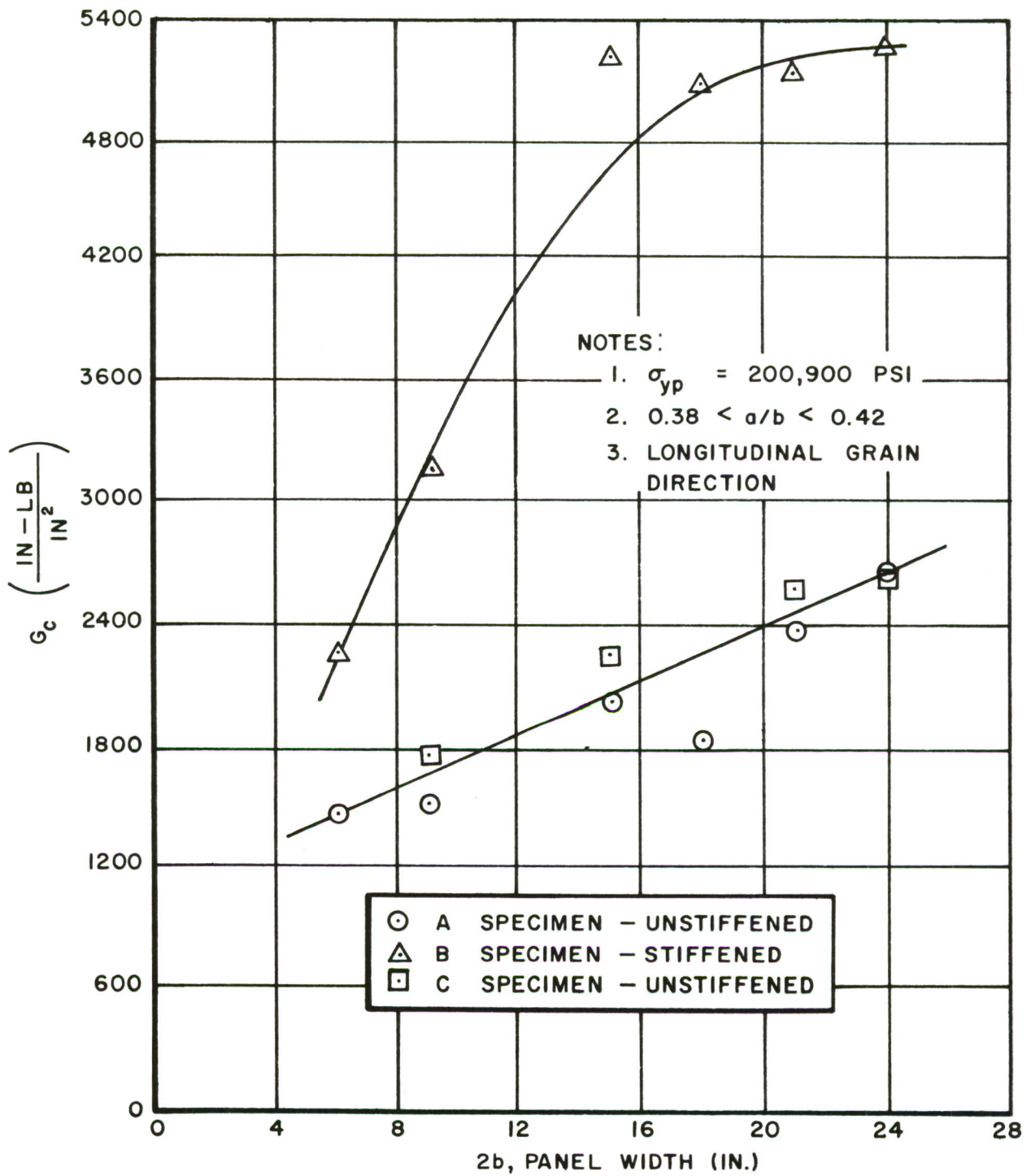

Figure 15. Variation in G_c with Panel Width at Constant a_o/b for 0.020 Gage AM350CRT Steel Sheet

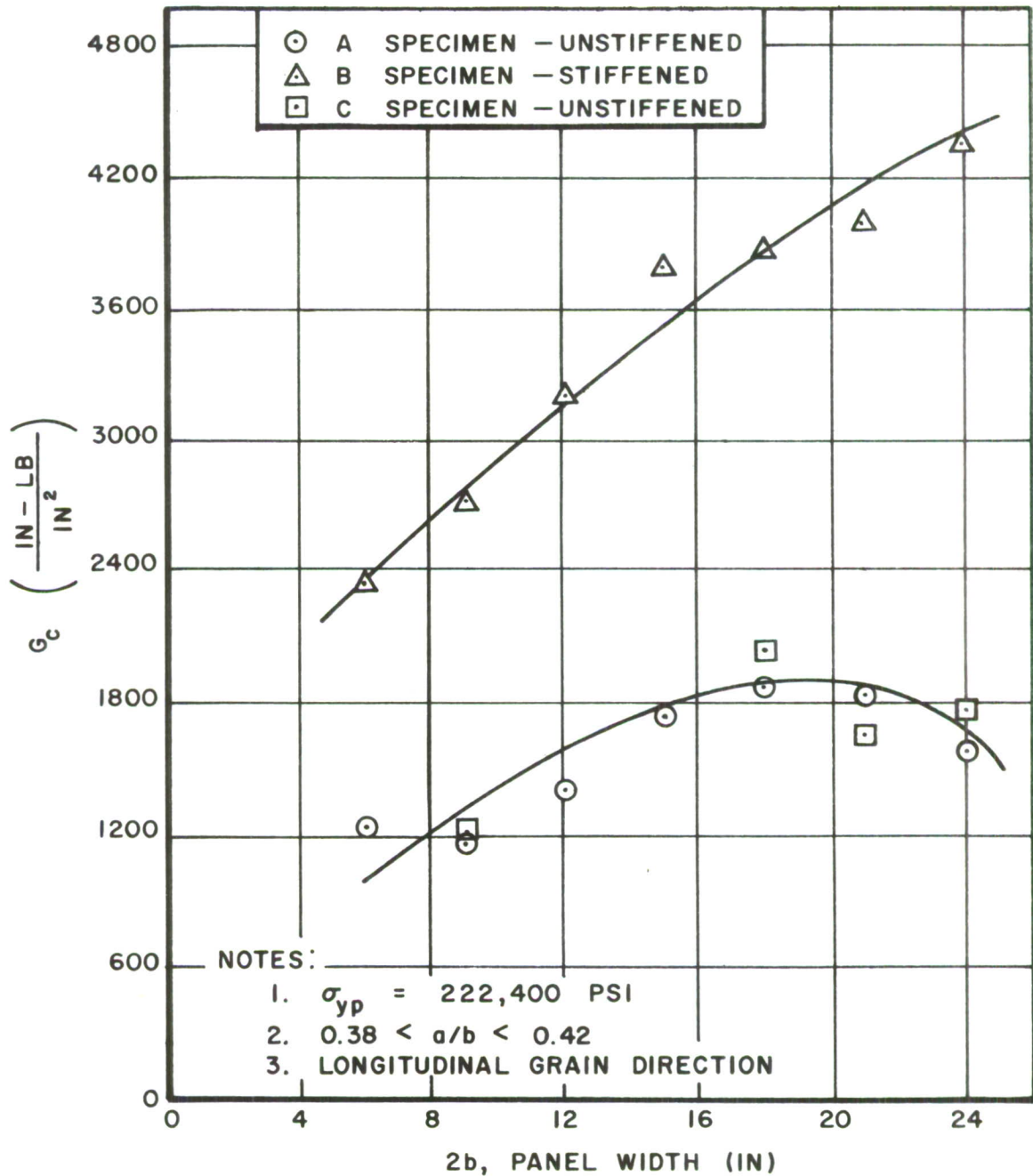

Figure 16. Variation in G_c with Panel Width at Constant a_0/b for 0.020 Gage AM355CRT Steel Coil

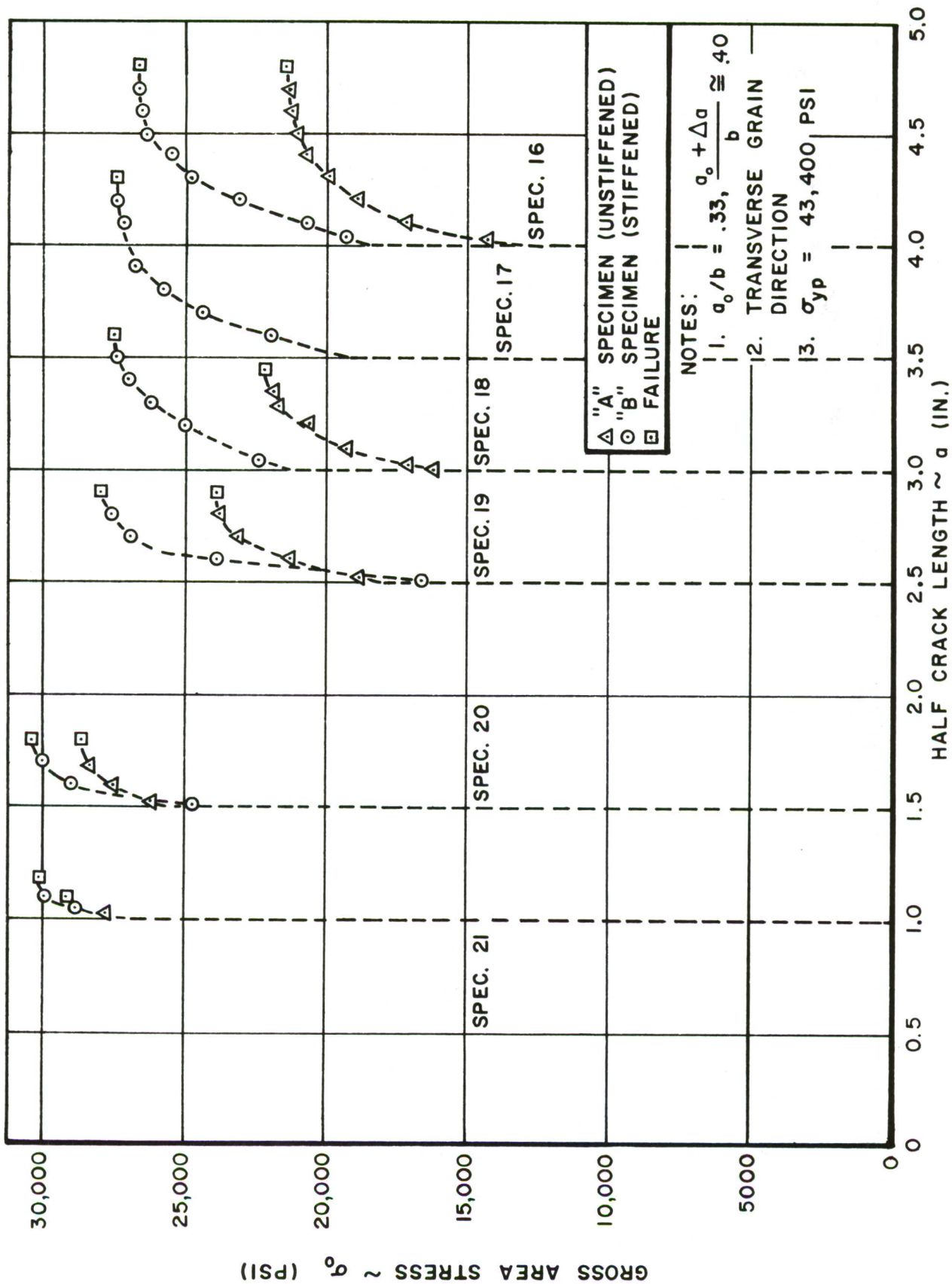

Figure 17. Variation in σ_0 with Half Crack Length, a , for 0.060 Gage 2024-T3 Aluminum Sheet

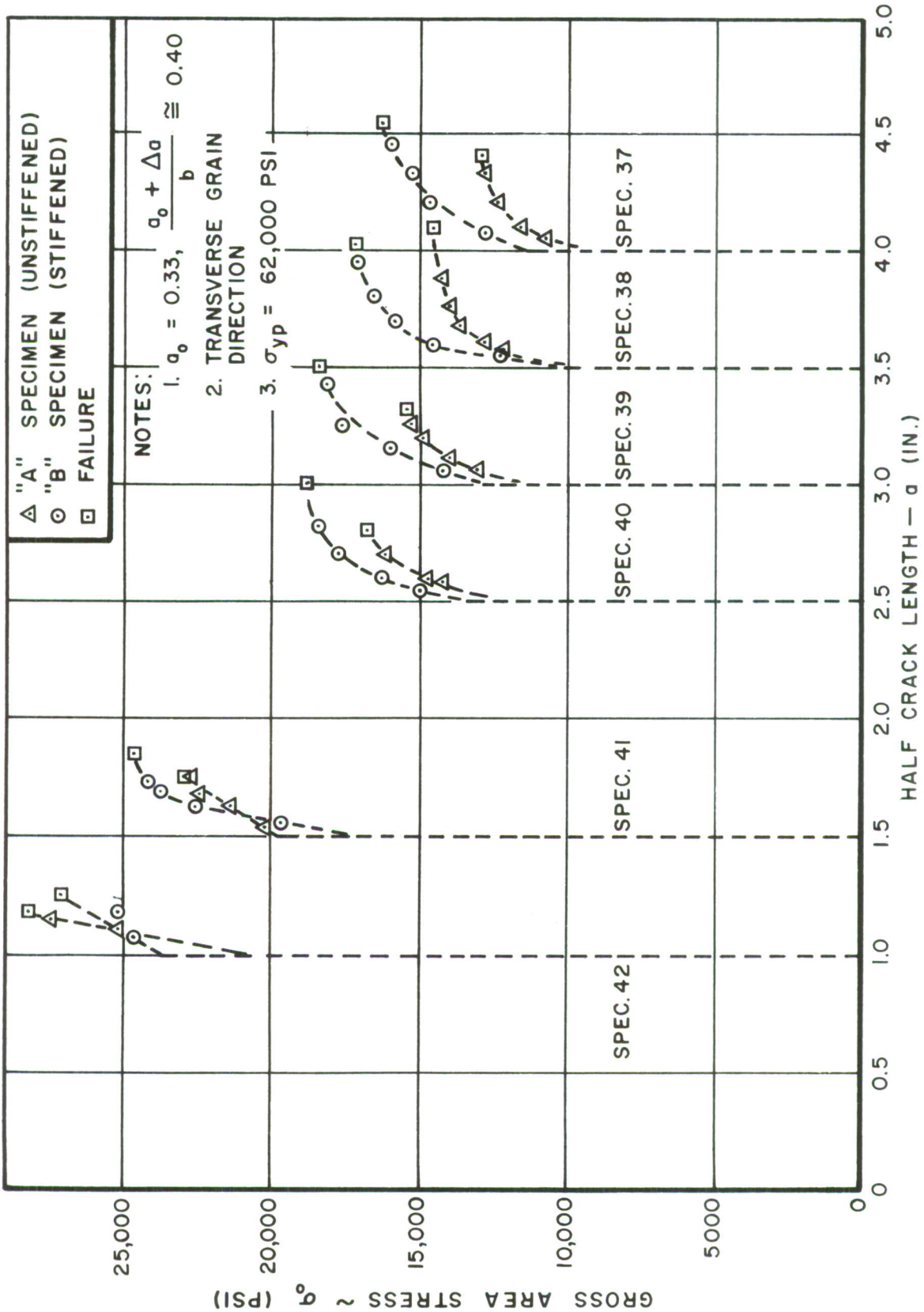

Figure 18. Variation in σ with Half Crack Length, a, for 0.060 Gage 2024-T81 Aluminum Sheet

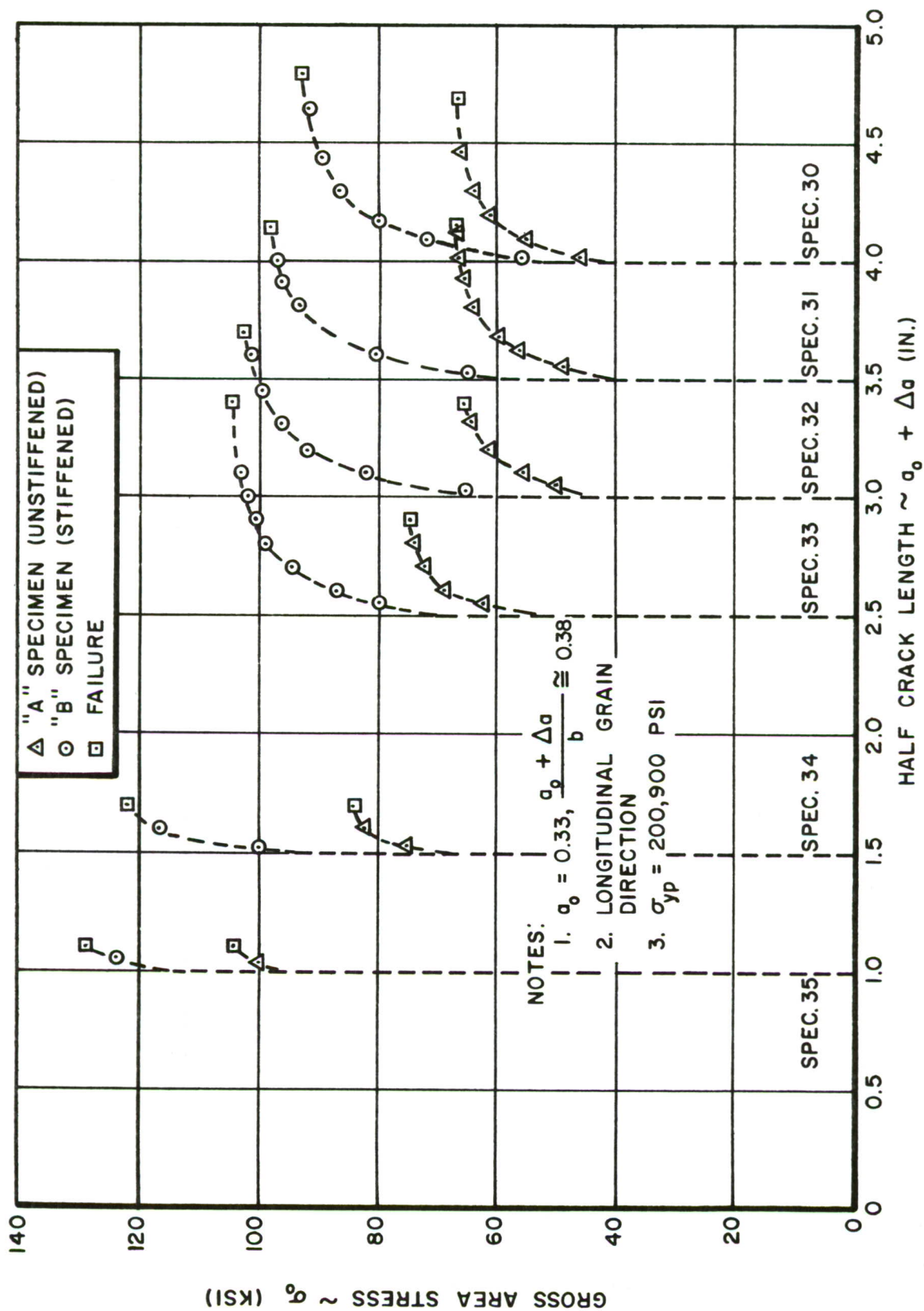

Figure 19. Variation in σ_0 with Half Crack Length, a, for 0.020 Gage AM350CRT Steel Sheet

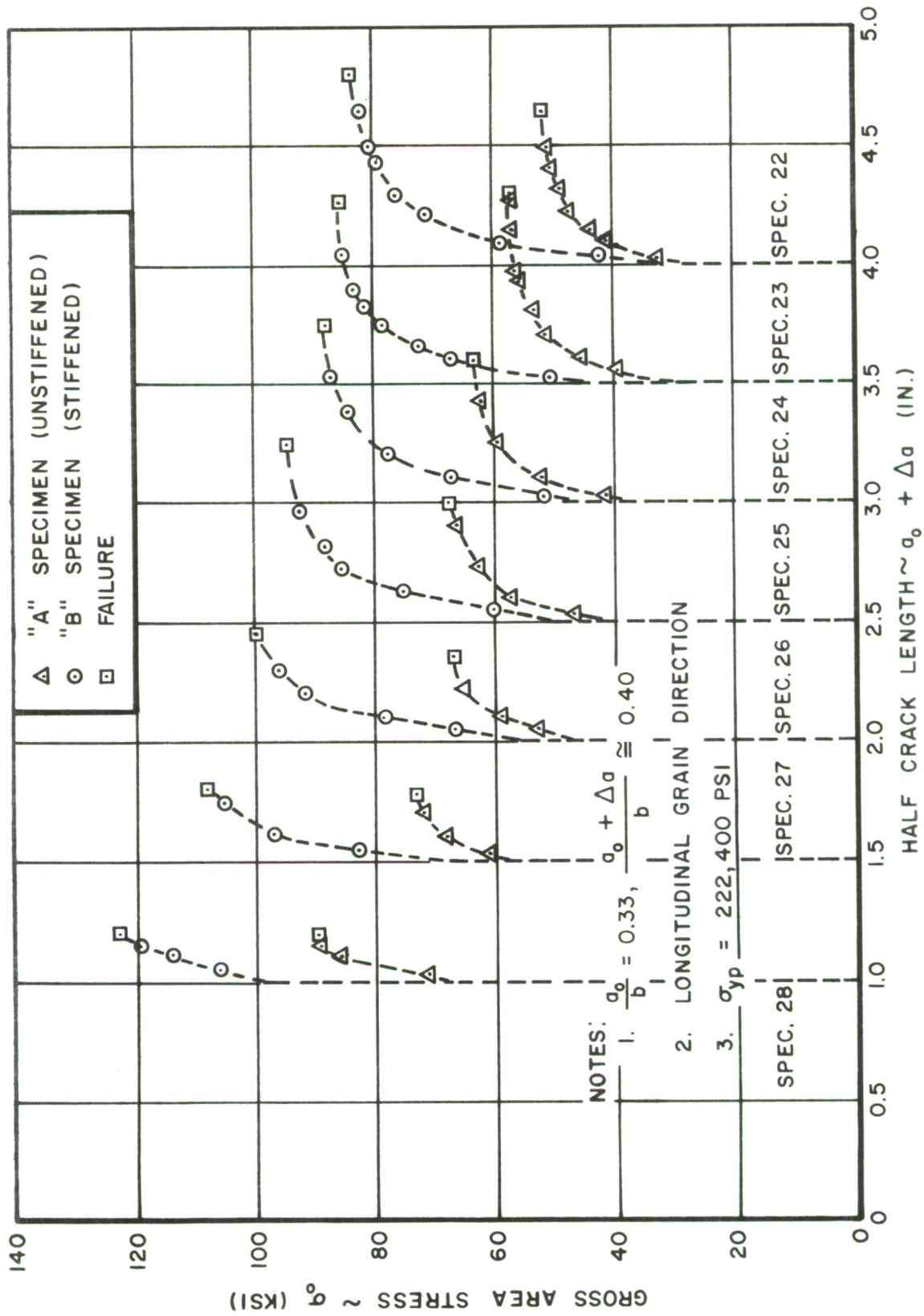

Figure 20. Variation in σ_0 with Half Crack Length, a, for 0.020 Gage AM355CRT Steel Coil

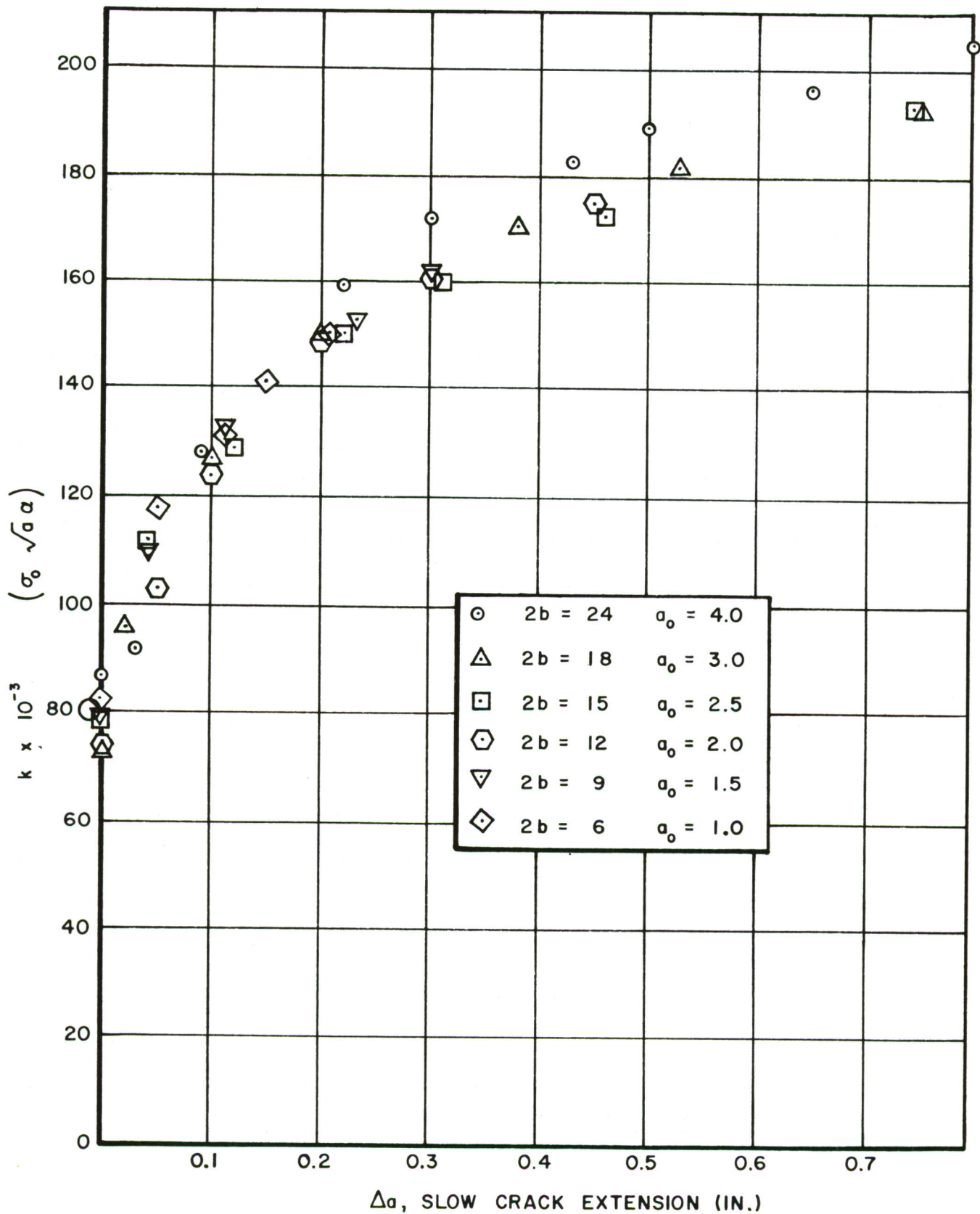

Figure 21. Variation in k with Δa for 0.020 Gage AM355CRT Steel Coil

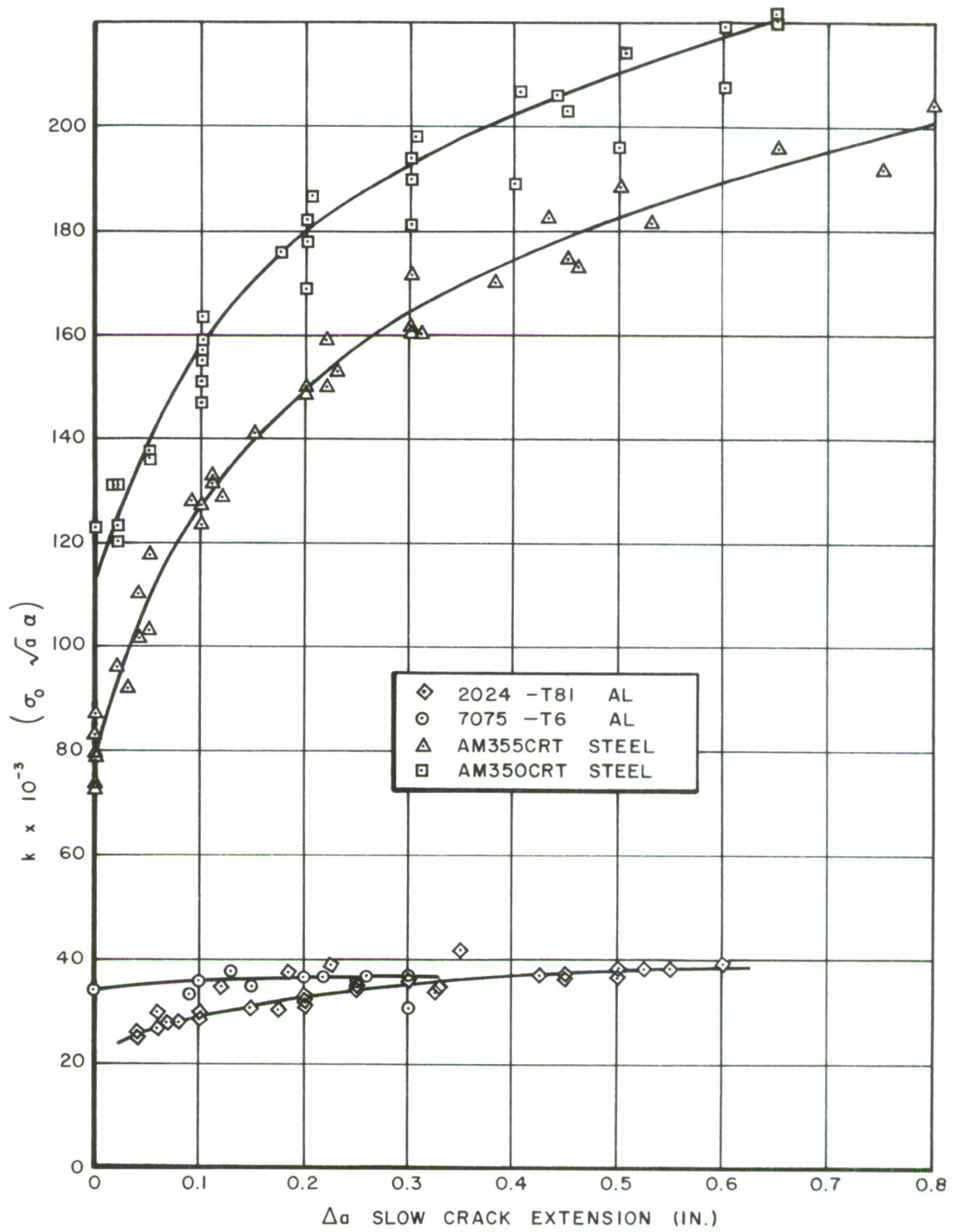

Figure 22. Variation in k with Δa

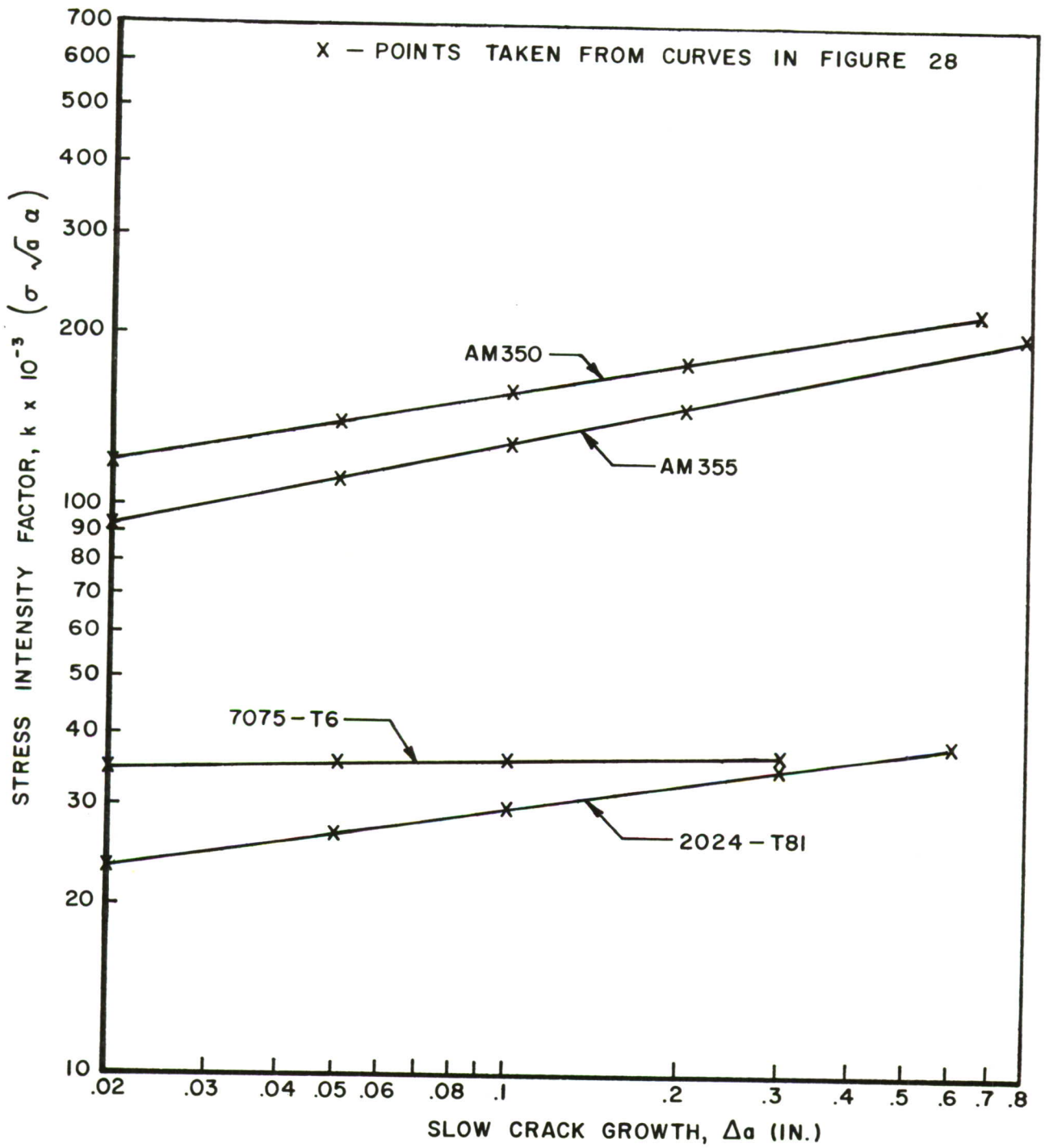
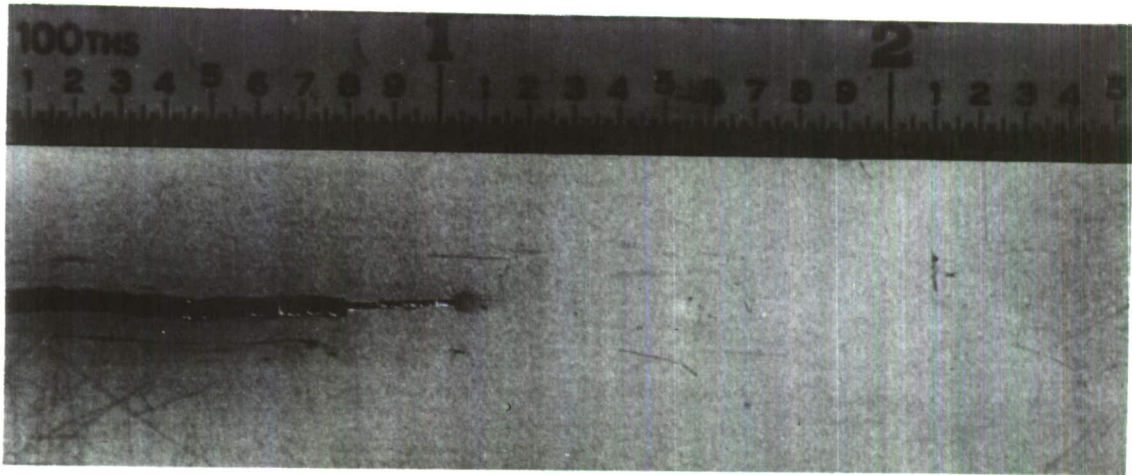
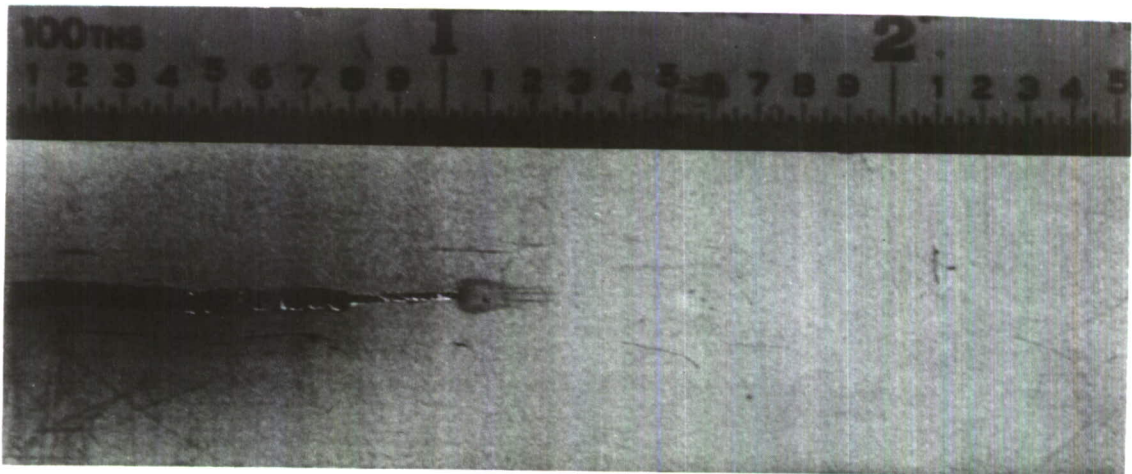
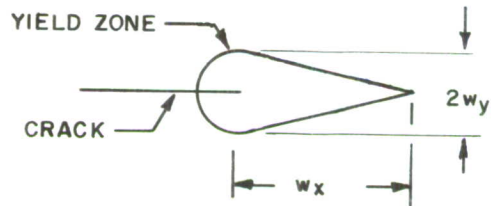

Figure 23. Variation in k with Δa



DATA TABLE

$\sigma_0 = 38,400 \text{ PSI}$
 $a_0 + \Delta a = 2.50 \text{ IN.}$
 $k = 65,000 \text{ LB-IN.}^{-3/2}$
 $2w_y = .04 \text{ IN.}$
 $w_x = .10 \text{ IN.}$



DATA TABLE

$\sigma_0 = 52,100 \text{ PSI}$
 $a_0 + \Delta a = 2.50 \text{ IN.}$
 $k = 88,200 \text{ LB-IN.}^{-3/2}$
 $2w_y = .07 \text{ IN.}$
 $w_x = .20 \text{ IN.}$

Figure 24. Yield Zone Photographs from Specimen No. 33B
0.020 Gage AM350CRT Steel Sheet

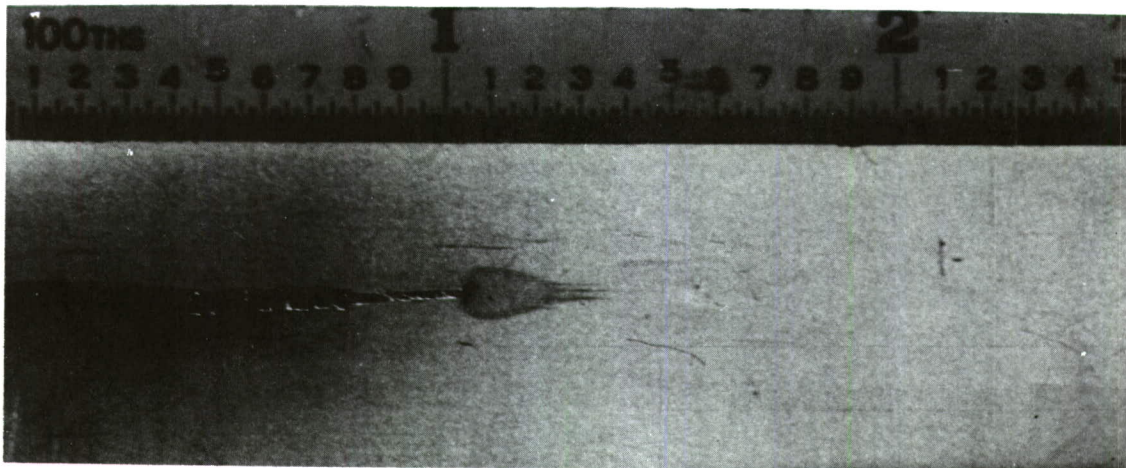

DATA TABLE

$\sigma_0 = 64,100$ PSI
 $a_0 + \Delta a = 2.50$ IN
 $k = 108,500$ LB-IN^{-3/2}
 $2w_y = .11$ IN.
 $w_x = .28$ IN.

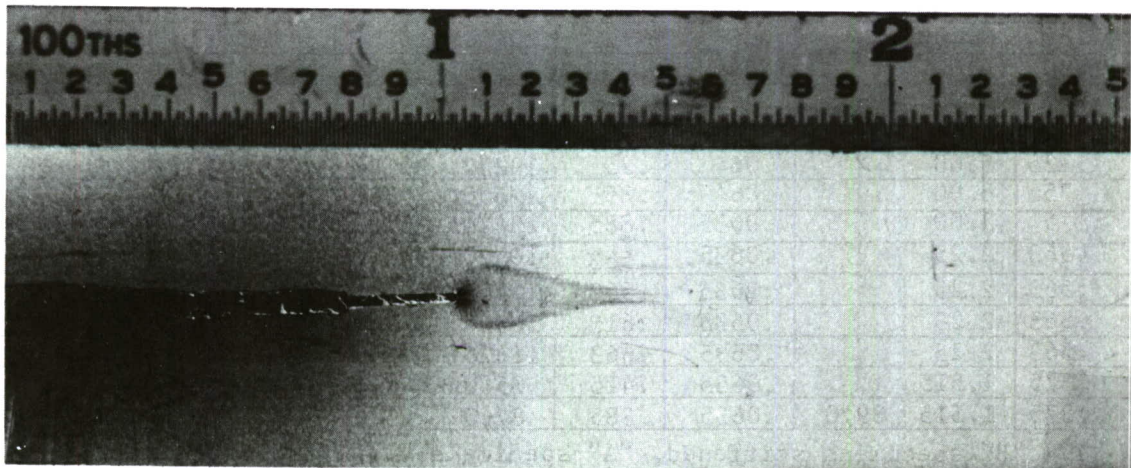

DATA TABLE

$\sigma_0 = 72,700$ PSI
 $a_0 + \Delta a = 2.50$ IN.
 $k = 123,000$ LB-IN^{-3/2}
 $2w_y = .13$ IN.
 $w_x = .43$ IN.

Figure 25. Yield Zone Photographs from Specimen No. 33B
0.020 Gage AM350CRT Steel Sheet

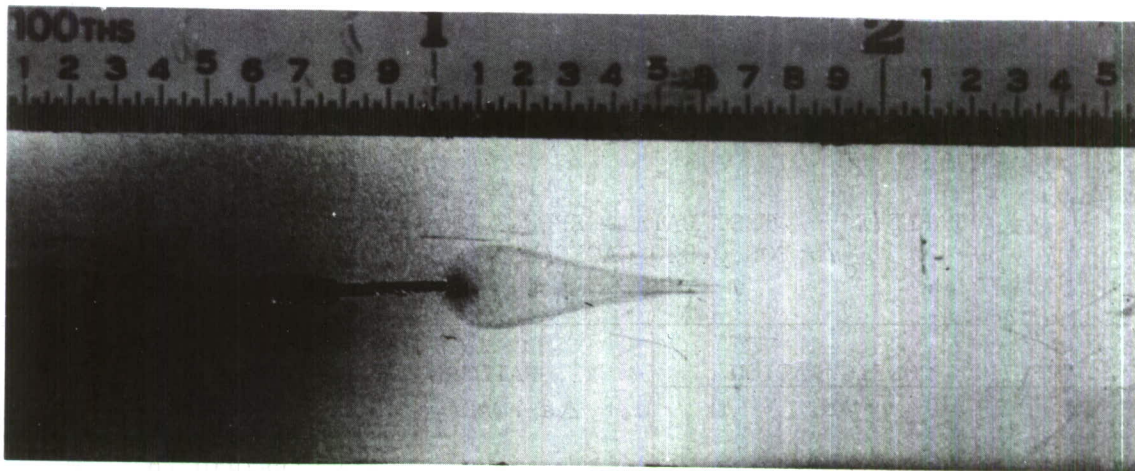

DATA TABLE

$\sigma_0 = 80,000 \text{ PSI}$
 $a_0 + \Delta a = 2.35 \text{ IN.}$
 $k = 136,500 \text{ LB-IN.}^{-3/2}$
 $2w_y = .18 \text{ IN.}$
 $w_x = .52 \text{ IN.}$

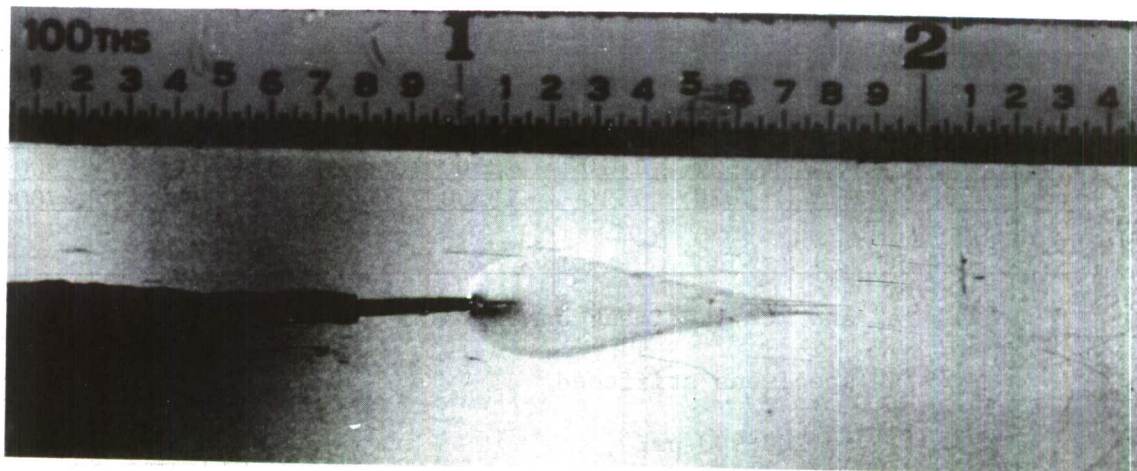

DATA TABLE

$\sigma_0 = 87,100 \text{ PSI}$
 $a_0 + \Delta a = 2.60 \text{ IN.}$
 $k = 151,000 \text{ LB-IN.}^{-3/2}$
 $2w_y = .21 \text{ IN.}$
 $w_x = .63 \text{ IN.}$

Figure 26. Yield Zone Photographs from Specimen No. 33B
0.020 Gage AM350CRT Steel Sheet

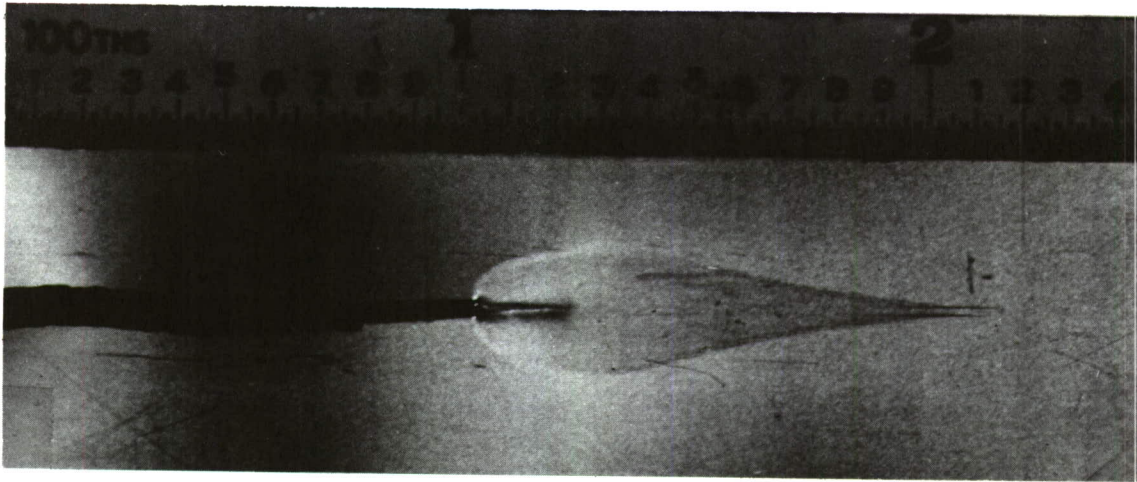

DATA TABLE

$\sigma_0 = 94,600 \text{ PSI}$
 $a_0 + \Delta a = 2.69 \text{ IN.}$
 $k = 168,000 \text{ LB-IN}^{-3/2}$
 $2w_y = .25 \text{ IN.}$
 $w_x = .85 \text{ IN.}$

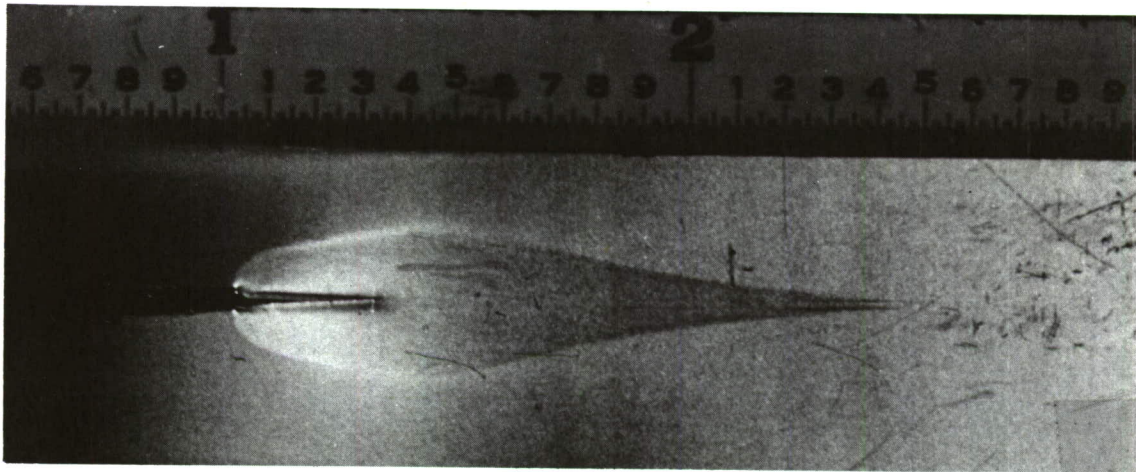

DATA TABLE

$\sigma_0 = 99,100 \text{ PSI}$
 $a_0 + \Delta a = 2.82 \text{ IN.}$
 $k = 182,000 \text{ LB-IN}^{-3/2}$
 $2w_y = .30 \text{ IN.}$
 $w_x = 1.08 \text{ IN.}$

Figure 27. Yield Zone Photographs from Specimen No. 33B
0.020 Gage AM350CRT Steel Sheet

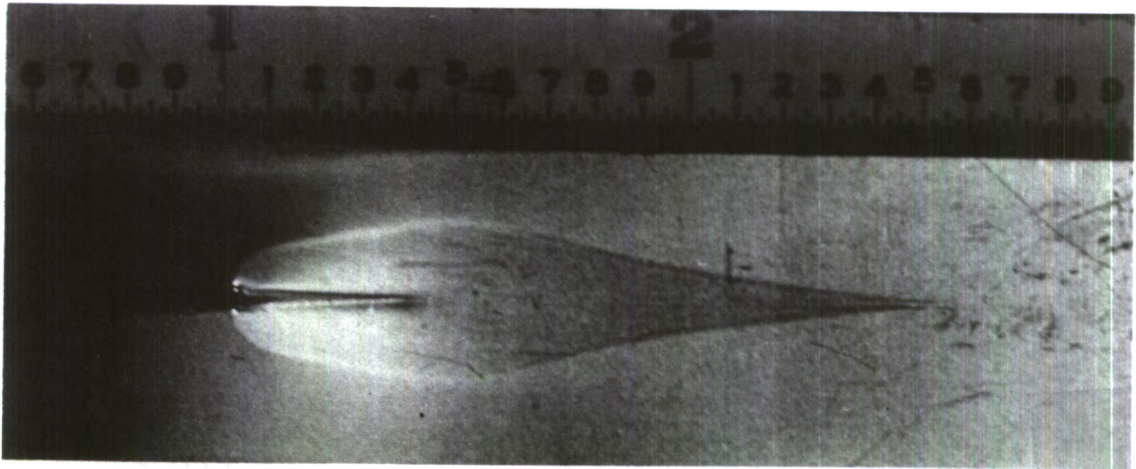

DATA TABLE

$\sigma_0 = 100,500 \text{ PSI}$
 $a_0 + \Delta a = 2.87 \text{ IN.}$
 $k = 189,000 \text{ LB-IN.}^{-3/2}$
 $2w_y = .325 \text{ IN.}$
 $w_x = 1.11 \text{ IN.}$

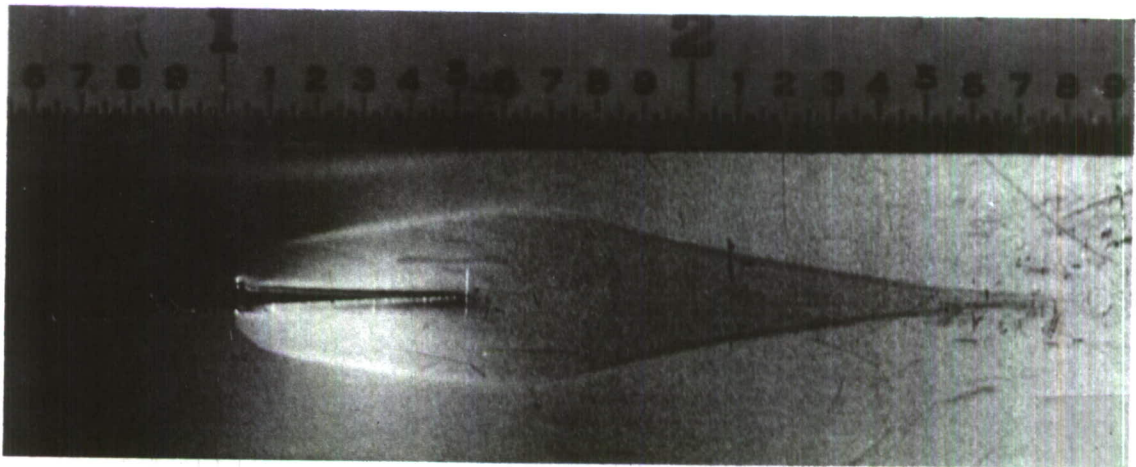

DATA TABLE

$\sigma_0 = 102,100 \text{ PSI}$
 $a_0 + \Delta a = 3.00 \text{ IN.}$
 $k = 197,000 \text{ LB-IN.}^{-3/2}$
 $2w_y = .360 \text{ IN.}$
 $w_x = 1.22 \text{ IN.}$

Figure 28. Yield Zone Photographs from Specimen No. 33B
0.020 Gage AM350CRT Steel Sheet

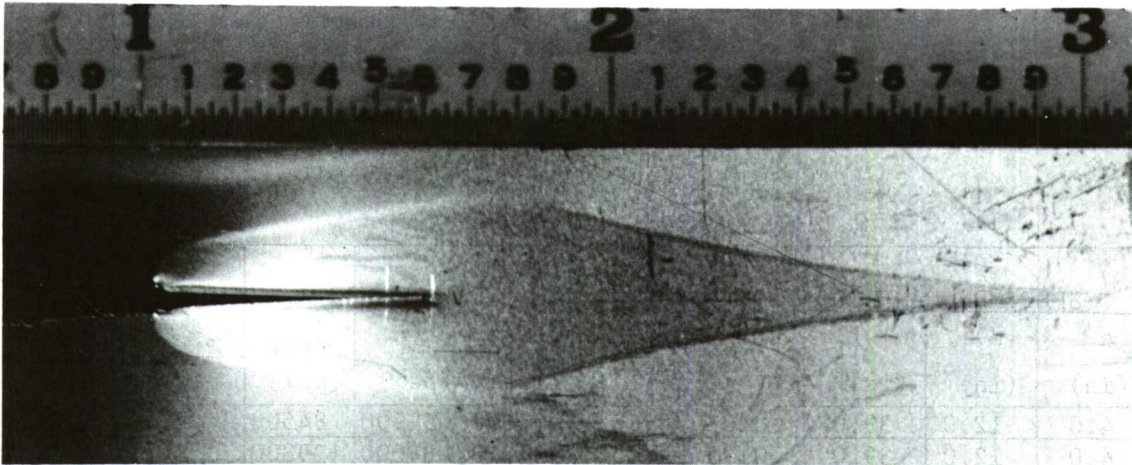

DATA TABLE

$\sigma_0 = 103,100 \text{ PSI}$
 $a_0 + \Delta a = 3.08 \text{ IN.}$
 $k = 202,000 \text{ LB-IN.}^{-3/2}$
 $2w_y = .390 \text{ IN.}$
 $w_x = 1.35 \text{ IN.}$



DATA TABLE

$\sigma_0 = 104,700 \text{ PSI}$
 $a_0 + \Delta a = 3.35 \text{ IN.}$
 $k = 220,000 \text{ LB-IN.}^{-3/2}$
 $2w_y = .45 \text{ IN.}$
 $w_x = 1.54 \text{ IN.}$

Figure 29. Yield Zone Photographs from Specimen No. 33B
0.020 Gage AM350CRT Steel Sheet

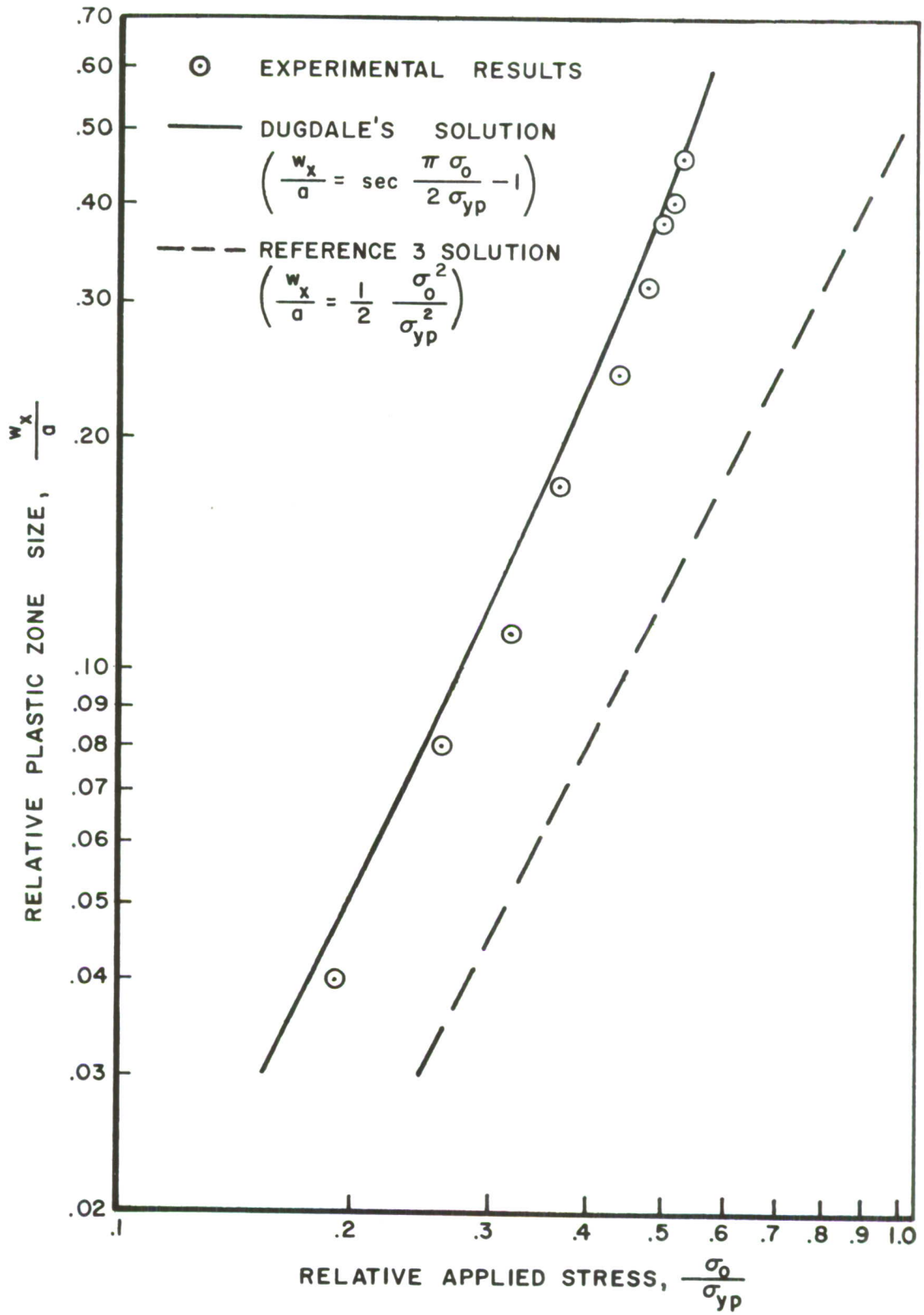

Figure 30. Comparison of Theoretical and Experimental Plastic Zone Sizes for Specimen No. 33B, 0.020 Gage AM350CRT Steel Sheet

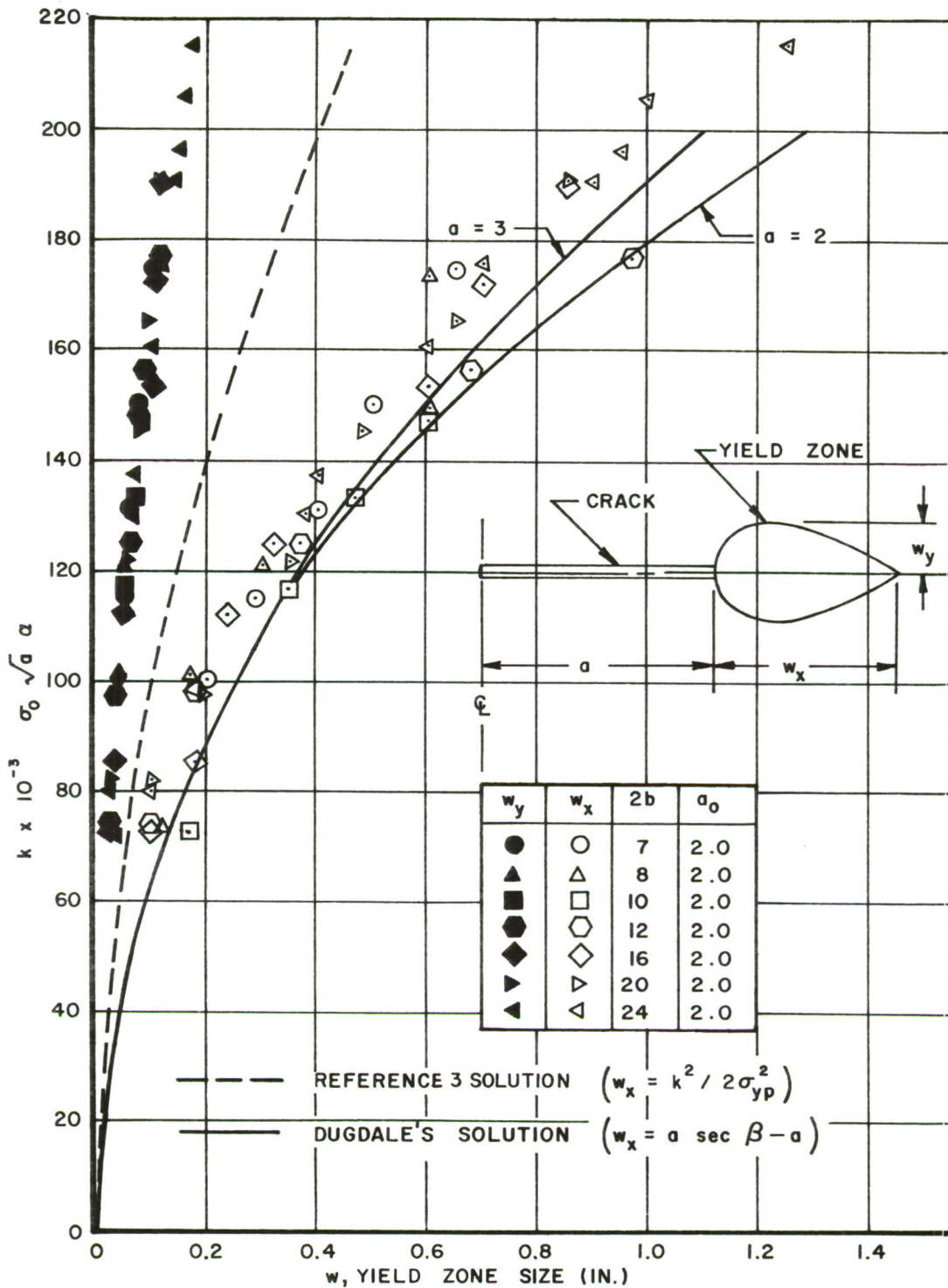

Figure 31. Variation in k with w for 0.020 Gage AM355CRT Steel Coil

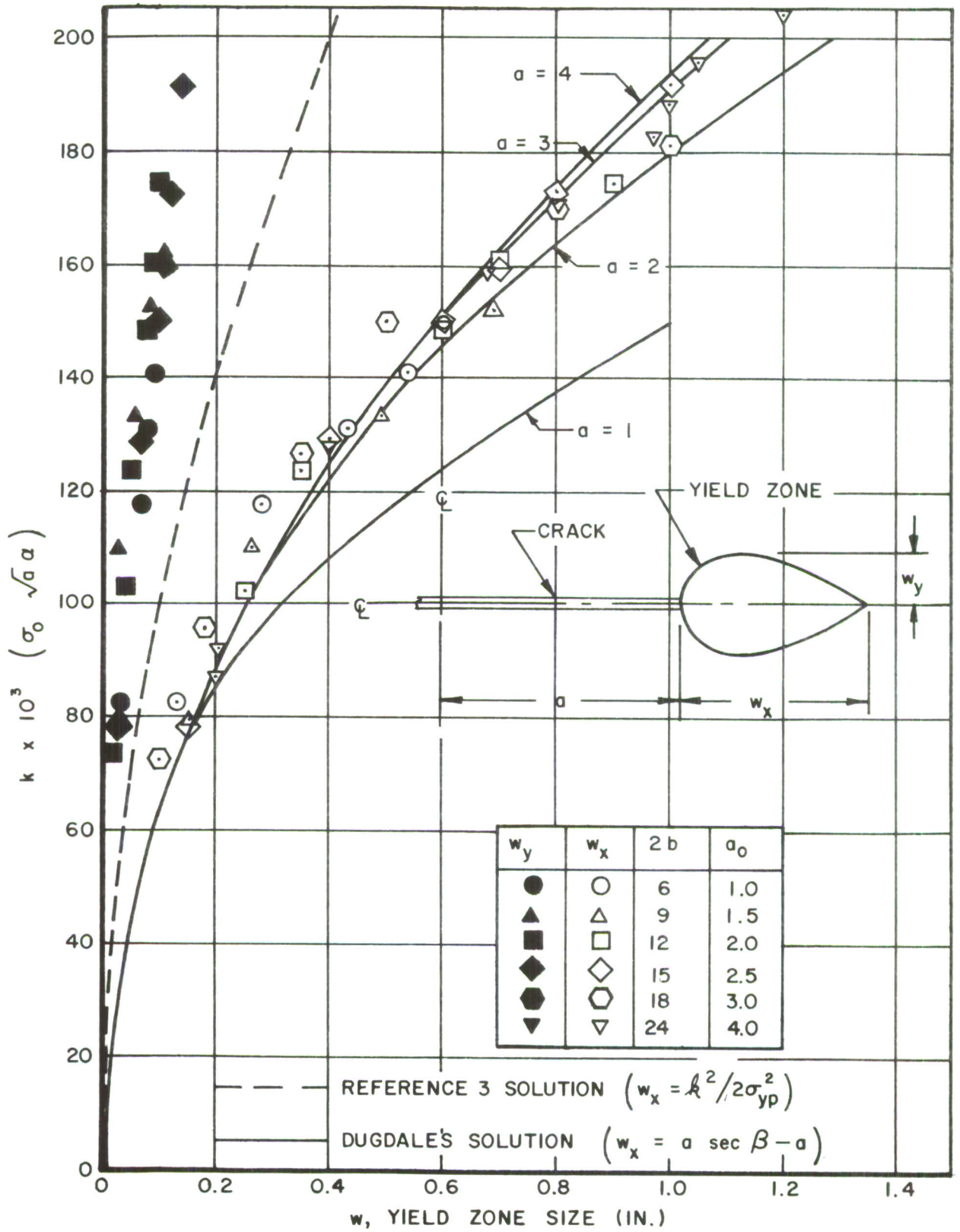

Figure 32. Variation in k with w for 0.020 Gage AM355CRT Steel Coil

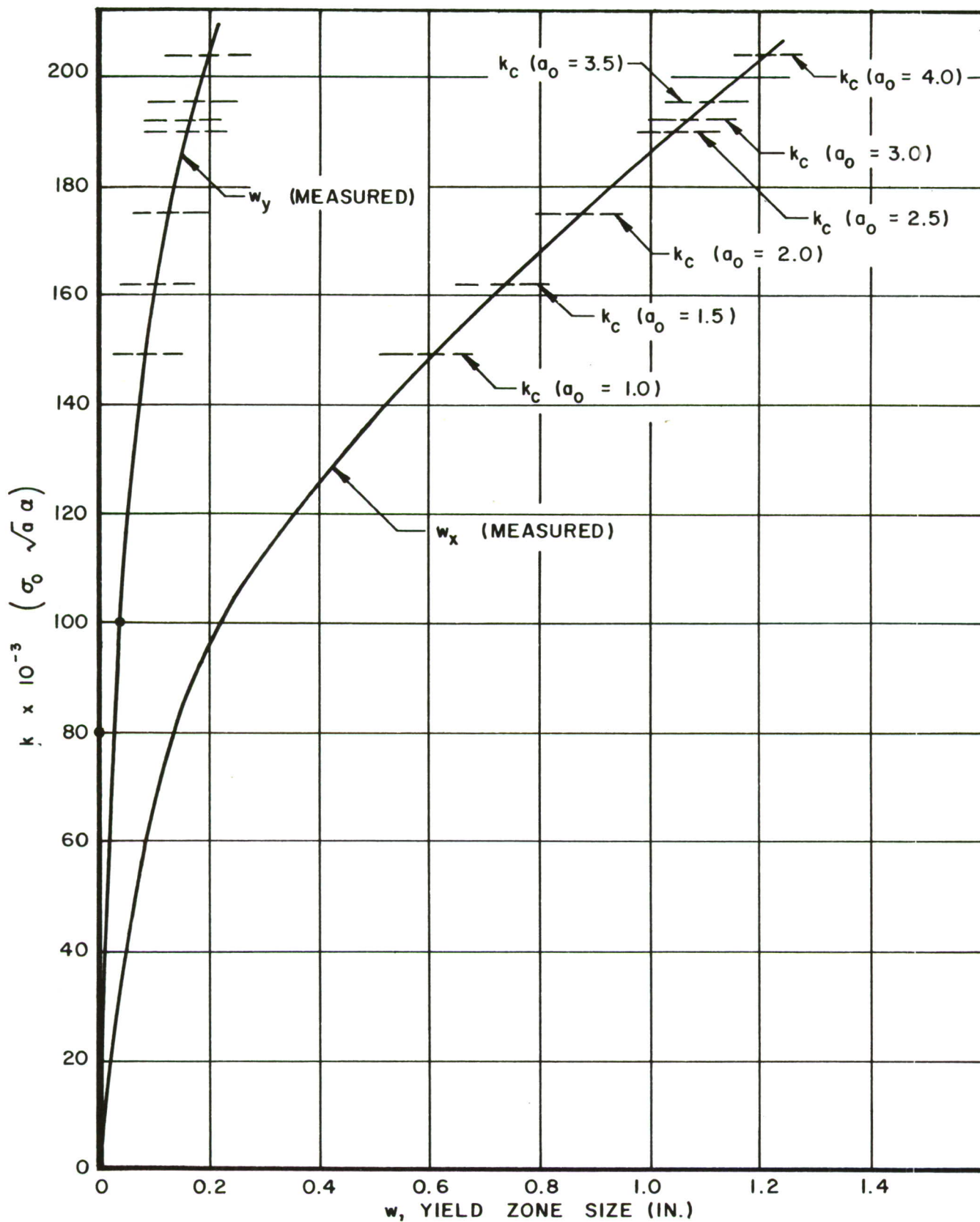









Figure 33. Change in k_c with w for 0.020 Gage AM355CRT Steel Coil













TABLE I TENSILE PROPERTIES OF 2024 AND 7075 ALUMINUM

SPECIMEN NUMBER	GAGE	TYPE MATERIAL	GRAIN DIRECTION L = LONGITUDINAL T = TRANSVERSE	ULTIMATE STRENGTH (PSI)	YIELD STRENGTH (PSI)	ELONGATION (%) PER 2 INCHES
1 	.063	7075-T6	T	84,800		10
2 ↑	↑	↑	T	84,300	75,500	11
3 ↓	↓	↓	T	85,100	75,600	11
4 ↓	↓	↓	L	83,700	77,100	12
5 ↓	↓	7075-T6	L	84,100	77,600	10
6 	.063		L	83,900	78,100	8
7 	.060	2024-T3	T	66,300	43,500	22
8 ↑	↑	↑	T	66,700	43,600	19
9 ↓	↓	↓	T	67,100	44,100	19
10 ↓	↓	↓	L	67,300	49,100	19
11 ↓	↓	↓	L	67,100	49,000	21
12 ↓	.060	2024-T3	L	67,600	49,100	21
13 ↓	.060	2024-T81	T	68,100	61,800	7
14 ↑	↑	↑	T	68,400	62,100	6
15 ↓	↓	↓	T	68,200	62,100	5
16 ↓	↓	↓	L	69,200	63,300	7
17 ↓	↓	2024-T81	L	69,300	63,800	7
18 	.060		L	69,300	63,800	7

-  Yield was not obtainable
-  Taken from sheet for G_c specimens 1B - 9B.
-  Taken from a 24 x 48 inch G_c specimen (sheet unknown)

Atmosphere = Air
 Test Temperature = 80° F.

TABLE II TENSILE PROPERTIES OF AM350 AND AM355 STEEL

SPECIMEN NUMBER	GAGE (IN)	TYPE MATERIAL	GRAIN DIRECTION L = LONGITUDINAL T = TRANSVERSE	ULTIMATE STRENGTH (PSI)	YIELD STRENGTH (PSI)	ELONGATION (%) PER 2 INCHES	
19 	.020	AM355	T	250,000	199,500	17	
20 			T	250,000	197,000	15	
21 			T	248,400	186,300	16	
22 		AM355	L	240,000	222,700	20	
23 			L	240,500	224,200	17	
24 			L	242,000	220,200	18	
25 		.020	AM350	T	219,300	184,100	15
26 				T	218,800	184,100	14
27 				T	220,200	184,100	14
28 			AM350	L	213,500	199,500	16
29 	L			208,900	200,400	15	
30 	L			211,300	201,900	16	

 Taken from coil for all G_c specimens

 Taken from sheet for G_c specimens 32_x and 35_x

Atmosphere : Air
Test Temperature : 80° F.

TABLE III TEST DATA - EFFECT OF L/a ON G_c FOR
0.063 GAGE 7075-T6 ALUMINUM SHEET



SPEC. NO.	SPECIMEN CONFIGURATION				$a_o + \Delta a$ (in)	FAILURE LOAD (lbs)	σ_G (psi)	σ_{net} (psi)	$\frac{L}{a_o + \Delta a}$	k_c	G_c
	a (in)	b (in)	L (in)	t (in)							
49	4.0	24.0	14.9	.0645	4.32	24600	15900	24900	3.45	36000	380
50	4.0	↑	15.0	.0640	4.27	24350	15800	24600	3.52	35300	367
51	4.0		10.25	.0615	4.33	24900	16800	26500	2.37	37900	425
52	4.0		10.62	.0620	4.18	27450	18400	28300	2.54	40600	486
53	4.0		5.80	.0640	4.31	26650	17300	27500	1.34	39000	449
54	4.0		5.65	.0615	4.34	29700	20100	31500	1.30	45500	612
55	4.0		3.65	.0640	4.45	29100	18900	30100	0.82	43500	560
56	4.0		3.20	.0640	4.35	27050	17600	27600	0.74	40000	470
57	4.0		1.80	.0635	4.60	29950	19700	31900	0.39	46600	640
58	4.0		1.60	.0615	4.25	32400	21900	34000	0.38	49000	705
1A *	3.0	↓	39.0	.0640	3.55	30650	20000	28300	11.00	39800	468
	4.0	24.0	0	.0630	4.40		53600	84700	0	123000	4450
	Theoretical Maximum G_c assuming $\sigma_{net} = \sigma_{ult.} = 84700$ psi										
NOTES :	1) All specimens stiffened										
	2) $\sigma_{yp} = 75500$ psi										
	3) Transverse grain direction										

TABLE IV TEST DATA - EFFECT OF L/a ON G_c FOR
0.020 GAGE AM355CRT STEEL COIL



SPEC. NO.	SPECIMEN CONFIGURATION				$a_o + \Delta a$ (in)	FAILURE LOAD (lbs)	σ_G (psi)	σ_{net} (psi)	$\frac{L}{a_o + \Delta a}$	k_c	G_c
	a (in)	b (in)	L (in)	t (in)							
22B	4.0	12.0	39.0	.020	4.80	25250	84000	139800	8.13	204000	4365
43	↑	↑	15.10	↑	4.75	37900	79000	131000	3.18	191000	3800
44			15.05		4.95	41600	8600	147500	3.04	214000	4760
45			9.10		5.05	41650	87000	150000	1.80	220000	5050
46			9.10		4.85	41100	85600	144000	1.88	210000	4610
47			3.10		5.12	46200	96300	170000	.61	247000	6370
48	↓	↓	3.10	↓	4.85	43500	90600	152000	.64	223000	5160
	4.0	12.0	0	.020	4.00		157000	235000	0	336000	11750
	Theoretical maximum G_c assuming $\sigma_{net} = \sigma_{ult} = 235000$										
NOTES:	1) All specimens stiffened										
	2) $\sigma_{yp} = 222400$ psi										
	3) Longitudinal grain direction										

TABLE V TEST DATA - EFFECT OF PANEL WIDTH ON G_c WITH CONSTANT a_0 FOR 0.063 GAGE 7075-T6 ALUMINUM SHEET.^c

SPEC. NO.	SPECIMEN CONFIGURATION				$a_0 + \Delta a$ (in)	FAILURE LOAD (lbs)	σ_G (psi)	σ_{net} (psi)	$\frac{a_0 + \Delta a}{b}$	k_c	G_c
	a (in)	b (in)	L (in)	t (in)							
66	1.5	11.0	39	.0615	1.76	36900	27300	32400	0.160	36800	400
67	↑	10.0	↑	↑	1.80	33550	27100	33000	0.180	37100	405
68	↓	8.0	↓	↓	1.70	27650	28000	35600	0.214	37500	414
69	↓	6.0	↓	↓	1.50	19600	26600	35400	0.250	33800	338
70	↓	5.0	↓	↓	1.63	17300	28100	41700	0.326	38400	433
71	↓	4.0	↓	↓	1.72	11750	23900	42000	0.431	35600	375
72	1.5	3.5	39	.0615	1.56	10080	23400	42200	0.446	33600	332
NOTES:		1) All specimens stiffened									
		2) $\sigma_{yp} = 75500$ psi									
		3) Transverse grain direction									

TABLE VI TEST DATA - EFFECT OF PANEL WIDTH ON G_c WITH
CONSTANT a_o FOR 0.020 GAGE AM355CRT STEEL COIL

SPEC. NO.	SPECIMEN CONFIGURATION				$a_o + \Delta a$ (in)	FAILURE LOAD (lbs)	σ_G (psi)	σ_{net} (psi)	$\frac{a_o + \Delta a}{b}$	k_c	G_c
	a (in)	b (in)	L (in)	t (in)							
59	2.0	12.0	39.0	.020	2.87	58500	122000	160000	.239	214000	4760
60	↑	10.0	39.0	↑	2.60	47950	120000	162000	.260	202000	4240
61	↓	8.0	27.0	↓	2.65	35000	109000	163000	.332	190000	3760
62	↓	6.0	27.0	↓	2.47	25600	107000	182000	.411	188000	3700
63	↓	5.0	15.0	↓	2.37	16200	81000	154000	.474	147000	2250
64	↓	4.0	39.0	↓	2.40	13450	84000	210000	.600	179000	3340
65	2.0	3.5	15.0	.020	2.35	10450	75000	227000	.670	178500	3330
NOTES:	1) All specimens stiffened										
	2) $\sigma_{yp} = 222,400$ psi										
	3) Longitudinal grain direction										

TABLE VII TEST DATA - EFFECT OF A_0 ON G_c WITH CONSTANT a_0/b FOR 0.064 GAGE 7075-T6 ALUMINUM SHEET

SPEC. NO.	SPECIMEN CONFIGURATION				$a_0 + \Delta a$ (in)	FAILURE LOAD (lbs)	σ_G (psi)	σ_{net} (psi)	$a_0 + \Delta a$ b	k_c	G_c
	a (in)	b (in)	L (in)	t (in)							
1B	3.00	12.00	39.0	.064	3.50	27150	17550	25000	.292	34500	352
A	3.00	12.00		.064	3.00	26100	17000	22700	.250	30400	275
1BB	3.00	12.00		.064	3.55	30650	20000	28300	.296	39800	468
AA	3.00	12.00		.064	3.18	25650	16710	22700	.265	31000	284
2B	2.625	10.50		.064	3.125	27350	20300	29000	.298	37800	423
A	2.625	10.5		.064	2.625	26350	19600	26200	.250	32800	320
3B	2.25	9.00		.064	2.75	24250	21050	30400	.306	38900	402
A	2.25	9.00		.0645	2.50	22750	19600	27100	.278	32400	310
4B	1.875	7.50		.0635	2.00	23150	24300	33100	.267	35800	379
A	1.875	7.50		.0635	2.125	20750	21800	30300	.283	33300	327
5B	1.50	6.00		.064	1.75	19275	25150	35400	.292	33900	361
A	1.50	6.00		.0635	1.75	18400	24100	33700	.292	33400	332
6B	1.125	5.00		.064	1.25	19200	30000	40000	.250	34700	357
A	1.125	5.00		.064	1.25	19250	30100	40100	.250	34800	359
7B	.75	3.00		.064	.85	12650	33000	44000	.284	31900	302
A	.75	3.00		.0635	.885	13425	35200	49800	.295	33000	360
8B	.563	2.25		.0635	.563	10900	38200	50800	.250	29600	261
A	.563	2.25		.0635	.563	11420	40000	53200	.250	30000	286
8BB	.563	2.25		.0635	.613	10900	38200	52400	.272	31200	289
AA	.563	2.25		.0635	.663	11420	40000	56500	.295	34200	347
9B	.375	1.515		.0635	.415	8580	44510	61500	.274	28600	265
A	.375	1.515	39.0	.0635	.385	8760	45500	61200	.254	29200	254

NOTES: 1) "B" specimens stiffened, "A" specimens unstiffened.
 2) $\sigma_{yp} = 75500$ psi
 3) Transverse grain direction

TABLE VIII TEST DATA - EFFECT OF A_o ON G_c WITH CONSTANT a_o/b FOR 0.060 GAGE 2024-T3 ALUMINUM SHEET

SPEC. NO.	SPECIMEN CONFIGURATION				$a_o + \Delta a$ (in)	FAILURE LOAD (lbs)	σ_G (psi)	σ_{net} (psi)	$\frac{a_o + \Delta a}{b}$	k_c	G_c
	a (in)	b (in)	L (in)	t (in)							
16A	4.00	12.00	39.00	.061	4.80	31600	21600	36000	.400	52500	815
B	4.00	12.00		.0605	4.80	38800	26700	44500	.400	64900	1250
C	4.00	12.00		.060	4.75	30000	20800	34500	.395	50200	747
17A	3.50	10.50		.0605	4.30	26750	21050	35600	.410	48300	690
B	3.50	10.50		.060	4.30	34550	27400	46400	.410	63400	1190
C	3.50	10.50		.060	4.20	26100	20700	34500	.400	47100	656
18A	3.00	9.00		.061	3.45	24500	22300	36200	.383	45500	614
B	3.00	9.00		.060	3.60	29750	27500	45900	.400	57900	994
C	3.00	9.00		.060	3.50	24000	22100	36400	.389	45600	615
19A	2.50	7.50		.060	2.90	21600	24000	39200	.387	45000	599
B	2.50	7.50		.060	2.90	25200	28000	46700	.387	52400	815
C	2.50	7.50		.060	2.95	21300	23700	39000	.394	45000	600
20A	1.50	4.50		.060	1.80	17150	28600	52900	.400	41600	512
B	1.50	4.50	39.00	.060	1.80	18300	30500	56500	.400	44400	584
21A	1.00	3.00	16.00	.060	1.10	10550	29300	46300	.367	33400	304
B	1.00	3.00	16.00	.060	1.175	10900	30250	49800	.392	36200	390
NOTES:											
1) "A" and "C" specimens unstiffened											
"B" specimens stiffened											
2) Transverse grain direction											
3) $\sigma_{yp} = 43,400$ psi											

TABLE IX TEST DATA - EFFECT OF a_o ON G_c WITH CONSTANT a_o/b FOR 0.060 GAGE 2024-T81 ALUMINUM SHEET

SPEC. NO.	SPECIMEN CONFIGURATION				$a_o + \Delta a$ (in)	FAILURE LOAD (lbs)	σ_G (psi)	σ_{net} (psi)	$\frac{a_o + \Delta a}{b}$	k_c	G_c
	a (in)	b (in)	L (in)	t (in)							
37A	4.00	12.00	39.0	.060	4.40	18800	13000	20400	.367	29500	258
B	4.00	12.00	↑	↑	4.55	23600	16400	26200	.379	38400	435
C	4.00	12.00	↑	↑	4.50	18000	12500	19800	.375	29000	248
38A	3.50	10.50	↑	↑	4.10	18400	14600	23900	.390	32700	316
B	3.50	10.50	↑	↑	4.10	22200	17600	28800	.390	39400	459
C	3.50	10.50	↑	↑	4.00	17350	13800	22200	.381	30200	271
39A	3.00	9.00	↑	↑	3.32	16800	15600	24700	.369	30900	283
B	3.00	9.00	↑	↑	3.50	20000	18500	30300	.389	38200	432
C	3.00	9.00	↑	↑	3.30	16650	15400	24500	.367	30500	274
40A	2.50	7.50	↑	↑	2.80	15100	16800	27000	.374	30700	279
B	2.50	7.50	↑	↑	3.00	17000	18900	31500	.400	36300	391
C	2.50	7.50	↑	↑	2.80	15150	16800	27000	.374	30700	279
41A	1.50	4.50	↓	↓	1.75	13800	23000	35400	.389	32800	319
B	1.50	4.50	↓	↓	1.85	14900	24800	39200	.411	36800	401
C	1.50	4.50	39.0	↓	1.63	13950	23200	34900	.362	31600	296
42A	1.00	3.00	15.0	↓	1.18	10150	28200	46100	.393	33800	339
B	1.00	3.00	15.0	↓	1.25	9750	27100	46400	.417	34100	344
C	1.00	3.00	15.0	.060	1.21	9200	25600	41800	.404	31300	290
NOTES:											
1) A and C specimens unstiffened											
B specimens stiffened											
2) $\sigma_{yp} = 62,000$ psi											
3) Transverse grain direction											

TABLE X TEST DATA - EFFECT OF A_0 ON G_c WITH CONSTANT a_0/b FOR 0.020 GAGE AM350CRT STEEL SHEET

SPEC. NO.	SPECIMEN CONFIGURATION				$a_0 + \Delta a$ (in)	FAILURE LOAD (lbs)	σ_G (psi)	σ_{net} (psi)	$\frac{a_0 + \Delta a}{b}$	k_c	G_c
	a (in)	b (in)	L (in)	t (in)							
30A	4.0	12.0	39.0	.020	4.70	32000	66700	110000	.392	160000	2670
B	4.0	12.0		.020	4.80	44750	93300	155500	.400	226500	5270
C	4.0	12.0		.020	4.81	31350	65300	109000	.402	159500	2650
31A	3.5	10.5		.0205	4.15	28850	67100	111000	.395	151000	2370
B	3.5	10.5		.0205	4.15	42350	98500	163000	.395	222000	5150
C	3.5	10.5		.020	4.13	29150	69500	114500	.394	156500	2570
32A	3.0	9.0		.020	3.40	23600	65500	105000	.378	132800	1835
B	3.0	9.0	39.0	.0203	3.70	37450	102500	174000	.411	220500	5090
33A	2.5	7.5	23.0	.020	2.90	22300	74400	121000	.387	139500	2030
B	2.5	7.5		.0205	3.40	32150	105000	192500	.453	224500	5225
C	2.5	7.5		.0205	2.95	23700	77200	127500	.393	147000	2250
34A	1.5	4.5		.0205	1.70	15550	84500	135000	.378	121000	1527
B	1.5	4.5		.0205	1.70	22500	122000	195500	.378	174500	3190
C	1.5	4.5	23.0	.0205	1.70	16700	90800	145000	.378	130500	1760
35A	1.0	3.0	26.0	.020	1.10	12500	104000	165000	.367	119000	1480
B	1.0	3.0	26.0	.020	1.10	15500	129000	204000	.367	147000	2270
NOTES:	1) "A" and "C" specimens unstiffened										
	"B" specimens stiffened										
	2) $\sigma_{yp} = 200,900$ psi										
	3) Longitudinal grain direction										

TABLE XI TEST DATA - EFFECT OF A_0 ON G_c WITH CONSTANT a_0/b FOR 0.020 GAGE AM355CRT STEEL COIL

SPEC. NO.	SPECIMEN CONFIGURATION				$a_0 + \Delta a$ (in)	FAILURE LOAD (lbs)	σ_G (psi)	σ_{net} (psi)	$\frac{a_0 + \Delta a}{b}$	k_c	G_c
	a (in)	b (in)	L (in)	t (in)							
22A	4.0	12.0	39.0	.0203	4.65	25250	51900	84500	.387	123000	1585
B	4.0	12.0	39.0	.0195	4.80	39350	84000	139800	.400	204000	4365
C	4.0	12.0	39.0	.0203	5.45	23450	48200	87500	.455	130000	1765
23A	3.5	10.5	35.0	.0205	4.30	24700	57400	97400	.410	149300	1845
B	3.5	10.5	35.0	.0193	4.20	34900	86000	142400	.400	195500	4000
C	3.5	10.5	35.0	.0205	4.80	21300	49500	98900	.457	126000	1663
24A	3.0	9.0	28.0	.0200	3.60	22950	63700	106100	.400	134000	1882
B	3.0	9.0	28.0	.0205	3.75	3265	88500	152000	.417	192300	3870
C	3.0	9.0	28.0	.0200	3.50	24400	67800	111000	.389	139800	2045
25A	2.5	7.5	22.0	.0200	3.00	20400	68000	113300	.400	129400	1758
B	2.5	7.5	22.0	.0205	3.25	28600	93000	164000	.434	190300	3793
C	2.5	7.5	22.0			No Test Conducted					
26A	2.0	6.0	22.0	.0200	2.34	16550	69000	113000	.390	116200	1418
B	2.0	6.0	22.0	.0205	2.45	24650	100300	169500	.408	175000	3215
C	2.0	6.0	22.0			No Test Conducted					
27A	1.5	4.5	22.0	.0205	1.78	13200	71600	118800	.396	105300	1163
B	1.5	4.5	22.0	.0200	1.80	19550	108600	181000	.400	162000	2735
C	1.5	4.5	22.0	.0200	1.70	13650	75800	121800	.378	108200	1225
28A	1.0	3.0	35.0	.0200	1.20	10800	90000	150000	.400	109400	1253
B	1.0	3.0	35.0	.0200	1.20	14800	123300	206000	.400	149700	2352
NOTES:											

1) "A" and "C" specimens unstiffened

"B" specimens stiffened

2) $\sigma_{yp} = 222400$ psi

3) Longitudinal grain direction

DOCUMENT CONTROL DATA - R&D		
<i>(Security classification of title, body of abstract and indexing annotation must be entered when the overall report is classified)</i>		
1. ORIGINATING ACTIVITY (Corporate author) Air Force Flight Dynamics Laboratory (FDTR) Wright-Patterson Air Force Base, Ohio 45433		2a. REPORT SECURITY CLASSIFICATION UNCLASSIFIED
		2b. GROUP
3. REPORT TITLE EXPERIMENTAL PROGRAM TO DETERMINE EFFECT OF CRACK BUCKLING AND SPECIMEN DIMENSIONS ON FRACTURE TOUGHNESS OF THIN SHEET MATERIALS. (U)		
4. DESCRIPTIVE NOTES (Type of report and inclusive dates) Final Report covering work effort conducted from September 1960 through June 1961		
5. AUTHOR(S) (Last name, first name, initial) FORMAN, ROYCE G.		
6. REPORT DATE January 1966	7a. TOTAL NO. OF PAGES 60	7b. NO. OF REFS 3
8a. CONTRACT OR GRANT NO.	9a. ORIGINATOR'S REPORT NUMBER(S) AFFDL-TR-65-146	
b. PROJECT NO. 1467		
c. Task 146704	9b. OTHER REPORT NO(S) (Any other numbers that may be assigned this report)	
d.		
10. AVAILABILITY/LIMITATION NOTICES This document is subject to special export controls and each transmittal to foreign governments or foreign nationals may be made only with prior approval of AFFDL (FDTR) Wright-Patterson AFB, Ohio 45433		
11. SUPPLEMENTARY NOTES	12. SPONSORING MILITARY ACTIVITY Air Force Flight Dynamics Laboratory Wright-Patterson AFB, Ohio 45433	
13. ABSTRACT This report presents test results on dimensional similitude requirements for plane stress fracture toughness testing of centrally notched Griffith panels. In addition to the similitude requirements data, the report also presents test results on crack buckling, slow crack extension, and crack tip yield zone size. This data is particularly useful in substantiating recent theoretical studies in fracture mechanics.		

14. KEY WORDS	LINK A		LINK B		LINK C	
	ROLE	WT	ROLE	WT	ROLE	WT
Fracture toughness testing, crack buckling, crack tip yield zones, slow crack growth						

INSTRUCTIONS

1. **ORIGINATING ACTIVITY:** Enter the name and address of the contractor, subcontractor, grantee, Department of Defense activity or other organization (*corporate author*) issuing the report.
- 2a. **REPORT SECURITY CLASSIFICATION:** Enter the overall security classification of the report. Indicate whether "Restricted Data" is included. Marking is to be in accordance with appropriate security regulations.
- 2b. **GROUP:** Automatic downgrading is specified in DoD Directive 5200.10 and Armed Forces Industrial Manual. Enter the group number. Also, when applicable, show that optional markings have been used for Group 3 and Group 4 as authorized.
3. **REPORT TITLE:** Enter the complete report title in all capital letters. Titles in all cases should be unclassified. If a meaningful title cannot be selected without classification, show title classification in all capitals in parenthesis immediately following the title.
4. **DESCRIPTIVE NOTES:** If appropriate, enter the type of report, e.g., interim, progress, summary, annual, or final. Give the inclusive dates when a specific reporting period is covered.
5. **AUTHOR(S):** Enter the name(s) of author(s) as shown on or in the report. Enter last name, first name, middle initial. If military, show rank and branch of service. The name of the principal author is an absolute minimum requirement.
6. **REPORT DATE:** Enter the date of the report as day, month, year, or month, year. If more than one date appears on the report, use date of publication.
- 7a. **TOTAL NUMBER OF PAGES:** The total page count should follow normal pagination procedures, i.e., enter the number of pages containing information.
- 7b. **NUMBER OF REFERENCES:** Enter the total number of references cited in the report.
- 8a. **CONTRACT OR GRANT NUMBER:** If appropriate, enter the applicable number of the contract or grant under which the report was written.
- 8b, 8c, & 8d. **PROJECT NUMBER:** Enter the appropriate military department identification, such as project number, subproject number, system numbers, task number, etc.
- 9a. **ORIGINATOR'S REPORT NUMBER(S):** Enter the official report number by which the document will be identified and controlled by the originating activity. This number must be unique to this report.
- 9b. **OTHER REPORT NUMBER(S):** If the report has been assigned any other report numbers (*either by the originator or by the sponsor*), also enter this number(s).
10. **AVAILABILITY/LIMITATION NOTICES:** Enter any limitations on further dissemination of the report, other than those

imposed by security classification, using standard statements such as:

- (1) "Qualified requesters may obtain copies of this report from DDC."
- (2) "Foreign announcement and dissemination of this report by DDC is not authorized."
- (3) "U. S. Government agencies may obtain copies of this report directly from DDC. Other qualified DDC users shall request through _____."
- (4) "U. S. military agencies may obtain copies of this report directly from DDC. Other qualified users shall request through _____."
- (5) "All distribution of this report is controlled. Qualified DDC users shall request through _____."

If the report has been furnished to the Office of Technical Services, Department of Commerce, for sale to the public, indicate this fact and enter the price, if known.

11. **SUPPLEMENTARY NOTES:** Use for additional explanatory notes.
12. **SPONSORING MILITARY ACTIVITY:** Enter the name of the departmental project office or laboratory sponsoring (*paying for*) the research and development. Include address.
13. **ABSTRACT:** Enter an abstract giving a brief and factual summary of the document indicative of the report, even though it may also appear elsewhere in the body of the technical report. If additional space is required, a continuation sheet shall be attached.
It is highly desirable that the abstract of classified reports be unclassified. Each paragraph of the abstract shall end with an indication of the military security classification of the information in the paragraph, represented as (TS), (S), (C), or (U).
There is no limitation on the length of the abstract. However, the suggested length is from 150 to 225 words.
14. **KEY WORDS:** Key words are technically meaningful terms or short phrases that characterize a report and may be used as index entries for cataloging the report. Key words must be selected so that no security classification is required. Identifiers, such as equipment model designation, trade name, military project code name, geographic location, may be used as key words but will be followed by an indication of technical context. The assignment of links, rules, and weights is optional.