

**UNCLASSIFIED**

**AD** 4 2 0 4 0 7

**DEFENSE DOCUMENTATION CENTER**

FOR

**SCIENTIFIC AND TECHNICAL INFORMATION**

**CAMERON STATION, ALEXANDRIA, VIRGINIA**



**UNCLASSIFIED**

## **REPRODUCTION QUALITY NOTICE**

**This document is the best quality available. The copy furnished to DTIC contained pages that may have the following quality problems:**

- **Pages smaller or larger than normal.**
- **Pages with background color or light colored printing.**
- **Pages with small type or poor printing; and or**
- **Pages with continuous tone material or color photographs.**

**Due to various output media available these conditions may or may not cause poor legibility in the microfiche or hardcopy output you receive.**

**If this block is checked, the copy furnished to DTIC contained pages with color printing, that when reproduced in Black and White, may change detail of the original copy.**

NOTICE: When government or other drawings, specifications or other data are used for any purpose other than in connection with a definitely related government procurement operation, the U. S. Government thereby incurs no responsibility, nor any obligation whatsoever; and the fact that the Government may have formulated, furnished, or in any way supplied the said drawings, specifications, or other data is not to be regarded by implication or otherwise as in any manner licensing the holder or any other person or corporation, or conveying any rights or permission to manufacture, use or sell any patented invention that may in any way be related thereto.

420407 ✓

PB 171809-5

552850

1

**CRYOGENIC MATERIALS DATA HANDBOOK.**

AD No.   
 DDC FILE COPY

THIRTEENTH PROGRESS REPORT

AIR FORCE MATERIALS LABORATORY  
RESEARCH AND TECHNOLOGY DIVISION  
AIR FORCE SYSTEMS COMMAND  
WRIGHT-PATTERSON AIR FORCE BASE, OHIO

*Wright*

PROJECT NO. 7381, TASK NO. 738103

DDC  
RECORDED  
OCT 18 1963  
TISIA B

(PREPARED UNDER CONTRACT NO. AF33(657)-9161  
BY THE MARTIN COMPANY, DENVER, COLORADO  
F.R. SCHWARTZBERG, S.H. OSGOOD AND R.D. KEYS)

10

11/17/63

## FOREWORD

The enclosed inserts for the Cryogenic Materials Data Handbook are issued as the second semiannual progress report on Air Force Contract AF33(657)-9161. This handbook of data on solid materials at low temperatures was initially prepared under the sponsorship of the Air Force Ballistic Missile Division by personnel of the Cryogenic Engineering Laboratory, National Bureau of Standards, Boulder, Colorado. During the performance of this work, the responsibility for the handbook was transferred to the Aeronautical Systems Division. The eleventh quarterly report, dated 15 February 1962, was the final addition to the handbook prepared by the National Bureau of Standards.

The contract for continuing the generation, assimilation, and presentation of data for the handbook has been awarded to the Materials Research Section of the Martin Company, Denver Division.

The handbook's scope has been increased so that additional properties and materials will be presented. The index insert shows the current scope of materials. The most significant addition to the properties list is the inclusion of data on the tensile strength of welded joints.

Handbook inserts are now being prepared with a slightly different format. The upper temperature limit of our graphs has been decreased from the original 500°F to 100°F, allowing us to provide the reader with more accurate and more legible curves. Other minor changes include the separation of unnotched, notched, and weld tension data and the inclusion of notch strength ratio.

This progress report consists chiefly of tensile data obtained by Martin Company under the subject contract effort. These data are identified by reference number 1115. Data obtained from other ASD programs, such as General Dynamics/Astronautics work on pressure vessel materials for cryogenic application [Contract AF33(616)-7719], are included. References 1107 and 1122 identify this work. A group of reports recently obtained from NASA-Huntsville has provided additional information for inclusion in the handbook.

To maintain the handbook as a comprehensive document, the contractor must keep a complete file of cryogenic data. Users of the handbook are urged to send appropriate data to us for inclusion in the handbook. Information can be forwarded to the following address:

Fred R. Schwartzberg, Mail No. L-8  
The Martin Company  
P.O. Box 179  
Denver, Colorado 80201

INDEX

MATERIAL

- A. Aluminum
  - 1. Tens-50
  - 2. 356
  - 3. 1100
  - 4. X2020
  - 5. 2024
  - 6. 6061
  - 7. 7075
  - 8. 2014
  - 9. 2219
  - 10. 5052
  - 11. 5456
  - 18. 1075
  - 19. 2800 (9% Ni)
  - 20. 4340
  - 21. AM-355
- B. Cobalt
  - 1. Elgiloy
  - 2. Stellite 3
  - 3. L-605(HS25)
- C. Copper
  - 1. Berylco 25
  - 2. 70/30 Brass
  - 3. Copper
- D. Iron
  - 1. Invar 36
  - 2. 34% Manganese Steel
  - 3. Ni-Span C
  - 4. Vascojet 1000 or Unimach #1
  - 5. 17-4 PH
  - 6. 17-7 PH
  - 7. A-286
  - 8. 301
  - 9. 302
  - 10. 303
  - 11. 304
  - 12. 310
  - 13. 321
  - 14. 347
  - 15. 410
  - 16. 416
  - 17. 440C
- E. Nickel
  - 1. Inconel
  - 2. Inconel X
  - 3. K Monel
  - 4. S Monel
  - 5. Nickel
  - 6. Rene 41
  - 7. Hastelloy B
  - 8. D-979
- F. Titanium
  - 1. Ti-5Al-2.5Sn
  - 2. Ti-13V-11Cr-3Al
  - 3. Ti-6Al-4V
  - 4. Ti-8Al-1Mo-1V
- G. Carbides
  - 1. Titanium Carbide
  - 2. Tungsten Carbide
- H. Nonmetals
  - 1. Ice
  - 2. Kel-F
  - 3. Mylar
  - 4. Nylon
  - 5. Teflon
- I. Miscellaneous Metals and Alloys
  - 1. Beryllium
  - 2. Molybdenum
- J. Comparisons
- K. Monographs
- L. References

## INDEX

### PROPERTIES

- |                                    |  |
|------------------------------------|--|
| a. Yield Strength<br>(0.2% Offset) | n. Fatigue Behavior and Strength         |
| b. Tensile Strength                | o. Creep Behavior and Stress-<br>Rupture |
| c. Elongation                      | p. Expansivity                           |
| d. Reduction of Area               | q. Poisson's Ratio                       |
| e. Stress-Strain Diagram           | r. Thermal Conductivity                  |
| f. Modulus of Elasticity           | s. Mechanical Hysteresis                 |
| g. Impact Energy                   | t. Electrical Resistivity                |
| h. Hardness                        | u. Magnetic Properties                   |
| i. Compressive Yield Strength      | v. Compression Set                       |
| j. Compressive Strength            | w. Compression Modulus                   |
| k. Shearing Yield Strength         | x. Flexural Strength                     |
| l. Shearing Strength               | y. Flexure Modulus                       |
| m. Modulus of Rigidity             |  |



## ACCUMULATIVE INDEX

The letters and numbers in the left column denote the general group and specific material as listed in the index. The letters of the top row denote a property, and the numbers within the squares refer to the last report in which data represented by the coordinates was issued. Numbers through 11 refer to quarterly reports issued by the National Bureau of Standards under the previous contract. Numbers 12 and over refer to semiannual progress reports issued by Martin under Air Force Materials Laboratory sponsorship.

	a	b	c	d	e	f	g	h	i	j	k	l	m	n	o	p	q	r	s	t	u	v	w	x	y	z
A.1	8	8	8	8	8	11	11							8	8											
A.2	8	8	8	8	8	11	11	11					8	8	8											
A.3	10	10	10	10	10	10	10	10				10		10	10	11		11		10						
A.4	8	8	8	8	11	11	11								11	11										
A.5	11	11	8	8	8	11	11	11	11	11		10		10	10	11	11	11								
A.6	13	13	13	10	10	10	10	10						11	10	8										
A.7	10	10	10	10	10	8	8	8	8			10		10	10	8		9								
A.8	13	13	12			12																				
A.9	13	13	13									13														
A.10	12	12	12			12																				
A.11	13	13	13			12																				
B.1	9	9	9	9	9	11							8		8		8									
B.2							11									10										
B.3	11	11	11				11									11		8								
C.1	10	10	10	10	10	11	11						8	12	11											
C.2	8	8	8	8	11	11	11						8	12	8	11		11								
C.3	11	11	11	11	10	11	11							8	8	8		8		8						
D.1	8	8	8	8	11	11	11	8					8		10											
D.2																										
D.3	8	8	8	8	8	11	11						8	12	10											
D.4	10	10	10	10	10	10	10	8						8	8											
D.5	9	9	9	9	9	11	11		11				11		10											
D.6	9	9	9	9	9	11	11		10			10	10	12	11		8									
D.7	13	13	13	13	10	11	11								11											
D.8	10	10	9	9	9	11	11	11	8			8		12	8					8						
D.9	10	10	11	11	8	11	11	11	8			8	8	10	10	8	8	8		8						
D.10	10	10	10	10	10	11	11								10		10		10		8					
D.11	12	12	12	11	10	12	11	10	10				10	10	11	9	9		10							
D.12	10	10	10	10	10	11	11						10		10	8	8		8							
D.13	11	11	10	10	10	11	10	10	8			8	10		10	8	10		10		10					
D.14	8	8	8	8	10	11	11						11	12	8	9	9		8							
D.15	9	9	9	9	9	11	11						8	8	8	9	9		9							
D.16	9	9	9	9	9		11								11											
D.17							11								10											
D.18	9	9	9	9	9	11	11						8	11	10											
D.19	8	8	8	8	11	11	11	8						12	8											
D.20	8	8	8	8		8	11	8						8	11					8						
D.21	12	12	12			12																				
E.1	10	10	10	10	10	11	11	8					8	12	11	9		11								
E.2	13	13	13	13	9	11	11	8	8			8	8	12	10	10	10		8							
E.3	11	11	11	11	11	11	11	11						11	12	8										
E.4	9	9	9	9	9	11	11								11											
E.5	8	8	8	8	8	11	11							11	12	11	9		9							
E.6	11	11	11	11	10	10	10								11											
E.7	13	13	13																							
E.8	13	13	13																							
F.1	13	13	13	11	10	11	11	11	10			8		8	11		11		11		11					
F.2	11	11	9	9	9	11	11	9				9		10	11	8										
F.3	13	13	13	11	8	11	11	8	8					8	12	8	8		8							
F.4	13	13	13																							
G.1							11									11										
G.2							11	11								8										
H.1	8	8										8				8										
H.2	11	11	11		11	11	11		11		11	11	11		11	11							11	11	11	
H.3	11	11	11			11								11												
H.4	11	11	11			11	11		11					11		11									11	
H.5	11	11	11		11	11	11		11	11				11		11							11	11	11	
I.1	11	11	11	8	8	8	8		8						8		8		8							
I.2	11	11	8	8	8	8	8	8				8	8		8		8		8		8					

### A.6.a

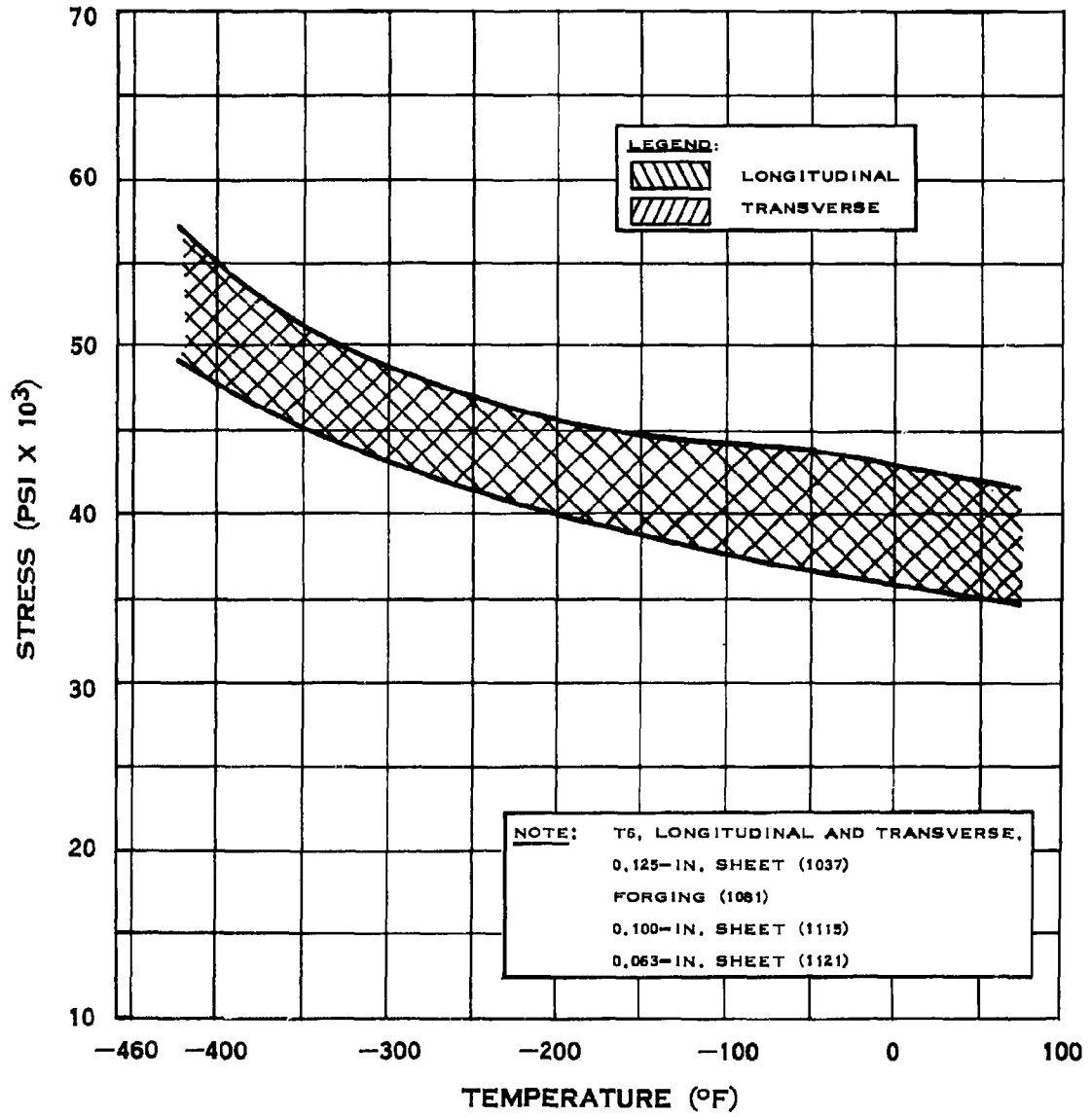

## YIELD STRENGTH OF 6061 ALUMINUM

### A.6.b

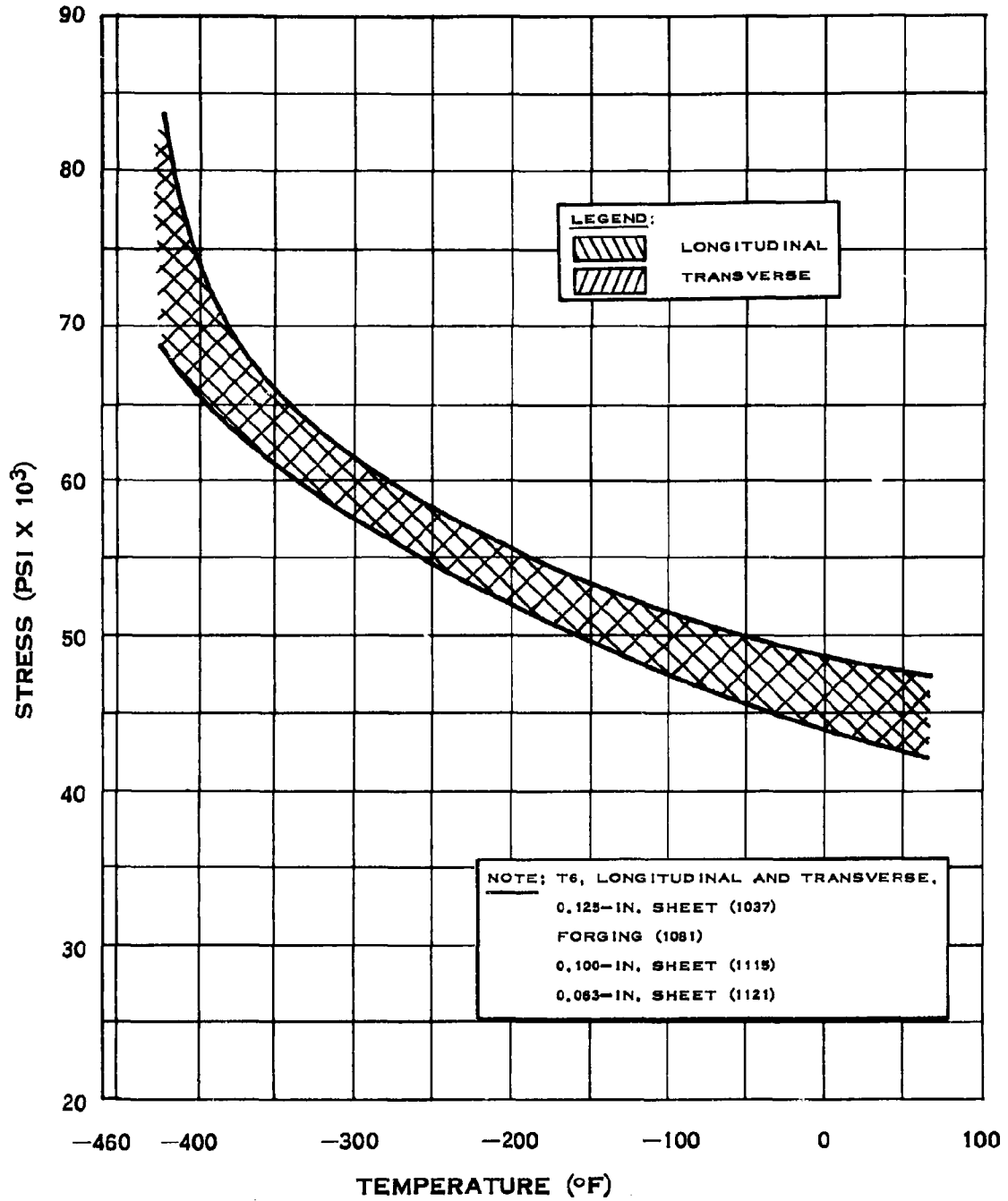

## TENSILE STRENGTH OF 6061 ALUMINUM

# A.6.b-1

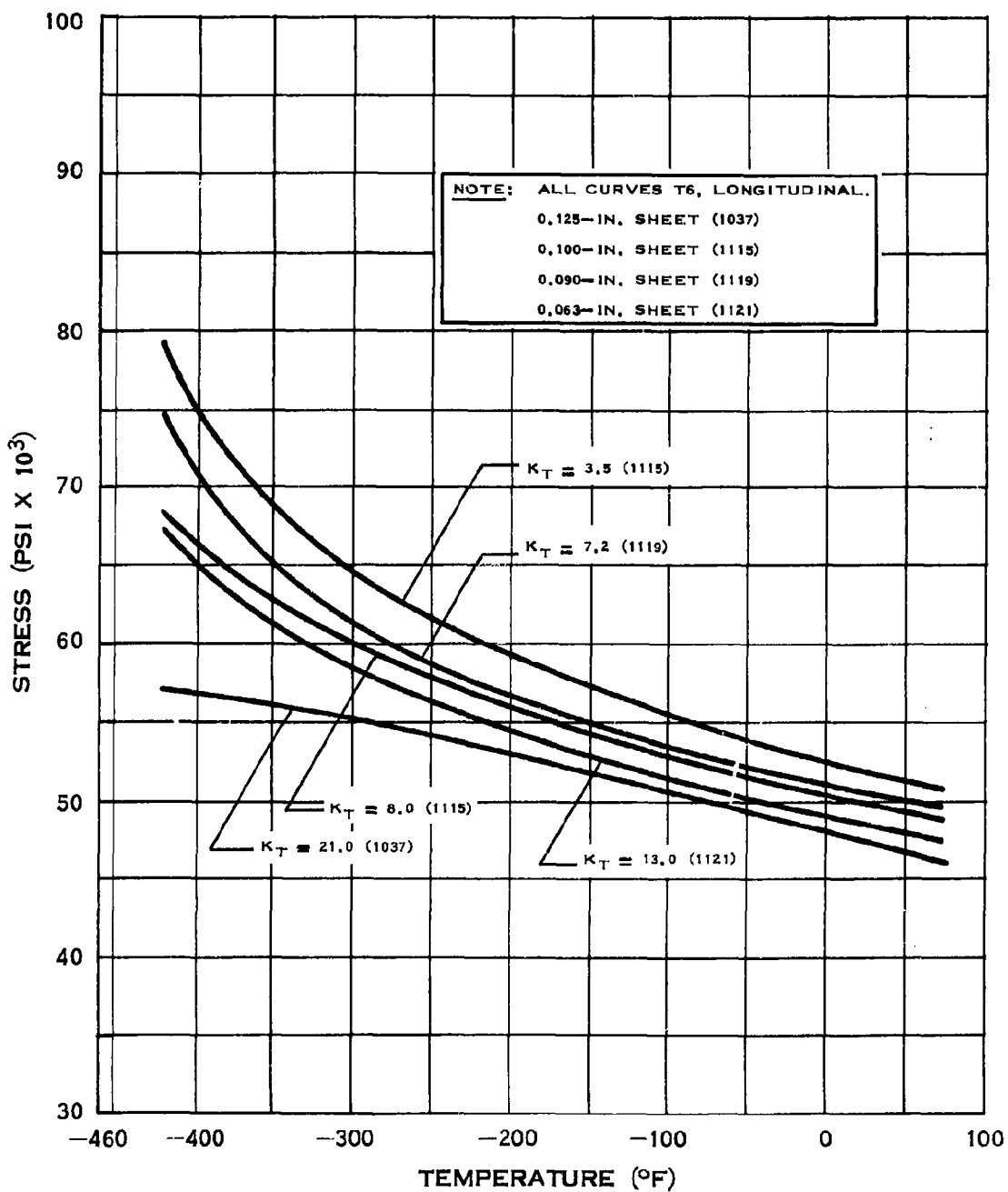

## NOTCH TENSILE STRENGTH OF 6061 ALUMINUM

### A.6.b-2

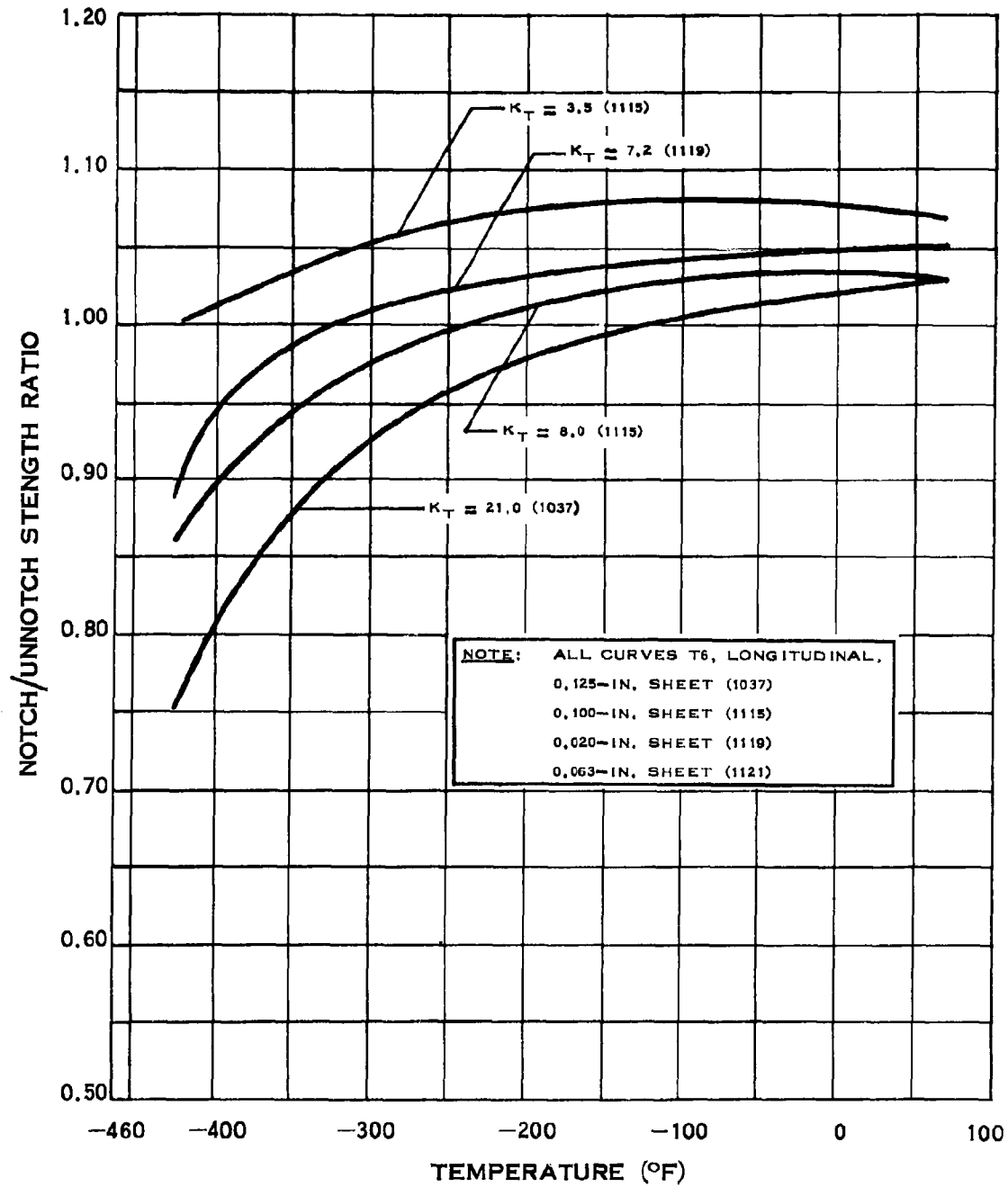

### NOTCH STRENGTH RATIO OF 6061 ALUMINUM

### A.6.b-3

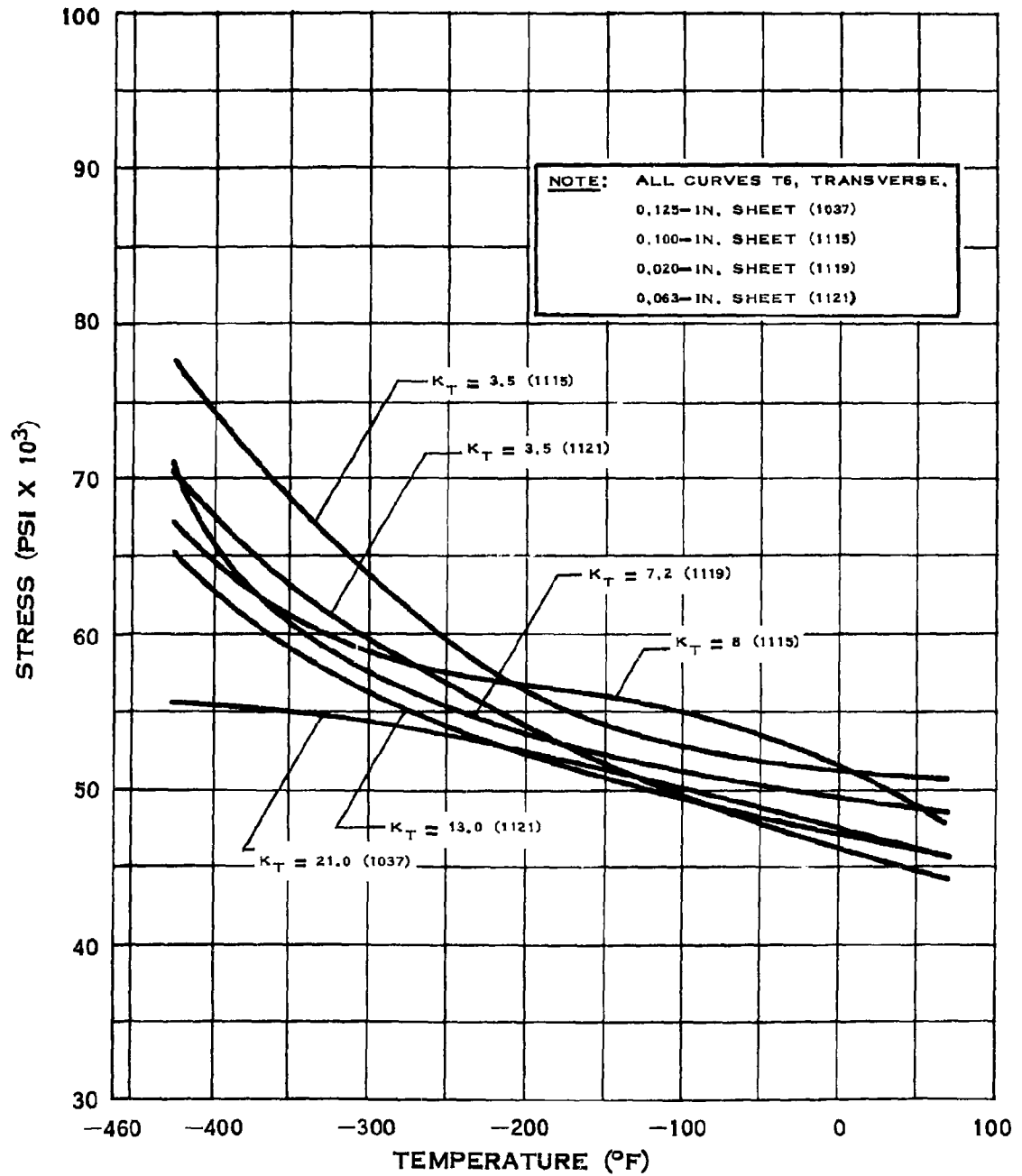

### NOTCH TENSILE STRENGTH OF 6061 ALUMINUM

### A.6.b-4

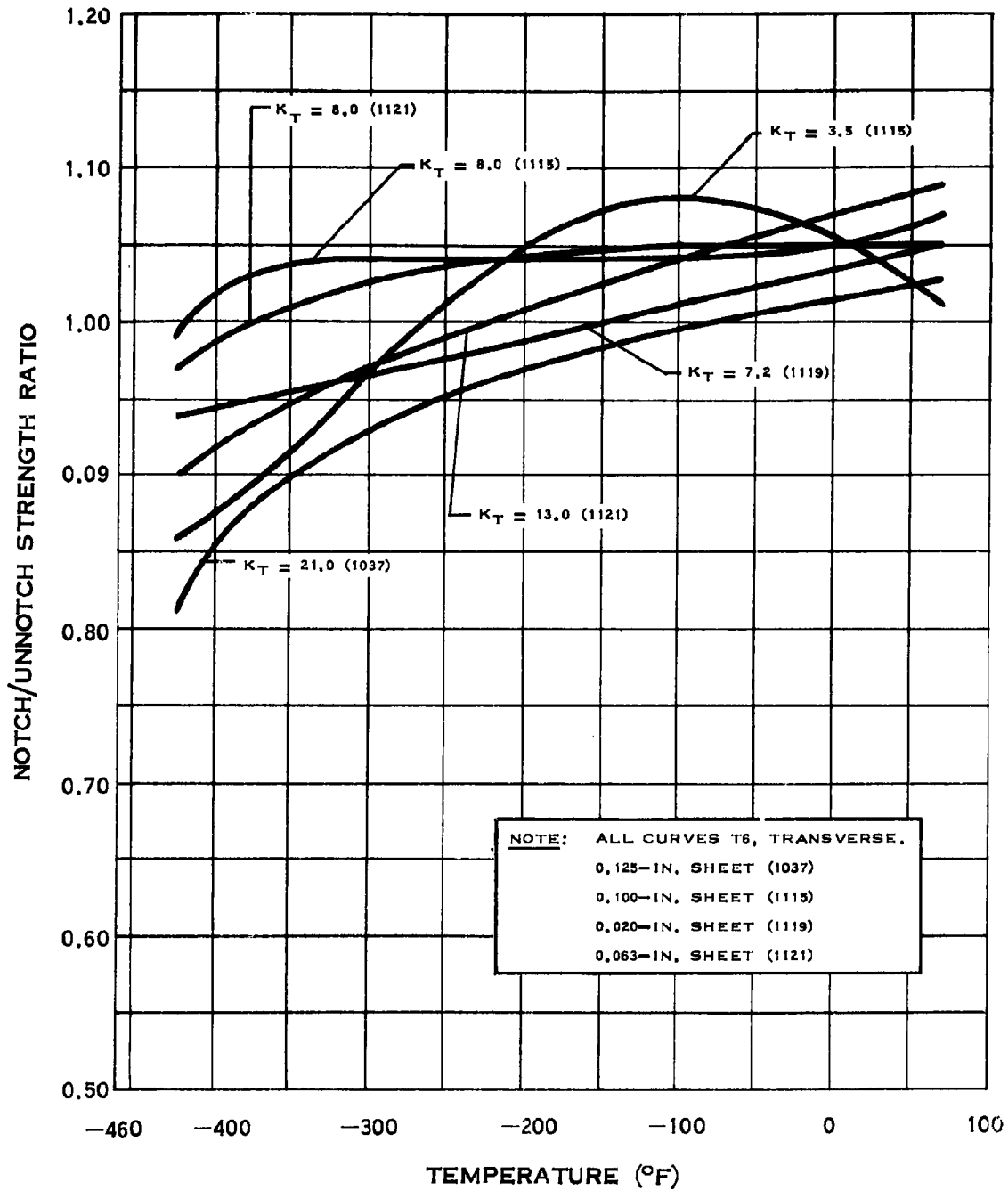

### NOTCH STRENGTH RATIO OF 6061 ALUMINUM



### A.6.b-5

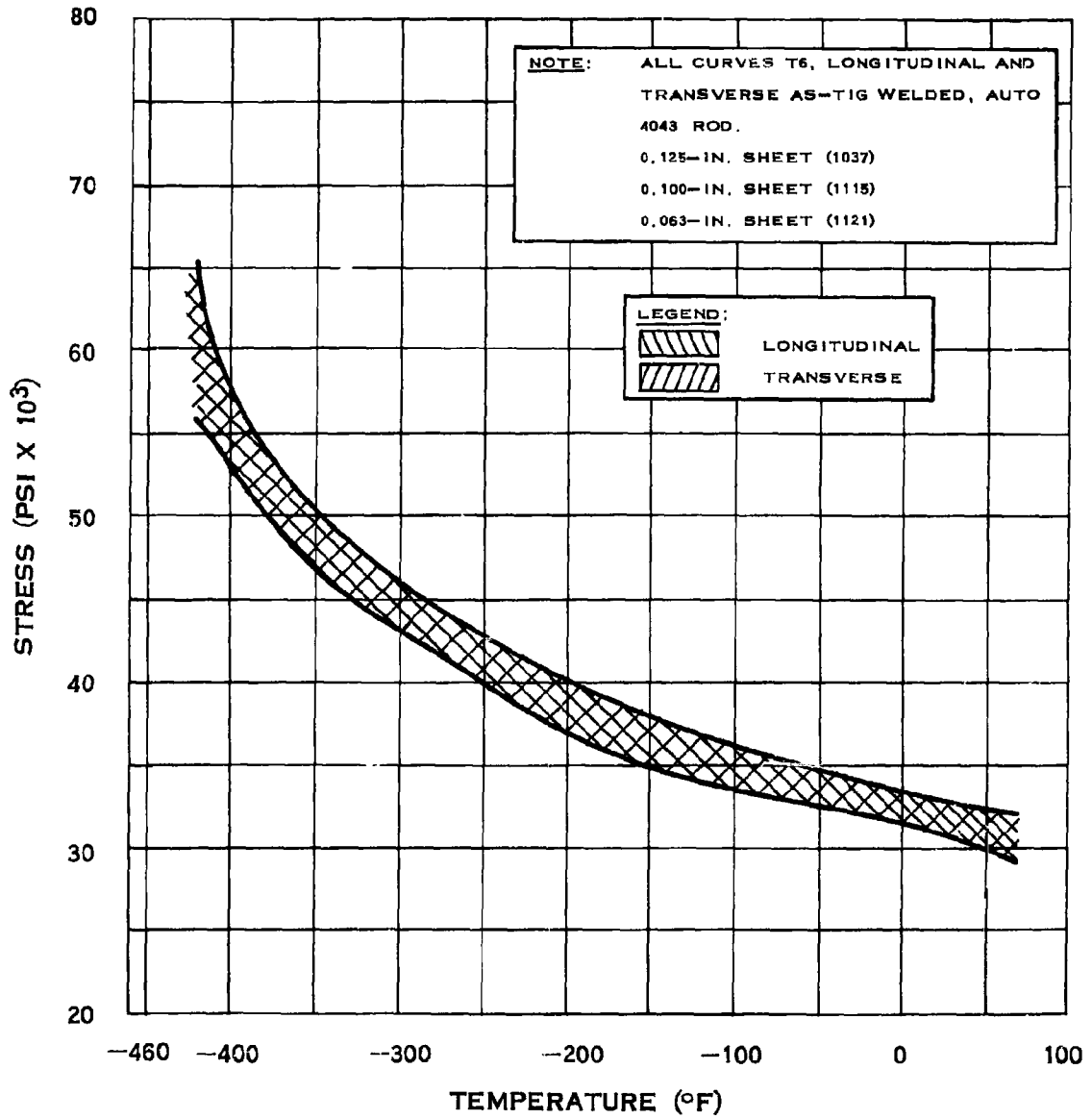

### WELD TENSILE STRENGTH OF 6061 ALUMINUM

# A.6.c

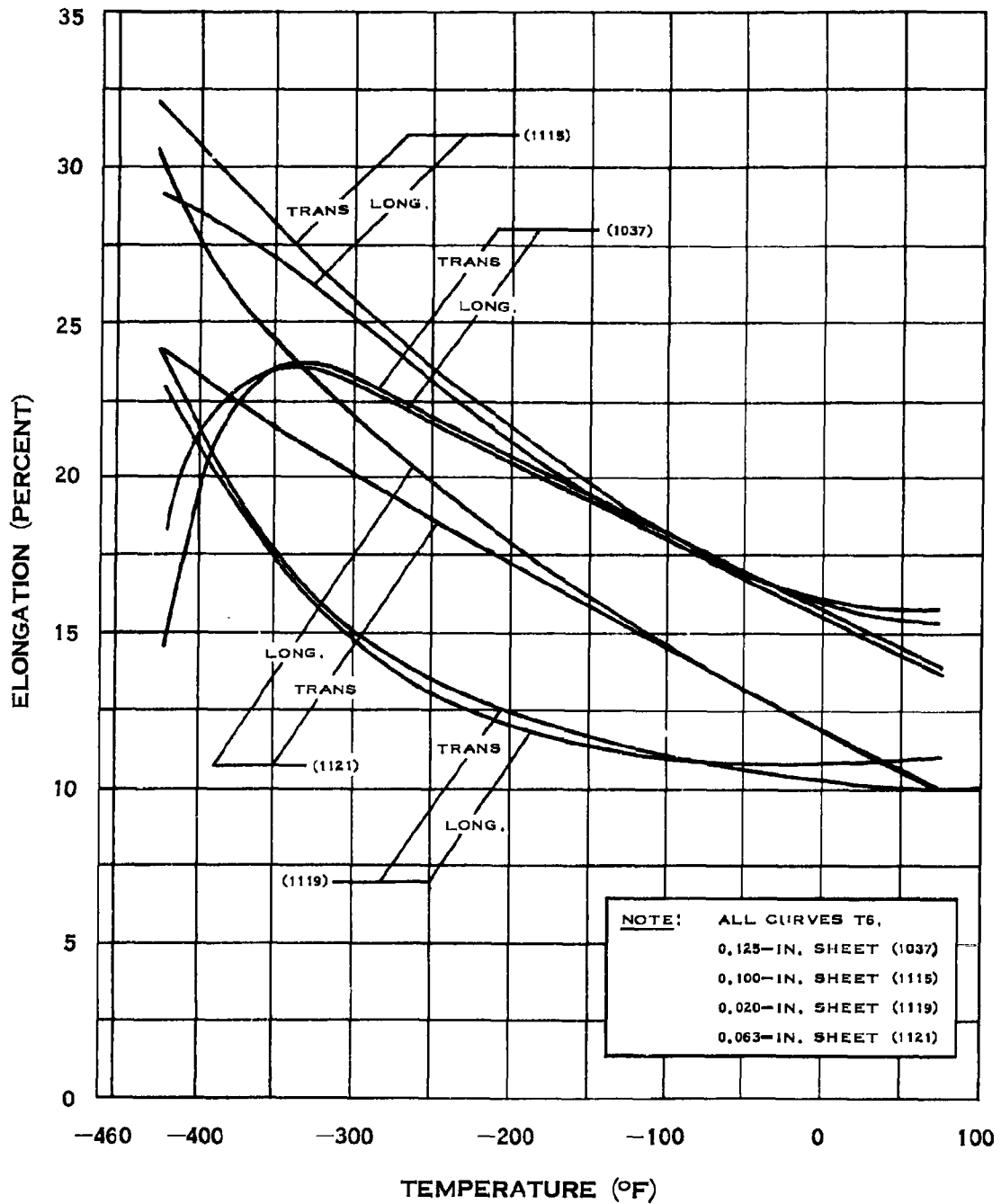

## ELONGATION OF 6061 ALUMINUM

### A.8.a

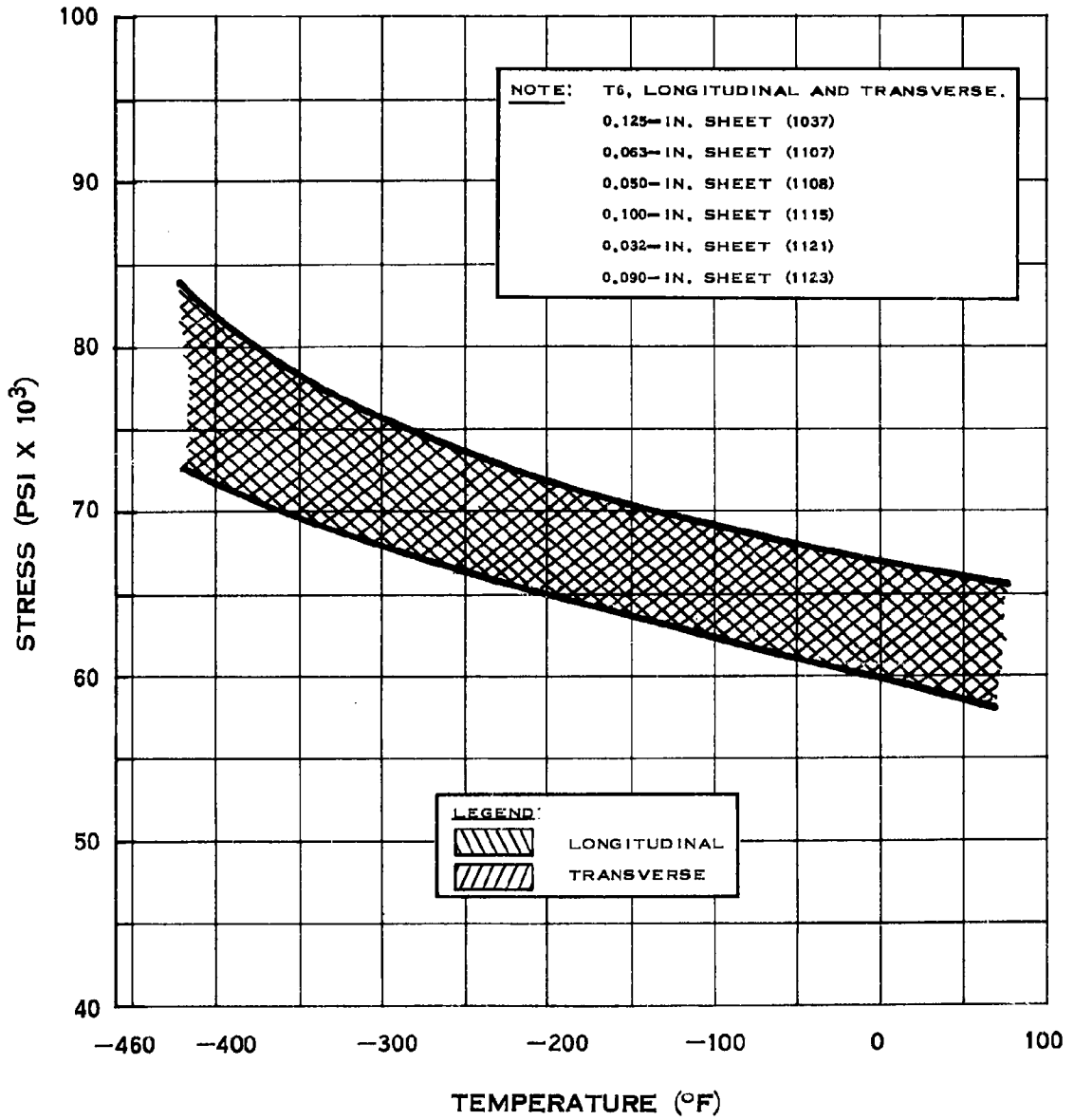

## YIELD STRENGTH OF 2014 ALUMINUM

### A.8.b

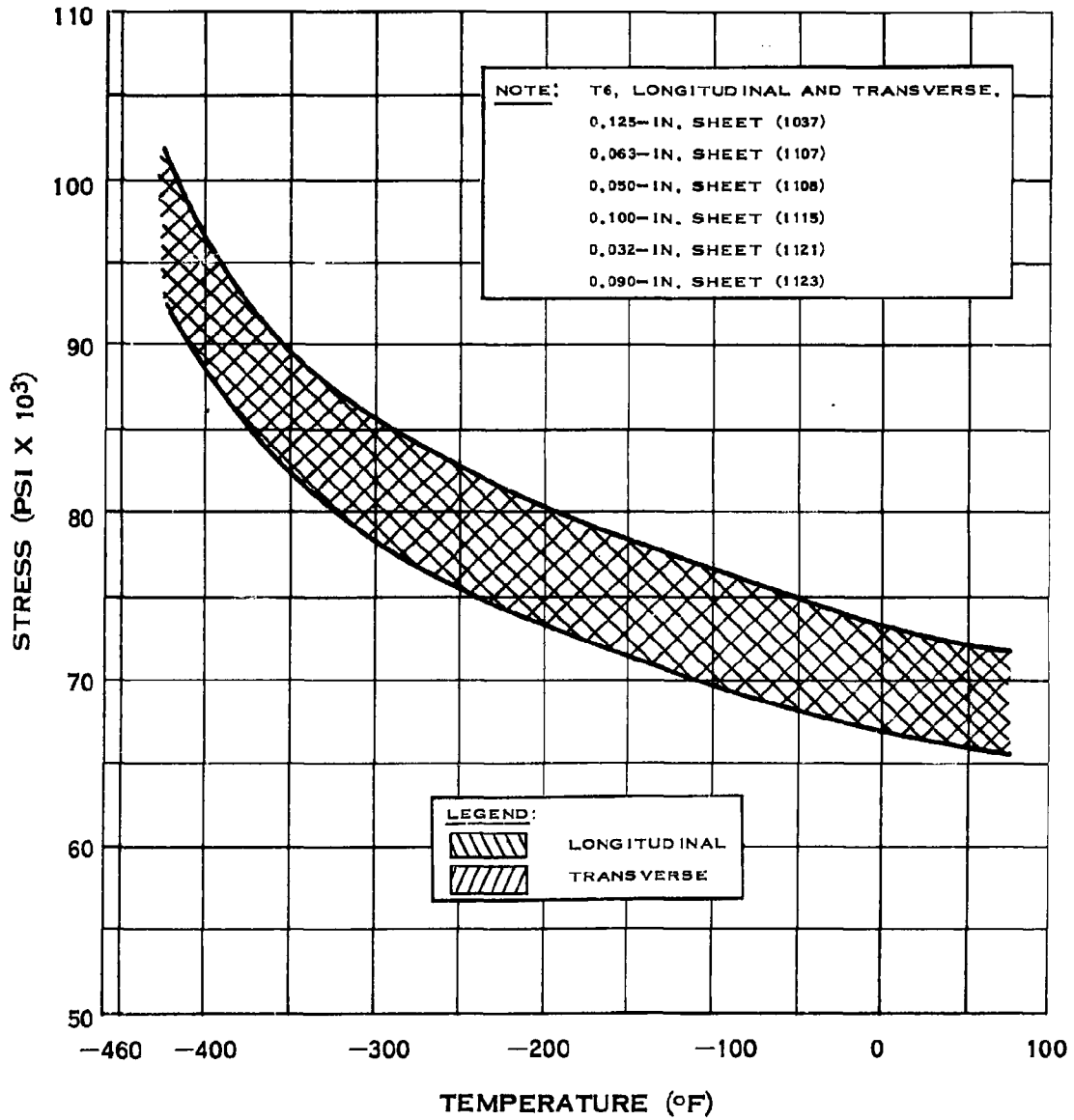

## TENSILE STRENGTH OF 2014 ALUMINUM

# A.8.b-1

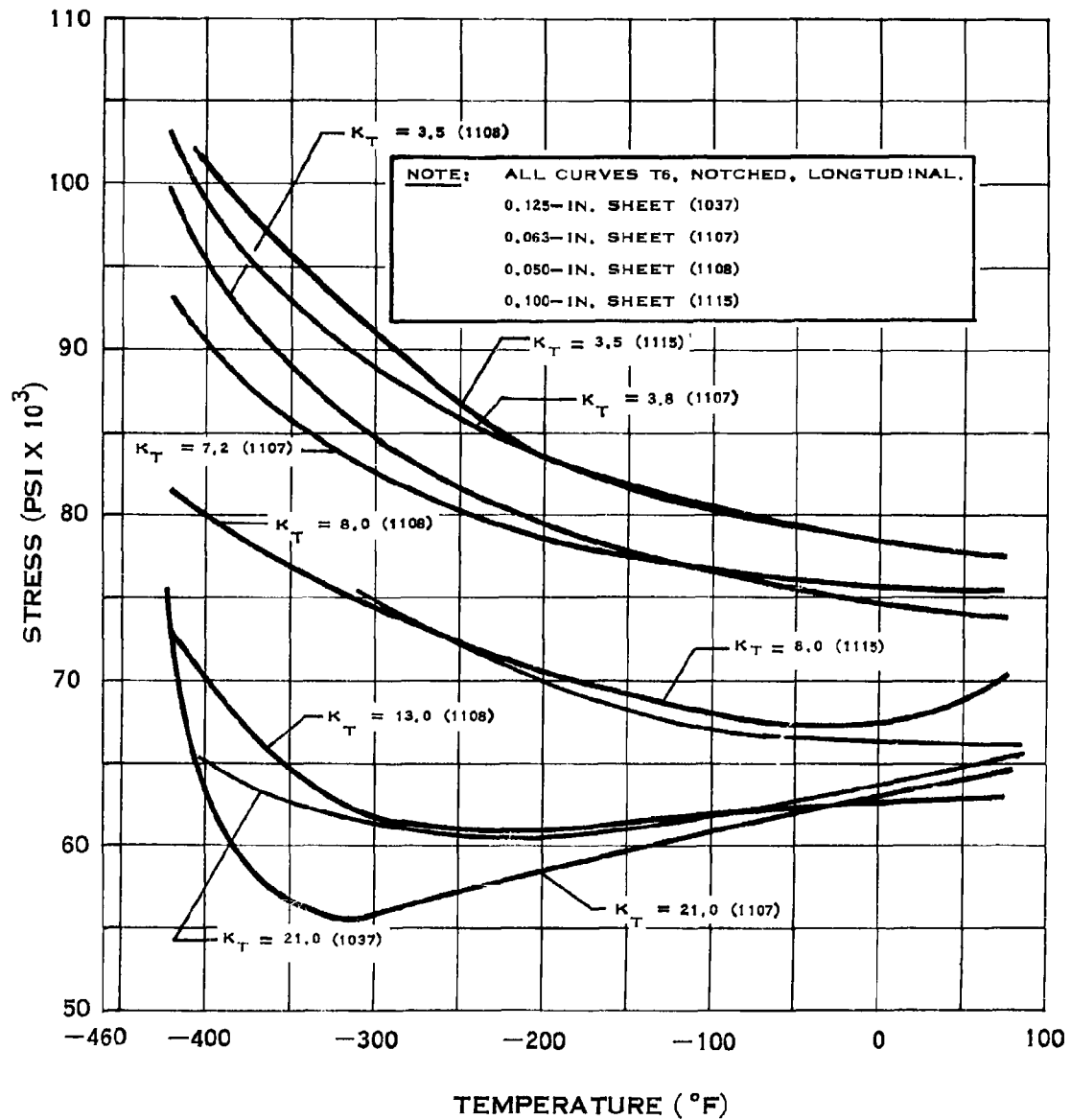

## NOTCH TENSILE STRENGTH OF 2014 ALUMINUM

## A.8.b-2

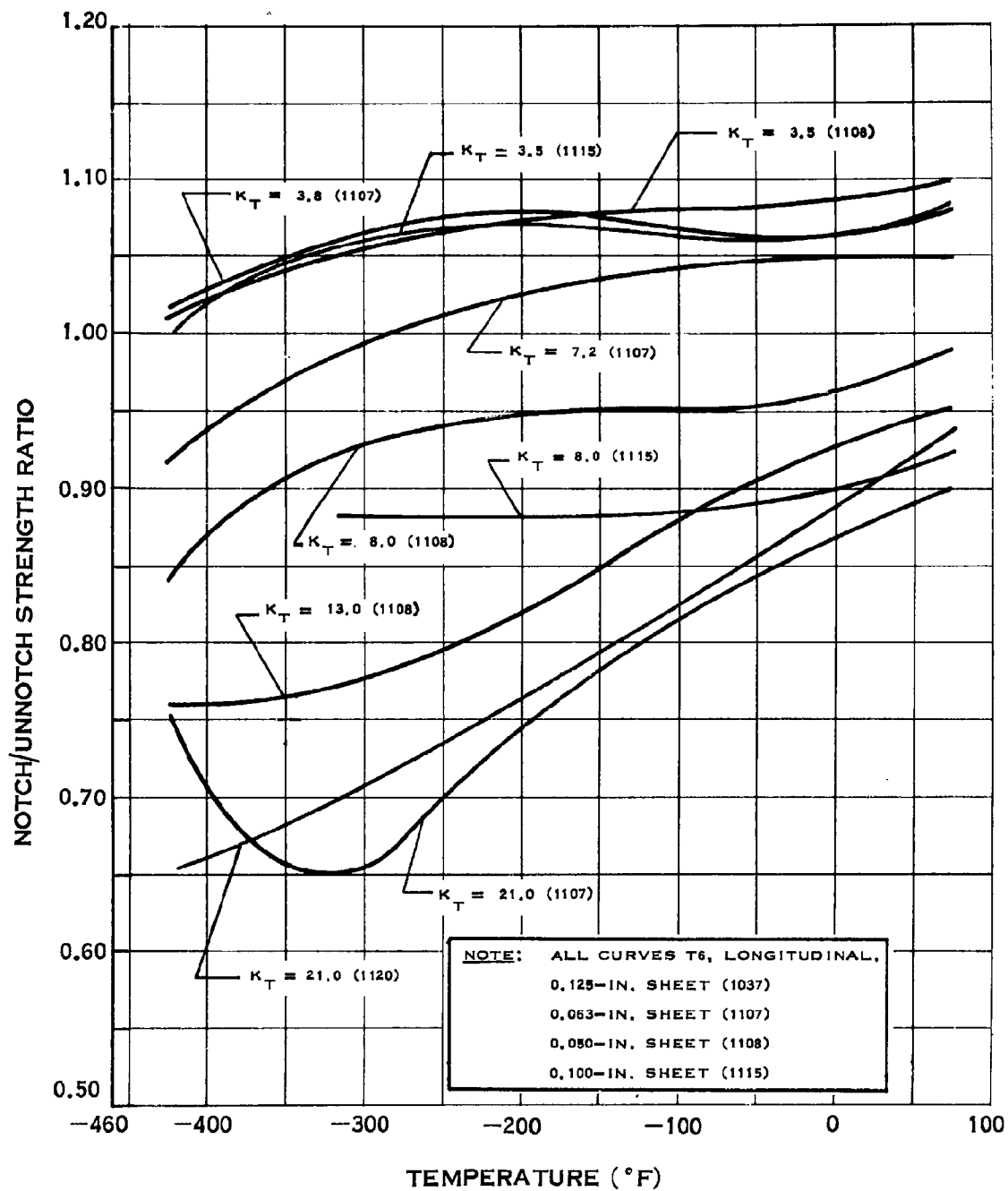

## NOTCH STRENGTH RATIO OF 2014 ALUMINUM

### A.8.b-3

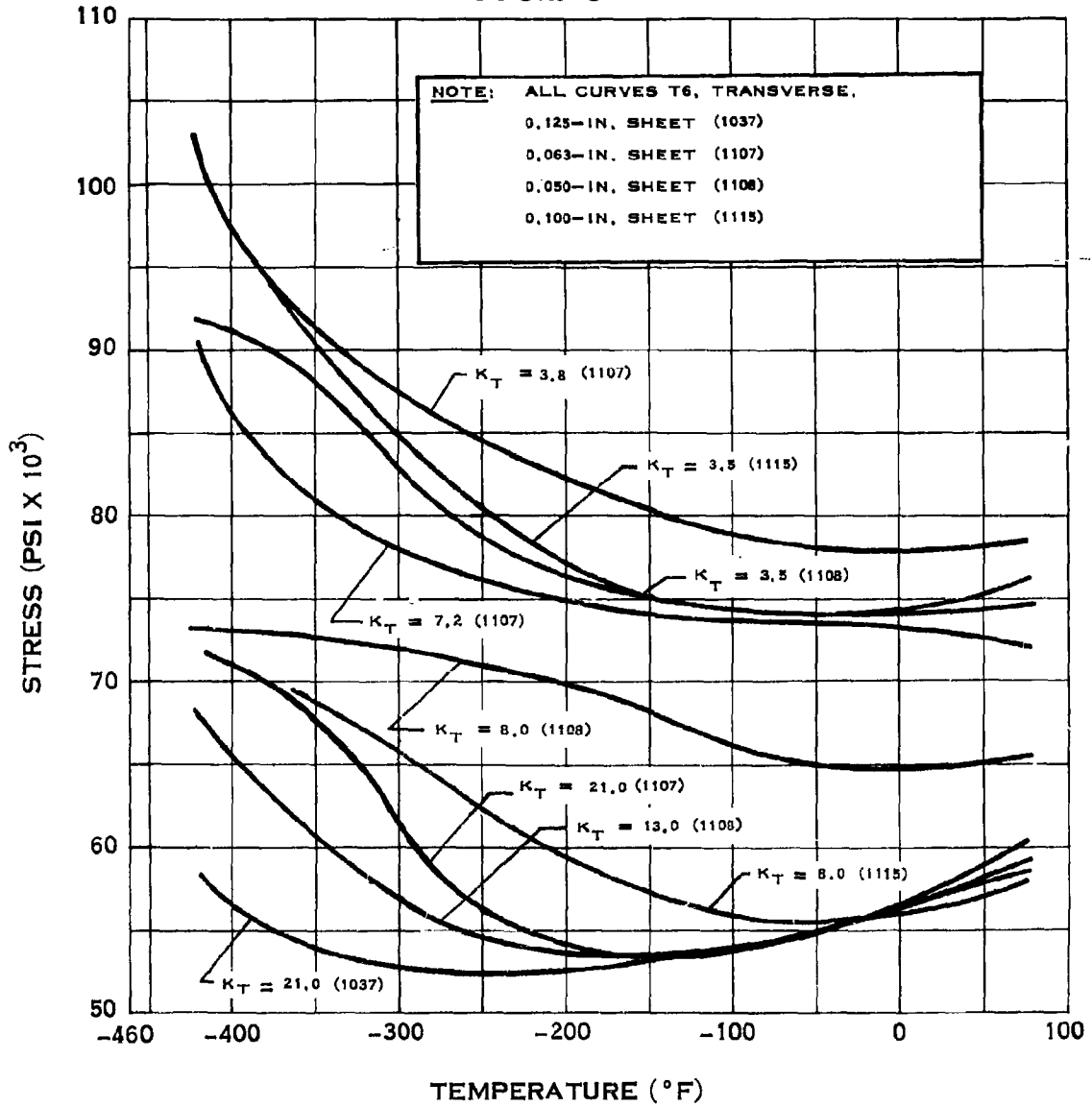

### NOTCH TENSILE STRENGTH OF 2014 ALUMINUM

### A.8.b-4

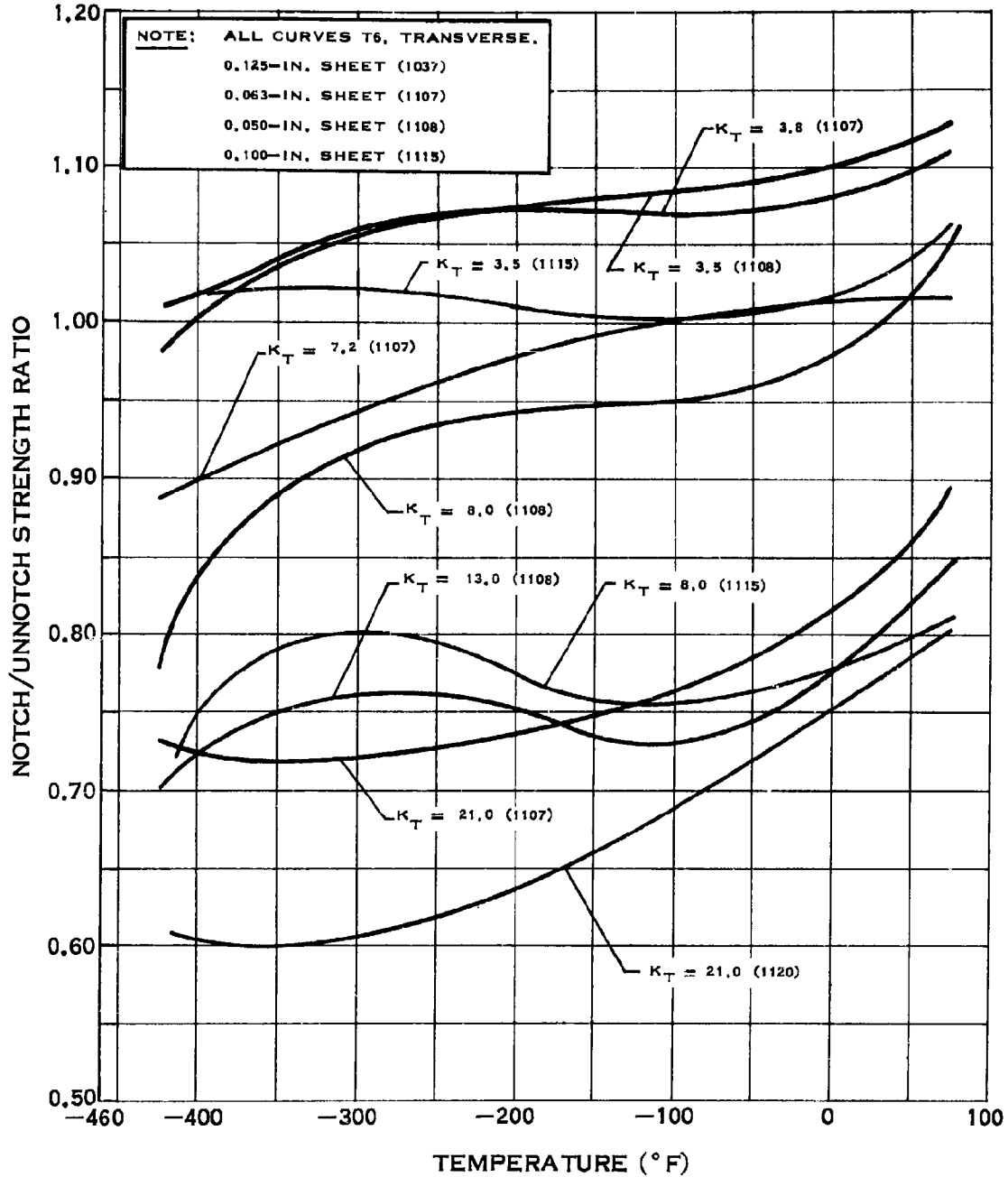

### NOTCH STRENGTH RATIO OF 2014 ALUMINUM



### A.8.b-5

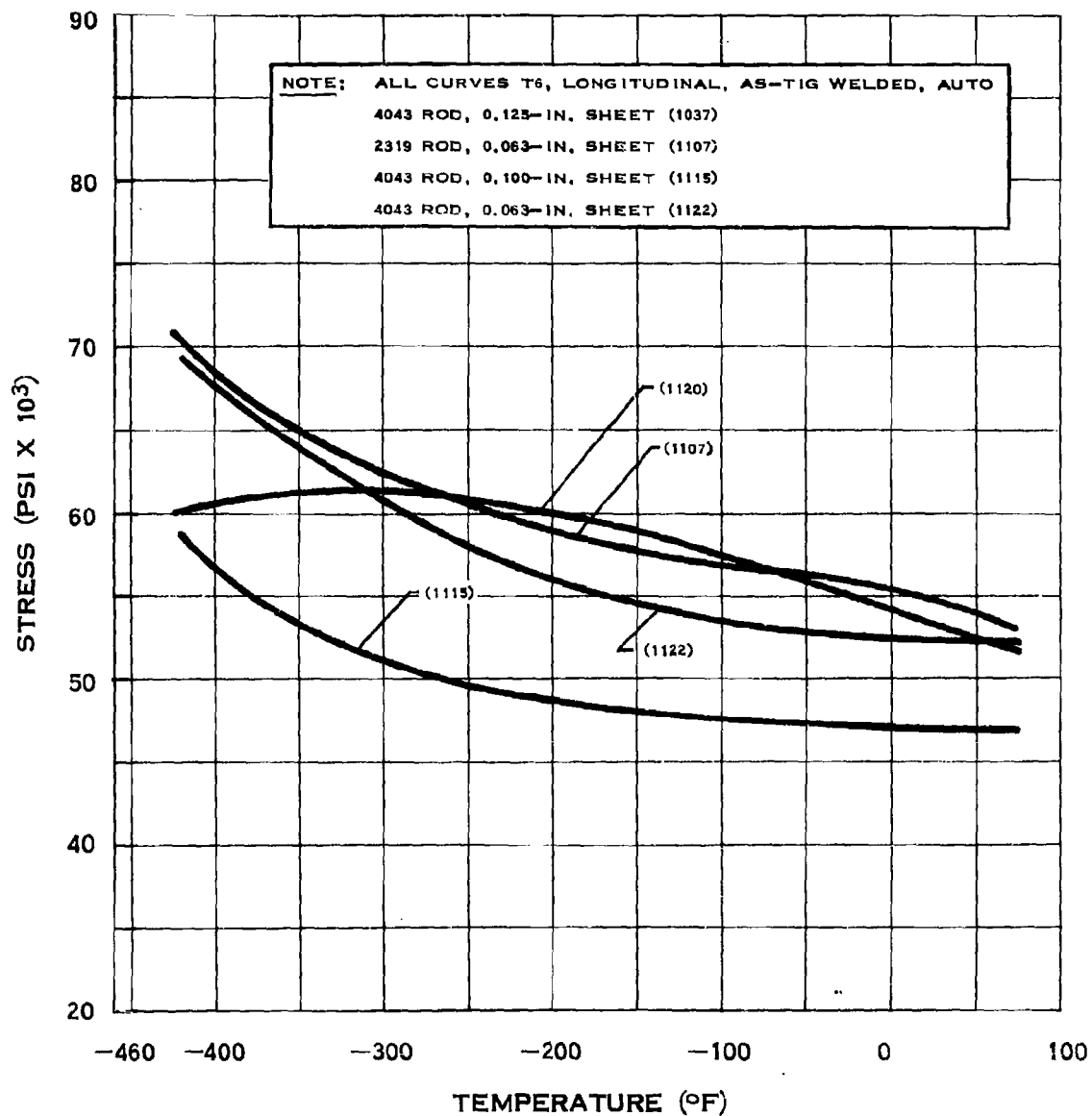

### WELD TENSILE STRENGTH OF 2014 ALUMINUM

## A.8.b-6

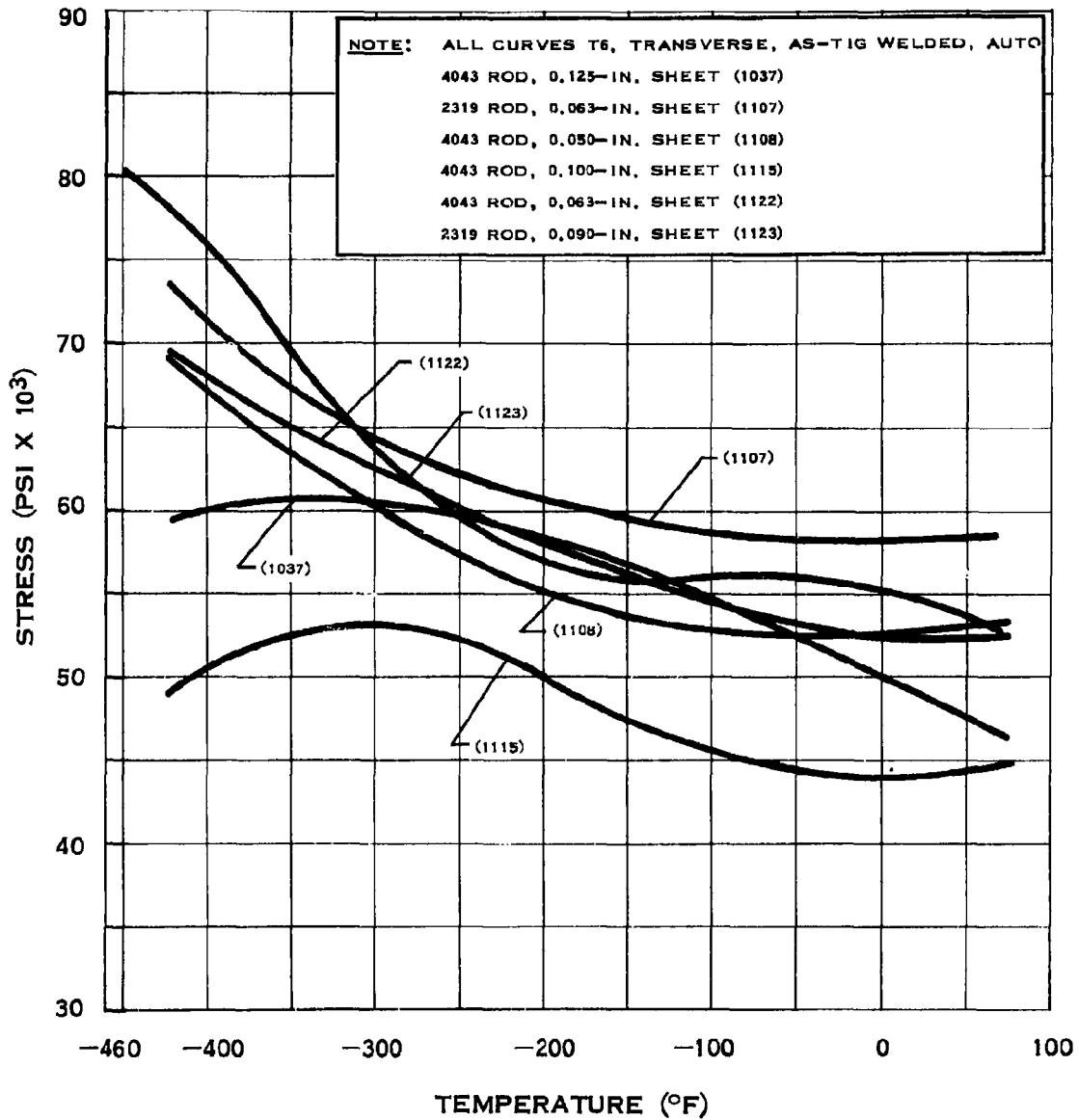

## WELD TENSILE STRENGTH OF 2014 ALUMINUM

### A.8.c

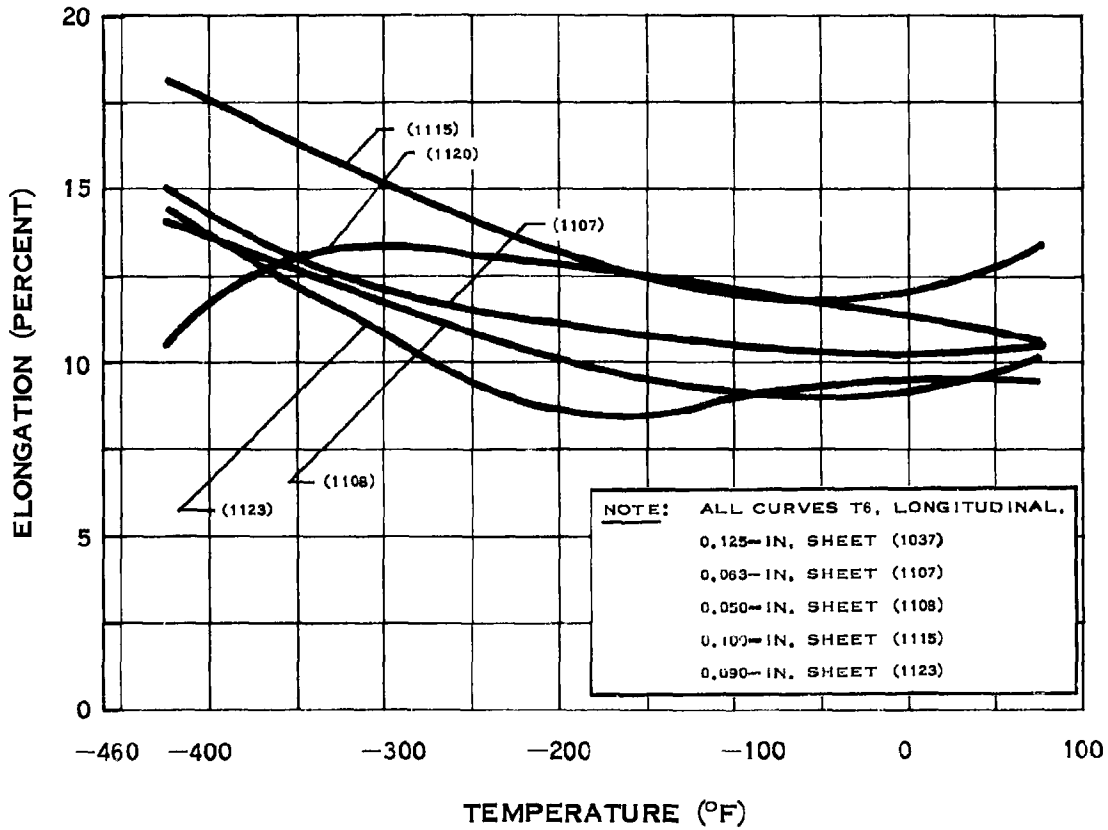

## ELONGATION OF 2014 ALUMINUM

### A.8.c-1

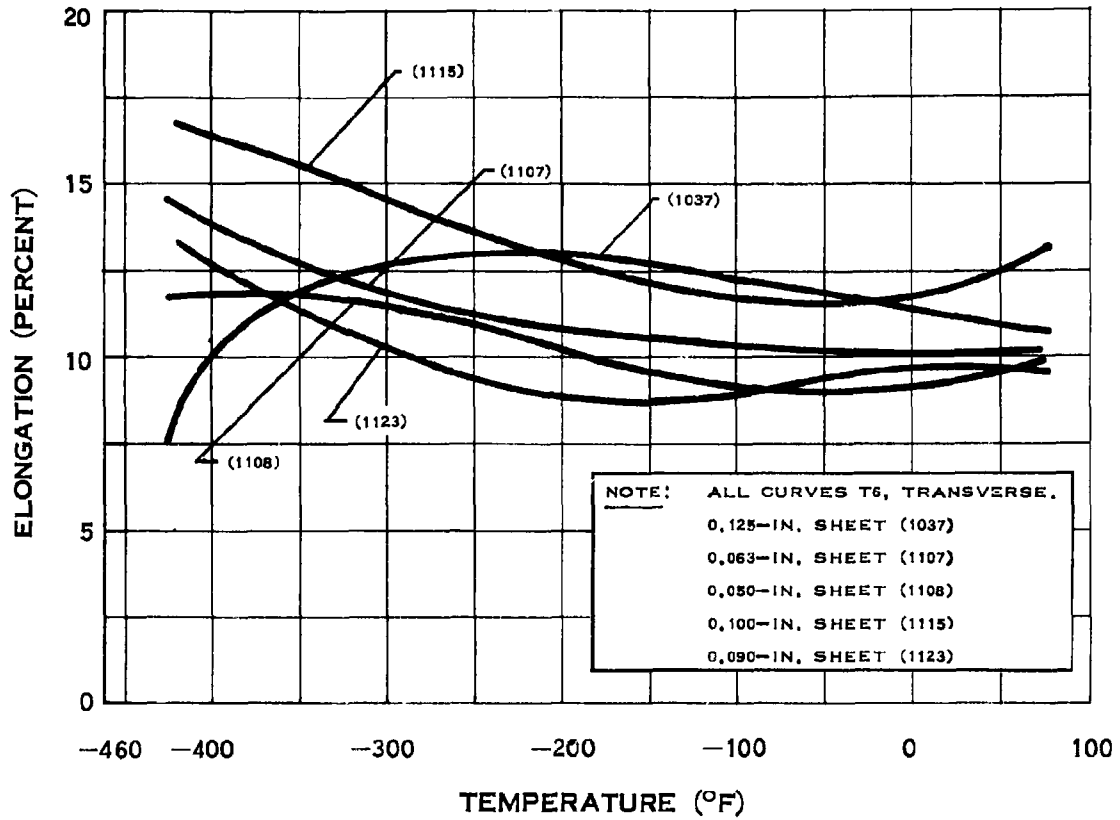

### ELONGATION OF 2014 ALUMINUM

### A.8.f

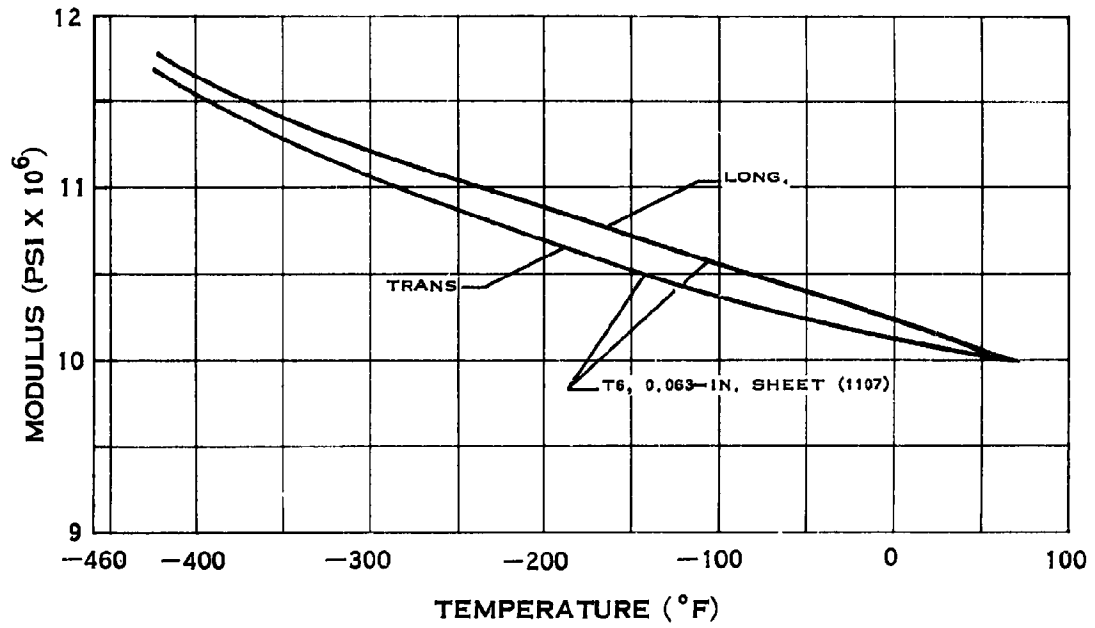

## MODULUS OF ELASTICITY OF 2014 ALUMINUM

### A.8.1

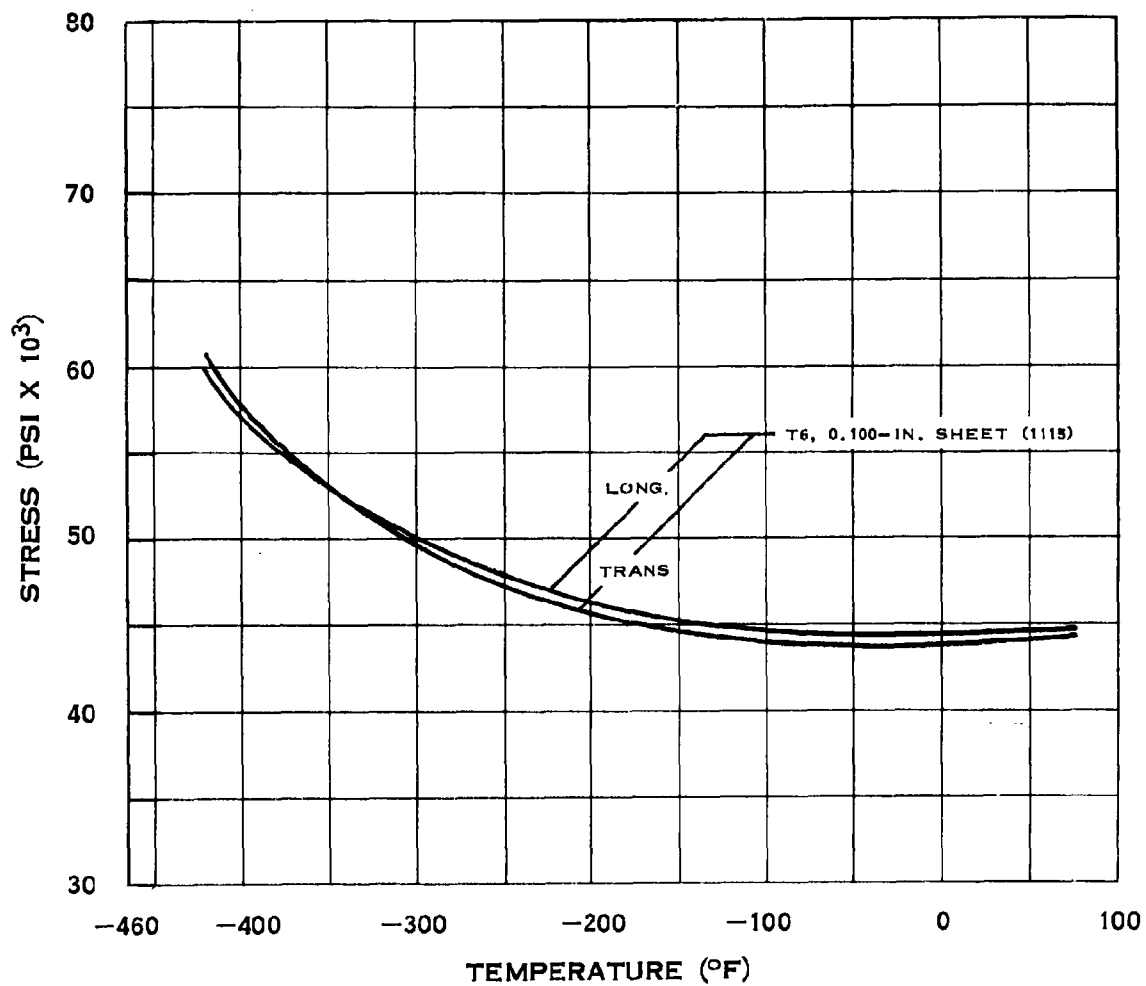

### SHEAR STRENGTH OF 2014 ALUMINUM

# A.9.a

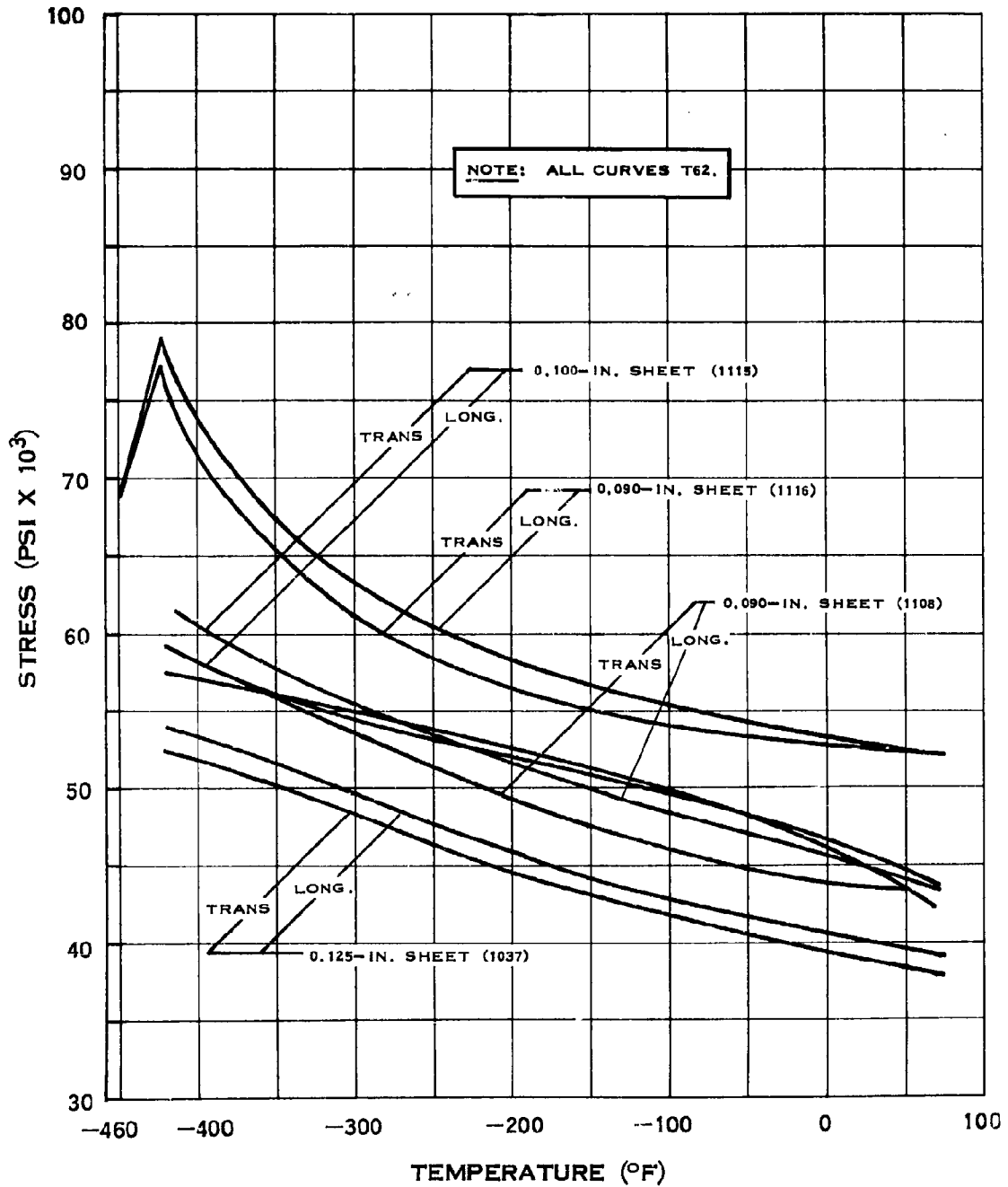

## YIELD STRENGTH OF 2219 ALUMINUM

# A.9.a-1

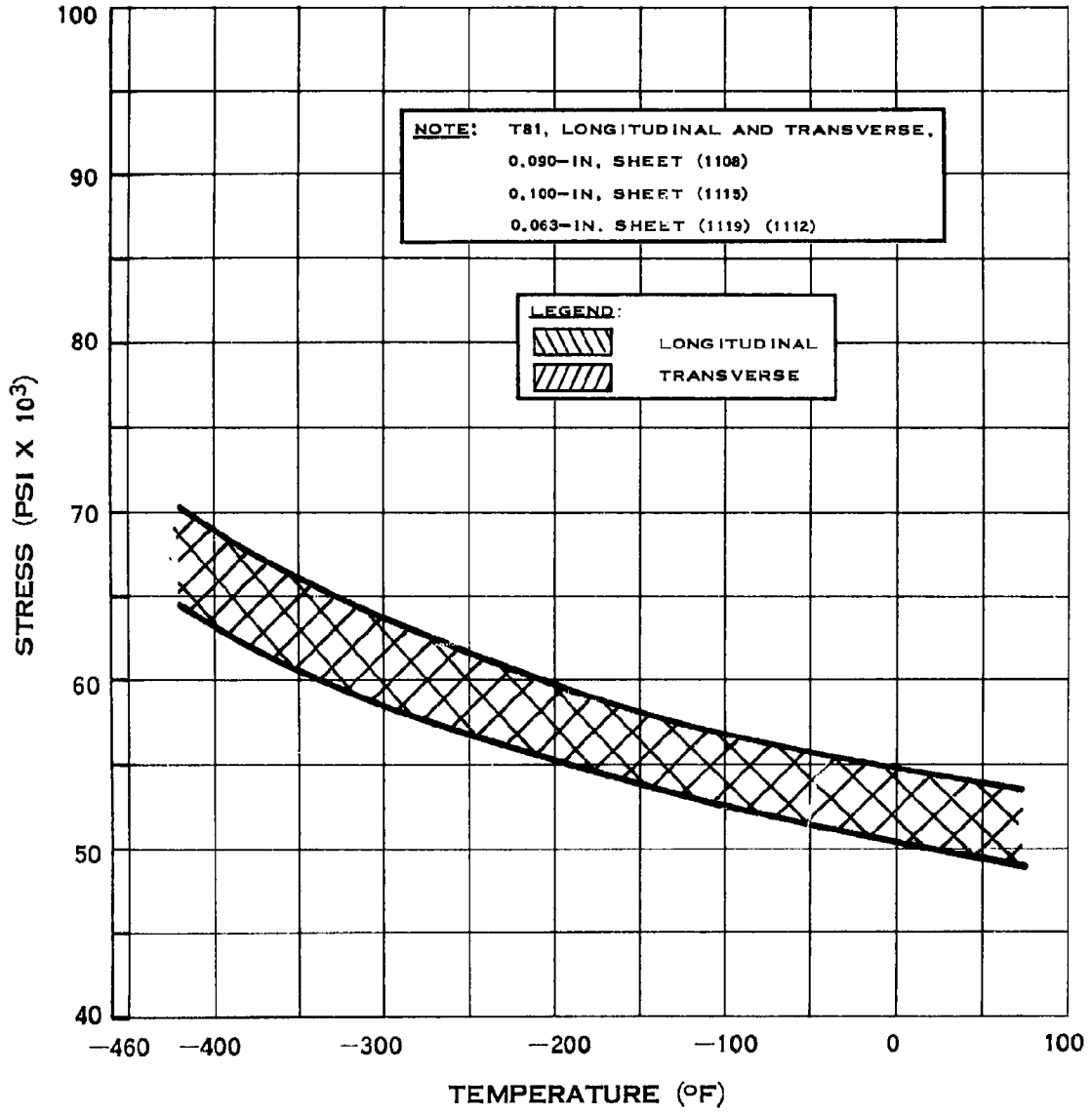

## YIELD STRENGTH OF 2219 ALUMINUM



# A.9.a-2

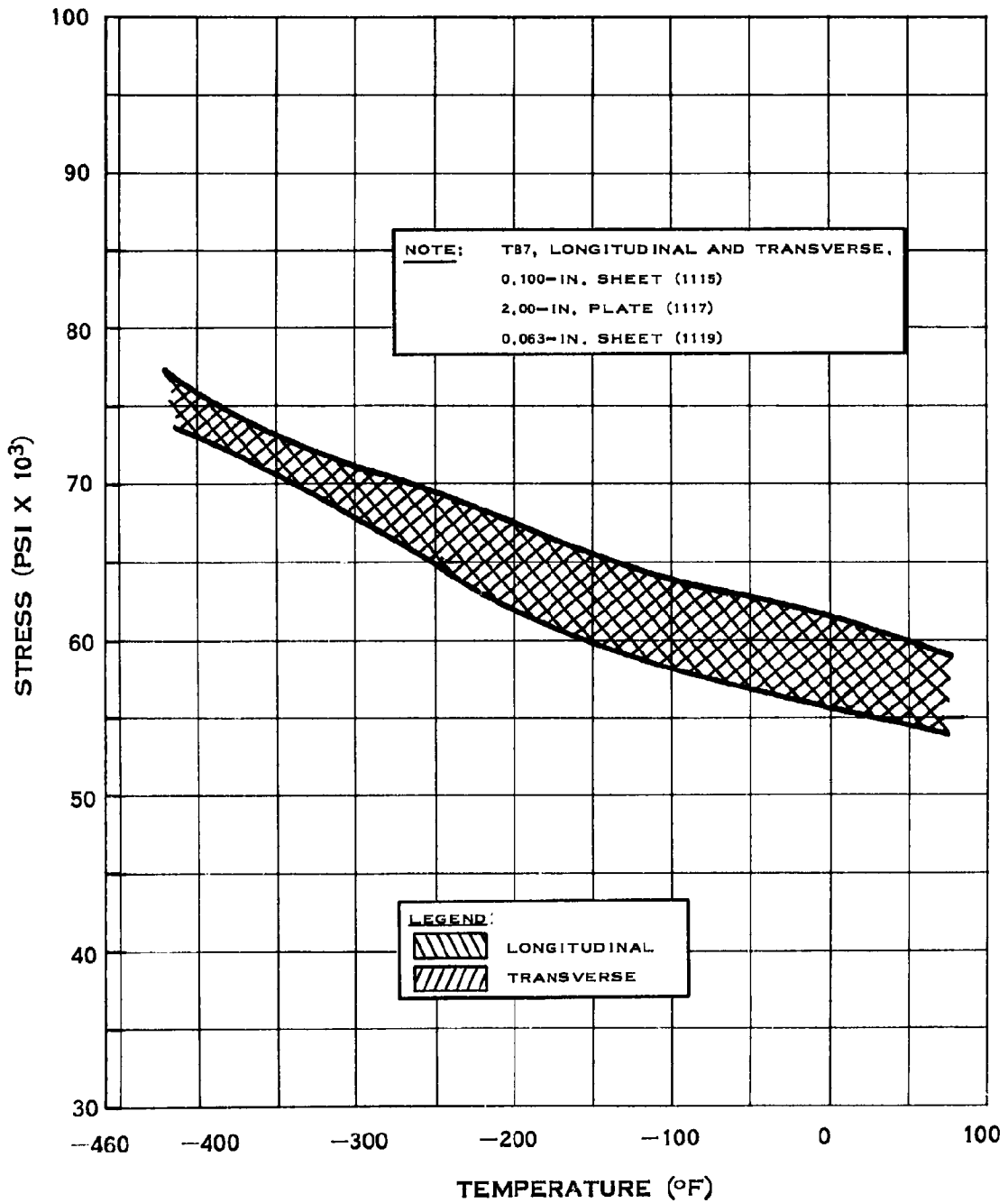

## YIELD STRENGTH OF 2219 ALUMINUM

### A.9.b

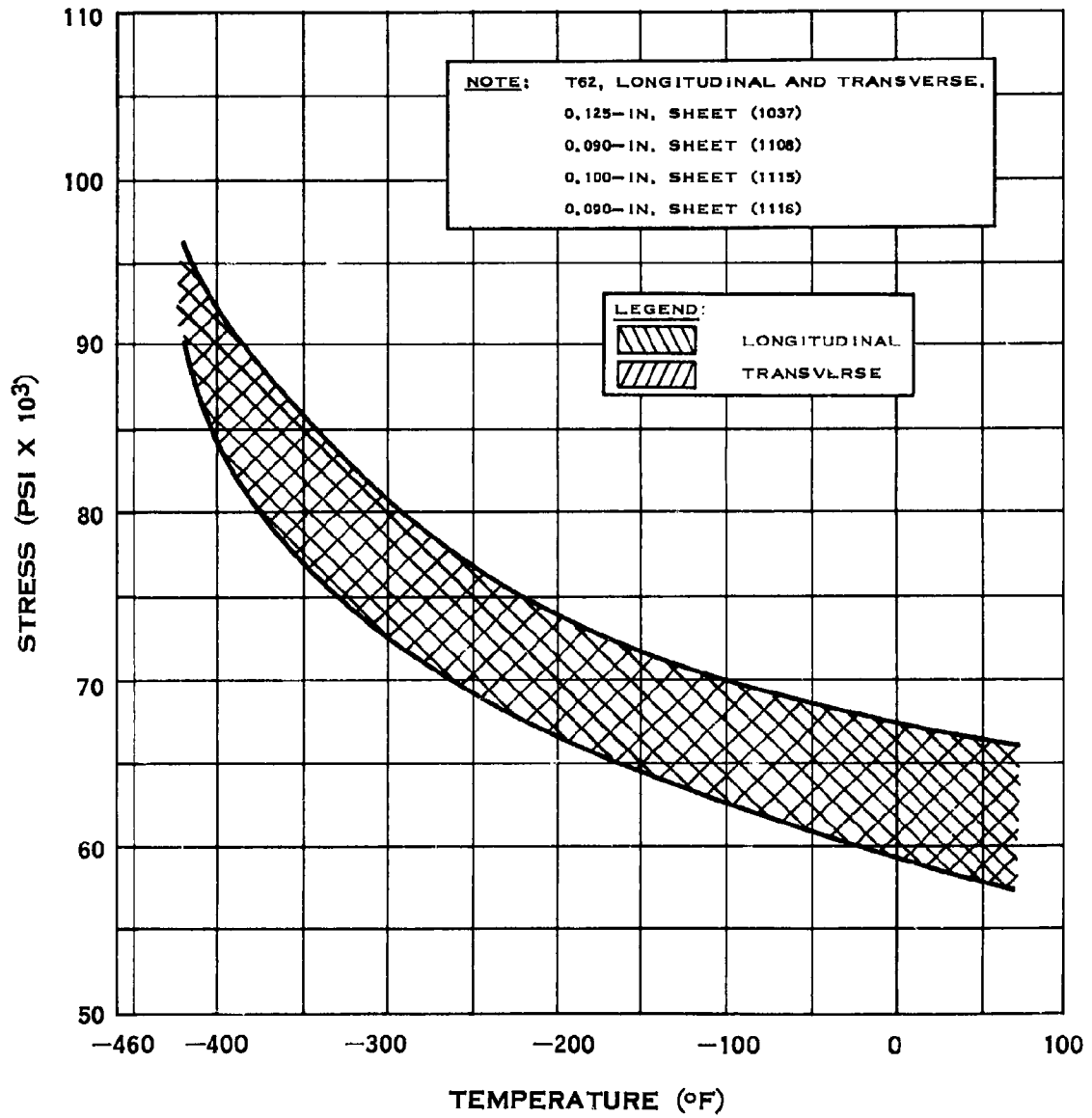

## TENSILE STRENGTH OF 2219 ALUMINUM

# A.9.b-1

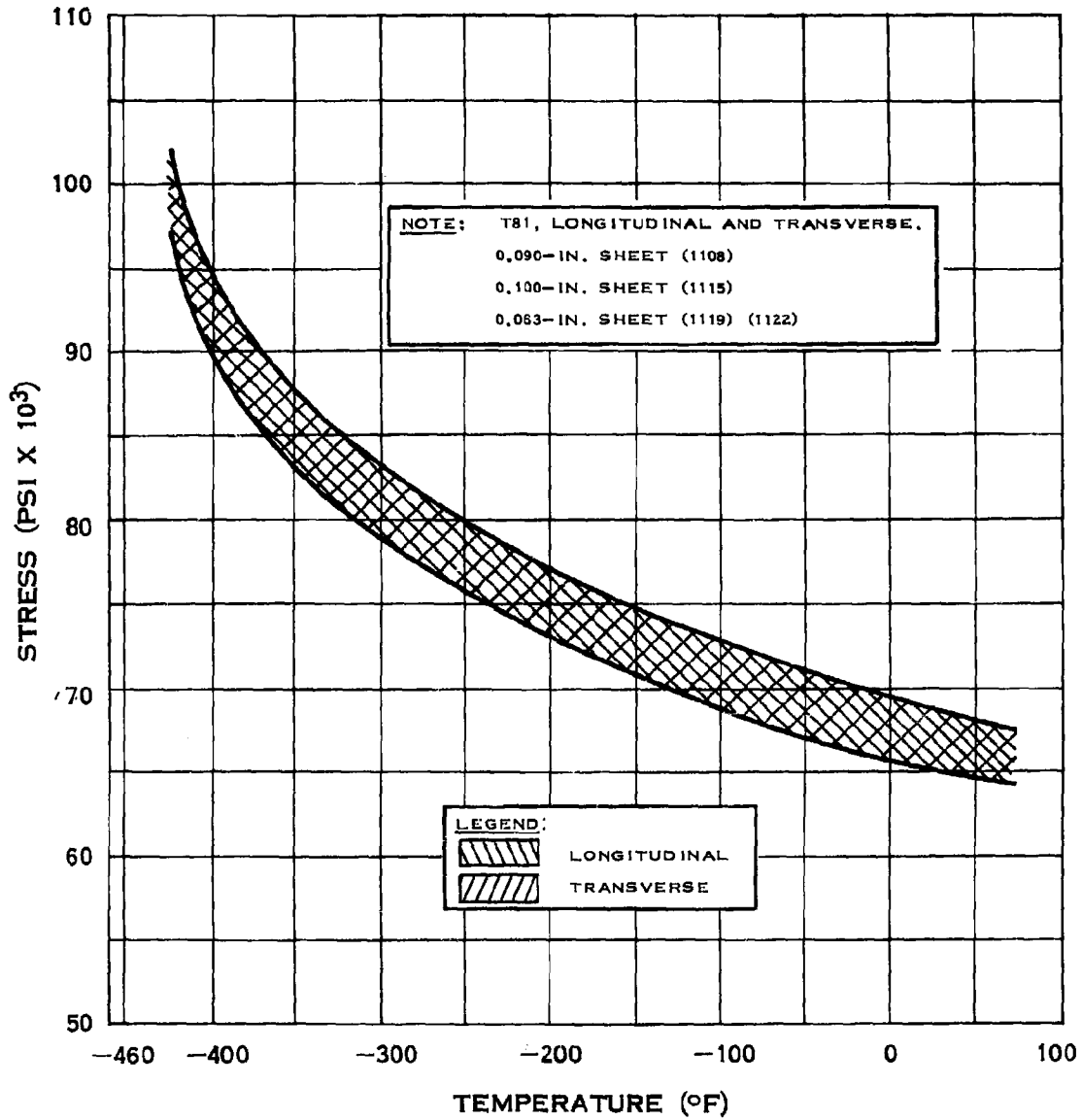

## TENSILE STRENGTH OF 2219 ALUMINUM

## A.9.b-2

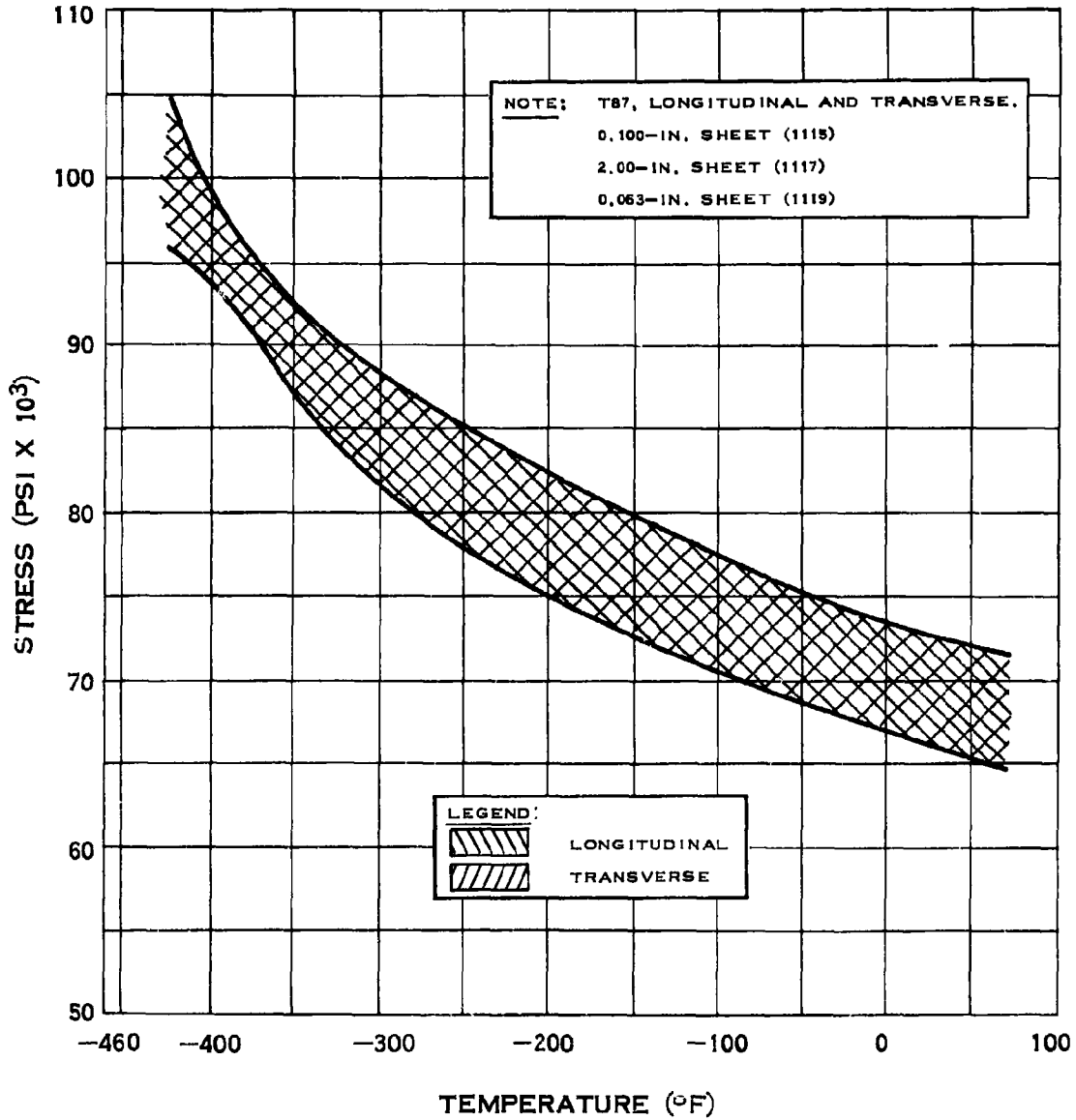

## TENSILE STRENGTH OF 2219 ALUMINUM

### A.9.b-3

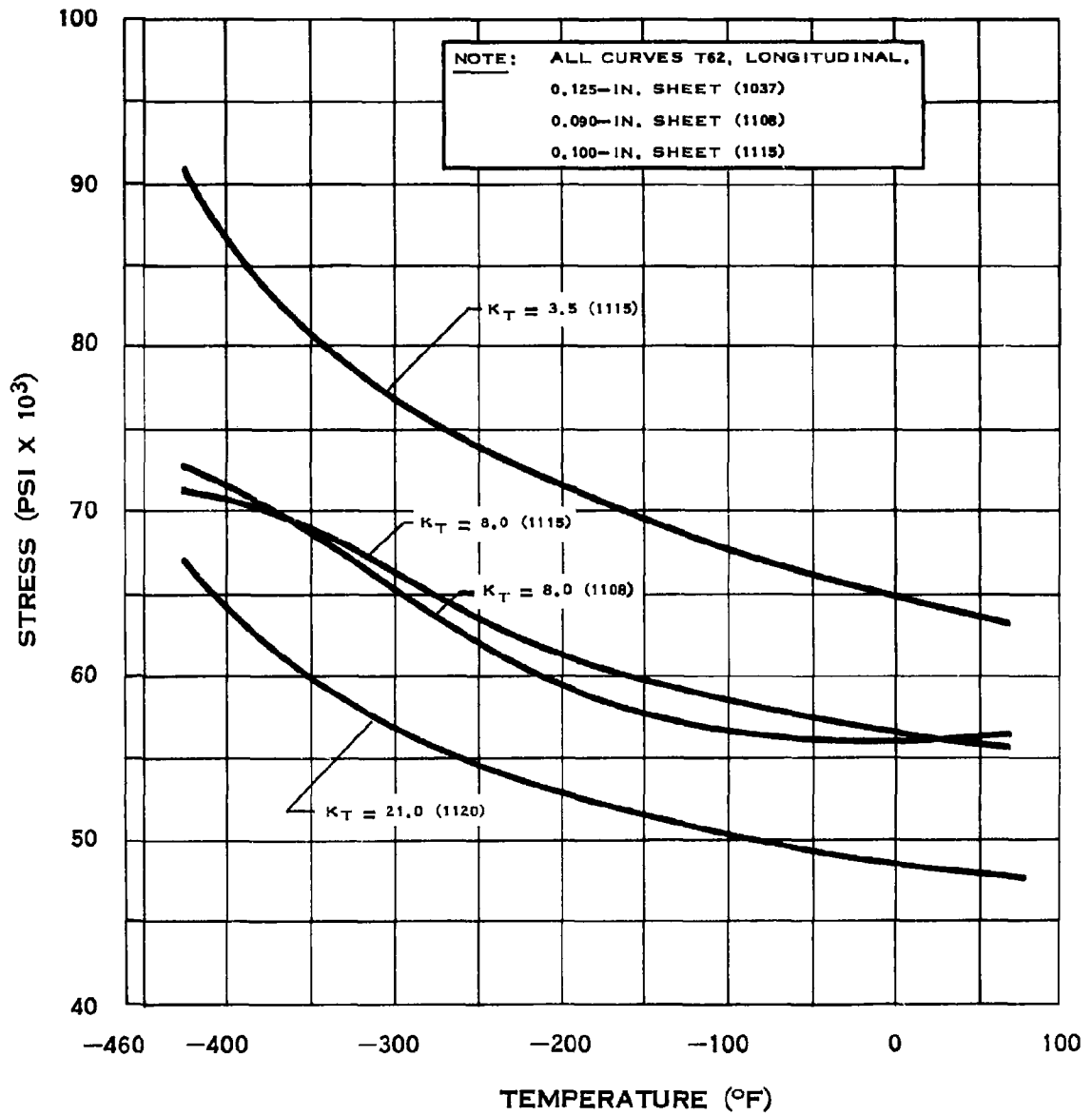

### NOTCH TENSILE STRENGTH OF 2219 ALUMINUM

# A.9.b-4

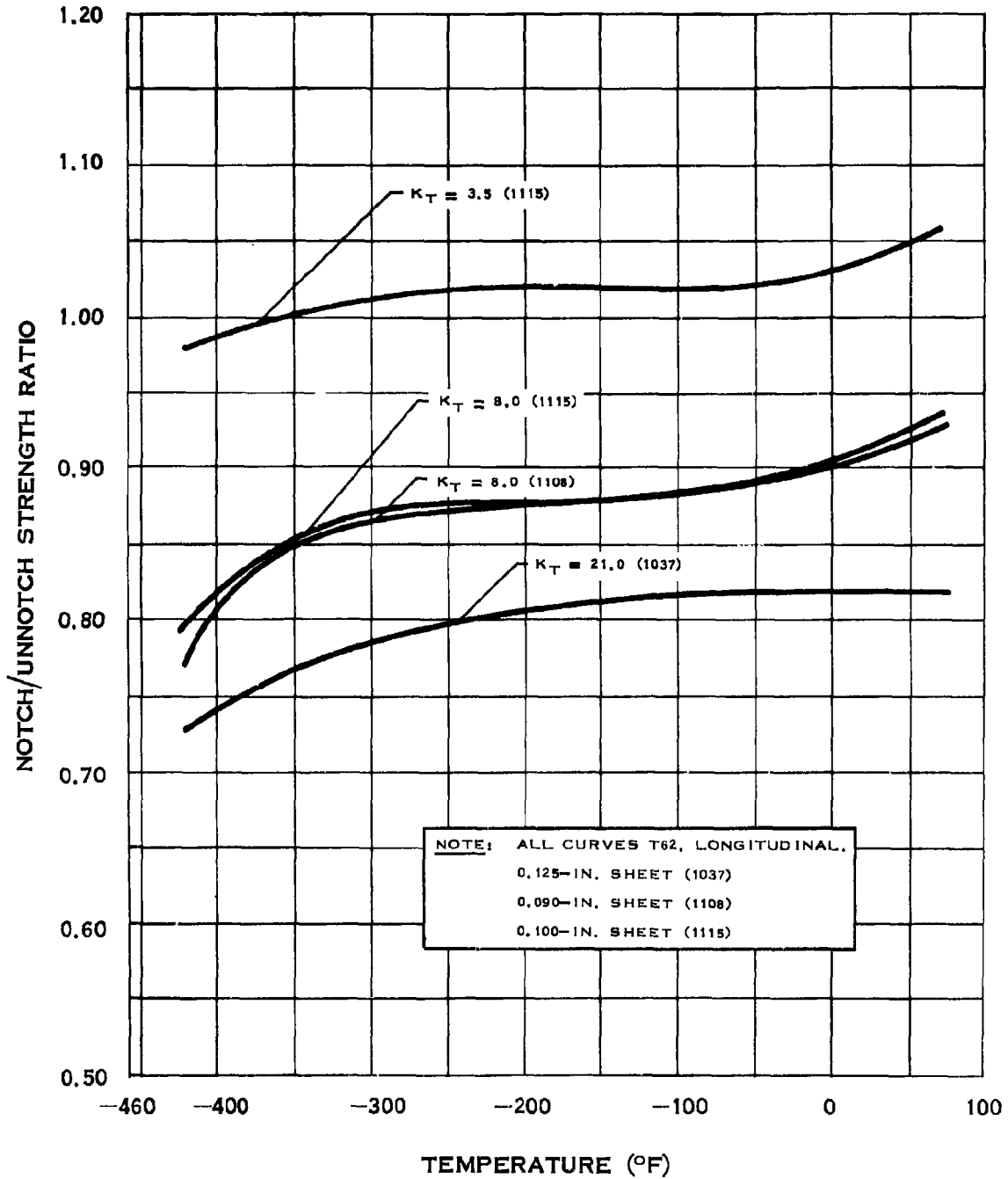

## NOTCH STRENGTH RATIO OF 2219 ALUMINUM

### A.9.b-5

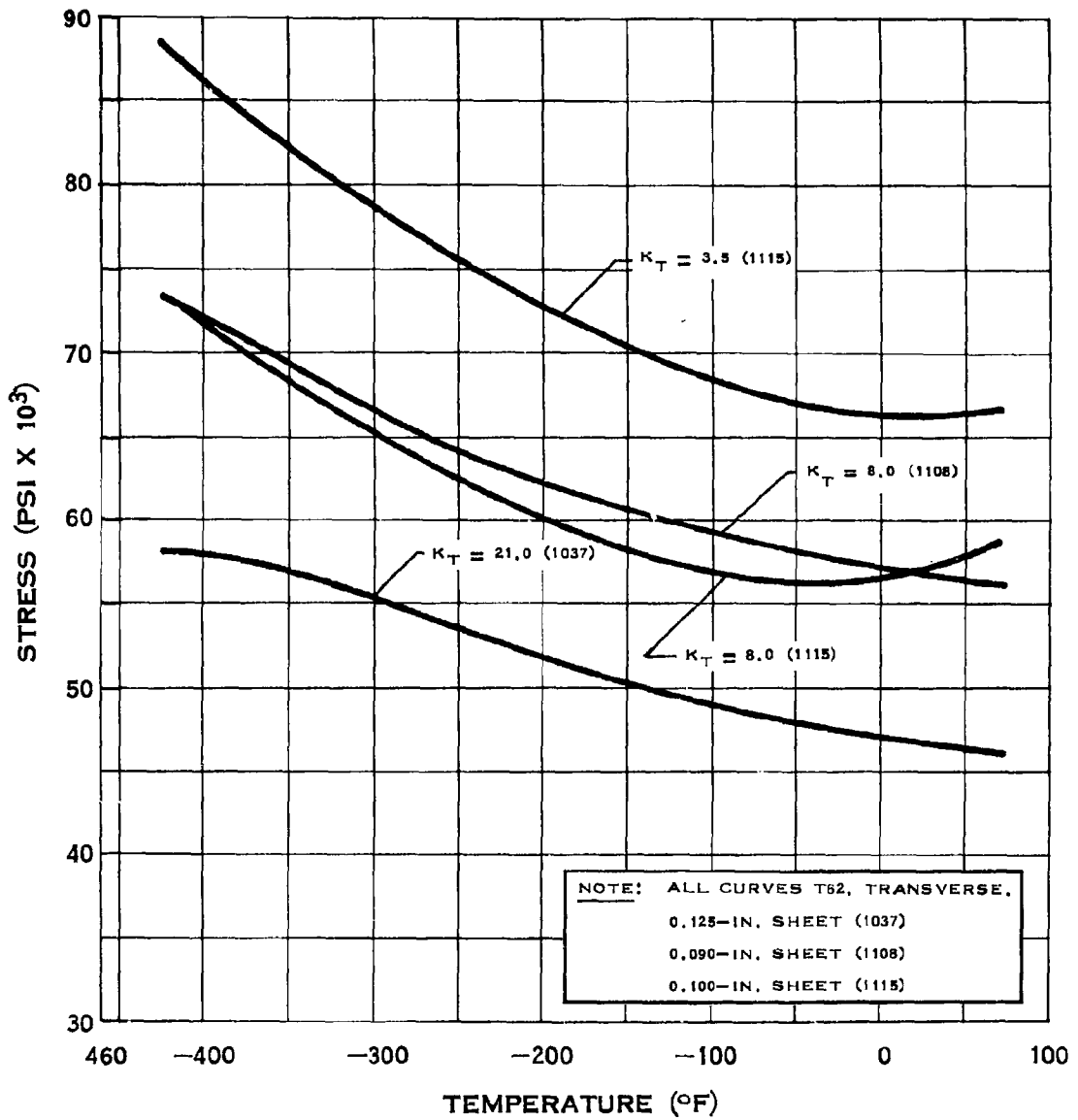

### NOTCH TENSILE STRENGTH OF 2219 ALUMINUM

# A.9.b-6

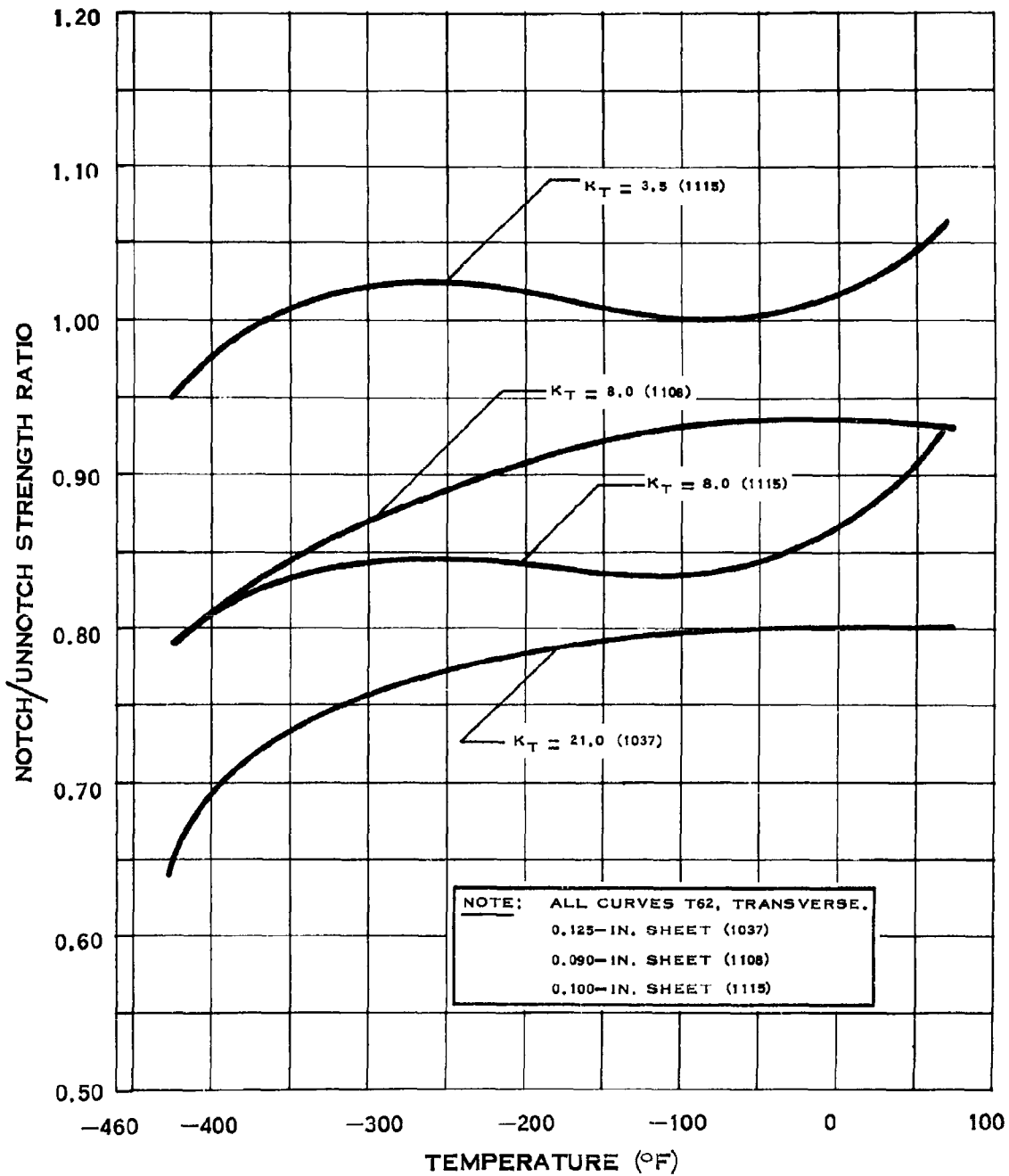

## NOTCH STRENGTH RATIO OF 2219 ALUMINUM



### A.9.b-7

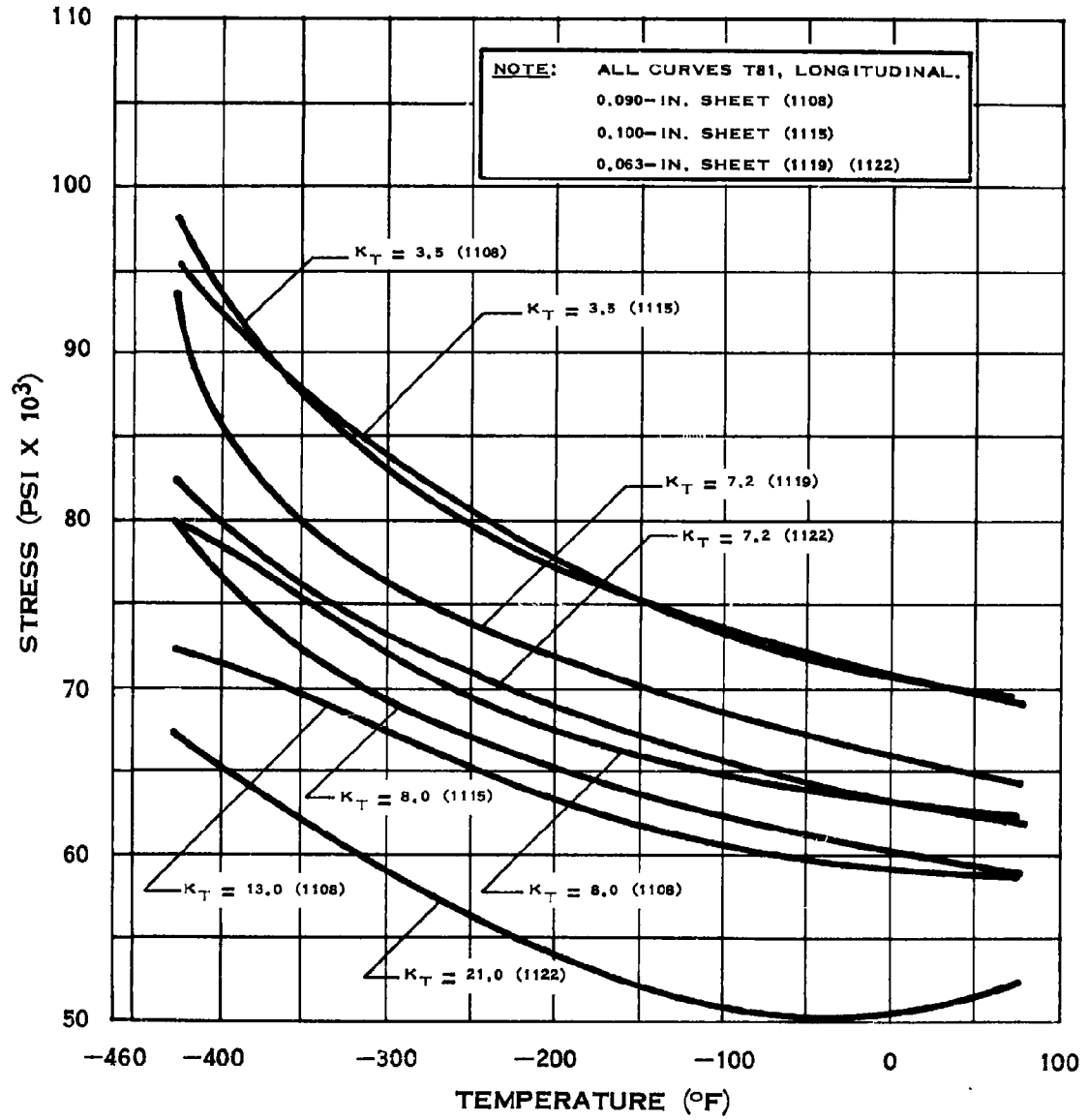

### NOTCH TENSILE STRENGTH OF 2219 ALUMINUM

# A.9.b-8

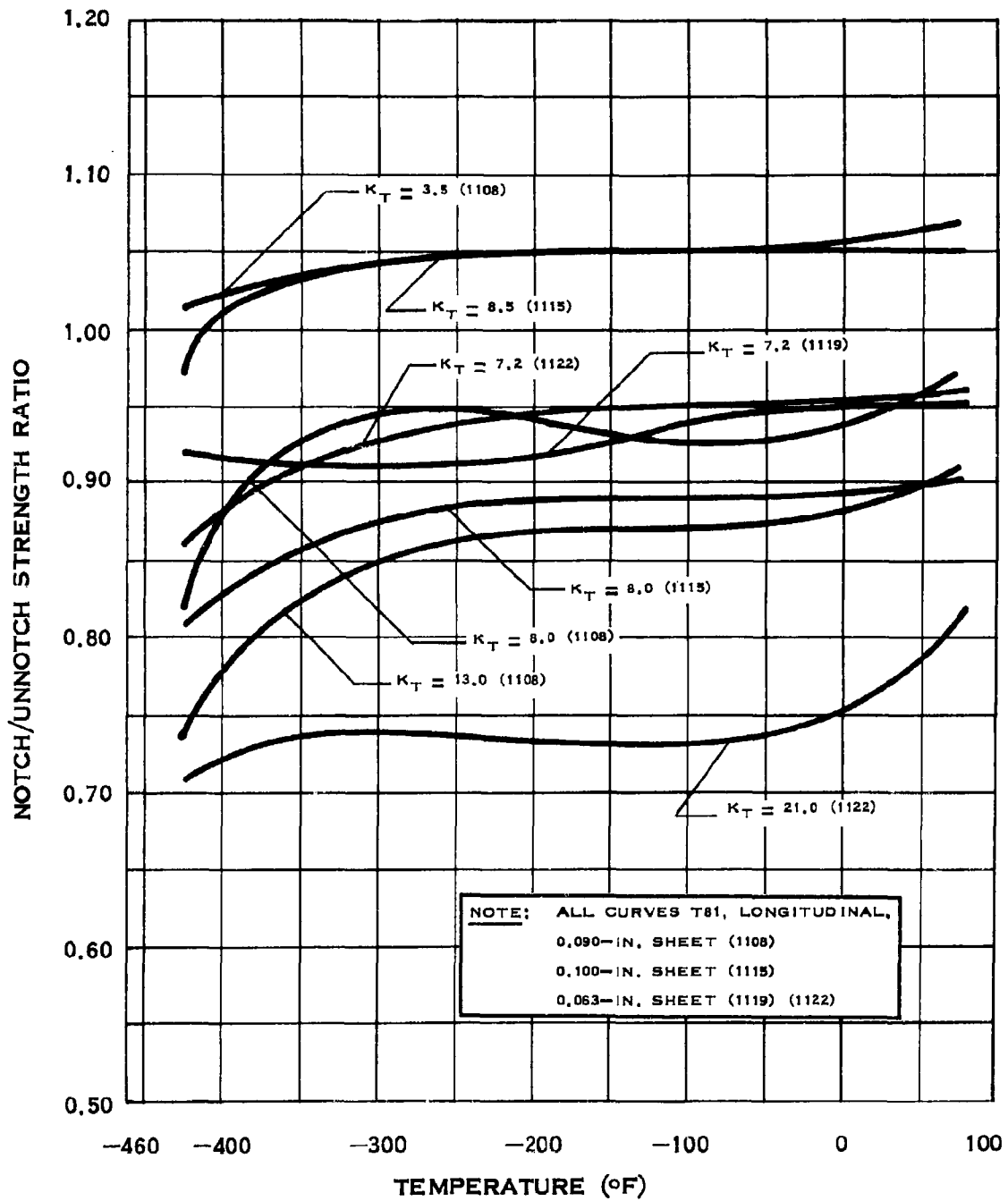

## NOTCH STRENGTH RATIO OF 2219 ALUMINUM

# A.9.b-9

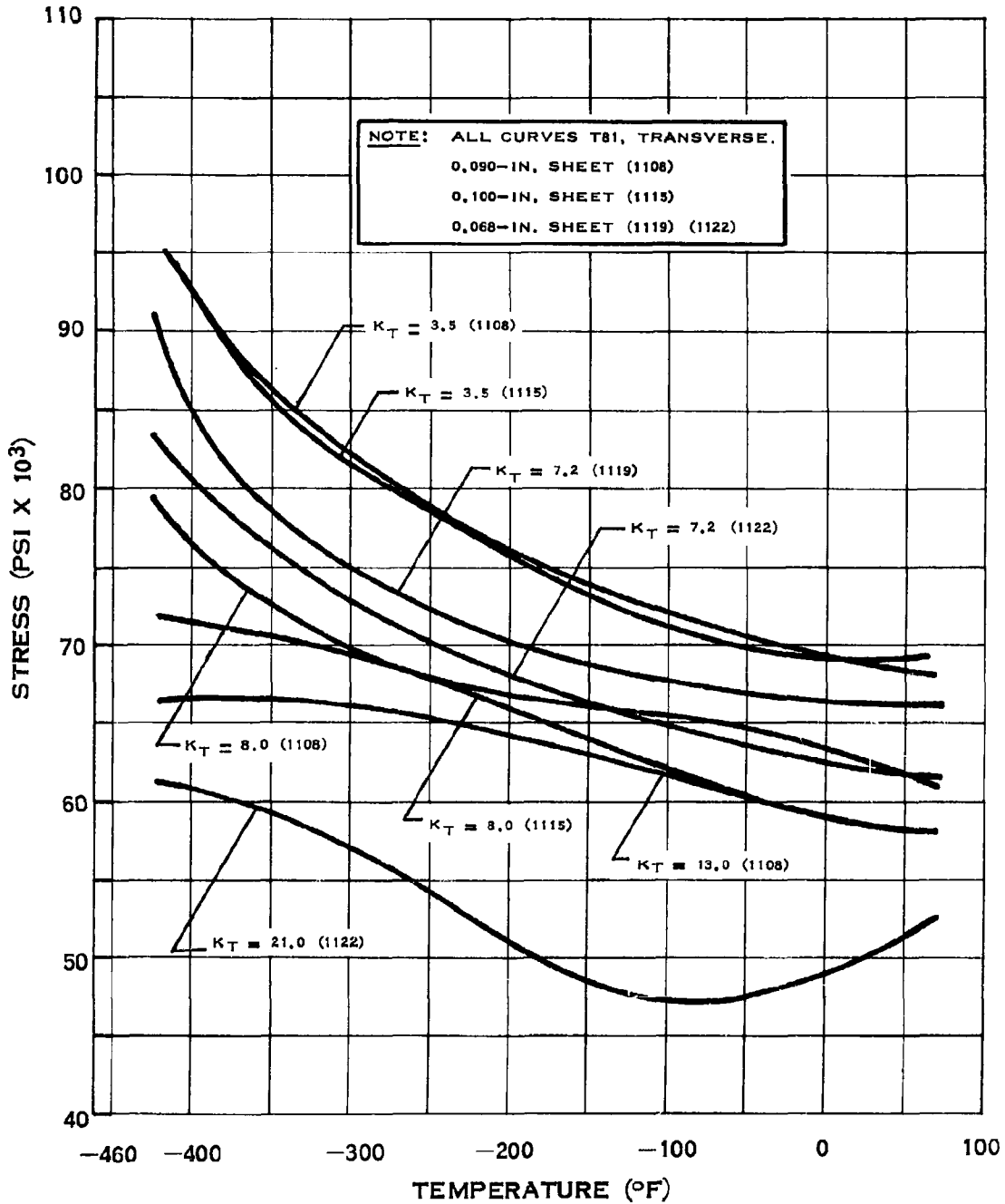

## NOTCH TENSILE STRENGTH OF 2219 ALUMINUM

# A.9.b-10

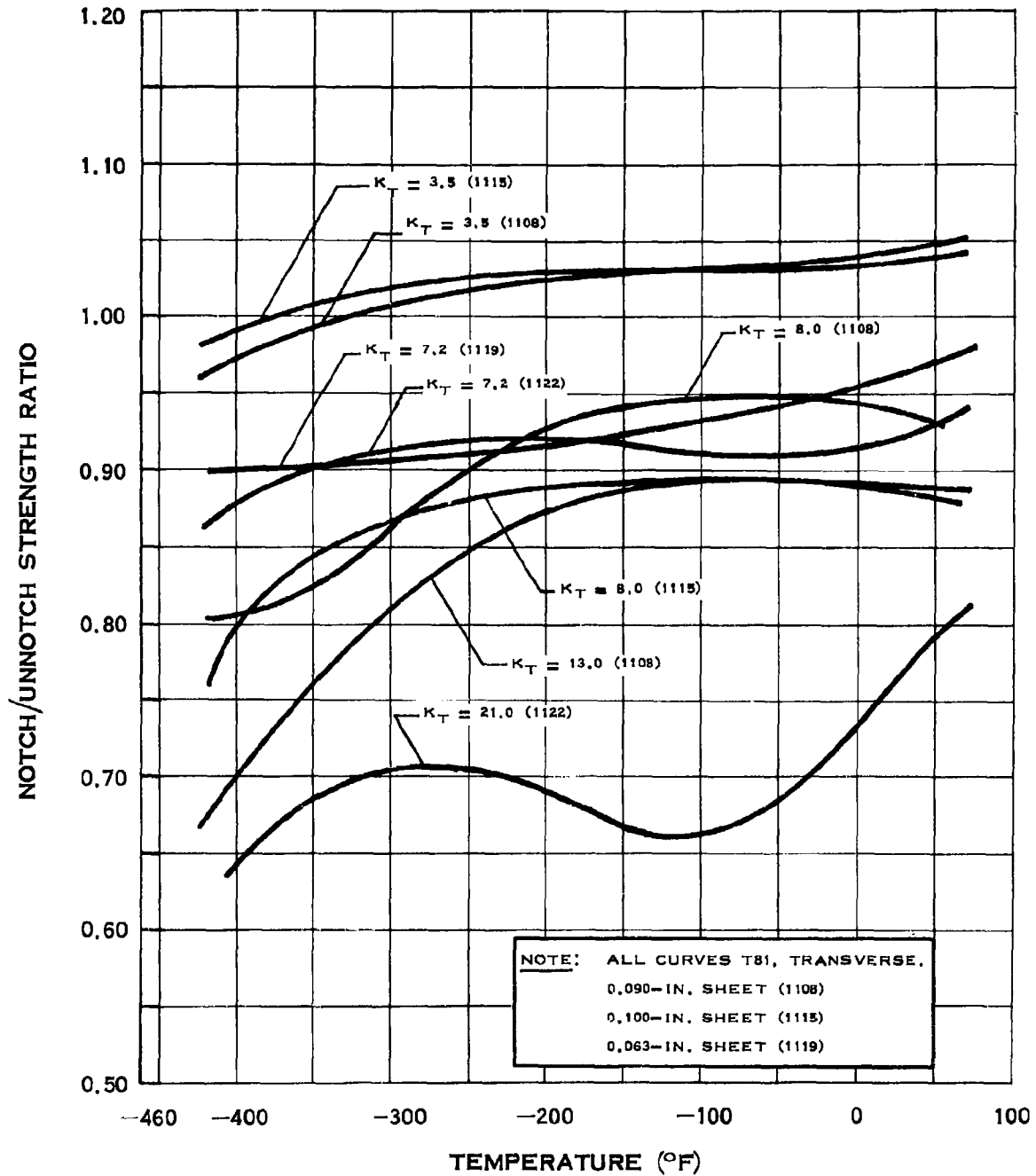

## NOTCH STRENGTH RATIO OF 2219 ALUMINUM

# A.9.b-11

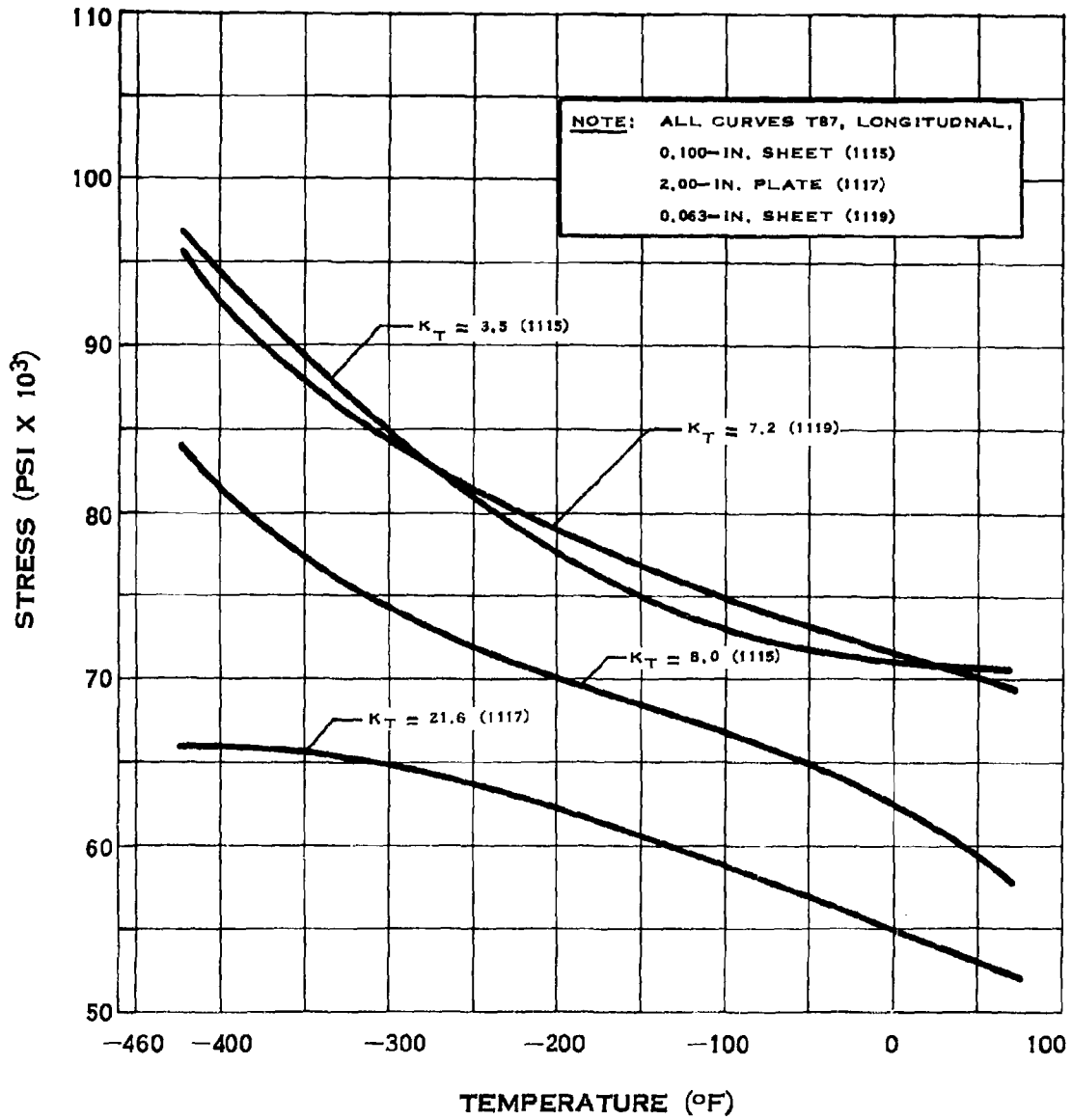

## NOTCH TENSILE STRENGTH OF 2219 ALUMINUM

# A.9.b-12

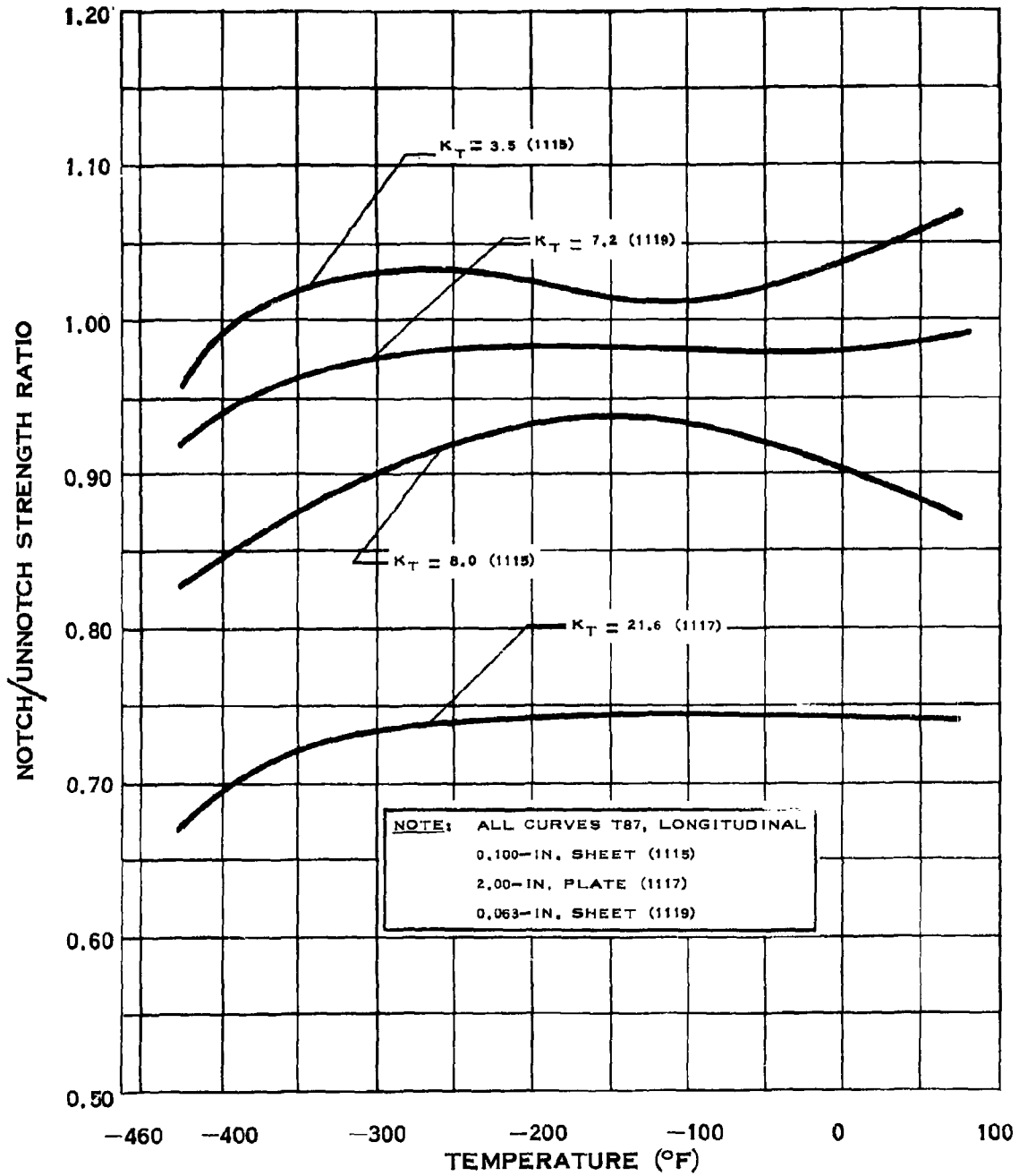

## NOTCH STRENGTH RATIO OF 2219 ALUMINUM

# A.9.b-13

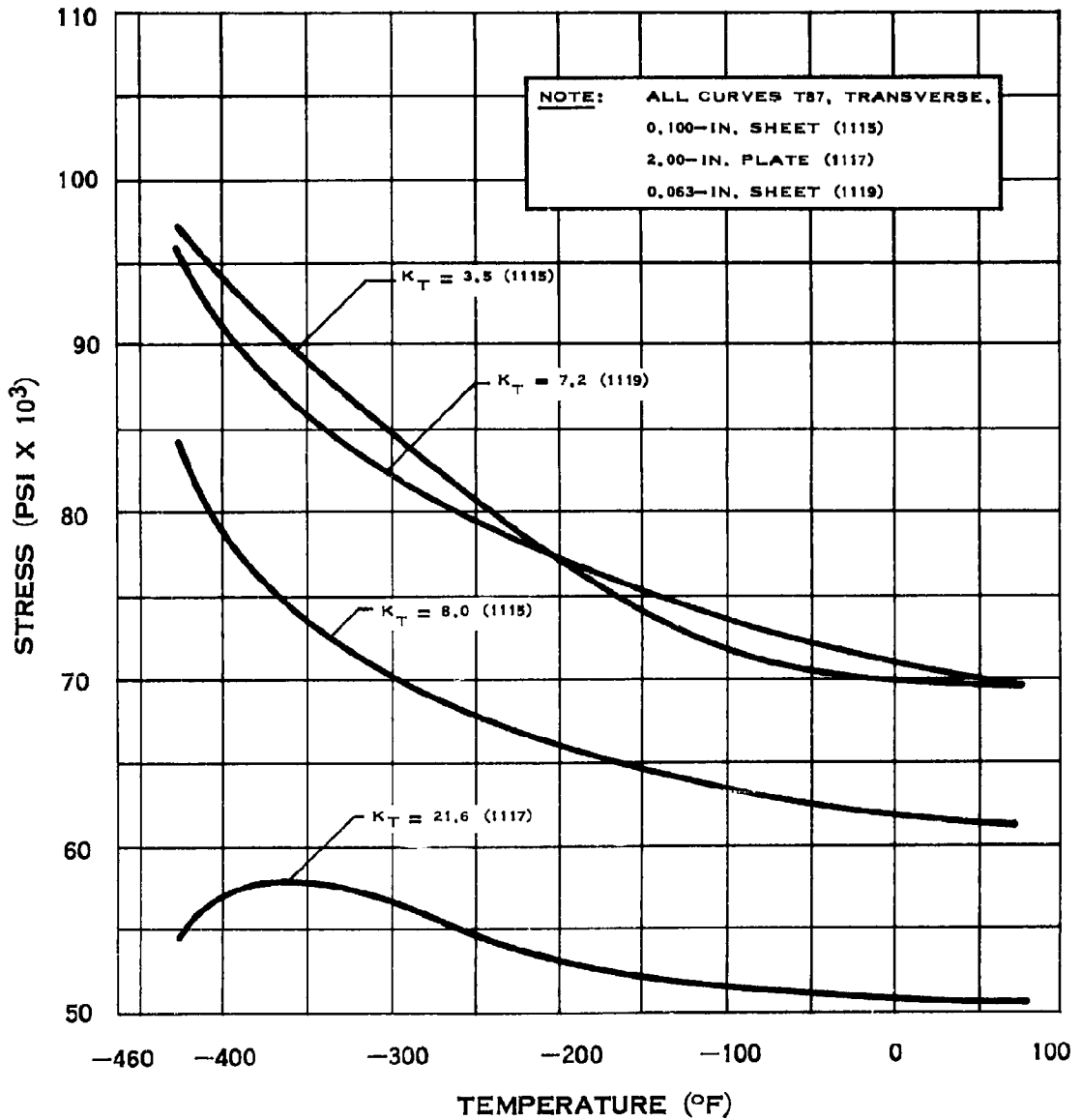

## NOTCH TENSILE STRENGTH OF 2219 ALUMINUM

# A.9.b-14

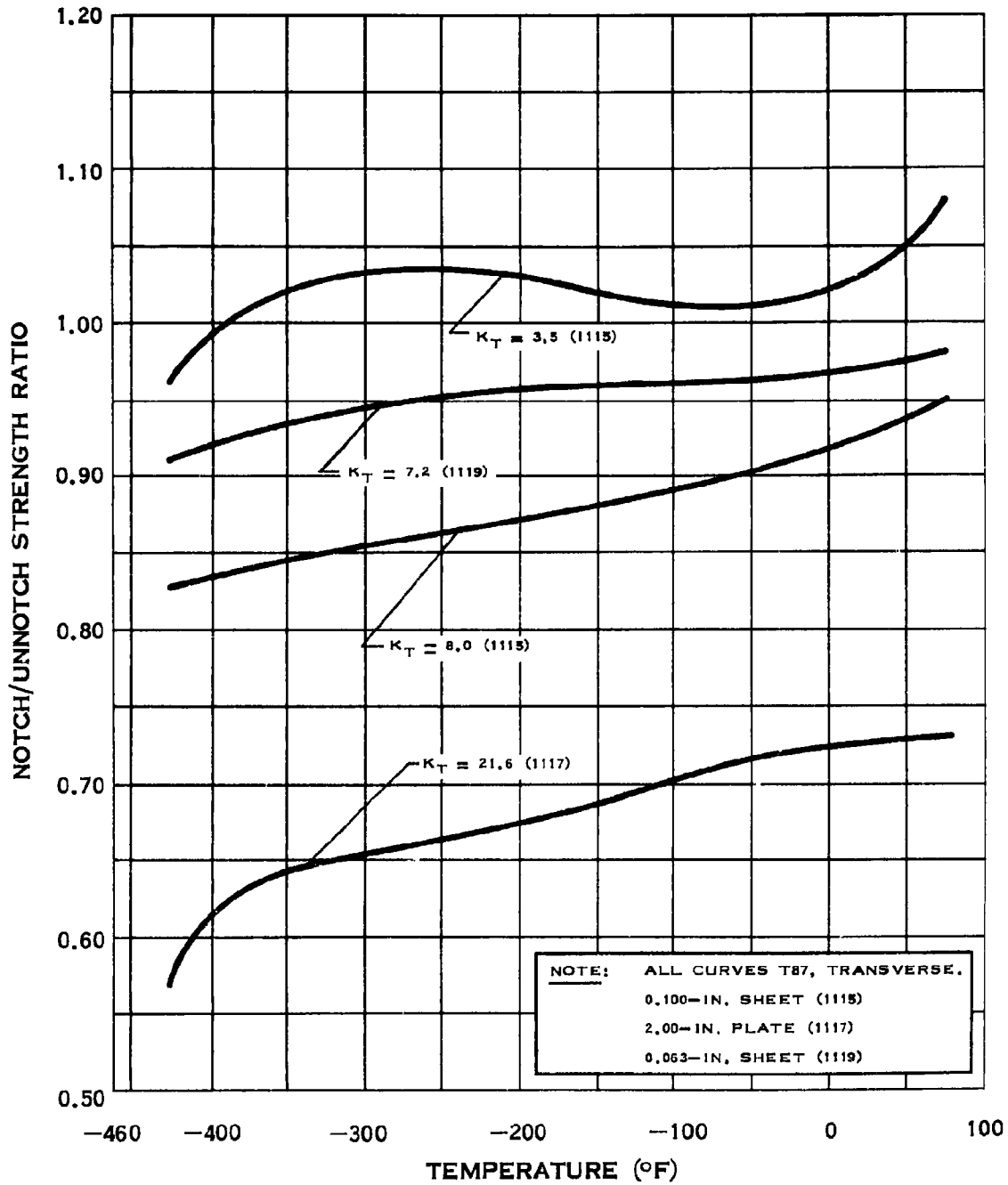

## NOTCH STRENGTH RATIO OF 2219 ALUMINUM



### A.9.b-15

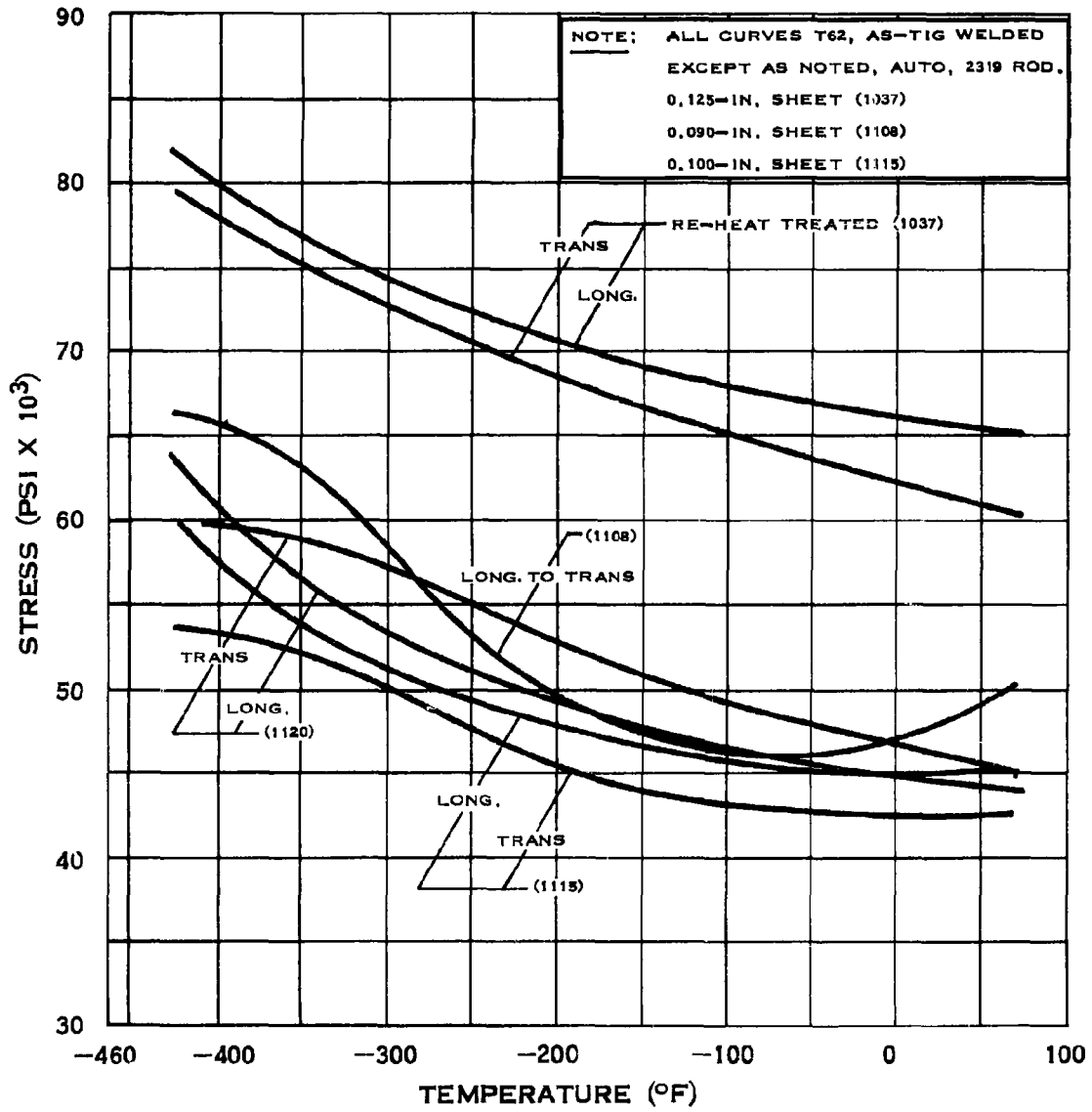

### WELD TENSILE STRENGTH OF 2219 ALUMINUM

# A.9.b-16

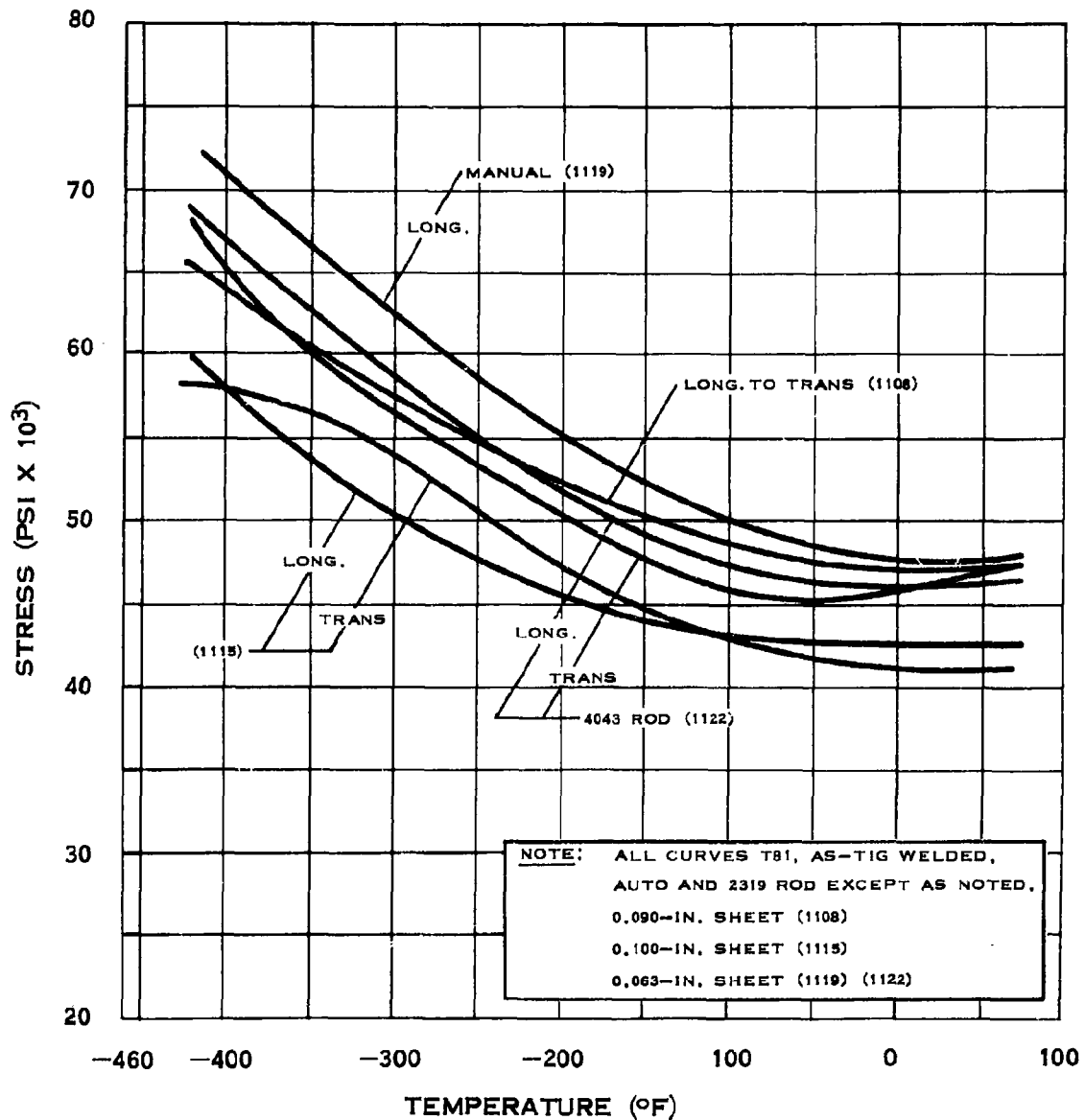

## WELD TENSILE STRENGTH OF 2219 ALUMINUM

### A.9.b-17

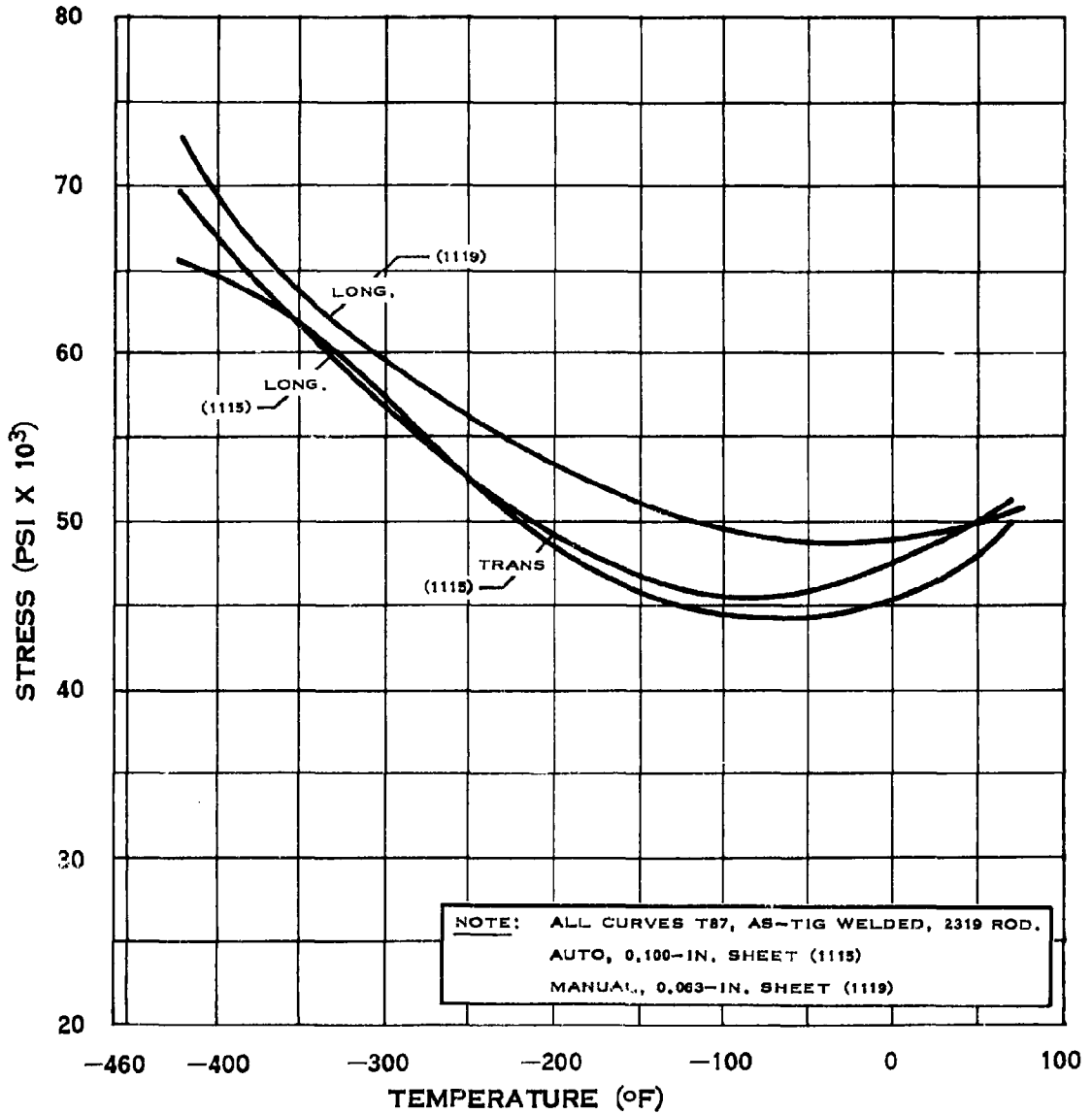

## WELD TENSILE STRENGTH OF 2219 ALUMINUM

### A.9.c

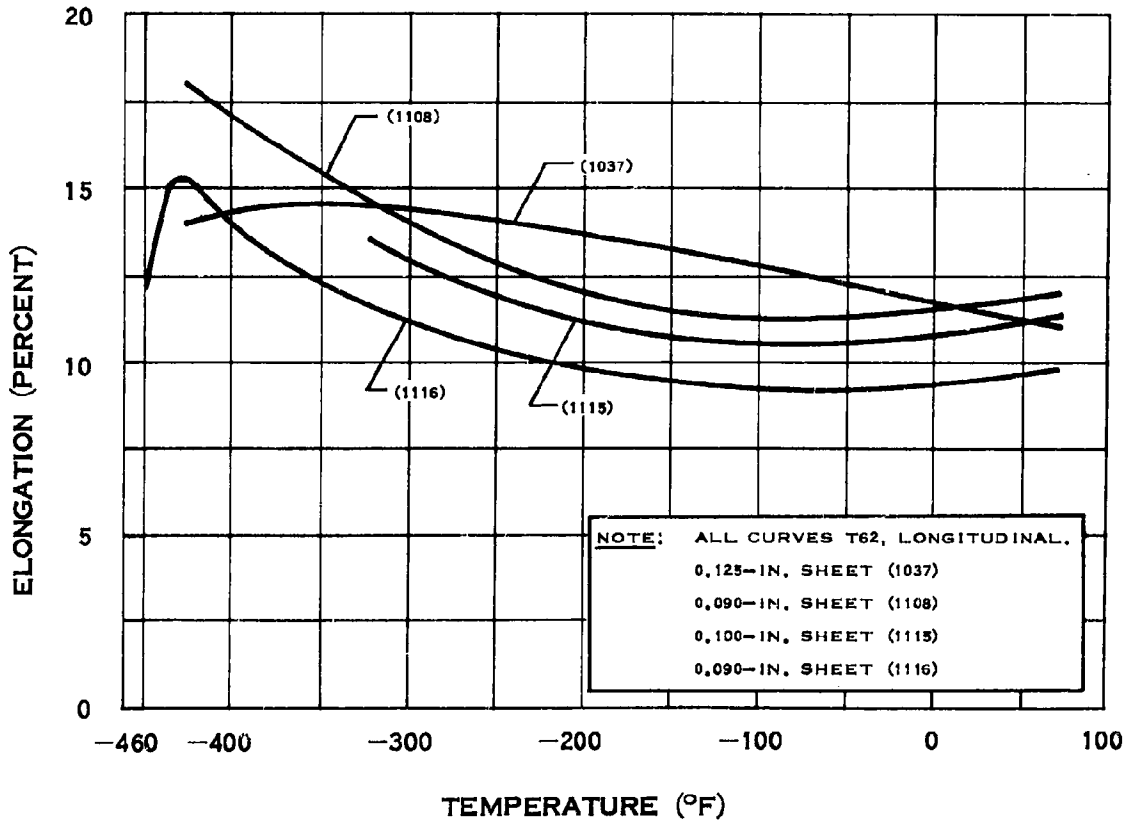

## ELONGATION OF 2219 ALUMINUM

### A.9.c-1

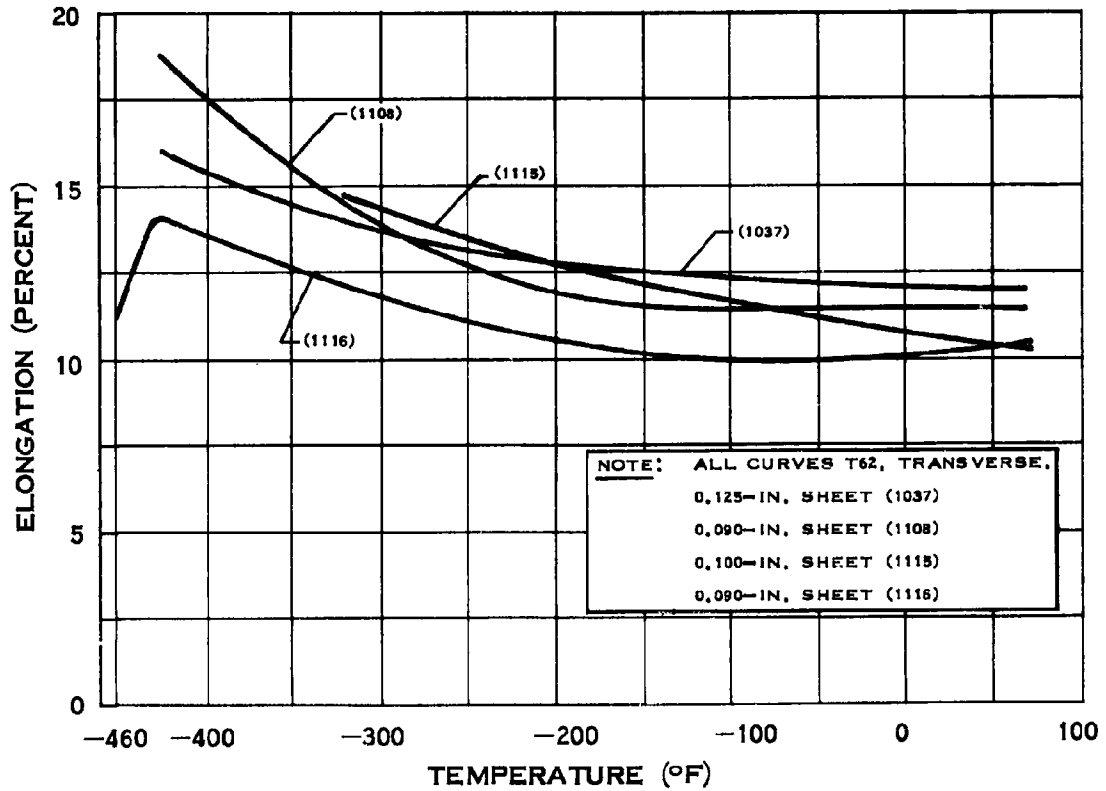

### ELONGATION OF 2219 ALUMINUM

### A.9.c-2

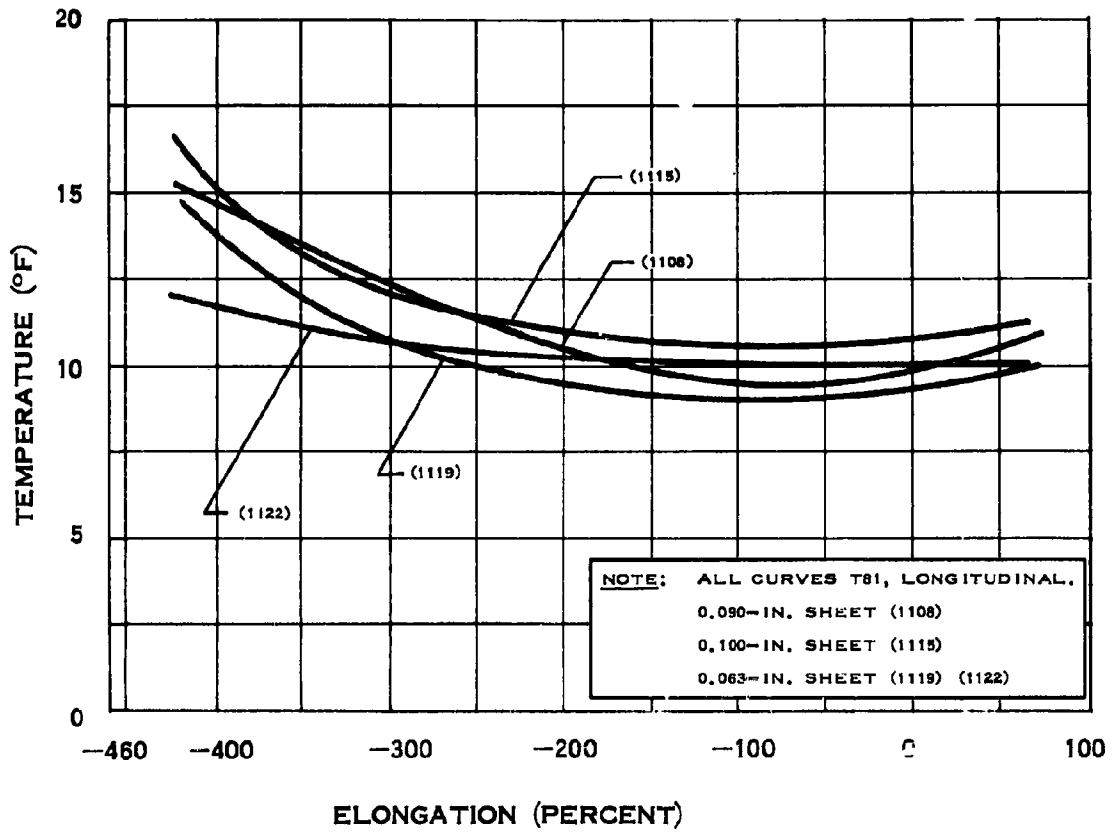

### ELONGATION OF 2219 ALUMINUM

### A.9.c-3

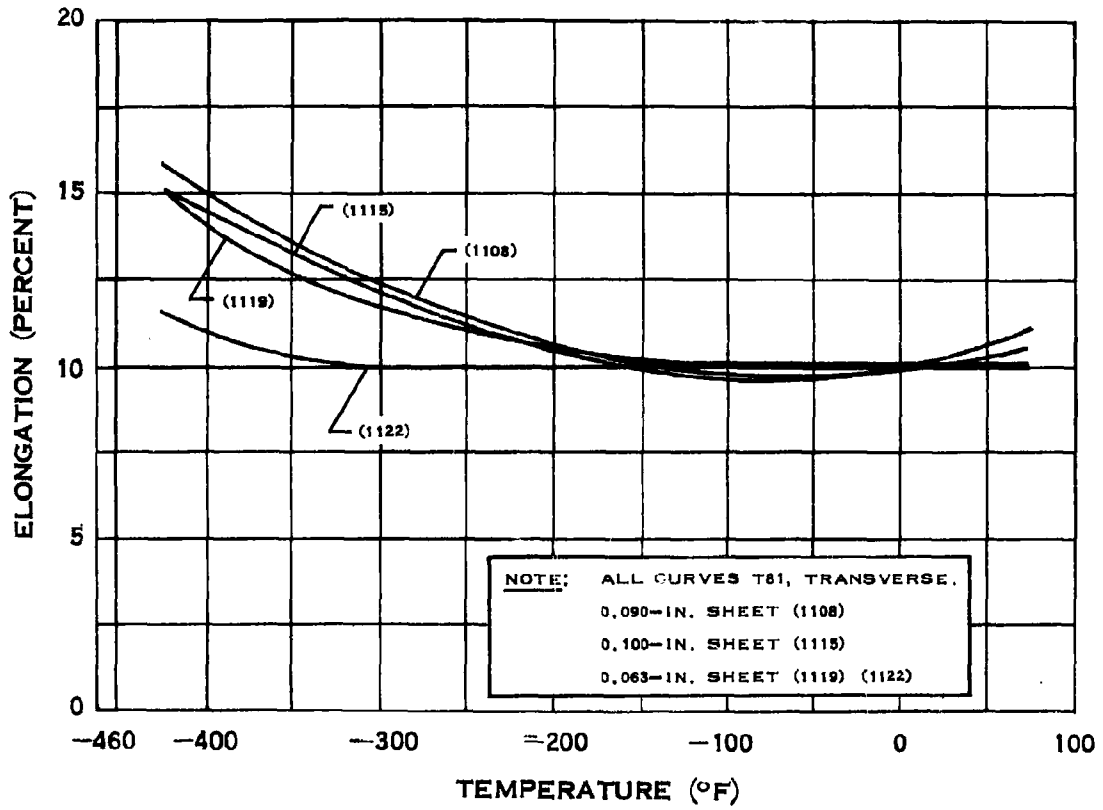

## ELONGATION OF 2219 ALUMINUM

### A.9.c-4

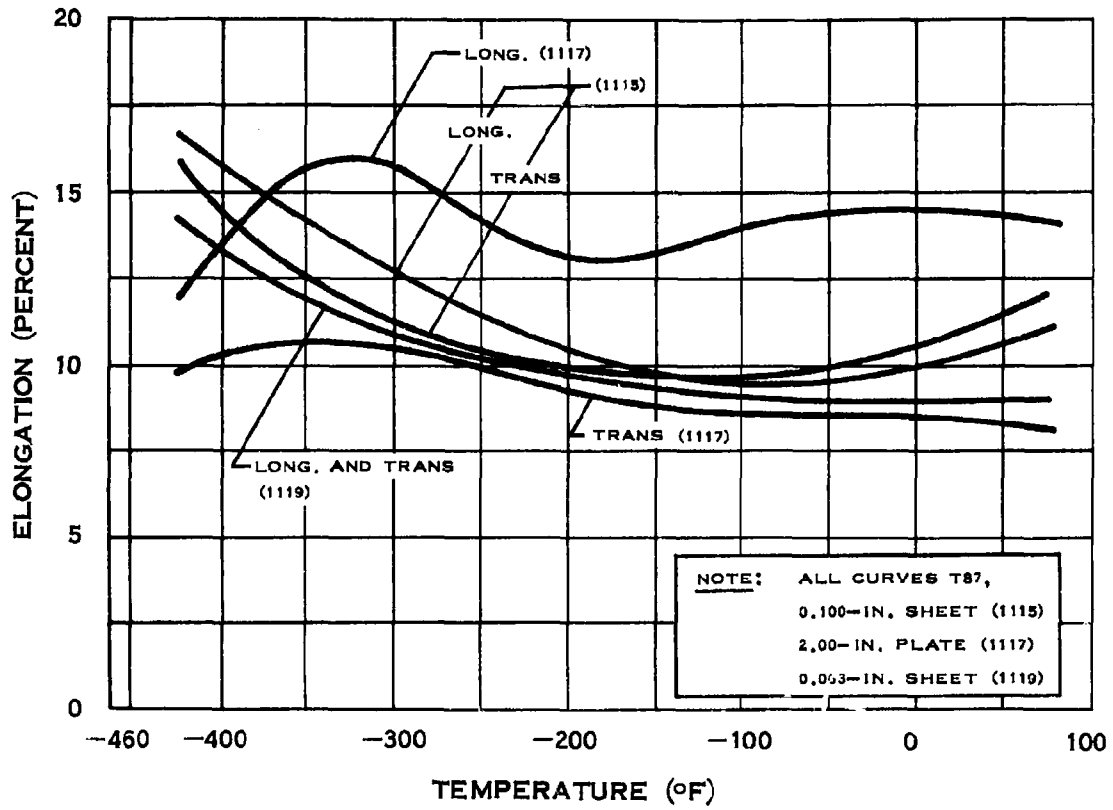

## ELONGATION OF 2219 ALUMINUM



### A.11.a

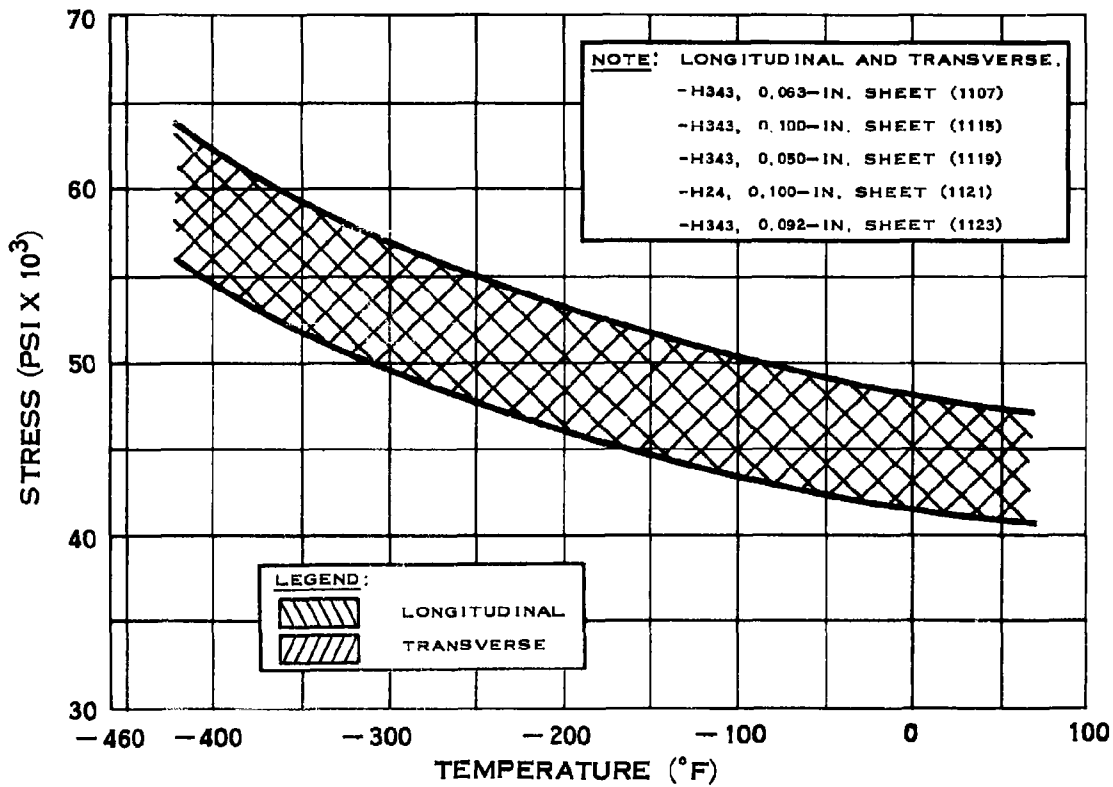

## YIELD STRENGTH OF 5456 ALUMINUM

### A.11.b

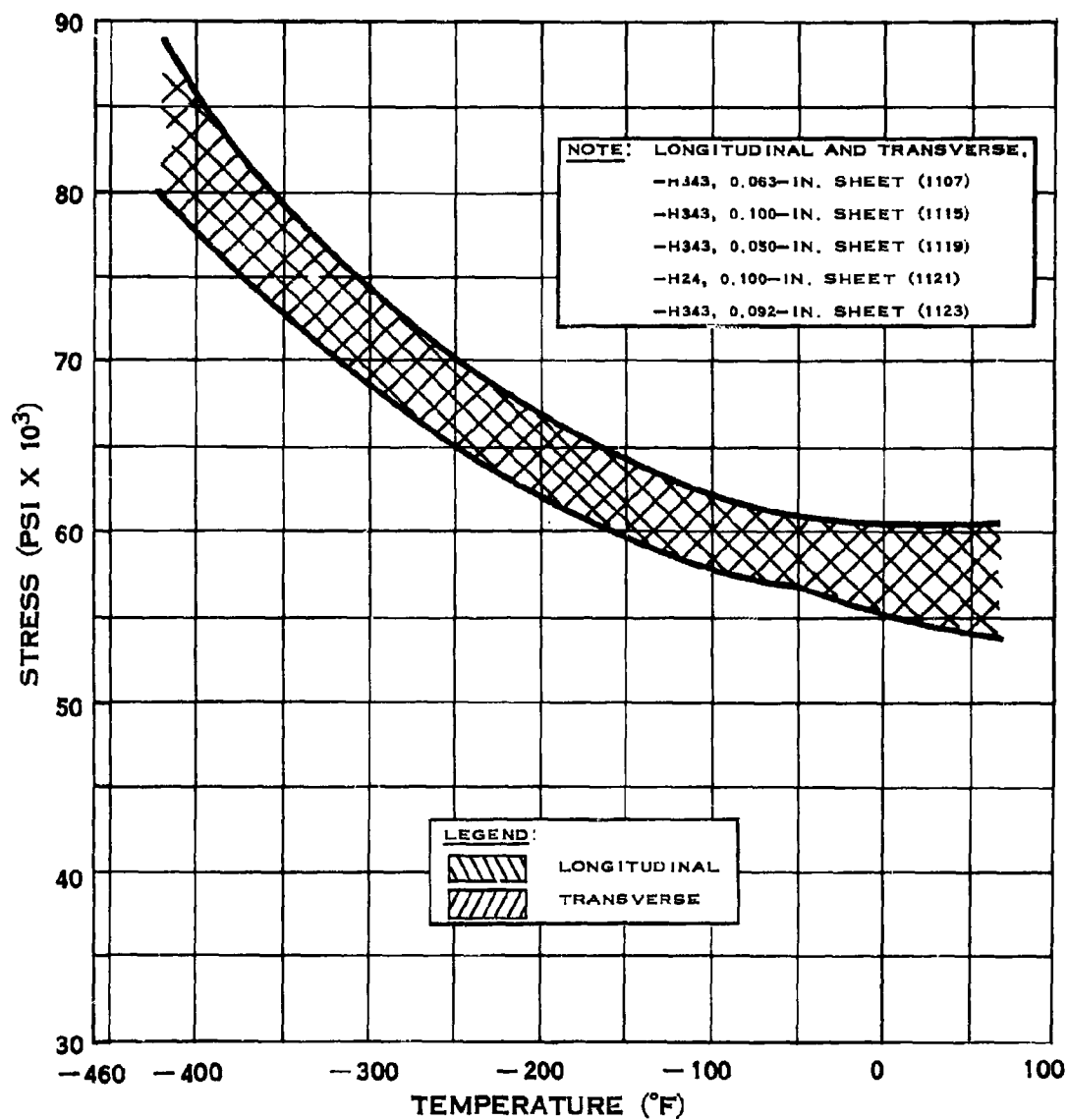

## TENSILE STRENGTH OF 5456 ALUMINUM

# A.11.b-1

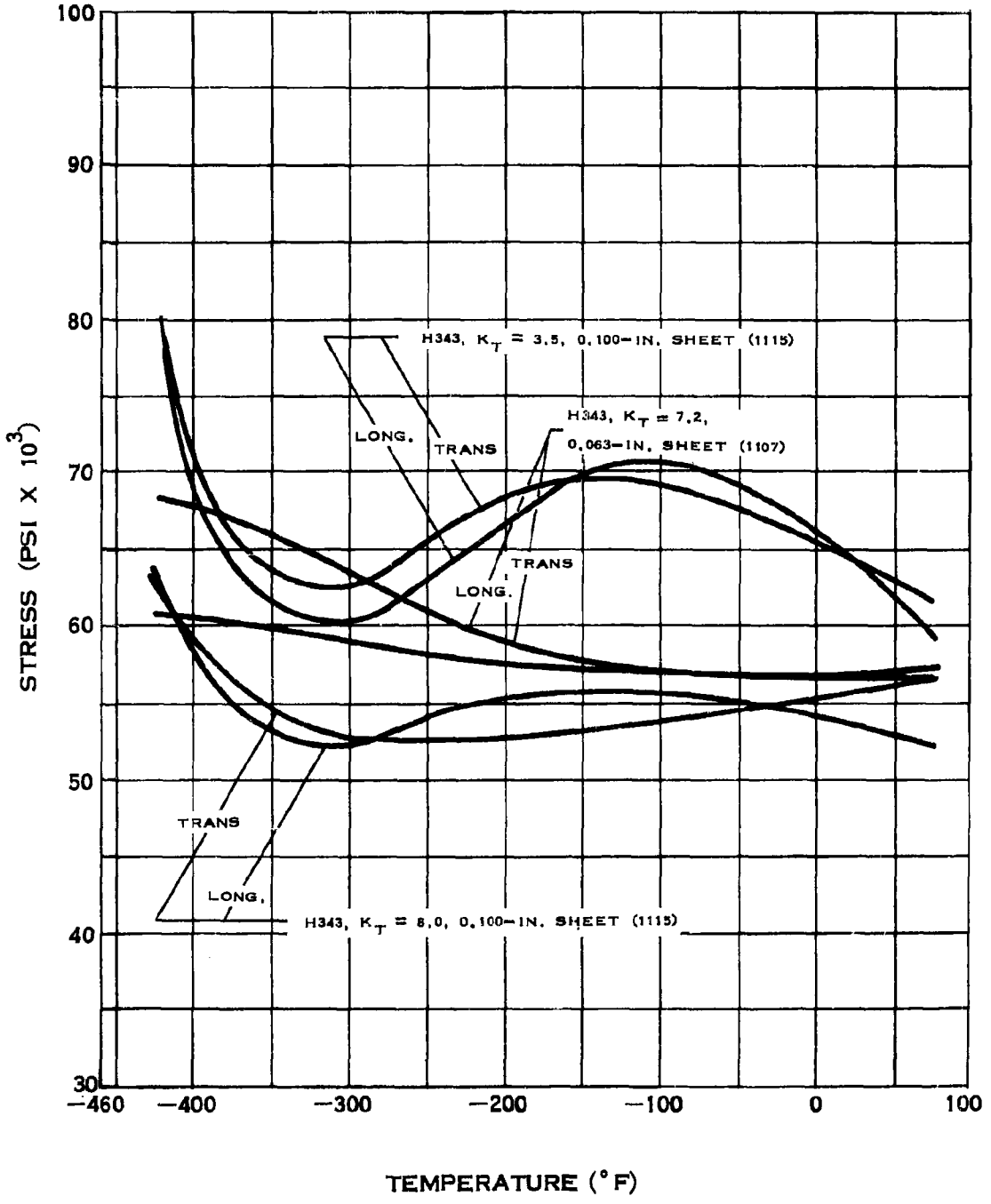

## NOTCH TENSILE STRENGTH OF 5456 ALUMINUM

### A.11.b-2

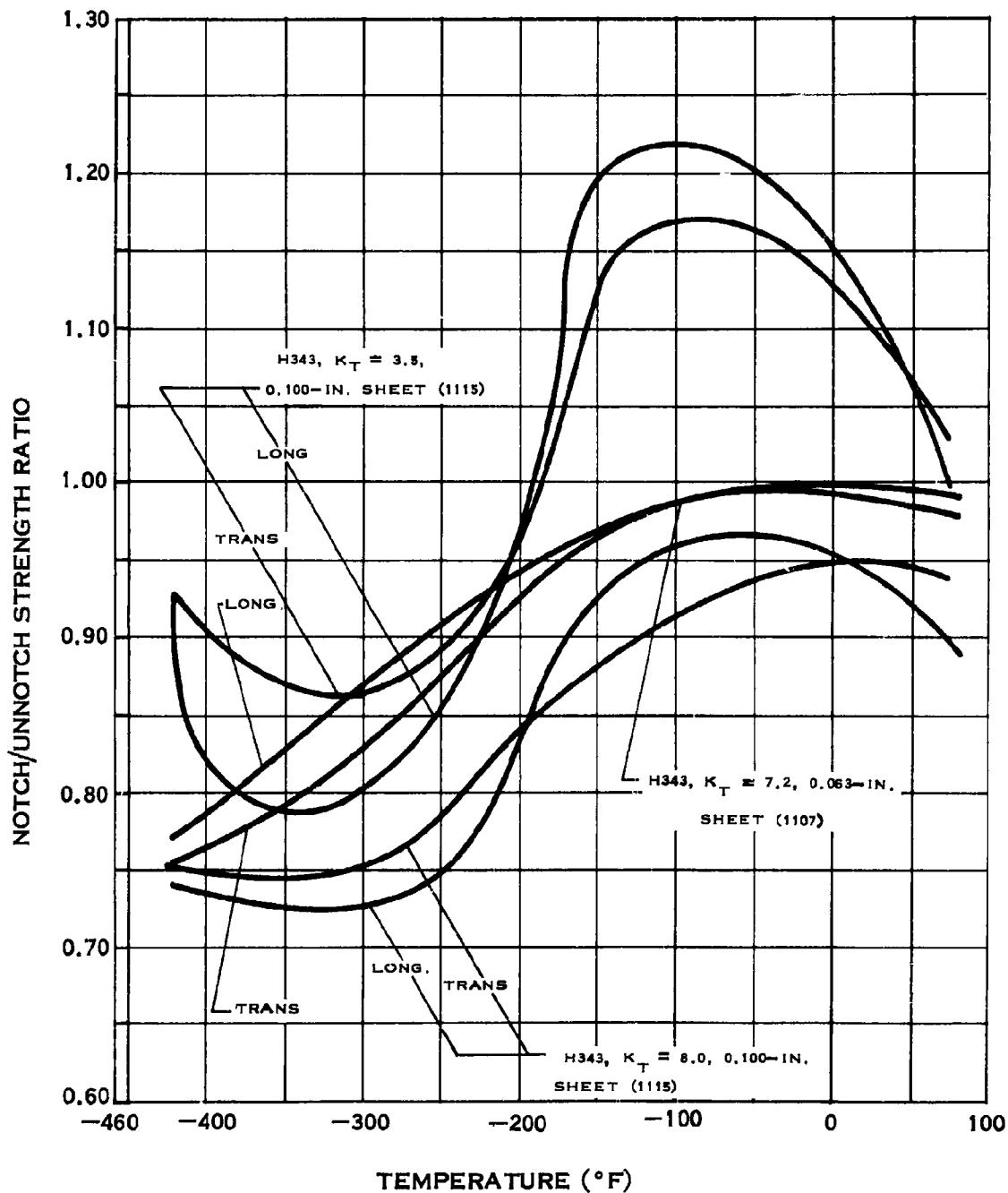

### NOTCH STRENGTH RATIO OF 5456 ALUMINUM

### A.11.b-3

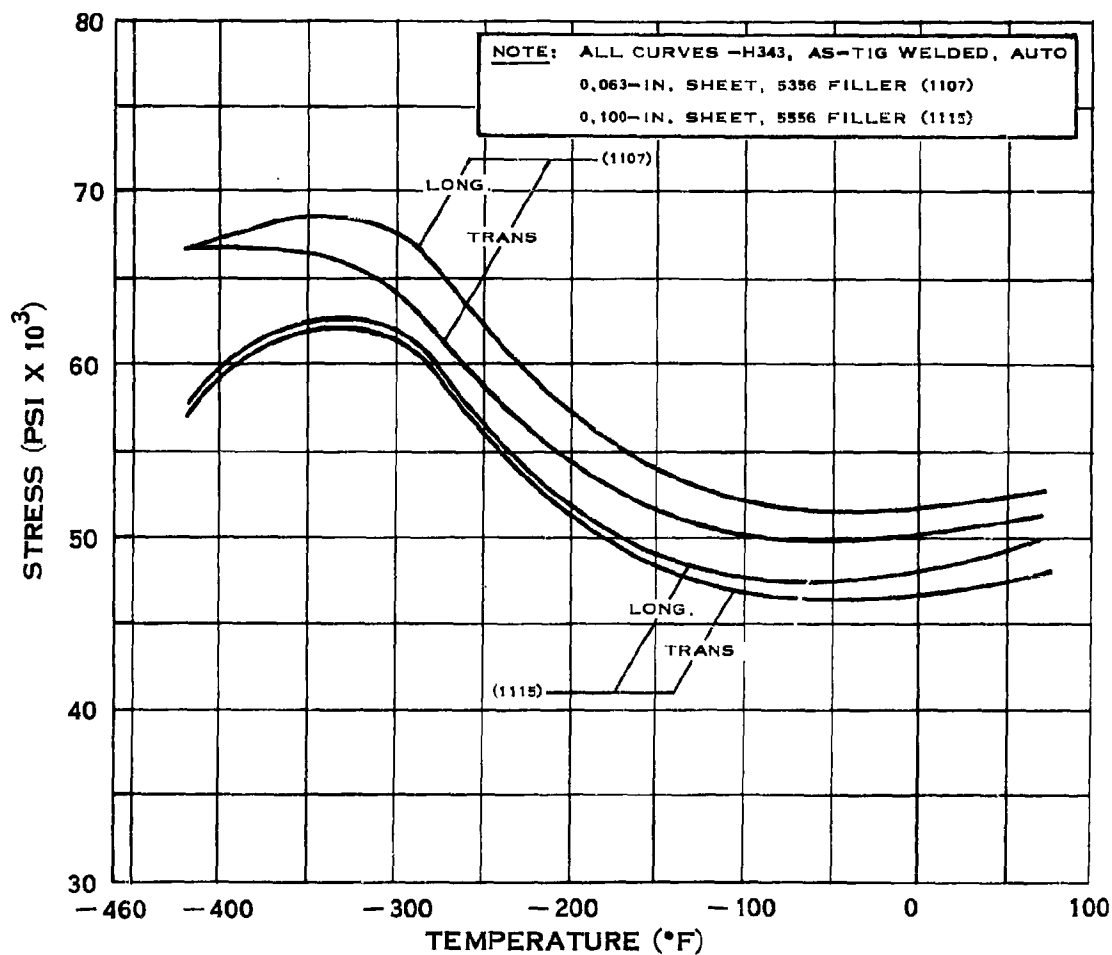

### WELD TENSILE STRENGTH OF 5456 ALUMINUM

# A.11.c

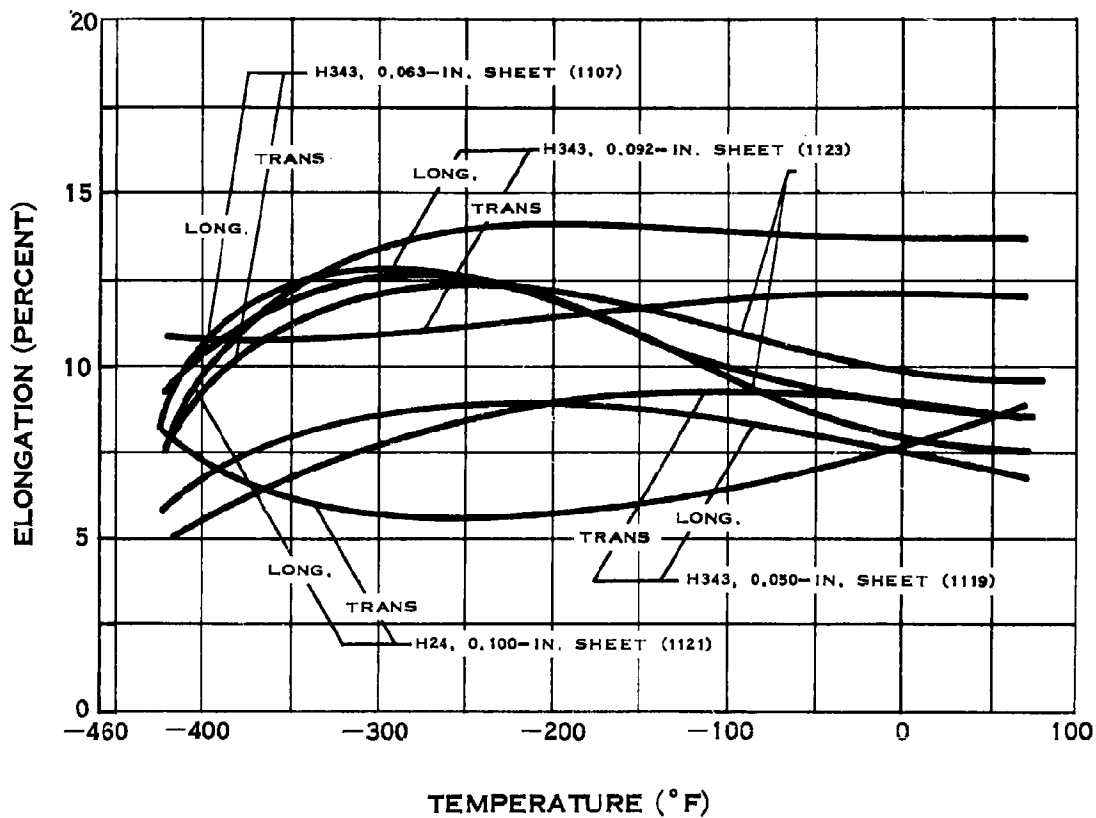

## ELONGATION OF 5456 ALUMINUM

### B.3.a

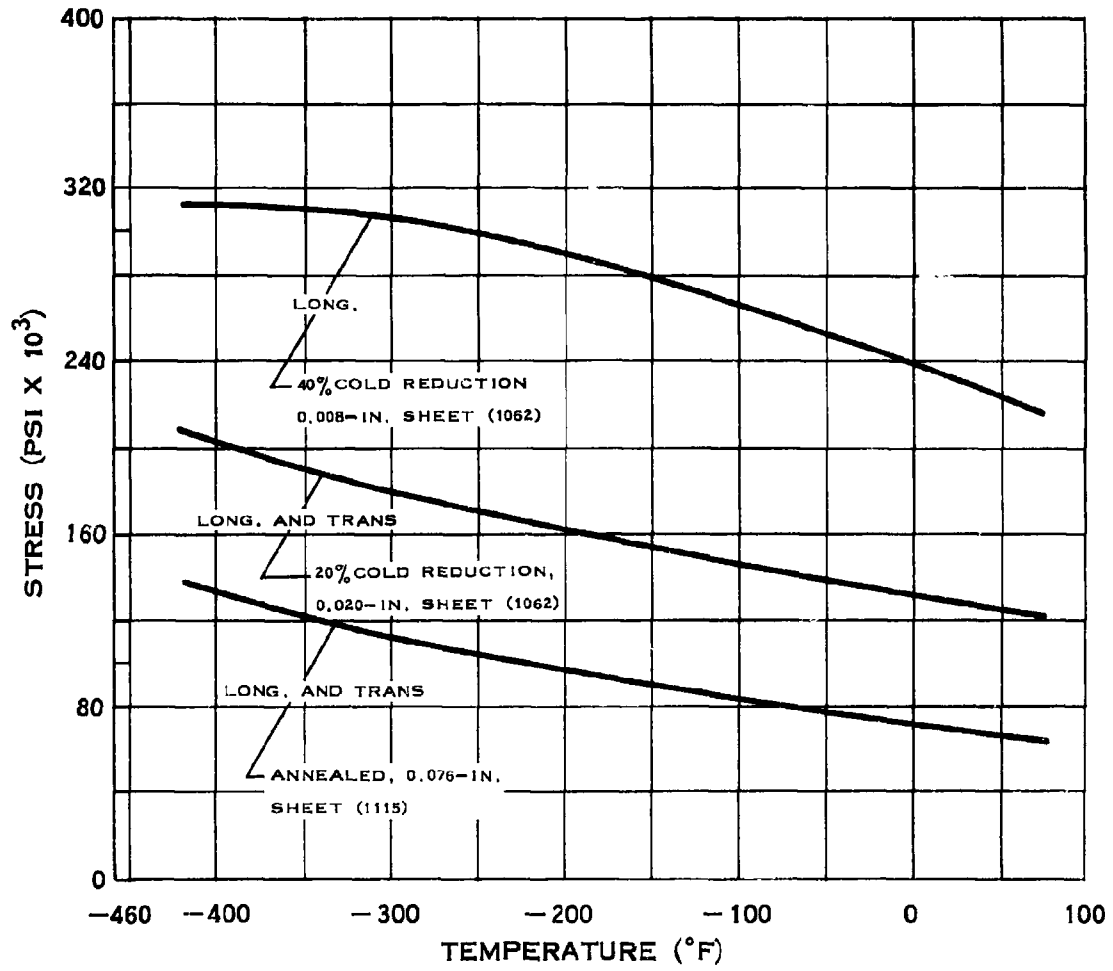

### YIELD STRENGTH OF L-605

### B.3.b

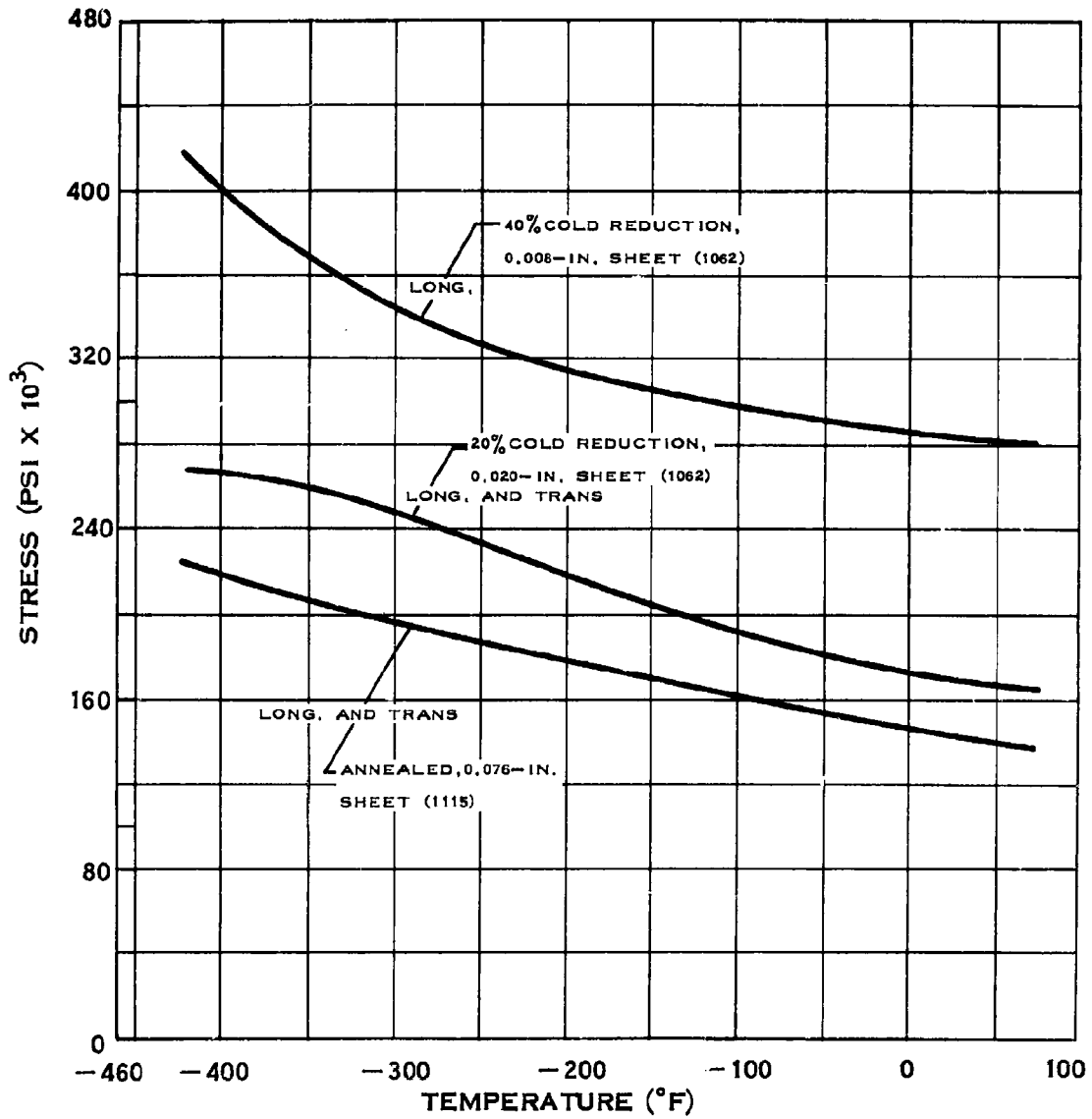

### TENSILE STRENGTH OF L-605



### B.3.b-1

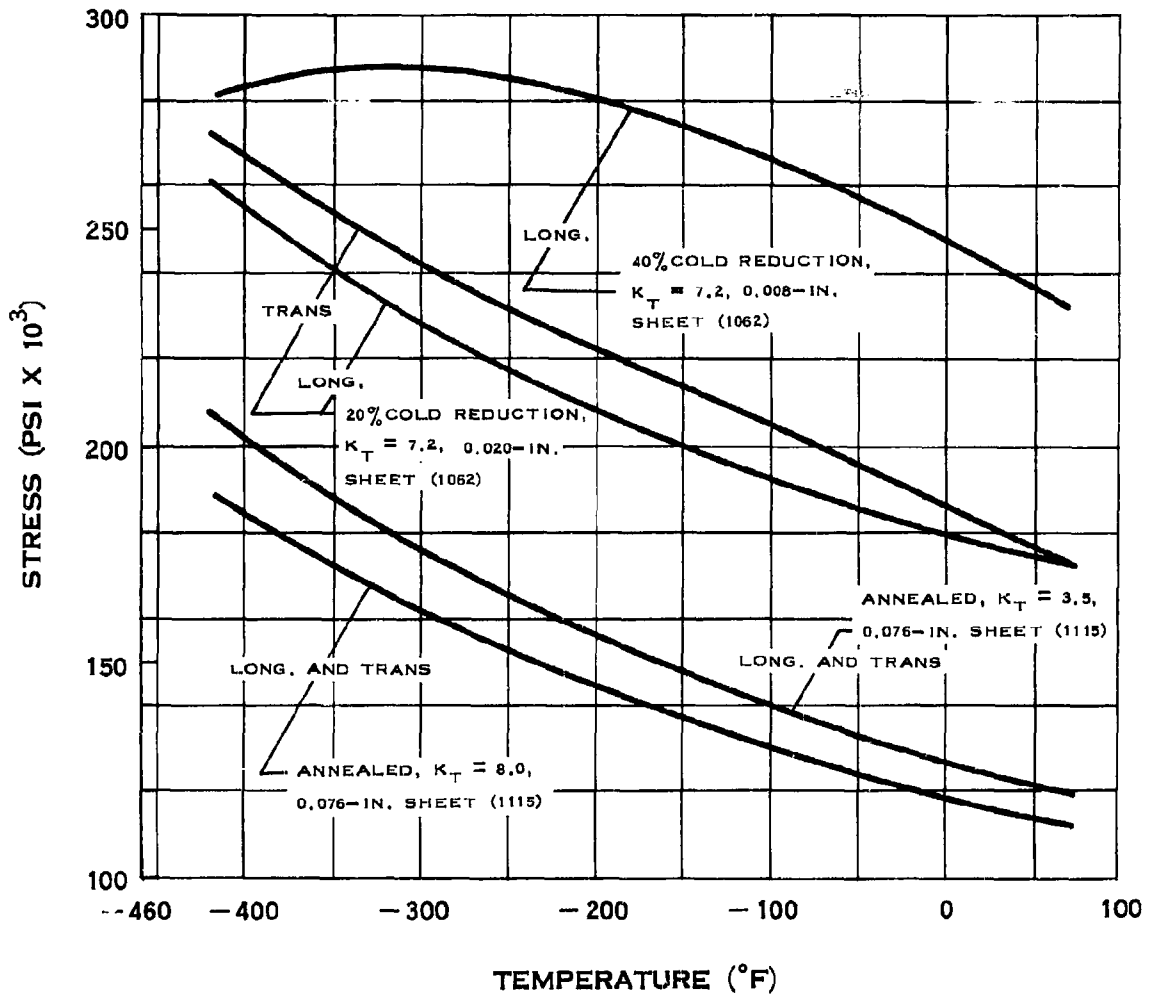

### NOTCH TENSILE STRENGTH OF L-605

### B.3.b-2

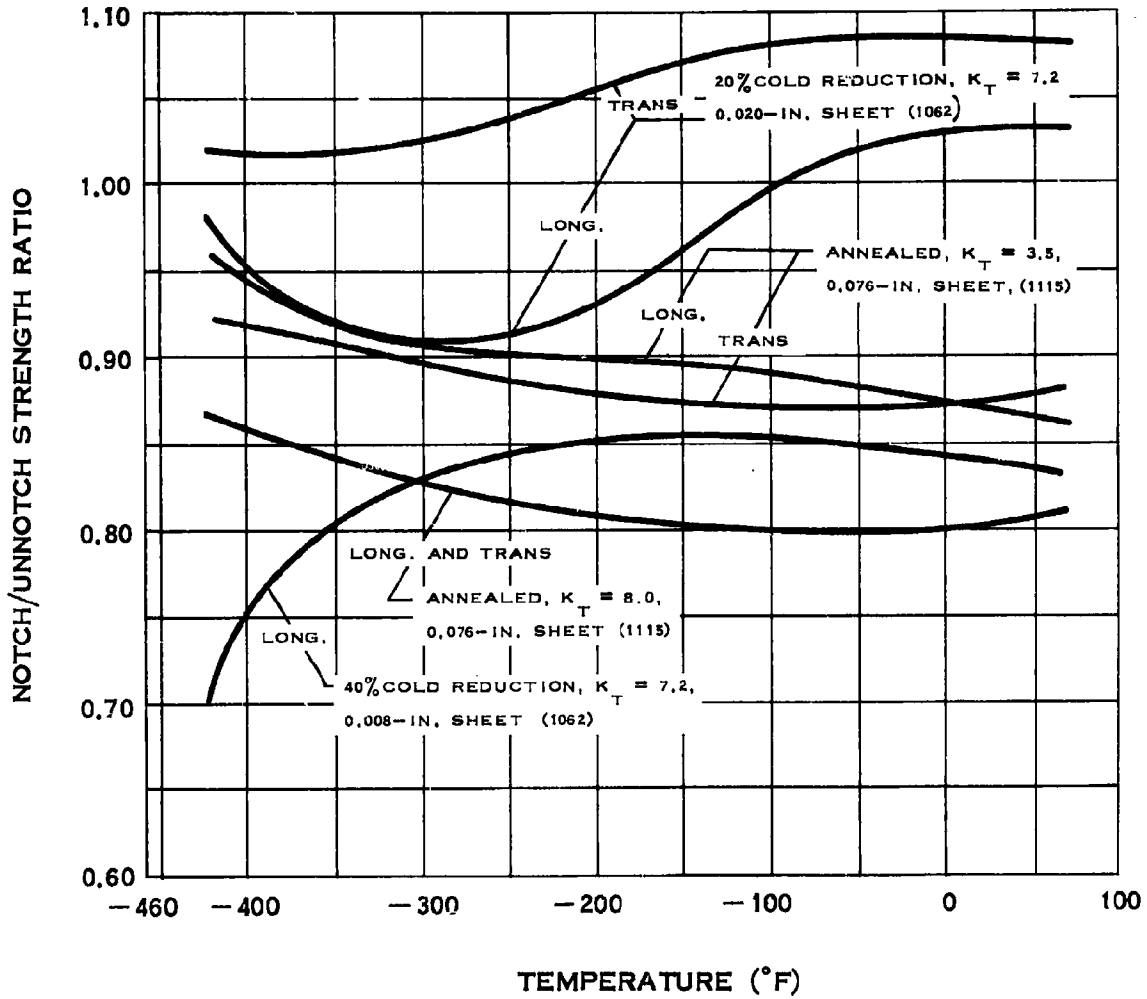

### NOTCH STRENGTH RATIO OF L-605

### B.3.b-3

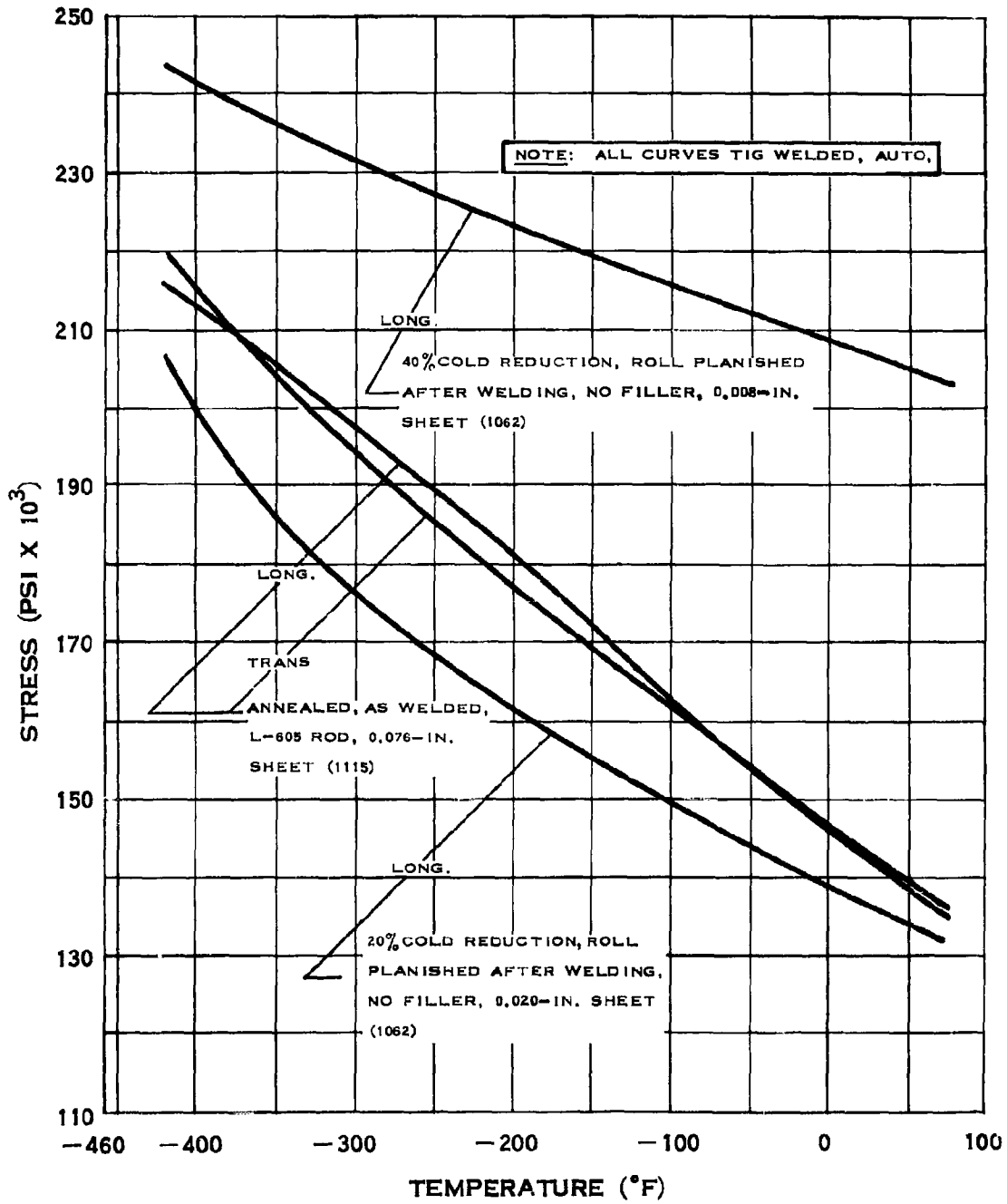

### TENSILE STRENGTH OF L-605

### B.3.c

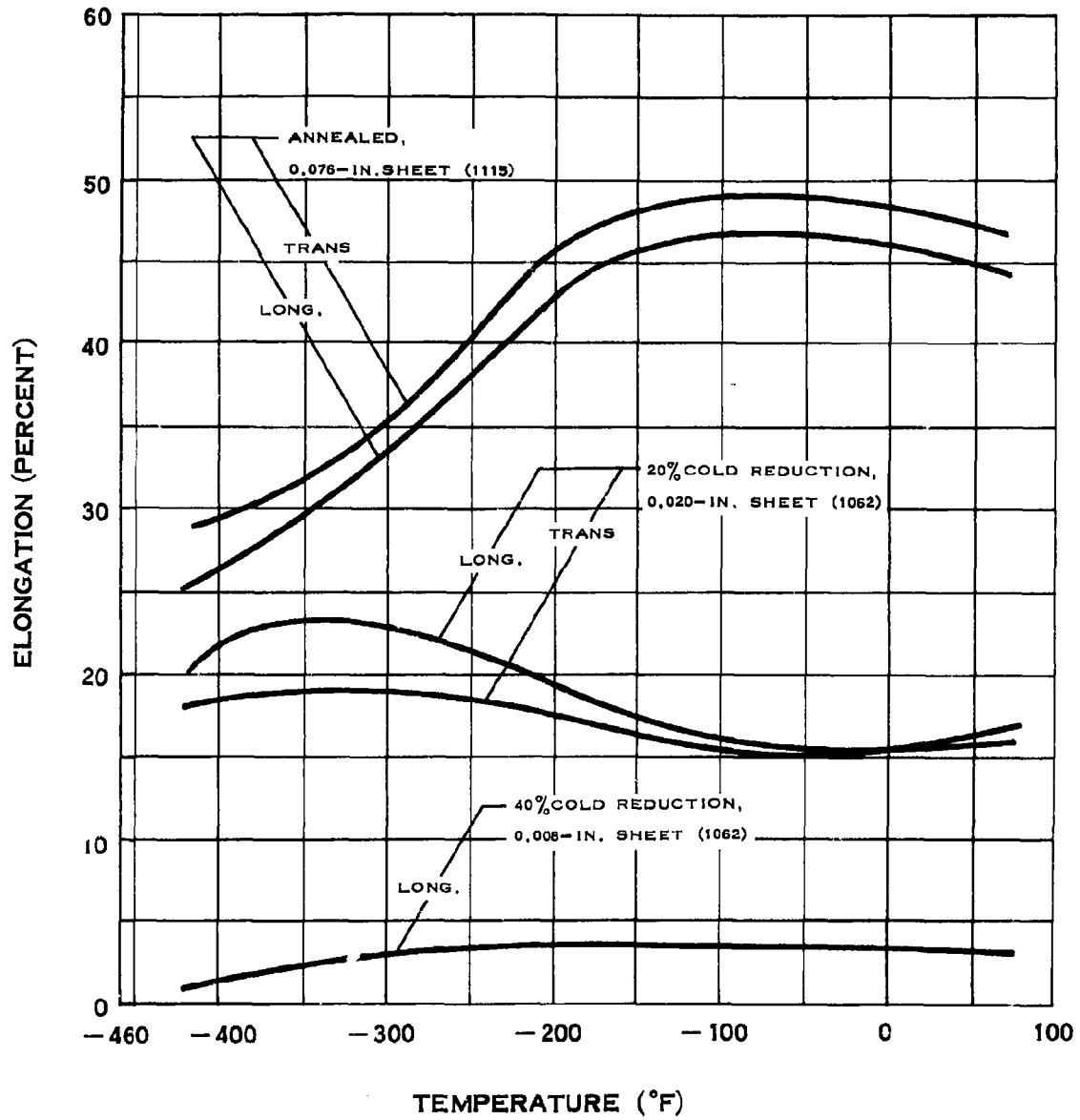

### ELONGATION OF L-605

### D.7.a

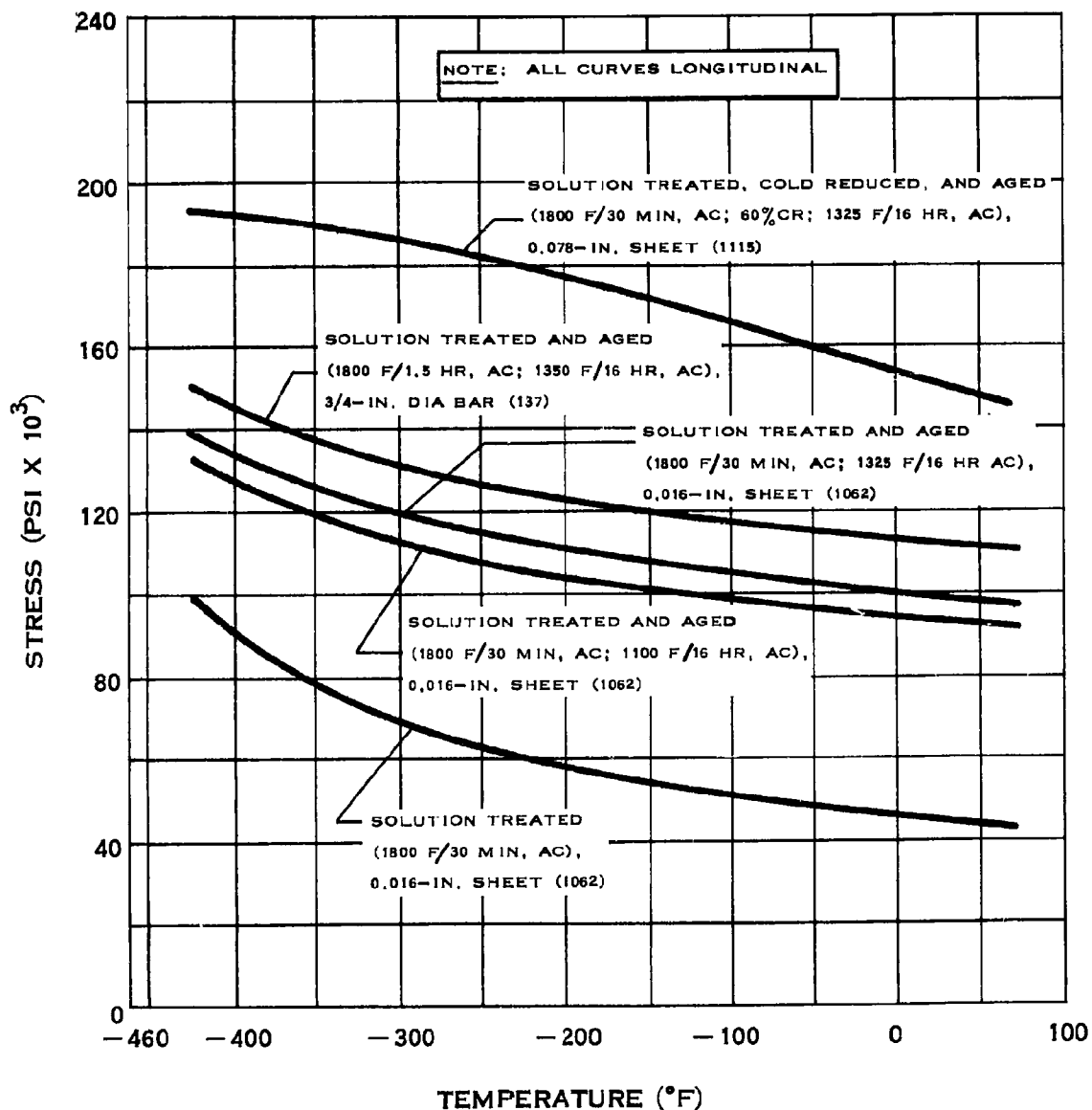

## YIELD STRENGTH OF A-286 STAINLESS STEEL

# D.7.b

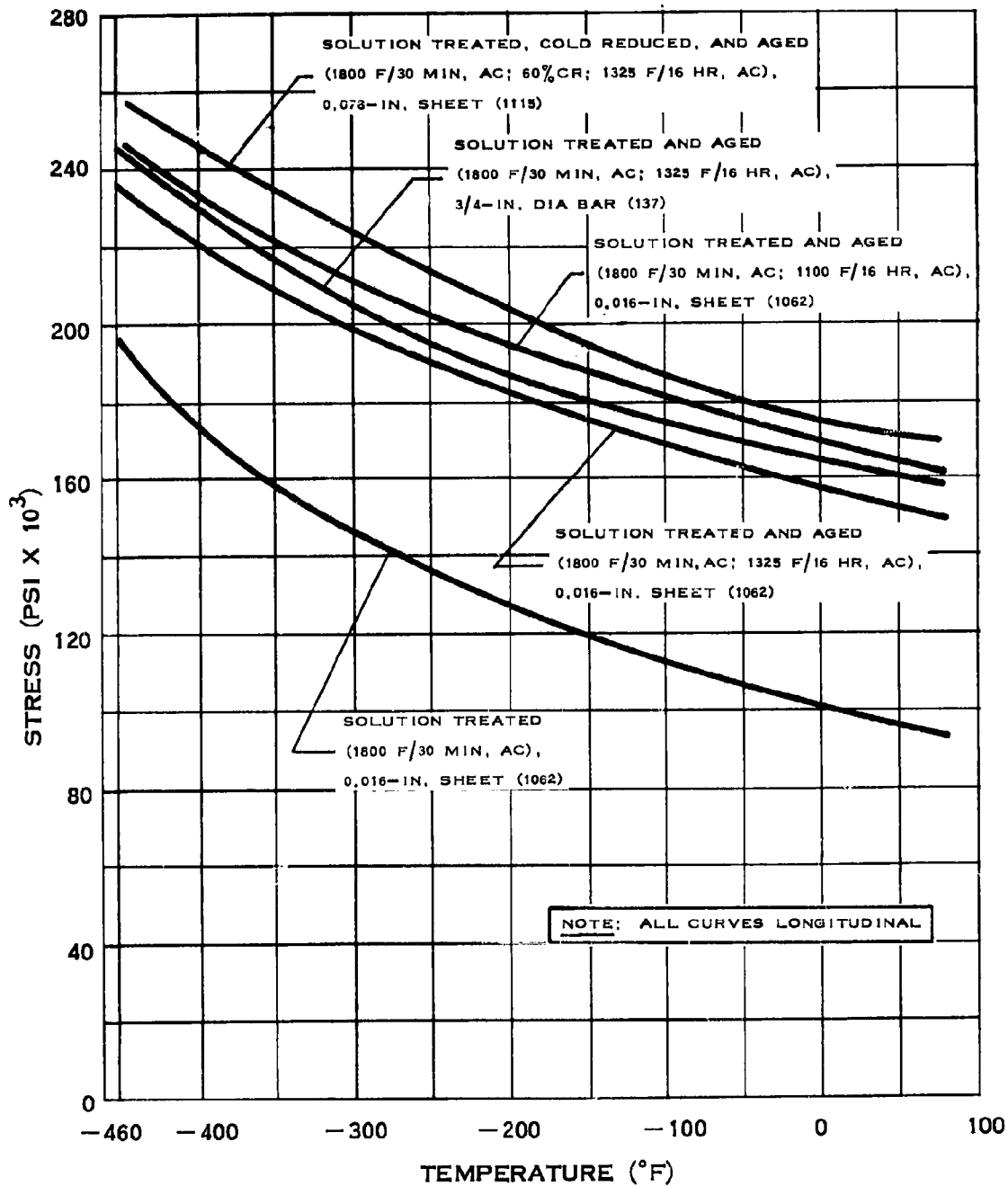

## TENSILE STRENGTH OF A-286

### D.7.b-1

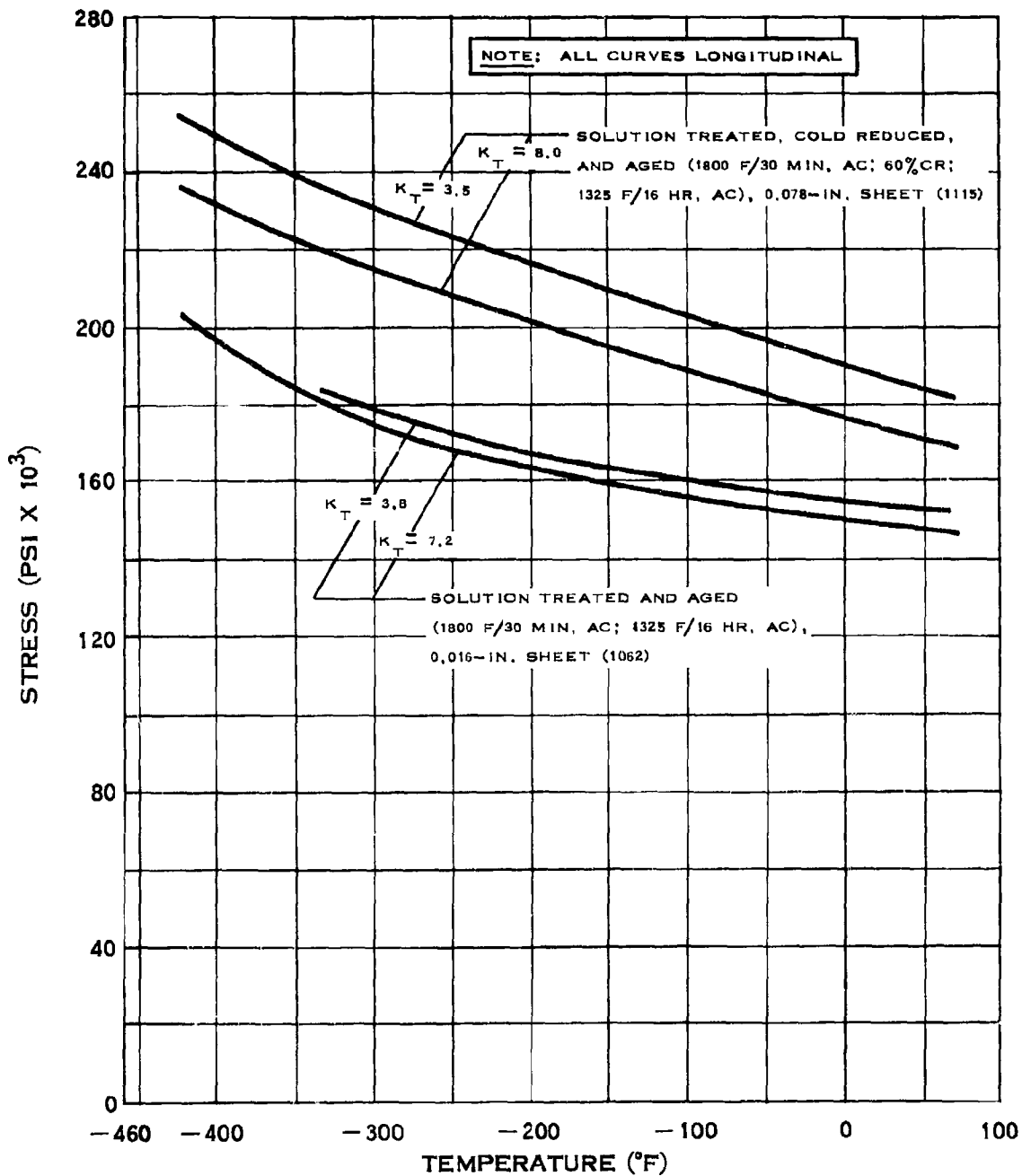

### NOTCH TENSILE STRENGTH OF A-286 STAINLESS STEEL

(7-15-63)

## D.7.b-2

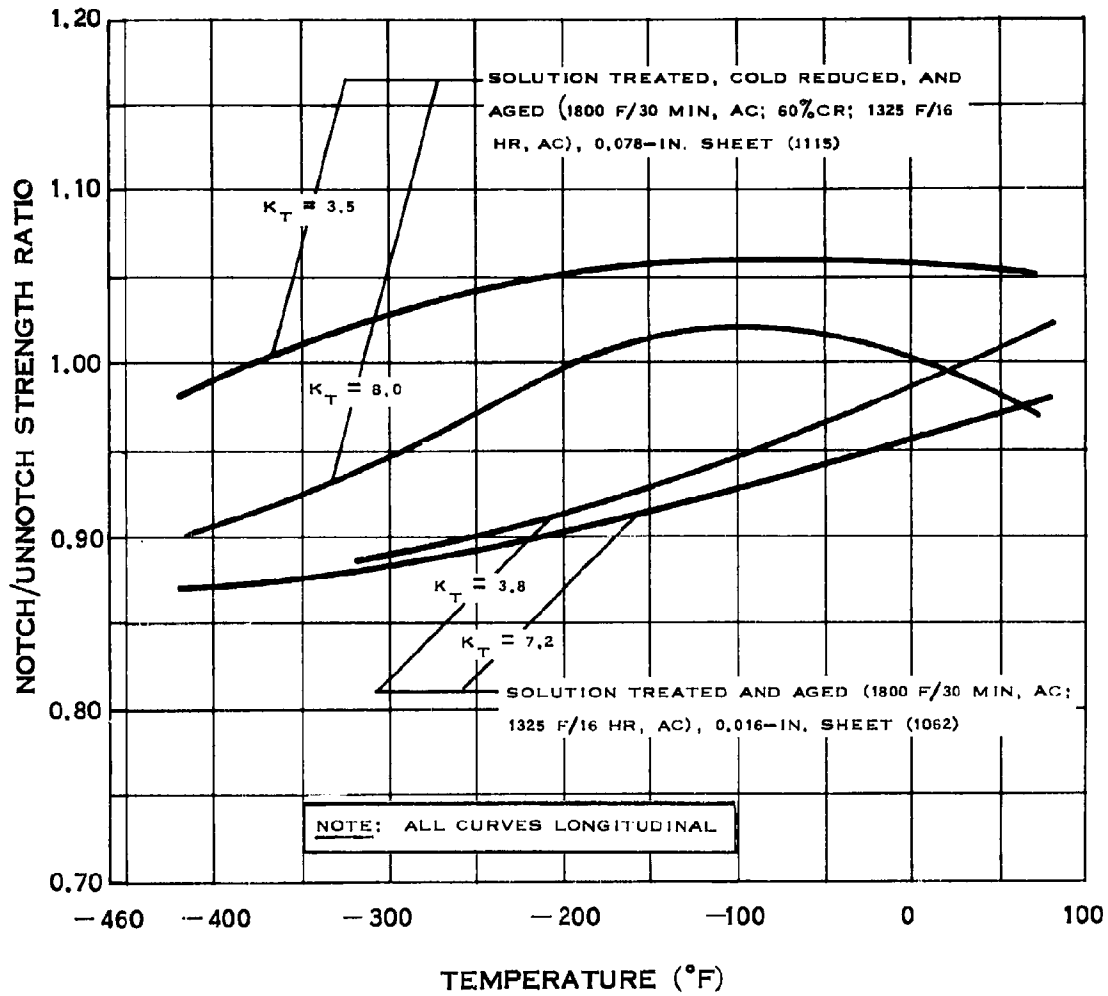

## NOTCH STRENGTH RATIO OF A-286 STAINLESS STEEL



### D.7.c

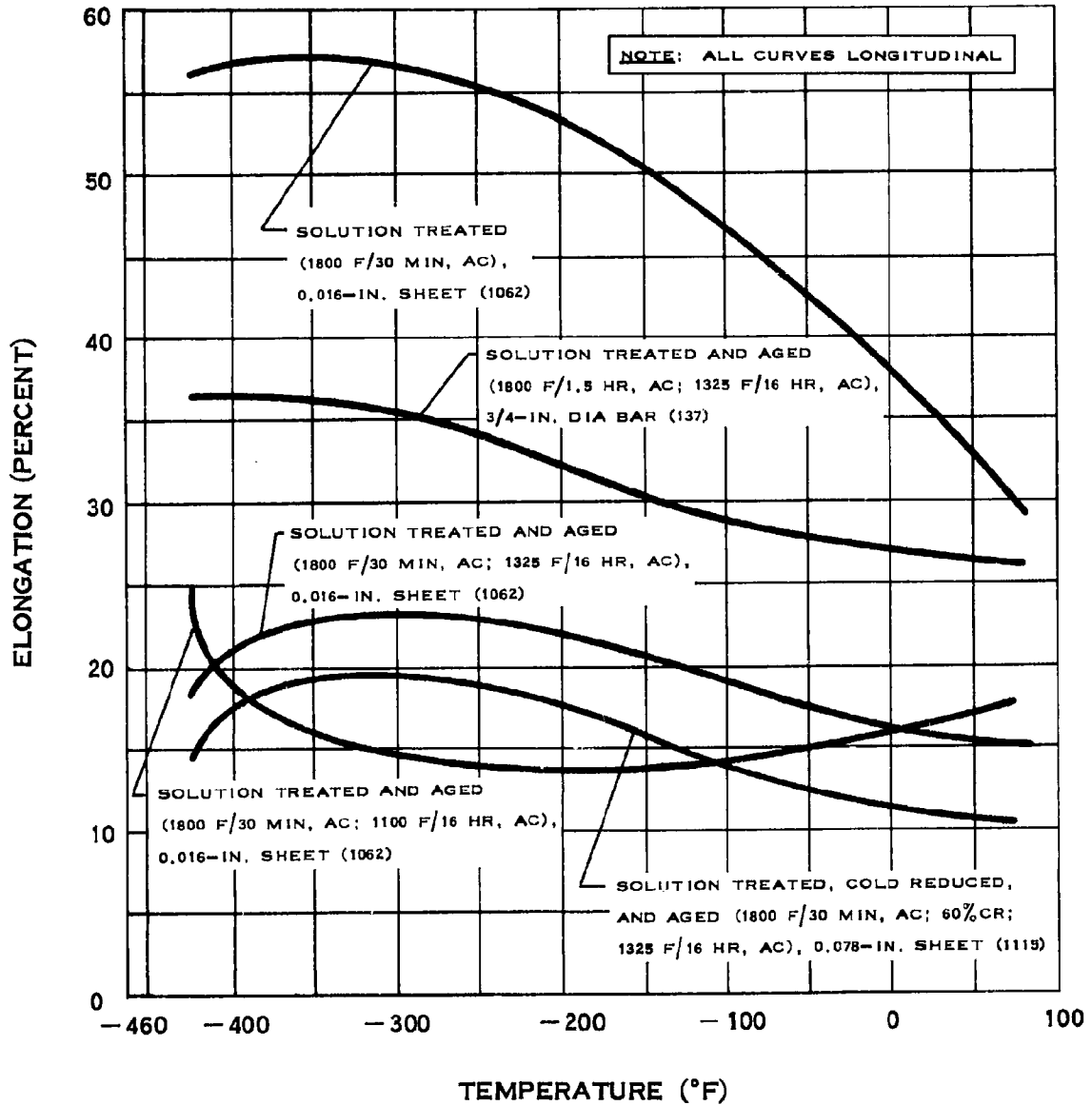

## ELONGATION OF A-286 STAINLESS STEEL

### D.7.d

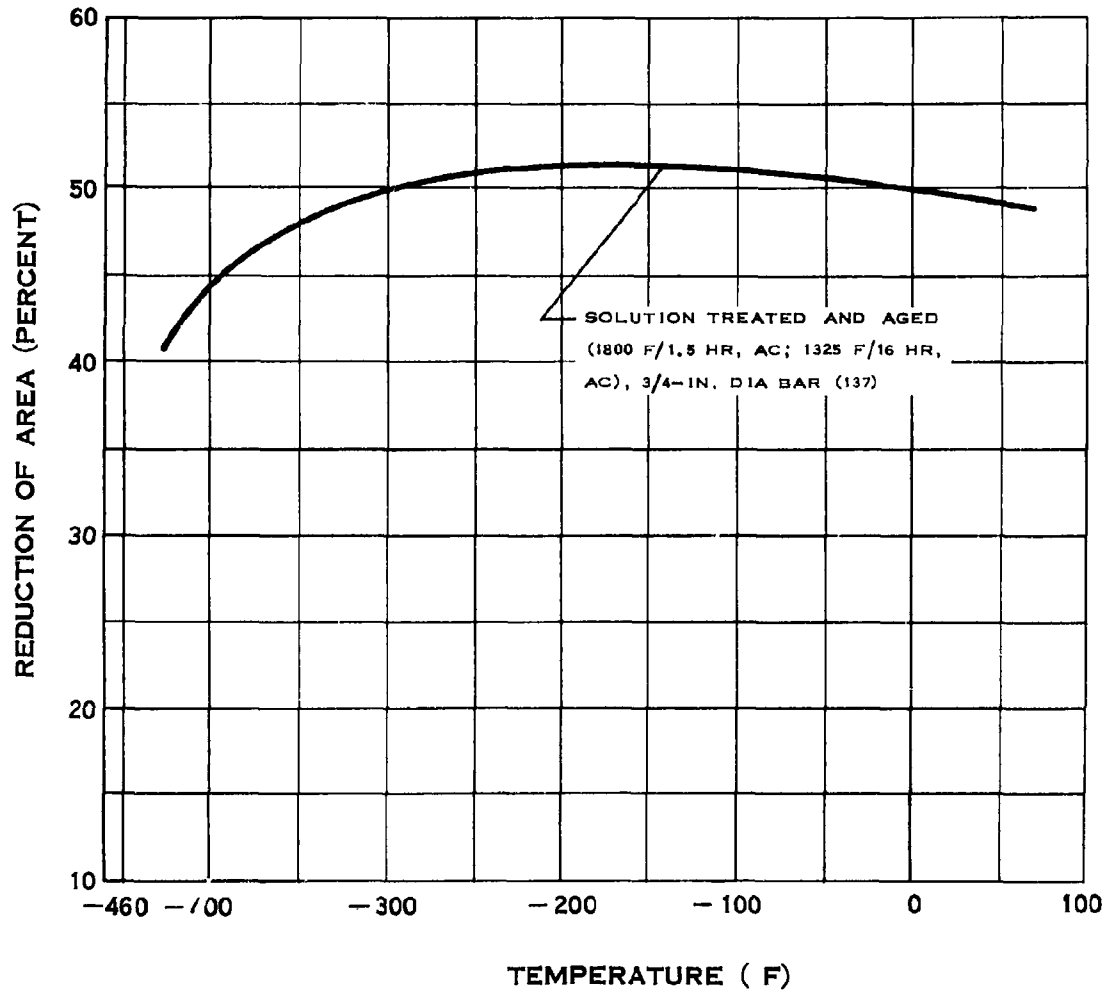

### REDUCTION OF AREA OF A-286 STAINLESS STEEL

## E.2.a

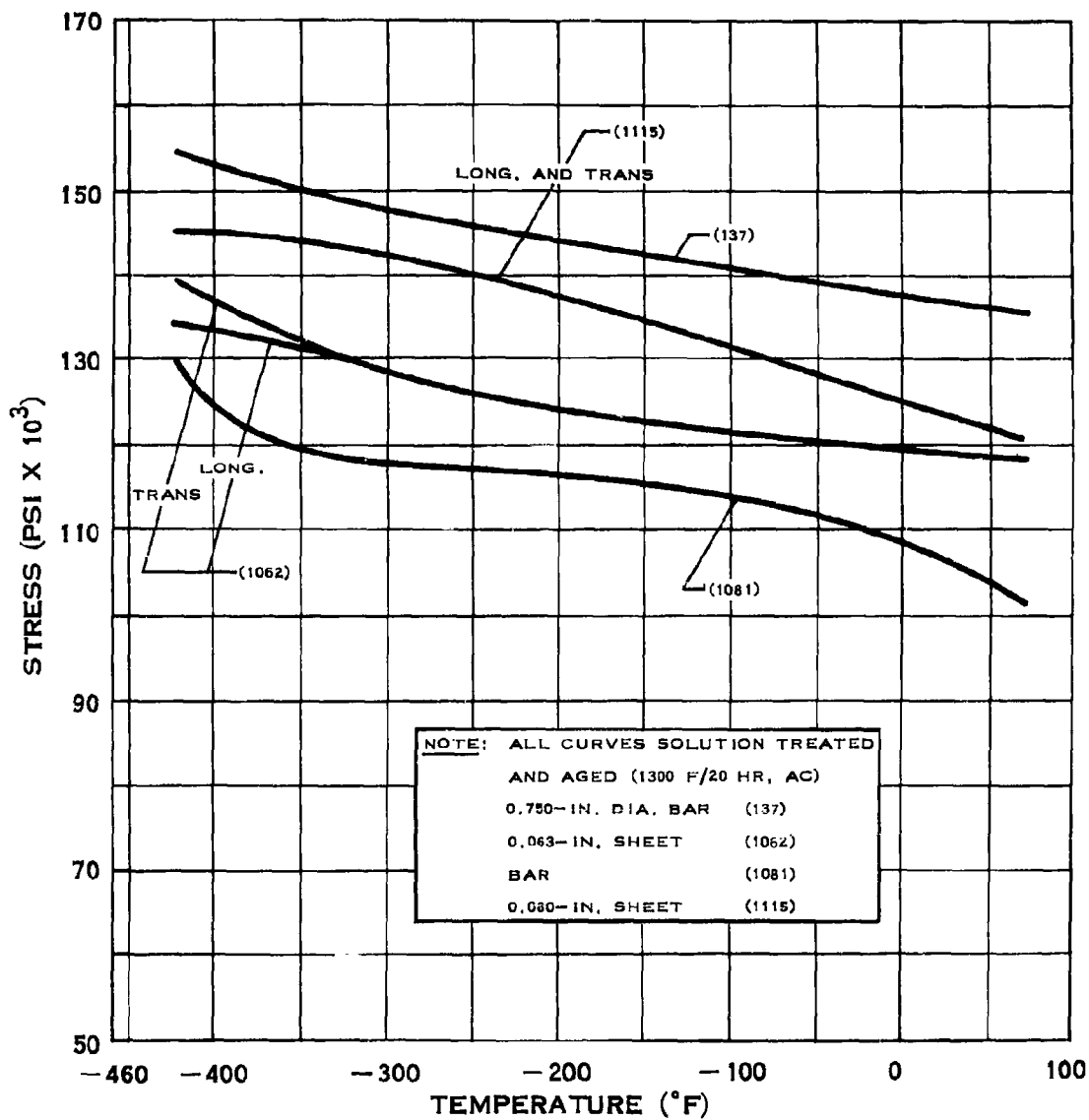

## YIELD STRENGTH OF INCONEL-X

## E.2.b

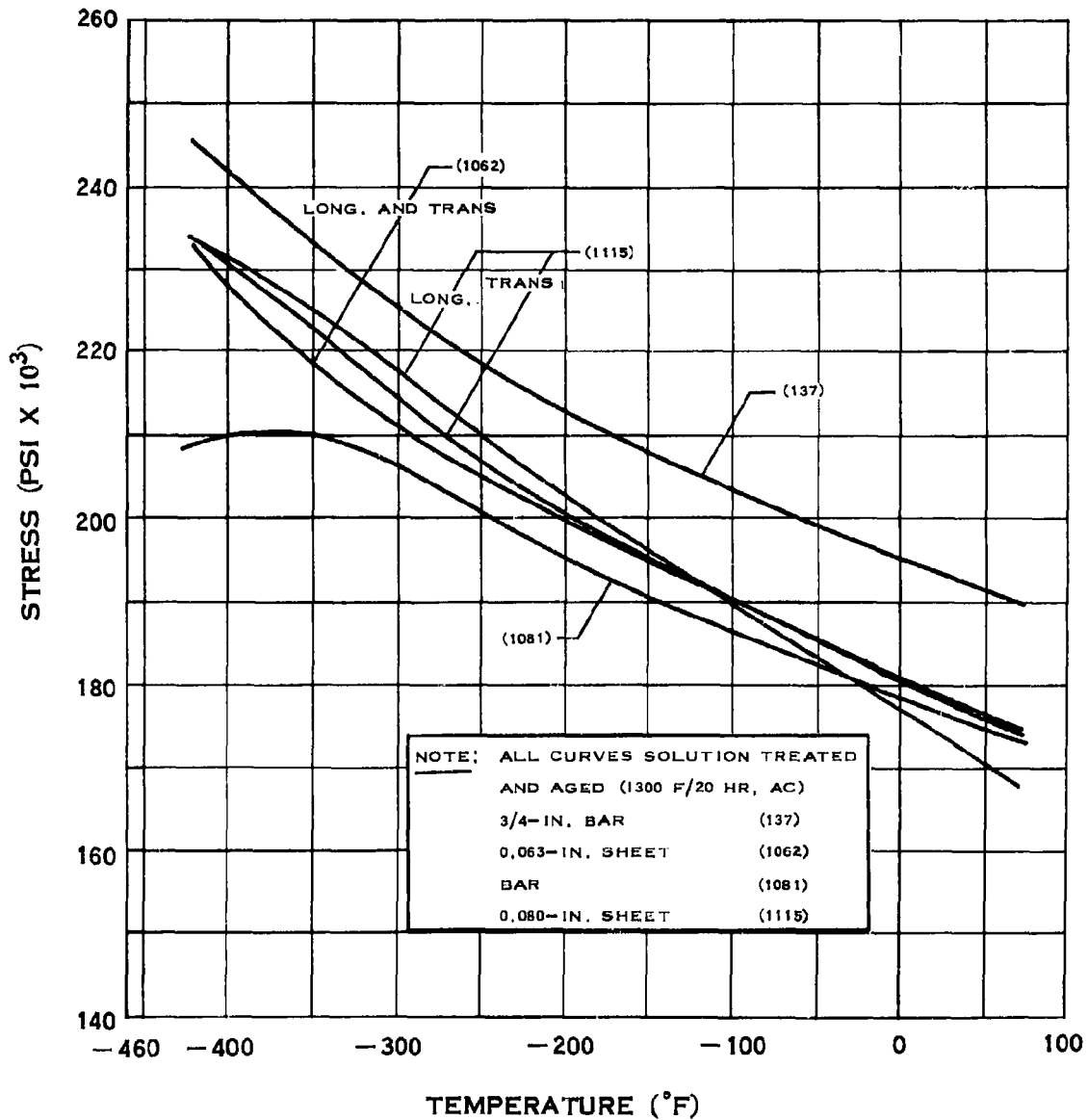

## TENSILE STRENGTH OF INCONEL-X

### E.2.b-1

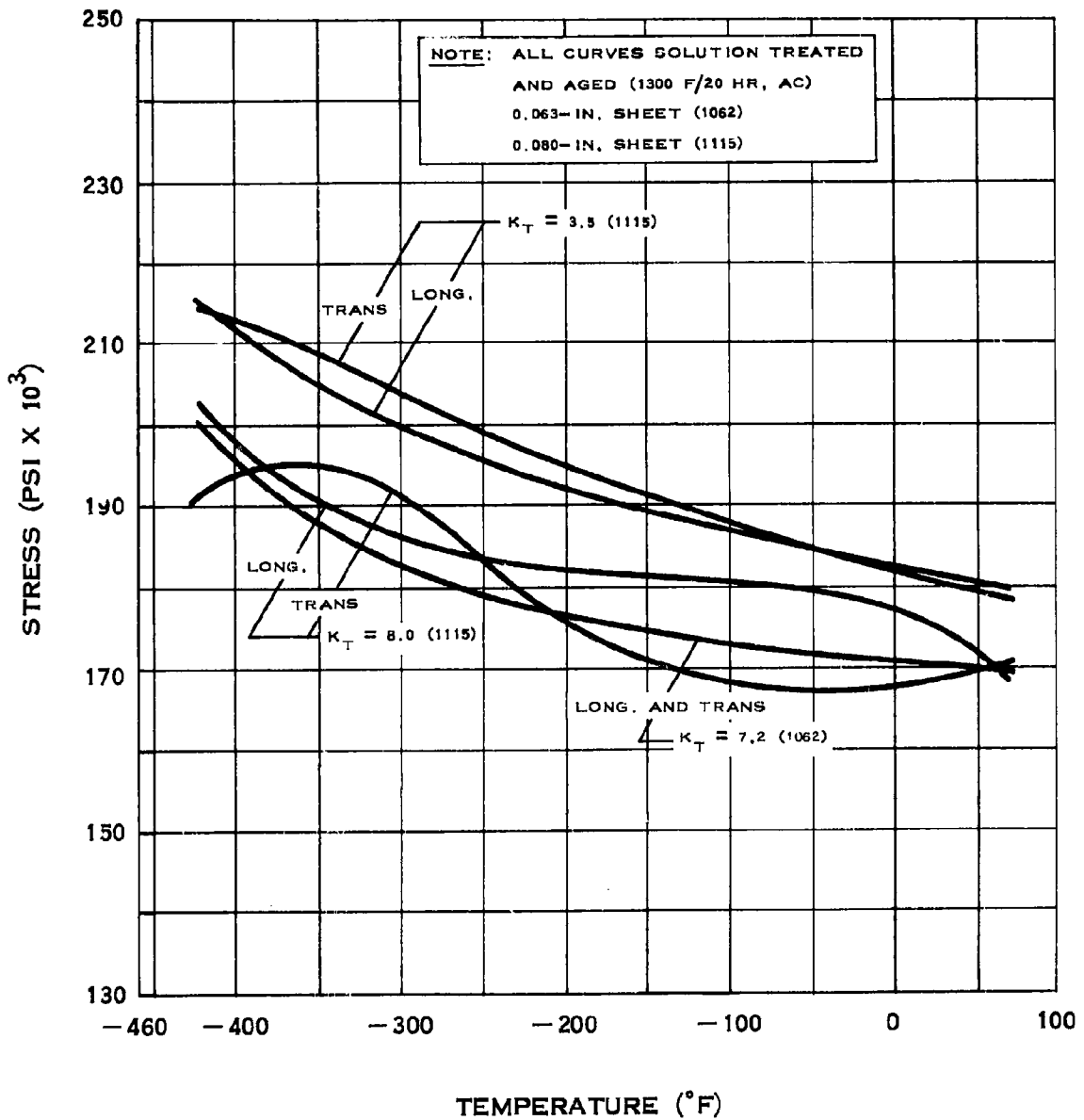

## NOTCH TENSILE STRENGTH OF INCONEL-X

### E.2.b-2

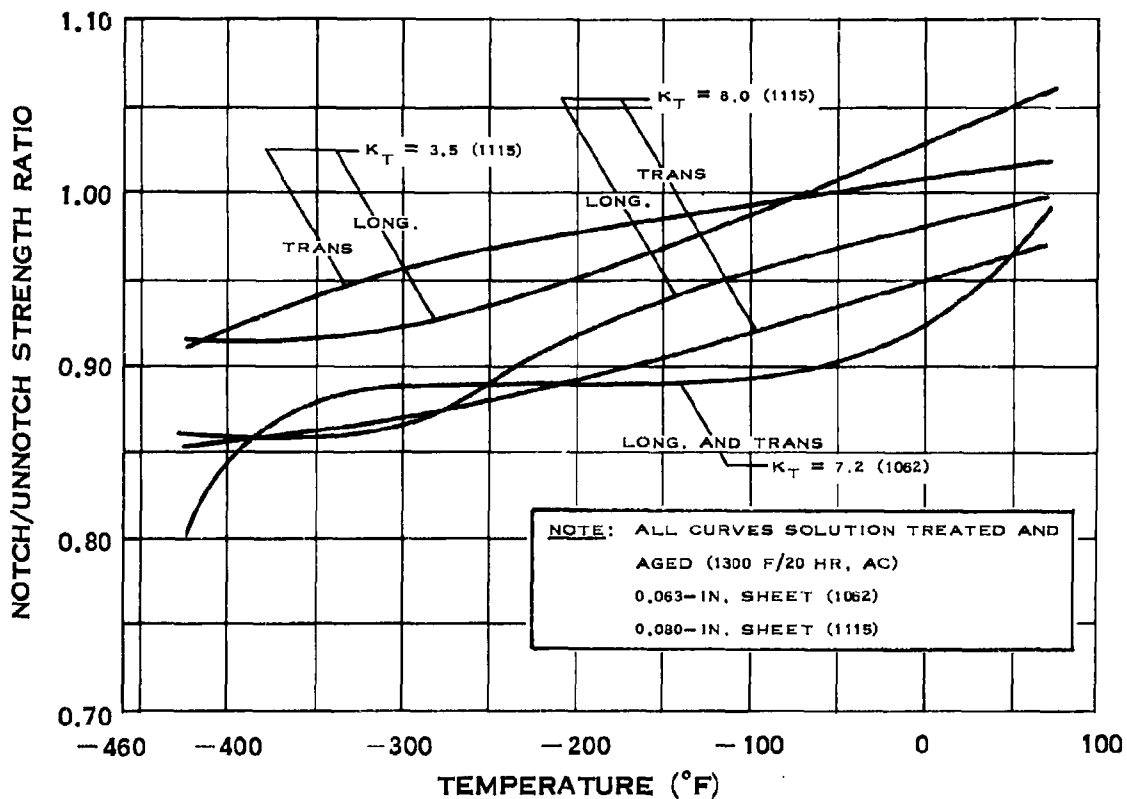

### NOTCH STRENGTH RATIO OF INCONEL-X

### E.2.b-3

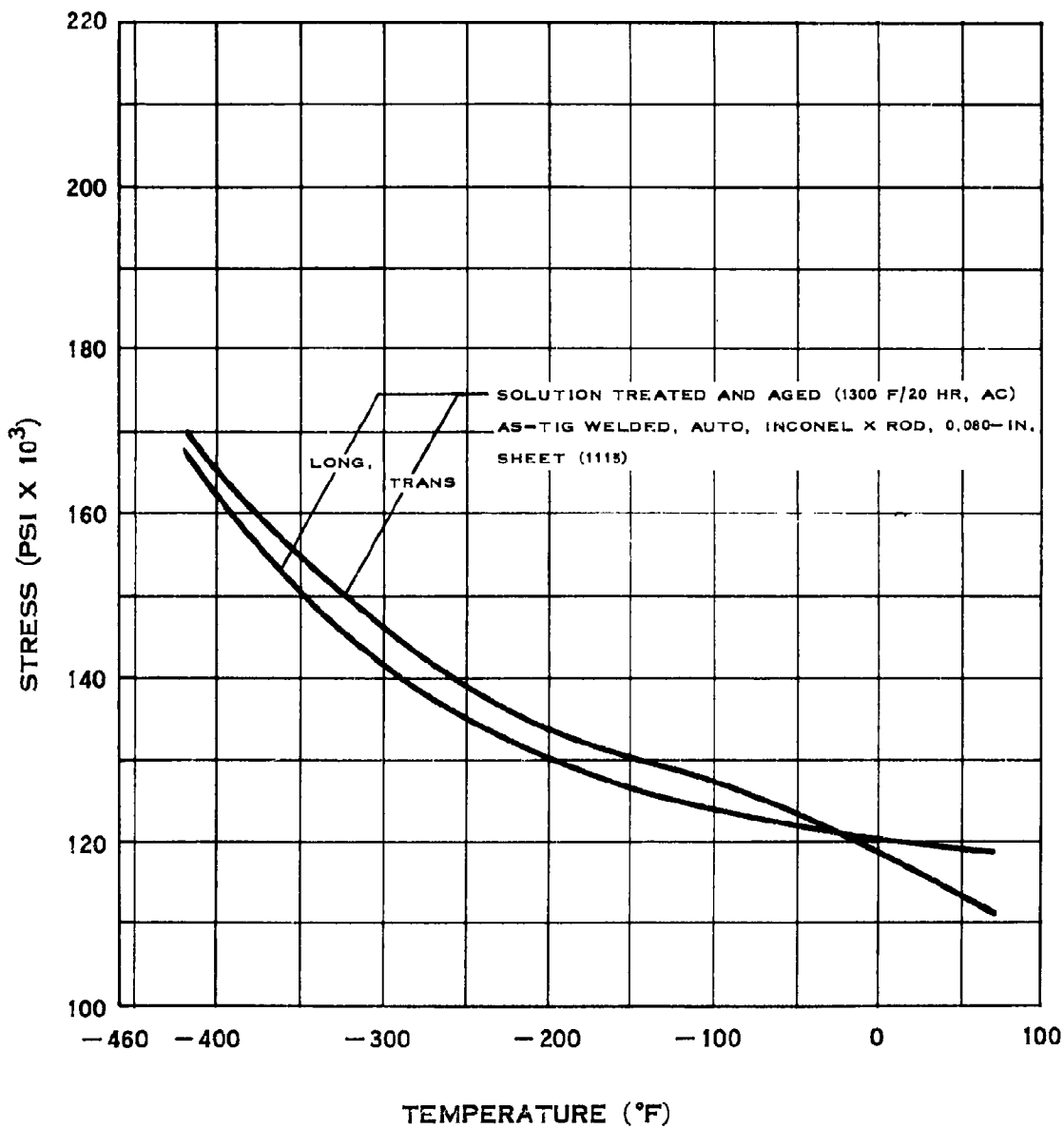

### WELD TENSILE STRENGTH OF INCONEL-X

### E.2.c

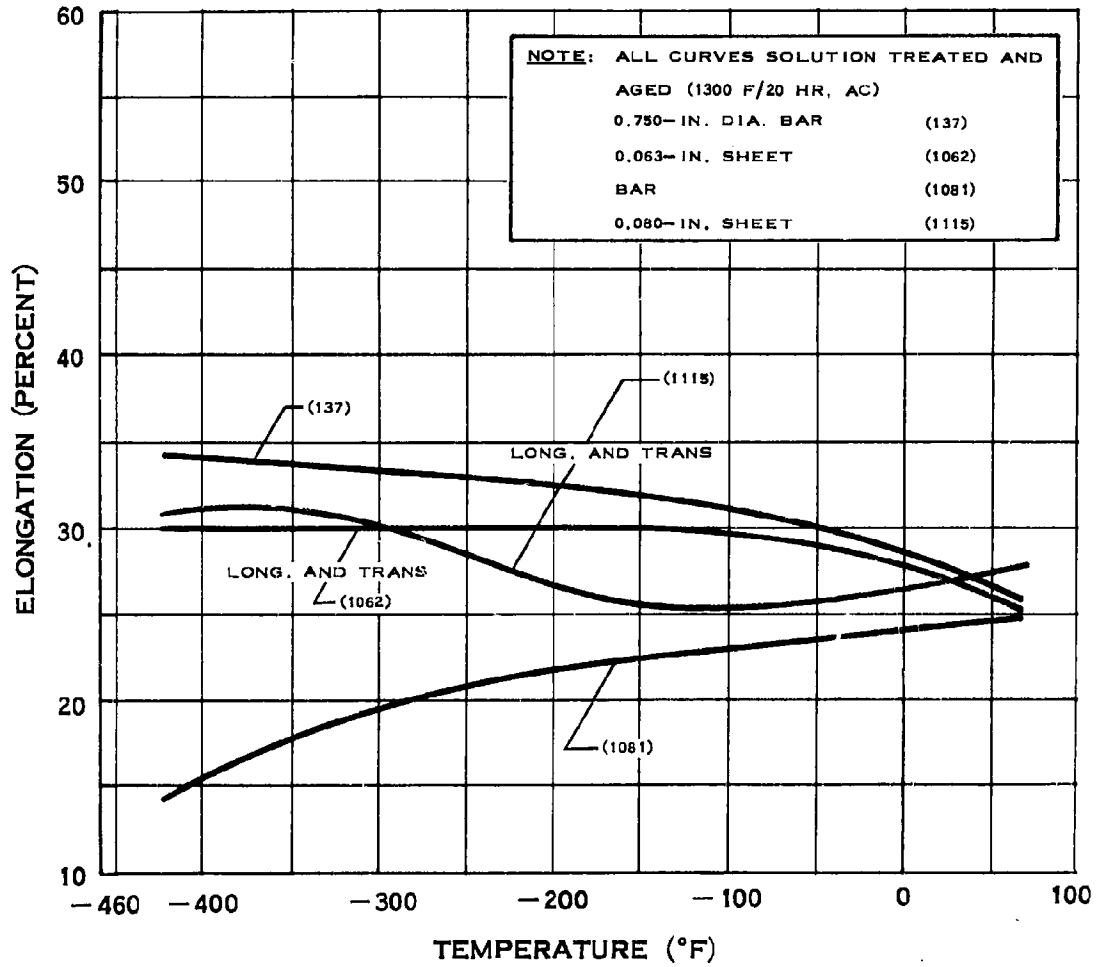

### ELONGATION OF INCONEL-X



### E.2.d

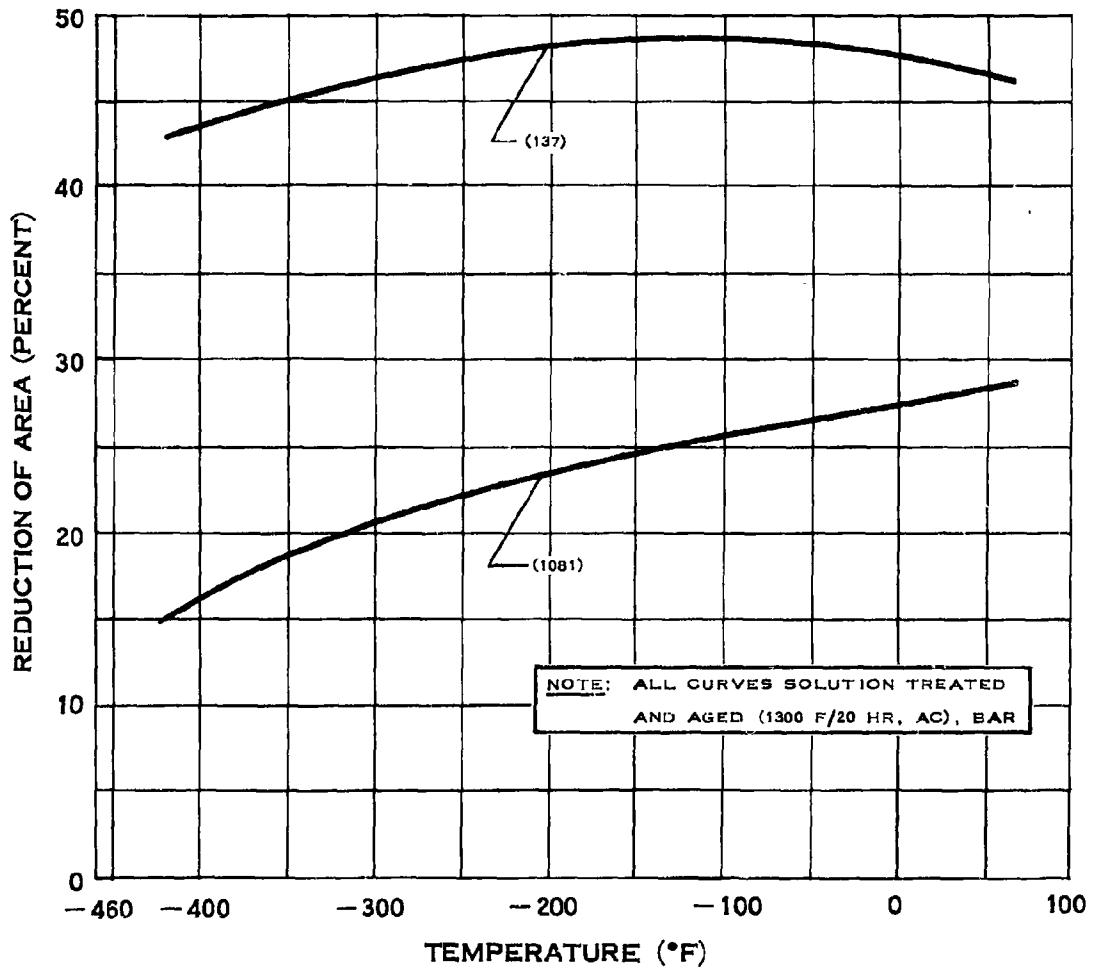

### REDUCTION OF AREA OF INCONEL-X

### E.7.a

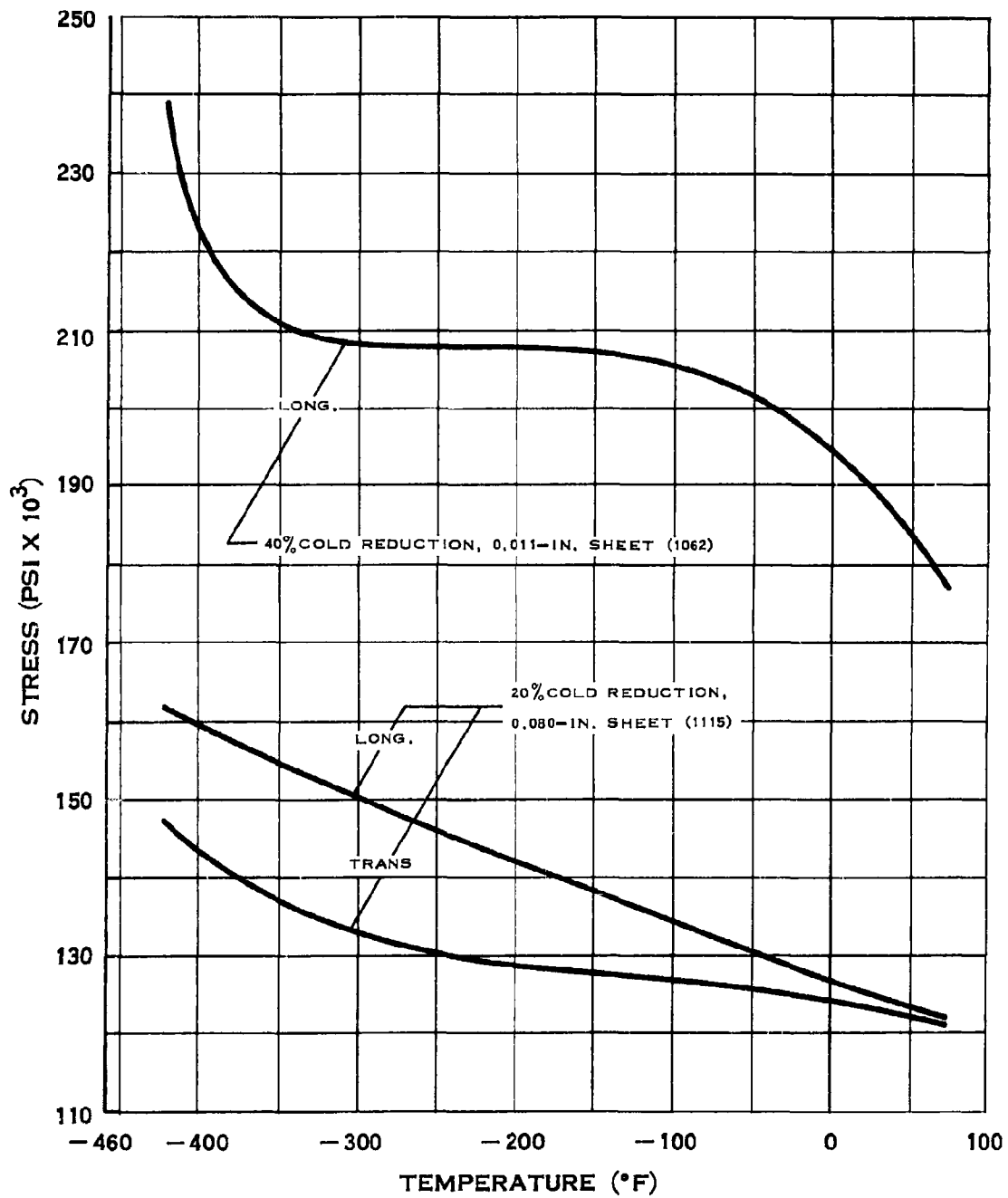

### YIELD STRENGTH OF HASTELLOY B

### E.7.b

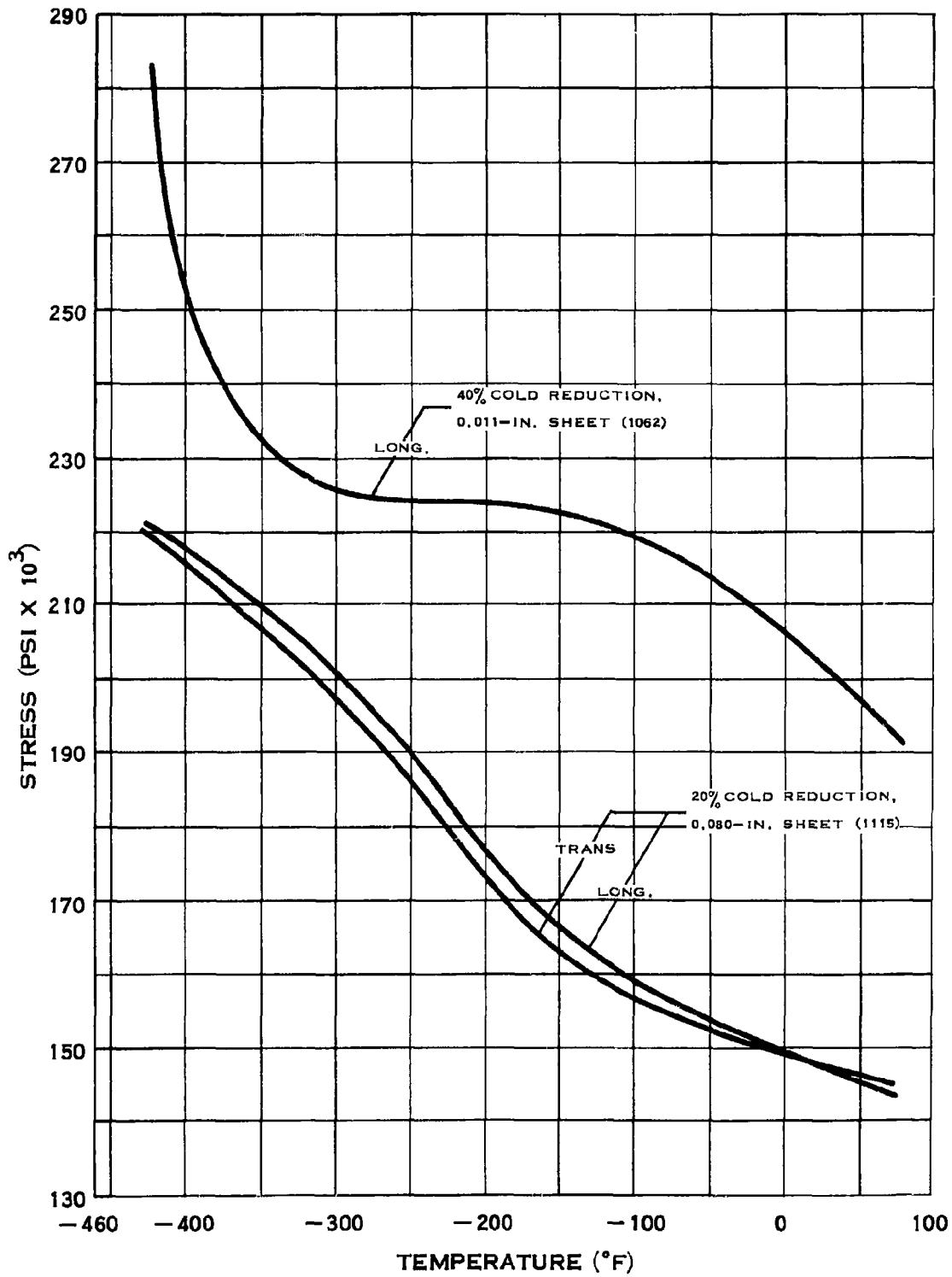

### E.7.b-1

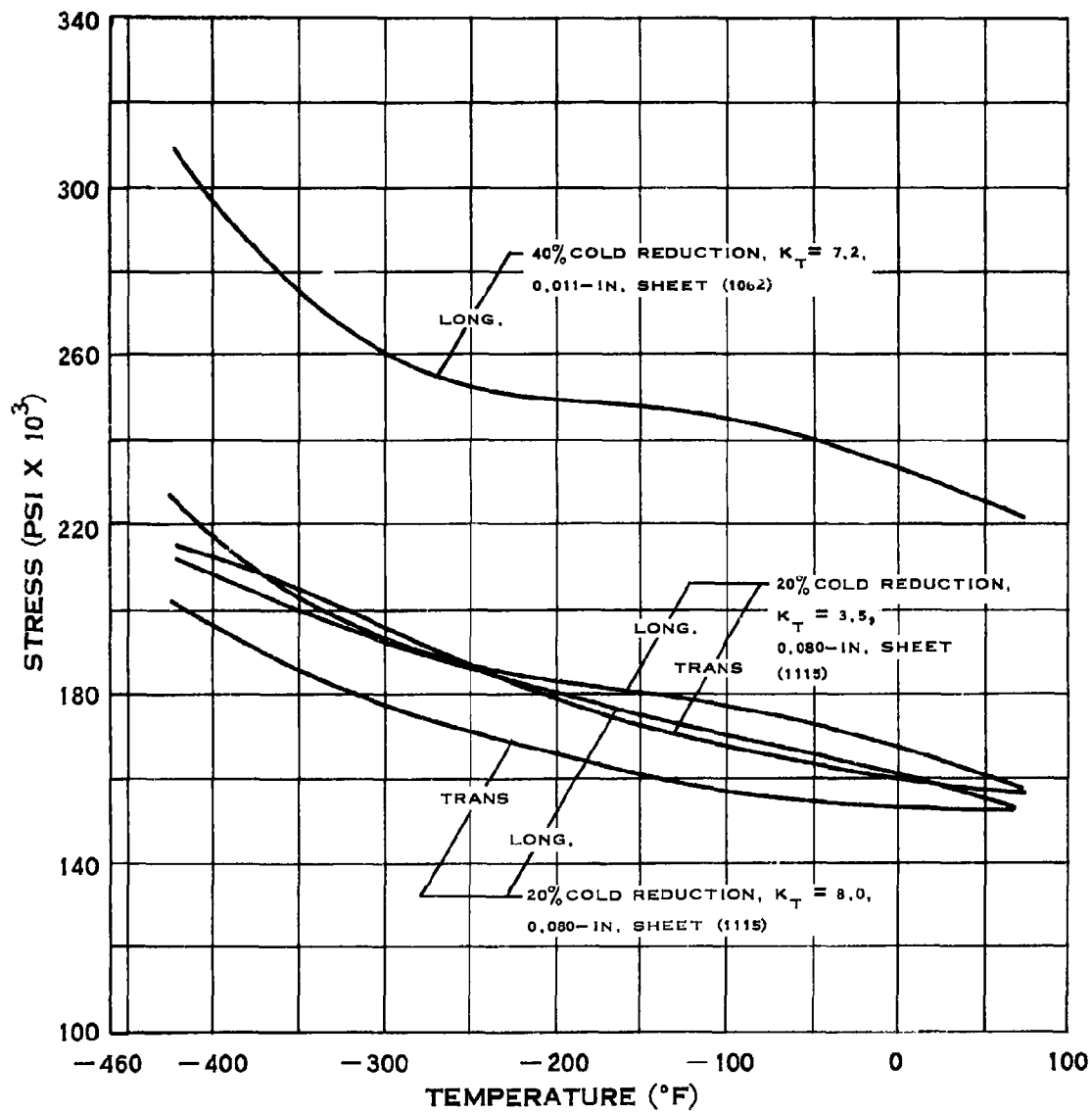

### NOTCH TENSILE STRENGTH OF HASTELLOY B

### E.7.b-2

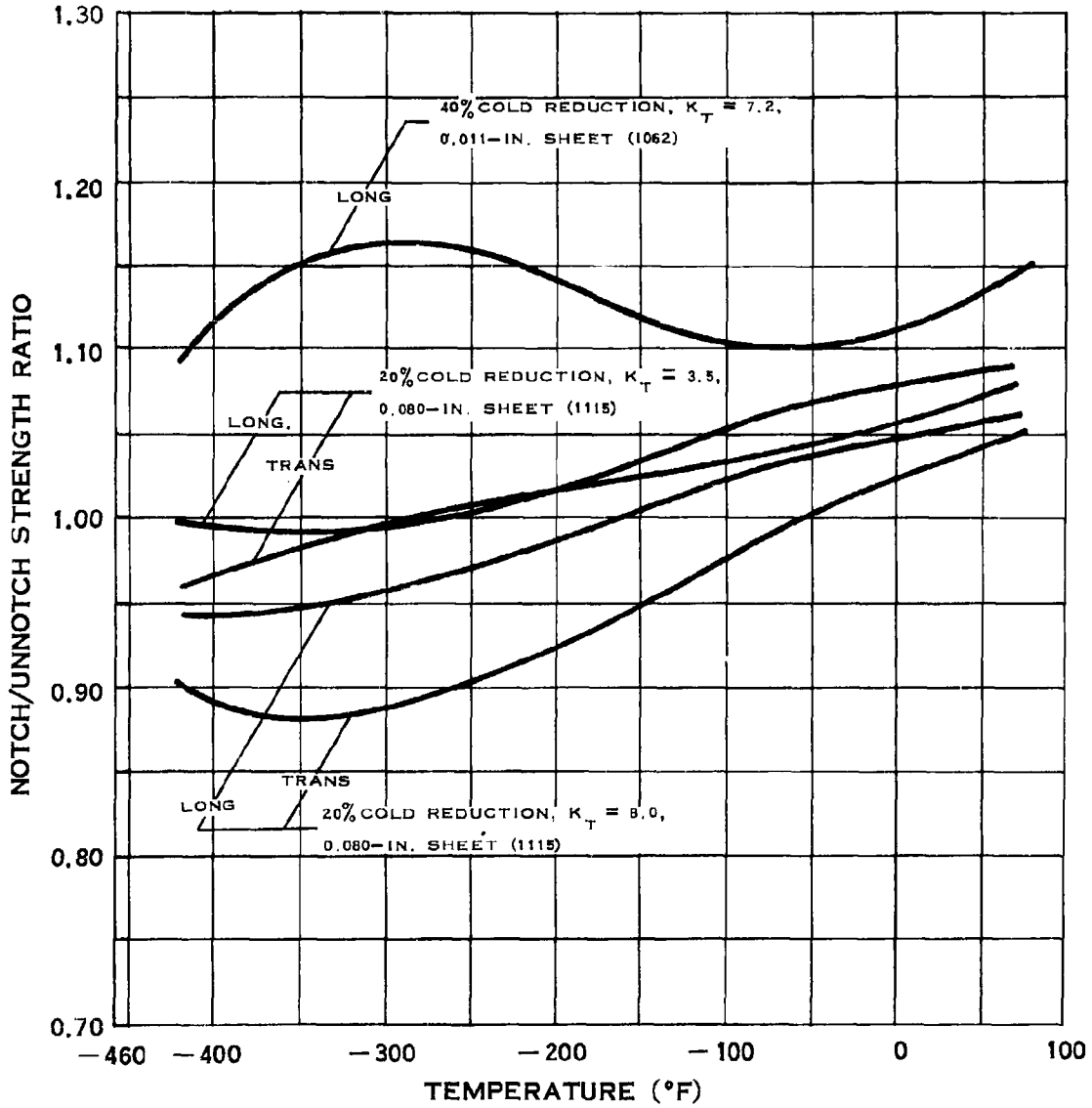

### NOTCH STRENGTH RATIO OF HASTELLOY B

### E.7.b-3

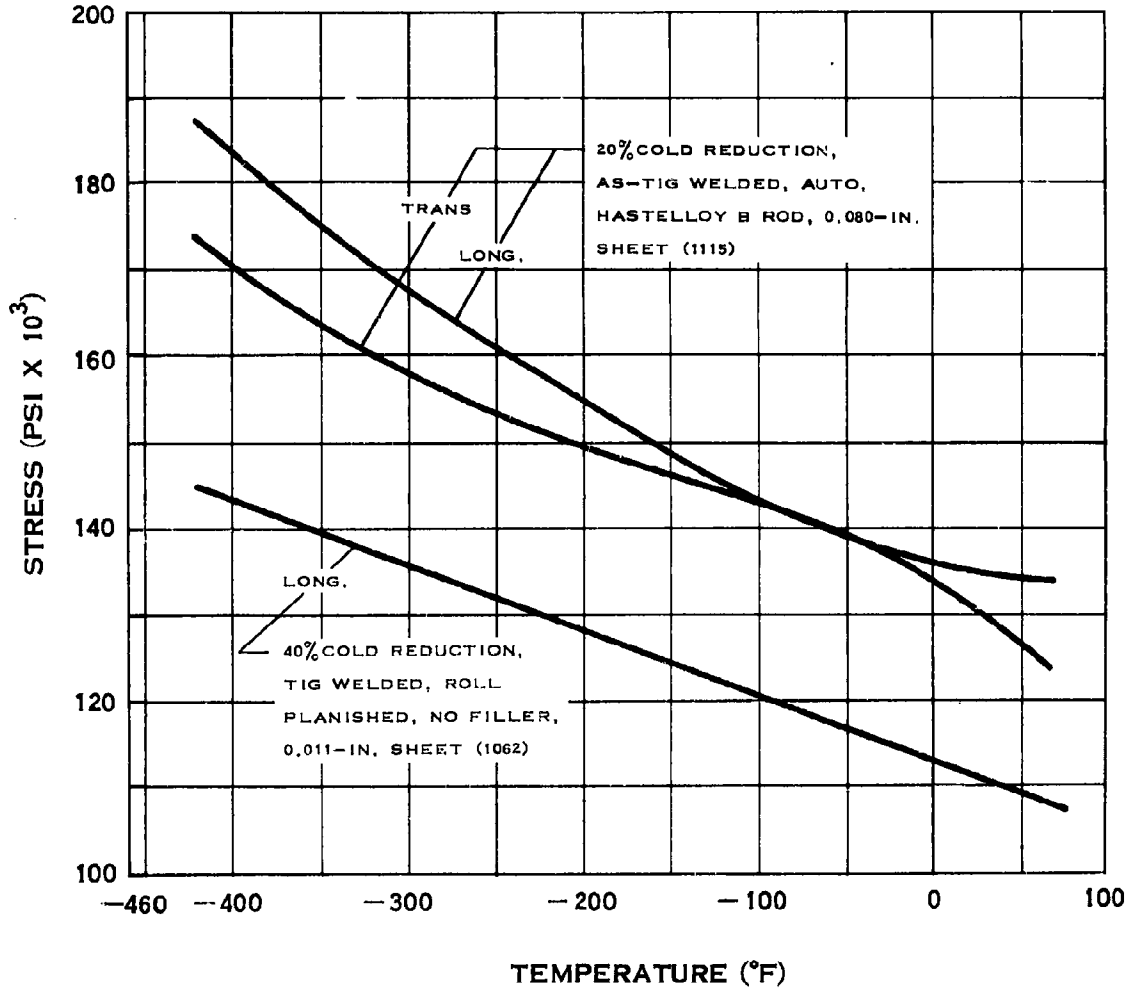

## WELD TENSILE STRENGTH OF HASTELLOY B

### E.7.c

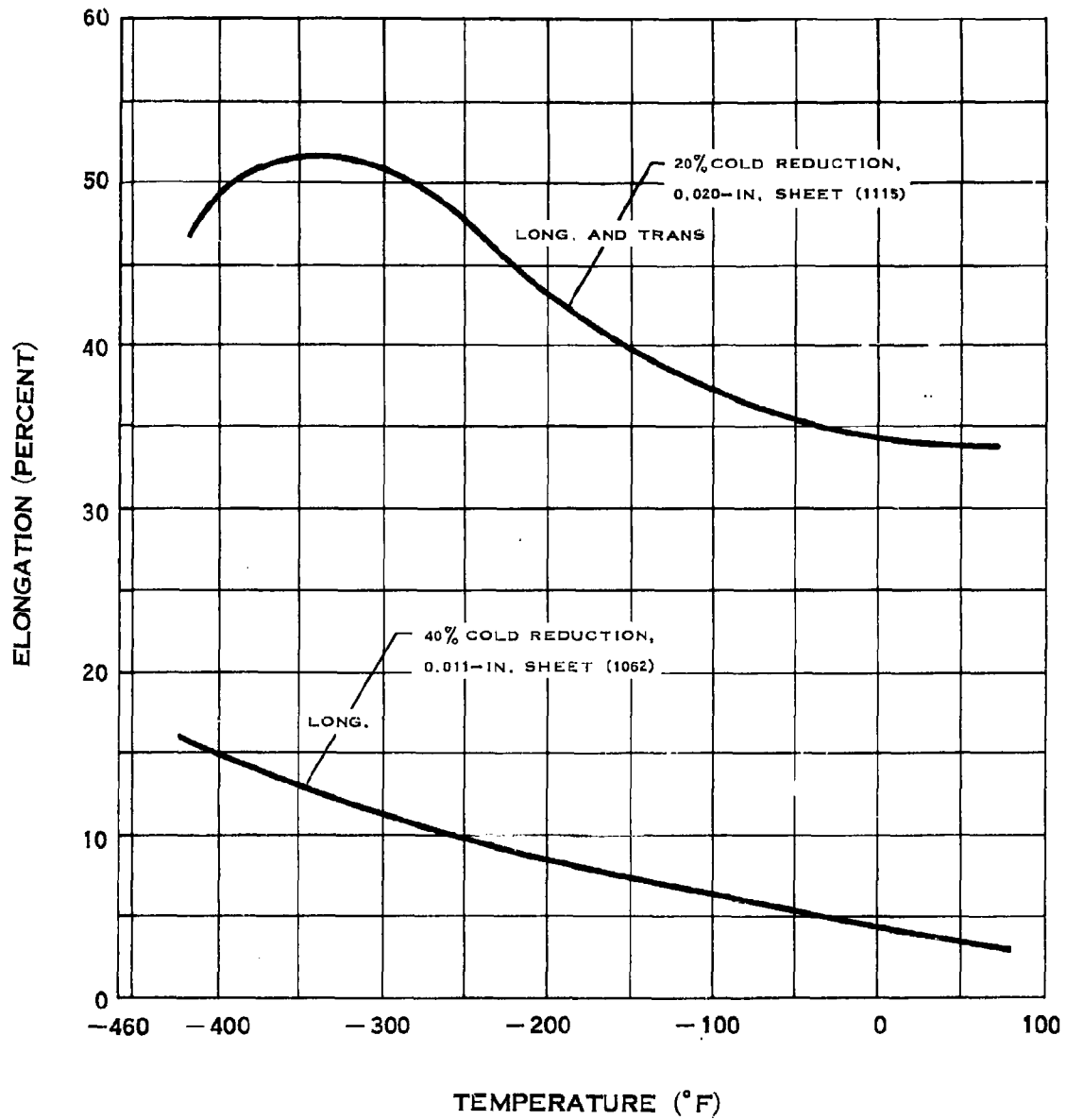

## ELONGATION OF HASTELLOY B

### E.8.a

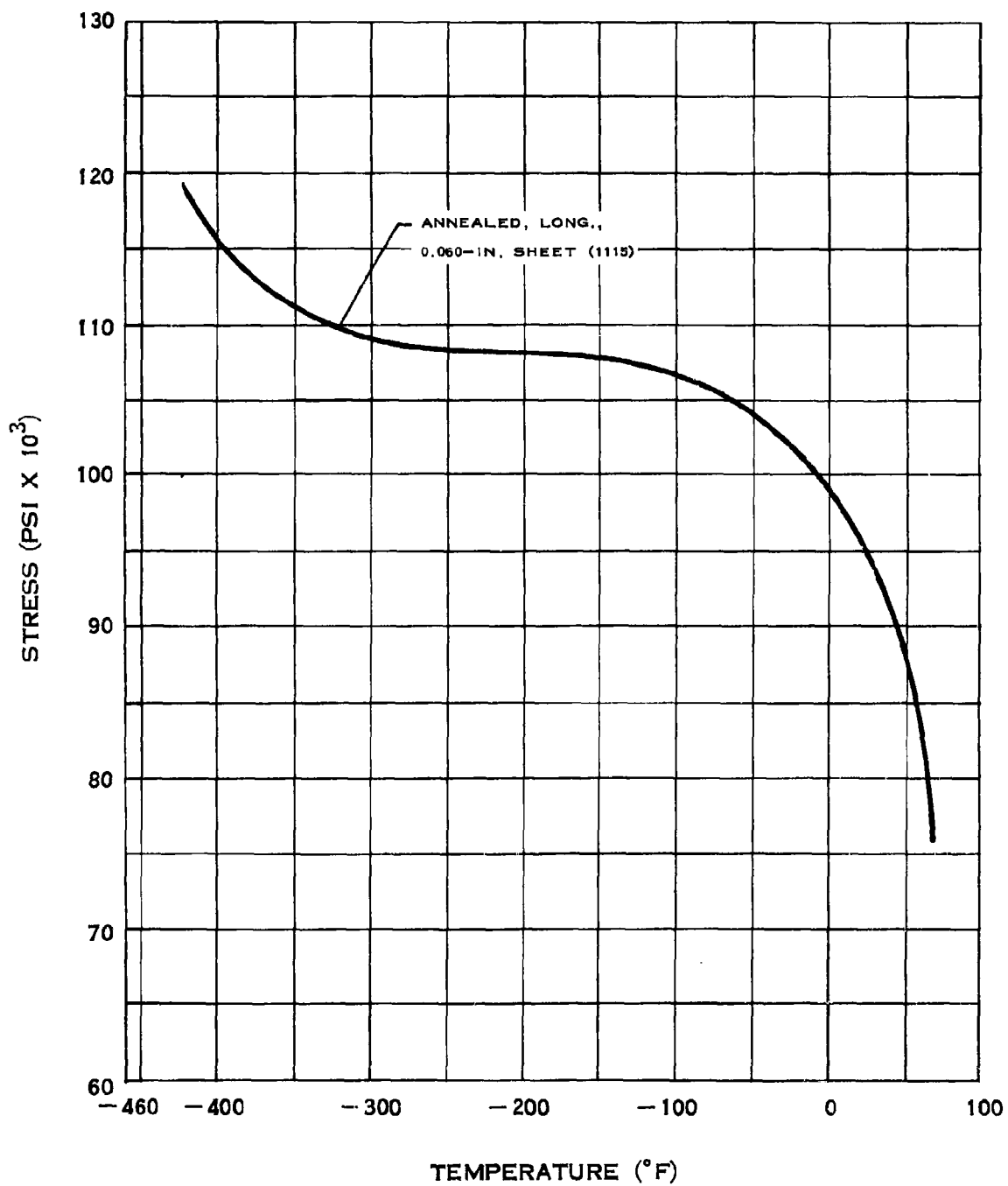

### YIELD STRENGTH OF D-979



### E.8.b

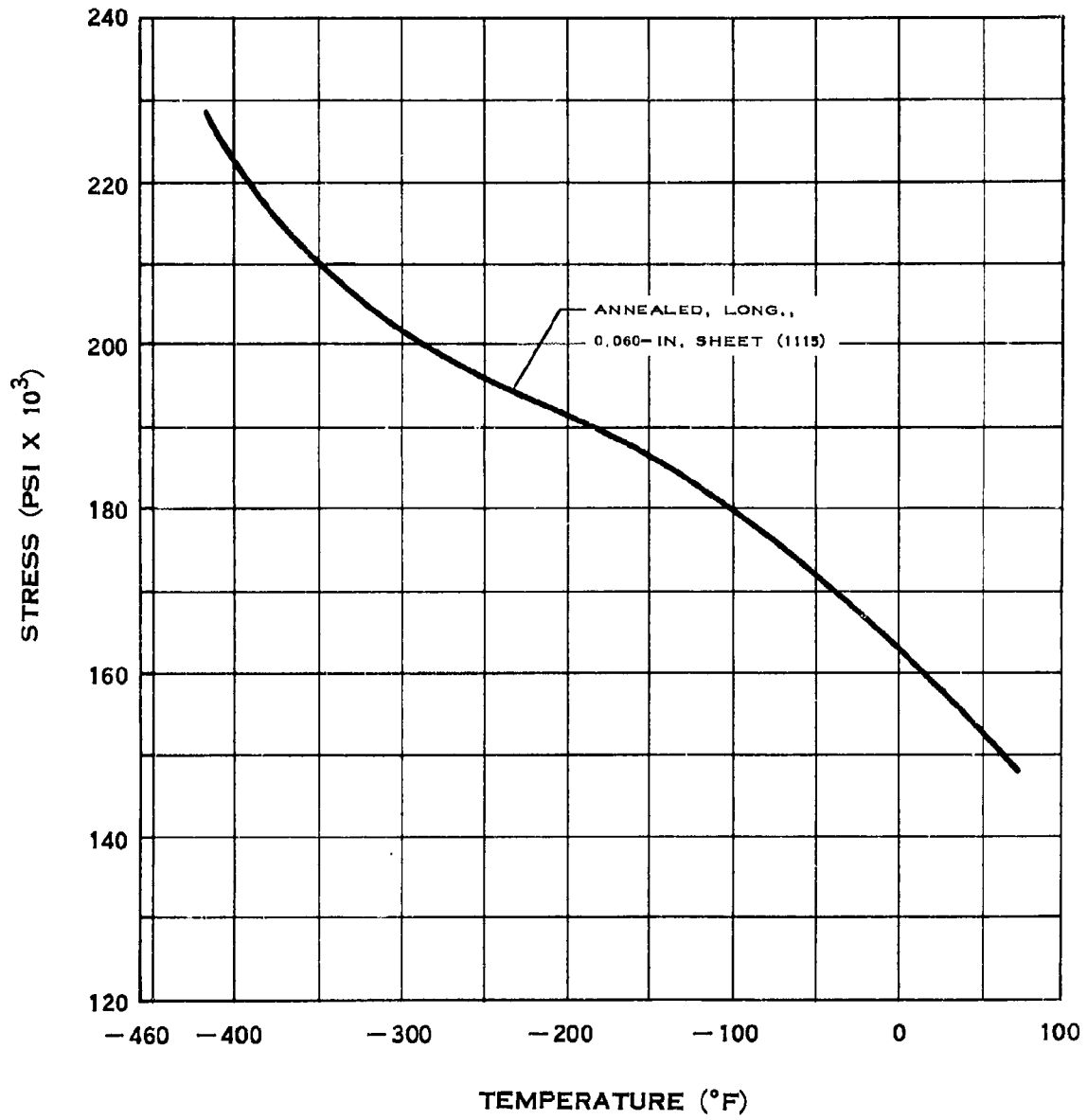

### TENSILE STRENGTH OF D-979

### E.8.b-1

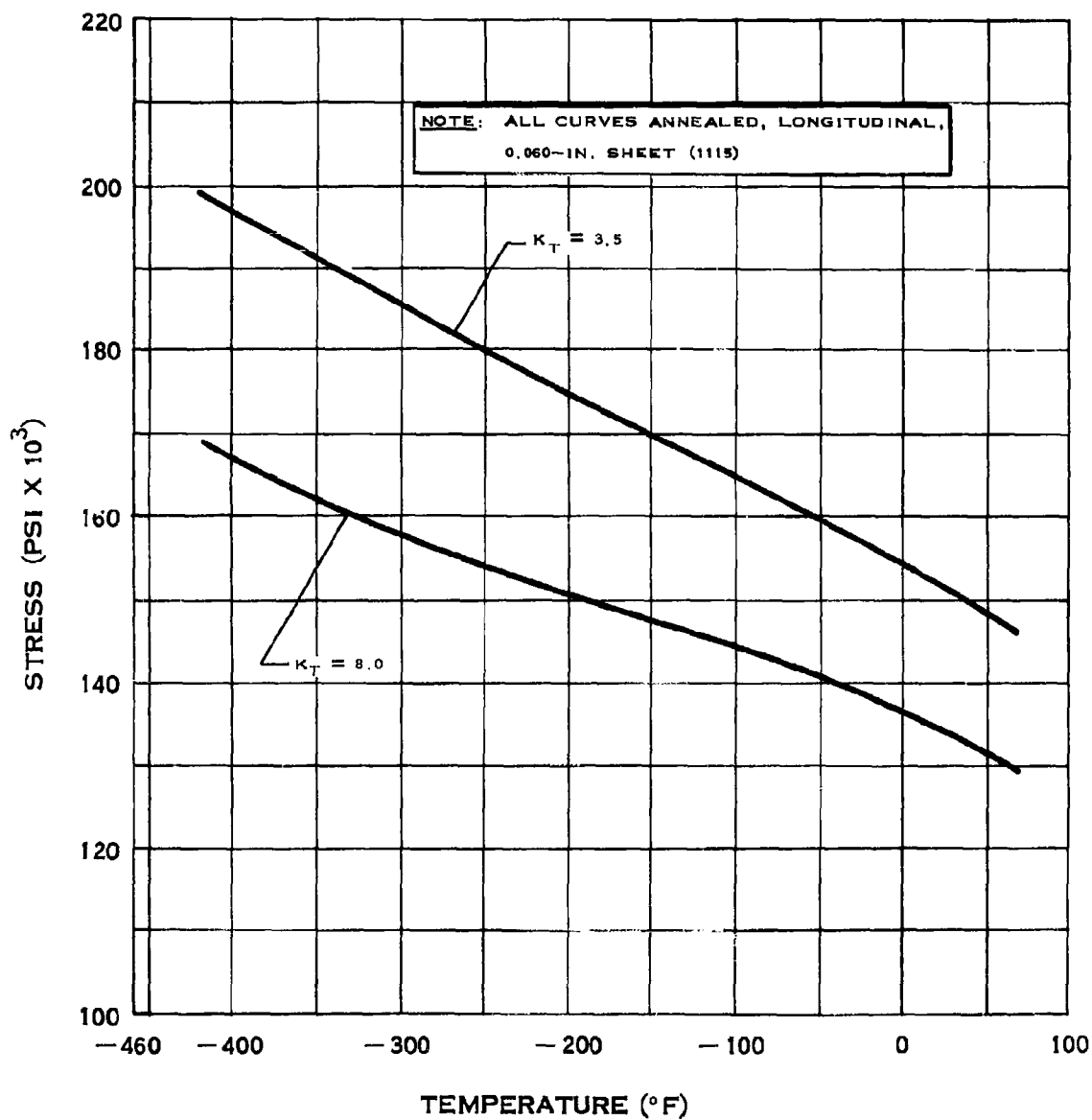

### NOTCH TENSILE STRENGTH OF D-979

### E.8.b-2

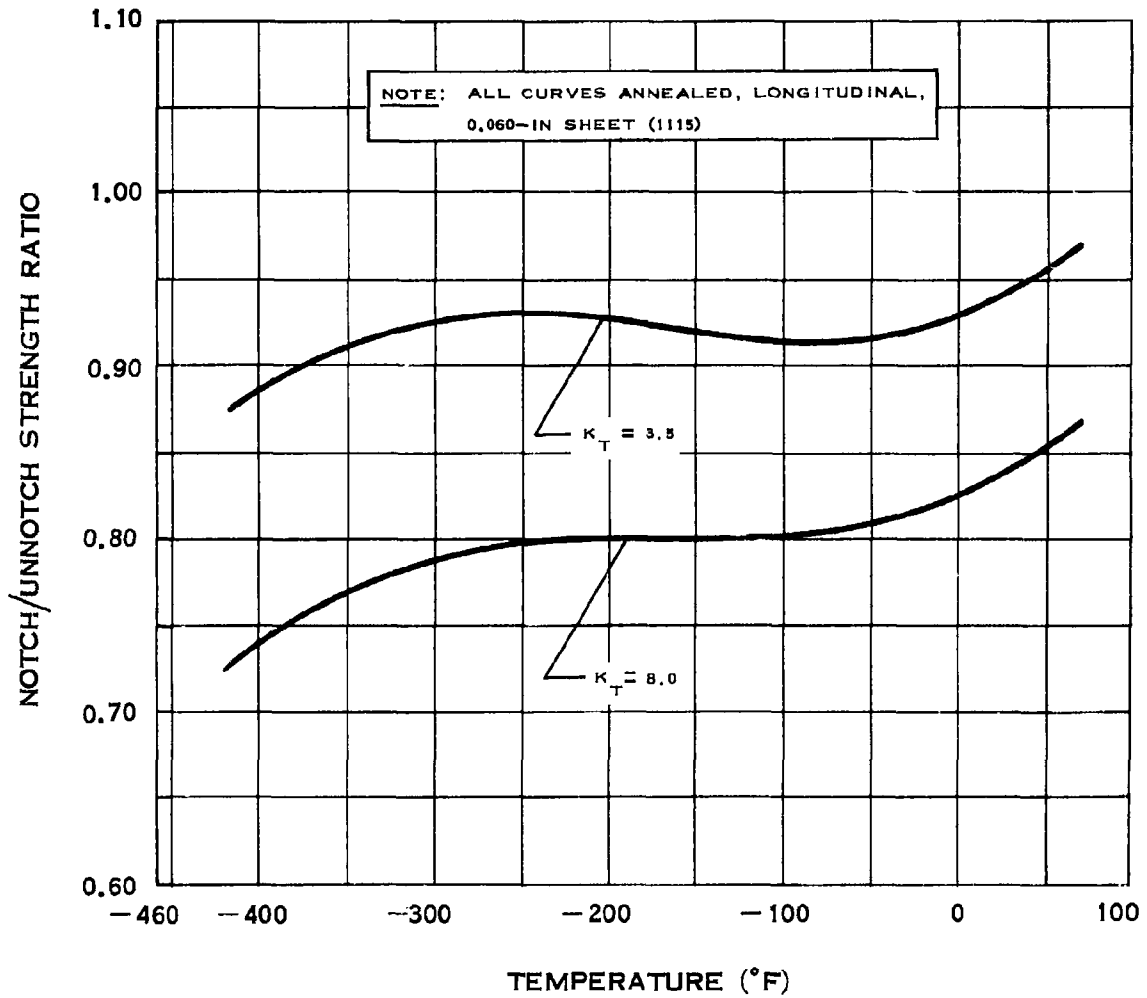

### NOTCH STRENGTH RATIO OF D-979

### E.8.c

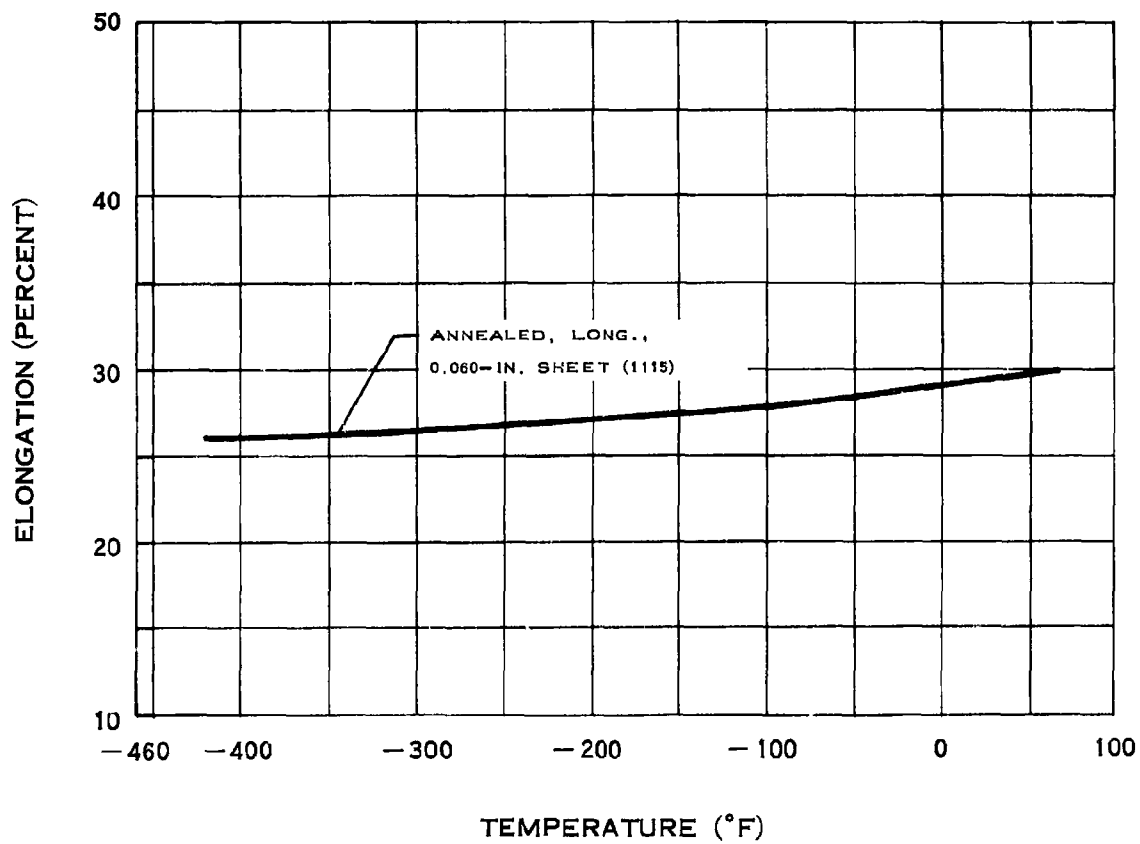

### ELONGATION OF D-979

## F.1.a-2

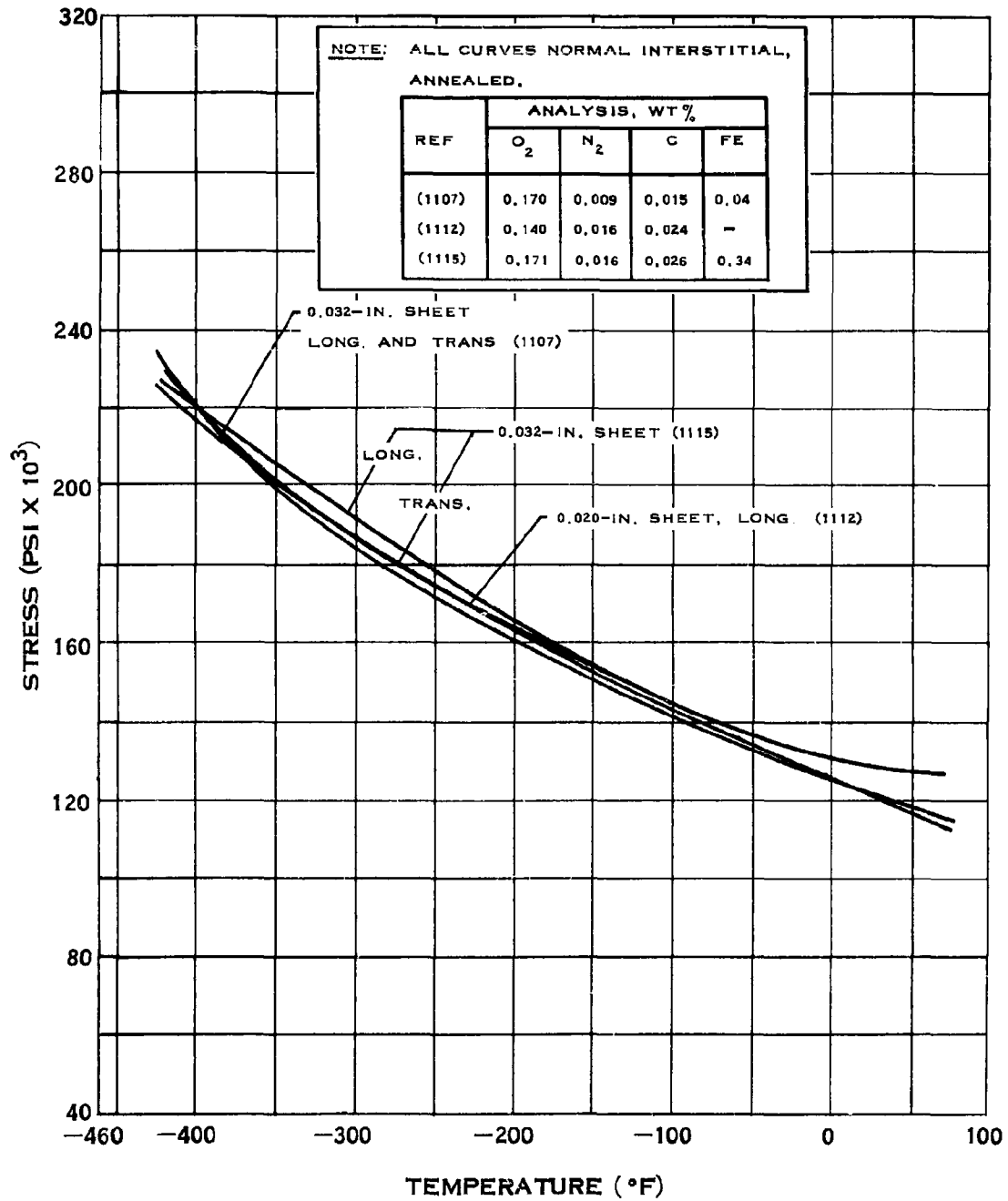

## YIELD STRENGTH OF 5Al-2.5 Sn TITANIUM

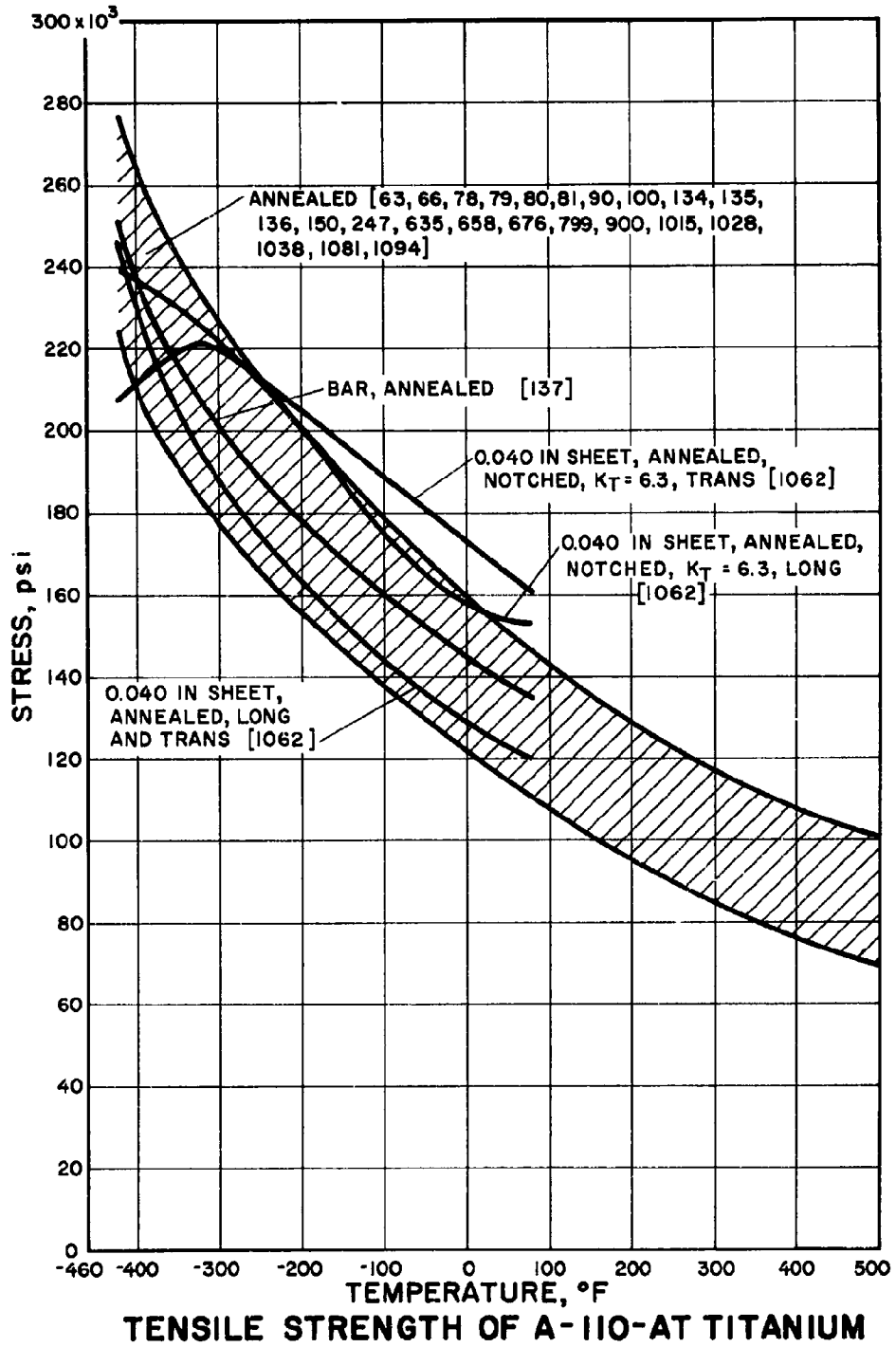

# F.1.b-1

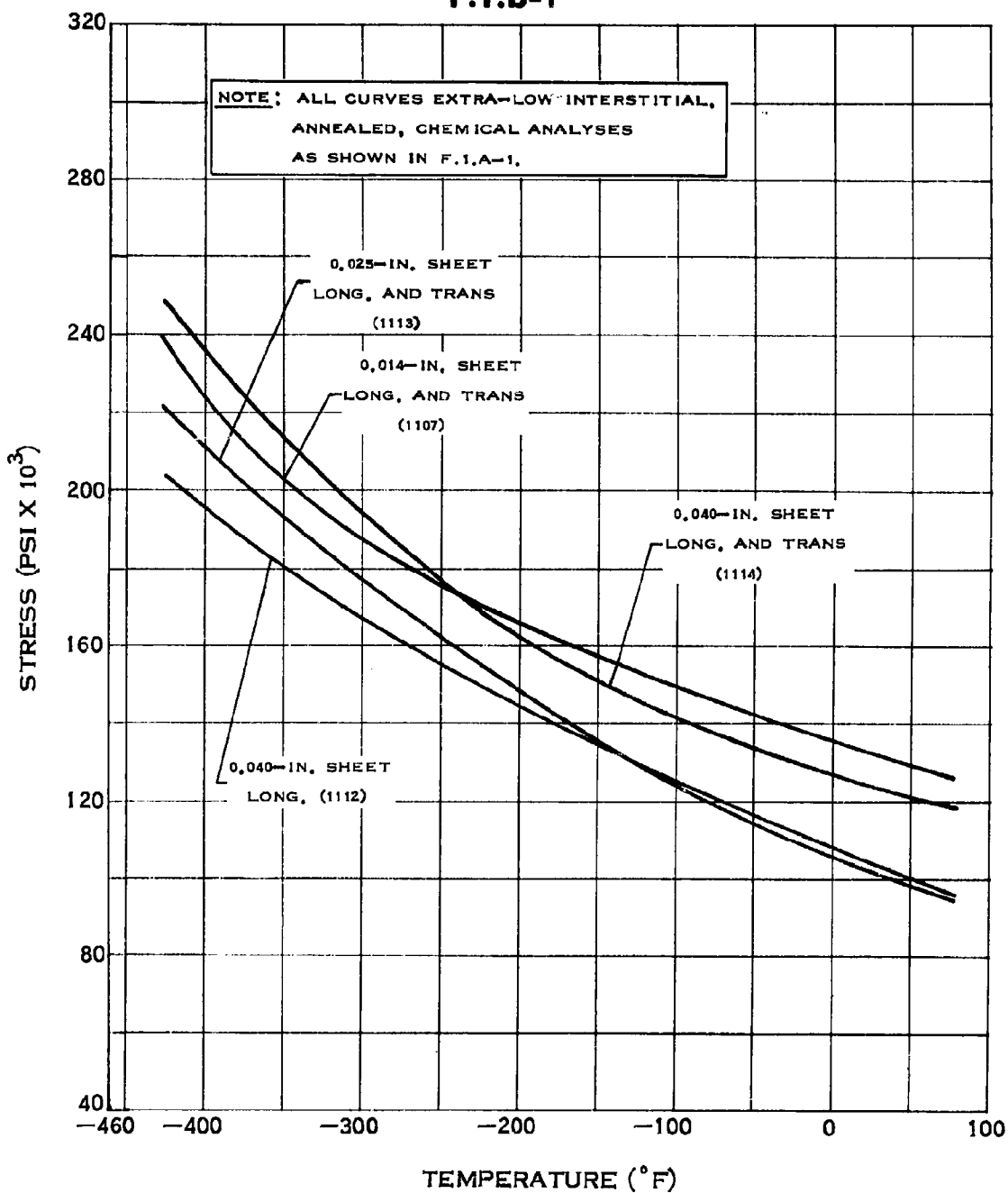

## TENSILE STRENGTH OF 5Al-2.5 Sn TITANIUM

# F.1.b-2

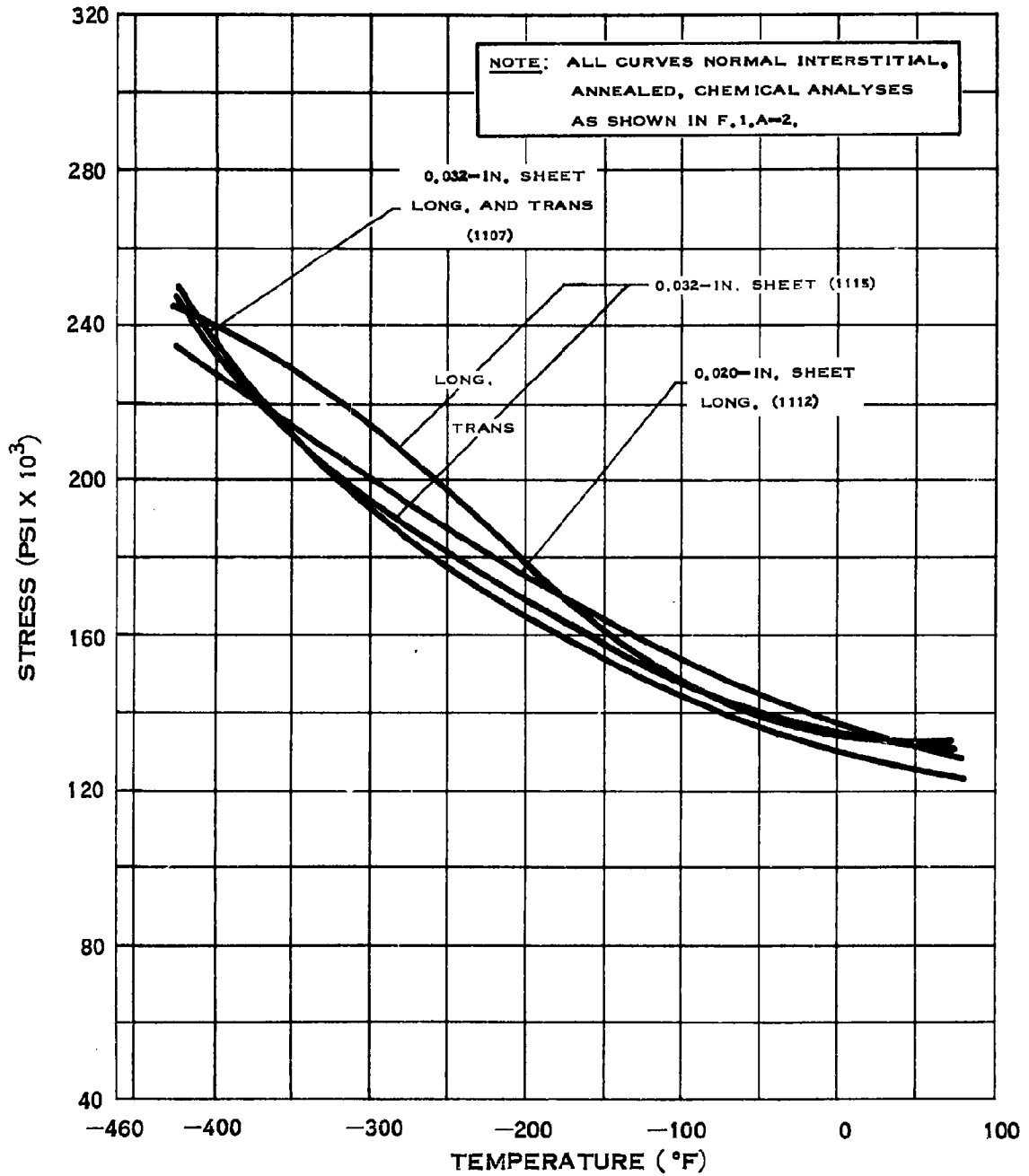

## TENSILE STRENGTH OF 5Al-2.5 Sn TITANIUM



### F.1.b-5

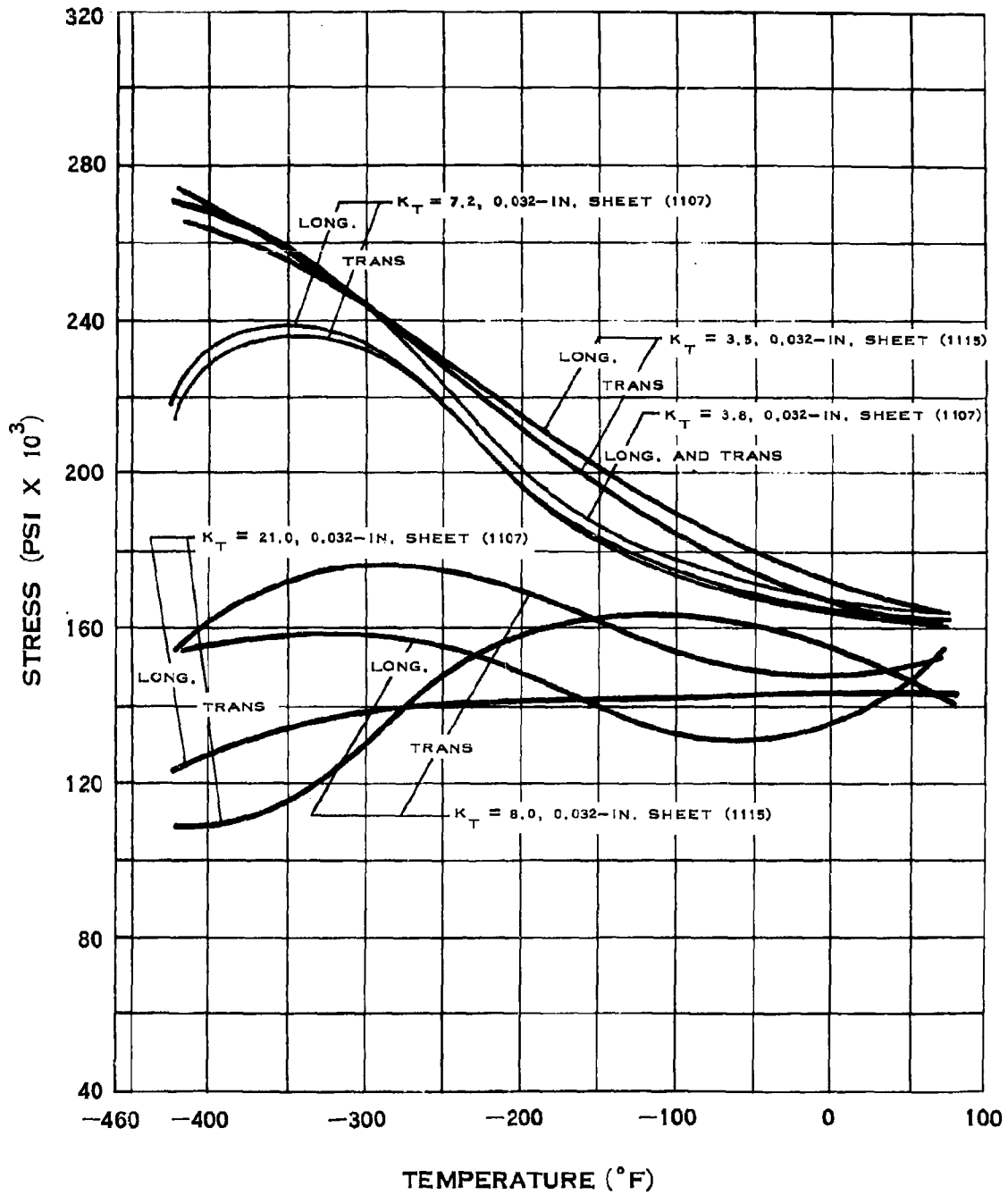

### NOTCH TENSILE STRENGTH OF 5Al-2.5 Sn TITANIUM

# F.1.b-6

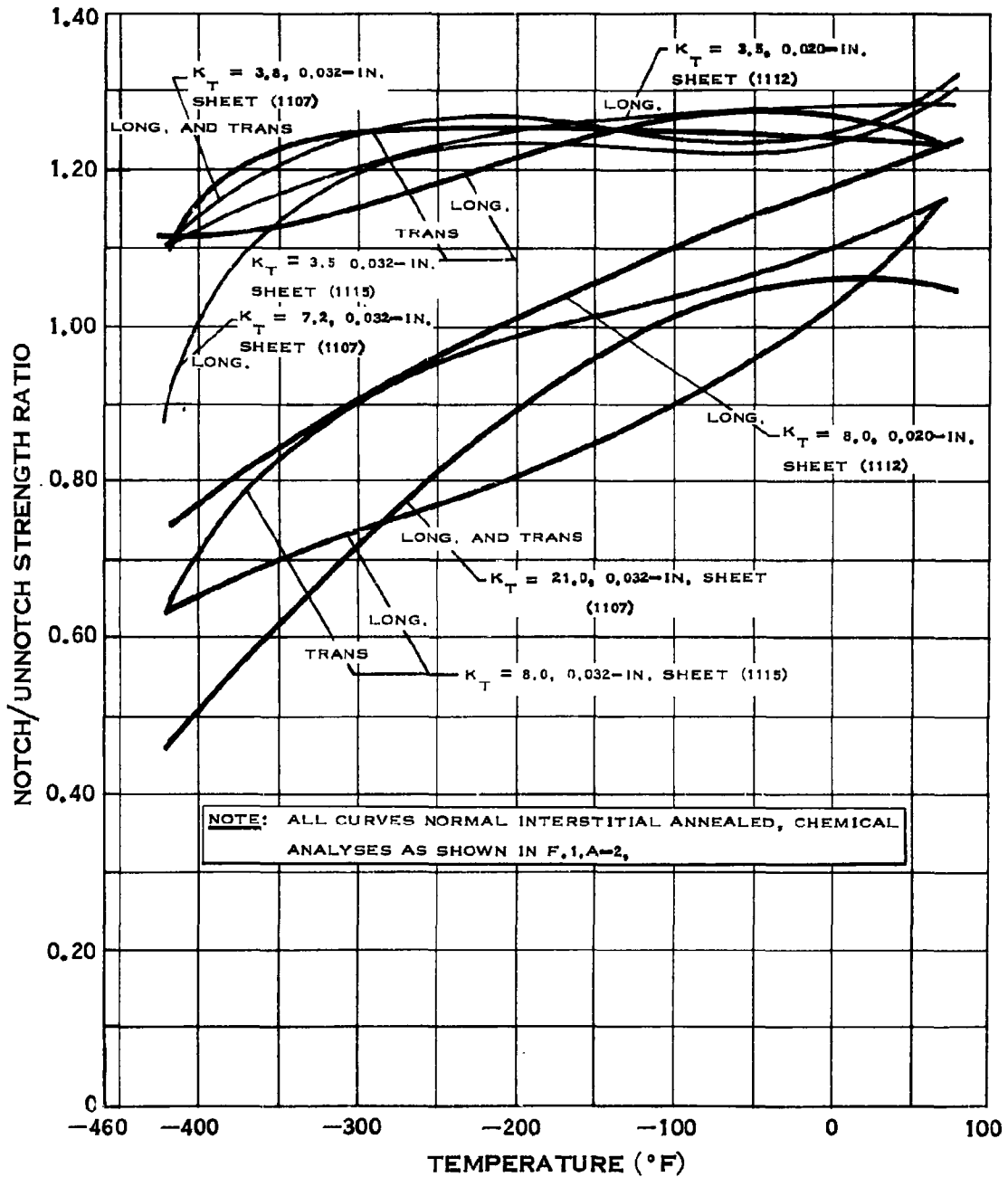

## NOTCH STRENGTH RATIO OF 5Al-2.5 Sn TITANIUM

### F.1.b-7

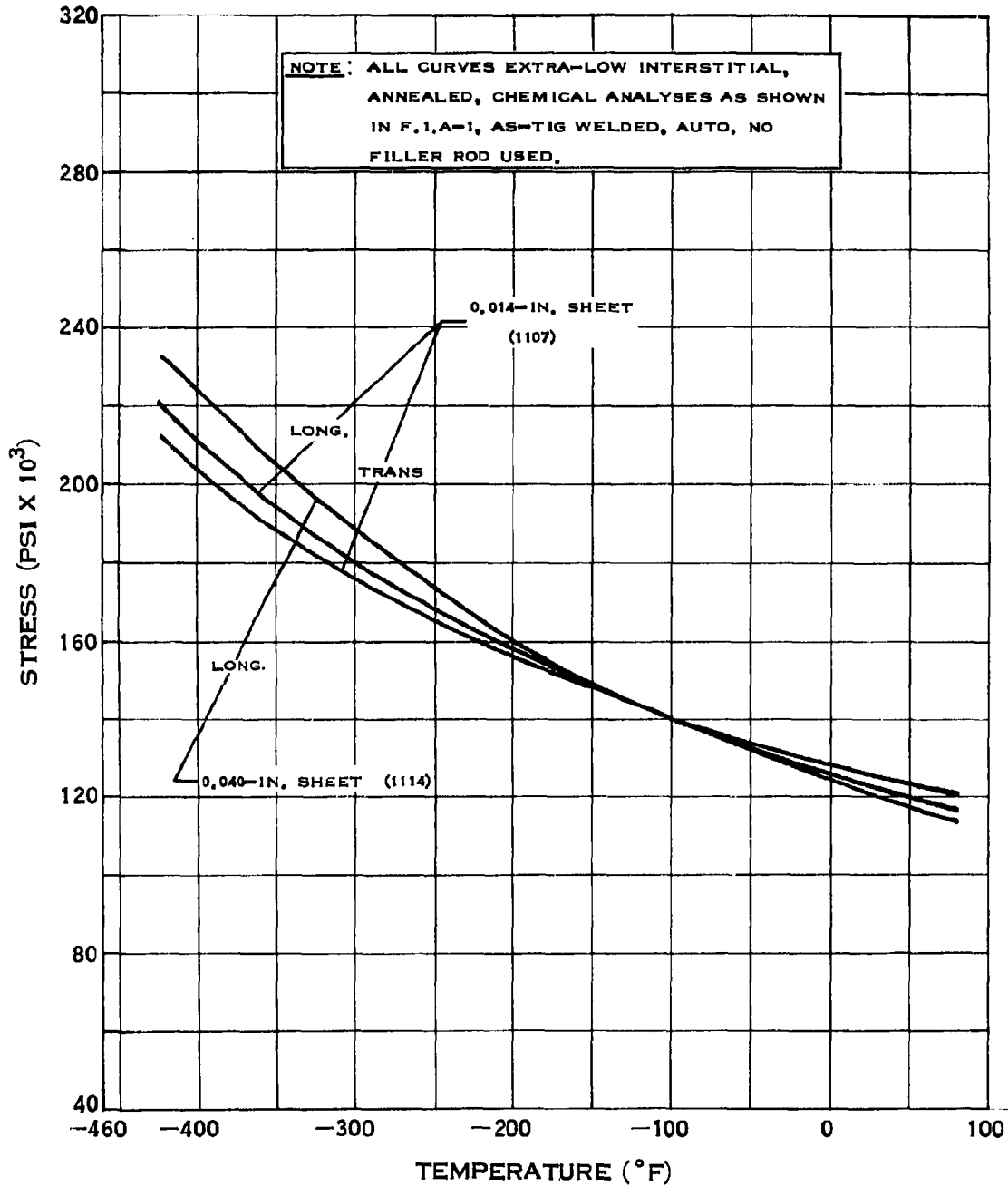

### WELD TENSILE STRENGTH OF 5Al-2.5 Sn TITANIUM

# F.1.b-8

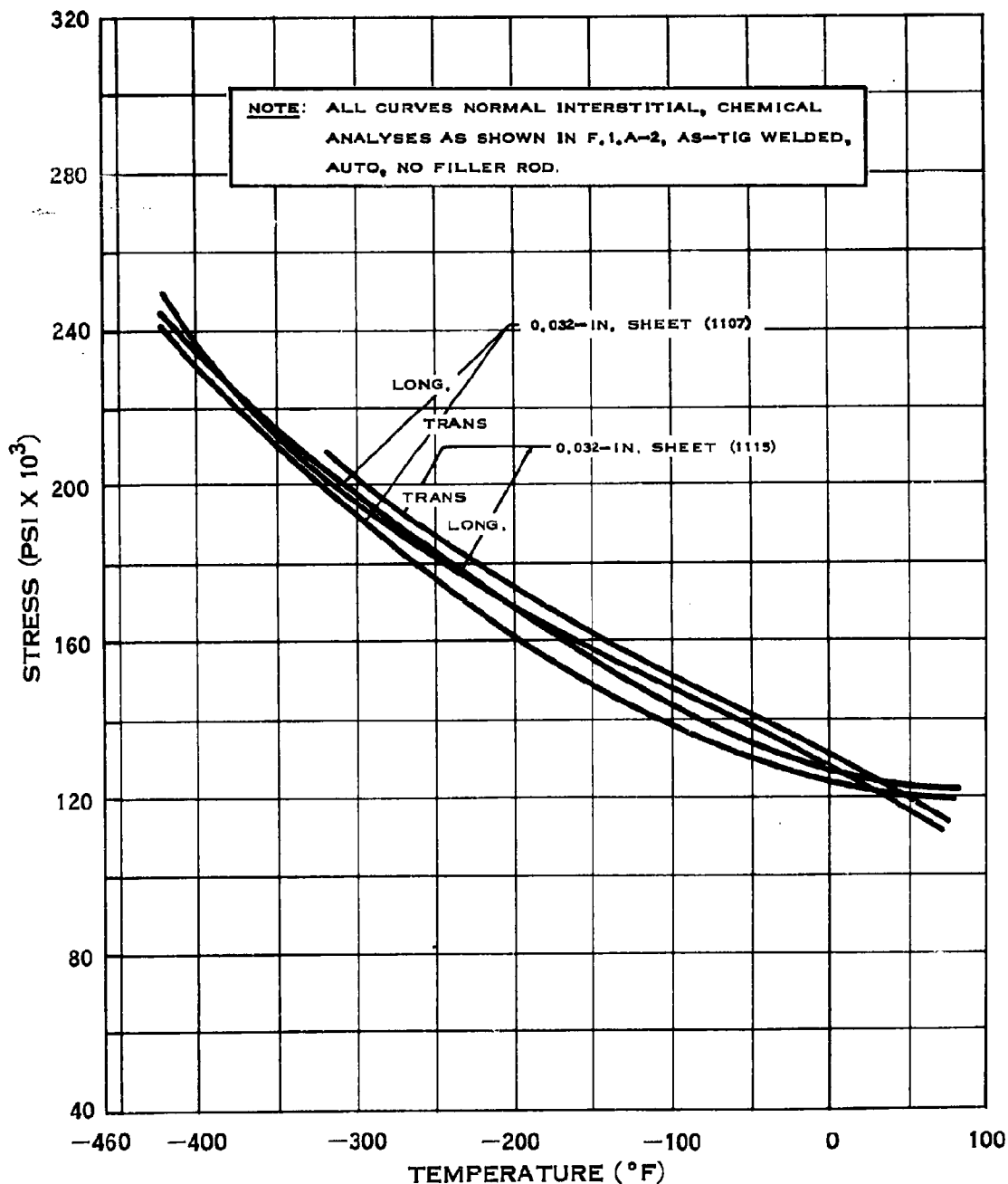

## WELD TENSILE STRENGTH OF 5Al-2.5 Sn TITANIUM

### F.1.c-2

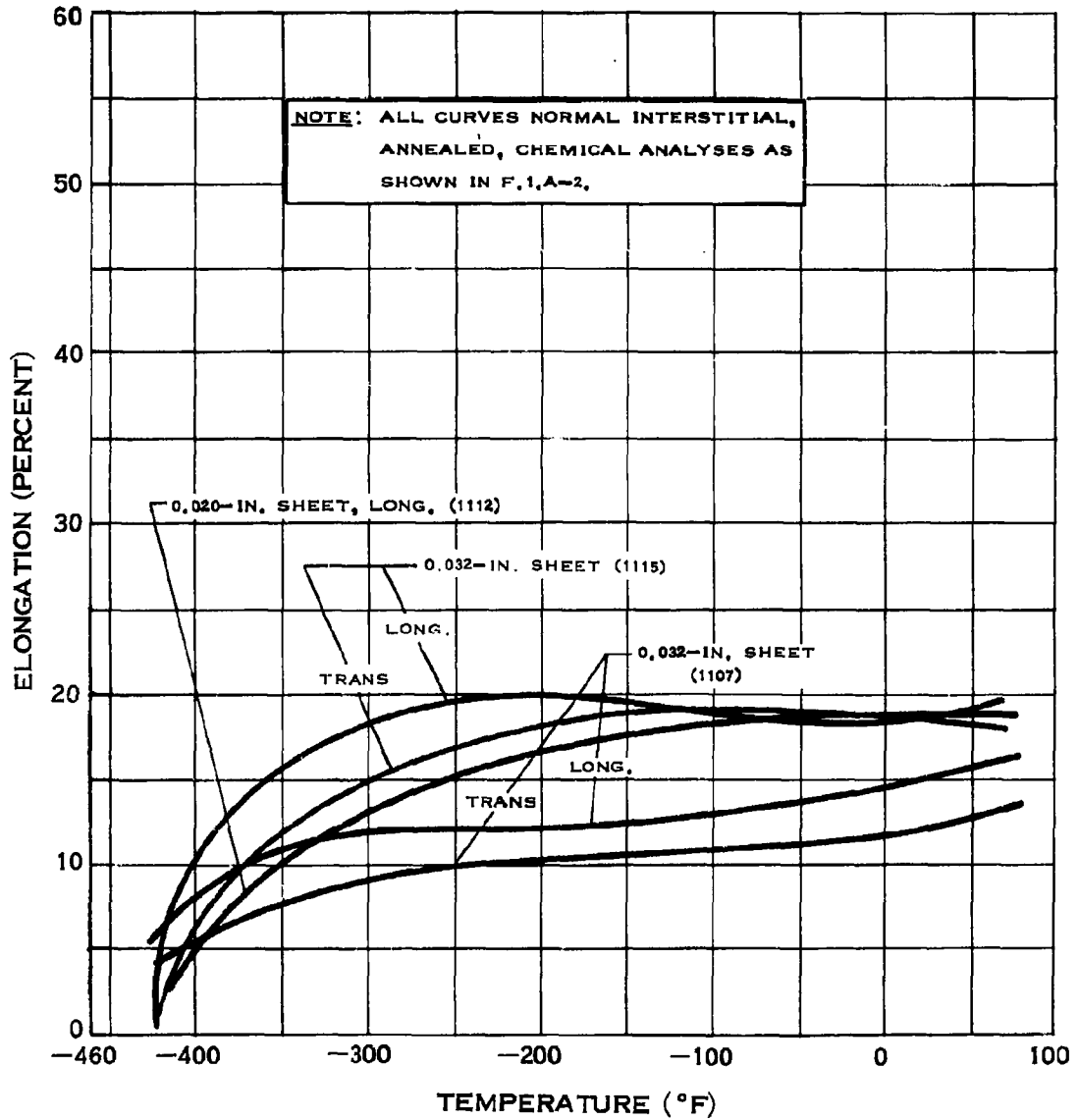

### ELONGATION OF 5Al-2.5 Sn TITANIUM

F. I. d

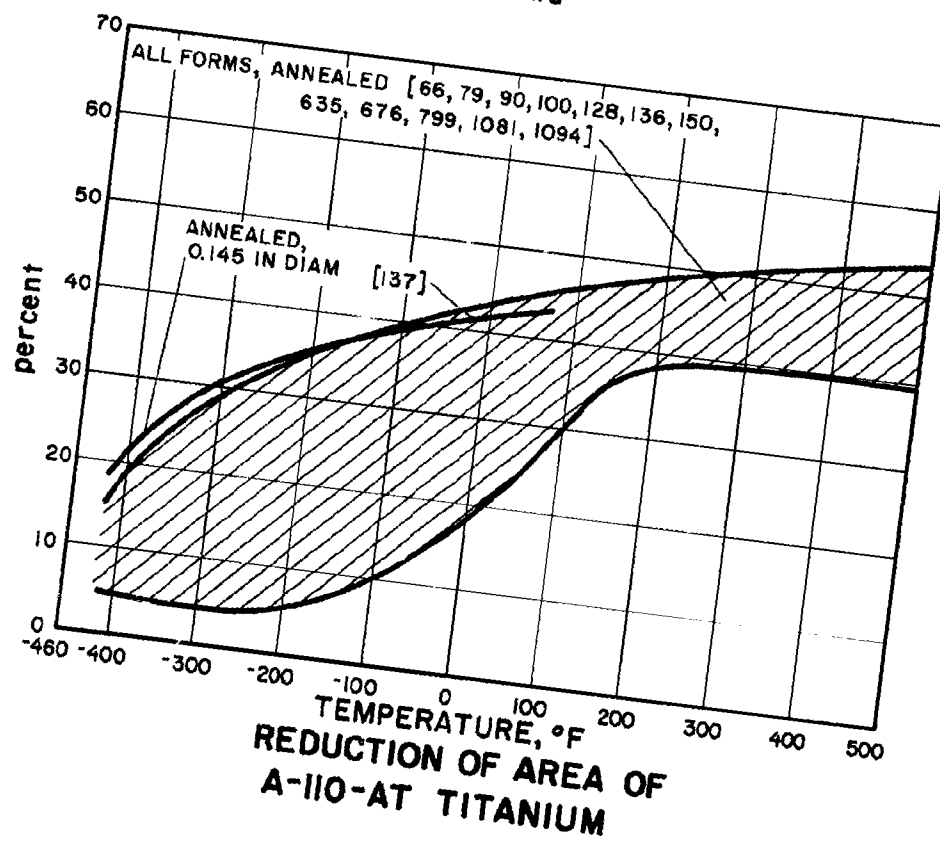

F.3.a

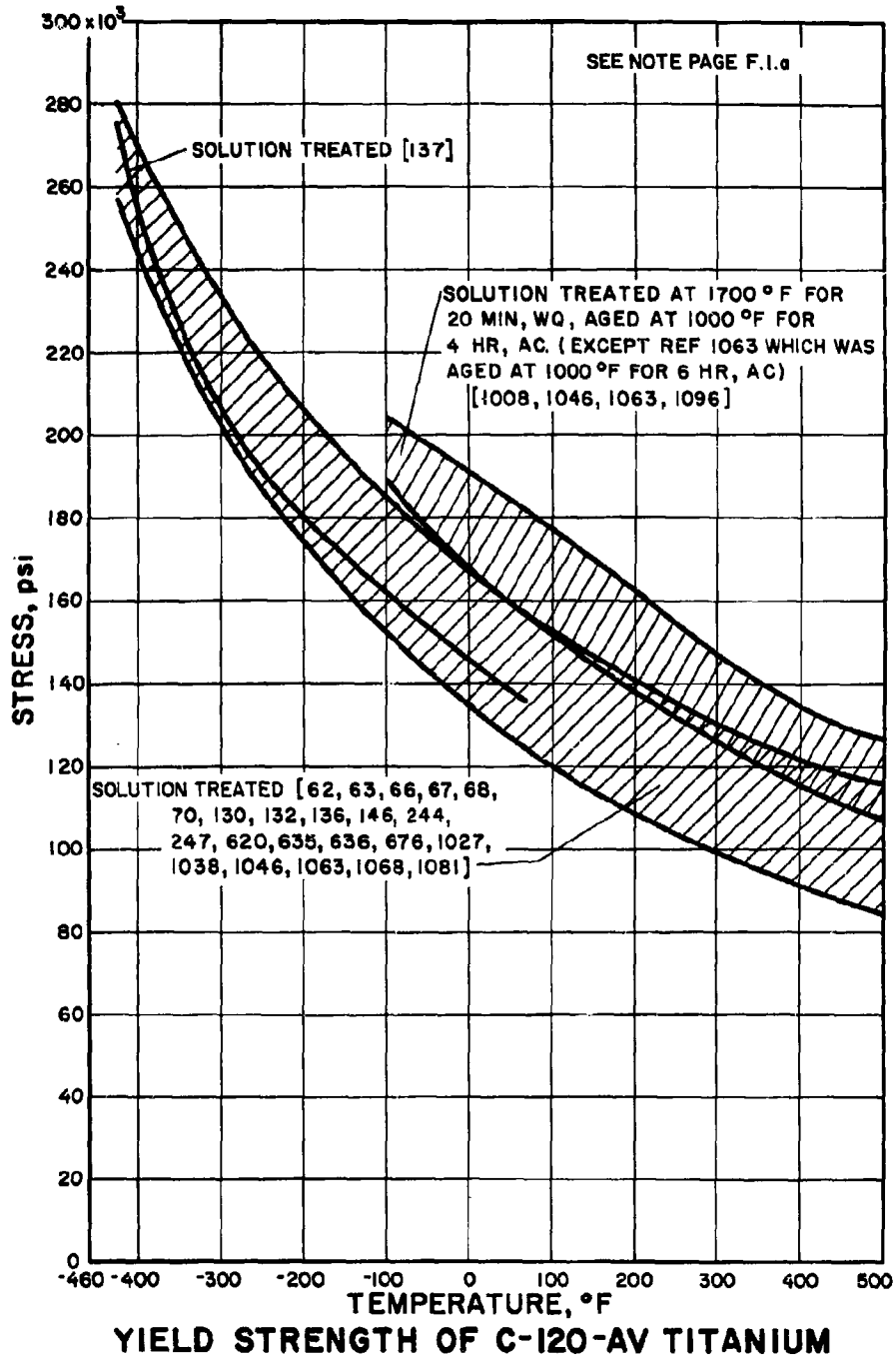

### F.3.a-1

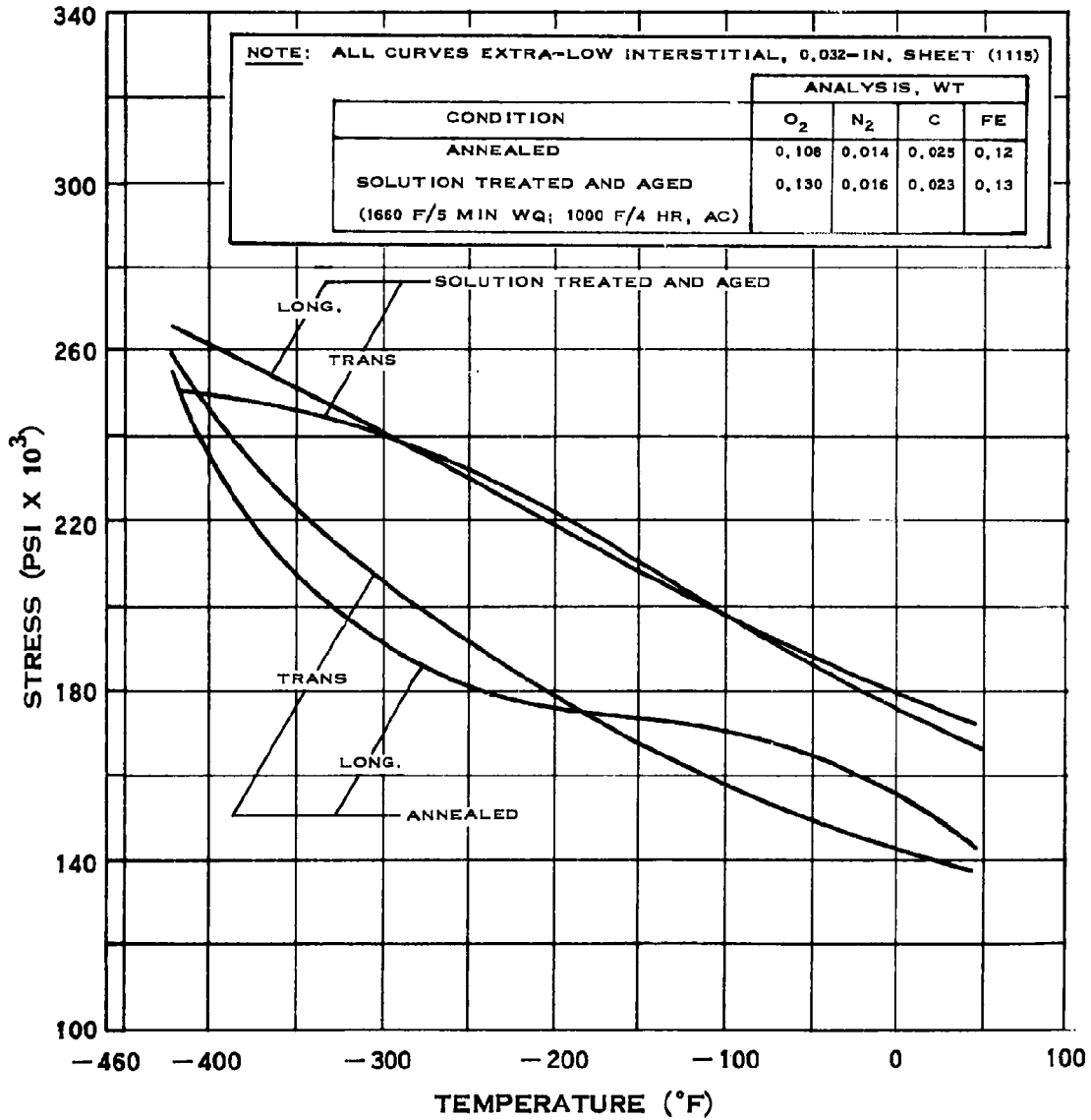

### YIELD STRENGTH OF 6AL-4V TITANIUM



F.3.b

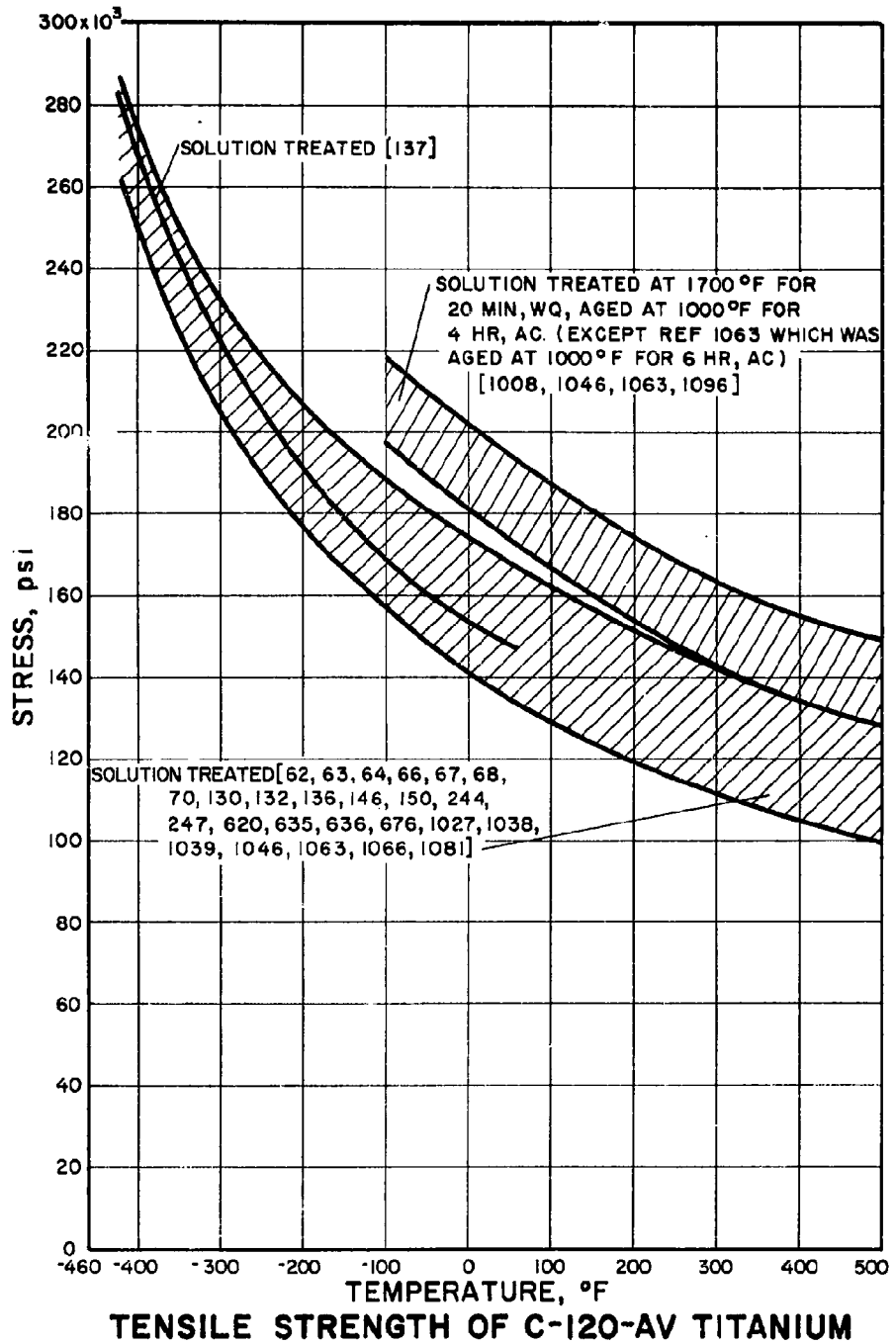

### F.3.b-1

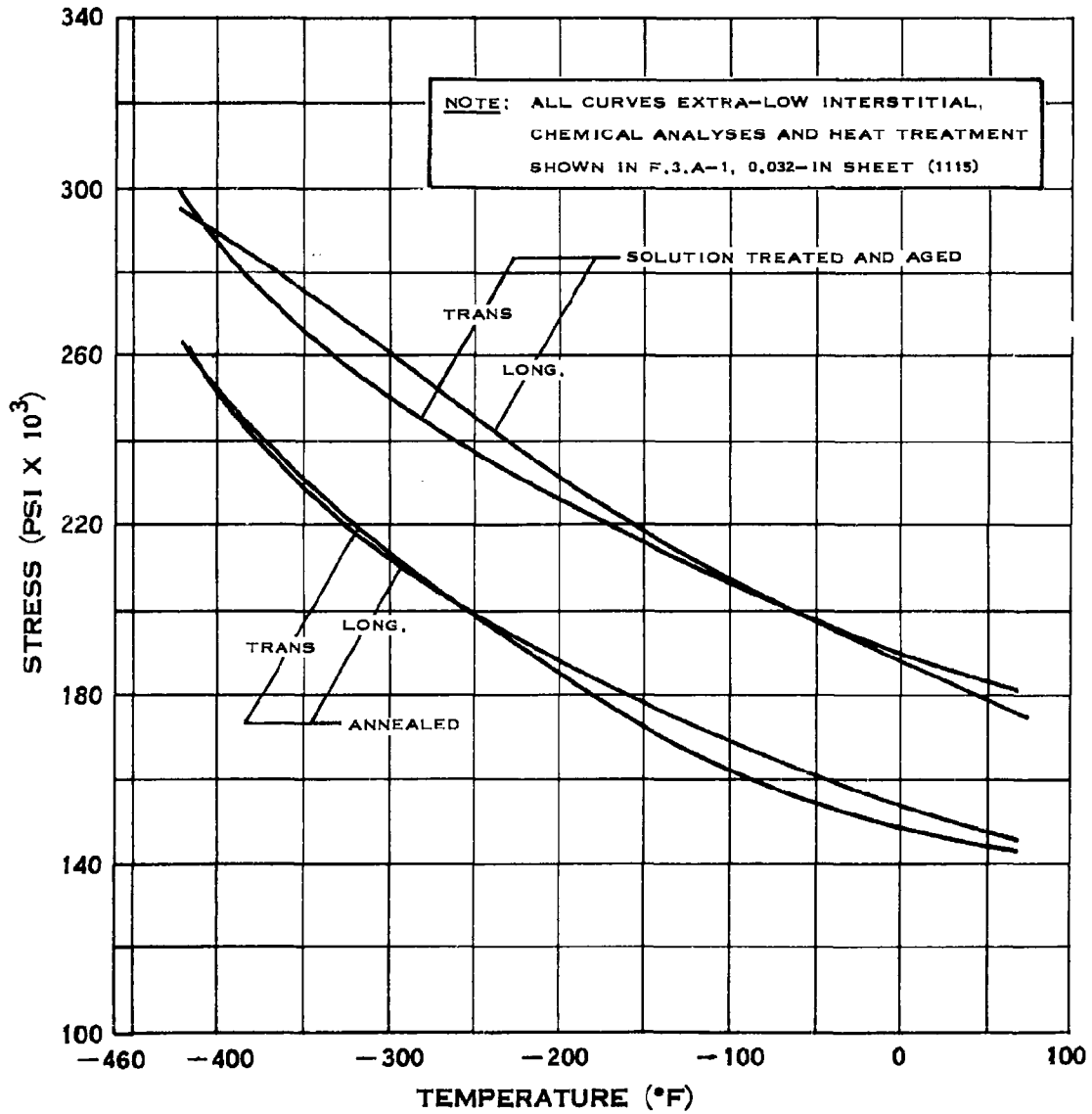

## TENSILE STRENGTH OF 6AL-4V TITANIUM

### F.3.b-2

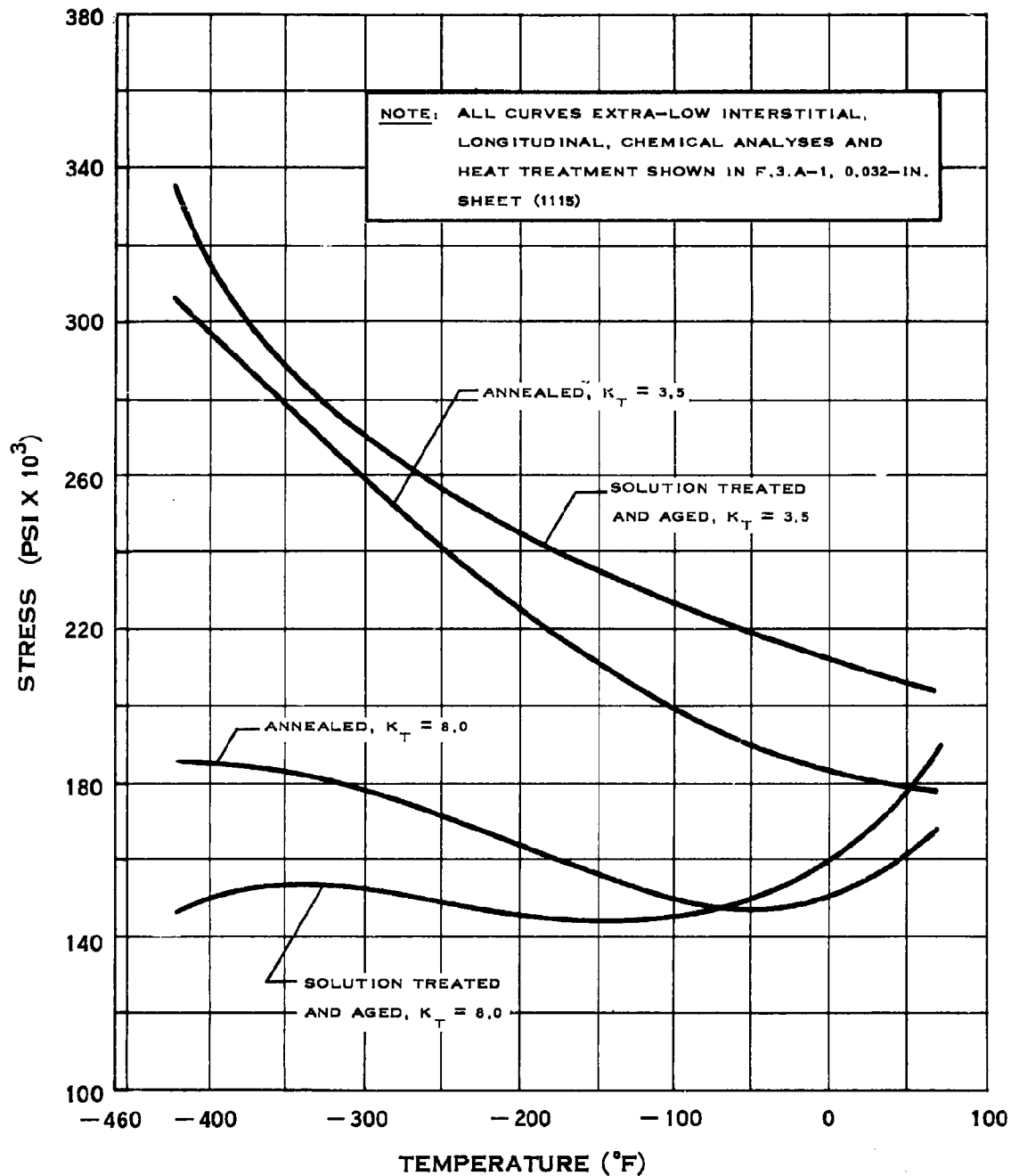

### NOTCH TENSILE STRENGTH OF 6AL-4V TITANIUM

### F.3.b-3

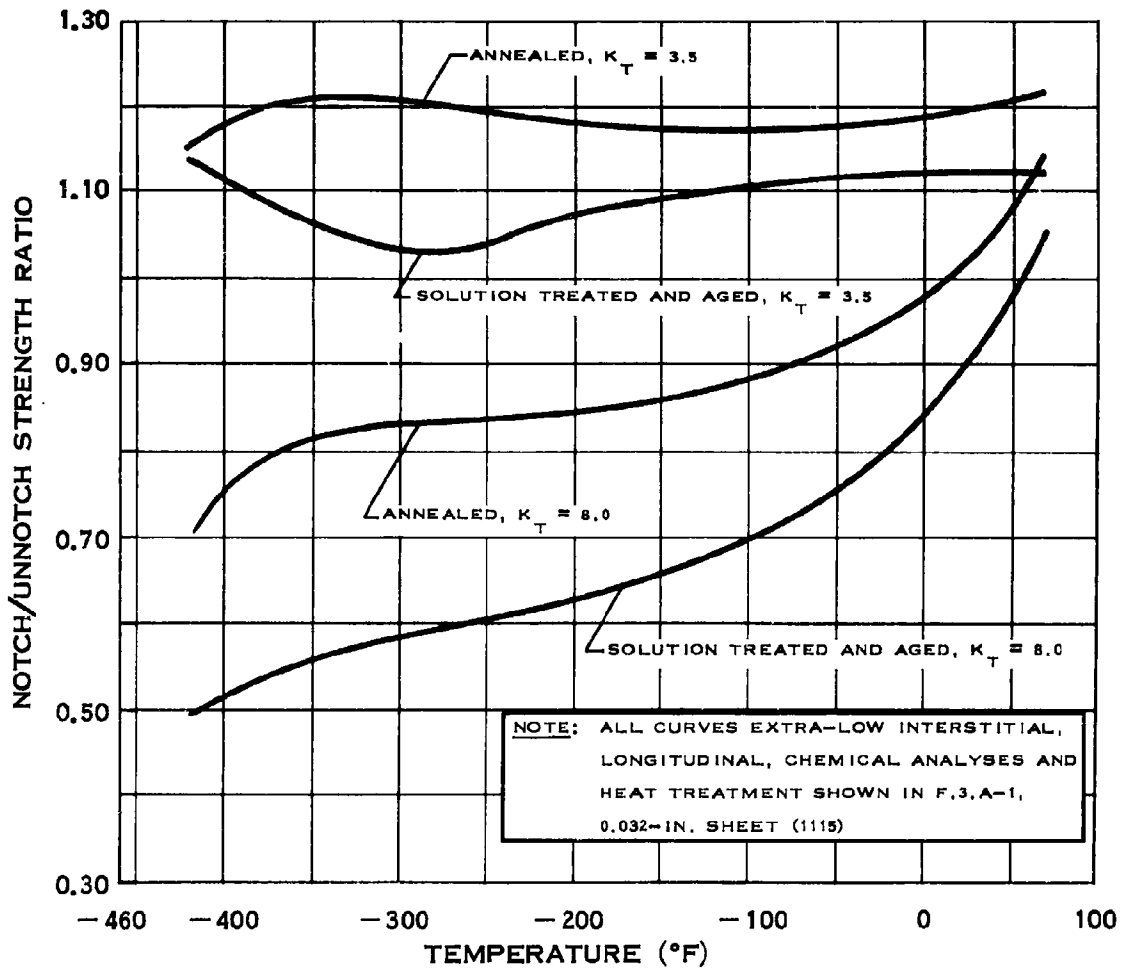

### NOTCH STRENGTH RATIO OF 6AL-4V TITANIUM

### F.3.b-4

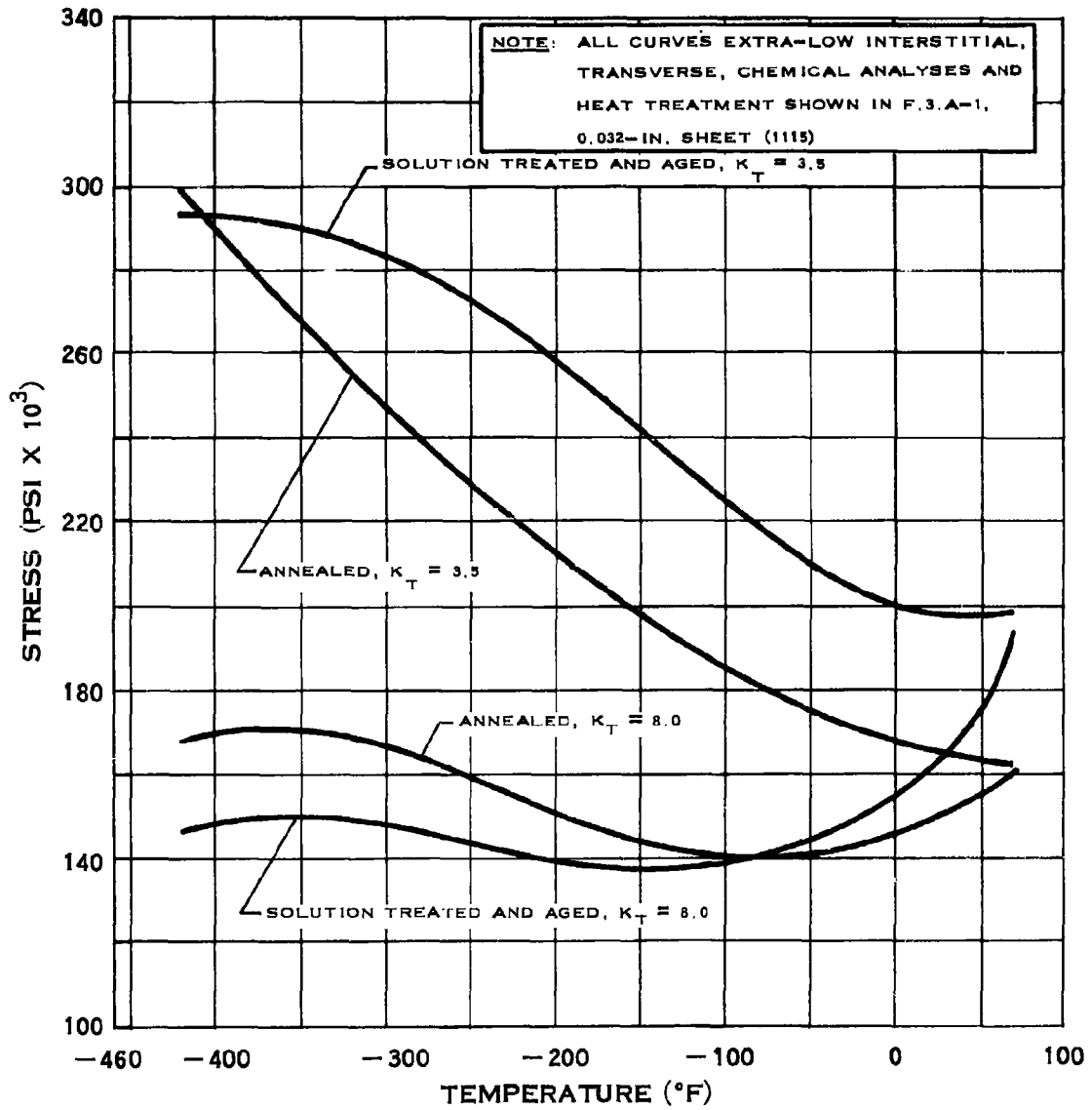

## NOTCH TENSILE STRENGTH OF 6AL-4V TITANIUM

### F.3.b-5

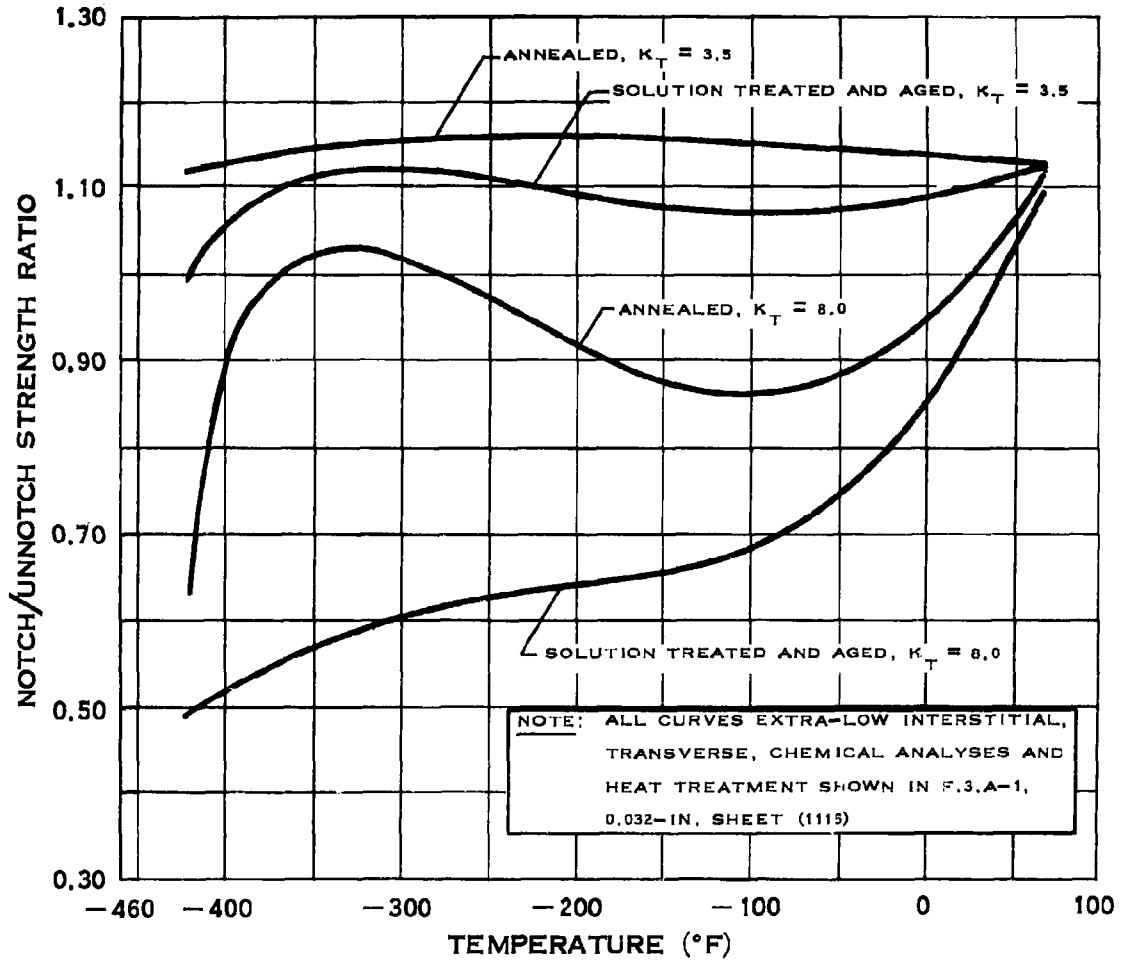

### NOTCH STRENGTH RATIO OF 6AL-4V TITANIUM

### F.3.b-6

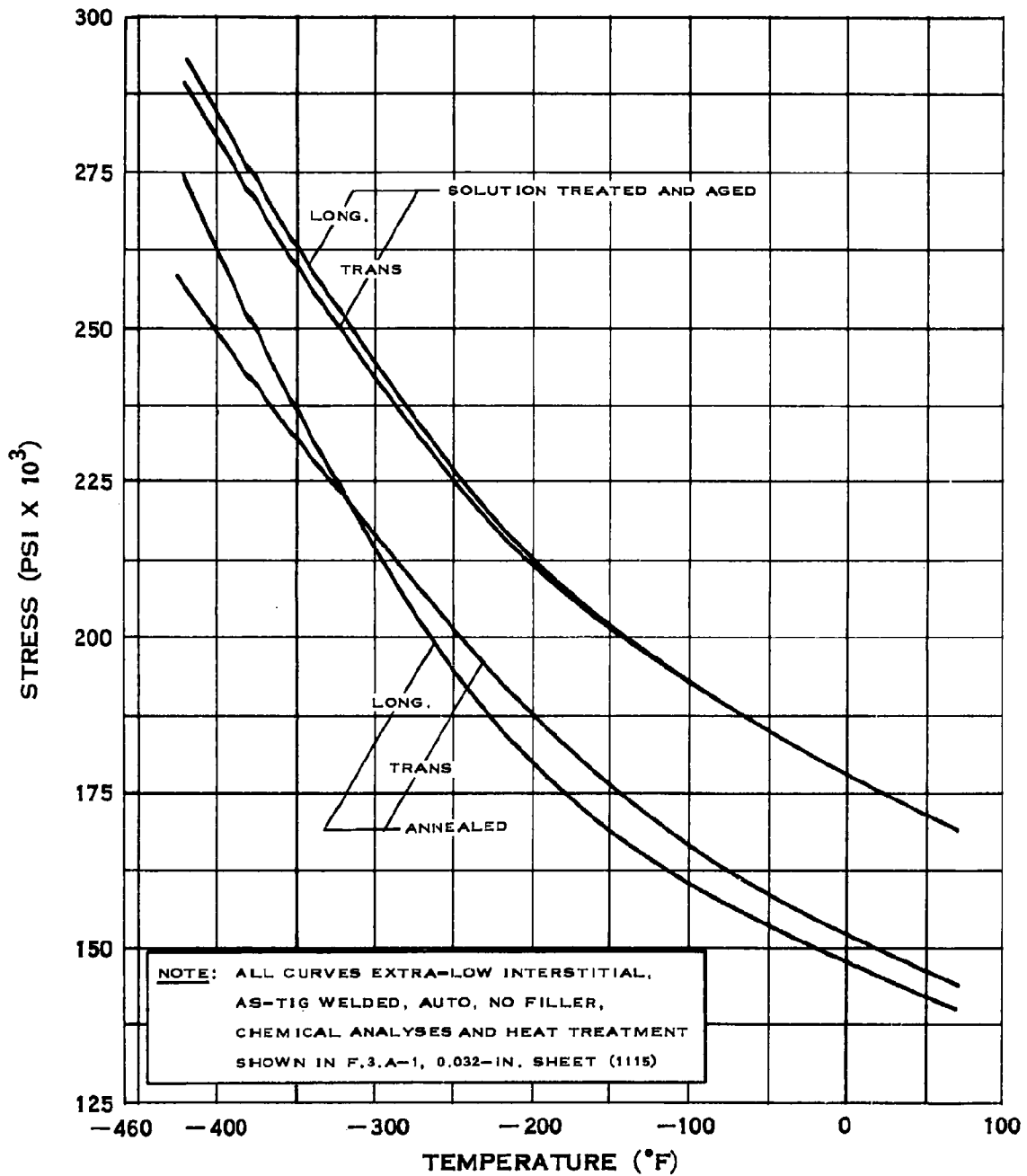

## WELD TENSILE STRENGTH OF 6AL-4V TITANIUM

F.3.c

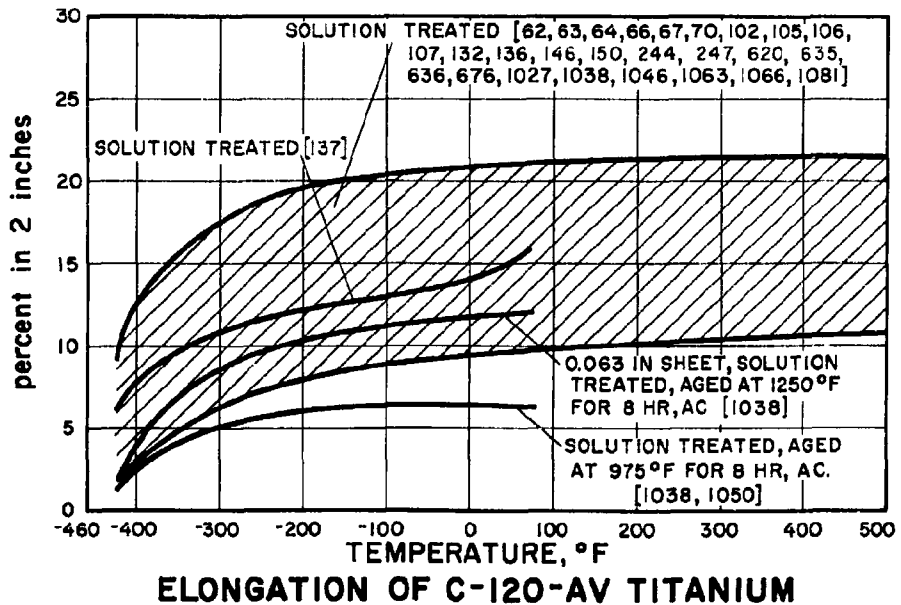
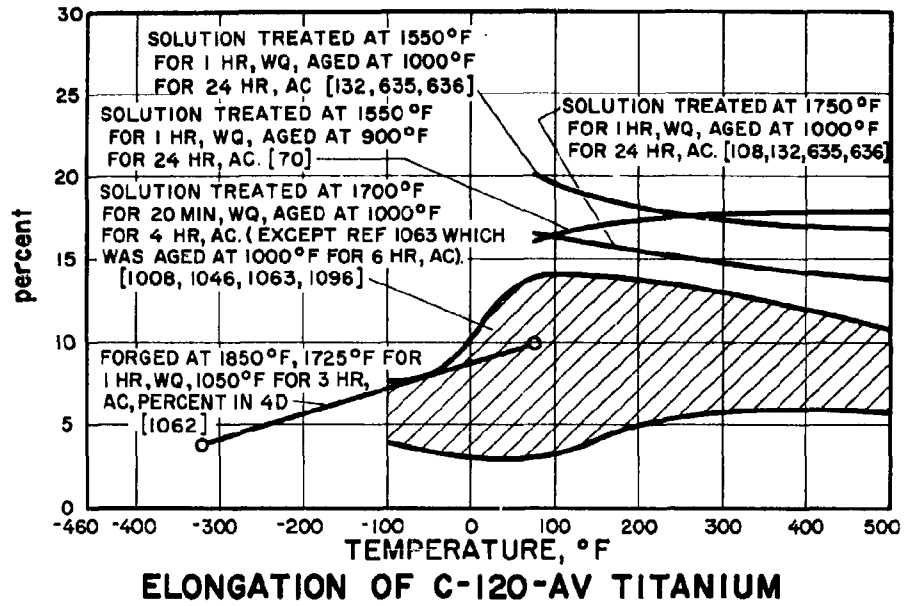



### F.3.c-1

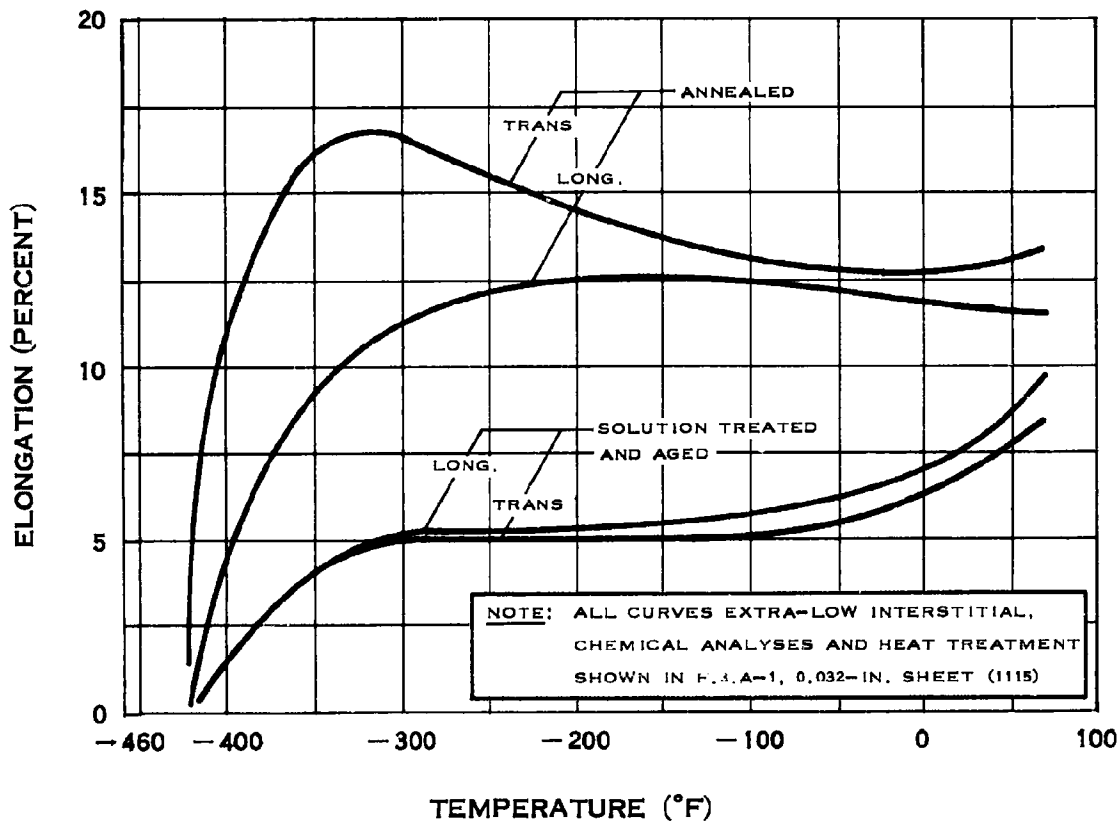

## ELONGATION OF 6AL-4V TITANIUM

### F.4.a

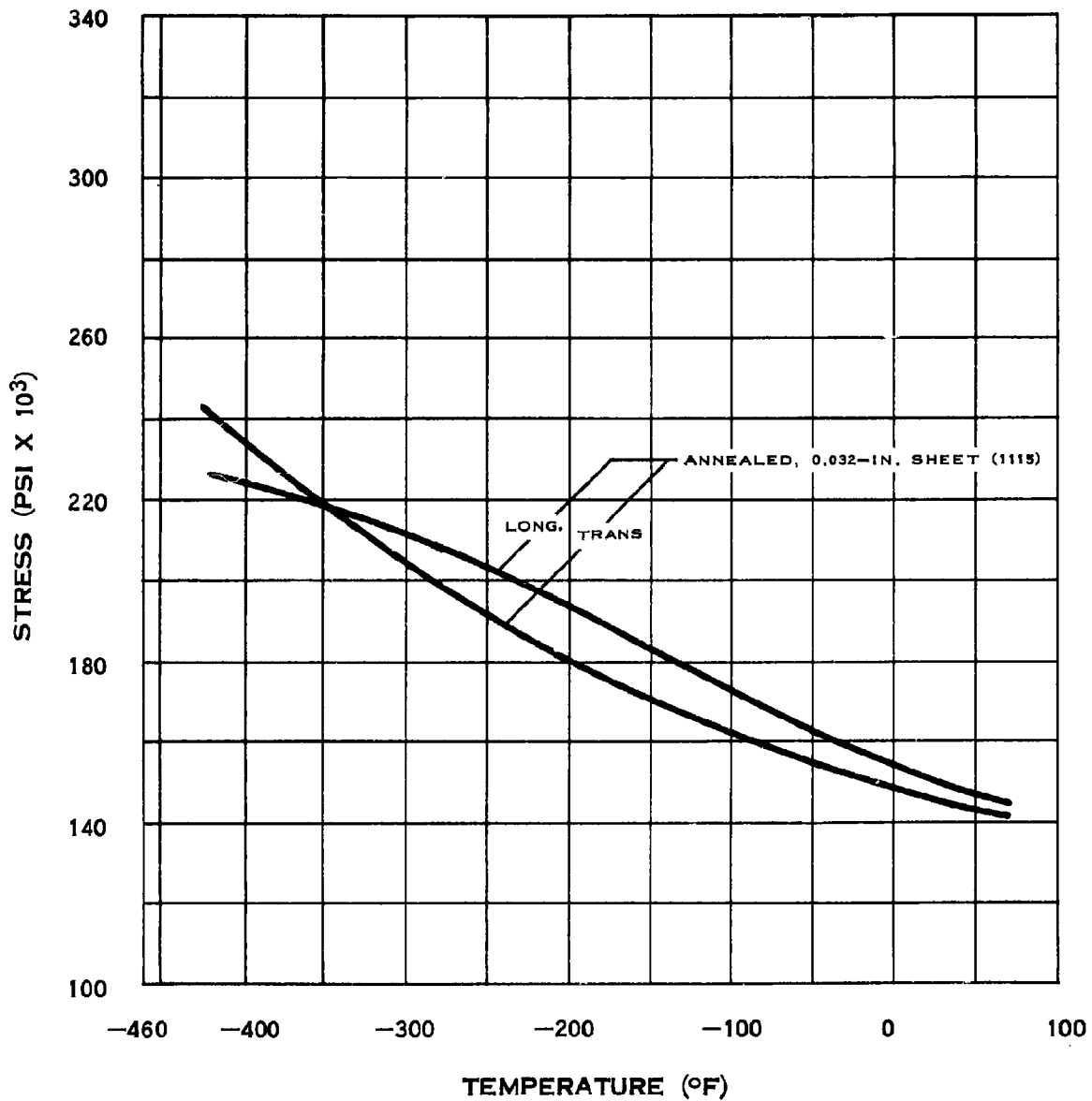

## YIELD STRENGTH OF 8AL-1MO-IV TITANIUM

### F.4.b

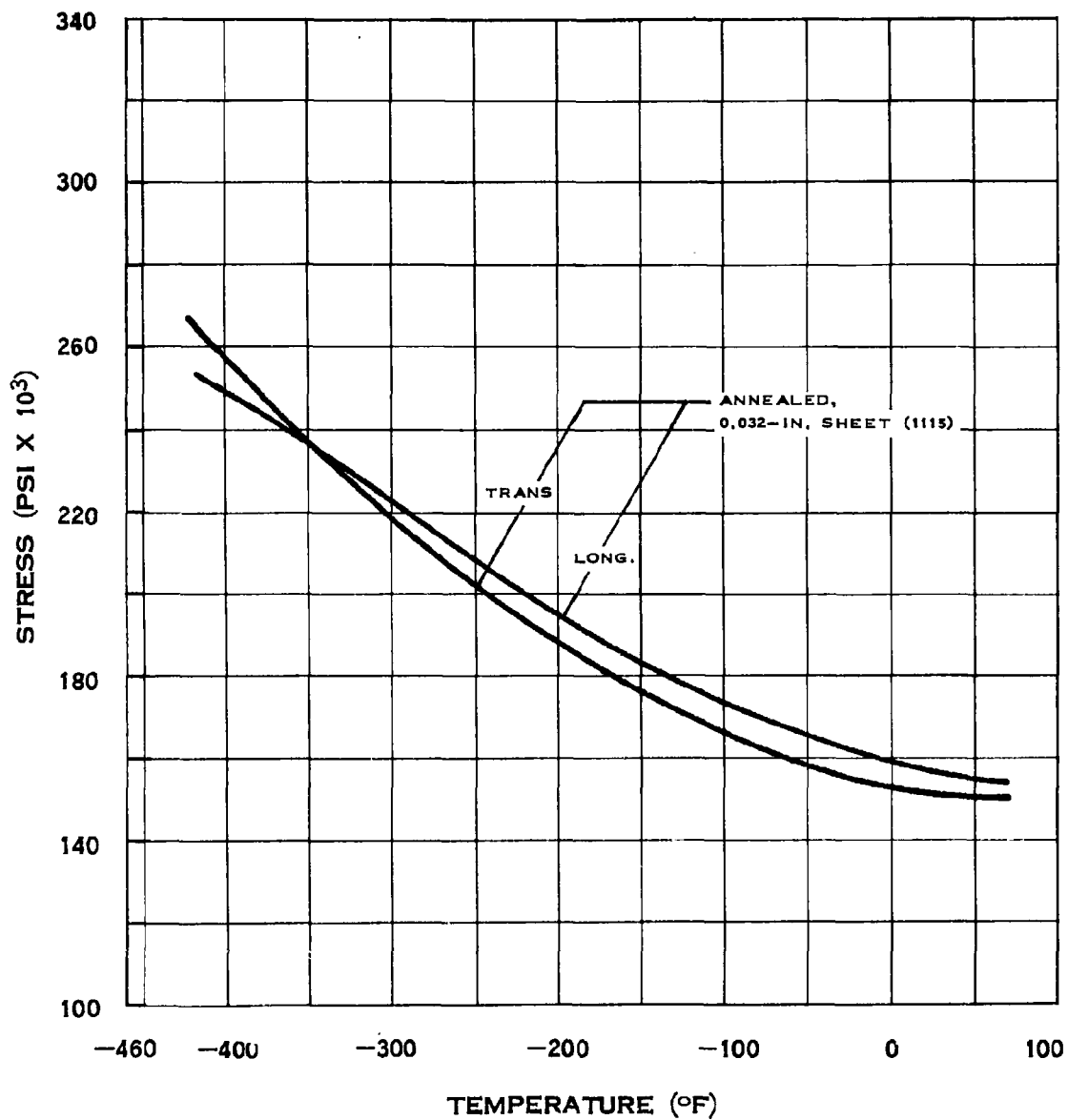

### TENSILE STRENGTH OF 8AL-1MO-1V TITANIUM

### F.4.b-1

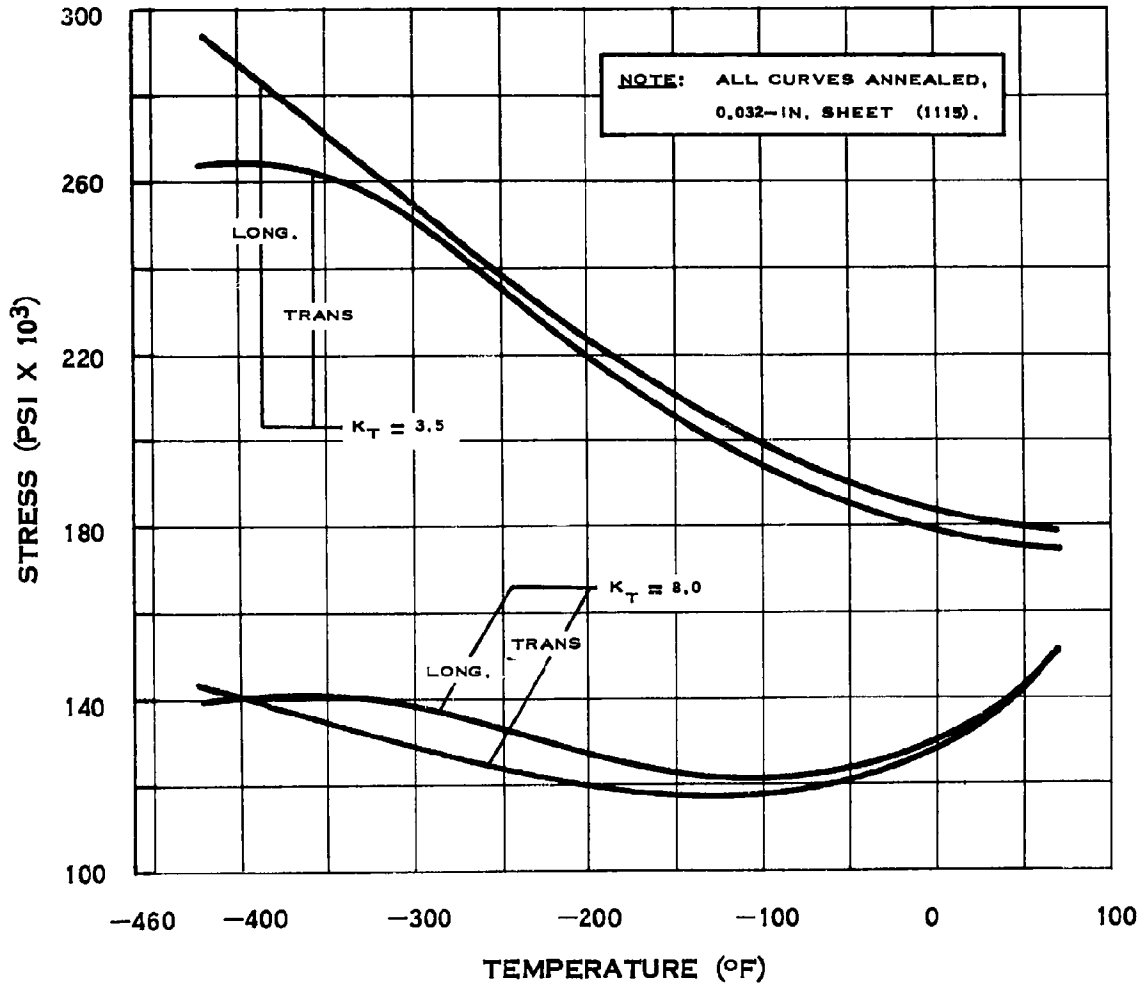

## NOTCH TENSILE STRENGTH OF 8AL-1MO-1V TITANIUM

### F.4.b-2

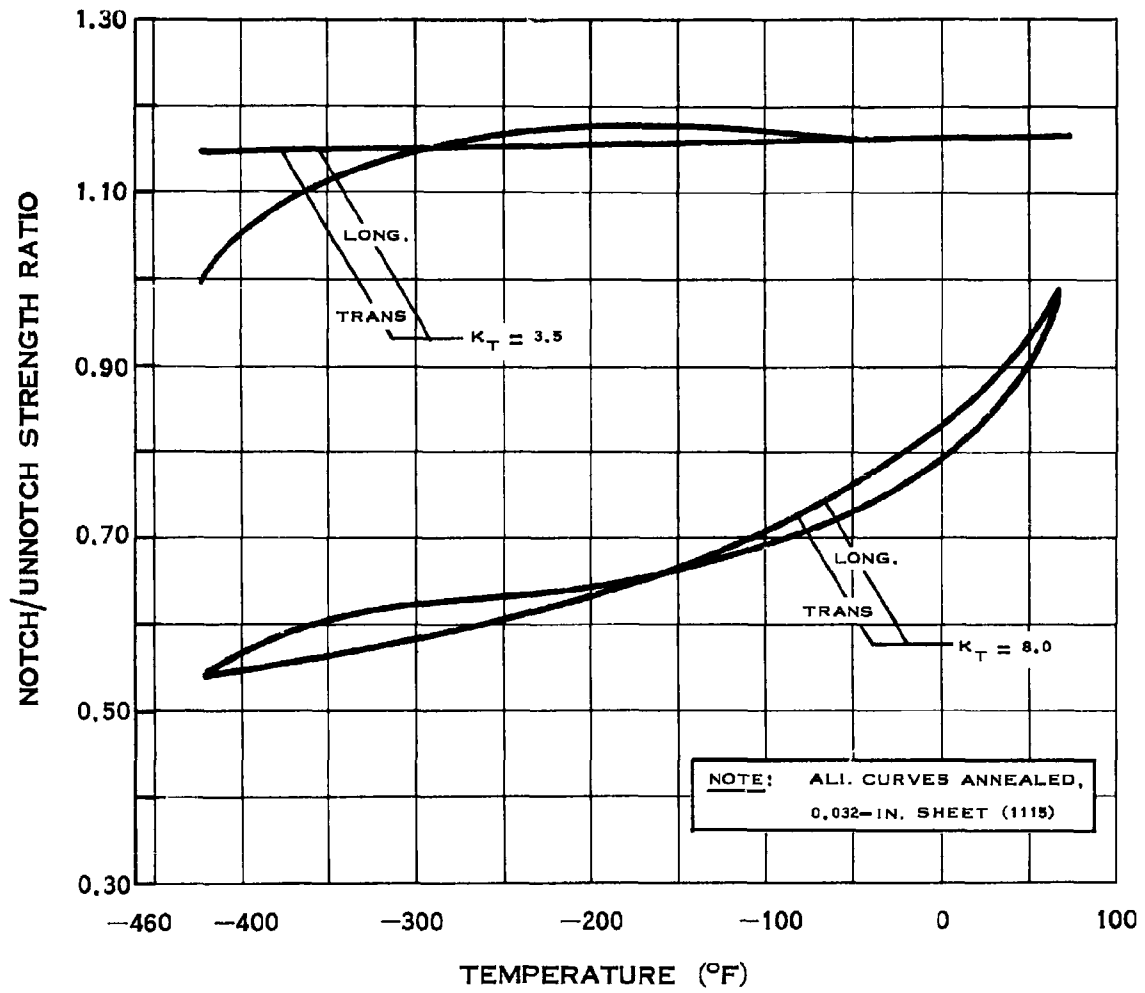

### NOTCH STRENGTH RATIO OF 8AL-1MO-1V TITANIUM

### F.4.b-3

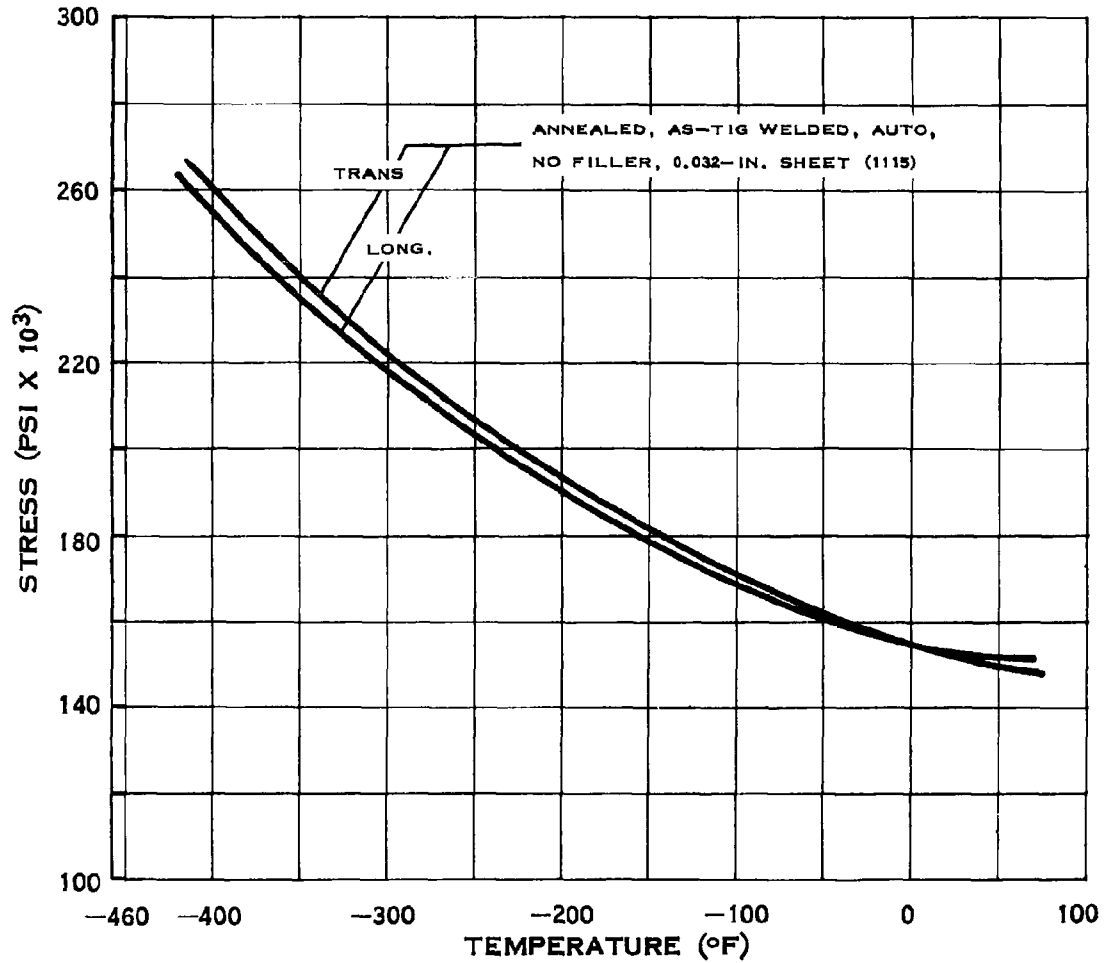

### WELD TENSILE STRENGTH OF 8AL-1MO-1V TITANIUM

### F.4.c

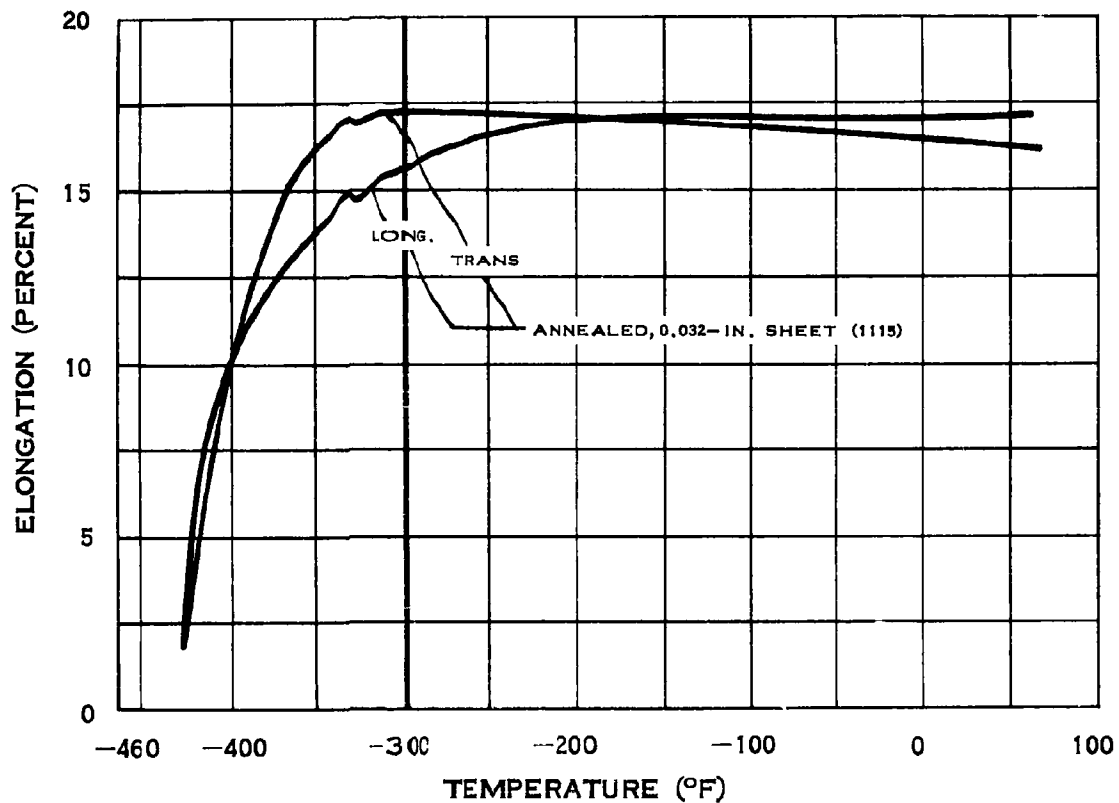

## ELONGATION OF 8AL-1MO-1V TITANIUM

- [1091] H. W. Altman, T. Rubin, and H. L. Johnston, Coefficient of Thermal Expansion of Solids, Part III, Technical Report 264-27, Ohio State Univ, Cryogenic Lab, (1954), as quoted in R. J. Corruccini and J. J. Gniewek, National Bureau of Standards Monograph 29, (1961).
- [1092] C. H. Lees, "The Effects of Temperatures and Pressure on the Thermal Conductivities of Solids," Part 2, Phil Trans Royal Society (London), Series A208 (1908), as quoted in National Bureau of Standards Circular 556, (1954).
- [1093] T. R. Butkovich, Ultimate Strength of Ice, Research Paper II, Snow, Ice and Permafrost Research Establishment, Corps of Engineers, U. S. Army, Willmette, Illinois, (1954).
- [1094] E. P. Klier and H. J. Feola, "Notch Tensile Properties of Selected Titanium Alloys," Transactions of the American Institute of Mechanical Engineers 209, 1271 (1957).
- [1095] G. T. Heimerl and J. Farquhar, Compressive and Tensile Creep of 7075-T6 and 2024-T3 Aluminum Alloy Sheet, NASA Tech Note D-160, Washington, D. C. (1959).
- [1096] H. L. Price, Tensile Properties of 6Al-4V Titanium Alloy Sheet under Rapid-Heating and Constant-Temperature Conditions, NASA Tech Note D-121 (1959).
- [1099] H. J. French, "Some Aspects of Hardenable Alloy Steels," Transaction of the American Institute of Metal Engineers 206, 770 (1956).
- [1103] Same as Reference 211.
- [1104] J. Dymant and H. Ziebland, "The Tensile Properties of Some Plastics at Low Temperatures," Journal of Applied Chemistry (London) 8, 203 (1958).
- [1105] Same as Reference 572.
- [1106] R. E. Mowers, J. H. Lieb, and S. Sherman, Investigation of Nonmetallic Materials at Cryogenic Temperatures, Edwards Rocket Site Contract AFO4(611)-6354, Rocketdyne, North American Aviation, Inc, Canoga Park, Calif. (to be published).



- [1107] J. L. Christian, Physical and Mechanical Properties of Pressure Vessel Materials for Application in a Cryogenic Environment, ASD-TDR-62-258, March 1962.
- [1108] F. R. Schwartzberg, R. D. Keys, Mechanical Properties of 2000 Series Aluminum Alloys at Cryogenic Temperatures, Martin Report R-61-32, October 1961.
- [1109] D. N. Gideon, R. J. Favor, A. Koppenhafer, H. J. Grover, and G. M. McClure, Investigation of Notch Fatigue Behavior of Certain Alloys in the Temperature Range of Room Temperature to -423 F, ASD-TDR-62-351, April 1962.
- [1110] J. F. Watson, J. L. Christian, Low Temperature Properties of Cold Rolled AISI Types 301, 302, 304L, and 301 Stainless Steel Sheet, ASTM Spec Tech Pub 287, p 170-193, 1960.
- [1111] J. F. Watson, J. L. Christian, Mechanical Properties of High Strength 301 Stainless Steel Sheet at 70, -320, and -423 F in the Base Metal and Welded Joint Configuration, ASTM Spec Tech Pub 287, p 136-149, 1960.
- [1112] F. R. Schwartzberg, R. D. Keys, Mechanical Properties of an Alpha Titanium Alloy at Cryogenic Temperatures, paper presented at Annual ASTM Meeting, New York, New York, June 1962.
- [1113] G. B. Espey, M. H. Jones, and W. F. Brown, Jr., Some Factors Influencing the Fracture Toughness of Sheet Alloys for Use in Lightweight Cryogenic Tankage, ASTM Spec Tech Pub 302, p 140-165, 1961.
- [1114] J. L. Christian, Mechanical Properties of Titanium and Titanium Alloys At Cryogenic Temperatures, Convair/Astronautics Report MRG-189, October 1960.
- [1115] F. R. Schwartzberg, S. H. Osgood, and R. D. Keys, data obtained under Air Force contract AF33(657)-9161.
- [1116] C. V. Lovoy, Low-Temperature Mechanical Properties of X2020-T6 and 2219-T6 Aluminum Sheet Alloys, George C. Marshall Space Flight Center Report No. IN-P&VE-M-62-3, May 1962.

- [1117] W. R. Morgan, Mechanical Properties of 2219-T87 Alloy Plate at Room and Cryogenic Temperatures, George C. Marshall Space Flight Center Report No. IN-P&VE-M-62-9, October 1962.
- [1118] C. E. Cataldo, Weldability Studies of 5456-H343 and 2219-T87 Aluminum Alloy Plates, George C. Marshall Space Flight Center Report No. IN-P&VE-M-62-2, April 1962.
- [1119] J. L. Christian, Mechanical Properties of Aluminum Alloys at Cryogenic Temperatures, Convair/Astronautics Report No. MRG-190, December 1962.
- [1121] R. Markovich and F. R. Schwartzberg, Testing Techniques and Evaluation of Materials for Use at Liquid Hydrogen Temperature ASTM STP302, 113, 1961.
- [1122] J. L. Christian and A. Hurlich, Physical and Mechanical Properties of Pressure Vessel Materials for Application in Cryogenic Environment, General Dynamics/Astronautics, ASD-TDR-G2-258, Part II, April 1963.
- [1123] P. C. Miller, Low-Temperature Mechanical Properties of of Several Aluminum Alloys and their Weldments, George C. Marshall Space Flight Center Report No. MTP-S&M-M-61-16, October 1961.

APPENDIX A

TEST MATERIALS

7-15-63

Table A-1 List of Sheet Materials Tested

Code Identification	Alloy Type	Designation	Condition or Temper	Sheet Thickness (in.)	Heat Number	Chemical Composition (Weight, %)														Remarks				
						Al	Cr	Cu	Fe	Mg	Mn	Mo	Ni	Si	Ti	V	C	H <sub>2</sub>	N <sub>2</sub>		O <sub>2</sub>	Other		
A-6	Aluminum	6061	-T6	0.100	--	Bal	--	0.15-0.4	0.7	0.8-1.2	--	--	--	--	--	--	--	--	--	--	--	--	Composition Limits	
A-8	Aluminum	2014	-T6	0.100	--	Bal	--	3.9-5.0	1.0	0.2-0.8	0.4-1.2	--	--	--	--	--	--	--	--	--	--	--	Composition Limits	
A-9	Aluminum	2219	-T62, -T81	0.100	--	Bal	--	9.3	--	0.3	0.3	--	0.1	--	--	--	--	--	--	--	0.15Zr	--	Nominal Analysis	
A-9	Aluminum	2219	-T87	0.163	--	Bal	--	9.3	--	0.3	0.3	--	0.1	--	--	--	--	--	--	--	0.15Zr	--	Nominal Analysis	
A-11	Aluminum	5456	-R343	0.100	--	Bal	--	--	--	4.7-5.5	0.5-1.0	--	--	--	--	--	--	--	--	--	0.4 Si + Fe	--	Composition Limits	
B-3	Cobalt	L-605	Annealed	0.078	D-11968	--	20.37	--	2.17	--	1.43	--	0.26	--	--	--	--	--	--	--	--	14.42 W; Bal Co	--	Actual Analysis
D-7	Iron	A-286	Solution-Treated, Cold-Reduced, and Aged (1800°F/30 min, AC; 60° CR; 1325°F/16 hr, AC)	0.078	24-26	--	1.5	--	Bal	--	--	1.3	26	--	2.1	0.3	--	--	--	--	--	--	--	Nominal Analysis
E-2	Nickel	Inconel X	Solution-Treated, and Aged (1300°F/20 hr, AC)	0.078	--	0.7	15.5	--	7	--	--	--	Bal	--	2.5	--	--	--	--	--	--	1.0 Co + Zn;	--	Nominal Analysis
E-7	Nickel	Hastelloy B	20% Cold-Reduced	0.080	B2-2270	--	--	--	4.91	--	--	26.73	Bal	--	--	--	--	--	--	--	--	0.59 Co	--	Actual Analysis
E-8	Nickel	D-979	Annealed	0.080	--	1	1.5	--	Bal	--	--	--	4.5	--	3	--	--	--	--	--	--	--	--	Nominal Analysis
F-1	Titanium	SAI-2.5n	Annealed	0.120	D-2986	5.0	--	--	0.32	--	--	--	--	--	Bal	--	0.026	0.008	0.016	0.173	2.35n	--	Actual Analysis	
F-3	Titanium	6Al-4V	Annealed	0.032	D-1546	4.0	--	--	0.12	--	--	--	--	--	Bal	4.1	0.023	0.007	0.014	0.108	--	--	Actual Analysis	
F-3	Titanium	SAI-4V	Solution-Treated and Aged (1860°F/4 hr, AC)	0.032	D-2019	6.0	--	--	0.13	--	--	--	--	--	Bal	4.1	0.023	0.013	0.016	0.130	--	--	Actual Analysis	

APPENDIX B

TEST PROCEDURE

7-15-63

This appendix briefly describes the specimens and test techniques used by the Martin Company to determine the mechanical properties of various structural sheet alloys at room and cryogenic temperatures under Contract AF33(657)-9161.

Tests were conducted to obtain the following properties for inclusion in the handbook:

Unnotched Tensile

Ultimate Tensile Strength  
Tensile Yield Strength  
Elongation  
Modulus of Elasticity  
Stress/Strain Diagram

Notched Tensile

Notched Tensile Strength  
Notched-to-Unnotched Strength Ratio

Weld Strength

Weld Tensile Strength

Shear Strength

Tensile Shear Strength

Properties were obtained at room temperature and three cryogenic temperatures, using the indicated constant-temperature baths.

Temperature (°F)	Bath
-110	Dry Ice/Alcohol
-320	Liquid Nitrogen
-423	Liquid Hydrogen

During unnotched tensile tests, platen speed was controlled. An approximate strain rate of 0.010 in./in./min was used in the elastic region for aluminum, stainless steel, and nickel alloys. Following yield, the speed was increased tenfold. Titanium alloys were similarly tested, except that a rate of 0.005 in./in./min was used.

7-15-63

Weld tensile tests were performed at the same rate, except that a constant rate of platen speed was maintained until failure.

Notch and shear tests were performed using constant platen speed control to failure at a rate of 0.010 in./min.

Specifications for test specimens are shown in Figures B-1 through B-5. Friction-gripped specimens were used for testing at 70°F. Pin-loaded specimens were used for all low-temperature tests. The pin-loaded specimens were designed for use with the multiple-linkage specimen tester designed by the Martin Company. This apparatus is described in detail in Appendix C.

Resistance strain gages were used to obtain stress versus strain curves.

More detailed information regarding the cryostats and associated equipment used at Martin are contained in the literature.\*

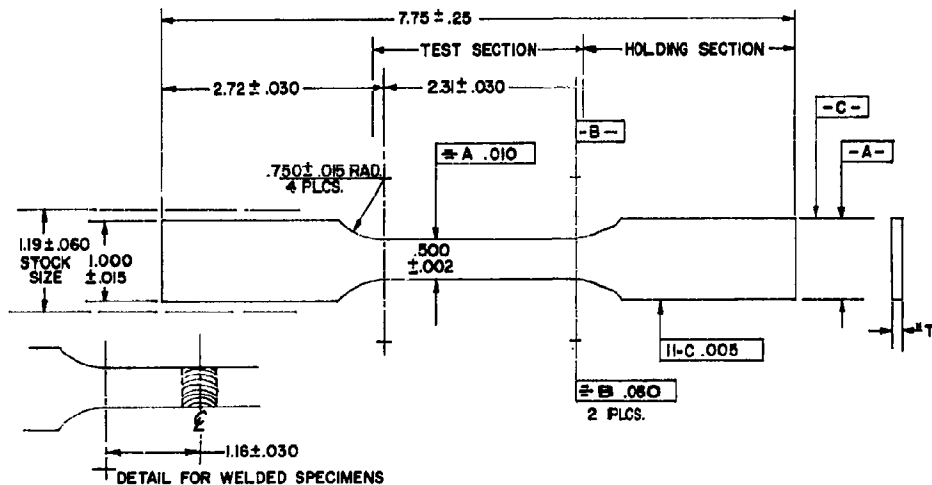

Figure B-1 Specification for Unnotched Tensile Specimen Tested at Room Temperature

\*R. Markovich and F. R. Schwartzberg: Testing Techniques and Evaluation of Materials for Use at Liquid Hydrogen Temperature. ASTM STP 302, 113, 1961.

F. R. Schwartzberg: "Mechanical Property Testing Techniques for the Cryogenic Temperature Range." Advances in Cryogenic Engineering, Vol VIII, Plenum Press, New York, N.Y., 1963.

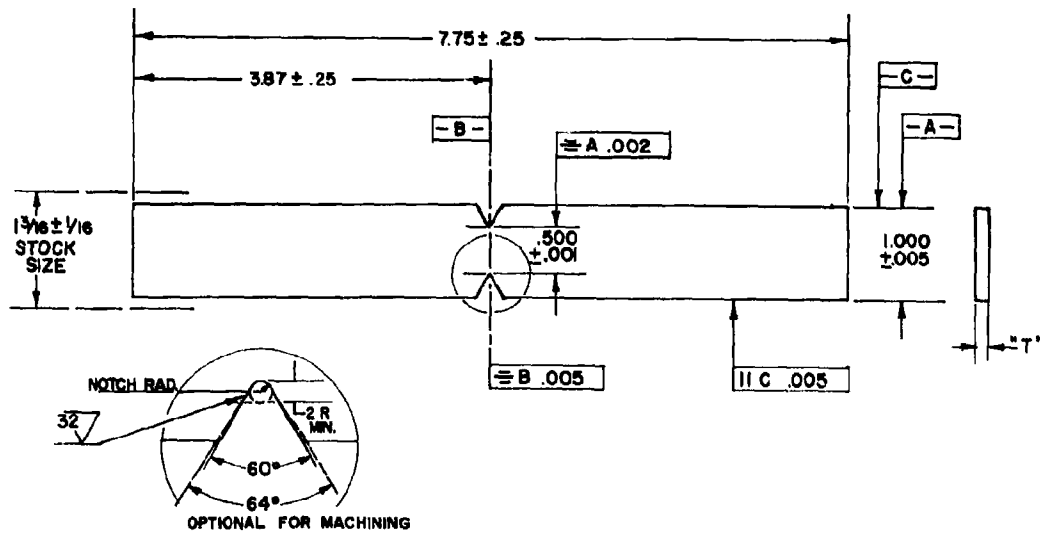

Figure B-2 Specification for Notched Tensile Specimen Tested at Room Temperature

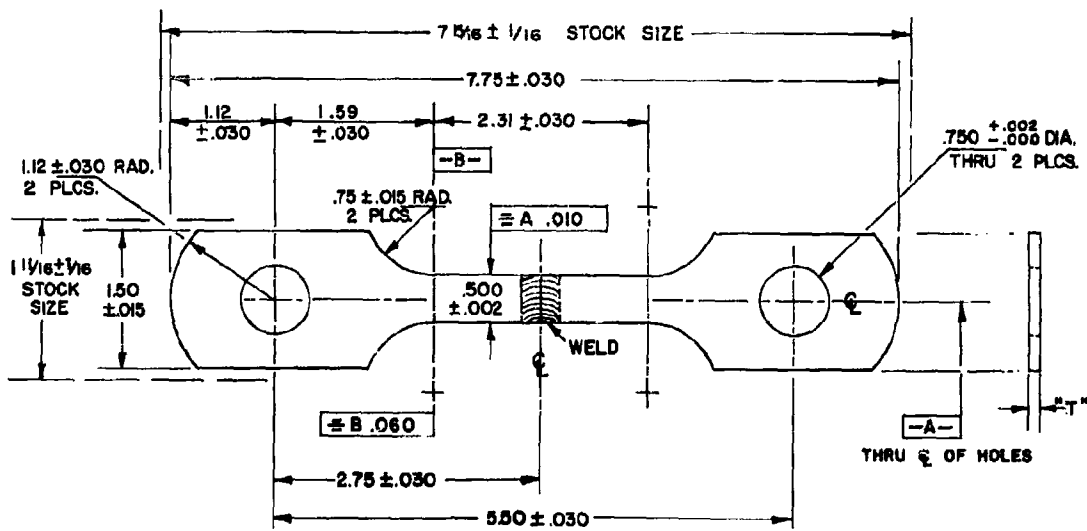

Figure B-3 Specification for Unnotched Tensile Specimen Tested at Cryogenic Temperatures



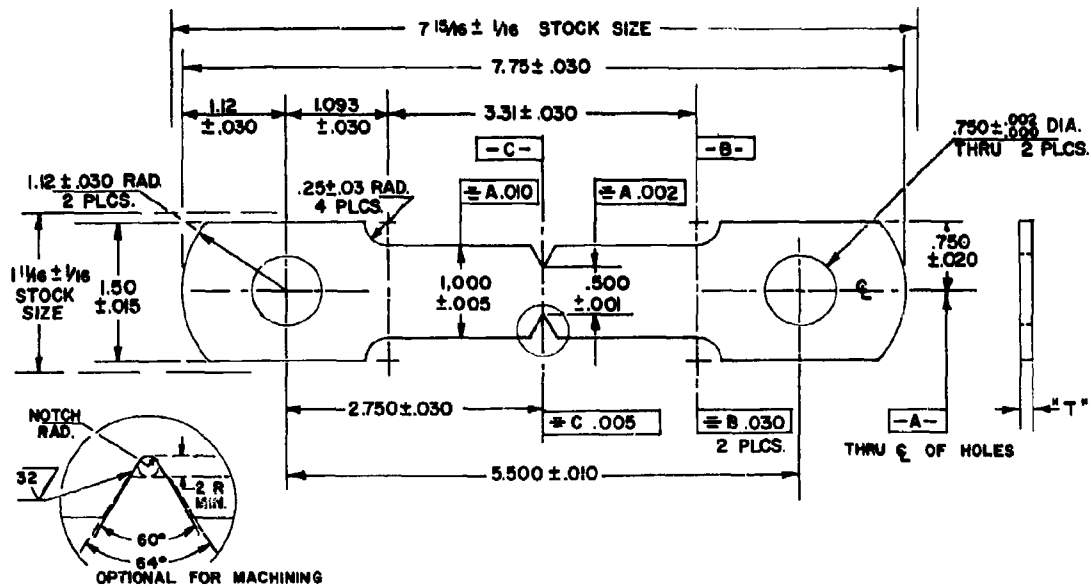

Figure B-4 Specification for Notched Tensile Specimen Tested at Cryogenic Temperatures

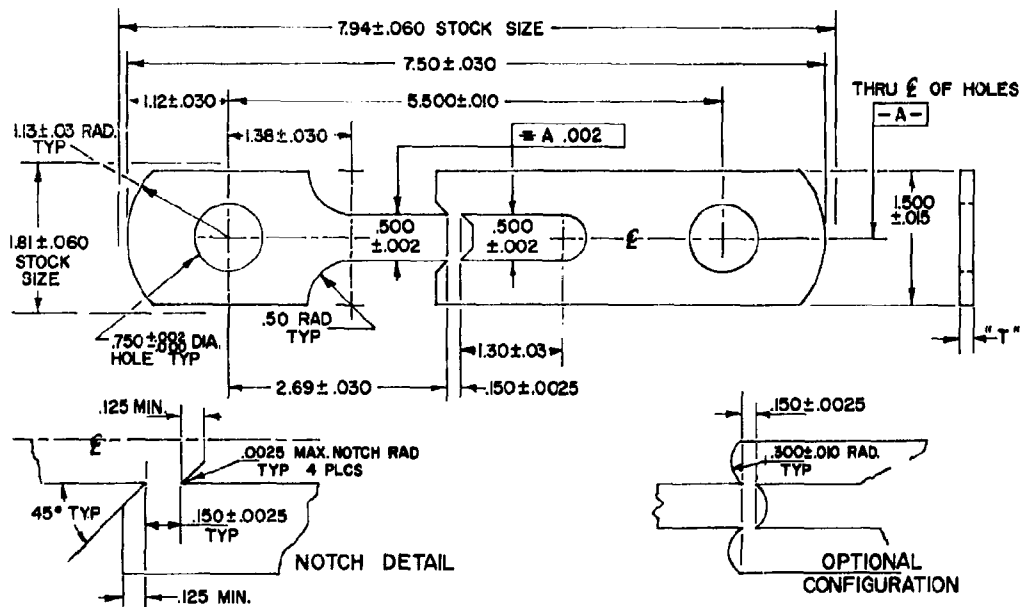

Figure B-5 Specification for Shear Specimen Tested at Room and Cryogenic Temperatures

APPENDIX C

A Multiple Tensile Specimen  
Test Device for Use  
in Liquid Hydrogen

(Copy of paper presented by R. D. Keys, Space  
Weapons Laboratories, Martin Company, Denver,  
Colorado, at the Cryogenic Conference, Univer-  
sity of Michigan at Ann Arbor, 15-17 August  
1961)

## A. INTRODUCTION

Tensile tests of materials in liquid hydrogen are usually accomplished in a rather slow and involved manner when compared with similar tests done at room temperature. This slow procedure is due mostly to the difficulties of transferring liquid hydrogen, as well as working inside a sealed container. The time spent in "pulling" a test specimen in liquid hydrogen amounts to only a fraction of the total time involved in conducting such a test. Most of the test time is spent on "conditioning" the test chamber; that is, the sealing, evacuating, purging, filling, emptying, warming, and re-opening necessary with liquid hydrogen testing.

One way to save time during such a test routine is to perform several tests in sequence, requiring only one filling. In this way the liquid hydrogen is handled in the usual manner but far less frequently, thus reducing time and costs. A multiple test specimen holding device (patent disclosure made) was developed for this purpose and put to use on cryogenic materials tests at the Denver Division.

## B. DESIGN AND OPERATION

Most of a missile's structure is of thin sheet material. Therefore, a multiple system to test flat sheet specimens was of primary interest to Martin. A chain-link loading and specimen series arrangement was developed. The linkage is shown, disassembled, in Figure C-1. Several test specimens are attached to the link pins in a series of flat link sections (A). The link pins are actually the loading pins for the top of the specimens. The specimens are held between the flat links when the second row of links is placed on the pins. The bottoms of the specimens are gathered together and held by one common, curved loading pin (B). The curved pin is retained by a V-shaped yoke (C). This yoke is held in place at the bottom of the test chamber by a loose fitting pin that allows the yoke unit to swing laterally under load.

The entire assembled test unit has the appearance of a quarter section of a spoked wheel (Fig. C-2), the rim being the chain-link belt, the specimens forming the spokes, and the hub made up of the lower loading pin and yoke.

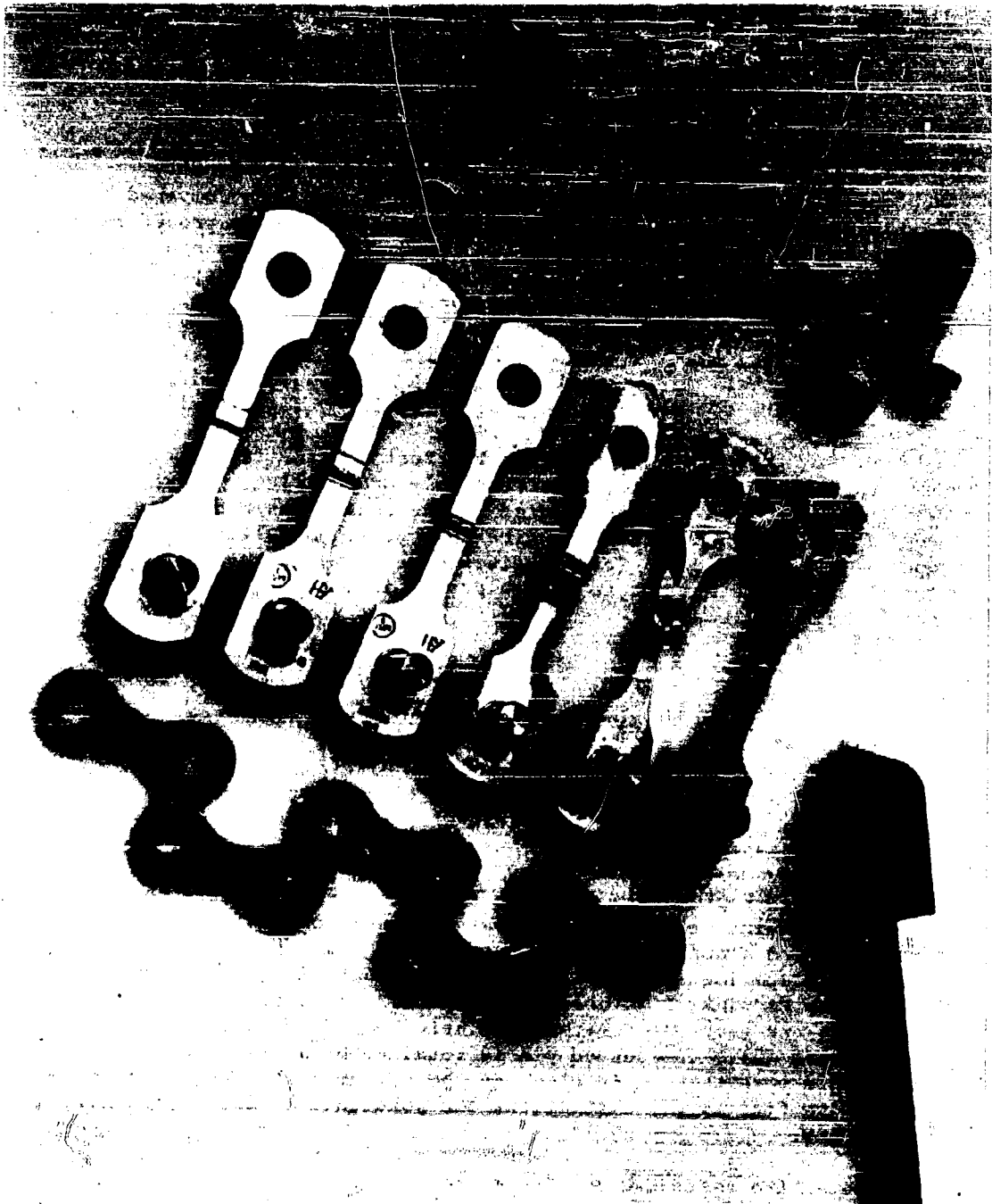

Fig. C-1 Chain-Link Loading Arrangement

7-15-63

C-2

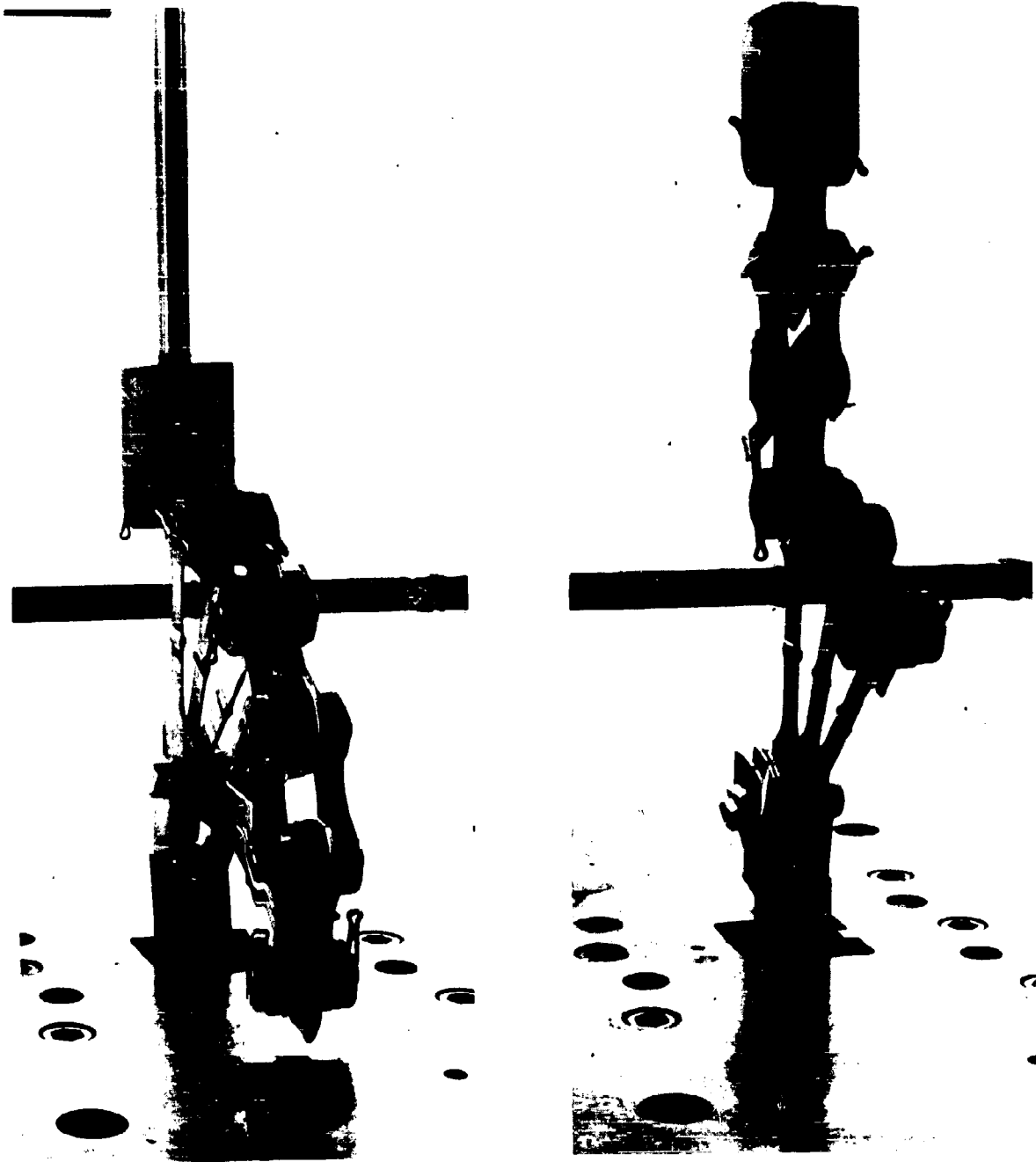

Fig. C-2 Assembled Test Unit

7-15-63

C-3

The test load is transmitted to the first specimen by a rod through a connecting clevis to the loading pin of the first specimen. This rod is the only moving unit that extends outside the test chamber. It moves vertically through the chamber lid.

When the first specimen fails, the lower half falls out of the way of the second specimen, which is then drawn into the vertical test position as the chain-link belt is drawn upward. This process continues [Fig. C-2(b)] until the last specimen fails. The specimen loading pins also provide self-alignment in one direction, and the lateral alignment is accomplished by the swing of the lower yoke under load.

The test chamber and linkage currently in use allow up to six specimens to be tested in sequence. Vertical movement of the loading rod, using 2-inch links, is slightly over 10 inches.

The linkage and yoke are made of Type 321 stainless steel, and the curved pin in the yoke of A-286 stainless steel, hardened to over 125,000 psi. Tolerances on lengths were held close enough to assure alignment of the chain links under load, but hole diameters made large to allow ease of assembly or disassembly while cold or frosty. Binding of the mechanism at low temperatures has proved to be no problem.

The success of the linkage system is demonstrated by the close agreement of test results. Typical examples are the results of eight tests performed on 6061-T6 aluminum alloy at -423°F. Specimens were taken from one sheet of 0.063 material transverse to direction of rolling.

#### Yield Strength

Specimen Number	0.2% Offset (1000 psi)	Ultimate Tensile Strength (1000 psi)
1	47.0	72.6
2	47.7	72.6
3	47.7	72.5
4	49.0	72.9
5	48.5	73.0
6	49.4	72.7
7	50.3	72.7
8	50.8	72.9

Alignment is indicated by the close agreement of data on similar notch tensile tests, where misalignment would show inconsistency of results. 1.000-inch specimens were taken from one sheet of material transverse to direction of rolling and vee-notched at 60 degrees to a 0.500-inch width.

Notch Root Radius (in.)	Specimen Number	Ultimate Strength (1000 psi)
0.001	1	65.7
	2	64.9
	3	65.6
0.030	1	70.2
	2	71.5
	3	69.9

Strain pickup on specimens is presently accomplished through the use of strain gages bonded directly to the specimens. (A remotely actuated extensometer can also be used for this purpose.)

The usefulness of the linkage system in rapid testing is evident from the present rate of up to 30 specimens tested in one eight-hour workday.

As with any mechanical system, there are some limitations. Because of the existing dimensions, specimen thickness cannot be changed greatly. Consequently, extremely thin specimens require doublers around the pin-loading holes to prevent buckling. (There is very little side support at the base.) The mass of the linkage (designed for a 20,000-lb load) and the test chamber require longer cooldown time and more liquid than the comparable single test unit. However, the volume of liquid lost per test specimen during cooldown is minimized by the use of the multiple system.

### C. CONCLUSIONS

The limitations of this device are partially designed into the mechanism and do not hamper the required test work. The disadvantages are more than offset by the reductions in liquid hydrogen consumption, testing, manpower and costs, as well as by increased safety.

# MARTIN COMPANY

DENVER  
DIVISION  
Denver 1,  
Colorado

3

Copy No. \_\_\_\_\_

To: Distribution

Subj: Contract AF33(657)-9161, Cryogenic Materials Data Handbook

1. Your name has been placed on the distribution list to receive one copy of the progress reports on the Cryogenic Materials Data Handbook. The contractor has a limited number of these reports for distribution so it would be desirable to send reports to those individuals having a current need for them. Please check the appropriate statements below and return this form to the address below.

We have a need for the progress reports.

The address is correct and the proper individual is receiving the report. If the address is incorrect, please provide corrected address:

---

---

---

---

\_\_\_\_\_  
(signature of person  
completing this form)

2. After the appropriate statements have been checked, return this form to:

Air Force Materials Laboratory  
Research and Technology Division  
Attn: MAAM/M. Knight  
Wright-Patterson AFB, Ohio

3. If this form is not returned to the above office within thirty (30) days, it will be assumed that you have no need for the reports, and your name will be removed from the distribution list. Please respond on this form so the copy number can be properly recorded.

THE AEROSPACE  
DIVISION OF  
**MARTIN**  
**MARIETTA** 



# MARTIN COMPANY

DENVER  
DIVISION  
Denver 1,  
Colorado

15 September 1963

Refer to:

Subj: Contract AF33(657)-9161, Cryogenic Materials Data  
Handbook

To: Distribution

Gentlemen:

1. At the request of the Application Division, Air Force Materials Laboratory, Research and Technology Division, one copy of a report covering the activity of this laboratory under the subject contract as of 15 June 1963, is enclosed for your information and retention.

2. Your comments on this work or its relationship to similar work being conducted by your own organization will be appreciated and should be forwarded to:

Air Force Materials Laboratory  
Attn: MAAM (M. Knight)  
Wright-Patterson AFB, Ohio

Very truly yours,

MARTIN COMPANY

*W.H. Clohessy*  
W.H. Clohessy  
Director of Research

THE AEROSPACE  
DIVISION OF  
**MARTIN**  
**MARIETTA** 