

UNCLASSIFIED

AD 408 988

DEFENSE DOCUMENTATION CENTER

FOR

SCIENTIFIC AND TECHNICAL INFORMATION

CAMERON STATION, ALEXANDRIA, VIRGINIA



UNCLASSIFIED

NOTICE: When government or other drawings, specifications or other data are used for any purpose other than in connection with a definitely related government procurement operation, the U. S. Government thereby incurs no responsibility, nor any obligation whatsoever; and the fact that the Government may have formulated, furnished, or in any way supplied the said drawings, specifications, or other data is not to be regarded by implication or otherwise as in any manner licensing the holder or any other person or corporation, or conveying any rights or permission to manufacture, use or sell any patented invention that may in any way be related thereto.

CATALOGED BY DDC
AS AD No. 408988

408988

ORIGINAL CONTAINS COLOR PLATES: ALL DDC
REPRODUCTIONS WILL BE IN BLACK AND WHITE.
ORIGINAL MAY BE SEEN IN DDC HEADQUARTERS.

ASD-TDR-63-196

Supersonic Hydrogen Combustion Studies

Duane R. Burnett

Paul Czysz

TECHNICAL DOCUMENTARY REPORT NR ASD-TDR-63-196
April 1963

Aerodynamics Division
Directorate of Engineering Test
Deputy for Test and Support
Air Force Systems Command
Wright-Patterson Air Force Base, Ohio

APR 15 1963
ASIA

Project Nr 3012, Task Nr 301201

NOTICES

When Government drawings, specifications, or other data are used for any purpose other than in connection with a definitely related Government procurement operation, the United States Government thereby incurs no responsibility nor any obligation whatsoever; and the fact that the Government may have formulated, furnished, or in any way supplied the said drawings, specifications, or other data, is not to be regarded by implication or otherwise as in any manner licensing the holder or any other person or corporation, or conveying any rights or permission to manufacture, use, or sell any patented invention that may in any way be related thereto.

Qualified requesters may obtain copies of this report from the Armed Services Technical Information Agency, (ASTIA), Arlington Hall Station, Arlington 12, Virginia.

This report has been released to the Office of Technical Services, U.S. Department of Commerce, Washington 25, D.C., in stock quantities for sale to the general public.

Copies of this report should not be returned to the Aeronautical Systems Division unless return is required by security considerations, contractual obligations, or notice on a specific document.

ORIGINAL CONTAINS COLOR PLATES: ALL DDC
REPRODUCTIONS WILL BE IN BLACK AND WHITE.
ORIGINAL MAY BE SEEN IN DDC HEADQUARTERS.

ASD-TDR-63-196

ABSTRACT

The purpose of this test was to develop diagnostic techniques for the detection of hydrogen combustion in a hypersonic high temperature airstream. This was accomplished by ejecting hydrogen through sonic nozzles oriented normal to the airstream in the case of the flat plate model and at a 45-degree angle downstream in the case of the stepped flat plate model. The hydrogen gas was ejected into a high temperature airstream ($T_0 \sim 4000^\circ\text{R}$) at Mach Number 4.14 to 4.24. The data is presented in three forms: (1) photographs; (2) graphical; and (3) oscillograph traces.

This technical documentary report has been reviewed and is approved.

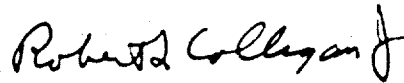

ROBERT L. COLLIGAN, JR.
Colonel, USAF
Deputy for Test and Support

REVIEW AND COORDINATION OF ASD-TDR-63-196

PREPARED BY:

Duane R. Burnett
DUANE R. BURNETT
Aerospace Project Engineer

CONCURRED IN:

Carl Reichert
WILLIAM J. DuBOIS
Colonel, USAF
Acting Director Engineering Test
Deputy for Test and Support

CONCURRED IN:

Hugh S. Lippman
HUGH S. LIPPMAN
Technical Director
Deputy for Test and Support

APPROVED BY:

Robert L. Colligan, Jr.
ROBERT L. COLLIGAN, JR.
Colonel, USAF
Deputy for Test and Support

ASD-TDR-63-196

FOREWORD

This report was prepared by Duane A. Burnett of the Hypersonic Gasdynamics Branch, Aerodynamics Division, Directorate of Engineering Test, Deputy for Test and Support, Aeronautical Systems Division, Wright-Patterson Air Force Base, Ohio. It describes the development of diagnostic techniques for the detection of hydrogen combustion in a hypersonic high temperature airstream.

The work covers the period from March 1962 through April 1962.

The development of diagnostic techniques for the detection of hydrogen combustion was authorized under Task Nr 301201 of Project Nr 3012, "Ramjet Combustion Studies."

The significant contributions of Messrs. A. J. Brigalli and W. E. Bennett in achieving a practical and safe hydrogen system is gratefully acknowledged.

ASD-TDR-63-196

TABLE OF CONTENTS

Section	Page
INTRODUCTION	1
TEST FACILITY	1
MODELS	2
GAS EJECTION SYSTEM	3
INSTRUMENTATION	3
TEST PROCEDURE	4
TEST RESULTS AND DISCUSSION	5
CONCLUSIONS	6
REFERENCES	6

ILLUSTRATIONS

Figure	Page
1. High Temperature Hypersonic Gasdynamic Facility	7
2. Test Section Arrangement	8
3. Stepped Flat Plate Model with Gas Ejecting Normal to the Local Flow	9
4. Flat Plate Model with Rearward Gas Ejection at 45 degrees	10
5. Basic Dimensions of the Stepped Flat Plate Model	11
6. Basic Dimensions of the Flat Plate Model	12
7. Schematic Layout of the Hydrogen Gas Ejection and Helium Purge System	13
8. Oscillograph Traces Showing the Photomultiplier Tube Response to Helium Gas Ejection (a) and no Gas Ejection (b)	14
9. Oscillograph Traces Showing the Photomultiplier Tube Response to Hydrogen Gas Ejection (a) and no Gas Ejection (b)	15
10. Infrared Photograph of Hydrogen Burning Over the Stepped Flat Plate at $\alpha = 0$ degrees	16
11. Infrared Photograph of Hydrogen Burning Over the Flat Plate at $\alpha = 8$ degrees	16
12. A Colored Photograph Taken at a 40-degree Angle Showing Hydrogen Burning Over the Flat Plate Model	17
13. Schlieren Photograph of Hydrogen Burning Over a Stepped Flat Plate Model at $\alpha = 0$ degrees	17
14. Pressure Distribution Over a Stepped Flat Plate at $\alpha = 0$ degrees with Gas Ejection: $P_1/P_\infty = 22$, $P_0 = 314$ psia, $T_0 = 4070^\circ\text{R}$, $M_\infty = 4.18$ and $Re/\ell = 1.08 \times 10^6$ per Foot	18
15. Pressure Distribution Over a Stepped Flat Plate at $\alpha = 8$ degrees with Gas Ejection: $P_1/P_\infty = 23$, $P_0 = 312$ psia, $T_0 = 3820^\circ\text{R}$, $M_\infty = 4.20$ and $Re/\ell = 1.16 \times 10^6$ per Foot	19
16. Pressure Distribution Over a Flat Plate at $\alpha = 0$ degrees with Hydrogen Ejection: $P_1/P_\infty = 47$, $P_0 = 313$ psia, $T_0 = 4430^\circ\text{R}$, $M_\infty = 4.14$ and $Re/\ell = 0.96 \times 10^6$ per Foot	20

ILLUSTRATIONS (CONT'D)

Figure	Page
17. Pressure Distribution Over a Flat Plate at $\alpha = 8$ degrees with Hydrogen Ejecting at a 45-degree Angle Downstream: $P_j/P_\infty = 44$, $P_o = 316$ psia, $T_o = 4540^\circ\text{R}$, $M_\infty = 4.14$ and $Re/l = 0.94 \times 10^6$ per Foot	21
18. Flow Field About a Jet Ejecting Hydrogen Normal to the Freestream	22
19. Flow Field About Jet Ejecting Hydrogen at a 45-degree Angle Downstream	23
20. Schlieren Photographs of the Stepped Flat Plate Model with Hydrogen Ejections: $P_o = 314$ psia, $T_o = 4260^\circ\text{R}$, $M_\infty = 4.16$ and $Re/l = 1.01 \times 10^6$ per Foot	24
21. Schlieren Photographs of the Stepped Flat Plate Model with Hydrogen Ejections, $P_o = 313$ psia, $T_o = 3790^\circ\text{R}$, $M_\infty = 4.20$ and $Re/l = 1.18 \times 10^6$ per Foot	25
22. Schlieren Photographs of the Stepped Flat Plate Model with Hydrogen Ejections: $P_o = 315$ psia, $T_o = 3880^\circ\text{R}$, $M_\infty = 4.19$ and $Re/l = 1.15 \times 10^6$ per Foot	26
23. Schlieren Photographs of the Stepped Flat Plate Model with Hydrogen Ejections: $P_o = 315$ psia, $T_o = 3760^\circ\text{R}$, $M_\infty = 4.20$ and $Re/l = 1.20 \times 10^6$ per Foot	27
24. Schlieren Photographs of the Stepped Flat Plate Model with Hydrogen Ejections: $P_o = 624$ psia, $T_o = 3710^\circ\text{R}$, $M_\infty = 4.21$ and $Re/l = 2.42 \times 10^6$ per Foot	28
25. Schlieren Photographs of the Flat Plate Model with Hydrogen Ejections: $P_o = 314$ psia, $T_o = 4290^\circ\text{R}$, $M_\infty = 4.16$ and $Re/l = 1.01 \times 10^6$ per Foot	29
26. Schlieren Photographs of the Flat Plate Model with Hydrogen Ejections: $P_o = 315$ psia, $T_o = 4700^\circ\text{R}$, $M_\infty = 4.13$ and $Re/l = 0.898 \times 10^6$ per Foot	30
27. Schlieren Photographs of the Flat Plate Model with Hydrogen Ejections: $P_o = 620$ psia, $T_o = 3390^\circ\text{R}$, $M_\infty = 4.24$ and $Re/l = 2.72 \times 10^6$ per Foot	31
28. Schlieren Photographs of the Flat Plate Model with Hydrogen Ejections: $P_o = 625$ psia, $T_o = 4190^\circ\text{R}$, $M_\infty = 4.16$ and $Re/l = 2.10 \times 10^6$ per Foot	32

SYMBOLS

M_∞	Freestream Mach number
P_j	Gas ejection pressure, psia
P_m	Model static pressure, psia
P_{m_3}	Model static pressure at orifice #3, psia
P_{m_5}	Model static pressure at orifice #5, psia
P_o	Tunnel stagnation pressure, psia
P_∞	Tunnel freestream pressure, psia
Re/z	Freestream Reynolds number per foot
T_G	Stagnation temperature of ejecting gas, °R
\dot{w}_G	Weight flow of ejecting gas, lb/sec
α	Angle of attack, degrees

INTRODUCTION

The objective of this investigation was to develop diagnostic techniques for detection of hydrogen combustion in a hypersonic high temperature airstream. Test efforts to achieve the objective were started on 28 March 1962 and completed on 18 April 1962.

In order to obtain thrust in a ramjet engine, the heat required must be less than the heat available. The heat available for combustion will essentially be constant while the heat required is a function of the Mach number. It can readily be seen that as the Mach number increases, the heat required also increases, thus limiting the ramjet engine from operating unless the static enthalpy is reduced and/or a higher energy fuel is used.

Hydrogen has been proposed as such a fuel. However, due to the high stagnation temperatures associated with high Mach numbers, unconventional approaches must be used if full advantage is to be taken of the high energy content of the fuel.

Such an approach would be to obtain hydrogen combustion in approximately static conditions. This could be accomplished by ejecting hydrogen into the airstream around a body at hypervelocity speeds where the static temperature is sufficiently high to autoignite the hydrogen thereby eliminating the conventional method of burning in a ramjet engine.

TEST FACILITY

The High Temperature Hypersonic Gasdynamics Facility (HTF) is a blowdown wind tunnel which operates at Mach Number 4, at stagnation pressures up to 40 atmospheres, and stagnation temperatures approaching 4500°R. Intermittent operation is provided using the principle of stored air and stored heat. A schematic layout of the system is shown in figure 1.

Air, stored at 80 atmospheres pressure is reduced to 40 atmospheres and heated as it passes vertically through the bed of the storage heater. Expansion to Mach Number 4 is provided by a 5-inch exit diameter axisymmetric water cooled nozzle. After passing through the free jet test section, the air is cooled in the diffuser by water sprays and is then exhausted in to the atmosphere.

A sealed plenum chamber installed around the free-jet test section with auxiliary pressure control, provides the necessary boundary condition so that essentially, parallel shock-free flow is obtained in the test section.

A rotary model support which is provided is capable of holding six models, and sequentially injecting them into the flow. The basic dimensions of the test section and model arrangement during running conditions are shown in figure 2 (reference 1 for further information on the HTF).

MODELS

Two models were used during the test: a flat plate model with a rearward facing step, and a flat plate model without a step.

The stepped flat plate model (figure 3) had a 0.187-inch rearward facing step which was located 3.00 inches from the leading edge. Five 0.086-inch-diameter holes provided gas ejection normal to the local flow.

The flat plate model (figure 4) had five 0.086-inch-diameter holes which provided gas ejection at a 45-degree angle downstream to the local flow.

The gas ejection holes for both models were located 2.375 inches from the leading edge on a centerline normal to the longitudinal centerline of the models.

The basic dimensions for both models are shown in figures 5 and 6 respectively.

Each model had a small gas stagnation chamber which was supplied by a 0.375-inch copper tube located on the trailing edge of the model support strut. Both the supply tube and the surface pressure orifice tubing were protected from the high temperature flow by a metal shield.

Ten 0.040-inch-diameter surface pressure orifices (top surface only) were located on the longitudinal centerline of each model. The locations of the orifices from the leading edge are given in the following table:

<u>ORIFICE NO.</u>	<u>DISTANCE FROM LE INCHES</u>
1	1.250
2	1.625
3	2.000
5	3.250
6	3.500
7	3.750
8	4.000
9	4.250
10	4.500
11	4.750

GAS EJECTION SYSTEM

Details of the gas ejection system are shown in figure 7. The gas ejection supply line originally went through the pressure plate (ref 2) to the gas supply source, and was switched pneumatically as were the pressure leads. For hydrogen the line was connected directly from the hydrogen source to the model stagnation chamber without going through the pressure plate.

The hub lock pin installed in the model support hub (ref 2), when engaged, energized a solenoid valve, S-1, in the gas supply line which enabled the hydrogen to flow into the model stagnation chamber. When the hub lock pin disengaged prior to rotating the hub, the solenoid valve, S-1, was automatically de-energized.

A constant helium purge of 10 psig, was induced in the model stagnation chamber at all times. This helium purge eliminated any possibility of air entering the model stagnation chamber during the period when the model was not in the flow. A check valve was installed in the helium line to prevent hydrogen from entering the purge line during gas ejections. Another helium purge line was connected to the hydrogen supply line downstream of the hydrogen solenoid valve, S-1, and the model.

The hydrogen pressure in the model stagnation chamber was regulated by a nitrogen actuated Grove Control Regulator.

INSTRUMENTATION

Pressure Capsules

A 300 psid unbonded strain gage type capsule was used to measure the pressure in the hydrogen stagnation chamber. Ten 7.50 psid exposed diaphragm, unbonded strain gage type pressure capsules were used to measure the model surface pressures.

Thermocouples

An exposed junction iron/constantan thermocouple with a reference temperature of 150°F was used to measure the temperature of the hydrogen in the model stagnation chamber.

Photomultiplier Tube

An RCA 1P28 9-stage photomultiplier tube for application involving low ultraviolet radiation was used. The wave length of maximum spectral response was 3400 Å. The output signal from the photomultiplier tube was amplified and recorded on an oscillograph recorder.

Photographic Equipment

Black and white sequential Schlieren stills of hydrogen ejection were recorded on Panatomic-X 35mm film utilizing a Nikon camera. Horizontal and vertical knife edge pictures were recorded simultaneously.

Colored Schlieren motion pictures were taken on a 16 mm Bell and Howell Cline' Specialist camera using standard Kodachrome film.

A 16 mm Bell and Howell BI-A motion picture camera was used to take infrared pictures of hydrogen burning. Standard Kodak Infrared film was used with a Kodak Wratten Filter Nr 29(F) which emitted light waves shorter than 6300 Å.

Another 16 mm Bell and Howell BI-A motion picture camera was used to record colored pictures of hydrogen burning at a 40-degree angle to the vertical. Standard Kodachrome film was used without a filter.

TEST PROCEDURE

The testing conditions are listed below for both models.

STEPPED FLAT PLATE MODEL

<u>P₀ (psi)</u>	<u>T₀ (*R)</u>	<u>P_G (psia)</u>	<u>α (DEGREES)</u>	<u>GAS EJECTED</u>
300	3587 - 4254	0 - 175	0, 4, 8, 12, 15	HELIUM
250	4218 - 4300	23 - 137	0	HYDROGEN
300	3425 - 4031	25 - 142	0, 4, 8	HYDROGEN
450	2703 - 2909	27 - 103	0, 8	HYDROGEN
600	3522 - 3834	26 - 84	0	HYDROGEN

FLAT PLATE MODEL

<u>P₀ (psi)</u>	<u>T₀ (*R)</u>	<u>P_G (psia)</u>	<u>α (DEGREES)</u>	<u>GAS EJECTED</u>
250	3973 - 4522	19 - 133	0, 8	HYDROGEN
300	4109 - 4548	0 - 135	0, 8	HYDROGEN
400	3681 - 3922	0 - 136	0, 8	HYDROGEN
600	3330 - 4535	0 - 141	0, 8	HYDROGEN

The models were in the flow from 0.77 to 2.47 seconds depending upon the tunnel stagnation temperature.

TEST RESULTS AND DISCUSSIONS

Photomultiplier Tubes

Figures 8 and 9 show the oscillograph traces of the photomultiplier tube response during hydrogen, helium, and, no gas ejection.

The amplitude of the photomultiplier trace for helium and no gas ejection was approximately the same as shown in figure 8. This was expected since helium, an inert gas, does not burn. The small response was probably due to the photon emission of the high temperature airstream behind the shock wave.

If a flammable gas was injected into a high temperature airstream and did not burn, the amplitude of the photomultiplier trace would be the same as for helium or no gas ejection; but, if the gas did burn the photon energy emitted from the burning flame would increase the amplitude of the photomultiplier trace. This is shown distinctly in figure 9a when hydrogen was used as the flammable gas.

Infrared Photography

The hydrogen burning was recorded on 16 mm infrared motion picture film. Figures 10 and 11 are single frame photographs, taken from the motion picture, showing the effects of hydrogen burning over the stepped flat plate at $\alpha = 0$ degrees and the flat plate at $\alpha = 8$ degrees. The hydrogen appeared to burn over the model surface with reasonable stability.

Forty-Degree Angle Colored Motion Picture

Figure 12 is a single frame colored photograph, taken from the motion picture showing an angled view of hydrogen burning over the flat plate model. This photograph shows clearly the heavy concentration of hydrogen burning aft of the model.

Schlieren Photographs

Figure 13 is a single frame photograph, taken from a 16 mm colored Schlieren motion picture showing the hydrogen concentration over the stepped flat plate model during ejection.

Figures 20 through 28 are Schlieren photographs of both models with hydrogen gas ejection, utilizing a vertical knife edge.

Pressure Distribution

The data obtained using the pressure capsules are presented as a series of graphs (figures 14 through 17) plotting the surface pressure ratio versus the chord length from the leading edge.

There was a pressure rise in front of the gas ejection and a pressure drop behind the gas ejection as was expected. There was also a sharp rise in pressure for the last orifice (Nr 11). This was a good indication that hydrogen started to burn on the aft section of the model as shown in figure 12.

Flow Phenomena

Figures 18 and 19 are schematic diagrams of the flow field of a jet ejecting hydrogen gas, normal to the flow, and at a 45-degree angle downstream. This of course, is only a centerline representation of what was actually a three-dimensional flow phenomenon.

The presence of the jet flow, as it issued into the supersonic free stream caused a strong bow wave ahead of the jet and boundary layer separation surrounding the jet. The strength of the gas ejection bow wave, and the depth of the boundary layer separation depended upon the gas ejection pressure (Figures 18 and 19 are schematic drawings for $P_j/P_\infty = 22$).

General

Hydrogen leakage was a continuous hinderance during the test. Because of the small size of the hydrogen atom, the gas diffused through the smallest opening.

On the first hydrogen ejection test run, the hydrogen diffused profusely through the asbestos gasket between the model strut support and the model. This was corrected to some extent by brazing the model to the strut but even then there were minute openings in the weld where the hydrogen diffused through which was detected by infrared motion pictures.

CONCLUSIONS

From the results of this test the conclusion was drawn that hydrogen burning in a hypersonic flow can be detected by the following methods:

1. Photomultiplier tube
2. Infrared photography
3. Colored motion pictures
4. Colored Schlieren photography
5. Pressure distribution curves.

The welded seams on the models will be a critical manufacturing item, and will be carefully controlled for future work.

REFERENCES

1. Milling, Robert W., Capt, USAF, The High Temperature Hypersonic Gasdynamics Facility, ASD TN 61-107, September 1961, AD Nr 266 728.
2. Cain, M. R., Model Support System - ASD M = 4 High Temperature System, ASTEA ETR 62-9R, July 1962.
3. Pearce, K., Samet, S., and Whalen, R. J., Similarity Studies for Dissociating Gases in Hypersonic, Low Density Flow, WADD TR 60-341, September 1960, AD Nr 258 786.

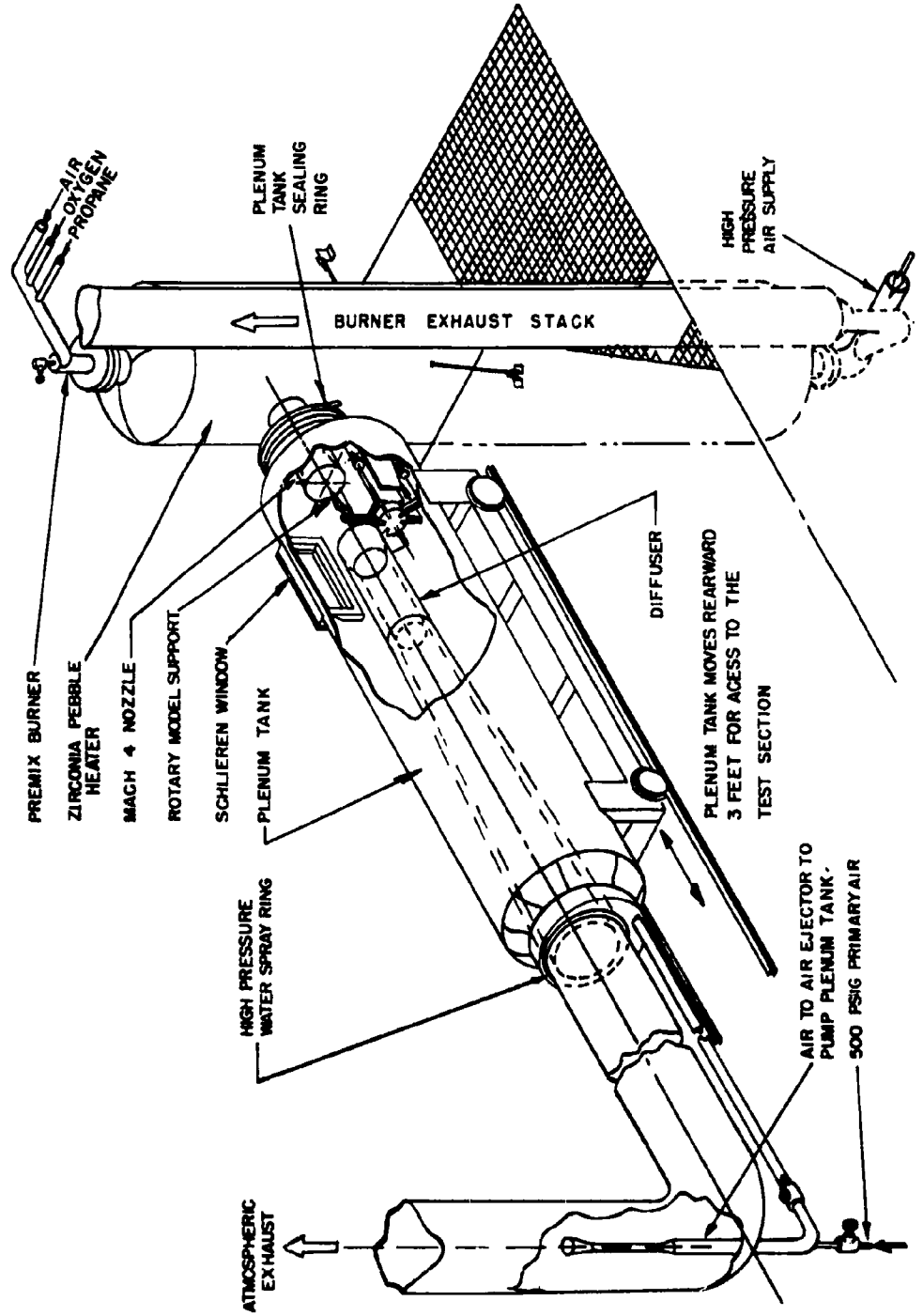

Figure 1. High Temperature Hypersonic Gasdynamic Facility

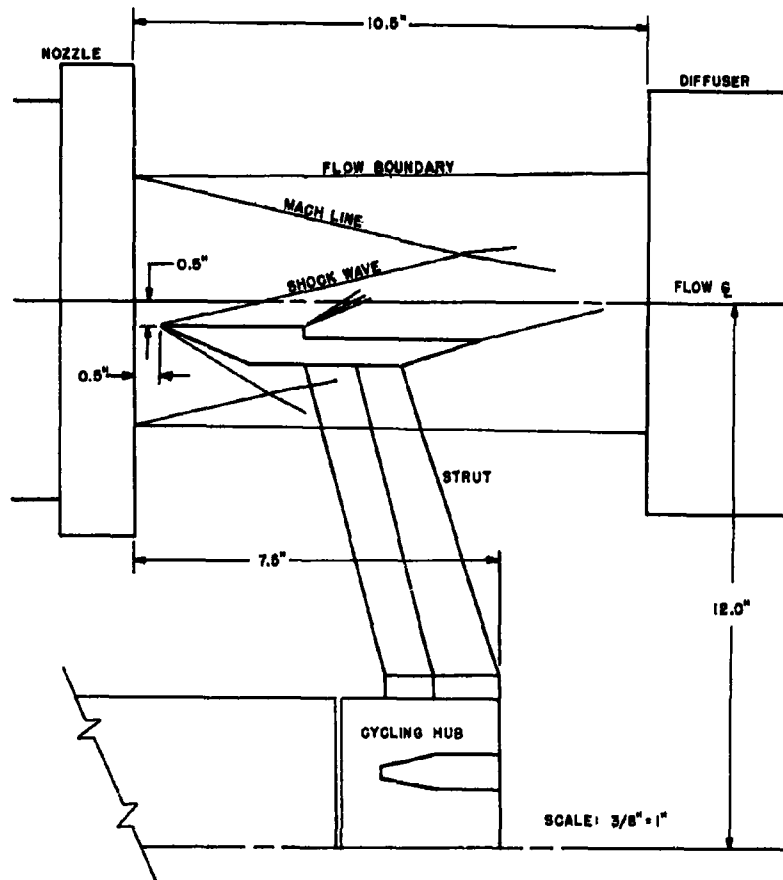

Figure 2. Test Section Arrangement

ASD-TDR-63-196



Figure 3. Stepped Flat Plate Model with Gas Ejecting Normal to the Local Flow

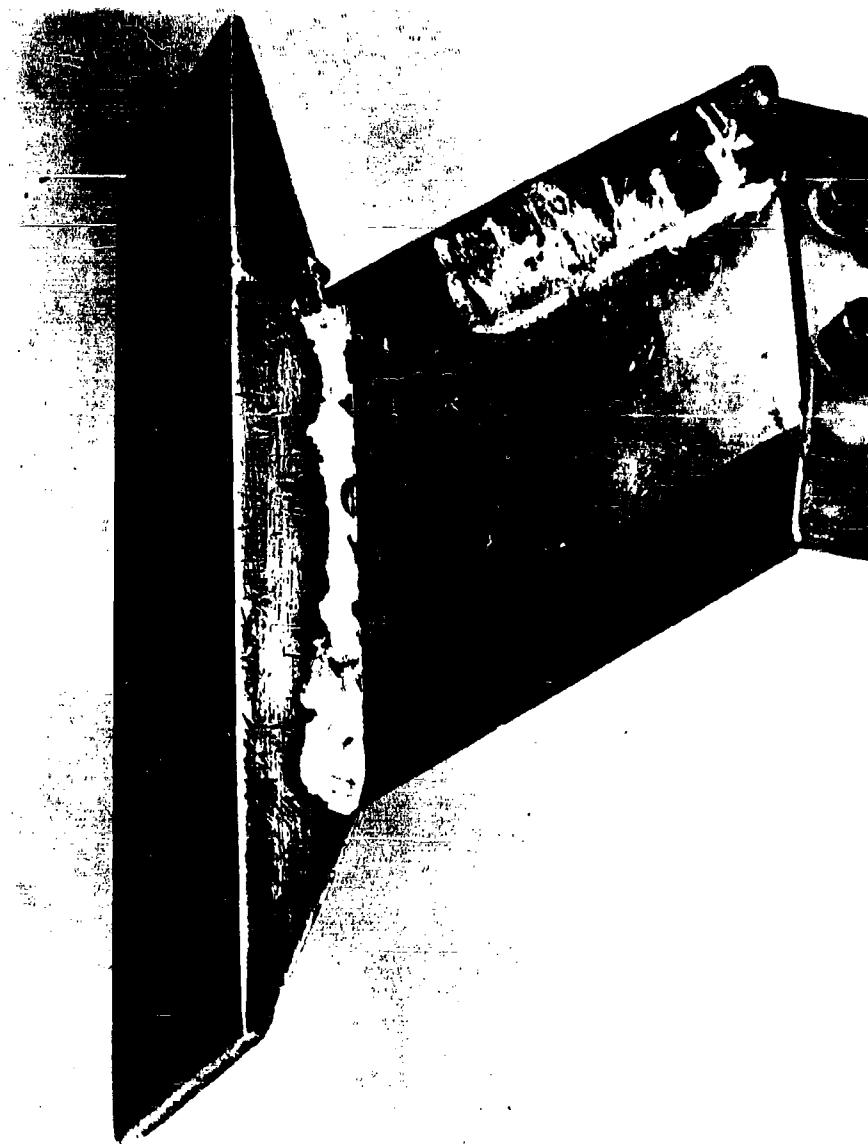

Figure 4. Flat Plate Model with Rearward Gas Ejection at 45 degrees

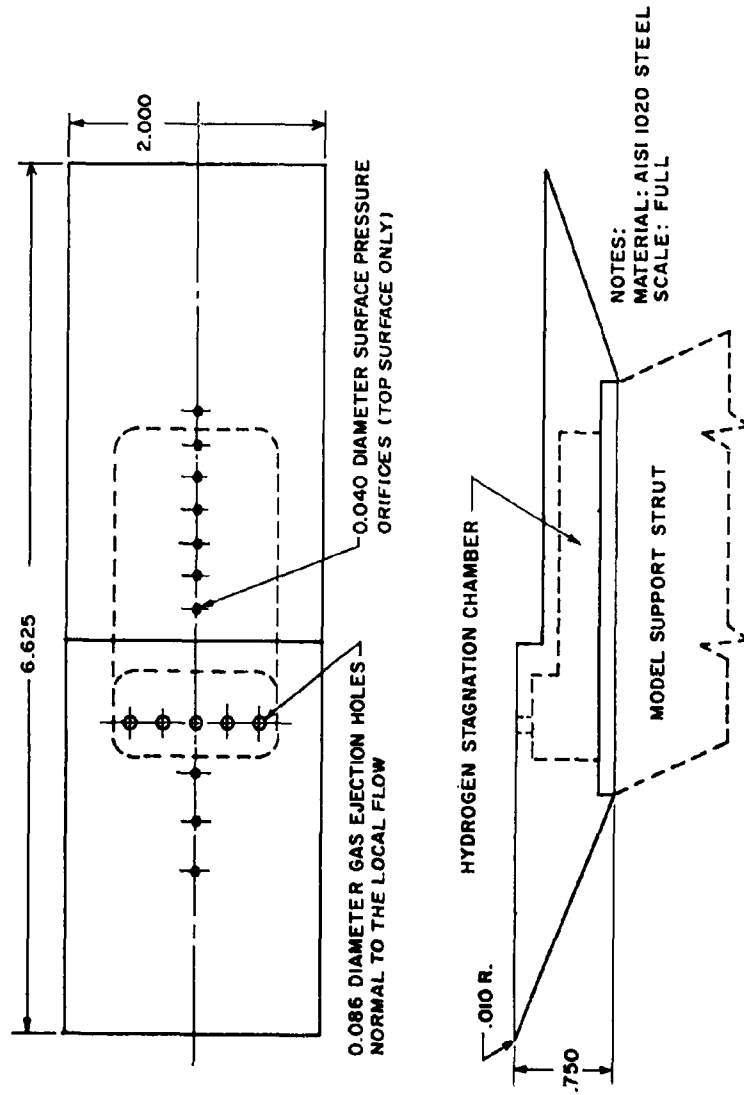

Figure 5. Basic Dimensions of the Stepped Flat Plate Model

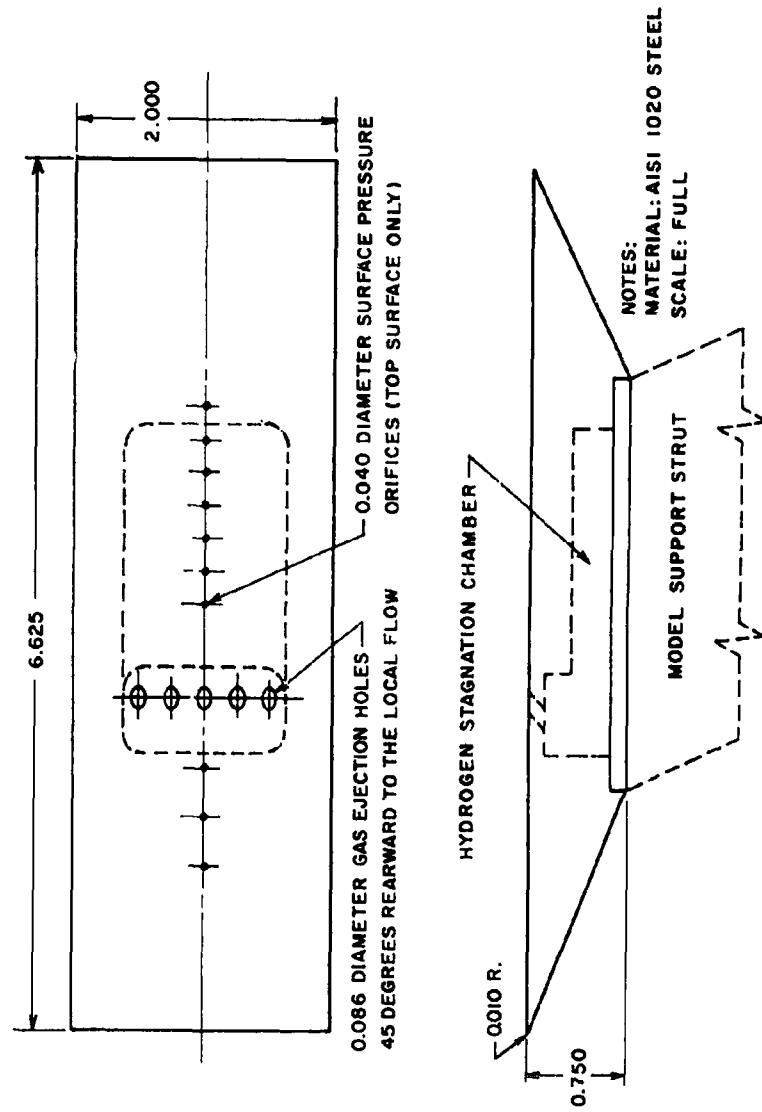

Figure 6. Basic Dimensions of the Flat Plate Model

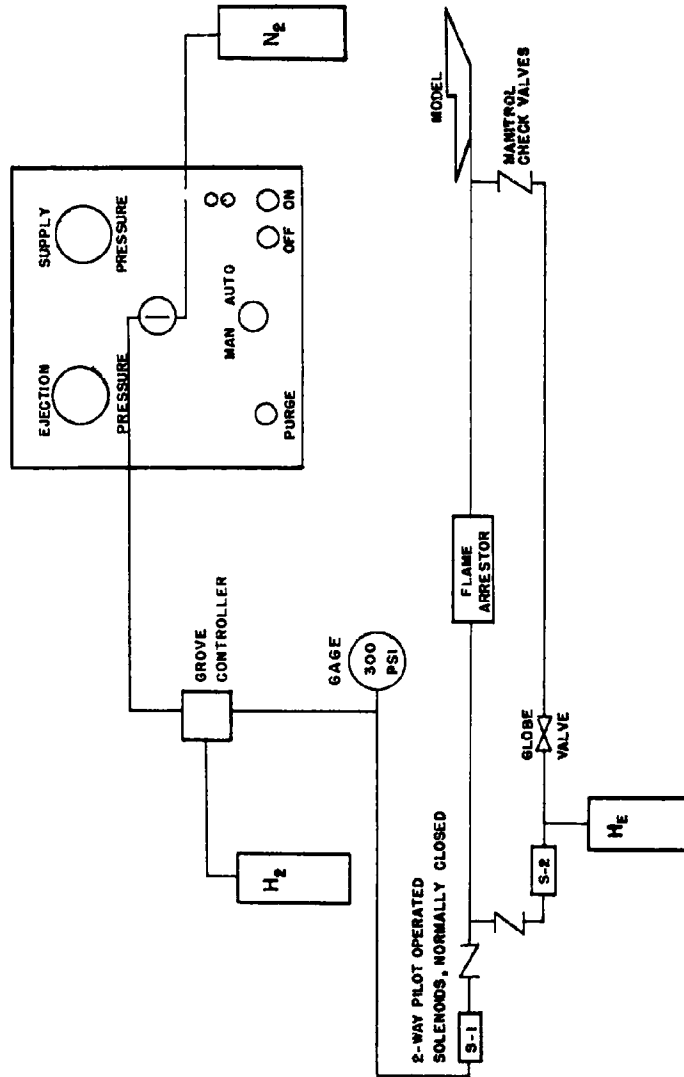
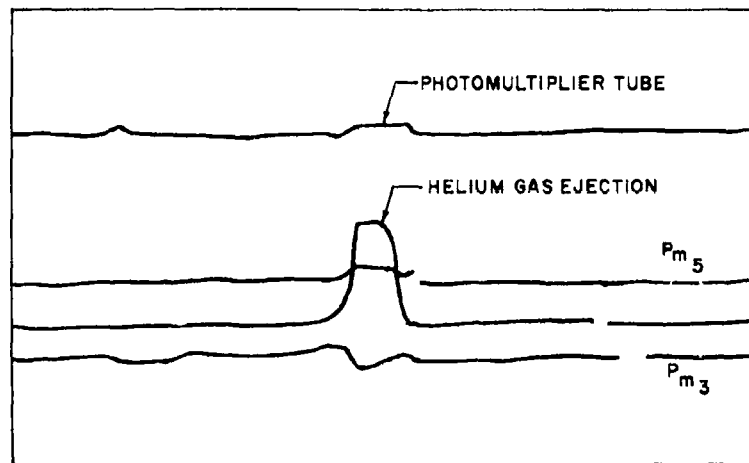
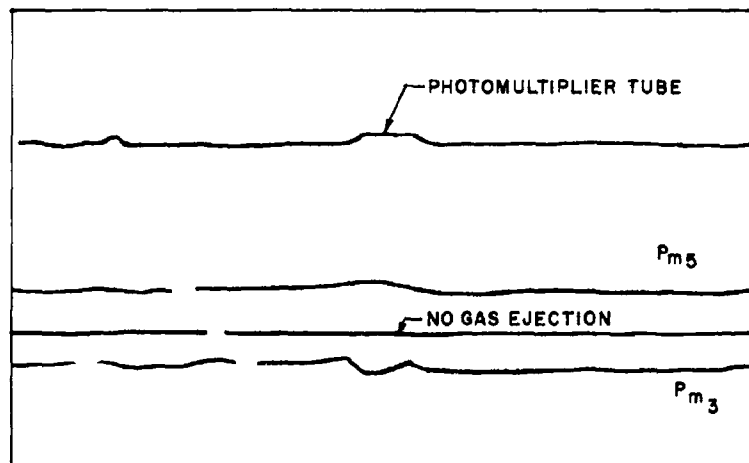

Figure 7. Schematic Layout of the Hydrogen Gas Ejection and Helium Purge System



(a)



(b)

Figure 8. Oscillograph Traces Showing the Photomultiplier Tube Response to Helium Gas Ejection (a) and no Gas Ejection (b)

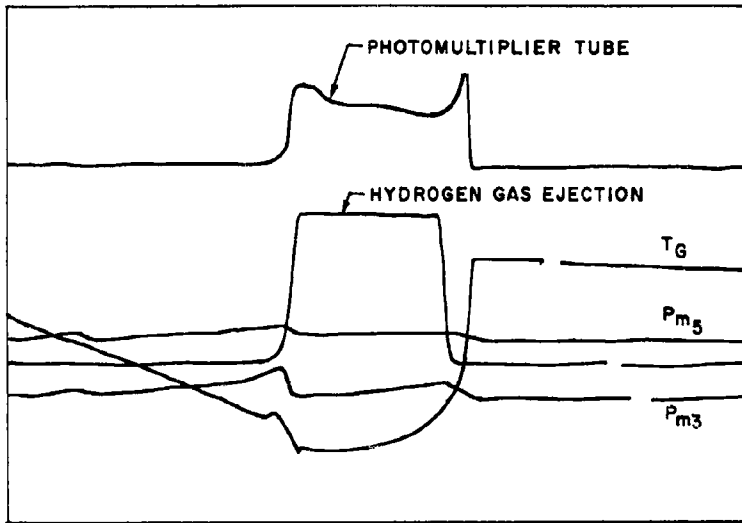

(a)

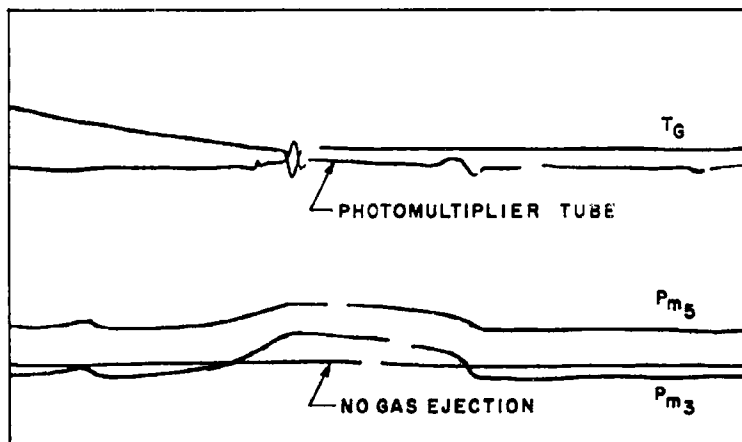

(b)

Figure 9. Oscilloscope Traces Showing the Photomultiplier Tube Response to Hydrogen Gas Ejection (a) and no Gas Ejection (b)

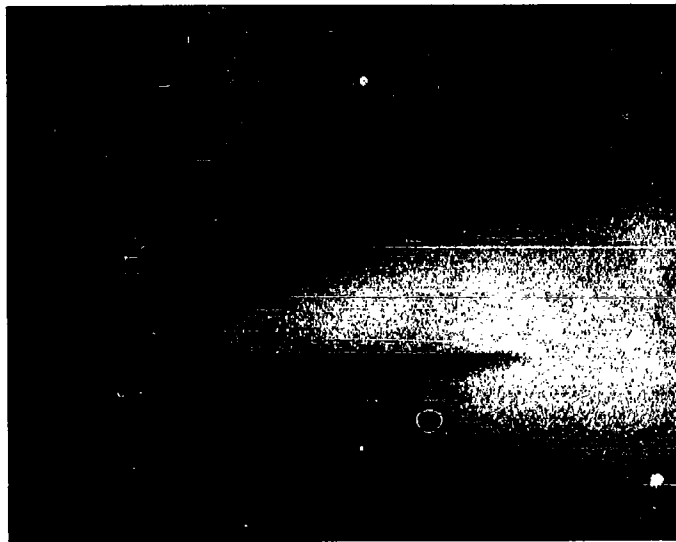

Figure 10. Infrared Photograph of Hydrogen Burning Over the Stepped Flat Plate at $\alpha = 0$ degrees



Figure 11. Infrared Photograph of Hydrogen Burning Over the Flat Plate at $\alpha = 8$ degrees

ASD-TDR-63-196

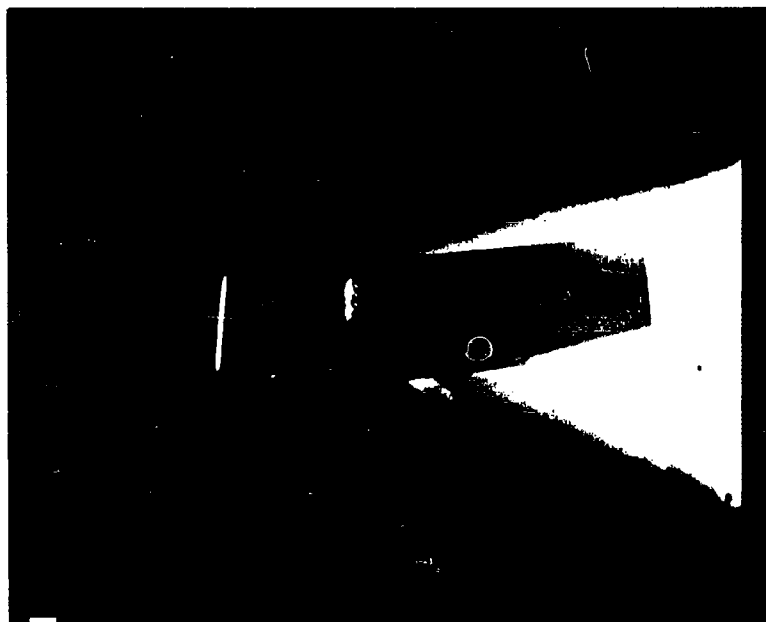

Figure 12. A Colored Photograph Taken at a 40-degree Angle Showing Hydrogen Burning Over the Flat Plate Model

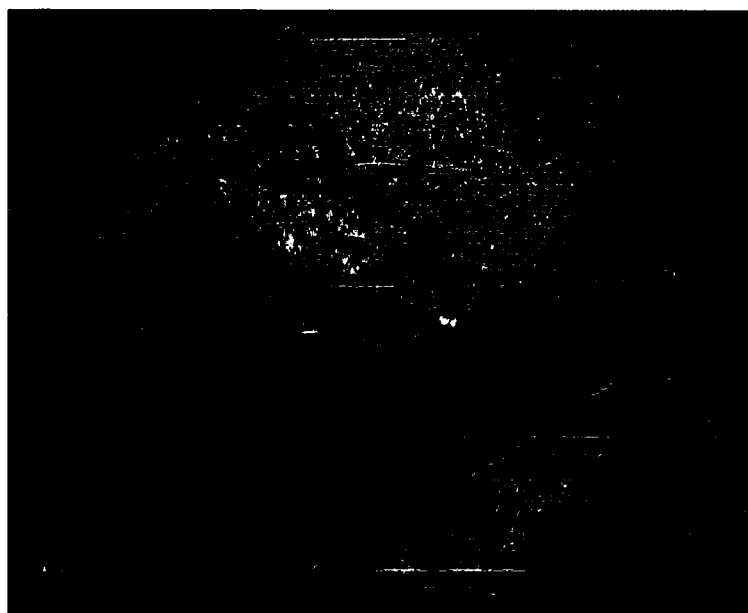

Figure 13. Schlieren Photograph of Hydrogen Burning Over a Stepped Flat Plate Model at $\alpha = 0$ degrees

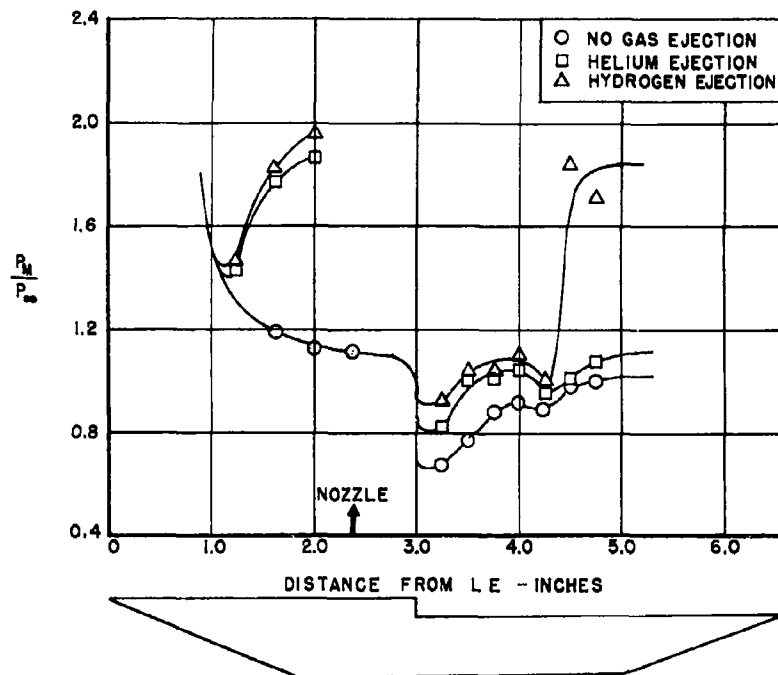

Figure 14. Pressure Distribution Over a Stepped Flat Plate at a $\alpha = 0$ degrees with Gas Ejection: $P_i/P_\infty = 22$, $P_0 = 314$ psia, $T_0 = 4070^\circ\text{R}$, $M_\infty = 4.18$ and $Re/\ell = 1.08 \times 10^6$ per Foot

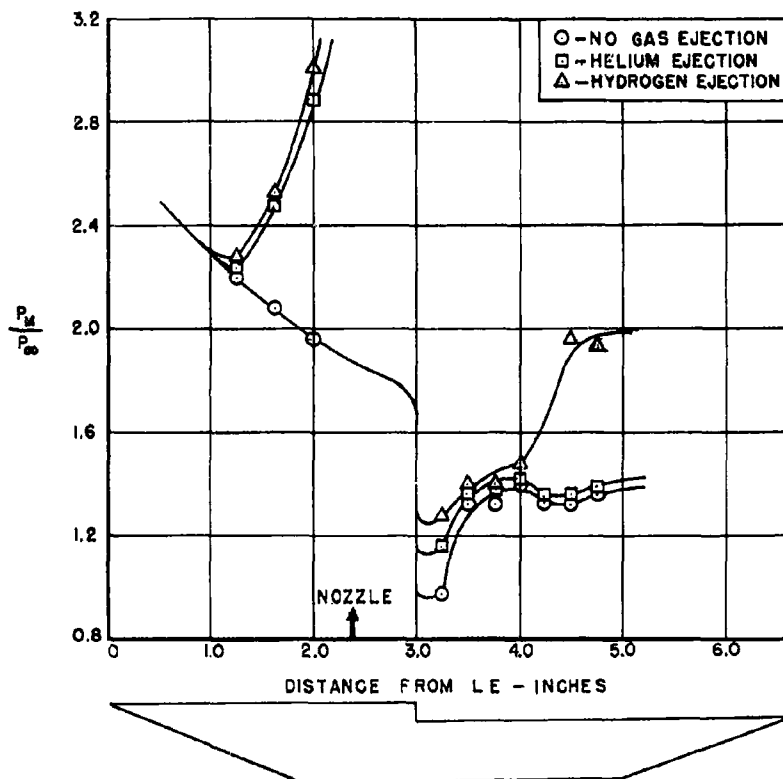

Figure 15. Pressure Distribution Over a Stepped Flat Plate at $\alpha = 8$ degrees with Gas Ejection: $P_1/P_\infty = 23$, $P_0 = 312$ psia, $T_0 = 3820^\circ\text{R}$, $M_\infty = 4.20$ and $Re/l = 1.16 \times 10^8$ per Foot

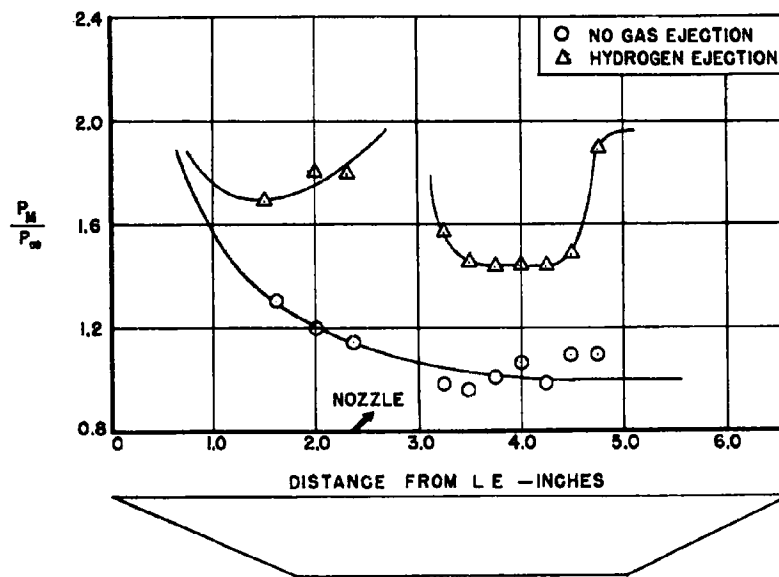

Figure 16. Pressure Distribution Over a Flat Plate at $\alpha = 0$ degrees with Hydrogen Ejection; $P_1/P_\infty = 47$, $P_0 = 313$ psia, $T_0 = 4430^\circ\text{R}$, $M_\infty = 4.14$ and $Re/l = 0.96 \times 10^8$ per Foot

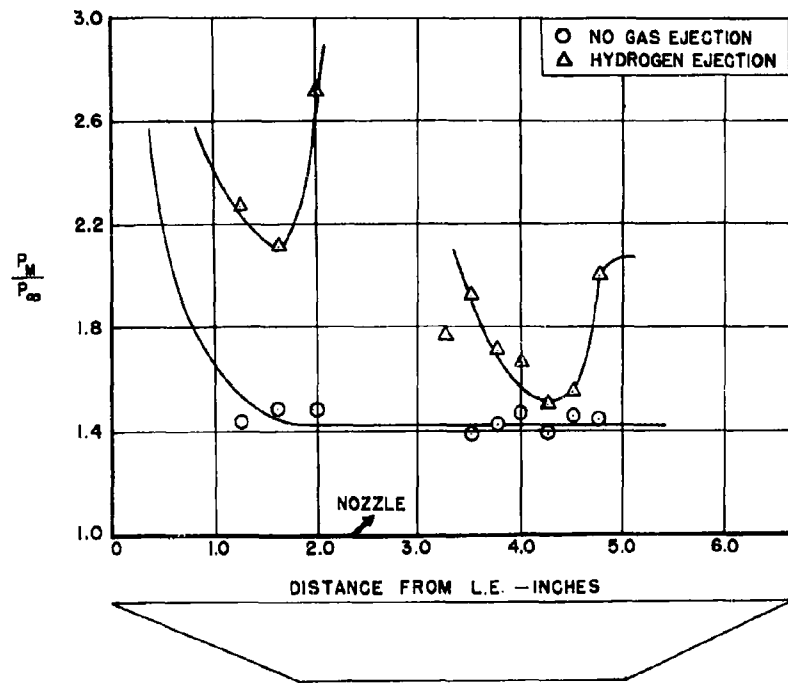

Figure 17. Pressure Distribution Over a Flat Plate at $\alpha = 8$ degrees with Hydrogen Ejecting at a 45-degree Angle Downstream; $P_j/P_0 = 44$, $P_0 = 316$ psia, $T_0 = 4540^\circ\text{R}$, $M_\infty = 4.14$ and $Re/\ell = 0.94 \times 10^6$ per Foot

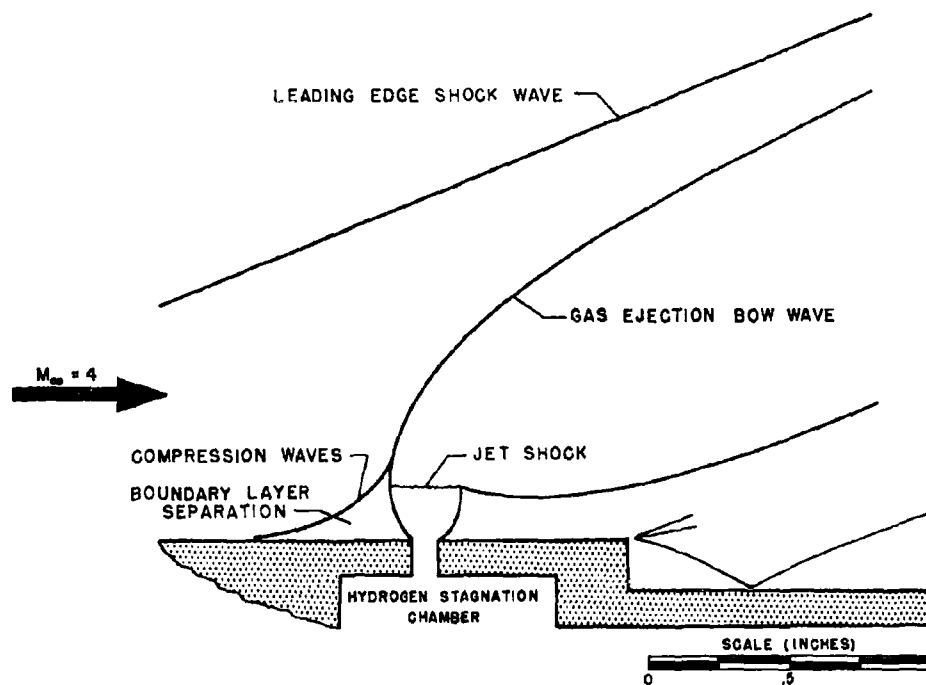

Figure 18. Flow Field about a Jet Ejecting Hydrogen Normal to the Freestream

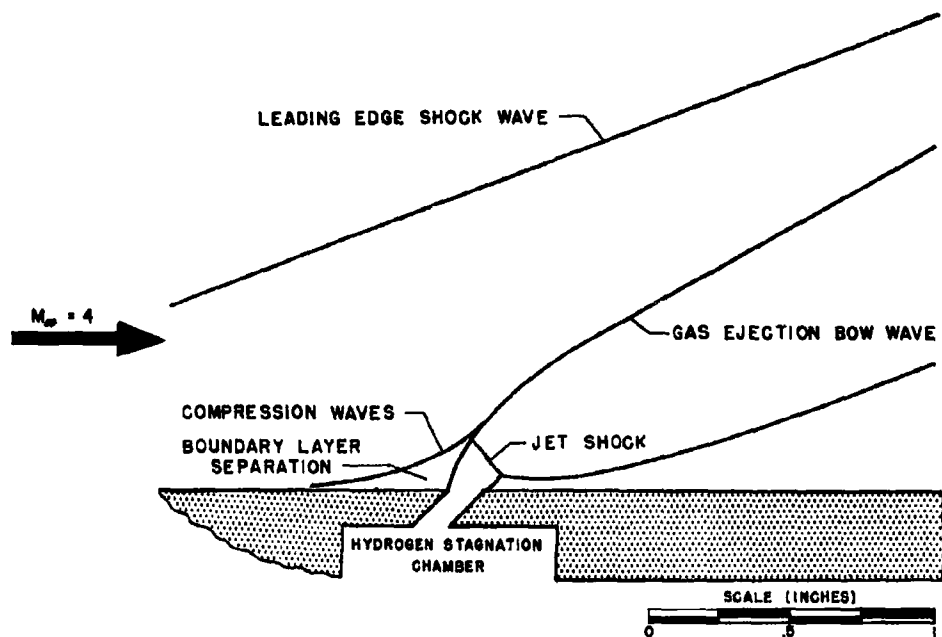
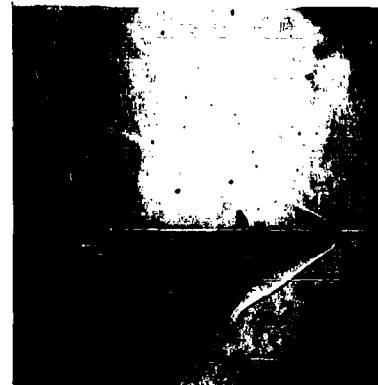

Figure 19. Flow Field About a Jet Ejecting Hydrogen at a 45-degree Angle Downstream



$P_j / P_\infty = 6.801$
 $\dot{w}_G = 0.003 \text{ lb/sec}$
 $\alpha = 0 \text{ degrees}$



$P_j / P_\infty = 20.731$
 $\dot{w}_G = 0.009 \text{ lb/sec}$
 $\alpha = 0 \text{ degrees}$



$P_j / P_\infty = 35.822$
 $\dot{w}_G = 0.0154 \text{ lb/sec}$
 $\alpha = 0 \text{ degrees}$



$P_j / P_\infty = 60.023$
 $\dot{w}_G = 0.0261 \text{ lb/sec}$
 $\alpha = 0 \text{ degrees}$

Figure 20. Schlieren Photographs of the Stepped Flat Plate Model with Hydrogen Ejections: $P_0 = 314 \text{ psia}$, $T_0 = 4260^\circ\text{R}$, $M_\infty = 4.16$ and $Re/\lambda = 1.01 \times 10^6$ per Foot

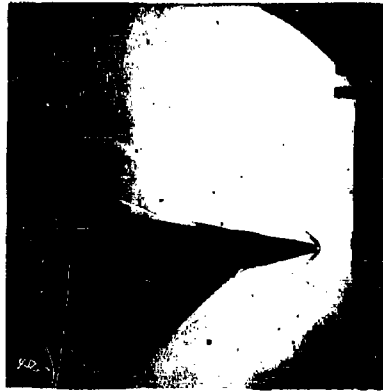

$P_j / P_\infty = 0.813$
 $\dot{w}_G = 0.0003 \text{ lb/sec}$
 $\alpha = 8 \text{ degrees}$

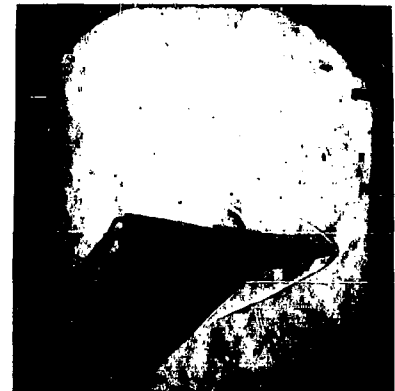

$P_j / P_\infty = 22.031$
 $\dot{w}_G = 0.0093 \text{ lb/sec}$
 $\alpha = 8 \text{ degrees}$

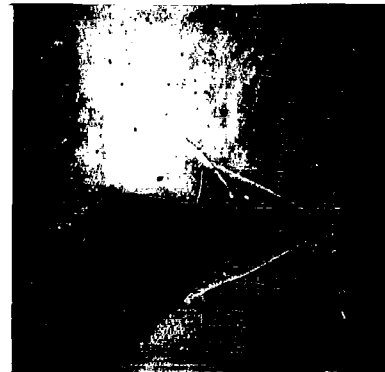

$P_j / P_\infty = 68.422$
 $\dot{w}_G = 0.0283 \text{ lb/sec}$
 $\alpha = 8 \text{ degrees}$

Figure 21. Schlieren Photographs of the Stepped Flat Plate Model with Hydrogen Ejections: $P_0 = 313 \text{ psia}$, $T_0 = 3790^\circ\text{R}$, $M_\infty = 4.20$ and $Re/\ell = 1.18 \times 10^6$ per Foot



$P_j / P_\infty = 9.955$
 $\dot{W}_G = 0.0042 \text{ lb/sec}$
 $\alpha = 0 \text{ degrees}$



$P_j / P_\infty = 22.349$
 $\dot{W}_G = 0.0094 \text{ lb/sec}$
 $\alpha = 0 \text{ degrees}$

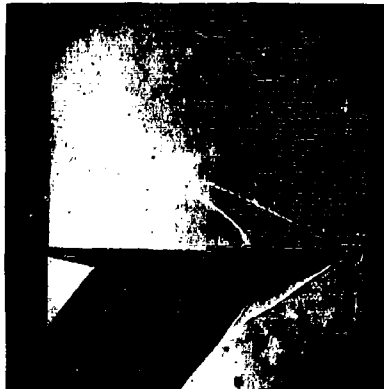

$P_j / P_\infty = 33.132$
 $\dot{W}_G = 0.0141 \text{ lb/sec}$
 $\alpha = 0 \text{ degrees}$



$P_j / P_\infty = 40.541$
 $\dot{W}_G = 0.0169 \text{ lb/sec}$
 $\alpha = 0 \text{ degrees}$

Figure 22. Schlieren Photographs of the Stepped Flat Plate Model with Hydrogen Ejections: $P_0 = 315 \text{ psia}$, $T_0 = 3880^\circ\text{R}$, $M_\infty = 4.19$ and $Re/l = 1.15 \times 10^6$ per Foot



$P_j / P_\infty = 9.658$
 $\dot{w}_G = 0.0036 \text{ lb/sec}$
 $\alpha = 8 \text{ degrees}$



$P_j / P_\infty = 23.804$
 $\dot{w}_G = 0.0093 \text{ lb/sec}$
 $\alpha = 8 \text{ degrees}$



$P_j / P_\infty = 34.440$
 $\dot{w}_G = 0.0138 \text{ lb/sec}$
 $\alpha = 8 \text{ degrees}$



$P_j / P_\infty = 54.942$
 $\dot{w}_G = 0.0225 \text{ lb/sec}$
 $\alpha = 8 \text{ degrees}$

Figure 23. Schlieren Photographs of the Stepped Flat Plate Model with Hydrogen Ejections: $P_0 = 315 \text{ psia}$, $T_0 = 3760^\circ\text{R}$, $M_\infty = 4.20$ and $Re/l = 1.20 \times 10^6$ per Foot

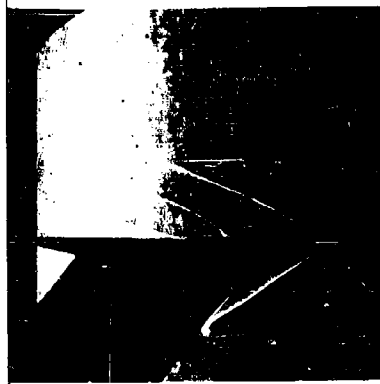

$P_j/P_\infty = 5.274$
 $\dot{w}_G = 0.0043 \text{ lb/sec}$
 $\alpha = 0 \text{ degrees}$



$P_j/P_\infty = 11.431$
 $\dot{w}_G = 0.0093 \text{ lb/sec}$
 $\alpha = 0 \text{ degrees}$

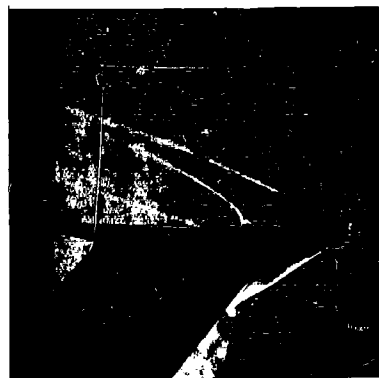

$P_j/P_\infty = 16.593$
 $\dot{w}_G = 0.0133 \text{ lb/sec}$
 $\alpha = 0 \text{ degrees}$

Figure 24. Schlieren Photographs of the Stepped Flat Plate Model with Hydrogen Ejections; $P_0 = 624 \text{ psia}$, $T_0 = 3710^\circ\text{R}$, $M_\infty = 4.21$ and $Re/\lambda = 2.42 \times 10^6$ per Foot

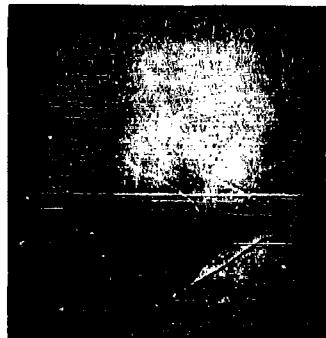

$P_j / P_\infty = 9.526$
 $\dot{w}_G = 0.0042 \text{ lb/sec}$
 $\alpha = 0 \text{ degrees}$



$P_j / P_\infty = 21.607$
 $\dot{w}_G = 0.0093 \text{ lb/sec}$
 $\alpha = 0 \text{ degrees}$



$P_j / P_\infty = 36.998$
 $\dot{w}_G = 0.0162 \text{ lb/sec}$
 $\alpha = 0 \text{ degrees}$

Figure 25. Schlieren Photographs of the Flat Plate Model with Hydrogen Ejections:
 $P_0 = 314 \text{ psia}$, $T_0 = 4290^\circ\text{R}$, $M_\infty = 4.16$ and $Re/\ell = 1.01 \times 10^8$ per
Foot

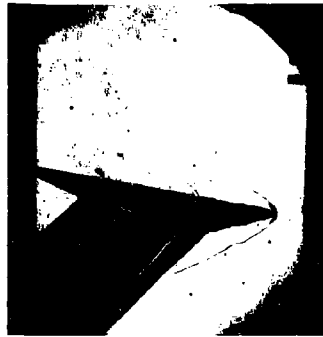

$P_j/P_\infty = 9.632$
 $\dot{w}_G = 0.0044 \text{ lb/sec}$
 $\alpha = 8 \text{ degrees}$

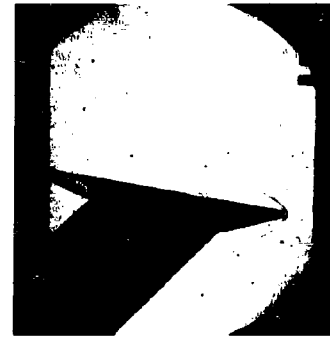

$P_j/P_\infty = 20.637$
 $\dot{w}_G = 0.0092 \text{ lb/sec}$
 $\alpha = 8 \text{ degrees}$



$P_j/P_\infty = 44.476$
 $\dot{w}_G = 0.0197 \text{ lb/sec}$
 $\alpha = 8 \text{ degrees}$

Figure 26. Schlieren Photographs of the Flat Plate Model with Hydrogen Ejections:
 $P_0 = 315 \text{ psia}$, $T_0 = 4700^\circ\text{R}$, $M_\infty = 4.13$ and $Re/\xi = 0.898 \times 10^6$ per
 Foot



$P_j/P_\infty = 12.858$
 $w_G = 0.0092 \text{ lb/sec}$
 $\alpha = 0 \text{ degrees}$



$P_j/P_\infty = 29.730$
 $w_G = 0.0221 \text{ lb/sec}$
 $\alpha = 0 \text{ degrees}$



$P_j/P_\infty = 19.159$
 $w_G = 0.0142 \text{ lb/sec}$
 $\alpha = 0 \text{ degrees}$

Figure 27. Schlieren Photographs of the Flat Plate Model with Hydrogen Ejections:
 $P_0 = 620 \text{ psia}$, $T_0 = -3390^\circ\text{R}$, $M_\infty = 4.24$ and $Re/l = 2.72 \times 10^6$ per
Foot

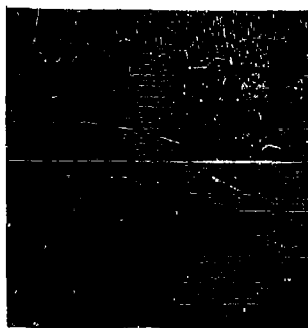

$P_j/P_\infty = 11.227$
 $\dot{w}_G = 0.009 \text{ lb/sec}$
 $\alpha = 8 \text{ degrees}$

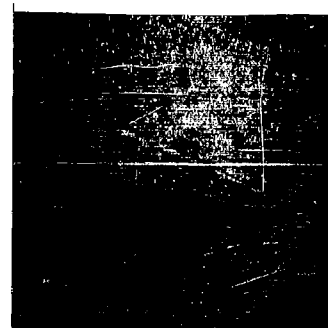

$P_j/P_\infty = 18.716$
 $\dot{w}_G = 0.0154 \text{ lb/sec}$
 $\alpha = 8 \text{ degrees}$



$P_j/P_\infty = 27.259$
 $\dot{w}_G = 0.0214 \text{ lb/sec}$
 $\alpha = 8 \text{ degrees}$

Figure 28. Schlieren Photographs of the Flat Plate Model with Hydrogen Ejections:
 $P_0 = 625 \text{ psia}$, $T_0 = 4190^\circ\text{R}$, $M_\infty = 4.16$ and $Re/2 = 2.10 \times 10^6$ per
 Foot

Aeronautical Systems Division, Directorate of Engineering Test, Deputy for Test and Support, Wright-Patterson AFB, Ohio.
Rpt No. ASD-TDR-63-196. SUPERSONIC HYDROGEN COMBUSTION STUDIES. Final report, Apr 63.
32p., incl. illus., refs.

Unclassified Report

The purpose of this test was to develop diagnostic techniques for the detection of hydrogen combustion in a hypersonic high temperature airstream. This was accomplished by ejecting hydrogen through sonic nozzles oriented normal to the airstream in the case of the flat plate model and at a 45-degree

(over)

angle downstream in the case of the stepped flat plate model. The hydrogen gas was ejected into a high temperature airstream (15-4000°R) at Mach Number 4.14 to 4.24. The data is presented in three forms:
(1) photographs; (2) graphical; and (3) oscillograph traces.

1. Hydrogen Combustion
2. Ramjet Engine
Operation
3. Hypersonic Gas
Flow

I. AFSC Project 3012

Task 301201

II. Duane R. Barnett,

Paul Czysz

III. Avail fr OCS

IV. In ASTIA collection

Aeronautical Systems Division, Directorate of Engineering Test, Deputy for Test and Support, Wright-Patterson AFB, Ohio.
Rpt No. ASD-TDR-63-196. SUPERSONIC HYDROGEN COMBUSTION STUDIES. Final report, Apr 63.
32p., incl illus., refs.

Unclassified Report

The purpose of this test was to develop diagnostic techniques for the detection of hydrogen combustion in a hypersonic high temperature airstream. This was accomplished by ejecting hydrogen through sonic nozzles oriented normal to the airstream in the case of the flat plate model and at a 45-degree

(over)

angle downstream in the case of the stepped flat plate model. The hydrogen gas was ejected into a high temperature airstream (15-4000°R) at Mach Number 4.14 to 4.24. The data is presented in three forms:
(1) photographs; (2) graphical; and (3) oscillograph traces.

Aeronautical Systems Division, Directorate of Engineering Test, Deputy for Test and Support, Wright-Patterson AFB, Ohio.
Rpt No. ASD-TDR-63-196. SUPERSONIC HYDROGEN COMBUSTION STUDIES. Final report, Apr 63.
32p., incl illus, refs.

Unclassified Report

The purpose of this test was to develop diagnostic techniques for the detection of hydrogen combustion in a hypersonic high temperature airstream. This was accomplished by ejecting hydrogen through sonic nozzles oriented normal to the airstream in the case of the flat plate model and at a 45-degree

(over)

angle downstream in the case of the stepped flat plate model. The hydrogen gas was ejected into a high temperature airstream ($T_0=4000^{\circ}\text{K}$) at Mach Number 4.14 to 4.24. The data is presented in three forms:
(1) photographs; (2) graphical; and (3) oscillograph traces.

1. Hydrogen Combustion
2. Ramjet Engine
Operation
3. Hypersonic Gas
Flow

I. AFSC Project 3012
Task 301201

II. Duane R. Burnett,
Paul Czysz
III. Avail fr CTS
IV. In ASTIA collection

Aeronautical Systems Division, Directorate of Engineering Test, Deputy for Test and Support, Wright-Patterson AFB, Ohio.
Rpt No. ASD-TDR-63-196. SUPERSONIC HYDROGEN COMBUSTION STUDIES. Final report, Apr 63.
32p., incl illus, refs.

Unclassified Report

The purpose of this test was to develop diagnostic techniques for the detection of hydrogen combustion in a hypersonic high temperature airstream. This was accomplished by ejecting hydrogen through sonic nozzles oriented normal to the airstream in the case of the flat plate model and at a 45-degree

(over)

angle downstream in the case of the stepped flat plate model. The hydrogen gas was ejected into a high temperature airstream ($T_0=4000^{\circ}\text{K}$) at Mach Number 4.14 to 4.24. The data is presented in three forms:
(1) photographs; (2) graphical; and (3) oscillograph traces.

Aeronautical Systems Division, Directorate of Engineering Test, Deputy for Test and Support, Wright-Patterson AFB, Ohio.
Rpt No. ASD-TDR-63-196. SUPERSONIC HYDROGEN COMBUSTION STUDIES. Final report, Apr 63.
32p.. incl illus. refs.

Unclassified Report

The purpose of this test was to develop diagnostic techniques for the detection of hydrogen combustion in a hypersonic high temperature airstream. This was accomplished by ejecting hydrogen through sonic nozzles oriented normal to the airstream in the case of the flat plate model and at a 45-degree

(over)

angle downstream in the case of the stepped flat plate model. The hydrogen gas was ejected into a high temperature airstream (T=4000°R) at Mach Number 4.14 to 4.24. The data is presented in three forms:
(1) photographs; (2) graphical; and (3) oscillograph traces.

1. Hydrogen Combustion
2. Ramjet Engine Operation
3. Hypersonic Gas Flow

I. AFSC Project 3012

Task 301201

II. Duane R. Burnett,

Paul Czysz

III. Aval fr ONS

IV. In ASTIA collection

Aeronautical Systems Division, Directorate of Engineering Test, Deputy for Test and Support, Wright-Patterson AFB, Ohio.
Rpt No. ASD-TDR-65-196. SUPERSONIC HYDROGEN COMBUSTION STUDIES. Final report, Apr 63.
32p.. incl illus. refs.

Unclassified Report

The purpose of this test was to develop diagnostic techniques for the detection of hydrogen combustion in a hypersonic high temperature airstream. This was accomplished by ejecting hydrogen through sonic nozzles oriented normal to the airstream in the case of the flat plate model and at a 45-degree

(over)

angle downstream in the case of the stepped flat plate model. The hydrogen gas was ejected into a high temperature airstream (T=4000°R) at Mach Number 4.14 to 4.24. The data is presented in three forms:
(1) photographs; (2) graphical; and (3) oscillograph traces.

1. Hydrogen Combustion
2. Ramjet Engine Operation
3. Hypersonic Gas Flow

I. AFSC Project 3012

Task 301201

II. Duane R. Burnett,

Paul Czysz

III. Aval fr ONS

IV. In ASTIA collection

Aeronautical Systems Division, Directorate of Engineering Test, Deputy for Test and Support, Wright-Patterson AFB, Ohio.
Rpt No. ASD-TDR-62-196. SUPERSONIC HYDROGEN COMBUSTION STUDIES. Final report, Apr 63.
32p., incl illus, refs.

Unclassified Report

The purpose of this test was to develop diagnostic techniques for the detection of hydrogen combustion in a hypersonic high temperature airstream. This was accomplished by ejecting hydrogen through sonic nozzles oriented normal to the airstream in the case of the flat plate model and at a 45-degree

(over)

angle downstream in the case of the stepped flat plate model. The hydrogen gas was ejected into a high temperature airstream (25-4000°R) at Mach Number 4.14 to 4.24. The data is presented in three forms:
(1) photographs; (2) graphical; and (3) oscillograph traces.

1. Hydrogen Combustion
2. Ramjet Engine Operation
3. Hypersonic Gas Flow

I. AFSC Project 3012

Task 501201

- II. Duane R. Burnett, Paul Czyz
- III. Avail fr ODS
- IV. In ASTIA collection

Aeronautical Systems Division, Directorate of Engineering Test, Deputy for Test and Support, Wright-Patterson AFB, Ohio.
Rpt No. ASD-TDR-63-196. SUPERSONIC HYDROGEN COMBUSTION STUDIES. Final report, Apr 63.
32p., incl illus, refs.

Unclassified Report

The purpose of this test was to develop diagnostic techniques for the detection of hydrogen combustion in a hypersonic high temperature airstream. This was accomplished by ejecting hydrogen through sonic nozzles oriented normal to the airstream in the case of the flat plate model and at a 45-degree

(over)

angle downstream in the case of the stepped flat plate model. The hydrogen gas was ejected into a high temperature airstream (25-4000°R) at Mach Number 4.14 to 4.24. The data is presented in three forms:
(1) photographs; (2) graphical; and (3) oscillograph traces.

UNCLASSIFIED

UNCLASSIFIED