

UNCLASSIFIED

AD _ 405 132 _

DEFENSE DOCUMENTATION CENTER

FOR

SCIENTIFIC AND TECHNICAL INFORMATION

CAMERON STATION, ALEXANDRIA, VIRGINIA



UNCLASSIFIED

NOTICE: When government or other drawings, specifications or other data are used for any purpose other than in connection with a definitely related government procurement operation, the U. S. Government thereby incurs no responsibility, nor any obligation whatsoever; and the fact that the Government may have formulated, furnished, or in any way supplied the said drawings, specifications, or other data is not to be regarded by implication or otherwise as in any manner licensing the holder or any other person or corporation, or conveying any rights or permission to manufacture, use or sell any patented invention that may in any way be related thereto.

63-3-5

TM-(L)-734/024/00

4054805

STANDARD DATA
A-1159

405 132

TECHNICAL MEMORANDUM

(TM Series)

DDC AVAILABILITY NOTICE

Qualified requesters may obtain copies of this report from DDC.

This document was produced by SDC in performance of contract AF 19(628)-1648, Space Systems Division Program, for Space Systems Division, AFSC.

1604 Simulation Program Descriptions	SYSTEM
Milestone 11	DEVELOPMENT
The Simulated Telemetry Data Generation Control Program (STGR)	CORPORATION
by	2500 COLORADO AVE.
J. Ng	SANTA MONICA
15 March 1963	CALIFORNIA
Approved	
J. B. Munson	

The views, conclusions or recommendations expressed in this document do not necessarily reflect the official views or policies of agencies of the United States Government.

Permission to quote from this document or to reproduce it, wholly or in part, should be obtained in advance from the System Development Corporation.

Although this document contains no classified information it has not been cleared for open publication by the Department of Defense. Open publication, wholly or in part, is prohibited without the prior approval of the System Development Corporation.



TABLE OF CONTENTS

	<u>Page</u>
1.0 IDENTIFICATION.....	1
2.0 PURPOSE.....	1
3.0 USAGE.....	1
3.1 Introduction.....	1
3.2 Input.....	2
3.2.1 Parameters.....	2
3.2.2 Input Function Card Format.....	4
3.3 Errors, Stops and Recovery Procedures.....	6
3.3.1 Comment Printouts.....	6
3.3.2 Error Printouts.....	7
3.4 Output.....	7
3.4.1 Output 1200 Bit Line.....	7
3.4.2 Output (5-Level Paper Tape).....	8
4.0 METHOD.....	10
4.1 Algorithm #1--"Step Function".....	11
4.2 Algorithm #2--"Steady State and Dynamic Functions".....	12
4.3 Algorithm #3--"Smoothing Function".....	14
4.4 Algorithm #4--"Switch Setting-Unequal Increment".....	14
4.5 Algorithm #5--"Switch Setting-Equal Increments".....	15
4.6 Algorithm #6--"Meter".....	16
4.7 Noise Error.....	16
5.0 RESTRICTIONS.....	17
5.1 Hardware Components.....	17
5.2 Program Restriction.....	17
6.0 TIMING.....	17
7.0 STORAGE REQUIREMENTS.....	17
8.0 VALIDATION TEST.....	17
8.1 Description of Input Parameters.....	17

15 March 1963

- ii -

TM-(L)-734/024/00

	<u>Page</u>
8.1.1 Hardware Configurations Control (from SIFSA Card).	20
8.1.2 Input Control Cards.....	20
8.1.3 Running Procedure.....	22
8.2 Expected Output from Test.....	22
9.0 REFERENCES.....	22
APPENDIX A - STGR Logic Flow.....	23
APPENDIX B - On-Line Printout of Input Cards.....	28

15 March 1963

- 1 -

TM-(L)-734/024/00

1.0 IDENTIFICATION

1.1 Title

STGR - Ident K07, Mod. 03

1.2 Programmed

15 December 1962, J. Ng, System Development Corporation

1.3 Documented

5 February 1963, J. Ng, System Development Corporation

2.0 PURPOSE

The Simulated Telemetry Data Generation Control Program (STGR) has been designed to provide realistic telemetry data (Fixed Format and Event Items) under card input control. The simulated data will be packed in the same format as the Telemetry Report Message (Message Type #13). In the present version, only the FM/FM telemetry data is simulated. Additional capability to simulate PAM and PCM telemetry data (exclusive of special vehicle-specific payload telemetry) will be incorporated (if desirable) at a future date, when adequate information is available.

3.0 USAGE

3.1 Introduction

The STGR program is an integral part of the Simulated Input Preparation System for Augmentation (SIPSA). Simulated telemetry data is generated by Request Cards, containing identifying information and parameters necessary to define uniquely an operational telemetry mode. The output of this program is a simulated telemetry report message which can be used as a simulated input, via the "Simulated" tracking station 160-A Computer, to the Bird Buffer at the STA. (See Appendix A for STGR Logic Flow.)

3.2 Input

3.2.1 Parameters

a. Telemetry Mode Selection (P1)

This parameter is a 4-digit octal number used to identify an operational telemetry mode.

b. Telemetry Item Specifications

A maximum number of three parameters must be specified to describe an "Event" item. If the item is to be reported as "Fixed Format", then only one parameter is necessary (P3). These parameters, in groups of three's, are repeated as often as the number of items are necessary for this mode. Each of these parameters are defined as follows:

1) "Event" Ident (P2)

This parameter is a 4-digit octal number, with the leading digit set to zero, to identify this "Event" item. If the item is to be reported as "Fixed Format", this parameter field must be blank.

2) Function Specification (P3)

This parameter is used by the STGR program to identify the appropriate function, utilized to generate telemetry data, and the associated algorithm applied to this data point. This parameter must be specified for each item. If the item is an "Event" item, the next parameter must be specified. If this parameter field is blank, the program will assume that there are no more items following.

15 March 1963

- 3 -

TM-(L)-734/024/00

3) "Event" Report (P4)

This parameter is used by the "Event" processing algorithm applied to this item. This field must start with a "T", "N", or "V", followed by an octal number, n, (where $1 < n < 7777$). This octal number, n, is identified as time in seconds between reports, if preceded by "T"; as a "Threshold" value, if preceded by "N"; and as the number of bits repeated, if preceded by "V". This field must be punched if the item is an "Event" item.

c. Paper-Tape Option (I.O.S.) (P5)

If the pre-selected tracking station is the Indian Ocean Station, then the telemetry report will be punched on a 5-level paper tape and each report will be updated by the number of seconds specified by P5. Paper tape output is not dependent on station number.

The following table (Item Specification Table) should be helpful to the user when preparing input cards.

ITEM SPECIFICATION TABLE

FUNCTION	EVENT			FIXED FORMAT	DATA GENERATION MODULE	TYPE OF DATA	MAX. NO. OF BITS
	PROC. ALGORITHM	P2 IDENT	P4 CRITERIA	PROC. ALGORITHM			
P ₃							
XXS	1	OCTAL	N-n(N)	Not Used	Step	OCTAL	8
XXL	2	OCTAL	T-n(T)	2	Steady State	OCTAL	8
XXL	3	OCTAL	T-n(T)	3	Steady State	OCTAL	8
B	4	OCTAL	T-n(T)	4	Steady State	4-BIT BCD	4
C	5	OCTAL	T-n(T)	5	Steady State	4-BIT BCD	4
V	6	OCTAL	V-n(V)	Not Used	Constant	OCTAL	16
XXW	2	OCTAL	T-n(T)	2	Dynamic	OCTAL	8
XXW	3	OCTAL	T-n(T)	3	Dynamic	OCTAL	8

XX → This represents some number ranging from 0-9. The number identifies one of the ten variable patterns provided within each Data Generation Module. These variations will be presented in a table form under "Algorithm Method".

3.2.2 Input Function Card Format

The input parameters described above are input to the SIPSA system by punched cards. In addition, certain system control cards are necessary (see Operating Instructions, Milestone 7, TM-(L)-734/022/00). A maximum of 44 input cards can be input to SIPSA to describe a telemetry mode. Each follower card must have a "plus" sign punched in Column 1. If the telemetry report is to be punched on paper tape (I.O.S.), then Column 80 of the first card must be punched with the time interval (in seconds) between reports (1-9). The input function card format is illustrated as follows:

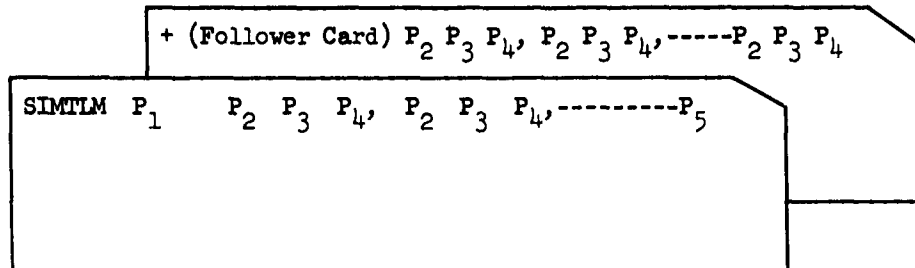

<u>Columns</u>	<u>Content</u>	<u>Description</u>
1-8	SIMTLM	Telemetry Request function identification, left justified with trailing blanks.
12-15	P ₁	Telemetry mode, octal number, right justified ($0 \leq P_1 < 7777$).
17-20) 33-36) 49-52) 65-68)	P ₂	"Event" item ident, octal number with a leading zero. If the item is "Fixed Format", this field must be blank.
22-24) 38-40) 54-56) 70-72)	P ₃	Type of telemetry function. The last column of this field specifies the data generation module; the preceding decimal number (0-9) specifies one of the ten variations.
27-31) 43-47) 59-63) 75-79)	P ₄	This field must be punched if the item is an "Event" item. This field begins with a T, N, or V, followed by an octal number, n, ($1 < n < 7777$).
80	P ₅	This column equals the time interval in seconds between reports, if paper tape output (5-level) is requested. P ₅ is specified only on the first card.

The input parameters P₂, P₃, and P₄ are repeated, if necessary, by follower cards with a "plus" sign in Column 1.

3.3 Errors, Stops and Recovery Procedures

In the process of generating telemetry data, the STGR program performs certain legality checks on the input parameters. If errors are detected, the program will stop. On-line printouts are provided with recovery procedures. There are two types of on-line printouts provided. The first type is a "Comment" printout, which is recoverable, and the second type is an "Error" printout, which is non-recoverable.

3.3.1 Comment Printouts

- a. The following printout is provided when the program is ready to start punching paper tape. The message on the printer will read:

ENABLE PAPER TAPE PUNCH FOR TELEMETRY. CHECK
TO BE SURE THE PAPER TAPE IS 5-LEVEL....PUSH
ON.

- b. The following printout is provided when the program has finished punching paper tape for one pass. The message on the printer will read:

ALL TELEMETRY DATA HAS BEEN PUNCHED....PUSH ON.

- c. The following printout is provided when the program has detected that one or more of the telemetry item specifications is out of sequence (i.e., a "Fixed Format" item is specified after an "Event" item). The message on the printer will read:

INPUT PARAMETER FOR TELEMETRY IS OUT OF SEQUENCE.
HIT START TO CONTINUE.

Upon recovery, the telemetry item that is out of sequence will be corrected by the STGR program. If a "Fixed Format" item is found after an "Event" item, the program will place this "Fixed Format" item behind the last "Fixed Format" item in a sequence table.

3.3.2 Error Printouts

When an error is found on an input card (parameters punched in the wrong column or mispunched), one of the following two messages will be printed and the program stops with no recovery.

- a. THERE IS AN ERROR ON A TELEMETRY SPECIFICATION CARD. RETURN JOB TO PROGRAMMER FOR CORRECTION.
- b. THERE ARE ILLEGAL CHARACTERS IN A CARD FIELD BEING CONVERTED TO BINARY. IF THE CARD CAN BE CORRECTED, DO SO, THEN RESTART.

3.4 Output

Two types of output are provided by STGR. One type is to be transferred through the Digital Data Line; the other is punched on 5-level paper tape. The output of the first type is packed in the exact format as the telemetry report message and will be written on the SIMTAPE. The output of the second type is punched directly on 5-level paper tape from STGR for an entire pass or for a period of time specified on the "GENERATE" card, whichever is smaller. The two types of output format are presented in the following paragraph.

3.4.1 Output 1200 Bit Line

	47	NUMBER OF 160A WORDS			0
SIMBUF					
+1		7777	SS13	MMM	XOTT
+2		TTTT	NNNN	NNNN	NNNN
		NNNN	XEEE	BBBB	CCCC
+n		BBBB	CCCC	CKSUM	

where:

7777 = New Message Header
SS = Station Number
13 = Telemetry Message Code
M's = Telemetry Mode
T's = System time, 6 most significant bits first, right justified, followed by 11 least significant bits in the next word, right justified.
X = High-order bit=1 and second high-order bit=0 if event.
N's = Fixed Format telemetry value
E's = 10 least significant bits of associated system time (for simulation, all associated system time for event items will be equal).
B's = Event ident with a leading zero.
C's = Event value
CKSUM = Arithmetic Complement Checksum for this message.

3.4.2 Output (5-Level Paper Tape)

The paper tape output will consist of the following:

a. Header Message

This is the Operational Telemetry Mode message sent to the Bird Buffer at the STA.

b. Telemetry Report Message

This is the message type #13 which is normally sent over the 1200 bps line.

c. Fade Message

This is the message sent to the STA when the vehicle fades or when the estimated time to track is zero.

Telemetry Report Header Message

H ₁₁	H ₇	H ₃	S ₅	S ₁	A ₃	M ₁₁	M ₇	M ₃	C ₁₁	C ₇	C ₃
H ₁₀	H ₆	H ₂	S ₄	S ₀	A ₂	M ₁₀	M ₆	M ₂	C ₁₀	C ₆	C ₂
H ₉	H ₅	H ₁	S ₃	A ₅	A ₁	M ₉	M ₅	M ₁	C ₉	C ₅	C ₁
H ₈	H ₄	H ₀	S ₂	A ₄	A ₀	M ₈	M ₄	M ₀	C ₈	C ₄	C ₀
P	P	P	P	P	P	P	P	P	P	P	P

- H₁₁ - H₀ = New Message Header (all 1's)
- S₅ - S₀ = Station Number
- A₅ - A₀ = Message Code (001010=12)
- M₁₁ - M₀ = Telemetry Mode
- C₁₁ - C₀ = Arithmetic Complement Checksum of the header message.
- P's = Parity (odd)

Telemetry Report Message

H ₁₁	H ₇	H ₃	S ₅	S ₁	A ₃	M ₁₁	M ₇	M ₃	B ₁₁	B	T ₁₄	B	T ₇	T ₃	N	N	--C ₁₁	D ₇	D ₃	B	I ₇	I ₃	E..K ₁₁	K ₇	K ₃	
H ₁₀	H ₆	H ₂	S ₄	S ₀	A ₂	M ₁₀	M ₆	M ₂	B	B	T ₁₃	T ₁₀	T ₆	T ₂	N	N	--B	D ₆	D ₂	B	I ₆	I ₂	E..K ₁₀	K ₆	K ₂	
H ₉	H ₅	H ₁	S ₃	A ₅	A ₁	M ₉	M ₅	M ₁	B	T ₁₆	T ₁₂	T ₉	T ₅	T ₁	N	N	--D ₉	D ₅	D ₁	B	I ₅	I ₁	E..K ₉	K ₅	K ₁	
H ₈	H ₄	H ₀	S ₂	A ₄	A ₀	M ₈	M ₄	M ₀	B	T ₁₅	T ₁₁	T ₈	T ₄	T ₀	N	N	--D ₈	D ₄	D ₀	I ₈	I ₄	I ₀	E..K ₈	K ₄	K ₀	
P	P	P	P	P	P	P	P	P	P	P	P	P	P	P	P	P	P	--P	P	P	P	P	P	P	P	P

- H₁₁ - H₀ = New Message Header (all 1's)
- S₅ - S₀ = Station Number
- A₅ - A₀ = Message Code (001011=13)
- M₁₁ - M₀ = Telemetry Mode
- B's = Blanks (except B₁₁=C₁₁=1 if message contains "Event" only)
- T₁₆ - T₁₁ = 6 most significant bits of system time, right justified.
- T₁₀ - T₀ = 11 least significant bits of system time, right justified.
- N = Fixed Format telemetry items
- C₁₁ = 1 (ident bit of "Event" associated system time)

but to provide compressed data which, for program checkout purposes, appears to have been processed by these algorithms. A description of the methods employed to achieve this will be presented in the following paragraphs.

4.1 Algorithm #1--"Step Function"

This algorithm is applied only to "Event" item requests.

a. Input

- 1) Event Ident (P2)
- 2) Function Request - XKS (P3)
- 3) Threshold Value (P4)

b. Procedure

Using P3, the variable pattern (XKS), a "Step Function" data point, X_i , is generated, where X_i is assumed to be the average value of the last four samples and the value is assumed to be within the noise level. The absolute difference is formed between the old and the new point. If this difference exceeds the threshold value (P4), then X_i is the output and the old value will be replaced by X_i . To help the user select the appropriate variable pattern for the Step Function, the following table should be used.

Equation: $X_i = b_i + (-1)^P \Delta b_i$ for K_i seconds ($2 < X_i < 254$)

XX	b_i	Δb_i	K_i	P*
0	125	8	10	0
1	135	10	20	0
2	145	12	30	0
3	155	14	40	0
4	165	16	50	0
5	125	18	60	1
6	135	20	70	1
7	145	22	80	1
8	155	24	90	1
9	165	26	100	1

where XX = Pattern variable specification in P3 (XXS).

*P is updated by 1 every K_i seconds as t increases.

4.2 Algorithm #2--"Steady State and Dynamic Functions"

This algorithm can be applied to both "Event" and "Fixed Format" telemetry items.

a. Input

- 1) Event Ident (P2), if item is "Event".
- 2) Function Request - XXL or XXW (P3).
- 3) Number of seconds between reports (P4), if item is "Event".

b. Procedure

Using P3, a data point, X_1 , is generated (use the same assumptions as Algorithm #1). The value X_1 will always be within the high and low calibration limits ($2 \leq X_1 \leq 254$). If the item is to be reported as an "Event", then X_1 is the output for the interval specified (P4). If the item is to be reported as "Fixed Format", then X_1 is reported every second. The following equations and tables are used:

$$\text{"Steady State": } X_1 = at + b - (\text{pak})$$

XX	a_1	b_1	X(min/max)	K_1	P*
0	2	8	248 max	120 sec.	0
1	4	8	248 max	60 sec.	0
2	8	8	248 max	30 sec.	0
3	16	8	248 max	15 sec.	0
4	32	8	248 max	7 sec.	0
5	-2	248	8 min	120 sec.	0
6	-4	248	8 min	60 sec.	0
7	-8	248	8 min	30 sec.	0
8	-16	248	8 min	15 sec.	0
9	-32	248	8 min	7 sec.	0

where XX = Pattern variable specification in P3 (XXL)

*P is updated by 1 for $X_1 \geq 248$ or $X_1 \leq 8$ as t increases.

"Dynamic Function": $X_1 = a \sin(Kt) + b$

XX	a_1	b_1	X(max)	K
0	118	128	248	1/2 π
1	108	128	248	1/2 π
2	98	128	248	1/2 π
3	88	128	248	1/2 π
4	78	128	248	1/2 π
5	68	128	248	1/2 π
6	58	128	248	1/2 π
7	48	128	248	1/2 π
8	38	128	248	1/2 π
9	28	128	248	1/2 π

where XX = Pattern variable specification in P3 (XXW)

4.3 Algorithm #3--"Smoothing Function"

Same as Algorithm #2.

4.4 Algorithm #4--"Switch Setting-Unequal Increment"

This algorithm is applied to both "Event" and "Fixed Format" telemetry items.

a. Input

- 1) Event Ident (P2), if item is "Event"
- 2) Function Request - OOB (P3)
- 3) Number of seconds between reports (P4), if item is "Event".

b. Procedure

A "Steady State" data point, X_i , is generated with noise. Then a switch-setting, Y_i , is assigned to this point by the following criteria:

If $240 < X_i$,	then switch-setting	$Y_i = 17$	(4 bits)
$192 < X_i < 240$	" "	= 5	
$144 < X_i < 192$	" "	= 4	
$96 < X_i < 144$	" "	= 3	
$48 < X_i < 96$	" "	= 2	
$X_i < 48$	" "	= 1	

If this item is to be reported as a "Fixed Format" item, then Y_i is the 4-bit BCD output.

If this item is to be reported as an "Event" item, then Y_i is compared against Y_{i-1} . If $Y_i \neq Y_{i-1}$, then Y_i is reported and Y_{i-1} is replaced by Y_i . If $Y_i = Y_{i-1}$, then P4 is tested to see if it is time for a periodic report. If it is, Y_i is reported.

4.5 Algorithm #5--"Switch Setting-Equal Increments"

Same as Algorithm #4, except that there are 10 switch settings instead of 5. The 10 switch settings are as follows:

If $240 < X_i$,	then switch-setting	$Y_i = 17$
$216 < X_i < 240$	" "	= 9
$192 < X_i < 216$	" "	= 8
$168 < X_i < 192$	" "	= 7
$144 < X_i < 168$	" "	= 6
$120 < X_i < 144$	" "	= 5

$96 < X_1 < 120$,	then switch-setting	Y_1	= 4
$72 < X_1 < 96$	"	"	= 3
$48 < X_1 < 72$	"	"	= 2
$24 < X_1 < 48$	"	"	= 1
$X_1 < 24$	"	"	=12 (zero for BCD)

The rest is the same as Algorithm #4.

4.6 Algorithm #6--"Meter"

Input

1. Event Ident (P2)
2. Function Request - OOV (P3)
3. Bits repeated - V0000 (P4)

This algorithm is applied only to the "Event" item on a continuous FM/FM channel. No method has been developed to simulate the bit pattern of this type of telemetry read-out. For the present time, the vehicle velocity value is used and the output is every second. The output value is split into two, 160-A words. The first word contains the most significant 8 bits and the second word contains the least significant 8 bits, both right justified.

4.7 Noise Error

Computations during the generation of simulated raw telemetry data are based on a set of mathematical equations resembling telemetry signals when plotted against time. However, actual telemetry data points, as would be input from the TDP to the Bird Buffer at the STA, contain noise. In order to simulate telemetry data more realistically, noise error is introduced into the raw data prior to processing.

The first step in the addition of noise error is by the generation of a random number ranging from 0 to 7. Then the result is selectively substituted into the three least significant bits of the data point.

5.0 RESTRICTIONS

5.1 Hardware Components

- a. 1604 Computer
- b. Paper tape punch (5-level paper tape) if paper tape output is requested.
- c. Three tape drives

5.2 Program Restriction

- a. The program assumes no "Out of limit" reports.
- b. There will be no on-line response to mode parameter changes.
- c. STGR can only be operated with the SIPSA system.
- d. Only 44 function input cards will be accepted.

6.0 TIMING

Operating time is a variable. The amount of time depends on the amount of data requested.

7.0 STORAGE REQUIREMENTS

	<u>Decimal</u>	<u>Octal</u>
Main Program (STGR)	492	754
Tables and Constants	<u>1527</u>	<u>2767</u>
Total Storage Requirement	2019	3743

8.0 VALIDATION TEST

8.1 Description of Input Parameters

In order to check out completely the telemetry data generation

15 March 1963

- 18 -

TM-(L)-734/024/00

program (STGR), many parameter checkout tests were completed. Included in this document, as Appendix B, are some of the results extracted from the final validation checkout run. In this test, 12 "Fixed Format" telemetry items and 11 "Event" items were specified. All 6 algorithms were used for this run. The output result in each telemetry report message can be identified as message type #13. Each of the telemetry items in the report can be identified by the following table of input specification summary.

Validation Test Input Specification Summary

ITEM NO.	TYPE OF REPORT	TELEMETRY FUNCTION	"EVENT" IDENT IN OCTAL	NO. OF BITS IN TELEMETRY VALUE	TIME BETWEEN REPORTS (SECONDS IN OCTAL)	"STEP" FUNCTION" THRESHOLD IN OCTAL	"METER" NO. OF BITS REPEATED
1-4	Fixed Format	Steady State	-	8	-	-	-
5-10	"	Dynamic	-	8	-	-	-
11-12	"	Switch Setting	-	4	-	-	-
13	Event	*Steady State	0111	8	2 sec.		
14	"	"	0222	8	3 sec.		
15	"	"	0333	8	4 sec.		
16	"	Step	0444	8		2	
17	"	Step	0555	8		4	
18	"	*Dynamic	0666	8	5 sec.		
19	"	"	0777	8	10 sec.		
20	"	"	0122	8	12 sec.		
21	"	"Meter"	0616	16	-	-	16
22	"	Switch Setting	0717	4	5 sec.		
23	"	"	0727	4	5 sec.		

*There is no "out of limit" report from either Algorithm #2 or #3 for the "Event" items.

8.1.1 Hardware Configurations Control (from SIPSA Card)

- a. Input Control Cards: Card Reader
- b. SIPSA System Master Tape: Tape Unit No. 1
- c. SIMTAPE (final output): Tape Unit No. 5
- d. Scratch tape (Utility): Tape Unit No. 3
- e. On-line output: Printer

8.1.2 Input Control Cards

The following cards were used for the validation test:

a. *SIPSA (SIPSA System Calling Card)

This card specifies the following input conditions:

- 1) Input source = 0 (card reader)
- 2) Tape Unit No. 5 to record "simulated" data.
- 3) Test I.D. = TMCHCK (6-character)
- 4) Type of SIMTAPE = BB (Bird Buffer)

b. START (Initialization Card)

This card specifies the program initial conditions prior to generation of data.

- 1) Station Number = 5
- 2) CCC "spigot" for Telemetry Computer = B
- 3) CCC "spigot" for Tracking Computer = A
- 4) Vehicle Number = 2041
- 5) Revolution Number = 8
- 6) Vehicle & System Start Time = 0
- 7) Telemetry Mode = 1234

c. SIMTLM (Telemetry Data Request Cards)

There are six telemetry item specification cards (see Appendix B).



d. GENERATE (Duration Card)

This card specifies, in seconds, the duration of the run. The output is one TIM message per second. The number used is 100.

e. END-XMIT (End of Transmission)

This card will cause the SIPSA system to generate an "End-of-Pass" record.

f. STOP (SIMTAPE prepared)

This card terminates the SIPSA operation.

The above cards were arranged in the following sequence:

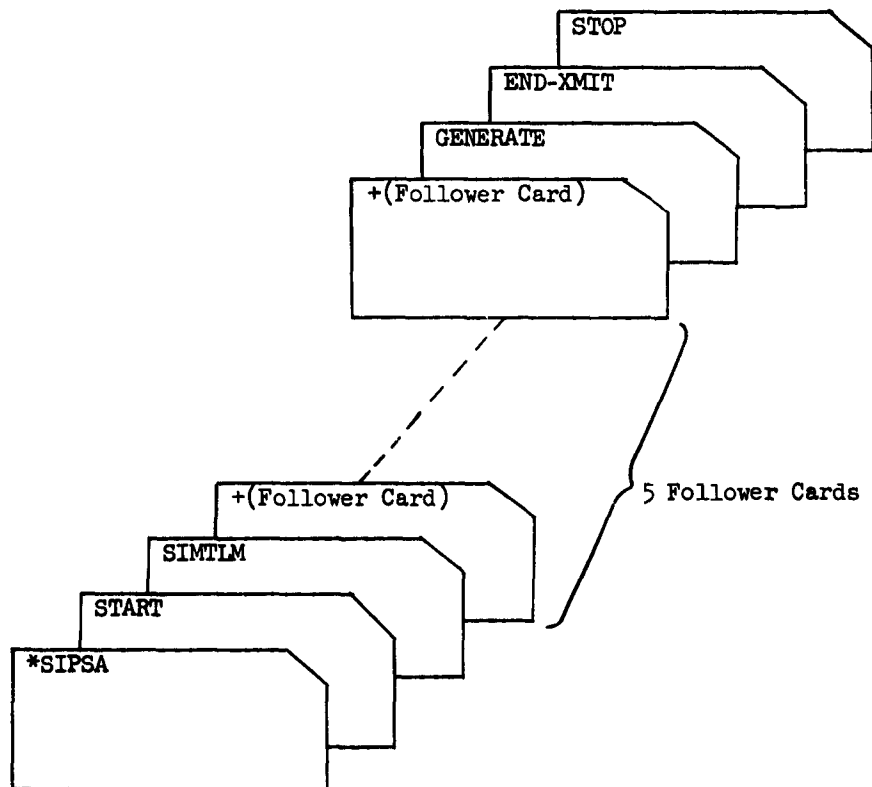

8.1.3 Running Procedure

- a. Input Cards placed in the Card Reader
- b. Tape Units Nos. 1, 3, and 5 ready
- c. Card-Reader & Printer ready
- d. Auto-load
- e. Repeat above test with paper tape output.

8.2 Expected Output from Test

- a. On-line printout indicating all cards read in.
- b. SIMTAPE prepared on Tape Unit No. 5.
- c. Total number of reports = 100.

9.0 REFERENCES

- a. TM-(L)-734/015/00, Computer Program Design Specifications for the Simulation of the Augmented SCF Environment at the STA and CPDC (Milestone 4), System Development Corporation, November 1962.
- b. N-(L)-19083/007/00*, Program Interfaces (FM/FM Telemetry Algorithms), System Development Corporation, December 1962.
- c. TM-(L)-949/000/00, Telemetry Data Flow for the Augmented SCF, System Development Corporation, January 1963.

*An internal document not available to non-SDC personnel.

- 23 -
APPENDIX A
STGR

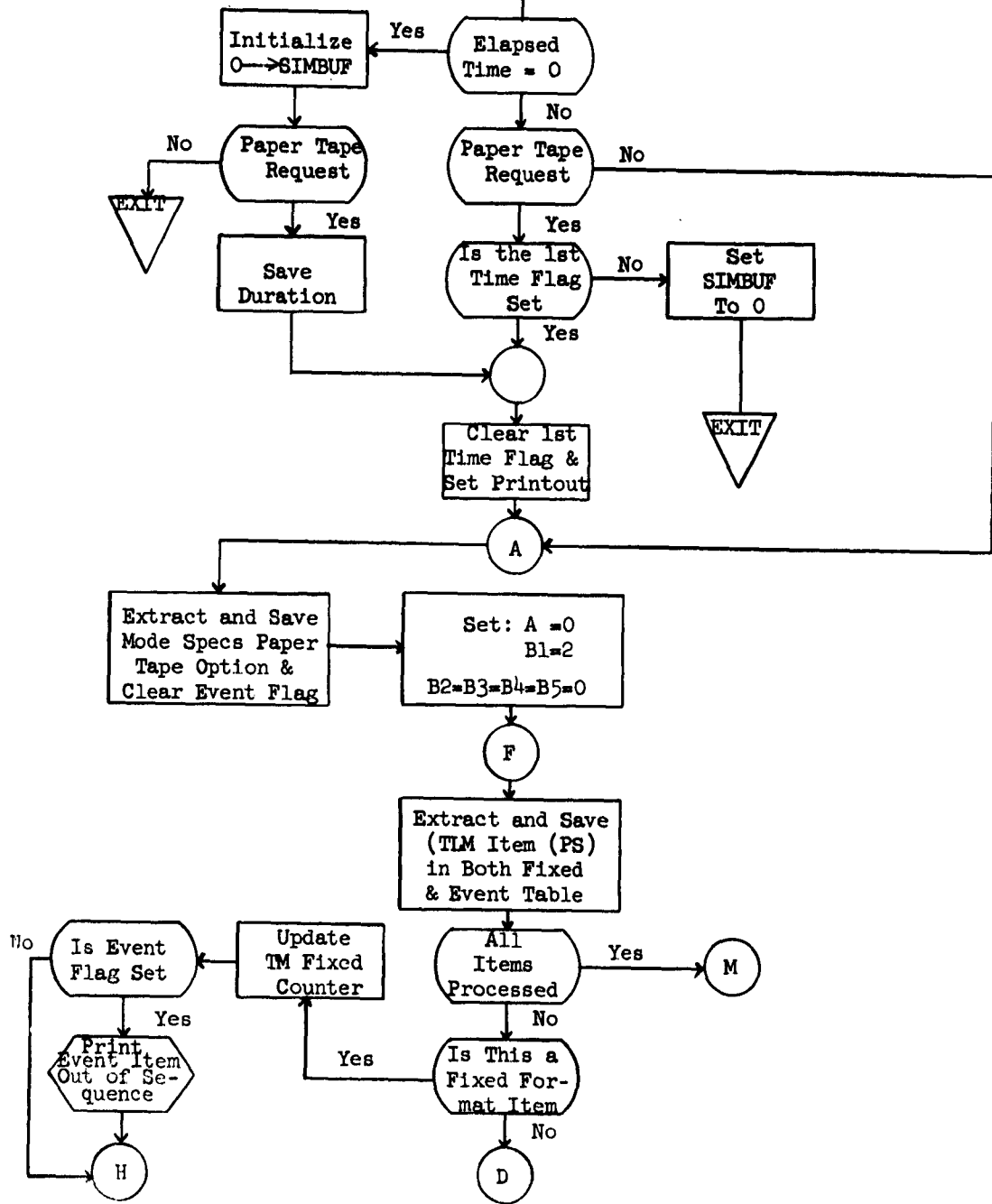

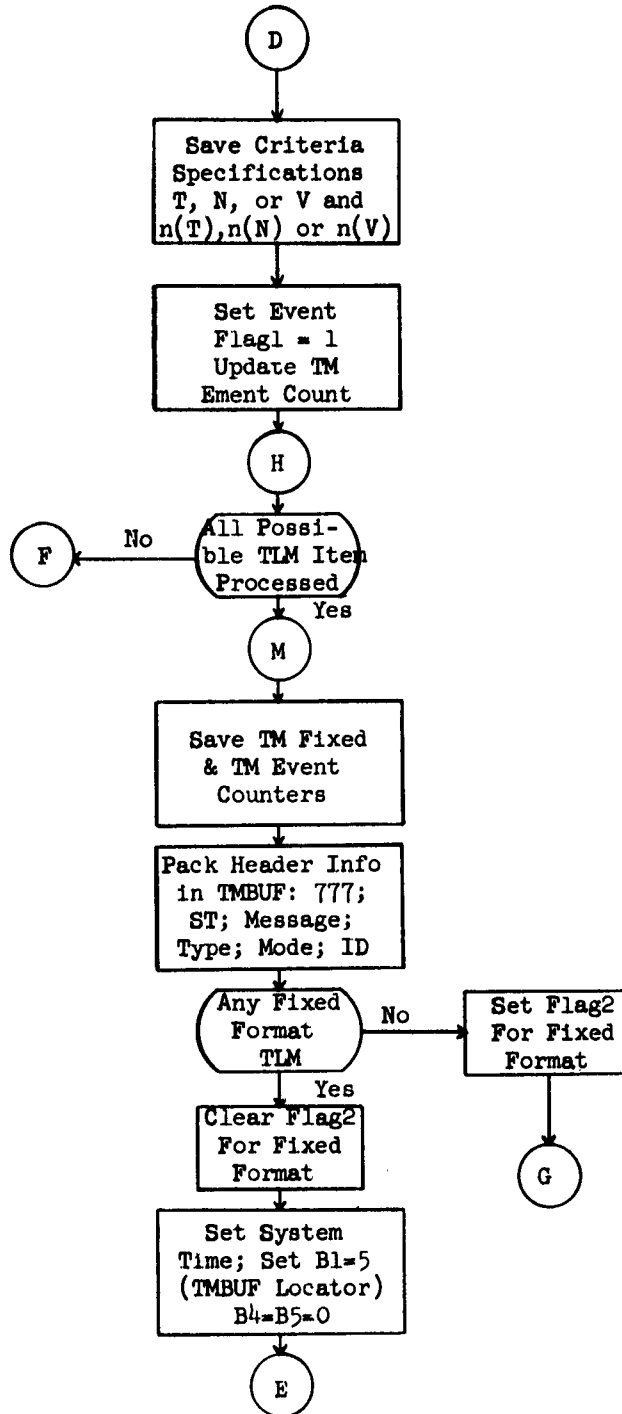

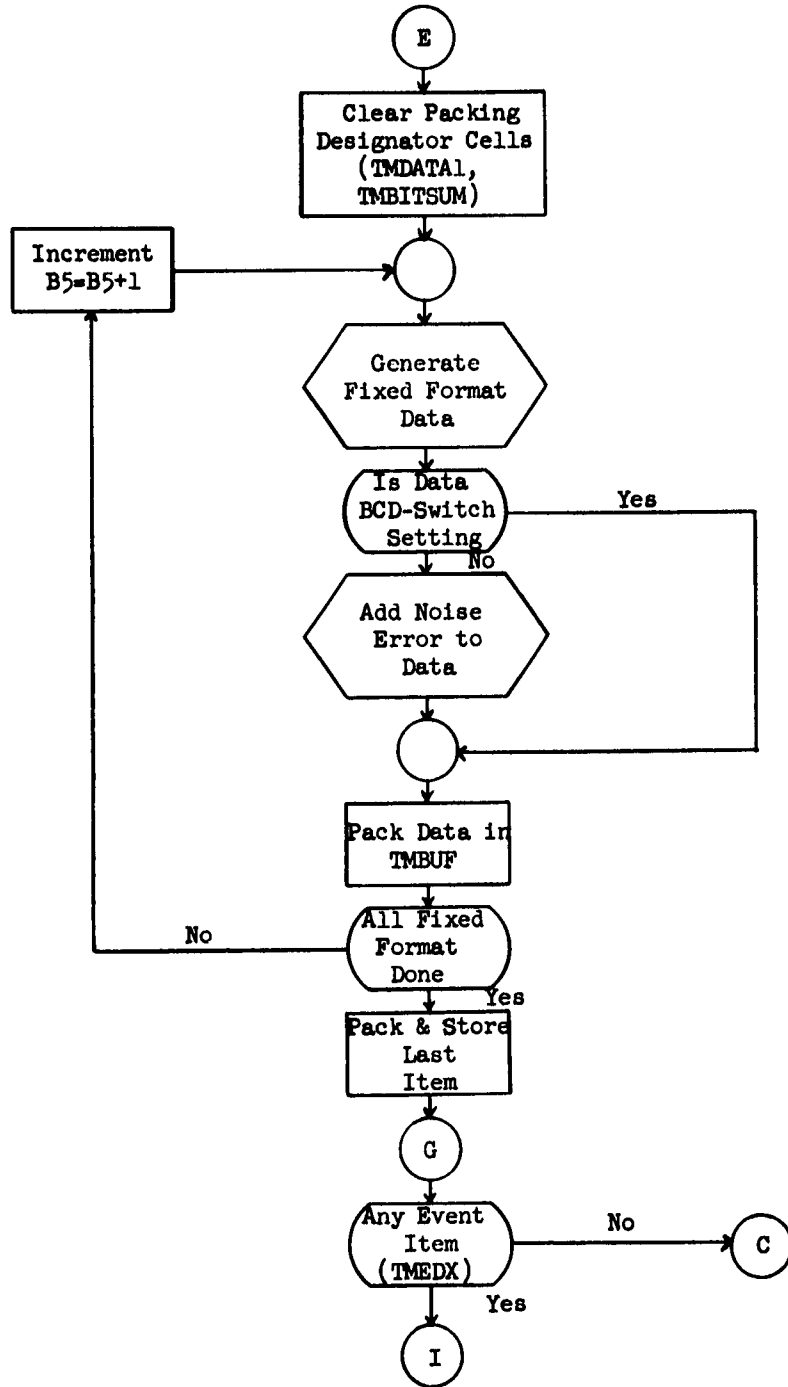

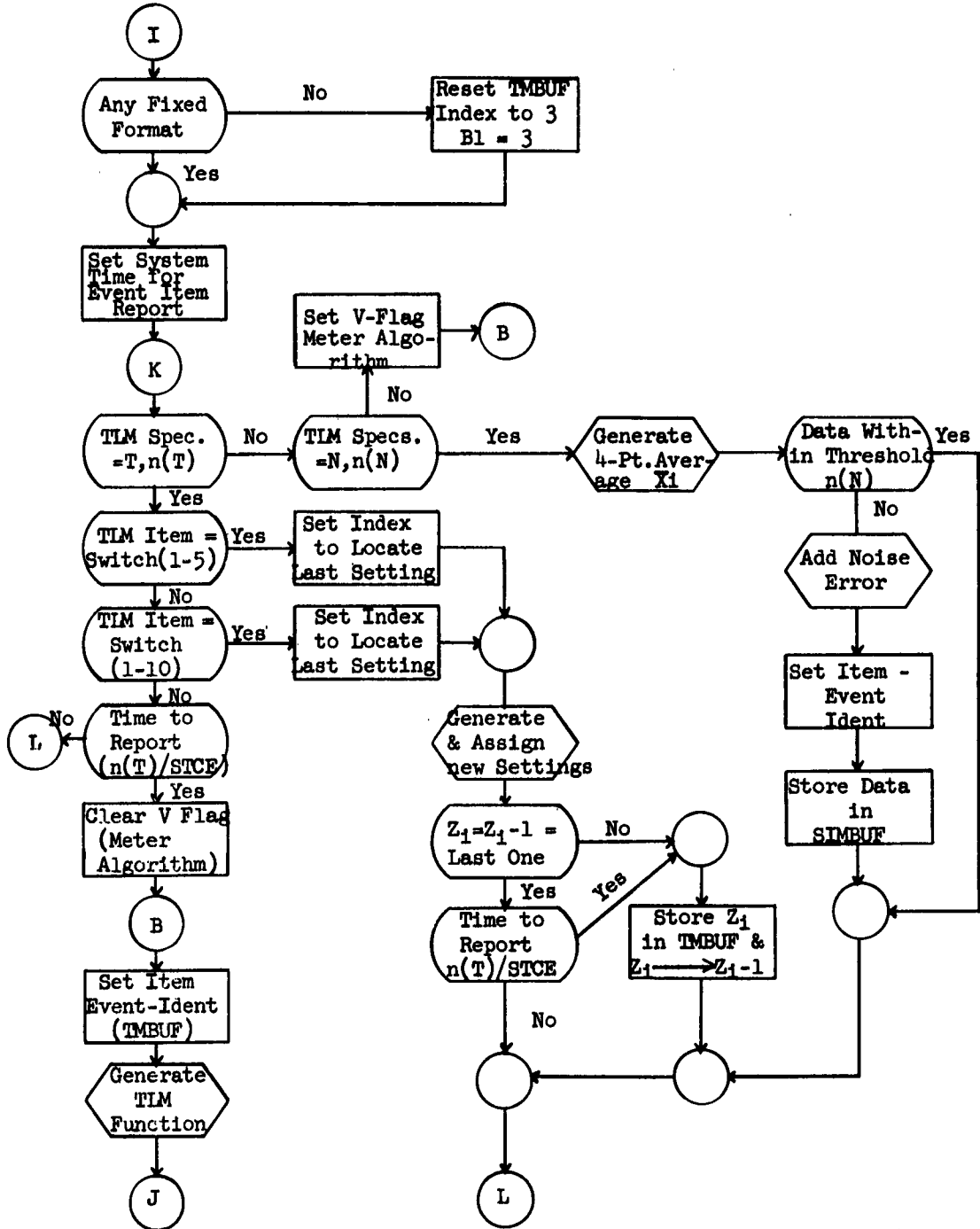

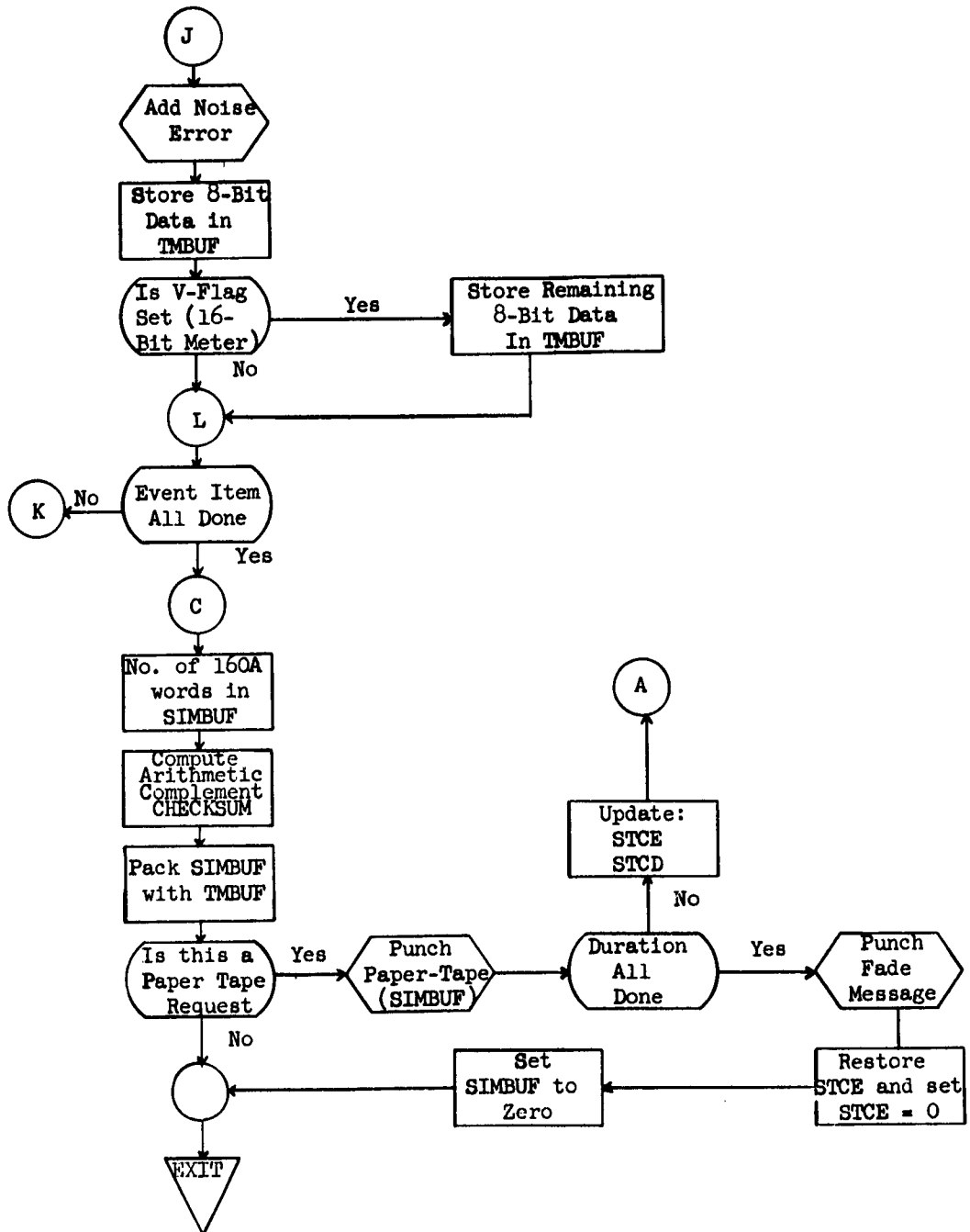

15 March 1963

- 28 -

TM-(L)-734/024/00

APPENDIX B

ON-LINE PRINTOUT OF INPUT CARDS

```
START      01      A B 02041 0008 1234
SIMTLM     1234      01L      02L      03L      04L
+          01W      02W      03W      04W
+          05W      06W      00B      00C
+          0111 01L T0002 0222 02L T0003 0333 03L T0004 0444 04S N0002
+          0555 05S N0004 0666 01W T0005 0777 02W T0010 0122 03W T0012
+          0616 00V V0016 0717 00B T0005 0727 00C T0005
GENERATE   0100
END-XMIT
STOP
```

A SIMULATED DATA TAPE HAS BEEN PREPARED. THE TAPE HAS
BEEN REWOUND AND MARKED WITH AN END-OF-FILE.

BB TAPE PROCESSED BY DROPSA

TAPE I.D. = TMCHCK

STATION	VEHICLE NO.	REVOLUTION NO.	PREPASS OPTION	TRK COMPUTER NO.	TLM COMPUTER NO.	TLM MODE
HULA	2041	8.0	0	1	2	1234

15 March 1963

- 29 -

TM-(L)-734/024/00

SITE-ON-LINE TIME MESSAGE

OCTAL

1.	7777	STATION
2.	0517	
3.	0000	SYSTEM TIME
4.	0000	0 SEC
5.	0000	CONTROL*STATUS
6.	7260	

OCTAL DUMP OF MESSAGE CONTAINING 26 WORDS

1.	2.	3.	4.	5.	6.	7.	8.
7777	0513	1234	0000	0001	0301	2431	1230
9.	10.	11.	12.	13.	14.	15.	16.
7611	4230	1601	4021	0400	4001	0444	0265
17.	18.	19.	20.	21.	22.	23.	24.
0555	0151	0616	0000	0000	0717	0001	0727
25.	26.						
0001	7010						

OCTAL DUMP OF MESSAGE CONTAINING 20 WORDS

1.	2.	3.	4.	5.	6.	7.	8.
7777	0513	1234	0000	0002	0421	4453	2231
9.	10.	11.	12.	13.	14.	15.	16.
4620	4510	6611	4221	0400	4002	0111	0021
17.	18.	19.	20.				
0616	0000	0000	4541				

1.

15 March 1963

- 30 -

TM-(L)-734/024/00

OCTAL DUMP OF MESSAGE CONTAINING 18 WORDS

1.	2.	3.	4.	5.	6.	7.	8.
7777	0513	1234	0000	0053	5427	3731	1232
9.	10.	11.	12.	13.	14.	15.	16.
5641	4631	4224	4322	2000	4053	0616	0000
17.	18.						
0000	1006						

OCTAL DUMP OF MESSAGE CONTAINING 26 WORDS

1.	2.	3.	4.	5.	6.	7.	8.
7777	0513	1234	0000	0054	5627	5751	2233
9.	10.	11.	12.	13.	14.	15.	16.
0254	5131	4631	4563	2400	4054	0111	0273
17.	18.	19.	20.	21.	22.	23.	24.
0333	0351	0616	0000	0000	0717	0003	0727
25.	26.						
0005	6213						

OCTAL DUMP OF MESSAGE CONTAINING 26 WORDS

1.	2.	3.	4.	5.	6.	7.	8.
7777	0513	1234	0000	0055	5710	2411	3233
9.	10.	11.	12.	13.	14.	15.	16.
7661	5232	1631	4423	2400	4055	0222	0205
17.	18.	19.	20.	21.	22.	23.	24.
0666	0311	0616	0000	0000	0717	0003	0727
25.	26.						
0005	3604						

OCTAL DUMP OF MESSAGE CONTAINING 20 WORDS

1.	2.	3.	4.	5.	6.	7.	8.
7777	0513	1234	0000	0056	6030	4433	4234
9.	10.	11.	12.	13.	14.	15.	16.
0670	5512	6641	4623	2400	4056	0111	0301
17.	18.	19.	20.				
0616	0000	0000	5032				

15 March 1963

- 31 -
(Last Page)

TM-(L)-734/024/00

OCTAL DUMP OF MESSAGE CONTAINING 20 WORDS

1.	2.	3.	4.	5.	6.	7.	8.
7777	0513	1234	0000	0127	3576	0711	3274
9.	10.	11.	12.	13.	14.	15.	16.
4701	5412	6245	4624	4000	4127	0222	0341
17.	18.	19.	20.				
0616	0000	0000	6535				

OCTAL DUMP OF MESSAGE CONTAINING 24 WORDS

1.	2.	3.	4.	5.	6.	7.	8.
7777	0513	1234	0000	0130	3636	4730	4314
9.	10.	11.	12.	13.	14.	15.	16.
6701	5632	7641	4624	4000	4130	0111	0171
17.	18.	19.	20.	21.	22.	23.	24.
0333	0330	0777	0324	0616	0000	0000	3672

OCTAM DUMP OF MESSAGE CONTAINING 18 WORDS

1.	2.	3.	4.	5.	6.	7.	8.
7777	0513	1234	0000	0131	3637	3751	5234
9.	10.	11.	12.	13.	14.	15.	16.
5701	5632	4244	4724	4000	4131	0616	0000
17.	18.						
0000	2734						

OCTAL DUMP OF MESSAGE CONTAINING 30 WORDS

1.	2.	3.	4.	5.	6.	7.	8.
7777	0513	1234	0000	0132	4020	5411	6234
9.	10.	11.	12.	13.	14.	15.	16.
4304	5732	4641	4764	4000	4132	0111	0203
17.	18.	19.	20.	21.	22.	23.	24.
0222	0011	0666	0341	0122	0310	0616	0000
25.	26.	27.	28.	29.	30.		
0000	0717	0004	0727	0010	4436		

15 March 1963

TM-(L)-734/024/00

DISTRIBUTION
(EXTERNAL)

Space Systems Division
(Contracting Agency)

Maj. C. R. Bond (SSOCD)
Maj. N. D. LaVally (SSOX)

PIR-E4 (GE-Box 8555)

J.S. Brainard
R. J. Katucki
J. D. Selby

6594th Aerospace Test Wing
(Contracting Agency)

Lt. Col. A. W. Dill (TWRD) (10)
Lt. Col. M. S. McDowell (TWRU)
TWACS (20)

PIR-E4 (GE-3198 Chestnut)

J.F. Butler
C. A. Cummings
H. D. Gilman

PIR-E1 (Lockheed)

J.A. Boysen
N. N. Epstein
W. E. Moorman
G. F. Taylor
R. L. Vader
P. E. Williams

PIR-E4 (GE-Bethesda)

W. L. Massey

PIR-E4 (GE-Box 8661)

F. T. Clark
J. D. Rogers
W. R. Weinrich

PIR-E2 (Philco)

J. A. Bean
J. A. Isaacs
R. Morrison
S. M. Stanley

PIR-E5 (Aerospace)

A. Bakst
J. W. Bengston
R. V. Bigelow
R. O. Brandsberg
L. H. Garcia
G. J. Hansen
M. L. Luther
T. R. Parkin
E. E. Retzlaff
R. G. Stephenson
D. D. Stevenson
V. White

PIR-E3 (LFE)

D. F. Criley
K. B. Williams

PIR-E4 (GE-Santa Clara)

D. Alexander

PIR-E8 (Mellonics)

F. Druding

PIR-E4 (GE-Sunnyvale)

J. Farrentine
N. Kirby

(3)

15 March 1963

TM-(L)-734/024/00

<u>NAME</u>	<u>ROOM</u>
D. Reilly	24121
A. Robinson	24132
M. Rockwell	24086
J. Schroeder	24124
R. Scott	24110
C. Seacat	Sunnyvale
H. Seiden	22126
R. Shapiro	24110
S. Shoel	23007
R. Skelton	22152
N. Speer	24086
E. Stone	24058
M. Sweeney	25026
W. Taber	22101
T. Tennant	27029
J. Thompson	24088
C. Toche	24121
R. Totschek	24120
A. Tucker	22109
A. Vorhaus	24076
M. Weinstock	22131
S. Weems	22109
G. West	Sunnyvale
G. P. West	22116
H. Williams	22110
G. Wilson	24124
M. Winsor	22156
J. Winter	24117
R. Wise	22085
J. Wong	Sunnyvale
C. Zubris	24075
AFCPL (5)	14059

15 March 1963

TM-(L)-(34/02)/00

DISTRIBUTION
(INTERNAL)

<u>NAME</u>	<u>ROOM</u>	<u>NAME</u>	<u>ROOM</u>
D. Allfree	24083	J. Haake	22153
J. Aldana	22131	D. Henley	22094
L. Alexander	22134	C. Hill	22101
N. Alperin	22153	J. Hillhouse	22078
E. Armstrong	24123	H. Holzman	24065
		G. Hudson	24126
C. Becerra	24082		
D. Biggar	24118	R. Johnson	22125
R. Bilek	23007		
L. Brenton	24103	P. Kastama	22076
B. Burke	24086	M. Katz	25014
R. Burke	22158	F. Kayser	24109
R. Busch	22088	J. Keddy	24105
C. Bustya	22134	D. Key	23013
		R. Keyes	24073
M. Champaign	22152	J. Kneemeyer	22088
C. Chiodini	24091	R. Knight	22119
B. Ciaccia	24082	L. Kolbo	22155
R. Clements	22109		
B. Cline	24127	J. Laughlin	24073
J. Cogley	22156	J. LaVine	24093
L. Conger	24088	H. Lewis	23010
P. Cooley	24086	J. Little	24088
D. Crum	24105	F. Long	22156
		J. Lytton	24077
L. DeCuir	24053		
W. Derango	24082	G. Madrid	22081
G. Dexter	25016	G. Mahon	24089
R. Disse	23014	J. Marioni	24076
G. Dobbs	22116	R. Marshall	22160
W. Dobrusky	24065	W. Martin	24127
R. Dugas	22125	J. McKeown	23013
		J. Milanese	22155
R. Ellis	22131	J. Munson	22087
R. Ericksen	22113	G. Myers	22095
H. Feldstein	24128	P. Nelson	24075
C. Francis	25013	J. Ng	22077
H. Franks	24122	L. Ngou	24127
R. Frey	22078		
L. Friedman	22122	M. Olson	22161
S. Gardner	25026	L. Padgett	24110
V. Gergen	25014	E. Patin	Sunnyvale
I. Greenwald	22094	D. Persico	24083
		T. Polk	24113

UNCLASSIFIED

System Development Corporation,
Santa Monica, California
1604 SIMULATION PROGRAM DESCRIPTIONS,
MILESTONE 11 THE SIMULATED TELEMETRY
DATA GENERATION CONTROL PROGRAM (STGR).
Scientific rept., TM(L)-734/024/00, by
J. Ng. 15 March 1963, 3lp., 3 refs.
(Contract AF 19(628)-1648, Space Systems
Division Program, for Space Systems
Division, AFSC)

Unclassified report

DESCRIPTORS: Programming (Computers).
Satellite Networks.

UNCLASSIFIED

Reports that the Simulated Telemetry
Data Generation Control Program (STGR)
has been designed to provide realistic
telemetry data (Fixed Format and Event
Items) under card input control.
Also reports that the simulated data
will be packed in the same format
as the Telemetry Report Message
(Message Type #13).

UNCLASSIFIED

UNCLASSIFIED