

63-3-4

404489  
CATALOG BY ASTIA  
AS

LANDING LOADS INVESTIGATION LABORATORY DROP TESTS

September 1962

Contract NOa(s) 59-6226-c

REPORT NO. ES 40641

MAY 23 1963  
TISIA A

Qualified requesters may obtain copies  
of this report direct from ASTIA.

Copy No. 6

DOUGLAS AIRCRAFT DIVISION • LONG BEACH, CALIFORNIA



**Best  
Available  
Copy**

REPORT NO. ES 40641

LANDING LOADS INVESTIGATION LABORATORY DROP TESTS

CONTRACT NO. NOa(s) 59-6226c  
MODEL A4D-2

DATE: SEPTEMBER, 1962

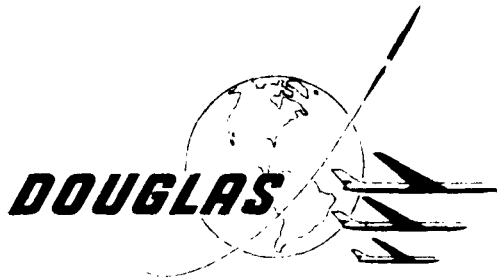

PREPARED BY: F. C. Allen  
H. D. Meriwether  
L. B. Mesby

APPROVED BY: *M. Stone*  
M. Stone, Chief  
Aerostructural Mechanics Section

DOUGLAS AIRCRAFT COMPANY, INC.  
LONG BEACH, CALIFORNIA

PREPARED BY: F.C.Allen **DOUGLAS AIRCRAFT COMPANY, INC.**  
CHECKED BY: L.B.Mosby 9/12/62 **LONG BEACH DIVISION**  
TITLE: LANDING LOADS INVESTIGATION LABORATORY DROP TESTS

PAGE: 11  
MODEL: A4D-2  
REPORT NO: ES 40641

#### FOREWORD

The work described in this report was accomplished by Douglas Aircraft Company, Aircraft Division, Long Beach, California, for the Bureau of Naval Weapons, Washington, D. C., under Contract NQa(s) 59-6226c. It represents one phase of a comprehensive program for the examination of loads experienced by Naval Aircraft during landings and the determination of the accuracy with which these loads may be duplicated by drop tests and analysis.

The project was performed under the general direction of Mr. C. T. Newby of the Bureau of Naval Weapons with Mr. D. C. Lindquist acting as cognizant technical project head. It was conducted by Douglas Aircraft Company with Mr. F. C. Allen providing the technical direction and Mr. L. B. Mosby acting as Chief Technical Investigator.

PREPARED BY: F. C. Allen **DOUGLAS AIRCRAFT COMPANY, INC.**  
CHECKED BY: L. B. Mosby DATE **LONG BEACH DIVISION**  
TITLE: LANDING LOADS INVESTIGATION LABORATORY DROP TESTS

PAGE: 111  
MODEL: A4D-2  
REPORT NO. ES-40641

TABLE OF CONTENTS

	<u>Page</u>
Foreword	11
Summary	iv
Symbols	v
Introduction	1
Descriptive Drawing of A4D-2 Airplane	2
Equipment	3
The Test Set-Up	7
Procedure	14
Reduction of Data	23
Results	29
Ground Load	63
Summary of Results and Conclusions	85
References	88
Appendix - Test Log	89

PREPARED BY: F.C. Allen DOUGLAS AIRCRAFT COMPANY, INC.  
CHECKED BY: L.B. Mosby <sup>DATE</sup> 9/12/62 LONG BEACH DIVISION  
TITLE: LANDING LOADS INVESTIGATION LABORATORY DROP TESTS

PAGE: 1V  
MODEL: A4D-2  
REPORT NO. ES 40641

### SUMMARY

This report describes and presents the results of certain airplane drop tests which are part of an extensive program to compare the landing loads experienced by an A4D-2 airplane during flight tests and drop tests with those computed by analytical methods. Other phases of the program are reported in References (1), (2) and (3).

The instrumentation used in these tests was nearly identical to that used in the flight test program and was sufficient to determine the loads applied to the airplane at the ground, the position of the strut, the internal pressures in the gear and significant structural accelerations.

The results are presented in the form of curves of measured parameter versus time. Vertical and horizontal loads on the gear at the ground were computed from the strut instrumentation and are compared with data from the reaction platforms.

Discussion on the significance of the data is reserved for the Summary Report on this project (Reference (3)), however, two recommendations pertaining to the need for further work arise from this drop test program. The first is that a study of the dynamic characteristics of the reaction platforms be made in order that confidence in the strut instrumentation can be improved, and second, that a sliding coefficient of friction test be made of the tire on the reaction platform surface for the purpose of substantiating the high coefficients of friction registered by the left hand strut.

PREPARED BY: F.C.Allen DOUGLAS AIRCRAFT COMPANY, INC.

PAGE: v

CHECKED BY: L.B.Mosby <sup>DATE</sup> 9/12/62 LONG BEACH DIVISION

MODEL: A4D-2

TITLE: LANDING LOADS INVESTIGATION LABORATORY DROP TESTS

REPORT NO: RS 40641

### SYMBOLS

- FA - Axial load in the strut at the axle, pounds. Positive up.
- FN - Normal load in the strut at the axle, pounds. Positive aft.
- FAA - Inertia force on the lower mass in the strut axial direction, pounds. Positive down.
  - Acceleration of the lower mass in g's times its weight. (The lower mass weight, which includes the wheel, tire axle and instrumentation, is 120 pounds.)
- FAN - Inertia force on the lower mass in a fore-aft direction normal to the strut, pounds. Positive forward.
- FHG - Force on the gear at the ground parallel to the ground, pounds.
- FVG - Force on the gear at the ground normal to the ground, pounds.
- I - Intercept constant. (except as noted)
- K - Calibration constant. (except as noted)
- L - Total wing lift, pounds.
- MUA - Average coefficient of frictions of the tire on the landing surface.
- MUA<sub>1</sub> - Instantaneous coefficient of friction.
- P - The value of any parameter. Subscript denotes the oscillograph channel from which the parameter was taken.
- t - Time, seconds.
- T - Time from instant of release to instant of ground contact, seconds.

PREPARED BY: F.C. Allen

DOUGLAS AIRCRAFT COMPANY, INC.

PAGE: V1

CHECKED BY: L.E. Mosby 9/12/62

LONG BEACH DIVISION

MODEL: A4D-2

TITLE: LANDING LOADS INVESTIGATION LABORATORY DROP TESTS

REPORT NO: ES 4-641

**SYMBOLS (Continued)**

- $V_v$  = Airplane vertical velocity (sinking speed), at contact, feet per second.
- $W$  = Airplane weight, pounds.
- $\delta$  = Displacement of any oscillograph trace from its zero position, inches.
- $\delta_1$  = Displacement of any oscillograph trace from the reference line, inches.
- $\Delta$  = Displacement of any oscillograph trace from zero during the calibration run, inches.
- $\Delta_0$  = Distance between the zero position of any trace and the reference line, inches.
- $\Delta_1$  = Displacement of any oscillograph trace from the reference line, inches.
- $\phi$  = Angle of the fuselage reference line with respect to the horizontal - degrees. Positive airplane nose up.

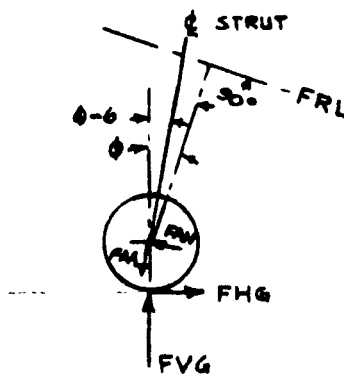

Positive Gear Forces

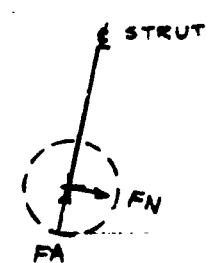

Positive Strut (Axle) Forces

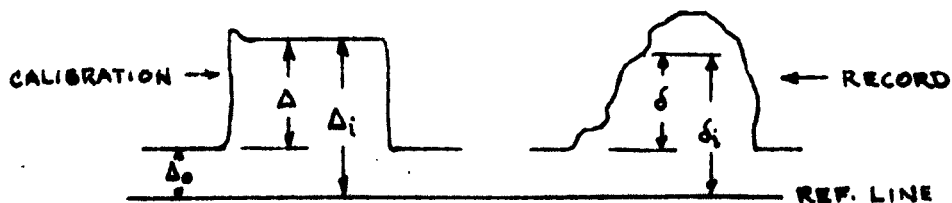

Oscillograph Trace Terminology



PREPARED BY: F.C.Allen DOUGLAS AIRCRAFT COMPANY, INC.PAGE: 1CHECKED BY: L.B.Mosby <sup>DATE</sup> 9/12/62 LONG BEACH DIVISIONMODEL: A4D-2TITLE: LANDING LOADS INVESTIGATION LABORATORY DROP TESTSREPORT NO. ES 40641

## INTRODUCTION

The landing loads investigation, of which this report forms a part, provides for an experimental flight test program and an airplane drop test program with consistent instrumentation in conjunction with an analytical dynamic loads program. The purpose of the investigation is to determine the differences, if any, in the loads experienced in actual landings and the loads experienced in drop tests, and to determine the accuracy with which the landing loads can be duplicated by advanced analytical methods. This report describes the airplane drop tests and presents the results of the drop test phase of the investigation.

An additional objective of the program was to compare the loads resulting from actual landings with the loads measured on the moving drop test rig at the landing loads test facility of the National Aeronautics and Space Administration (NASA) at Langley Field, Virginia.

The airplane used was the Douglas A4D-2, general characteristics of which are shown in Figure 1. The NASA tests used a left hand A4D-2 gear which, together with similar instrumentation, was later used on the airplane during its flight tests and drop tests. In the flight and drop tests, a right hand gear with nearly identical instrumentation was also used.

The complete investigation is contained in three reports in addition to the present volume. A detailed description of the instrumentation and the calibration techniques is presented in Reference (1). A description of the flight tests and the results thereof are given in Reference (2) and the analytical investigation including the comparisons described above is presented in Reference (3). The NASA test results are contained in Reference (4).

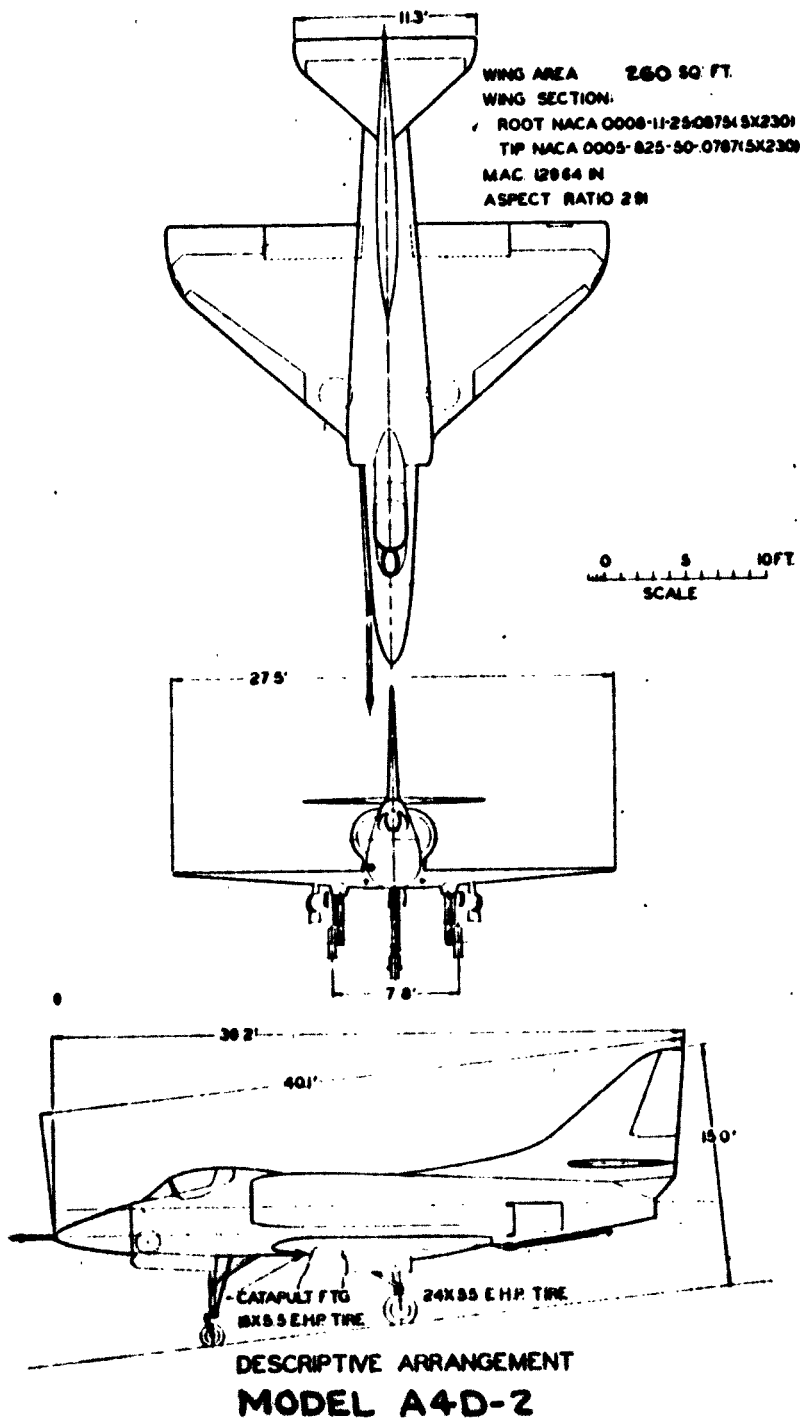

Figure 1.

PREPARED BY: F.C. Allen DOUGLAS AIRCRAFT COMPANY, INC. PAGE: 3  
CHECKED BY: L.E. Mosby <sup>DATE</sup> 9/12/62 LONG BEACH DIVISION MODEL: A4D-2  
TITLE: LANDING LOADS INVESTIGATION LABORATORY DROP TESTS REPORT NO. ES 40641

### EQUIPMENT

Details of the airplane instrumentation used in this program are provided in Reference (1). A summary is provided in Table I for the reader's convenience.

Landing gear vertical and drag loads were measured by the landing gear instrumentation and by reaction platforms the configuration of which is shown in Figure 2. Variations in friction coefficient were obtained by varying the size of grooves in the surface of the platform. An average coefficient of friction of approximately 0.4 was sought by this procedure.

The airplane used in the drop tests was not the same as that used in flight test although the mass distribution and rigidities were identical in all important respects. Thus, all accelerometers in the body of the drop test article were mounted at the same location and with brackets that were identical to the flight test article. The landing gears were those used in flight test and the recording apparatus was the same.

In these flight tests, the recording apparatus was contained in a reworked 300 gallon external fuel tank mounted on the centerline of the airplane. This store was returned to the laboratory after flight testing for use in the drop test program. In the first 62 drops this store was mounted on the airplane in the same manner as in flight test. After Drop 62, the instrumented store was removed from the airplane and placed on the ground. Data was transmitted from the airplane to the store by a cable. This change reduced the maintenance required on the recording apparatus and eliminated some of the high frequency pulses on the oscillograph traces. A dummy store of equivalent mass and inertia was mounted on the airplane to replace the instrumentation package.

TABLE I  
 INSTRUMENTATION FOR DROP TESTS  
 Oscillograph 1

	<u>Parameter Measured</u>	<u>Method of Measurement</u>	<u>Transducer</u>	
			<u>Range</u>	<u>Type</u>
1	L.H. Strut Vertical Load	Strain Gauge Installation on Axle	0-60K ± 20K	18V 350 Ω
2	*L.H. Strut Drag Load	Strain Gauge Installation on Axle		
3	*L.H. Strut Position	Slide Wire Device	0-16 in.	DAC
4	*L.H. Strut Velocity	Velocity Generator	± 30 FPS	Sanborn IOLV 17-n
5	*L.H. Air Chamber Press.	Pressure Transducer	0-5 KSI	DAC
6	*L.H. Metering Chamber Press.	Pressure Transducer	0-5 KSI	DAC
7	*L.H. Lower Mass Vert. Accel.	Miniature Accelerometer in Axle	± 90g's	**A6-100-350
8	*L.H. Lower Mass Long. Accel.	Miniature Accelerometer in Axle	± 100g's	A6-100-350
9	*L.H. Lower Mass Side Accel.	Miniature Accelerometer in Axle	± 100g's	A6-100-350
10	*L.H. Gear Upper Mass V. Accel.	Accelerometer	± 50g's	A5-50-350
11	*L.H. Gear Upper Mass V. Accel.	Accelerometer	± 50g's	A5-50-350
12	*L.H. Gear Upper Mass D. Accel.	Accelerometer	± 30g's	A5-50-350
13	*L.H. Drag Brace Axial Ld.	Strain Gauges	± 50K	18V 350 Ω
14	L.H. Gear Side Bending Mom.	Strain Gauge Installation		18V 350 Ω
15	*L.H. Wheel Angular Position	36 Magnets on Wheel - Pick-up on Strut	0-150KC	Electro 3010
16	Nose Gear Strut Position	Slide Wire Device	0-18 in.	DAC
17	Nose Gear Upper Mass V. Accel.	Accelerometer	± 30g's	A5-30-350
18	C.G. Normal Accel.	Accelerometer	± 1g	AJ26-1-350
19	C.G. Normal Accel.	Accelerometer	± 10g's	AJ43-10-350
20	C.G. Long. Accel.	Accelerometer	± 1g	D-06-350
21	Airplane Pitch Attitude	Vertical Gyro Installation	± 800	P.R. Gyro
22	Airplane Roll Attitude	Vertical Gyro Installation	± 160°	P.R. Gyro
23	L.H. Platform Vertical	Reaction Platform (Fig. 2)	0-60K	DAC
24	L.H. Platform Drag	Reaction Platform (Fig. 2)	± 15K	DAC

TABLE I (Cont.)

INSTRUMENTATION FOR DROP TESTS

Oscillograph 2

	<u>Parameter Measured</u>	<u>Method of Measurement</u>	<u>Transducer</u>	
			<u>Range</u>	<u>Type</u>
1	*R.H. Strut Vertical Load	Strain Gauge Installation on Axle	0-60K	18V 350 Ω
2	*R.H. Strut Drag Load	Strain Gauge Installation on Axle	± 20K	18V 350 Ω
3	R.H. Strut Side Load	Strain Gauge Installation on Axle	± 8K	18V 350 Ω
4	*R.H. Strut Position	Slide Wire Device	0-16 in.	DAC
5	*R.H. Strut Velocity	Velocity Generator	± 30 PPS	Sanborn 10LV 17-n
6	*R.H. Air Chamber Pressure	Pressure Transducer	0-5 KSI	DAC
7	*R.H. Metering Chamber Press.	Pressure Transducer	0-5 KSI	DAC
8	*R.H. Lower Mass Vert. Accel.	Miniature Accelerometer in Axle	± 90g's	**A6-100-350
9	*R.H. Lower Mass Long. Accel.	Miniature Accelerometer in Axle	± 100g's	A6-100-350
10	*R.H. Lower Mass Side Accel.	Miniature Accelerometer in Axle	± 100g's	A6-100-350
11	*R.H. Gr.Upper Mass Vert. Accel.	Accelerometer	± 50g's	A5-50-350
12	*R.H. Gr.Upper Mass Drag Accel.	Accelerometer	± 3g's	A5-50-350
13	*R.H. Drag Brace Axial Load	Strain Gauges	± 50K	18V 350 Ω
14	*R.H. Wheel Angular Position	36 Magnets on Wheel - Pick-up on Strut	0-150KC	Electro 3010
15	L.H. Lift Damper Link	Strain Gauges	0-10K	18V 350 Ω
16	R.H. Lift Damper Link	Strain Gauges	0-10K	18V 350 Ω
17	L.H. Wing Tip Acceleration	Accelerometer	± 50g's	A6-50-35
18	R.H. Wing Tip Acceleration	Accelerometer	± 50g's	A6-50-35
19	*Time	Oscillograph Trace	20-20KC	205AG(H.P.)

\* Items Identical on Both Gears

\*\* All Accelerometers by Statham

PREPARED BY: **F. G. ALLEN**

**DOUGLAS AIRCRAFT COMPANY, INC.**

PAGE: **6**

CHECKED BY: **J. R. SMITH**

LONG BEACH DIVISION

MODEL: **40-2**

TITLE: **REAR DECK STRUCTURE LANDING GEAR TESTS**

REPORT NO. **12-102**

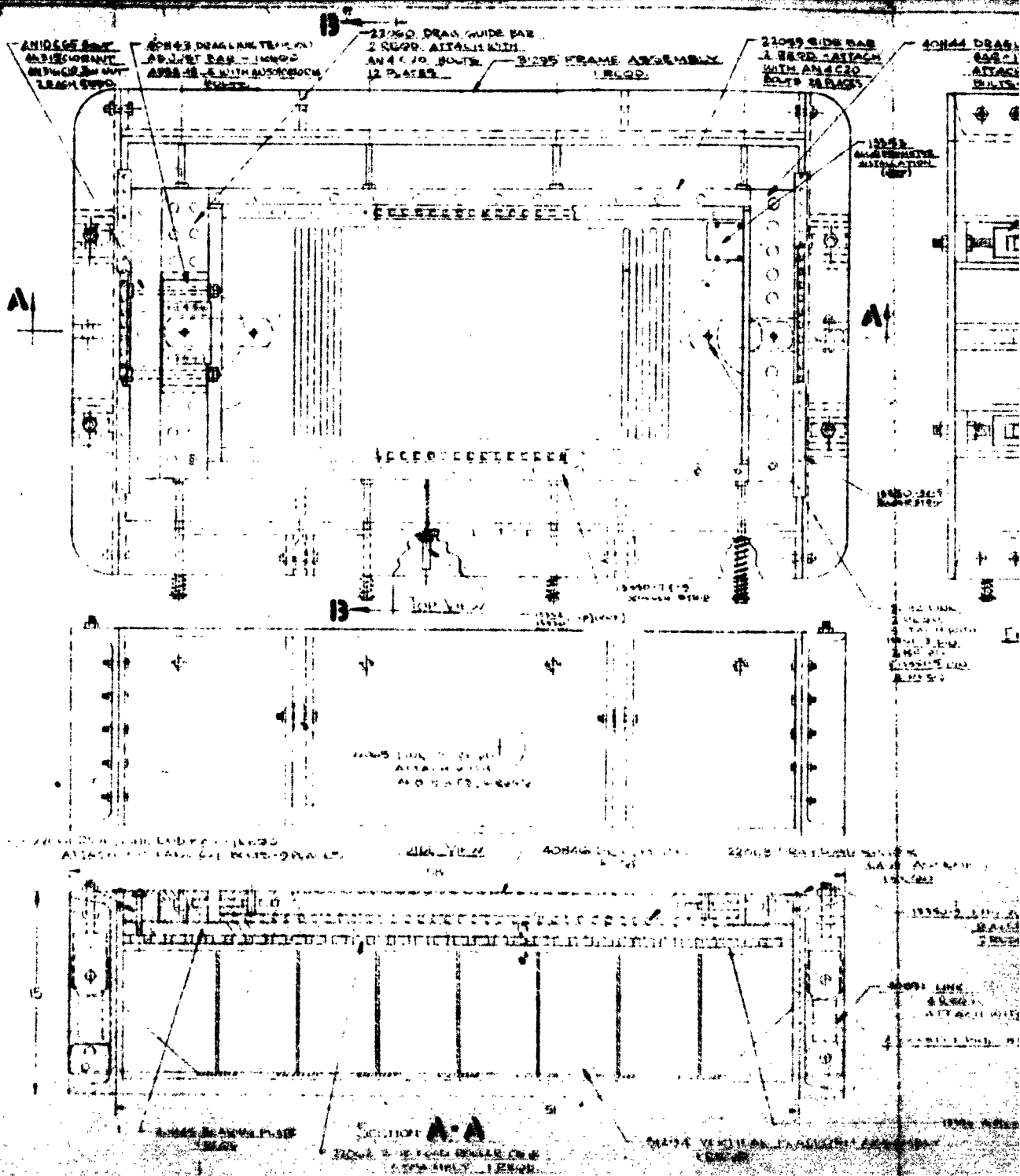

A4D-2  
 ES 40691

22059 SUBS. PAB. 1 RETD. ATTACH. WITH 412 C23. BOWS 28 PLACES.

40844 DRAG LINK ATTACH. 540 - USE 20. ATTACH WITH AUG. 21. HANDLE 1211 C23.

1395 CLEVIS 4 8500.

1395 - 1396 SPINDLE SHAFT WITH ATTACH. PLACES FROM. 2000 2 1/2" DIA. 40 HANDLE 1211 C23. 1395 - ATTACH. SPINDLE TO HANDLE WITH AN ISERT.

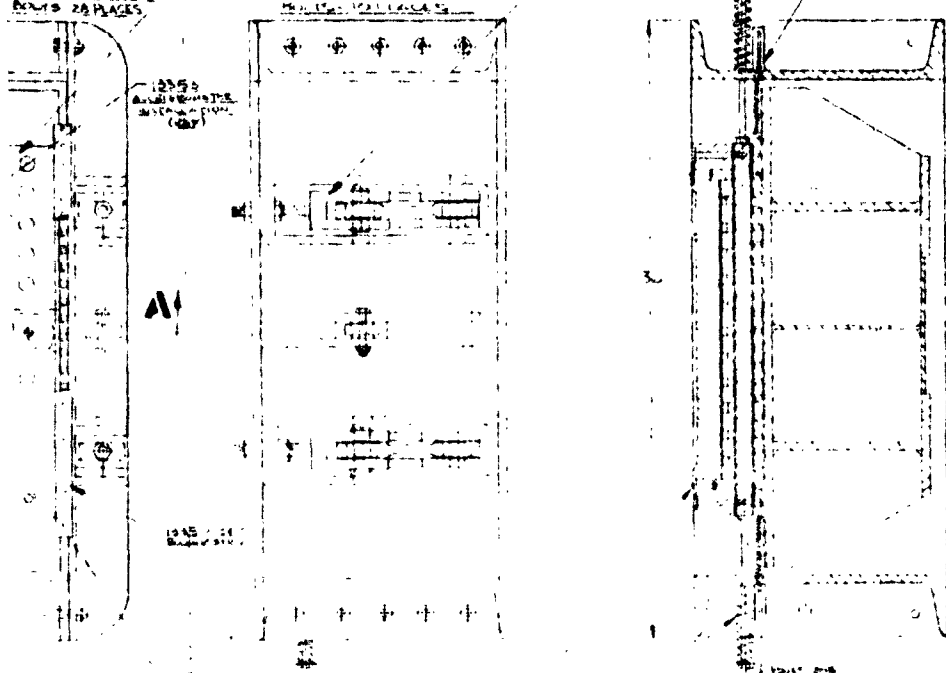

Part No.	DESCRIPTION
1395	VERTICAL ASSEMBLY
1396	VERTICAL SHAFT WITH BUSH
1397	DRAG LINK PIVOT
1398	ROUND END CONNECTING SHAFT
1399	DRAG LINK ASSEMBLY WITH BUSH
1400	VERTICAL CLEVIS WITH BUSH
1401	VERTICAL LINK CLEVIS
1402	ROUND END CONNECTING SHAFT

1393	DRAG LINK
1394	DRAG LINK WITH BUSH
1395	DRAG LINK BUSH
1396	DRAG LINK PIVOT
1397	DRAG LINK ASSEMBLY WITH BUSH
1398	DRAG LINK WITH BUSH
1399	DRAG LINK WITH BUSH
1400	DRAG LINK WITH BUSH
1401	DRAG LINK WITH BUSH
1402	DRAG LINK WITH BUSH

1395	VERTICAL ASSEMBLY
1396	VERTICAL SHAFT WITH BUSH
1397	DRAG LINK PIVOT
1398	ROUND END CONNECTING SHAFT
1399	DRAG LINK ASSEMBLY WITH BUSH
1400	VERTICAL CLEVIS WITH BUSH
1401	VERTICAL LINK CLEVIS
1402	ROUND END CONNECTING SHAFT

1395	VERTICAL ASSEMBLY
1396	VERTICAL SHAFT WITH BUSH
1397	DRAG LINK PIVOT
1398	ROUND END CONNECTING SHAFT
1399	DRAG LINK ASSEMBLY WITH BUSH
1400	VERTICAL CLEVIS WITH BUSH
1401	VERTICAL LINK CLEVIS
1402	ROUND END CONNECTING SHAFT

13-13

31296

Figure 2. Reaction Platform

PREPARED BY: F.C. Allen DOUGLAS AIRCRAFT COMPANY, INC.PAGE 7CHECKED BY: L.B. Mosby 9/12/62 LONG BEACH DIVISIONMODEL: A4D-2TITLE: LANDING LOADS INVESTIGATION LABORATORY DROP TESTSREPORT NO. ES 40641

## THE TEST SET-UP

Figure 3 shows the airplane in its pre-drop position and provides a picture of the test set-up. The apparatus and test procedures are, perhaps, typical of those used in the industry with the possible exceptions discussed below.

Because of the special instrumentation located on the main landing gear axles, the wheel spin-up device shown in Figures 4 and 5 was designed. Angular velocity was imparted to the airplane wheels by bringing the tires in contact with two additional tires mounted on a jack shaft which was driven by two air motors. The jack shaft and its mounting was assembled on a carriage which was moved clear of the airplane immediately before it was dropped.

Wing lift was simulated by two 36 inch diameter pneumatic dampers (lift pots) shown in Figure 6. These were attached to the airplane at wing Stations 52.0 (right and left) as shown in Figure 7. The attachment mechanism was such that the load was applied shortly before the wheel contacted the ground. An essentially constant load was maintained throughout the stroke. Since this method of load application was one of the known significant differences between drop tests and flight tests, the attachment links of the dampers to the airplane were instrumented with strain gauges in order that the wing lift time-history could be determined. As indicated in Figure 7, additional lift dampers were provided to catch the airplane in the event of a structural failure. These lift pots applied no load to the airplane under normal circumstances.

Sinking speed was measured during the tests by a THODI instrument set-up as shown in Figure 8. Sinking speed could not be obtained directly from the drop height without correcting for the forces introduced by the lift pots prior to wheel contact, hence THODI was used as a rapid means of obtaining this parameter during test.



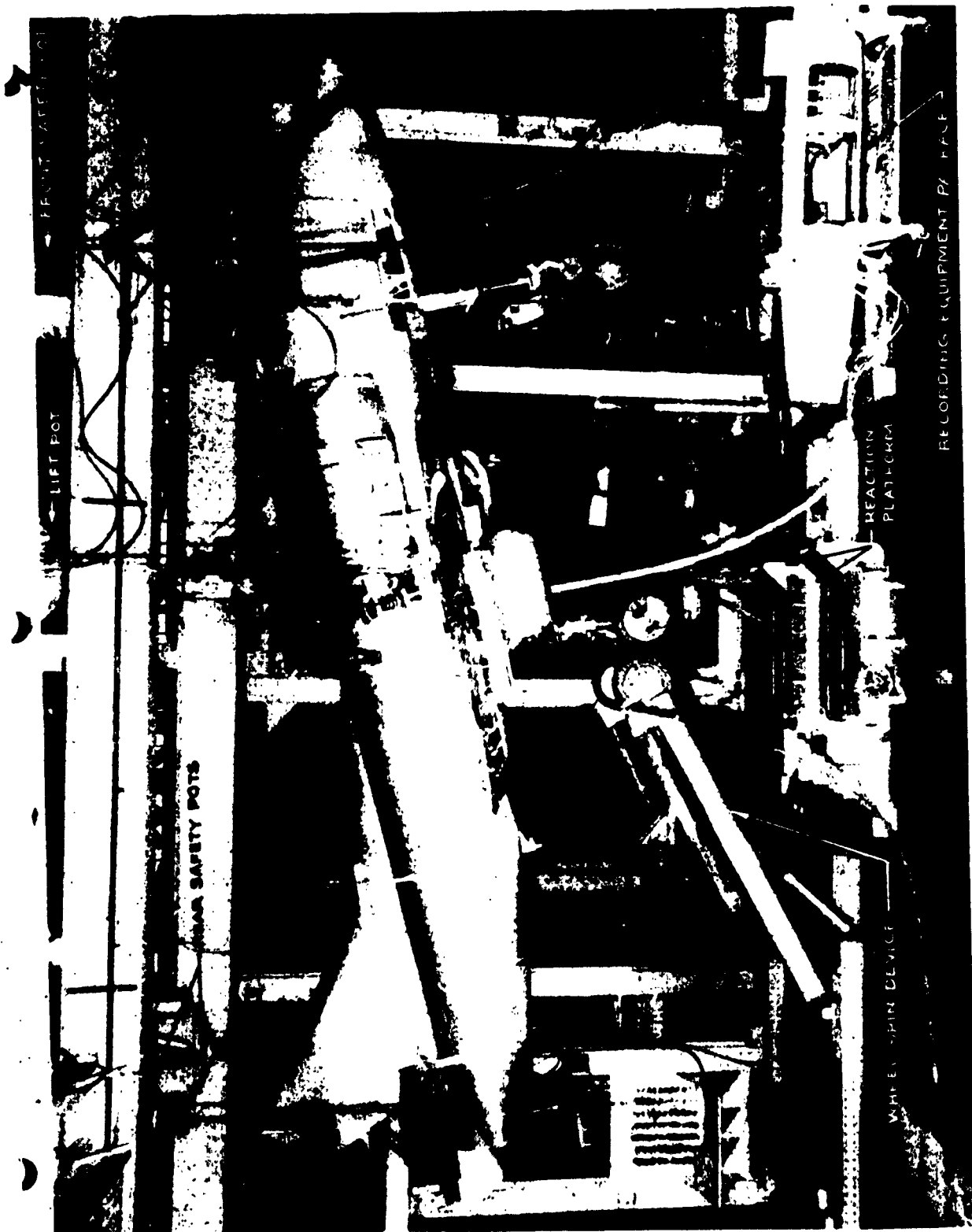

Figure 3. Drop Test Airplane in Pre-drop Position

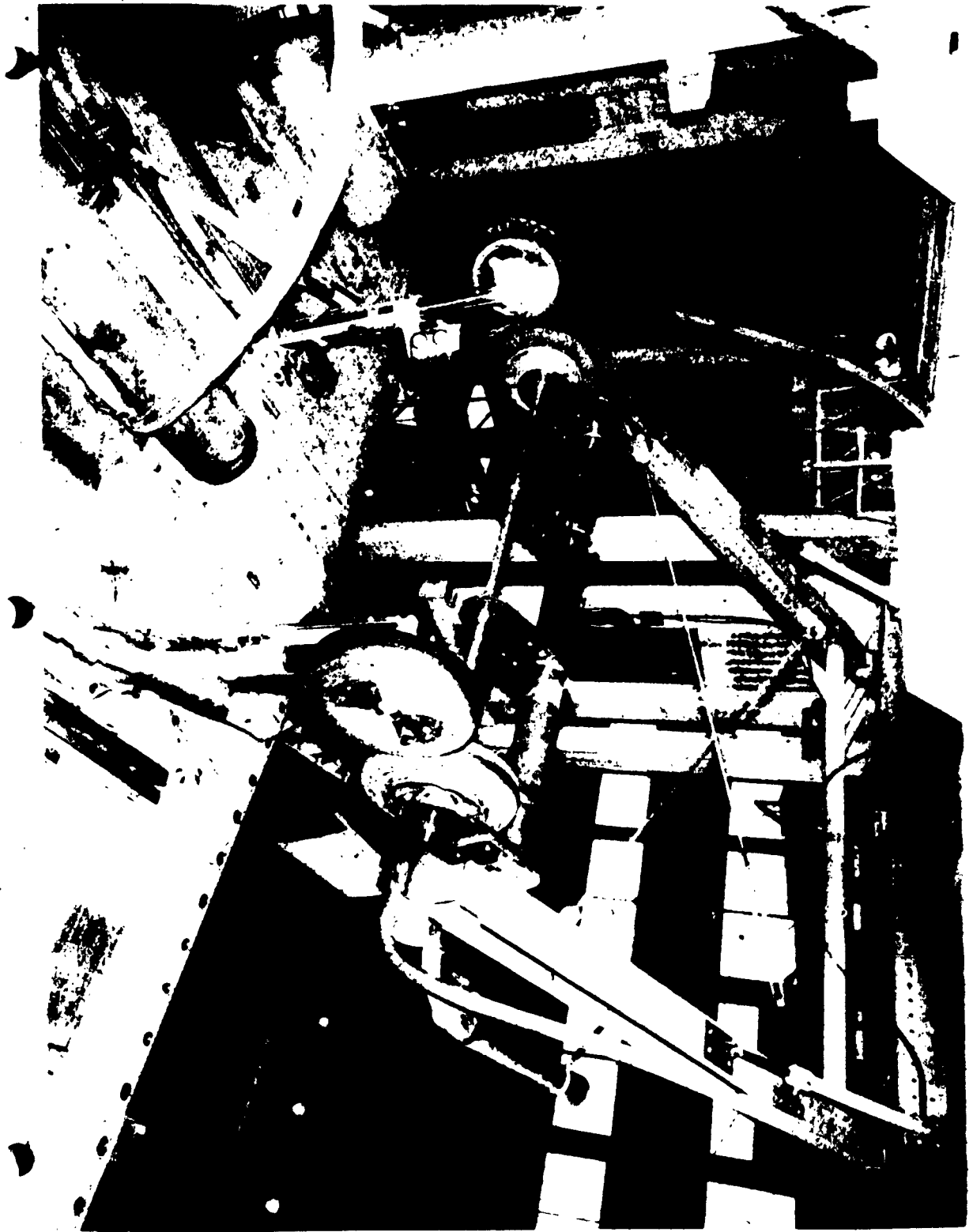
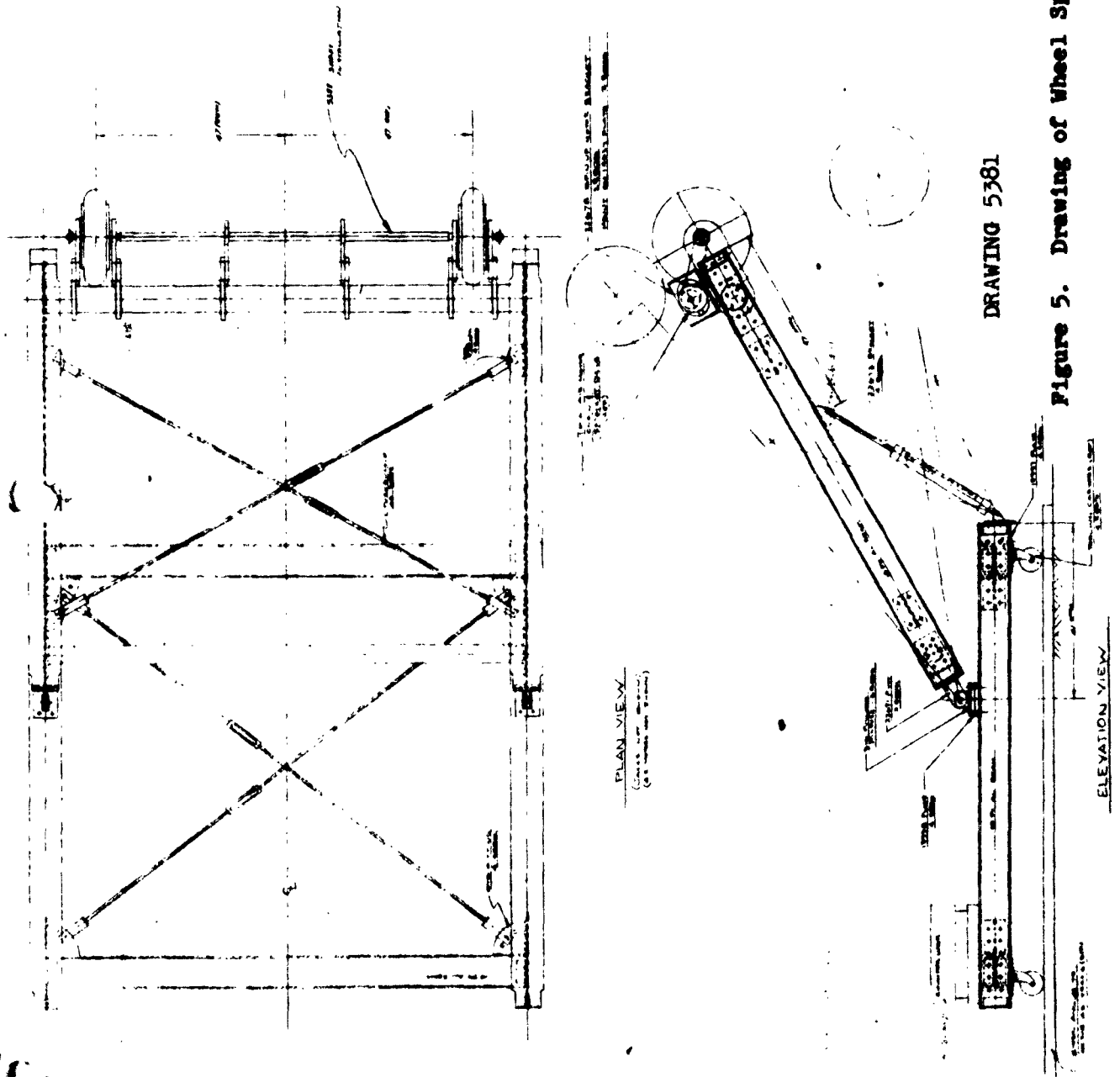

Figure 4. Wheel Spin-up Device



DRAWING 5381

Figure 5. Drawing of Wheel Spin-up Device

PREPARED BY F.C. Allen DOUGLAS AIRCRAFT COMPANY, INC.  
CHECKED BY L.B. Neaby 9/12/62 LONG BEACH DIVISION  
TITLE: LANDING LOADS INVESTIGATION LABORATORY DROP TEST

PAGE: 11  
MODEL: A4D-2  
REPORT NO: ES 40641

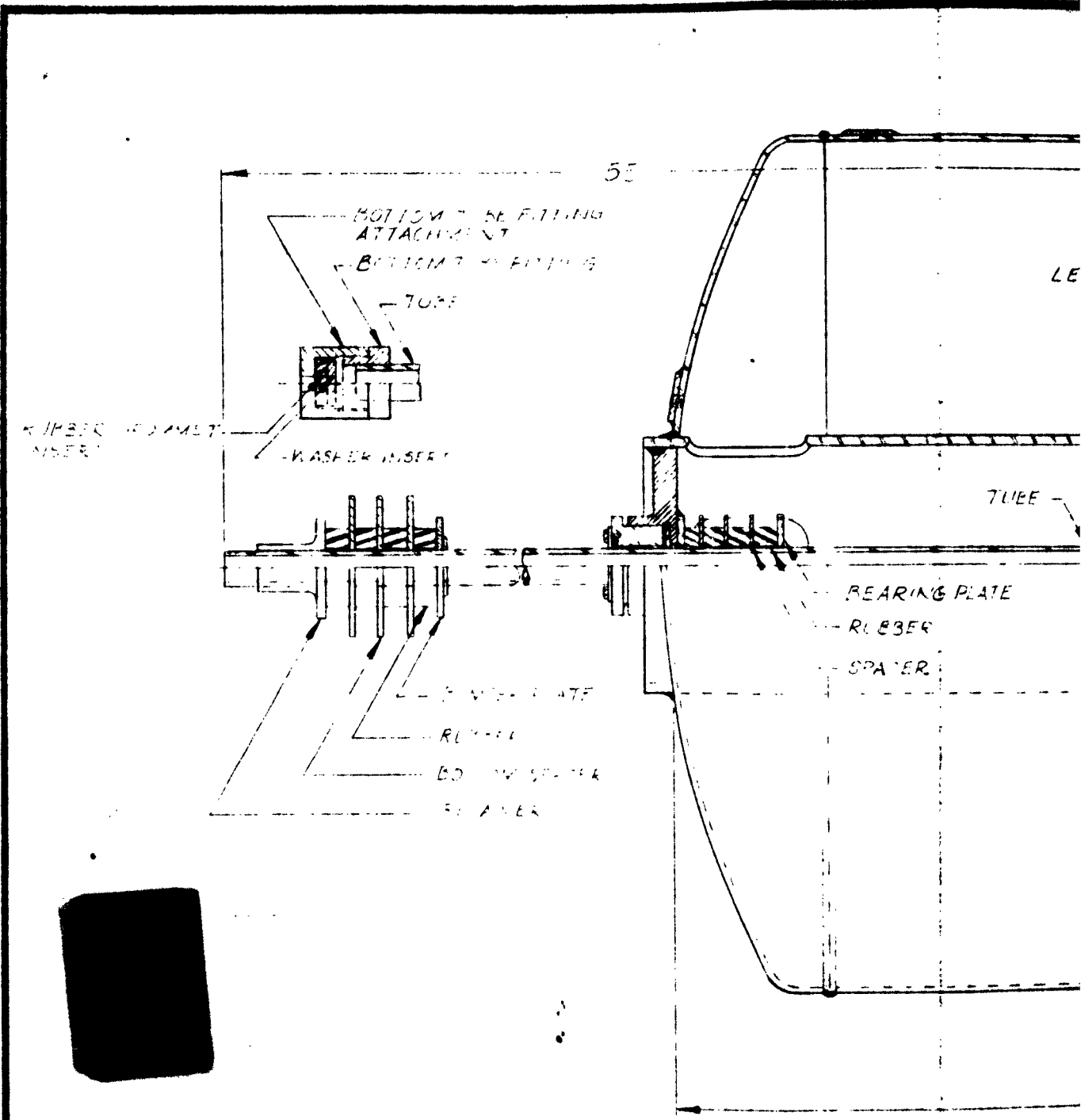
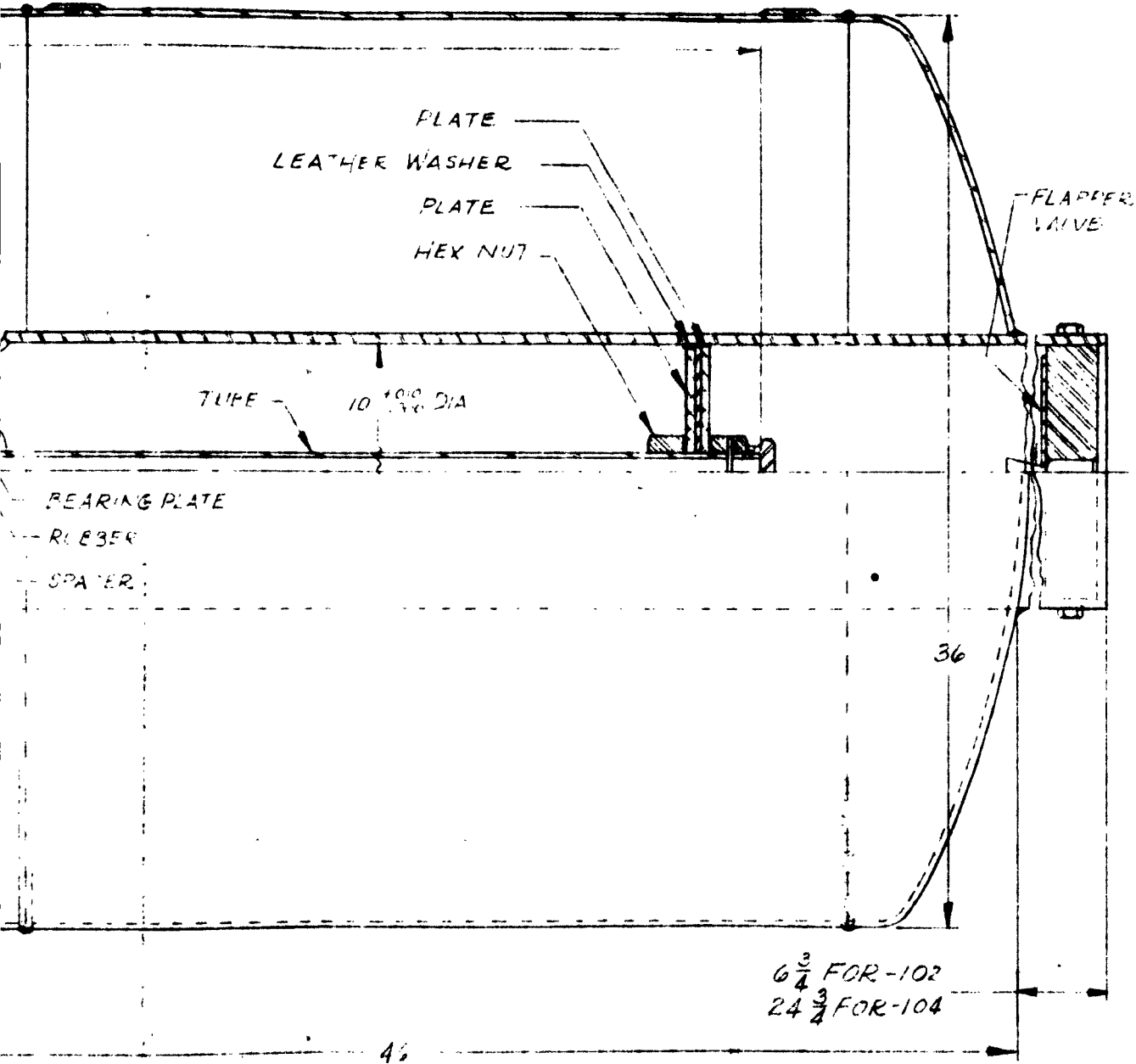

Figure 6. Wing Lift Damper

A4D-2  
NO. 40641



PREPARED BY: F.C. Allen

DOUGLAS AIRCRAFT COMPANY, INC.

PAGE: 12

CHECKED BY: L.B. Mosby 9/12/62

LONG BEACH DIVISION

MODEL: A4D-2

TITLE: LANDING LOADS INVESTIGATION LABORATORY DROP TESTS

REPORT NO. ES 40641

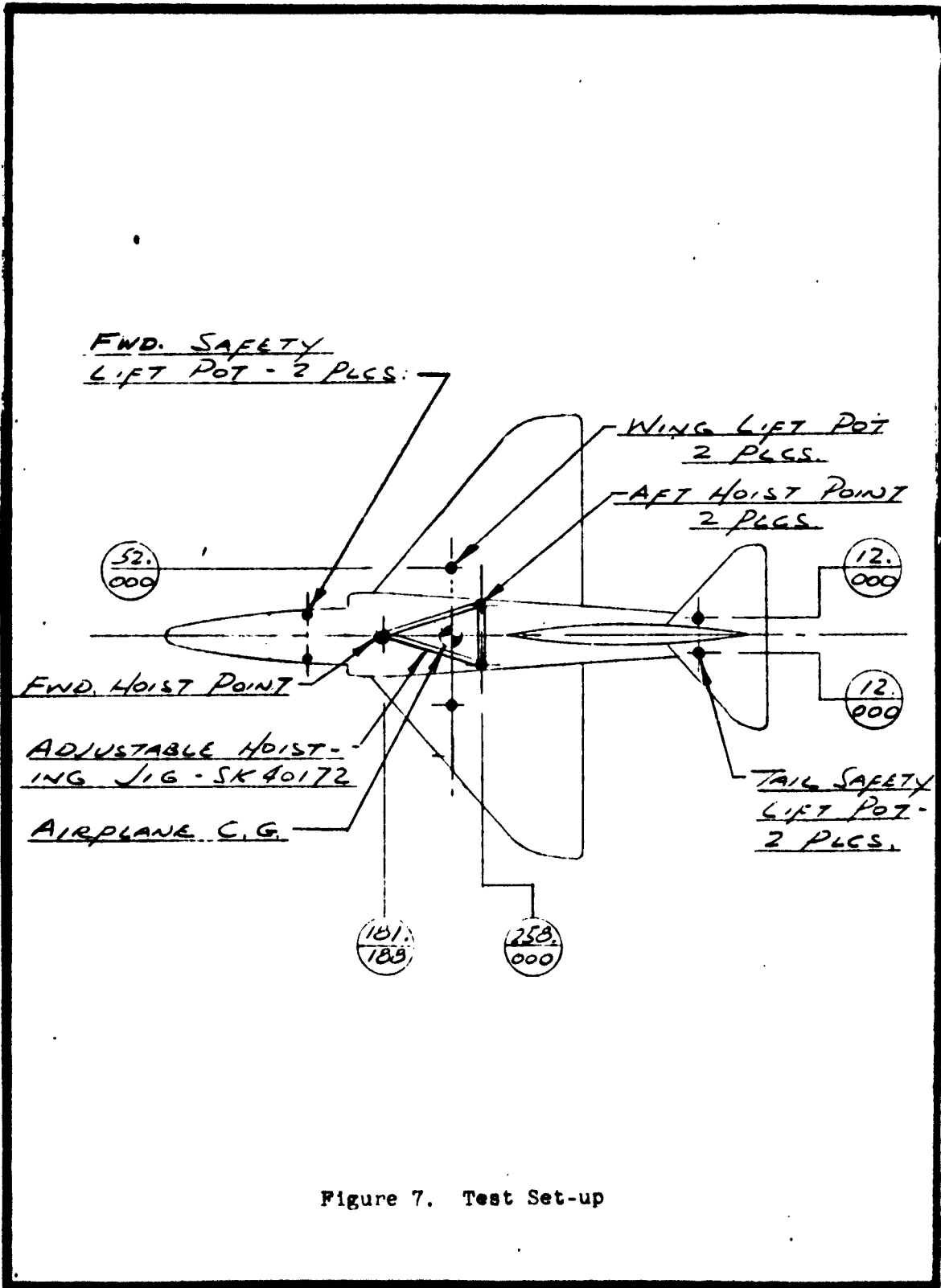
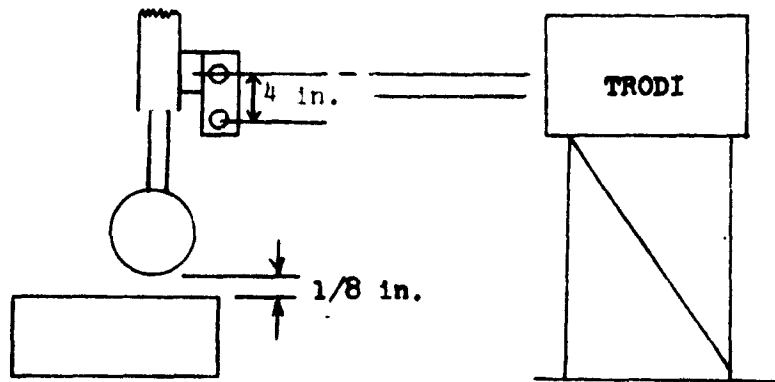

Figure 7. Test Set-up

PREPARED BY: April 1962 DOUGLAS AIRCRAFT COMPANY, INC.  
CHECKED BY: H. Meriwether <sup>DATE</sup> LONG BEACH DIVISION  
TITLE: LANDING LOADS INVESTIGATION LABORATORY DROP TESTS

PAGE: 13  
MODEL: A4D-2  
REPORT NO. 40641



Top beam cut 1/8 inch above platform.  
Sink speed measured 2 1/8 inch above platform.

Figure 8. TRODI Installation

PREPARED BY: F.C. Allen DOUGLAS AIRCRAFT COMPANY, INC.PAGE: 14CHECKED BY: L.B. Mosby <sup>DATE</sup> 9/12/62 LONG BEACH DIVISIONMODEL: A4D-2TITLE: LANDING LOADS INVESTIGATION LABORATORY DROP TESTSREPORT NO. RS 40641

## PROCEDURE

From a preliminary examination of the flight test data, several landings were chosen for duplication in drop tests. Numerous drops were made for the purpose of checking the instrumentation and to provide accurate duplication of the landings. A log of all drops is contained in Appendix A.

Table II provides a list of the initial conditions of all drops for which detailed data are presented herein and the initial conditions of those flight landings which will be compared with drop tests in the Summary Report (Reference 3). Not all drop tests were duplicated by landings because of the fact that after the drop tests were conducted, the data from some flight landings were found to be unacceptable.

The following paragraphs describe the methods of measuring the initial conditions and the estimated accuracy of the readings.

## A. Weight and Weight Distribution.

Weight and C.G. position were determined by means of Cox and Stevens Electronic Weighing Units placed under the jacking points of the airplane. The accuracy of the weighing units is  $\pm 0.1\%$  and their location was known within 0.2 inch. The maximum possible error on airplane weight is, therefore,  $\pm 3.5$  lb. and on C.G. position 0.4 inch.

The moment of inertia of the airplane in pitch was determined by measuring the frequency of oscillation of the airplane when supported in the manner shown in Figure 10. The measurement was made for one distribution only, analytical corrections being made for other gross weights. Overall accuracy of  $\pm 2\%$  is estimated for the moment of inertia.



PREPARED BY: **F.C.Allen** DOUGLAS AIRCRAFT COMPANY, INC.

CHECKED BY: **L.B.Nesby 9/15/62** LONG BEACH DIVISION

TITLE: **LANDING LOADS INVESTIGATION LABORATORY DROP TESTS**

PAGE: 15  
MODEL: A4D-2  
REPORT NO. EE 40641

TABLE II  
INITIAL CONDITIONS  
AIRPLANE DROPS AND CORRESPONDING FLIGHT TEST LANDINGS

Landing No.	Drop No.	Gross Weight Lbs.	FRL Angle Degrees	Horiz. C.G. Position*	Wing Lift ÷ Weight	Sink Speed fps	Horizontal Speed Knots	Wheel RPM
121		12,876	13.0	232.9	1.10	13.2	106.1	1793
	84	12,876	13.4	232.9	1.055	13.9	1811(L) 1794(R)	
123		13,735	8.5	235.2	1.10	12.0	113.9	1930
	70	13,516	9.5	234.5	1.03	12.2	2097(L) 2089(R)	
125		13,446	9.5	234.3	1.07	15.0	112.9	1933
	68	13,446	8.8	234.3	1.07	15.0	1925(L) 1918(R)	
126		13,276	9.3	233.9	1.06	17.0	110.6	1933
	93	13,276	10.0	233.9	1.045	16.7	1936(L) 1912(R)	
128		12,775	10.5	232.7	1.00	14.7	109.1	1872
	82	12,876	6.0	232.9	1.05	16.2	2074(L) 2044(R)	
	75	13,226	5.4	233.7	1.015	17.0**	2062(L) 2048(R)	
	78	13,186	11.0	233.6	1.07	13.5**	1965(L) 1972(R)	
	88	12,776	21.1	232.7	1.04	12.3**	1801(L) 1784(R)	

\* Refer to Figure 9 \*\* FRODI Readings (See Discussion p. 19)

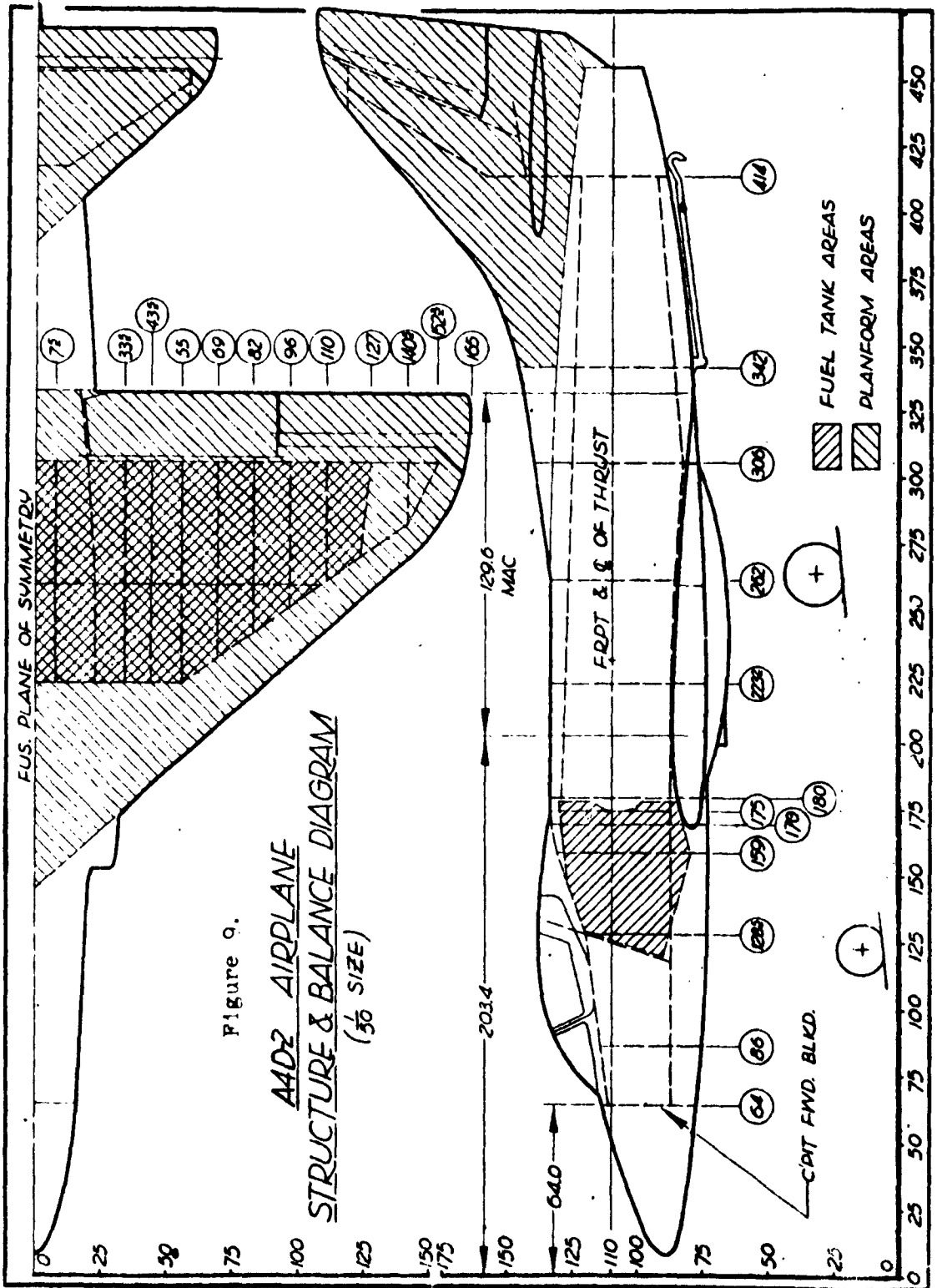

DATE April 1962

EL SEGUNDO DIVISION

PREPARED BY H. MeriwetherTITLE Ldg. Loads - Drop TestsPAGE 17  
MODEL A4D-2  
REPORT 40641A4D-2 DROP TEST ARTICLEMOMENT OF INERTIA

$$f = \frac{1}{2\pi} \sqrt{\frac{Ka^2 - Wc}{I + M(b^2 + c^2)}}$$

$$I = \frac{Ka^2 - Wc}{4\pi^2 f^2} - M(b^2 + c^2)$$

$$K = 6400 \text{ lbs/ft.}$$

$$a = (132.6/12) \text{ ft.}$$

$$W = 12770 \text{ lbs.} = Mg$$

$$c = (17.3/12) \text{ ft.}$$

$$b = (28.1/12) \text{ ft.}$$

$$f = 0.88 \text{ cps}$$

$$I = 19328.2/f^2 - 2998.8 = 21960 \text{ slug ft}^2$$

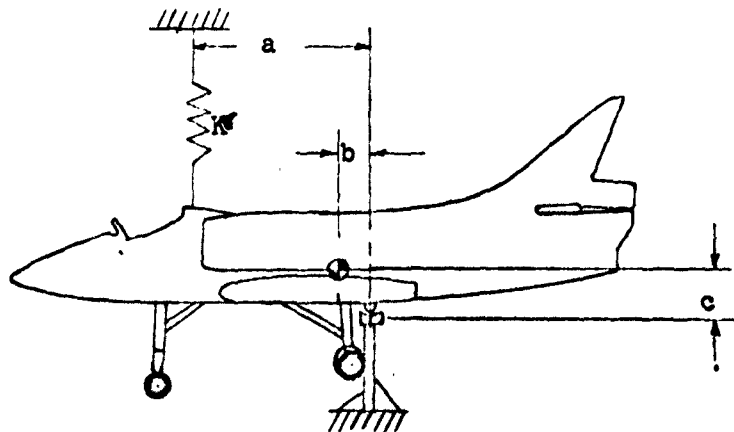

$$X_{cg} = 0$$

$$Y_{cg} = 232.5$$

$$Z_{cg} = -16.0$$

Figure 10. Measurement of Moment of Inertia

PREPARED BY: F.C.Allen DOUGLAS AIRCRAFT COMPANY, INC.

PAGE: 18

CHECKED BY: L.B.Nesby 9/12/62 LONG BEACH DIVISION

MODEL: A4D-2

TITLE: LANDING LOADS INVESTIGATION LABORATORY DROP TESTS

REPORT NO. DA 40641

### B. Fuselage Reference Line Angle ( $\phi$ )

The fuselage reference angle was measured prior to drop by a bubble protractor level. The pitch-roll gyro in the airplane (Item 20 Page 4 ) was set on this value, and the airplane attitude at the time of contact was determined from the oscillograph trace of this instrument. The angle listed in Table II is the angle at time of contact.

The protractor was placed on the airplane at the gun-sight level points which were manufactured parallel to the fuselage reference line within  $\pm 0.1$  degree at the time the fuselage was in its tooling jig. Structural deflections caused by differences in method of support created a certain amount of change in the relative position of the level points and the fuselage reference line and, consequently, introduced an error in the value of  $\phi$ . Investigations of such deflections made for the purpose of calculating gun-sight errors lead to the conclusion that the error in this case is of the order of 0.1 degree. The combined error introduced by the protractor and gyro is also estimated at 0.1 degree, hence, the overall accuracy of the value of  $\phi$  is estimated to be within  $\pm 0.2$  degree.

Variation in pitch attitude was obtained by moving the hoist point fore and aft. Oscillations of the aircraft caused by wheel spin-up and airplane rotation after release caused lack of precise duplication of the landing attitude, however, analytical considerations indicated that accuracy greater than  $\pm 1.0$  degree was unnecessary.

PREPARED BY: F.C.Allen DOUGLAS AIRCRAFT COMPANY, INC.  
CHECKED BY: L.B.Mesby 9/12/62 LONG BEACH DIVISION  
TITLE: LANDING LOADS INVESTIGATION LABORATORY DROP TESTSPAGE: 19  
MODEL: A4D-2  
REPORT NO. ES 40641

## C. Wing Lift

Wing lift was determined from the instrumented links attaching the lift dampers to the airplane. Since fluctuations of the lift occurred during the stroke, the average values shown in Table II were computed from the oscillograph records. Lack of precise agreement between flight test and drop test values was caused by the fact that the average lift was approximated during drop tests and computed more accurately later. The accuracy of the lift, as measured, was within  $\pm 2\%$ .

## D. Sink Speed

Sink speed was measured during the tests by a TRODI instrument set-up as shown in Figure 8. Sinking speed was subsequently obtained for Drops 68, 70, 82, 84 and 93 by the following application of the classic equations of motion in which consideration was given to the effect of wing lift applied prior to the instant of ground contact:

$$V_v = g \cdot \bar{t} - \frac{g}{W} \int L dt$$

where  $\bar{t}$  is the time from the instant of release to the instant of ground contact,  $L$  is the lift applied to the airplane through the lift pots and  $W$  is the gross weight of the airplane. A comparison of the TRODI readings with  $V_v$  obtained from solution of the above equation is of interest in the evaluation of the accuracy of the sinking speed measurement.

The variation of wing lift with time, as obtained from the oscillograph records, for the period before ground contact is shown in Figure 11. Integration of these curves provides the information for the second term of the right hand member of the above equation. The following table provides a comparison of sinking speeds obtained by the two methods.

PREPARED BY: F.O. Allen DOUGLAS AIRCRAFT COMPANY, INC.

PAGE: 20

CHECKED BY: L.B. Mesby <sup>DATE</sup> 9/12/62 LONG BEACH DIVISION

MODEL: A4D-2

TITLE: LANDING LOADS INVESTIGATION LABORATORY DROP TESTS

REPORT NO: 40641

Drop No.	$\bar{t}$	$g\bar{t}$	$\frac{S}{W}$	Ldt	$V_v$ -fps (Computed)	$V_v$ -fps (TRODI)
84	.460	14.8	.90		13.9	13.8
70	.419	13.5	1.34		12.2	12.0
68	.504	16.2	1.15		15.0	14.8
93	.551	17.7	.95		16.7	16.8
82	.540	17.4	1.20		16.2	15.8

TRODI readings agree with the calculated within  $\pm 0.2$  fps with the exception of Drop 82. A notation on the log (Appendix A) for drops made on the same day as Drop 82 to the effect that the TRODI sensitivity was set too low leads to the conclusion that the computed value is more correct. In addition, the only experimental parameter in the computed value having a significant effect on the results is  $\bar{t}$ . A conservative estimate of the maximum error in  $\bar{t}$  is  $\pm 0.004$  sec. which produces  $\pm 1.13$  fps error in sinking speed. In view of these factors, the computed sink speeds are used in preference to the TRODI readings for the drop tests which are to be compared with flight landings in subsequent investigations.

PREPARED BY: **F.C. Allen**

**DOUGLAS AIRCRAFT COMPANY, INC.**

PAGE: **81**

CHECKED BY: **L.B. Hooby** 9/12/62

LONG BEACH DIVISION

MODEL: **A4D-2**

TITLE: **LANDING LOADS INVESTIGATION LABORATORY DROP TESTS**

REPORT NO. **406A1**

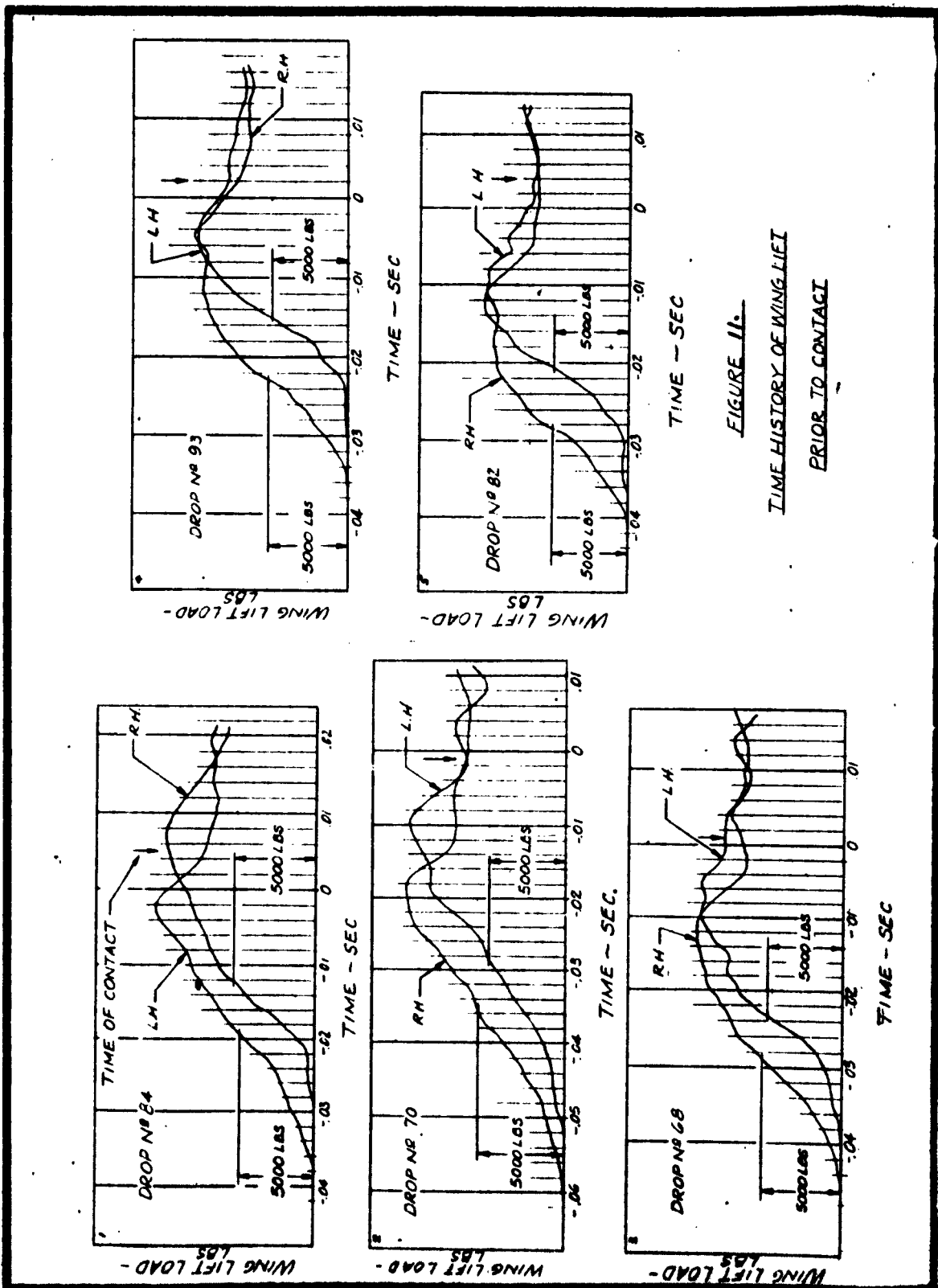

**FIGURE II.**  
**TIME HISTORY OF WING LIFT**  
**PRIOR TO CONTACT**

PREPARED BY: F.C.Allen DOUGLAS AIRCRAFT COMPANY, INC.PAGE: 22CHECKED BY: L.B.Mosby <sup>DATE</sup> 9/12/62

LONG BEACH DIVISION

MODEL: A4D-2TITLE: LANDING LOADS INVESTIGATION LABORATORY DROP TESTSREPORT NO. 40641

#### E. Horizontal Speed (Wheel Rotational Velocity)

The rotational velocity of the wheels of the drop test airplane and of the flight test airplane was measured by a magnetic pickup mounted on the brake assembly which was activated by steel studs fastened to the wheel at 10 degree intervals. As each stud passed the sensor, an electrical current was generated which was recorded on the oscillograph.

The relationship between wheel maximum rotational velocity and airplane forward velocity on the flight landings was a variable which depended upon the tire deflection at the time of spin-up. The procedure used in the drop tests was to match as closely as possible the maximum wheel RPM obtained in the flight landings. Since the relationship between RPM and airplane velocity is indefinite, no airplane speed is listed for the drop tests in Table II.

In drop tests the wheels were spun by the device described on Page 7. After spin-up it was necessary for the spin-up apparatus to be moved and for the airplane to stop oscillating, during which time the wheel rotational velocity varied. It was necessary, therefore, to make allowance for this variation and, again, exact duplication of the flight condition was not possible.

The accuracy of the rotational speed measurement at these speeds was very good being limited only by the accuracy of the recording apparatus and the time signal. Without a detailed analysis it can be stated that the accuracy is well within  $\pm 1$  RPM. Accuracy of this device reduced as the speed reduced, hence, it was not possible to obtain a satisfactory reading as the rotational velocity approached zero or to determine accurately the time at which rotation stopped.



PREPARED BY: F.C.Allen DOUGLAS AIRCRAFT COMPANY, INC.

PAGE: 23

CHECKED BY: L.B.Mesby <sup>DATE</sup> 9/12/62 LONG BEACH DIVISION

MODEL: A4D-2

TITLE: LANDING LOADS INVESTIGATION LABORATORY DROP TESTS

REPORT NUMBER 40641

### REDUCTION OF DATA

Figure 12 is a reproduction of the oscillograph records obtained during a typical drop test. In accordance with standard practice, each record was preceded by a calibration run in which zero's and the response of each channel to known voltages were obtained. Channel 22 on each oscillograph monitored the voltage of the power supply since this was not precisely constant throughout the run.

The oscillograph data, in terms of trace deflection from a reference line was read by a Bensen-Lorimer "Oscar J" reader which provided punched cards for input to an IBM program for reduction of the data. The data were read at .001 sec. intervals.

The reduction equations were not identical for all channels. The channels and the equations used by the machine are identified in Table III and in the following paragraph:

$$\text{When Flag 1} = 1 \text{ and Flag 3} = 0; \quad \frac{\delta}{\Delta} = \frac{\delta_1 - \Delta_0}{\Delta_1 - \Delta_0} \quad (1)$$

$$\text{When Flag 1} = 1 \text{ and Flag 3} = 1; \quad \frac{\delta}{\Delta} = \frac{\delta_1 - \delta_0}{\Delta_1 - \Delta_0} \quad (2)$$

$$\text{When Flag 1} = 0 \text{ and Flag 3} = 0; \quad \frac{\delta}{\Delta} = \frac{\delta_1 - \Delta_0}{\left(\frac{\delta}{\Delta_{22}}\right) (\Delta_1 - \Delta_0)} \quad (3)$$

$$\text{When Flag 1} = 0 \text{ and Flag 3} = 1 \quad \frac{\delta}{\Delta} = \frac{\delta_1 - \delta_0}{\left(\frac{\delta}{\Delta_{22}}\right) (\Delta_1 - \Delta_0)} \quad (4)$$

Flags 2 and 4 control the equations to be used in converting  $\delta/\Delta$  to parameter value, "P".

When Flag 2 = 0,

$$P = \frac{\delta}{\Delta} (K+) \quad (5)$$

PREPARED BY: F.C.Allen DOUGLAS AIRCRAFT COMPANY, INC.  
 CHECKED BY: L.B.Mosby <sup>DATE</sup> 9/12/62 LONG BEACH DIVISION  
 TITLE: LANDING LOADS INVESTIGATION LABORATORY DROP TESTS

PAGE: 24  
 MODEL: A4D-2  
 REPORT NO: ES 40641

When Flag 2 = 1,  $\frac{\delta}{\Delta}$  is minus, and the alternate constant is used:

$$P = \frac{\delta}{\Delta} (K-) \quad (6)$$

When Flag 4 = 1, an intercept constant is added. Then,

$$P = I + \frac{\delta}{\Delta} (K) \quad (7)$$

Table III provides the calibration constants, K, and the flag information pertaining to each channel. The intercept, I, applies to pressures only and is equal to the strut initial absolute pressure with strut extended (14.7 + 25.0 = 39.7 psi).

Additional operations were required on certain parameters to present information in a preferred form. Thus, the axle strain gauge readings, channels 10 and 14, were converted to strut axial and normal force, after which strut axial and normal force combined with the axle accelerations were converted to loads at the ground. Also, the instantaneous, coefficient of friction was computed as well as the average coefficient. The equations applicable to these operations are as follows:

A. Axle readings to strut load\*

L.H. Gear (Osc 1)

$$F_A = (43,574 - 142.1P_6)P_{10} + (-223.8 - 66.7P_6)P_{13} \quad (8)$$

$$F_N = (983.3 - 99.1P_6)P_{10} + (4575.0 - 5.0P_6)P_{13} \quad (9)$$

R.H. Gear (Osc 2)

$$F_A = (56,995 + 337.2P_6)P_{10} + (1200 - 101.1P_6)P_{13} \quad (10)$$

$$F_N = (4800 - 145.3P_6)P_{10} + (8,455.8 + 30.8P_6)P_{13} \quad (11)$$

\* The equations are derived in reference (1).

PREPARED BY: F.C. Allen DOUGLAS AIRCRAFT COMPANY, INC.

CHECKED BY: L.B. Mosby <sup>DATE</sup> 9/12/62 LONG BEACH DIVISION

TITLE: LANDING LOADS INVESTIGATION LABORATORY DROP TESTS

PAGE: 25  
MODEL: A4D-2  
REPORT NO. ES 40641

**B. Strut leads to ground leads**

$$FVG = (FA + FAA) \cos(\delta-6) - (FN + FAN) \sin(\delta-6) \quad (12)$$

$$FHG = (FN + FAN) \cos(\delta-6) + (FA + FAA) \sin(\delta-6) \quad (13)$$

**C. Coefficient of friction**

$$MUA_1 = \frac{FHG}{FVG} \quad (14)$$

$$\text{Average MUA} = \sum \left[ \frac{1}{2}(MUA_{1-1} + MUA_1) \right] \frac{\Delta \text{ TIME}}{\Sigma \Delta \text{ TIME}} \quad (15)$$

The reduced data were printed numerically and plotted mechanically.

PREPARED BY: F.C. Allen DOUGLAS AIRCRAFT COMPANY, INC.  
CHECKED BY: L.B. Mosby DATE: 9/12/62 LONG BEACH DIVISION  
TITLE: LANDING LOADS INVESTIGATION LABORATORY DROP TESTS

PAGE: 26  
MODEL: A4D-2  
REPORT NO. RS 40641

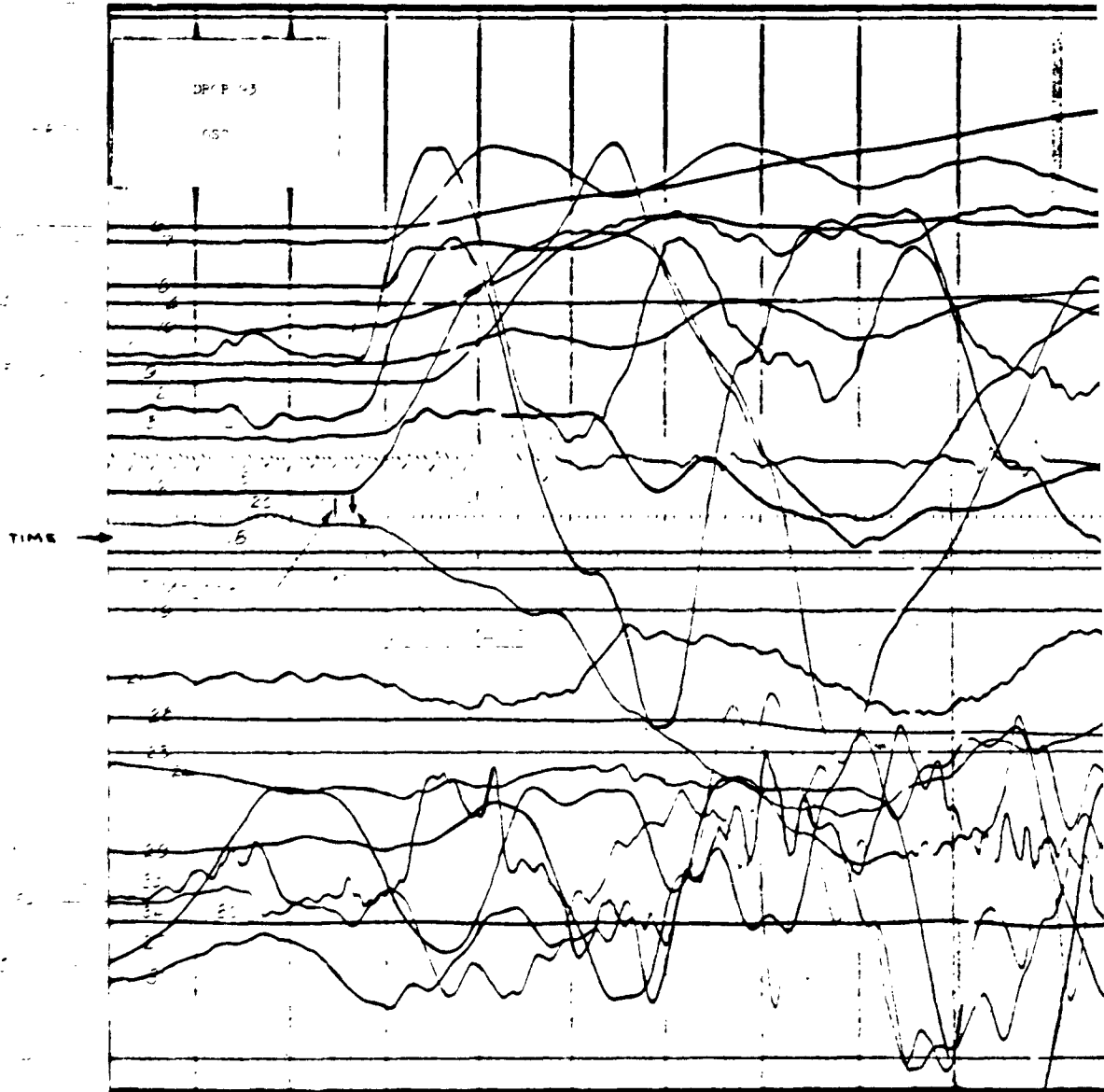
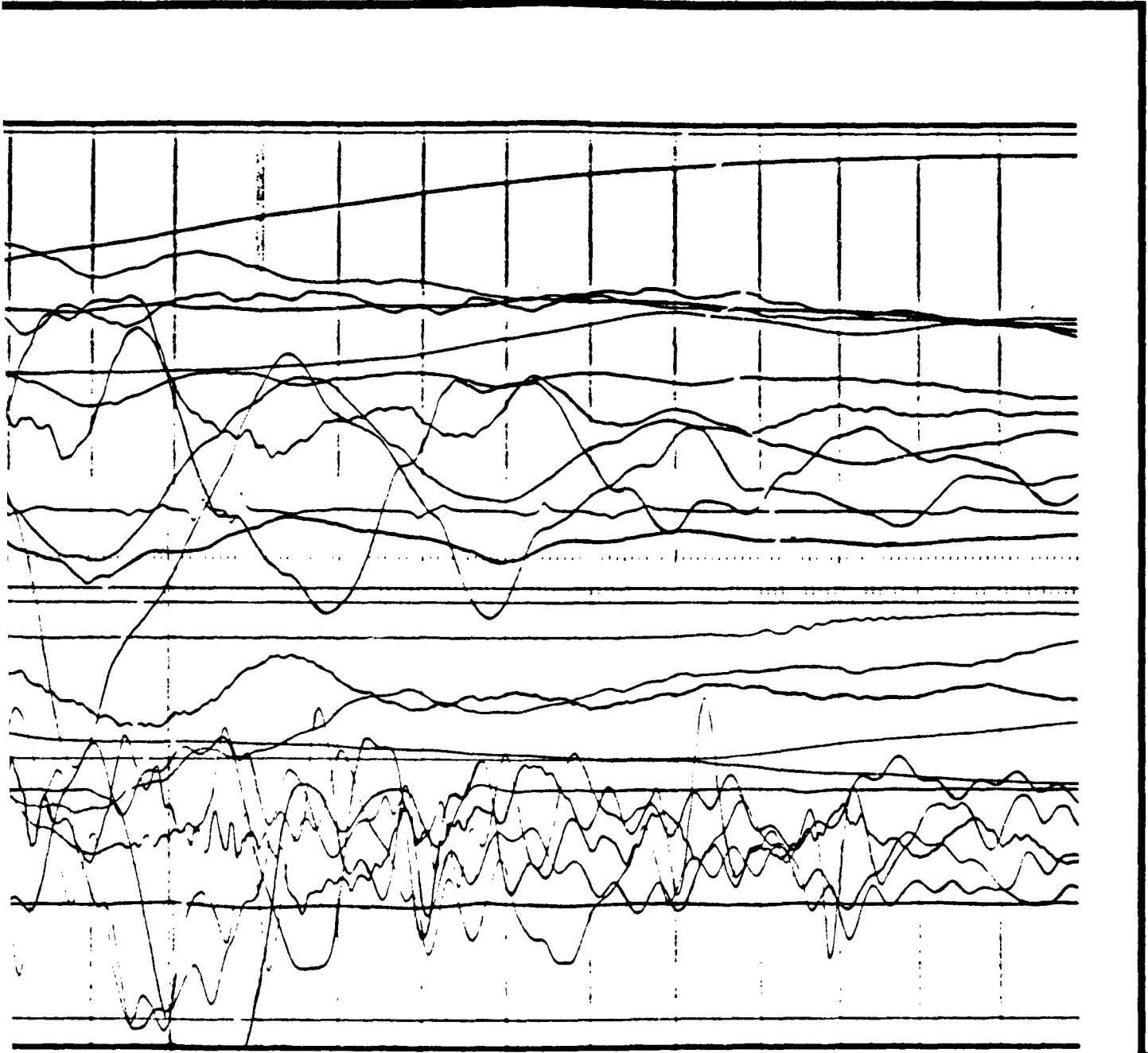

Figure 12. Reproduction of Typical Oscillograph Record

L: A4D-2

RT NO. ES 40641



rd

PREPARED BY: F.C.Allen DOUGLAS AIRCRAFT COMPANY, INC.  
CHECKED BY: L.B.Mosby <sup>DATE</sup> 9/12/62 LONG BEACH DIVISION  
TITLE: LANDING LOADS INVESTIGATION LABORATORY DROP TESTS

PAGE: 27  
MODEL: A4D-2  
REPORT NO. ES 40641

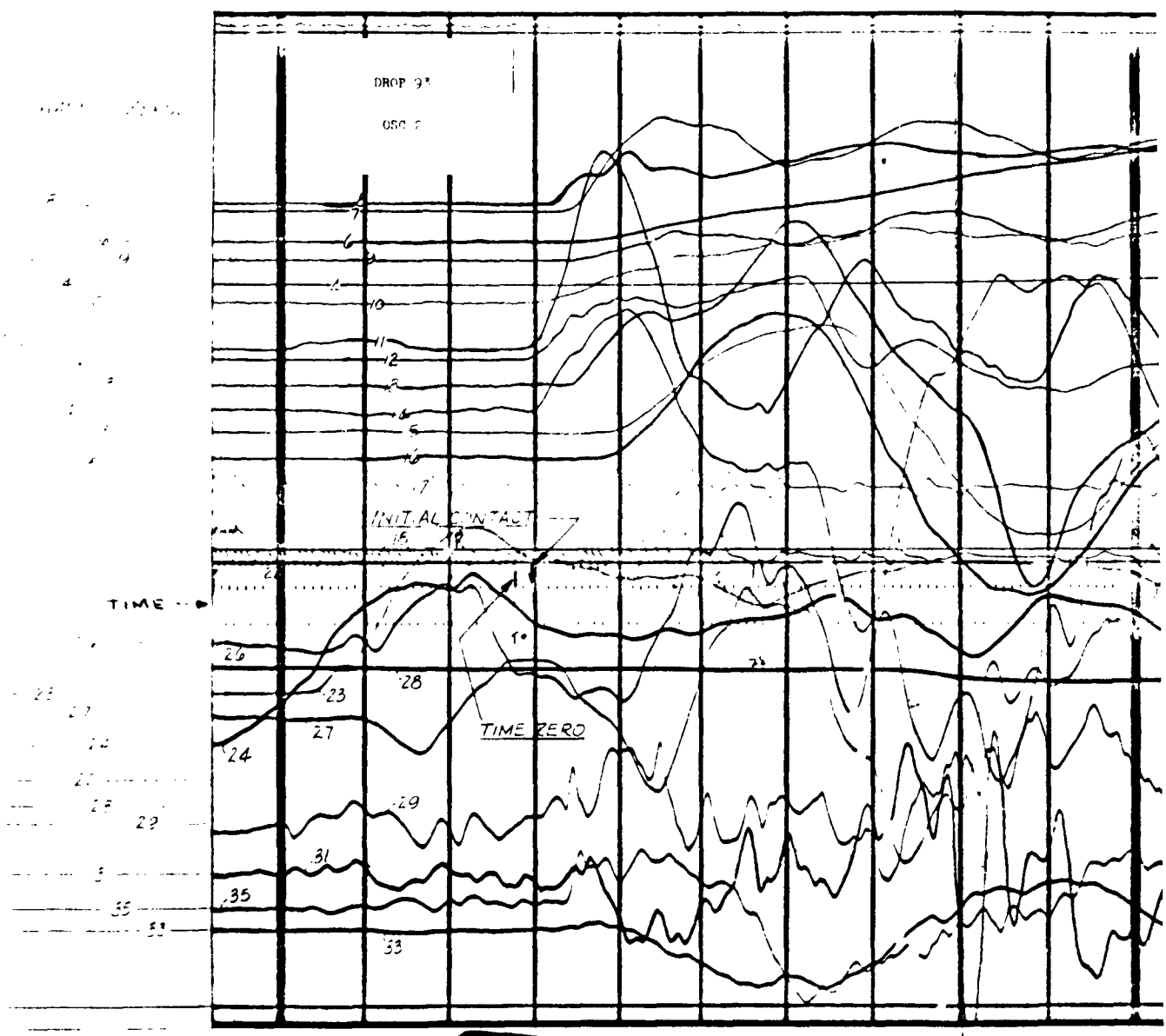
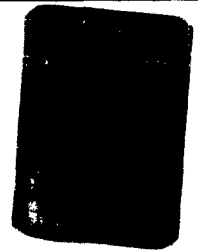
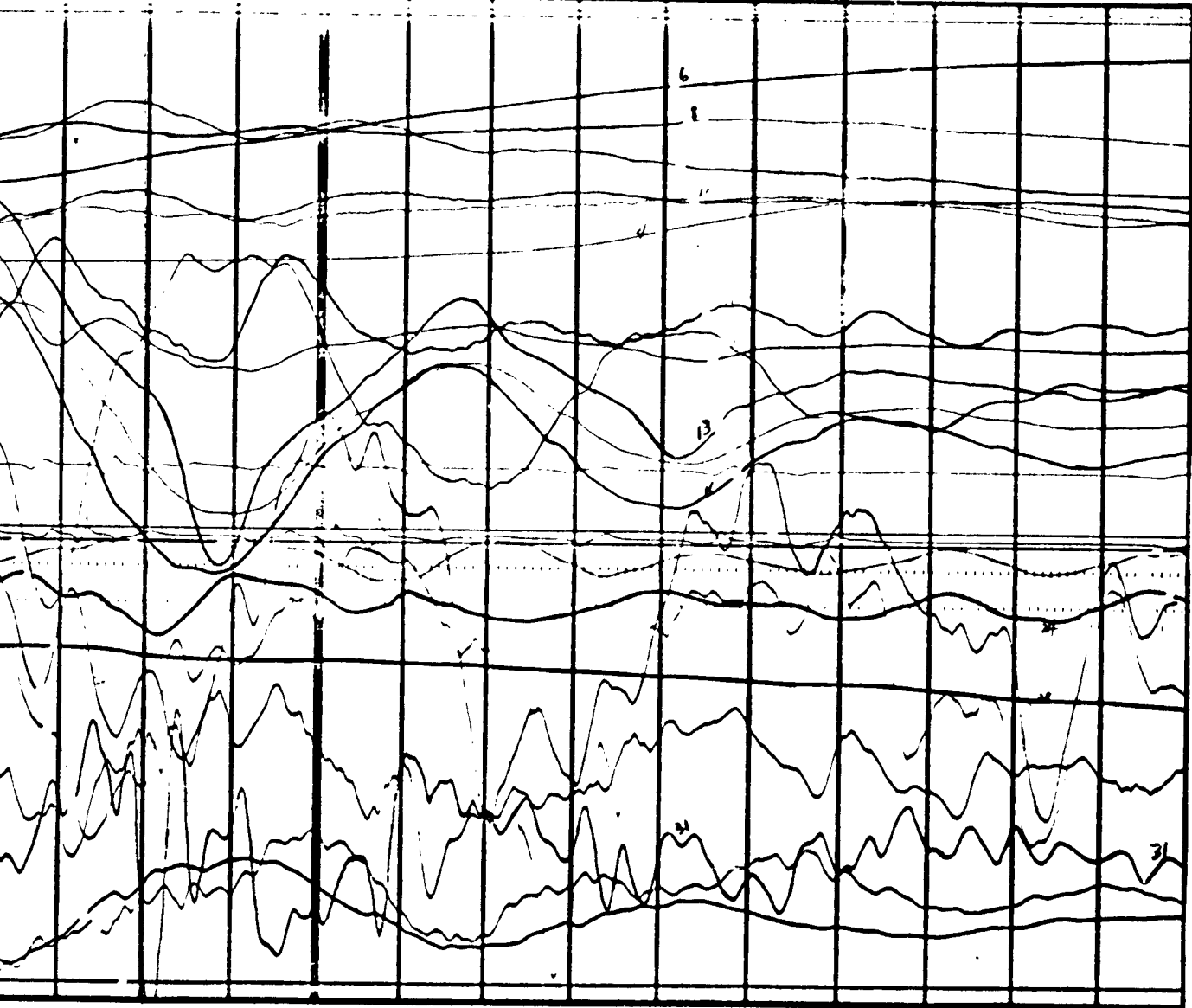

Figure 12. (Cont'd.)





PREPARED BY: F.C.Allen DOUGLAS AIRCRAFT COMPANY, INC.  
 CHECKED BY: L.B.Nosby 9/12/62 LONG BEACH DIVISION  
 TITLE: LANDING LOADS INVESTIGATION LABORATORY DROP TESTS

PAGE: 28  
 MODEL: A4D-2  
 REPORT NO. RS 40641

TABLE III. OSCILLOGRAPH TRACE IDENTIFICATION AND CALIBRATION CONSTANTS.

OSCILLOGRAPH NUMBER 1

CHANNEL NO.	TITLE	CONST. (K+)	CONST. (K-)	FLAG			
				1	2	3	4
4.	L. H. STRUT AIR PRESSURE, P.S.I.	3942.0000	0.	0.	0.	1.	1.
6.	L.H.STRUT POSITION, INCHES	16.0040	0.	1.	0.	1.	0.
7.	L.H.STRUT VELOCITY, F.P.S.	21.7300	0.	1.	0.	1.	0.
8.	L.H.VERTICAL PLATFORM, LBS.	48450.0000	0.	1.	0.	1.	0.
9.	L.H.STRUT METERING PRESSURE, P.S.I.	4406.0000	0.	1.	0.	1.	1.
10.	L.H.AXLE STRAIN GAGE 1, VERTICAL	0.9947	0.	0.	0.	1.	0.
11.	L.H.AXLE VERTICAL ACCELERATION, G S	51.2398	0.	0.	0.	1.	0.
12.	L.H.DRAG BRACE, LBS.	56970.0000	56777.0000	0.	1.	1.	0.
13.	L.H.AXLE DRAG ACCELERATION, G S	52.3510	0.	0.	0.	1.	0.
14.	L.H.AXLE STRAIN GAGE 3, DRAG	1.0107	0.	0.	0.	1.	0.
16.	L.H.DRAG PLATFORM, LBS.	11644.0000	0.	1.	0.	1.	0.
19.	L.H.REBOUND CHAMBER PRESSURE	5640.0000	0.	1.	0.	1.	1.
21.	L.H.AXLE LATERAL ACCELERATION, G S	49.9610	0.	0.	0.	1.	0.
22.	VOLTAGE MONITOR	1.0000	0.	1.	0.	0.	0.
23.	NOSE GEAR STRUT POSITION, INCHES	16.0060	0.	1.	0.	1.	0.
24.	NOSE GEAR UPPER MASS VERT.ACC., G S	-11.4840	0.	0.	0.	1.	0.
20.	STRUT SIDE BENDING STRAIN GAGE	0.9980	0.	0.	0.	1.	0.
27.	C.G.NORMAL ACCELERATION 1, G S	0.6117	0.	0.	0.	1.	0.
28.	FRL PITCH ATTITUDE, DEGREES	3.5950	0.	0.	0.	0.	0.
29.	C.G.LONGITUDINAL ACCELERATION, G S	0.5488	0.	0.	0.	1.	0.
30.	A/C ROLL ATTITUDE, DEGREES	11.0950	0.	0.	0.	0.	0.
31.	C.G.NORMAL ACCELERATION 10, G S	7.8645	0.	0.	0.	1.	0.
33.	L.H.GEAR UPPER MASS VERT.ACC., G S	18.5320	0.	0.	0.	1.	0.
34.	L.H.GEAR UPPER MASS LONG.ACC., G S	11.8390	0.	0.	0.	1.	0.

OSCILLOGRAPH NUMBER 2

4.	R.H.STRUT AIR PRESSURE, P.S.I.	3850.0000	0.	0.	0.	1.	1.
6.	R.H.STRUT POSITION, INCHES	16.0000	0.	1.	0.	1.	0.
7.	R.H.STRUT VELOCITY, F.P.S.	21.3400	0.	1.	0.	1.	0.
8.	R.H.VERTICAL PLATFORM, LBS.	47650.0000	0.	1.	0.	1.	0.
9.	R.H.STRUT METERING PRESSURE, P.S.I.	5290.0000	0.	1.	0.	1.	1.
10.	R.H.AXLE STRAIN GAGE 4 VERTICAL	1.0040	0.	0.	0.	1.	0.
11.	R.H.AXLE VERTICAL ACCELERATION, G S	53.6280	0.	0.	0.	1.	0.
12.	R.H.DRAG PLATFORM, LBS.	11411.7999	0.	1.	0.	1.	0.
13.	R.H.AXLE STRAIN GAGE 5 DRAG	1.0000	0.	0.	0.	1.	0.
14.	R.H.AXLE DRAG ACCELERATION, G S	67.2030	0.	0.	0.	1.	0.
15.	R.H. DRAG BRACE, LBS.	57626.0000	57638.0000	0.	1.	1.	0.
16.	L.H. DRAG BRACE, LBS.	57243.0000	56775.0000	0.	1.	1.	0.
22.	VOLTAGE MONITOR	1.0000	0.	1.	0.	0.	0.
23.	L.H.WING LIFT, LBS.	5044.0000	0.	0.	0.	1.	0.
24.	R.H.WING LIFT, LBS.	5123.0000	0.	0.	0.	1.	0.
26.	R.H.WING TIP ACCELEROMETER, G S	38.0670	0.	0.	0.	1.	0.
27.	L.H.WING TIP ACCELEROMETER, G S	37.4680	0.	0.	0.	1.	0.
28.	FRL PITCH ATTITUDE, DEGREES	3.5340	0.	0.	0.	0.	0.
29.	R.H.GEAR UPPER MASS VERT.ACC., G S	19.4330	0.	0.	0.	1.	0.
31.	R.H.GEAR UPPER MASS LONG.ACC., G S	12.0950	0.	0.	0.	1.	0.
33.	R.H.AXLE STRAIN GAGE 3 SIDE	1.0033	0.	0.	0.	1.	0.
35.	R.H.AXLE LATERAL ACCELERATION, G S	-39.7000	0.	0.	0.	1.	0.



## RESULTS

The results of the drop tests are presented on pages 38 to 61 in the form of curves showing the variation of parameter versus time. Wherever right and left hand readings are available, the curves are drawn so as to present a comparison of left and right parameters. The accuracy of the data is estimated in Reference (1). A summary of these estimates is included herein as Table IV for convenience. The response characteristics of each channel are described in Table V. Since the records were read at .001 second intervals and in most cases plotted at .002 second intervals, the accuracy of the plotted results with respect to frequency response will be limited in some instances by the number of points per cycle.

The comments which follow are made in the order that data appears on Pages 38 to 40.

### 1. C.G. Accelerations

The normal acceleration (10 g's) trace is the most significant and useful. Both the normal accelerometer (1g) and the longitudinal accelerometer had maximum ranges of approximately  $\pm 1.5g$  and higher accelerations were not recorded. The 1g normal accelerometer was used during flight tests to measure wing lift.

### 2. Nose and Main Gear Strut Position

This is the reading from the slide-wire instrumentation. Left and right gear positions are consistent. These data are compared to the strut position determined from integrating the strut velocity under Item 14 and comment on the accuracy of this measurement is included therein.

### 3. Main Gear Side Bending Gauge

No calibration was obtained for this portion of the instrumentation in terms of the basic ground loads, hence these data are not useful except as a qualitative indication of the variation of bending stress in the gear at the point of attachment of the gauges.

PREPARED BY: F.C.Allen DOUGLAS AIRCRAFT COMPANY, INC.  
CHECKED BY: L.B.Mosby DATE \_\_\_\_\_ LONG BEACH DIVISION  
TITLE: LANDING LOADS INVESTIGATION LABORATORY DROP TESTS

PAGE: 30  
MODEL: A4D-2  
REPORT NO: ES 40641

4. Main Gear Drag Gauge

This is the gauge on the axle responding primarily to fore and aft force at the ground. The readings presented here were used in conjunction with the vertical strain gauge reading to give the ground loads presented on Pages 69 to 84. Differences in magnitude of the trace displacement between right and left gears is compensated for by different calibration constants (see Table III). The first .08 second of this record is of greatest importance in this investigation since it includes the spin-up and spring back phenomena of interest to designers.

5. Pitch and Roll Attitude

The attitude readings were derived from the pitch-roll gyro. Pitch attitude at time zero provides the initial condition for Table II and the subsequent values were used as  $\theta$  in the expressions for FVG and FHG in Equations (12) and (13) to determine the ground loads plotted on Pages 69 to 84. The roll attitude readings substantiate the fact that the drops were essentially symmetrical. Maximum readings of  $1/2$  degree were registered.

6. Main Gear Vertical Gauge

This gauge, mounted on the axle, responded primarily to vertical load and the reading was used in conjunction with the main gear drag gauge to obtain the ground loads plotted on Pages 69 to 84. The ground loads are one of the most important parameters in this investigation. Their accuracy and reliability are discussed in detail on Pages 63 to 68.

PREPARED BY: F.C.Allen DOUGLAS AIRCRAFT COMPANY, INC.  
CHECKED BY: L.B.Mosby <sup>DATE</sup> 9/12/62 LONG BEACH DIVISION  
TITLE: LANDING LOADS INVESTIGATION LABORATORY DROP TESTS

PAGE: 31  
MODEL: A4D-2  
REPORT NO. ES 40641

7. Wing Tip Acceleration

The consistency between right and left accelerations creates confidence in these readings. Certain differences can be expected, especially in the initial accelerations because of the slight time differential in the application of the wing lift loads (Figure 11).

8. Nose Gear Vertical Acceleration

With the exception of Drops 82 and 93, the nose gear vertical accelerations are those induced by main gear loads. In Drops 82 and 93 the nose gear touched down before the main gear load history was complete and additional accelerations were produced by the nose gear load.

9. Right and Left Upper Mass Accelerations

Certain of these records show inconsistencies between right and left gear both in the magnitude and phasing. Where such is the case, it is recommended that the results be used with caution, since no reason has been established for this lack of symmetry.

10. Right and Left Lower Mass Accelerations

The vertical and drag acceleration data are used in the determination of the ground loads and consequently are of primary interest. Detailed examination and extensive usage of these data has established a high confidence in their accuracy. The side accelerations have not been used as extensively, but because of the similarity of sensing and recording units, the reliability of these curves is also considered to be good.

PREPARED BY: F.C. Allen DOUGLAS AIRCRAFT COMPANY, INC.

PAGE: 32

CHECKED BY: L.B. Mosby <sup>DATE</sup> 9/12/62 LONG BEACH DIVISION

MODEL: A4D-2

TITLE: LANDING LOADS INVESTIGATION LABORATORY DROP TESTS

REPORT NO. ES 40641

### 11. Wing Lift

These curves show the extent to which a constant lift was maintained during the stroke. Variations of + 10% from the mean are noted with the larger variation occurring generally in the first part of the stroke. Inasmuch as the lift dampers may have individual characteristics and are not applied exactly simultaneously, consistency of phase relationship between right and left lift curves is not expected. Also, during the drop the wing will be vibrating because of the impulse introduced at the instant of release, and the lift damper will connect at difference times in the wing's deflection cycle. Hence, precise consistency between drops cannot be expected. The average values of lift determined from these data were used for comparison with the flight test landing lift (Table II). It is believed that these records present an accurate description of the loads applied to the airplane by the lift dampers, and the data can be used with confidence.

### 12. Drag Brace Axial Load

Good consistency between right and left drag braces is noted for all records except Drop 70. The differences noted in the Drop 70 record are consistent with a similar departure from symmetry between right and left axle drag acceleration (Item 10) and metering chamber pressure (Item 12). These phenomena may be associated with roll of the airplane since Drop 70 has the largest initial angle of roll.

PREPARED BY: F.C.Allen DOUGLAS AIRCRAFT COMPANY, INC.PAGE: 33CHECKED BY: L.B.Mosby <sup>DATE</sup> 9/12/62 LONG BEACH DIVISIONMODEL: A4D-2TITLE: LANDING LOADS INVESTIGATION LABORATORY DROP TESTSREPORT NOES 40641

### 13. Pressure Readings

Good consistency is noted between right and left gear readings both as to magnitude and phasing again with the exception of Drop 70. Because of the fact that non-symmetry of data in Drop 70 is registered on several channels, it is considered a real phenomenon, and the reliability of the records is strengthened rather than reduced by the noted differences between right and left readings.

The rebound chamber pressure was measured only on the left gear and only in drop tests. This instrumentation was added as a result of the analytical study which showed that the rebound chamber pressure had a pronounced effect on the gear operation during the compression stroke.

### 14. Strut Velocity

As indicated in Table I, strut velocity was measured by a Sanborn velocity generator. The accuracy of this instrument has been estimated at  $\pm 4\%$  (Table IV). The resulting data appears consistent within itself and in comparison to the opposite side. A comparison was made for three cases of the integrated velocity and the stroke (Item 2 above) with the results shown in Figure 13. The agreement between slide-wire reading and integrated velocity reading is substantially less than the accuracy of each instrument since at certain times a difference of stroke of 1 1/2 inches is noted. In an effort to establish which of the readings is more reliable, a comparison was made with the analytical, or computed, stroke (see Figure 14). Slightly better correlation is noted for the integrated stroke. It is of interest to note that both the theory and the integrated stroke are high with respect to the slide wire reading in the middle time range.

There is insufficient evidence to establish which of the two measured values is more correct, however, the comparisons presented here cast some doubt on the accuracy of the slide wire. Further work needs to be done to clarify this point.

FORM 107-1A  
(1-5)

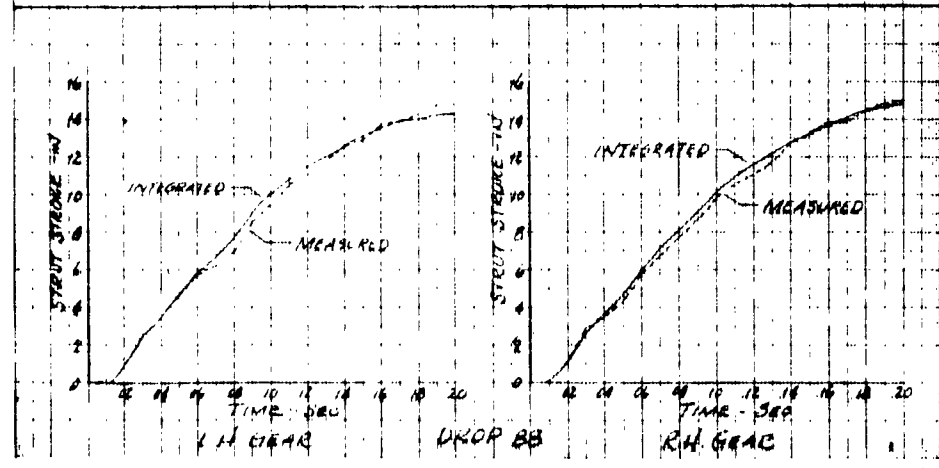
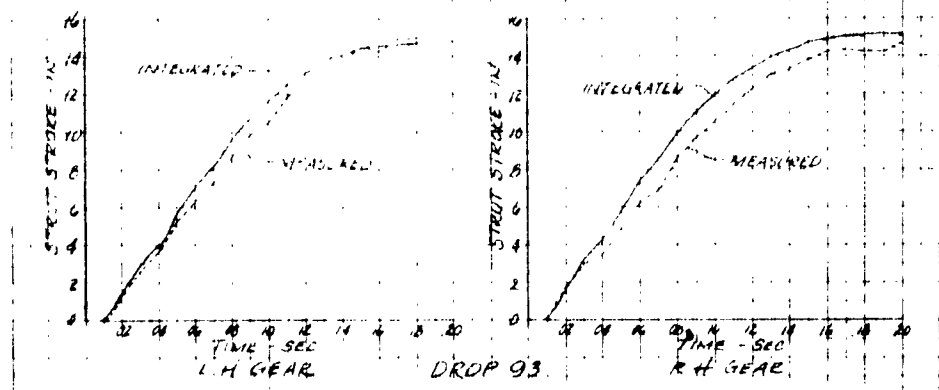
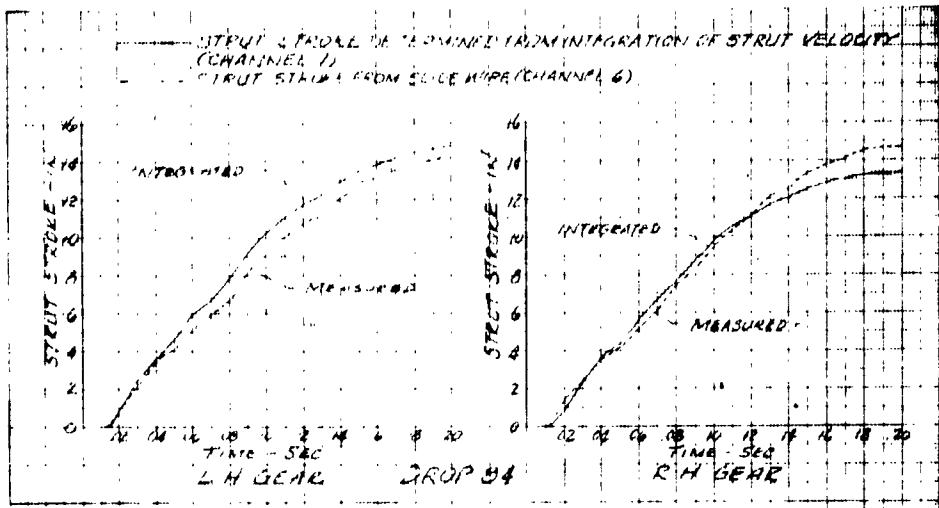

13. ...

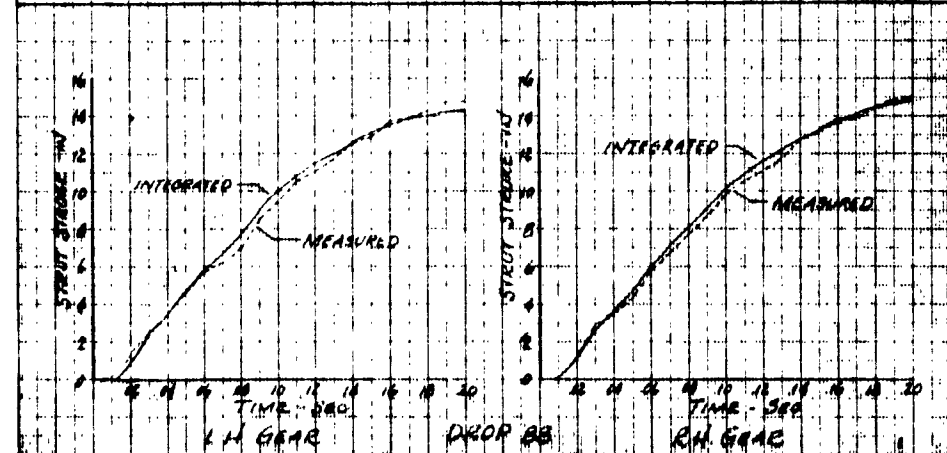
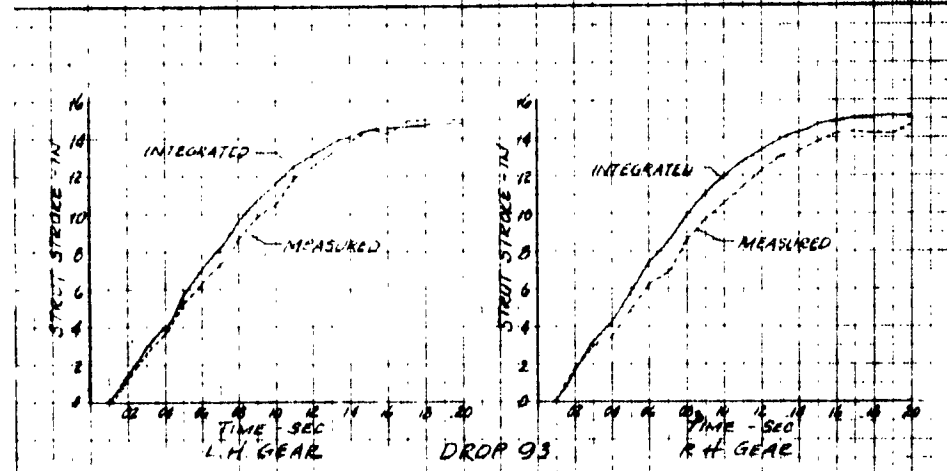
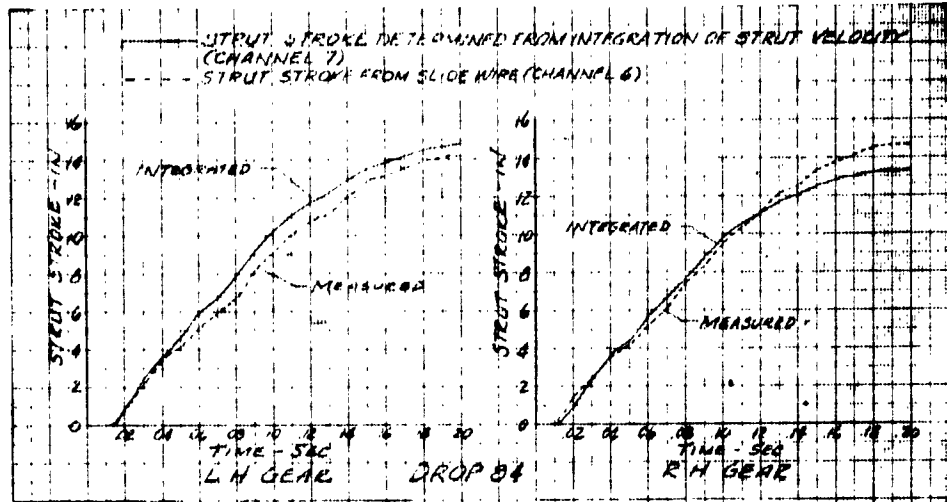
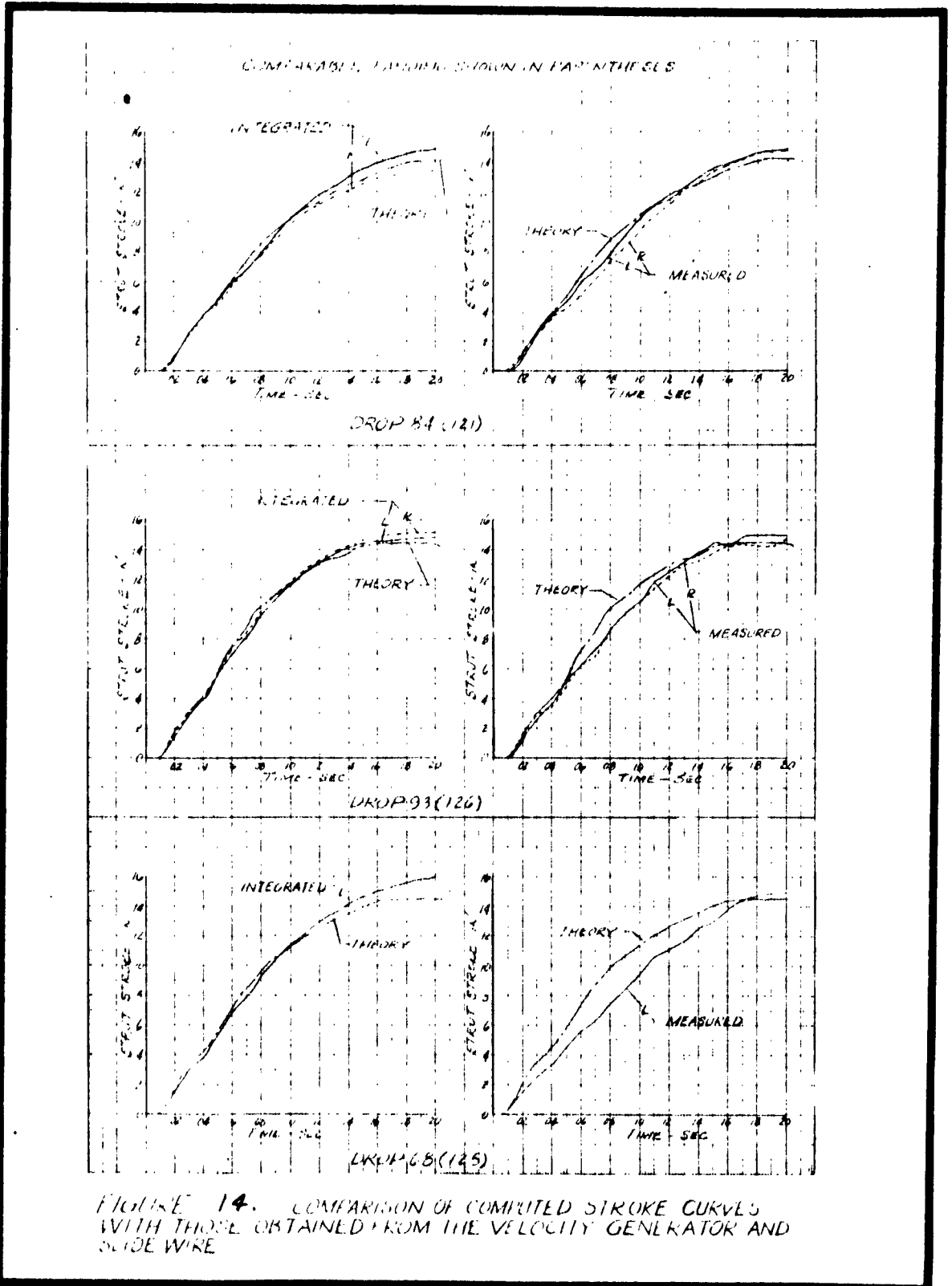

FIGURE 13. STRUT STROKE IN INCHES VERSUS TIME AS DETERMINED FROM THE SLIDE WIRE AND THE VELOCITY GENERATOR.





PREPARED BY: S. Tydeman DOUGLAS AIRCRAFT COMPANY, INC.  
 CHECKED BY: \_\_\_\_\_ DATE \_\_\_\_\_ LONG BEACH DIVISION  
 TITLE: LANDING LOADS INVESTIGATION LABORATORY DROP TESTS

PAGE: 36  
 MODEL: A4D-2  
 REPORT NO. ES 40641

**TABLE IV**  
**ESTIMATED OVERALL RECORDED PARAMETER ACCURACY**

<u>PARAMETER</u>	<u>ACCURACY ± %</u>
R.H. Gear Vertical Load	3
R.H. Gear Drag Load	3
L.H. Gear Vertical Load	3
L.H. Gear Drag Load	3
L.H. Gear Lower Mass Vertical Acceleration	2
L.H. Gear Lower Mass Drag Acceleration	2
L.H. Gear Lower Mass Lateral Acceleration	2
R.H. Gear Lower Mass Vertical Acceleration	2
R.H. Gear Lower Mass Drag Acceleration	2
R.H. Gear Lower Mass Lateral Acceleration	2
R.H. Gear Upper Mass Vertical Acceleration	2
R.H. Gear Upper Mass Longitudinal Acceleration	2
L.H. Gear Upper Mass Vertical Acceleration	2
L.H. Gear Upper Mass Longitudinal Acceleration	2
R.H. Gear Strut Position	3
L.H. Gear Strut Position	3
R.H. Gear Strut Velocity	4
L.H. Gear Strut Velocity	4
R.H. Gear Metering Chamber Pressure	3
L.H. Gear Metering Chamber Pressure	3
L.H. Gear Shock Strut Rebound Chamber Pressure	2
R.H. Gear Strut Air Pressure	3
L.H. Gear Strut Air Pressure	3
R.H. Gear Drag Brace Load	2
L.H. Gear Drag Brace Load	2
Nose Gear Strut Position	3
Nose Gear Upper Mass Vertical Acceleration	2
C.G. Normal Acceleration (Low Range)	2
C.G. Normal Acceleration (High Range)	2
C.G. Longitudinal Acceleration	2
Aircraft Pitch Attitude	3
Aircraft Roll Attitude	3
R.H. Wing Tip Vertical Acceleration	2
L.H. Wing Tip Vertical Acceleration	2
R.H. Gear Reaction Platform Vertical Load	2
R.H. Gear Reaction Platform Drag Load	8
L.H. Gear Reaction Platform Vertical Load	2
L.H. Gear Reaction Platform Drag Load	8
Nose Gear Reaction Platform Vertical Load	2
R.H. Wing Lift Link Load	2
L.H. Wing Lift Link Load	2
Timing Clock	0.1

PREPARED BY: S. Tydeman DOUGLAS AIRCRAFT COMPANY, INC.

PAGE: 37

CHECKED BY: \_\_\_\_\_ DATE \_\_\_\_\_ LONG BEACH DIVISION

MODEL: A4D-2

TITLE: LANDING LOADS INVESTIGATION LABORATORY DROP TESTS

REPORT NO. ES 40641

TABLE V  
FREQUENCY RESPONSE CHARACTERISTICS OF RECORDED PARAMETERS

PARAMETER	FLAT RESPONSE-CPS	
	<u>+2%</u>	<u>+5%</u>
R.H. Gear Vertical Load	115	135
R.H. Gear Drag Load	55	95
R.H. Gear Side Bending Moment	90	180
L.H. Gear Vertical Load	65	195
L.H. Gear Drag Load	50	100
L.H. Gear Side Bending Moment	65	190
L.H. Gear Lower Mass Vertical Acceleration	60	180
L.H. Gear Lower Mass Drag Acceleration	135	150
L.H. Gear Lower Mass Lateral Acceleration	155	175
R.H. Gear Lower Mass Vertical Acceleration	110	130
R.H. Gear Lower Mass Drag Acceleration	45	75
R.H. Gear Lower Mass Lateral Acceleration	40	60
R.H. Gear Upper Mass Vertical Acceleration	50	85
R.H. Gear Upper Mass Longitudinal Acceleration	105	130
L.H. Gear Upper Mass Vertical Acceleration	50	85
L.H. Gear Upper Mass Longitudinal Acceleration	60	90
R.H. Gear Strut Position	65	110
L.H. Gear Strut Position	55	90
R.H. Gear Strut Velocity	45	70
L.H. Gear Strut Velocity	50	90
R.H. Gear Metering Chamber Pressure	70	180
L.H. Gear Metering Chamber Pressure	60	185
L.H. Gear Strut Rebound Chamber Pressure	55	185
R.H. Gear Strut Air Pressure	15	40
L.H. Gear Strut Air Pressure	15	40
R.H. Gear Drag Brace Load	60	100
L.H. Gear Drag Brace Load	50	80
Nose Gear Strut Position	80	135
Nose Gear Upper Mass Vertical Acceleration	120	145
C.G. Normal Acceleration (Low Range)	25	40
C.G. Normal Acceleration (High Range)	40	55
C.G. Longitudinal Acceleration	20	35
Aircraft Pitch Attitude	30	35
Aircraft Roll Attitude	20	35
R.H. Wing Tip Vertical Acceleration	65	160
L.H. Wing Tip Vertical Acceleration	50	80
R.H. Wing Lift Link Load	55	170
L.H. Wing Lift Link Load	125	145

FIGURE 15

LANDING LOAD  
 AIRPLANE  
 70

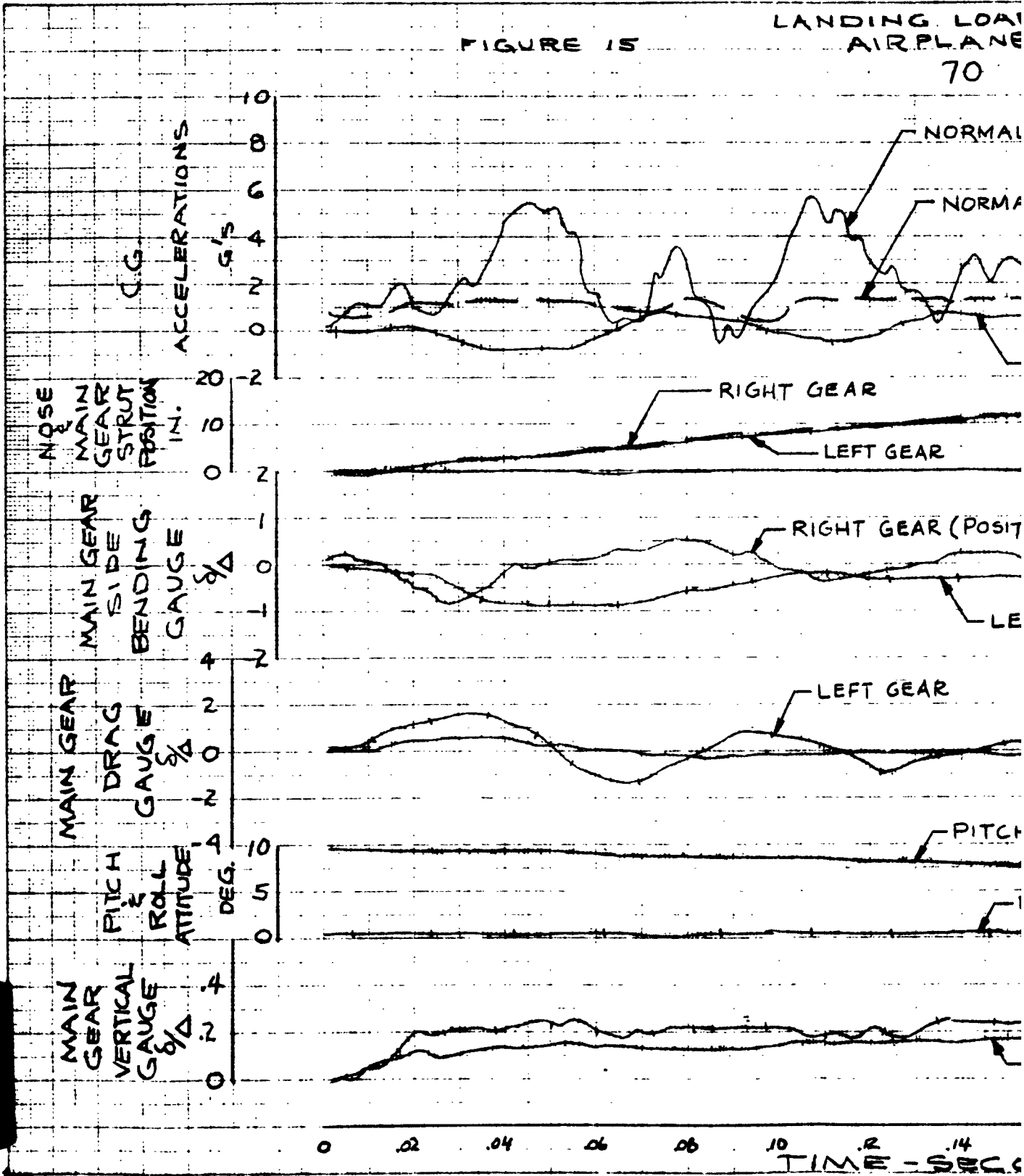

PREPARED BY: L. B. Wosky  
CHECKED BY:                       
DATE: August 1962  
TITLE: DROP TESTS FOR LANDING LOADS INVESTIGATION

DOUGLAS AIRCRAFT COMPANY, INC.

PAGE: 38  
MODEL: A4D-2  
REPORT NO.: EC-40041

LANDING LOADS PROGRAM  
AIRPLANE DROP

70

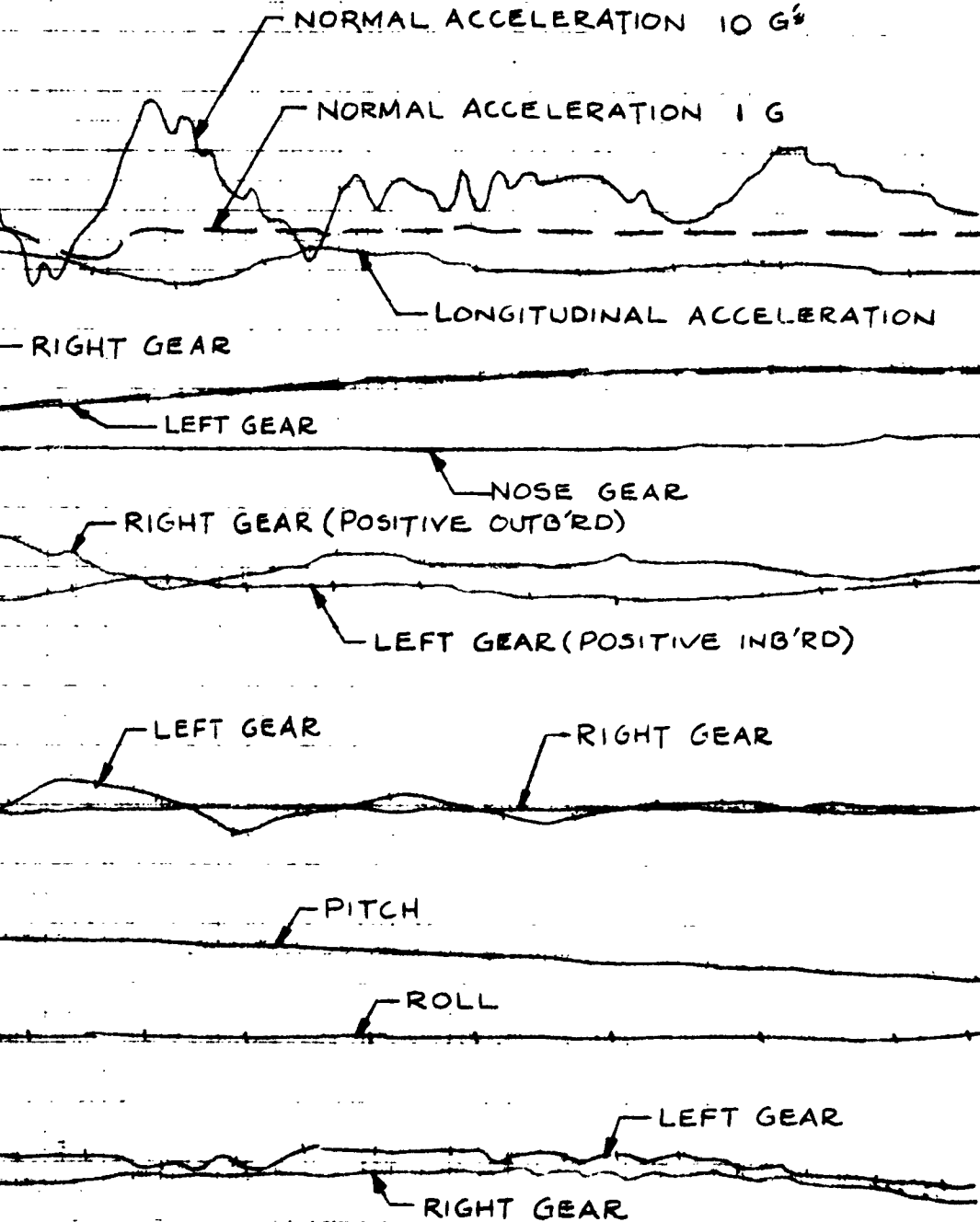

POSITIVE :  
UP & AFT

POSITIVE :  
COMPRESSION

POSITIVE :  
AFT

10 .2 .14 .16 .18 .20 .22 .24 .26 28  
TIME - SECONDS



FIGURE 15 (CONT'D)

LANDING LC AIRPLANE

70

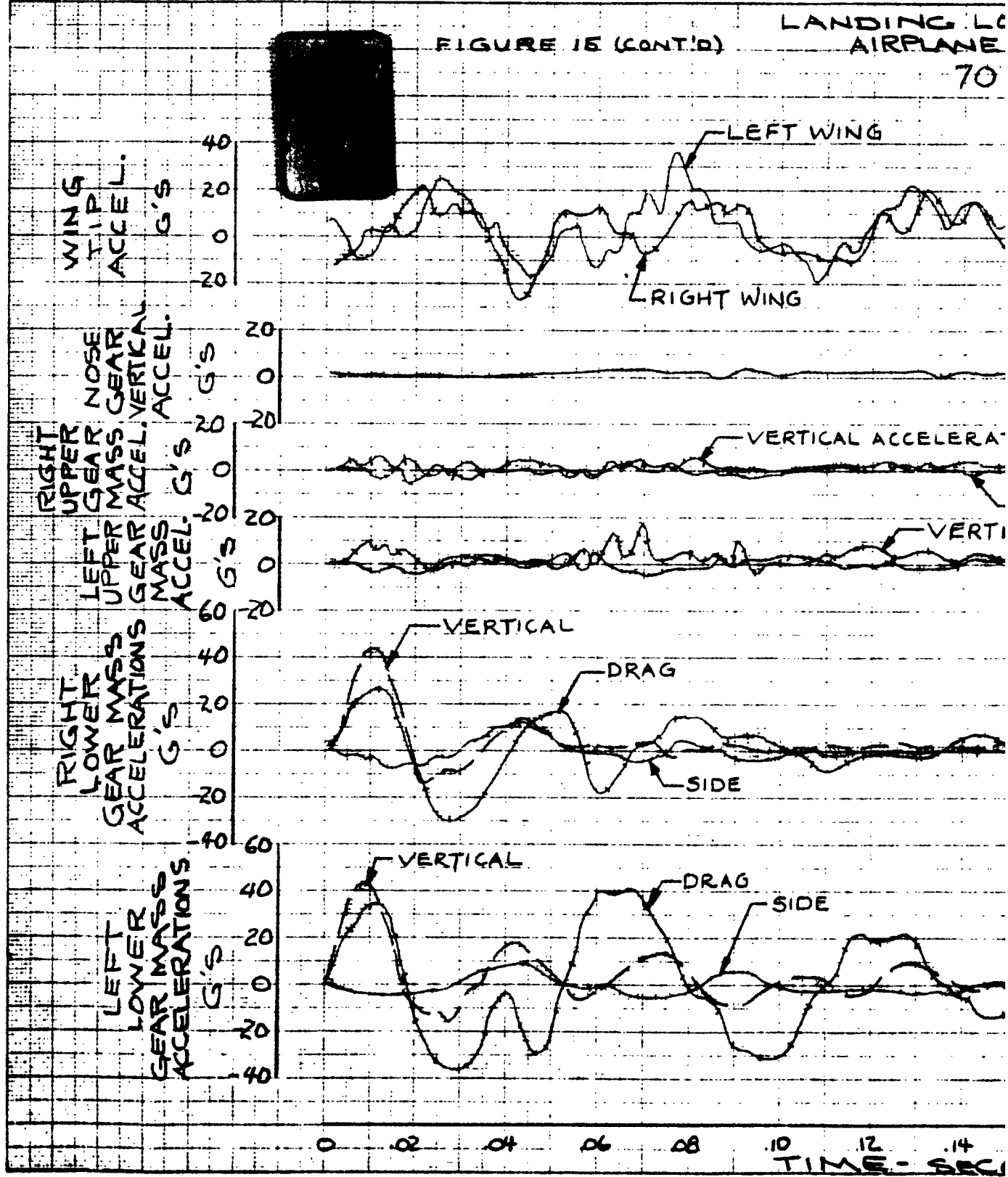

PREPARED BY: L.H. Mosby  
CHECKED BY: F.L.A.  
DATE: AUGUST 1962  
TITLE: PROP TESTS FOR LANDING LOAD INVESTIGATION

DOUGLAS AIRCRAFT COMPANY, INC.

PAGE: 39  
MODEL: A4C-2  
REPORT NO.: ES-40641

LANDING LOADS PROGRAM  
AIRPLANE DROP

70

ACCELERATIONS ARE  
POSITIVE UPWARD,  
FWD, AND IN'RD

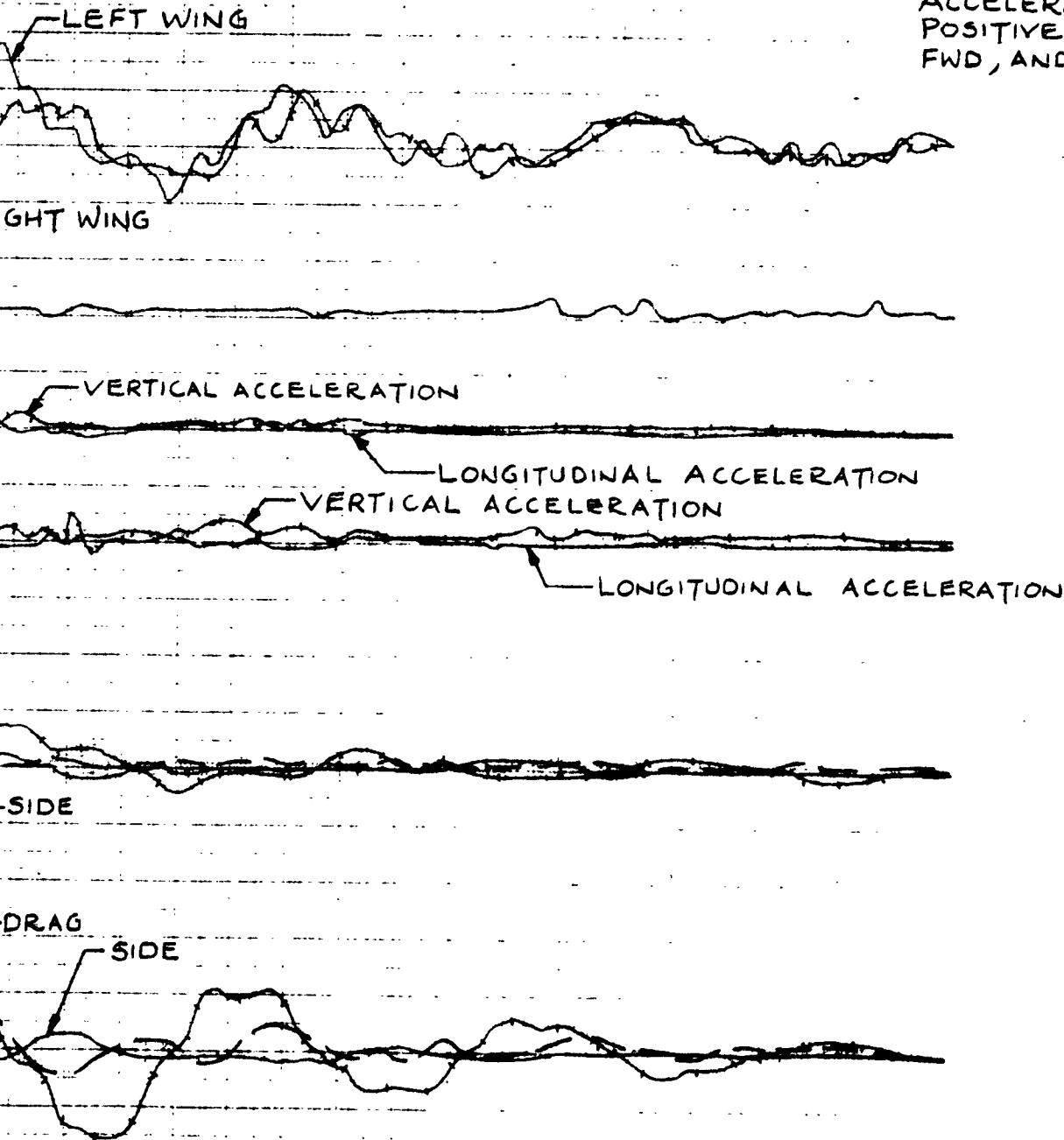

0 .10 .12 .14 .16 .18 .20 .22 .24 .26 .28  
TIME - SECONDS



PREPARED BY:  
 CHECKED BY:  
 DATE: AUG 1  
 TITLE: DROP

FIGURE 15 (CONT'D) LANDING LOADING AIRPLANE 70

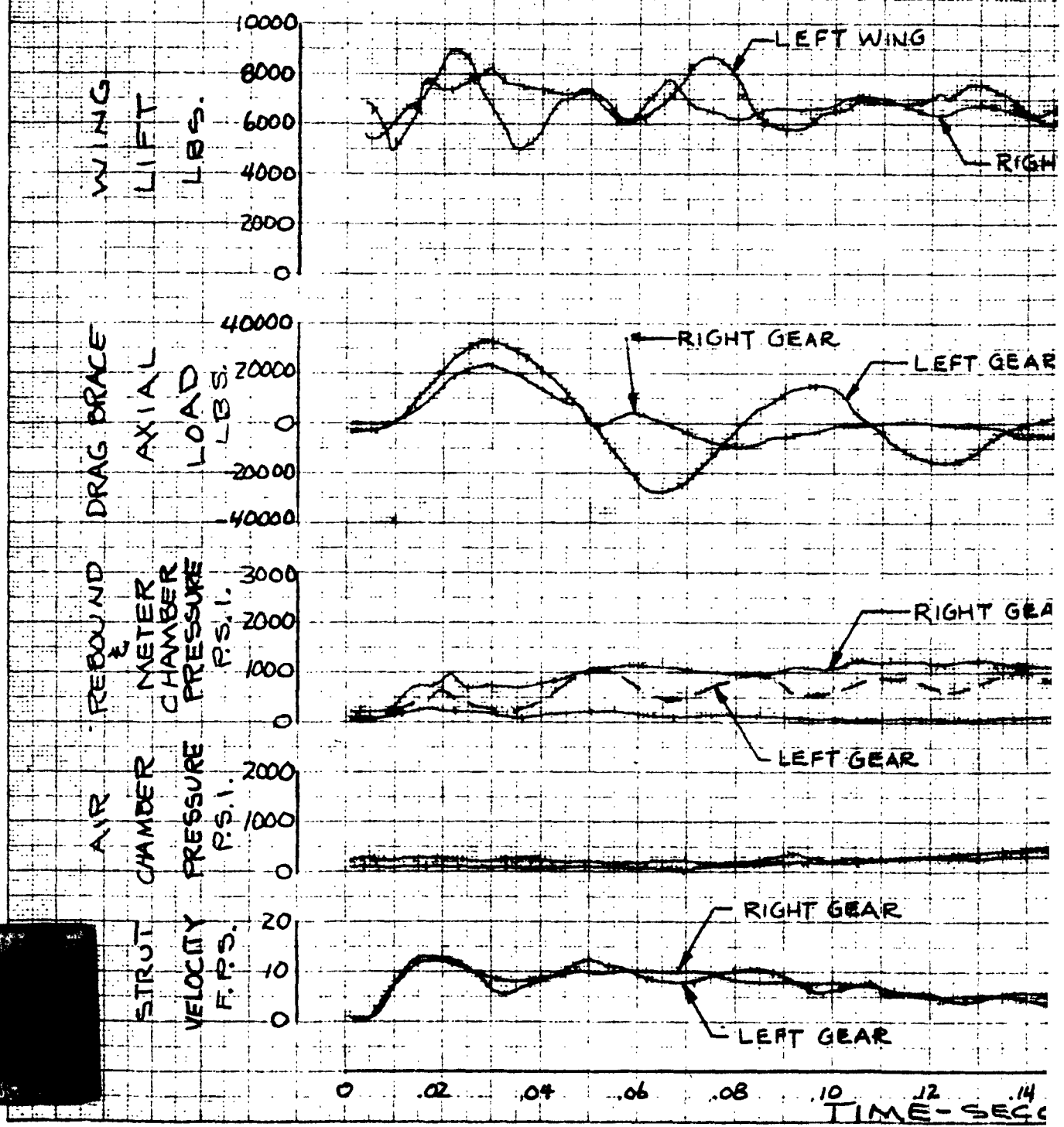

PREPARED BY: L. B. Mosby  
CHECKED BY: F. J. J.  
DATE: AUGUST 1960  
TITLE: DROP TESTS FOR LANDING LOADS INVESTIGATION

DOUGLAS AIRCRAFT COMPANY, INC.  
AIRCRAFT \_\_\_\_\_ DIVISION \_\_\_\_\_

PAGE: 40  
MODEL: A41-2  
REPORT NO.: ES-40641

LANDING LOADS PROGRAM  
AIRPLANE DROP

70

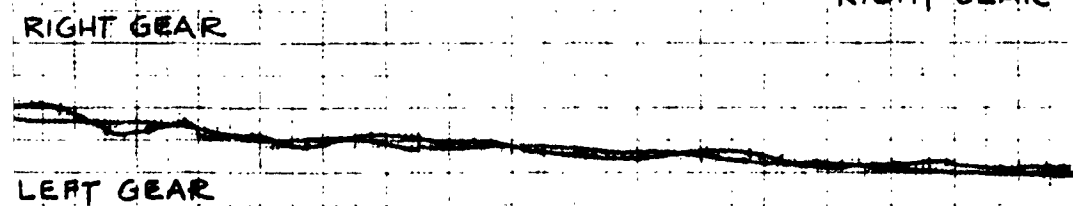
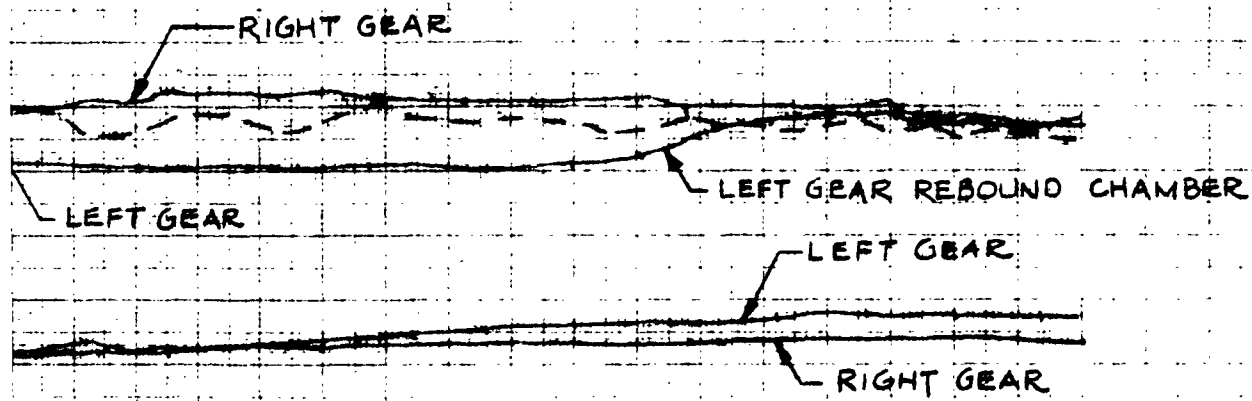
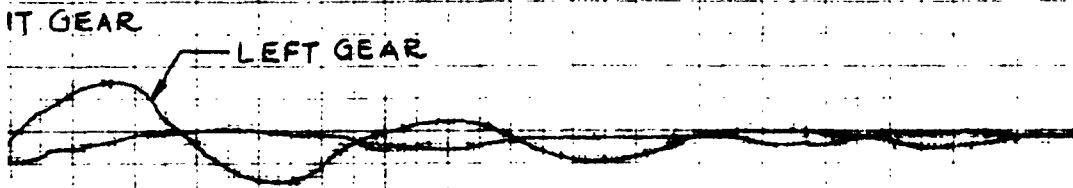
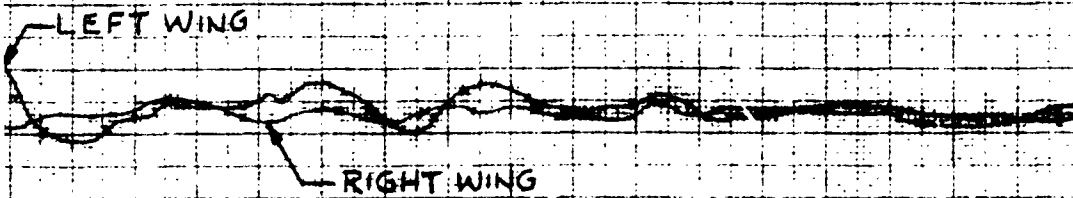

TIME - SECONDS  
0 .10 .12 .14 .16 .18 20 .22 .24 .26 .28

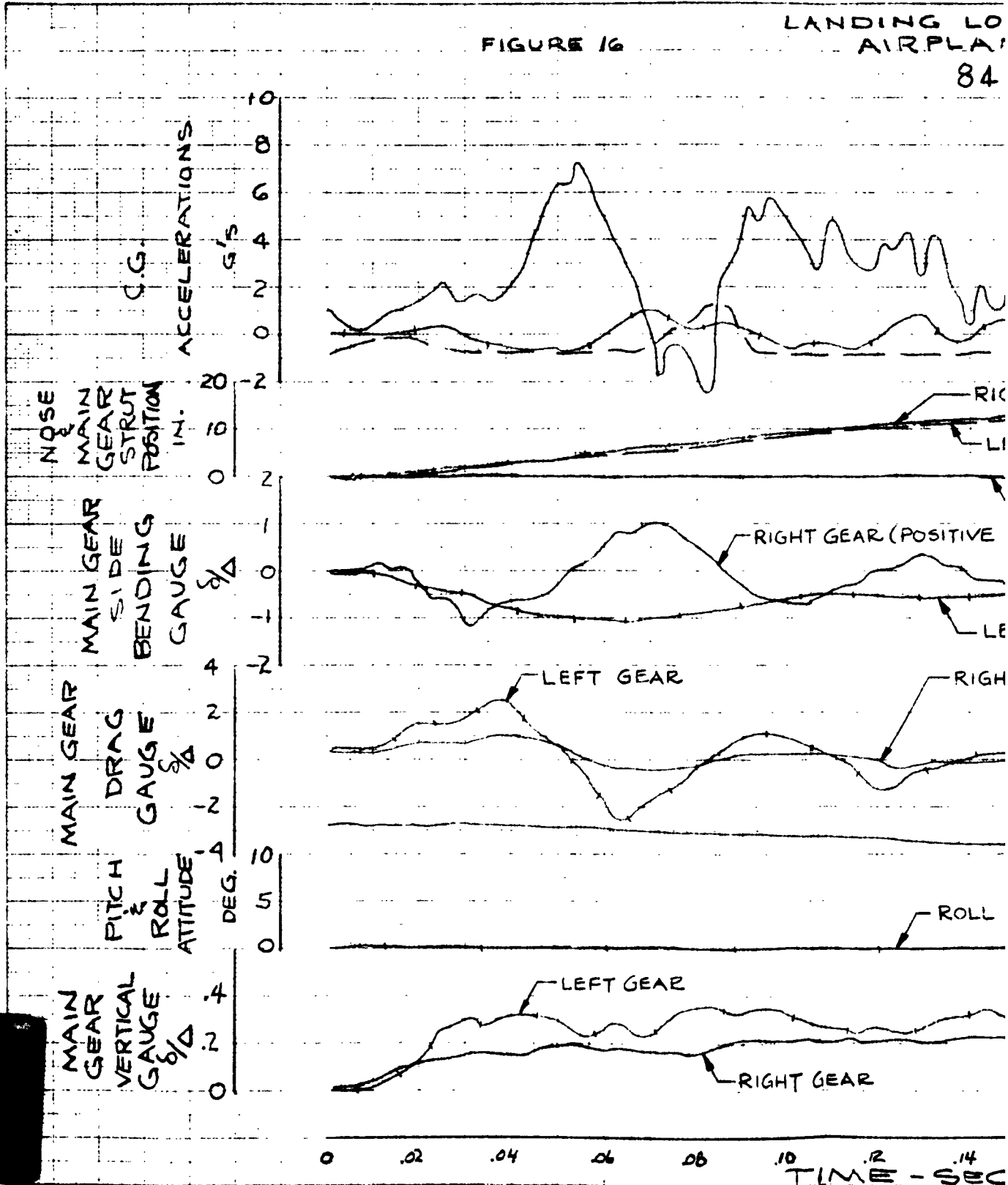



FIGURE 16

LANDING LO  
 AIRPLA

84



PREPARED BY: J. R. Mosby  
CHECKED BY: F. C. M.  
DATE: AUGUST 1962  
TITLE: LUMP TESTS FOR LANDING LOADS INVESTIGATION

DOUGLAS AIRCRAFT COMPANY, INC.

PAGE: 41  
MODEL: A4D-2  
REPORT NO.: ES-4041

LANDING LOADS PROGRAM  
AIRPLANE DROP

84

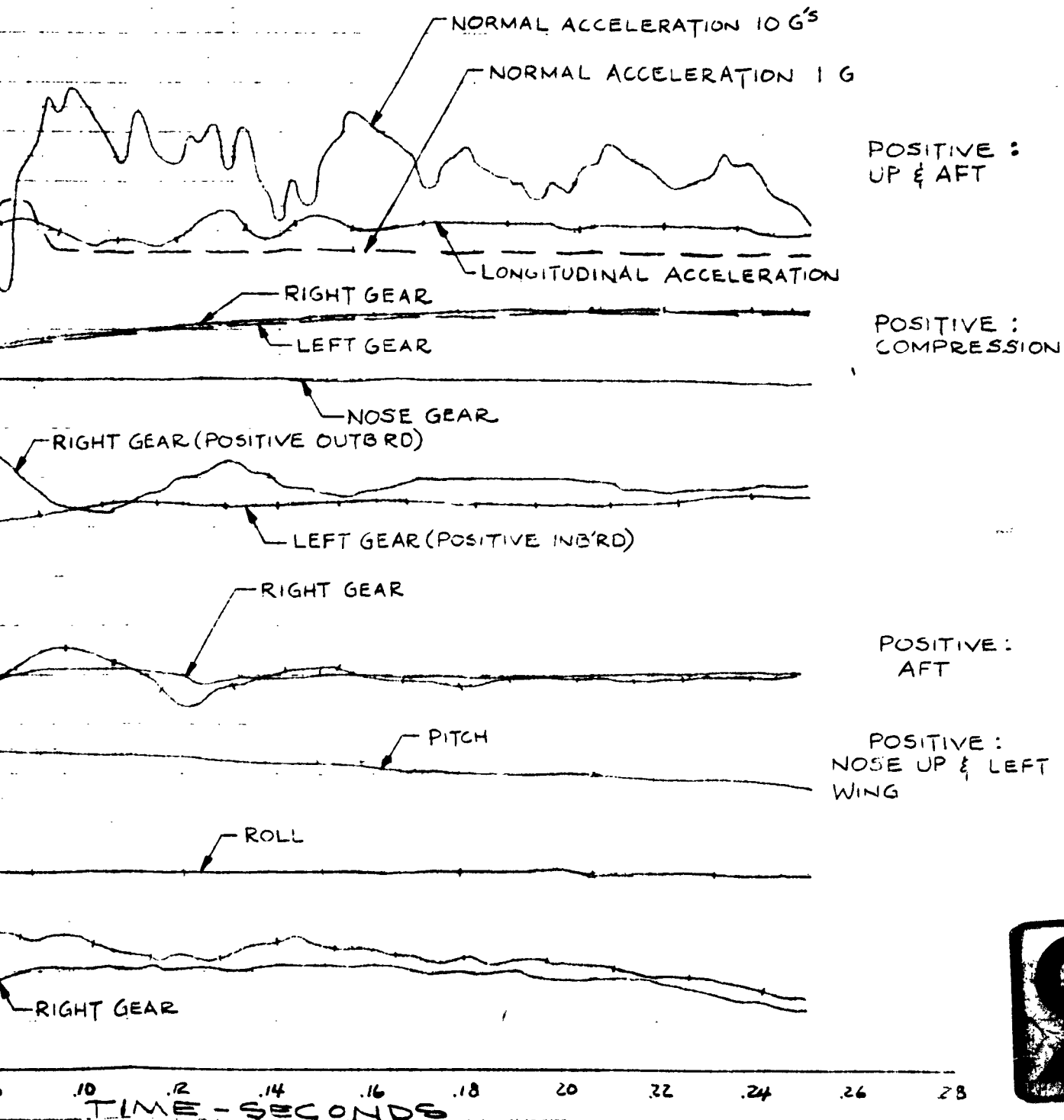
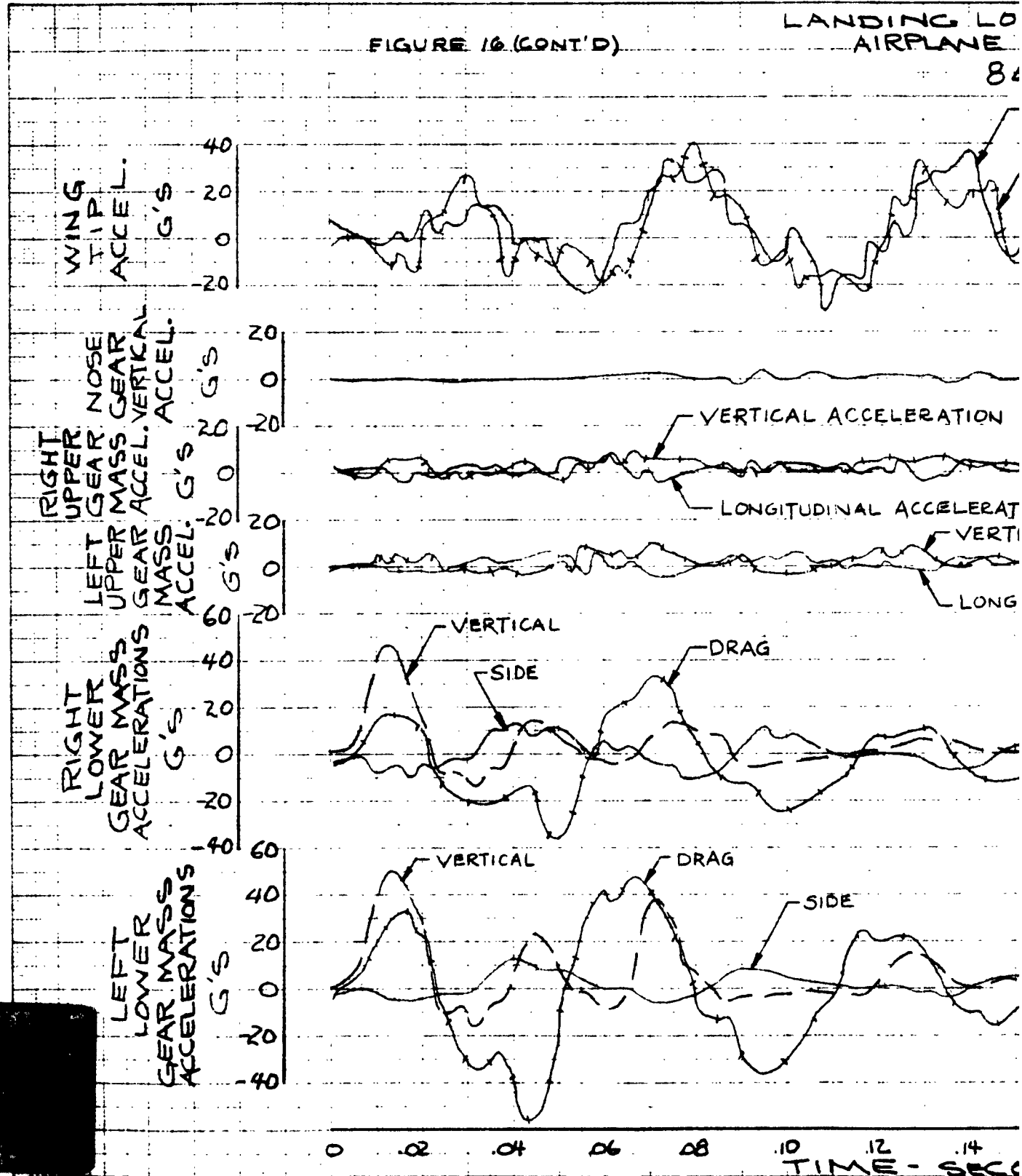

FIGURE 16 (CONT'D)

LANDING LO  
AIRPLANE

84



PREPARED BY: L. R. Mosby  
CHECKED BY: W. D. J.  
DATE: August 1962  
TITLE: LOAD TESTS FOR LANDING LOAD INVESTIGATION

DOUGLAS AIRCRAFT COMPANY, INC.

PAGE 40  
MODEL: A4D-2  
REPORT NO.: ES-40641

LANDING LOADS PROGRAM  
AIRPLANE DROP

84

ACCELERATIONS ARE  
POSITIVE UPWARD, FWD,  
AND INB'RD

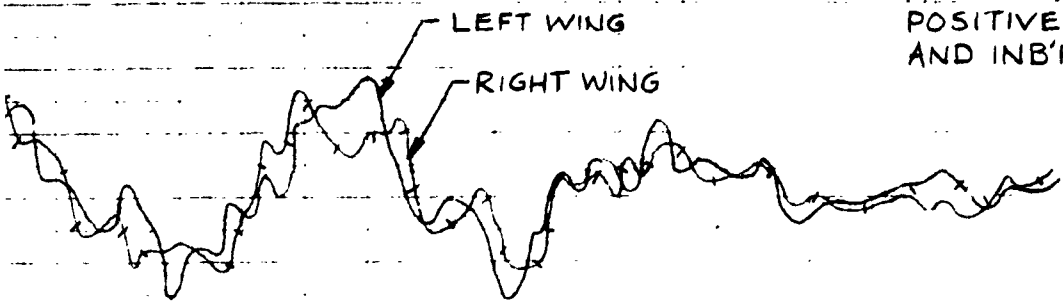

VERTICAL ACCELERATION

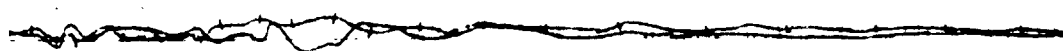

LONGITUDINAL ACCELERATION

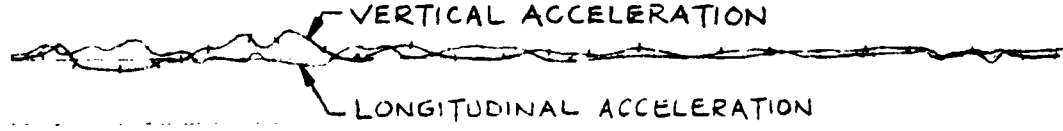

DRAG

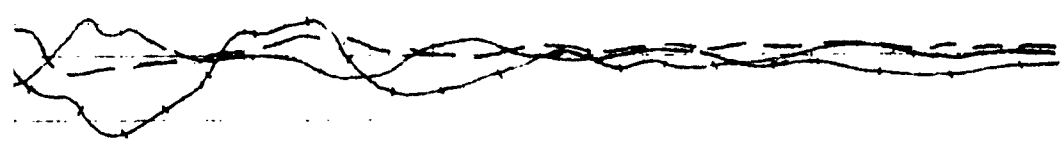

AG

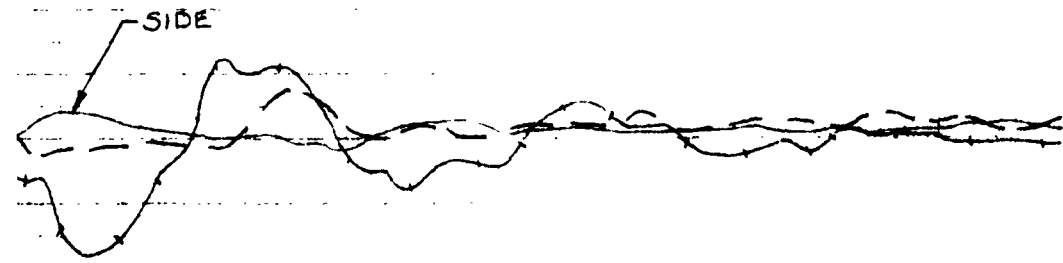

.10 .12 .14 .16 .18 .20 .22 .24 .26 .28  
TIME - SECONDS



FIGURE 16 (CONT'D) LANDING LOADS AIRPLANE 84

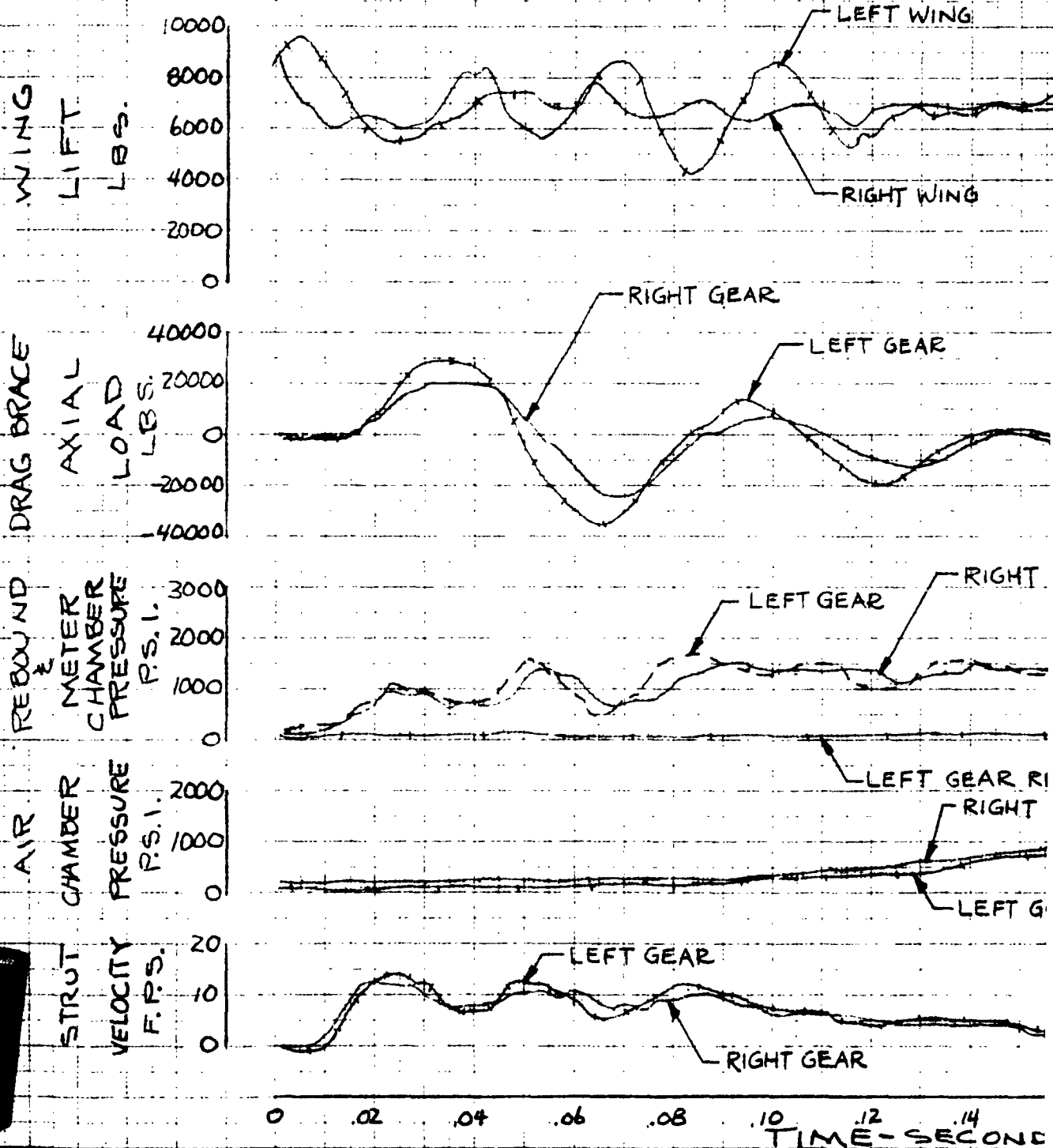

PREPARED BY: I. B. Mosby  
CHECKED BY: F. C. A.  
DATE: August 1962  
TITLE: DROP TESTS FOR LANDING LOADS INVESTIGATION

DOUGLAS AIRCRAFT COMPANY, INC.

PAGE: 43  
MODEL: A4D-2  
REPORT NO.: ES-40641

LANDING LOADS PROGRAM  
AIRPLANE DROP

84

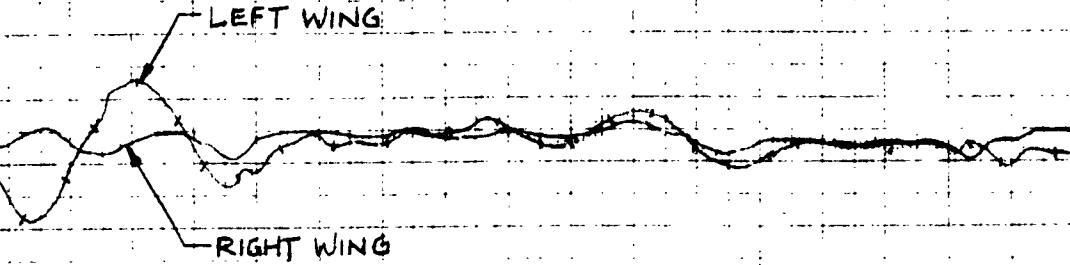

POSITIVE:  
UPWARD

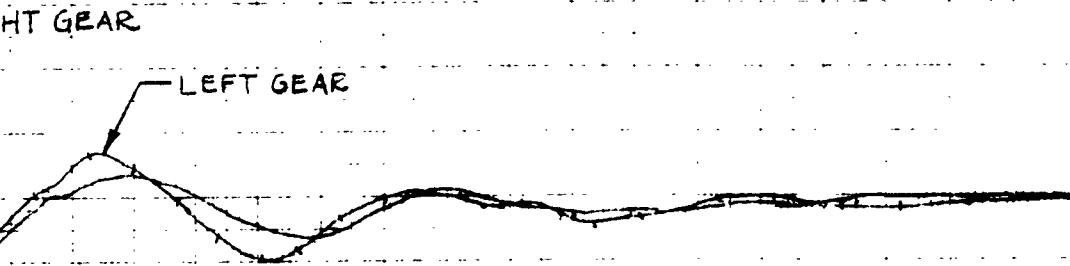

POSITIVE:  
TENSION

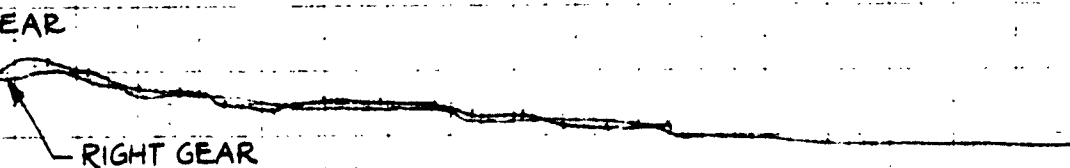
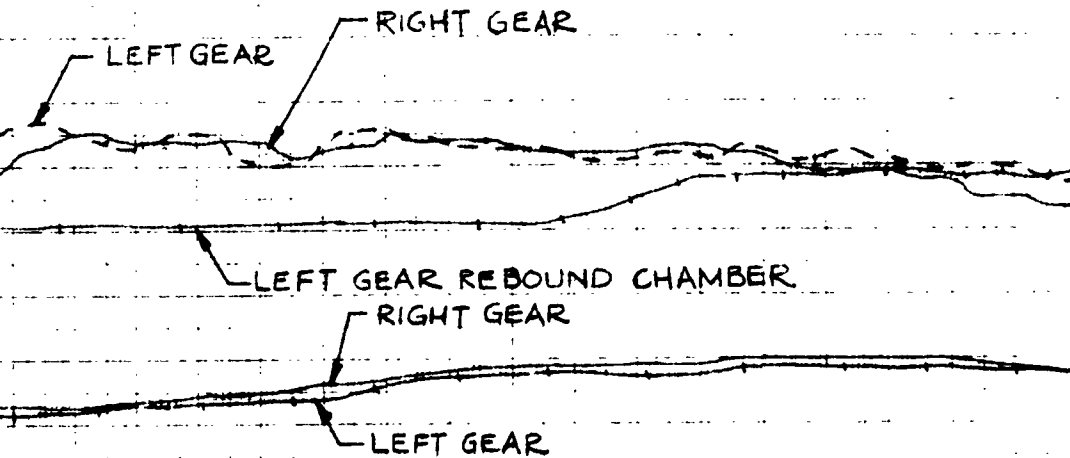

08 .10 .12 .14 .16 .18 20 .22 .24 .26 .28  
TIME - SECONDS



LANDING LOAD  
 AIRPLAN  
 68

FIGURE 17

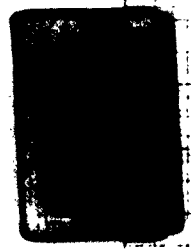
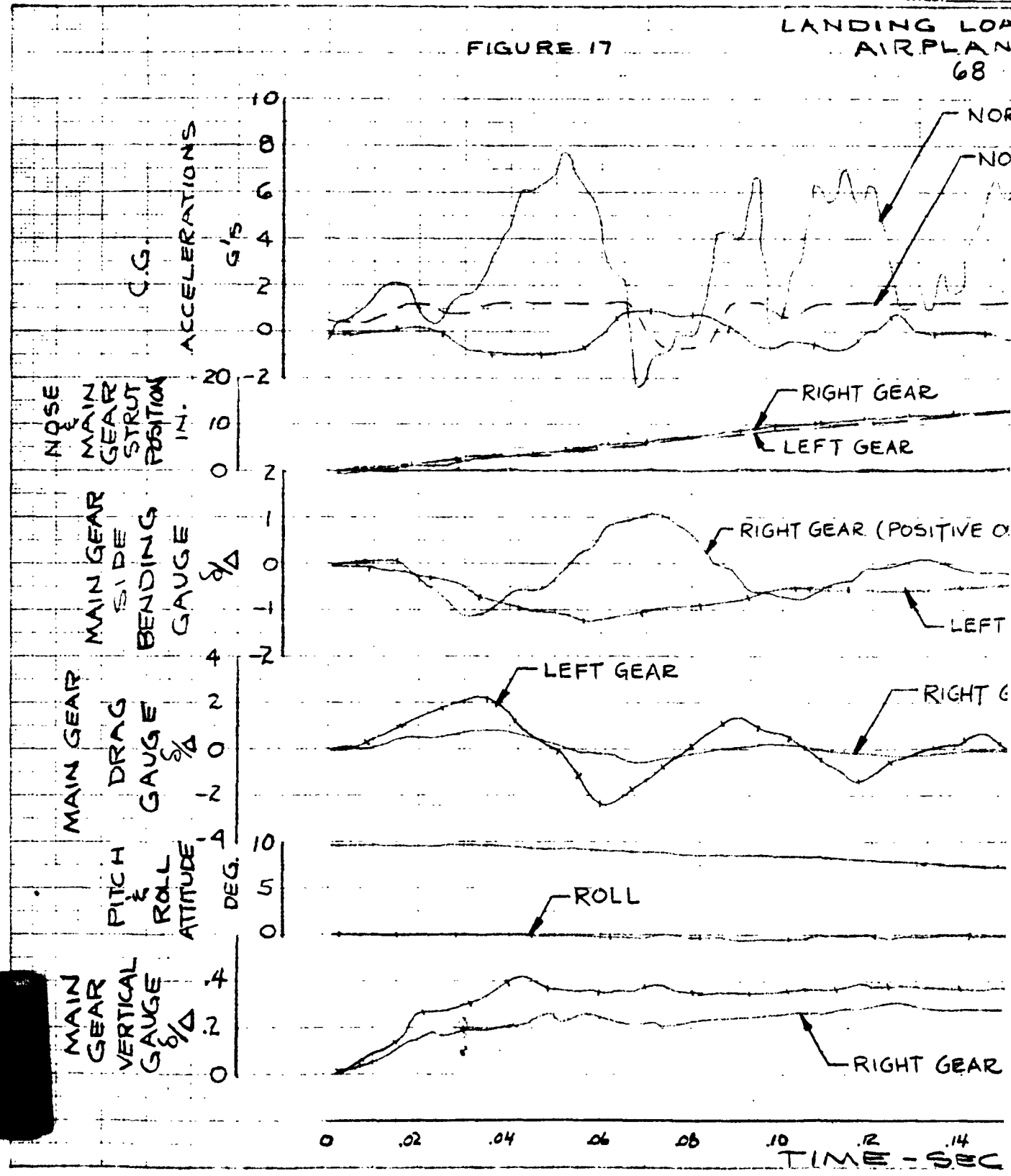

PREPARED BY: I.B. Mosby  
CHECKED BY: F.S.  
DATE: August 1967  
TITLE: DROP TESTS FOR LANDING LOAD INVESTIGATION

DOUGLAS AIRCRAFT COMPANY, INC.  
AIRCRAFT DIVISION

PAGE: 44  
MODEL: A4D-2  
REPORT NO.: EC-40641

# LANDING LOADS PROGRAM AIRPLANE DROP 68

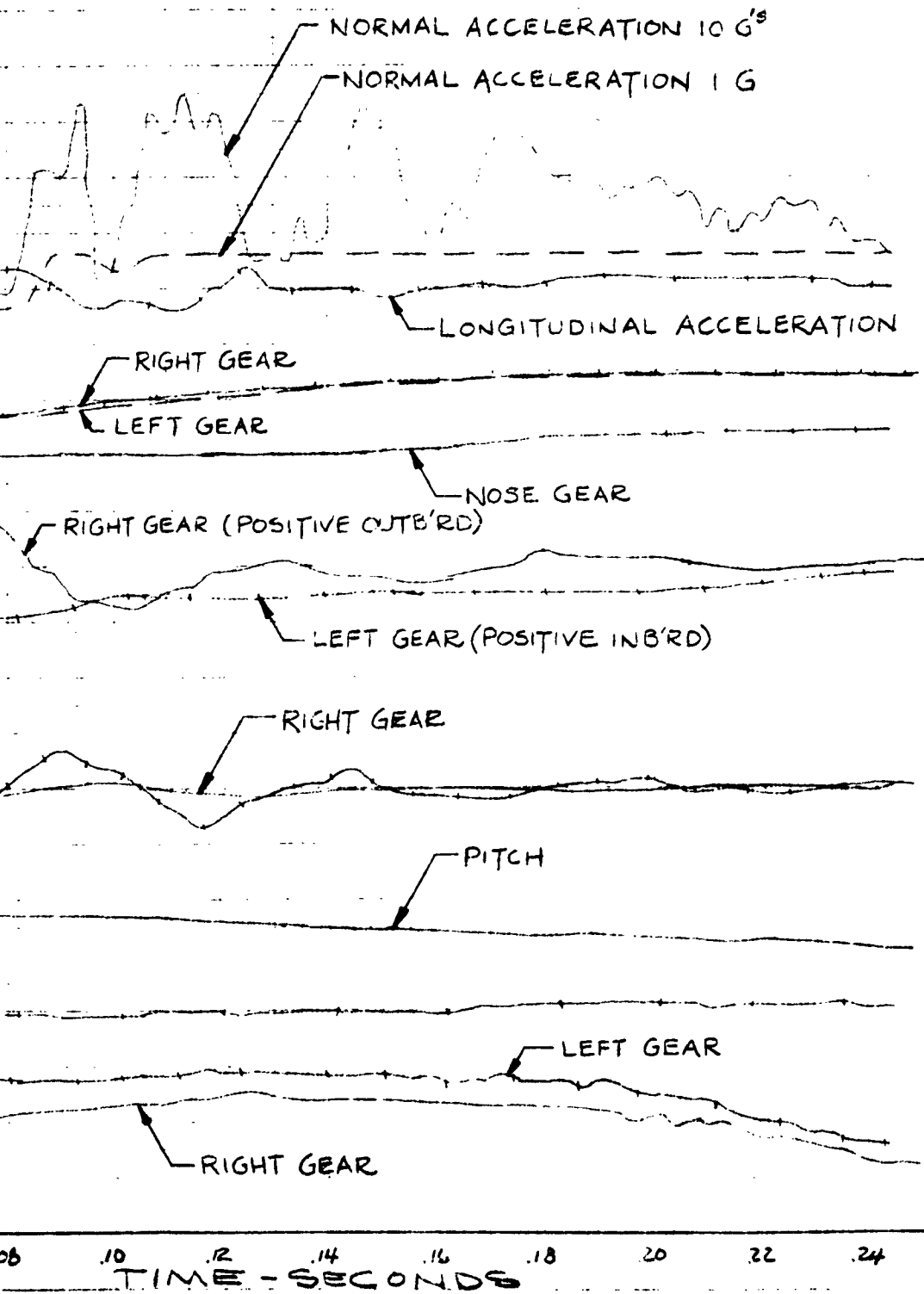

POSITIVE :  
UP & AFT

POSITIVE :  
COMPRESSION

POSITIVE :  
AFT

POSITIVE :  
NOSE UP & LEFT  
WING





FIGURE 17 (CONT'D)

LANDING LOAD  
 AIRPLANE D  
 68

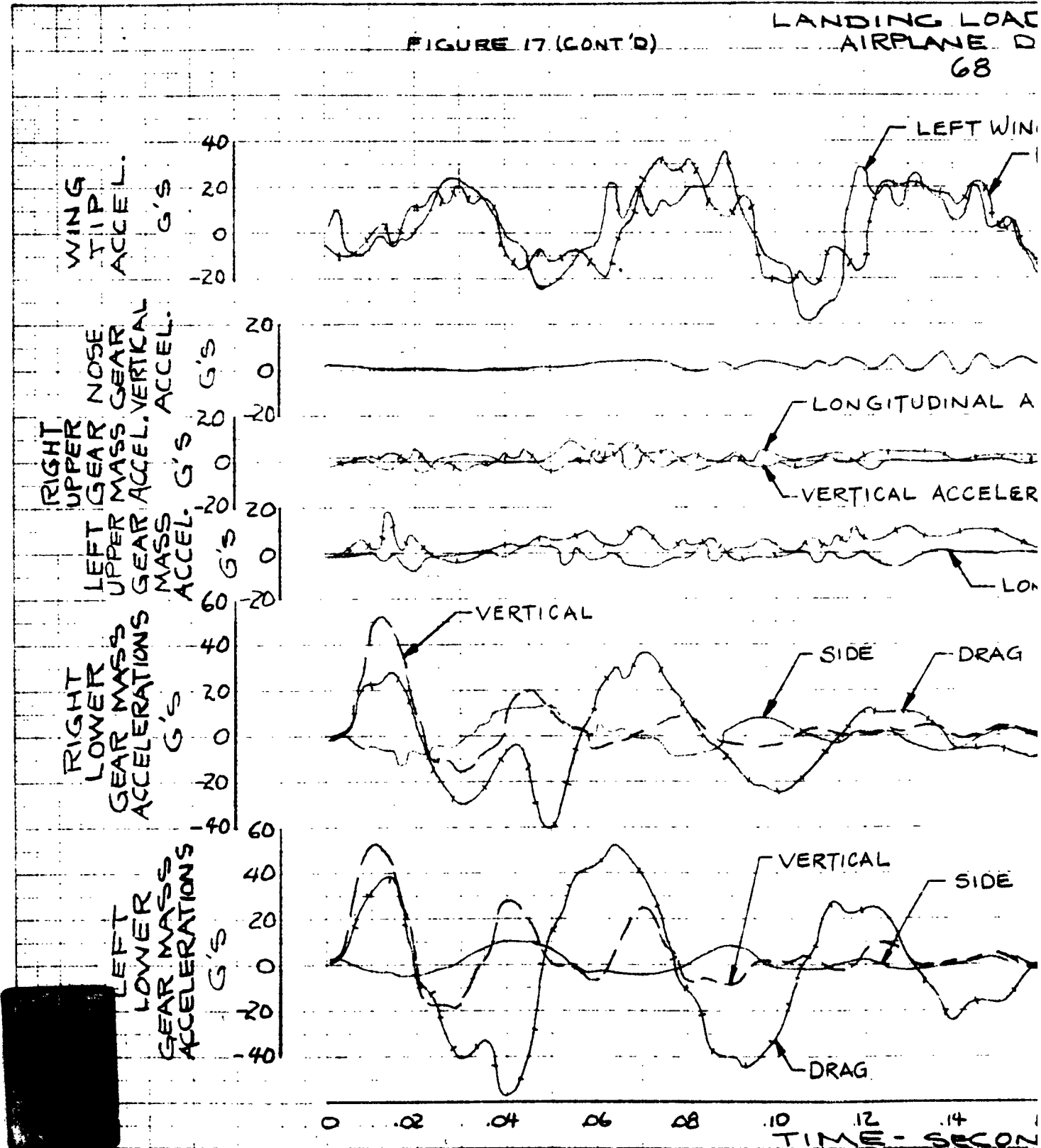

PREPARED BY: L.B. Mosby  
CHECKED BY: P.S.A.  
DATE: AUGUST 1952  
TITLE: F-4E DROPTAIL LANDING LOADS INVESTIGATION

DOUGLAS AIRCRAFT COMPANY, INC.

AIRCRAFT

DIVISION

PAGE: 41  
MODEL: 747-2  
REPORT NO.: FS-40641

LANDING LOADS PROGRAM  
AIRPLANE DROP  
68

ACCELERATIONS ARE  
POSITIVE UPWARD, FWD,  
& INBRD

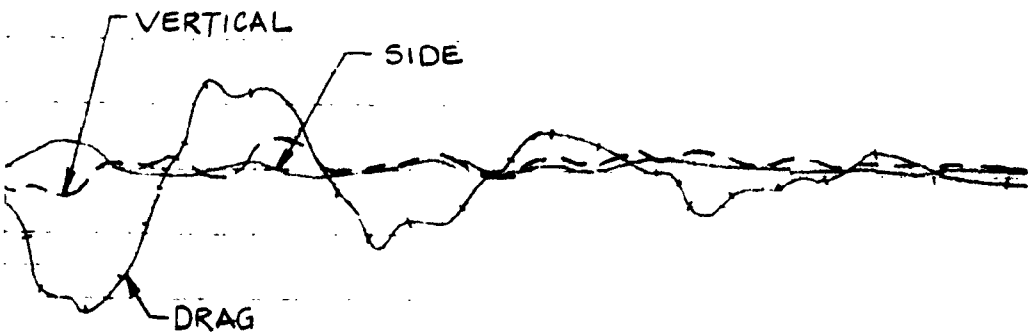
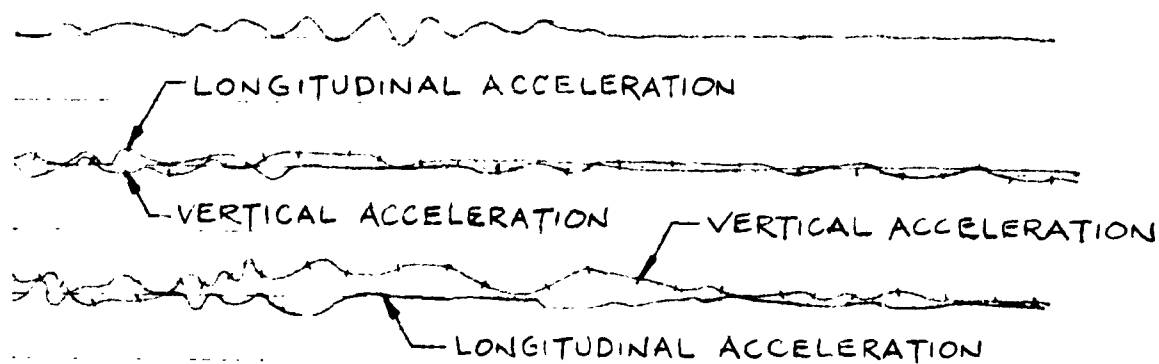
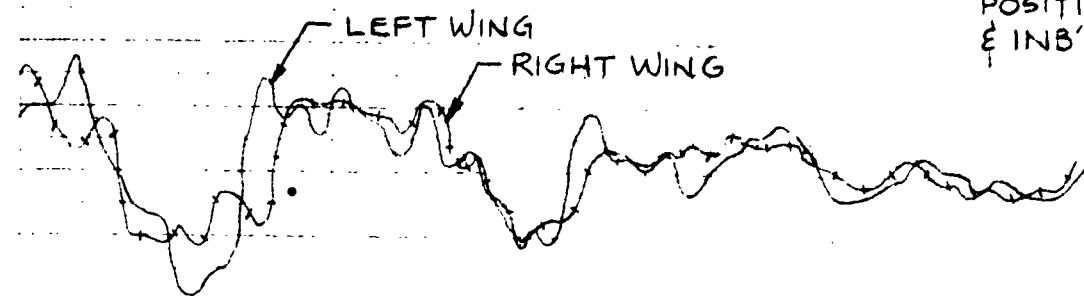

8 .10 .12 .14 .16 .18 .20 .22 .24 .26 28  
TIME - SECONDS



PREPARED BY: L.  
 CHECKED BY: F.  
 DATE: August  
 TITLE: DROP T

FIGURE 17 (CONT'D)

LANDING LOAD  
 AIRPLANE  
 68

WING  
 LIFT  
 LBS.

10000  
 8000  
 6000  
 4000  
 2000  
 0

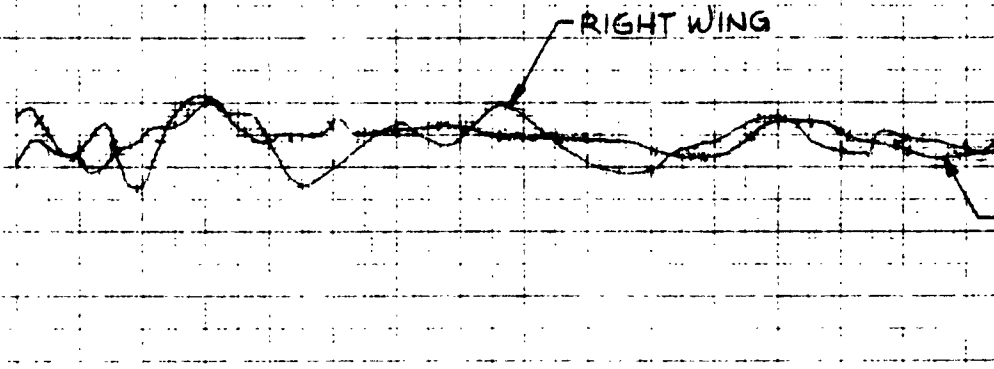

DRAG BRACE  
 AXIAL  
 LOAD  
 LBS.

40000  
 20000  
 0  
 -20000  
 -40000

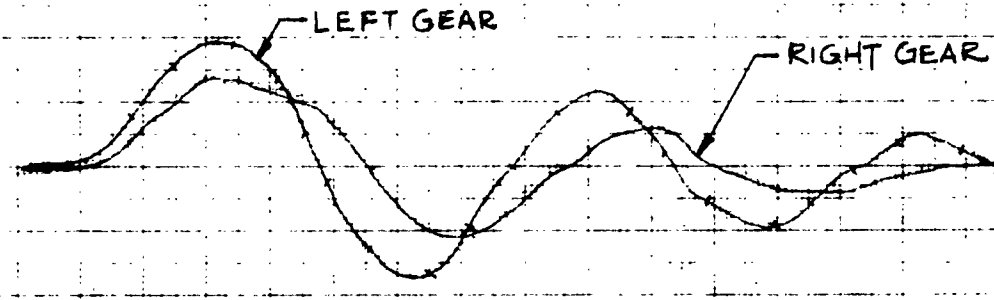

REBOUND  
 METER  
 CHAMBER  
 PRESSURE  
 P.S.I.

3000  
 2000  
 1000  
 0

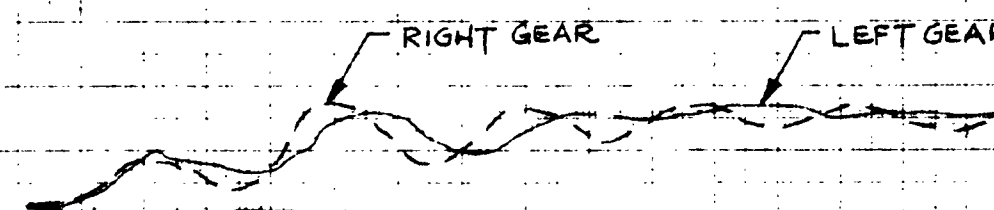

AIR  
 CHAMBER  
 PRESSURE  
 P.S.I.

2000  
 1000  
 0

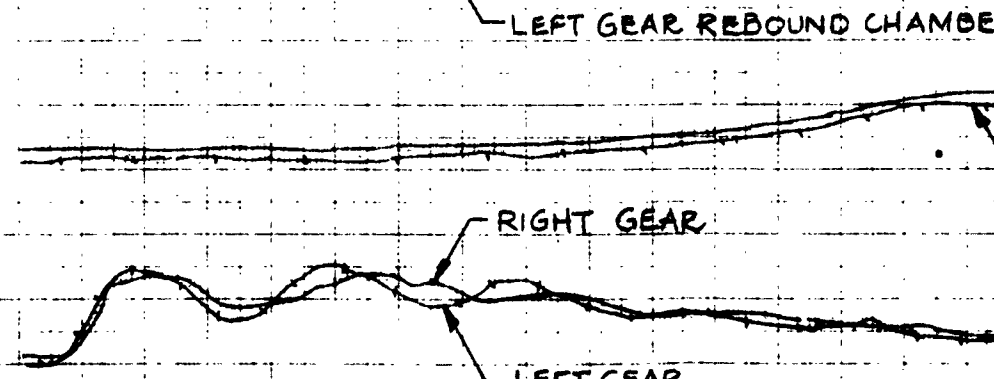

STRT  
 VELOCITY  
 F.P.S.

20  
 10  
 0

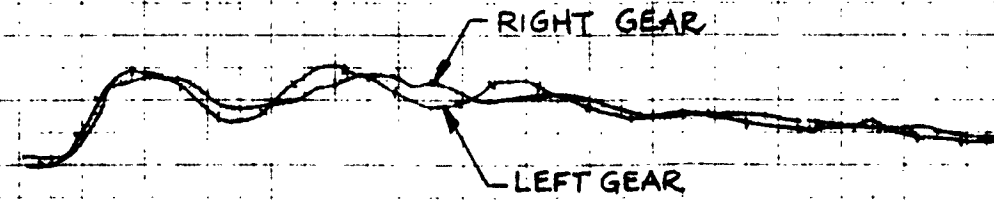

0 .02 .04 .06 .08 .10 .12 .14  
 TIME - SECONDS

PREPARED BY: L.B. Mosby  
CHECKED BY: F.C.A.  
DATE: August 1962  
TITLE: DROP TESTS FOR LANDING LOADS INVESTIGATION

DOUGLAS AIRCRAFT COMPANY, INC.

AIRCRAFT

DIVISION

PAGE: 46  
MODEL: A4D-2  
REPORT NO.: ES-40641

(D) LANDING LOADS PROGRAM  
AIRPLANE DROP

68

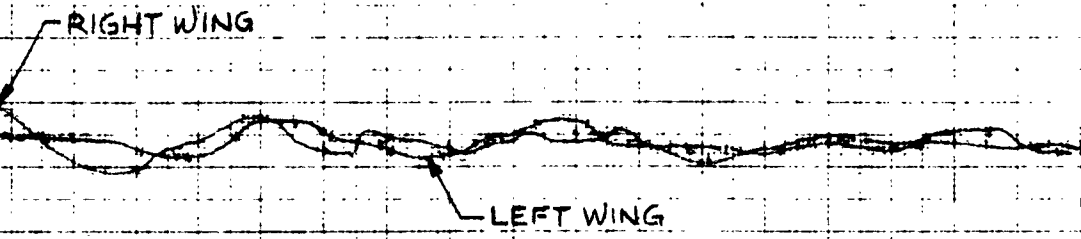

POSITIVE:  
UPWARD

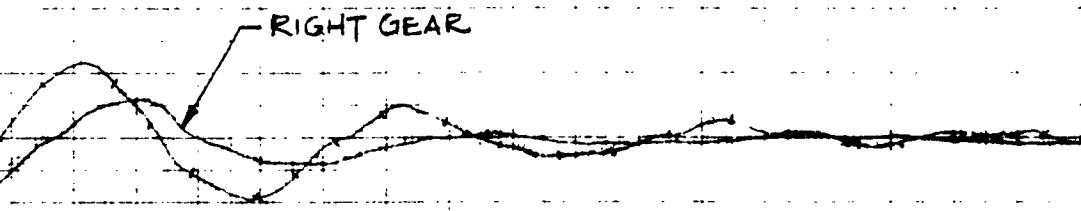

POSITIVE:  
TENSION

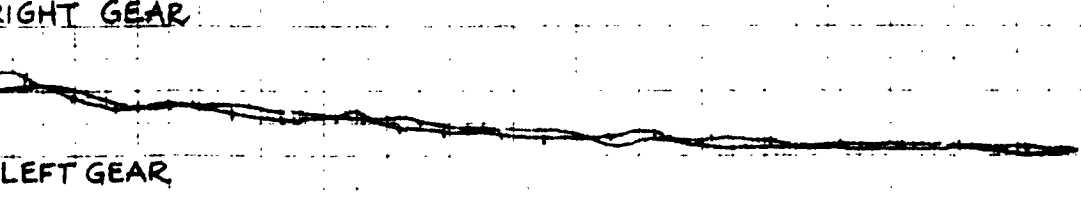
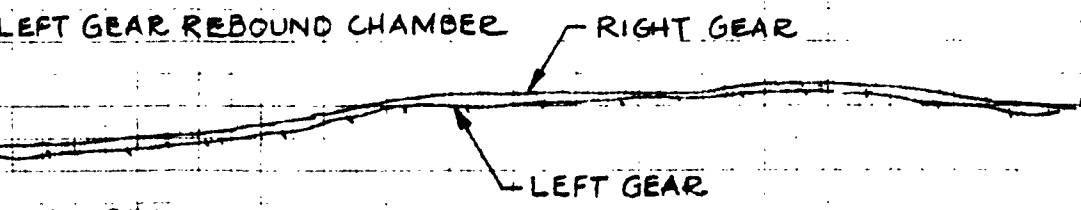
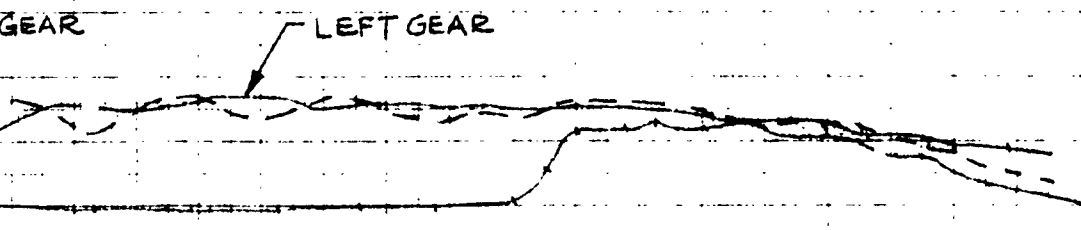

08 .10 .12 .14 .16 .18 20 .22 .24 .26 .28  
TIME - SECONDS



PREPARED BY: I.B  
 CHECKED BY: F.C  
 DATE: August  
 TITLE: D-CP T

LANDING LOAD  
 AIRPLANE  
 93

FIGURE 18

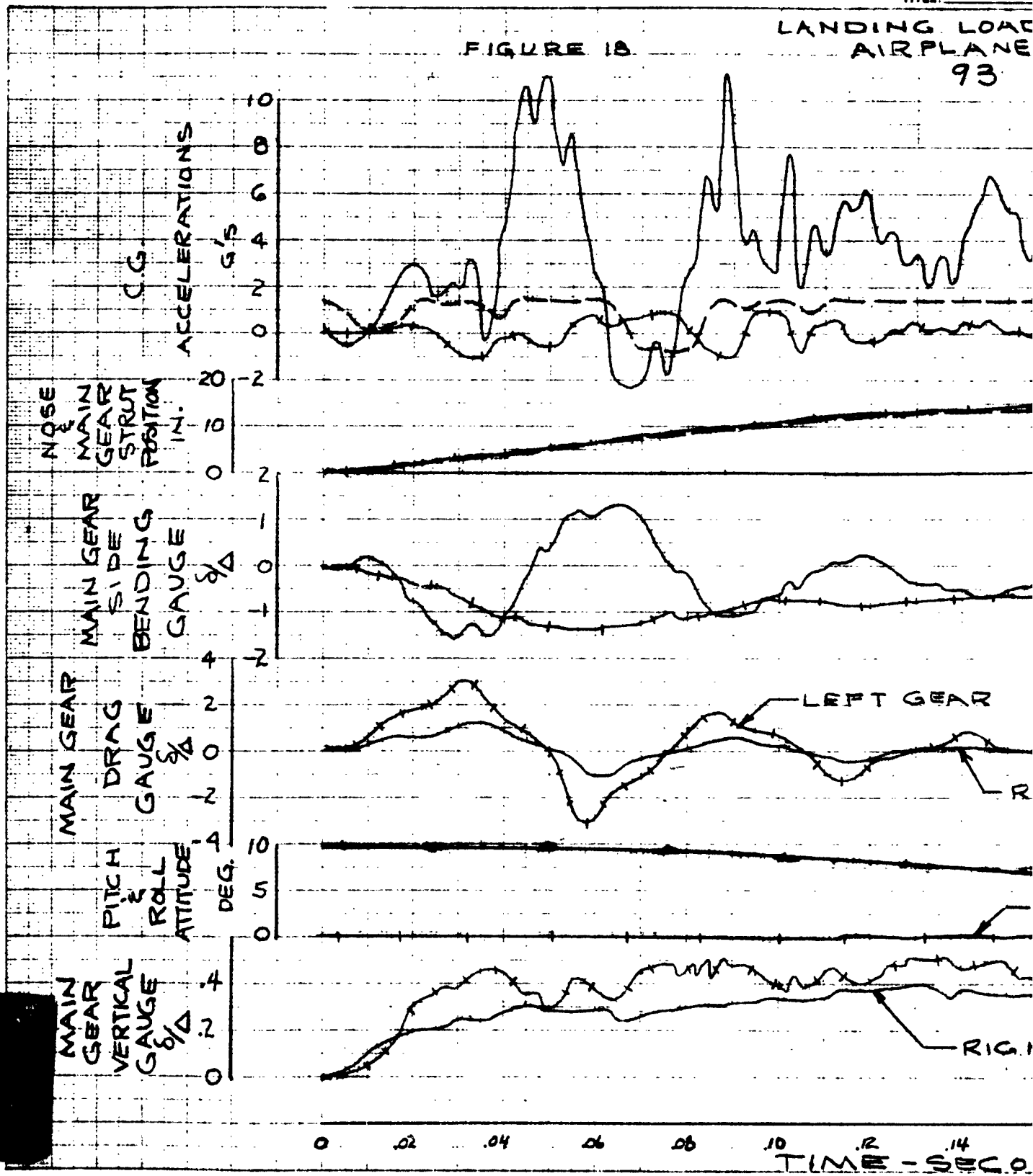

PREPARED BY: I.B. Mosby  
CHECKED BY: F.C.A.  
DATE: August 1962  
TITLE: DROP TESTS FOR LANDING LOADS INVESTIGATION

DOUGLAS AIRCRAFT COMPANY, INC.

AIRCRAFT

DIVISION

PAGE: 47

MODEL: A4D-2

REPORT NO.: ES-40641

LANDING LOADS PROGRAM  
AIRPLANE DROP

93

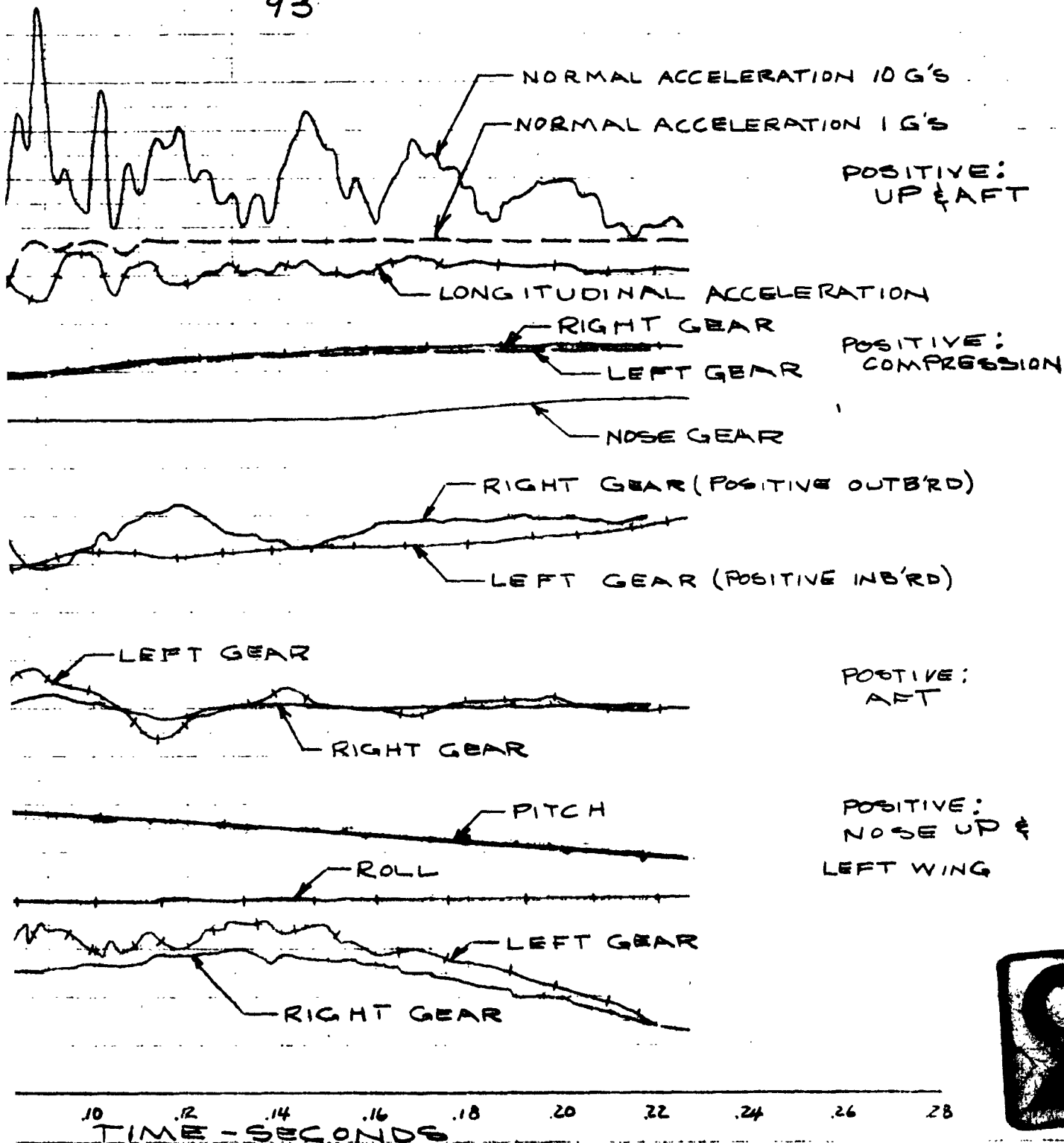

LANDING LOAD  
 AIRPLANE  
 93

FIGURE 18 (CONT'D)

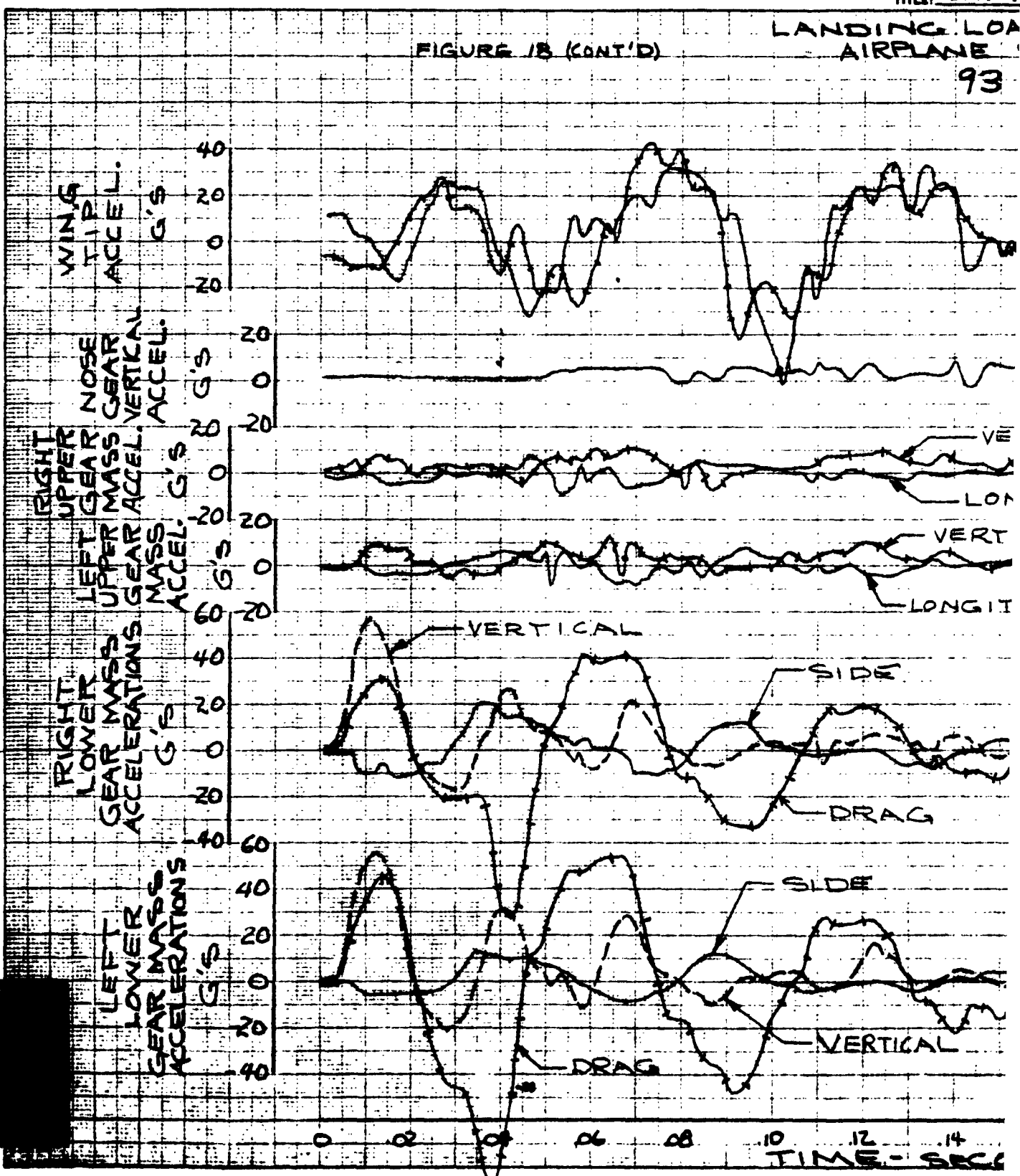

PREPARED BY: L.B. Mosby  
CHECKED BY: F.S.A.  
DATE: August 1967  
TITLE: DROP TESTS FOR LANDING LOADS INVESTIGATION

DOUGLAS AIRCRAFT COMPANY, INC.

AIRCRAFT

DIVISION

PAGE: 48  
MODEL: A4D-2  
REPORT NO.: ES-40641

LANDING LOADS PROGRAM  
AIRPLANE DROP

93

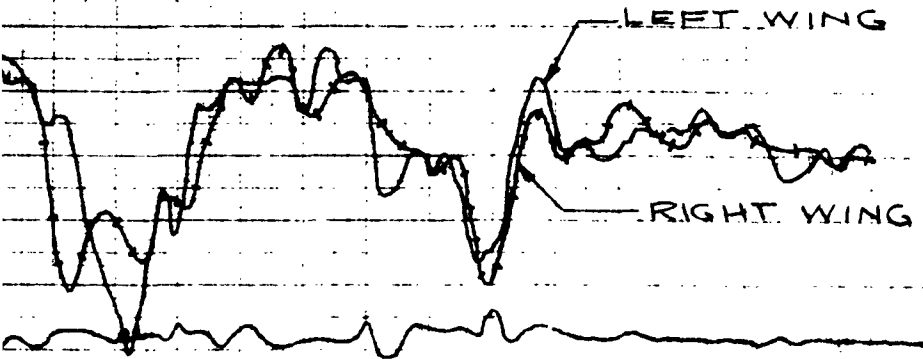

ACCELERATIONS ARE  
POSITIVE UPWARD,  
FWD., AND INBRD

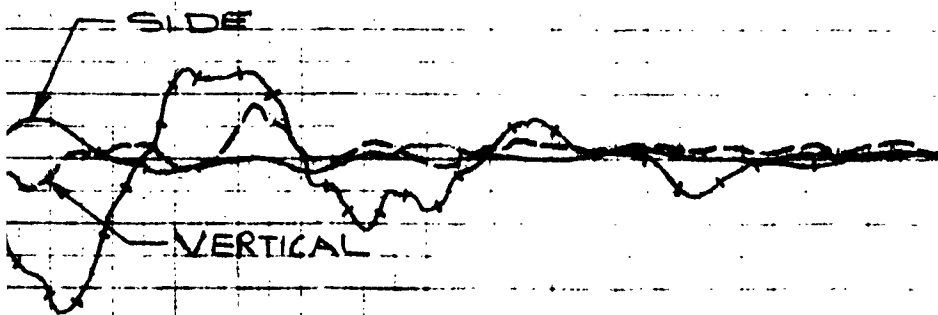
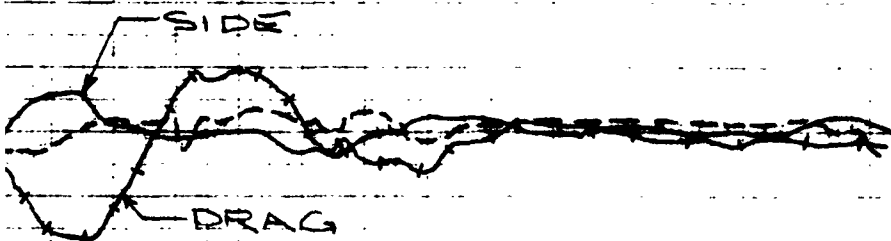
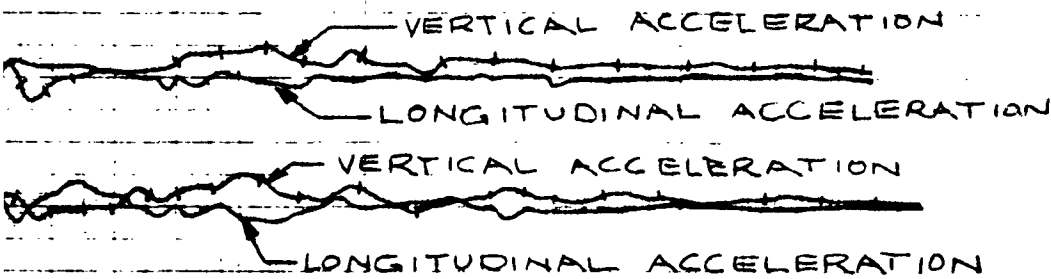

10 .12 .14 .16 .18 .20 .22 .24 .26 .28  
TIME - SECONDS





2-571  
7-541

PREPARED BY L.P.  
CHECKED BY: F.C.  
DATE August  
TITLE DROP TEST

LANDING LOADS  
AIRPLANE D  
93

FIGURE 1B (CONT'D)

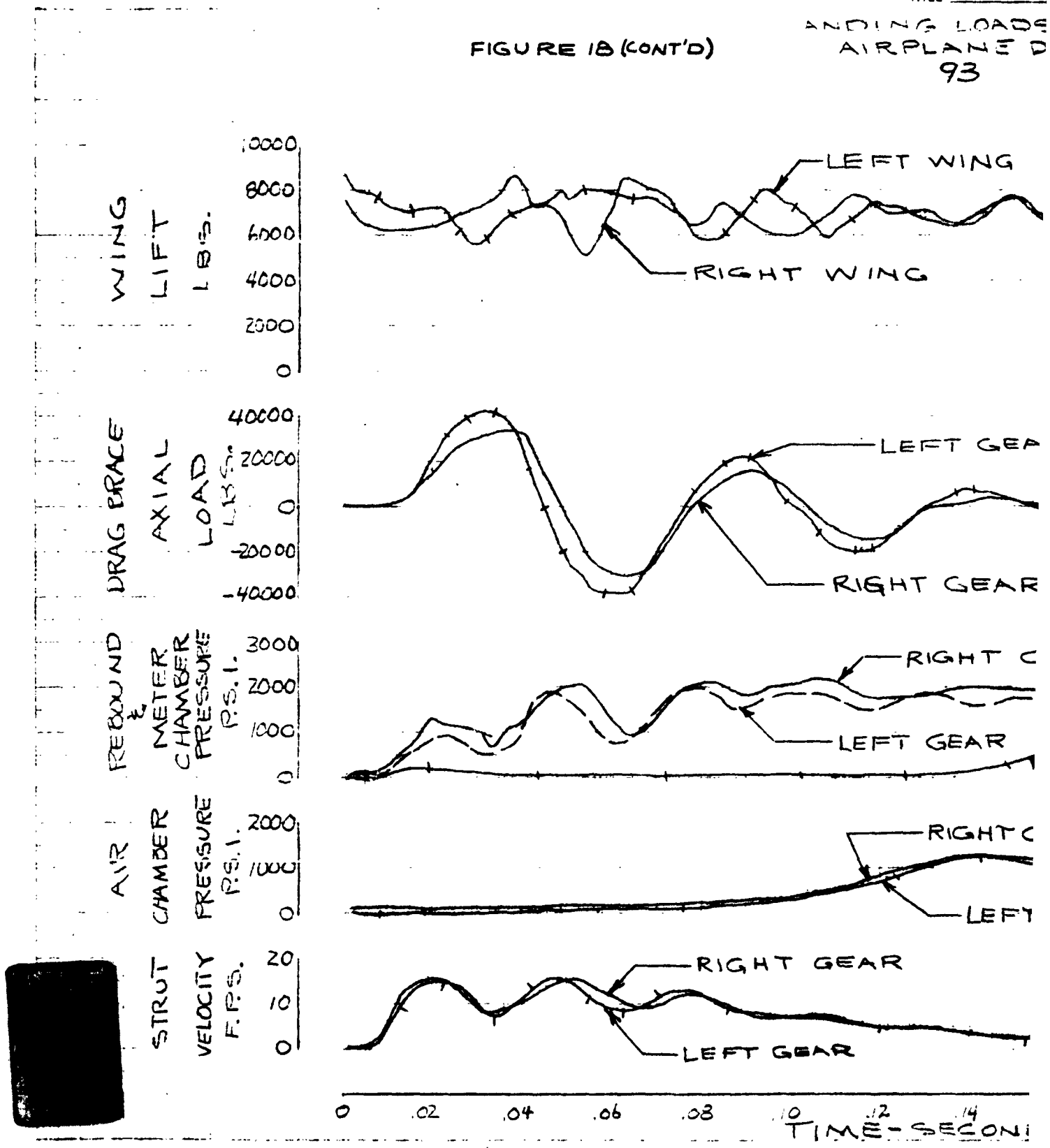

RECORDED BY L.P. Mosby  
CHECKED BY F.C.F.  
DATE August 1962  
TITLE DROP TESTS FOR LANDING LOADS INVESTIGATION

DOUGLAS AIRCRAFT COMPANY, INC.  
AIRCRAFT \_\_\_\_\_ DIVISION \_\_\_\_\_

PAGE: 49  
MODEL: A4D-2  
REPORT NO.: ES-40841

LANDING LOADS PROGRAM  
AIRPLANE DROP  
93



POSITIVE :  
UPWARD

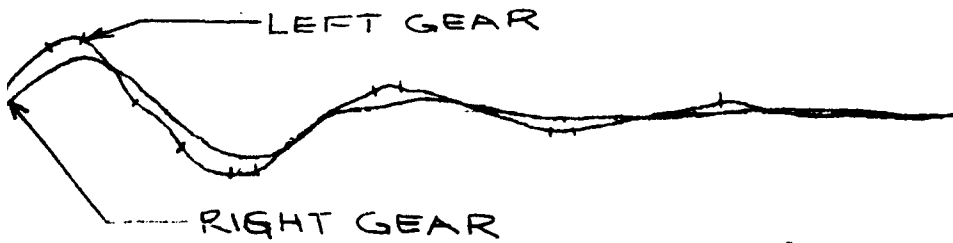

POSITIVE :  
TENSION

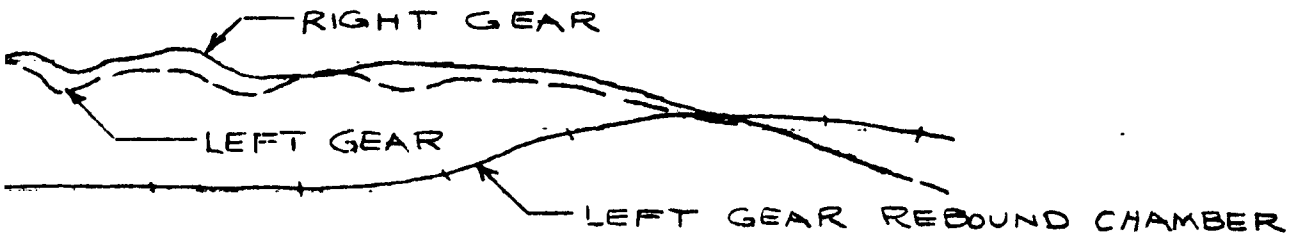

8 10 12 14 16 18 20 22 24 26 28  
TIME - SECONDS



FIGURE 19

LANDING LOADS  
 AIRPLANE D  
 82

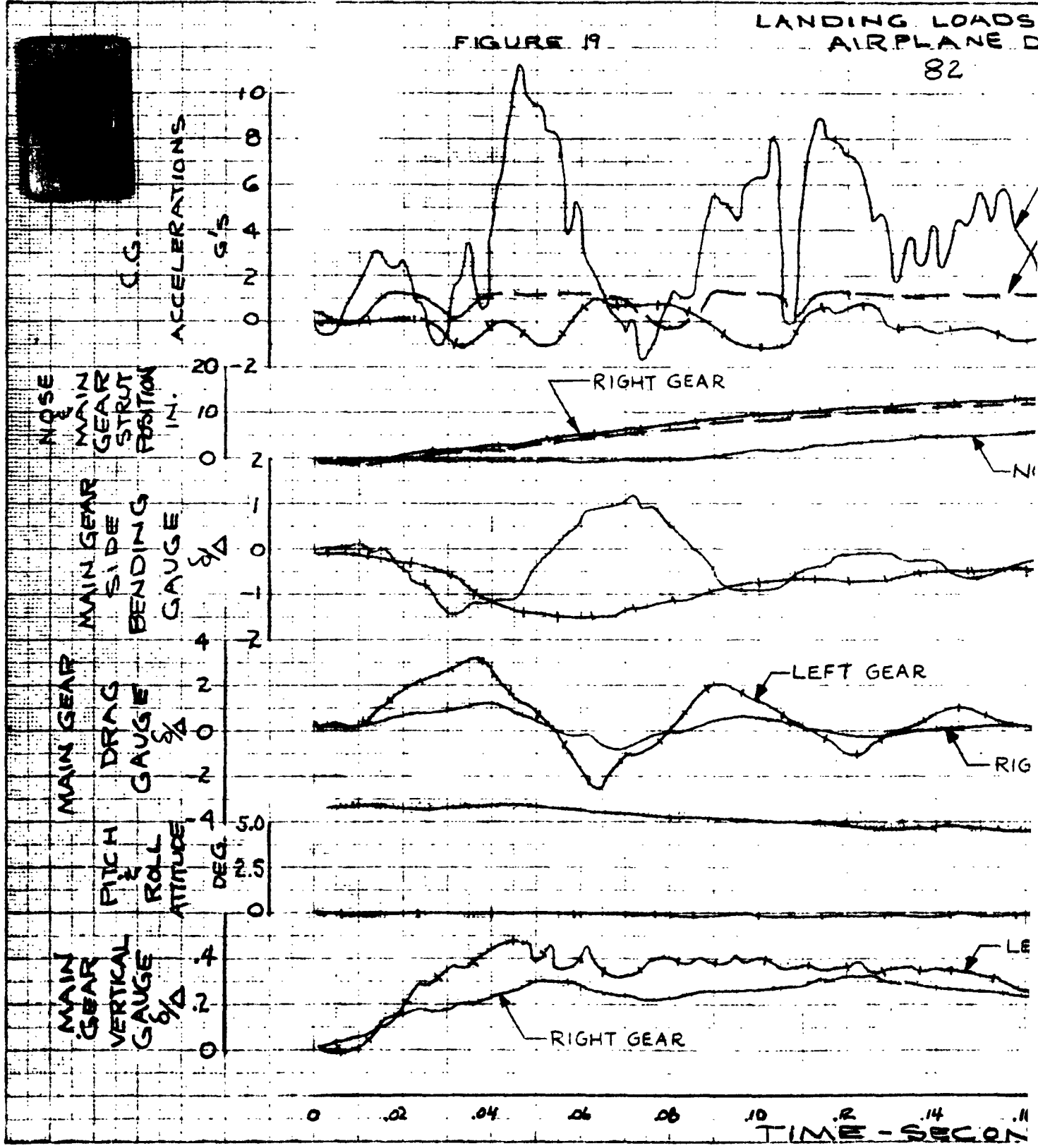

PREPARED BY: I.E. Mesby  
CHECKED BY: F.D.A.  
DATE: August 1961  
TITLE: DROP TESTS FOR LANDING LOAD INVESTIGATION

DOUGLAS AIRCRAFT COMPANY, INC.

AIRCRAFT DIVISION

PAGE: 50  
MODEL: A4D-2  
REPORT NO.: DS-40541

# LANDING LOADS PROGRAM AIRPLANE DROP

82

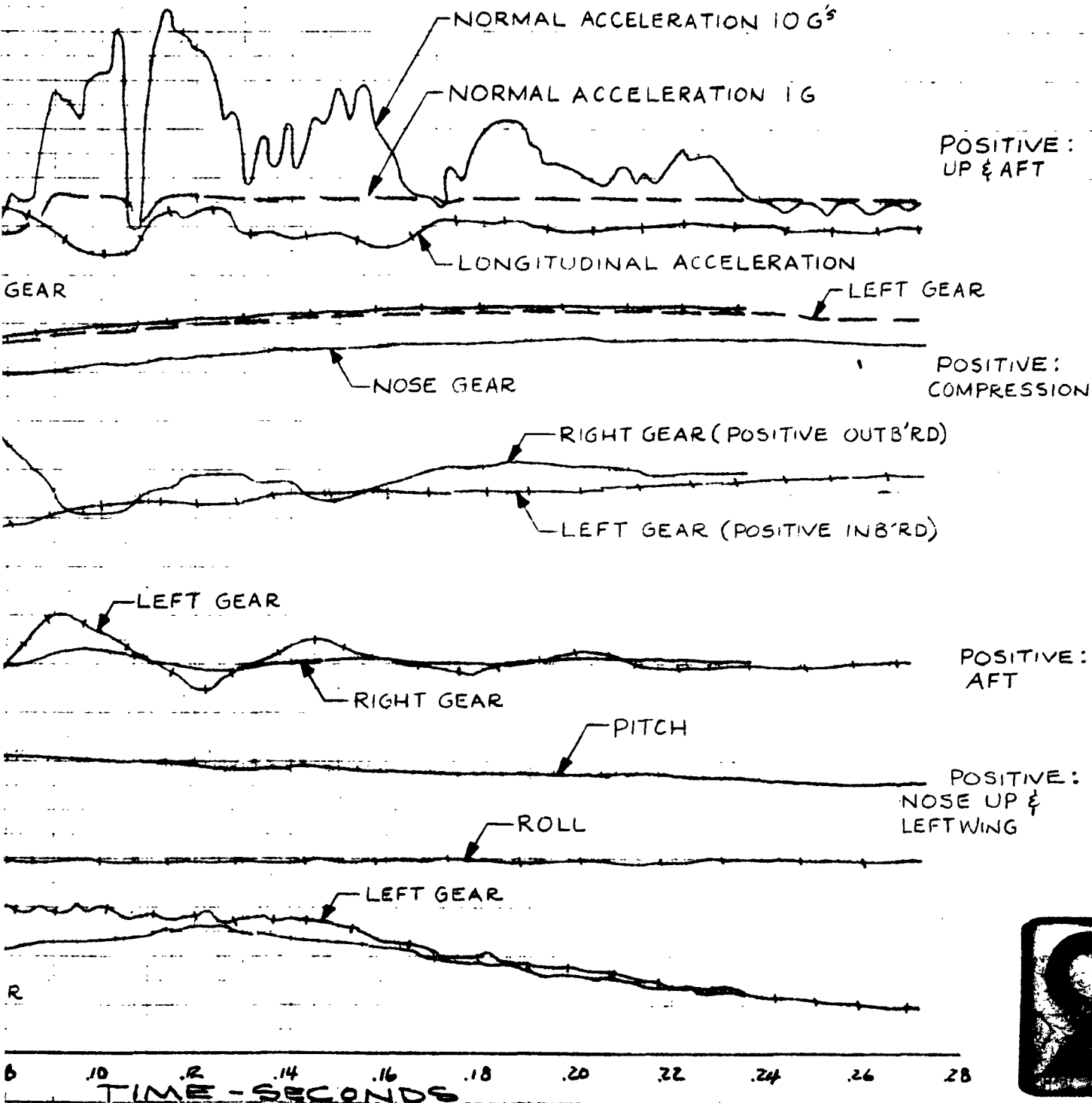
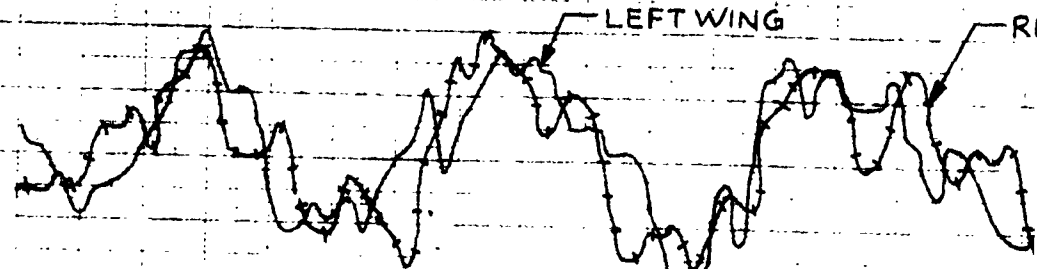

FIGURE 19 (CONT'D)

LANDING LOADS  
 AIRPLANE DE  
 82

WING TIP ACCEL. G'S

40  
20  
0  
-20



RIGHT UPPER GEAR MASS ACCEL. VERTICAL ACCEL. G'S

20  
0  
-20

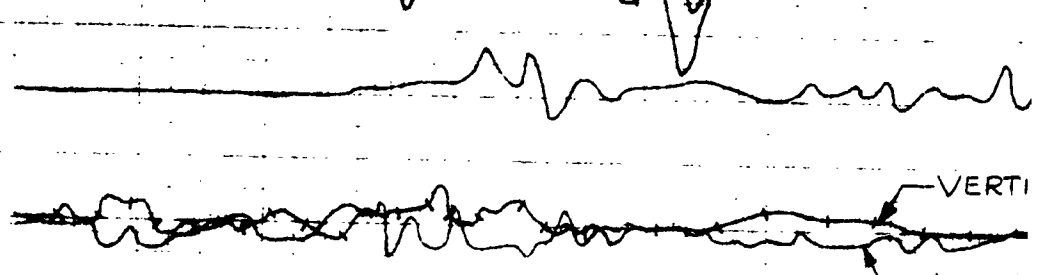

LEFT UPPER GEAR MASS ACCEL. VERTICAL ACCEL. G'S

20  
0  
-20

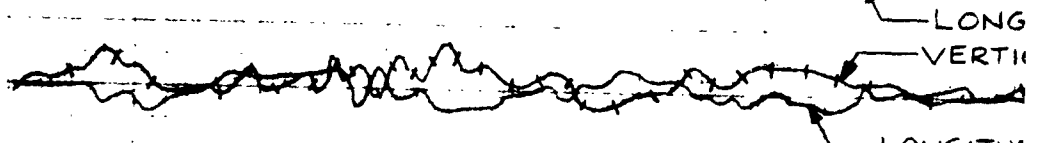

RIGHT LOWER GEAR MASS ACCELERATIONS G'S

60  
40  
20  
0  
-20

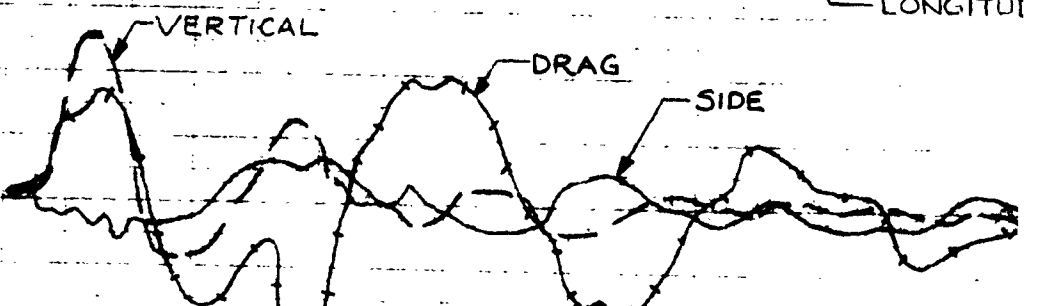

LEFT LOWER GEAR MASS ACCELERATIONS G'S

60  
40  
20  
0  
-20

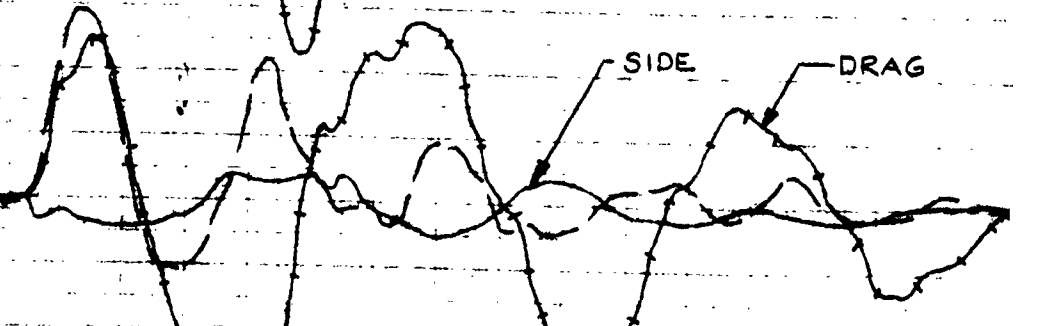

0 .02 .04 .06 .08 .10 .12 .14 .16  
 TIME - SECONDS

PREPARED BY: I. H. Mosby  
CHECKED BY: F. S. F.  
DATE: AUGUST 1962  
TITLE: DROP TESTS FOR LANDING LOADS INVESTIGATION

DOUGLAS AIRCRAFT COMPANY, INC.  
AIRCRAFT \_\_\_\_\_ DIVISION \_\_\_\_\_

PAGE: 51  
MODEL: A4D-2  
REPORT NO.: ES-40641

LANDING LOADS PROGRAM  
AIRPLANE DROP  
82

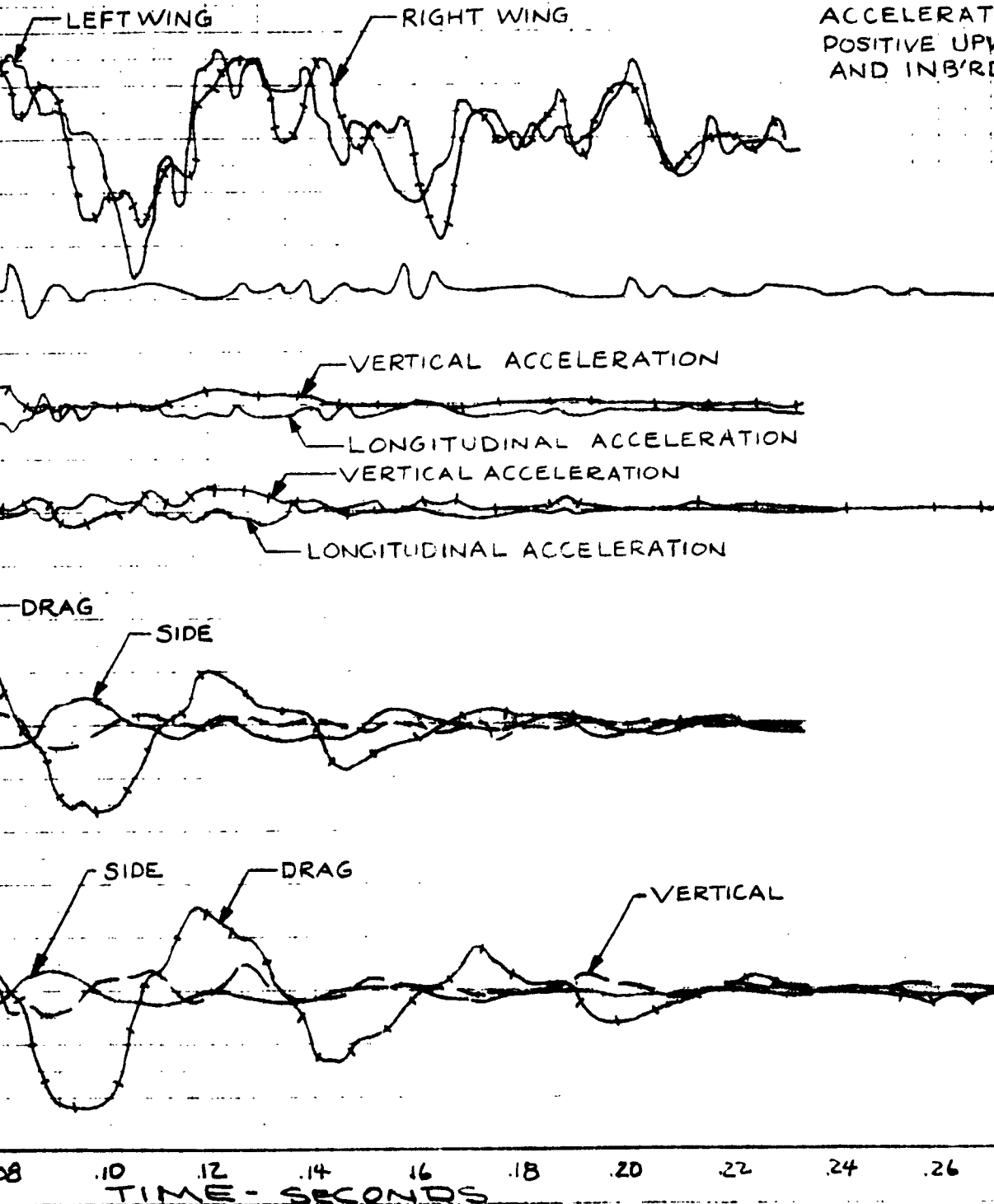

FIGURE 19 (CONT'D)

LANDING LOADS FROM AIRPLANE DROP

82

WING LIFT  
 LBS.

10000  
 8000  
 6000  
 4000  
 2000  
 0

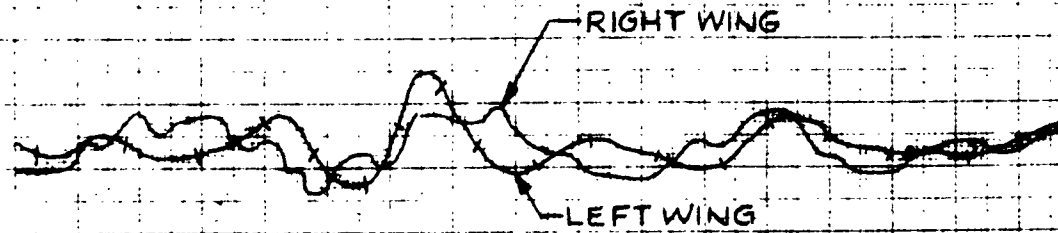

DRAG BRACE AXIAL LOAD  
 LBS.

40000  
 20000  
 0  
 -20000  
 -40000

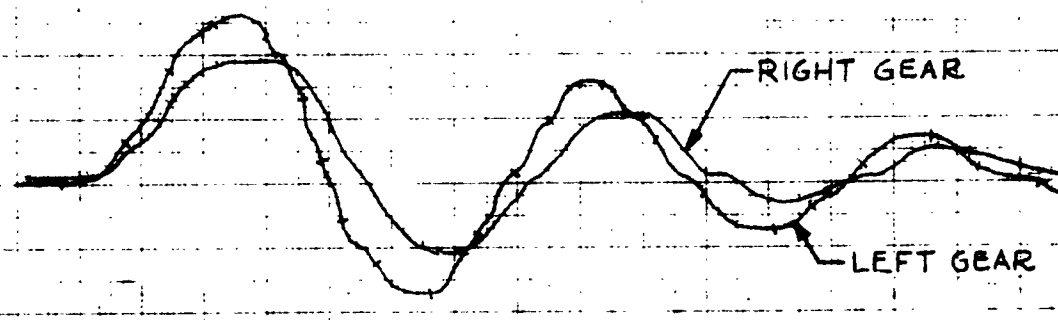

REBOUND METER CHAMBER PRESSURE  
 P.S.I.

3000  
 2000  
 1000  
 0

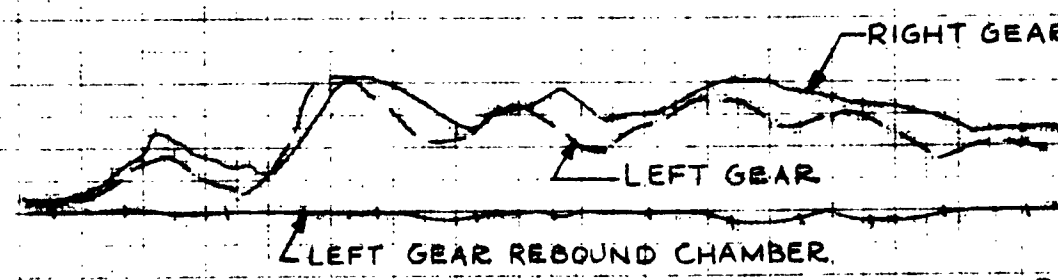

AIR CHAMBER PRESSURE  
 P.S.I.

2000  
 1000  
 0

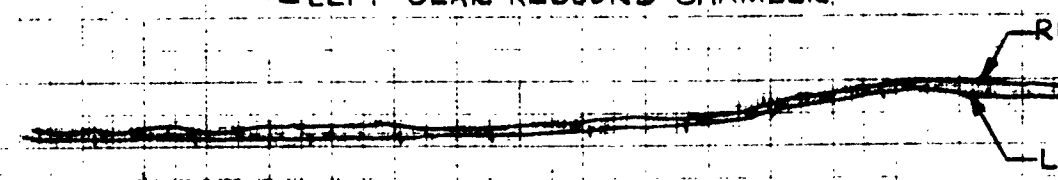

STRUT VELOCITY  
 F.P.S.

20  
 10  
 0

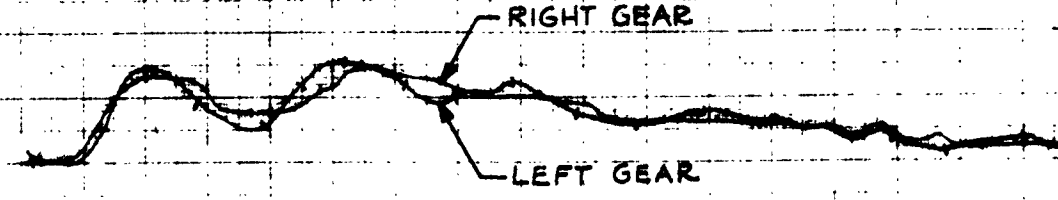

0 .02 .04 .06 .08 .10 .12 .14 .16  
 TIME - SECONDS

PREPARED BY: L.B. Mosby  
CHECKED BY: F.C.A.  
DATE: August 1962  
TITLE: DROP TESTS FOR LANDING LOADS INVESTIGATION

DOUGLAS AIRCRAFT COMPANY, INC.  
AIRCRAFT

PAGE: 52  
MODEL: A4D-2  
REPORT NO.: EC-40641

LANDING LOADS PROGRAM  
AIRPLANE DROP

82

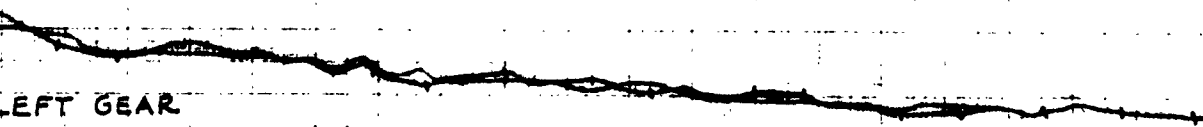
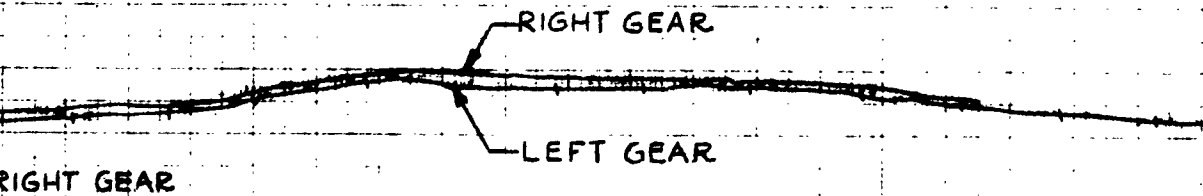
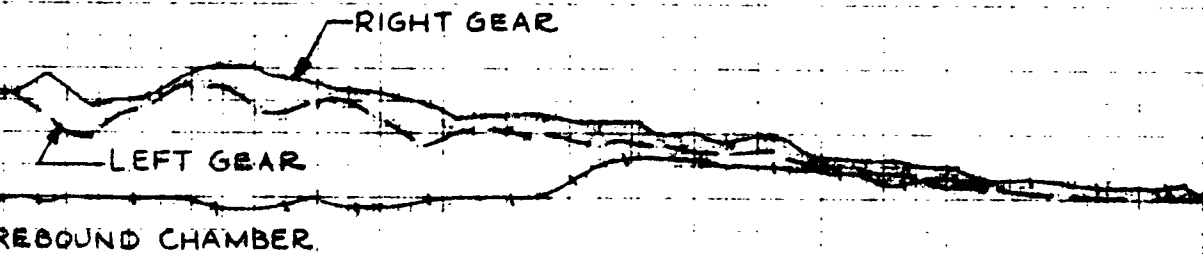
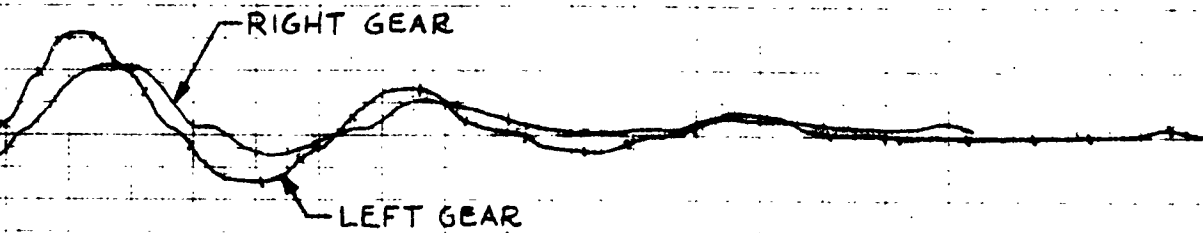
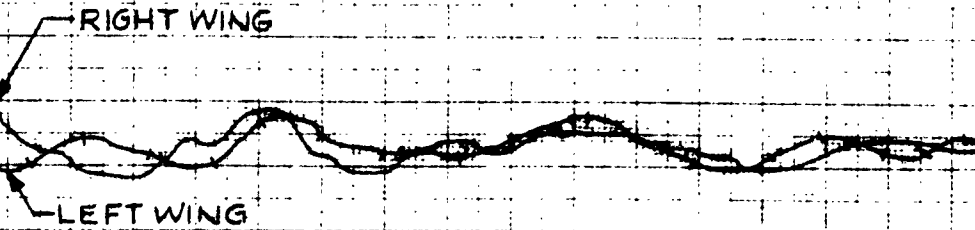

TIME - SECONDS  
8 .10 .12 .14 .16 .18 20 .22 .24 .26 .28





PREPARED BY: L.B.  
 CHECKED BY: F.C.  
 DATE: August  
 TITLE: DROP TEST

FIGURE 20

LANDING LOADS  
 AIRPLANE  
 75

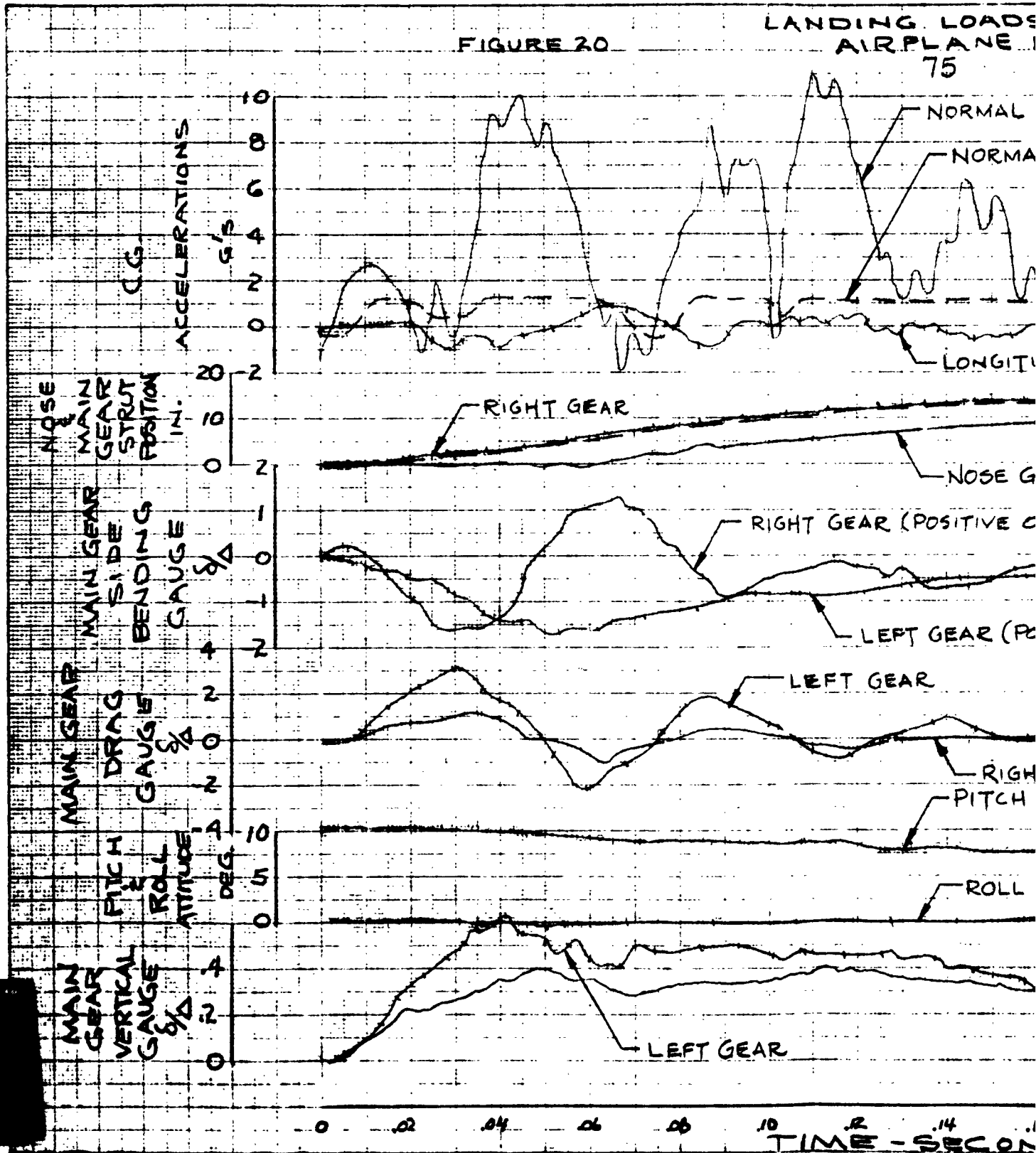

PREPARED BY: L.B. Mosby  
CHECKED BY: P.C.A.  
DATE: August 1962  
TITLE: DROP TEST FOR LANDING LOADS INVESTIGATION

DOUGLAS AIRCRAFT COMPANY, INC.  
AIRCRAFT \_\_\_\_\_ DIVISION \_\_\_\_\_

PAGE: 53  
MODEL: 4D-2  
REPORT NO.: ES-40641

LANDING LOADS PROGRAM  
AIRPLANE DROP

75

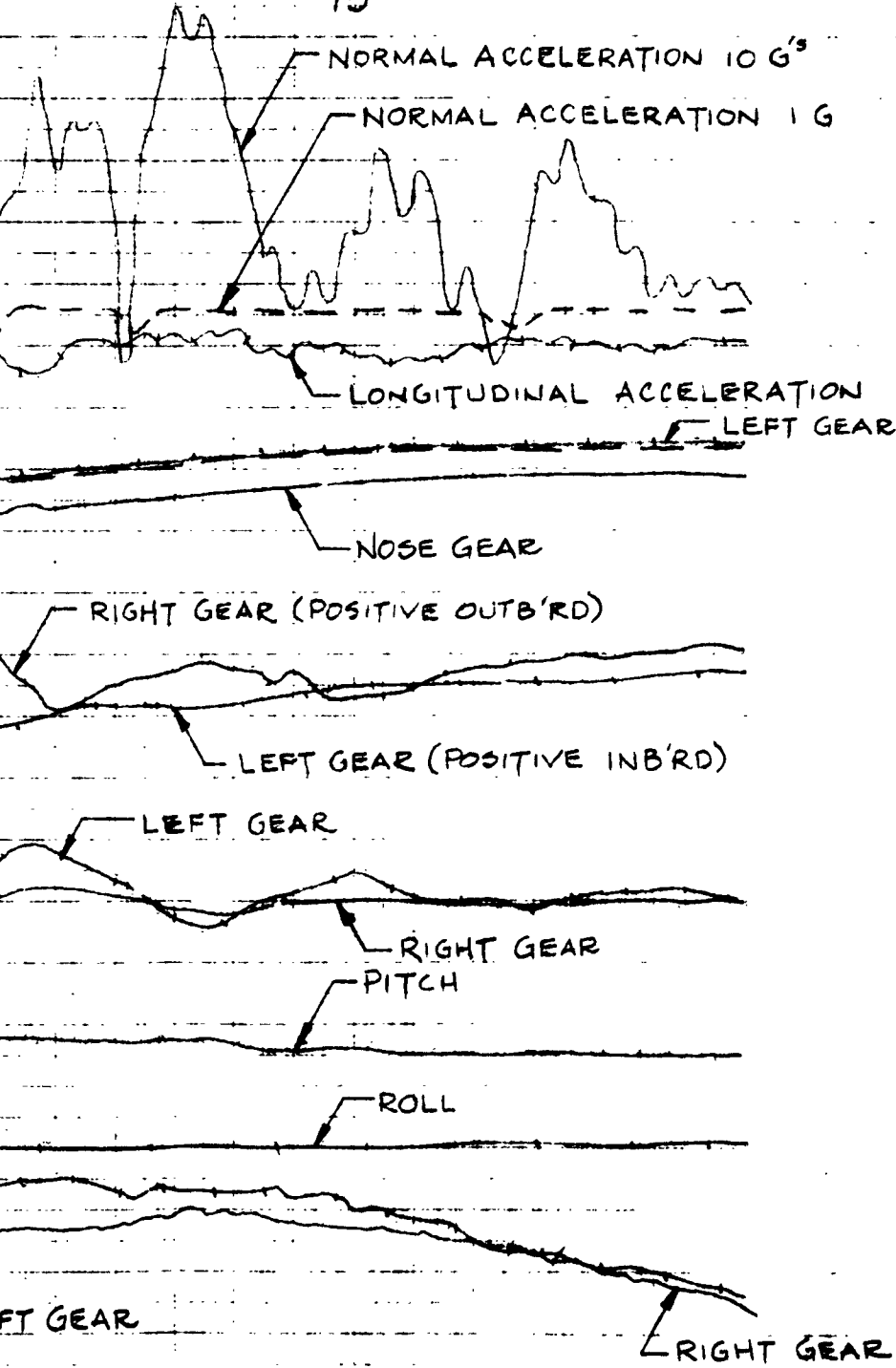

POSITIVE :  
UP & AFT

POSITIVE :  
COMPRESSION

POSITIVE :  
AFT

POSITIVE :  
NOSE UP & LEFT  
WING



TIME - SECONDS .10 .12 .14 .16 .18 .20 .22 .24 .26 .28

FIGURE 20 (CONT'D)

LANDING LOAD  
AIRPLANE  
75

LEFT WING

WING  
TIP  
ACCEL.  
G'S

40  
20  
0  
-20

RIGHT  
UPPER  
GEAR  
MASS  
ACCEL.  
G'S

20  
0  
-20

LEFT  
UPPER  
GEAR  
MASS  
ACCEL.  
G'S

20  
0  
-20

RIGHT  
LOWER  
GEAR  
MASS  
ACCEL.  
G'S

40  
20  
0  
-20

LEFT  
LOWER  
GEAR  
MASS  
ACCEL.  
G'S

60  
40  
20  
0  
-20  
-40

VERTIC

LONGITU

VERTIC

LONGITU

VERTICAL

SIDE

DRAG

VERTICAL

DRAG

0 .02 .04 .06 .08 .10 .12 .14  
TIME - SECS

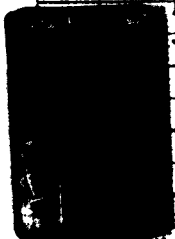

PREPARED BY: L.B. Mosby  
CHECKED BY: F.C.A.  
DATE: August 1962  
TITLE: DROP TESTS FOR LANDING LOADS INVESTIGATION

DOUGLAS AIRCRAFT COMPANY, INC.  
AIRCRAFT \_\_\_\_\_ DIVISION \_\_\_\_\_

PAGE: 54  
MODEL: A4D-2  
REPORT NO.: ES-40641

LANDING LOADS PROGRAM  
AIRPLANE DROP

75

LEFT WING

RIGHT WING

ACCELERATIONS ARE  
POSITIVE UPWARD, FWD,  
AND INB'RD

VERTICAL ACCELERATION

LONGITUDINAL ACCELERATION

VERTICAL ACCELERATION

LONGITUDINAL ACCELERATION

SIDE

DRAG

VERTICAL

DRAG

SIDE

10 12 14 16 18 20 22 24 26 28  
TIME - SECONDS



PREPARED BY: L.B. MO  
 CHECKED BY: P.C.A.  
 DATE: August 1966  
 TITLE: DRIF TESTS

FIGURE 20 (CONT'D)

LANDING LOADS F  
 AIRPLANE DRO  
 75

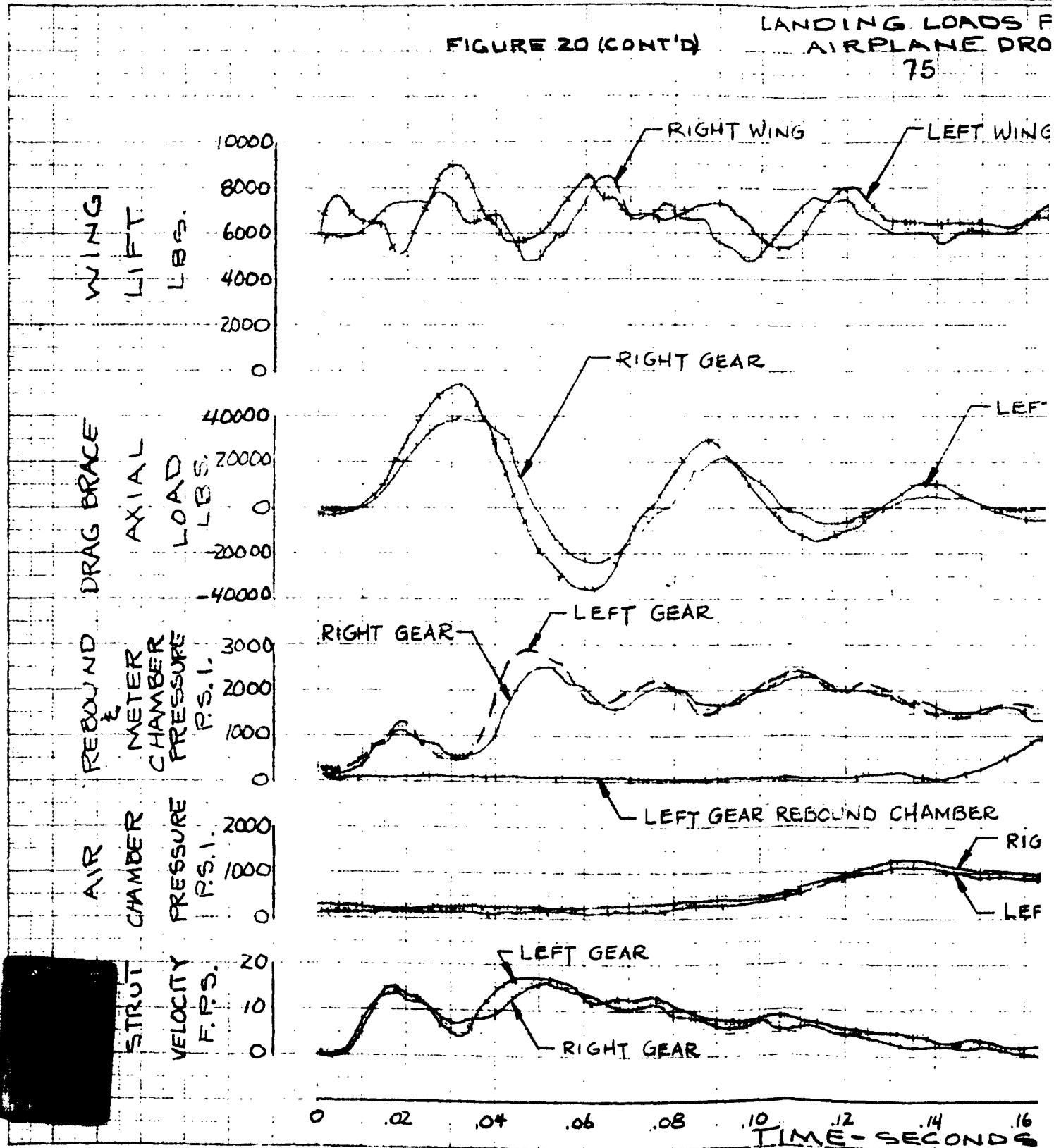

PREPARED BY: E.B. Mosby

DOUGLAS AIRCRAFT COMPANY, INC.

PAGE: 5

CHECKED BY: P. G. A.

AIRPLANE

DIVISION

MODEL: A4D-1

DATE: August 1962

TITLE: DEFEAT TESTS FOR LANDING LOADS INVESTIGATION

REPORT NO.: ES-40541

# LANDING LOADS PROGRAM AIRPLANE DROP

75

RIGHT WING

LEFT WING

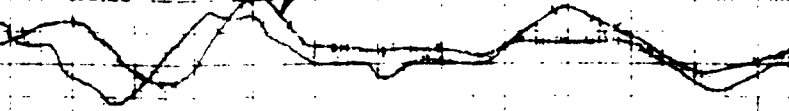

POSITIVE :  
UPWARD

RIGHT GEAR

LEFT GEAR

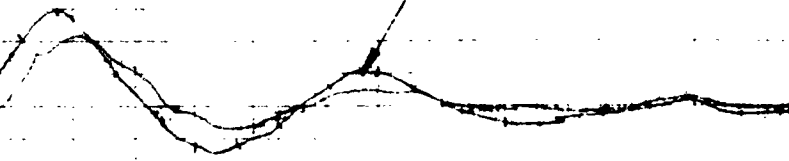

POSITIVE :  
TENSION

REAR GEAR

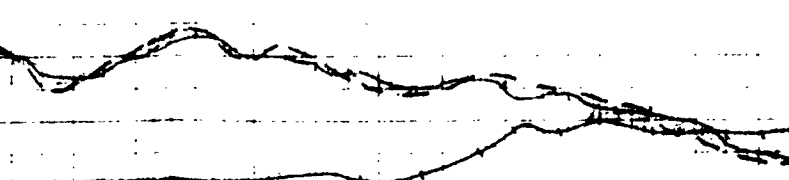

LEFT GEAR REBOUND CHAMBER

RIGHT GEAR

LEFT GEAR

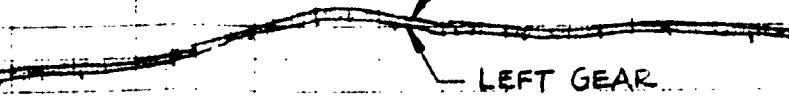

REAR GEAR

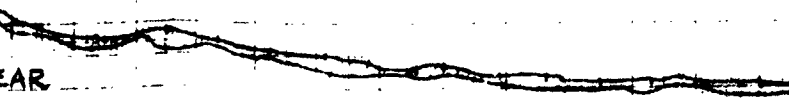

08 .10 .12 .14 .16 .18 20 .22 .24 .26 .28  
TIME - SECONDS



FIGURE 21

LANDING LOADS  
 AIRPLANE D

78

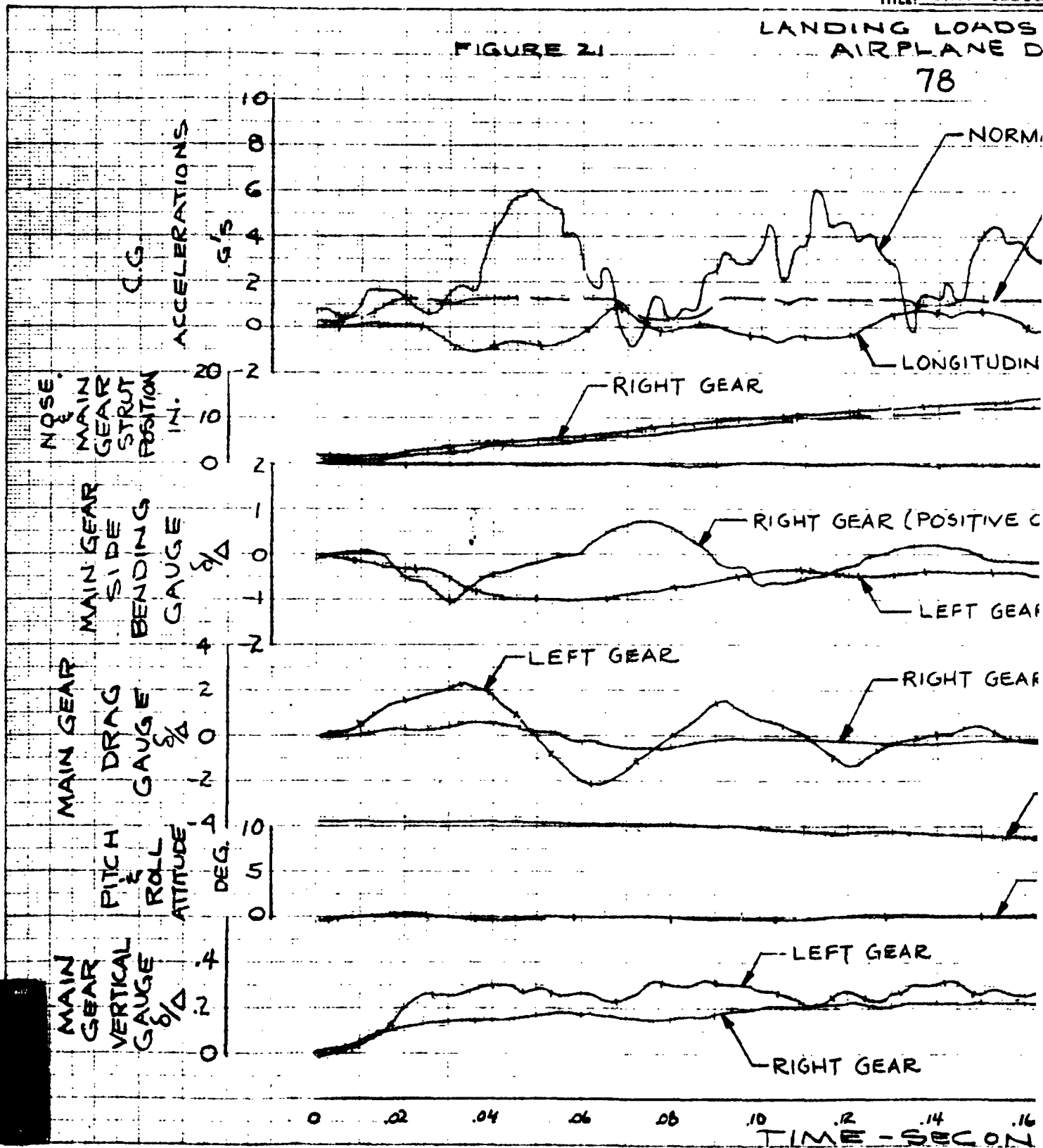

PREPARED BY: L.B. Mosby  
CHECKED BY: F.C.A.  
DATE: August 1962  
TITLE: DROP TESTS FOR LANDING LOADS INVESTIGATION

DOUGLAS AIRCRAFT COMPANY, INC.  
AIRCRAFT \_\_\_\_\_  
DIVISION \_\_\_\_\_

PAGE: 56  
MODEL: A4D-2  
REPORT NO.: ES-40641

LANDING LOADS PROGRAM  
AIRPLANE DROP

78

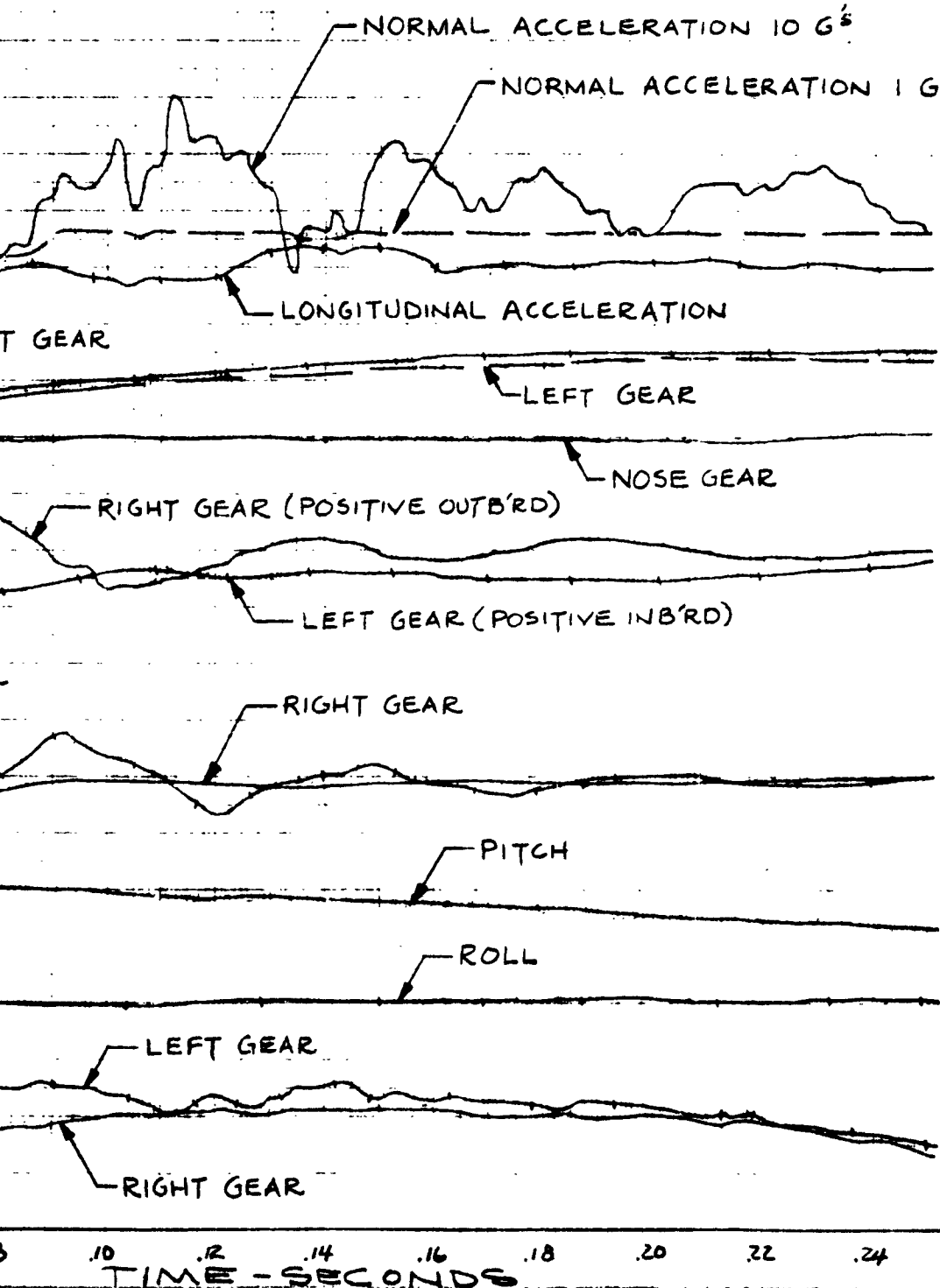

POSITIVE:  
UP & AFT

POSITIVE:  
COMPRESSION

POSITIVE:  
AFT

POSITIVE:  
NOSE UP &  
LEFT WING





FIGURE 21 (CONT'D)

LANDING LOAD  
 AIRPLANE C  
 78

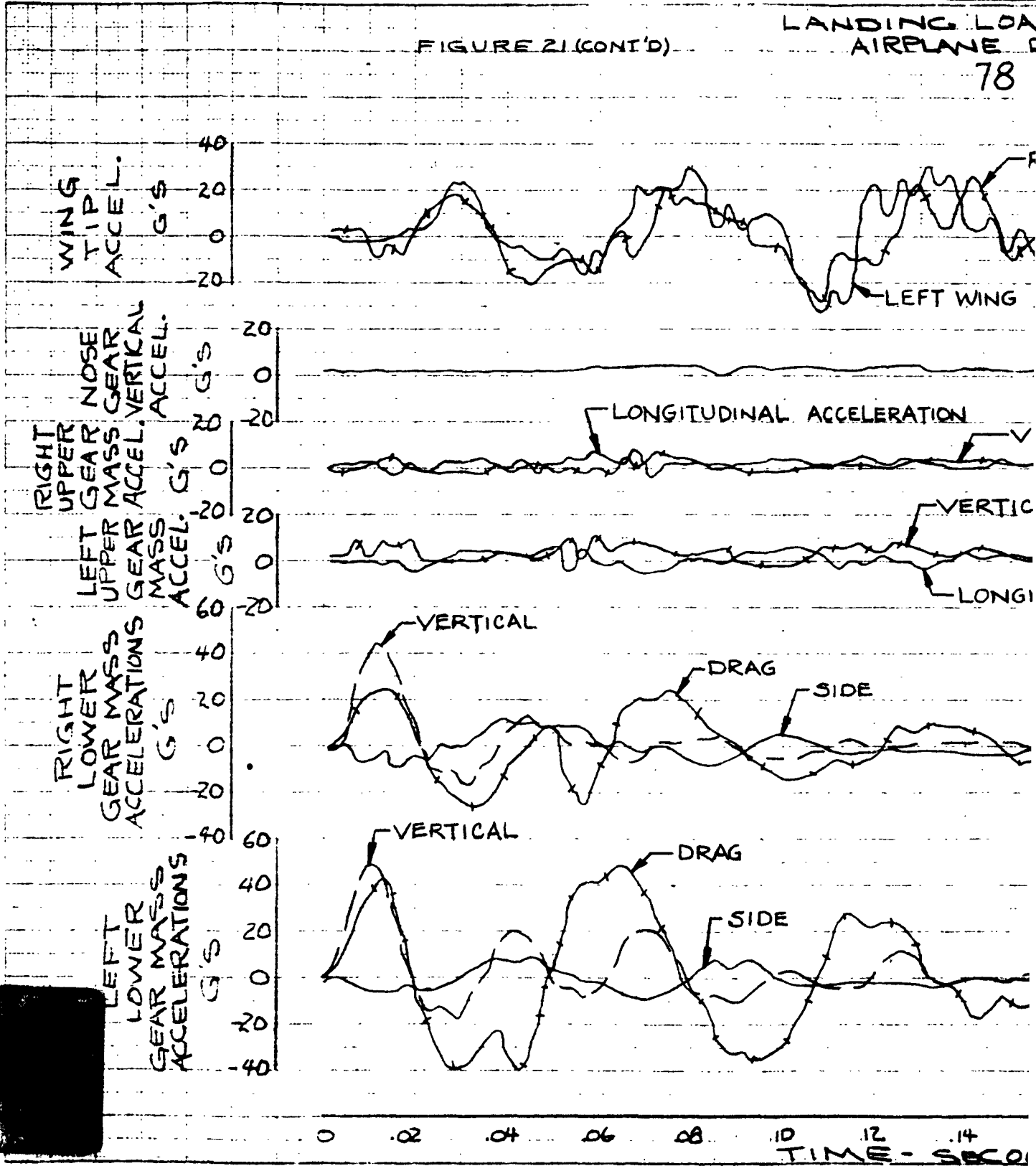

PREPARED BY: L.B. Mosby  
CHECKED BY: F.C.A.  
DATE: August 1962  
TITLE: DROP TESTS FOR LANDING LOADS INVESTIGATION

DOUGLAS AIRCRAFT COMPANY, INC.  
AIRCRAFT \_\_\_\_\_ DIVISION \_\_\_\_\_

PAGE: 57  
MODEL: A4D-2  
REPORT NO.: ES-40641

LANDING LOADS PROGRAM  
AIRPLANE DROP

78

ACCELERATIONS ARE  
POSITIVE UPWARD, FWD,  
& INB'RD

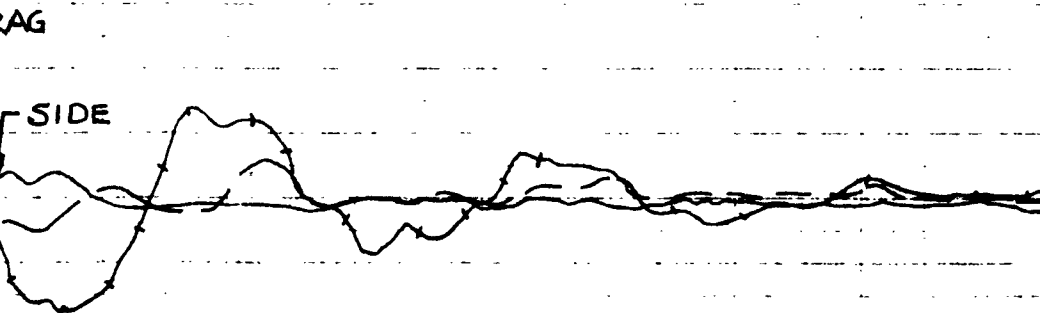
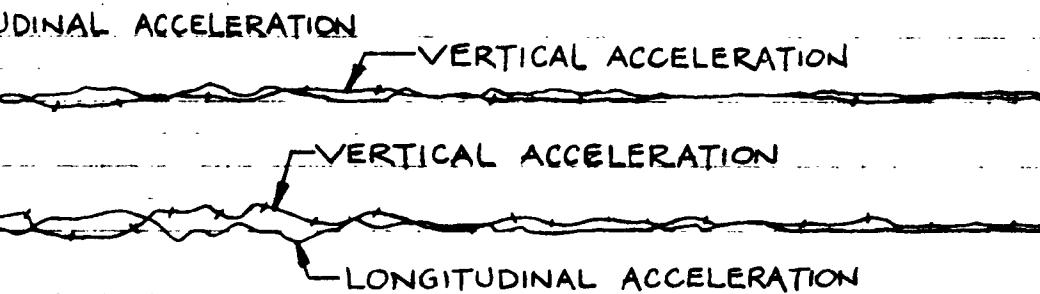

10 12 14 16 18 20 22 24 26 28  
TIME - SECONDS



FIGURE 21 (CONT'D)

LANDING LOADS OF AIRPLANE DRO

78

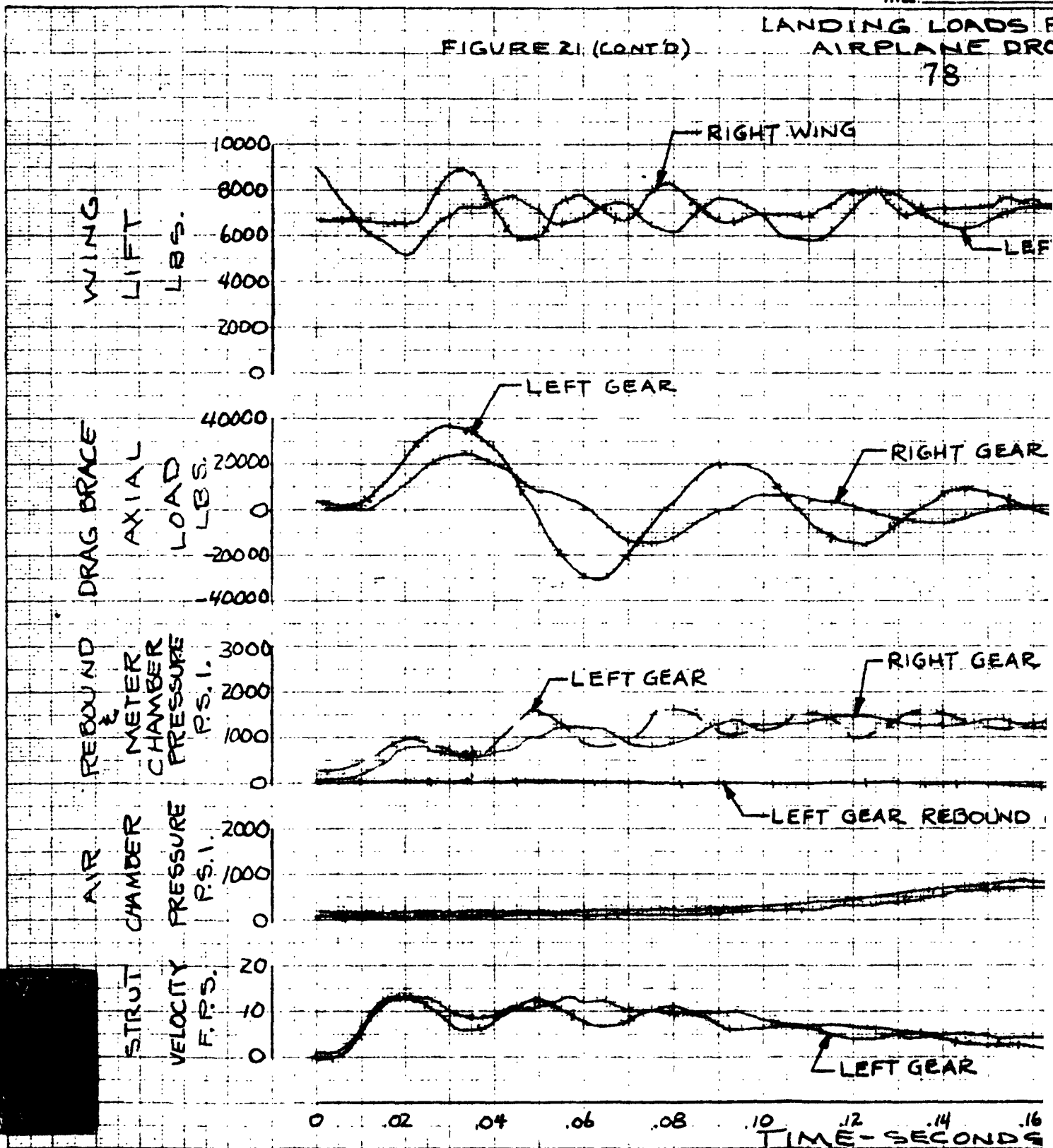

PREPARED BY: L.B. Mosby  
CHECKED BY: F.C.A.  
DATE: August 1962  
TITLE: DROP TESTS FOR LANDING LOADS INVESTIGATION

DOUGLAS AIRCRAFT COMPANY, INC.  
AIRCRAFT DIVISION

PAGE: 58  
MODEL: A4D-2  
REPORT NO.: ES-40641

### LANDING LOADS PROGRAM AIRPLANE DROP

78

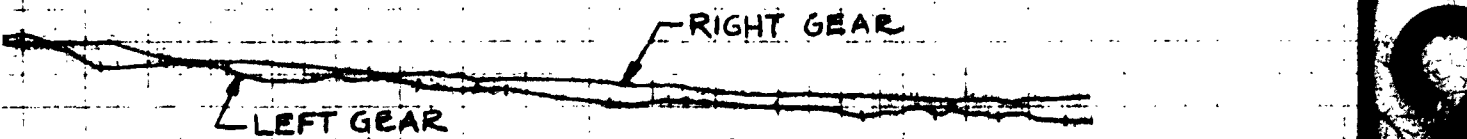
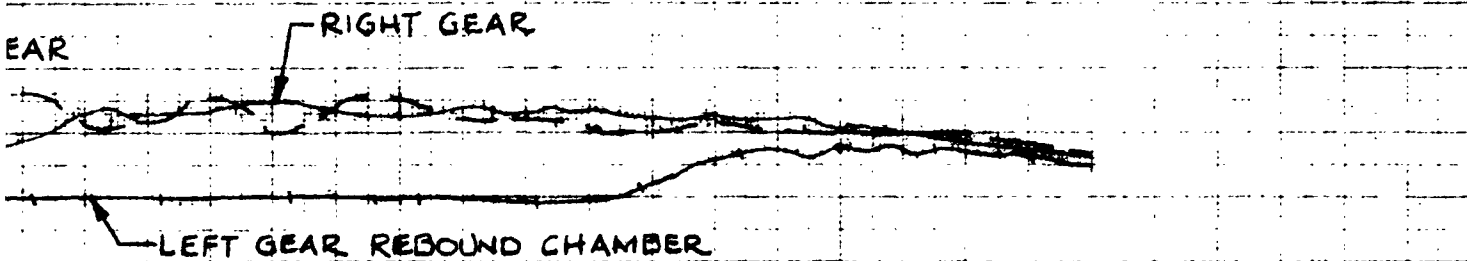
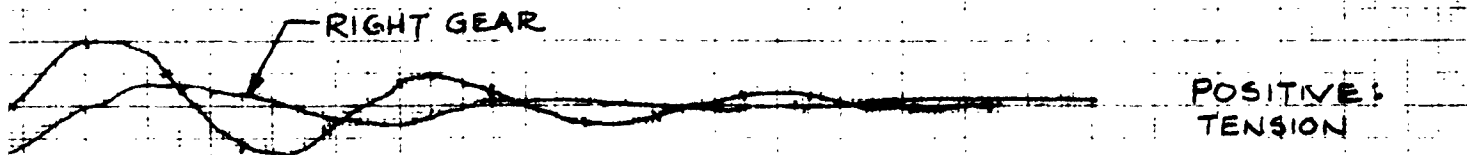
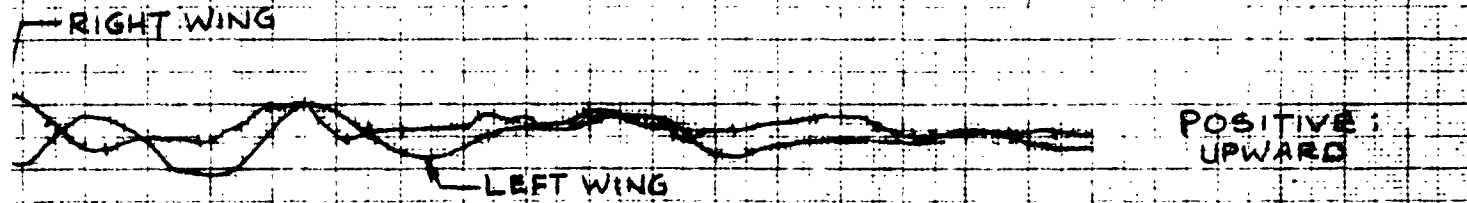

08 .10 .12 .14 .16 .18 20 .22 .24 26 28  
TIME - SECONDS



FIGURE 22

LANDING LOAD AIRPLANE

88

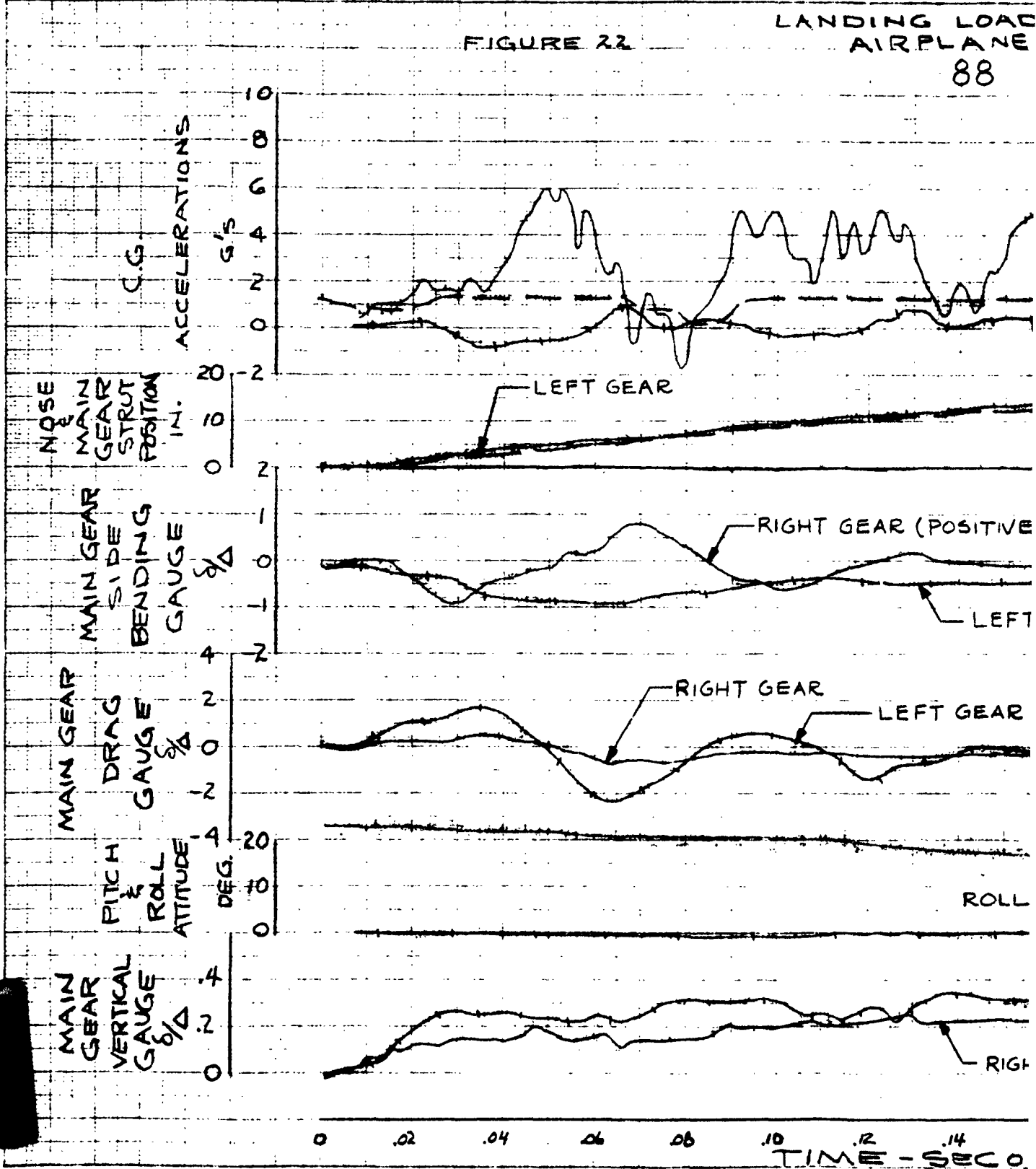

PREPARED BY: I.B. Mosby  
CHECKED BY: F.C.A.  
DATE: August 1962  
TITLE: DROP TESTS FOR LANDING LOADS INVESTIGATION

DOUGLAS AIRCRAFT COMPANY, INC.  
AIRCRAFT \_\_\_\_\_ DIVISION \_\_\_\_\_

PAGE: 59  
MODEL: A4D-2  
REPORT NO.: ES-40641

LANDING LOADS PROGRAM  
AIRPLANE DROP

88

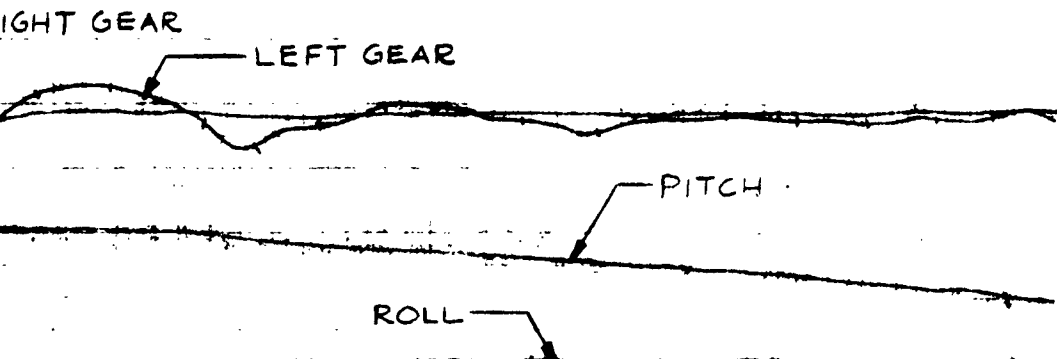
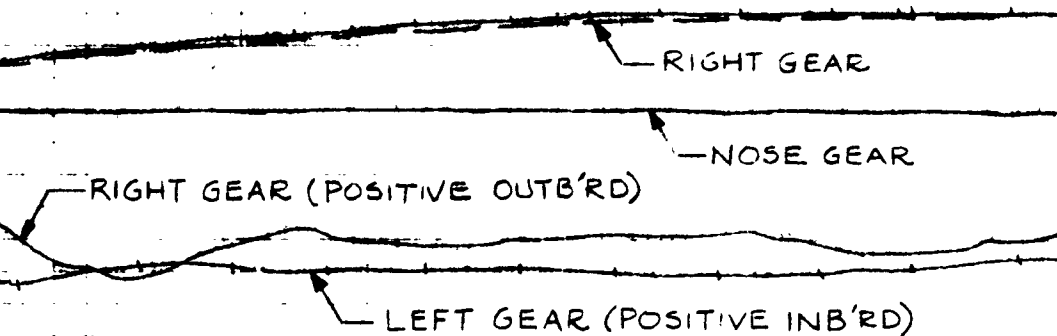
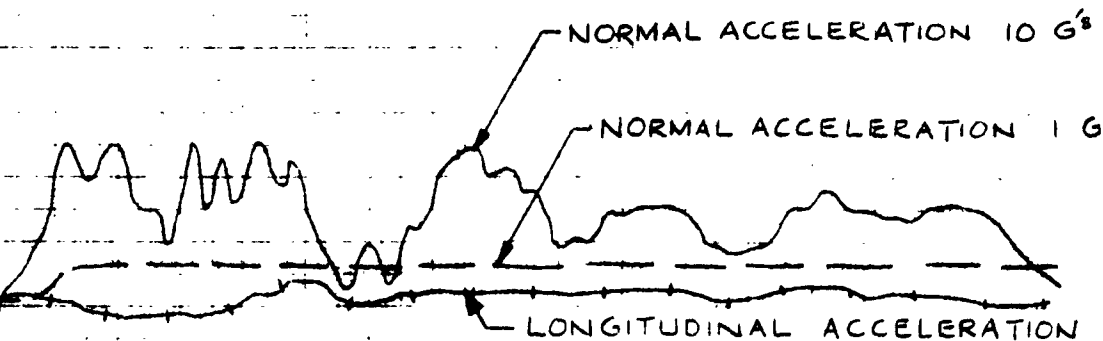

.10 .12 .14 .16 .18 .20 .22 .24 .26 .28  
TIME - SECONDS



FIGURE 22 (CONT'D)

LANDING LOADS  
AIRPLANE DR  
88

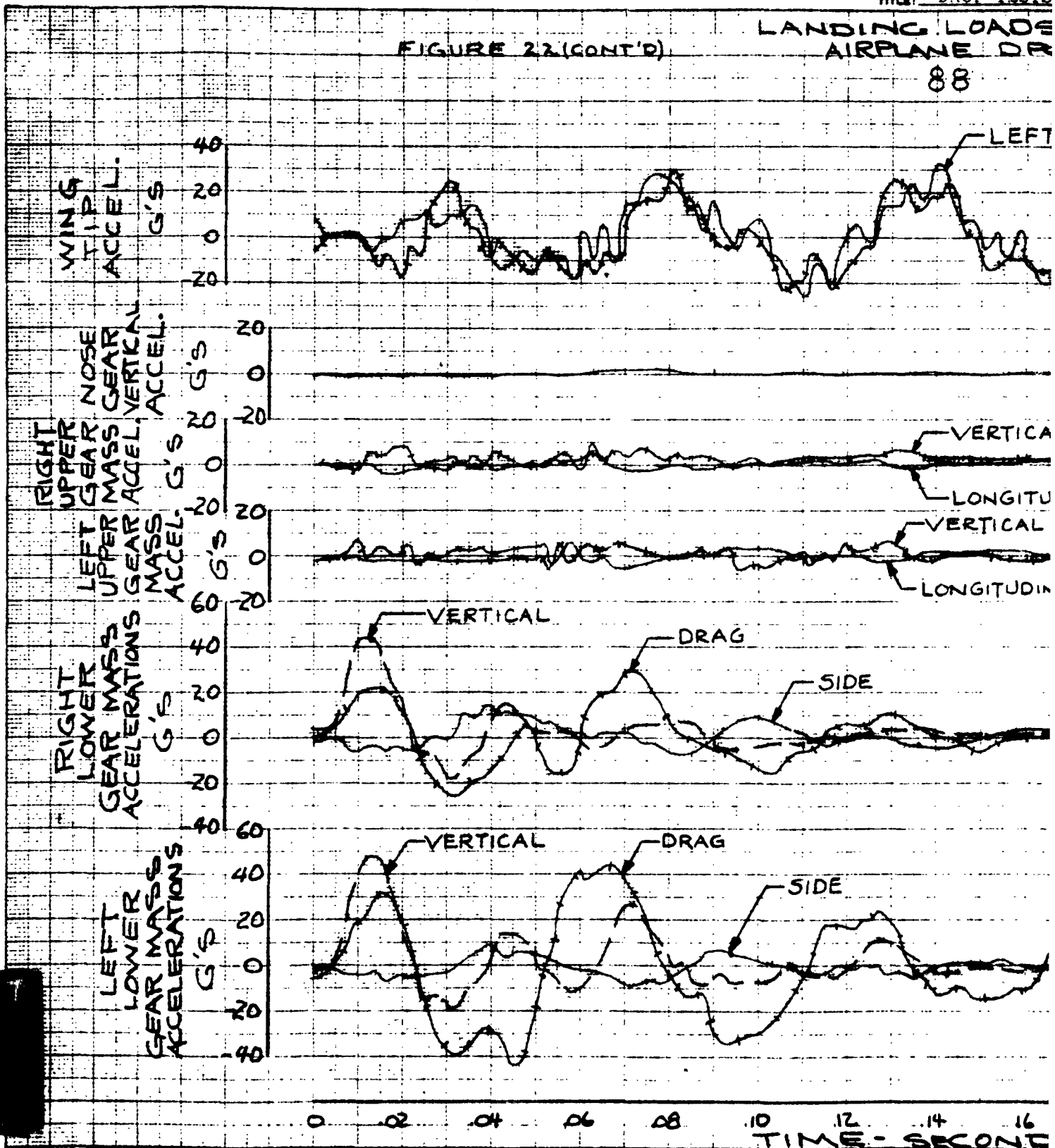

PREPARED BY: L.B. Mosby  
CHECKED BY: F.C.A.  
DATE: August 1962  
TITLE: DROP TESTS FOR LANDING LOADS INVESTIGATION

DOUGLAS AIRCRAFT COMPANY, INC.  
AIRCRAFT \_\_\_\_\_  
DIVISION \_\_\_\_\_

PAGE: 60  
MODEL: A4D-2  
REPORT NO.: ES-40641

LANDING LOADS PROGRAM  
AIRPLANE DROP

88

ACCELERATIONS ARE  
POSITIVE UPWARD, FWD,  
AND INBRD

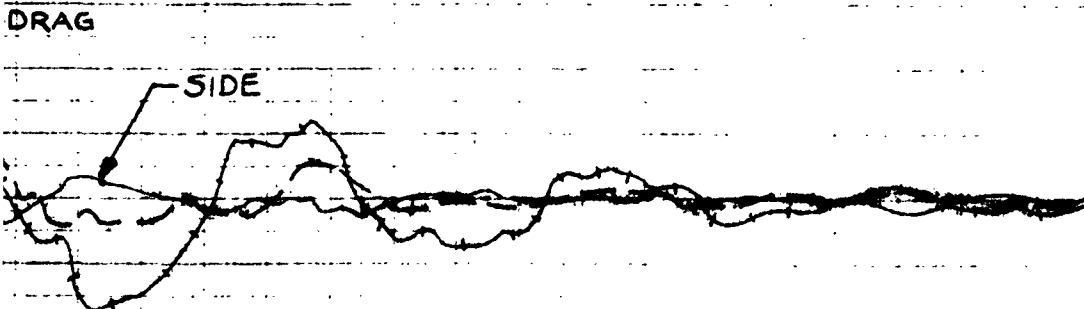
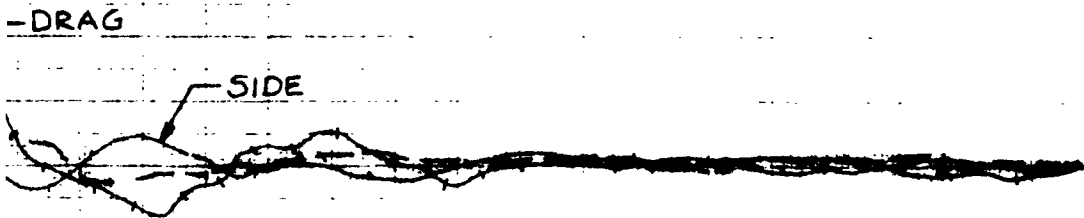
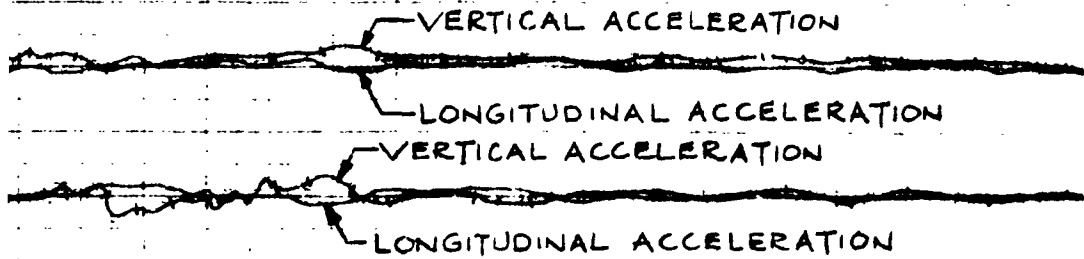

08 .10 .12 .14 .16 .18 .20 .22 .24 .26 .28  
TIME - SECONDS

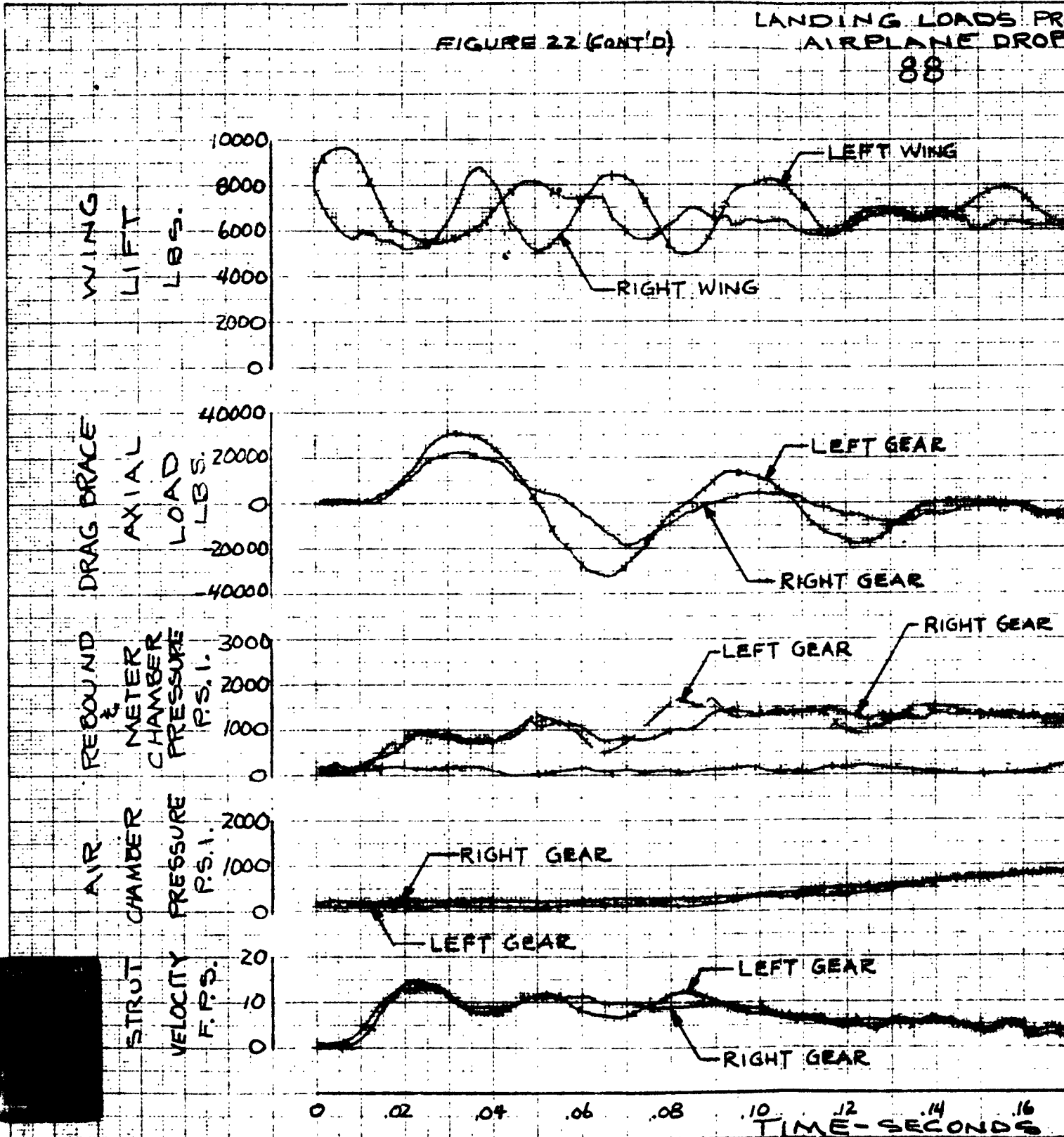



FIGURE 22 (CONT'D)

LANDING LOADS FR  
AIRPLANE DROP

88



PREPARED BY: L.B. Mosby  
CHECKED BY: F.C.A.  
DATE: August 1962  
TITLE: DROP TESTS FOR LANDING LOADS INVESTIGATION

DOUGLAS AIRCRAFT COMPANY, INC.  
AIRCRAFT

PAGE: 61  
MODEL: A4D-2  
REPORT NO.: ES-40641

LANDING LOADS PROGRAM  
AIRPLANE DROP

88

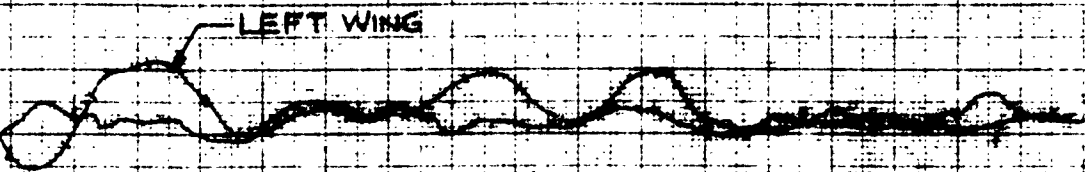

POSITIVE :  
UPWARD

RIGHT WING

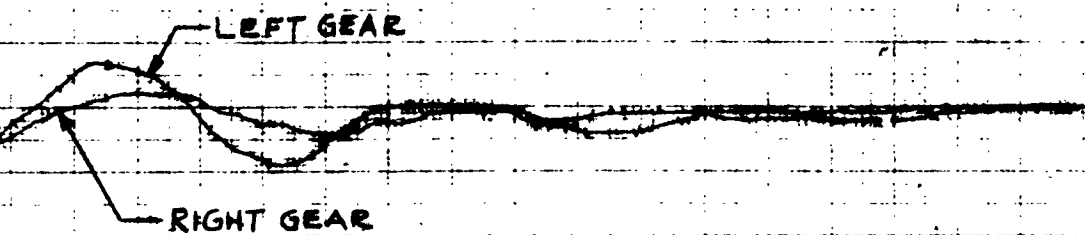

POSITIVE :  
TENSION

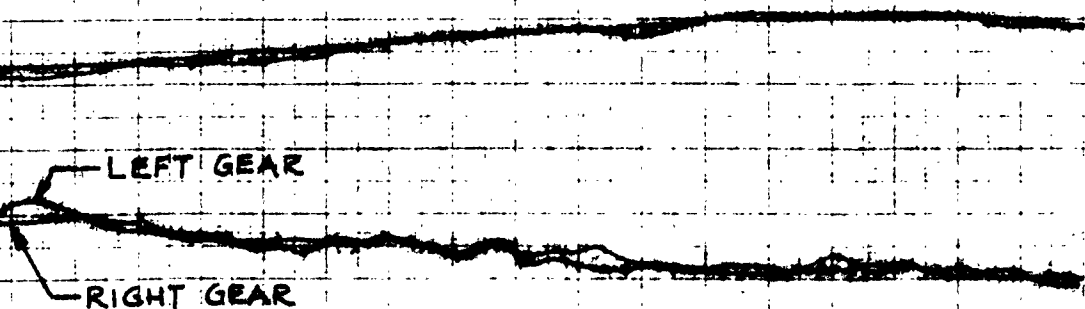
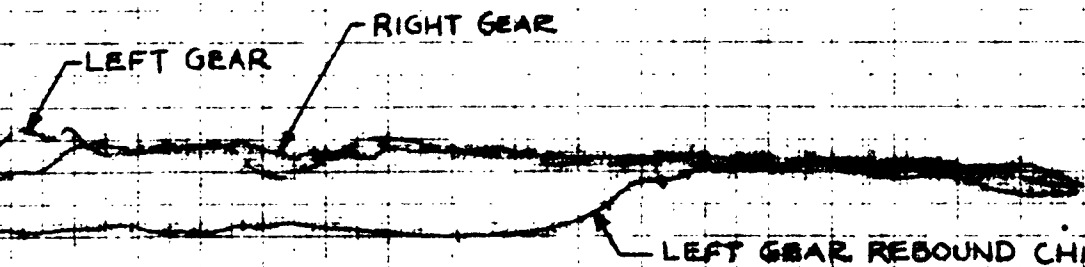

08 .10 .12 .14 .16 .18 20 22 24 26 28  
TIME - SECONDS



PREPARED BY: F. C. Allen

DOUGLAS AIRCRAFT COMPANY, INC.

PAGE: 62

CHECKED BY: I. B. Mosby <sup>DATE</sup>

LONG BEACH DIVISION

MODEL: A4D-2

TITLE: LANDING LOADS INVESTIGATION LABORATORY DROP TESTS

REPORT NO. ES-40641

GROUND LOADS

PREPARED BY: F.C. Allen DATE

DOUGLAS AIRCRAFT COMPANY, INC.

PAGE: 63

CHECKED BY: L.B.M. DATE

LONG BEACH DIVISION

MODEL: A4D-2

TITLE: LANDING LOADS INVESTIGATION LABORATORY DROP TESTS

REPORT NO. ES-40641

## GROUND LOADS

Vertical and horizontal loads at the ground obtained from the strut instrumentation and the equations on Page 24 are presented on Pages 69 to 84. A comparison is made with the loads registered on the reaction platform.

In discussing the probable accuracy and reliability of these data, it is desirable to review briefly the procedure used in the calibration of the axle strain gauges which supply the primary input for the "strut" ground loads data. A complete discussion of the calibration procedure is contained in Reference 1.

This procedure consisted of comparing the vertical ground load from strut data computed by Equation 12, with the vertical readings of the reaction platform. The comparison was made at .002 second intervals and the strain gauge constants were chosen such that the average error was minimum. Since the reaction platform drag measurement was not considered to be reliable, comparisons were made for the drag direction in perfectly vertical drops without spin-up, in which the drag load was known to be zero.

Thus, good agreement between the average vertical platform load and the average vertical strut load could be expected by the nature of the calibration. At any instant of time, however, differences might be expected, such differences being introduced primarily by relative accuracy of the dynamic responses of the strut instrumentation and the platform.

It is noted that in the first .03 seconds the peak vertical load from the reaction platform always exceeds the peak vertical load measured by the strut. This phenomenon is attributed to the response characteristic of the platform. Although a complete investigation of the dynamic characteristics of the platform has not been made, it has been determined (Reference 5) that the fundamental frequency in the vertical direction is 22 cycles per second which is close to the frequency of the first load peak. The high reaction platform load at this point is, therefore, believed to be dynamic overshoot. In view of this fact, the load variation shown by the strut in this region is considered more reliable.

PREPARED BY: F. C. Allen DOUGLAS AIRCRAFT COMPANY, INC.

PAGE: 64

CHECKED BY: L. B. M. DATE LONG BEACH DIVISION

MODEL: A4D-2

TITLE: LANDING LOADS INVESTIGATION LABORATORY DROP TESTS

REPORT NO. ES-40641

Substantial differences are noted between the strut drag lead and the reaction platform drag load. Readings of the reaction platform in the drag direction have been viewed with skepticism for some time inasmuch as there is a high coefficient of friction between the plate and the rollers under high lead which inhibits an accurate response to high frequencies. This lack of high frequency response is evident both in the initial peak drag leads and in the subsequent oscillations where the reaction platform appears to be a rough average between the peaks of the load obtained by the strut instrumentation. On the other hand, the coefficients of friction computed from the left hand gear strut leads are higher than any known previous observation, and in view of the differences between the left and right hand coefficients, some skepticism regarding the accuracy of the left gear drag lead readings is warranted. The following paragraphs discuss this point in detail.

Table VI summarizes the coefficients of friction data.

PREPARED BY: F. C. Allen DATE DOUGLAS AIRCRAFT COMPANY, INC.  
 CHECKED BY: L. E. M. DATE LONG BEACH DIVISION 9  
 TITLE: LANDING LOADS INVESTIGATION LABORATORY DROP TESTS

PAGE: 65  
 MODEL: A4D-2  
 REPORT NO. ES-40641

Table VI  
 COEFFICIENTS OF FRICTION AND SPIN-UP TIME

Drop No.	Source	Coefficient of Friction				Spin-Up Time**	
		Left Gear		Right Gear		Left	Right
		Average	Maximum*	Average	Maximum*	Seconds	Seconds
84	Strut	.73	1.28	.48	.76	.044	.050
	Platform	.52	.64	.30	.42	.044	.048
70	Strut	.65	1.19	.55	.68	.047	.059
	Platform	.63	.63	.46	.60	.046	.058
68	Strut	.66	1.04	.53	.75	.041	.050
	Platform	.46	.59	.44	.61	.040	.047
93	Strut	.80	1.33	.54	.70	.036	.040
	Platform	.47	.58	.46	.70	.036	.040
82	Strut	.76	1.14	.65	.72	.042	.048
	Platform	.50	.64	.54	.78	.041	.048
75	Strut	.72	1.10	.52	.66	.035	.042
	Platform	.48	.63	.51	.63	.035	.043
78	Strut	.72	1.36	.44	.68	.047	.054
	Platform	.48	.66	.50	.91	.043	.053
88	Strut	.87	1.55	.62	1.03	.048	.057
	Platform	.47	.62	.45	.61	.045	.053

\* Points prior to  $t = .01$  are ignored.

\*\* To be precise, in drop tests this is "spin-down" time.

PREPARED BY: F. C. Allen DOUGLAS AIRCRAFT COMPANY, INC.

PAGE: 66

CHECKED BY: L. B. N. DATE

LONG BEACH DIVISION

MODEL: A4D-2

TITLE: LANDING LOADS INVESTIGATION LABORATORY DROP TESTS

REPORT NO. ES-40641

The data are further summarized in the following table in which the peculiar nature of the left gear data is apparent:

	Coefficient of Friction		Avg. Spin-Up Time-Sec
	Average	Maximum Average	
Left gear - Strut	1.25	.74	.43
Platform	.63	.50	.41
Right gear - Strut	.75	.54	.50
Platform	.66	.46	.49

This table shows that the strut instrumentation (both right and left) gives higher drag loads than the platform. It also shows that the left gear spin-up time is on the average substantially less than the right, hence higher drag loads would be expected for the left gear.

To further explore the accuracy of the drag data, the wheel RPM was computed from the equation

$$RPM = \frac{60}{2\pi I_p} \int (R - C) \cdot FHG \cdot dt$$

where  $I_p$  = the polar moment of inertia of the rotating mass,

R = Tire radius

C = Tire deflection

FHG = Drag force at the ground

The integration was carried out from time of contact to the time that FHG reduces to zero. The following results were obtained:

PREPARED BY: F. C. Allen DOUGLAS AIRCRAFT COMPANY, INC.

PAGE: 67

CHECKED BY: L. B. M. DATE

LONG BEACH DIVISION

MODEL: A4D-2

TITLE: LANDING LOADS INVESTIGATION LABORATORY DROP TESTS

REPORT NO. ES-40641

Table VII

Comparison of Calculated and Measured Wheel Angular Velocity

Drop No.	Source	Wheel Rotational Velocity			
		Left Gear		Right Gear	
		RPM	Dev. From Meas. %	RPM	Dev. From Meas. %
84	Direct Measurement	1811		1794	
	Calculated - Strut Data	2112.8	+16	1671	- 7.1
	Calculated - Platform Data	1734.6	-4.3	928	-48.4
70	Direct Measurement	2097		2089	
	Calculated - Strut Data	2082	- .1	2037	- 2.8
	Calculated - Platform Data	2035	- .3	1937	- 7.9
68	Direct Measurement	1925		1918	
	Calculated - Strut Data	2138	+11	2137	+11
	Calculated - Platform Data	1670	-15	1810	- 5.7
93	Direct Measurement	1936		1912	
	Calculated - Strut Data	2352	+21	2016	+ 5.1
	Calculated - Platform Data	1628	-19	1781	- 7.1
82	Direct Measurement	2074		2044	
	Calculated - Strut Data	2542	+22	2257	+10
	Calculated - Platform Data	1794	-15	1921	- 6.3

Average Deviation from Measured RPM

	Left	Right
Strut	+14.4	+ 3.3
Platform	-10.1	- 6.8 *

\* Neglects Drop 84



PREPARED BY: F. C. Allen DOUGLAS AIRCRAFT COMPANY, INC.

PAGE: 68

CHECKED BY: L. B. M. DATE \_\_\_\_\_ LONG BEACH DIVISION

MODEL: A4D-2

TITLE: LANDING LOADS INVESTIGATION LABORATORY DROP TESTS

REPORT NO. ES-40641

The calculations associated with the foregoing table are inherently of low accuracy because of the possible variation in polar moment of inertia of the wheel and tire. The value used in these calculations, 11.26 slug-in<sup>2</sup>, was obtained from manufacturer's data and is considered accurate within ±15%. In addition to variations caused by dimensional tolerances and wear of the tire,  $I_p$  will vary with rotational velocity and with age, these latter variations tending to increase the moment of inertia by approximately 10%. If the left hand gear moment of inertia were 10% higher than the right, Table VII would show reasonable correlation for the left hand gear (i.e., the deviations shown would be reduced by 10%). Definite conclusions regarding the accuracy of the drag data cannot, therefore, be drawn from the spin-up calculations.

The high coefficient of friction for the left gear still remains to intrude an element of doubt on the accuracy of the left gear drag data. Before the possibility of drag coefficients in excess of 1.0 is abandoned, it is recommended that a low speed sliding coefficient of friction test be conducted using the actual platform surface. Reference (6), Page 23, shows a rough correlation between sliding coefficient of friction and values obtained from dynamic tests. Should the sliding coefficient of friction for the platform be substantially higher than that shown in Reference (6), there would be cause to believe that dynamic coefficients in excess of 1.0 could be reached in drop test.

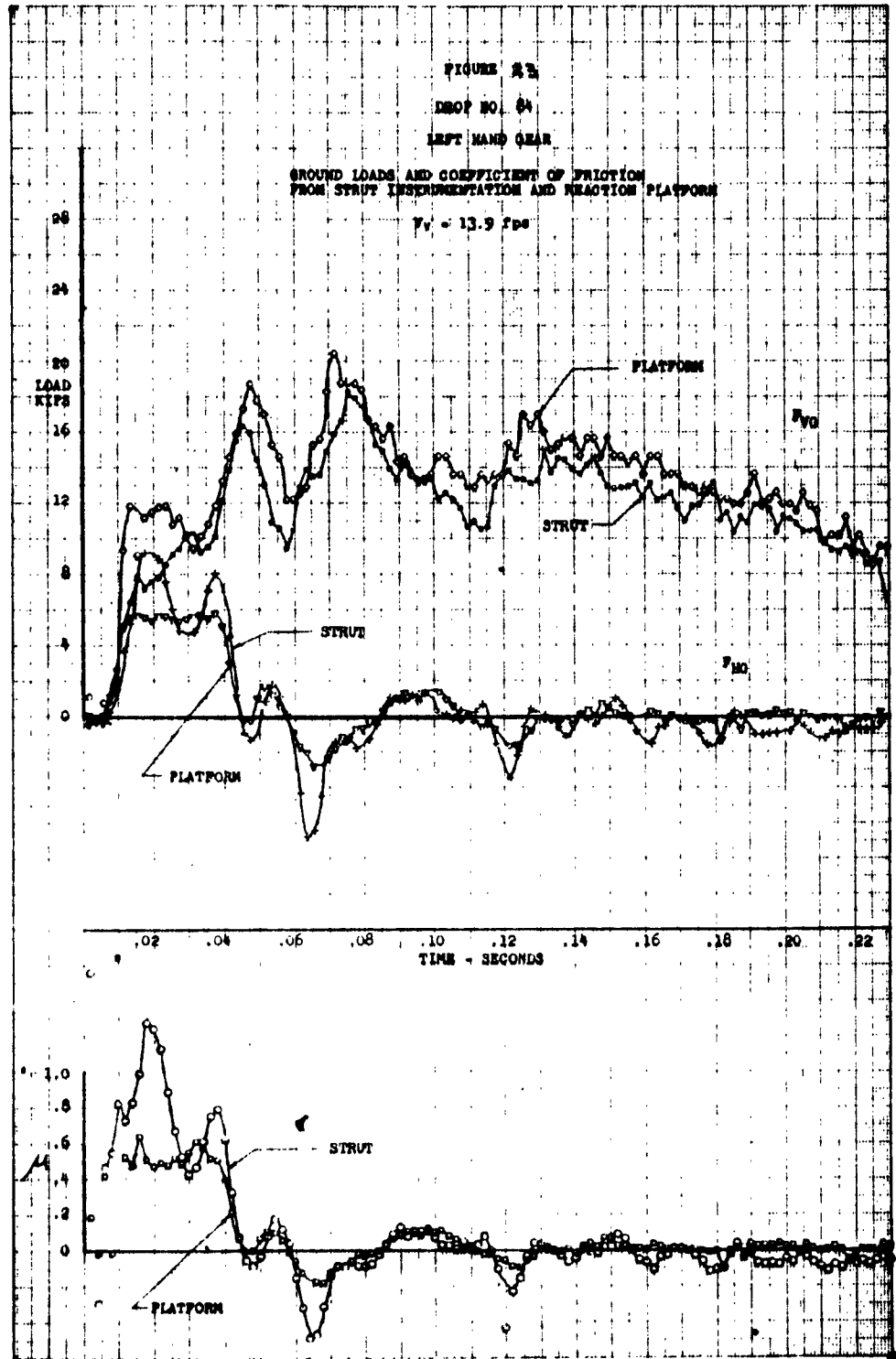

PREPARED BY: L. B. Mosby DOUGLAS AIRCRAFT COMPANY, INC.

PAGE: 70

CHECKED BY: F. C. A. DATE

LONG BEACH DIVISION

MODEL: A4D-2

TITLE: LANDING LOADS INVESTIGATION LABORATORY DROP TESTS

REPORT NO. ES-40641

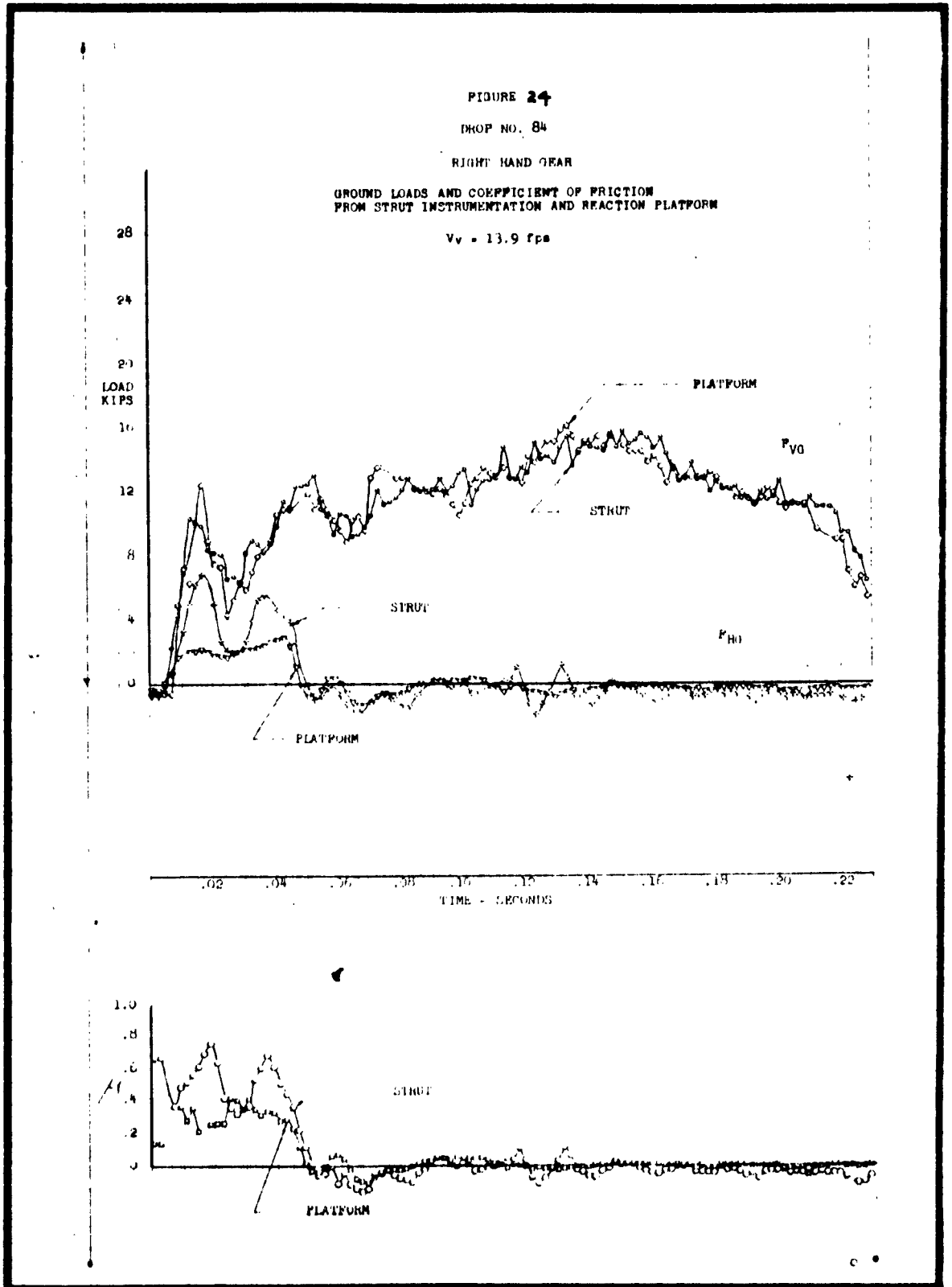

PREPARED BY: L. B. Mosby **DOUGLAS AIRCRAFT COMPANY, INC.**  
CHECKED BY: P. C. A. **LONG BEACH DIVISION**  
TITLE: LANDING LOADS INVESTIGATION LABORATORY DROP TESTS

PAGE: 71  
MODEL: A4D-2  
REPORT NO. ES-40641

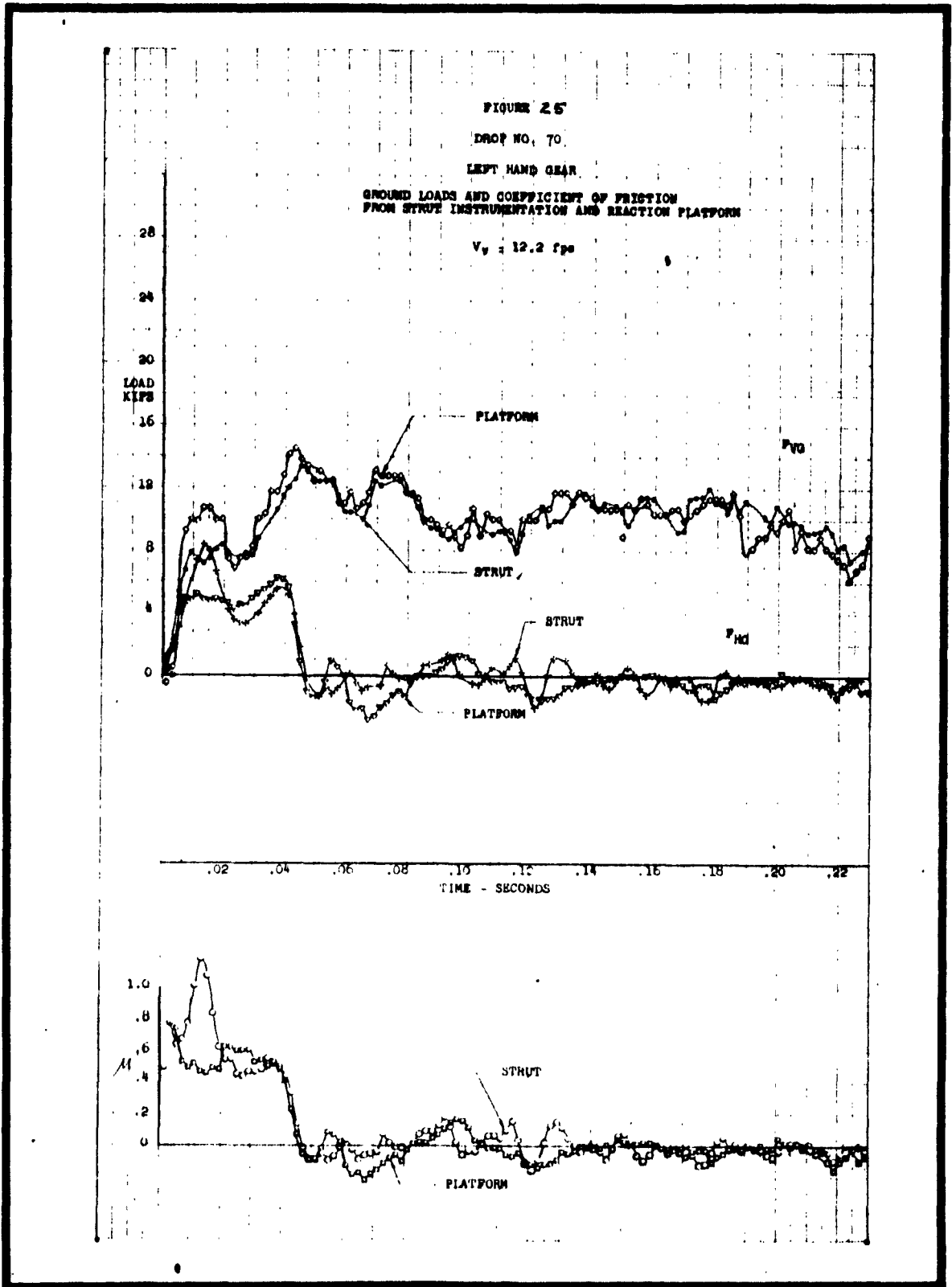

PREPARED BY: L. B. Mosby DOUGLAS AIRCRAFT COMPANY, INC.  
CHECKED BY: F. C. A. DATE LONG BEACH DIVISION  
TITLE: LANDING GEAR INVESTIGATION LABORATORY DROP TESTS

PAGE: 72  
MODEL: A4D-2  
REPORT NO. ES-40641

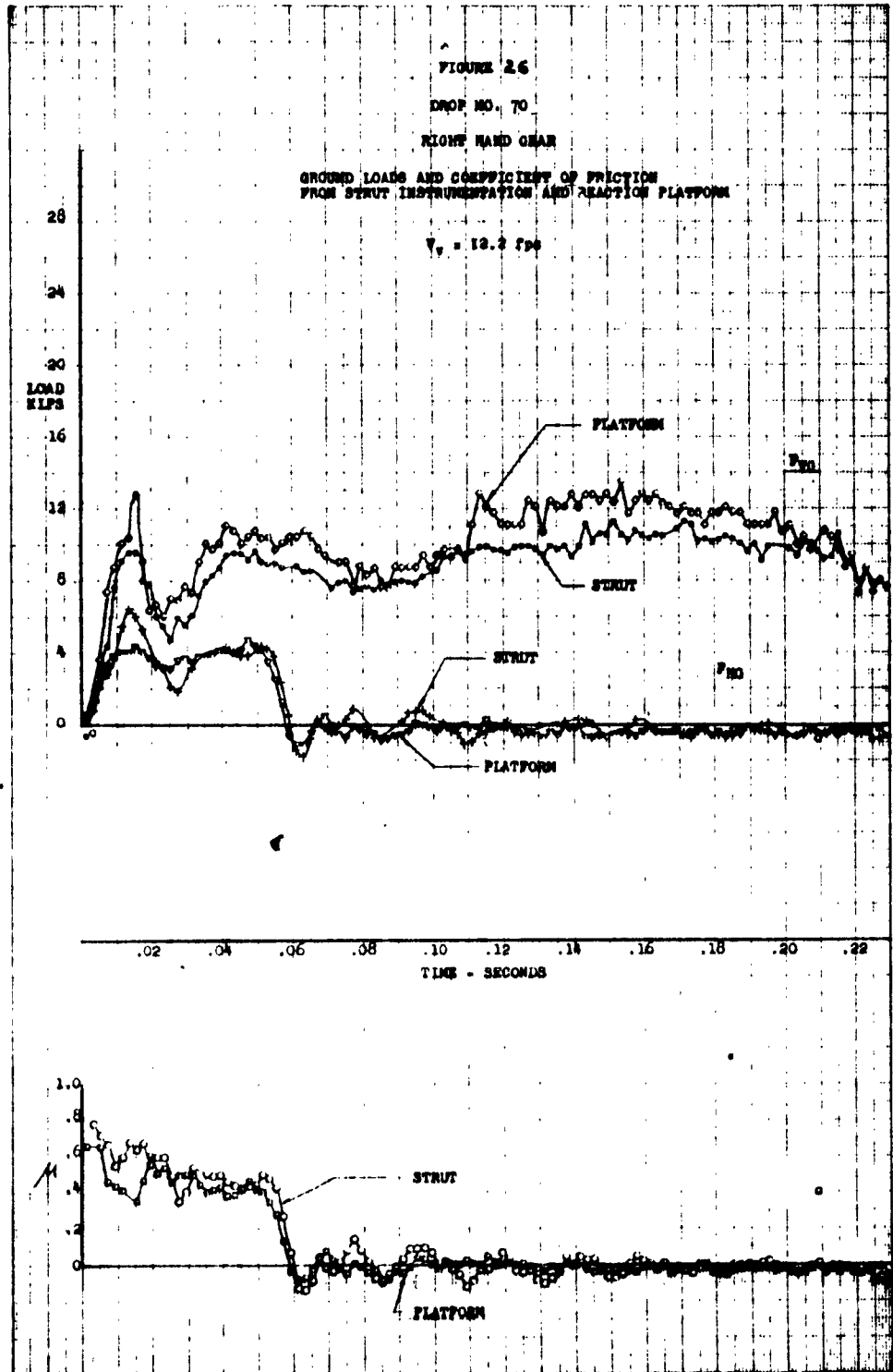

PREPARED BY: L. B. Mosby DOUGLAS AIRCRAFT COMPANY, INC.  
CHECKED BY: F. C. A. DATE \_\_\_\_\_ LONG BEACH DIVISION  
TITLE: LANDING LOADS INVESTIGATION LABORATORY DROP TESTS

PAGE: 73  
MODEL: A4D-2  
REPORT NO. ES-40641

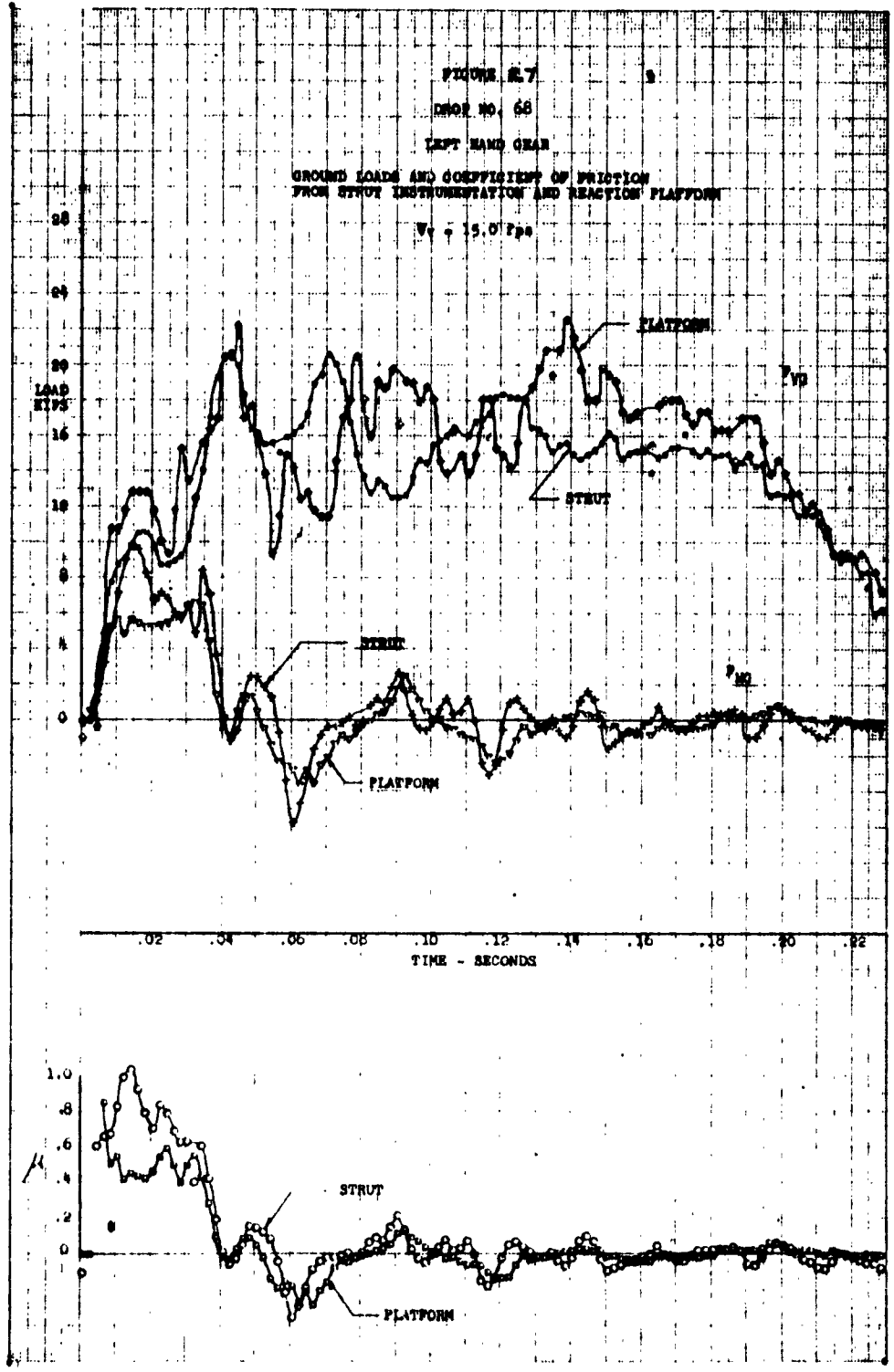

PREPARED BY: L. B. Mosby DATE

DOUGLAS AIRCRAFT COMPANY, INC.

PAGE: 74

CHECKED BY: F. C. A. DATE

LONG BEACH DIVISION

MODEL: A4D-2

TITLE: LANDING GEAR INVESTIGATION LABORATORY DROP TESTS

REPORT NO. ES-40641

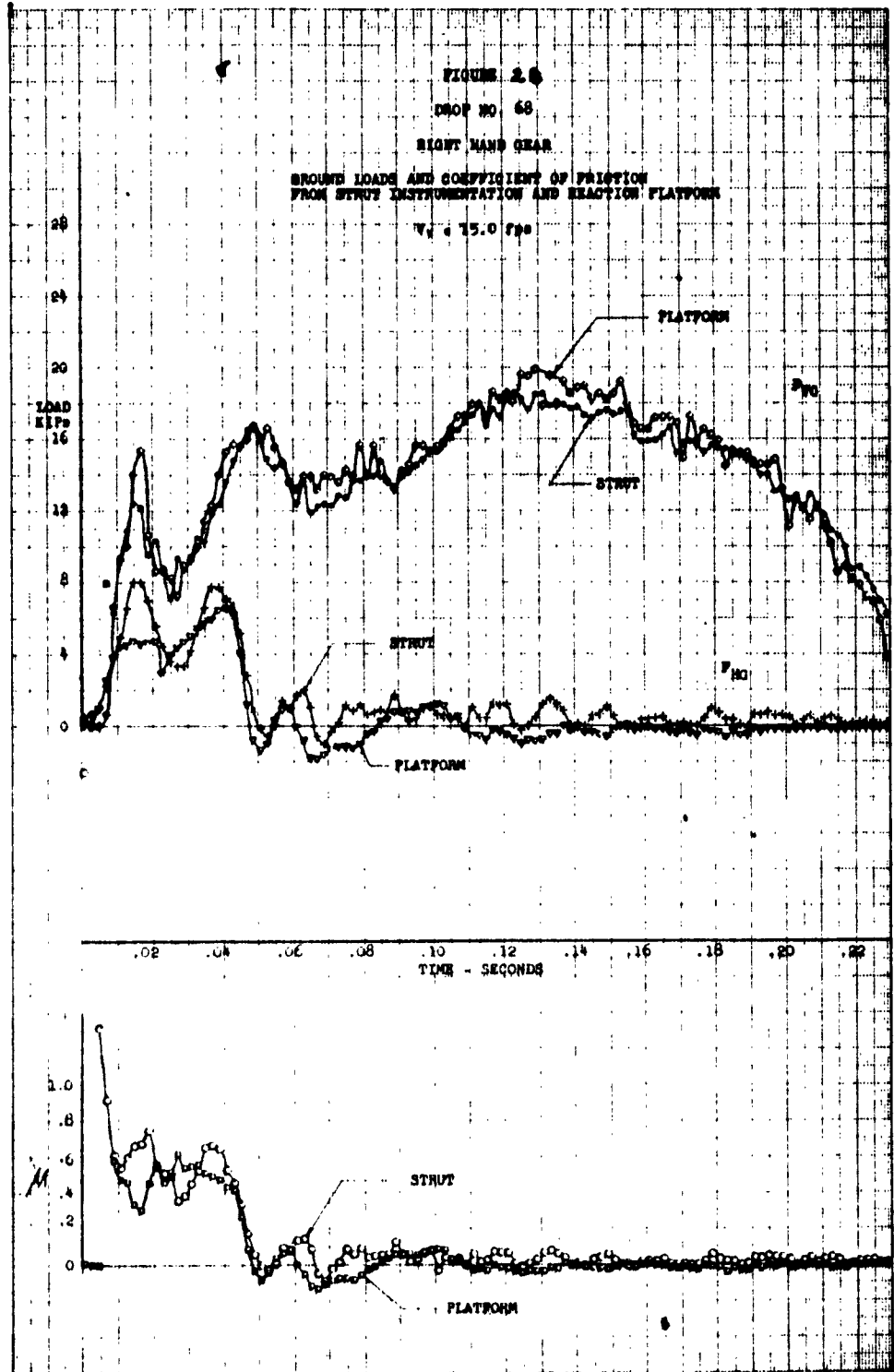

PREPARED BY: I. H. Masby DATE \_\_\_\_\_ DOUGLAS AIRCRAFT COMPANY, INC.  
CHECKED BY: R. C. A. DATE \_\_\_\_\_ LONG BEACH DIVISION  
TITLE: LANDING LOAD INVESTIGATION LABORATORY DROP TESTS

PAGE: 75  
MODEL: A4D-2  
REPORT NO. ES-40641

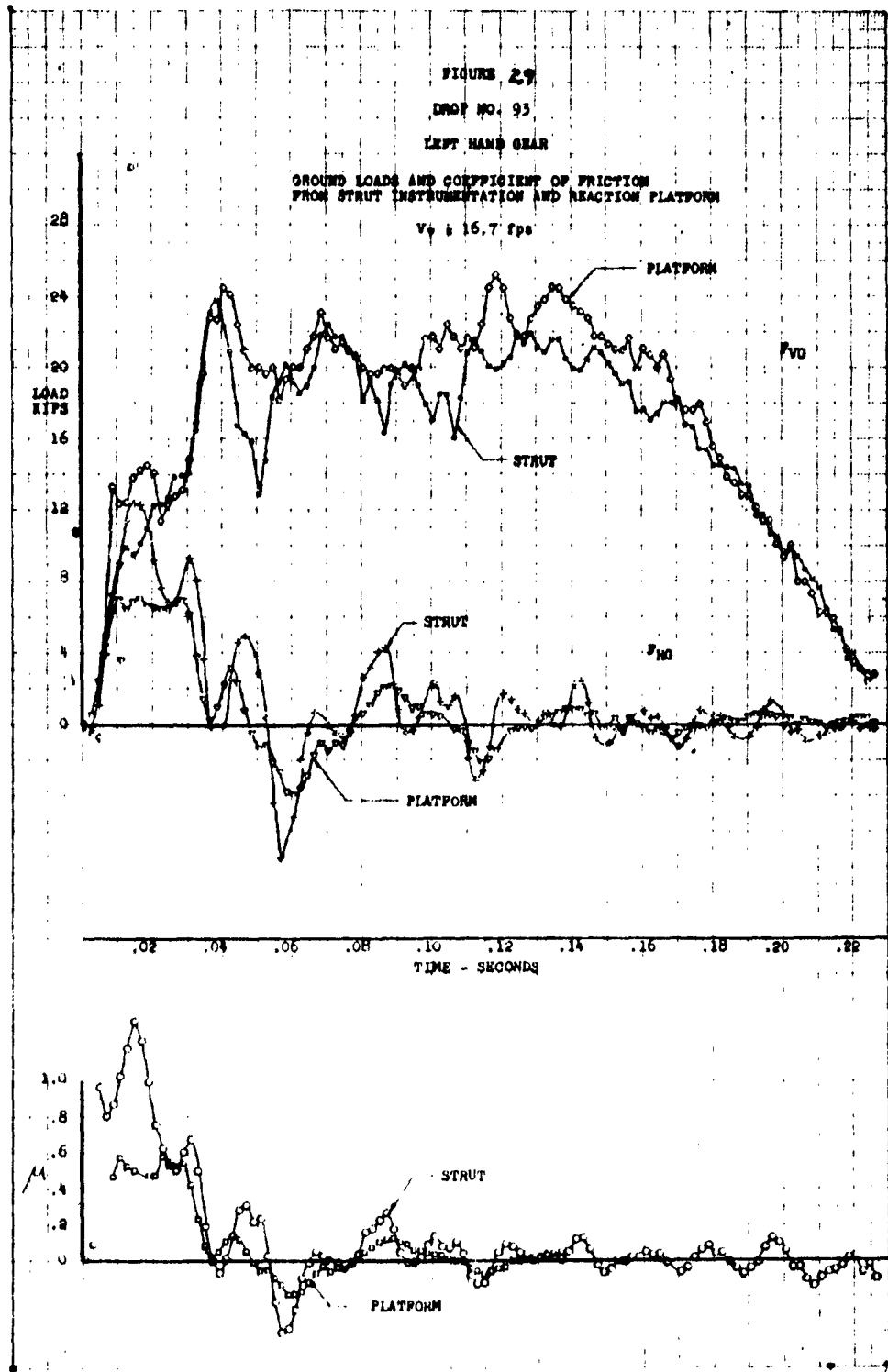



PREPARED BY: L. B. Mosby DATE \_\_\_\_\_  
CHECKED BY: F. C. A. DATE \_\_\_\_\_  
TITLE: LANDING LOADS INVESTIGATION LABORATORY DROP TESTS

DOUGLAS AIRCRAFT COMPANY, INC.  
LONG BEACH DIVISION

PAGE: 76  
MODEL: A4D-2  
REPORT NO. ES-40641

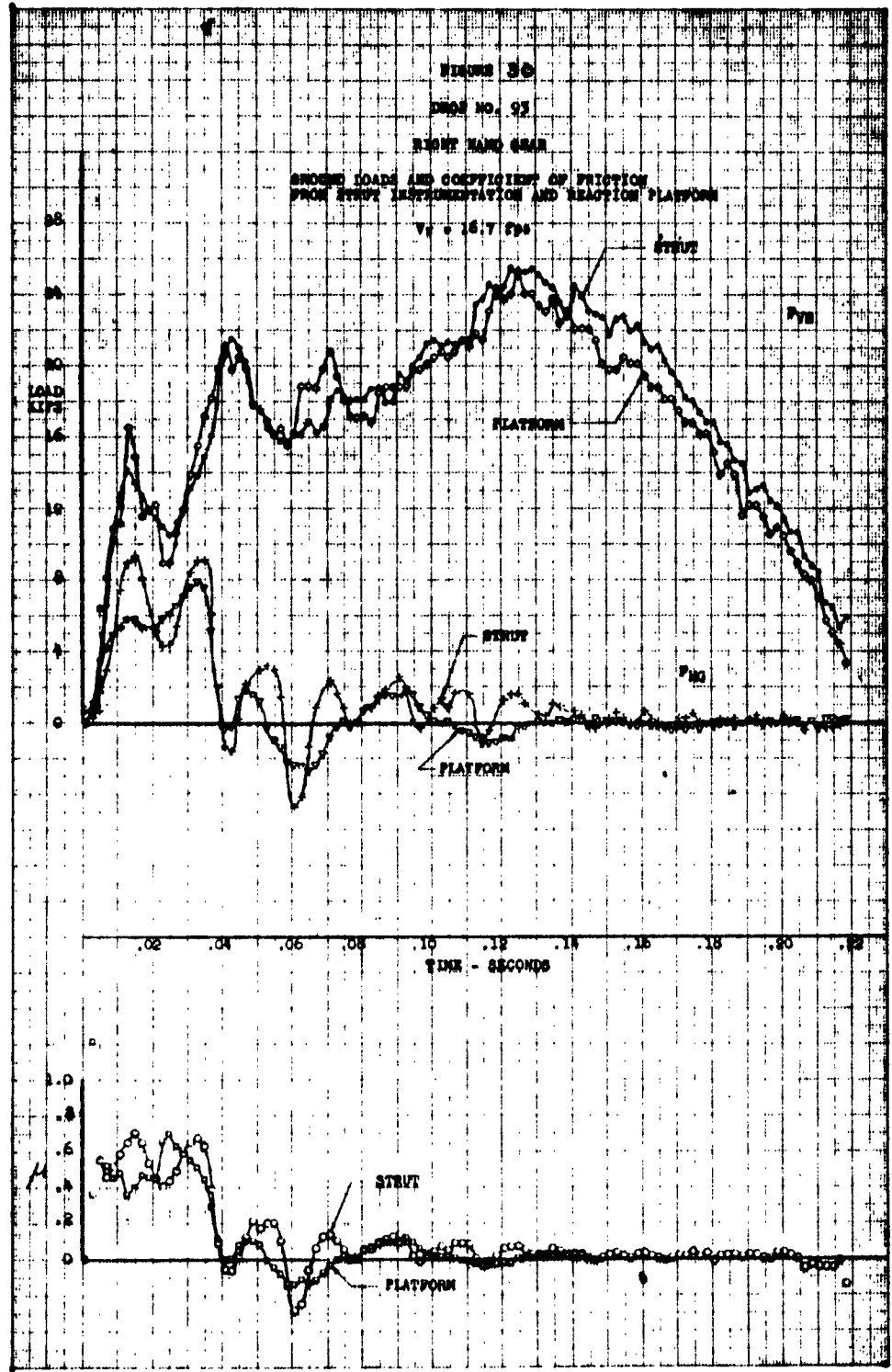

PREPARED BY: L. B. Mosby **DOUGLAS AIRCRAFT COMPANY, INC.**  
CHECKED BY: R. C. Allen DATE **LONG BEACH DIVISION**  
TITLE: LANDING GEAR INVESTIGATION LABORATORY DROP TESTS

PAGE: 77  
MODEL: A4D-2  
REPORT NO. ES-40641

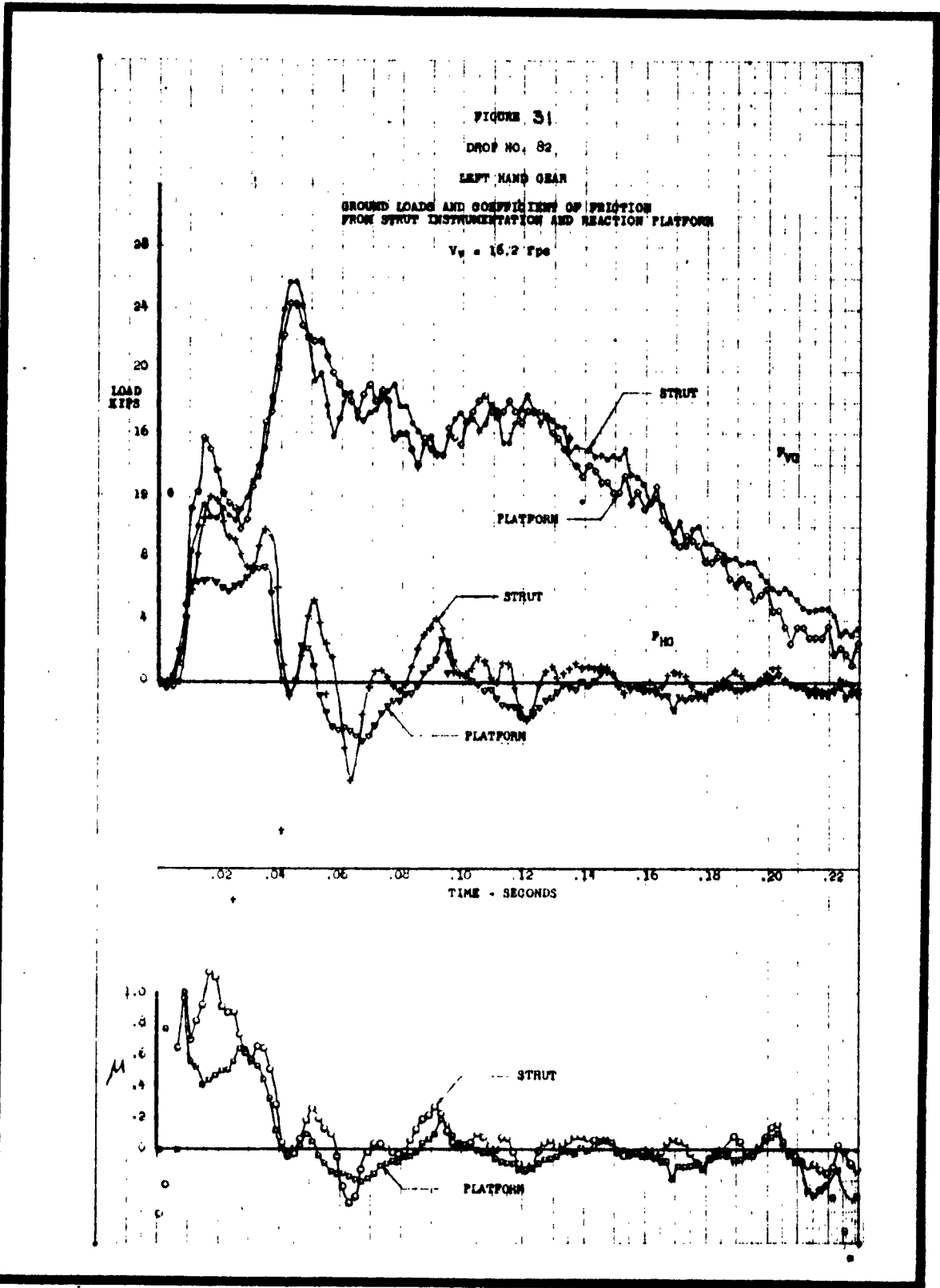

PREPARED BY: L. B. Mosby DATE

DOUGLAS AIRCRAFT COMPANY, INC.

PAGE: 78

CHECKED BY: F. C. A.

LONG BEACH DIVISION

MODEL: A4D-2

TITLE: LANDING GEAR INVESTIGATION LABORATORY DROP TESTS

REPORT NO. ES-40641

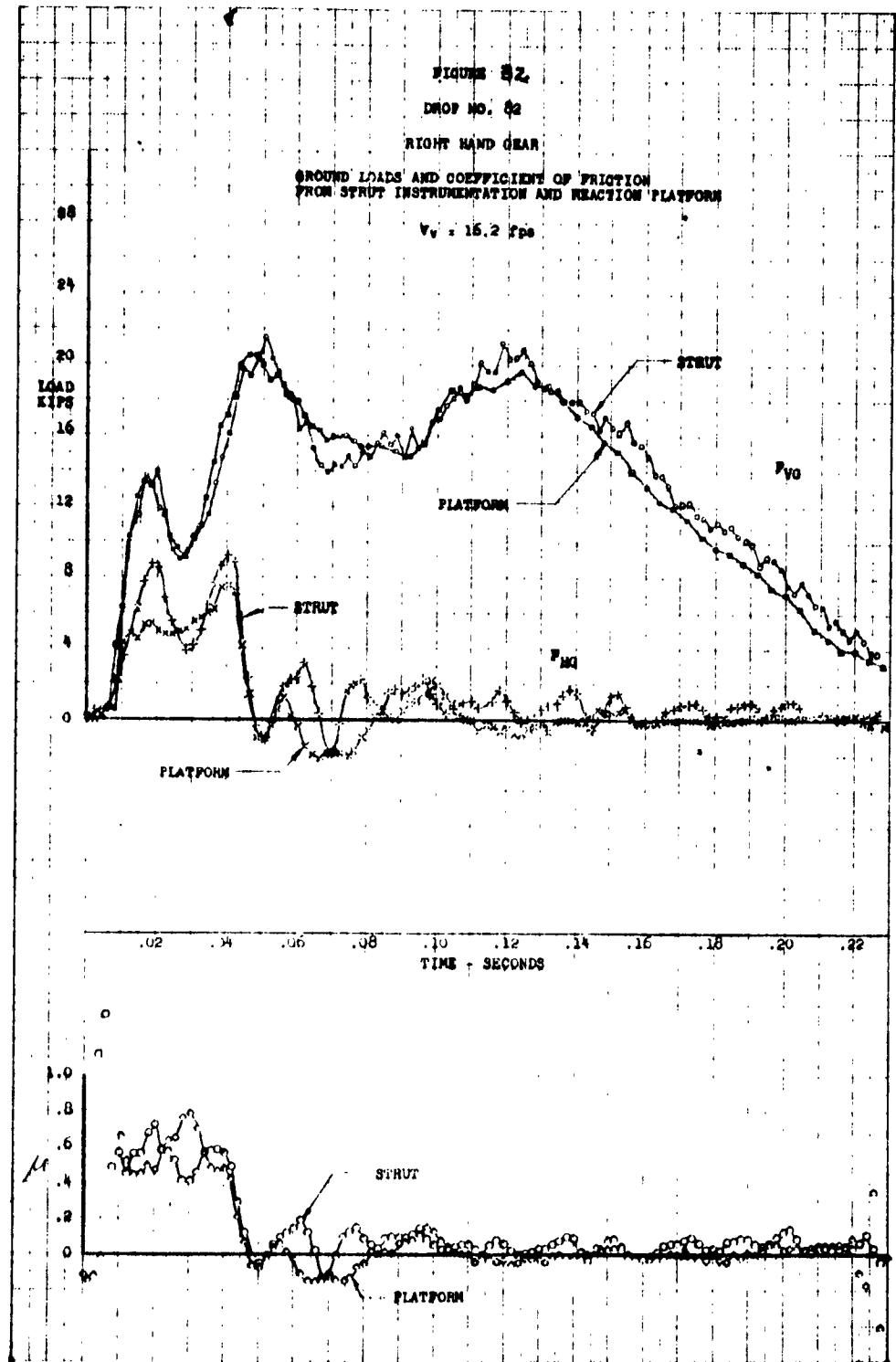

PREPARED BY: I. B. Mosby DATE \_\_\_\_\_  
CHECKED BY: F. C. A. DATE \_\_\_\_\_  
TITLE: LANDING LOADS INVESTIGATION LABORATORY DROP TESTS

DOUGLAS AIRCRAFT COMPANY, INC.

LONG BEACH DIVISION

PAGE: 79  
MODEL: A4D-2  
REPORT NO. ES-40641

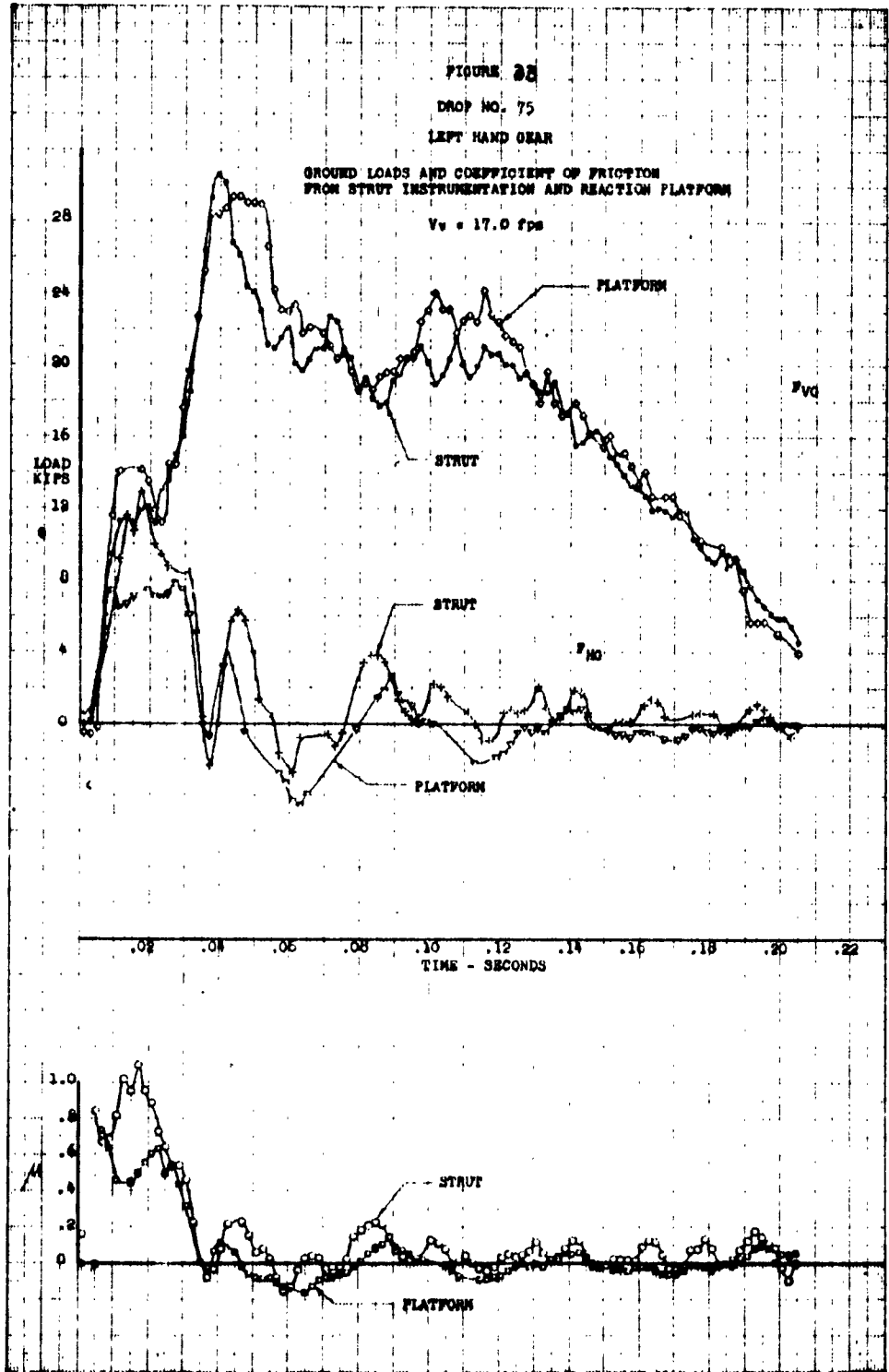

PREPARED BY: L. P. M. SEDY DATE \_\_\_\_\_  
CHECKED BY: F. C. A.

DOUGLAS AIRCRAFT COMPANY, INC.

LONG BEACH DIVISION

PAGE: 80  
MODEL: A4D-2  
REPORT NO. ES-40641

TITLE: LANDING LOADS INVESTIGATION LABORATORY DROP TESTS

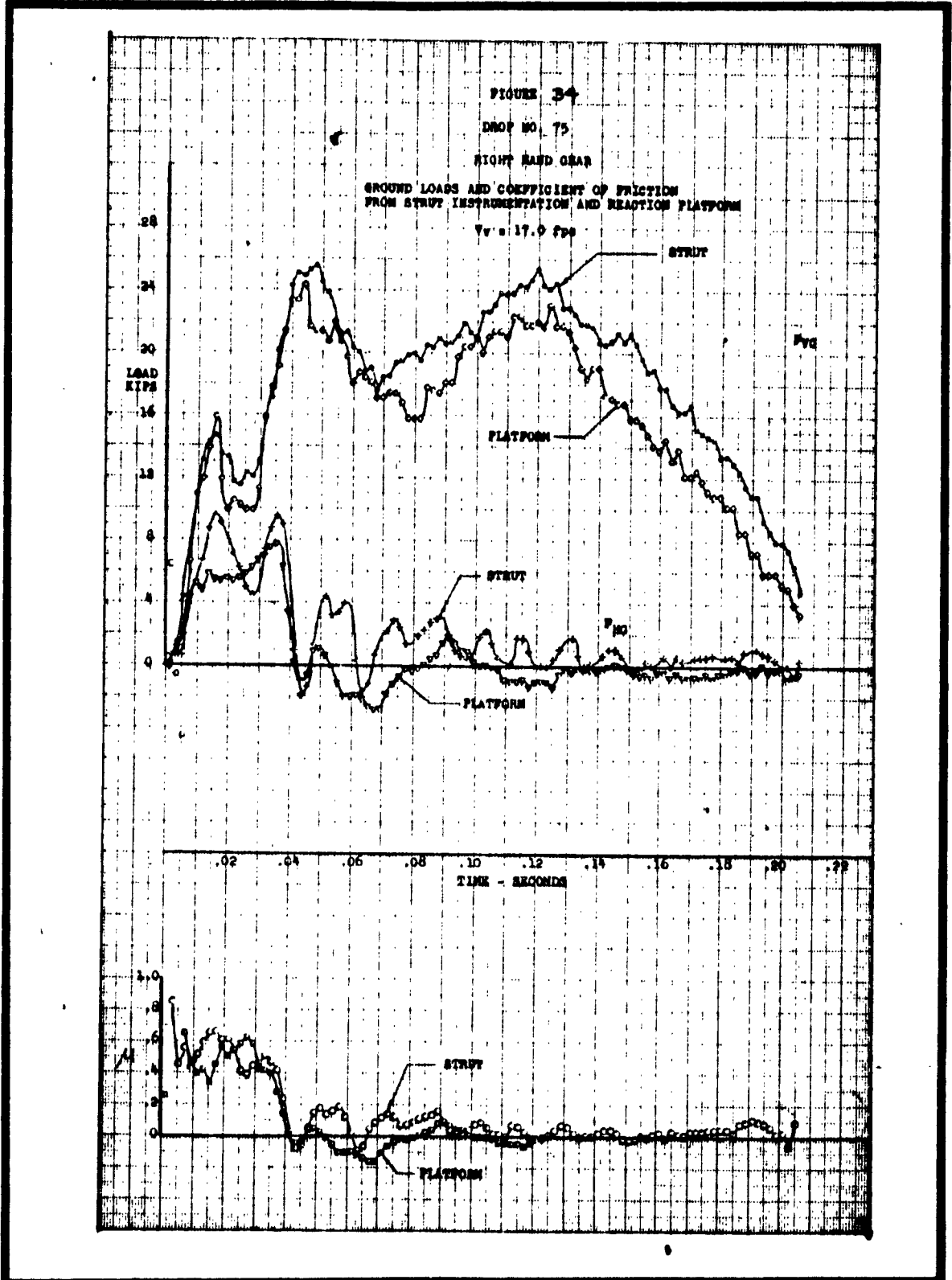

PREPARED BY: L. B. Masby DATE

DOUGLAS AIRCRAFT COMPANY, INC.

PAGE: 81

CHECKED BY: F. C. A. DATE

LONG BEACH DIVISION

MODEL: A4D-2

TITLE: LANDING LOADS INVESTIGATION LABORATORY DROP TESTS

REPORT NO. ES-40641

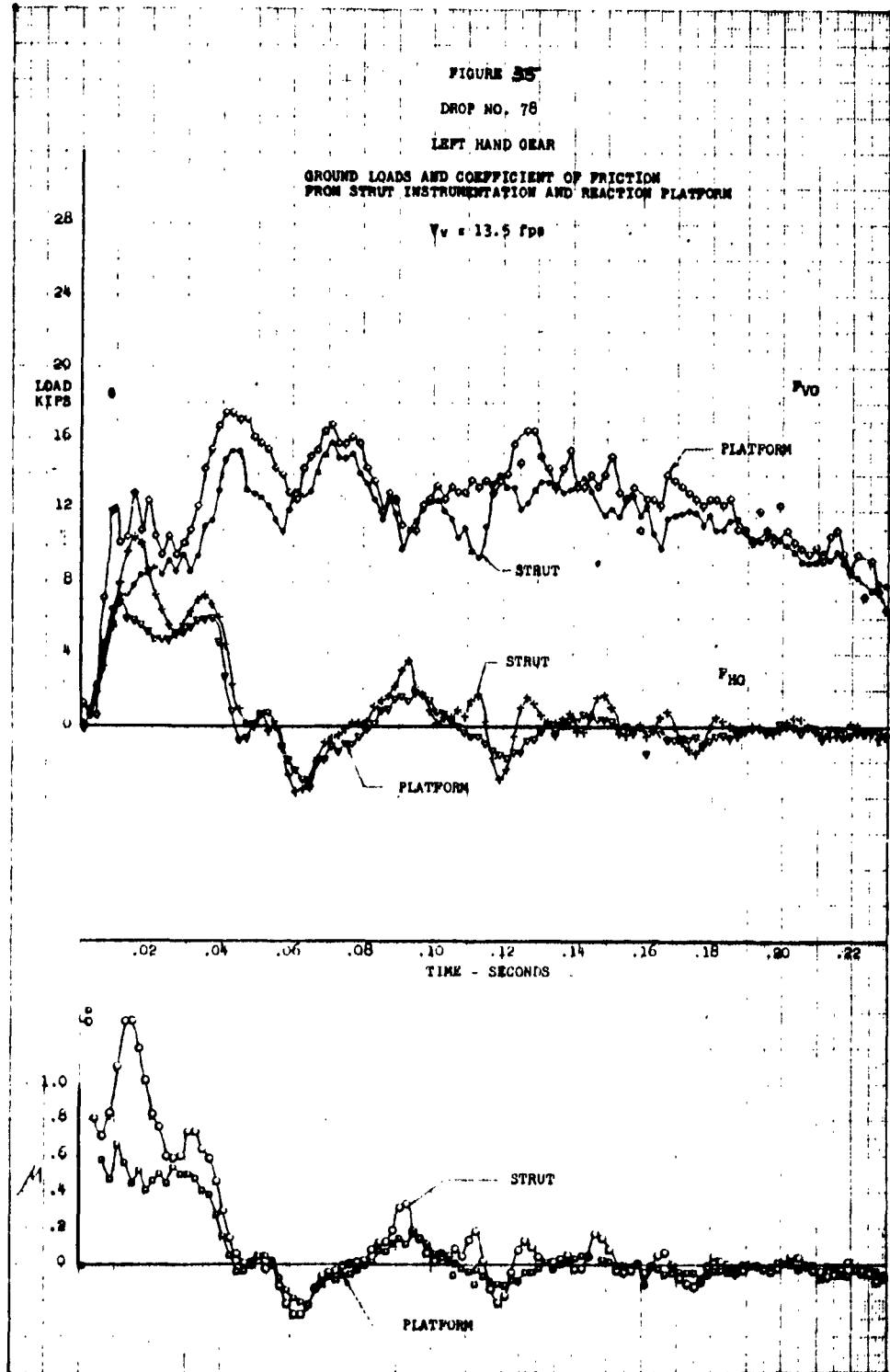

PREPARED BY: L. B. Mosby DOUGLAS AIRCRAFT COMPANY, INC.

PAGE: 82

CHECKED BY: F. C. A. DATE \_\_\_\_\_ LONG BEACH DIVISION

MODEL: A4D-2

TITLE: LANDING LOADS INVESTIGATION LABORATORY DROP TESTS

REPORT NO. ES-40641

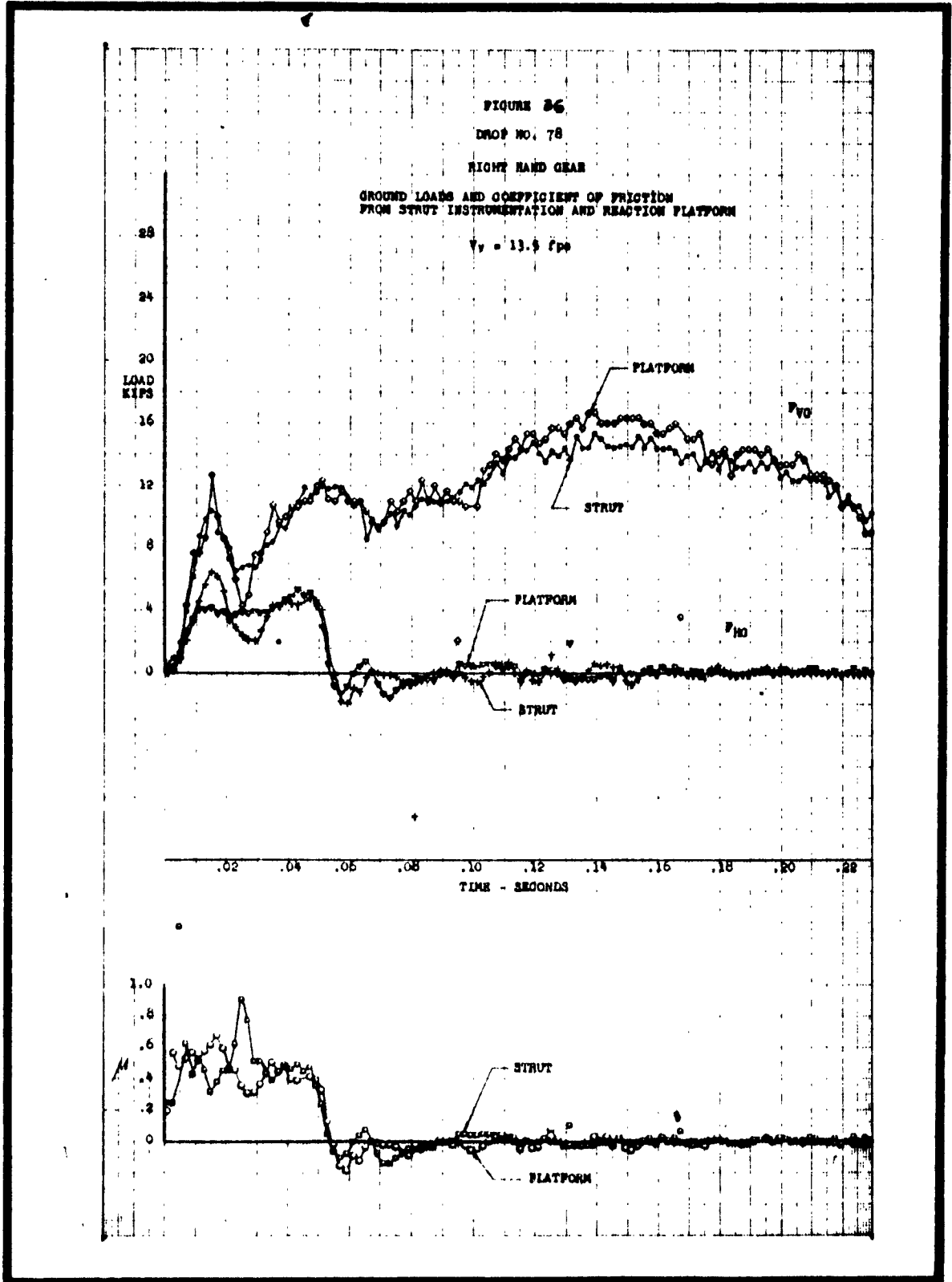

PREPARED BY: I. B. Mosby DATE \_\_\_\_\_  
CHECKED BY: F. C. A.  
TITLE: LANDING LOADS INVESTIGATION LABORATORY DROP TESTS

LONG BEACH DIVISION

PAGE: 83  
MODEL: A4D-2  
REPORT NO. ES-40641

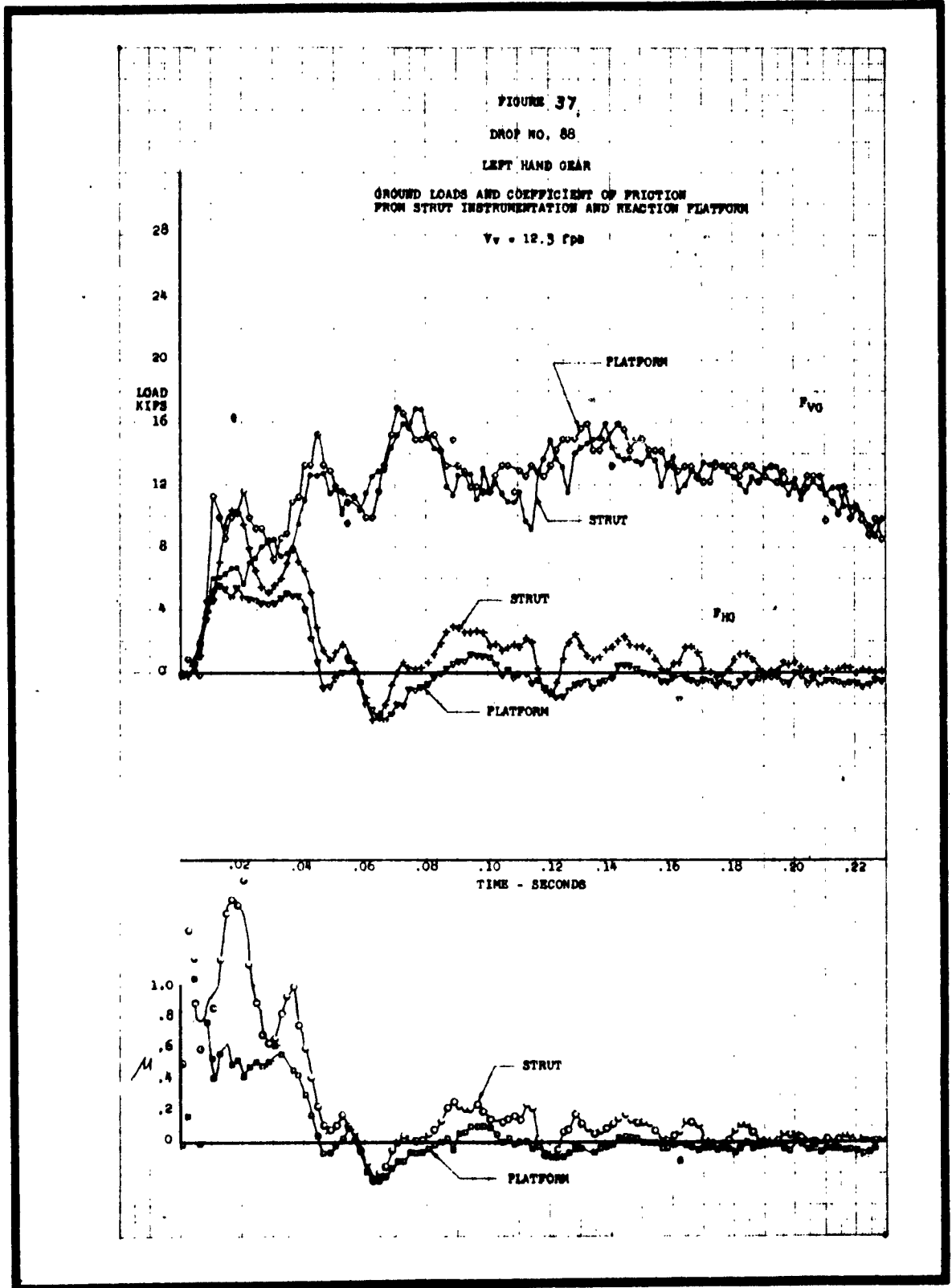



PREPARED BY: J. R. Mosby DOUGLAS AIRCRAFT COMPANY, INC.  
CHECKED BY: F. C. A. DATE LONG BEACH DIVISION  
TITLE: LANDING GEAR INVESTIGATION LABORATORY DROP TESTS

PAGE: 84  
MODEL: A4D-2  
REPORT NO. ES-40641

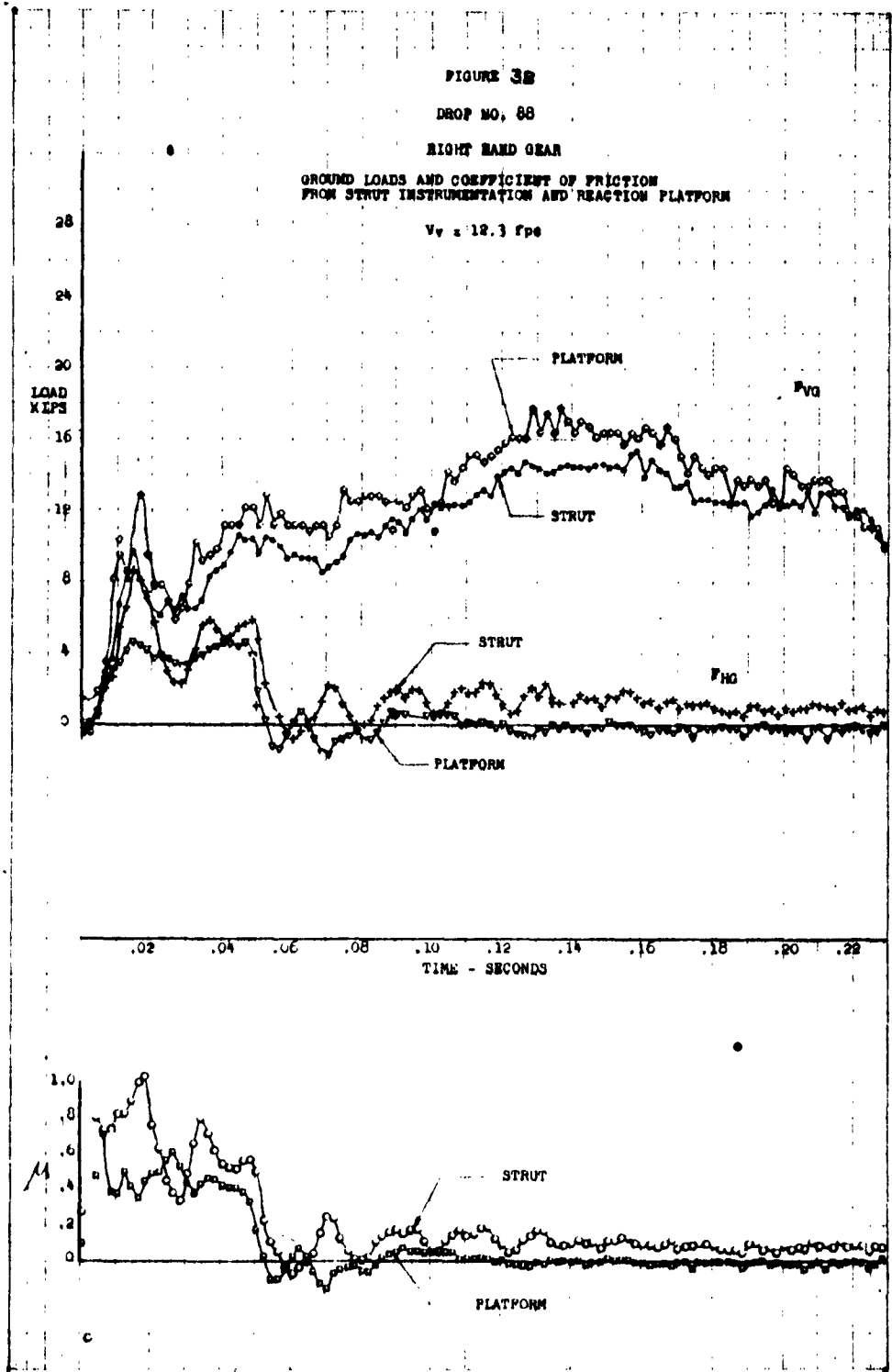

PREPARED BY: F. C. Allen DOUGLAS AIRCRAFT COMPANY, INC.  
CHECKED BY: L. B. M. DATE \_\_\_\_\_ LONG BEACH DIVISION  
TITLE: LANDING LOADS INVESTIGATION LABORATORY DROP TESTS

PAGE: 85  
MODEL: A4D-2  
REPORT NO. ES-40641

### SUMMARY OF RESULTS AND CONCLUSIONS

The significance of these drop test data and comparisons with flight landings, theory and NASA data are considered in the summary report (Reference (3)). The present report is more concerned with the presentation of data and an evaluation of the overall accuracy of the instrumentation under test conditions.

The estimated accuracy of the individual instruments supplied by Reference (1) and summarized in Table IV is for the most part substantiated by a study of the resulting data and by subsequent usage in the comparisons carried out in Reference (3). Areas of concern have been noted and discussed in previous sections and consist principally of the following:

#### 1. Sinking Speed

Accurate measurement of the sinking speed,  $V_v$ , has proved difficult even under laboratory conditions. As noted on Page 19, the determination of sinking speed by the elapsed time method is the most accurate and is limited by the determination of the precise moments of release and contact. Instrument accuracy is sufficient to determine time to .001 seconds or less, but since the airplane is flexible, accelerations created by operation of the release mechanism and by contact with the ground are not felt simultaneously by all parts of the airplane. Hence,  $t$ , can be ascertained only to  $\pm .004$  seconds which introduces a possible error of  $\pm .13$  feet per second. This, in turn, creates a possible error of 2% in the kinetic energy of a nominal 13 fps drop.

The difficulties described above will probably be encountered with any existing method of measurement and considerable effort would be required to improve accuracy. It is believed, however, that the accuracy obtained is sufficient for the purposes of this project.

PREPARED BY: F. C. Allen DOUGLAS AIRCRAFT COMPANY, INC.PAGE: 86CHECKED BY: L. B. M. DATE

LONG BEACH DIVISION

MODEL: A4D-2TITLE: LANDING LOADS INVESTIGATION LABORATORY DROP TESTSREPORT NO. ES-40641

## 2. Strut Position

Strut position was obtained from two sources, namely, the slide-wire device and by integration of the velocity generator reading. Differences up to 1.5 inches have been noted in data from these two instruments. Since the slide wire is the more direct measurement and is less complicated, its readings would normally be considered the more reliable. However, the data from the velocity generator agrees better with theory and, hence, some doubt is cast on the slide-wire reading. This discrepancy can only be resolved by additional testing or calibration. Such work should consist of (a) simultaneous readings of the two instruments while the strut is being moved rapidly through a known displacement and (b) with the strut fixed, simultaneous readings during the application of a high load. The first test would determine the effects of velocity on instrument accuracy, and the second, the effects of structural deformations.

## 3. Ground Loads

The comparison of vertical ground loads provided on Pages 69 to 84 indicates general agreement between strut instrumentation and reaction platform. One exception is on the first peak where the reaction platform is consistently higher. This has been attributed to dynamic overshoot of the reaction platform.

Agreement between drag loads obtained from strut instrumentation and the reaction platform is generally poor. This lack of agreement was expected since lack of accuracy of the reaction platform in the drag direction under dynamic conditions has been previously noted in other work. The right hand gear drag loads from strut instrumentation appear to be generally consistent and reasonable. The left hand gear drag loads from strut instrumentation appears to be high by a factor of 10 to 20% although definite proof of this fact is not available.

PREPARED BY: F. C. Allen DOUGLAS AIRCRAFT COMPANY, INC.  
CHECKED BY: L. B. M. DATE \_\_\_\_\_ LONG BEACH DIVISION  
TITLE: LANDING LOADS INVESTIGATION LABORATORY DROP TESTS

PAGE: 87  
MODEL: A4D-2  
REPORT NO. ES-40641

### Conclusions

1. The drop test data presented herein can generally be used with confidence within the limits of accuracy specified in Table IV with the following exceptions:
  - a. Sinking speed,  $V_v$ , accuracy is within  $\pm 0.13$  feet per second.
  - b. Strut position given by the slide wire is in question since results obtained therefrom differ from the velocity generator data by as much as 1.5 inches.
  - c. Vertical ground loads and right hand gear drag loads are considered to be accurate within  $\pm 5\%$ . Left hand gear drag loads appear to be high and should be used with discretion.
  
2. Additional calibration of the slide wire and velocity generator is recommended in order to resolve the discrepancy noted above. A dynamic calibration of the reaction platform is also recommended in order to provide better data on future tests. A test is recommended for determining the sliding coefficient of friction of the tire on the platform surface.

PREPARED BY: F.C.Allen DOUGLAS AIRCRAFT COMPANY, INC.

PAGE: 88

CHECKED BY: L.B.Mosby DATE

LONG BEACH DIVISION

MODEL: A4D-2

TITLE: LANDING LOADS INVESTIGATION LABORATORY DROP TESTS

REPORT NO. 40641

#### REFERENCES

1. Harris, I. E. and Meriwether, H. D.: Landing Loads Investigation Instrumentation. Douglas Aircraft Co. Report ES 40636, September 1962.
2. Harris, I. E. and Tydeman, S. F.: Flight Test Measurement of Landing Loads on the A4D-2 Airplane. Douglas Aircraft Co. Report DEV 3616, October 1962.
3. Mosby, L. B.: An Investigation of the Landing Loads Experienced by the A4D-2 Airplane During Flight Tests and Drop Tests and a Comparison with Theory. Douglas Aircraft Co. Report LB-31038, October 1962.
4. Horne, Walter B.: Experimental Investigation of Spin-Up Friction Coefficients on Concrete and Non-Skid Carrier Deck Surfaces. NASA TN D-214, April 1960.
5. Cook, F. E.: Analysis of Model A3D Series Landing Gear and Flexible Airplane Structure During Landing Impact. Douglas Aircraft Co. Report ES 26886, November 1957.
6. Batterson, Sidney A.: Investigation of the Maximum Spin-Up Coefficients of Friction Obtained During Tests of a Landing Gear Having a Static Load Rating of 20,000 Pounds. NASA Memo 12-20-58L.

PREPARED BY: P. C. Allen DOUGLAS AIRCRAFT COMPANY, INC.

PAGE: 89

CHECKED BY: L. B. M. DATE

LONG BEACH DIVISION

MODEL: A4D-2

TITLE: LANDING LOADS INVESTIGATION LABORATORY DROP TESTS

REPORT NO. ES-40641

APPENDIX A

TEST LOG

DOUGLAS AIRCRAFT COMPANY, INC.

DATE April 1, 1962  
 PREPARED BY H. Meriwether  
 TITLE Ldg. Loads - Drop Tests

EL SEGUNDO DIVISION

Page 90  
 Model A4D-2  
 Report 40641

Page 1 of 9					LANDING LOADS INVESTIGATION - DROP TEST LOG	
DATE	DROP	HT.	POT PRESS.	COUNTS	TRODI	COMMENTS
3/14/1	0	3	80	0	-	System check out, no spin up, landing no. 49 simulated
3/14/1	1	9	80	0	5.2	Instrumentation check out, no spin up
3/14/1	2	9	80	1635	5.1	Instrumentation check out, corrected instrumentation malfunctions, moved some traces, let out links, 2 RH, 1 LH
3/15/1	3	21	87	1640	10.0	Tire and strut pressures checked. Main strut 25 psi, nose strut 210 psi, main tires 325 psi
3/15/1	4	27	82	1640	11.0	Reversed LH drag brace trace direction, moved some more channels
3/16/1	5	21	80	1650	9.7	
3/16/1	6	36	78	1640	13.0	Raised Osc. 2 traces 33 and 35 1/2 inch, spin up rpm has been too high, added two disks to wing lift attach rods
3/16/1	7	36	82	1450	13.0	
3/16/1	8	34	82	1460	12.5	Wing lift too spengy, removing 3 disks, lengthening RH chain 1 link
3/17/1	9	33	81	1400	12.4	Attitude reset to 15.1° from 15.8°
3/17/1	10	32	85	1410	12.3	Shut down to balance wheels, shortened LH chain 4 links, RH 5 links and to repair RH velocity generator
3/20/1	11	33	85	1400	12.0	RH wheel statically balanced
3/20/1	12	33	85	0	12.3	RH wheel looks good, fix LH wheel (static balance), RH pot OK, LH to be shortened 2 links, RH velocity generator OK

DOUGLAS AIRCRAFT COMPANY, INC.

DATE April 1962  
 PREPARED BY H. Meriwether  
 TITLE Ldg. Loads - Drop Tests

EL SEGUNDO DIVISION

Page 91  
 Model A4D-2  
 Report 40641

LANDING LOADS INVESTIGATION - DROP TEST LOG					COMMENTS	
DATE	DROP	HT.	POT PRESS.	COUNTS		TRODI
3/21/1	13	36	85	1400	12.3	Main gear strut and tire pressures checked. LH wheel statically balanced, LH chain shortened 2 links, aft safety hung up on dummy horizontal stabilizer
3/21/1	14	36	85	1400	12.4	Dropped on spin up rig, repaired shaft, installed new balance panels to increase amplitude of platform and metering pressure pick ups, installed rebound chamber pressure pick up
3/27/1	15	36	87	1400	no drop	Strut and tire pressures checked, broke spin up motor shaft, failed LH wheel position pick up mount, LH lower mass lateral accelerometer, and tore out aircraft balance panels power wires
4/10/1	15	36	80	1200	12.2	Strut and tire pressures checked, new wheel spin up right in use, schedule 2 in effect, oscillograph 1 inoperative
4/10/1	16	36	87	1200	12.5	Oscillograph 1 inoperative
4/10/1	17	36	86	1127	12.6	Flat contact
4/10/1	18	36	86	1100	12.5	Dirty slidewire, LH; LH drag brace out, RH velocity generator going bad, rebound pressure wrong direction, move LH platform up, pitch attitude acting up
4/12/1	19	36	87	1107	12.5	Fastax taken, 1801 rpm, galvo 551cg bad, RH vert. platform inoperative, RH velocity generator opening, RH oscillograph 2 pitch
4/12/1	20	36	87	1100	12.4	Platform OK, velocity generator still opens, 400 on both velocity generators



DOUGLAS AIRCRAFT COMPANY, INC.

DATE April 1962 EL SEGUNDO DIVISION  
 PREPARED BY H. Meriwether  
 TITLE Ldg. Loads - Drop Tests

PAGE 92  
 MODEL A5D-2  
 REPORT 40641

LANDING LOADS INVESTIGATION - DROP TEST LOG						
DATE	DROP	HT.	POT PRESS.	COUNTS	TRODI	COMMENTS
4/12/1	21	36	87	1090	12.5	Micro press. fitting on spin up rig failed, 50~ time Standard disconnected, RH oscillograph shored up with rubber pads, galvo 551cg replaced by 13213
4/13/1	22	36	87	1117	12.3	LH platform opens up - no vertical load recorded
4/13/1	23	36	87	1142	12.5	LH platform open up, no vertical load, no pitch recorded, changing strain gage voltage circuit
4/18/1	24	36	87	1090	12.3	Pressure pick up No. 7B RH metering chamber, new voltage monitor circuit - new galvo, deepened cut in RH engine mount beam - new strain gage
4/18/1	25	36	87	1180	12.5	
4/18/1	26	36	87	1060	12.5	
4/19/1	27	36	87	1040	12.6	
4/19/1	28	36	87	1100	12.6	
4/19/1	29	36	87	1140	12.5	
4/20/1	30	39	91	1120	13.2	12876 lbs. @ 232.9, added 50 lbs. shot bags each wing at station 256.5 (outboard of fuselage)
4/20/1	31	39	90	1070	13.3	
4/24/1	32	39	89	1070	13.2	Nose and LH platforms switched
4/24/1	33	39	89	1120	13.0	} Landing No. 121
4/24/1	34	39	89	1100	13.1	

DOUGLAS AIRCRAFT COMPANY, INC.

DATE April 11 1962  
 PREPARED BY H. Meriwether  
 TITLE Ldg. Loads - Drop Tests

EL SEGUNDO DIVISION

PAGE 93  
 MODEL A4D-2  
 REPORT 40641

LANDING LOADS INVESTIGATION - DROP TEST LOG						
DATE	DROP	HT.	POT PRESS.	COUNTS	TRODI	COMMENTS
4/25/1	35	36	86	1110	12.5	Removed 50 lb. shot bags each wing } 12776 lbs. @ 232.7 } Landing No. 49
4/25/1	36	36	86	1220	12.5	Added 50 lb. shot bags at each wing } @ 258.5, 12876 lbs. at 232.9, (basic } configuration - 12776 lbs. at 232.7) } Landing } No. 70
4/25/1	37	36	86	1110	12.5	
4/25/1	38	54	89	1300	16.0	
4/25/1	39	54	89	1300	16.0	LH wheel spin up magnetic pick up } unscrewed during this drop } Landing } No. 26
4/25/1	40	54	89	1300	16.0	Added 210 lb. shot bags each wing at } 261.5, 13196 lbs. - c.g. at 233.6 - } (basic configuration 12776 lbs. - og } at 232.7) LH wheel binding } Changed wheels - LH gear } Landing } No. 68
4/27/1	41	40	90	1210	13.4	
4/27/1	42	40	90	1210	13.5	
4/27/1	43	40	90	1190	13.5	Added 20 lb. each wing at 266.0, 13236 } lbs. og at 233.7 (basic configuration } 13196 at 233.6) } Drops No. 44-46, inclusive - Oscillo- } graph No. 1 switch turned off by wire } bundle
4/27/1	44	63	92	1310	17.5	
4/27/1	45	63	92	1320	17.4	
4/27/1	46	63	92	1400	----	

DOUGLAS AIRCRAFT COMPANY, INC.

DATE April 1962  
 PREPARED BY H. Meriwether  
 TITLE Ldg. Loads - Drop Tests

EL SEGUNDO DIVISION

Page 94  
 Model A4D-2  
 Report 40641

LANDING LOADS INVESTIGATION - DROP TEST LOG						
DATE	DROP	HT.	POT PRESS.	COUNTS	TRODI	COMMENTS
4/28/1	47	63	92	1400	17.8	Excessive hash on Oscillograph No. 2  LH and RH wing tip accelerometer inactivated, installed hard rubber shock pads on Oscillograph No. 1 and No. 2 to check effect of shock mounting
4/28/1	48	63	92	1400	17.4	
4/28/1	49	63	92	1350	17.4	
4/28/1	50	63	92	1360	17.4	Added 20 lbs. each wing at station 300.0 (basic configuration - 13236 lbs. at 233.7) 13276 lbs. at 233.9
5/1/1	51	60	89	1210	17.2	
5/1/1	52	60	89	1150	16.7	Added 80 lb. each wing at sta. 282.0 13436 lbs. at 234.3 (basic configuration - 13276 lbs. at 233.9)
5/1/1	53	48	89	1210	15.6	
5/1/1	54	45	91	1150	14.3	Reactivated LH and RH wing tip accelerometer, drops 53-56 inclusive
5/1/1	55	48	91	1160	14.3	
5/1/1	56	51	91	1170	15.5	Slide wire and velocity generator re-adjusted
5/2/1	57	51	91	1320	15.4	
5/2/1	58	51	91	1320	15.3	
5/2/1	59	48	90	1120	15.0	

DOUGLAS AIRCRAFT COMPANY, INC.

DATE April 1962  
 PREPARED BY H. Meriwether  
 TITLE Ldg. Loads - Drop Tests

EL SEGUNDO DIVISION

PAGE 95  
 MODEL A4D-2  
 REPORT 40641

Page 6 of 9							LANDING LOADS INVESTIGATION - DROP TEST LOG	
DATE	DROP	HT.	POT PRESS.	COUNTS	TRODI	COMMENTS		
5/3/1	60	30	91	1360	11.0	Added 40 lbs. each wing @ sta. 268.0 } 13516 lbs. @ 234.5 (basic configura- } tion - 13436 lbs. at 234.3 } Landing No. 8		
5/3/1	61	34	91	1280	11.6			
5/3/1	62	34	91	1320	11.6			
5/5/1	63	34	91	8	12.0	Stere replaced with 1000 lbs. bomb aircraft re-weighed (100 lbs. removed). Trodi recalibrated engine mount strain gage 3 installed, oscillograph		
5/5/1	64	32	91	8	11.8			
5/5/1	65	31	91	8	11.6	RH vel. generator inoperative last 3 drops		
5/5/1	66	50	91	125	15.4	Osc. 1 and 2 paper speeds 100 in/sec.		
5/5/1	67	48	91	125	15.0			
5/5/1	68	48	91	125	14.8	Platform cleaned		
5/8/1	69	31	91	8	11.2			
5/8/1	70	33	90	8	12.0			
5/8/1	71	32	91	8	11.7	LH upper mass vertical accelerometer loose, struts to be checked		
5/8/1	72	60	90	126	16.6	Platform cleaned, sprocket jumped off spin up motor		
5/8/1	73	61	91	126	16.4	RH vertical axle opened, sprocket jumped off spin up motor		
5/8/1	74	65	91	68	17.0	Vertical/gage channel repaired, sprocket fixed axle		

DOUGLAS AIRCRAFT COMPANY, INC.

DATE April 1962 EL SEGUNDO DIVISION  
 PREPARED BY H. Meriwether  
 TITLE Ldg. Loads - Drop Tests

PAGE 96  
 MODEL A4D-2  
 REPORT 40641

Page 7 of 9							LANDING LOADS INVESTIGATION - DROP TEST LOG		
DATE	DROP	HT.	POT PRESS.	LANDING	TRODI	COMMENTS			
5/8/1	75	68	91	68	17.0				
5/8/1	76	70	91	Counts 1290 Land. 68	17.9	No record - osc. 1 and 2			
5/9/1	77	40	90	26	13.8	Platforms cleaned			
5/9/1	78	39	90	26	13.5				
5/9/1	79	39	90	26	13.5				
5/9/1	80	54	89	70	15.4				
5/9/1	81	56	89	70	15.8	Wheel bound up - left hand			
5/9/1	82	56	89	70	15.8				
5/9/1	83	56	89	70	15.9				
5/9/1	84	40	89	121	13.8				
5/9/1	85	39	89	121	13.9				
5/9/1	86	36	90	121	13.3				
5/9/1	87	36	87	49	----				
5/9/1	88	36	87	49	12.3				
5/9/1	89	36	87	49	----	Trodi sensitivity control set too low, re-adjusted			
5/9/1	90	36	87	49	12.3	Pitch attitude Osc. 2 out, last 4 drops			
5/11/1	91	65	89	126	17.8	Norm			
5/11/1	92	60	89	126	17.4	Norm			

DOUGLAS AIRCRAFT COMPANY, INC.

DATE April 1962  
 PREPARED BY H. Meriwether  
 TITLE Ldg. Loads - Drop Tests

EL SEGUNDO DIVISION

PAGE 97  
 MODEL A4D-2  
 REPORT 40641

Page 8 of 9					LANDING LOADS INVESTIGATION - DROP TEST LOG		COMMENTS
DATE	DROP	HT.	POT PRESS.	LANDING	TRODI		
5/11/1	93	58	89	126	16.8	Norm	
5/11/1	94	59	89	126	17.0	Norm	
5/11/1	95	59	89	126A	17.0	120 knots	
5/11/1	96	59	89	126A	17.0	90 knots	
5/11/1	97	59	89	126A	17.0	60 knots	
5/11/1	98	59	89	126A	16.9	0 knots	
5/11/1	99	57	59	126A	16.5	2/3 wing lift (not enough sink)	
5/11/1	100	59	59	126A	16.8	2/3 wing lift (not enough sink)	
5/11/1	101	61	59	126A	16.3	2/3 wing lift (not enough sink)	
5/11/1	102	61	59	126A	17.1	2/3 wing lift - OK	
5/11/1	103	57	0	126A	17.0	0 wing lift	
5/11/1	104	60	89	126A	16.7	200 psi in tires (found wheel LH bound up) (and loosened it up)	
5/11/1	105	61	89	126A	16.3	200 psi in tires - not enough sink	
5/11/1	106	61	89	126A	16.2	200 psi in tires - not enough sink	
5/11/1	107	61	89	126A	16.4	400 psi in tires	
5/11/1	108	64	89	126A	17.3	400 psi in tires	
5/11/1	109	62	89	126A	17.1	400 psi in tires	
5/11/1	110	62	89	126A	16.6	200 psi in tires	
5/11/1	111	62	89	126A	17.1	200 psi tire pressure spin up too low	

DATE April 1962 EL SEGUNDO DIVISION  
 PREPARED BY H. Meriwether  
 TITLE Ldg. Loads - Drop Tests

PAGE 98  
 MODEL A4D-2  
 REPORT 40641

Page 9 of 9						LANDING LOADS INVESTIGATION - DROP TEST LOG	
DATE	DROP	HT.	POT PRESS.	LANDING	TRODI	COMMENTS	
5/11/1	112	62	89	126A	17.0	200 psi tire pressure - OK	
5/11/1	113	62	89	126A	16.9	Platform restraint in lateral direction - platform cleaned	
5/12/1	114	62	89	126A	17.0	6° ANU - no wheel spin-up	
5/12/1	115	57	89	126A	16.1	2° ANU - touched tail	
5/12/1	116	57	89	126A	16.0	2° ANU	
5/12/1	117	72	89	126A	18.5	2° ANU	
5/12/1	118	57	89	126A	16.7	12° ANU - osc. set to 2000 cps	
5/12/1	119	57	89	126A	16.8	No spin up, 12° ANU	
5/12/1	120	72	89	126A	18.5	12° ANU	
5/12/1	121	72	89	126A	19.0	12° ANU - no spin up	
5/15/1	122	57	89	126A	16.1	Tapped tail - 3 point	
5/15/1	123	72	89	126A	18.6	Tapped tail - 3 point	
5/15/1	124	57	89	126A	15.9	Tapped tail - 3 point	
5/15/1	125	72	89	126A	18.4	Tapped tail - 3 point, engine mount beam strain gage channel tab broke	
5/15/1	126	72	89	126A	18.8	12° ANU - tapped tail	
5/18/1	127	72	89	126A	18.8		
5/22/1	128	60	59	126A	----	Show for Brazilian Navy brass	

<p>Douglas Aircraft Co., Aircraft Div., Long Beach, Calif. Report No. ES 40641. Prepared for Bureau of Naval Weapons, Wash. D. C. LANDING LOADS INVESTIGATION LABORATORY DROP TESTS, Sept. 1962. Final Report 104 p. inc illus., tables, refs.</p> <p>This report describes and presents the results of certain drop tests on the A4D-2 airplane which were part of a program to compare the loads developed during actual landings with those obtained by standard airplane laboratory drop test techniques. The complete investigation also included a comparison of test loads with those determined by a dynamic analysis. A summary of the complete investigation is contained in Douglas Aircraft Company Report LB-31038.</p>	<p>1. Loads, Landing 2. Landing Gear Load 3. Drop Tests 4. Tests, Airplane Drop I. Contract NOa(s) 59-6226c II. Douglas Aircraft Co., Inc. Aircraft Div. Long Beach, Calif. III. F. C. Allen, L. B. Mosby IV. Aval fr Naval BuWeps</p>	<p>Douglas Aircraft Co., Aircraft Div., Long Beach, Calif. Report No. ES 40641. Prepared for Bureau of Naval Weapons, Wash. D. C. LANDING LOADS INVESTIGATION LABORATORY DROP TESTS, Sept. 1962. Final Report 104 p. inc illus., tables, refs.</p> <p>This report describes and presents the results of certain drop tests on the A4D-2 airplane which were part of a program to compare the loads developed during actual landings with those obtained by standard airplane laboratory drop test techniques. The complete investigation also included a comparison of test loads with those determined by a dynamic analysis. A summary of the complete investigation is contained in Douglas Aircraft Company Report LB-31038.</p>	<p>1. Loads, Landing 2. Landing Gear Load 3. Drop Tests 4. Tests, Airplane Drop I. Contract NOa(s) 59-6226c II. Douglas Aircraft Co., Inc. Aircraft Div. Long Beach, Calif. III. F. C. Allen, L. B. Mosby IV. Aval fr Naval BuWeps</p>
<p>Douglas Aircraft Co., Aircraft Div., Long Beach, Calif. Report No. ES 40641. Prepared for Bureau of Naval Weapons, Wash. D. C. LANDING LOADS INVESTIGATION LABORATORY DROP TESTS, Sept. 1962. Final Report 104 p. inc illus., tables, refs.</p> <p>This report describes and presents the results of certain drop tests on the A4D-2 airplane which were part of a program to compare the loads developed during actual landings with those obtained by standard airplane laboratory drop test techniques. The complete investigation also included a comparison of test loads with those determined by a dynamic analysis. A summary of the complete investigation is contained in Douglas Aircraft Company Report LB-31038.</p>	<p>1. Loads, Landing 2. Landing Gear Load 3. Drop Tests 4. Tests, Airplane Drop I. Contract NOa(s) 59-6226c II. Douglas Aircraft Co., Inc. Aircraft Div. Long Beach, Calif. III. F. C. Allen, L. B. Mosby IV. Aval fr Naval BuWeps</p>	<p>Douglas Aircraft Co., Aircraft Div., Long Beach, Calif. Report No. ES 40641. Prepared for Bureau of Naval Weapons, Wash. D. C. LANDING LOADS INVESTIGATION LABORATORY DROP TESTS, Sept. 1962. Final Report 104 p. inc illus., tables, refs.</p> <p>This report describes and presents the results of certain drop tests on the A4D-2 airplane which were part of a program to compare the loads developed during actual landings with those obtained by standard airplane laboratory drop test techniques. The complete investigation also included a comparison of test loads with those determined by a dynamic analysis. A summary of the complete investigation is contained in Douglas Aircraft Company Report LB-31038.</p>	<p>1. Loads, Landing 2. Landing Gear Load 3. Drop Tests 4. Tests, Airplane Drop I. Contract NOa(s) 59-6226c II. Douglas Aircraft Co., Inc. Aircraft Div. Long Beach, Calif. III. F. C. Allen, L. B. Mosby IV. Aval fr Naval BuWeps</p>

