

6333

402813

U. S. NAVAL AIR DEVELOPMENT CENTER

JOHNSVILLE PENNSYLVANIA

CATALOGED BY ASTIA

AS 402813

AERONAUTICAL INSTRUMENTS LABORATORY	
REPORT NO. NADC-AI-6320	26 MARCH 1963
DESIGN REPORT	
OF AN	
ENGINE PERFORMANCE INDICATOR	
BUREAU OF NAVAL WEAPONS WEPTASK RAV09J011/2021/F012-12-01	
PROBLEM 16 (AV-43034)	

QUALIFIED REQUESTERS MAY OBTAIN COPIES OF THIS REPORT DIRECT FROM ASTIA

402813

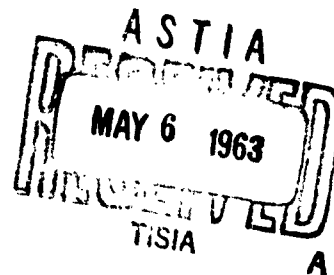
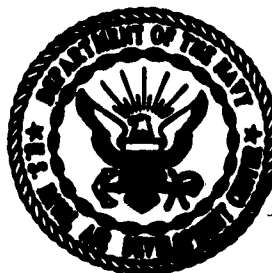

U. S. NAVAL AIR DEVELOPMENT CENTER
JOHNSVILLE, PENNSYLVANIA

AERONAUTICAL INSTRUMENTS LABORATORY

REPORT NO. NADC-AI-6320

26 March 1963

DESIGN REPORT

OF AN

ENGINE PERFORMANCE INDICATOR

BUREAU OF NAVAL WEAPONS WEPTASK RAV09J011/2021/F012-12-01
PROBLEM 16 (AV-43034)

The design report covers the development of a simplified version of an Engine Performance Indicator. The instrument is a three-module, servo-driven indicator which displays information relative to Engine Speed (%RPM), Exhaust Gas Temperature (EGT), and Fuel Flow (F.F.) utilizing vertical tape type of readout.

Reported by: Thomas D. DePasqua
Thomas D. DePasqua
Design & Development Branch

Approved by: L. S. Guarino
L. S. Guarino, Supt.,
Design & Stabilization Division

M. W. Trawick
M. W. Trawick,
Technical Director

AERONAUTICAL INSTRUMENTS LABORATORY

REPORT NO. NADC-AI-6320

S U M M A R Y

INTRODUCTION

WEPTASK RAV09J011/2021/FO12-12-06, Problem 16, was established by the Bureau of Naval Weapons for the purpose of developing and evaluating cockpit displays. To conduct flight tests and evaluation of such displays, an experimental aircraft, type YTF-9J (F9F-8T) BuNo 146410, is assigned to the Aeronautical Instruments Laboratory (AIL).

The particular implementation under discussion concerns the proposal submitted to the Bureau of Naval Weapons (BuWeps) as a study of integrated instrumentation for light attack aircraft. The major displays to be evaluated in this phase of the problem are the Simplified Contact Analog Display System (SIMCADS), the Horizontal Display, and the Engine Performance Indicator (EPI).

Specifically, this report covers the work accomplished to effect a simplified version of an EPI developed as a result of a feasibility study. The objective of this development was to produce a relatively simple mechanism, of high reliability, which could be fabricated inexpensively and could be maintained at peak operating efficiency and performance with a minimum of servicing.

SUMMARY OF RESULTS

The laboratory tests conducted to date indicate that the performance of this indicator proved to be, at least, consistent with that of standard indicators currently in use in Navy aircraft.

CONCLUSIONS

Some conclusions may be drawn as a result of experience gained during the design, fabrication and laboratory testing of the device.

1. The device is adaptable to the modular concept thereby simplifying the production process and reducing unit cost.
2. Field servicing is feasible with a minimum amount of time and labor. Common usage tools only are required.
3. The driving mechanism, in each case, is a simple servomechanism which is relatively trouble free.
4. Lighting is accomplished by utilizing a self-contained element producing a highly efficient, low cost system.

AERONAUTICAL INSTRUMENTS LABORATORY

REPORT NO. NADC-AI-6320

5. The tapes are of fiber-glass base material which will give long life and trouble-free operation.

RECOMMENDATION

It is recommended that the device be procured in sufficient numbers to permit fleet evaluation under actual service conditions.

AERONAUTICAL INSTRUMENTS LABORATORY

REPORT NO. NADC-AI-6320

T A B L E O F C O N T E N T S

<u>Title</u>	<u>Page</u>
SUMMARY	i
Introduction	i
Summary of Results	i
Conclusions	i
Recommendations	ii
LIST OF FIGURES	iv
PRELIMINARY CONSIDERATIONS	1
HISTORICAL BACKGROUND	1
DESCRIPTION OF THE EQUIPMENT	1
OPERATION OF THE EQUIPMENT	2
Fuel Flow	2
Percent RPM	3
Exhaust Gas Temperature	3
Markers and Lighting	3
TEST RESULTS	3
REFERENCES	4

AERONAUTICAL INSTRUMENTS LABORATORY

REPORT NO. NADC-AI-6320

L I S T O F F I G U R E S

- Figure 1. Side View of YTF-9J Aircraft BuNo 146410**
- Figure 2. Navigation Mode, Cruise Contact Analog and Map**
- Figure 3. Instrument Panel, Experimental Aft Cockpit of YTF-9J**
- Figure 4. Electro-Mechanical Schematic Diagram of $\%RPM$ Module**
- Figure 5. Electro-Mechanical Schematic Diagram of Engine Performance Module**
- Figure 6. Electro-Mechanical Schematic Diagram of Fuel Flow Module**
- Figure 7. Front View of Typical Module**
- Figure 8. Three-Quarter View of Typical Module**
- Figure 9. Side View of Typical Module**
- Figure 10. Three-Quarter Front View of Engine Performance Indicator**
- Figure 11. Three-Quarter Right Rear View of EPI Assembly**
- Figure 12. Three-Quarter Left Rear View of EPI Assembly**
- Figure 13. Electro-Mechanical Schematic Diagram**
- Figure 14. Engine Performance Indicator - Night View**
- Figure 15. Calibration Curve for Vertical Scale Indicator, Fuel Flow**
- Figure 16. Calibration Curve for Vertical Scale Indicator, Exhaust Gas Temperature**
- Figure 17. Calibration Curve for Vertical Scale Indicator, $\%RPM$**

AERONAUTICAL INSTRUMENTS LABORATORY

REPORT NO. NADC-AI-6320

P R E L I M I N A R Y C O N S I D E R A T I O N S

The philosophy of integrated instrumentation for light attack aircraft was propounded in the report issued by the U. S. Naval Air Development Center (NAVAIRDEVCEN) as the result of a study conducted by the Aeronautical Instruments Laboratory (AIL) (Reference (1)). To effect a prototype of the ideas presented therein, a service aircraft (Figure 1) assigned to the laboratory was utilized as a flying test bed.

The Navigation Mode, Cruise-Contact Analog and Map (Reference (1), Figure 3) was selected for implementation. Figure 2 is a reproduction of this conceptual mode.

It was the intent of the designers to use hardware existing in the Navy inventory and to utilize simplified versions of items developed previously.

This report covers the design development of the Engine Performance Indicator (EPI).

H I S T O R I C A L B A C K G R O U N D

The design of the EPI was undertaken to effect a simplification and improvement over the operational feasibility model procured at an earlier date. In accordance with NAVAIRDEVCEN Experimental Specification XAI-2-16, the John Oster Manufacturing Company developed EPI, Type 9831-01. Three units were produced under the contract. Reference (2) covers the tests conducted on these units.

In an effort to satisfy the philosophy of Reference (1), a value engineering study was made of the Oster device, and the indicator described herein evolved.

D E S C R I P T I O N O F T H E E Q U I P M E N T

The Engine Performance Indicator is a three-module, servo-driven instrument which displays information concerning Engine Speed (%RPM), Exhaust Gas Temperature (EGT) and Fuel Flow (F.F.). The display is of the vertical tape type with provision for the manual insertion of command information via knobs located on the face of the instrument. Integral lighting of the tapes is effected by transillumination and wedge techniques and meet the requirements of the General Lighting Specification MIL-L-25467. Markings on the plastic cover plate meet the requirements of Specification MIL-P-7788.

The system, in addition to the indicator, consists of adapters (or converters) and transducers. The amplifiers to drive the servoed

AERONAUTICAL INSTRUMENTS LABORATORY

REPORT NO. NADC-AI-6320

indicators are contained within the display assembly.

The weight and volume of the system is given in the following table:

	L	W	H	WT.
ZRPM Module	4-3/4	1-1/2	5-7/16	1 Lb. 11.95 Oz.
EGT Module	4-3/4	1-1/2	5-7/16	1 Lb. 9.52 Oz.
F.F. Module	4-3/4	1-1/2	5-7/16	1 Lb. 11.58 Oz.
EPI Assembly	5-5/32	5-3/4	5-5/8	6 Lbs.
RPM Converter	7"	2" Dia.	-	3 Lbs.
EGT Amplifier	6	4	6-1/2	5-3/4 Lbs.
TOTAL SYSTEM WT. (Less Cabling)				15 Lbs.

Figures 4, 5, and 6 are the electric-mechanical diagrams of the individual modules. Figures 7, 8, 9 are random views to show simplicity of the modular construction. Figures 10, 11, and 12 show the overall indicator assembly. The overall system schematic diagram, including interconnection to sensors and adapters, is presented as Figure 13.

Reference to the photographs discloses that there is no interconnection between modules, other than the front mounting plate. Electrically and mechanically, the modules are independent. Lighting of the tape displays is on an individual basis.

O P E R A T I O N O F E Q U I P M E N T

FUEL FLOW (Reference Figures 6 and 13).

The fuel flow transducer is a simple transmitter synchro device connected directly to the stator of the control transformer (C.T.) in the fuel flow module. Error voltages generated within the C.T. provide the driving force, when amplified, for the servo motor which is in the null-seeking circuit. Damping is provided by a rate generator which is serially connected between C.T. rotor and servo-amplifier. Rotation of the motor, through suitable gearing, is used to position an indicator against a calibrated scale tape. By means of the panel-mounted knob, the scale tape may be positioned relative to a lubber line or fiducial

AERONAUTICAL INSTRUMENTS LABORATORY

REPORT NO. NADC-AI-6320

marker on the instrument case. To maintain consonance between the scale and indicator, differential action between C.T. rotor and stator is effected by rotating the stator housing.

PERCENT RPM (Reference Figures 6 and 13)

The %RPM module is essentially similar to that used for fuel flow. The gearing between circuit elements is modified to suit the scale factor.

Of major importance is the fact that a converter device is interposed between the engine driven tachometer generator and the indicator. The addition of this unit is necessary to effect compatibility between the transducer (Tach.-Gen.) existing on the engine and the simplified indicator. It is pointed out that in production models of this equipment, many solutions to this problem are possible. For our purpose here this appeared to be the least complex and the most feasible one.

EXHAUST GAS TEMPERATURE (Reference Figures 6 and 13)

As in the previous instances, the basic philosophy is similar. A null-seeking servo, with appropriate gearing to accommodate scaling differences is used. The major difference is the use of potentiometer follow-up.

To achieve compatibility between the thermocouple sensor and the indicator, a bridge amplifier and power supply was used. The device had been previously tested at NAVAIRDEVGEN and found satisfactory.

MARKERS AND LIGHTING

Power indication on each module is accomplished by means of a white flag at the base of each module. The flag ("OFF" engraved in black) is held out of view by energizing a servo motor with line power. Disrupting the supply for any reason will cause the spring-loaded flag to appear in the display area.

Lighting for each module is accomplished by encapsulating approved lamps (MS24367) in a plastic base. By appropriate toning, a lamp unit of uniform intensity and color is obtained. Integral lighting is effected by routing the translucent tapes over the lamp unit.

The fiducial marker is lighted by bleeding light from the lamp unit. The flag is lighted by a small wedge device.

T E S T R E S U L T S

The indicator modules were laboratory tested under conditions simulating installation in the aircraft. In each case the test indicator was calibrated against a conventional indicator as a standard. Figures 15, 16, and 17 are curves drawn from the laboratory data. Figure 14 is a night view of the Engine Performance Indicator.

AERONAUTICAL INSTRUMENTS LABORATORY

REPORT NO. NADC-AI-6320

R E F E R E N C E S

1. CONF Report No. NADC-AI-6165 "Report on Study of Integrated Instrumentation for Light Attack Aircraft," of 15 Aug 1961.
2. Report No. NADC-AI-6173 "Test Report on the Engine Performance Indicator Utilizing Vertical Scale Tapes," of 6 Sep 1961.

AERONAUTICAL INSTRUMENTS LABORATORY

REPORT NO. NADC-AI-6320



Figure 1. Side View of YTF-9J Aircraft BuNo 146410

AERONAUTICAL INSTRUMENTS LABORATORY

REPORT NO. NADC-AI-6320

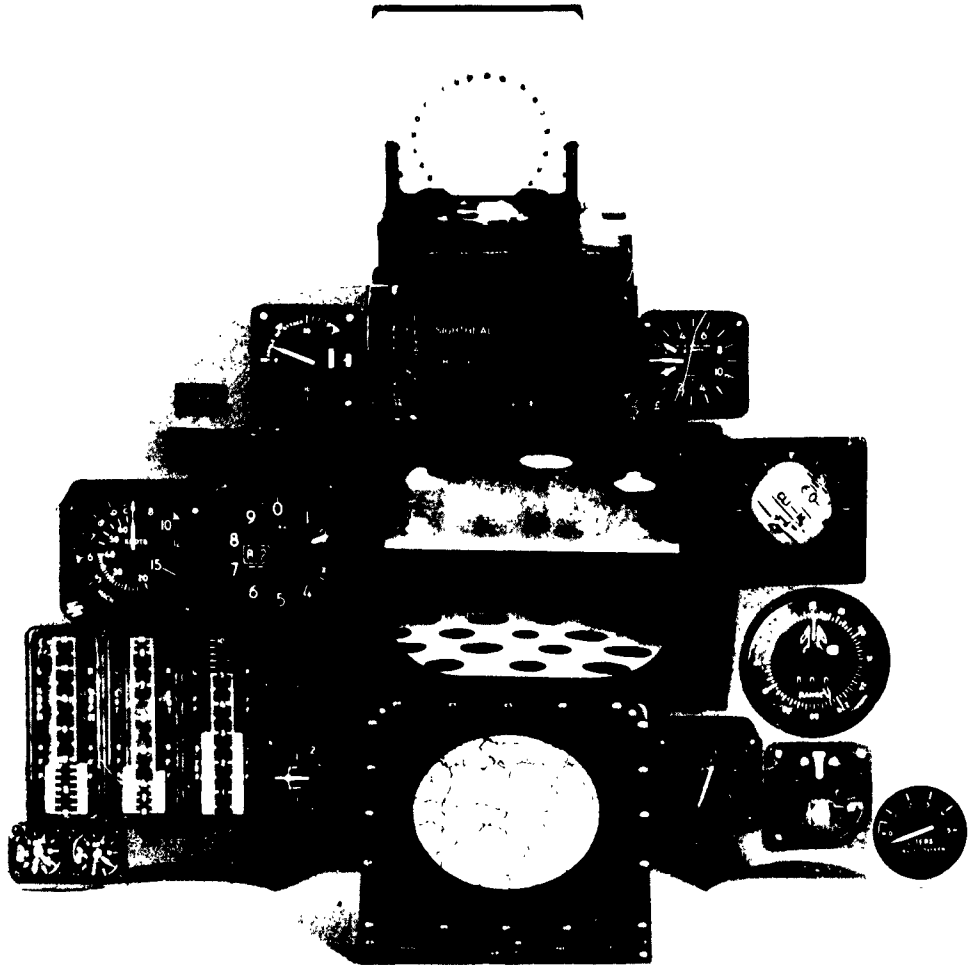

Figure 2. Navigation Mode, Cruise - Contact Analog and Map

AERONAUTICAL INSTRUMENTS LABORATORY

REPORT NO. NADC-AI-6320

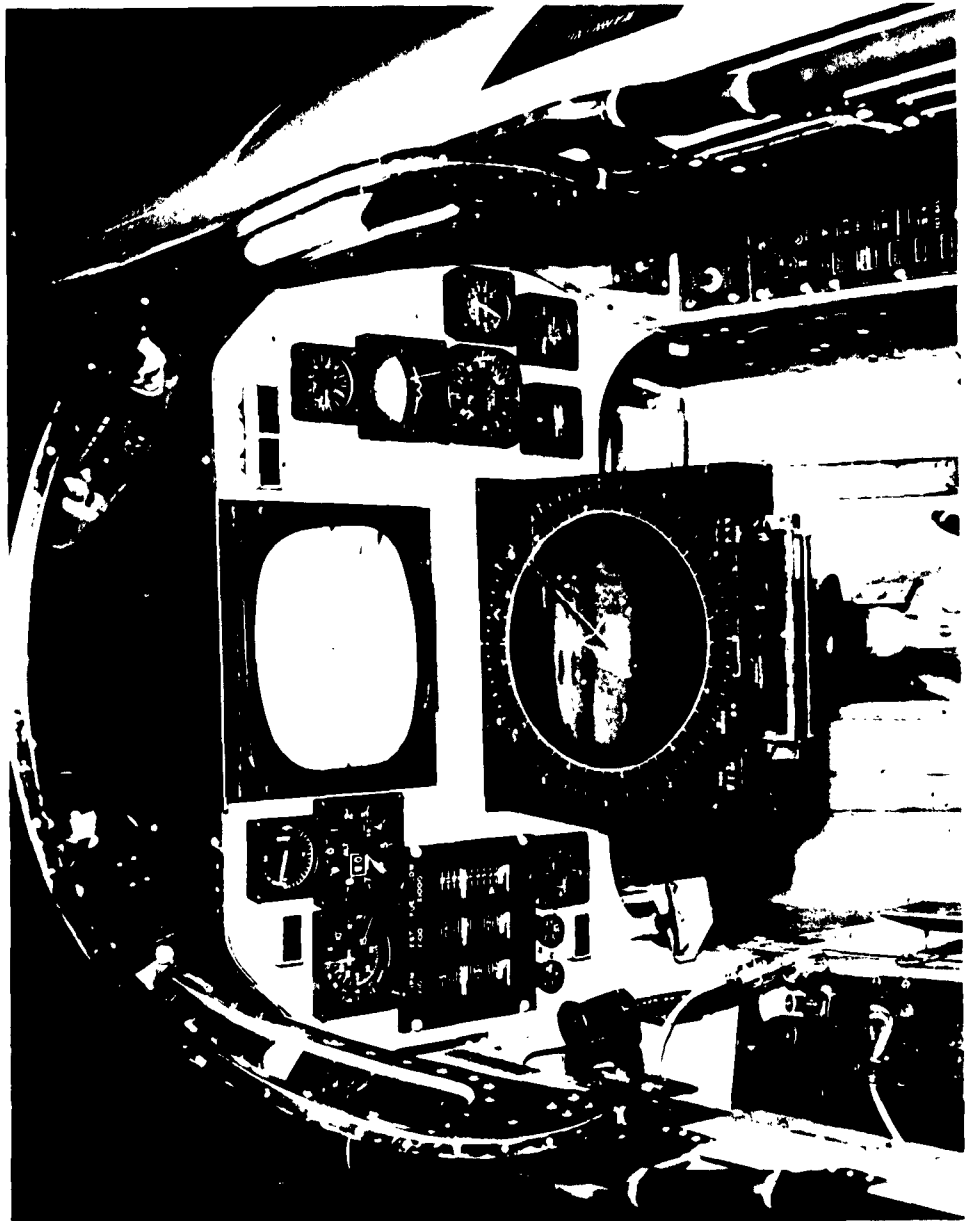

Figure 3. Instrument Panel, Experimental Aft Cockpit of YF-9J

AERONAUTICAL INSTRUMENTS LABORATORY

REPORT NO. NADC-AI-6320

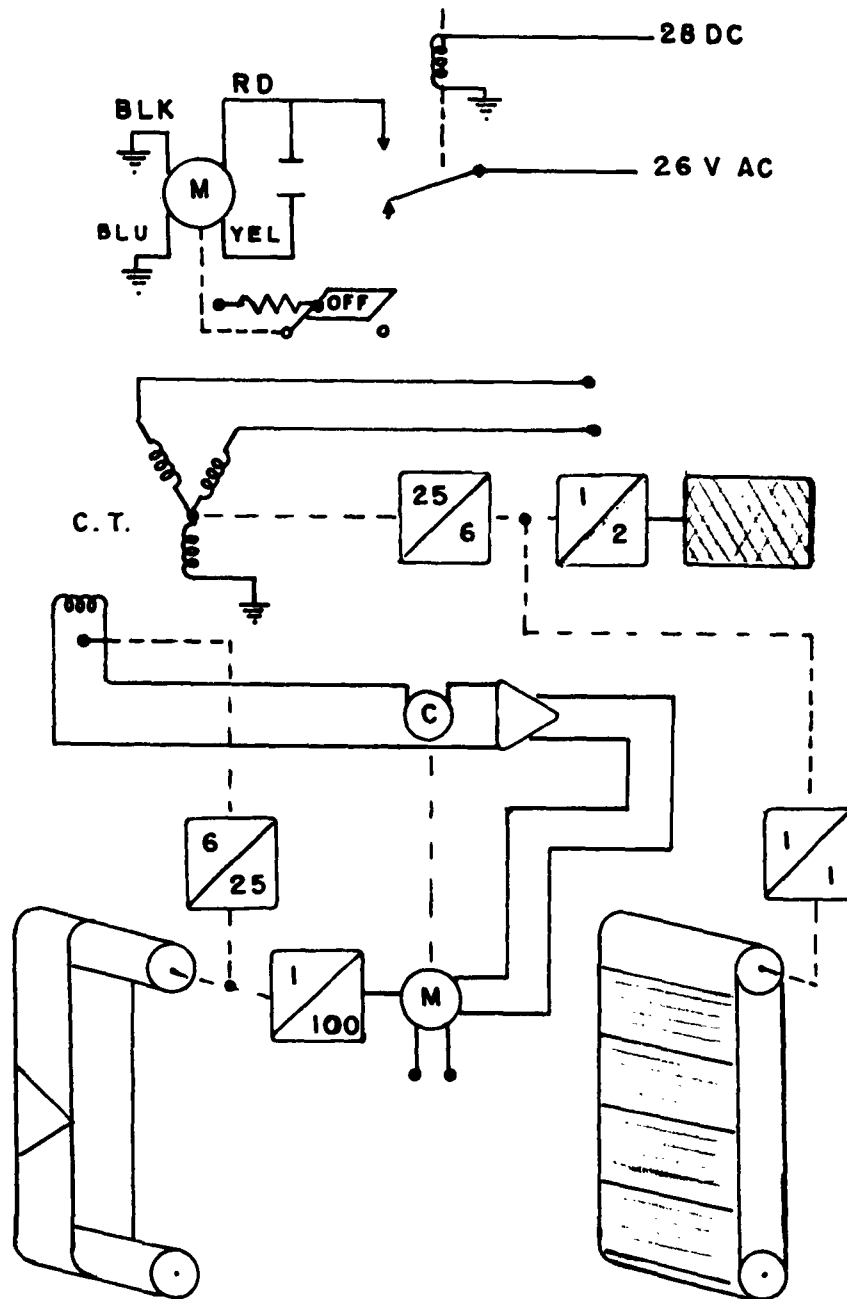

FIG. 4 - ELECTRO-MECHANICAL SCHEMATIC DIAGRAM OF % RPM MODULE

AERONAUTICAL INSTRUMENTS LABORATORY

REPORT NO. NADC-AI-6320

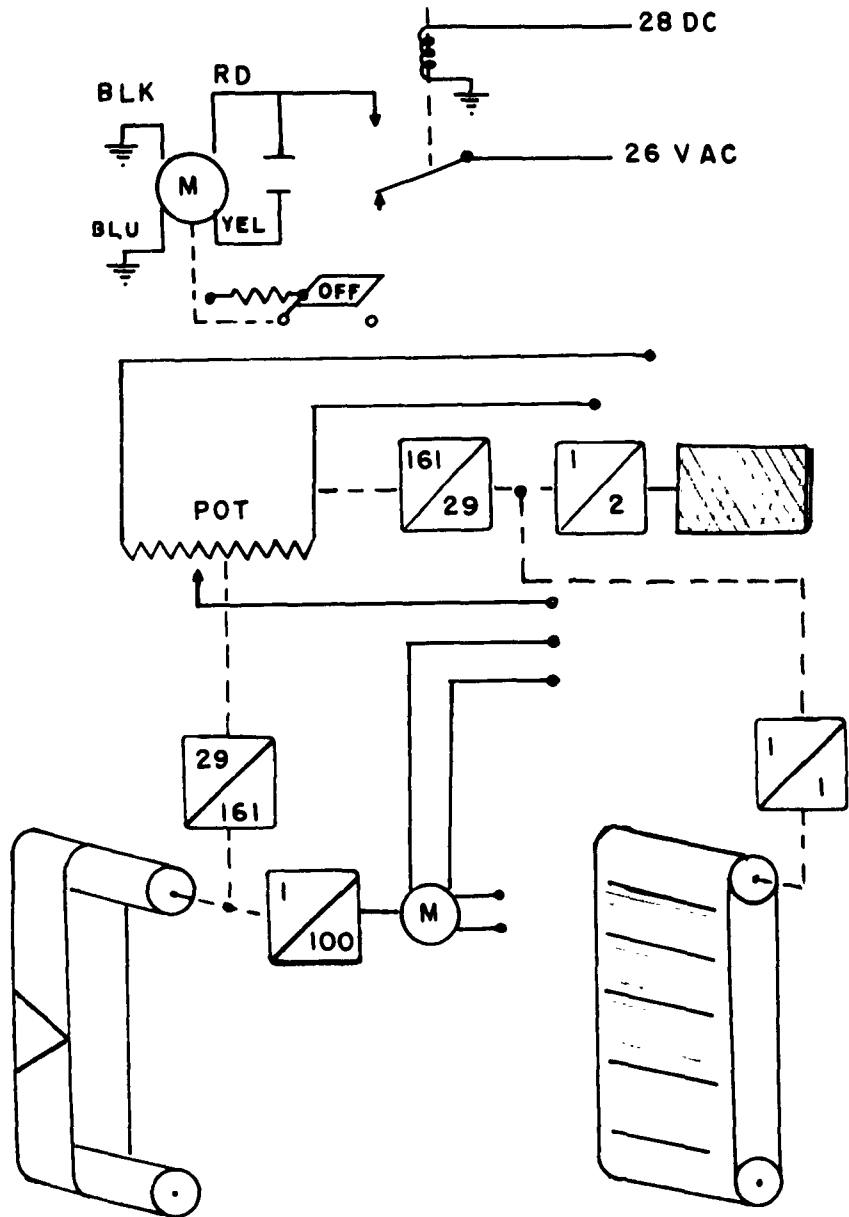

FIG. 5 - ELECTROMECHANICAL SCHEMATIC DIAGRAM OF E. G. T. MODULE

AERONAUTICAL INSTRUMENTS LABORATORY

REPORT NO. NADC-AI-6320

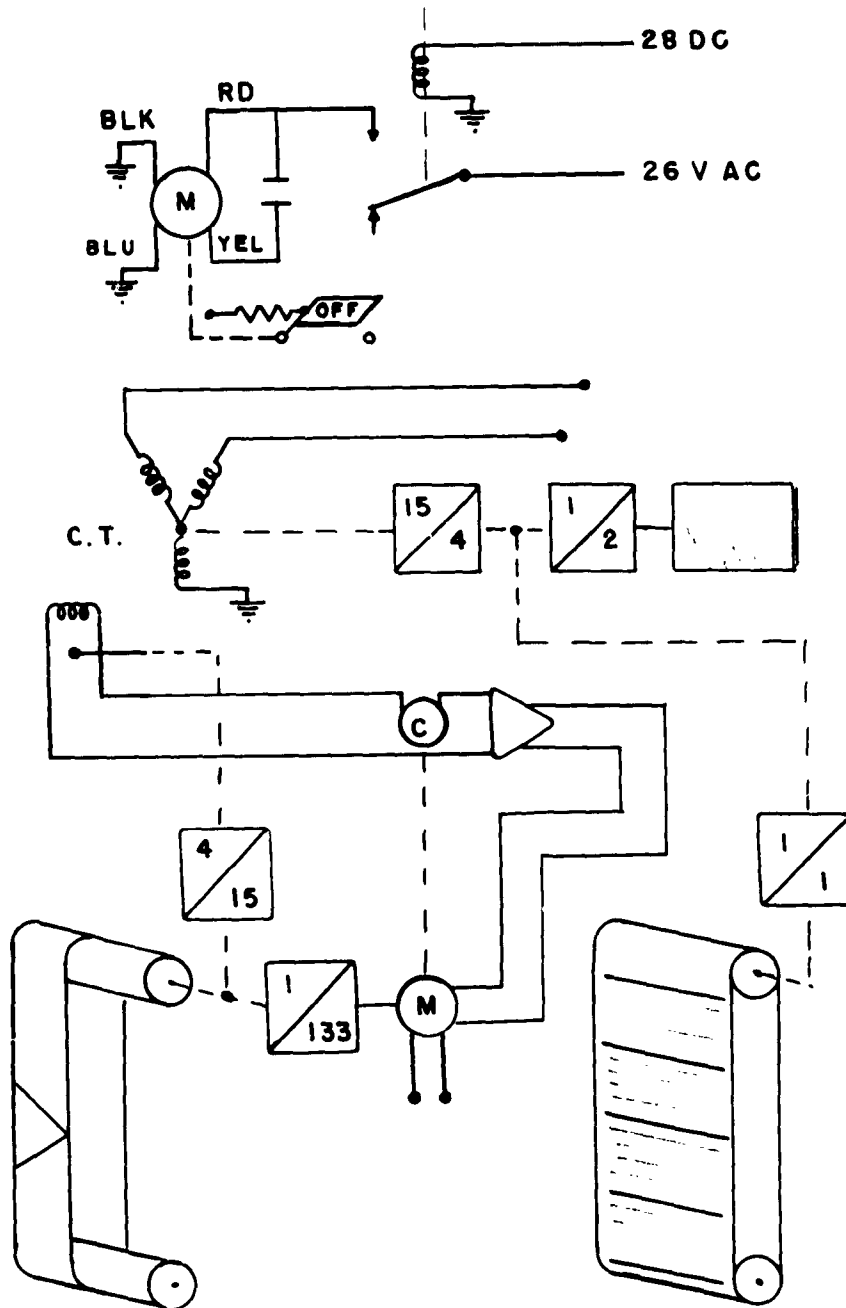

FIG. 6- ELECTRO-MECHANICAL
SCHEMATIC DIAGRAM OF FUEL FLOW MODULE

AERONAUTICAL INSTRUMENTS LABORATORY

REPORT NO. NADC-AI-6320

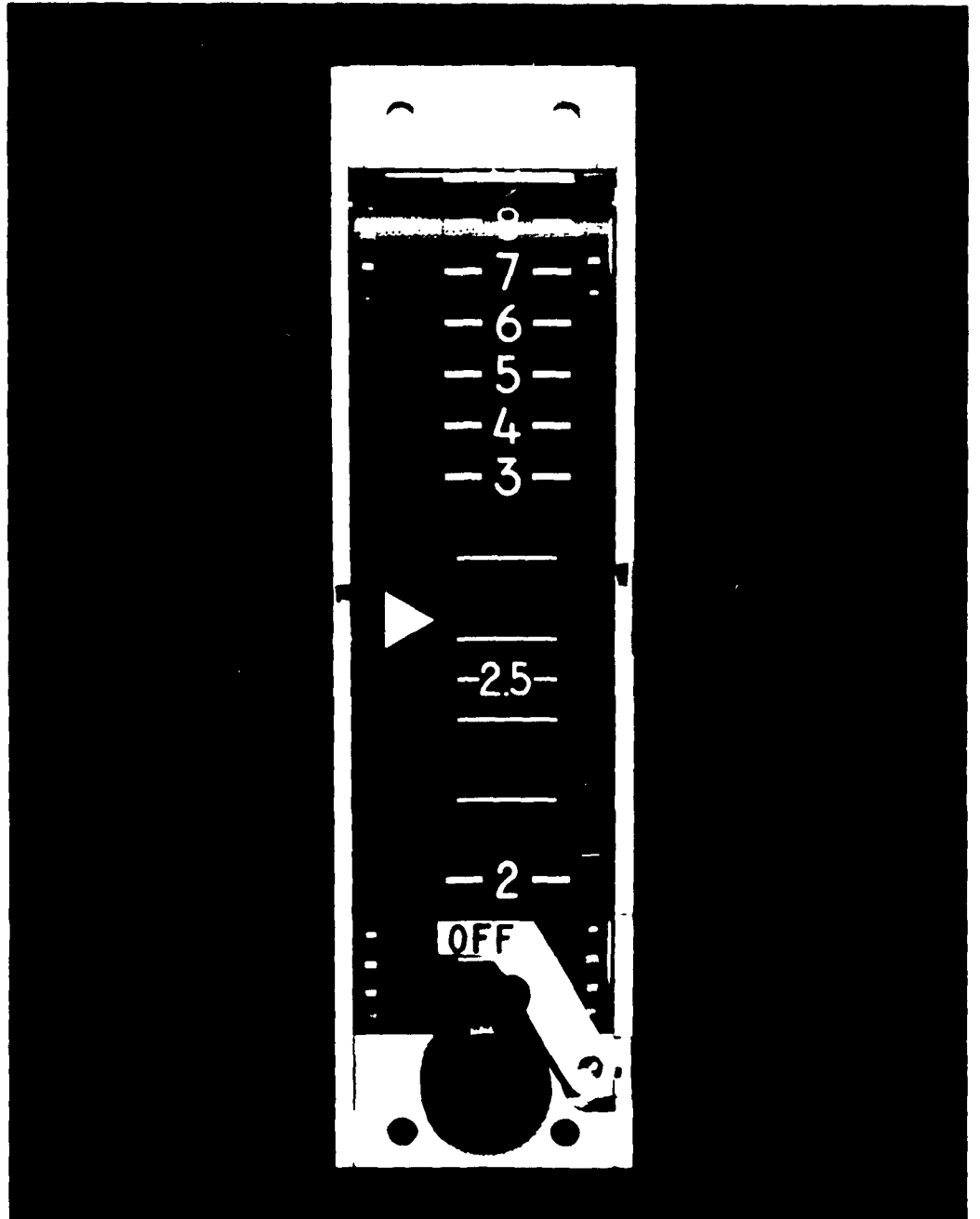

Figure 7. Front View of Typical Module

AERONAUTICAL INSTRUMENTS LABORATORY

REPORT NO. NADC-AI-6320

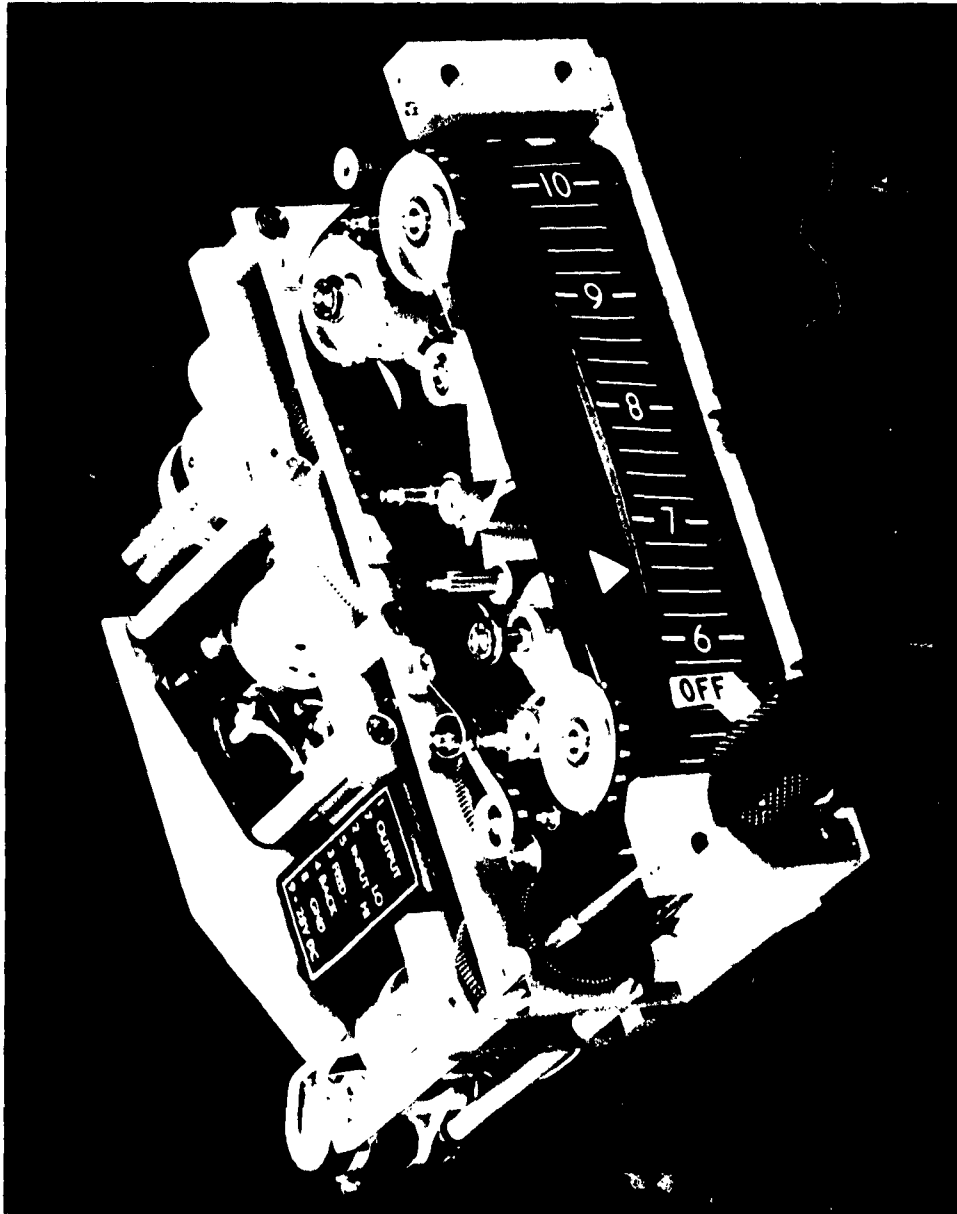

Figure 8. Three-Quarter View of Typical Module

AERONAUTICAL INSTRUMENTS LABORATORY

REPORT NO. NADC-AI-6320

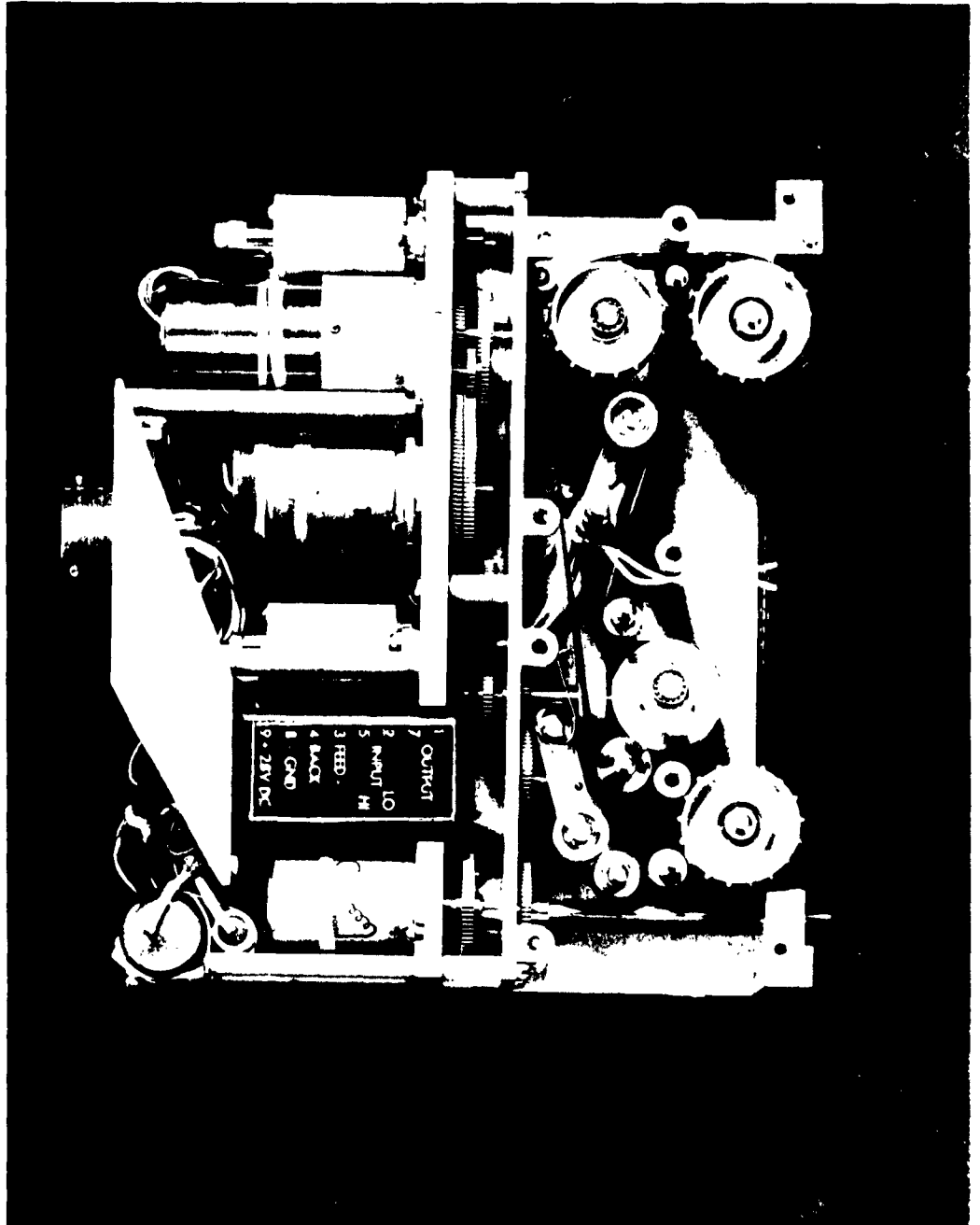

Figure 9. Side View of Typical Module

AERONAUTICAL INSTRUMENTS LABORATORY

REPORT NO. NADC-AI-6320

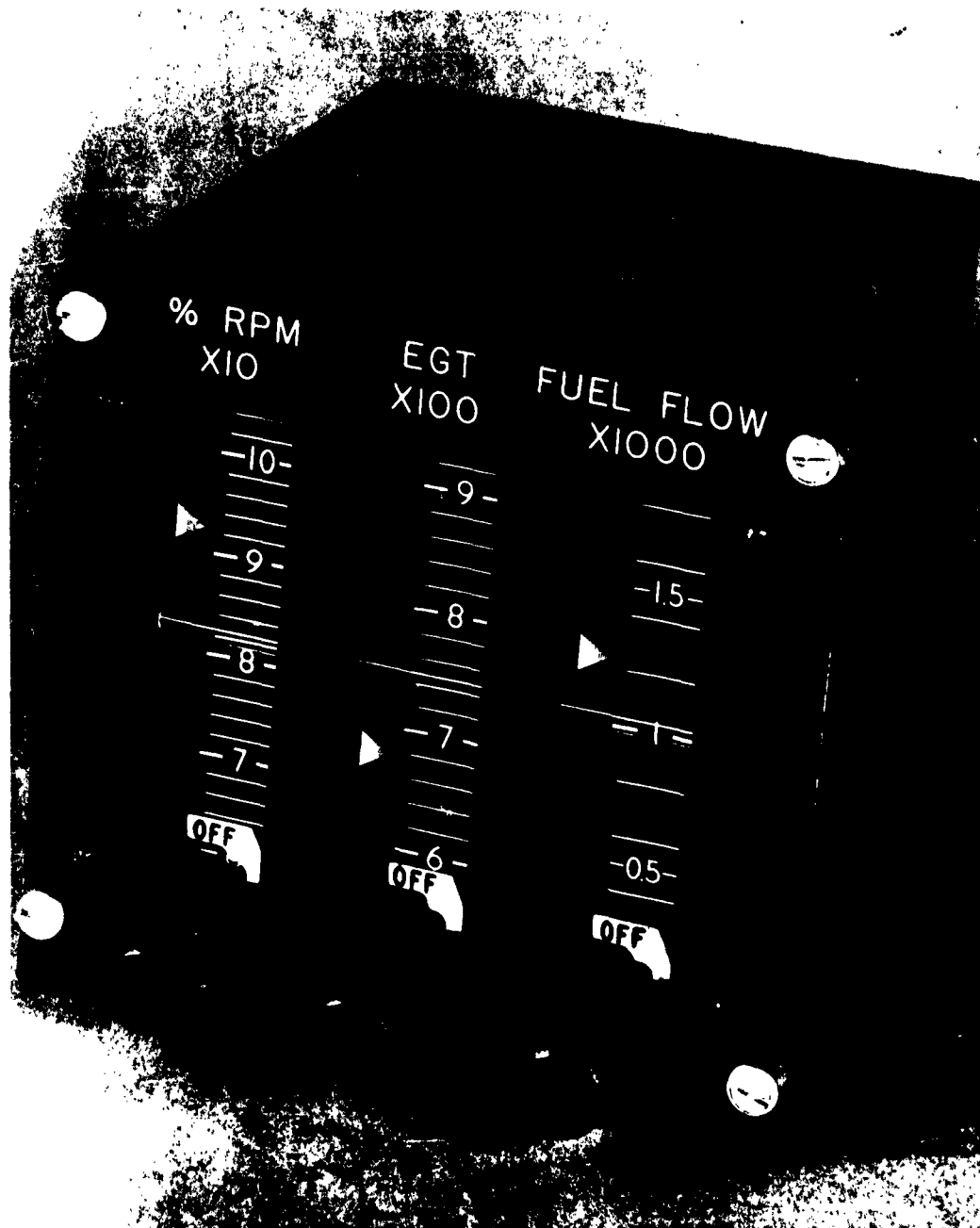

Figure 10. Three-Quarter Front View of Engine Performance Indicator

AERONAUTICAL INSTRUMENTS LABORATORY

REPORT NO. NADC-AI-6320

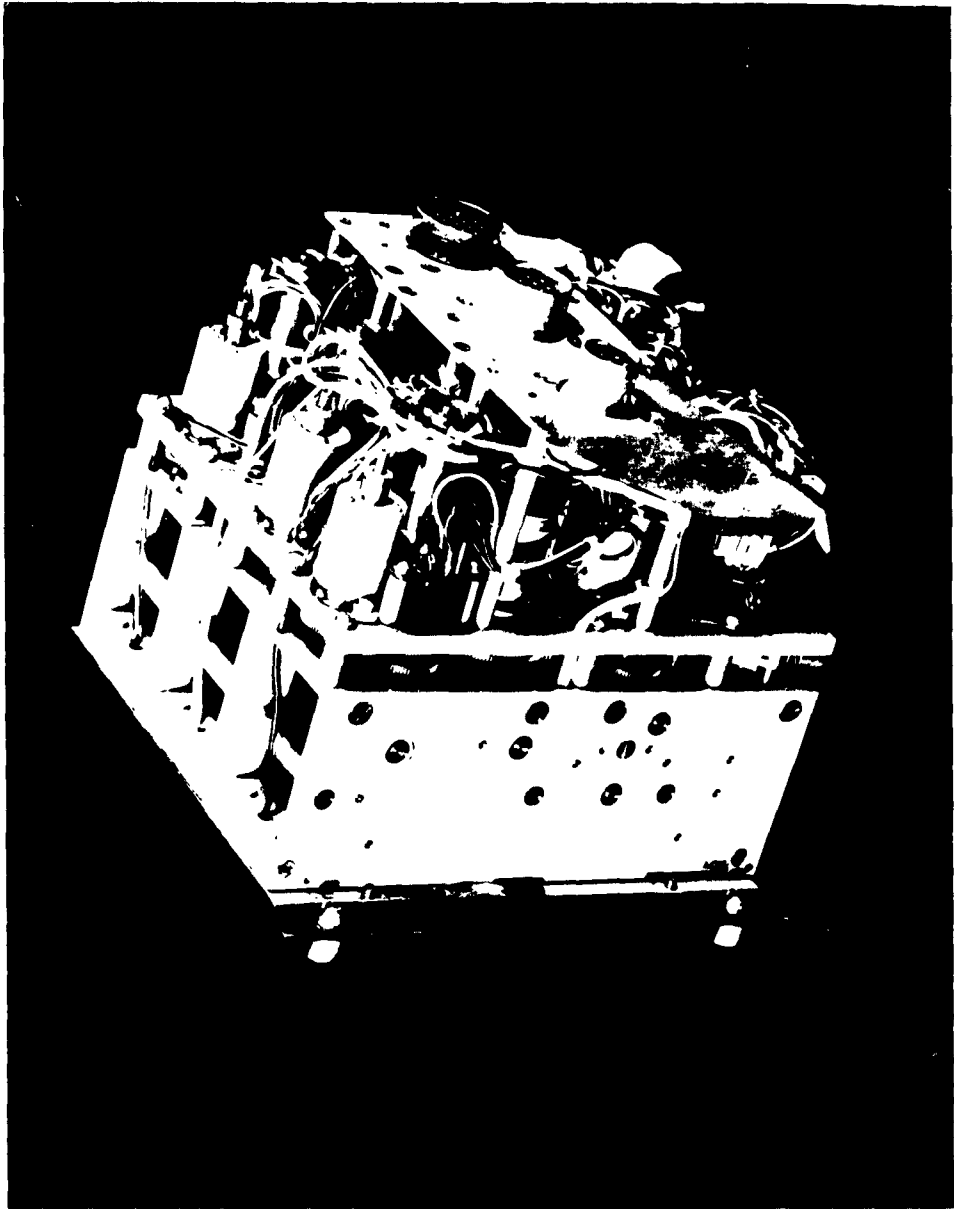

Figure 11. Three-Quarter Right Rear View of EPI Assembly

AERONAUTICAL INSTRUMENTS LABORATORY

REPORT NO. NADC-AI-6320

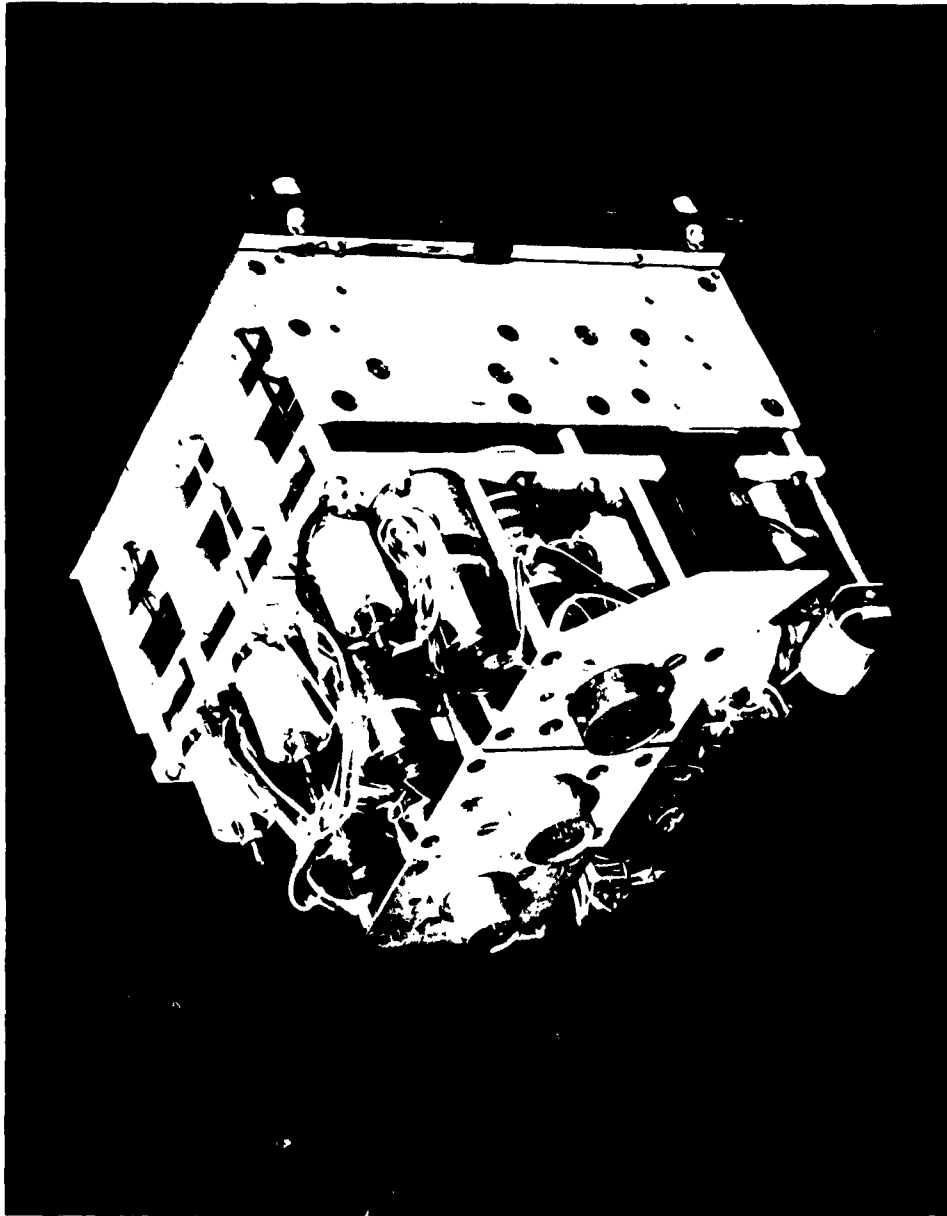

Figure 12. Three-Quarter Left Rear View of EPI Assembly

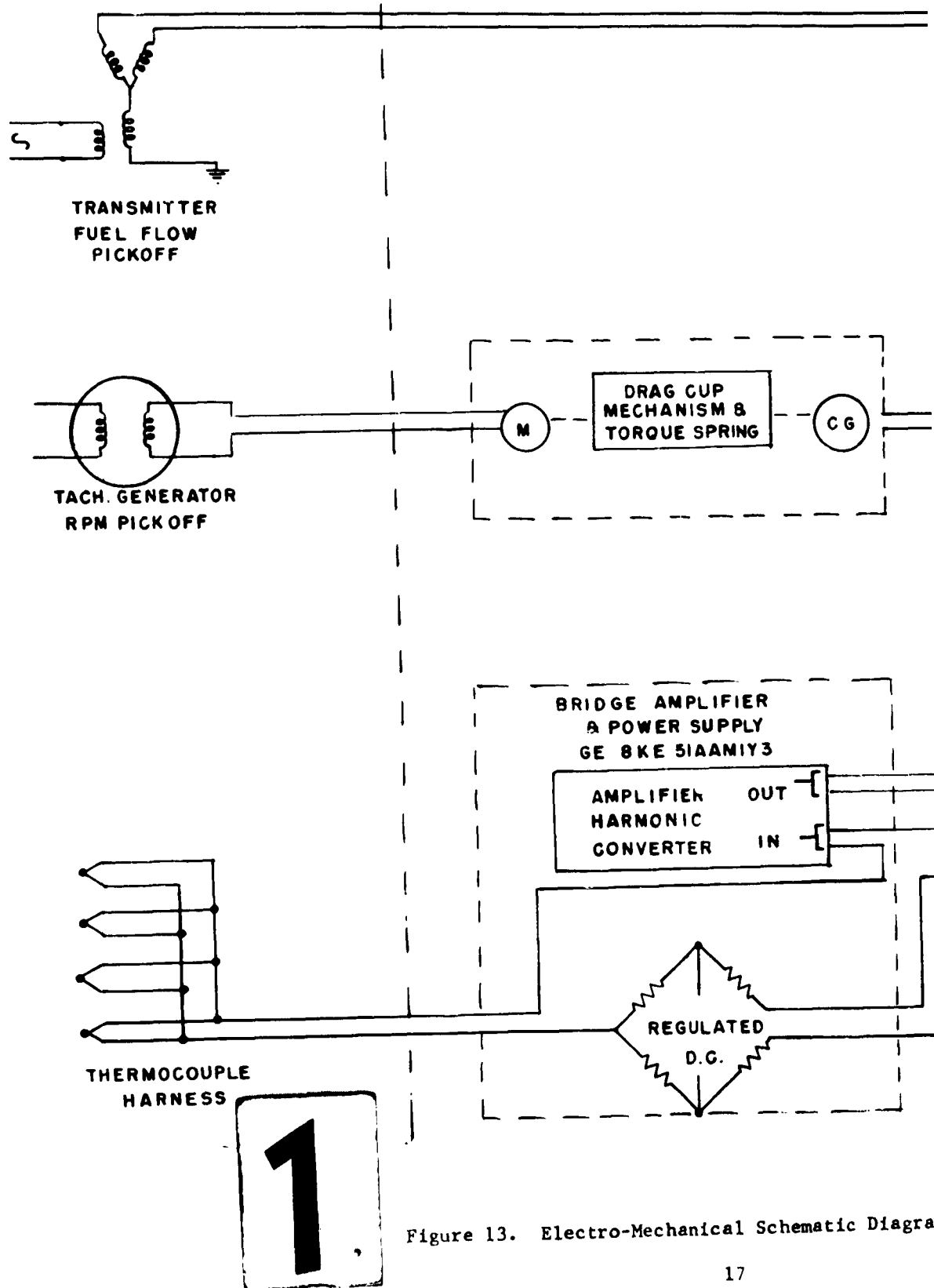
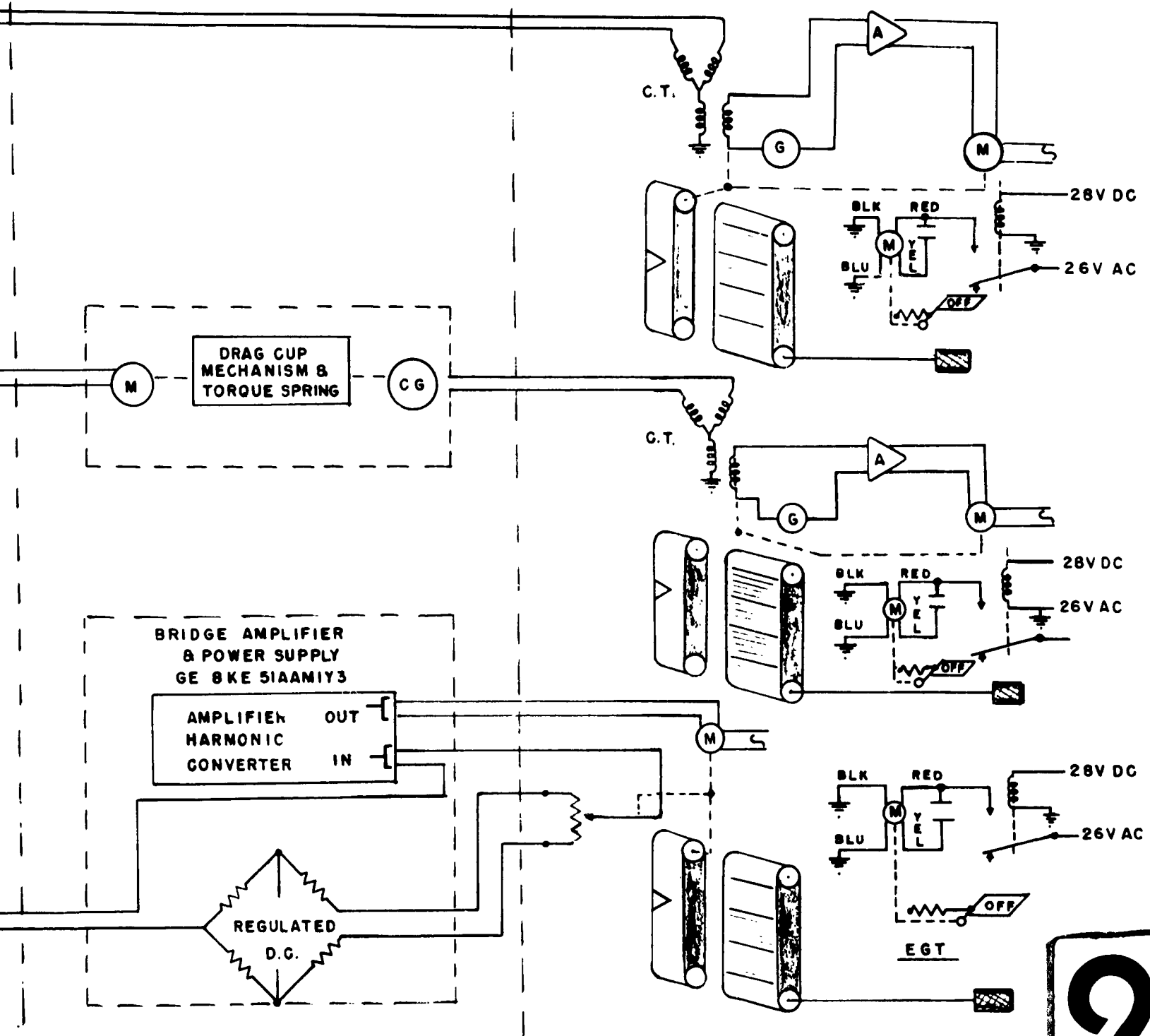

Figure 13. Electro-Mechanical Schematic Diagram

AERONAUTICAL INSTRUMENTS LABORATORY

REPORT NO. NADC-AI-6320



2

Figure 13. Electro-Mechanical Schematic Diagram

AERONAUTICAL INSTRUMENTS LABORATORY

REPORT NO. NADC-AI-6320

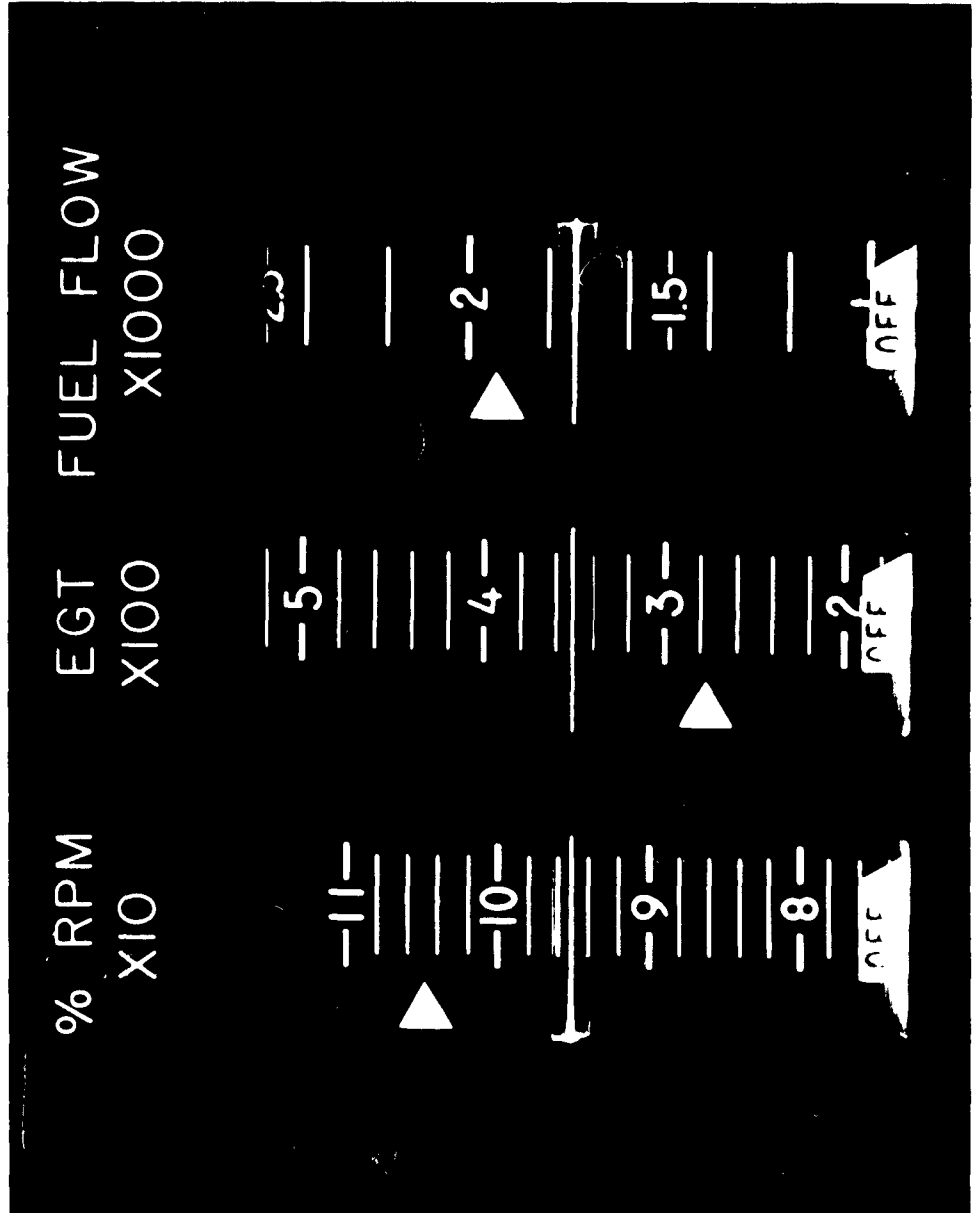

Figure 14. Engine Performance Indicator - Night View

AERONAUTICAL INSTRUMENTS LABORATORY

REPORT NO. NADC-AI-6320

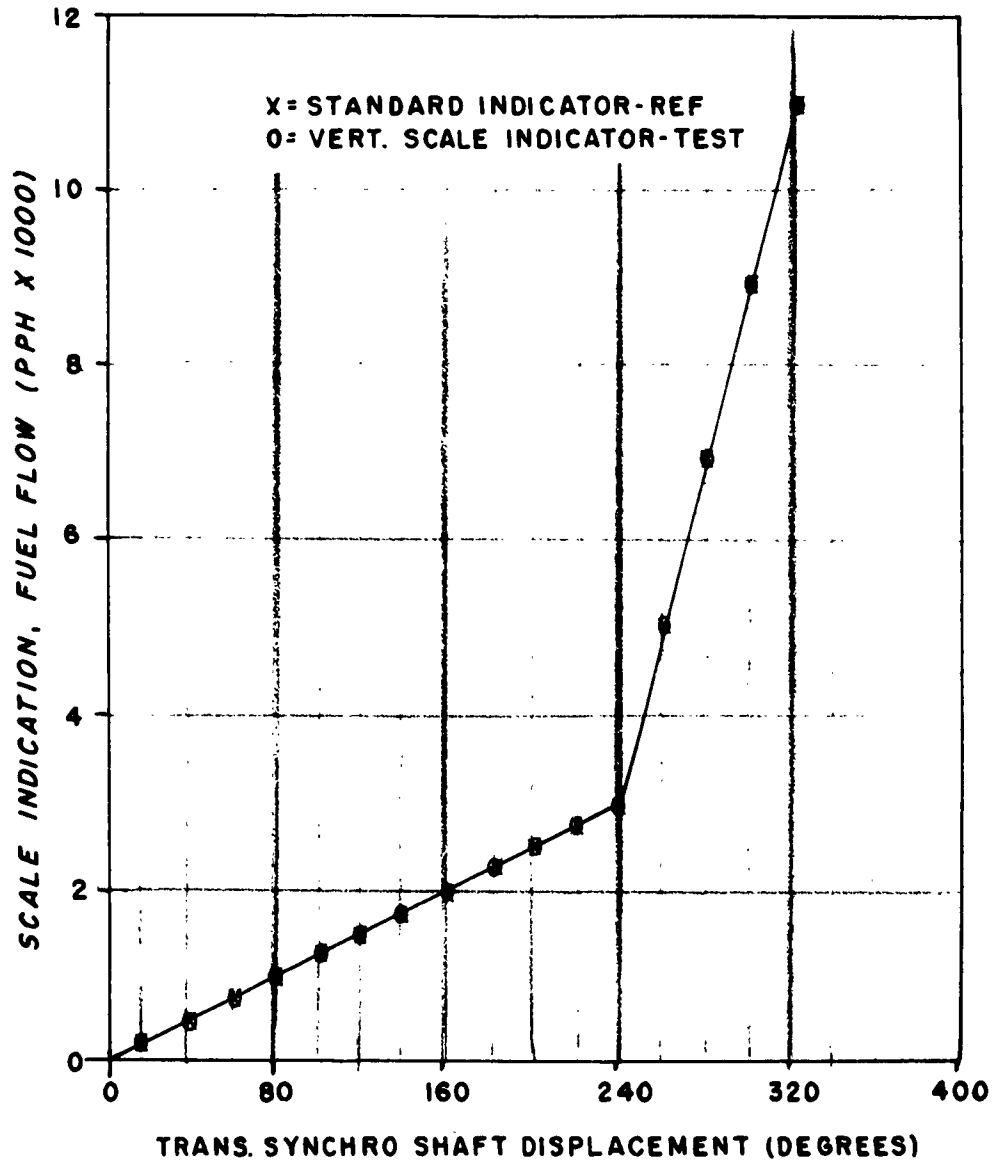

FIG. 15- CALIBRATION CURVE FOR VERTICAL SCALE INDICATOR,
FUEL FLOW. AIL DWG. E3345-1000 SER. NO. 1

AERONAUTICAL INSTRUMENTS LABORATORY

REPORT NO. NADC-AI-6320

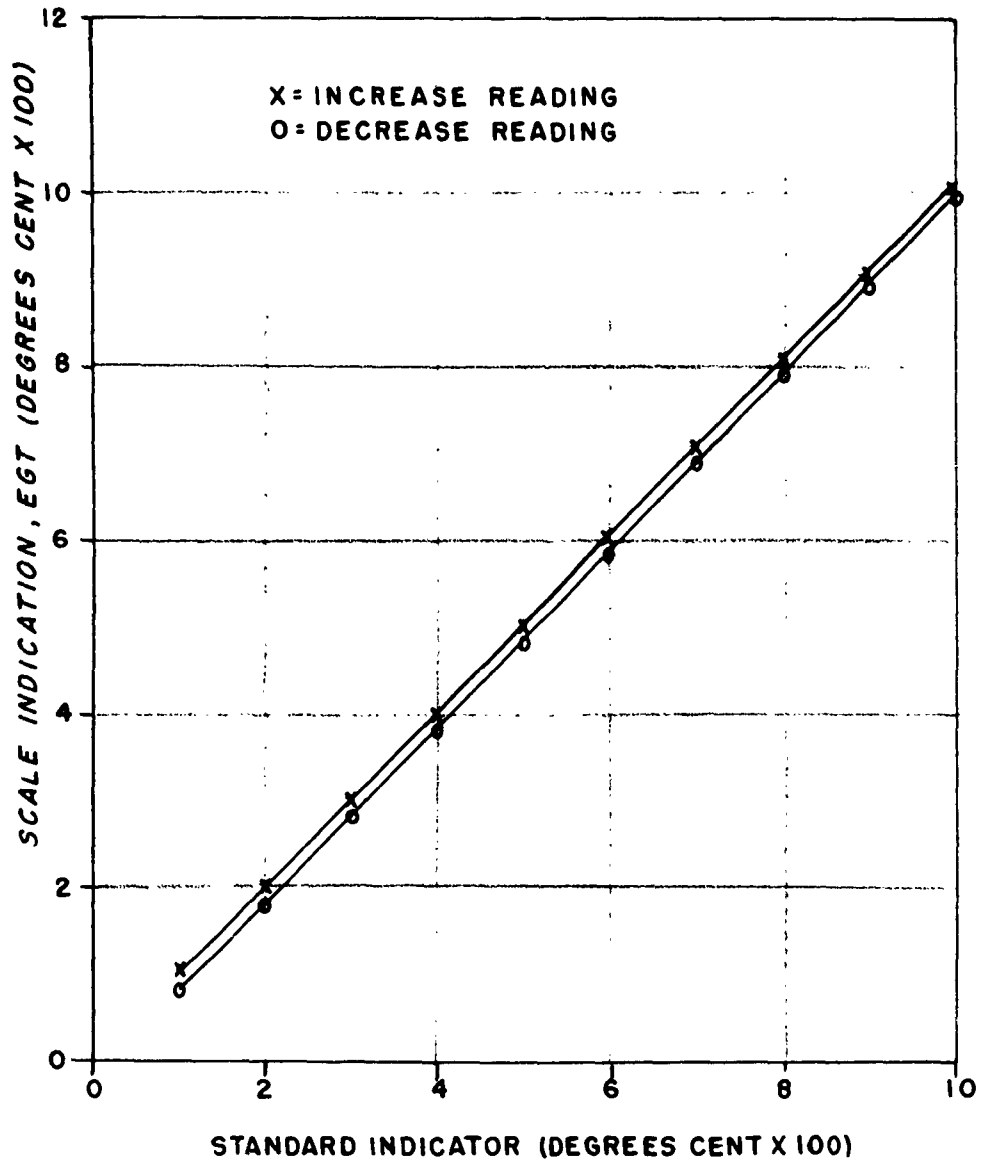

FIG 16 - CALIBRATION CURVE FOR VERTICAL SCALE INDICATOR,
EGT AIL DWG. E3345-200

AERONAUTICAL INSTRUMENTS LABORATORY

REPORT NO. NADC-AI-6320

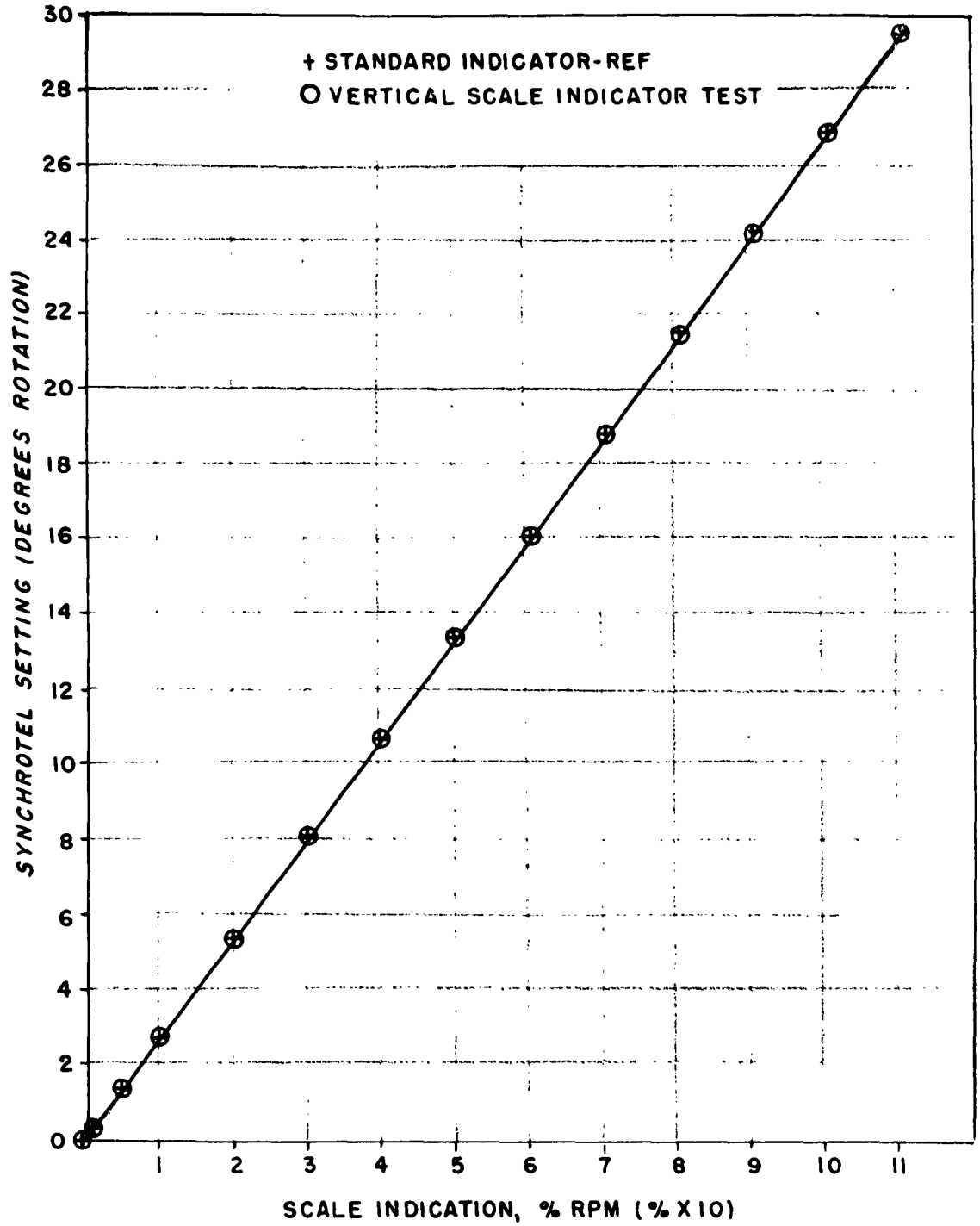

FIG.17 - CALIBRATION CURVE FOR VERTICAL SCALE INDICATOR,
PERCENT RPM AIL DWG. E 3345-300

<p>U. S. Naval Air Development Center, Johnsville, Pa. Aeronautical Instruments Laboratory</p> <p>DESIGN REPORT OF AN ENGINE PERFORMANCE INDICATOR; by T. D. DePasqua; 26 Mar 1963; 26 p; Report No. NADC-AI-6320 on Weptask RAV09J011/2021/F012-12-01 Problem 16</p> <p>The design report covers the development of a simplified version of an Engine Performance Indicator. The instrument is a three-module, servo-driven indicator which displays information relative to Engine Speed (TRPM), Exhaust Gas Temperature (EGT) and Fuel Flow (F.F.) utilizing vertical tape type of readout.</p>	<p>I. DePasqua, T. D.</p>
<p>U. S. Naval Air Development Center, Johnsville, Pa. Aeronautical Instruments Laboratory</p> <p>DESIGN REPORT OF AN ENGINE PERFORMANCE INDICATOR; by T. D. DePasqua; 26 Mar 1963; 26 p; Report No. NADC-AI-6320 on Weptask RAV09J011/2021/F012-12-01 Problem 16</p> <p>The design report covers the development of a simplified version of an Engine Performance Indicator. The instrument is a three-module, servo-driven indicator which displays information relative to Engine Speed (TRPM), Exhaust Gas Temperature (EGT) and Fuel Flow (F.F.) utilizing vertical tape type of readout.</p>	<p>I. DePasqua, T. D.</p>

D I S T R I B U T I O N L I S T

REPORT NO. WADC-AI-6304

WEPTASK RAV09J011/2021/F012-12-01

P.A. 16

BUWEP8, DLI-31.....	15
(1 copy for RAAV-9)	
(14 copies for retention)	
AFSC, STOL-NAVAIRDEVCEN	1
ASD, ASAD/Library	1
Technical Library, NAVAIRDEVCEN	2
ASTIA	10