

UNCLASSIFIED

AD NUMBER	
AD392736	
CLASSIFICATION CHANGES	
TO:	unclassified
FROM:	confidential
LIMITATION CHANGES	
TO:	Approved for public release, distribution unlimited
FROM:	Distribution authorized to DoD only; Administrative/Operational Use; JUL 1968. Other requests shall be referred to Office of Naval Research, Attn: Code 466, Washington, DC 20360.
AUTHORITY	
Office of Naval Research ltr dtd 9 Nov 1977; Office of Naval Research ltr dtd 9 Nov 1977	

THIS PAGE IS UNCLASSIFIED

SECURITY

MARKING

The classified or limited status of this report applies to each page, unless otherwise marked.

Separate page printouts MUST be marked accordingly.

THIS DOCUMENT CONTAINS INFORMATION AFFECTING THE NATIONAL DEFENSE OF THE UNITED STATES WITHIN THE MEANING OF THE ESPIONAGE LAWS, TITLE 18, U.S.C., SECTIONS 793 AND 794. THE TRANSMISSION OR THE REVELATION OF ITS CONTENTS IN ANY MANNER TO AN UNAUTHORIZED PERSON IS PROHIBITED BY LAW.

NOTICE: When government or other drawings, specifications or other data are used for any purpose other than in connection with a definitely related government procurement operation, the U. S. Government thereby incurs no responsibility, nor any obligation whatsoever; and the fact that the Government may have formulated, furnished, or in any way supplied the said drawings, specifications, or other data is not to be regarded by implication or otherwise as in any manner licensing the holder or any other person or corporation, or conveying any rights or permission to manufacture, use or sell any patented invention that may in any way be related thereto.

CONFIDENTIAL

AD392736

HUDSON LABORATORIES of Columbia University
145 Palisade Street, Dobbs Ferry, N. Y. 10522

TECHNICAL REPORT No. 152

AMBIENT NOISE IN THE
MEDITERRANEAN SEA

by
Elizabeth M. Arase
and
T. Arase

RECEIVED
JUL 23 1968
July 23, 1968

Group 4. Downgraded at 3 year intervals.
Declassified after 12 years.

In addition to security requirements which
apply to this document and must be met,
each transmittal outside the Department of
Defense must have prior approval of the
Office of Naval Research, Code 466.

Work 85, 70360

CONFIDENTIAL

Hudson Laboratories
of
Columbia University
Dobbs Ferry, New York 10522

Technical Report No. 152

AMBIENT NOISE IN THE MEDITERRANEAN SEA (U)

by

Elizabeth M. Arase and T. Arase

CONFIDENTIAL

July 23, 1968

This report consists
of 58 pages.

Copy No. 
of  copies.

This work was supported by the Office of Naval Research under Contract Nonr-266(84). In addition to security requirements which apply to this document and must be met, each transmittal outside the Department of Defense must have prior approval of the Office of Naval Research, Code 466.

This document contains information affecting the national defense of the United States within the meaning of the Espionage Laws, Title 18, U.S.C., Sections 793 and 794. The transmission or the revelation of its contents in any manner to an unauthorized person is prohibited by law.

UNCLASSIFIED

ABSTRACT

Ambient noise was measured in four deep basins of the Mediterranean Sea for three consecutive days at each station during June of 1968. Sonobuoys with hydrophones suspended at a depth of 95 ft were used to collect and transmit the data to a quiet ship several miles distant. Eight frequencies in 1/2-octave bands were used in the range from 16 to 800 Hz. Levels in these bands were read at 10-min intervals, sight averaged over this time, and are presented as distribution functions and average values for each station along with wind information. Environmental data such as velocity and temperature profiles, depth measurements and traffic observations are reported.

UNCLASSIFIED

CONFIDENTIAL

INTRODUCTION

Many measurements of ambient noise have been performed in the open ocean, harbors and lakes, in deep as well as shallow water and have been summarized extensively.^{1,2} However, while many characteristics of the Mediterranean Sea, such as sound propagation, temperature, velocity, salinity and bottom structure have been studied and most recently been summarized by C. C. Leroy,³ only one previous short series of measurements of ambient noise has been performed in the Tyrrhenian basin off the west coast of Italy during four dives of the Bathyscaph Trieste.⁴ These data are necessarily limited, since the longest dive was of 9 hours duration and the data were taken at varying depth. The results for that particular basin are in general agreement with our findings.

The Mediterranean Sea is composed of many distinct geologic areas including five deep basins, an extensive slope area, and the shallow broken area of the Aegean Sea. Previous propagation information shows the best propagation to be by refraction surface-reflection paths which occur in the deep basins. On this basis, as well as the available ship time, a compromise of the number of stations and time on station led to a choice of four stations, each of three days duration (Fig. 1). The location and duration of each station are summarized in Table I.

At each station, a sonobuoy was launched, the ship moved off several miles, went to quiet ship conditions, and the recordings commenced. Because of the winds and currents, the ship and sonobuoys drifted from the original stations. Plots of the dead reckoning locations are given in Figs. 2-6. The numbers in the bracket indicate the depth in fathoms.

CONFIDENTIAL

CONFIDENTIAL

EQUIPMENT

Calibrated sonobuoys AN/SSQ-48(XN-2) and receivers ARR-52 were provided by the Navy. The sonobuoys are composed of a weight, hydrophone, and preamplifier which are suspended 95 ft below a surface buoy (block diagram is given in Fig. 7). Shock cord is used for the suspension to reduce the effects of surface motion. In the audio amplifier, the electrical signals are given a rising response of 4 dB/octave from 10 Hz to 5 kHz (Fig. 10), to compensate approximately for the decrease in ambient noise level with frequency. The signals frequency-modulate a crystal-controlled transmitter. The sonobuoy calibration specifies that a sound pressure field of $2\mu\text{b}$ at 440 Hz will result in a 19 kHz frequency deviation of the carrier. The solid dots on this figure give the calibration for a particular sonobuoy.

The FM signals were received with a steerable Yagi antenna of 12 dB gain (Fig. 8). A radio frequency amplifier was used at times to extend the receiving range. A power splitter isolated the receivers. The radio receiver has four channels, each switchable to any one of the 16 sonobuoy frequencies. The "High Audio" output provides an output of 16 Vrms for a frequency deviation of 75 kHz over a bandwidth from 10 Hz to 3 kHz. Therefore, the sonobuoy + receiver combination calibration is

$$2 \mu\text{b} = \frac{19 \text{ kc deviation}}{75 \text{ kc deviation}} \times 16 \text{ Vrms}$$

or,

$$1 \mu\text{b} \text{ corresponds to } 2.03 \text{ volts at } 440 \text{ Hz.}$$

CONFIDENTIAL

CONFIDENTIAL

From Fig. 10, the sensitivity for each of the frequencies used was read.

The audio signals were then filtered, amplified, and recorded by a logarithmic level recorder (Fig. 9). The system was calibrated by using an oscillator signal at the center frequency of the filters. Noise pressure spectral levels were computed as follows.

Let p = noise pressure spectral level in a 1 Hz band in $\mu\text{b}/\sqrt{\text{Hz}}$
 B = bandwidth of system or filter in Hz
 H = sonobuoy + receiver sensitivity
= 2.03 volts/ μb at 440 Hz
 d_n = deflection for ambient noise in dB
 d_c = deflection for calibration signal in dB
 e_c = calibration voltage in volts.

Then, since the noise in adjacent frequency bands is assumed to be independent,

$$p^2 = \frac{1}{B} \left(\frac{d_n e_c}{H d_c} \right)^2$$

Table II gives the factor $10 \log B + 10 \log H^2$ for an assumed white noise of $1 \mu\text{b}/\text{Hz}^{1/2}$.

Over-all system errors are approximately ± 1 to 2 dB based on the sonobuoy and the recording system calibrations. At low frequencies, some self-noise is present due to motion induced in the hydrophone by surface wave action. This motion is heard as creaking and gurgling sounds which occur at intervals of several seconds. We have minimized these effects

CONFIDENTIAL

by reading the minima of the noise levels recorded in the two lowest frequency bands. The analysis of the self noise of the sonobuoys is a difficult task and beyond the scope of this report.

RESULTS

For each station, temperature profiles, sound velocity profile, wind speed frequency distribution, and ambient noise frequency distributions are given.

At each station, the 1500 ft temperature profiles were taken twice daily. The envelope of these results is shown. Usually, the temperature decreases rapidly with depth to a depth of 70 to 100 ft, and then decreases more slowly. At times, slight inversion layers were observed.

Velocimeter casts were taken from the surface to about 2000 ft above the bottom. The rapid decrease in sound velocity with depth corresponds to the rapid decrease in temperature with depth. Below 2500 ft, the sound velocity increases uniformly with depth with a gradient of about 0.0175 sec^{-1} . These results correspond well to those reported previously.³

During the experiment, seas were calm, typical of the Mediterranean in June, with average wind speeds of about 5 knots, except for Station 4 where the average wind was about 10 knots, with a range from 0 to 23 knots.

Frequency distributions are given for the ambient noise spectrum levels for each of the filters used to demonstrate the variability of the ambient noise. The ambient noise was recorded using 1/2-octave filters

CONFIDENTIAL

CONFIDENTIAL

with center frequencies of 16, 32, 63, 90, 180, 250, 360, and 800 Hz. No 800 Hz data were obtained for Station 2, and relatively short samples for Stations 1 and 3A. At distances greater than 2 n.m. our own ship noise could not be detected while under quiet ship conditions. Measurements were taken under silent ship conditions but since no differences in noise levels were detected, the remaining measurements were taken under quiet ship conditions.

Stations 1 and 4 were comparatively quiet, the ambient noise levels at the higher frequencies comparing well with oceanic ambient noise levels. At Station 2, animal noises were particularly loud and continuous, consisting of snapping noises, hammering noises, dolphin and whale-like noises, and a random sonar-like signal at about 5 kHz. These noises were so loud and continuous that an additional sonobuoy was installed to determine whether the first was working; and for a further check, another hydrophone was suspended from the ship. Such animal noises were intermittent at the other stations.

At Station 2, ambient noise data were taken at 300-ft depth by splicing additional cable between the hydrophone and the surface buoy. The noise levels in this case were estimated to be about the same as at the 95-ft depth. The actual measurements showed the levels to be slightly less at the 300-ft depth, corresponding to the lower wind speeds at that time and not to any depth effect.

At Station 3, naval and shipping activities were particularly heavy so the station was moved to position 3B, about 30 n.m. south. The ambient noise did not change noticeably.

CONFIDENTIAL

The last set of figures compares the average ambient noise results with those measured over one year in the Atlantic Ocean near Bermuda using a hydrophone located near the axis of the deep sound channel. The hydrophone used was an omnidirectional hydrophone of the Artemis Array. At 360 and 800 Hz, at Stations 1 and 4, the levels compare well with the Artemis results. From the ambient noise studies made at that time, and on the basis of many other observations, ambient noise at the higher frequencies is known to be due mainly to local surface effects so this result is expected. At the lower frequencies, the ambient noise level is much higher; at Station 1 about 3 to 4 dB higher; at Station 2 about 10 to 11 dB higher (heavy animal noise); at Station 3 about 15 to 16 dB higher due to naval exercises and shipping traffic headed for the Straits of Messina; and, at Station 4, about 5 to 6 dB higher. Table III gives the average ambient noise levels, wind speeds, and length of data-taking for each station and 95-ft depth. Table IV summarizes the 300-ft data at Station 2.

Low-frequency noise in the oceans has been shown to be due to shipping^{1,5,6} and was expected to be important for these measurements when the experiment was first planned. Naturally, the actual extent of the shipping, the source levels of the smaller ships, and the complex effect of the propagation were not known, so arrangements were made with the Sixth Fleet, via ONR, for a shipping survey to be made daily while the Gibbs was on station. This information will be reported separately. The importance of shipping as a contributor to the ambient noise is self-evident, for the shipping noise adds incoherently; that is, a 10 dB increase

CONFIDENTIAL

CONFIDENTIAL

in noise is due to a ten-fold increase in shipping activity. Since the deep basins of the Mediterranean are small compared to the Atlantic Ocean, this means that many more ships at relatively close ranges will be present at all times.

Ambient noise levels in the Mediterranean Sea differ markedly from the Atlantic Ocean and indeed, from basin to basin. The principal differences are at the low frequencies, from 16 to 90 Hz, due to the higher density of shipping and animals. At the higher frequencies, 360 and 800 Hz, the ambient noise approximates the deep ocean results, since this noise is due to local surface action.

Future experimental procedures should include some auxiliary method of surveillance as ship-borne radar has insufficient range (about 17 n.m.) to monitor shipping. Widely spaced sonobuoy channels are also desirable since radio interference was observed on sonobuoy channels, mainly 3 through 8, from mobile stations, telephone relays, and broadcast stations. The language used was Italian, and the interference was present at times at Stations 1 and 2 and most of the time at Station 3. No interference was detected at Station 4.

ACKNOWLEDGMENTS

The authors thank the Captain, officers and crew of the USNS Gibbs as well as the members of the Hudson Laboratories Electronic and Mechanical Engineering Departments, whose splendid cooperation made this experiment possible.

CONFIDENTIAL

Table I
STATION LOG

	Nominal Location	Starting Time	Finishing Time
I.	Tyrrhenian Sea 40° 10' N, 12° 58' E	6/11/1968, 1145Z	6/14/1968, 1000Z
II.	Algero-Provencal Basin 39° 10' N, 6° 30' E	6/15/1968, 0800Z	6/18/1968, 0830Z
III.	Ionian Sea 36° 40' N, 17° 40' E	6/19/1968, 2200Z	6/23/1968, 0030Z
IV.	South of Crete 33° 40' N, 25° 10' E	6/24/1968, 0125Z	6/27/1968, 0200Z

Table II

Frequency in Hz	16	32	63	90	180	250	360	800
Sonobuoy + Receiver Sensitivity = $10 \log H^2$ (Reference at 180 Hz) dB re 1 volt for 1 μ b at center frequency of filter.	-15.7	-10.6	-7.0	-4.6	0	+2.0	+4.6	+9.9
Filter Bandwidth = $10 \log B$ dB re 1 Hz	8.9	13.1	15.2	16.4	19.6	21.0	22.6	26.4
Receiver output for white noise of $1 \mu\text{b}/\text{Hz}^{1/2} =$ $10 \log B + 10 \log H^2,$ dB re 1 volt.	-6.8	+2.5	+8.2	+11.8	+19.6	+23.0	+28.0	36.3

! φ

Table III
 Summary of Ambient Noise in the Mediterranean Sea
 (95 ft depth)

Frequency (Hz)	Station 1		Station 2		Station 3A		Station 3B		Station 4	
	No. of hours	Average level (db)	No. of hours	Average level (db)	No. of hours	Average level (db)	No. of hours	Average level (db)	No. of hours	Average level (db)
16	57	-19.3	52	-11.4	16	-9.7	46	-8.9	63	-17.9
32	→	-17.8	→	- 8.1	→	-4.1	→	-5.3	→	-13.8
63	→	-16.5	→	- 8.9	→	-7.9	→	-8.3	→	-15.2
90	→	-19.0	→	-13.6	→	-11.4	→	-11.0	→	-19.7
180	→	-27.7	→	-22.8	→	-21.9	→	-22.4	→	-32.0
250	→	-33.7	→	-29.6	→	-27.2	→	-27.0	→	-35.3
360	→	-38.2	→	-32.9	→	-31.9	→	-31.9	→	-38.8
800	14	-43.3	-	-	3	-33.1	→	-37.5	→	-42.0
Average Windspeed (Knots)	5.4		5.2		2.4		8.7		10.7	

Table IV
 Ambient Noise at 300 ft Depth
 Station 2

Frequency (Hz)	No. of hours	Average Level (db)
16	8.5	-13.1
32	↓	-10.4
63		-11.8
90		-15.4
180		-23.8
250		-32.2
360		-35.6
Average Windspeed (Knots)	↓	2.2 K

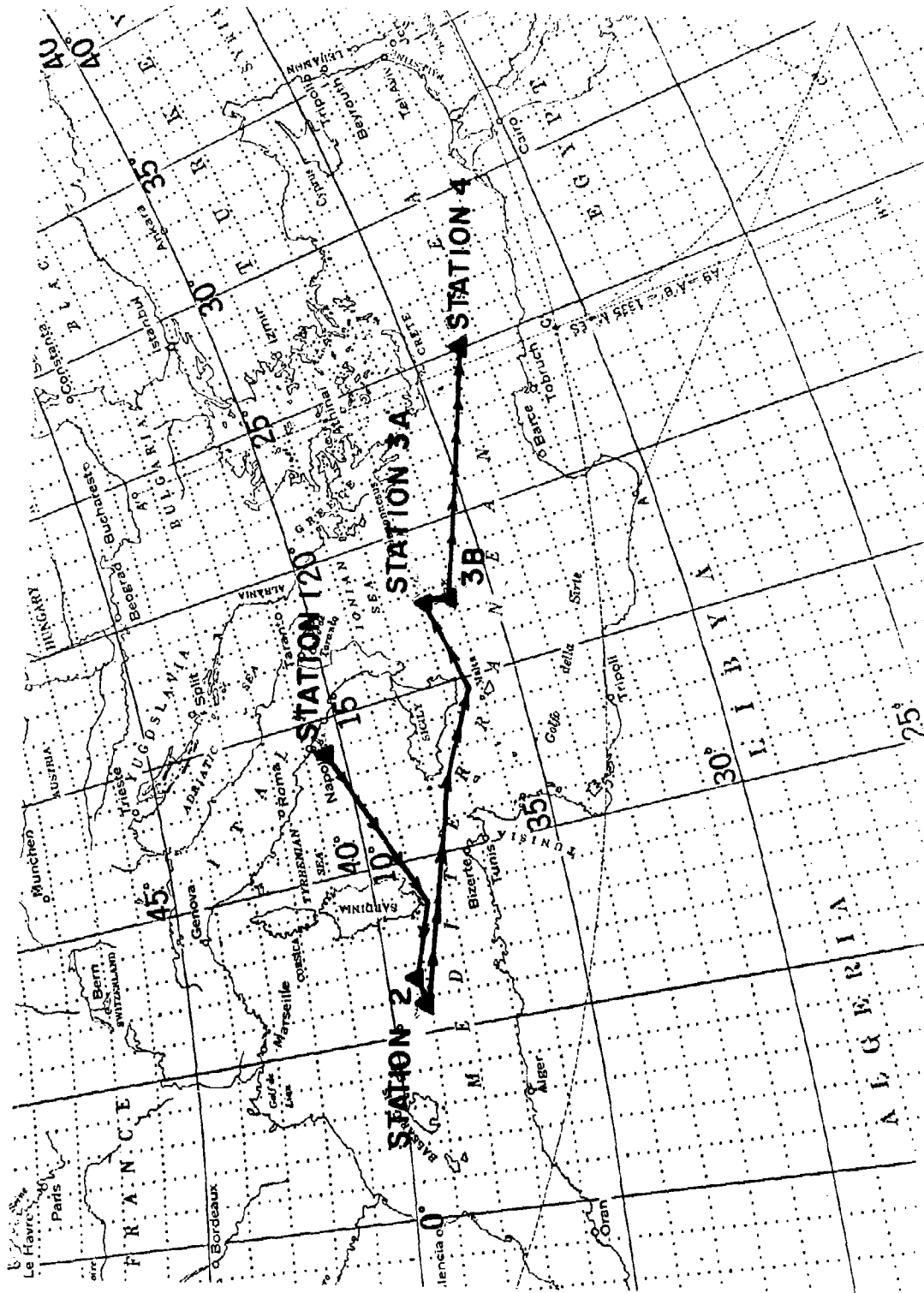

Figure 1. Location of stations.

UNCLASSIFIED

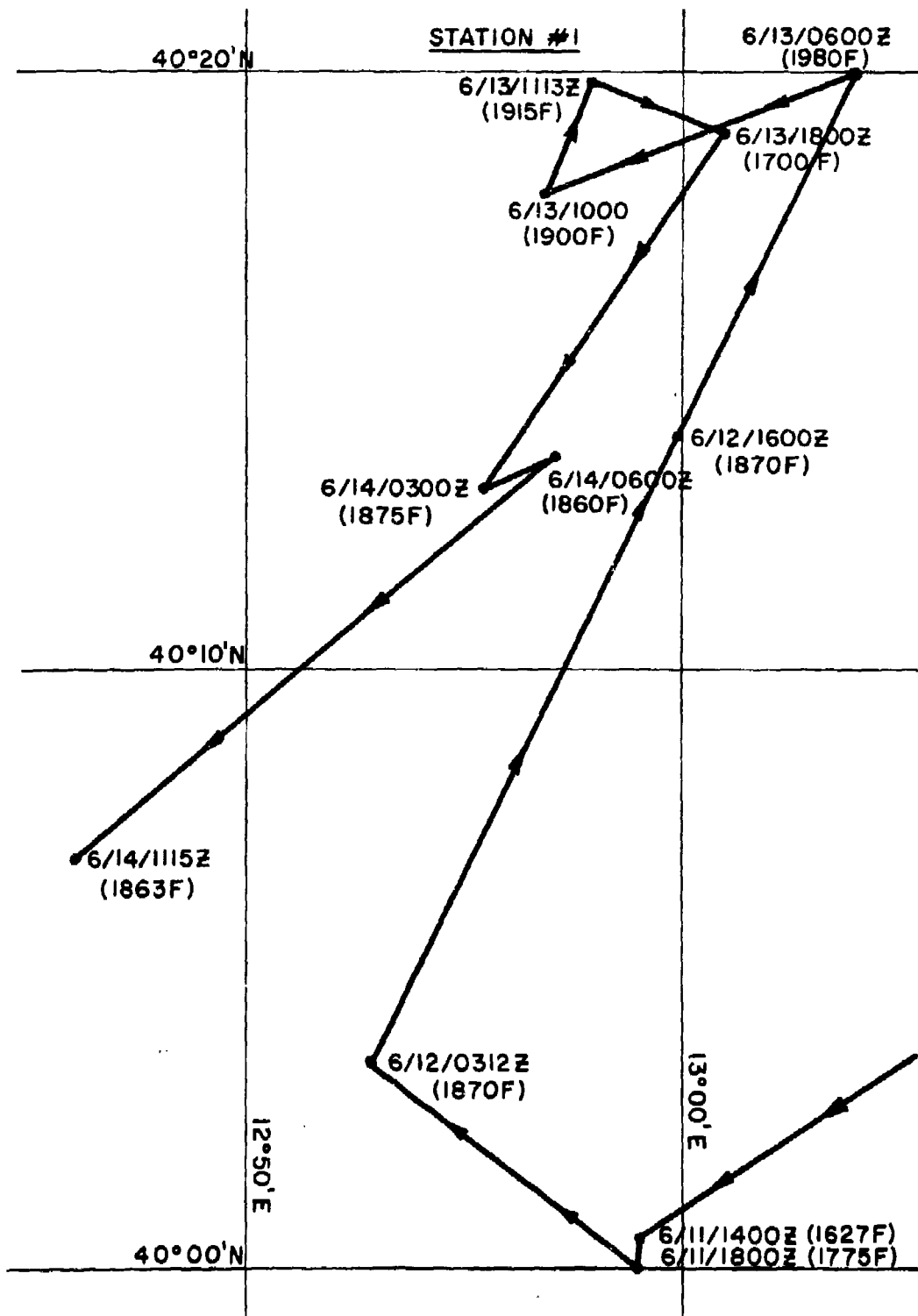

Figure 2. Drift at Station 1.

UNCLASSIFIED

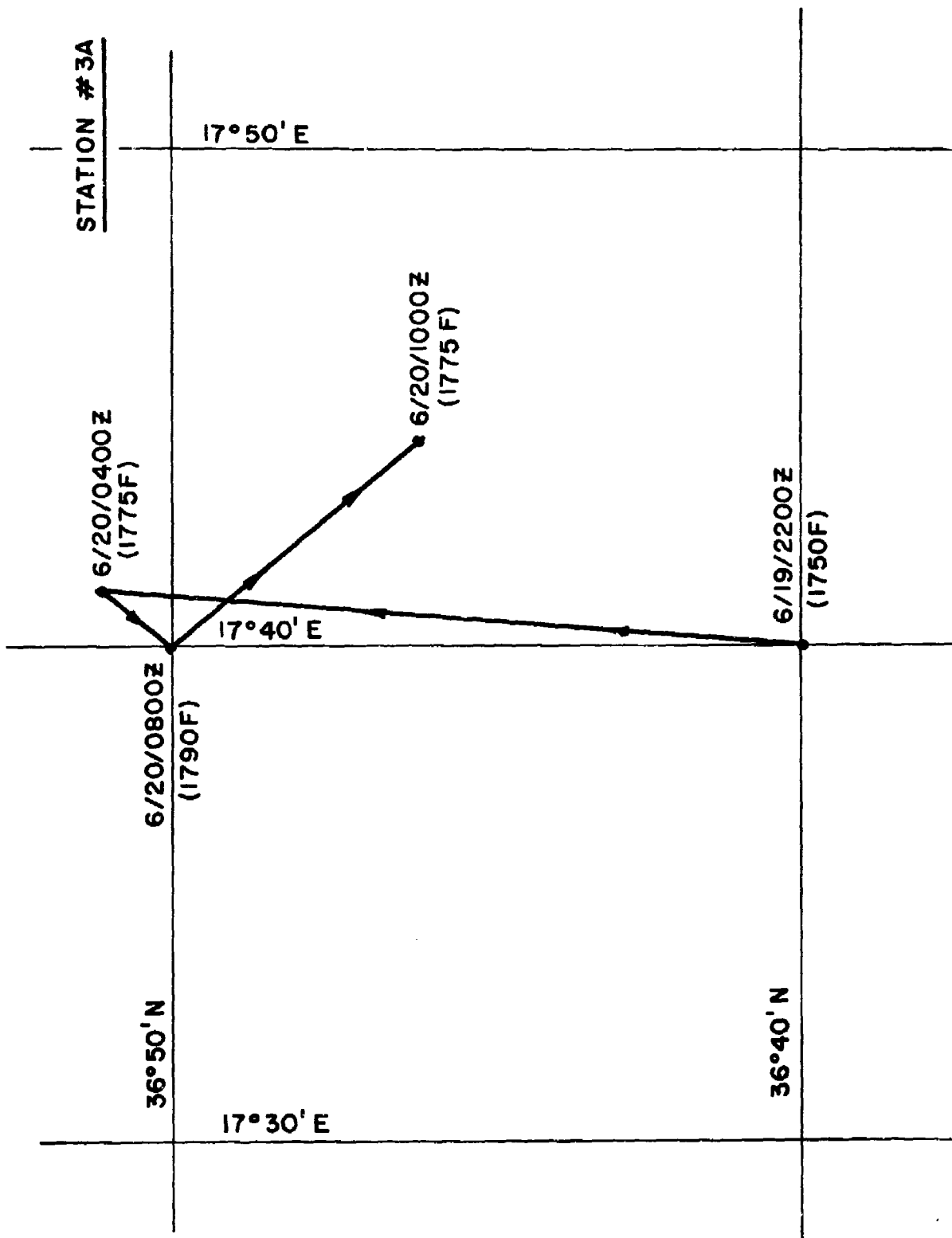

Figure 4. Drift at Station 3A.

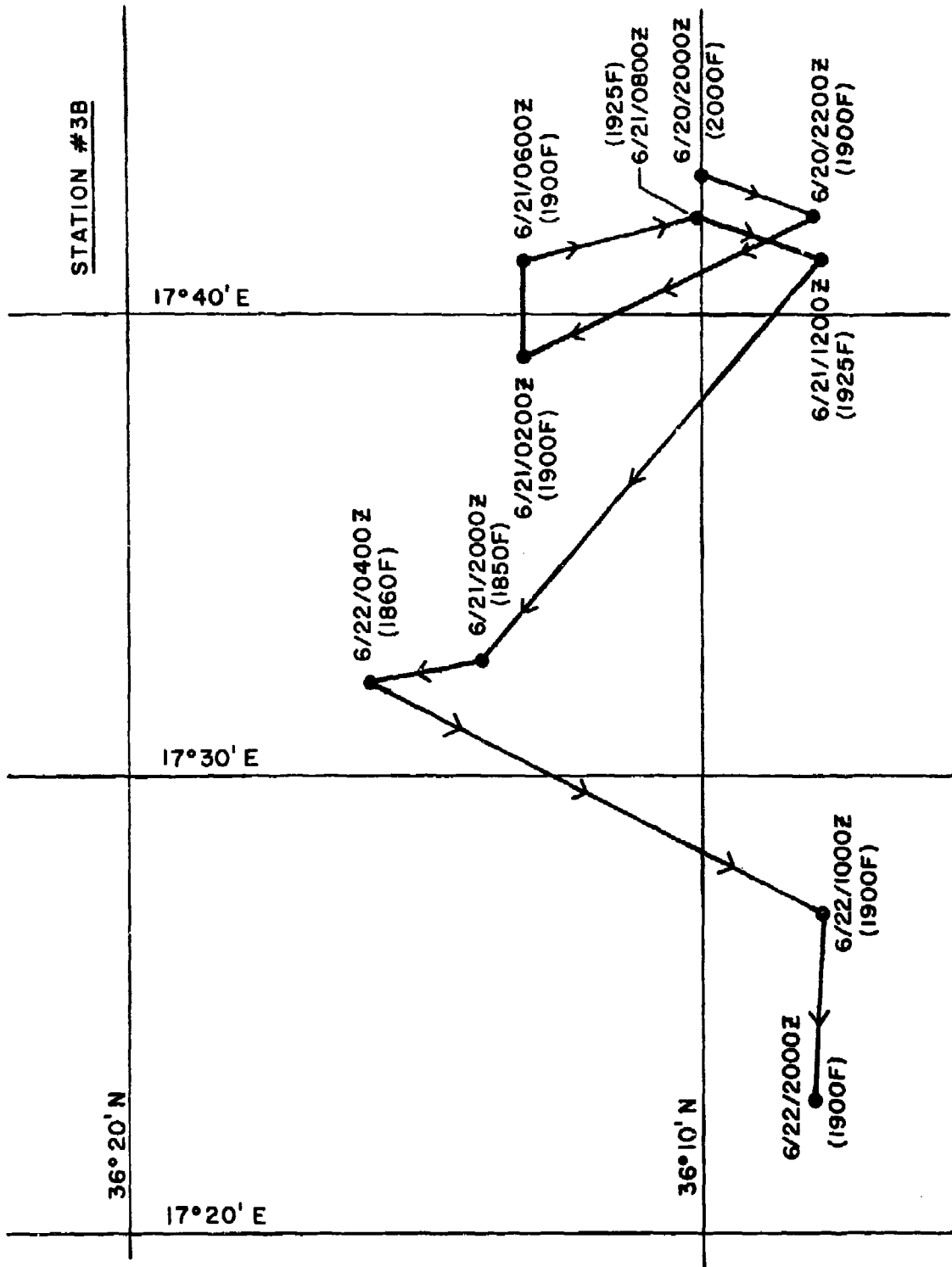

Figure 5. Drift at Station 3B.

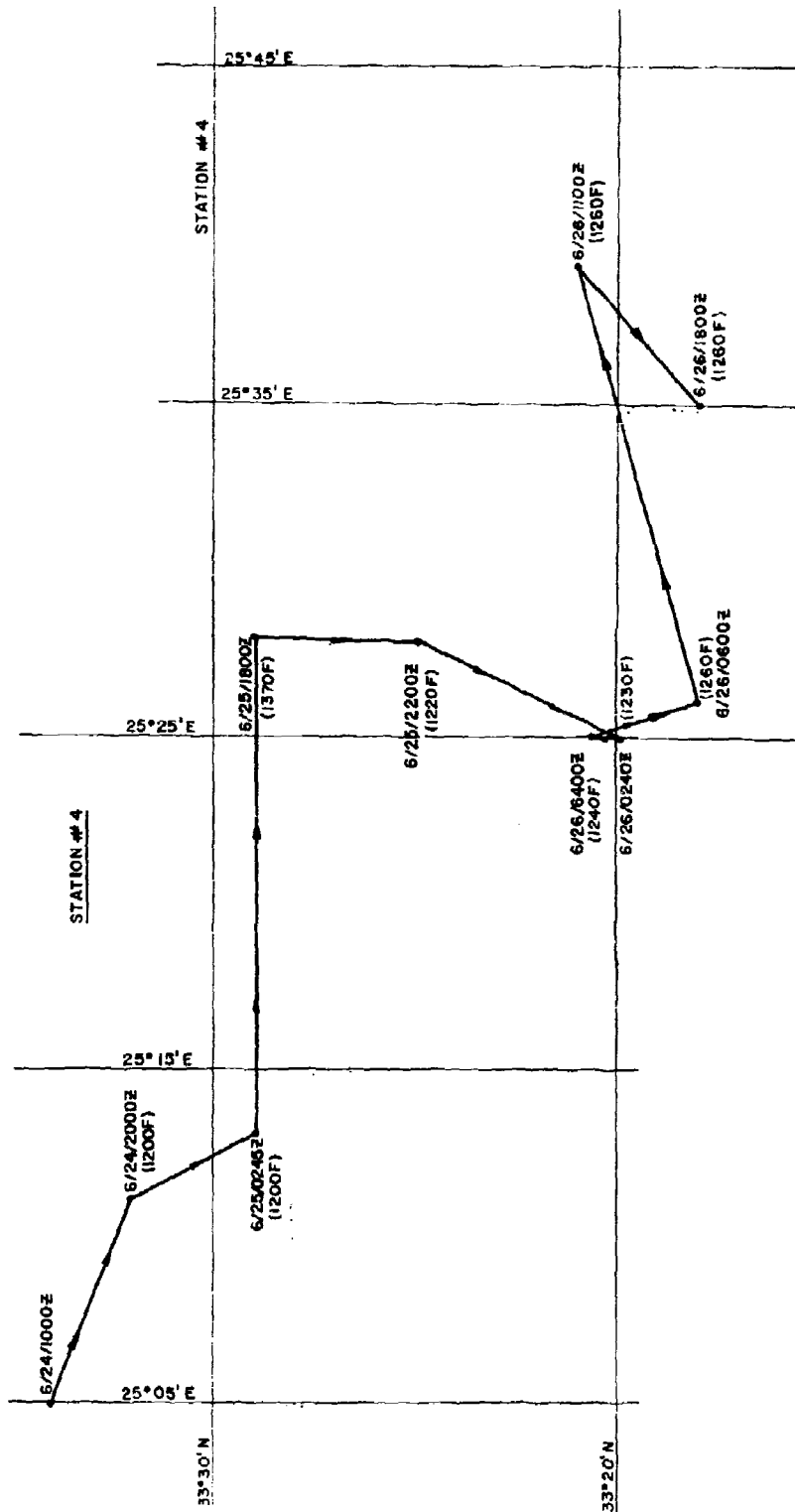

Figure 6. Drift at Station 4.

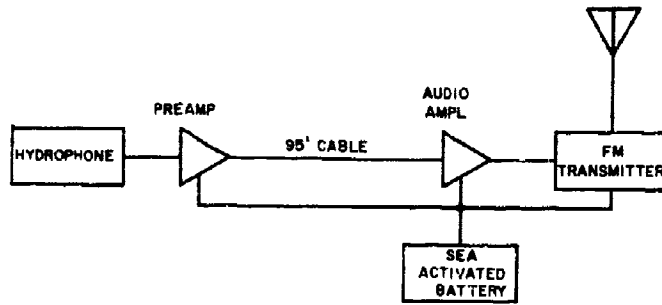

Figure 7. Block diagram of sonobuoy AN/SSQ-48(XN-2).

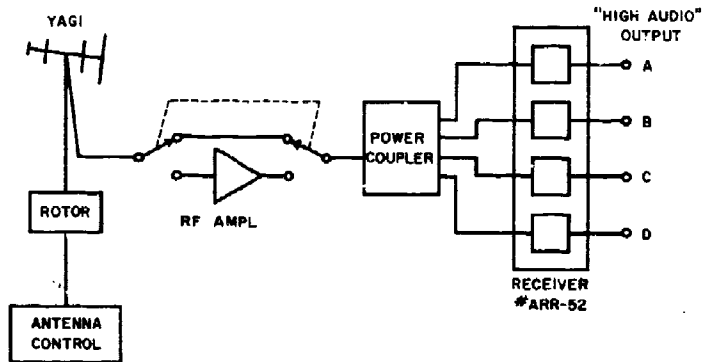
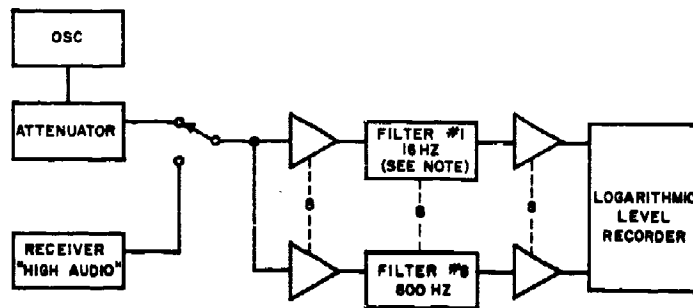

Figure 8. Receiving system.



NOTE: 1/2 OCTAVE FILTERS, CENTER FREQUENCIES OF 18, 32, 63, 90, 180, 280, 360 AND 800HZ.

Figure 9. Ambient noise level recording system.

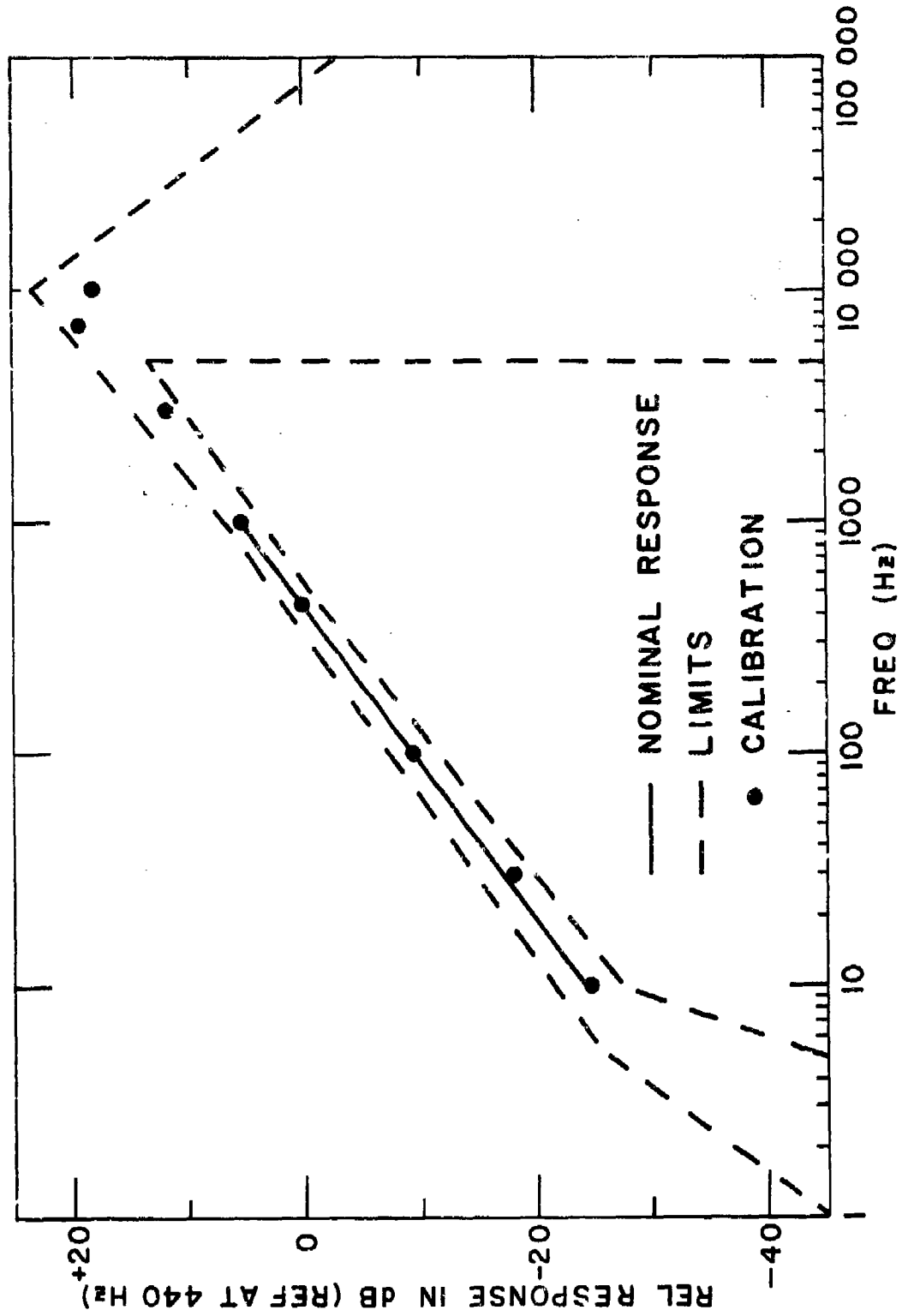

Figure 10. AN/SSQ-48 (XN-2) response curve.

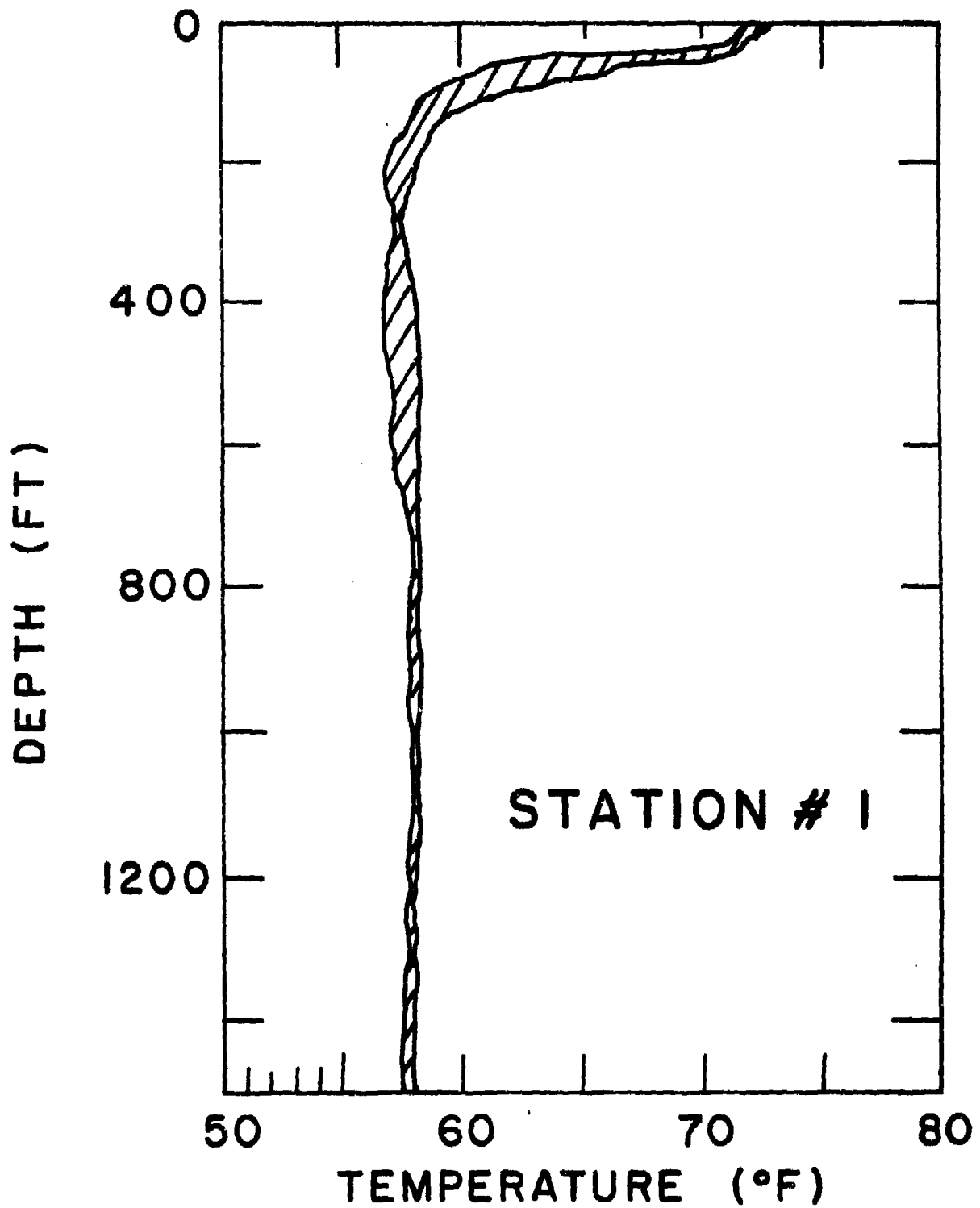

Figure 11. Temperature profile envelope at Station 1.

UNCLASSIFIED

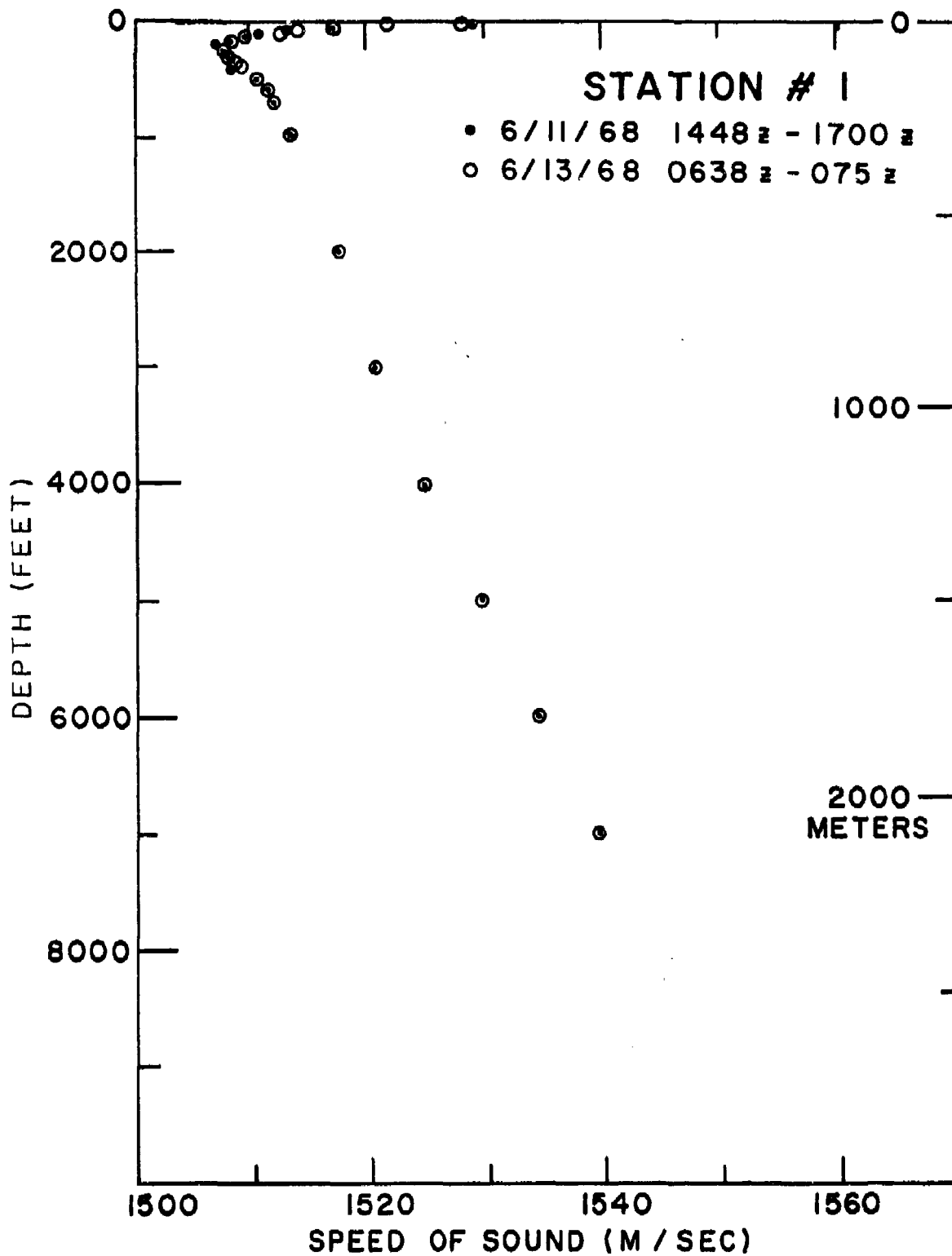

Figure 12. Sound velocity from velocimeter casts for Station 1.

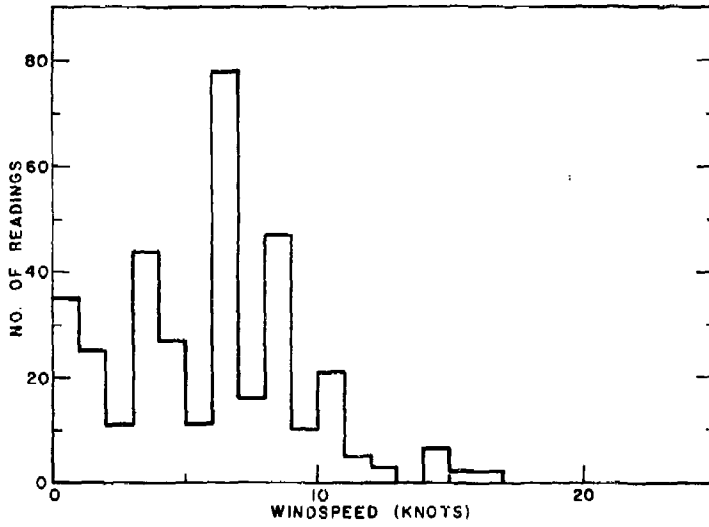

Figure 13. Wind speed distribution at Station 1.

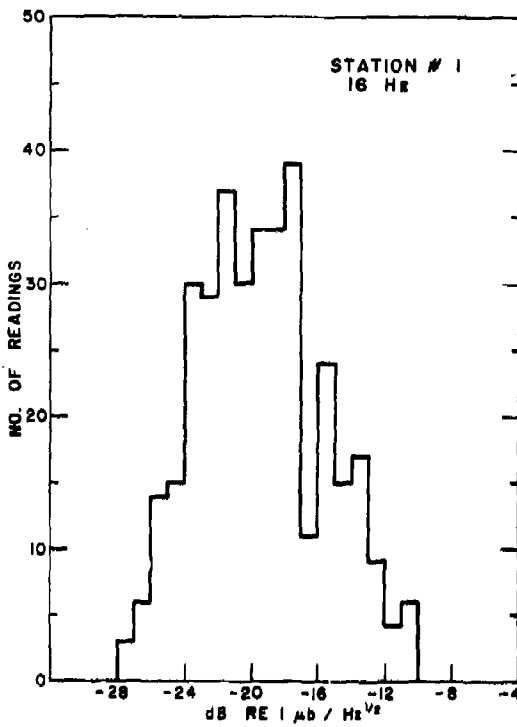

Figure 14. 16 Hz ambient noise distribution at Station 1.

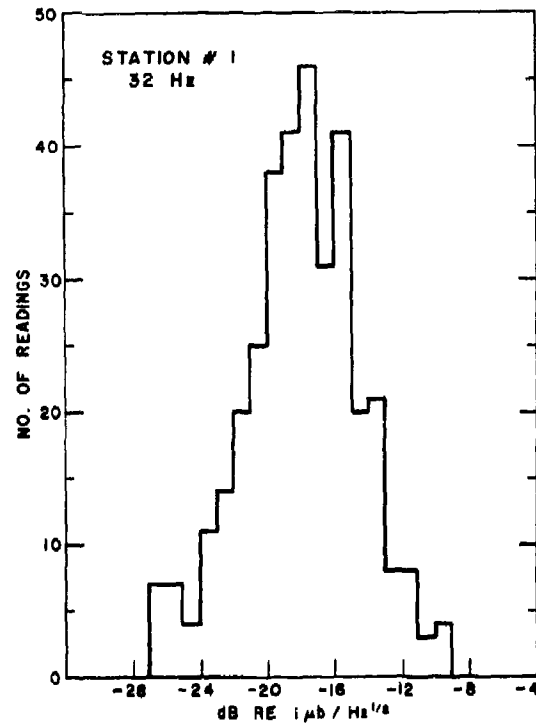

Figure 15. 32 Hz ambient noise distribution at Station 1.

UNCLASSIFIED

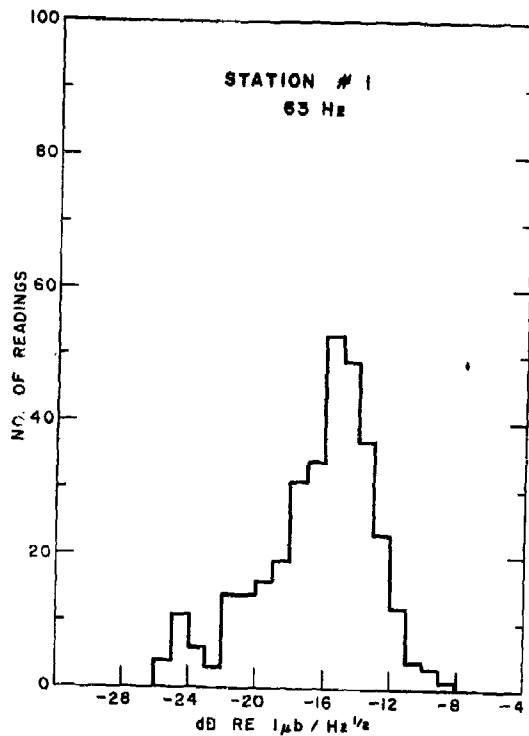

Figure 16. 63 Hz ambient noise distribution at Station 1.

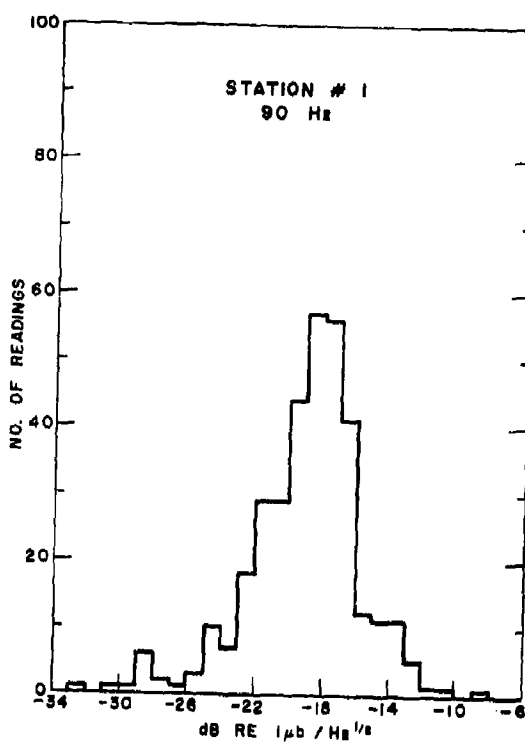

Figure 17. 90 Hz ambient noise distribution at Station 1.

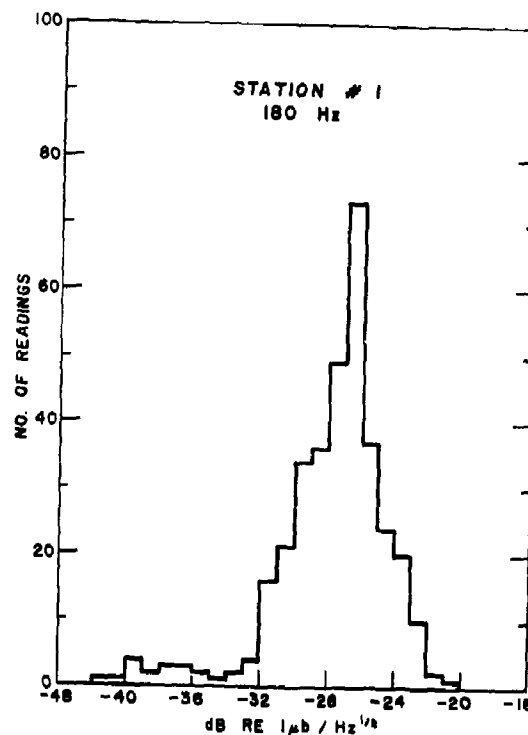

Figure 18. 180 Hz ambient noise distribution at Station 1.

UNCLASSIFIED

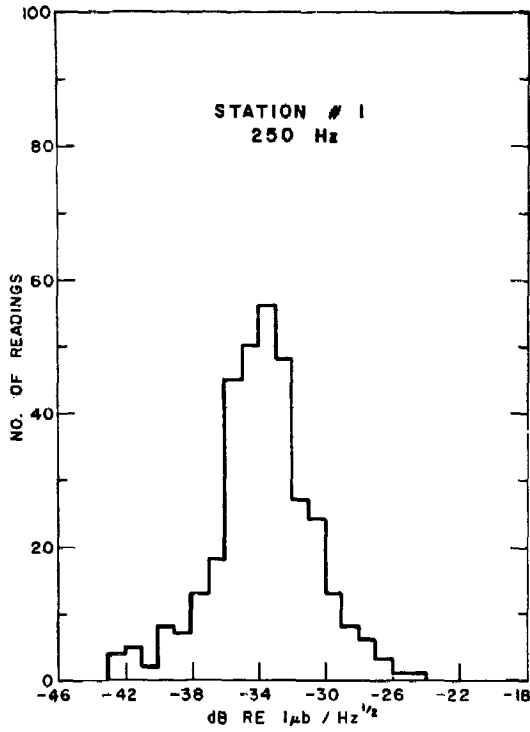

Figure 19. 250 Hz ambient noise distribution at Station 1.

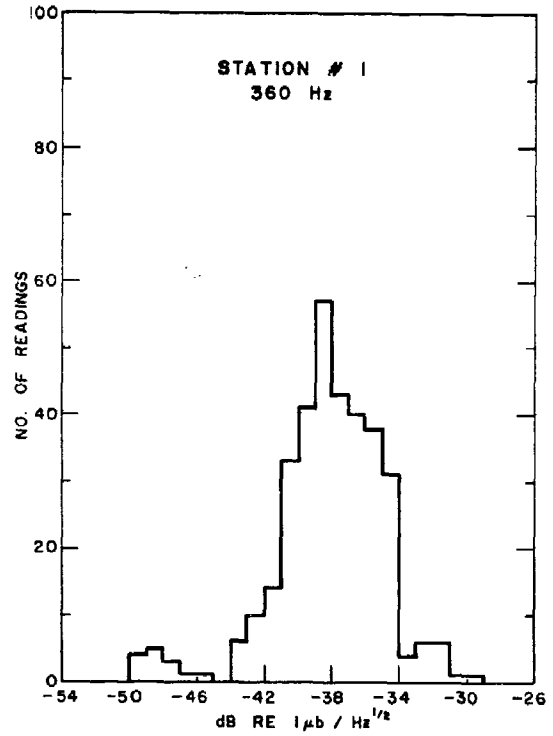

Figure 20. 360 Hz ambient noise distribution at Station 1.

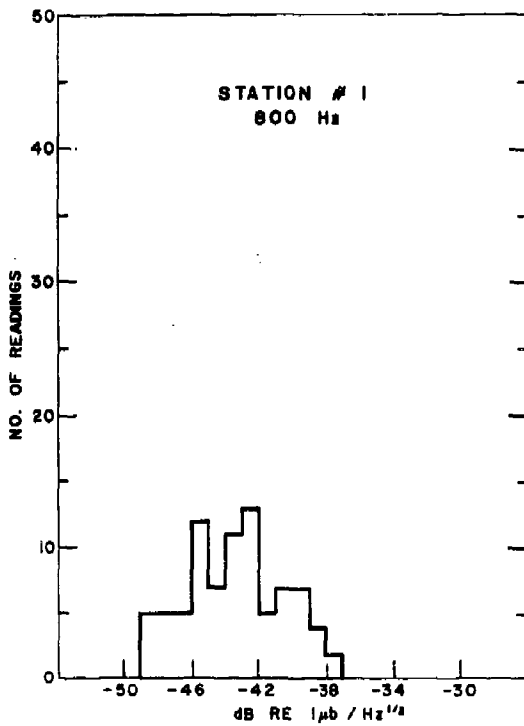

Figure 21. 800 Hz ambient noise distribution at Station 1.

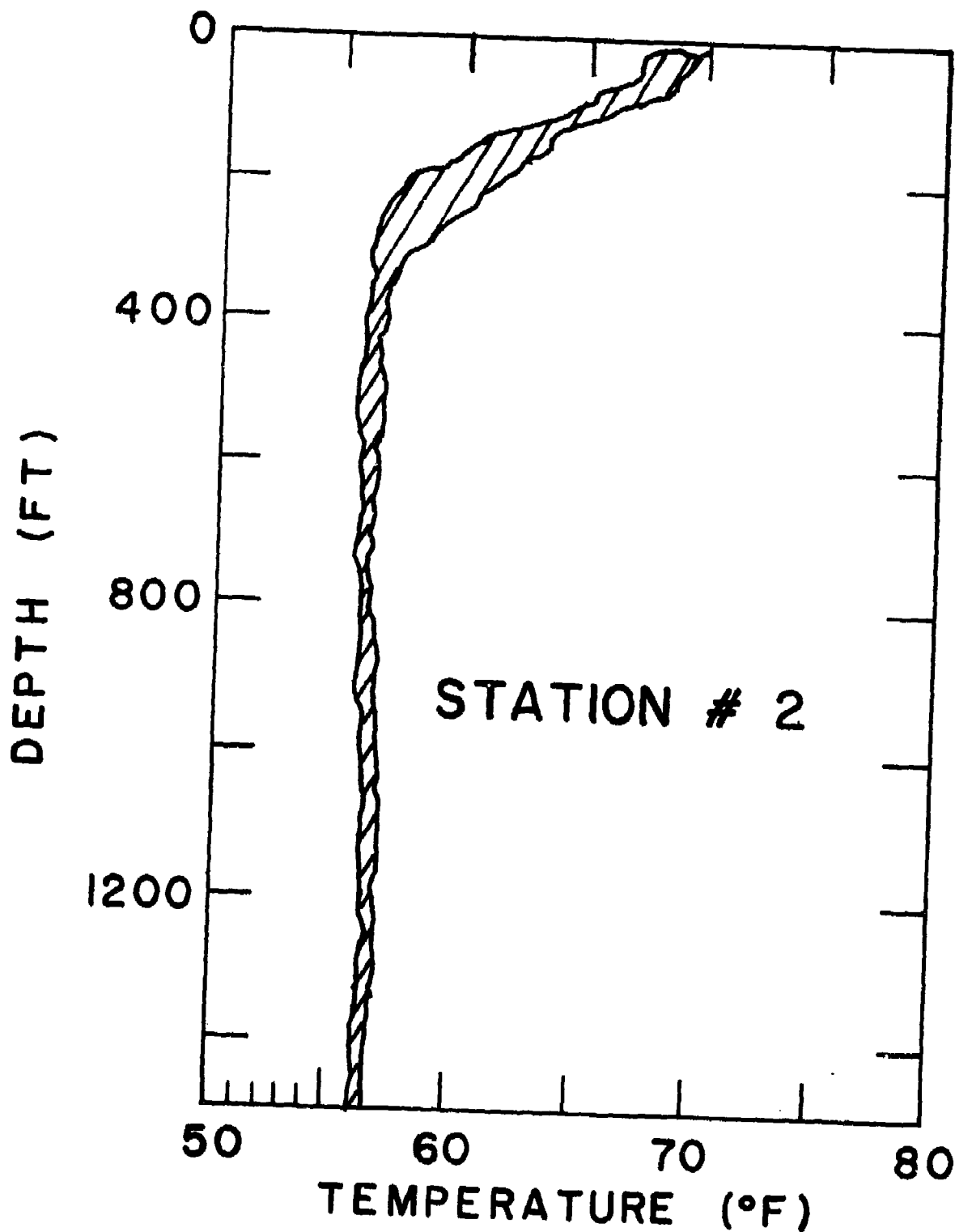

Figure 22. Temperature profile envelope at Station 2.

UNCLASSIFIED

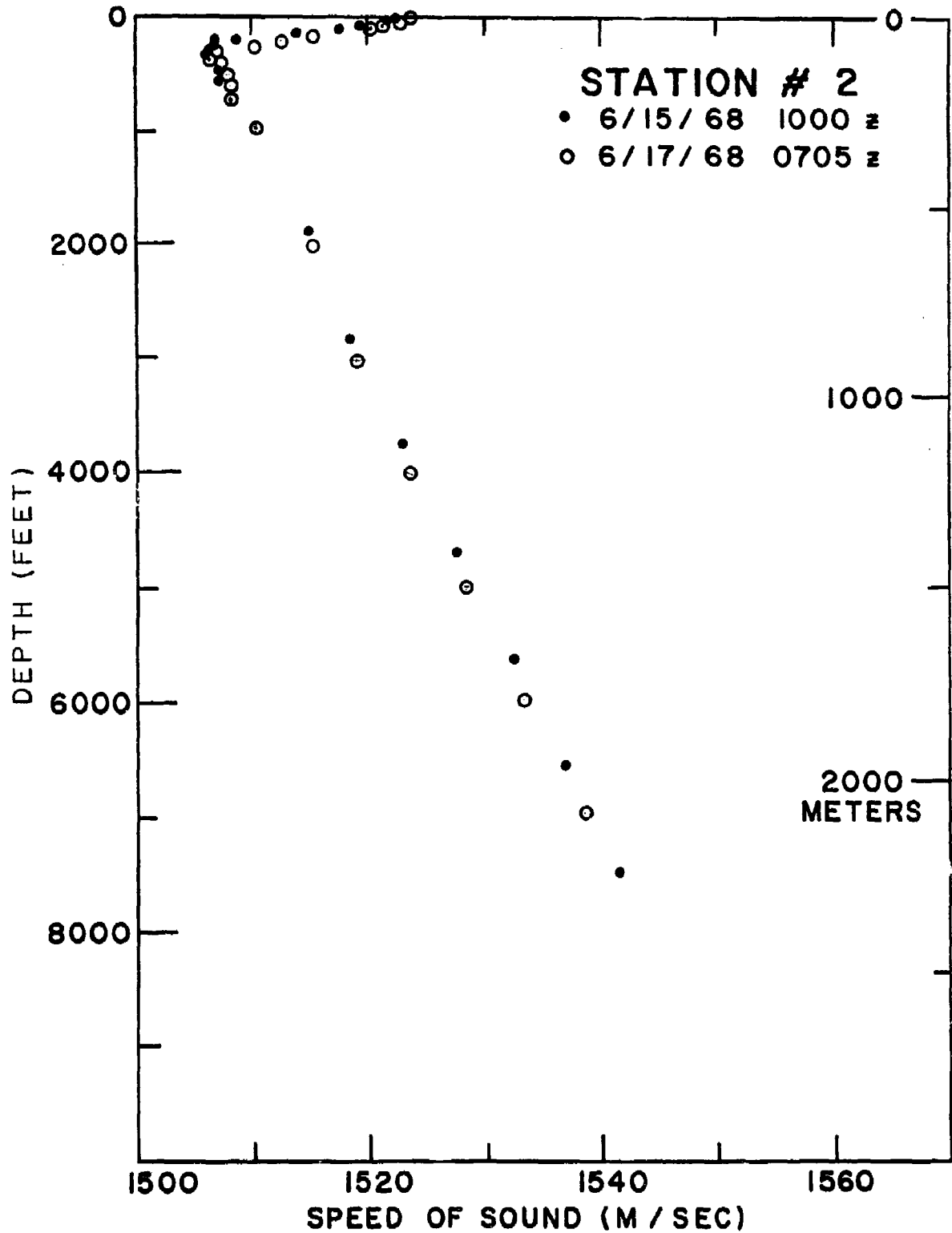

Figure 23. Sound velocity from velocimeter cast for Station 2.

UNCLASSIFIED

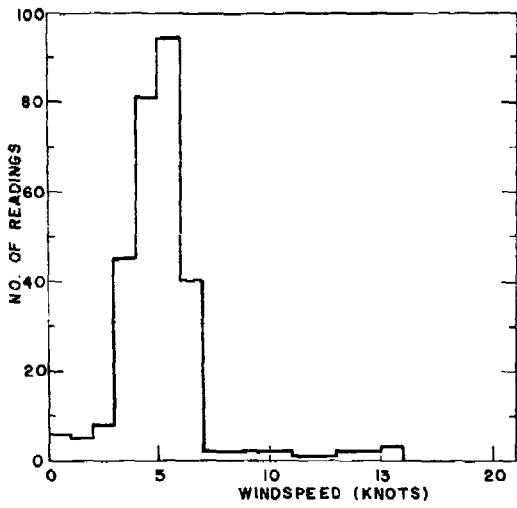

Figure 24. Windspeed distribution at Station 2.

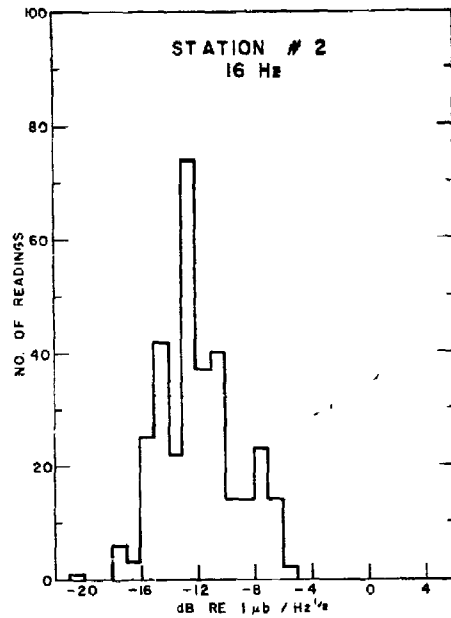

Figure 25. 16 Hz ambient noise distribution at Station 2.

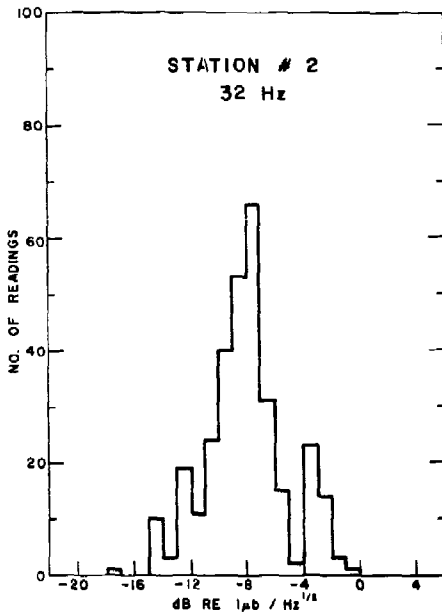

Figure 26. 32 Hz ambient noise distribution at Station 2.

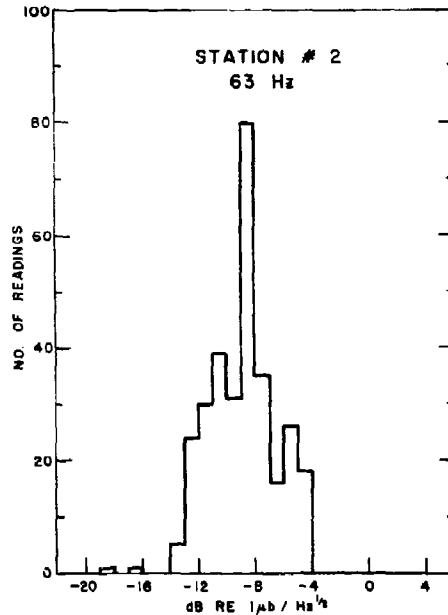

Figure 27. 63 Hz ambient noise distribution at Station 2.

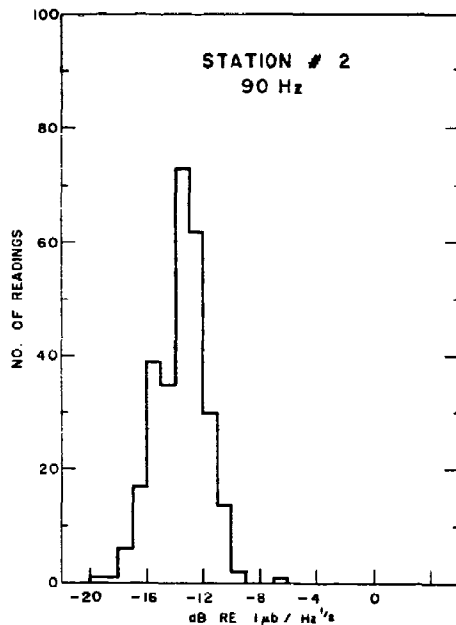

Figure 28. 90 Hz ambient noise distribution at Station 2.

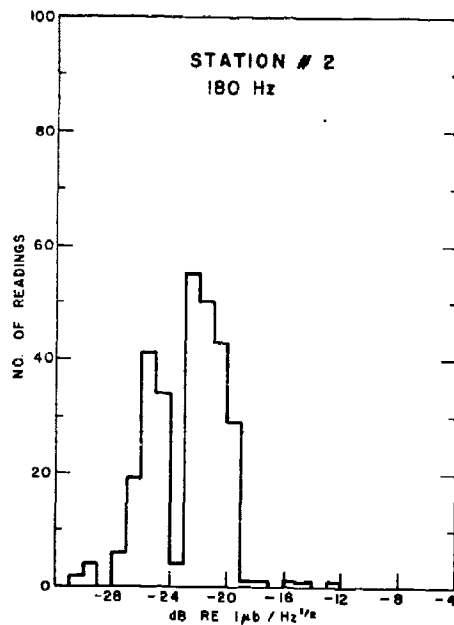

Figure 29. 180 Hz ambient noise distribution at Station 2.

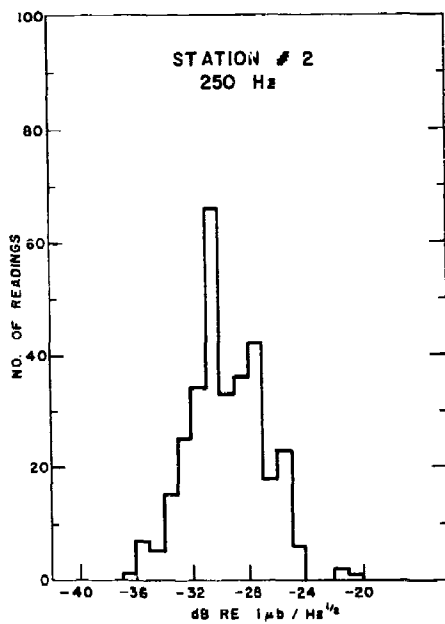

Figure 30. 250 Hz ambient noise distribution at Station 2.

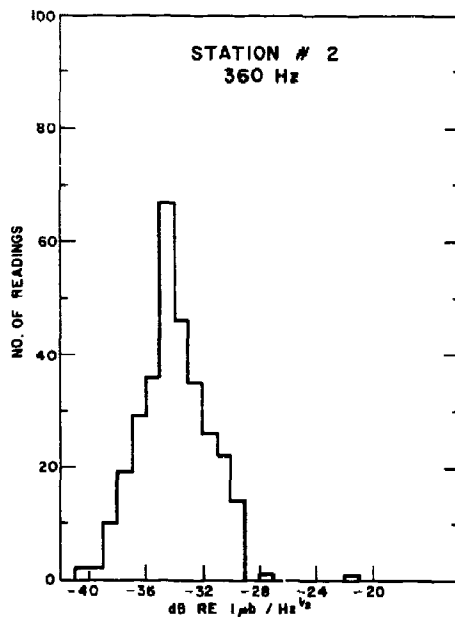

Figure 31. 360 Hz ambient noise distribution at Station 2.

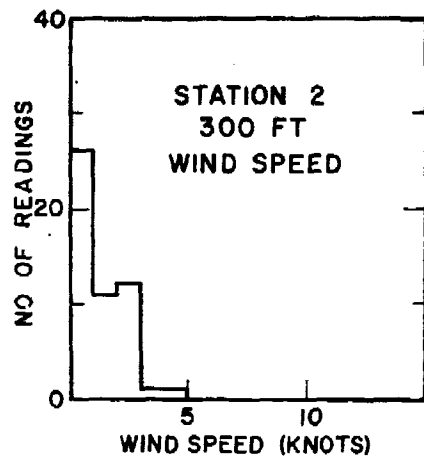

Figure 32. Distribution of windspeed for Station 2, with hydrophone at 300 ft depth.

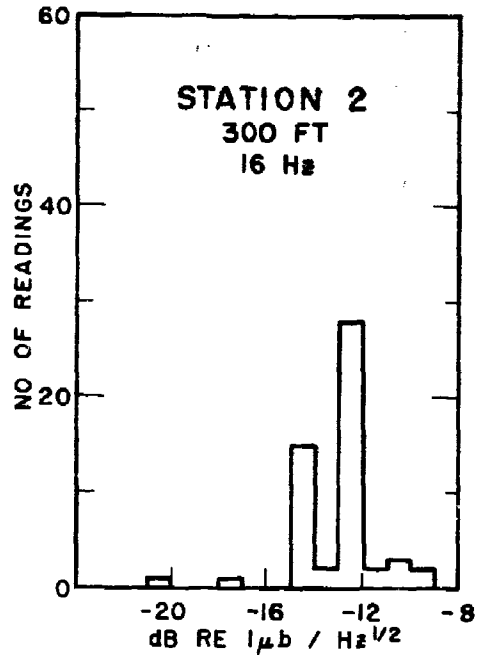

Figure 33. 16 Hz ambient noise distribution at Station 2 and 300 ft depth.

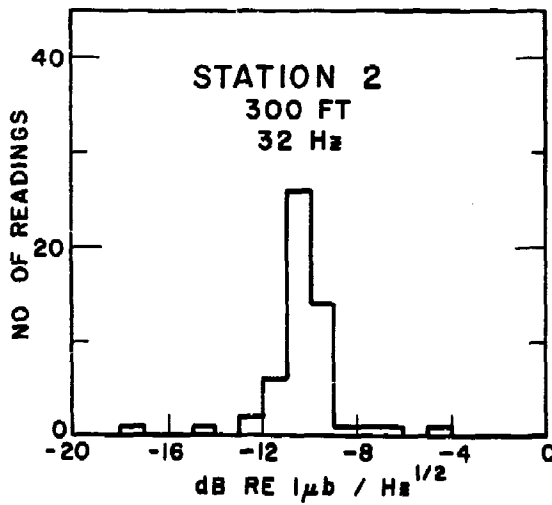

Figure 34. 32 Hz ambient noise distribution at Station 2 and 300 ft depth.

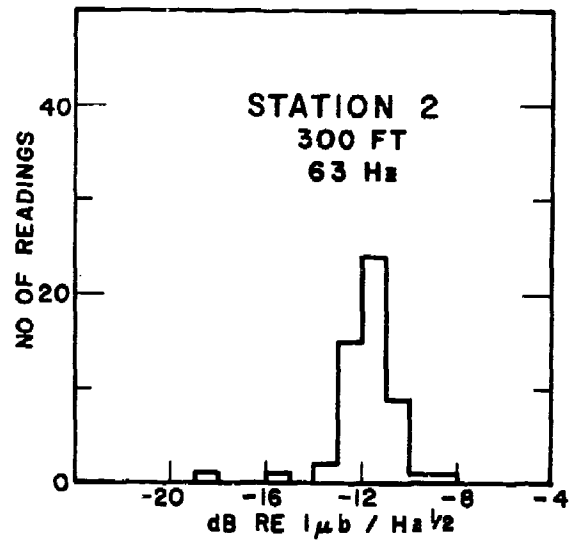

Figure 35. 63 Hz ambient noise distribution at Station 2 and 300 ft depth.

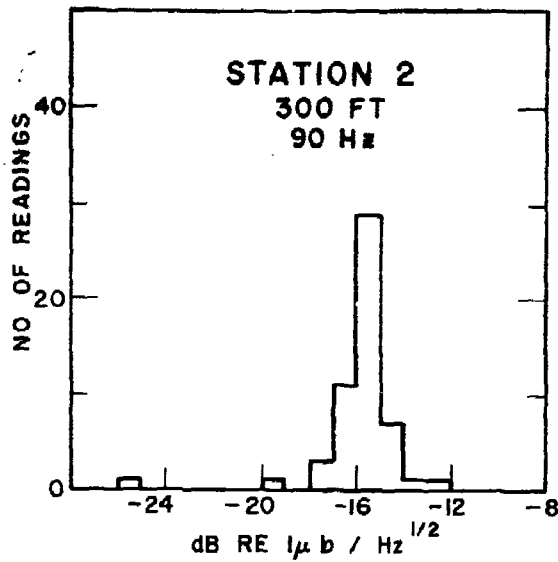

Figure 36. 90 Hz ambient noise distribution at Station 2 and 300 ft depth.

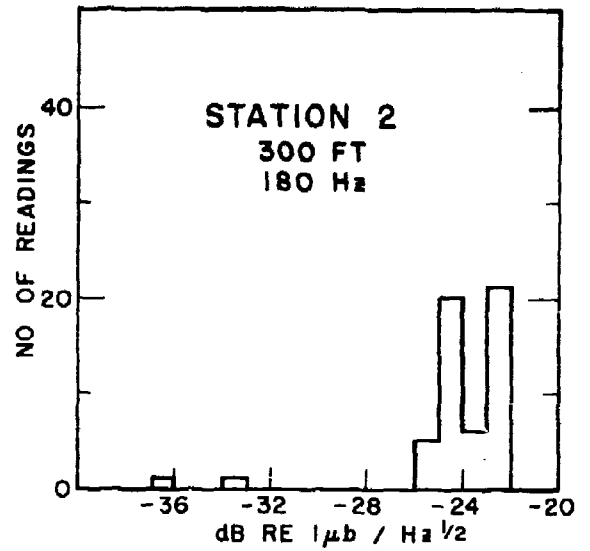

Figure 37. 180 Hz ambient noise distribution at Station 2 and 300 ft depth.

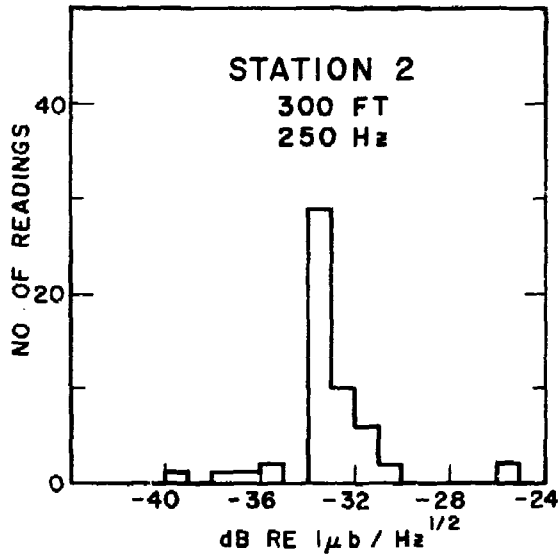

Figure 38. 250 Hz ambient noise distribution at Station 2 and 300 ft depth.

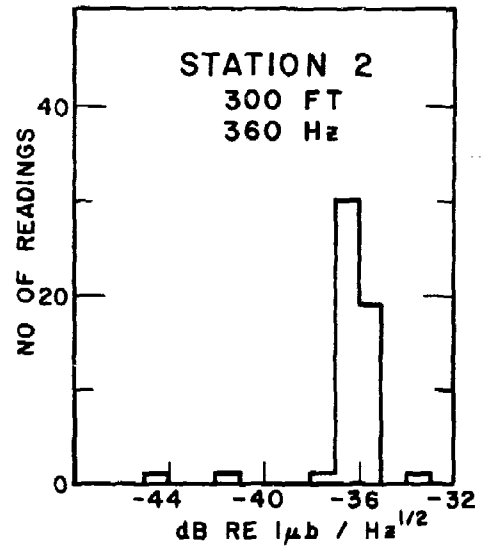

Figure 39. 360 Hz ambient noise distribution at Station 2 and 300 ft depth.

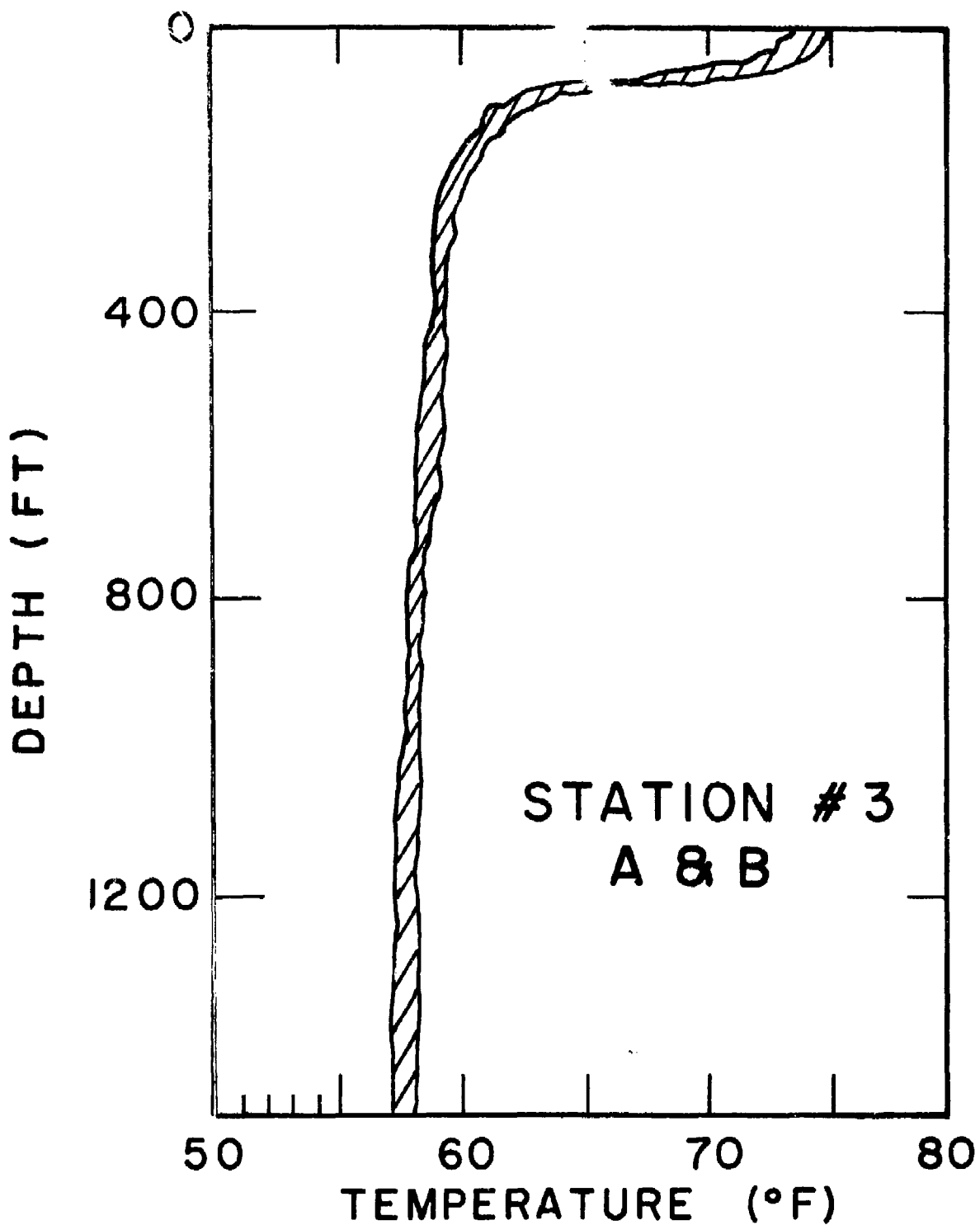

Figure 40. Temperature profile envelope for Stations 3A and 3B.

UNCLASSIFIED

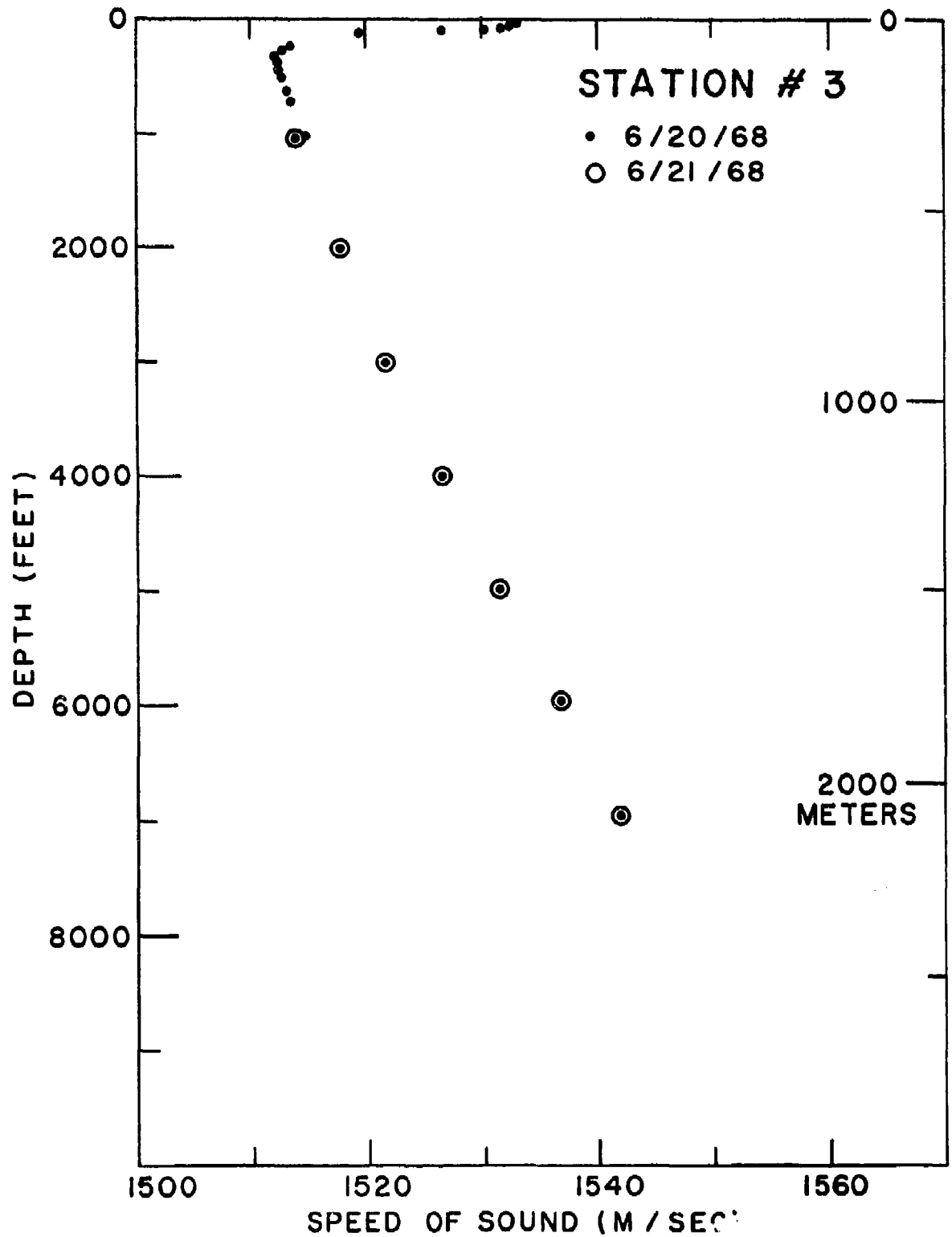

Figure 41. Sound velocity from velocimeter cast for Stations 3A and 3B.

UNCLASSIFIED

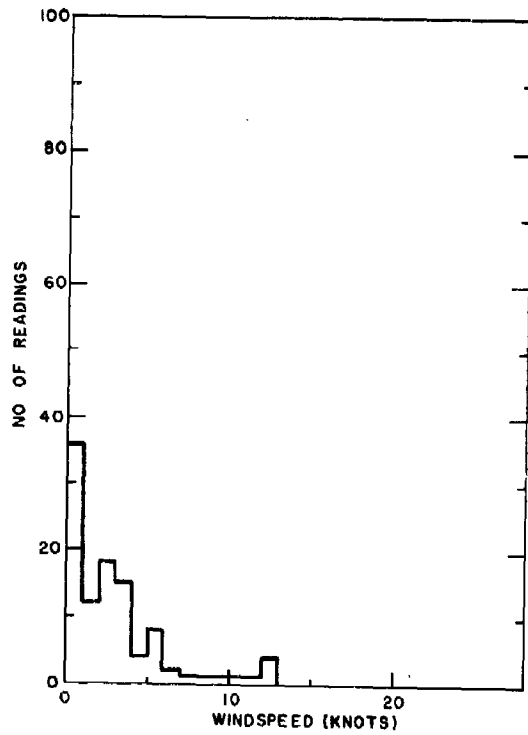

Figure 42. Distribution of windspeed at Station 3A.

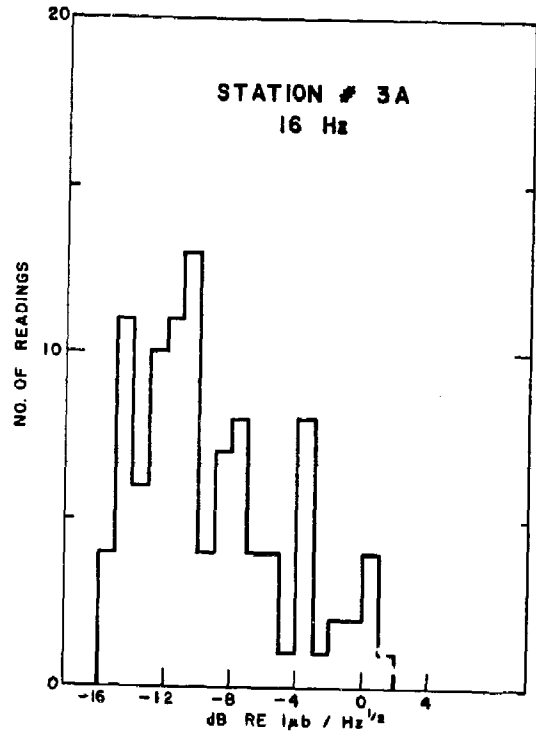

Figure 43. 16 Hz ambient noise distribution at Station 3A.

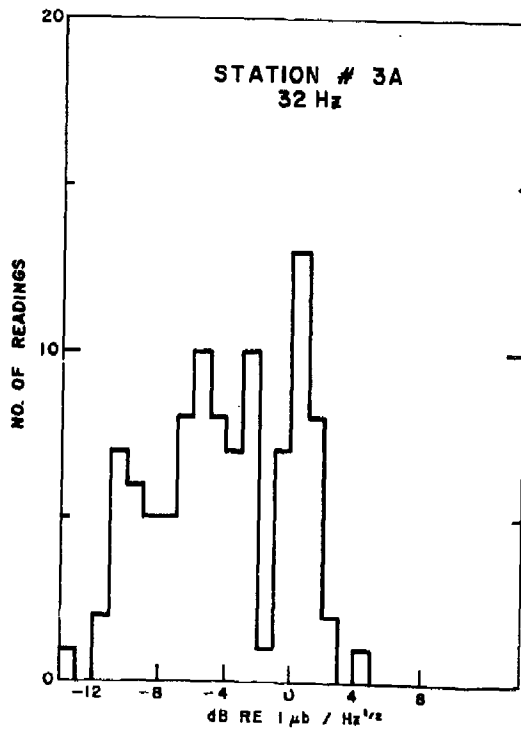

Figure 44. 32 Hz ambient noise distribution at Station 3A.

UNCLASSIFIED

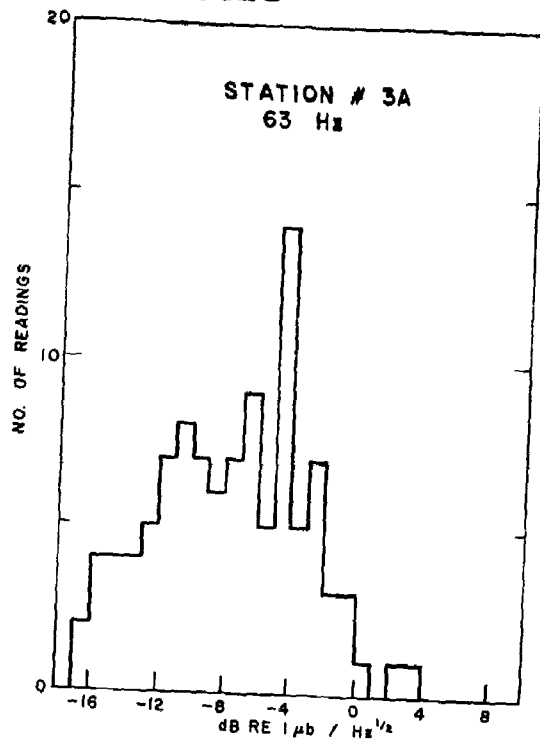

Figure 45. 63 Hz ambient noise distribution at Station 3A.

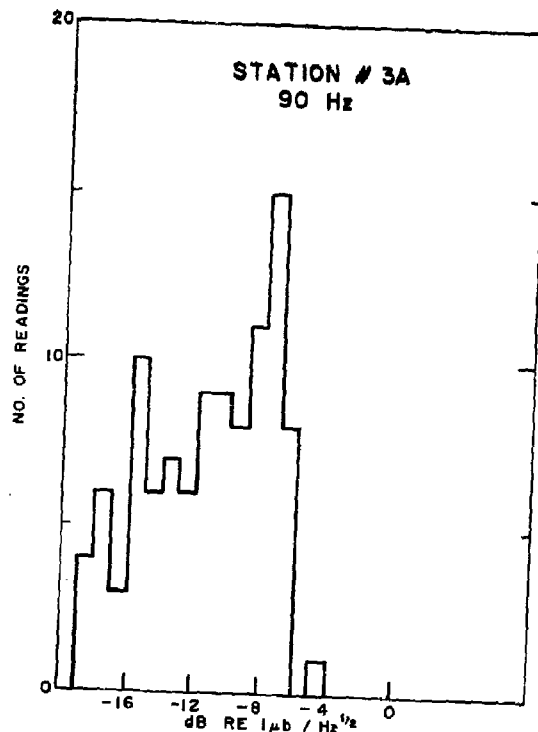

Figure 46. 90 Hz ambient noise distribution at Station 3A.

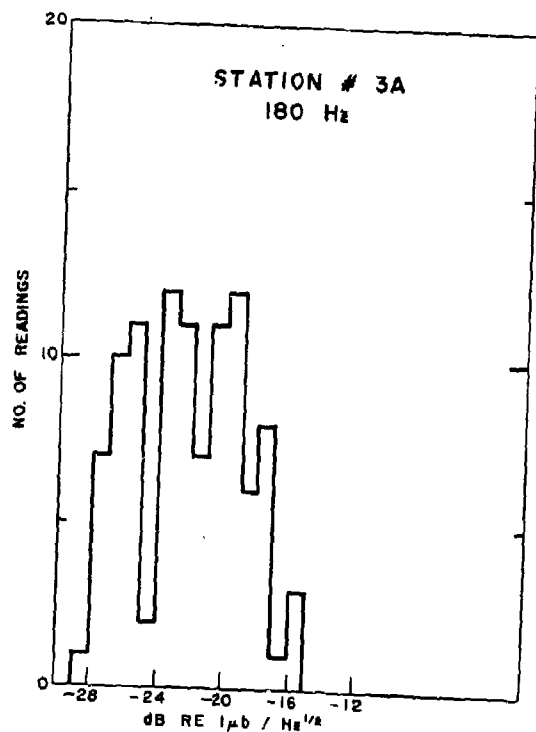

Figure 47. 180 Hz ambient noise distribution at Station 3A.

UNCLASSIFIED

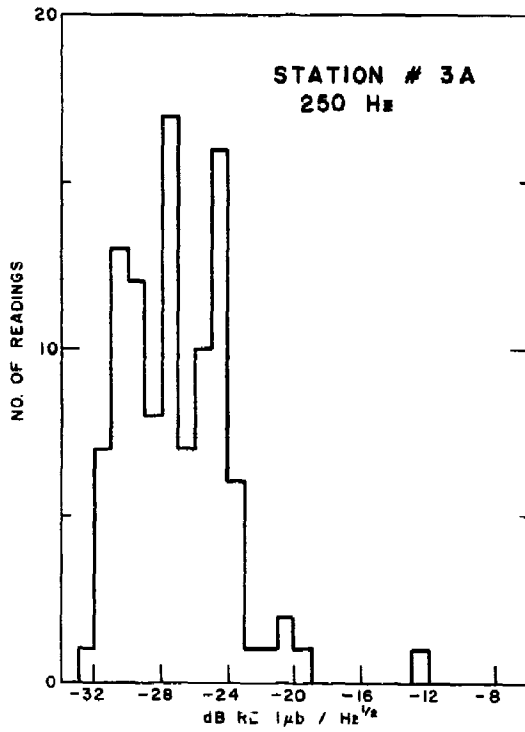

Figure 48. 250 Hz ambient noise distribution at Station 3A.

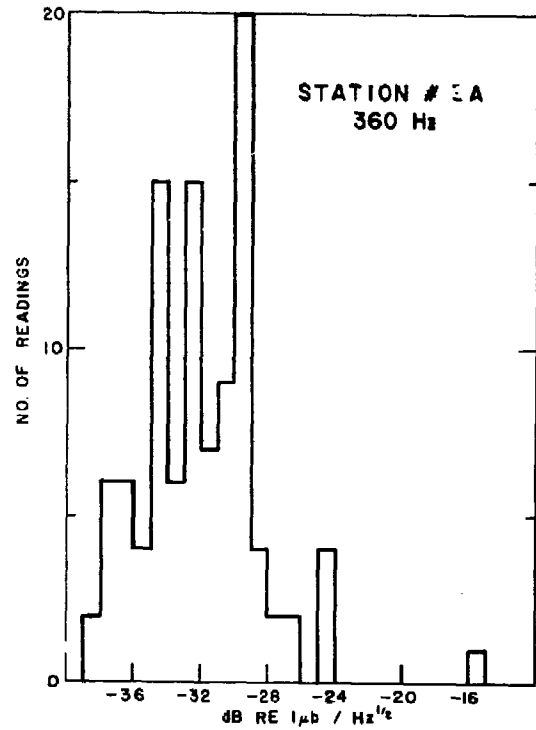

Figure 49. 360 Hz ambient noise distribution at Station 3A.

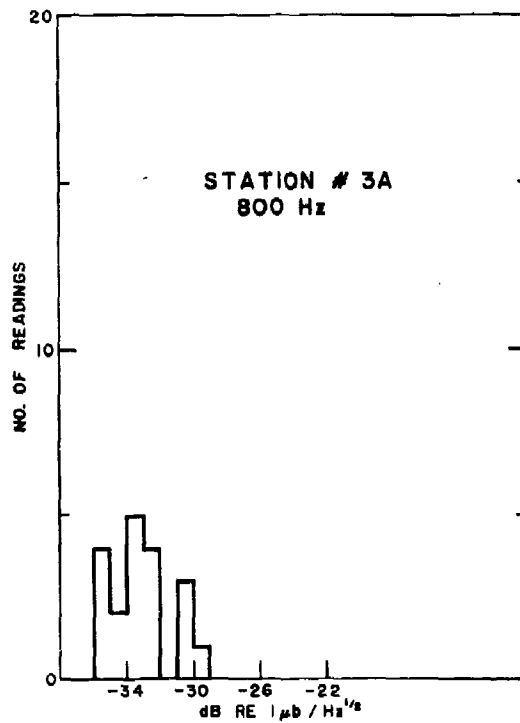

Figure 50. 800 Hz ambient noise distribution at Station 3A.

UNCLASSIFIED

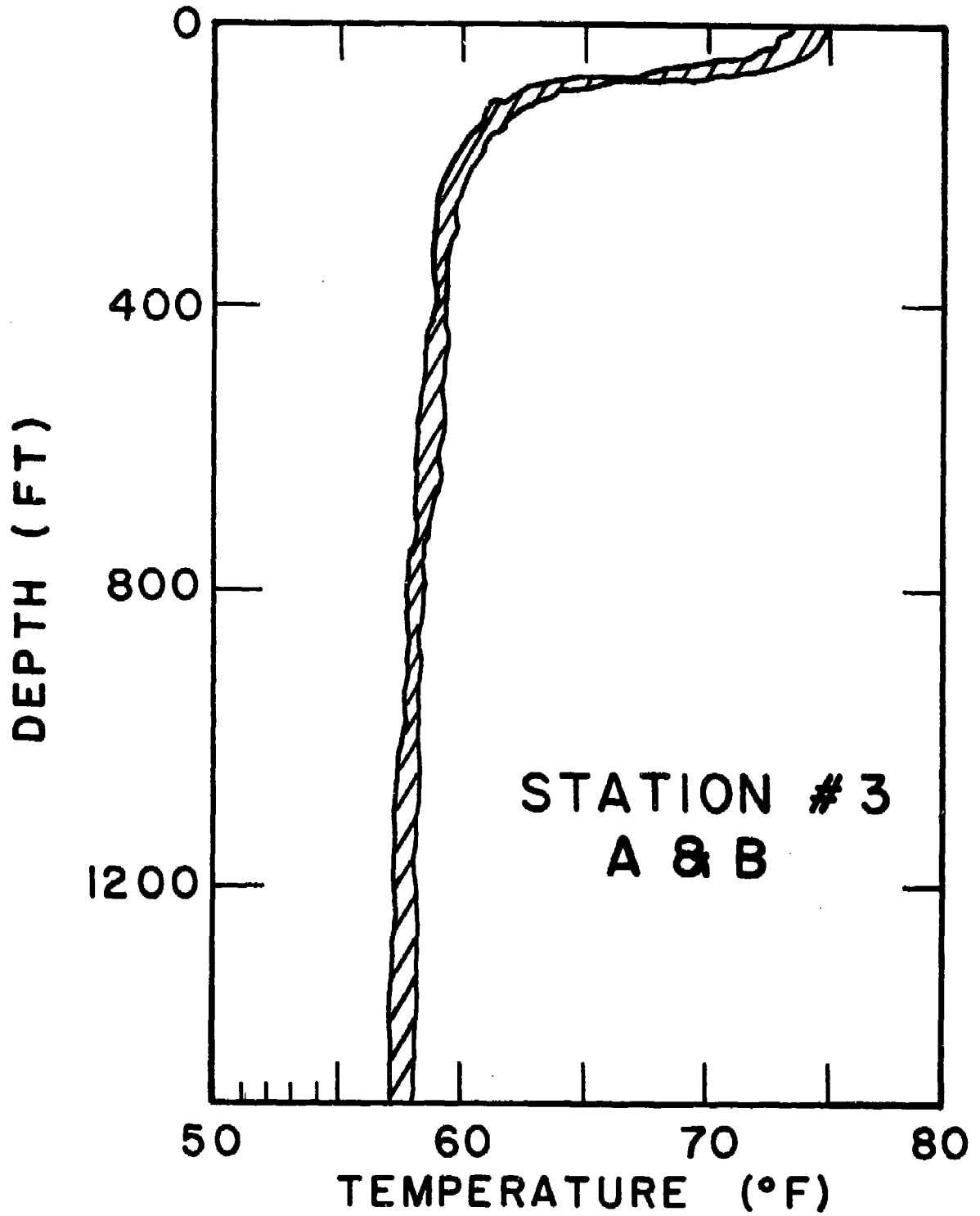

Figure 51. Temperature profile envelope for Stations 3A and 3B.

UNCLASSIFIED

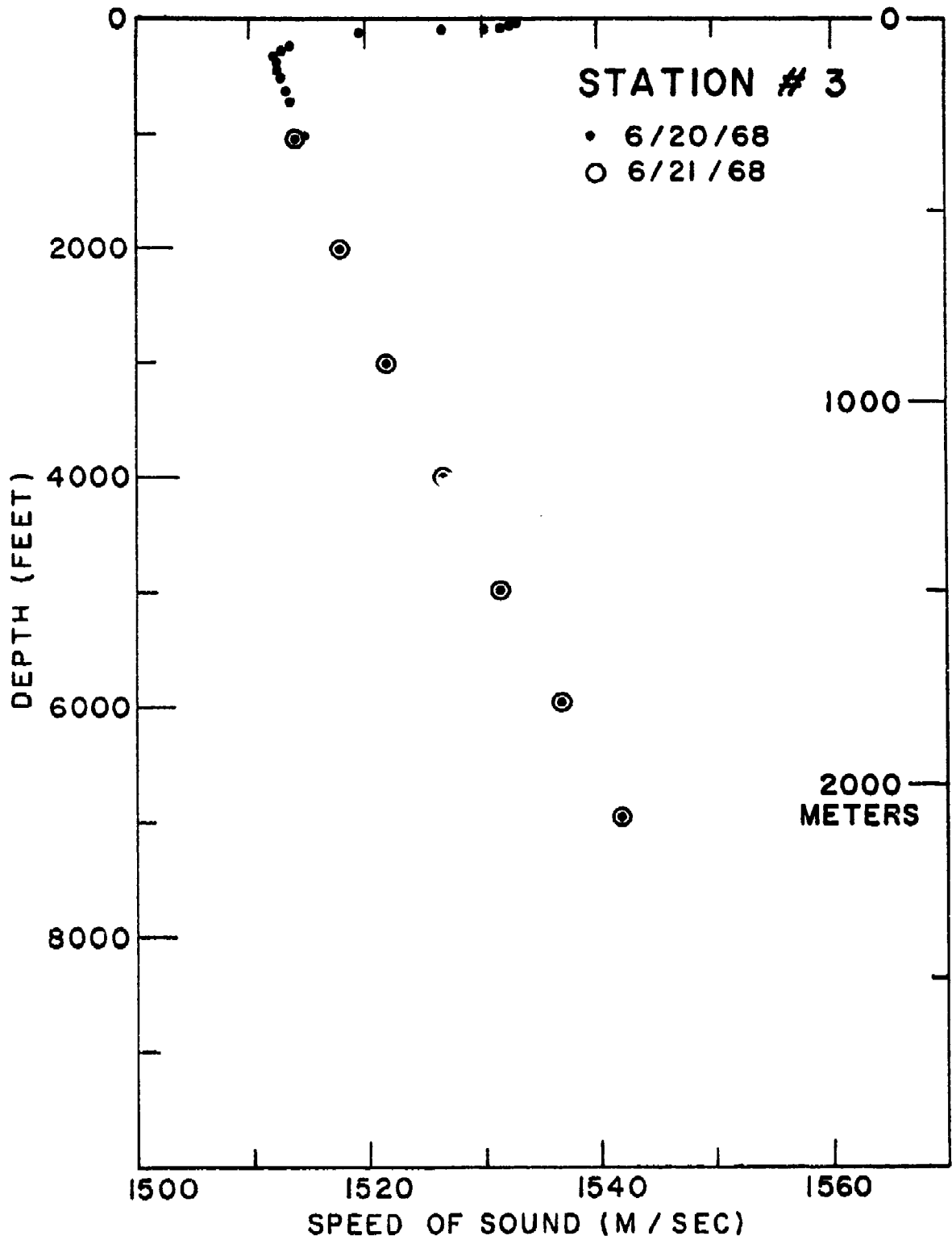

Figure 52. Sound velocity from velocimeter cast for Stations 3A and 3B.

UNCLASSIFIED

UNCLASSIFIED

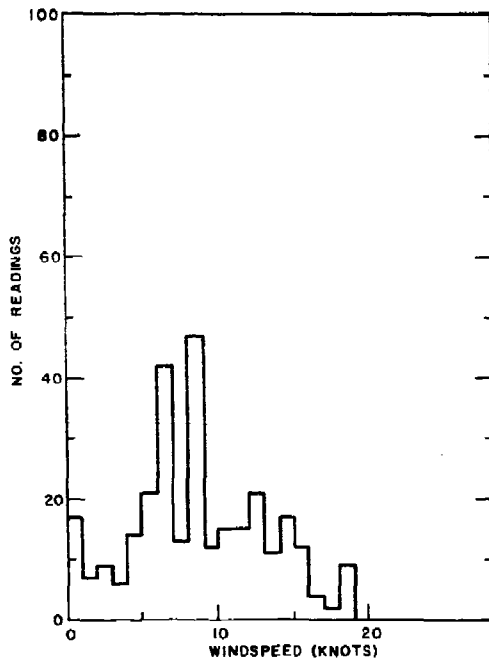

Figure 53. Distribution of windspeed for Station 3B.

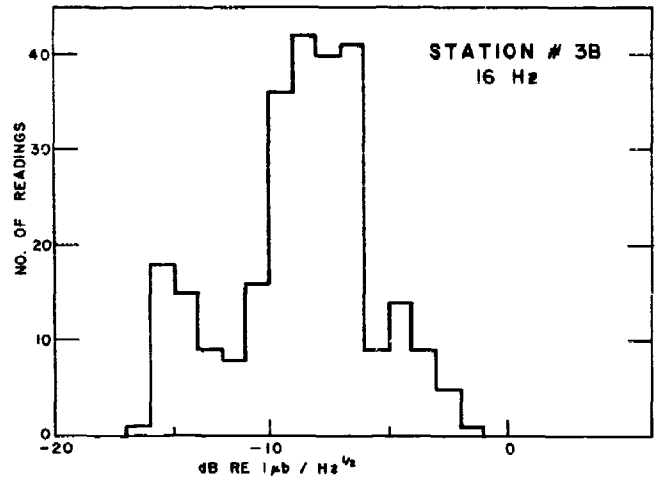

Figure 54. 16 Hz ambient noise distribution at Station 3B.

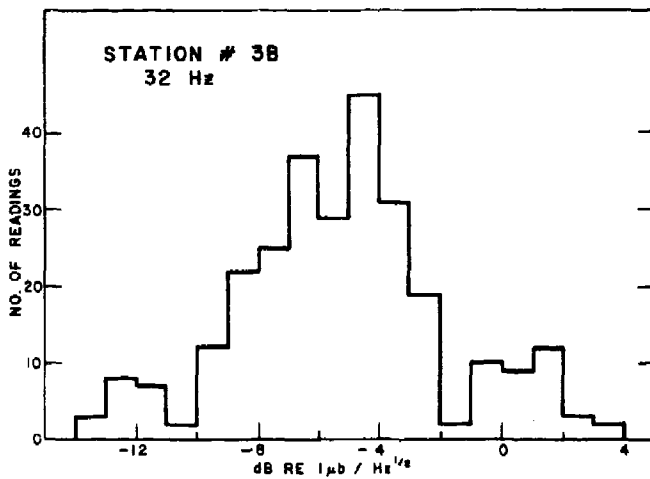

Figure 55. 32 Hz ambient noise distribution at Station 3B.

UNCLASSIFIED

UNCLASSIFIED

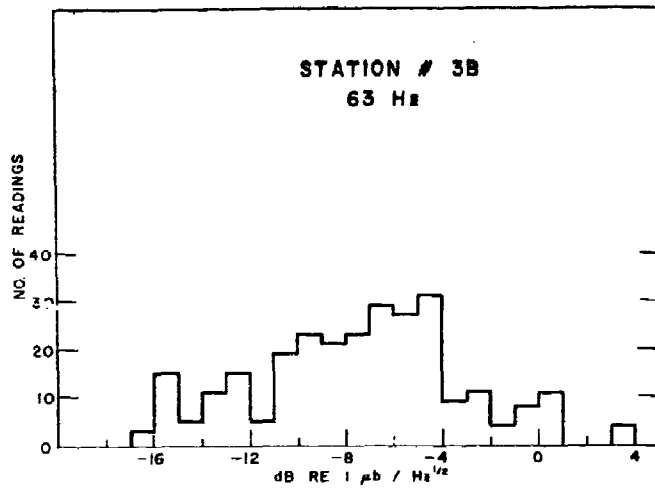

Figure 56. 63 Hz ambient noise distribution at Station 3B.

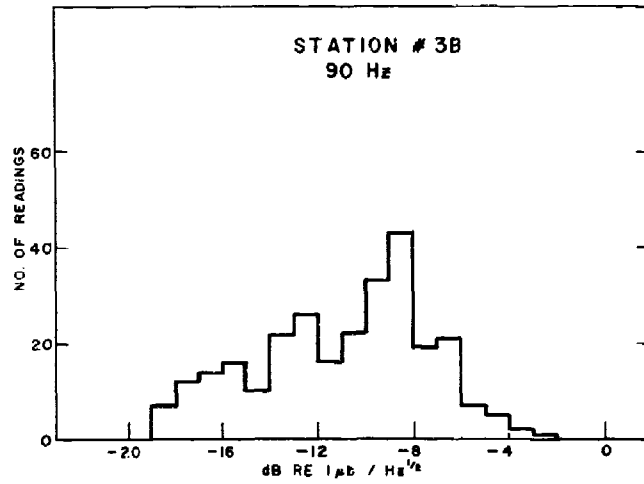

Figure 57. 90 Hz ambient noise distribution at Station 3B.

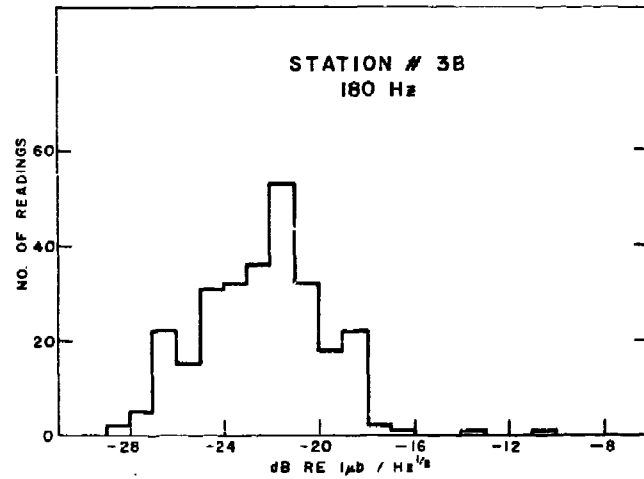

Figure 58. 180 Hz ambient noise distribution at Station 3B.

UNCLASSIFIED

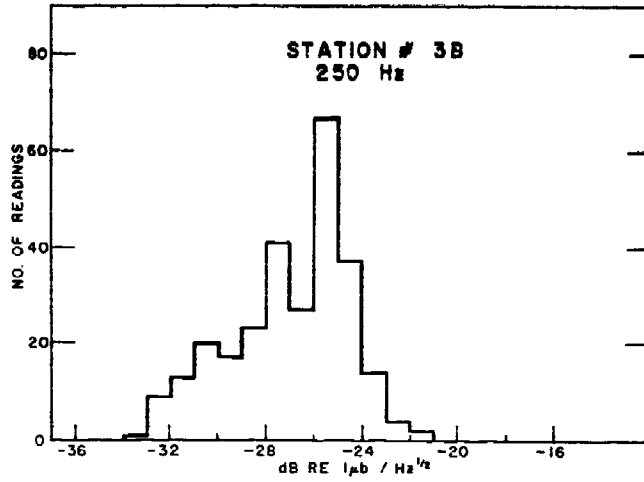

Figure 59. 250 Hz ambient noise distribution at Station 3B.

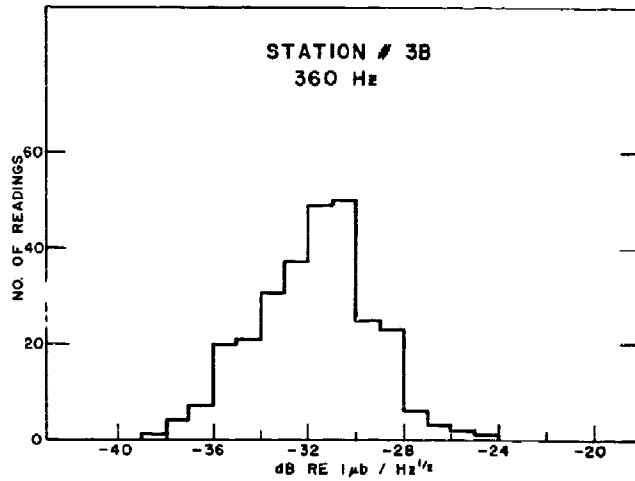

Figure 60. 360 Hz ambient noise distribution at Station 3B.

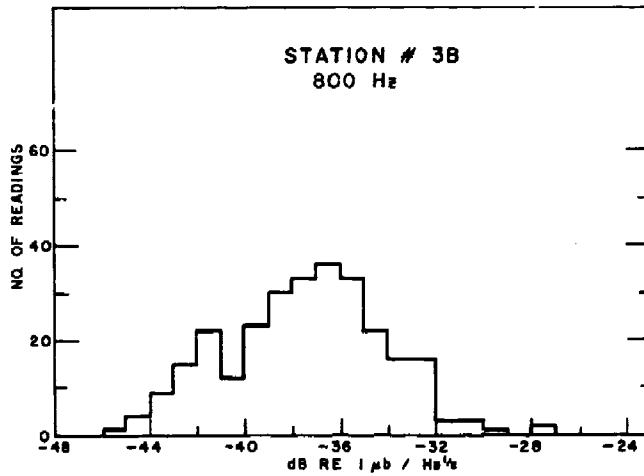

Figure 61. 800 Hz ambient noise distribution at Station 3B.

UNCLASSIFIED

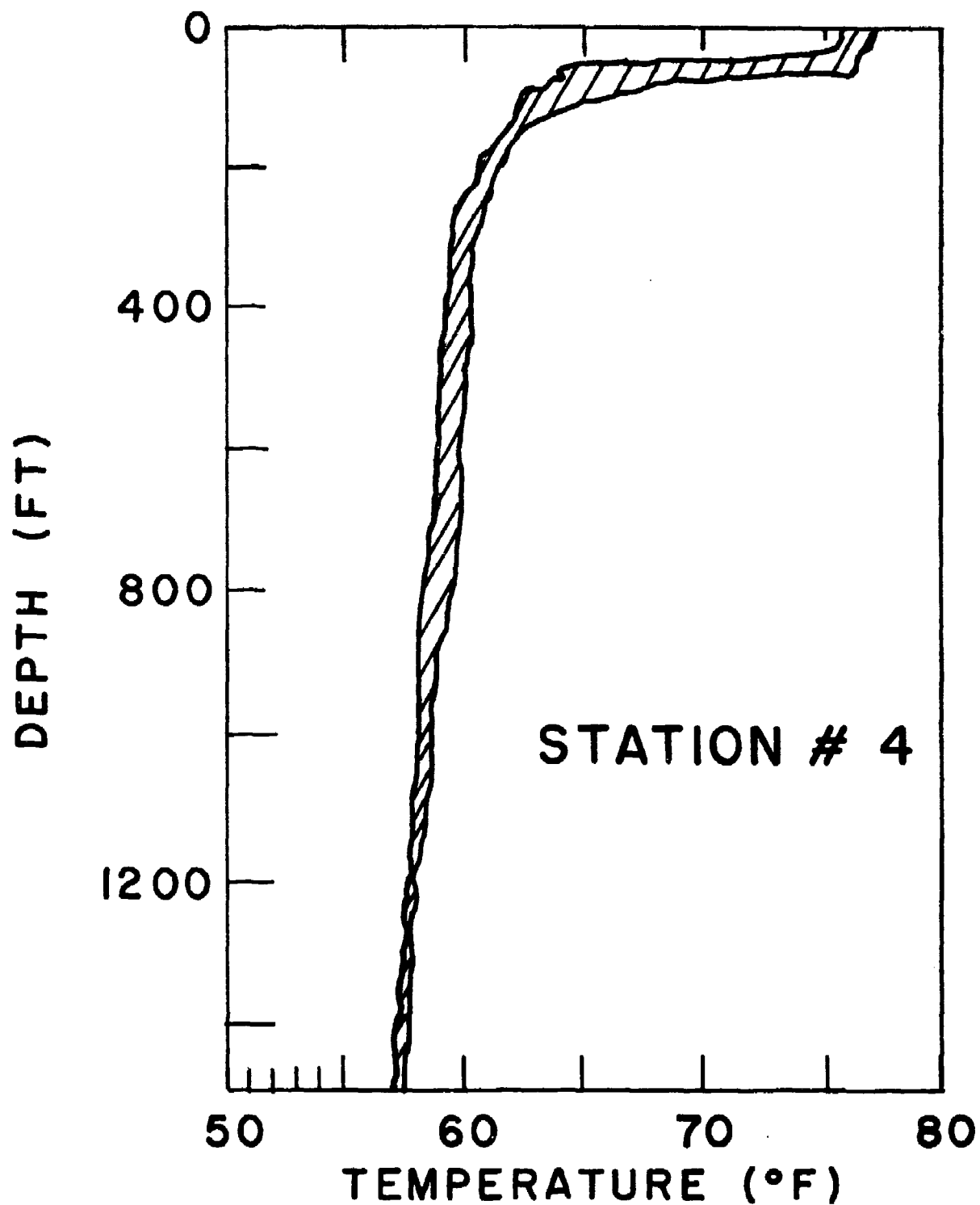

Figure 62. Temperature profile envelope for Station 4.

UNCLASSIFIED

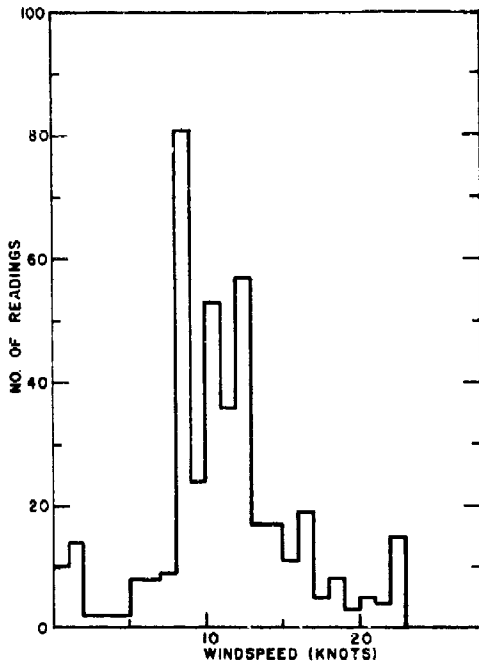

Figure 64. Distribution of windspeed for Station 4.

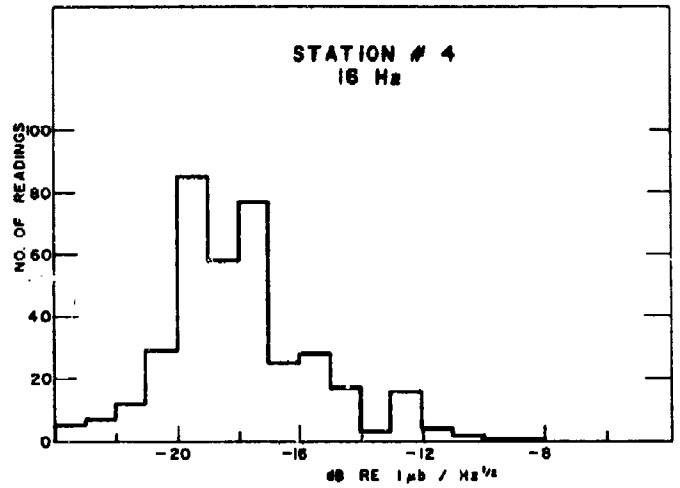

Figure 65. 16 Hz ambient noise distribution at Station 4.

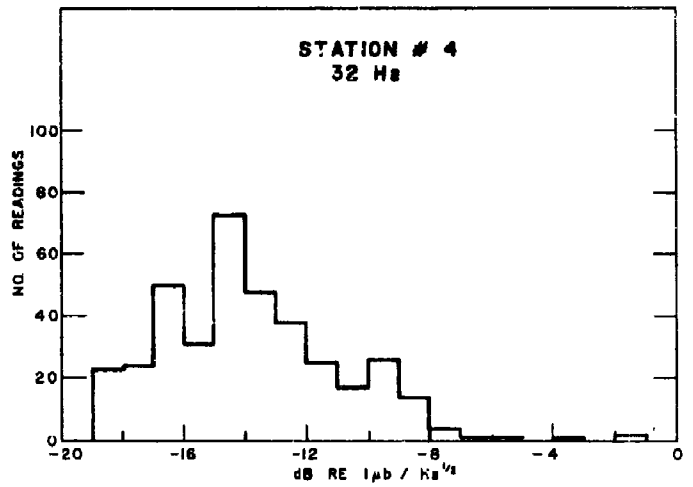

Figure 66. 32 Hz ambient noise distribution at Station 4.

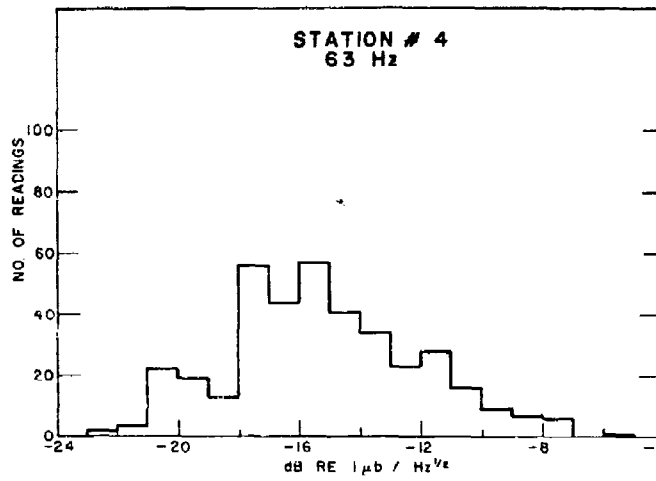

Figure 67. 63 Hz ambient noise distribution at Station 4.

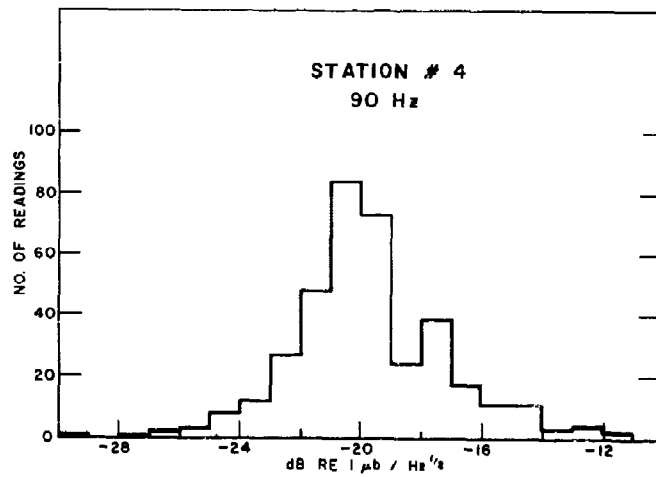

Figure 68. 90 Hz ambient noise distribution at Station 4.

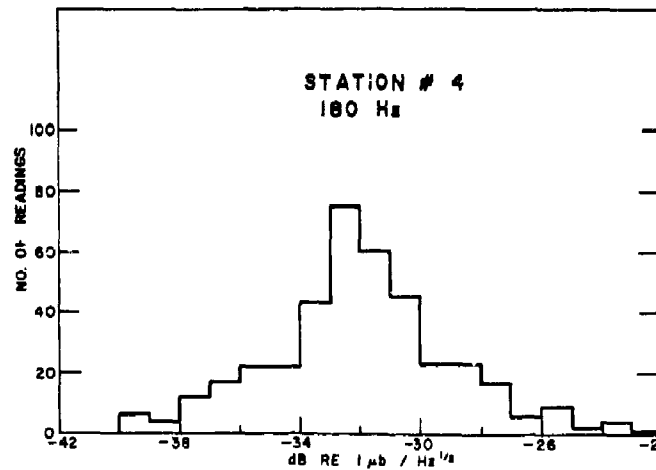

Figure 69. 180 Hz ambient noise distribution at Station 4.

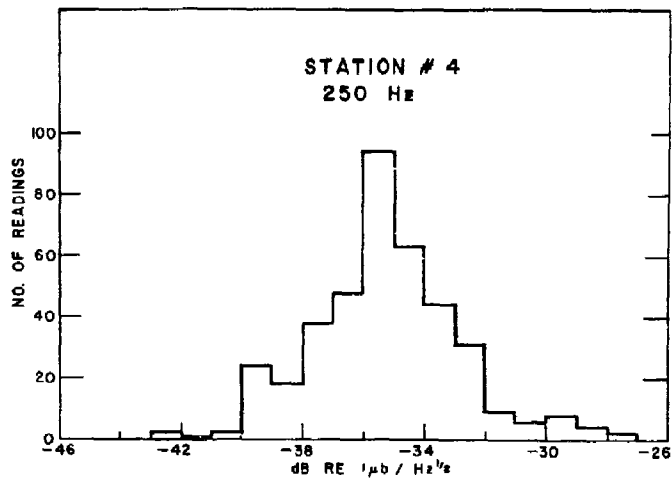

Figure 70. 250 Hz ambient noise distribution at Station 4.

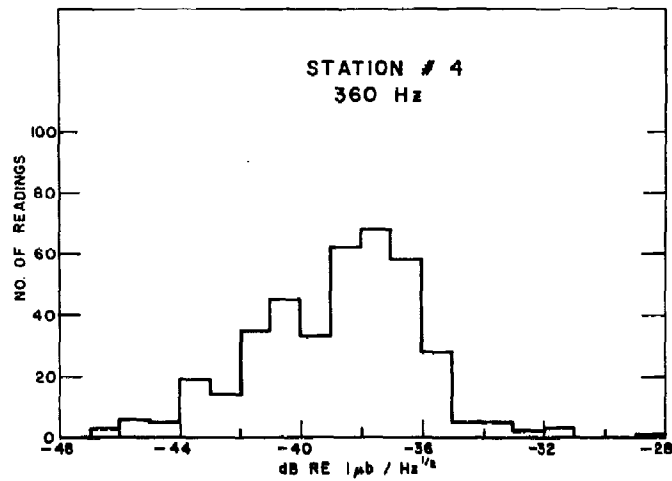

Figure 71. 360 Hz ambient noise distribution at Station 4.

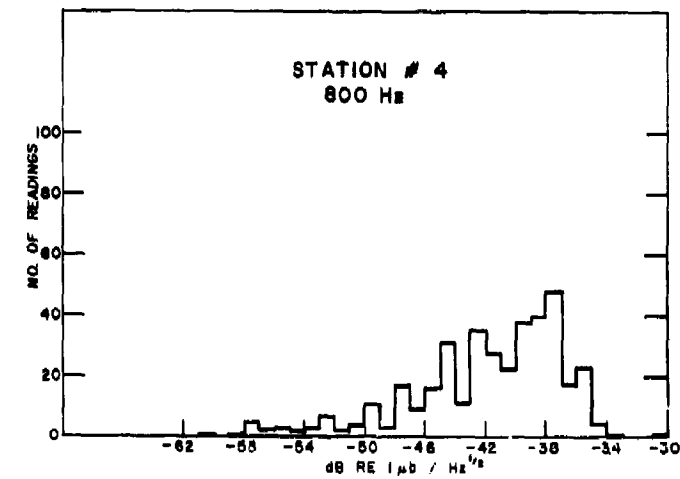

Figure 72. 800 Hz ambient noise distribution at Station

UNCLASSIFIED

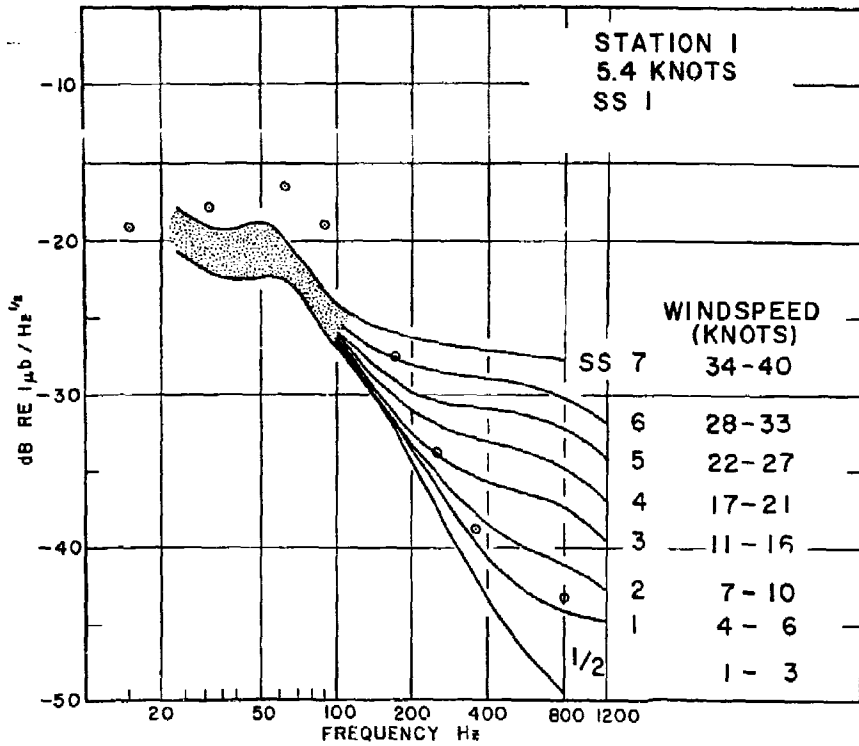

Figure 73. Average ambient noise spectra at Station 1, open circles, superimposed on a year's observation of ambient noise at the Artemis Array near Bermuda.

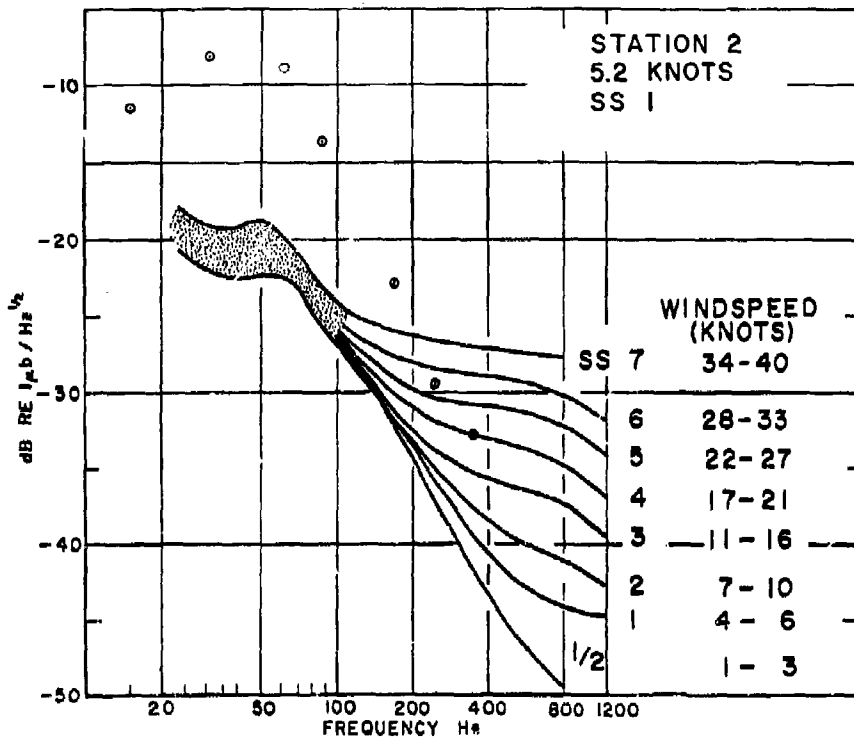

Figure 74. Average ambient noise spectra at Station 2, open circles, superimposed on a year's observation of ambient noise at the Artemis Array near Bermuda.

UNCLASSIFIED

UNCLASSIFIED

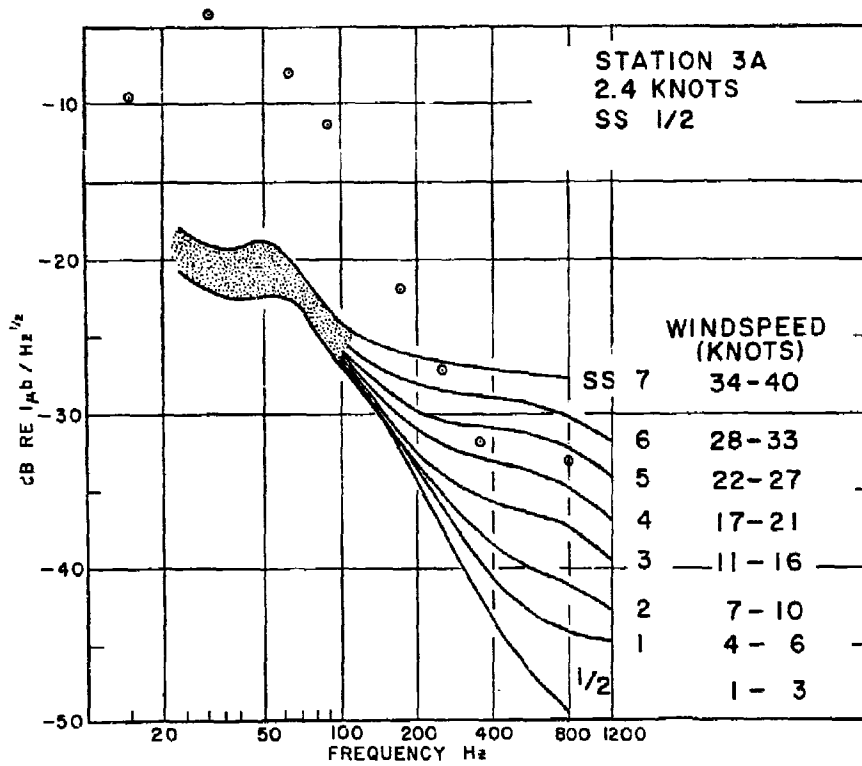

Figure 75. Average ambient noise spectra at Station 3A, open circles, superimposed on a year's observation of ambient noise at the Artemis Array near Bermuda.

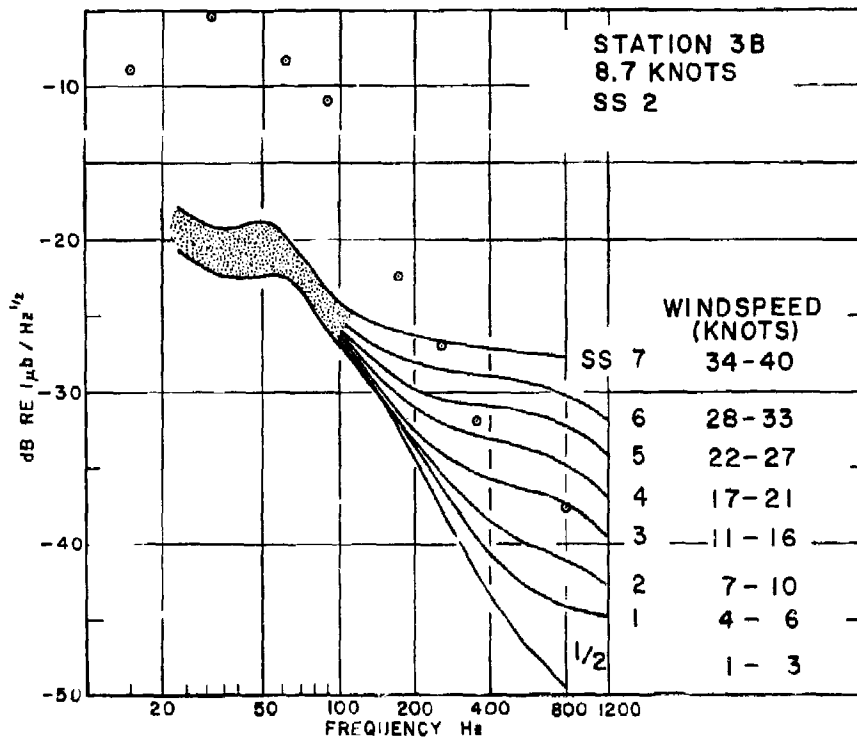

Figure 76. Average ambient noise spectra at Station 3B, open circles, superimposed on a year's observation of ambient noise at the Artemis Array near Bermuda.

UNCLASSIFIED

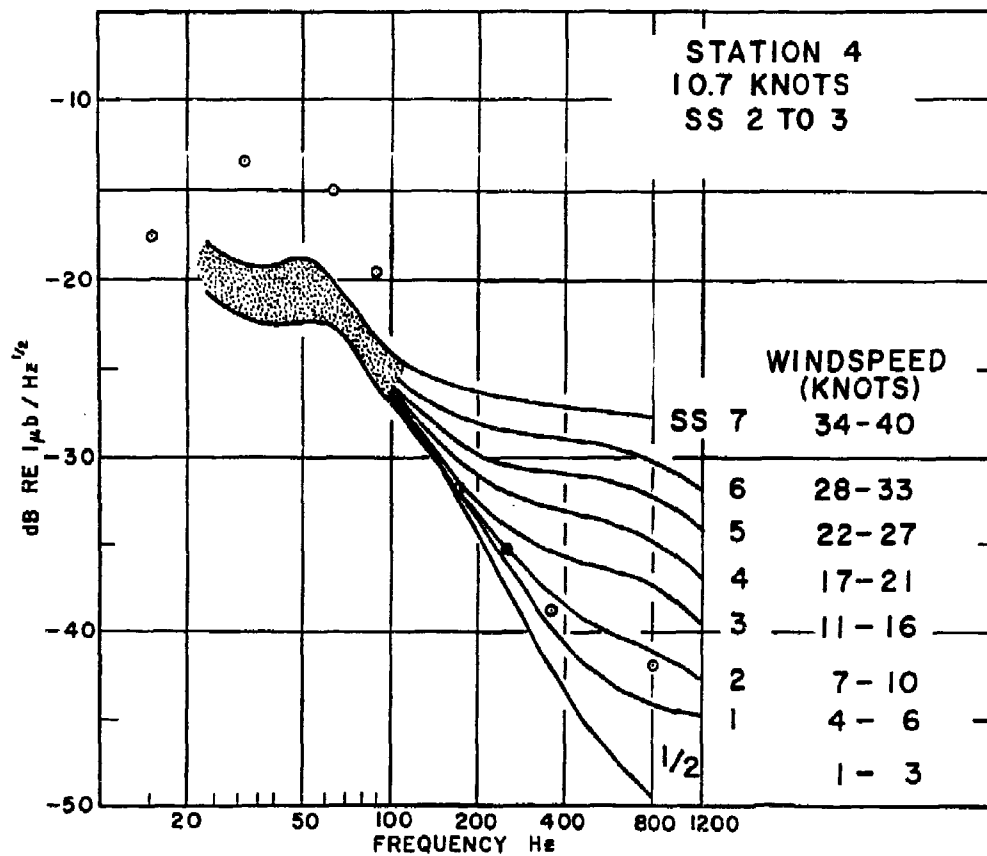

Figure 77. Average ambient noise spectra at Station 4, open circles, superimposed on a year's observation of ambient noise at the Artemis Array near Bermuda..

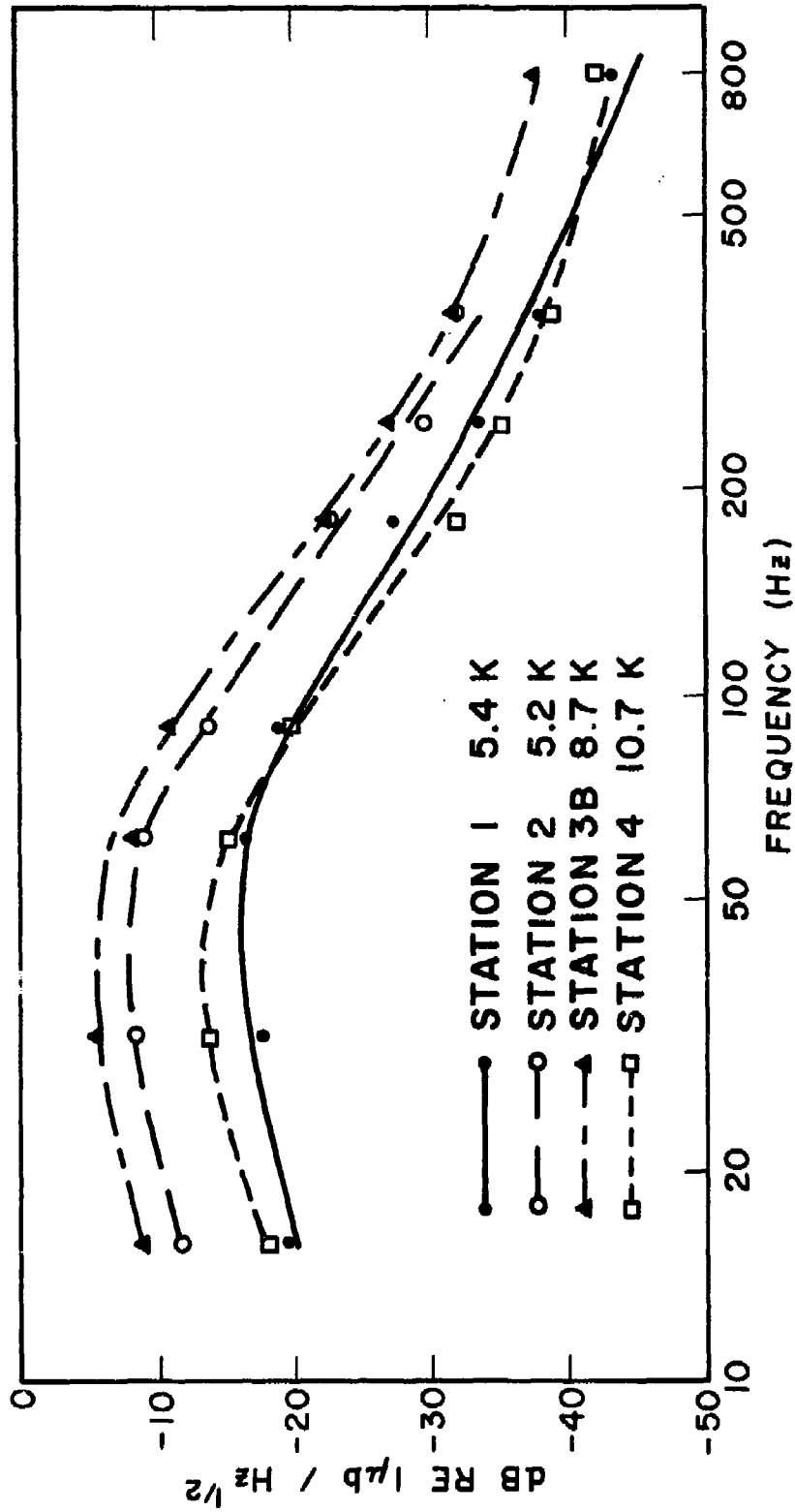

Figure 78. Average ambient noise spectra of Stations 1, 2, 3B and 4.

UNCLASSIFIED

REFERENCES

1. G. M. Wenz, "Acoustic ambient noise in the ocean: spectra and sources," J. Acoust. Soc. Am. 34, 1936-56 (1962) and "Acoustic ambient noise in the ocean: supplementary remarks," JUA (USN) 13, 517-519 (1963). Conf.
2. T. Arase and Elizabeth M. Arase, "A review of recent research in underwater ambient noise," JUA (USN) 15, 589-601 (1965). Conf.
3. C. C. Leroy, "Sound propagation in the Mediterranean Sea," V. M. Albers, ed., Underwater Acoustics, Vol. 2 (Plenum Press, New York, 1967) pp. 203-241.
4. M. Lomask and R. Frassetto, "Acoustic measurements in deep water using the Bathyscaph," J. Acoust. Soc. Am. 32, 1028-1031 (1960).
5. R. H. Nichols, Jr., "Correlation between sound transmission and ambient noise at low frequencies in the North Atlantic Ocean," JUA (USN) 10, 601 (Oct. 1960). Conf.
6. E. M. Arase and T. Arase, "Ambient noise in the deep and shallow ocean," J. Acoust. Soc. Am. 42, 73-77 (1967).

UNCLASSIFIED

UNCLASSIFIED

Security Classification

DOCUMENT CONTROL DATA - R & D

(Security classification of title, body of abstract and indexing annotation must be entered when the overall report is classified)

1. ORIGINATING ACTIVITY (Corporate author) Hudson Laboratories of Columbia University Dobbs Ferry, New York 10522		2a. REPORT SECURITY CLASSIFICATION Confidential	
		2b. GROUP 4	
3. REPORT TITLE AMBIENT NOISE IN THE MEDITERRANEAN SEA (U)			
4. DESCRIPTIVE NOTES (Type of report and, inclusive dates) Technical Report			
5. AUTHOR(S) (First name, middle initial, last name) Elizabeth M. Arase and T. Arase			
6. REPORT DATE July 23, 1968		7a. TOTAL NO. OF PAGES 58	7b. NO. OF REFS 6
8a. CONTRACT OR GRANT NO. Nonr-266(84)		9a. ORIGINATOR'S REPORT NUMBER(S) Technical Report No. 152	
b. PROJECT NO.		9b. OTHER REPORT NO(S) (Any other numbers that may be assigned this report)	
c.			
d.			
10. DISTRIBUTION STATEMENT In addition to security requirements which apply to this document and must be met, each transmittal outside the Department of Defense must have prior approval of the Office of Naval Research, Code 466.			
11. SUPPLEMENTARY NOTES		12. SPONSORING MILITARY ACTIVITY Office of Naval Research, Code 466.	
13. ABSTRACT <p>Ambient noise was measured in four deep basins of the Mediterranean Sea for three consecutive days at each station during June of 1968. Sonobuoys with hydrophones suspended at a depth of 95 ft were used to collect and transmit the data to a quiet ship several miles distant. Eight frequencies in 1/2-octave bands were used in the range from 16 to 800 Hz. Levels in these bands were read at 10-min intervals, sight averaged over this time, and are presented as distribution functions and average values for each station along with wind information. Environmental data such as velocity and temperature profiles, depth measurements and traffic observations are reported.</p>			

UNCLASSIFIED

Security Classification

14.

KEY WORDS

LINK A

LINK B

LINK C

ROLE

WT

ROLE

WT

ROLE

WT

Mediterranean

Ambient noise

DD FORM 1 NOV 65 1473 (BACK)

S/N 0101-807-6821

UNCLASSIFIED

Security Classification

A-31409

UNCLASSIFIED CATALOG CARDS

Hudson Labs., Columbia Univ., Dobbs Ferry, N. Y.
AMBIENT NOISE IN THE MEDITERRANEAN SEA,
 by Elizabeth M. Arase and T. Arase, July 23, 1968.
 58 p. (Technical rept. no. 152; CU-180-68-ONR-266-Phys.)
 (Contract Nonr-266(84)) Confidential report

Ambient noise was measured in four deep basins of the Mediterranean Sea for three consecutive days at each station during June of 1968. Sonobuoys with hydrophones suspended at a depth of 95 ft were used to collect and transmit the data to a quiet ship several miles distant. Eight frequencies in 1/2-octave bands were used in the range from 16 to 800 Hz. Levels in these bands were read at 10-min intervals, sight averaged over this time, and are presented as distribution functions and average values for each station along with wind information. Environmental data such as velocity and temperature profiles, depth measurements and traffic observations are reported.

- I. Underwater sound-Ambient noise-Mediterranean Sea
- II. Shipping-Acoustic properties-Mediterranean Sea
- III. Arase, Elizabeth M. Arase, T. Contract Nonr-266(84)

Hudson Labs., Columbia Univ., Dobbs Ferry, N. Y.
AMBIENT NOISE IN THE MEDITERRANEAN SEA,
 by Elizabeth M. Arase and T. Arase, July 23, 1968.
 58 p. (Technical rept. no. 152; CU-180-68-ONR-266-Phys.)
 (Contract Nonr-266(84)) Confidential report

Ambient noise was measured in four deep basins of the Mediterranean Sea for three consecutive days at each station during June of 1968. Sonobuoys with hydrophones suspended at a depth of 95 ft were used to collect and transmit the data to a quiet ship several miles distant. Eight frequencies in 1/2-octave bands were used in the range from 16 to 800 Hz. Levels in these bands were read at 10-min intervals, sight averaged over this time, and are presented as distribution functions and average values for each station along with wind information. Environmental data such as velocity and temperature profiles, depth measurements and traffic observations are reported.

- I. Underwater sound-Ambient noise-Mediterranean Sea
- II. Shipping-Acoustic properties-Mediterranean Sea
- III. Arase, Elizabeth M. Arase, T. Contract Nonr-266(84)

Hudson Labs., Columbia Univ., Dobbs Ferry, N. Y.
AMBIENT NOISE IN THE MEDITERRANEAN SEA,
 by Elizabeth M. Arase and T. Arase, July 23, 1968.
 58 p. (Technical rept. no. 152; CU-180-68-ONR-266-Phys.)
 (Contract Nonr-266(84)) Confidential report

Ambient noise was measured in four deep basins of the Mediterranean Sea for three consecutive days at each station during June of 1968. Sonobuoys with hydrophones suspended at a depth of 95 ft were used to collect and transmit the data to a quiet ship several miles distant. Eight frequencies in 1/2-octave bands were used in the range from 16 to 800 Hz. Levels in these bands were read at 10-min intervals, sight averaged over this time, and are presented as distribution functions and average values for each station along with wind information. Environmental data such as velocity and temperature profiles, depth measurements and traffic observations are reported.

- I. Underwater sound-Ambient noise-Mediterranean Sea
- II. Shipping-Acoustic properties-Mediterranean Sea
- III. Arase, Elizabeth M. Arase, T. Contract Nonr-266(84)

Hudson Labs., Columbia Univ., Dobbs Ferry, N. Y.
AMBIENT NOISE IN THE MEDITERRANEAN SEA,
 by Elizabeth M. Arase and T. Arase, July 23, 1968.
 58 p. (Technical rept. no. 152; CU-180-68-ONR-266-Phys.)
 (Contract Nonr-266(84)) Confidential report

Ambient noise was measured in four deep basins of the Mediterranean Sea for three consecutive days at each station during June of 1968. Sonobuoys with hydrophones suspended at a depth of 95 ft were used to collect and transmit the data to a quiet ship several miles distant. Eight frequencies in 1/2-octave bands were used in the range from 16 to 800 Hz. Levels in these bands were read at 10-min intervals, sight averaged over this time, and are presented as distribution functions and average values for each station along with wind information. Environmental data such as velocity and temperature profiles, depth measurements and traffic observations are reported.

- I. Underwater sound-Ambient noise-Mediterranean Sea
- II. Shipping-Acoustic properties-Mediterranean Sea
- III. Arase, Elizabeth M. Arase, T. Contract Nonr-266(84)

Hudson Laboratories
of
Columbia University
145 Palisade Street
Dobbs Ferry, New York 10522

Contract Nonr-260(8-0)
December 5, 1968

TO: Distribution List

SUBJECT: Erratum to Hudson Laboratories of Columbia University
Technical Report No. 152, "Ambient Noise in the
Mediterranean Sea," by Elizabeth M. Arase and T. Arase,
July 23, 1968, CONFIDENTIAL. CU-180-68-ONR-260-
Phys.

Page 3, lines 11 and 12, delete "in dB."

THIS REPORT HAS BEEN DELIMITED
AND CLEARED FOR PUBLIC RELEASE
UNDER DOD DIRECTIVE 5200.20 AND
NO RESTRICTIONS ARE IMPOSED UPON
ITS USE AND DISCLOSURE.

DISTRIBUTION STATEMENT A

APPROVED FOR PUBLIC RELEASE;
DISTRIBUTION UNLIMITED.